

Test of APIN0224, APIN0225 802.11a/b/g/n/ac  
DFS Spot-check Results Only

To: FCC 47 CFR Part 15.407 & IC RSS-210

Test Report Serial No.: ARUB146-U1 Rev A-1



# TEST REPORT

FROM



Test of APIN0224, APIN0225 802.11a/b/g/n/ac

to

To FCC 47 CFR Part 15.407 & IC RSS-210

Test Report Serial No.: ARUB146-U1 Rev A-1

Note: this report contains DFS spot-check data with regard to the 5,470 - 5,725 MHz DFS band for Aruba Networks, APIN0224 and APIN0225 Wireless Access Point.

This report supersedes None

Applicant: Aruba Networks  
1344 Crossman Avenue  
Sunnyvale, California 94089  
USA

Product Function: Wireless Access Point

Copy No: pdf Issue Date: 13th June 2013

**This Test Report is Issued Under the Authority of:**

**MiCOM Labs, Inc.**

440 Boulder Court, Suite 200

Pleasanton, CA 94566 USA

Phone: +1 (925) 462-0304

Fax: +1 (925) 462-0306

[www.micomlabs.com](http://www.micomlabs.com)



TEST CERTIFICATE #2381.01

**MiCOM Labs is an ISO 17025 Accredited Testing Laboratory**



**Title:** APIN0224, APIN0225 802.11a/b/g/n/ac  
**To:** FCC 47 CFR Part 15.407 & IC RSS-210  
**Serial #:** ARUB146-U1 Rev A-1  
**Issue Date:** 13th June 2013  
**Page:** 3 of 68

---

This page has been left intentionally blank

---

This test report may be reproduced in full only. The document may only be updated by MiCOM Labs personnel. Any changes will be noted in the Document History section of the report.



## TABLE OF CONTENTS

<b>ACCREDITATION, LISTINGS &amp; RECOGNITION</b> .....	<b>5</b>
TESTING ACCREDITATION .....	5
RECOGNITION .....	6
PRODUCT CERTIFICATION .....	7
<b>DOCUMENT HISTORY</b> .....	<b>8</b>
<b>1. TEST RESULT CERTIFICATE</b> .....	<b>9</b>
<b>2. REFERENCES AND MEASUREMENT UNCERTAINTY</b> .....	<b>10</b>
2.1. Normative References.....	10
2.2. Test and Uncertainty Procedures.....	11
<b>3. PRODUCT DETAILS AND TEST CONFIGURATIONS</b> .....	<b>12</b>
3.1. Technical Details.....	12
3.2. Scope of Test Program .....	13
3.3. Equipment Model(s) and Serial Number(s).....	17
3.4. Antenna Details.....	17
3.5. Cabling and I/O Ports.....	18
3.6. Test Configurations .....	19
3.7. Equipment Modifications .....	20
3.8. Deviations from the Test Standard.....	20
3.9. Subcontracted Testing or Third Party Data .....	20
<b>4. TEST RESULTS</b> .....	<b>21</b>
4.1. Dynamic Frequency Selection (DFS).....	21
<b>5. PHOTOGRAPHS</b> .....	<b>66</b>
5.1. Dynamic Frequency Selection (DFS).....	66
<b>6. TEST EQUIPMENT DETAILS</b> .....	<b>67</b>

---

This test report may be reproduced in full only. The document may only be updated by MiCOM Labs personnel. Any changes will be noted in the Document History section of the report.



Title: APIN0224, APIN0225 802.11a/b/g/n/ac  
To: FCC 47 CFR Part 15.407 & IC RSS-210  
Serial #: ARUB146-U1 Rev A-1  
Issue Date: 13th June 2013  
Page: 5 of 68

## ACCREDITATION, LISTINGS & RECOGNITION

### TESTING ACCREDITATION

MiCOM Labs, Inc. is an accredited Electrical testing laboratory per the international standard EN ISO/IEC 17025. The company is accredited by the American Association for Laboratory Accreditation (A2LA) [www.a2la.org](http://www.a2la.org) test laboratory number 2381.01. MiCOM Labs test schedule is available at the following URL; <http://www.a2la.org/scopepdf/2381-01.pdf>



This test report may be reproduced in full only. The document may only be updated by MiCOM Labs personnel. Any changes will be noted in the Document History section of the report.



## **RECOGNITION**

MiCOM Labs, Inc has widely recognized Electrical testing capabilities. Our international recognition includes Conformity Assessment Body designation by APEC MRA\*\* countries. Our test reports are widely accepted for global type approvals.

<b>Country</b>	<b>Recognition Body</b>	<b>Status</b>	<b>Phase</b>	<b>Identification No.</b>
USA	Federal Communications Commission (FCC)	TCB	-	US0159 Listing #: 102167
Canada	Industry Canada (IC)	FCB	APEC MRA 2	US0159 Listing #: 4143A-2
Japan	MIC (Ministry of Internal Affairs and Communication)	CAB	APEC MRA 2	RCB 210
	VCCI	--	--	A-0012
Europe	European Commission	NB	EU MRA	NB 2280
Australia	Australian Communications and Media Authority (ACMA)	CAB	APEC MRA 1	US0159
Hong Kong	Office of the Telecommunication Authority (OFTA)	CAB	APEC MRA 1	
Korea	Ministry of Information and Communication Radio Research Laboratory (RRL)	CAB	APEC MRA 1	
Singapore	Infocomm Development Authority (IDA)	CAB	APEC MRA 1	
Taiwan	National Communications Commission (NCC) Bureau of Standards, Metrology and Inspection (BSMI)	CAB	APEC MRA 1	
Vietnam	Ministry of Communication (MIC)	CAB	APEC MRA 1	

\*\*APEC MRA – Asia Pacific Economic Community Mutual Recognition Agreement.

Is a recognition agreement under which test lab is accredited to regulatory standards of the APEC member countries.

Phase I - recognition for product testing

Phase II – recognition for both product testing and certification

N/A – Not Applicable

\*\*EU MRA – European Union Mutual Recognition Agreement.

Is a recognition agreement under which test lab is accredited to regulatory standards of the EU member countries.

\*\*NB – Notified Body

This test report may be reproduced in full only. The document may only be updated by MiCOM Labs personnel. Any changes will be noted in the Document History section of the report.

## **PRODUCT CERTIFICATION**

MiCOM Labs, Inc. is an accredited Product Certification Body per the international standard EN ISO/IEC Guide 65. The company is accredited by the American Association for Laboratory Accreditation (A2LA) [www.a2la.org](http://www.a2la.org) test laboratory number 2381.02. MiCOM Labs test schedule is available at the following URL; <http://www.a2la.org/scopepdf/2381-02.pdf>



The American Association for Laboratory Accreditation

### *Accredited Product Certification Body*

A2LA has accredited

**MICOM LABS**

*Pleasanton, CA*

for technical competence as a

**Product Certification Body**

This product certification body is accredited in accordance with the recognized International Standard ISO/IEC Guide 65:1996 *General requirements for bodies operating product certification systems*. This accreditation demonstrates technical competence for a defined scope and the operation of a quality management system.

Presented this 27<sup>th</sup> day of March 2012.



  
\_\_\_\_\_  
President & CEO  
For the Accreditation Council  
Certificate Number 2381.02  
Valid to November 30, 2013

*For the product certification schemes to which this accreditation applies, please refer to the organization's Product Certification Scope of Accreditation*

**USA Telecommunication Certification Body (TCB)** - TCB Identifier – US0159

**Industry Canada Certification Body** - CAB Identifier – US0159

**European Notified Body** - Notified Body Identifier - 2280

**Japan – Recognized Certification Body (RCB)** - RCB Identifier - 210

This test report may be reproduced in full only. The document may only be updated by MiCOM Labs personnel. Any changes will be noted in the Document History section of the report.



**DOCUMENT HISTORY**

Document History		
Revision	Date	Comments
Draft		
Rev A-1	13 <sup>th</sup> June 2013	<p>Change Section 4.1 Dynamic Frequency Selection</p> <p>Updated software build which potentially affected DFS operation. Build release changed from “37654” to “38251 built on Friday 3<sup>rd</sup> May 10:19:12”</p> <p>This program performed a complete retest on Statistical Performance for the following operational modes:-</p> <ul style="list-style-type: none"><li>• 802.11a</li><li>• 802.11HT-40</li><li>• 802.11ac-80</li></ul> <p>Spot-check was also performed on all modes for Channel Availability Check (CAC), Non–Occupancy and Channel Shutdown however data presented for these parameters is from the original report, report #:</p> <p>ARUB146-U1 Rev A</p>

This test report may be reproduced in full only. The document may only be updated by MiCOM Labs personnel. Any changes will be noted in the Document History section of the report.





**Title:** APIN0224, APIN0225 802.11a/b/g/n/ac  
**To:** FCC 47 CFR Part 15.407 & IC RSS-210  
**Serial #:** ARUB146-U1 Rev A-1  
**Issue Date:** 13th June 2013  
**Page:** 9 of 68

## 1. TEST RESULT CERTIFICATE

<b>Applicant:</b>	Aruba Networks 1344 Crossman Avenue Sunnyvale, California 94089 USA	<b>Tested By:</b>	MiCOM Labs, Inc. 440 Boulder Court Suite 200 Pleasanton California, 94566, USA
<b>EUT:</b>	Wireless LAN Access point	<b>Tel:</b>	+1 925 462 0304
<b>Model:</b>	APIN0224 & APIN0225	<b>Fax:</b>	+1 925 462 0306
<b>S/N:</b>	BX0000206		
<b>Test Date(s):</b>	15th January - 31st March 2013	<b>Website:</b>	www.micomlabs.com

STANDARD(S)	TEST RESULTS
FCC 47 CFR Part 15.407 & IC RSS-210 (DFS Bands Only)	EQUIPMENT COMPLIES

MiCOM Labs, Inc. tested the equipment mentioned in accordance with the requirements set forth in the above standards. Test results indicate that the equipment tested is capable of demonstrating compliance with the requirements as documented within this report.

### Notes:

1. This document reports conditions under which testing was conducted and the results of testing performed.
2. Details of test methods used have been recorded and kept on file by the laboratory.
3. Test results apply only to the item(s) tested.

Approved & Released for MiCOM Labs, Inc. by:

  
\_\_\_\_\_  
Graeme Grieve  
Quality Manager MiCOM Labs,

  
\_\_\_\_\_  
Gordon Hurst  
President & CEO MiCOM Labs, Inc.



TESTING CERTIFICATE #2381.01

This test report may be reproduced in full only. The document may only be updated by MiCOM Labs personnel. Any changes will be noted in the Document History section of the report.

## 2. REFERENCES AND MEASUREMENT UNCERTAINTY

### 2.1. Normative References

Ref.	Publication	Year	Title
(i)	FCC 47 CFR Part 15.407	2012	Code of Federal Regulations
(ii)	FCC 06-96	June 2006	Memorandum Opinion and Order
(iii)	FCC OET KDB 662911	4 <sup>th</sup> April 2011	Emissions Testing of Transmitters with Multiple Outputs in the Same Band
(iv)	Industry Canada RSS-210	2010	Low Power License-Exempt Radiocommunication Devices (All Frequency Bands): Category 1 Equipment
(v)	Industry Canada RSS-Gen	2010	General Requirements and Information for the Certification of Radiocommunication Equipment
(vi)	ANSI C63.4	2009	American National Standards for Methods of Measurement of Radio-Noise Emissions from Low-Voltage Electrical and Electronic Equipment in the Range of 9 kHz to 40 GHz
(vii)	CISPR 22/ EN 55022	2008 2006+A1:2007	Limits and Methods of Measurements of Radio Disturbance Characteristics of Information Technology Equipment
(viii)	M 3003	Edition 1 Dec. 1997	Expression of Uncertainty and Confidence in Measurements
(ix)	LAB34	Edition 1 Aug 2002	The expression of uncertainty in EMC Testing
(x)	ETSI TR 100 028	2001	Parts 1 and 2 Electromagnetic compatibility and Radio Spectrum Matters (ERM); Uncertainties in the measurement of mobile radio equipment characteristics
(xi)	A2LA	July 2012	Reference to A2LA Accreditation Status – A2LA Advertising Policy
(xii)	FCC Public Notice – DA 02-2138	2002	Guidelines for Assessing Unlicensed National Information Infrastructure (U-NII) Devices



**Title:** APIN0224, APIN0225 802.11a/b/g/n/ac  
**To:** FCC 47 CFR Part 15.407 & IC RSS-210  
**Serial #:** ARUB146-U1 Rev A-1  
**Issue Date:** 13th June 2013  
**Page:** 11 of 68

---

## **2.2. Test and Uncertainty Procedures**

Conducted and radiated emission measurements were conducted in accordance with American National Standards Institute ANSI C63.4, listed in the Normative References section of this report.

Measurement uncertainty figures are calculated in accordance with ETSI TR 100 028 Parts 1 and 2.

Measurement uncertainties stated are based on a standard uncertainty multiplied by a coverage factor  $k = 2$ , providing a level of confidence of approximately 95 % in accordance with UKAS document M 3003 listed in the Normative References section of this report.

---

This test report may be reproduced in full only. The document may only be updated by MiCOM Labs personnel. Any changes will be noted in the Document History section of the report.



**Title:** APIN0224, APIN0225 802.11a/b/g/n/ac  
**To:** FCC 47 CFR Part 15.407 & IC RSS-210  
**Serial #:** ARUB146-U1 Rev A-1  
**Issue Date:** 13th June 2013  
**Page:** 12 of 68

### 3. PRODUCT DETAILS AND TEST CONFIGURATIONS

#### 3.1. Technical Details

Details	Description
Purpose:	Test of the APIN0224, APIN0225 802.11a/b/g/n/ac in the frequency range 5,250 – 5,350 and 5,470 - 5725 MHz (DFS Bands) to FCC Part 15.407 and Industry Canada RSS-210 regulations.
Applicant:	Aruba Networks 1344 Crossman Avenue Sunnyvale, California 94089,USA
Manufacturer:	As applicant
Laboratory performing the tests:	MiCOM Labs, Inc. 440 Boulder Court, Suite 200 Pleasanton, California 94566 USA
Test report reference number:	ARUB146-U1 Rev A-1
Date EUT received:	4 <sup>th</sup> January 2013
Standard(s) applied:	FCC 47 CFR Part 15.407 & IC RSS-210
Dates of test (from - to):	15th January - 31st March 2013
No of Units Tested:	One
Type of Equipment:	802.11a/b/g/n/ac Wireless Access Point 3x3 Spatial Multiplexing MIMO configuration
Applicants Trade Name:	Wireless Access Point
Model(s):	APIN0224, APIN0225
Location for use:	Indoor only
Declared Frequency Range(s):	5250 – 5,350 and 5,470 – 5,725 MHz
Software Rev	6.3.0.0 Build 38251
Type of Modulation:	Per 802.11 – OFDM
EUT Modes of Operation:	Legacy 802.11a, HT-20, HT-40, ac-40, ac-80
Declared Nominal Output Power: (Average Power)	802.11a: Legacy +18 dBm, 802.11n: HT-20 +18 dBm 802.11n: HT-40 +18 dBm 802.11ac-40 +18 dBm, 802.11ac-80 +18 dBm
Transmit/Receive Operation:	Time Division Duplex
Rated Input Voltage and Current:	POE 12 Vdc 1.25 A
Operating Temperature Range:	Declared range -20° to +40°C
ITU Emission Designator:	802.11a 17M7D1D 802.11n HT-20 17M7D1D 802.11n HT-40 36M4D1D 802.11ac-40 36M9D1D 802.11ac-80 75M9D1D
Equipment Dimensions:	203mm x 203mm x 65mm / 8.0"x8.0"x2.6" (WxDxH)
Weight:	750 g / 27 oz
Primary function of equipment:	Wireless Access Point for transmitting data and voice.

This test report may be reproduced in full only. The document may only be updated by MiCOM Labs personnel. Any changes will be noted in the Document History section of the report.



**Title:** APIN0224, APIN0225 802.11a/b/g/n/ac  
**To:** FCC 47 CFR Part 15.407 & IC RSS-210  
**Serial #:** ARUB146-U1 Rev A-1  
**Issue Date:** 13th June 2013  
**Page:** 13 of 68

---

### **3.2. Scope of Test Program**

#### **Aruba Networks APIN0224, APIN0225 Access Point RF Testing**

The scope of the test program was to retest the Aruba Networks APIN0224 Wireless LAN Access Point, 3X3 Spatial Multiplexing MIMO configurations in the frequency range 5,250 – 5,350 and 5,470 – 5,725 MHz for compliance against FCC 47 CFR Part 15.407 and Industry Canada RSS-210 specifications. This was for DFS only.

---

This test report may be reproduced in full only. The document may only be updated by MiCOM Labs personnel. Any changes will be noted in the Document History section of the report.

Aruba Networks Inc  
APIN0224 External Antenna 802.11 a/b/g/n/ac Wireless Access Point



---

This test report may be reproduced in full only. The document may only be updated by MiCOM Labs personnel. Any changes will be noted in the Document History section of the report.

Aruba Networks Inc  
APIN0225 Integral Antenna 802.11 a/b/g/n/ac Wireless Access Point



---

This test report may be reproduced in full only. The document may only be updated by MiCOM Labs personnel. Any changes will be noted in the Document History section of the report.

Aruba Networks Inc  
802.11 a/b/g/n/ac Wireless Access Point (Rear)







### 3.3. Equipment Model(s) and Serial Number(s)

Type (EUT/Support)	Equipment Description (Including Brand Name)	Mfr	Model No.	Serial No.
EUT	Wireless LAN Access Point	Aruba Networks	APIN0224	BX0000206
Support	Laptop PC	IBM	Thinkpad	None

### 3.4. Antenna Details

Model	Type	Gain	Freq. Band	Note
		dBi	MHz	
AP-ANT-1B	Omni	3.8	2400 - 2500	(2x per unit)
		5.8	4900 - 5875	
AP-ANT-13B	Omni	4.4	2400 - 2500	(2x per unit)
		3.3	4900 - 5900	
AP-ANT-16	Omni	3.9	2400 - 2500	(1x per unit) 3x3 MIMO
		4.7	4900 - 5900	
AP-ANT-17	Directional 120degr.	6.0	2400 - 2500	(1x per unit) 3x3 MIMO
		5.0	4900 - 5875	
AP-ANT-18	Directional 60degr.	7.5	2400 - 2500	(1x per unit) 3x3 MIMO
		7.5	5150 - 5875	
AP-ANT-19	Omni	3.0	2400 - 2500	(2 x per unit)
		6.0	5150 - 5875	

This test report may be reproduced in full only. The document may only be updated by MiCOM Labs personnel. Any changes will be noted in the Document History section of the report.



**APIN0225 Integrated Antennas**

Model	Type	Gain	Freq. Band	Note
		dBi	MHz	
metal sheet	Omni	4.0	2400 - 2500	(3x per band, per unit)
		5.0	4900 - 5875	

### 3.5. Cabling and I/O Ports

Number and type of I/O ports

1. 2 x 10/100/1000 Ethernet ENET0, ENET1
2. Console - Serial maintenance terminal
3. 12 Vdc, supply connector
4. RF Antenna Connectors (x3) – Reverse SMA (APIN0224 Only)
5. USB



### 3.6. Test Configurations

Testing was performed to determine the highest power level versus bit rate. The variant with the highest power was used to exercise the product.

Matrix of test configurations

<b>Operational Mode(s) (802.11)</b>	<b>Variant</b>	<b>Data Rates with Highest Power</b>	<b>Frequencies (MHz)</b>
5250-5350 5470-5725	802.11a	6 MBit/s	5260,5280,5300,5320 5500,5580,5700
	802.11n HT-20	6.5 MBit/s	
	802.11n HT-40	13.5 MBit/s	5270,5310 5510,5550,5670
	ac-40		
	ac-80	29.3 MBit/s	5290 5530, 5690

---

This test report may be reproduced in full only. The document may only be updated by MiCOM Labs personnel. Any changes will be noted in the Document History section of the report.



**Title:** APIN0224, APIN0225 802.11a/b/g/n/ac  
**To:** FCC 47 CFR Part 15.407 & IC RSS-210  
**Serial #:** ARUB146-U1 Rev A-1  
**Issue Date:** 13th June 2013  
**Page:** 20 of 68

---

### **3.7. Equipment Modifications**

The following modifications were required to bring the equipment into compliance:

1. NONE

### **3.8. Deviations from the Test Standard**

The following deviations from the test standard were required in order to complete the test program:

1. NONE

### **3.9. Subcontracted Testing or Third Party Data**

1. NONE

---

This test report may be reproduced in full only. The document may only be updated by MiCOM Labs personnel. Any changes will be noted in the Document History section of the report.



## 4. TEST RESULTS

### 4.1. Dynamic Frequency Selection (DFS)

FCC, Part 15 Subpart C §15.407(h)  
FCC 06-96 Memorandum Opinion and Order  
Industry Canada RSS-210 A9.4

#### 4.1.1.1. Interference Threshold values, Master or Client incorporating In-Service Monitoring

Maximum Transmit Power	Value (see note)
≥ 200 milliwatt	-64 dBm
< 200 milliwatt	-62 dBm

Note 1: This is the level at the input of the receiver assuming a 0 dBi receive antenna

#### DFS Response requirement values

Parameter	Value
<i>Non-occupancy period</i>	Minimum 30 minutes
<i>Channel Availability Check Time</i>	60 seconds
<i>Channel Move Time</i>	10 seconds See Note 1.
<i>Channel Closing Transmission Time</i>	200 milliseconds + an aggregate of 60 milliseconds over remaining 10 second period. See Notes 1 and 2.
<i>U-NII Detection Bandwidth</i>	Minimum 80% of the 99% power bandwidth See Note 3.

Note 1: The instant that the *Channel Move Time* and the *Channel Closing Transmission Time* begins is as follows:

- For the Short pulse radar Test Signals this instant is the end of the *Burst*.
- For the Frequency Hopping radar Test Signal, this instant is the end of the last radar *Burst* generated.
- For the Long Pulse radar Test Signal this instant is the end of the 12 second period defining the radar transmission.

Note 2: The *Channel Closing Transmission Time* is comprised of 200 milliseconds starting at the beginning of the *Channel Move Time* plus any additional intermittent control signals required to facilitate *Channel* changes (an aggregate of 60 milliseconds) during the remainder of the 10 second period. The aggregate duration of control signals will not count quiet periods in between transmissions.

Note 3: During the *U-NII Detection Bandwidth* detection test, radar type 1 is used and for each frequency step the minimum percentage of detection is 90%. Measurements are performed with no data traffic.



#### 4.1.1.2. Radar Test Waveforms

This section provides the parameters for required test waveforms, minimum percentage of successful detections, and the minimum number of trials that must be used for determining DFS conformance. Step intervals of 0.1 microsecond for Pulse Width, 1 microsecond for PRI, 1 MHz for chirp width and 1 for the number of pulses will be utilized for the random determination of specific test waveforms.

##### Short Pulse Radar Test Waveforms

Radar Type	Pulse Width (µsec)	PRI (µsec)	Number of Pulses	Minimum Percentage of Successful Detection	Minimum Trials
1	1	1428	18	60%	30
2	1-5	150-230	23-29	60%	30
3	6-10	200-500	16-18	60%	30
4	11-20	200-500	12-16	60%	30
Aggregate (Radar Types 1-4)				80%	120

A minimum of 30 unique waveforms are required for each of the short pulse radar types 2 through 4. For short pulse radar type 1, the same waveform is used a minimum of 30 times. If more than 30 waveforms are used for short pulse radar types 2 through 4, then each additional waveform must also be unique and not repeated from the previous waveforms. The aggregate is the average of the percentage of successful detections of short pulse radar types 1-4.

##### Long Pulse Radar Test Waveform

Radar Type	Pulse Width (µsec)	Chirp Width (MHz)	PRI (µsec)	Number of Pulses per Burst	Number of Bursts	Minimum Percentage of Successful Detection	Minimum Trials
5	50-100	5-20	1000-2000	1-3	8-20	80%	30

The parameters for this waveform are randomly chosen. Thirty unique waveforms are required for the Long Pulse radar test signal. If more than 30 waveforms are used for the Long Pulse radar test signal, then each additional waveform must also be unique and not repeated from the previous waveforms.



**Title:** APIN0224, APIN0225 802.11a/b/g/n/ac  
**To:** FCC 47 CFR Part 15.407 & IC RSS-210  
**Serial #:** ARUB146-U1 Rev A-1  
**Issue Date:** 13th June 2013  
**Page:** 23 of 68

---

Each waveform is defined as follows:

- 1) The transmission period for the Long Pulse Radar test signal is 12 seconds.
- 2) There are a total of 8 to 20 *Bursts* in the 12 second period, with the number of *Bursts* being randomly chosen. This number is *Burst Count*.
- 3) Each *Burst* consists of 1 to 3 pulses, with the number of pulses being randomly chosen. Each *Burst* within the 12 second sequence may have a different number of pulses.
- 4) The pulse width is between 50 and 100 microseconds, with the pulse width being randomly chosen. Each pulse within a *Burst* will have the same pulse width. Pulses in different *Bursts* may have different pulse widths.
- 5) Each pulse has a linear FM chirp between 5 and 20 MHz, with the chirp width being randomly chosen. Each pulse within a *Burst* will have the same chirp width. Pulses in different *Bursts* may have different chirp widths. The chirp is centered on the pulse. For example, with a radar frequency of 5300 MHz and a 20 MHz chirped signal, the chirp starts at 5290 MHz and ends at 5310 MHz.
- 6) If more than one pulse is present in a *Burst*, the time between the pulses will be between 1000 and 2000 microseconds, with the time being randomly chosen. If three pulses are present in a *Burst*, the time between the first and second pulses is chosen independently of the time between the second and third pulses.
- 7) The 12 second transmission period is divided into even intervals. The number of intervals is equal to *Burst\_Count*. Each interval is of length  $(12,000,000 / \textit{Burst\_Count})$  microseconds. Each interval contains one *Burst*. The start time for the *Burst*, relative to the beginning of the interval, is between 1 and  $[(12,000,000 / \textit{Burst\_Count}) - (\textit{Total Burst Length}) + (\textit{One Random PRI Interval})]$  microseconds, with the start time being randomly chosen. The step interval for the start time is 1 microsecond. The start time for each *Burst* is chosen independently.

---

This test report may be reproduced in full only. The document may only be updated by MiCOM Labs personnel. Any changes will be noted in the Document History section of the report.

**A representative example of a Long Pulse radar test waveform:**

- 1) The total test signal length is 12 seconds.
- 2) 8 *Bursts* are randomly generated for the *Burst\_Count*.
- 3) *Burst 1* has 2 randomly generated pulses.
- 4) The pulse width (for both pulses) is randomly selected to be 75 microseconds.
- 5) The PRI is randomly selected to be at 1213 microseconds.
- 6) *Bursts 2* through 8 are generated using steps 3 – 5.
- 7) Each *Burst* is contained in even intervals of 1,500,000 microseconds. The starting location for Pulse 1, *Burst 1* is randomly generated (1 to 1,500,000 minus the total *Burst 1* length + 1 random PRI interval) at the 325,001 microsecond step. *Bursts 2* through 8 randomly fall in successive 1,500,000 microsecond intervals (i.e. *Burst 2* falls in the 1,500,001 – 3,000,000 microsecond range).

**Graphical representation of the Long Pulse radar Test Waveform.**

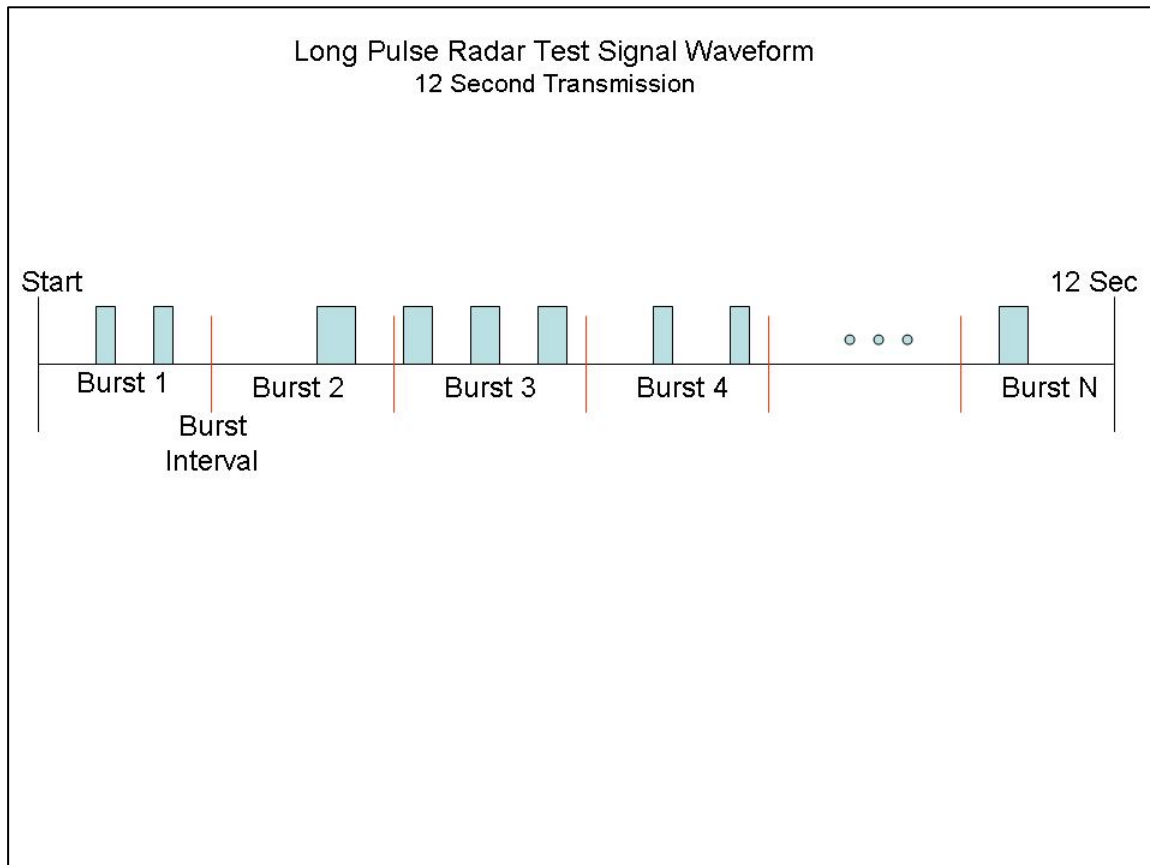



#### 4.1.1.3. Frequency Hopping Radar Test Waveform

**Frequency Hopping Radar Test Waveform**

Radar Type	Pulse Width (μsec)	PRI (μsec)	Pulses per Hop	Hopping Rate (kHz)	Hopping Sequence Length (msec)	Minimum Percentage of Successful Detection	Minimum Trials
6	1	333	9	.333	300	70%	30

For the Frequency Hopping Radar Type, the same *Burst* parameters are used for each waveform. The hopping sequence is different for each waveform and a 100-length segment is selected from the hopping sequence defined by the following algorithm:

#### 4.1.1.4. Radar Waveform Calibration

The following equipment setup was used to calibrate the conducted Radar Waveform. A spectrum analyzer was used to establish the test signal level for each radar type. During this process there were no transmissions by either the Master or Client Device. The spectrum analyzer was switched to the zero span (Time Domain) mode at the frequency of the Radar Waveform generator. Peak detection was utilized. The spectrum analyzer resolution bandwidth (RBW) and video bandwidth (VBW) were set to 3 MHz.

The signal generator amplitude was set so that the power level measured at the spectrum analyzer was -61dBm (Ref Section 5.1). The 30dB amplifier gain was entered as an amplitude offset on the spectrum analyzer.

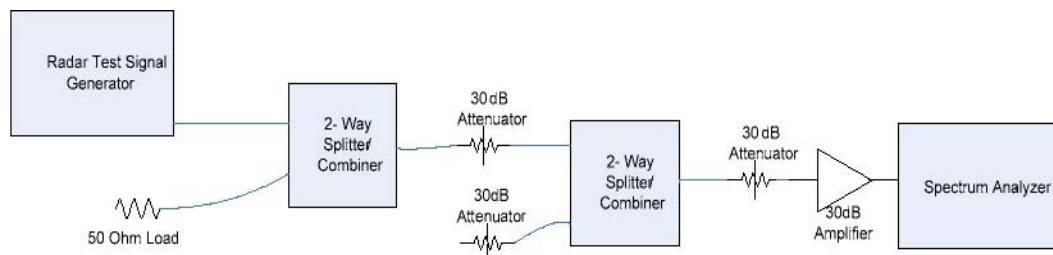

**Conducted Calibration Setup**



#### 4.1.1.5. Weather Radar Band Edge Plots

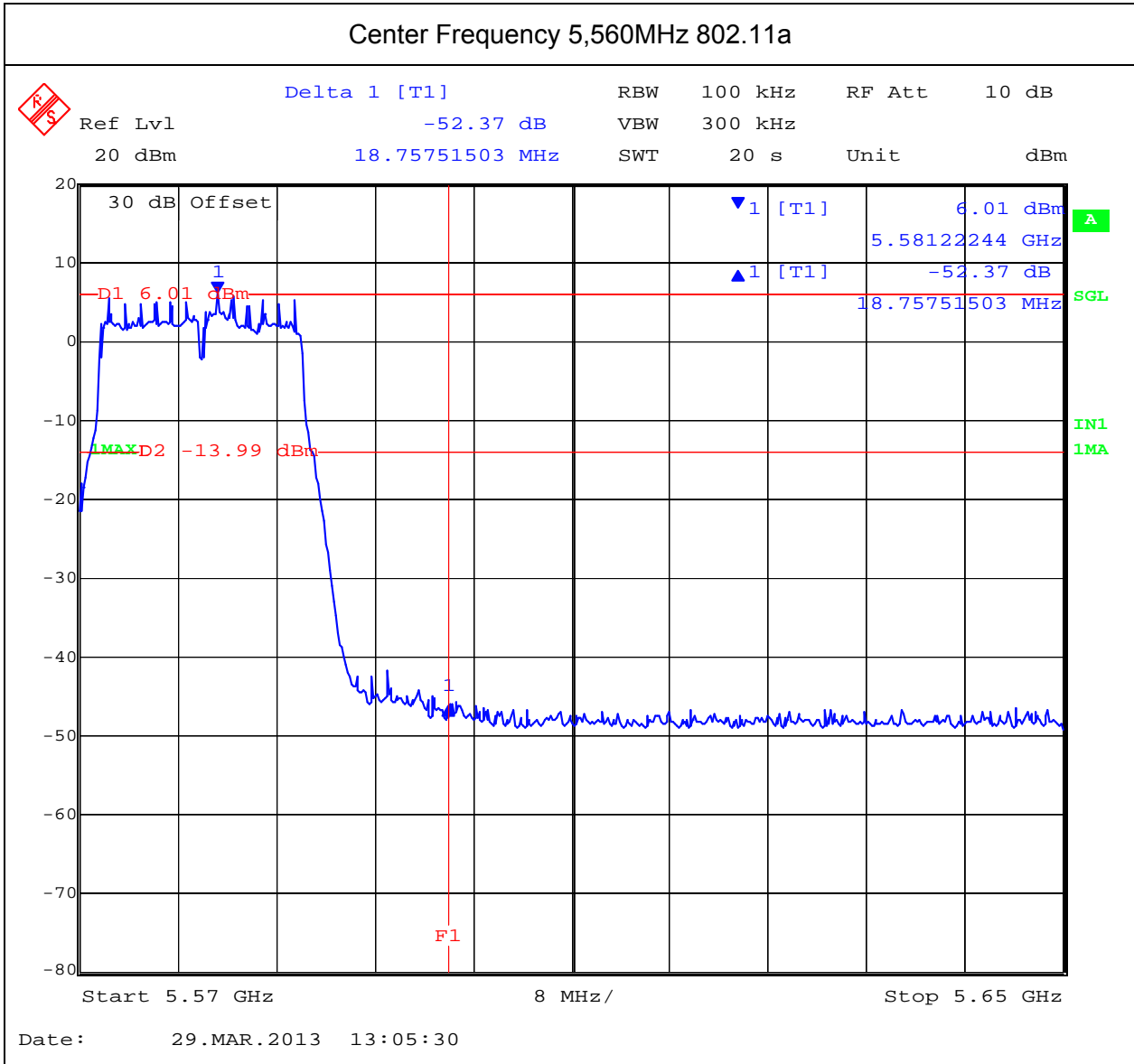

This test report may be reproduced in full only. The document may only be updated by MiCOM Labs personnel. Any changes will be noted in the Document History section of the report.



Title: APIN0224, APIN0225 802.11a/b/g/n/ac  
To: FCC 47 CFR Part 15.407 & IC RSS-210  
Serial #: ARUB146-U1 Rev A-1  
Issue Date: 13th June 2013  
Page: 27 of 68

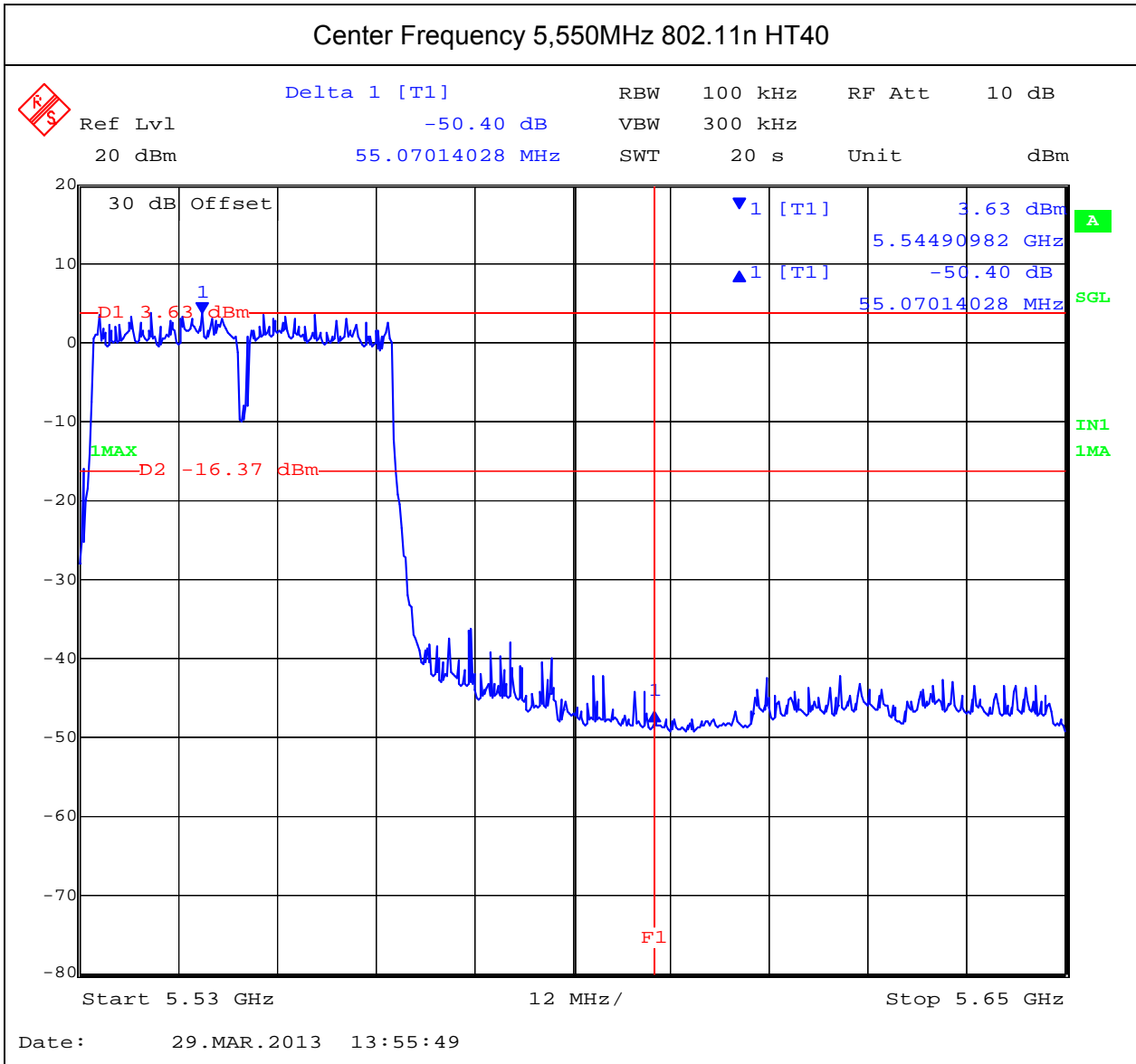

This test report may be reproduced in full only. The document may only be updated by MiCOM Labs personnel. Any changes will be noted in the Document History section of the report.

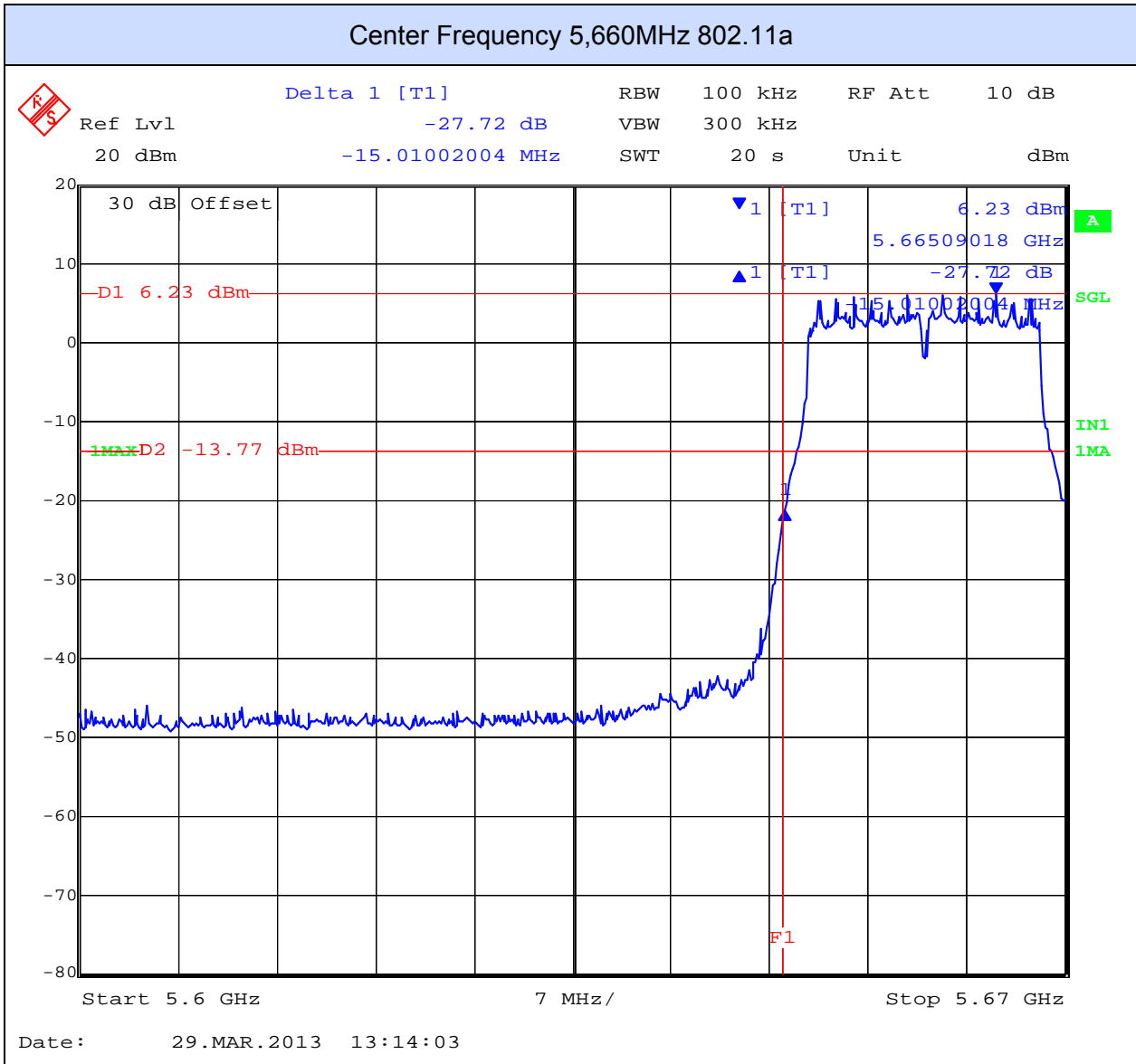

This test report may be reproduced in full only. The document may only be updated by MiCOM Labs personnel. Any changes will be noted in the Document History section of the report.

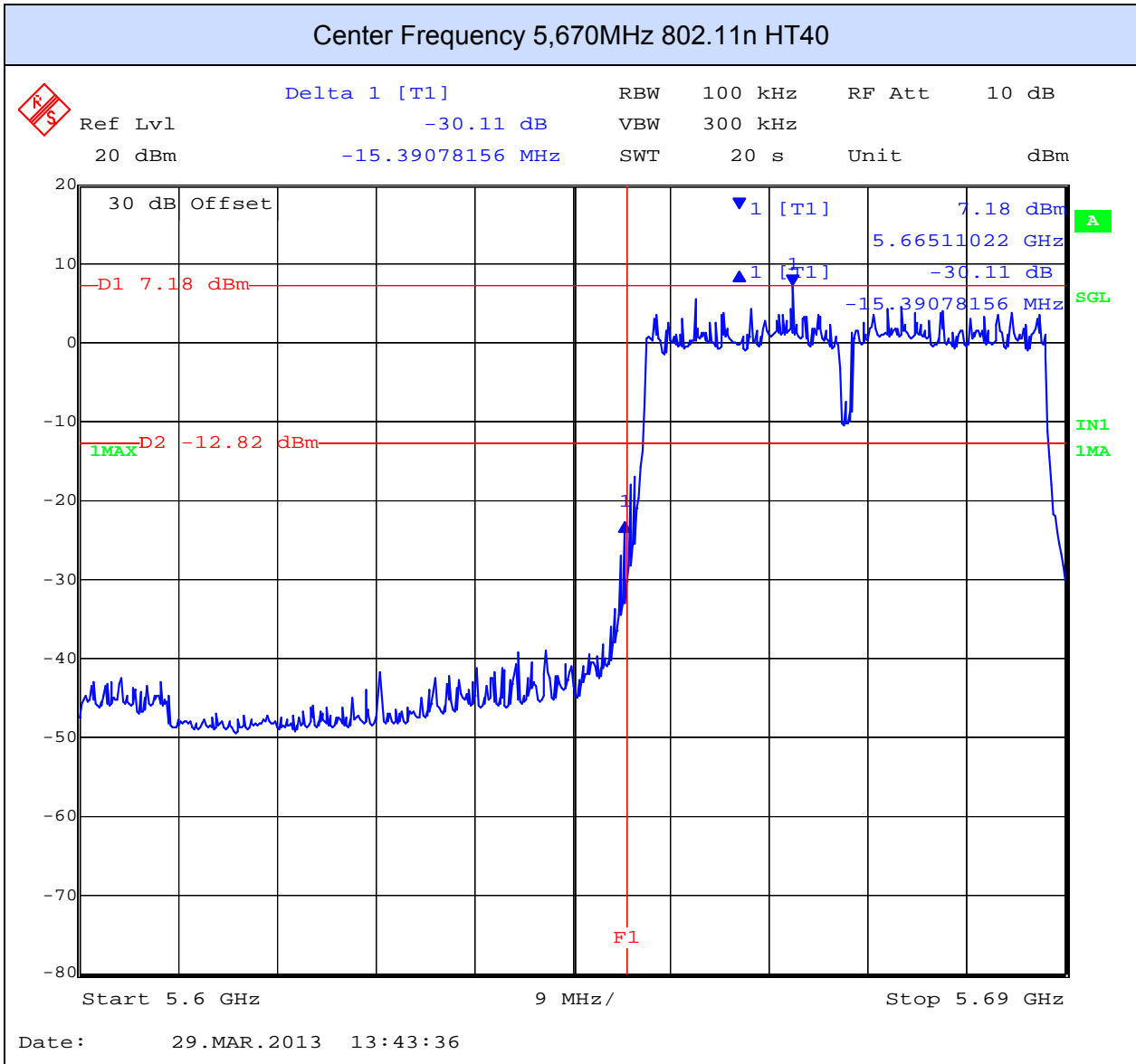

This test report may be reproduced in full only. The document may only be updated by MiCOM Labs personnel. Any changes will be noted in the Document History section of the report.

#### 4.1.1.6. DFS Test Results

Setup for Conducted Measurements where the EUT is the Master with injection of Radar Test Waveforms at the Master.

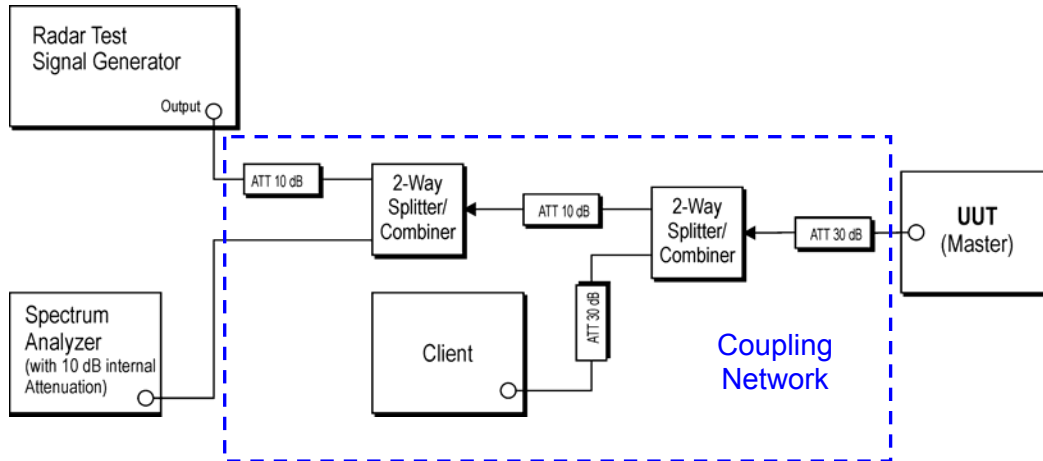

#### Support Equipment Configuration

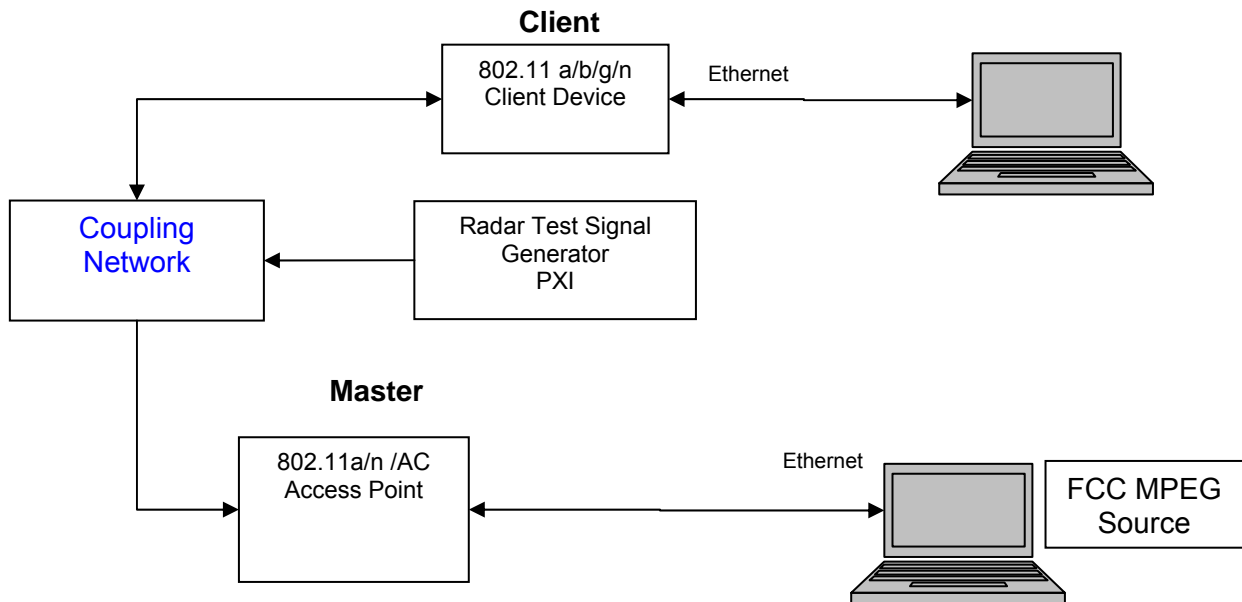

This test report may be reproduced in full only. The document may only be updated by MiCOM Labs personnel. Any changes will be noted in the Document History section of the report.



The EUT is a Master Device with radar detection.

**Applicability of DFS Requirements Prior to Use of a Channel**  
**(Ref Table 1 of FCC 06-96)**

Requirement	Operational Mode		
	Master	Client Without Radar Detection	Client With Radar Detection
<i>Non-Occupancy Period</i>	Yes	Not required	Yes
<i>DFS Detection Threshold</i>	Yes	Not required	Yes
<i>Channel Availability Check Time</i>	Yes	Not required	Not required
<i>Uniform Spreading</i>	Yes	Not required	Not required
<i>U-NII Detection Bandwidth</i>	Yes	Not required	Yes

**Applicability of DFS requirements during normal operation**  
**(Ref Table 2 of FCC 06-96)**

Requirement	Operational Mode		
	Master	Client Without Radar Detection	Client With Radar Detection
<i>DFS Detection Threshold</i>	Yes	Not required	Yes
<i>Channel Closing Transmission Time</i>	Yes	Yes	Yes
<i>Channel Move Time</i>	Yes	Yes	Yes
<i>U-NII Detection Bandwidth</i>	Yes	Not required	Yes

This test report may be reproduced in full only. The document may only be updated by MiCOM Labs personnel. Any changes will be noted in the Document History section of the report.



**Title:** APIN0224, APIN0225 802.11a/b/g/n/ac  
**To:** FCC 47 CFR Part 15.407 & IC RSS-210  
**Serial #:** ARUB146-U1 Rev A-1  
**Issue Date:** 13th June 2013  
**Page:** 32 of 68

---

For the frequency band 5,470 – 5,725 MHz, the Master device provides, on aggregate, uniform loading of the spectrum across all devices by selecting an operating channel among the available channels using a random algorithm. The EUT was tested in HT-40 mode.

Declared minimum antenna gain 2.5 dBi. ;

Radar receive signal level = -62 dBm + minimum antenna gain

$$= -62 + 2.5$$

Radar receive signal level = -59.5 dBm

### **Measurement Results - Dynamic Frequency Selection (DFS)**

Ambient conditions.

Temperature: 17 to 23 °C    Relative humidity: 31 to 57%    Pressure: 999 to 1012 mbar

Radio parameters.

Test methodology: Conducted

Device Type: Master

Transmit Power: Maximum

### **Operational Details - Dynamic Frequency Selection (DFS)**

Operational Modes: 802.11a & 802.11n HT40 & 802.11 ac-80

Data Rates: 6mpbs 802.11a/ 0MCS 802.11n; 29.3 0MCS 802.11 ac

*\*Note\* No video pixilation was observed during the video stream at these rates. Video frames per second were noted to be at 30fps.*

### **Video Streaming Method - Dynamic Frequency Selection (DFS)**

Using the VideoLan player a video stream was setup on the master laptop with the destination being the client laptop. The video profile chosen for the video stream is "MPEG-2 + MPGA (TS)". On the client laptop the VideoLan player was setup to listen to an incoming video stream from the master device.

The requisite MPEG video file ("TestFile.mpg" available on the NTIA website at the following link <http://ntiacsd.ntia.doc.gov/dfs/>) is used during this video stream.

### **EUT Image Version Build: 38251**

**Note: EUT provided and ARM scan function, this had to be disabled to complete testing**

---

This test report may be reproduced in full only. The document may only be updated by MiCOM Labs personnel. Any changes will be noted in the Document History section of the report.





**Title:** APIN0224, APIN0225 802.11a/b/g/n/ac  
**To:** FCC 47 CFR Part 15.407 & IC RSS-210  
**Serial #:** ARUB146-U1 Rev A-1  
**Issue Date:** 13th June 2013  
**Page:** 33 of 68

---

#### **4.1.1.6.1. UNII Detection Bandwidth:**

All UNII channels for this device have identical channel bandwidths and DFS testing was completed on channel 5,500 MHz (802.11a) and 5510MHz (HT40).

The generating equipment is configured as shown in the Conducted Test Setup above. A single Burst of the short pulse radar Type 1 through 6 was produced at 5,500 MHz (802.11a) and 5,510 MHz (802.11n HT40) at a level of -61 dBm (Ref Section 5.1). The EUT is set up as a standalone device (no associated Client and no traffic).

A single radar Burst is generated for a minimum of 10 trials, and the response of the EUT is noted. The EUT must detect the Radar Waveform 90% or more of the time.

The radar frequency is increased in 1 MHz steps, repeating the above test sequence, until the detection rate falls below 90%. The highest frequency at which detection is greater than or equal to 90% is denoted as  $F_H$ .

The radar frequency is decreased in 1 MHz steps, repeating the above test sequence, until the detection rate falls below 90%. The lowest frequency at which detection is greater than or equal to 90% is denoted as  $F_L$ .

The U-NII Detection Bandwidth is calculated as follows:

$$\text{U-NII Detection Bandwidth} = F_H - F_L$$

The U-NII Detection Bandwidth must be at least 80% of the EUT transmitter 99% power  
Table of results are continued on the next page.

---

This test report may be reproduced in full only. The document may only be updated by MiCOM Labs personnel. Any changes will be noted in the Document History section of the report.



**Title:** APIN0224, APIN0225 802.11a/b/g/n/ac  
**To:** FCC 47 CFR Part 15.407 & IC RSS-210  
**Serial #:** ARUB146-U1 Rev A-1  
**Issue Date:** 13th June 2013  
**Page:** 34 of 68

EUT Frequency= 5,500 MHz 802.11a (Detection = √, No Detection = 0)											
Radar Frequency (MHz)	1	2	3	4	5	6	7	8	9	10	Detection Rate (%)
-20											%
-19											%
-18											%
-17											%
-16											%
-15											%
-14											%
-13											%
-12											%
-11											%
-10											%
-9	0	0									<90%
-8	√	√	√	√	√	√	√	√	√	√	100%
-7	√	√	√	√	√	√	√	√	√	√	100%
-6	√	√	√	√	√	√	√	√	√	√	100%
-5	√	√	√	√	√	√	√	√	√	√	100%
-4	√	√	√	√	√	√	√	√	√	√	90%
-3	√	√	√	√	√	√	√	√	√	√	100%
-2	√	√	√	√	√	√	√	√	√	√	100%
-1	√	√	√	√	√	√	√	√	√	√	100%
F <sub>0</sub>	√	√	√	√	√	√	√	√	√	√	100%
+1	√	√	√	√	√	√	√	√	√	√	100%
+2	√	√	√	√	√	√	√	√	√	√	90%
+3	√	√	√	√	√	√	√	√	√	√	100%
+4	√	√	√	√	√	√	√	√	√	√	100%
+5	√	√	√	√	√	√	√	√	√	√	100%
+6	√	√	√	√	√	√	√	√	√	√	100%
+7	√	√	√	√	√	√	√	√	√	√	100%
+8	√	√	√	√	√	√	√	√	√	√	100%
+9	0	0									<90%
+10											%
+11											%
+12											%
+13											%
+14											%
+15											%
+16											%
+17											%
Detection Bandwidth = F <sub>H</sub> -F <sub>L</sub> = 5508-5492 = 16 MHz											
EUT 99% Bandwidth = 18.03 MHz (ref. bandwidth channel 5500 MHz)											
18.03 MHz *80% = 14.4MHz											

For each frequency step the minimum percentage detection is 90%

This test report may be reproduced in full only. The document may only be updated by MiCOM Labs personnel. Any changes will be noted in the Document History section of the report.



**Title:** APIN0224, APIN0225 802.11a/b/g/n/ac  
**To:** FCC 47 CFR Part 15.407 & IC RSS-210  
**Serial #:** ARUB146-U1 Rev A-1  
**Issue Date:** 13th June 2013  
**Page:** 35 of 68

EUT Frequency= 5,510 MHz 802.11n HT40 (Detection = √, No Detection = 0)											
Radar Frequency (MHz)	1	2	3	4	5	6	7	8	9	10	Detection Rate (%)
-23											%
-22	0	0									<90%
-21	v	v	v	v	v	v	v	v	v	v	100%
-20	v	v	v	v	v	v	v	v	v	v	100%
-19	v	v	v	v	v	v	v	v	v	v	100%
-18	v	v	v	v	v	v	v	v	v	v	100%
-17	v	v	v	v	v	v	v	v	v	v	100%
-16	v	v	v	v	v	v	v	v	v	v	100%
-15	v	v	v	v	v	v	v	v	v	v	100%
-14	v	v	v	v	v	v	v	v	v	v	100%
-13	v	v	v	v	v	v	v	v	v	v	100%
-12	v	v	v	v	v	v	v	v	v	v	100%
-11	v	v	v	v	v	v	v	v	v	v	100%
-10	v	v	v	v	v	v	v	v	v	v	100%
-9	v	v	v	v	v	v	v	v	v	v	100%
-8	v	v	v	v	v	v	v	v	v	v	100%
-7	v	v	v	v	v	v	v	v	v	v	100%
-6	v	v	v	v	v	v	v	v	v	v	100%
-5	v	v	v	v	v	v	v	v	v	v	100%
-4	v	v	v	v	v	v	v	v	v	v	100%
-3	v	v	v	v	v	v	v	v	v	v	100%
-2	v	v	v	v	v	v	v	v	v	v	100%
-1	v	v	v	v	v	v	v	v	v	v	100%
F <sub>0</sub>	v	v	v	v	v	v	v	v	v	v	100%

This test report may be reproduced in full only. The document may only be updated by MiCOM Labs personnel. Any changes will be noted in the Document History section of the report.



**Title:** APIN0224, APIN0225 802.11n HT40 (Detection =  $\sqrt{\quad}$ , No Detection = 0)  
**To:** FCC 47 CFR Part 15.407 & IC RSS-210  
**Serial #:** ARUB146-U1 Rev A-1  
**Issue Date:** 13th June 2013  
**Page:** 36 of 68

EUT Frequency= 5,510 MHz 802.11n HT40 (Detection = $\sqrt{\quad}$ , No Detection = 0)											
Radar Frequency (MHz)	1	2	3	4	5	6	7	8	9	10	Detection Rate (%)
F <sub>0</sub>	v	v	v	v	v	v	v	v	v	v	100%
+1	v	v	v	v	v	v	v	v	v	v	100%
+2	v	v	v	v	v	v	v	v	v	v	100%
+3	v	v	v	v	v	v	v	v	v	v	100%
+4	v	v	v	v	v	v	v	v	v	v	100%
+5	v	v	v	v	v	v	v	v	v	v	100%
+6	v	v	v	v	v	v	v	v	v	v	100%
+7	v	v	v	v	v	v	v	v	v	v	100%
+8	v	v	v	v	v	v	v	v	v	v	100%
+9	v	v	v	v	v	v	v	v	v	v	100%
+10	v	v	v	v	v	v	v	v	v	v	100%
+11	v	v	v	v	v	v	v	v	v	v	100%
+12	v	v	v	v	v	v	v	v	v	v	100%
+13	v	v	v	v	v	v	v	v	v	v	100%
+14	v	v	v	v	v	v	v	v	v	v	100%
+15	v	v	v	v	v	v	v	v	v	v	100%
+16	v	v	v	v	v	v	v	v	v	v	100%
+17	v	v	v	v	v	v	v	v	v	v	100%
+18	v	v	v	v	v	v	v	v	v	v	100%
+19	v	v	v	v	v	v	v	v	v	v	100%
+20	v	v	v	v	v	v	v	v	v	v	100%
+21	v	v	v	v	v	v	v	v	v	v	100%
+22	0	0									<90%
+23											%
Detection Bandwidth = F <sub>H</sub> -F <sub>L</sub> = 5531-5489 = 42 MHz											
EUT 99% Bandwidth = 36.6 MHz (ref. bandwidth channel 5510 MHz)											
36.6 MHz *80% = 29.28 MHz											

For each frequency step the minimum percentage detection is 90%

This test report may be reproduced in full only. The document may only be updated by MiCOM Labs personnel. Any changes will be noted in the Document History section of the report.



**Title:** APIN0224, APIN0225 802.11a/b/g/n/ac  
**To:** FCC 47 CFR Part 15.407 & IC RSS-210  
**Serial #:** ARUB146-U1 Rev A-1  
**Issue Date:** 13th June 2013  
**Page:** 37 of 68

---

#### 4.1.1.6.2. Initial Channel Availability Check Time

This test verifies that the EUT does not emit pulse, control, or data signals on the test Channel until the power-up sequence has been completed and the U-NII device checks for Radar Waveforms for one minute on the test Channel. This test does not use any Radar Waveforms.

The U-NII device is powered on and be instructed to operate at 5,500MHz 802.11a and 5,510MHz 802.11n HT40. At the same time the EUT is powered on, the spectrum analyzer is set for zero span with a 1 MHz resolution bandwidth at 5,500& 5,510 MHz with a 260 second sweep time. The analyzer's sweep will be started the same time power is applied to the U-NII device.

The EUT should not transmit any pulse or data transmissions until at least 1 minute after the completion of the power-on cycle.

The first red marker line shown on the following plot denotes the instant when the EUT starts its power-up sequence i.e.  $T_0$  (as defined within the FCC's MO&O 06-96 Normative Reference 2 ). The power-up reference  $T_0$  is determined by the time it takes for the EUT to start "beaconing" i.e. initial beacon – 60 secs = end of power-up.

The Channel Availability Check Time commences at instant  $T_0$  and will end no sooner than  $T_0 + 60$  seconds.

---

This test report may be reproduced in full only. The document may only be updated by MiCOM Labs personnel. Any changes will be noted in the Document History section of the report.



**EUT power up and Initial Channel Availability Check Time**  
**5,500MHz 802.11a Power On = 88.57 Seconds**

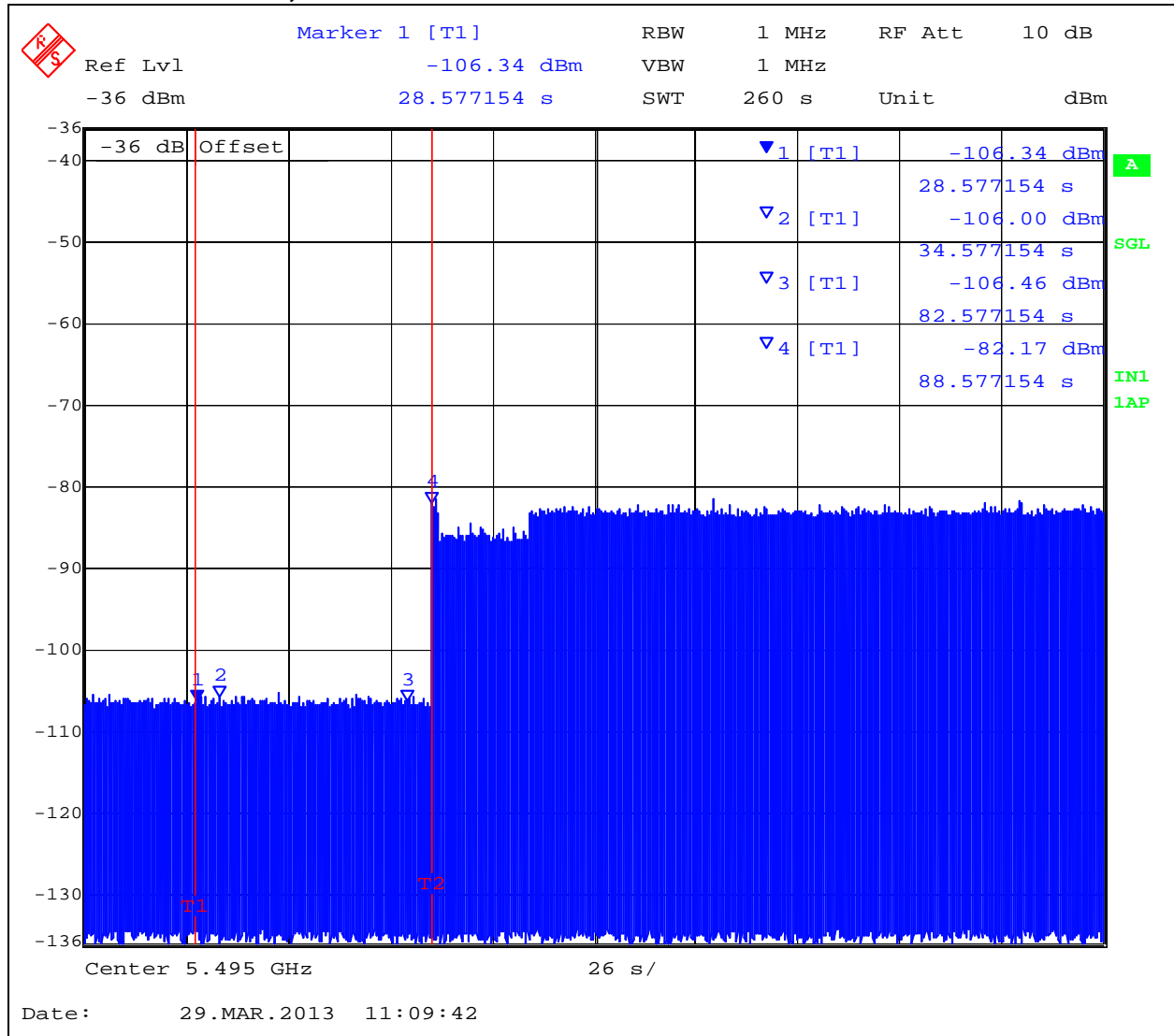

This test report may be reproduced in full only. The document may only be updated by MiCOM Labs personnel. Any changes will be noted in the Document History section of the report.



**EUT power up and Initial Channel Availability Check Time**  
**5,510MHz 802.11n HT40 Power On = 88.05 Seconds**

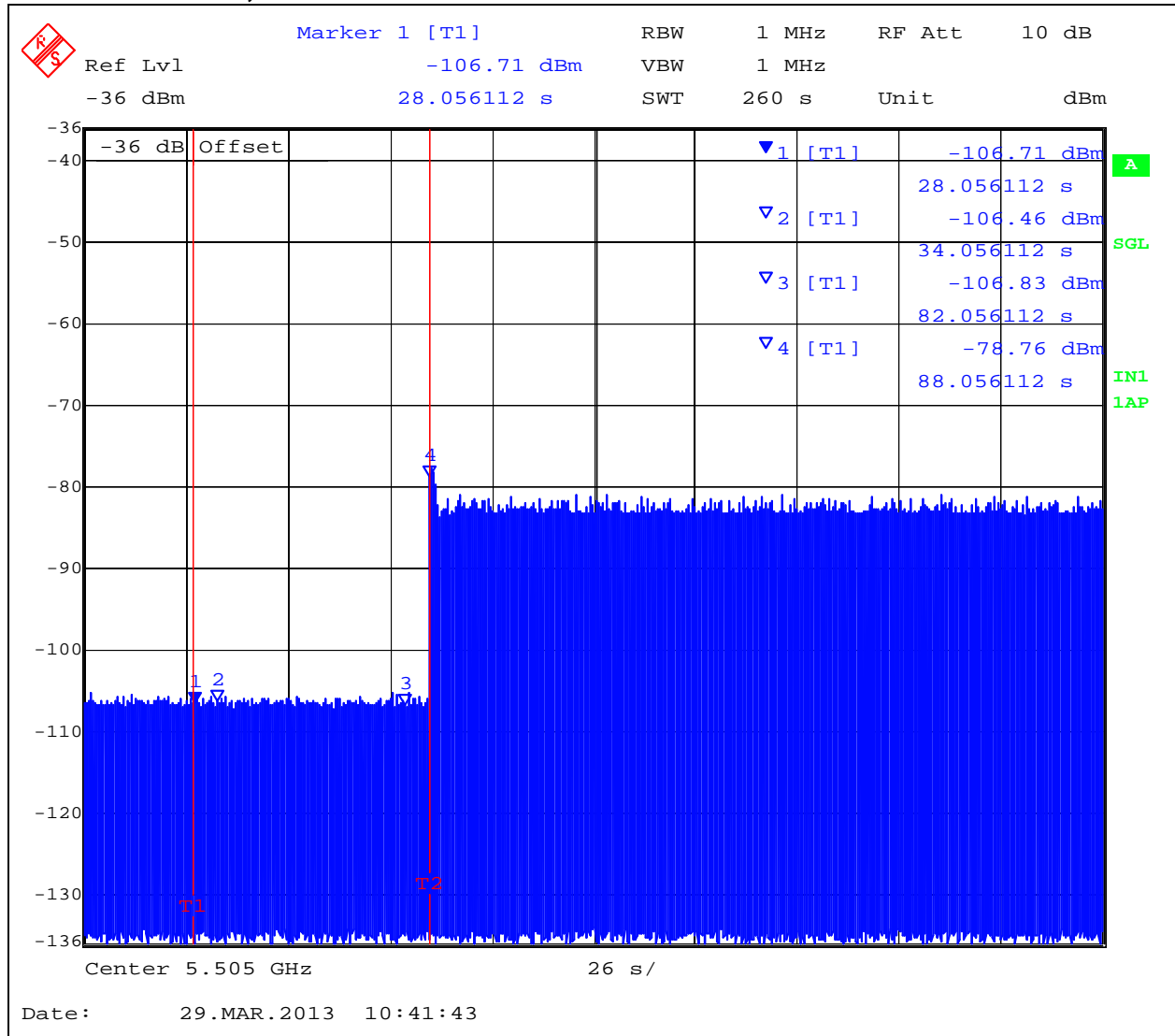

This test report may be reproduced in full only. The document may only be updated by MiCOM Labs personnel. Any changes will be noted in the Document History section of the report.



**Title:** APIN0224, APIN0225 802.11a/b/g/n/ac  
**To:** FCC 47 CFR Part 15.407 & IC RSS-210  
**Serial #:** ARUB146-U1 Rev A-1  
**Issue Date:** 13th June 2013  
**Page:** 40 of 68

---

#### **4.1.1.6.3. Radar Burst at the Beginning of the Channel Availability Check Time:**

The steps below define the procedure to verify successful radar detection on the selected Channel during a period equal to the Channel Availability Check Time and avoidance of operation on that Channel when a radar Burst with a level equal to the DFS Detection Threshold +6 dB (-62 dBm Ref Section 6.1.7) occurs at the beginning of the Channel Availability Check Time.

A single Burst of short pulse of radar Type 1 will commence within a 6 second window starting at  $T_0$  (first red marker line on the following plot).

Visual indication on the EUT of successful detection of the radar Burst will be recorded and reported. Observation of emissions at 5,500MHz 802.11a & 5,510MHz 802.11n HT40 will continue for 2.5 minutes after the radar burst has been generated.

---

This test report may be reproduced in full only. The document may only be updated by MiCOM Labs personnel. Any changes will be noted in the Document History section of the report.





Channel Availability Check Time at the start T0 + 6 seconds Check Time  
5,500MHz 802.11a

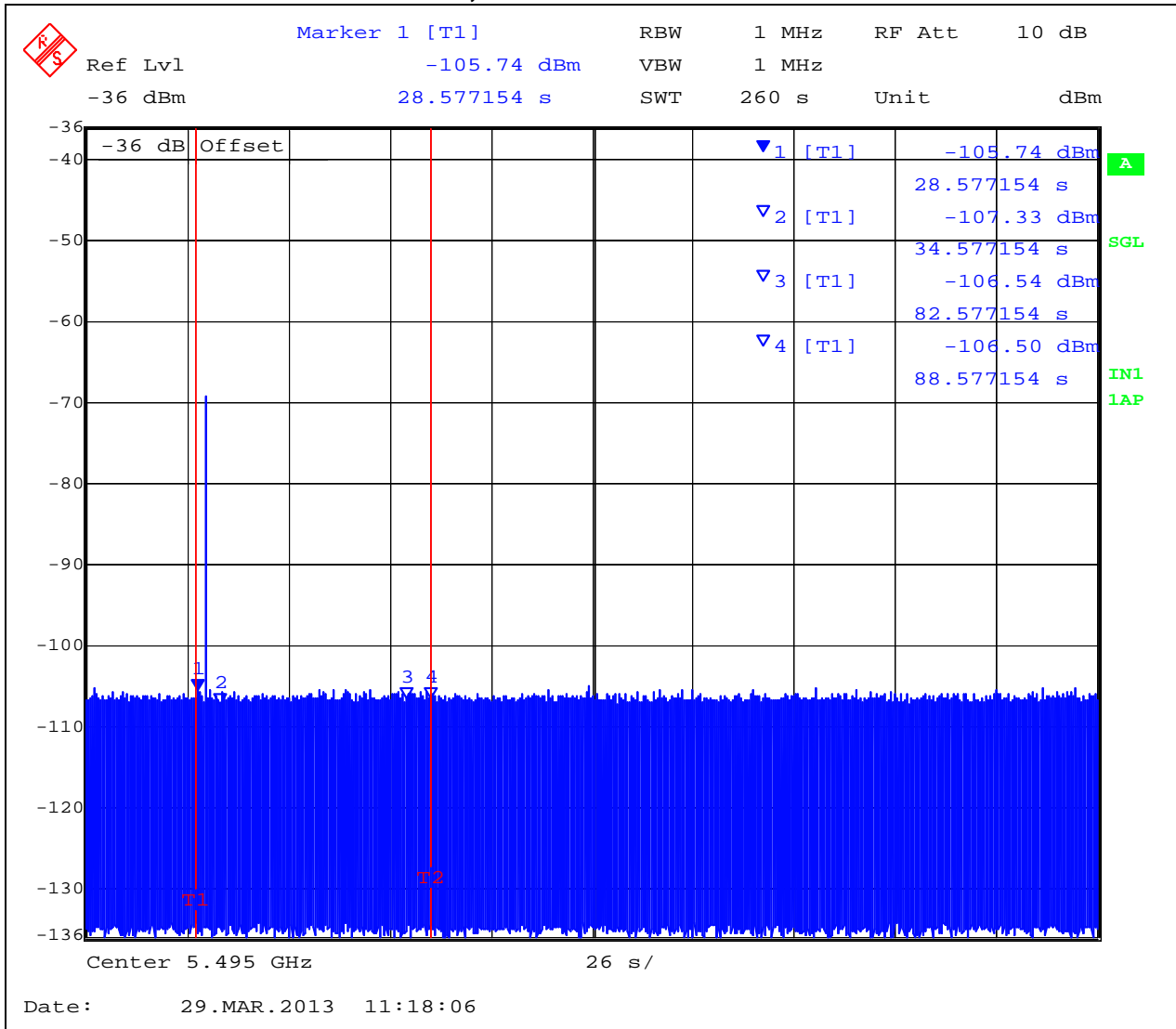

This test report may be reproduced in full only. The document may only be updated by MiCOM Labs personnel. Any changes will be noted in the Document History section of the report.



Channel Availability Check Time at the start T0 + 6 seconds Check Time  
5,510MHz 802.11n HT40

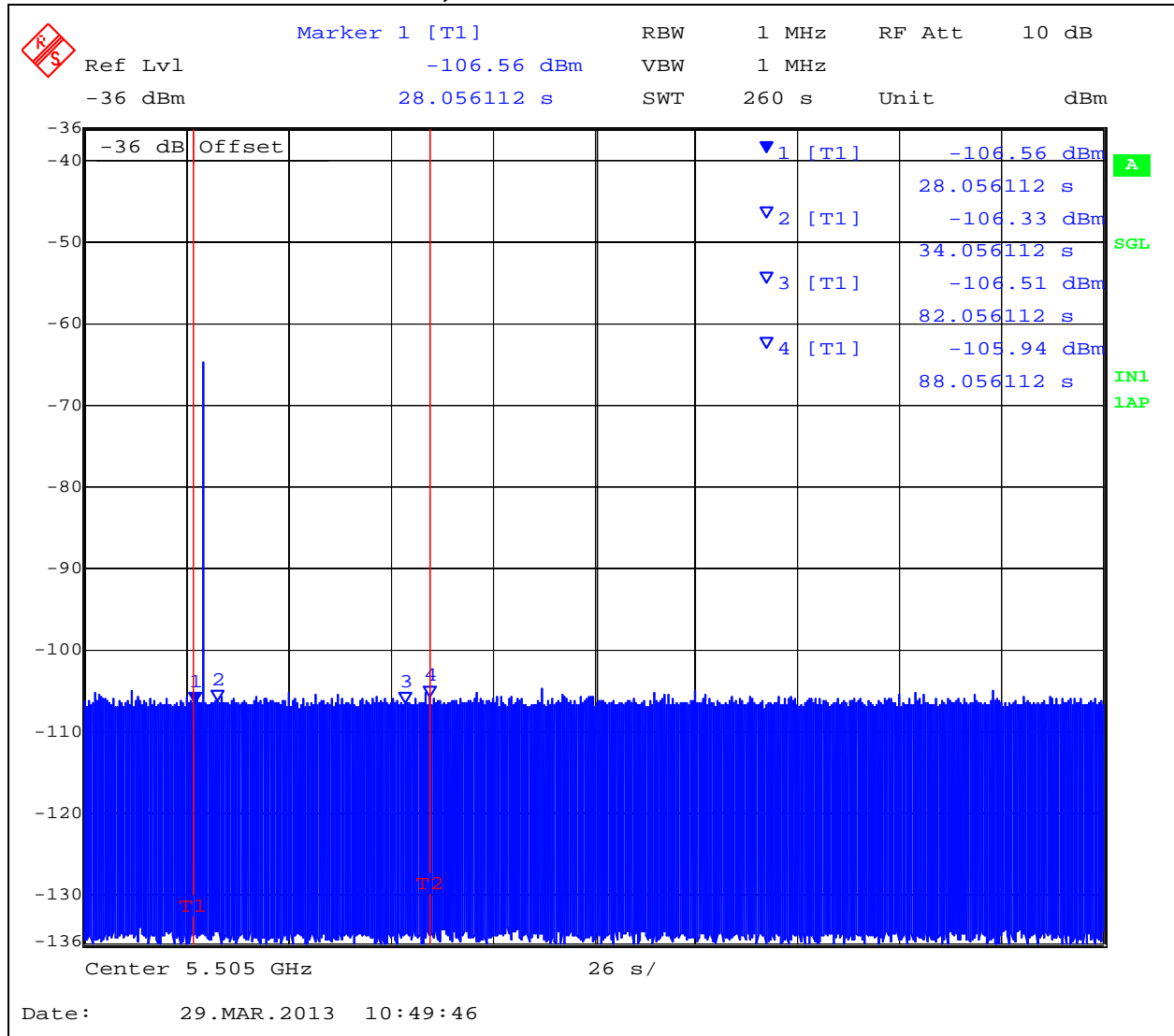

This test report may be reproduced in full only. The document may only be updated by MiCOM Labs personnel. Any changes will be noted in the Document History section of the report.



**Title:** APIN0224, APIN0225 802.11a/b/g/n/ac  
**To:** FCC 47 CFR Part 15.407 & IC RSS-210  
**Serial #:** ARUB146-U1 Rev A-1  
**Issue Date:** 13th June 2013  
**Page:** 43 of 68

---

#### **4.1.1.6.4. Radar Burst at the End of the Channel Availability Check Time:**

The steps below define the procedure to verify successful radar detection on the selected Channel during a period equal to the Channel Availability Check Time and avoidance of operation on that Channel when a radar Burst with a level equal to the DFS Detection Threshold occurs at the end of the Channel Availability Check Time.

A single Burst of short pulse of radar type 1 will commence within a 6 second window starting at  $T_0 + 54$  seconds. The window will commence at marker 2 and end at the red frequency line  $T_2$ .

Visual indication on the EUT of successful detection of the radar Burst will be recorded and reported. Observation of emissions at 5,500MHz 802.11a & 5,510MHz 802.11n HT40 will continue for 2.5 minutes after the radar burst has been generated.

---

This test report may be reproduced in full only. The document may only be updated by MiCOM Labs personnel. Any changes will be noted in the Document History section of the report.



Channel Availability Check Time at T0 + 54 seconds Check Time  
5,500MHz 802.11a

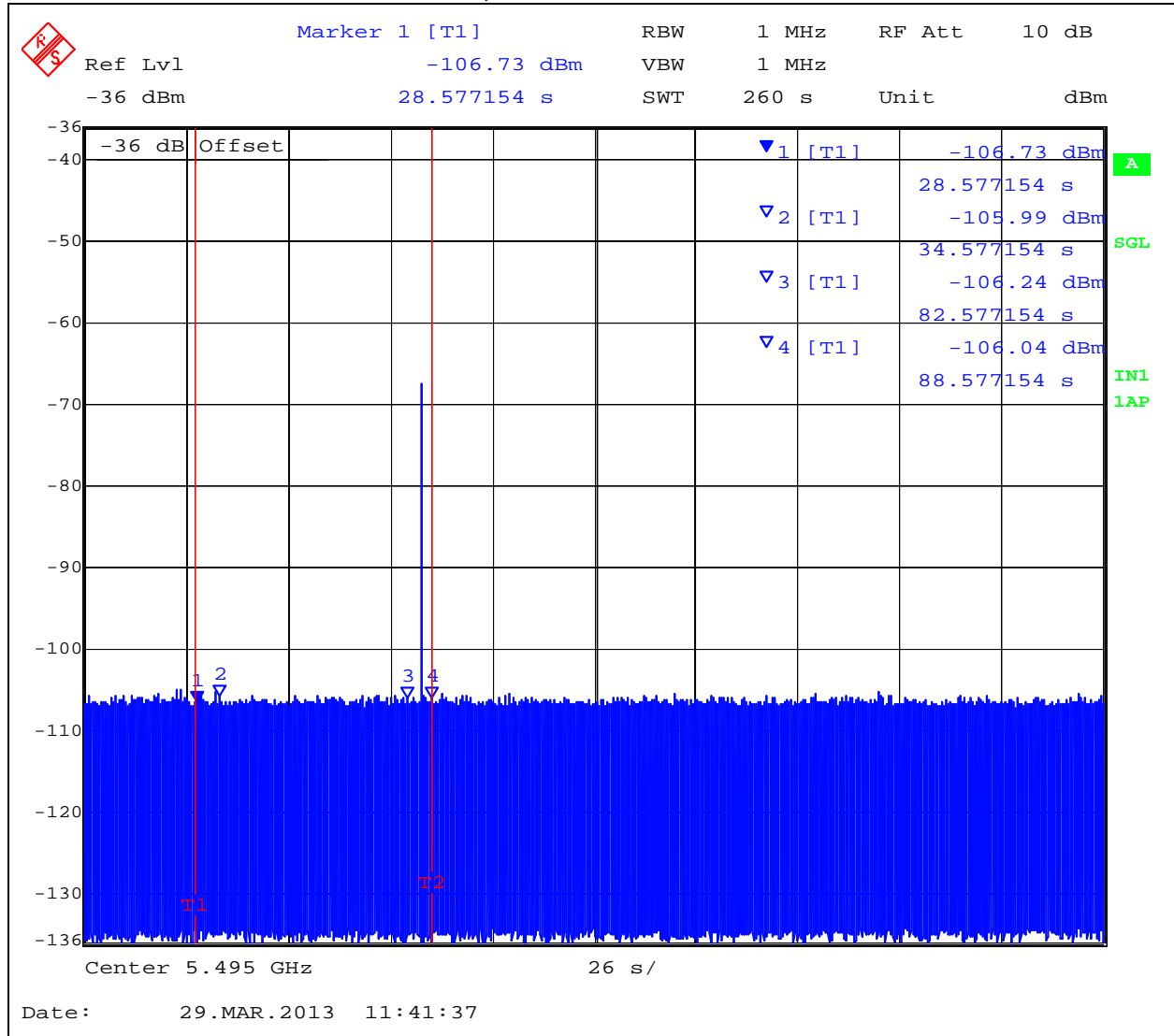

This test report may be reproduced in full only. The document may only be updated by MiCOM Labs personnel. Any changes will be noted in the Document History section of the report.



### Channel Availability Check Time at T0 + 54 seconds Check Time 5,510MHz 802.11n HT40

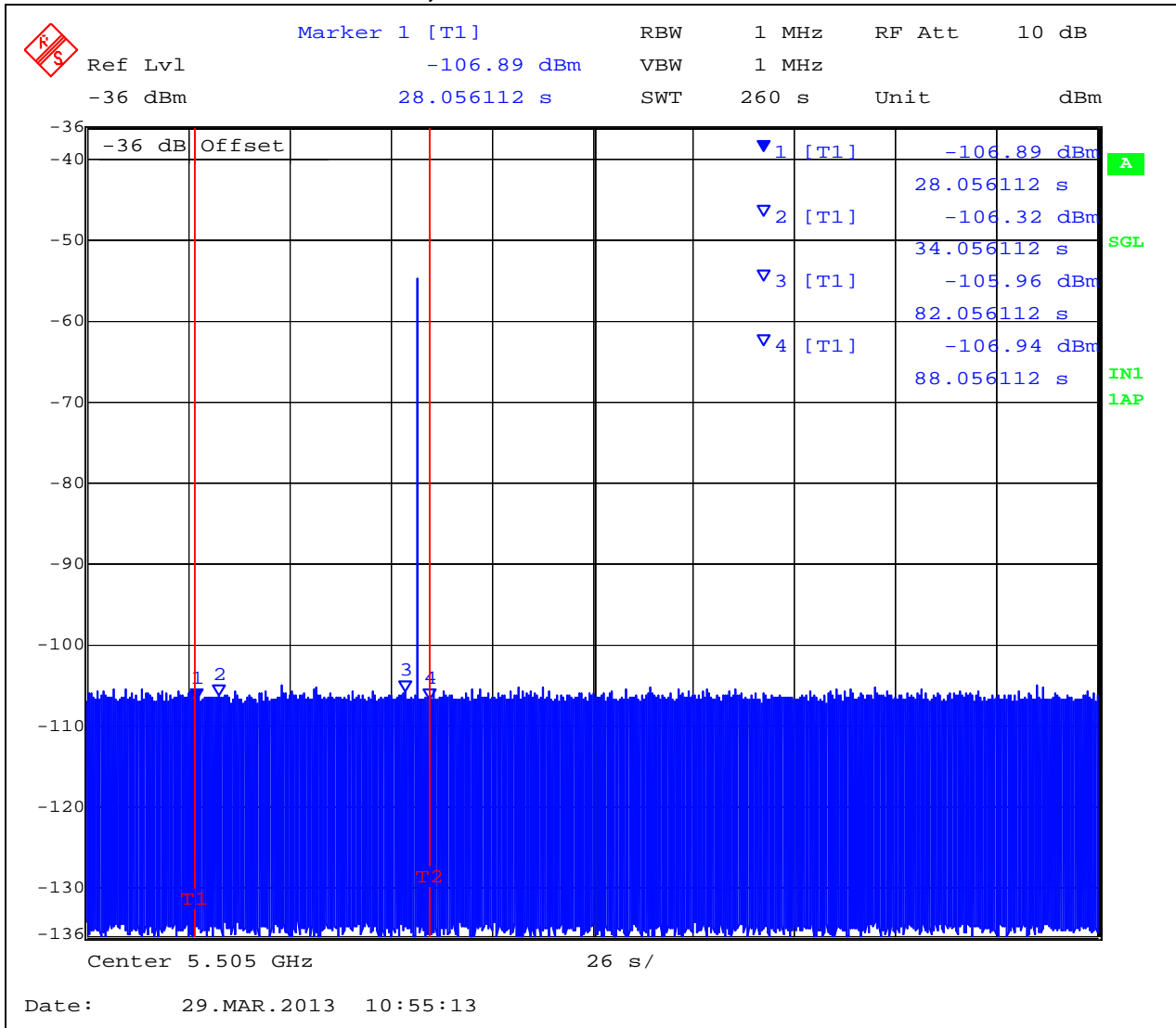

This test report may be reproduced in full only. The document may only be updated by MiCOM Labs personnel. Any changes will be noted in the Document History section of the report.



#### 4.1.1.6.5. In-Service Monitoring for Channel Move Time, Channel Closing Transmission Time and Non-Occupancy Period

##### **FCC §15.407(h)(2)(iii)**

The steps below define the procedure to determine the above mentioned parameters when a radar Burst with a level equal to the DFS Detection Threshold is generated on the Operating Channel of the U-NII device.

A U-NII device operating as a Client Device will associate with the EUT (Master). The requisite MPEG video file ("TestFile.mpg" available on the NTIA website at the following link <http://ntiacsd.ntia.doc.gov/dfs/>) is streamed from the master device (AP) to the client.

##### **Channel Closing Transmission Time - Measurement**

A Type 1 waveform was introduced to the EUT, from which a 12 second transmission record was digitally captured, collecting nearly 250M samples of data, which included in excess of 600 ms of pre-trigger data. This Type 1 waveform had an integral marker built into its construction, marking the start of the radar waveform play, which directly triggered the PXI digitizer's data capture via the PXI backplane trigger bus.

The test system was set-up to capture all transmission data for access point events above a threshold level of -50 dBm. The test equipment time stamps all captured events with respect to  $T_0$  (zero time indicating the start of the measurements sequence) starting the 612.1 ms pre-trigger period followed by the radar type 1 burst period.

Radar (Type 1) Pre-trigger period      612.1 ms

Type 1 burst period                      25.70 ms

(The period of the 18 pulse burst includes [18 pulses \* 1.428mS PRI] = 25.704 ms. Then add 1  $\mu$ s pulse width for the final pulse.)

Channel Closing Transmission Time starts immediately after the last radar pulse is transmitted i.e. 637.8 ms after the start of the trace capture period.



**Title:** APIN0224, APIN0225 802.11a/b/g/n/ac  
**To:** FCC 47 CFR Part 15.407 & IC RSS-210  
**Serial #:** ARUB146-U1 Rev A-1  
**Issue Date:** 13th June 2013  
**Page:** 47 of 68

Therefore, pulses seen after this 637.8 ms boundary are identified and totaled to provide an aggregate total of transmissions in order to determine whether the EUT is compliant with the Channel Closing Transmission Time requirements as described in MO&O FCC 06-96. In this case, it was found that an aggregate total of 0.00 ms of transmission time accrued. This value is found at the right hand side at the foot of the following plot (10s Total).

**Channel Closing Transmission Time 5,500 MHz (802.11a) = 17.42 mSecs (limit 260 mSecs)**

**Channel Move Time 5,500MHz (802.11a) = 0.4622 Secs (limit 10 Secs)**

### Channel Move Time, Channel Closing Transmission Time for Type 1 Radar Captured by the Test System - 0 to 2 seconds

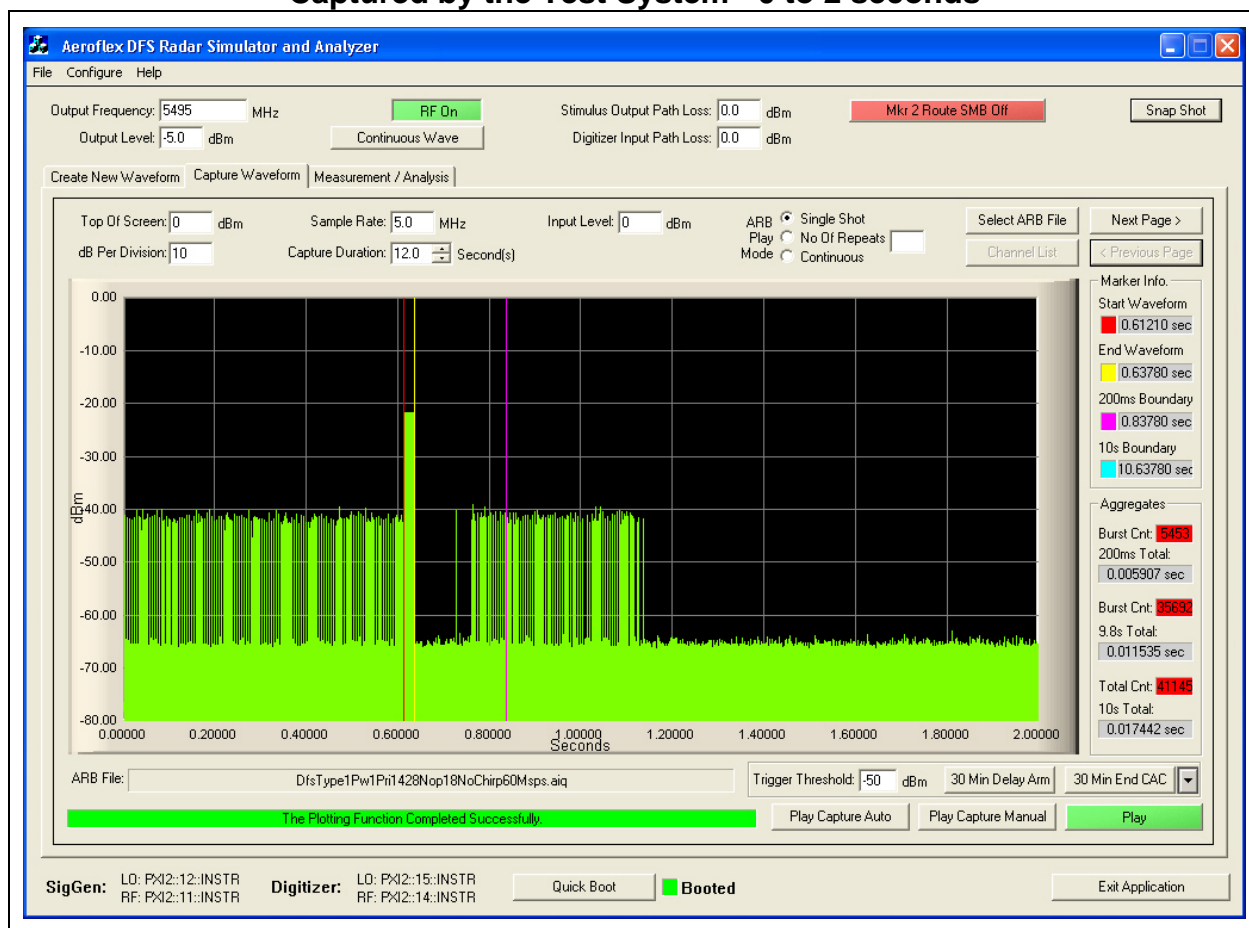

This test report may be reproduced in full only. The document may only be updated by MiCOM Labs personnel. Any changes will be noted in the Document History section of the report.



Title: APIN0224, APIN0225 802.11a/b/g/n/ac  
To: FCC 47 CFR Part 15.407 & IC RSS-210  
Serial #: ARUB146-U1 Rev A-1  
Issue Date: 13th June 2013  
Page: 48 of 68

### Channel Move Time, Channel Closing Transmission Time for Type 1 Radar Captured by the Test System - 2 to 4 seconds

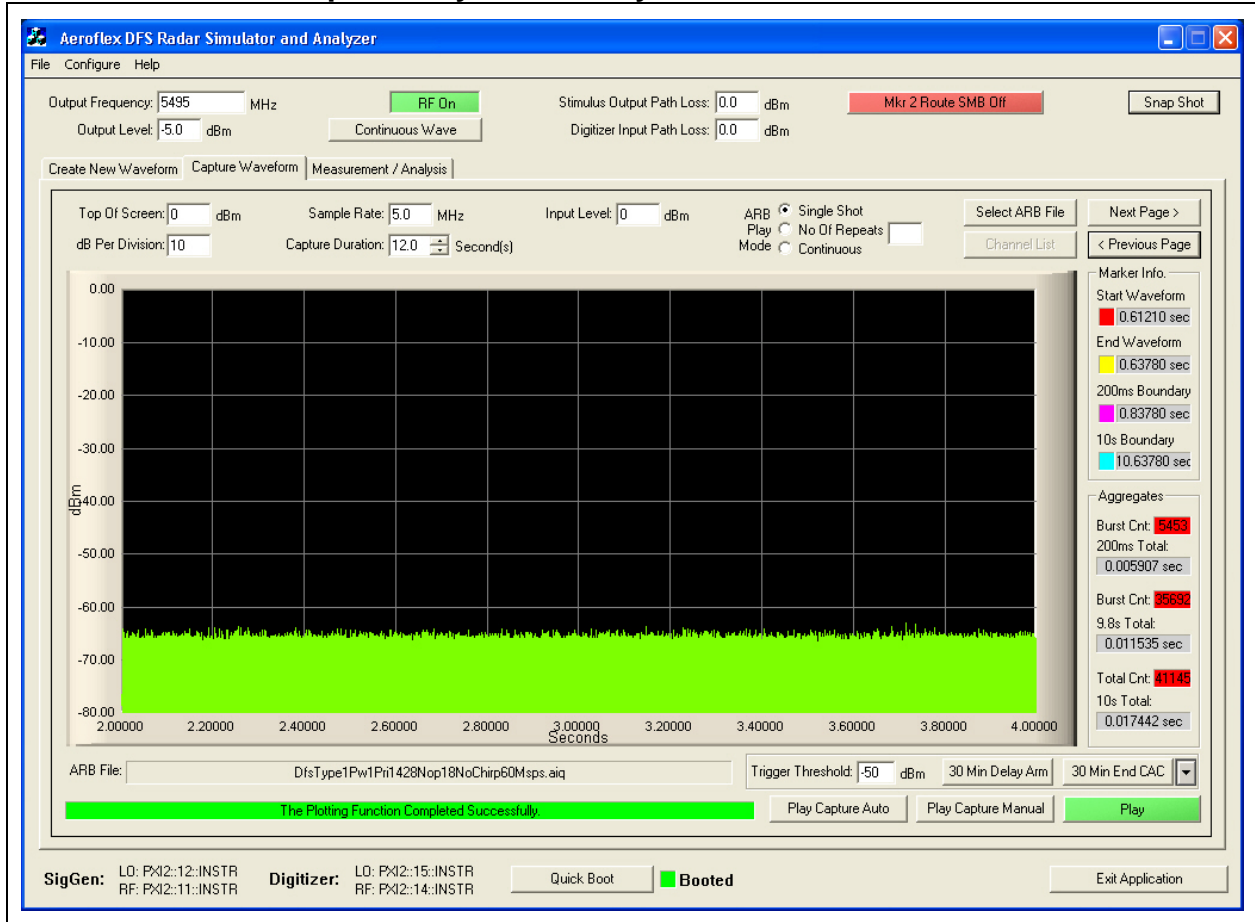

This test report may be reproduced in full only. The document may only be updated by MiCOM Labs personnel. Any changes will be noted in the Document History section of the report.





**Title:** APIN0224, APIN0225 802.11a/b/g/n/ac  
**To:** FCC 47 CFR Part 15.407 & IC RSS-210  
**Serial #:** ARUB146-U1 Rev A-1  
**Issue Date:** 13th June 2013  
**Page:** 49 of 68

### Channel Move Time, Channel Closing Transmission Time for Type 1 Radar Captured by the Test System - 4 to 6 seconds

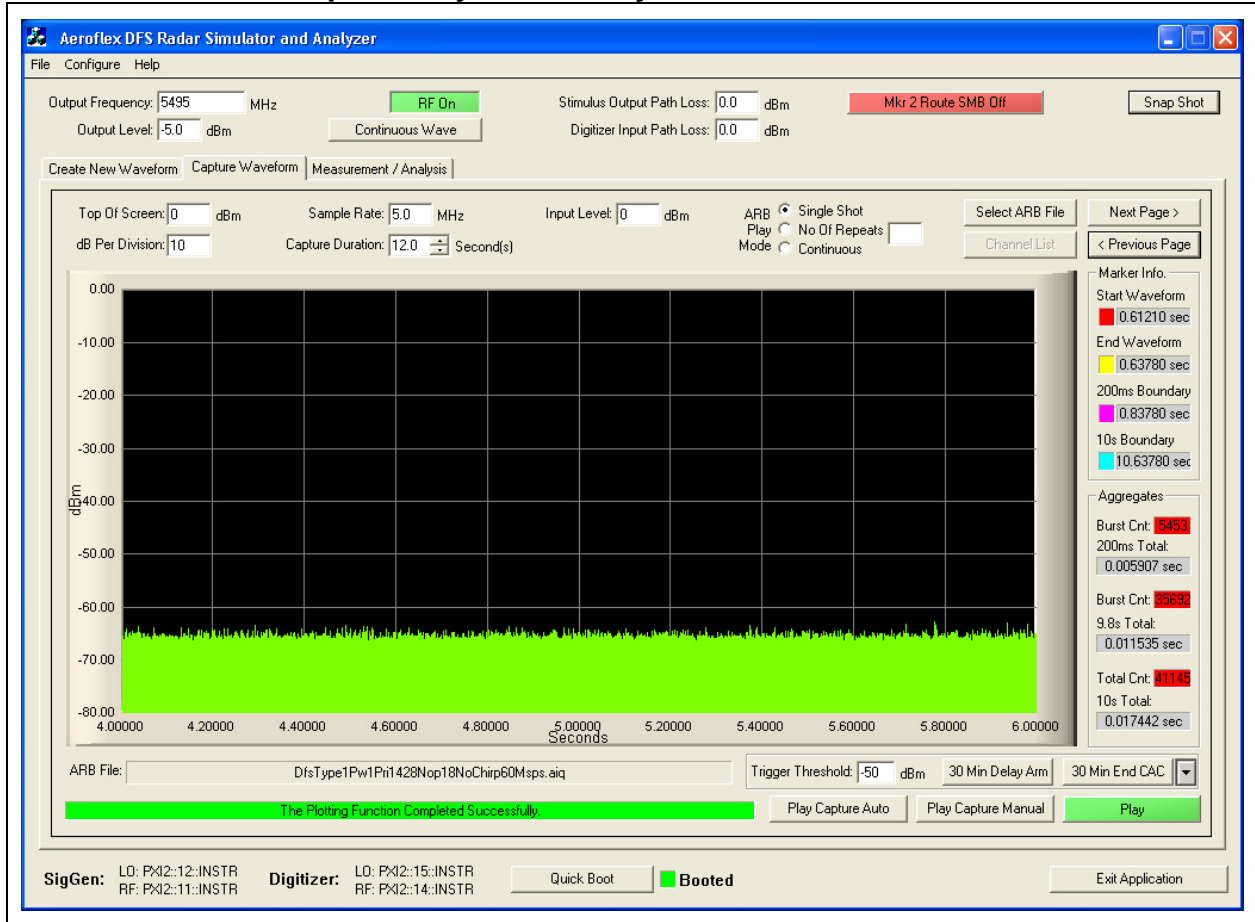

This test report may be reproduced in full only. The document may only be updated by MiCOM Labs personnel. Any changes will be noted in the Document History section of the report.



Title: APIN0224, APIN0225 802.11a/b/g/n/ac  
To: FCC 47 CFR Part 15.407 & IC RSS-210  
Serial #: ARUB146-U1 Rev A-1  
Issue Date: 13th June 2013  
Page: 50 of 68

### Channel Move Time, Channel Closing Transmission Time for Type 1 Radar Captured by the Test System - 6 to 8 seconds

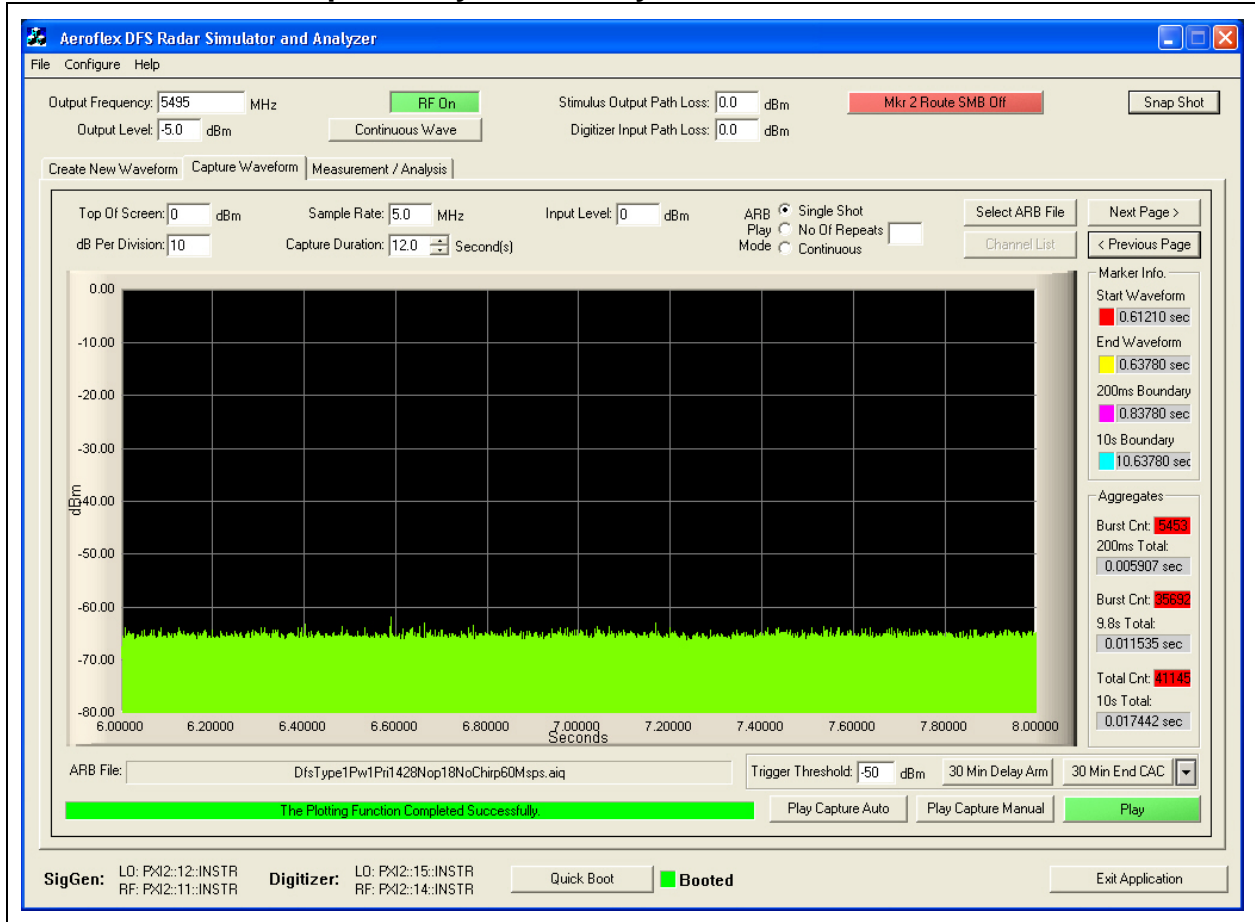

This test report may be reproduced in full only. The document may only be updated by MiCOM Labs personnel. Any changes will be noted in the Document History section of the report.



Title: APIN0224, APIN0225 802.11a/b/g/n/ac  
To: FCC 47 CFR Part 15.407 & IC RSS-210  
Serial #: ARUB146-U1 Rev A-1  
Issue Date: 13th June 2013  
Page: 51 of 68

### Channel Move Time, Channel Closing Transmission Time for Type 1 Radar Captured by the Test System - 8 to 10 seconds

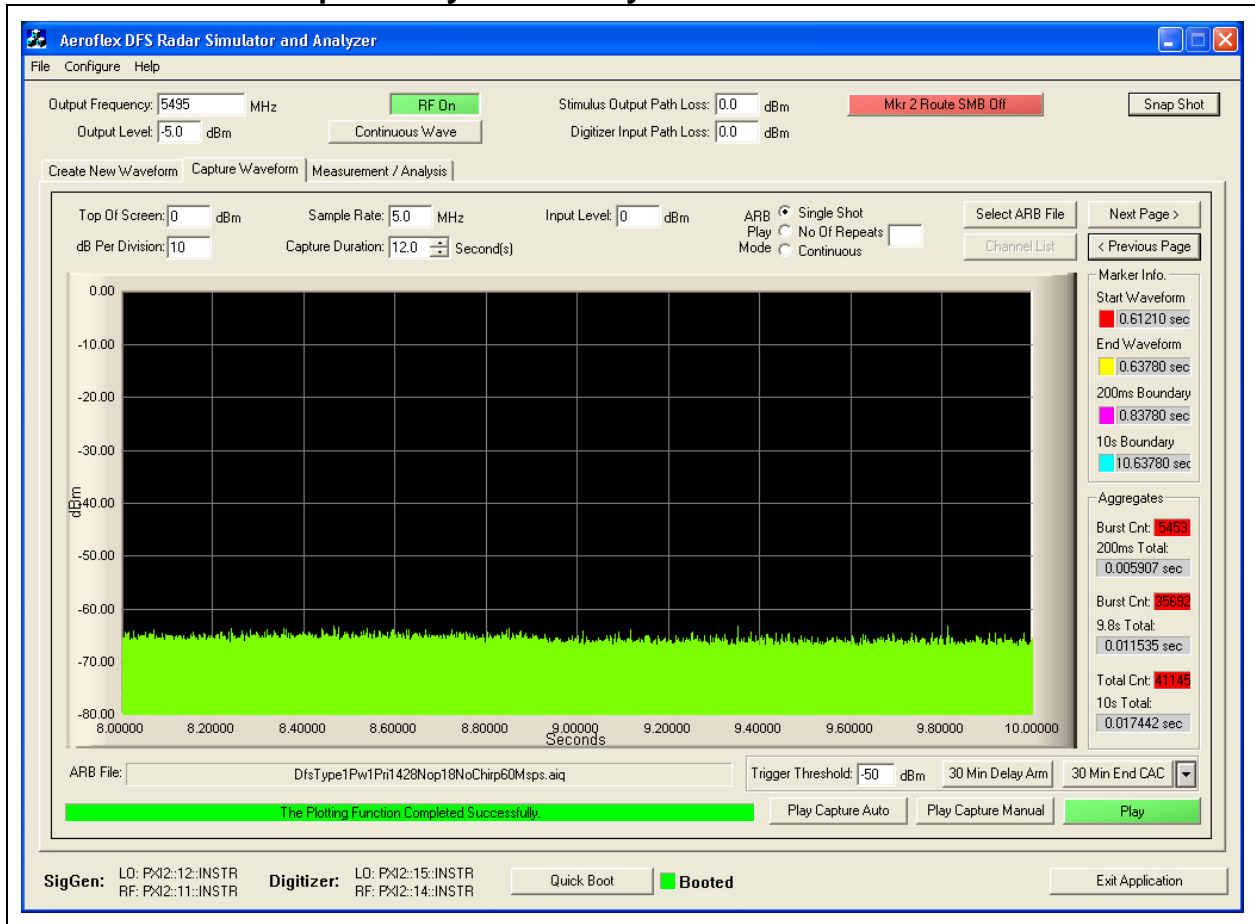

This test report may be reproduced in full only. The document may only be updated by MiCOM Labs personnel. Any changes will be noted in the Document History section of the report.



**Title:** APIN0224, APIN0225 802.11a/b/g/n/ac  
**To:** FCC 47 CFR Part 15.407 & IC RSS-210  
**Serial #:** ARUB146-U1 Rev A-1  
**Issue Date:** 13th June 2013  
**Page:** 52 of 68

### Channel Move Time, Channel Closing Transmission Time for Type 1 Radar Captured by the Test System - 10 to 12 seconds

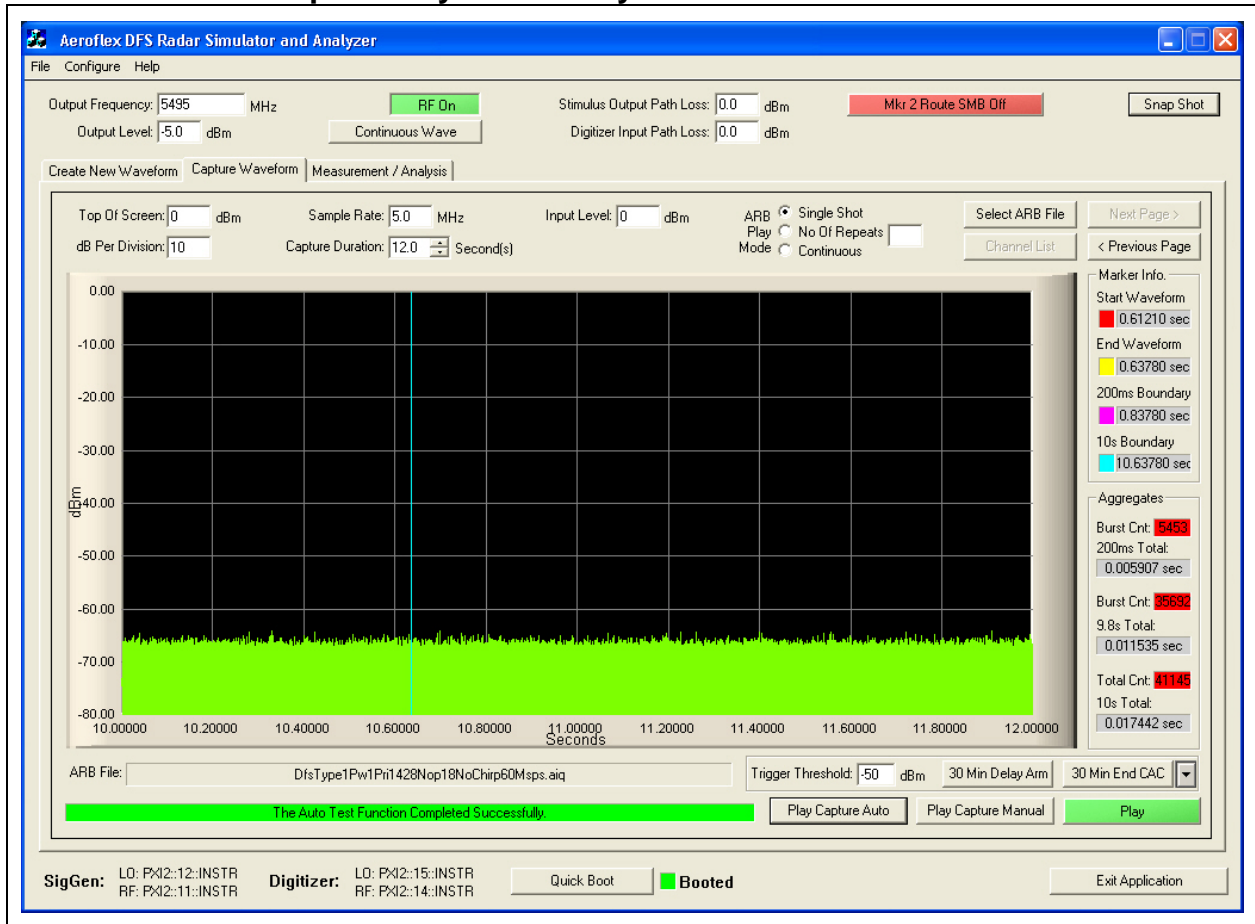

This test report may be reproduced in full only. The document may only be updated by MiCOM Labs personnel. Any changes will be noted in the Document History section of the report.



Title: APIN0224, APIN0225 802.11a/b/g/n/ac  
To: FCC 47 CFR Part 15.407 & IC RSS-210  
Serial #: ARUB146-U1 Rev A-1  
Issue Date: 13th June 2013  
Page: 53 of 68

**Channel Closing Transmission Time 5,510 MHz (802.11n HT40) = 42.29 mSecs**  
**(limit 260 mSecs)**

**Channel Move Time 5,510 MHz (802.11n HT40) = 1.1422 Secs (limit 10 Secs)**

### Channel Move Time, Channel Closing Transmission Time for Type 1 Radar Captured by the Test System - 0 to 2 seconds

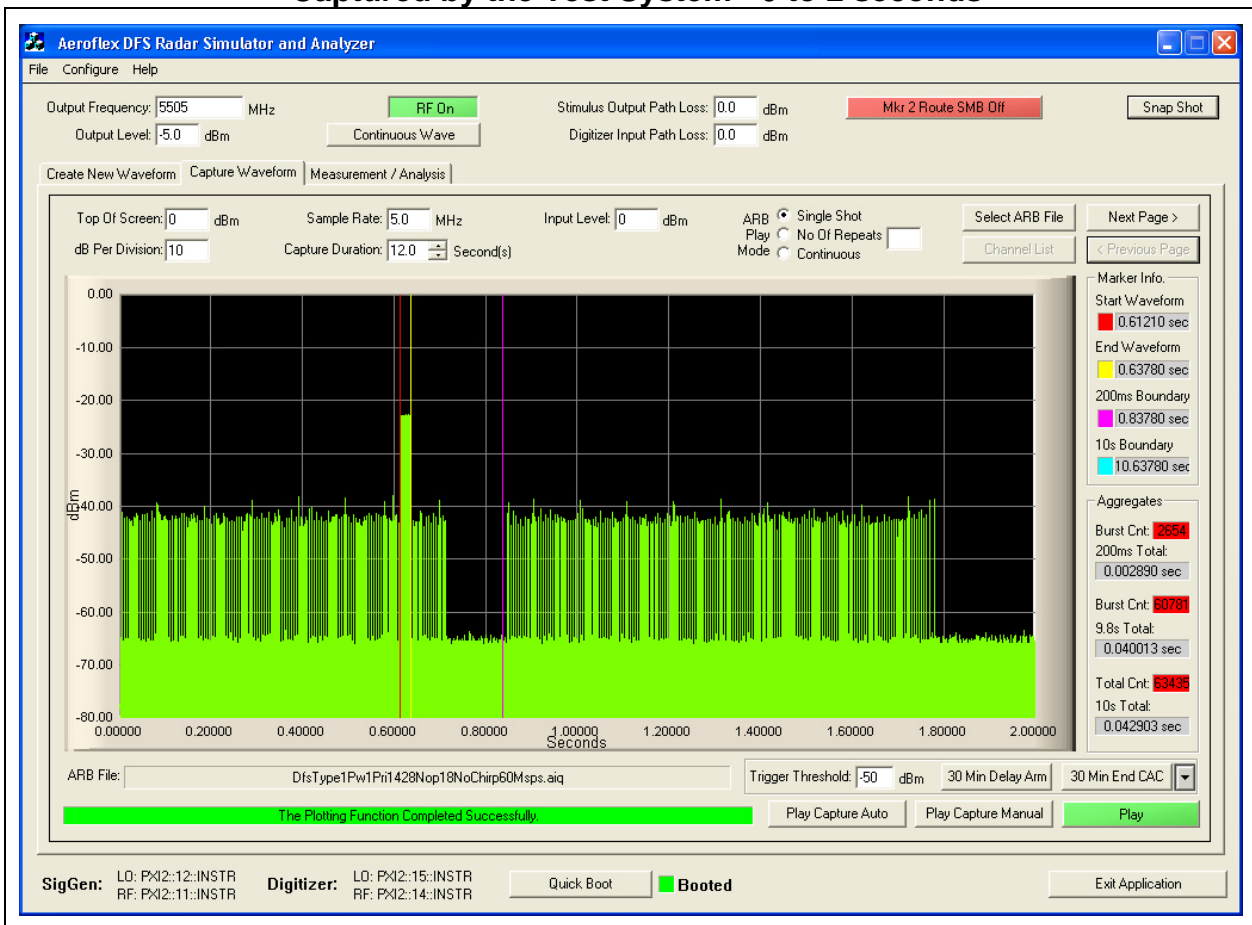

This test report may be reproduced in full only. The document may only be updated by MiCOM Labs personnel. Any changes will be noted in the Document History section of the report.



Title: APIN0224, APIN0225 802.11a/b/g/n/ac  
To: FCC 47 CFR Part 15.407 & IC RSS-210  
Serial #: ARUB146-U1 Rev A-1  
Issue Date: 13th June 2013  
Page: 54 of 68

### Channel Move Time, Channel Closing Transmission Time for Type 1 Radar Captured by the Test System - 2 to 4 seconds

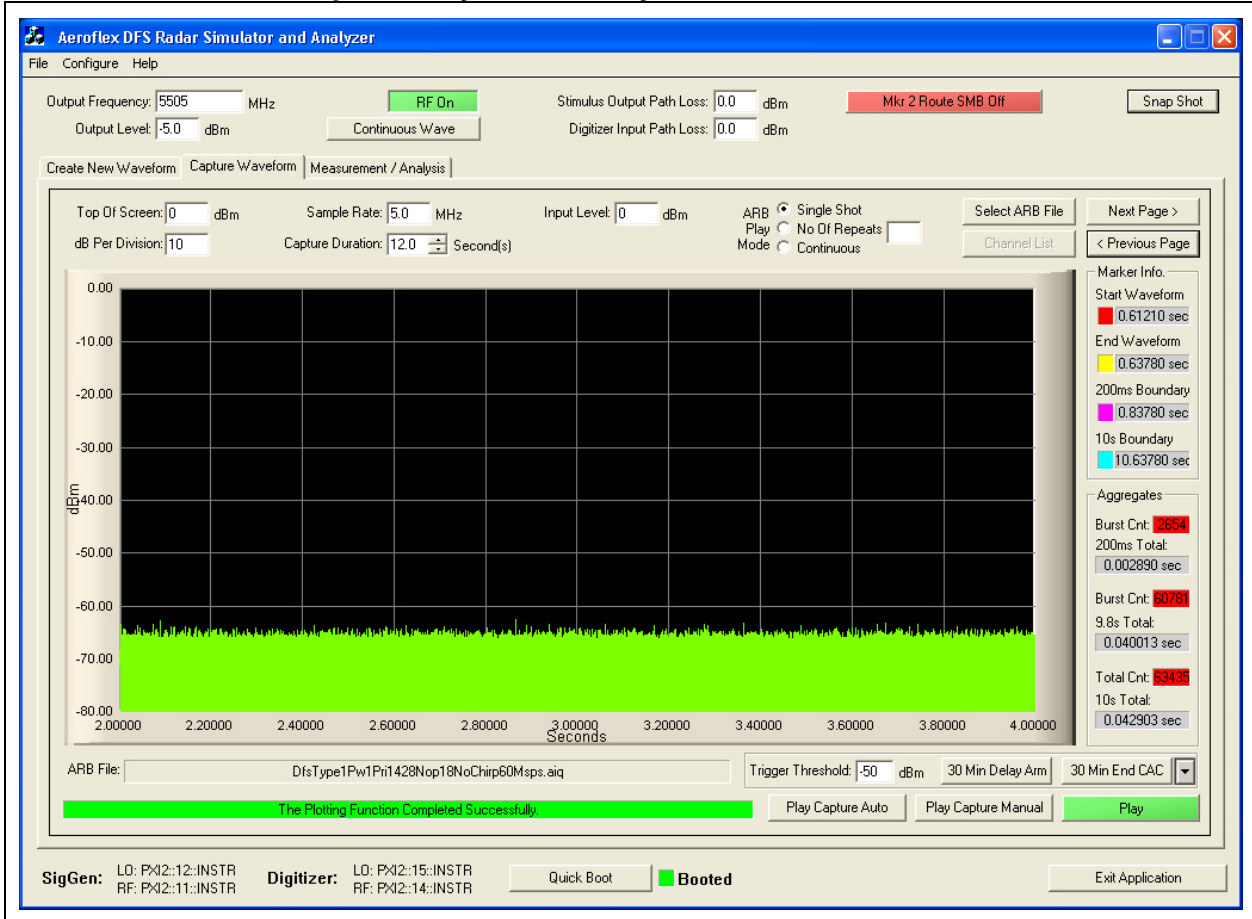

This test report may be reproduced in full only. The document may only be updated by MiCOM Labs personnel. Any changes will be noted in the Document History section of the report.



Title: APIN0224, APIN0225 802.11a/b/g/n/ac  
To: FCC 47 CFR Part 15.407 & IC RSS-210  
Serial #: ARUB146-U1 Rev A-1  
Issue Date: 13th June 2013  
Page: 55 of 68

### Channel Move Time, Channel Closing Transmission Time for Type 1 Radar Captured by the Test System - 4 to 6 seconds

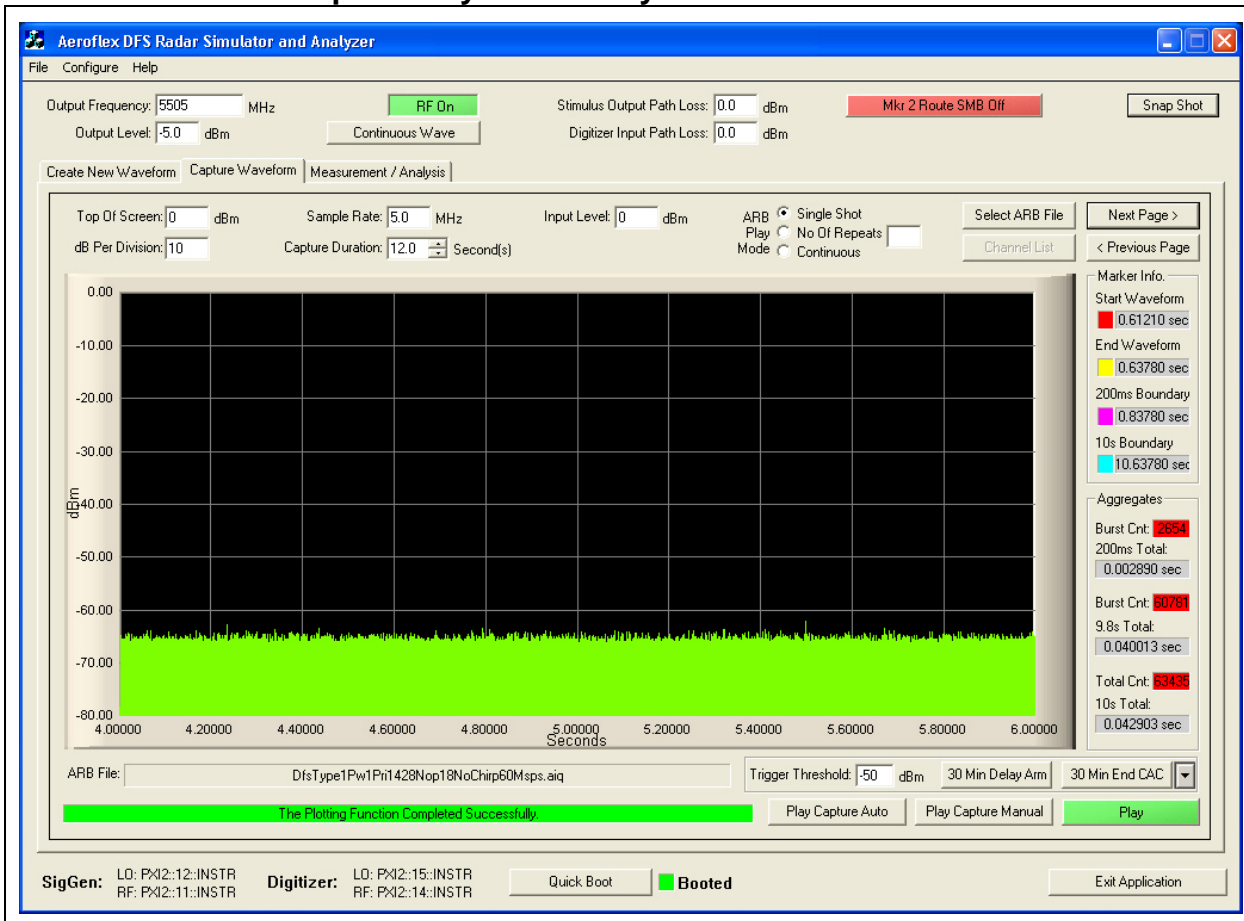

This test report may be reproduced in full only. The document may only be updated by MiCOM Labs personnel. Any changes will be noted in the Document History section of the report.



Title: APIN0224, APIN0225 802.11a/b/g/n/ac  
To: FCC 47 CFR Part 15.407 & IC RSS-210  
Serial #: ARUB146-U1 Rev A-1  
Issue Date: 13th June 2013  
Page: 56 of 68

### Channel Move Time, Channel Closing Transmission Time for Type 1 Radar Captured by the Test System - 6 to 8 seconds

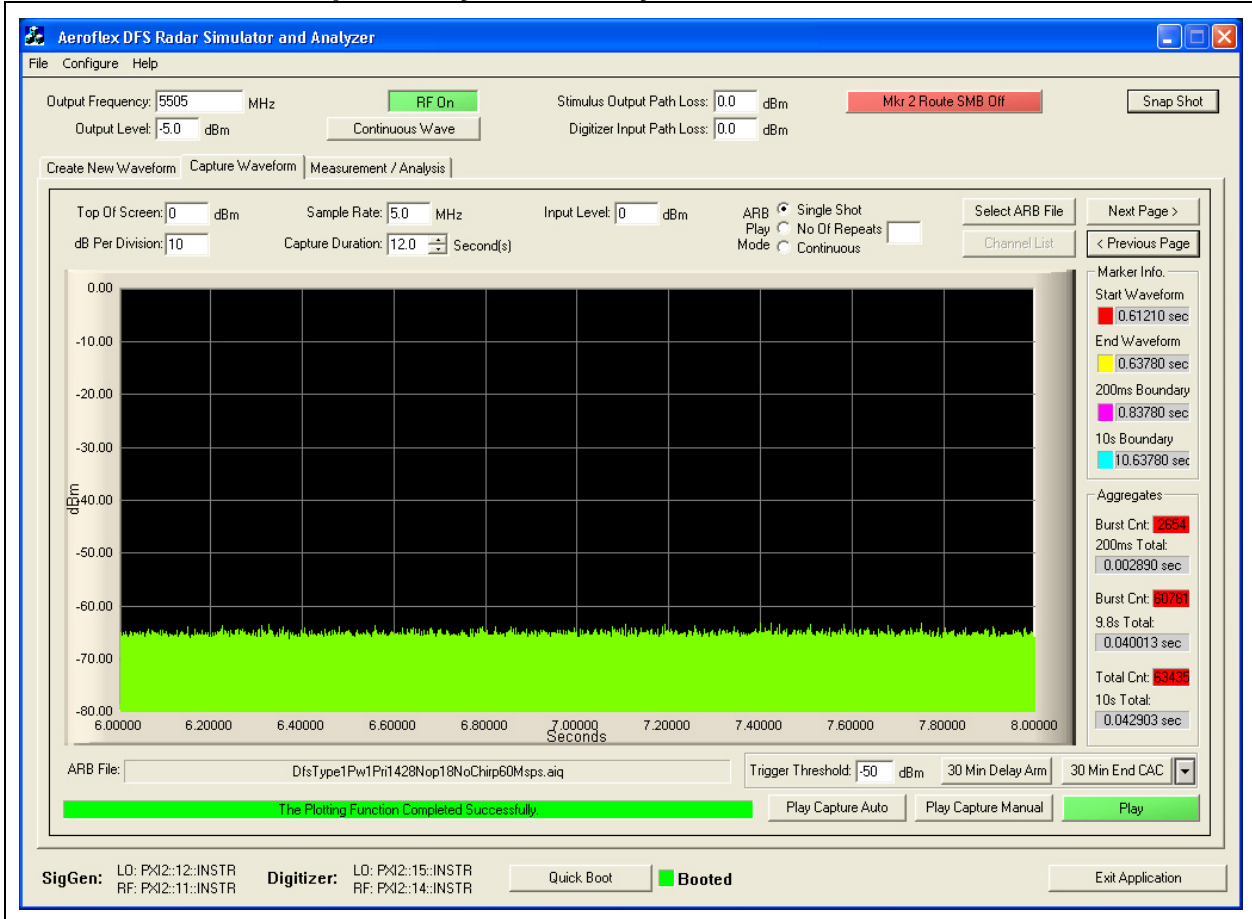

This test report may be reproduced in full only. The document may only be updated by MiCOM Labs personnel. Any changes will be noted in the Document History section of the report.





Title: APIN0224, APIN0225 802.11a/b/g/n/ac  
To: FCC 47 CFR Part 15.407 & IC RSS-210  
Serial #: ARUB146-U1 Rev A-1  
Issue Date: 13th June 2013  
Page: 57 of 68

### Channel Move Time, Channel Closing Transmission Time for Type 1 Radar Captured by the Test System - 8 to 10 seconds

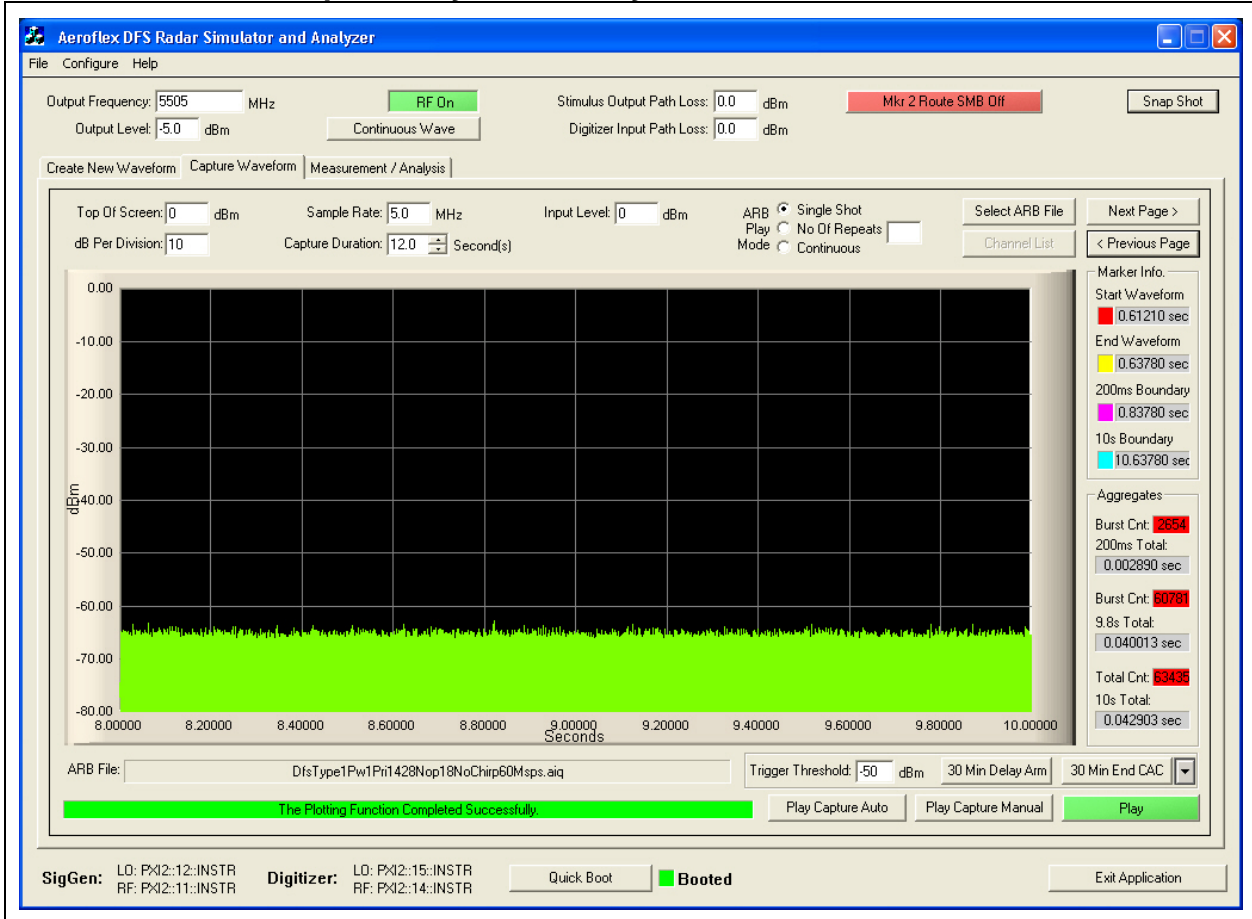

This test report may be reproduced in full only. The document may only be updated by MiCOM Labs personnel. Any changes will be noted in the Document History section of the report.



Title: APIN0224, APIN0225 802.11a/b/g/n/ac  
To: FCC 47 CFR Part 15.407 & IC RSS-210  
Serial #: ARUB146-U1 Rev A-1  
Issue Date: 13th June 2013  
Page: 58 of 68

### Channel Move Time, Channel Closing Transmission Time for Type 1 Radar Captured by the Test System - 10 to 12 seconds

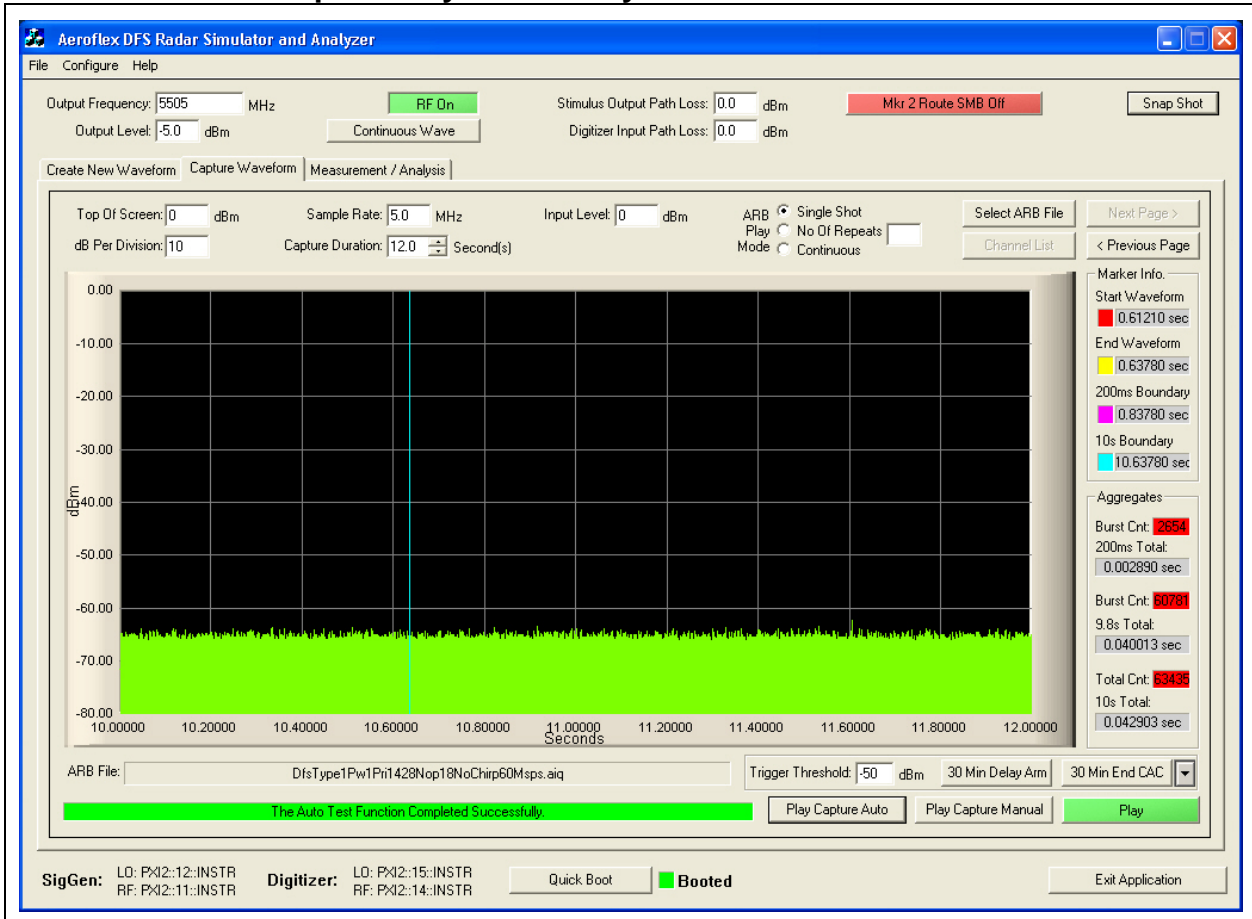

This test report may be reproduced in full only. The document may only be updated by MiCOM Labs personnel. Any changes will be noted in the Document History section of the report.



### 30 Minute Non-Occupancy Period

The EUT is monitored for more than 30 minutes following the channel close/move time to verify no transmissions resume on this Channel.

### 30 Minute Non-Occupancy Period Type 1 Radar 5,500MHz 802.11a

	Delta 1 [T1]	RBW	1 MHz	RF Att	10 dB
	Ref Lvl	-43.92 dB	VBW	1 MHz	
	-36 dBm	1.800000 ks	SWT	2000 s	Unit dBm

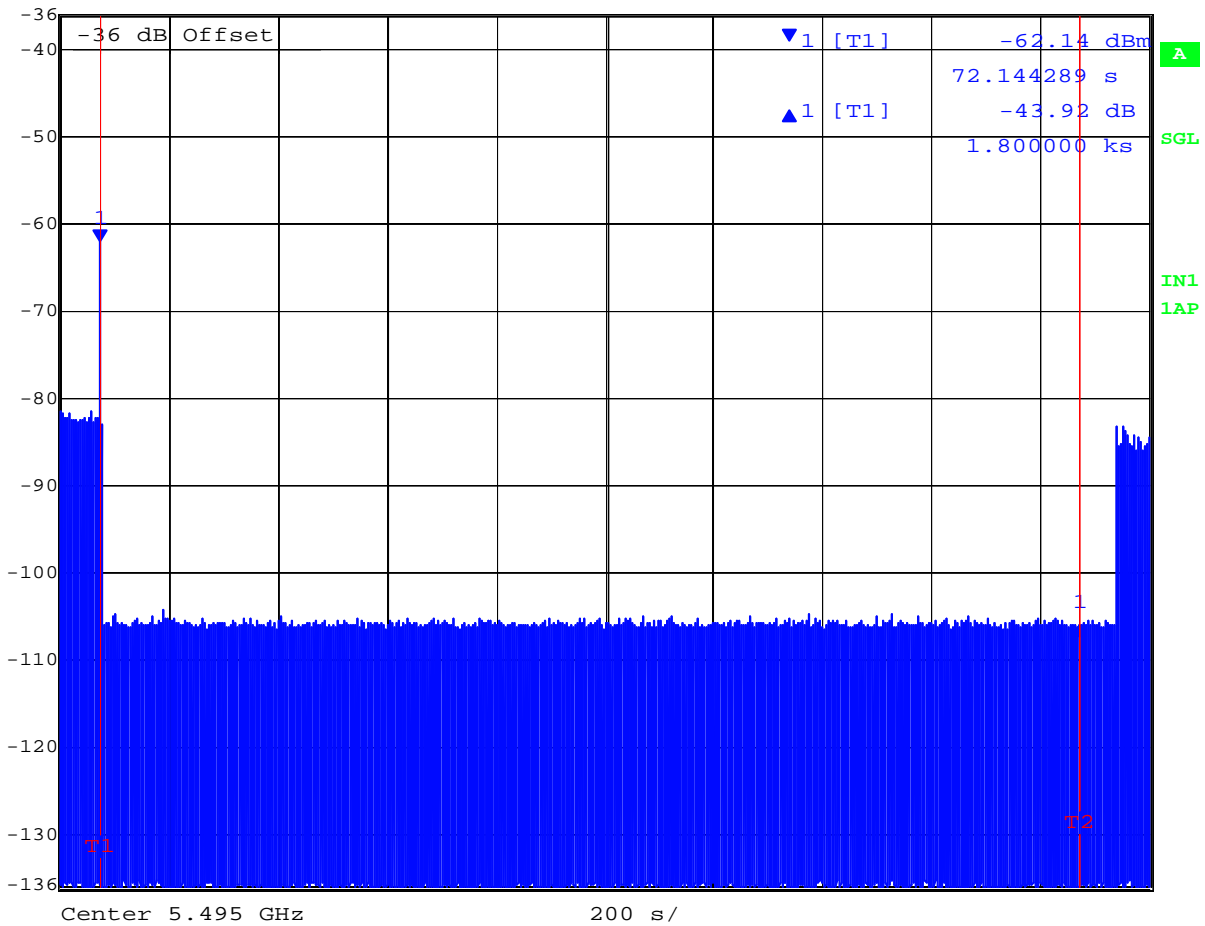

Date: 29.MAR.2013 12:27:39

This test report may be reproduced in full only. The document may only be updated by MiCOM Labs personnel. Any changes will be noted in the Document History section of the report.



**Title:** APIN0224, APIN0225 802.11a/b/g/n/ac  
**To:** FCC 47 CFR Part 15.407 & IC RSS-210  
**Serial #:** ARUB146-U1 Rev A-1  
**Issue Date:** 13th June 2013  
**Page:** 60 of 68

**30 Minute Non-Occupancy Period Type 1 Radar**  
**5,510 MHz 802.11n HT40**

 Delta 1 [T1]      RBW      1 MHz      RF Att      10 dB  
 Ref Lvl              -35.59 dB      VBW      1 MHz  
 -36 dBm              1.800000 ks      SWT      2000 s      Unit              dBm

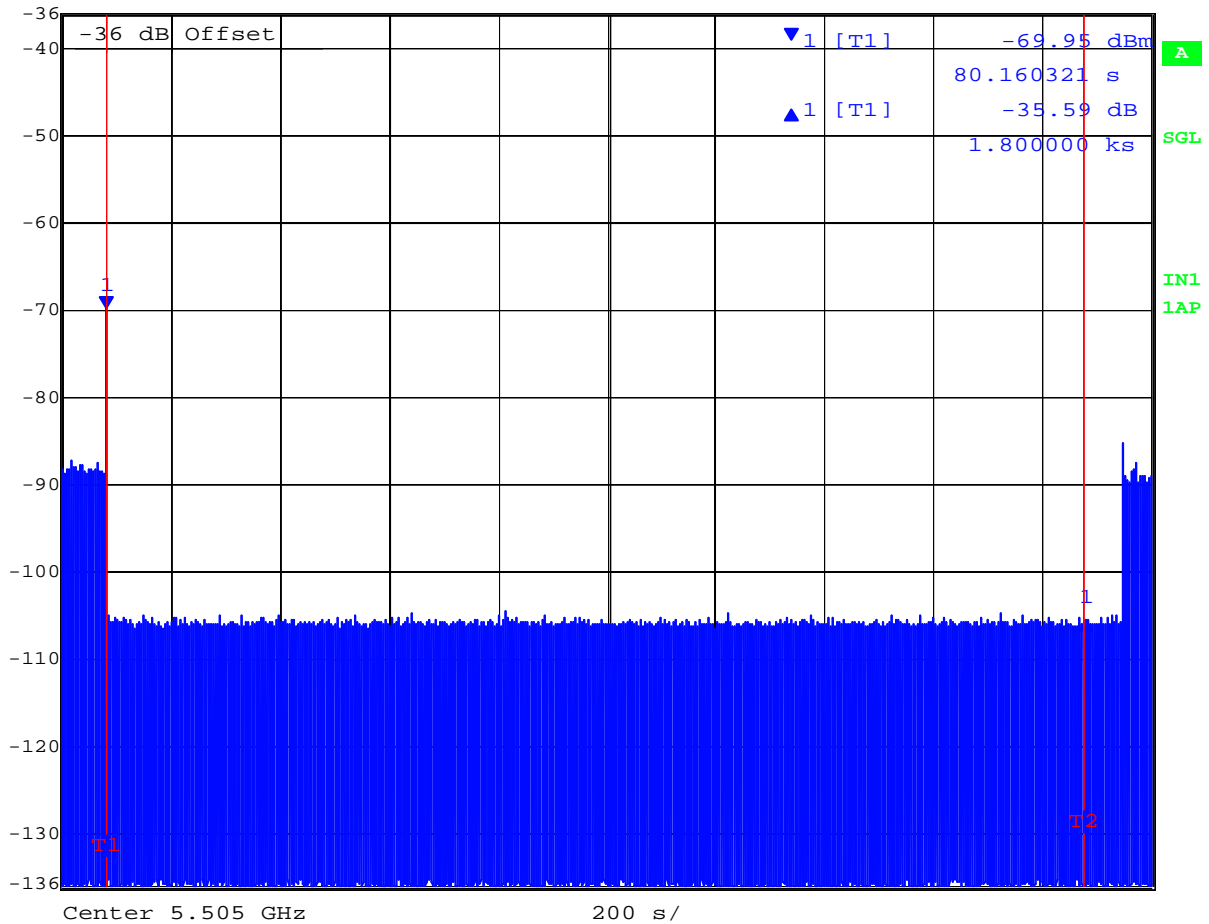

Date: 29.MAR.2013 10:19:46

This test report may be reproduced in full only. The document may only be updated by MiCOM Labs personnel. Any changes will be noted in the Document History section of the report.



**Title:** APIN0224, APIN0225 802.11a/b/g/n/ac  
**To:** FCC 47 CFR Part 15.407 & IC RSS-210  
**Serial #:** ARUB146-U1 Rev A-1  
**Issue Date:** 13th June 2013  
**Page:** 61 of 68

---

#### **4.1.1.6.6. Statistical Performance Check**

The steps below define the procedure to determine the minimum percentage of detection when a radar burst with a level equal to the DFS Detection Threshold is generated on the Operating Channel of the U-NII device.

A U-NII device operating as a Client Device will associate with the UUT (Master) at 5,500MHz 802.11a and 5,510MHz 802.11n HT40.

The Radar Waveform generator sends the individual waveform for each of the radar types 1-6. Statistical data will be gathered to determine the ability of the device to detect the radar test waveforms. The device can utilize a test mode to demonstrate when detection occurs to prevent the need to reset the device between trial runs. The percentage of successful detection is calculated by:

$$\text{Total \# of detections} \div \text{Total \# of Trials} \times 100 = \text{Probability of Detection}$$

The Minimum number of trails, minimum percentage of successful detection and the average minimum percentage of successful detection are found in the Radar Test Waveforms section.

---

This test report may be reproduced in full only. The document may only be updated by MiCOM Labs personnel. Any changes will be noted in the Document History section of the report.



**Verification of Detection 5,500MHz (5 MHz Offset 5495MHz) 802.11a**

Trial #	Detection = √, No Detection = 0					
	Type 1	Type 2	Type 3	Type 4	Type 5	Type 6
1	√	√	√	√	√	√
2	√	√	√	√	√	√
3	√	√	√	√	√	√
4	√	√	√	√	0	√
5	√	√	√	√	√	√
6	√	√	√	√	√	√
7	√	√	0	√	0	√
8	√	√	√	√	√	√
9	√	√	√	√	√	√
10	√	√	√	√	√	√
11	√	√	√	√	√	√
12	√	√	√	√	√	√
13	√	√	√	√	√	√
14	√	√	√	√	0	√
15	√	√	√	√	√	√
16	√	√	√	√	√	√
17	√	√	√	√	√	√
18	√	√	√	√	√	√
19	√	√	√	√	√	√
20	√	√	√	√	√	√
21	√	√	√	√	√	√
22	√	√	√	√	√	√
23	√	√	√	√	√	√
24	√	√	√	√	0	√
25	√	√	√	√	√	√
26	√	√	√	√	√	√
27	√	√	√	√	√	√
28	√	√	√	√	√	√
29	√	√	√	√	0	√
30	√	√	√	√	√	√
<b>Detection Percentage</b>	100% (>60%)	100% (>60%)	96.6% (>60%)	100% (>60%)	83.3% (>80%)	100% (>70%)

In addition an average minimum percentage of successful detection across all four Short pulse radar test waveforms is required and calculated as follows;

$$(P_{d1} + P_{d2} + P_{d3} + P_{d4}) / 4 = (100\% + 100\% + 96.6\% + 100\%) / 4 = 99.15\% (> 80\%)$$

This test report may be reproduced in full only. The document may only be updated by MiCOM Labs personnel. Any changes will be noted in the Document History section of the report.



**Verification of Detection 5,510MHz (5 MHz Offset 5505MHz) 802.11n HT40**

Trial #	Detection = √, No Detection = 0					
	Type 1	Type 2	Type 3	Type 4	Type 5	Type 6
1	√	√	√	√	√	√
2	√	√	√	√	√	√
3	√	√	√	√	√	√
4	√	√	√	√	√	√
5	√	√	√	√	√	√
6	√	√	√	√	√	√
7	√	√	√	√	√	√
8	√	√	√	√	√	√
9	√	√	√	√	√	√
10	√	√	√	√	√	√
11	√	√	√	√	√	√
12	√	√	√	√	√	√
13	√	√	√	√	√	√
14	√	√	√	√	√	√
15	√	√	√	√	√	√
16	√	√	√	√	√	√
17	√	√	√	√	√	√
18	√	√	√	√	√	√
19	√	√	√	√	√	√
20	√	√	√	√	√	√
21	√	√	√	√	√	√
22	√	√	√	√	√	√
23	√	√	√	√	√	√
24	√	√	√	√	√	√
25	√	√	√	√	√	√
26	√	√	√	√	√	√
27	√	√	√	√	√	√
28	√	√	√	√	√	√
29	√	√	√	√	√	√
30	√	√	√	√	√	√
<b>Detection Percentage</b>	100% (>60%)	100% (>60%)	100% (>60%)	100% (>60%)	100% (>80%)	100% (>70%)

In addition an average minimum percentage of successful detection across all four Short pulse radar test waveforms is required and calculated as follows;

$$(P_{d1} + P_{d2} + P_{d3} + P_{d4}) / 4 = 100\% (> 80\%)$$

This test report may be reproduced in full only. The document may only be updated by MiCOM Labs personnel. Any changes will be noted in the Document History section of the report.



**Verification of Detection 5,530MHz (5 MHz Offset 5525MHz) 802.11ac**

Trial #	Detection = √, No Detection = 0					
	Type 1	Type 2	Type 3	Type 4	Type 5	Type 6
1	√	√	√	√	√	√
2	√	√	√	√	√	√
3	√	√	√	√	√	√
4	√	√	√	√	√	√
5	√	√	√	√	√	√
6	√	√	√	√	√	√
7	√	√	√	√	0	√
8	√	√	√	√	√	√
9	√	√	√	√	√	√
10	√	√	√	√	√	√
11	√	√	√	√	√	√
12	√	√	√	√	√	√
13	√	√	√	√	√	√
14	√	√	√	√	√	√
15	√	√	√	√	√	√
16	√	√	√	√	√	√
17	√	√	√	√	√	√
18	√	√	√	√	√	√
19	√	√	√	√	√	√
20	√	√	√	√	√	√
21	√	√	√	√	√	√
22	√	√	√	√	√	√
23	√	√	√	√	√	√
24	√	√	√	√	√	√
25	√	√	√	√	0	√
26	√	√	√	√	√	√
27	√	√	√	√	√	√
28	√	√	√	√	√	√
29	√	√	√	√	√	√
30	√	√	√	√	√	√
<b>Detection Percentage</b>	100% (>60%)	100% (>60%)	100% (>60%)	100% (>60%)	93.3% (>80%)	100% (>70%)

In addition an average minimum percentage of successful detection across all four Short pulse radar test waveforms is required and calculated as follows;

$$(P_{d1} + P_{d2} + P_{d3} + P_{d4}) / 4 = 100\% (> 80\%)$$

This test report may be reproduced in full only. The document may only be updated by MiCOM Labs personnel. Any changes will be noted in the Document History section of the report.





**Title:** APIN0224, APIN0225 802.11a/b/g/n/ac  
**To:** FCC 47 CFR Part 15.407 & IC RSS-210  
**Serial #:** ARUB146-U1 Rev A-1  
**Issue Date:** 13th June 2013  
**Page:** 65 of 68

---

**Measurement Uncertainty Time/Power**

Measurement uncertainty		
- Time		4%
- Power		1.33dB

**Traceability**

Test Equipment Used
0072, 0083, 0098, 0116, 0132, 0158, 0313, 0314, 0193, 0223, 0252, 0253, 0251, 0256, 0328, 0329

---

This test report may be reproduced in full only. The document may only be updated by MiCOM Labs personnel. Any changes will be noted in the Document History section of the report.

## 5. PHOTOGRAPHS

### 5.1. Dynamic Frequency Selection (DFS)



---

This test report may be reproduced in full only. The document may only be updated by MiCOM Labs personnel. Any changes will be noted in the Document History section of the report.



**Title:** APIN0224, APIN0225 802.11a/b/g/n/ac  
**To:** FCC 47 CFR Part 15.407 & IC RSS-210  
**Serial #:** ARUB146-U1 Rev A-1  
**Issue Date:** 13th June 2013  
**Page:** 67 of 68

## 6. TEST EQUIPMENT DETAILS

Asset #	Instrument	Manufacturer	Part #	Serial #	Calibration Due Date
0070	Power Meter	Hewlett Packard	437B	3125U11552	28 <sup>th</sup> Nov 13
0117	Power Sensor	Hewlett Packard	8487D	3318A00371	15 <sup>th</sup> Nov 13
0223	Power Meter	Hewlett Packard	EPM-442A	US37480256	15 <sup>th</sup> Nov 13
0374	Power Sensor	Hewlett Packard	8485A	3318A19694	29 <sup>th</sup> Nov 13
0158	Barometer /Thermometer	Control Co.	4196	E2846	8 <sup>th</sup> Dec 13
0193	EMI Receiver	Rhode & Schwartz	ESI 7	838496/007	2 <sup>nd</sup> Dec 13
0287	EMI Receiver	Rhode & Schwartz	ESIB40	100201	16 <sup>th</sup> Nov 13
0338	30 - 3000 MHz Antenna	Sunol	JB3	A052907	8 <sup>th</sup> Nov 13
0335	1-18 GHz Horn Antenna	EMCO	3117	00066580	7 <sup>th</sup> Nov 13
0252	SMA Cable	Megaphase	Sucoflex 104	None	N/A
0293	BNC Cable	Megaphase	1689 1GVT4	15F50B001	N/A
0307	BNC Cable	Megaphase	1689 1GVT4	15F50B002	N/A
0310	2m SMA Cable	Micro-Coax	UFA210A-0-0787-3G03G0	209089-001	N/A
0312	3m SMA Cable	Micro-Coax	UFA210A-1-1181-3G0300	209092-001	N/A
0314	30dB N-Type Attenuator	ARRA	N9444-30	1623	N/A
	EMC Test Software	EMISoft	Vasona	5.0051	N/A
	RF Conducted Test Software	National Instruments	Labview	Version 8.2	N/A
	RF Conducted Test Software	MiCOM Labs ATS		Version 1.5	N/A

This test report may be reproduced in full only. The document may only be updated by MiCOM Labs personnel. Any changes will be noted in the Document History section of the report.



440 Boulder Court, Suite 200  
Pleasanton, CA 94566, USA  
Tel: 1.925.462.0304  
Fax: 1.925.462.0306  
[www.micomlabs.com](http://www.micomlabs.com)