



FCC RF Test Report

APPLICANT : Hewlett Packard Enterprise Company
EQUIPMENT : Wireless Access Point
BRAND NAME : aruba
MODEL NAME : APIN0207
FCC ID : Q9DAPIN0207
STANDARD : FCC Part 15 Subpart C §15.247
CLASSIFICATION : (DTS) Digital Transmission System

The product was received on Apr. 27, 2016 and testing was completed on May 12, 2016. We, SPORTON INTERNATIONAL INC., would like to declare that the tested sample has been evaluated in accordance with the test procedures and has been in compliance with the applicable technical standards.

The test results in this report apply exclusively to the tested model / sample. Without written approval of SPORTON INTERNATIONAL INC., the test report shall not be reproduced except in full.

Reviewed by: Joseph Lin / Supervisor

Approved by: Jones Tsai / Manager



SPORTON INTERNATIONAL INC.

No. 52, Hwa Ya 1st Rd., Hwa Ya Technology Park, Kwei-Shan District, Tao Yuan City, Taiwan, R.O.C.



TABLE OF CONTENTS

SUMMARY OF TEST RESULT 5

1 GENERAL DESCRIPTION..... 6

1.1 Applicant 6

1.2 Manufacturer..... 6

1.3 Product Feature of Equipment Under Test..... 6

1.4 Product Specification of Equipment Under Test..... 6

1.5 Modification of EUT 7

1.6 Specification of Accessory..... 7

1.7 Testing Location 7

1.8 Applicable Standards..... 8

1.9 Test Condition..... 8

2 TEST CONFIGURATION OF EQUIPMENT UNDER TEST..... 9

2.1 Descriptions of Test Mode 9

2.2 Test Mode..... 10

2.3 Connection Diagram of Test System..... 11

2.4 Support Unit used in test configuration and system 13

2.5 EUT Operation Test Setup 13

2.6 Measurement Results Explanation Example..... 13

3 TEST RESULT 15

3.1 6dB and 99% Bandwidth Measurement 15

3.2 Peak Output Power Measurement 20

3.3 Power Spectral Density Measurement 21

3.4 Conducted Band Edges and Spurious Emission Measurement 26

3.5 Radiated Band Edges and Spurious Emission Measurement 35

3.6 AC Conducted Emission Measurement..... 40

3.7 Antenna Requirements 44

4 LIST OF MEASURING EQUIPMENT..... 45

5 UNCERTAINTY OF EVALUATION..... 46

APPENDIX A. CONDUCTED TEST RESULTS

APPENDIX B. RADIATED TEST RESULTS

APPENDIX C. RADIATED SPURIOUS EMISSION PLOTS

APPENDIX D. DUTY CYCLE PLOTS



APPENDIX E. SETUP PHOTOGRAPHS



REVISION HISTORY

REPORT NO.	VERSION	DESCRIPTION	ISSUED DATE
FR671301A	Rev. 01	Initial issue of report	Sep. 09, 2016
FR671301A	Rev. 02	Revising the Normal Voltage for POE in section 1.9	Sep. 23, 2016



SUMMARY OF TEST RESULT

Report Section	FCC Rule	Description	Limit	Result	Remark
3.1	15.247(a)(2)	6dB Bandwidth	$\geq 0.5\text{MHz}$	Pass	-
3.1	-	99% Bandwidth	-	Pass	-
3.2	15.247(b)(1)	Peak Output Power	$\leq 30\text{dBm}$	Pass	-
3.3	15.247(e)	Power Spectral Density	$\leq 8\text{dBm}/3\text{kHz}$	Pass	-
3.4	15.247(d)	Conducted Band Edges and Spurious Emission	$\leq 20\text{dBc}$	Pass	-
3.5	15.247(d)	Radiated Band Edges and Spurious Emission	15.209(a) & 15.247(d)	Pass	Under limit 3.71 dB at 250.050 MHz
3.6	15.207	AC Conducted Emission	15.207(a)	Pass	Under limit 13.10 dB at 0.166 MHz
3.7	15.203 & 15.247(b)	Antenna Requirement	N/A	Pass	-



1 General Description

1.1 Applicant

Hewlett Packard Enterprise Company
3000 Hanover Street, Palo Alto, CA 94304

1.2 Manufacturer

Hewlett Packard Enterprise Company
3000 Hanover Street, Palo Alto, CA 94304

1.3 Product Feature of Equipment Under Test

Product Feature	
Equipment	Wireless Access Point
Brand Name	aruba
Model Name	APIN0207
FCC ID	Q9DAPIN0207
S/N	DX0000039 (for RF Conducted and Radiation) DX0000061 (for Conduction)
EUT supports Radios application	WLAN 11a/b/g/n HT20/HT40 WLAN 11ac VHT20/VHT40/VHT80 Bluetooth v4.0 LE
SW Version	6.5.1.0 build 55812
EUT Stage	Identical Prototype

Remark: The above EUT's information was declared by manufacturer. Please refer to the specifications or user's manual for more detailed description.

1.4 Product Specification of Equipment Under Test

Standards-related Product Specification	
Tx/Rx Frequency Range	2402 MHz ~ 2480 MHz
Number of Channels	40
Carrier Frequency of Each Channel	40 Channel(37 hopping + 3 advertising channel)
Maximum Output Power to Antenna	7.99 dBm (0.0063 W)
99% Occupied Bandwidth	1.054MHz
Antenna Type	PIFA Antenna type with gain 2.20 dBi
Type of Modulation	Bluetooth LE : GFSK



1.5 Modification of EUT

No modifications are made to the EUT during all test items.

1.6 Specification of Accessory

Specification of Accessory				
AC Adapter	Brand Name	CUI INC	Model Name	EMSA120300
	Power Rating	I/P: 100-240Vac, 1A, O/P: 12Vdc, 1.5A		
Power over Ethernet (POE) DC Power	Brand Name	PowerDsine	Model Name	PD-3501G/AC
	Power Rating	I/P: 100-240Vac, 0.43A, O/P: 57Vdc, 600mA		

1.7 Testing Location

Sporton Lab is accredited to ISO 17025 by Taiwan Accreditation Foundation (TAF code : 1190) and the FCC designation No. TW1022 under the FCC 2.948(e) by Mutual Recognition Agreement (MRA) in FCC Test.

Test Site	SPORTON INTERNATIONAL INC.		
Test Site Location	No. 52, Hwa Ya 1 st Rd., Hwa Ya Technology Park, Kwei-Shan District, Tao Yuan City, Taiwan, R.O.C. TEL: +886-3-327-3456 FAX: +886-3-328-4978		
Test Site No.	Sporton Site No.		
	TH02-HY	CO05-HY	03CH06-HY

Note: The test site complies with ANSI C63.4 2014 requirement.



1.8 Applicable Standards

According to the specifications of the manufacturer, the EUT must comply with the requirements of the following standards:

- ♦ FCC Part 15 Subpart C §15.247
- ♦ FCC KDB Publication No. 558074 D01 DTS Meas. Guidance v03r05
- ♦ ANSI C63.10-2013

Remark:

1. All test items were verified and recorded according to the standards and without any deviation during the test.
2. This EUT has also been tested and complied with the requirements of FCC Part 15, Subpart B, recorded in a separate test report.

1.9 Test Condition

Normal Voltage	DC 12V for Adapter DC 57V for POE
Normal Temperature	25°C
Extreme Temperature	0°C and 50°C

Note: The test temperature was between 0°C ~ 50°C by manufacturer requested.



2 Test Configuration of Equipment Under Test

2.1 Descriptions of Test Mode

The RF output power was recorded in the following table:

Channel	Frequency	Bluetooth 4.0 – LE RF Output Power	
		Data Rate / Modulation	
		GFSK	
		1Mbps	
Ch00	2402MHz	7.05 dBm	
Ch19	2440MHz	7.99 dBm	
Ch39	2480MHz	6.99 dBm	

- a. The EUT has been associated with peripherals and configuration operated in a manner tended to maximize its emission characteristics in a typical application. Frequency range investigated: conduction (150 kHz to 30 MHz), radiation (9 kHz to the 10th harmonic of the highest fundamental frequency or to 40 GHz, whichever is lower). Pre-scanned tests, X, Y, Z in three orthogonal panels to determine the final configuration (Y plane as worst plane) from all possible combinations.

- b. AC power line Conducted Emission was tested under maximum output power.



2.2 Test Mode

The following summary table is showing all test modes to demonstrate in compliance with the standard.

Summary table of Test Cases	
Test Item	Data Rate / Modulation
	Bluetooth 4.0 – LE / GFSK
Conducted TCs	Mode 1: Bluetooth Tx CH00_2402 MHz_1Mbps
	Mode 2: Bluetooth Tx CH19_2440 MHz_1Mbps
	Mode 3: Bluetooth Tx CH39_2480 MHz_1Mbps
Radiated TCs	Mode 1: Bluetooth Tx CH00_2402 MHz_1Mbps
	Mode 2: Bluetooth Tx CH19_2440 MHz_1Mbps
	Mode 3: Bluetooth Tx CH39_2480 MHz_1Mbps
AC Conducted Emission	Mode 1: Bluetooth Link + LAN Link + WLAN (2.4GHz) Link + Adapter
	Mode 2: Bluetooth Link + LAN Link + WLAN (2.4GHz) Link + POE Adapter
Remark: The worst case of conducted emission is mode 1; only the test data of it was reported.	

2.3 Connection Diagram of Test System

<Bluetooth 4.0 – LE Tx with Adapter Mode>

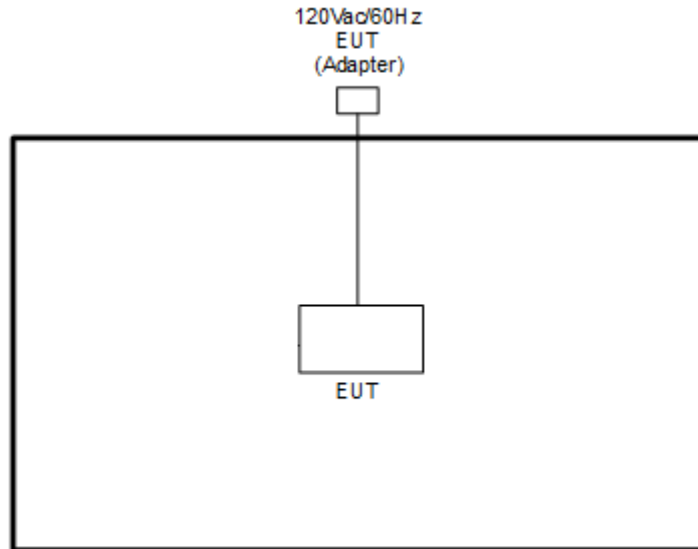

<Bluetooth 4.0 – LE Tx with POE Adapter Mode>

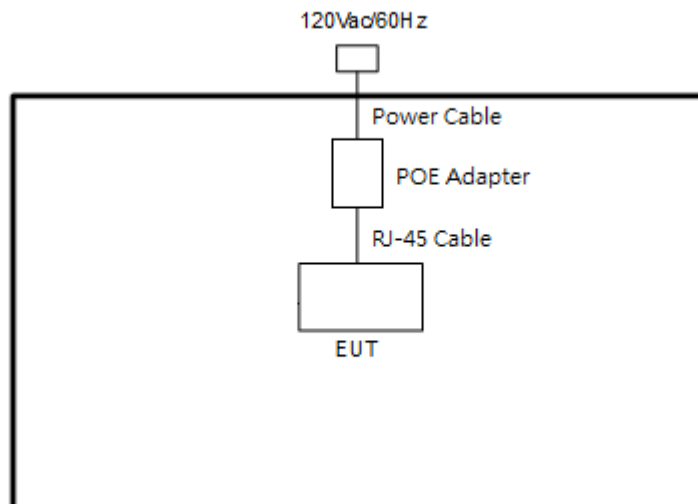

<AC Conducted Emission with Adapter Mode>

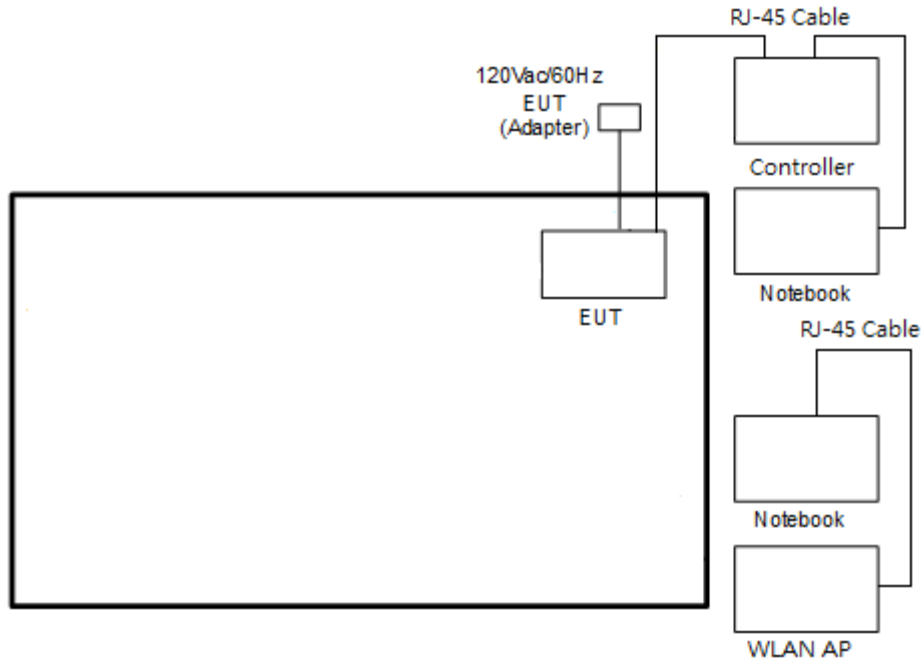

<AC Conducted Emission with POE Adapter Mode>

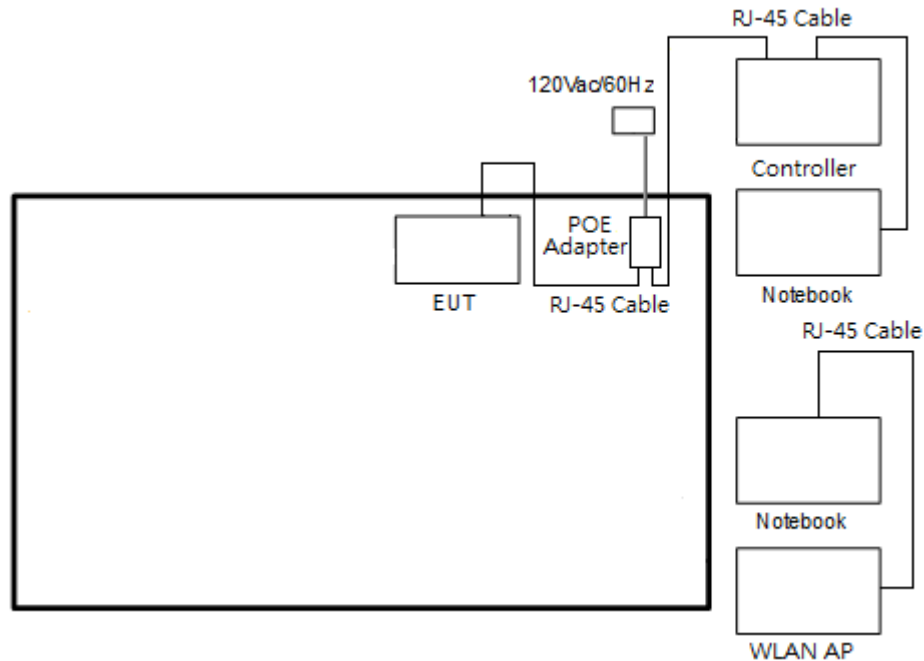

2.4 Support Unit used in test configuration and system

Item	Equipment	Trade Name	Model Name	FCC ID	Data Cable	Power Cord
1.	WLAN AP	ARUBA	RFQ-207	N/A	N/A	Unshielded, 1.6 m
2.	Notebook	DELL	P20G	FCC DoC/ Contains FCC ID: QDS-BRCM1051	N/A	AC I/P: Unshielded, 1.2 m DC O/P: Shielded, 1.8 m
3.	Notebook	DELL	Latitude E6320	FCC DoC/ Contains FCC ID: QDS-BRCM1054	N/A	AC I/P: Unshielded, 1.2 m DC O/P: Shielded, 1.8 m
4.	POE	Microsemi	PD-3501G	FCC DoC	N/A	Unshielded, 1.2 m
5.	Controller	ARUBA	ARCN7030	Verification	N/A	Unshielded, 1.2 m

2.5 EUT Operation Test Setup

For Bluetooth function, programmed RF utility, “Command prompt” installed in the notebook make the EUT provide functions like channel selection and power level for continuous transmitting and receiving signals.

2.6 Measurement Results Explanation Example

For all conducted test items:

The offset level is set in the spectrum analyzer to compensate the RF cable loss and attenuator factor between EUT conducted output port and spectrum analyzer. With the offset compensation, the spectrum analyzer reading level is exactly the EUT RF output level.

Example :

The spectrum analyzer offset is derived from RF cable loss and attenuator factor.

Offset = RF cable loss + attenuator factor.

Following shows an offset computation example with cable loss 4.2 dB and 10dB attenuator.

$$\begin{aligned}
 \text{Offset(dB)} &= \text{RF cable loss(dB)} + \text{attenuator factor(dB)}. \\
 &= 4.2 + 10 = 14.2 \text{ (dB)}
 \end{aligned}$$



3 Test Result

3.1 6dB and 99% Bandwidth Measurement

3.1.1 Limit of 6dB and 99% Bandwidth

The minimum 6 dB bandwidth shall be at least 500 kHz.

3.1.2 Measuring Instruments

The section 4.0 of List of Measuring Equipment of this test report is used for test.

3.1.3 Test Procedures

1. The testing follows FCC KDB Publication No. 558074 D01 DTS Meas. Guidance v03r05.
2. The RF output of EUT was connected to the spectrum analyzer by RF cable and attenuator. The path loss was compensated to the results for each measurement.
3. Set to the maximum power setting and enable the EUT transmit continuously.
4. Make the measurement with the spectrum analyzer's resolution bandwidth (RBW) = 100 kHz. Set the Video bandwidth (VBW) = 300 kHz. In order to make an accurate measurement. The 6 dB bandwidth must be greater than 500 kHz.
5. For 99% Bandwidth Measurement, the spectrum analyzer's resolution bandwidth (RBW) is set 30kHz and set the Video bandwidth (VBW) = 100kHz.
6. Measure and record the results in the test report.

3.1.4 Test Setup

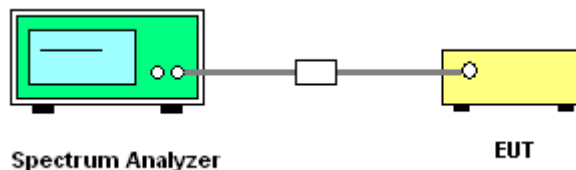



3.1.5 Test Result of 6dB Bandwidth

Test data refer to Appendix A.

6 dB Bandwidth Plot on Channel 00

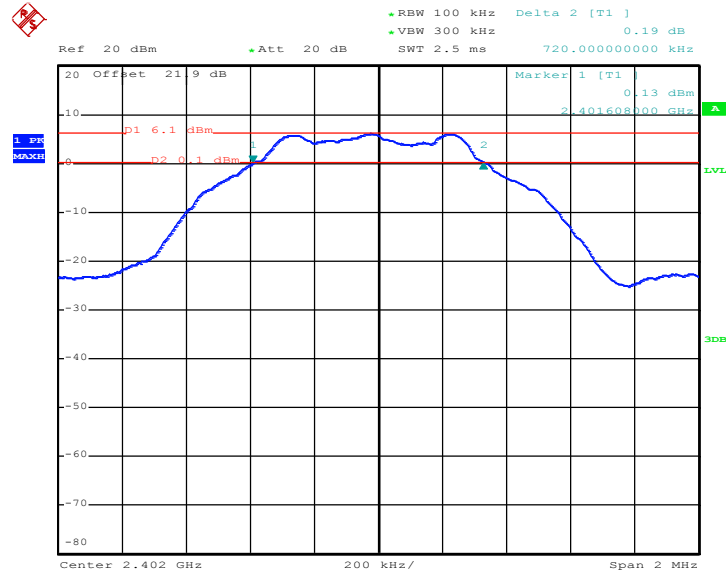

Date: 29.APR.2016 05:04:56



6 dB Bandwidth Plot on Channel 19

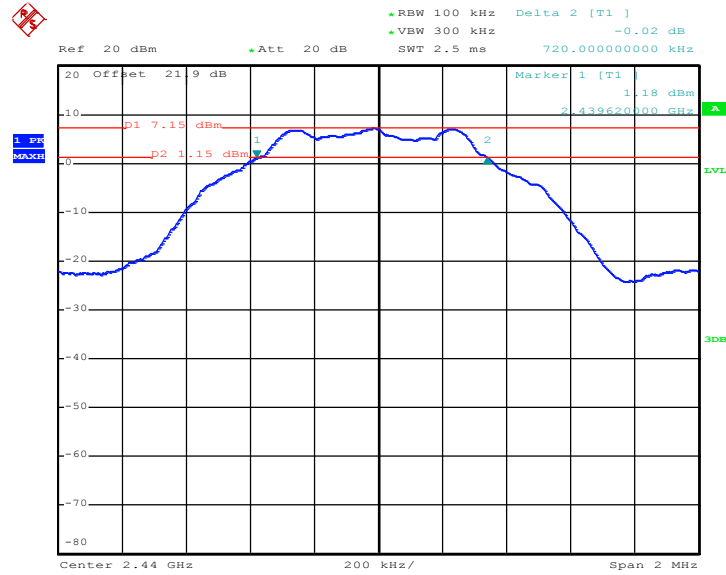

Date: 29.APR.2016 04:56:30

6 dB Bandwidth Plot on Channel 39

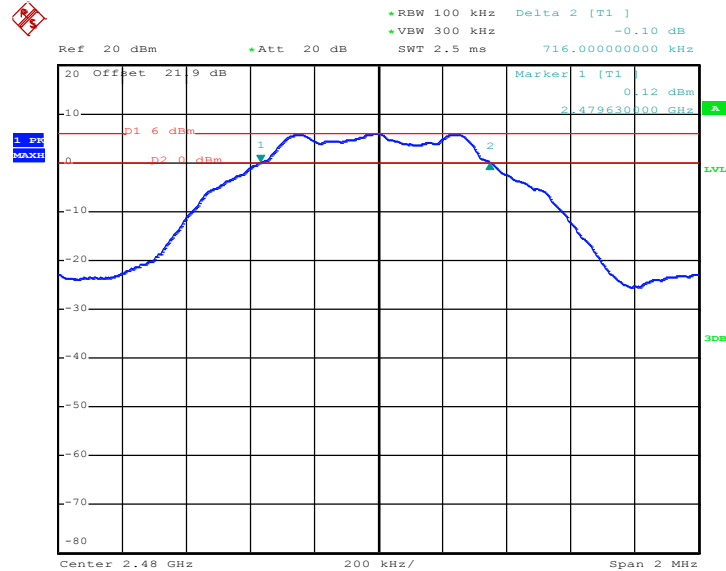

Date: 29.APR.2016 05:15:43



3.1.6 Test Result of 99% Occupied Bandwidth

Test data refer to Appendix A.

99% Bandwidth Plot on Channel 00

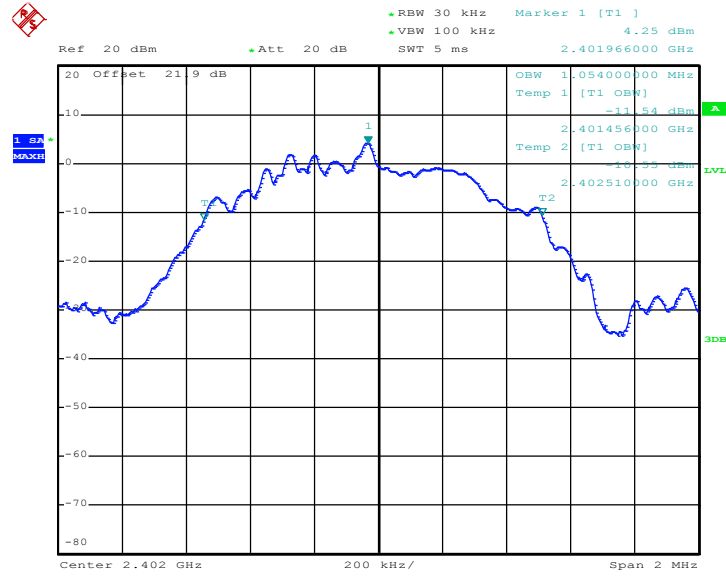

Date: 29.APR.2016 05:09:05



99% Occupied Bandwidth Plot on Channel 19

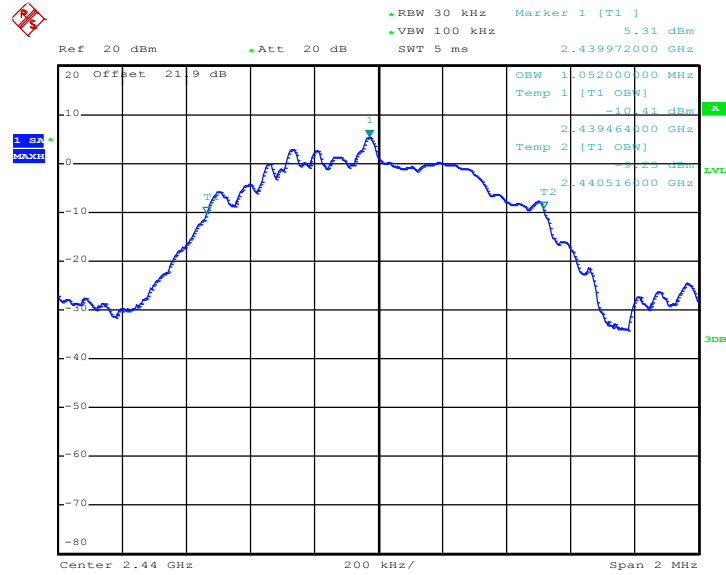

Date: 29.APR.2016 04:59:42

99% Occupied Bandwidth Plot on Channel 39

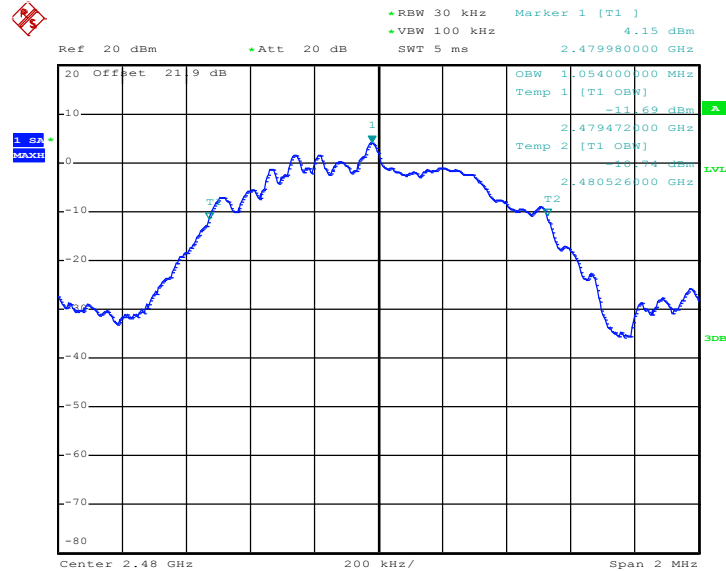

Date: 29.APR.2016 05:24:43

Note : The occupied channel bandwidth is maintained within the band of operation for all of the modulations.

3.2 Peak Output Power Measurement

3.2.1 Limit of Peak Output Power

For systems using digital modulation in the 2400-2483.5MHz, the limit for peak output power is 30dBm. If transmitting antenna of directional gain greater than 6dBi is used, the peak output power from the intentional radiator shall be reduced below the above stated value by the amount in dB that the directional gain of the antenna exceeds 6 dBi. In case of point-to-point operation, the limit has to be reduced by 1dB for every 3dB that the directional gain of the antenna exceeds 6dBi.

3.2.2 Measuring Instruments

The section 4.0 of List of Measuring Equipment of this test report is used for test.

3.2.3 Test Procedures

1. The testing follows the Measurement Procedure of FCC KDB No. 558074 DTS D01 Meas. Guidance v03r05 section 9.1.2 PKPM1 Peak power meter method.
2. The RF output of EUT was connected to the power meter by RF cable and attenuator. The path loss was compensated to the results for each measurement.
3. Set to the maximum power setting and enable the EUT transmit continuously.
4. Measure the conducted output power and record the results in the test report.

3.2.4 Test Setup

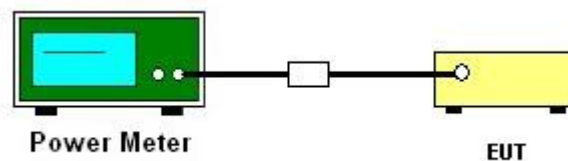

3.2.5 Test Result of Peak Output Power

Test data refers to Appendix A.

3.3 Power Spectral Density Measurement

3.3.1 Limit of Power Spectral Density

The peak power spectral density shall not be greater than 8dBm in any 3kHz band at any time interval of continuous transmission.

3.3.2 Measuring Instruments

The section 4.0 of List of Measuring Equipment of this test report is used for test.

3.3.3 Test Procedures

1. The testing follows Measurement Procedure 10.2 Method PKPSD of FCC KDB Publication No. 558074 D01 DTS Meas. Guidance v03r05
2. The RF output of EUT was connected to the spectrum analyzer by RF cable and attenuator. The path loss was compensated to the results for each measurement.
3. Set to the maximum power setting and enable the EUT transmit continuously.
4. Make the measurement with the spectrum analyzer's resolution bandwidth (RBW) = 3 kHz. Video bandwidth VBW = 10 kHz In order to make an accurate measurement, set the span to 1.5 times DTS Channel Bandwidth. (6dB BW)
5. Detector = peak, Sweep time = auto couple, Trace mode = max hold, Allow trace to fully stabilize. Use the peak marker function to determine the maximum power level.
6. Measure and record the results in the test report.
7. The Measured power density (dBm)/ 100kHz is a reference level and used as 20dBc down limit line for Conducted Band Edges and Conducted Spurious Emission.

3.3.4 Test Setup

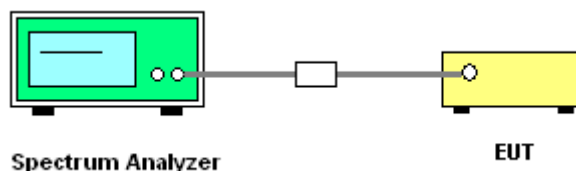



3.3.5 Test Result of Power Spectral Density

Test data refers to Appendix A.

3.3.6 Test Result of Power Spectral Density Plots (100kHz)

PSD 100kHz Plot on Channel 00

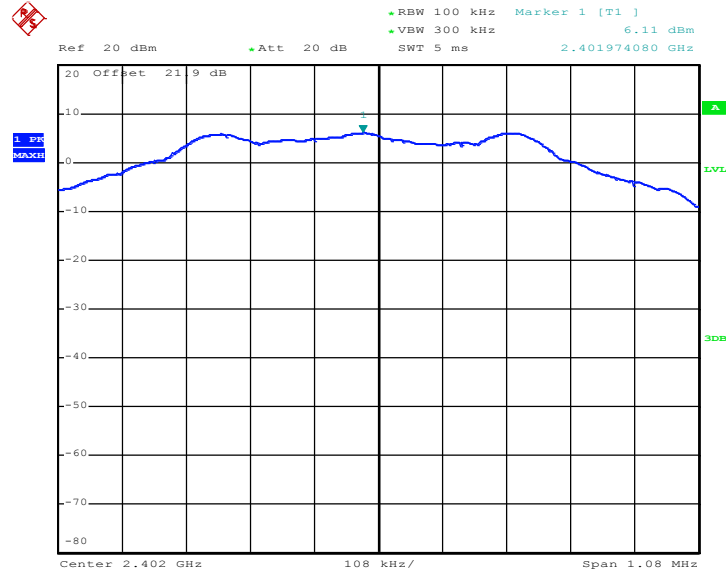

Date: 29.APR.2016 05:05:41



PSD 100kHz Plot on Channel 19

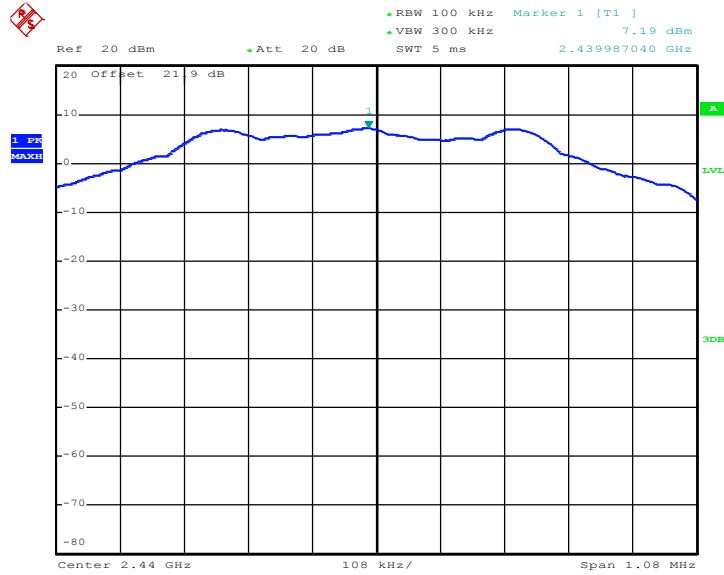

Date: 29.APR.2016 04:57:35

PSD 100kHz Plot on Channel 39

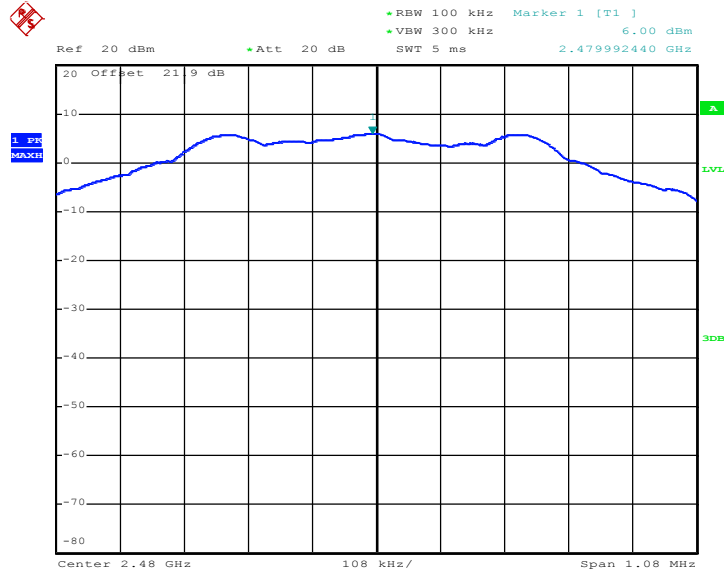

Date: 29.APR.2016 05:17:07



3.3.7 Test Result of Power Spectral Density Plots (3kHz)

PSD 3kHz Plot on Channel 00

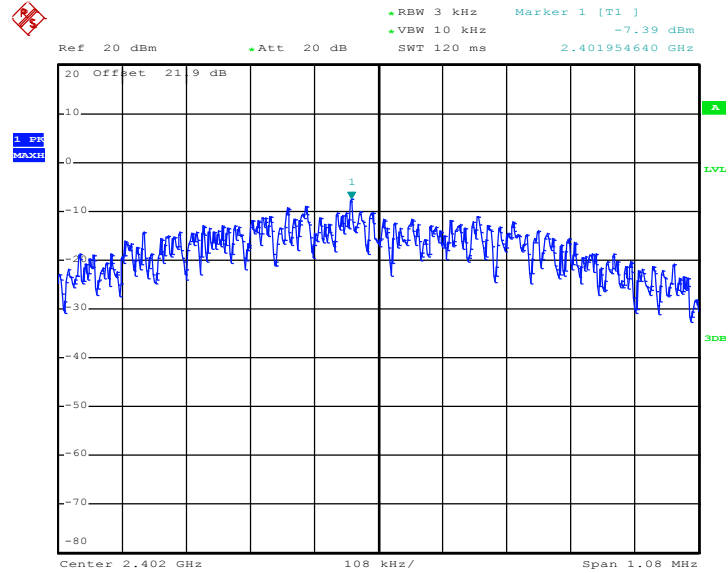

Date: 29.APR.2016 05:05:22



PSD 3kHz Plot on Channel 19

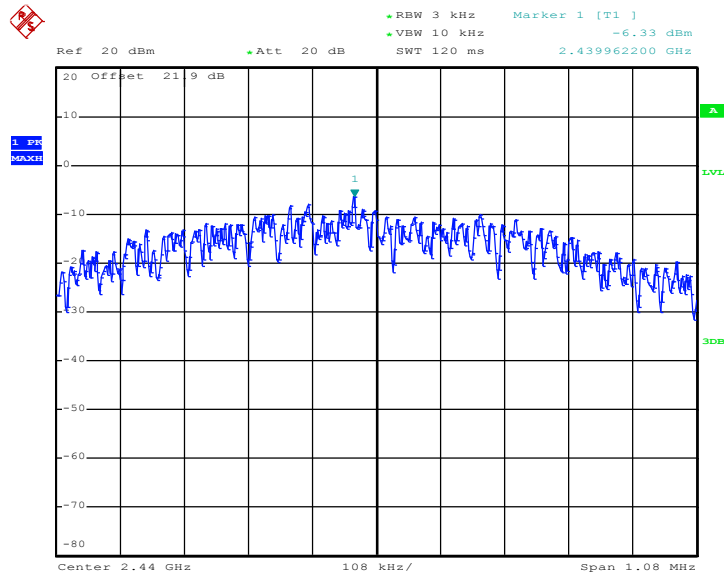

Date: 29.APR.2016 04:57:00

PSD 3kHz Plot on Channel 39

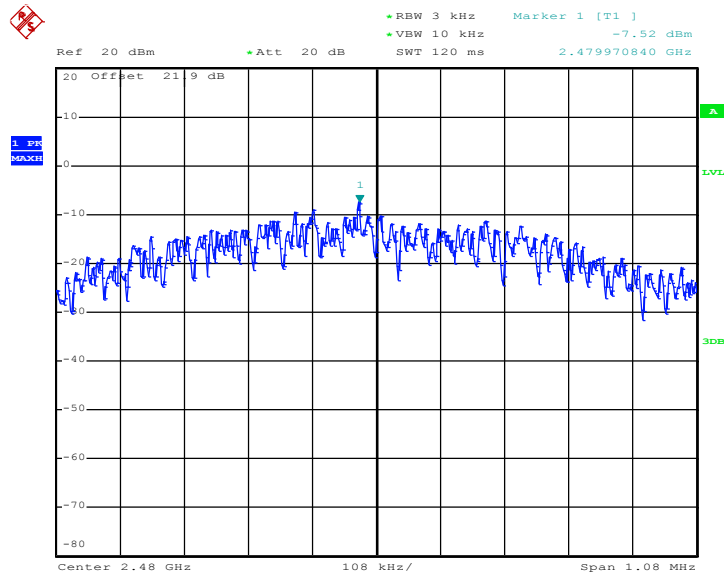

Date: 29.APR.2016 05:16:22

3.4 Conducted Band Edges and Spurious Emission Measurement

3.4.1 Limit of Conducted Band Edges and Spurious Emission

All harmonics/spurious must be at least 20 dB down from the highest emission level within the authorized band.

3.4.2 Measuring Instruments

The section 4.0 of List of Measuring Equipment of this test report is used for test.

3.4.3 Test Procedure

1. The testing follows FCC KDB Publication No. 558074 D01 DTS Meas. Guidance v03r05.
2. The RF output of EUT was connected to the spectrum analyzer by RF cable and attenuator. The path loss was compensated to the results for each measurement.
3. Set to the maximum power setting and enable the EUT transmit continuously.
4. Set RBW = 100 kHz, VBW=300 kHz, Peak Detector. Unwanted Emissions measured in any 100 kHz bandwidth outside of the authorized frequency band shall be attenuated by at least 20 dB relative to the maximum in-band peak PSD level in 100 kHz when maximum peak conducted output power procedure is used. If the transmitter complies with the conducted power limits based on the use of RMS averaging over a time interval, the attenuation required under this paragraph shall be 30 dB instead of 20 dB per 15.247(d).
5. Measure and record the results in the test report.
6. The RF fundamental frequency should be excluded against the limit line in the operating frequency band.

3.4.4 Test Setup

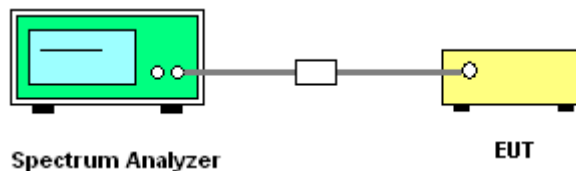



3.4.5 Test Result of Conducted Band Edges Plots

Low Band Edge Plot on Channel 00

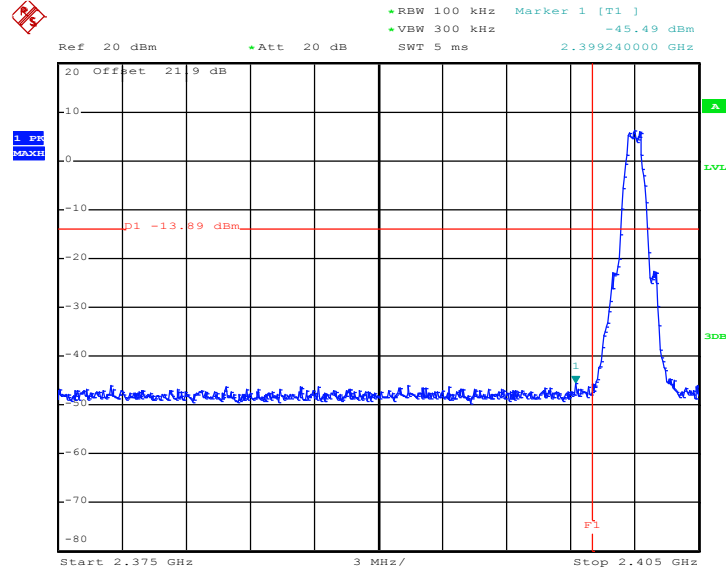

Date: 29.APR.2016 05:12:44



High Band Edge Plot on Channel 39

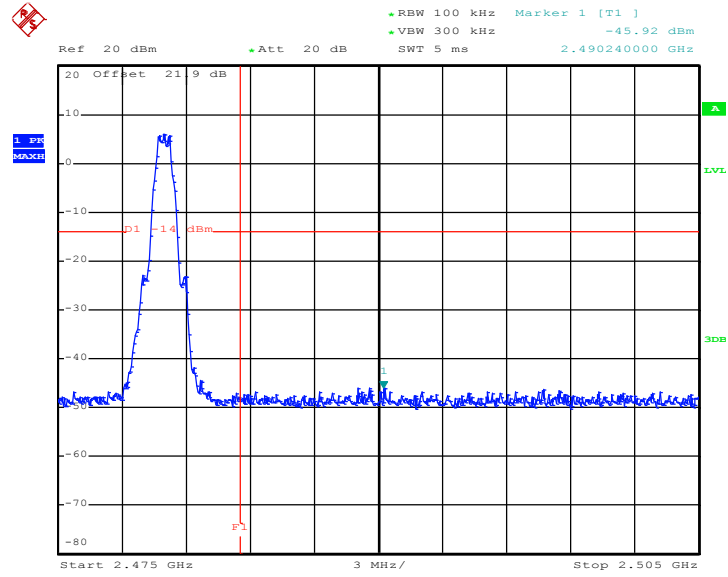

Date: 29.APR.2016 05:19:32



3.4.6 Test Result of Conducted Spurious Emission Plots

Conducted Spurious Emission Plot on Bluetooth LE 1Mbps GFSK Channel 00

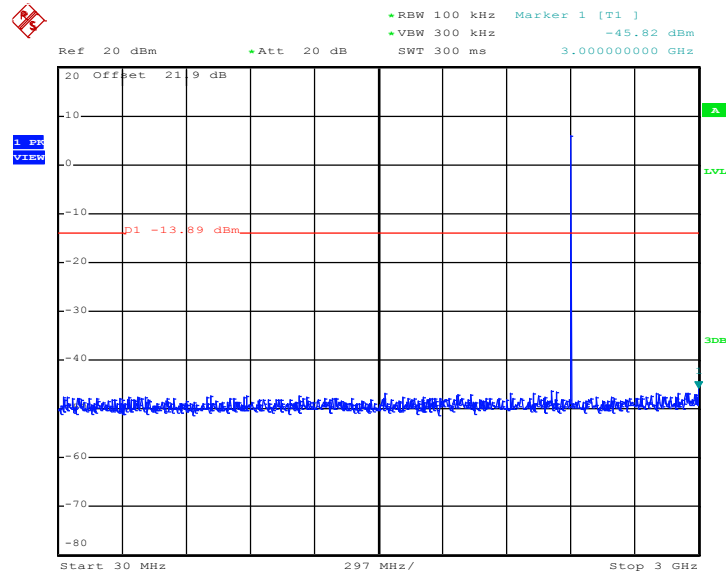

Date: 29.APR.2016 05:08:02



Conducted Spurious Emission Plot on Bluetooth LE 1Mbps
GFSK Channel 00

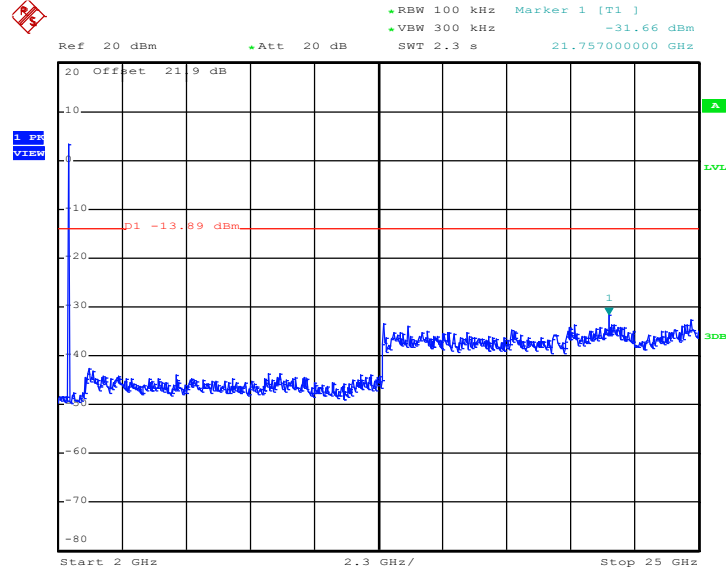

Date: 29.APR.2016 05:08:10



Conducted Spurious Emission Plot on Bluetooth LE 1Mbps
GFSK Channel 19

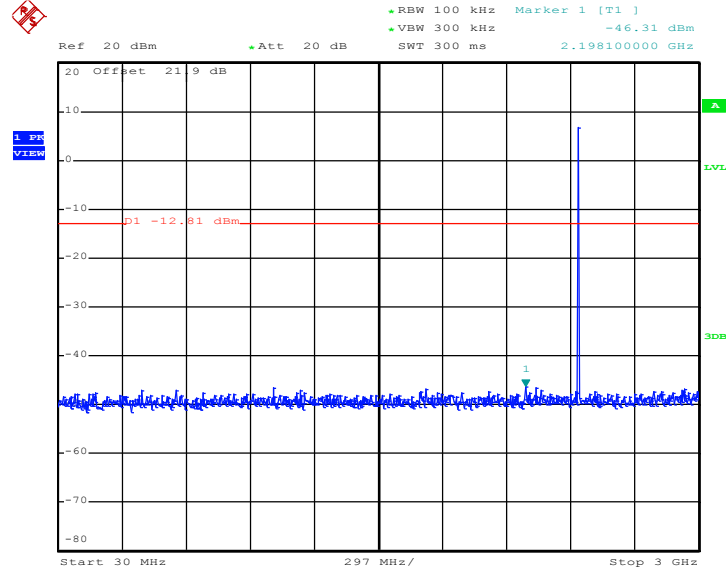

Date: 29.APR.2016 04:58:49



Conducted Spurious Emission Plot on Bluetooth LE 1Mbps GFSK Channel 19

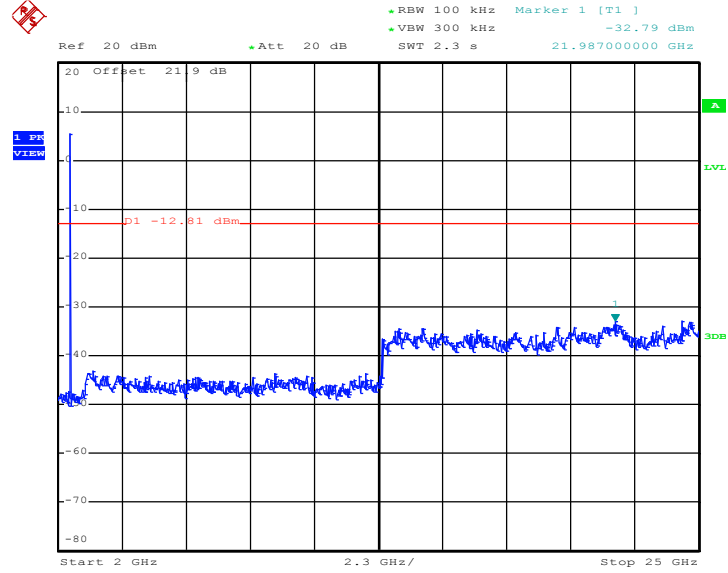

Date: 29.APR.2016 04:58:58



Conducted Spurious Emission Plot on Bluetooth LE 1Mbps
GFSK Channel 39

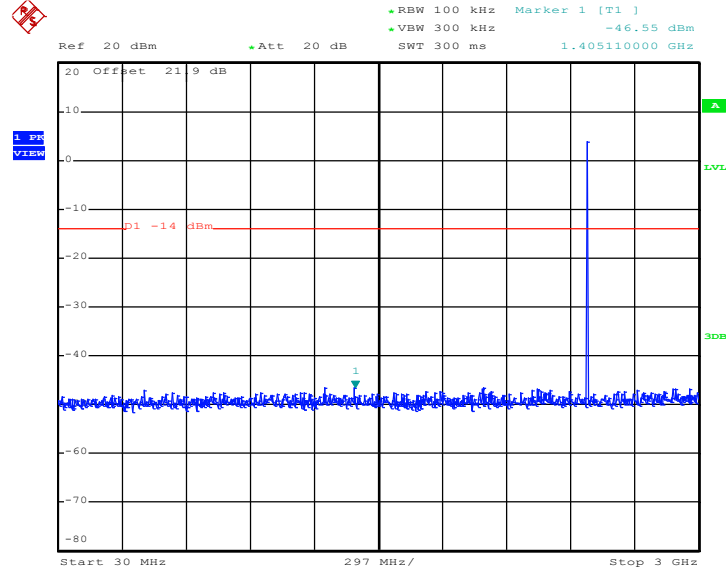

Date: 29.APR.2016 05:23:46



Conducted Spurious Emission Plot on Bluetooth LE 1Mbps
GFSK Channel 39

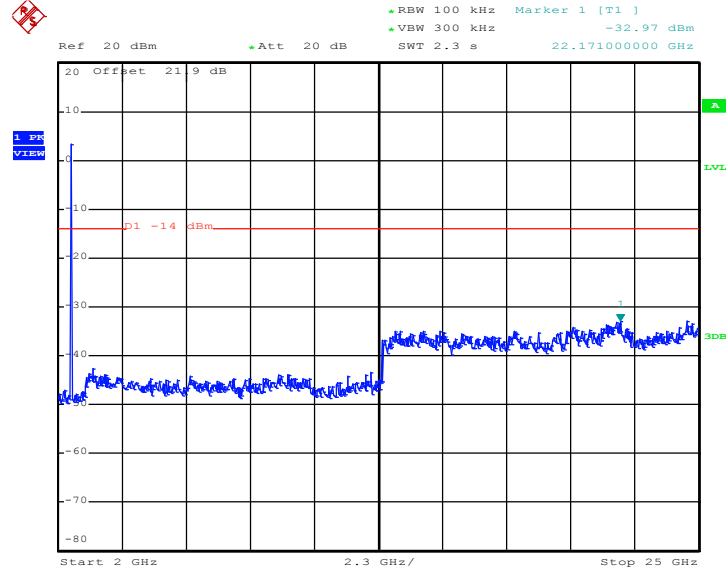

Date: 29.APR.2016 05:23:54



3.5 Radiated Band Edges and Spurious Emission Measurement

3.5.1 Limit of Radiated Band Edges and Spurious Emission

In any 100 kHz bandwidth outside the intentional radiator frequency band, all harmonics/spurious must be at least 20 dB below the highest emission level within the authorized band. If the output power of this device was measured by spectrum analyzer, the attenuation under this paragraph shall be 30 dB instead of 20 dB. In addition, radiated emissions which fall in the restricted bands must also comply with the FCC section 15.209 limits as below.

Frequency (MHz)	Field Strength (microvolts/meter)	Measurement Distance (meters)
0.009 – 0.490	2400/F(kHz)	300
0.490 – 1.705	24000/F(kHz)	30
1.705 – 30.0	30	30
30 – 88	100	3
88 – 216	150	3
216 - 960	200	3
Above 960	500	3

3.5.2 Measuring Instruments

The section 4.0 of List of Measuring Equipment of this test report is used for test.



3.5.3 Test Procedures

1. The testing follows FCC KDB Publication No. 558074 D01 DTS Meas. Guidance v03r05.
2. The EUT was arranged to its worst case and then tune the antenna tower (from 1 m to 4 m) and turntable (from 0 degree to 360 degrees) to find the maximum reading. A pre-amp and a high pass filter are used for the test in order to get better signal level.
3. The EUT was placed on a turntable with 0.8 meter for frequency below 1GHz and 1.5 meter for frequency above 1GHz respectively above ground.
4. The EUT was set 3 meters from the interference receiving antenna, which was mounted on the top of a variable height antenna tower.
5. Corrected Reading: Antenna Factor + Cable Loss + Read Level - Preamp Factor = Level
6. For measurement below 1GHz, If the emission level of the EUT measured by the peak detector is 3 dB lower than the applicable limit, the peak emission level will be reported. Otherwise, the emission measurement will be repeated using the quasi-peak detector and reported.
7. Use the following spectrum analyzer settings:
 - (1) Span shall wide enough to fully capture the emission being measured;
 - (2) Set RBW=100 kHz for $f < 1$ GHz; $VBW \geq RBW$; Sweep = auto; Detector function = peak; Trace = max hold;
 - (3) Set RBW = 1 MHz, VBW= 3MHz for $f \geq 1$ GHz for peak measurement.
For average measurement:
 - $VBW = 10$ Hz, when duty cycle is no less than 98 percent.
 - $VBW \geq 1/T$, when duty cycle is less than 98 percent where T is the minimum transmission duration over which the transmitter is on and is transmitting at its maximum power control level for the tested mode of operation.

3.5.4 Test Setup

For radiated emissions below 30MHz

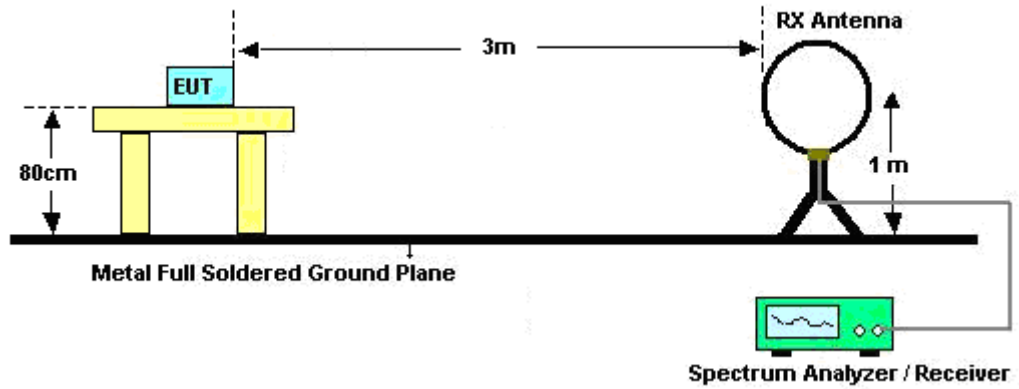

For radiated emissions from 30MHz to 1GHz

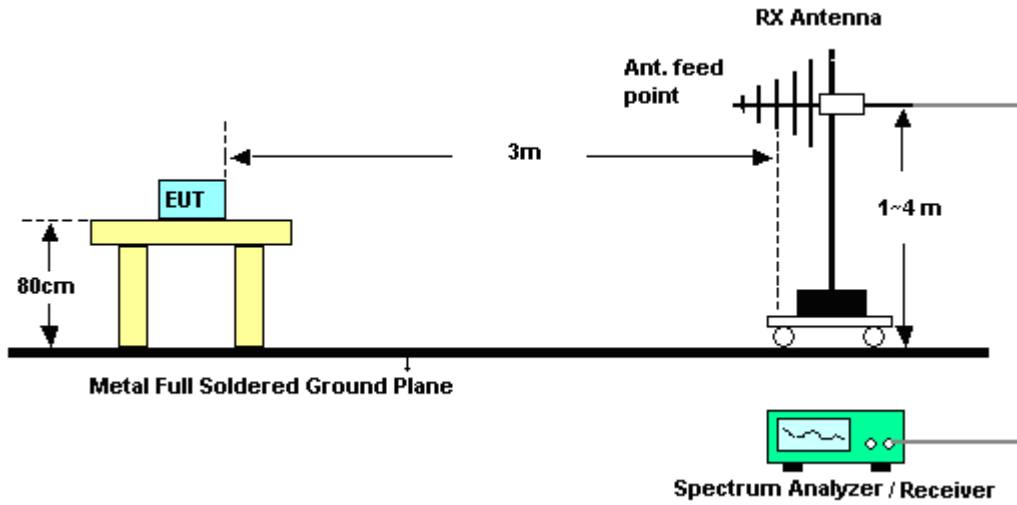

For radiated emissions above 1GHz

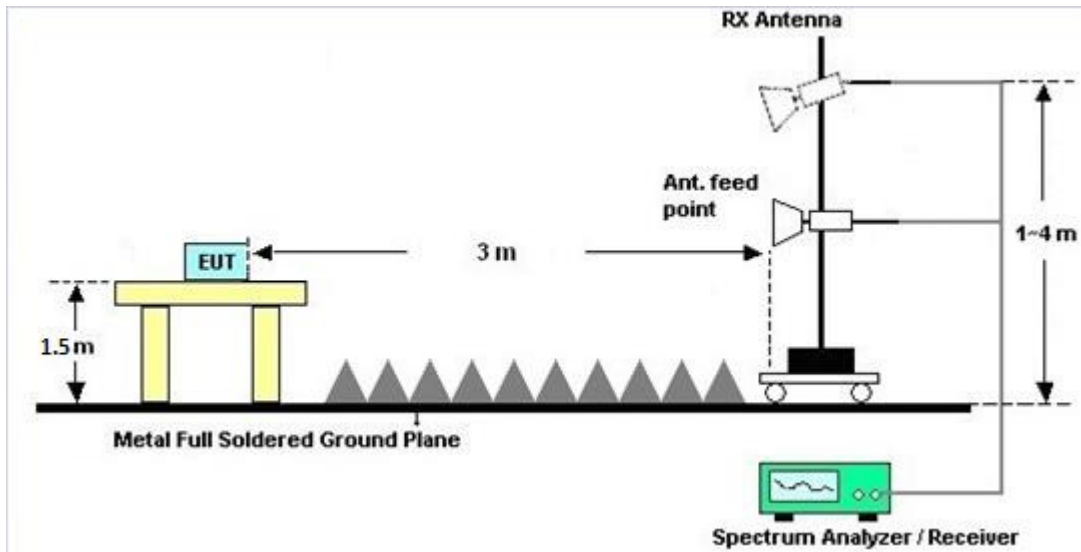

3.5.5 Test Results of Radiated Spurious Emissions (9 kHz ~ 30 MHz)

The low frequency, which started from 9 kHz to 30MHz, was pre-scanned and the result which was 20dB lower than the limit line per 15.31(o) was not reported.



3.5.6 Test Result of Radiated Spurious at Band Edges

Please refer to Appendix B and C.

3.5.7 Duty Cycle

Please refer to Appendix D.

3.5.8 Test Result of Radiated Spurious Emission (30MHz ~ 10th Harmonic)

Please refer to Appendix B and C.



3.6 AC Conducted Emission Measurement

3.6.1 Limit of AC Conducted Emission

For equipment that is designed to be connected to the public utility (AC) power line, the radio frequency voltage that is conducted back onto the AC power line on any frequency or frequencies within the band 150 kHz to 30 MHz shall not exceed the limits in the following table.

Frequency of emission (MHz)	Conducted limit (dB μ V)	
	Quasi-peak	Average
0.15-0.5	66 to 56*	56 to 46*
0.5-5	56	46
5-30	60	50

*Decreases with the logarithm of the frequency.

3.6.2 Measuring Instruments

The section 4.0 of List of Measuring Equipment of this test report is used for test.

3.6.3 Test Procedures

1. The EUT was placed 0.4 meter from the conducting wall of the shielding room was kept at least 80 centimeters from any other grounded conducting surface.
2. Connect EUT to the power mains through a line impedance stabilization network (LISN).
3. All the support units are connecting to the other LISN.
4. The LISN provides 50 ohm coupling impedance for the measuring instrument.
5. The FCC states that a 50 ohm, 50 microhenry LISN should be used.
6. Both sides of AC line were checked for maximum conducted interference.
7. The frequency range from 150 kHz to 30 MHz was searched.
8. Set the test-receiver system to Peak Detect Function and specified bandwidth (IF Bandwidth = 9kHz) with Maximum Hold Mode. Then measurement is also conducted by Average Detector and Quasi-Peak Detector Function respectively.

3.6.4 Test Setup

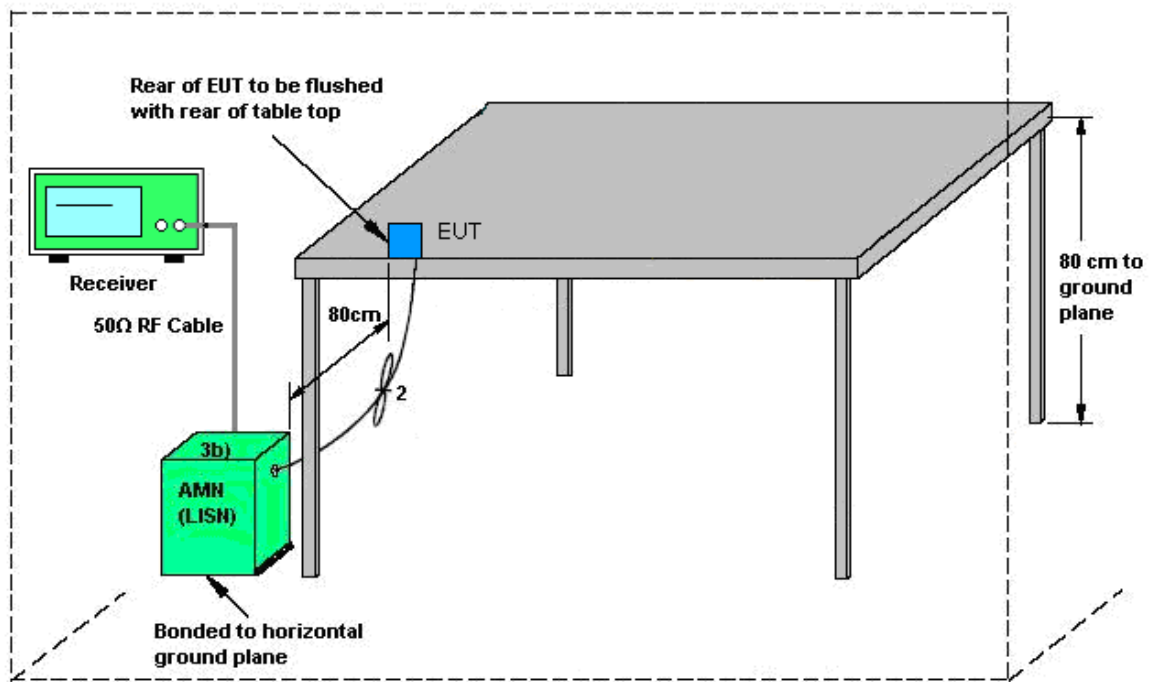

AMN = Artificial mains network (LISN)
AE = Associated equipment
EUT = Equipment under test
ISN = Impedance stabilization network



3.6.5 Test Result of AC Conducted Emission

Test Mode :	Mode 1	Temperature :	21~22°C
Test Engineer :	Derreck Chen	Relative Humidity :	51~52%
Test Voltage :	120Vac / 60Hz	Phase :	Line
Function Type :	Bluetooth Link + LAN Link + WLAN (2.4GHz) Link + Adapter		

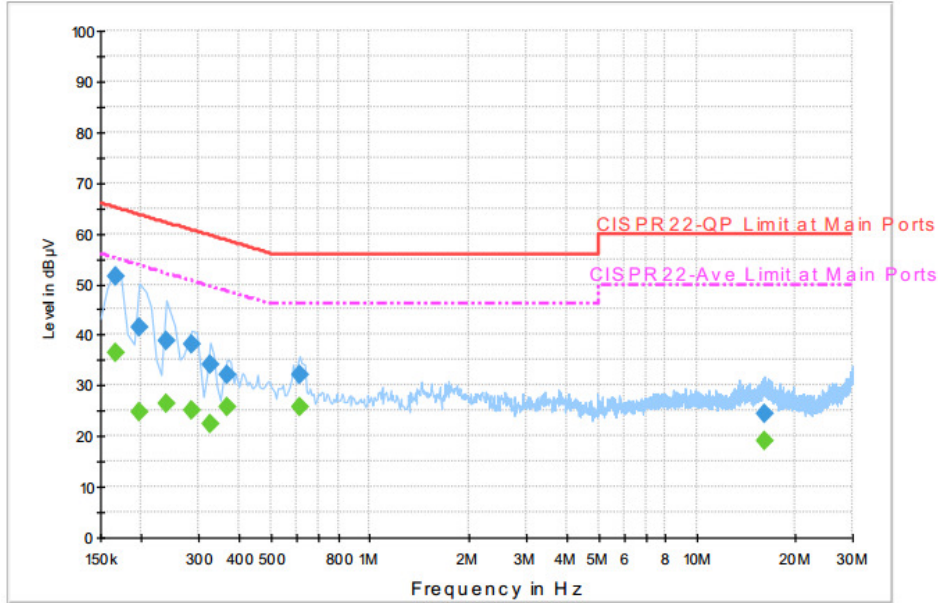

Final Result : Quasi-Peak

Frequency (MHz)	Quasi-Peak (dBµV)	Filter	Line	Corr. (dB)	Margin (dB)	Limit (dBµV)
0.166000	52.1	Off	L1	19.6	13.1	65.2
0.198000	41.4	Off	L1	19.6	22.3	63.7
0.238000	38.9	Off	L1	19.6	23.3	62.2
0.286000	38.1	Off	L1	19.6	22.5	60.6
0.326000	34.1	Off	L1	19.6	25.5	59.6
0.366000	32.0	Off	L1	19.6	26.6	58.6
0.614000	32.0	Off	L1	19.6	24.0	56.0
16.238000	24.5	Off	L1	19.8	35.5	60.0

Final Result : Average

Frequency (MHz)	Average (dBµV)	Filter	Line	Corr. (dB)	Margin (dB)	Limit (dBµV)
0.166000	36.5	Off	L1	19.6	18.7	55.2
0.198000	24.8	Off	L1	19.6	28.9	53.7
0.238000	26.3	Off	L1	19.6	25.9	52.2
0.286000	24.9	Off	L1	19.6	25.7	50.6
0.326000	22.5	Off	L1	19.6	27.1	49.6
0.366000	25.8	Off	L1	19.6	22.8	48.6
0.614000	25.7	Off	L1	19.6	20.3	46.0
16.238000	18.9	Off	L1	19.8	31.1	50.0



Test Mode :	Mode 1	Temperature :	21~22°C
Test Engineer :	Derreck Chen	Relative Humidity :	51~52%
Test Voltage :	120Vac / 60Hz	Phase :	Neutral
Function Type :	Bluetooth Link + LAN Link + WLAN (2.4GHz) Link + Adapter		

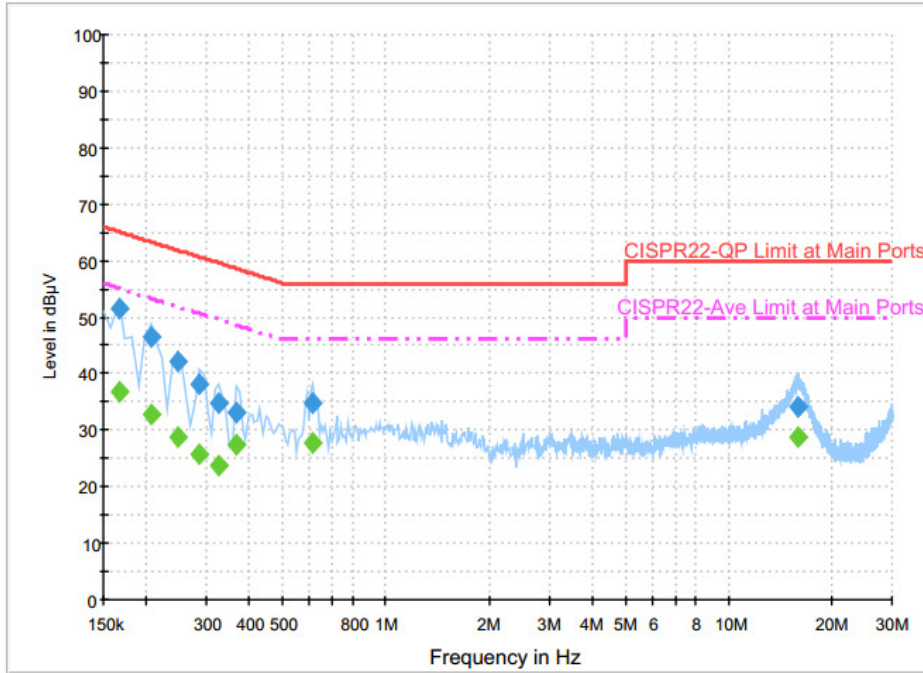

Final Result : Quasi-Peak

Frequency (MHz)	Quasi-Peak (dBµV)	Filter	Line	Corr. (dB)	Margin (dB)	Limit (dBµV)
0.166000	51.7	Off	N	19.6	13.5	65.2
0.206000	46.4	Off	N	19.6	17.0	63.4
0.246000	42.0	Off	N	19.6	19.9	61.9
0.286000	38.1	Off	N	19.6	22.5	60.6
0.326000	34.8	Off	N	19.6	24.8	59.6
0.366000	33.1	Off	N	19.6	25.5	58.6
0.614000	34.8	Off	N	19.6	21.2	56.0
15.958000	34.1	Off	N	19.9	25.9	60.0

Final Result : Average

Frequency (MHz)	Average (dBµV)	Filter	Line	Corr. (dB)	Margin (dB)	Limit (dBµV)
0.166000	36.9	Off	N	19.6	18.3	55.2
0.206000	32.6	Off	N	19.6	20.8	53.4
0.246000	28.8	Off	N	19.6	23.1	51.9
0.286000	25.6	Off	N	19.6	25.0	50.6
0.326000	23.6	Off	N	19.6	26.0	49.6
0.366000	27.4	Off	N	19.6	21.2	48.6
0.614000	27.8	Off	N	19.6	18.2	46.0
15.958000	28.9	Off	N	19.9	21.1	50.0



3.7 Antenna Requirements

3.7.1 Standard Applicable

If directional gain of transmitting antennas is greater than 6dBi, the power shall be reduced by the same level in dB comparing to gain minus 6dBi. The use of a permanently attached antenna or of an antenna that uses a unique coupling to the intentional radiator shall be considered sufficient to comply with the FCC rule.

3.7.2 Antenna Anti-Replacement Construction

Non-standard antenna connector is used.

3.7.3 Antenna Gain

The antenna peak gain of EUT is less than 6 dBi. Therefore, it is not necessary to reduce maximum peak output power limit.



4 List of Measuring Equipment

Instrument	Manufacturer	Model No.	Serial No.	Characteristics	Calibration Date	Test Date	Due Date	Remark
Power Meter	Agilent	E4416A	GB412923 44	300MHz~40GHz	Jan. 08, 2016	Apr. 29, 2016	Jan. 07, 2017	Conducted (TH02-HY)
Power Sensor	Agilent	E9327A	US404415 48	300MHz~40GHz	Jan. 07, 2016	Apr. 29, 2016	Jan. 06, 2017	Conducted (TH02-HY)
Spectrum Analyzer	Rohde & Schwarz	FSP40	100055	9kHz~40GHz	Jun. 18, 2015	Apr. 29, 2016	Jun. 17, 2016	Conducted (TH02-HY)
AC Power Source	ChainTek	APC-1000W	N/A	N/A	N/A	Apr. 27, 2016	N/A	Conduction (CO05-HY)
EMI Test Receiver	Rohde & Schwarz	ESCI 7	100724	9kHz~7GHz	Aug. 26, 2015	Apr. 27, 2016	Aug. 25, 2016	Conduction (CO05-HY)
LISN	Rohde & Schwarz	ENV216	100080	9kHz~30MHz	Dec. 02, 2015	Apr. 27, 2016	Dec. 01, 2016	Conduction (CO05-HY)
LF Cable	HUBER + SUHNER	RG-214/U	LF01	N/A	Jan. 06, 2016	Apr. 27, 2016	Jan. 05, 2017	Conduction (CO05-HY)
Pulse Limiter	Rohde & Schwarz	ESH3-Z2	100851	N/A	Jan. 08, 2016	Apr. 27, 2016	Jan. 07, 2017	Conduction (CO05-HY)
Bilog Antenna	Schaffner	CBL6111C	2725	30MHz~1GHz	Nov. 17, 2015	May 12, 2016	Nov. 16, 2016	Radiation (03CH06-HY)
Horn Antenna	SCHWARZBECK	BBHA 9120 D	9120D-115 6	1GHz~18GHz	Aug. 21, 2015	May 12, 2016	Aug. 20, 2016	Radiation (03CH06-HY)
EMI Test Receiver	Rohde & Schwarz	ESU26	100472	20Hz~26.5GHz	Jan. 07, 2016	May 12, 2016	Jan. 06, 2017	Radiation (03CH06-HY)
Preamplifier	MITEQ	AMF-7D-0010 1800-30-10P	1850117	1GHz ~ 18GHz	Jul. 01, 2015	May 12, 2016	Jun. 30, 2016	Radiation (03CH06-HY)
Preamplifier	SONOMA	310N	186713	9kHz~1GHz	Apr. 19, 2016	May 12, 2016	Apr. 18, 2017	Radiation (03CH06-HY)
Preamplifier	Agilent	8449B	3008A019 17	1GHz~26.5GHz	Apr. 18, 2016	May 12, 2016	Apr. 17, 2017	Radiation (03CH06-HY)
Controller	INN-CO	EM1000	060782	Control Turn table & Ant Mast	N/A	May 12, 2016	N/A	Radiation (03CH06-HY)
Antenna Mast	MF	MF-7802	MF780208 212	1m~4m	N/A	May 12, 2016	N/A	Radiation (03CH06-HY)
Turn Table	INN-CO	DS2000	420/650/00	0-360 degree	N/A	May 12, 2016	N/A	Radiation (03CH06-HY)



5 Uncertainty of Evaluation

Uncertainty of Conducted Emission Measurement (150 kHz ~ 30 MHz)

Measuring Uncertainty for a Level of Confidence of 95% ($U = 2Uc(y)$)	2.26
---	------

Uncertainty of Radiated Emission Measurement (30 MHz ~ 1000 MHz)

Measuring Uncertainty for a Level of Confidence of 95% ($U = 2Uc(y)$)	4.00
---	------



Appendix A. Conducted Test Results

Bluetooth Low Energy

Test Engineer:	Osolemio Chang	Temperature:	21~25	°C
Test Date:	2016/4/29	Relative Humidity:	51~54	%

TEST RESULTS DATA
6dB and 99% Occupied Bandwidth

Mod.	Data Rate	NTX	CH.	Freq. (MHz)	99% Occupied BW (MHz)	6dB BW (MHz)	6dB BW Limit (MHz)	Pass/Fail
BLE	1Mbps	1	0	2402	1.05	0.72	0.50	Pass
BLE	1Mbps	1	19	2440	1.05	0.72	0.50	Pass
BLE	1Mbps	1	39	2480	1.05	0.72	0.50	Pass

TEST RESULTS DATA
Peak Power Table

Mod.	Data Rate	NTX	CH.	Freq. (MHz)	Peak Conducted Power (dBm)	Conducted Power Limit (dBm)	DG (dBi)	EIRP Power (dBm)	EIRP Power Limit (dBm)	Pass /Fail
BLE	1Mbps	1	0	2402	7.05	30.00	2.20	9.25	36.00	Pass
BLE	1Mbps	1	19	2440	7.99	30.00	2.20	10.19	36.00	Pass
BLE	1Mbps	1	39	2480	6.99	30.00	2.20	9.19	36.00	Pass

TEST RESULTS DATA
Average Power Table
(Reporting Only)

Mod.	Data Rate	NTX	CH.	Freq. (MHz)	Duty Factor (dB)	Average Conducted Power (dBm)
BLE	1Mbps	1	0	2402	2.09	6.82
BLE	1Mbps	1	19	2440	2.09	7.73
BLE	1Mbps	1	39	2480	2.09	6.67

TEST RESULTS DATA
Peak Power Density

Mod.	Data Rate	NTX	CH.	Freq. (MHz)	Peak PSD (dBm /100kHz)	Peak PSD (dBm /3kHz)	DG (dBi)	Peak PSD Limit (dBm /3kHz)	Pass/Fail
BLE	1Mbps	1	0	2402	6.11	-7.39	2.20	8.00	Pass
BLE	1Mbps	1	19	2440	7.19	-6.33	2.20	8.00	Pass
BLE	1Mbps	1	39	2480	6.00	-7.52	2.20	8.00	Pass

Note: PSD (dBm/ 100kHz) is a reference level used for Conducted Band Edges and Conducted Spurious Emission 20dBc limit.



Appendix B. Radiated Spurious Emission

Test Engineer :	Donny Tang	Temperature :	19~23°C
		Relative Humidity :	55~60%

<AC Adapter>

2.4GHz 2400~2483.5MHz

BLE (Band Edge @ 3m)

BLE	Note	Frequency	Level	Over Limit	Limit Line	Read Level	Antenna Factor	Cable Loss	Preamp Factor	Ant Pos	Table Pos	Peak Avg.	Pol.
		(MHz)	(dBμV/m)	(dB)	(dBμV/m)	(dBμV)	(dB/m)	(dB)	(dB)	(cm)	(deg)	(P/A)	(H/V)
BLE CH 00 2402MHz		2377.05	47.39	-26.61	74	48.11	27.13	6.71	34.56	225	121	P	H
		2376.42	36.5	-17.5	54	37.22	27.13	6.71	34.56	225	121	A	H
	*	2402	102.69	-	-	103.33	27.17	6.75	34.56	225	121	P	H
	*	2402	101.97	-	-	102.61	27.17	6.75	34.56	225	121	A	H
		2326.56	47.57	-26.43	74	48.44	27.02	6.67	34.56	352	169	P	V
		2389.11	36.42	-17.58	54	37.06	27.17	6.75	34.56	352	169	A	V
	*	2402	104.08	-	-	104.72	27.17	6.75	34.56	352	169	P	V
	*	2402	100.9	-	-	101.54	27.17	6.75	34.56	352	169	A	V
BLE CH 19 2440MHz		2359.95	47.6	-26.4	74	48.35	27.1	6.71	34.56	221	135	P	H
		2360.04	37.65	-16.35	54	38.4	27.1	6.71	34.56	221	135	A	H
	*	2440	103.93	-	-	104.35	27.29	6.84	34.55	221	135	P	H
	*	2440	103.14	-	-	103.56	27.29	6.84	34.55	221	135	A	H
		2488.64	47.05	-26.95	74	47.26	27.4	6.94	34.55	221	135	P	H
		2499.84	36.75	-17.25	54	36.96	27.4	6.94	34.55	221	135	A	H
		2344.47	47.13	-26.87	74	47.96	27.06	6.67	34.56	328	214	P	V
		2359.68	36.66	-17.34	54	37.41	27.1	6.71	34.56	328	214	A	V
	*	2440	101.61	-	-	102.03	27.29	6.84	34.55	328	214	P	V
	*	2440	100.92	-	-	101.34	27.29	6.84	34.55	328	214	A	V
		2495.88	47.09	-26.91	74	47.3	27.4	6.94	34.55	328	214	P	V
		2488.52	36.62	-17.38	54	36.83	27.4	6.94	34.55	328	214	A	V



BLE CH 39 2480MHz	*	2482	103.02	-	-	103.27	27.36	6.94	34.55	147	135	P	H
	*	2480	102.22	-	-	102.47	27.36	6.94	34.55	147	135	A	H
		2484.64	47.92	-26.08	74	48.17	27.36	6.94	34.55	147	135	P	H
		2483.52	38.12	-15.88	54	38.37	27.36	6.94	34.55	147	135	A	H
													H
													H
	*	2480	101.11	-	-	101.36	27.36	6.94	34.55	229	212	P	V
	*	2480	99.66	-	-	99.91	27.36	6.94	34.55	229	212	A	V
		2485.44	47.86	-26.14	74	48.11	27.36	6.94	34.55	229	212	P	V
		2483.64	37.53	-16.47	54	37.78	27.36	6.94	34.55	229	212	A	V
													V
													V
Remark	1. No other spurious found. 2. All results are PASS against Peak and Average limit line.												



2.4GHz 2400~2483.5MHz

BLE (Harmonic @ 3m)

BLE	Note	Frequency (MHz)	Level (dBμV/m)	Over Limit (dB)	Limit Line (dBμV/m)	Read Level (dBμV)	Antenna Factor (dB/m)	Cable Loss (dB)	Preamp Factor (dB)	Ant Pos (cm)	Table Pos (deg)	Peak Avg. (P/A)	Pol. (H/V)	
BLE CH 00 2402MHz		4804	40.94	-33.06	74	58.5	31.2	11.01	59.77	100	0	P	H	
													H	
													H	
													H	
			4804	43.91	-30.09	74	61.47	31.2	11.01	59.77	100	0	P	V
														V
														V
BLE CH 19 2440MHz		4880	44.35	-29.65	74	61.44	31.31	11.06	59.46	100	0	P	H	
		7320	42.11	-31.89	74	54.81	36.02	11.71	60.43	100	0	P	H	
													H	
													H	
			4880	47.18	-26.82	74	64.27	31.31	11.06	59.46	100	0	P	V
			7320	43.12	-30.88	74	55.82	36.02	11.71	60.43	100	0	P	V
														V
BLE CH 39 2480MHz		4960	42.75	-31.25	74	59.15	31.44	11.22	59.06	100	0	P	H	
		7440	41.48	-32.52	74	54.06	36.29	11.61	60.48	100	0	P	H	
													H	
													H	
			4960	46.63	-27.37	74	63.03	31.44	11.22	59.06	100	0	P	V
			7440	41.16	-32.84	74	53.74	36.29	11.61	60.48	100	0	P	V
														V
Remark	1. No other spurious found. 2. All results are PASS against Peak and Average limit line.													



Emission below 1GHz

2.4GHz BLE (LF)

BLE	Note	Frequency	Level	Over	Limit	Read	Antenna	Cable	Preamp	Ant	Table	Peak	Pol.	
		(MHz)	(dBμV/m)	(dB)	(dBμV/m)	(dBμV)	(dB/m)	(dB)	(dB)	(cm)	(deg)	(P/A)	(H/V)	
2.4GHz BLE LF		31.62	29.68	-10.32	40	34.99	24.58	1.91	31.8			P	H	
		176.88	25.73	-17.77	43.5	40.03	15.42	2	31.72			P	H	
		299.19	23.7	-22.3	46	33.61	19.5	2.28	31.69			P	H	
		624.8	34.96	-11.04	46	37.94	25.85	3.19	32.02			P	H	
		886.6	34.2	-11.8	46	33.09	29.32	3.37	31.58			P	H	
		928.6	35.95	-10.05	46	33.88	30.14	3.19	31.26	100	100	P	H	
													H	
													H	
													H	
													H	
													H	
													H	
			31.62	33.72	-6.28	40	39.03	24.58	1.91	31.8	100	111	P	V
			41.61	24.55	-15.45	40	35.7	18.88	1.75	31.78			P	V
			92.64	23.36	-20.14	43.5	37.98	15.09	2.01	31.72			P	V
			624.8	34.62	-11.38	46	37.6	25.85	3.19	32.02			P	V
			904.1	33.9	-12.1	46	32.53	29.5	3.36	31.49			P	V
			944	35.77	-10.23	46	33.25	30.55	3.09	31.12			P	V
													V	
													V	
												V		
												V		
												V		
												V		
Remark	1. No other spurious found. 2. All results are PASS against limit line.													



Note symbol

*	Fundamental Frequency which can be ignored. However, the level of any unwanted emissions shall not exceed the level of the fundamental frequency.
!	Test result is over limit line.
P/A	Peak or Average
H/V	Horizontal or Vertical



A calculation example for radiated spurious emission is shown as below:

WIFI	Note	Frequency	Level	Over	Limit	Read	Antenna	Cable	Preamp	Ant	Table	Peak	Pol.
Ant.				Limit	Line	Level	Factor	Loss	Factor	Pos	Pos	Avg.	
1+2		(MHz)	(dBμV/m)	(dB)	(dBμV/m)	(dBμV)	(dB/m)	(dB)	(dB)	(cm)	(deg)	(P/A)	(H/V)
802.11b		2390	55.45	-18.55	74	54.51	32.22	4.58	35.86	103	308	P	H
CH 01		2390	43.54	-10.46	54	42.6	32.22	4.58	35.86	103	308	A	H
2412MHz													

- Level(dBμV/m) =
Antenna Factor(dB/m) + Cable Loss(dB) + Read Level(dBμV) - Preamp Factor(dB)
- Over Limit(dB) = Level(dBμV/m) – Limit Line(dBμV/m)

For Peak Limit @ 2390MHz:

- Level(dBμV/m)
= Antenna Factor(dB/m) + Cable Loss(dB) + Read Level(dBμV) - Preamp Factor(dB)
= 32.22(dB/m) + 4.58(dB) + 54.51(dBμV) – 35.86 (dB)
= 55.45 (dBμV/m)
- Over Limit(dB)
= Level(dBμV/m) – Limit Line(dBμV/m)
= 55.45(dBμV/m) – 74(dBμV/m)
= -18.55(dB)

For Average Limit @ 2390MHz:

- Level(dBμV/m)
= Antenna Factor(dB/m) + Cable Loss(dB) + Read Level(dBμV) - Preamp Factor(dB)
= 32.22(dB/m) + 4.58(dB) + 42.6(dBμV) – 35.86 (dB)
= 43.54 (dBμV/m)
- Over Limit(dB)
= Level(dBμV/m) – Limit Line(dBμV/m)
= 43.54(dBμV/m) – 54(dBμV/m)
= -10.46(dB)

Both peak and average measured complies with the limit line, so test result is “PASS”.



<POE Adapter>

2.4GHz 2400~2483.5MHz

BLE (Band Edge @ 3m)

BLE	Note	Frequency	Level	Over Limit	Limit Line	Read Level	Antenna Factor	Cable Loss	Preamp Factor	Ant Pos	Table Pos	Peak Avg.	Pol.
		(MHz)	(dBμV/m)	(dB)	(dBμV/m)	(dBμV)	(dB/m)	(dB)	(dB)	(cm)	(deg)	(P/A)	(H/V)
BLE CH 39 2480MHz	*	2480	104.57	-	-	104.82	27.36	6.94	34.55	262	249	P	H
	*	2480	103.33	-	-	103.58	27.36	6.94	34.55	262	249	A	H
		2483.8	48.15	-25.85	74	48.4	27.36	6.94	34.55	262	249	P	H
		2483.84	38.44	-15.56	54	38.69	27.36	6.94	34.55	262	249	A	H
													H
													H
	*	2480	103.01	-	-	103.26	27.36	6.94	34.55	293	180	P	V
	*	2480	102.2	-	-	102.45	27.36	6.94	34.55	293	180	A	V
		2483.72	48.87	-25.13	74	49.12	27.36	6.94	34.55	293	180	P	V
		2483.88	38.06	-15.94	54	38.31	27.36	6.94	34.55	293	180	A	V
													V
												V	
Remark	1. No other spurious found. 2. All results are PASS against Peak and Average limit line.												



2.4GHz 2400~2483.5MHz

BLE (Harmonic @ 3m)

BLE	Note	Frequency (MHz)	Level (dBµV/m)	Over Limit (dB)	Limit Line (dBµV/m)	Read Level (dBµV)	Antenna Factor (dB/m)	Cable Loss (dB)	Preamp Factor (dB)	Ant Pos (cm)	Table Pos (deg)	Peak Avg. (P/A)	Pol. (H/V)	
BLE CH 39 2480MHz		4960	44.3	-29.7	74	60.7	31.44	11.22	59.06	100	0		H	
		7440	41.09	-32.91	74	53.67	36.29	11.61	60.48	100	0		H	
													H	
													H	
			4960	45.83	-28.17	74	62.23	31.44	11.22	59.06	100	0		V
			7440	41.18	-32.82	74	53.76	36.29	11.61	60.48	100	0		V
														V
														V
Remark	1. No other spurious found. 2. All results are PASS against Peak and Average limit line.													



Emission below 1GHz

2.4GHz BLE (LF)

BLE	Note	Frequency	Level	Over	Limit	Read	Antenna	Cable	Preamp	Ant	Table	Peak	Pol.	
		(MHz)	(dBμV/m)	(dB)	(dBμV/m)	(dBμV)	(dB/m)	(dB)	(dB)	(cm)	(deg)	(P/A)	(H/V)	
2.4GHz BLE LF		95.07	27.21	-16.29	43.5	41.51	15.35	2.07	31.72			P	H	
		190.11	30.2	-13.3	43.5	44.66	15.3	1.96	31.72			P	H	
		250.05	42.29	-3.71	46	53.08	18.7	2.21	31.7	100	161	P	H	
		856.5	34.18	-11.82	46	33.43	29.14	3.32	31.71			P	H	
		920.2	34.65	-11.35	46	32.8	29.94	3.25	31.34			P	H	
		953.1	35.83	-10.17	46	33.11	30.7	3.05	31.03			P	H	
													H	
													H	
													H	
													H	
													H	
													H	
			31.62	29.68	-10.32	40	34.99	24.58	1.91	31.8			P	V
			77.25	35.2	-4.8	40	51.57	13.17	2.2	31.74	100	199	P	V
			190.11	33.02	-10.48	43.5	47.48	15.3	1.96	31.72			P	V
			824.3	33.04	-12.96	46	32.89	28.64	3.34	31.83			P	V
			902.7	34.25	-11.75	46	32.9	29.48	3.37	31.5			P	V
			937.7	35.72	-10.28	46	33.37	30.39	3.13	31.17			P	V
													V	
													V	
												V		
												V		
												V		
												V		
Remark	1. No other spurious found. 2. All results are PASS against limit line.													



Note symbol

*	Fundamental Frequency which can be ignored. However, the level of any unwanted emissions shall not exceed the level of the fundamental frequency.
!	Test result is over limit line.
P/A	Peak or Average
H/V	Horizontal or Vertical



A calculation example for radiated spurious emission is shown as below:

WIFI	Note	Frequency	Level	Over	Limit	Read	Antenna	Cable	Preamp	Ant	Table	Peak	Pol.
Ant.				Limit	Line	Level	Factor	Loss	Factor	Pos	Pos	Avg.	
1+2		(MHz)	(dBμV/m)	(dB)	(dBμV/m)	(dBμV)	(dB/m)	(dB)	(dB)	(cm)	(deg)	(P/A)	(H/V)
802.11b		2390	55.45	-18.55	74	54.51	32.22	4.58	35.86	103	308	P	H
CH 01													
2412MHz		2390	43.54	-10.46	54	42.6	32.22	4.58	35.86	103	308	A	H

- Level(dBμV/m) =
Antenna Factor(dB/m) + Cable Loss(dB) + Read Level(dBμV) - Preamp Factor(dB)
- Over Limit(dB) = Level(dBμV/m) – Limit Line(dBμV/m)

For Peak Limit @ 2390MHz:

- Level(dBμV/m)
= Antenna Factor(dB/m) + Cable Loss(dB) + Read Level(dBμV) - Preamp Factor(dB)
= 32.22(dB/m) + 4.58(dB) + 54.51(dBμV) – 35.86 (dB)
= 55.45 (dBμV/m)
- Over Limit(dB)
= Level(dBμV/m) – Limit Line(dBμV/m)
= 55.45(dBμV/m) – 74(dBμV/m)
= -18.55(dB)

For Average Limit @ 2390MHz:

- Level(dBμV/m)
= Antenna Factor(dB/m) + Cable Loss(dB) + Read Level(dBμV) - Preamp Factor(dB)
= 32.22(dB/m) + 4.58(dB) + 42.6(dBμV) – 35.86 (dB)
= 43.54 (dBμV/m)
- Over Limit(dB)
= Level(dBμV/m) – Limit Line(dBμV/m)
= 43.54(dBμV/m) – 54(dBμV/m)
= -10.46(dB)

Both peak and average measured complies with the limit line, so test result is “PASS”.



Appendix C. Radiated Spurious Emission

Test Engineer :	Donny Tang	Temperature :	19~23°C
		Relative Humidity :	55~60%

<AC Adapter>

Note symbol

-L	Low channel location
-R	High channel location



2.4GHz 2400~2483.5MHz

BLE (Band Edge @ 3m)

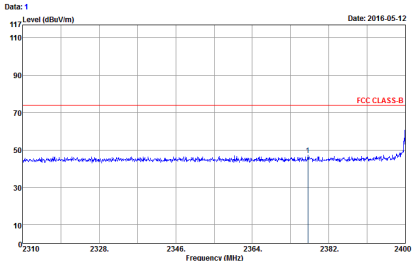
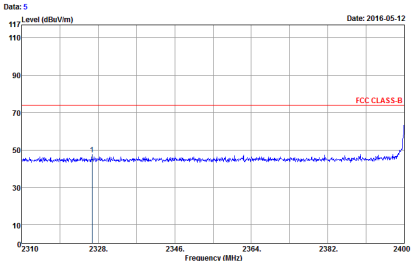
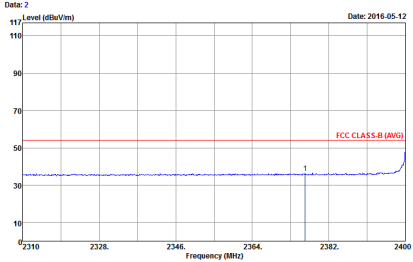
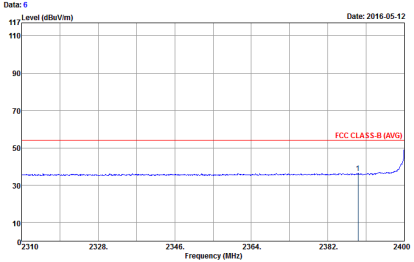
BLE	2.4GHz 2400~2483.5MHz Band Edge @ 3m	
ANT	BLE CH00 2402MHz	
1	Horizontal	Vertical
Peak	 <p>Date: 1 Level (dBuV/m) Date: 2016-05-12</p> <p>Site : 03CH06-HY Condition : FCC CLASS-B 3m 9120D_1156_150827 HORIZONTAL RBW:1000.000KHz VBW:3000.000KHz SWT:Auto Detector : Peak</p>	 <p>Date: 5 Level (dBuV/m) Date: 2016-05-12</p> <p>Site : 03CH06-HY Condition : FCC CLASS-B 3m 9120D_1156_150827 VERTICAL RBW:1000.000KHz VBW:3000.000KHz SWT:Auto Detector : Peak</p>
Avg.	 <p>Date: 2 Level (dBuV/m) Date: 2016-05-12</p> <p>Site : 03CH06-HY Condition : FCC CLASS-B (AVG) 3m 9120D_1156_150827 HORIZONTAL RBW:1000.000KHz VBW:3.000KHz SWT:Auto Detector : Peak</p>	 <p>Date: 6 Level (dBuV/m) Date: 2016-05-12</p> <p>Site : 03CH06-HY Condition : FCC CLASS-B (AVG) 3m 9120D_1156_150827 VERTICAL RBW:1000.000KHz VBW:3.000KHz SWT:Auto Detector : Peak</p>

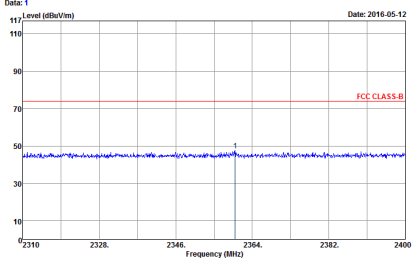
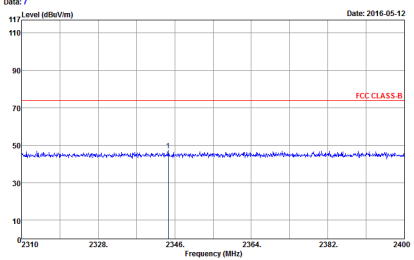
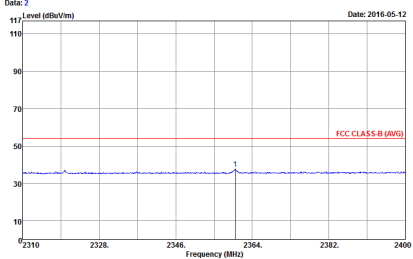
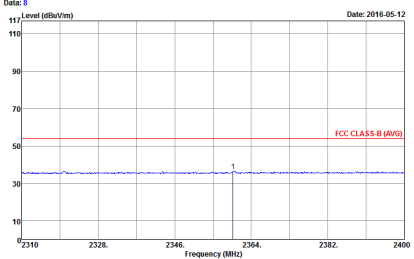

BLE	2.4GHz 2400~2483.5MHz Band Edge @ 3m	
ANT	BLE CH19 2440MHz - L	
1	Horizontal	Vertical
Peak	 <p>Data: 1 Date: 2016-05-12</p> <p>Site : 03CH06-HY Condition : FCC CLASS-B 3m 9120D_1156_150827 HORIZONTAL RBW:1000.000KHz VBW:3000.000KHz SWT:Auto Detector : Peak</p>	 <p>Data: 7 Date: 2016-05-12</p> <p>Site : 03CH06-HY Condition : FCC CLASS-B 3m 9120D_1156_150827 VERTICAL RBW:1000.000KHz VBW:3000.000KHz SWT:Auto Detector : Peak</p>
Avg.	 <p>Data: 2 Date: 2016-05-12</p> <p>Site : 03CH06-HY Condition : FCC CLASS-B (AVG) 3m 9120D_1156_150827 HORIZONTAL RBW:1000.000KHz VBW:3.000KHz SWT:Auto Detector : Peak</p>	 <p>Data: 8 Date: 2016-05-12</p> <p>Site : 03CH06-HY Condition : FCC CLASS-B (AVG) 3m 9120D_1156_150827 VERTICAL RBW:1000.000KHz VBW:3.000KHz SWT:Auto Detector : Peak</p>

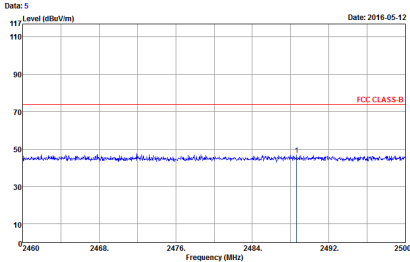
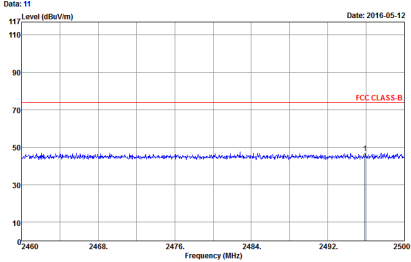
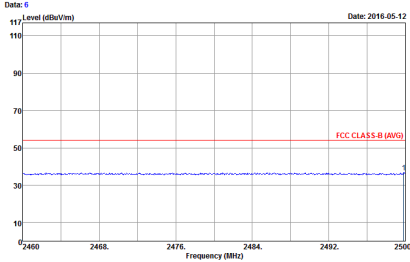
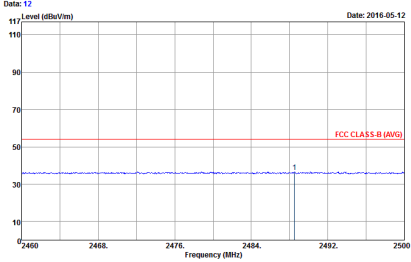

BLE	2.4GHz 2400~2483.5MHz Band Edge @ 3m	
ANT	BLE CH19 2440MHz - R	
1	Horizontal	Vertical
Peak	 <p>Site : 03CH06-HY Condition : FCC CLASS-B 3m 91200_1156_150827 HORIZONTAL Detector : Peak</p>	 <p>Site : 03CH06-HY Condition : FCC CLASS-B 3m 91200_1156_150827 VERTICAL Detector : Peak</p>
Avg.	 <p>Site : 03CH06-HY Condition : FCC CLASS-B (AVG) 3m 91200_1156_150827 HORIZONTAL Detector : Peak</p>	 <p>Site : 03CH06-HY Condition : FCC CLASS-B (AVG) 3m 91200_1156_150827 VERTICAL Detector : Peak</p>

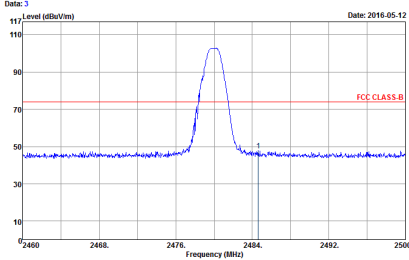
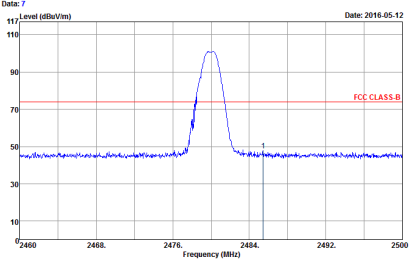
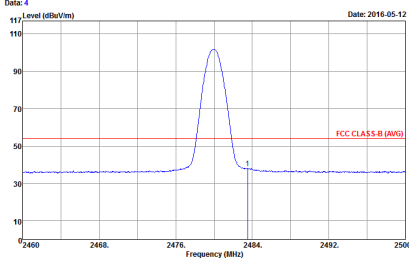
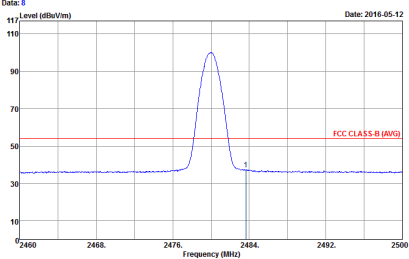

BLE	2.4GHz 2400~2483.5MHz Band Edge @ 3m	
ANT	BLE CH39 2480MHz	
1	Horizontal	Vertical
Peak	 <p> Date: 3 Level (dBuV/m) Date: 2016-05-12 Site : 03CH06-HY Condition : FCC CLASS-B 3m 91200_1156_150827 HORIZONTAL RBW:1000.000KHz VBW:3000.000KHz SWT:Auto Detector : Peak </p>	 <p> Date: 7 Level (dBuV/m) Date: 2016-05-12 Site : 03CH06-HY Condition : FCC CLASS-B 3m 91200_1156_150827 VERTICAL RBW:1000.000KHz VBW:3000.000KHz SWT:Auto Detector : Peak </p>
Avg.	 <p> Date: 4 Level (dBuV/m) Date: 2016-05-12 Site : 03CH06-HY Condition : FCC CLASS-B (AVG) 3m 91200_1156_150827 HORIZONTAL RBW:1000.000KHz VBW:3.000KHz SWT:Auto Detector : Peak </p>	 <p> Date: 8 Level (dBuV/m) Date: 2016-05-12 Site : 03CH06-HY Condition : FCC CLASS-B (AVG) 3m 91200_1156_150827 VERTICAL RBW:1000.000KHz VBW:3.000KHz SWT:Auto Detector : Peak </p>



2.4GHz 2400~2483.5MHz

BLE (Harmonic @ 3m)

BLE	2.4GHz 2400~2483.5MHz Harmonic @ 3m	
ANT	BLE CH00 2402MHz	
1	Horizontal	Vertical
Peak Avg.	<p>Data: 5 Date: 2016-05-12</p> <p>Site : 03CH06-11Y Condition : FCC CLASS-B 3m 91200_1156_150827 HORIZONTAL Detector : Peak</p>	<p>Data: 6 Date: 2016-05-12</p> <p>Site : 03CH06-11Y Condition : FCC CLASS-B 3m 91200_1156_150827 VERTICAL Detector : Peak</p>



BLE	2.4GHz 2400~2483.5MHz Harmonic @ 3m	
ANT	BLE CH19 2440MHz	
1	Horizontal	Vertical
<p>Peak</p> <p>Avg.</p>	<p>Site : 03CH06-FY Condition : FCC CLASS-B 3m 9120D_1156_150827 HORIZONTAL Detector : Peak</p>	<p>Site : 03CH06-FY Condition : FCC CLASS-B 3m 9120D_1156_150827 VERTICAL Detector : Peak</p>



BLE	2.4GHz 2400~2483.5MHz Harmonic @ 3m	
ANT	BLE CH39 2480MHz	
1	Horizontal	Vertical
Peak	<p>Site : 03CH06-FY Condition : FCC CLASS-B 3m 9120D_1156_150827 HORIZONTAL Detector : Peak</p>	<p>Site : 03CH06-FY Condition : FCC CLASS-B 3m 9120D_1156_150827 VERTICAL Detector : Peak</p>



Emission below 1GHz

2.4GHz BLE (LF)

BLE	2.4GHz 2400~2483.5MHz	
ANT	BLE LF	
1	Horizontal	Vertical
QP / Peak	<p>Horizontal emission spectrum plot showing Level (dBuV/m) vs Frequency (MHz) for Horizontal polarization. The plot includes a blue signal line, a red FCC CLASS-B limit line, and a date of 2016-05-12. Site: 03CH06-HY, Condition: FCC CLASS-B 3m LF_ANT_2725 HORIZONTAL.</p>	<p>Vertical emission spectrum plot showing Level (dBuV/m) vs Frequency (MHz) for Vertical polarization. The plot includes a blue signal line, a red FCC CLASS-B limit line, and a date of 2016-05-12. Site: 03CH06-HY, Condition: FCC CLASS-B 3m LF_ANT_2725 VERTICAL.</p>



<POE Adapter>

Note symbol

-L	Low channel location
-R	High channel location



2.4GHz 2400~2483.5MHz

BLE (Band Edge @ 3m)

BLE	2.4GHz 2400~2483.5MHz Band Edge @ 3m	
ANT	BLE CH39 2480MHz	
1	Horizontal	Vertical
Peak		
Avg.		



2.4GHz 2400~2483.5MHz

BLE (Harmonic @ 3m)

BLE	2.4GHz 2400~2483.5MHz Harmonic @ 3m	
ANT	BLE CH39 2480MHz	
1	Horizontal	Vertical
Peak	<p>Site : 03CH06-HY Condition : FCC CLASS-B 3m 9120D_1156_150827 HORIZONTAL Detector : Peak</p>	<p>Site : 03CH06-HY Condition : FCC CLASS-B 3m 9120D_1156_150827 VERTICAL Detector : Peak</p>



Emission below 1GHz

2.4GHz BLE (LF)

BLE	2.4GHz 2400~2483.5MHz	
ANT	BLE LF	
1	Horizontal	Vertical
QP / Peak		



Appendix D. Duty Cycle Plots

Band	Duty Cycle(%)	T(us)	1/T(kHz)	VBW Setting
Bluetooth 4.0	61.78	388	2.58	3kHz

Bluetooth 4.0

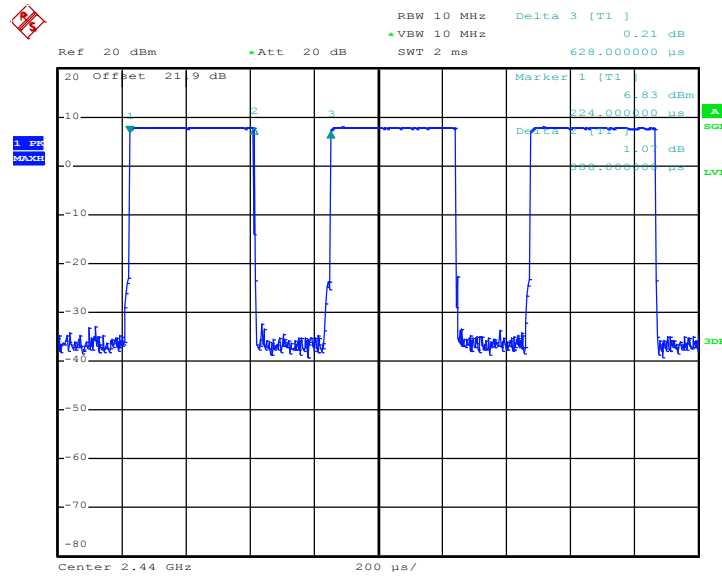

Date: 29.APR.2016 04:54:15