

EMC Test Report

Application for FCC Grant of Equipment Authorization Canada Certification Class III Permissive Change/Reassessment

FCC Part 15, Subpart E

Model: APIN0103

FCC ID: Q9DAPIN0103

APPLICANT: Aruba Networks
1344 Crossman Ave
Sunnyvale, CA 94089

TEST SITE(S): National Technical Systems - Silicon Valley
41039 Boyce Road.
Fremont, CA. 94538-2435

IC SITE REGISTRATION #: 2845B-7

REPORT DATE: May 9, 2016

FINAL TEST DATES: March 7 and 8, 2016

TOTAL NUMBER OF PAGES: 58

PROGRAM MGR /
TECHNICAL REVIEWER:

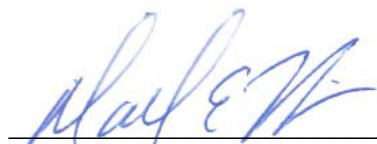

Mark E Hill
Staff Engineer

QUALITY ASSURANCE DELEGATE /
FINAL REPORT PREPARER:



David Guidotti
Senior Technical Writer



National Technical Systems - Silicon Valley is accredited by the A2LA, certificate number 0214.26, to perform the test(s) listed in this report, except where noted otherwise. This report and the information contained herein represent the results of testing test articles identified and selected by the client performed to specifications and/or procedures selected by the client. National Technical Systems (NTS) makes no representations, expressed or implied, that such testing is adequate (or inadequate) to demonstrate efficiency, performance, reliability, or any other characteristic of the articles being tested, or similar products. This report should not be relied upon as an endorsement or certification by NTS of the equipment tested, nor does it represent any statement whatsoever as to its merchantability or fitness of the test article, or similar products, for a particular purpose. This report shall not be reproduced except in full



REVISION HISTORY

| Rev# | Date | Comments | Modified By |
|------|-------------|---------------|-------------|
| - | May 9, 2016 | First release | |

TABLE OF CONTENTS

| | |
|--|-----------|
| REVISION HISTORY | 2 |
| TABLE OF CONTENTS | 3 |
| SCOPE | 4 |
| OBJECTIVE | 4 |
| STATEMENT OF COMPLIANCE | 5 |
| DEVIATIONS FROM THE STANDARDS | 5 |
| TEST RESULTS SUMMARY | 6 |
| UNII / LELAN DEVICES | 6 |
| MEASUREMENT UNCERTAINTIES..... | 8 |
| EQUIPMENT UNDER TEST (EUT) DETAILS | 9 |
| GENERAL..... | 9 |
| OTHER EUT DETAILS..... | 9 |
| ANTENNA SYSTEM | 9 |
| ENCLOSURE..... | 9 |
| MODIFICATIONS..... | 9 |
| SUPPORT EQUIPMENT | 10 |
| EUT INTERFACE PORTS | 10 |
| EUT OPERATION | 10 |
| TEST SITE | 11 |
| GENERAL INFORMATION..... | 11 |
| CONDUCTED EMISSIONS CONSIDERATIONS | 11 |
| RADIATED EMISSIONS CONSIDERATIONS | 11 |
| MEASUREMENT INSTRUMENTATION | 12 |
| RECEIVER SYSTEM | 12 |
| INSTRUMENT CONTROL COMPUTER | 12 |
| LINE IMPEDANCE STABILIZATION NETWORK (LISN)..... | 12 |
| FILTERS/ATTENUATORS | 13 |
| ANTENNAS..... | 13 |
| ANTENNA MAST AND EQUIPMENT TURNTABLE..... | 13 |
| INSTRUMENT CALIBRATION..... | 13 |
| TEST PROCEDURES | 14 |
| EUT AND CABLE PLACEMENT | 14 |
| CONDUCTED EMISSIONS..... | 14 |
| RADIATED EMISSIONS..... | 14 |
| CONDUCTED EMISSIONS FROM ANTENNA PORT | 18 |
| BANDWIDTH MEASUREMENTS | 18 |
| SPECIFICATION LIMITS AND SAMPLE CALCULATIONS | 19 |
| CONDUCTED EMISSIONS SPECIFICATION LIMITS: FCC 15.207; FCC 15.107(A), RSS GEN | 19 |
| GENERAL TRANSMITTER RADIATED EMISSIONS SPECIFICATION LIMITS | 20 |
| RECEIVER RADIATED SPURIOUS EMISSIONS SPECIFICATION LIMITS | 20 |
| FCC 15.407 (A) OUTPUT POWER LIMITS | 21 |
| SPURIOUS EMISSIONS LIMITS –UNII AND LELAN DEVICES | 21 |
| SAMPLE CALCULATIONS - CONDUCTED EMISSIONS | 22 |
| SAMPLE CALCULATIONS - RADIATED EMISSIONS..... | 22 |
| SAMPLE CALCULATIONS - FIELD STRENGTH TO EIRP CONVERSION..... | 23 |
| APPENDIX A TEST EQUIPMENT CALIBRATION DATA | 24 |
| APPENDIX B TEST DATA | 25 |
| END OF REPORT | 58 |

SCOPE

An electromagnetic emissions test has been performed on the Aruba Networks model APIN0103, pursuant to the following rules:

FCC Part 15, Subpart E requirements for UNII Devices

Conducted and radiated emissions data has been collected, reduced, and analyzed within this report in accordance with measurement guidelines set forth in the following reference standards and as outlined in National Technical Systems - Silicon Valley test procedures:

FCC General UNII Test Procedures KDB789033

The intentional radiator above has been tested in a simulated typical installation to demonstrate compliance with the relevant Industry Canada performance and procedural standards.

Final system data was gathered in a mode that tended to maximize emissions by varying orientation of EUT, orientation of power and I/O cabling, antenna search height, and antenna polarization.

Every practical effort was made to perform an impartial test using appropriate test equipment of known calibration. All pertinent factors have been applied to reach the determination of compliance.

OBJECTIVE

The primary objective of the manufacturer is compliance with the regulations outlined in the previous section.

Prior to marketing in the USA, all unlicensed transmitters and transceivers require certification. Receive-only devices operating between 30 MHz and 960 MHz are subject to either certification or a manufacturer's declaration of conformity, with all other receive-only devices exempt from the technical requirements.

Certification is a procedure where the manufacturer submits test data and technical information to a certification body and receives a certificate or grant of equipment authorization upon successful completion of the certification body's review of the submitted documents. Once the equipment authorization has been obtained, the label indicating compliance must be attached to all identical units, which are subsequently manufactured.

Maintenance of compliance is the responsibility of the manufacturer. Any modification of the product which may result in increased emissions should be checked to ensure compliance has been maintained (i.e., printed circuit board layout changes, different line filter, different power supply, harnessing or I/O cable changes, etc.).

STATEMENT OF COMPLIANCE

The tested sample of Aruba Networks model APIN0103 complied with the requirements of the following regulations:

FCC Part 15, Subpart E requirements for UNII Devices

Maintenance of compliance is the responsibility of the manufacturer. Any modifications to the product should be assessed to determine their potential impact on the compliance status of the device with respect to the standards detailed in this test report.

The test results recorded herein are based on a single type test of Aruba Networks model APIN0103 and therefore apply only to the tested sample. The sample was selected and prepared by Rob Hastings of Aruba Networks.

DEVIATIONS FROM THE STANDARDS

No deviations were made from the published requirements listed in the scope of this report.

TEST RESULTS SUMMARY

UNII / LELAN DEVICES

OPERATION IN THE 5.725 – 5.85 GHZ BAND

| FCC Rule Part | RSS Rule Part | Description | Measured Value / Comments | Limit / Requirement | Result (margin) |
|---------------------------|----------------------|-----------------------------------|---|---|-----------------|
| 15.407(e) | RSS-247 6.2.4 (1) | 6dB Bandwidth | Unchanged from original filing | | |
| 15.407(a) (3) | RSS-210 A9.2(2) | Output Power (multipoint systems) | a: 22.5dBm (178.3 mW) n20: 21.6dBm (145.0 mW) n40: 20.9dBm (123.6 mW) (Max eirp: 0.480W) | 30 dBm (1 W) EIRP <= 4W | Complies |
| 15.407(a) (3) | RSS-247 6.2.3 (1) | Power Spectral Density | a: 12.1dBm/MHz n20: 10.8dBm/MHz n40: 7.2dBm/MHz | 30 dBm / 500 kHz | Complies |
| 15.407(b) (4) / 15.209 | RSS-247 6.2.4 (2) | Spurious Emissions | 78.0 dBµV/m @ 5724.9 MHz (-0.3 dB) | Refer to the limits section (p20) for restricted bands, all others -17 dBm/MHz EIRP bandedge and -27 dBm/MHz EIRP | Complies |

REQUIREMENTS FOR ALL U-NII/LELAN BANDS

| FCC Rule Part | RSS Rule Part | Description | Measured Value / Comments | Limit / Requirement | Result |
|---------------|--------------------------------------|---|--|---|----------|
| 15.407 | RSS-247 6.1 | Modulation | Unchanged from original filing | | |
| 15.31 (m) | RSS-247 6.4 (1) RSS-Gen 6.8 | Channel Selection | Emissions tested at outermost and middle channels in each band | Device was tested on the top, bottom and center channels in each band | N/A |
| 15.407 (c) | RSS-247 6.4 (2) | Operation in the absence of information to transmit | Unchanged from original filing | | |
| 15.407 (g) | | Frequency Stability | | | |
| 15.407 (h1) | RSS-247 6.2.2 (1) 6.2.3 (1) | Transmit Power Control | | | |
| 15.407 (h2) | RSS-247 6.3 | Dynamic frequency Selection (device with radar detection) | Refer to separate test report | Threshold -62dBm (-64dBm if eirp > 200mW) Channel Availability Check > 60s Channel closing transmission time < 260ms Channel move time < 10s Non occupancy period > 30minutes | Complies |

GENERAL REQUIREMENTS APPLICABLE TO ALL BANDS

| FCC Rule Part | RSS Rule part | Description | Measured Value / Comments | Limit / Requirement | Result (margin) |
|--------------------------|-----------------|--------------------------|--|---------------------|-----------------|
| 15.203 | - | RF Connector | Unchanged from original filing | | |
| 15.407 (b) (6) | RSS-Gen Table 3 | AC Conducted Emissions | 34.2dB μ V @ 0.36MHz. (-14.6dB) | Refer to page 19 | Complies |
| 15.247 (i) 15.407 (f) | RSS 102 | RF Exposure Requirements | Original filing MPE exhibit represents worse case. | | |

MEASUREMENT UNCERTAINTIES

ISO/IEC 17025 requires that an estimate of the measurement uncertainties associated with the emissions test results be included in the report. The measurement uncertainties given below are based on a 95% confidence level and were calculated in accordance with UKAS document LAB 34.

| Measurement Type | Measurement Unit | Frequency Range | Expanded Uncertainty |
|---|------------------|-------------------|----------------------|
| RF power, conducted (power meter) | dBm | 25 to 7000 MHz | ± 0.52 dB |
| RF power, conducted (Spectrum analyzer) | dBm | 25 to 7000 MHz | ± 0.7 dB |
| Conducted emission of transmitter | dBm | 25 to 26500 MHz | ± 0.7 dB |
| Conducted emission of receiver | dBm | 25 to 26500 MHz | ± 0.7 dB |
| Radiated emission (substitution method) | dBm | 25 to 26500 MHz | ± 2.5 dB |
| Radiated emission (field strength) | dB μ V/m | 25 to 1000 MHz | ± 3.6 dB |
| | | 1000 to 40000 MHz | ± 6.0 dB |
| Conducted Emissions (AC Power) | dB μ V | 0.15 to 30 MHz | ± 2.4 dB |

EQUIPMENT UNDER TEST (EUT) DETAILS**GENERAL**

The Aruba Networks model APIN0103 is an IEEE 802.11 abgn 2x2 access point.

The sample was received on March 7, 2016 and tested on March 7 and 8, 2016. The EUT consisted of the following component(s):

| Company | Model | Description | Serial Number | FCC ID |
|---------------|------------|--------------------|---------------|----------------|
| Aruba Network | APIN0103 | Access Point | CU0006604 | 4675A-APIN0103 |
| Aruba Network | APIN0103 | Access Point | CU0005990 | 4675A-APIN0103 |
| CUINC | 6A-301DB12 | AC/DC Power Supply | - | - |

OTHER EUT DETAILS

Supports 20/40MHz bandwidths
2x2 only, CDD only

ANTENNA SYSTEM

Integral antenna, 3.9dBi for 2.4GHz, 4.1dBi for 5.15-5.35GHz band, 4.3dBi for 5.475-5.850GHz band

ENCLOSURE

The EUT enclosure is primarily constructed of plastic. It measures approximately 15 x 15 x 4cm high.

MODIFICATIONS

No modifications were made to the EUT during the time the product was at NTS Silicon Valley.

SUPPORT EQUIPMENT

No local support equipment was used during testing.

The following equipment was used as remote support equipment for emissions testing:

| Company | Model | Description | Serial Number | FCC ID |
|---------|-------|-------------|---------------|--------|
| Dell | E5440 | Laptop | GMPNP12 | - |

EUT INTERFACE PORTS

The I/O cabling configuration during testing was as follows:

| Port | Connected To | Description | Cable(s) | |
|---------|--------------|-------------|------------------------|-----------|
| | | | Shielded or Unshielded | Length(m) |
| ENET | Laptop | UTP | Unshielded | 10 |
| Console | Laptop | Serial | Shielded | 10 |

EUT OPERATION

During testing, the EUT was configured for continuous transmission on the noted channel. The data rate with the highest output power was used for each mode.

TEST SITE**GENERAL INFORMATION**

Final test measurements were taken at the test sites listed below. Pursuant to section 2.948 of the FCC's Rules and section 3.3 of RSP-100, construction, calibration, and equipment data has been filed with the Commission and with industry Canada.

| Site | Designation / Registration Numbers | | Location |
|-----------|------------------------------------|---------|---|
| | FCC | Canada | |
| Chamber 7 | US0027 | 2845B-7 | 41039 Boyce Road Fremont, CA 94538-2435 |

ANSI C63.4 recommends that ambient noise at the test site be at least 6 dB below the allowable limits. Ambient levels are below this requirement. The test site(s) contain separate areas for radiated and conducted emissions testing. Considerable engineering effort has been expended to ensure that the facilities conform to all pertinent requirements of ANSI C63.4.

CONDUCTED EMISSIONS CONSIDERATIONS

Conducted emissions testing is performed in conformance with ANSI C63.10. Measurements are made with the EUT connected to the public power network through a nominal, standardized RF impedance, which is provided by a line impedance stabilization network, known as a LISN. A LISN is inserted in series with each current-carrying conductor in the EUT power cord.

RADIATED EMISSIONS CONSIDERATIONS

The FCC has determined that radiation measurements made in a shielded enclosure are not suitable for determining levels of radiated emissions. Radiated measurements are performed in an open field environment or in a semi-anechoic chamber. The test sites are maintained free of conductive objects within the CISPR defined elliptical area incorporated in ANSI C63.4 guidelines and meet the Normalized Site Attenuation (NSA) requirements of ANSI C63.4.

MEASUREMENT INSTRUMENTATION

RECEIVER SYSTEM

An EMI receiver as specified in CISPR 16-1-1 is used for emissions measurements. The receivers used can measure over the frequency range of 9 kHz up to 2000 MHz. These receivers allow both ease of measurement and high accuracy to be achieved. The receivers have Peak, Average, and CISPR (Quasi-peak) detectors built into their design so no external adapters are necessary. The receiver automatically sets the required bandwidth for the CISPR detector used during measurements. If the repetition frequency of the signal being measured is below 20Hz, peak measurements are made in lieu of Quasi-Peak measurements.

For measurements above the frequency range of the receivers, a spectrum analyzer is utilized because it provides visibility of the entire spectrum along with the precision and versatility required to support engineering analysis. Average measurements above 1000MHz are performed on the spectrum analyzer using the linear-average method with a resolution bandwidth of 1 MHz and a video bandwidth of 10 Hz, unless the signal is pulsed in which case the average (or video) bandwidth of the measuring instrument is reduced to onset of pulse desensitization and then increased.

INSTRUMENT CONTROL COMPUTER

Software is used to view and convert receiver measurements to the field strength at an antenna or voltage developed at the LISN measurement port, which is then compared directly with the appropriate specification limit. This provides faster, more accurate readings by performing the conversions described under Sample Calculations within the Test Procedures section of this report. Results are printed in a graphic and/or tabular format, as appropriate. A personal computer is used to record all measurements made with the receivers. The software used for radiated and conducted emissions measurements is NTS EMI Test Software (rev 2.10)

LINE IMPEDANCE STABILIZATION NETWORK (LISN)

Line conducted measurements utilize a fifty microhenry Line Impedance Stabilization Network as the monitoring point. The LISN used also contains a 250 uH CISPR adapter. This network provides for calibrated radio frequency noise measurements by the design of the internal low pass and high pass filters on the EUT and measurement ports, respectively.

FILTERS/ATTENUATORS

External filters and precision attenuators are often connected between the receiving antenna or LISN and the receiver. This eliminates saturation effects and non-linear operation due to high amplitude transient events.

ANTENNAS

A loop antenna is used below 30 MHz. For the measurement range 30 MHz to 1000 MHz either a combination of a biconical antenna and a log periodic or a bi-log antenna is used. Above 1000 MHz, horn antennas are used. The antenna calibration factors to convert the received voltage to an electric field strength are included with appropriate cable loss and amplifier gain factors to determine an overall site factor, which is then programmed into the test receivers or incorporated into the test software.

ANTENNA MAST AND EQUIPMENT TURNTABLE

The antennas used to measure the radiated electric field strength are mounted on a non-conductive antenna mast equipped with a motor-drive to vary the antenna height. Measurements below 30 MHz are made with the loop antenna at a fixed height of 1m above the ground plane.

ANSI C63.10 specifies that the test height above ground for table mounted devices shall be 80 centimeters. Floor mounted equipment shall be placed on the ground plane if the device is normally used on a conductive floor or separated from the ground plane by insulating material from 3 to 12 mm if the device is normally used on a non-conductive floor as specified in ANSI C63.4. During radiated measurements, the EUT is positioned on a motorized turntable in conformance with this requirement.

INSTRUMENT CALIBRATION

All test equipment is regularly checked to ensure that performance is maintained in accordance with the manufacturer's specifications. All antennas are calibrated at regular intervals with respect to tuned half-wave dipoles. An exhibit of this report contains the list of test equipment used and calibration information.

TEST PROCEDURES

EUT AND CABLE PLACEMENT

The regulations require that interconnecting cables be connected to the available ports of the unit and that the placement of the unit and the attached cables simulate the worst case orientation that can be expected from a typical installation, so far as practicable. To this end, the position of the unit and associated cabling is varied within the guidelines of ANSI C63.10, and the worst-case orientation is used for final measurements.

CONDUCTED EMISSIONS

Conducted emissions are measured at the plug end of the power cord supplied with the EUT. Excess power cord length is wrapped in a bundle between 30 and 40 centimeters in length near the center of the cord. Preliminary measurements are made to determine the highest amplitude emission relative to the specification limit for all the modes of operation. Placement of system components and varying of cable positions are performed in each mode. A final peak mode scan is then performed in the position and mode for which the highest emission was noted on all current carrying conductors of the power cord.

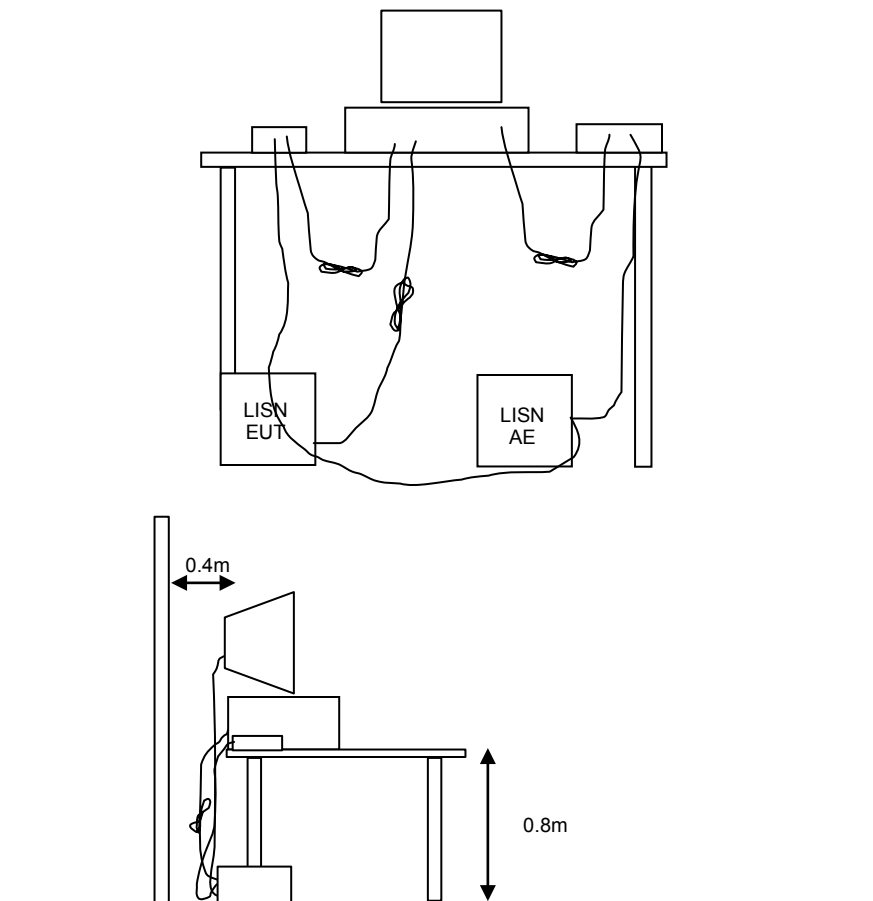

Figure 1 Typical Conducted Emissions Test Configuration

RADIATED EMISSIONS

A preliminary scan of the radiated emissions is performed in which all significant EUT frequencies are identified with the system in a nominal configuration. At least two scans are performed, one scan for each antenna polarization (horizontal and vertical; loop parallel and perpendicular to the EUT). During the preliminary scans, the EUT is rotated through 360°, the antenna height is varied (for measurements above 30 MHz) and cable positions are varied to determine the highest emission relative to the limit. Preliminary scans may be performed in a fully anechoic chamber for the purposes of identifying the frequencies of the highest emissions from the EUT.

A speaker is provided in the receiver to aid in discriminating between EUT and ambient emissions. Other methods used during the preliminary scan for EUT emissions involve scanning with near field magnetic loops, monitoring I/O cables with RF current clamps, and cycling power to the EUT.

Final maximization is a phase in which the highest amplitude emissions identified in the spectral search are viewed while the EUT azimuth angle is varied from 0 to 360 degrees relative to the receiving antenna. The azimuth, which results in the highest emission is then maintained while varying the antenna height from one to four meters (for measurements above 30 MHz, measurements below 30 MHz are made with the loop antenna at a fixed height of 1m). The result is the identification of the highest amplitude for each of the highest peaks. Each recorded level is corrected in the receiver using appropriate factors for cables, connectors, antennas, and preamplifier gain.

When testing above 18 GHz, the receive antenna is located at 1meter from the EUT and the antenna height is restricted to a maximum of 2.5 meters.

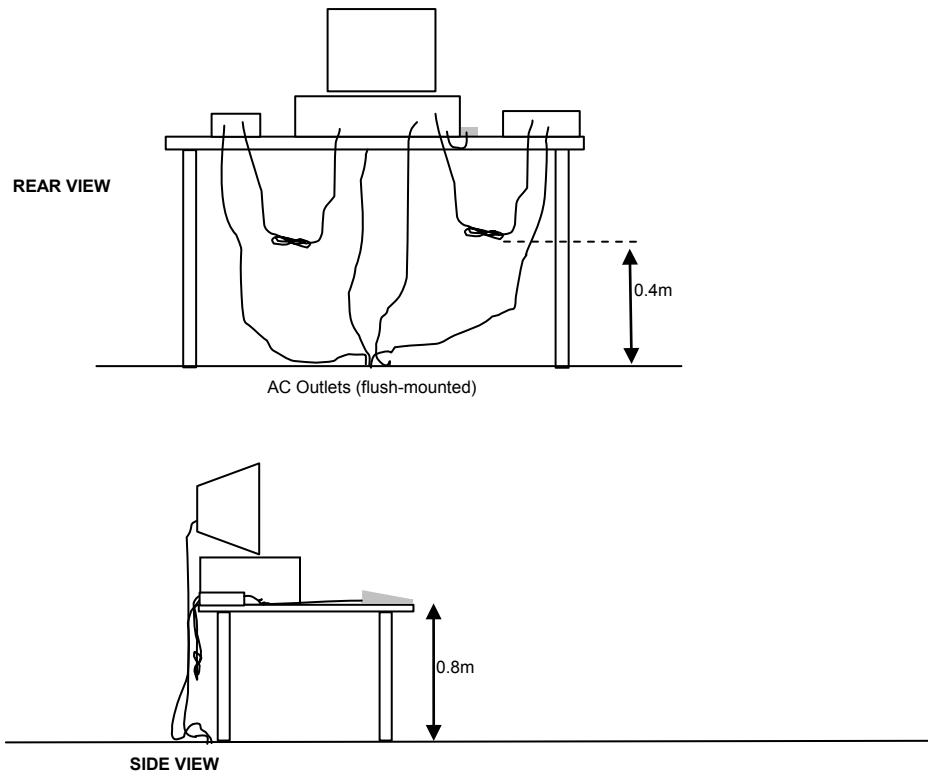

Typical Test Configuration for Radiated Field Strength Measurements

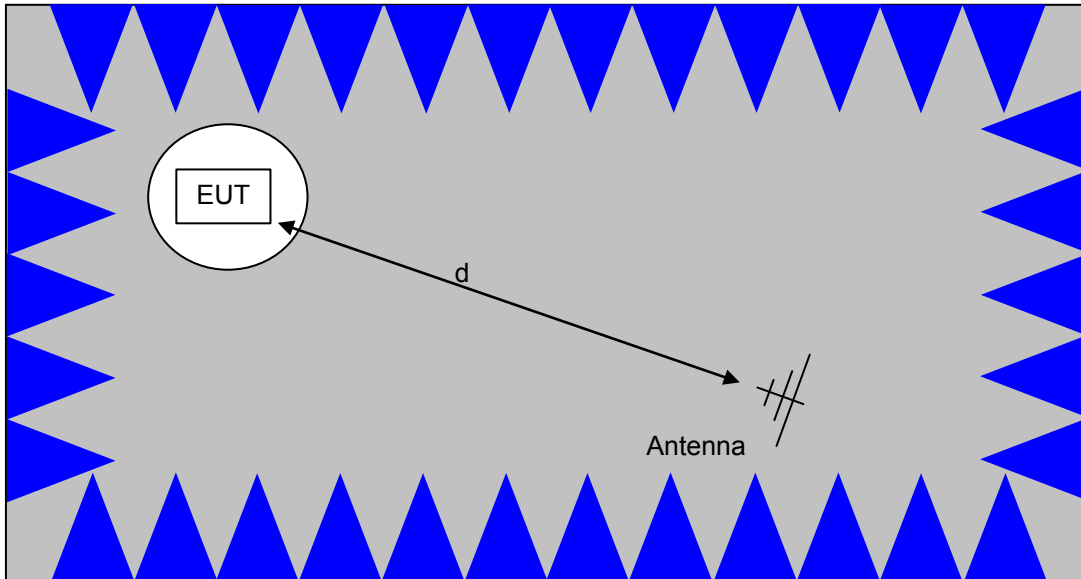

The anechoic materials on the walls and ceiling ensure compliance with the normalized site attenuation requirements of CISPR 16 / CISPR 22 / ANSI C63.4 for an alternate test site at the measurement distances used.

Floor-standing equipment is placed on the floor with insulating supports between the unit and the ground plane.

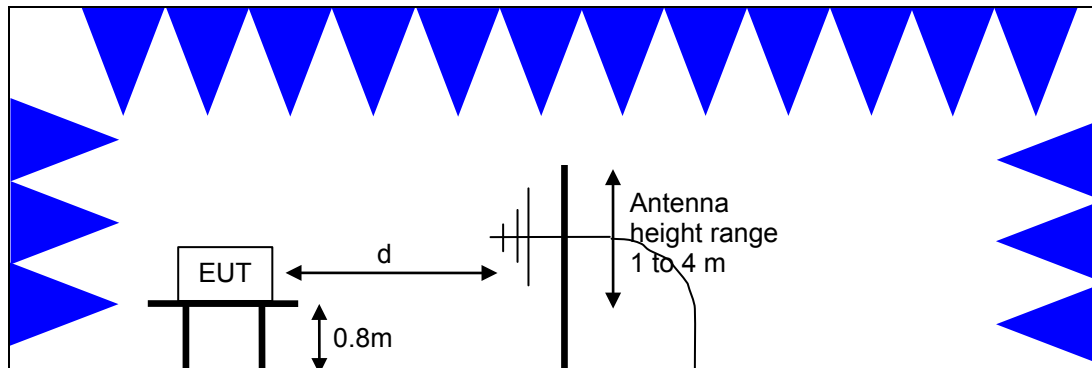

Test Configuration for Radiated Field Strength Measurements
Semi-Anechoic Chamber, Plan and Side Views

CONDUCTED EMISSIONS FROM ANTENNA PORT

Direct measurements of power, bandwidth and power spectral density are performed, where possible, with the antenna port of the EUT connected to either the power meter or spectrum analyzer via a suitable attenuator and/or filter. These are used to ensure that the front end of the measurement instrument is not overloaded by the fundamental transmission.

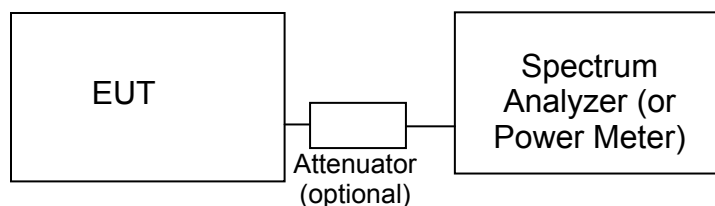
Test Configuration for Antenna Port Measurements

Measurement bandwidths (video and resolution) are set in accordance with the relevant standards and NTS Silicon Valley's test procedures for the type of radio being tested. When power measurements are made using a resolution bandwidth less than the signal bandwidth the power is calculated by summing the power across the signal bandwidth using either the analyzer channel power function or by capturing the trace data and calculating the power using software. In both cases the summed power is corrected to account for the equivalent noise bandwidth (ENBW) of the resolution bandwidth used.

If power averaging is used (typically for certain digital modulation techniques), the EUT is configured to transmit continuously. Power averaging is performed using either the built-in function of the analyzer or, if the analyzer does not feature power averaging, using external software. In both cases the average power is calculated over a number of sweeps (typically 100). When the EUT cannot be configured to continuously transmit then either the analyzer is configured to perform a gated sweep to ensure that the power is averaged over periods that the device is transmitting or power averaging is disabled and a max-hold feature is used.

If a power meter is used to make output power measurements the sensor head type (peak or average) is stated in the test data table.

BANDWIDTH MEASUREMENTS

The 6dB, 20dB, 26dB and/or 99% signal bandwidth are measured using the bandwidths recommended by ANSI C63.10 and RSS GEN.

SPECIFICATION LIMITS AND SAMPLE CALCULATIONS

The limits for conducted emissions are given in units of microvolts, and the limits for radiated emissions are given in units of microvolts per meter at a specified test distance. Data is measured in the logarithmic form of decibels relative to one microvolt, or dB microvolts (dBuV). For radiated emissions, the measured data is converted to the field strength at the antenna in dB microvolts per meter (dBuV/m). The results are then converted to the linear forms of uV and uV/m for comparison to published specifications.

For reference, converting the specification limits from linear to decibel form is accomplished by taking the base ten logarithm, then multiplying by 20. These limits in both linear and logarithmic form are as follows:

CONDUCTED EMISSIONS SPECIFICATION LIMITS: FCC 15.207; FCC 15.107(a), RSS GEN

The table below shows the limits for the emissions on the AC power line from an intentional radiator and a receiver.

| Frequency (MHz) | Average Limit (dBuV) | Quasi Peak Limit (dBuV) |
|-----------------|---|---|
| 0.150 to 0.500 | Linear decrease on logarithmic frequency axis between 56.0 and 46.0 | Linear decrease on logarithmic frequency axis between 66.0 and 56.0 |
| 0.500 to 5.000 | 46.0 | 56.0 |
| 5.000 to 30.000 | 50.0 | 60.0 |

GENERAL TRANSMITTER RADIATED EMISSIONS SPECIFICATION LIMITS

The table below shows the limits for the spurious emissions from transmitters that fall in restricted bands¹.

| Frequency Range (MHz) | Limit (uV/m) | Limit (dBuV/m @ 3m) |
|-----------------------|------------------------------|--|
| 0.009-0.490 | 2400/F _{KHz} @ 300m | 67.6-20*log ₁₀ (F _{KHz}) @ 300m |
| 0.490-1.705 | 24000/F _{KHz} @ 30m | 87.6-20*log ₁₀ (F _{KHz}) @ 30m |
| 1.705 to 30 | 30 @ 30m | 29.5 @ 30m |
| 30 to 88 | 100 @ 3m | 40 @ 3m |
| 88 to 216 | 150 @ 3m | 43.5 @ 3m |
| 216 to 960 | 200 @ 3m | 46.0 @ 3m |
| Above 960 | 500 @ 3m | 54.0 @ 3m |

RECEIVER RADIATED SPURIOUS EMISSIONS SPECIFICATION LIMITS

The table below shows the limits for the spurious emissions from receivers as detailed in FCC Part 15.109 and RSS GEN Table 2. Note that receivers operating outside of the frequency range 30 MHz – 960 MHz are exempt from the requirements of 15.109 and receivers that are not stand-alone are exempt from the ISED Canada requirements per RSS-GEN.

| Frequency Range (MHz) | Limit (uV/m @ 3m) | Limit (dBuV/m @ 3m) |
|-----------------------|-------------------|---------------------|
| 30 to 88 | 100 | 40 |
| 88 to 216 | 150 | 43.5 |
| 216 to 960 | 200 | 46.0 |
| Above 960 | 500 | 54.0 |

¹ The restricted bands are detailed in FCC 15.205 and RSS-Gen Table 6

FCC 15.407 (a) OUTPUT POWER LIMITS

The table below shows the limits for output power and output power density. For the 5250-5350 and 5470-5725 MHz bands, where the signal bandwidth is less than 20 MHz the maximum output power is reduced to the power spectral density limit plus 10 times the log of the bandwidth (in MHz).

| Operating Frequency (MHz) | Output Power | Power Spectral Density |
|---------------------------|-----------------|------------------------|
| 5150 – 5250 | 1Watt (30 dBm) | 17 dBm/MHz |
| 5250 – 5350 and 5470-5725 | 250 mW (24 dBm) | 11 dBm/MHz |
| 5725 – 5825 | 1 Watt (30 dBm) | 30 dBm/500kHz |

For system using antennas with gains exceeding 6dBi, the output power and power spectral density limits are reduced by 1dB for every dB the antenna gain exceeds 6dBi.

SPURIOUS EMISSIONS LIMITS –UNII and LELAN DEVICES

The spurious emissions limits for signals below 1GHz are the FCC/RSS-Gen general limits. For emissions above 1GHz, signals in restricted bands are subject to the FCC/RSS-Gen general limits. All other signals have a limit of -27dBm/MHz , which is field strength of 68.3dBuV/m/MHz at a distance of 3m. For devices operating in the 5725-5850 MHz bands under the LELAN/UNII rules, the limit within 10MHz of the allocated band is increased to -17dBm/MHz .

SAMPLE CALCULATIONS - CONDUCTED EMISSIONS

Receiver readings are compared directly to the conducted emissions specification limit (decibel form) as follows:

$$R_r - S = M$$

where:

R_r = Receiver Reading in dBuV

S = Specification Limit in dBuV

M = Margin to Specification in +/- dB

SAMPLE CALCULATIONS - RADIATED EMISSIONS

Receiver readings are compared directly to the specification limit (decibel form). The receiver internally corrects for cable loss, preamplifier gain, and antenna factor. The calculations are in the reverse direction of the actual signal flow, thus cable loss is added and the amplifier gain is subtracted. The Antenna Factor converts the voltage at the antenna coaxial connector to the field strength at the antenna elements.

A distance factor, when used for electric field measurements above 30MHz, is calculated by using the following formula:

$$F_d = 20 * \text{LOG}_{10} (D_m/D_s)$$

where:

F_d = Distance Factor in dB

D_m = Measurement Distance in meters

D_s = Specification Distance in meters

For electric field measurements below 30MHz the extrapolation factor is either determined by making measurements at multiple distances or a theoretical value is calculated using the formula:

$$F_d = 40 * \text{LOG}_{10} (D_m/D_s)$$

Measurement Distance is the distance at which the measurements were taken and Specification Distance is the distance at which the specification limits are based. The antenna factor converts the voltage at the antenna coaxial connector to the field strength at the antenna elements.

The margin of a given emission peak relative to the limit is calculated as follows:

$$R_c = R_r + F_d$$

and

$$M = R_c - L_s$$

where:

R_r = Receiver Reading in dBuV/m

F_d = Distance Factor in dB

R_c = Corrected Reading in dBuV/m

L_s = Specification Limit in dBuV/m

M = Margin in dB Relative to Spec

SAMPLE CALCULATIONS - FIELD STRENGTH TO EIRP CONVERSION

Where the radiated electric field strength is expressed in terms of the equivalent isotropic radiated power (eirp), or where a field strength measurement of output power is made in lieu of a direct measurement, the following formula is used to convert between eirp and field strength at a distance of d (meters) from the equipment under test:

$$E = \frac{1000000 \sqrt{30 P}}{d} \text{ microvolts per meter}$$

where P is the eirp (Watts)

For a measurement at 3m the conversion from a logarithmic value for field strength (dBuV/m) to an eirp power (dBm) is -95.3dB.

Appendix A Test Equipment Calibration Data

Radiated Emissions, 1000 - 40,000 MHz, 07-Mar-16

| <u>Manufacturer</u> | <u>Description</u> | <u>Model</u> | <u>Asset #</u> | <u>Calibrated</u> | <u>Cal Due</u> |
|---------------------|--|--------------------|----------------|-------------------|----------------|
| EMCO | Antenna, Horn, 1-18GHz | 3115 | 868 | 6/26/2014 | 6/26/2016 |
| Hewlett Packard | Microwave Preamplifier, 1-26.5GHz | 8449B | 870 | 1/21/2016 | 1/21/2017 |
| HP / Miteq | SA40 Head (Red) | TTA1840-45-5P-HG-S | 1145 | 7/17/2015 | 7/17/2016 |
| Hewlett Packard | Spectrum Analyzer (SA40) Red 30 Hz -40 GHz | 8564E (84125C) | 1148 | 10/17/2015 | 10/17/2016 |
| Micro-Tronics | Band Reject Filter, 5725-5875 MHz | BRC50705-02 | 1682 | 7/8/2015 | 7/8/2016 |
| Hewlett Packard | High Pass filter, 8.2 GHz (Purple System) | P/N 84300-80039 | 1767 | 11/3/2015 | 11/3/2016 |
| A. H. Systems | Purple System Horn, 18-40GHz | SAS-574, p/n: 2581 | 2160 | 8/28/2014 | 8/28/2017 |

Conducted Emissions - AC Power Ports, 08-Mar-16

| <u>Manufacturer</u> | <u>Description</u> | <u>Model</u> | <u>Asset #</u> | <u>Calibrated</u> | <u>Cal Due</u> |
|---------------------|--|--------------|----------------|-------------------|----------------|
| Rohde & Schwarz | EMI Test Receiver, 20 Hz-7 GHz | ESIB7 | 1538 | 12/19/2015 | 12/19/2016 |
| Rohde & Schwarz | Pulse Limiter | ESH3 Z2 | 1594 | 5/14/2015 | 5/14/2016 |
| Com-Power | 9KHz-30MHz, 50uH, 15Aac, 10Adc, max CISPR 15 | LI-215A | 2671 | 6/26/2015 | 6/26/2016 |

Radio Antenna Port (Power and Spurious Emissions), 08-Mar-16

| <u>Manufacturer</u> | <u>Description</u> | <u>Model</u> | <u>Asset #</u> | <u>Calibrated</u> | <u>Cal Due</u> |
|----------------------|---|--------------|----------------|-------------------|----------------|
| Agilent Technologies | PSA, Spectrum Analyzer, (installed options, 111, 115, 123, 1DS, B7J, HYX, | E4446A | 2139 | 6/22/2015 | 6/22/2016 |

Appendix B Test Data

T101080 Pages 26 – 57



EMC Test Data

| | | | |
|------------------------|--------------------------------|----------------------|-------------------|
| Client: | Aruba Networks | Job Number: | JD100928 |
| Product: | APIN0103 (FCC ID: Q9DAPIN0103) | T-Log Number: | T101080 |
| System Configuration: | - | Project Manager: | Christine Krebill |
| Contact: | Rob Hastings | Project Coordinator: | - |
| Emissions Standard(s): | FCC 15.407 | Class: | B |
| Immunity Standard(s): | - | Environment: | - |

EMC Test Data

For The

Aruba Networks

Product

APIN0103 (FCC ID: Q9DAPIN0103)

Date of Last Test: 3/8/2016

| | | | |
|-----------|--------------------------------|----------------------|-------------------|
| Client: | Aruba Networks | Job Number: | JD100928 |
| Model: | APIN0103 (FCC ID: Q9DAPIN0103) | T-Log Number: | T101080 |
| | | Project Manager: | Christine Krebill |
| Contact: | Rob Hastings | Project Coordinator: | - |
| Standard: | FCC 15.407 | Class: | N/A |

Power vs. Data Rate

In normal operating modes the card uses power settings stored on EEPROM to set the output power. For a given nominal output power the actual transmit power normally is reduced as the data rate increases, therefore testing was performed at the data rate in the mode with highest power to determine compliance with the requirements.

The following power measurements were made using a **GATED** average power meter and with the device configured in a continuous transmit mode on Chain 1 at the various data rates in each mode to verify the highest power mode:

Sample Notes

Sample S/N: CU0005990

Driver:

Duty Cycle

Date of Test: 3/7/2016

Test Engineer: Mehran Birgani

Test Location: Lab 3

Duty cycle measurements performed on the worse case data rate for power.

Notes: Measurements taken with maximum RBW/VBW settings allowed.

| Mode | Data Rate | Duty Cycle (x) | Constant DC? | T (ms) | Pwr Cor Factor* | Lin Volt Cor Factor** | Min VBW for FS (Hz) |
|------|-----------|----------------|--------------|--------|-----------------|-----------------------|---------------------|
| 11a | 12 MBps | 98.4% | Yes | 2.70 | 0 | 0 | 10 |
| n20 | MCS 0 | 99.0% | Yes | 4.98 | 0 | 0 | 10 |
| n40 | MCS 0 | 98.8% | Yes | 2.41 | 0 | 0 | 10 |

* Correction factor when using RMS/Power averaging - $10 \cdot \log(1/x)$

** Correction factor when using linear voltage average - $20 \cdot \log(1/x)$

T = Minimum transmission duration

| | |
|---------------------------------------|------------------------------------|
| Client: Aruba Networks | Job Number: JD100928 |
| Model: APIN0103 (FCC ID: Q9DAPIN0103) | T-Log Number: T101080 |
| | Project Manager: Christine Krebill |
| Contact: Rob Hastings | Project Coordinator: - |
| Standard: FCC 15.407 | Class: N/A |

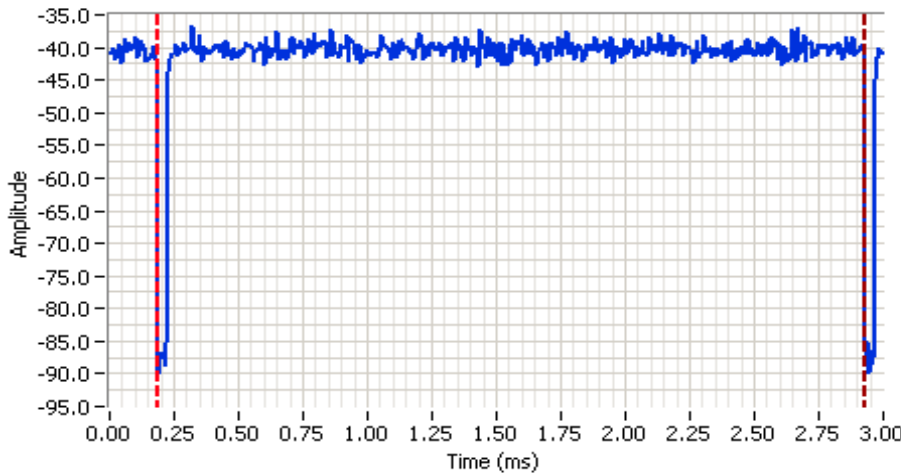

Analyzer Settings
 Rohde&Schwarz,ESI
 CF: 5745.000 MHz
 SPAN: 0.000 MHz
 RB: 10.000 MHz
 VB: 10.000 MHz
 Detector: POS
 Attn: 0 DB
 RL Offset: 0.0 DB
 Sweep Time: 3.0ms
 Ref Lvl: -35.0 DBM

Comments
 802.11a 12Mbps
 Off time: 0.04ms
 One time: 2.70ms
 Duty cycle: 98.4%

Cursor 1: 0.1836 0.00 [Icons] Delta Time (ms): 2.746

Cursor 2: 2.9297 0.00 [Icons] Delta Amplitude: 0.00

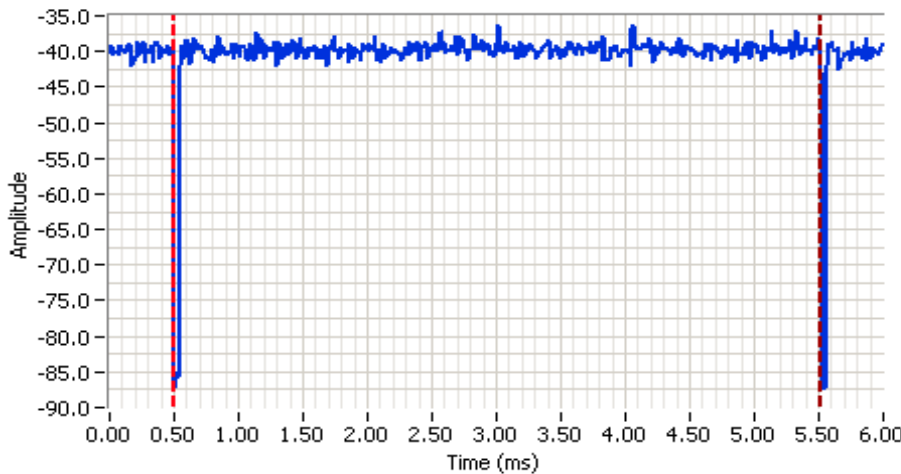

Analyzer Settings
 Rohde&Schwarz,ESI
 CF: 5745.000 MHz
 SPAN: 0.000 MHz
 RB: 10.000 MHz
 VB: 10.000 MHz
 Detector: POS
 Attn: 0 DB
 RL Offset: 0.0 DB
 Sweep Time: 6.0ms
 Ref Lvl: -35.0 DBM

Comments
 802.11n 20 MCS 0
 Off time: 0.05ms
 One time: 4.98ms
 Duty cycle: 99.0%

Cursor 1: 0.4922 0.00 [Icons] Delta Time (ms): 5.029

Cursor 2: 5.5208 0.00 [Icons] Delta Amplitude: 0.00



| | |
|---------------------------------------|------------------------------------|
| Client: Aruba Networks | Job Number: JD100928 |
| Model: APIN0103 (FCC ID: Q9DAPIN0103) | T-Log Number: T101080 |
| | Project Manager: Christine Krebill |
| Contact: Rob Hastings | Project Coordinator: - |
| Standard: FCC 15.407 | Class: N/A |

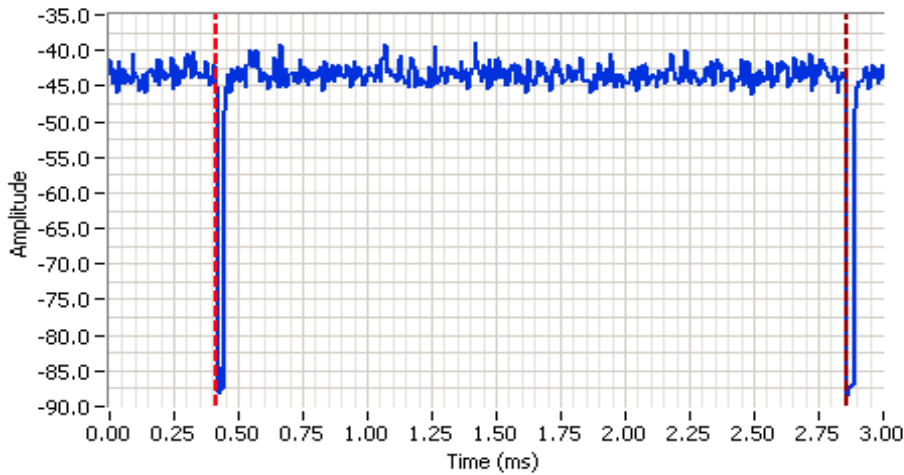

Analyzer Settings

Rohde&Schwarz, ESI
 CF: 5745.000 MHz
 SPAN: 0.000 MHz
 RB: 10.000 MHz
 VB: 10.000 MHz
 Detector: POS
 Attn: 0 DB
 RL Offset: 0.0 DB
 Sweep Time: 3.0ms
 Ref Lvl: -35.0 DBM

Comments

802.11n 40 MCS 0
 Off time: 0.03ms
 One time: 2.41ms
 Duty cycle: 98.8%

| | | | | | |
|----------|--------|------|--|-----------------|-------|
| Cursor 1 | 0.4154 | 0.00 | | Delta Time (ms) | 2.441 |
| Cursor 2 | 2.8561 | 0.00 | | Delta Amplitude | 0.00 |

| | |
|---------------------------------------|------------------------------------|
| Client: Aruba Networks | Job Number: JD100928 |
| Model: APIN0103 (FCC ID: Q9DAPIN0103) | T-Log Number: T101080 |
| | Project Manager: Christine Krebill |
| Contact: Rob Hastings | Project Coordinator: - |
| Standard: FCC 15.407 | Class: N/A |

Date of Test: 3/7/2016
 Test Engineer: Mehran Birgani
 Test Location: Lab 3

Data Rate

| Mode | Data Rate | Power (dBm) | Power setting |
|---------------------|-----------|-------------|---------------|
| 802.11a | 6 | 19.5 | 20.0 |
| | 9 | 19.6 | |
| | 12 | 19.7 | |
| | 18 | 19.4 | |
| | 24 | 19.6 | |
| | 36 | 19.4 | |
| | 48 | 19.4 | |
| | 54 | 19.4 | |
| 802.11n 20MHz | 6.5 | 19.5 | 20.0 |
| | 13 | 19.4 | |
| | 19.5 | 19.4 | |
| | 26 | 19.3 | |
| | 39 | 19.5 | |
| | 52 | 19.4 | |
| | 58.5 | 19.3 | |
| | 65 | 19.3 | |
| 802.11n/ac 40MHz | 13.5 | 19.3 | 20.0 |
| | 27 | 19.3 | |
| | 40.5 | 19.2 | |
| | 54 | 19.2 | |
| | 81 | 19.2 | |
| | 108 | 19.0 | |
| | 121.5 | 19.1 | |
| | 135 | 19.0 | |

Note : Power setting - the software power setting used during testing, included for reference only.



EMC Test Data

| | |
|---------------------------------------|------------------------------------|
| Client: Aruba Networks | Job Number: JD100928 |
| Model: APIN0103 (FCC ID: Q9DAPIN0103) | T-Log Number: T101080 |
| | Project Manager: Christine Krebill |
| Contact: Rob Hastings | Project Coordinator: - |
| Standard: FCC 15.407 | Class: N/A |

Summary of Results

| Run # | Mode | Channel | Target Setting | Final Setting | Test Performed | Limit | Result / Margin |
|---|------|---------------|----------------|---------------|---------------------------|-------|------------------------------------|
| 20MHz Bandwith Modes | | | | | | | |
| 1 | a | 149 - 5745MHz | 18 | 19 | Band Edge 5715 MHz | 15E | 62.6 dBµV/m @ 5715.0 MHz (-5.7 dB) |
| | | | | | Band Edge 5715 - 5725 MHz | | 78.0 dBµV/m @ 5724.9 MHz (-0.3 dB) |
| | | 165 - 5825MHz | 18 | 23 | Band Edge 5850 MHz | | 76.1 dBµV/m @ 5850.8 MHz (-2.2 dB) |
| | | | | | Band Edge 5860 MHz | | 65.8 dBµV/m @ 5860.3 MHz (-2.5 dB) |
| 20MHz Bandwith Modes (continued) | | | | | | | |
| 2 | HT20 | 149 - 5745MHz | 18 | 17 | Band Edge 5715 MHz | 15E | 60.8 dBµV/m @ 5712.5 MHz (-7.5 dB) |
| | | | | | Band Edge 5715 - 5725 MHz | | 77.6 dBµV/m @ 5725.0 MHz (-0.7 dB) |
| | | 165 - 5825MHz | 18 | 21 | Band Edge 5850 MHz | | 73.6 dBµV/m @ 5850.8 MHz (-4.7 dB) |
| | | | | | Band Edge 5860 MHz | | 66.9 dBµV/m @ 5862.6 MHz (-1.4 dB) |
| 40MHz Bandwith Modes | | | | | | | |
| 3 | HT40 | 151 - 5755MHz | 18 | 15 | Band Edge 5715 MHz | 15E | 67.8 dBµV/m @ 5711.2 MHz (-0.5 dB) |
| | | | | | Band Edge 5715 - 5725 MHz | | 74.0 dBµV/m @ 5723.2 MHz (-4.3 dB) |
| | | 159 - 5795MHz | 18 | 21 | Band Edge 5850 MHz | | 72.2 dBµV/m @ 5854.3 MHz (-6.1 dB) |
| | | | | | Band Edge 5860 MHz | | 66.7 dBµV/m @ 5860.9 MHz (-1.6 dB) |

| | |
|---------------------------------------|------------------------------------|
| Client: Aruba Networks | Job Number: JD100928 |
| Model: APIN0103 (FCC ID: Q9DAPIN0103) | T-Log Number: T101080 |
| | Project Manager: Christine Krebill |
| Contact: Rob Hastings | Project Coordinator: - |
| Standard: FCC 15.407 | Class: N/A |

Procedure Comments:

Measurements performed in accordance with FCC KDB 789033

Peak measurements performed with: RBW=1MHz, VBW=3MHz, peak detector, max hold, auto sweep time

Unless otherwise stated/noted, emission has duty cycle $\geq 98\%$ and was measured using RBW=1MHz, VBW=10Hz, peak detector, linear average mode, auto sweep time, max hold 50 traces. (method VB of KDB 789033)

| Mode | Data Rate | Duty Cycle (x) | Constant DC? | T (ms) | Pwr Cor Factor* | Lin Volt Cor Factor** | Min VBW for FS (Hz) |
|------|-----------|----------------|--------------|--------|-----------------|-----------------------|---------------------|
| 11a | 12 MBps | 98.4% | Yes | 2.70 | 0 | 0 | 10 |
| n20 | MCS 0 | 99.0% | Yes | 4.98 | 0 | 0 | 10 |
| n40 | MCS 0 | 98.8% | Yes | 2.41 | 0 | 0 | 10 |

Sample Notes

Sample S/N: CU0006604

Driver: -

Antenna: Internal

Measurement Specific Notes:

| | |
|---------|--|
| Note 1: | For emissions outside of the restricted bands the limit is -27dBm/MHz eirp (68.3dBuV/m). The measurement method required is a peak measurement (RB=1MHz, VB \geq 3MHz, peak detector). Per KDB 789033 2) c) (i), compliance can be demonstrated by meeting the average and peak limits of 15.209, as an alternative. |
| Note 3: | Emission has constant duty cycle < 98%, average measurement performed: RBW=1MHz, VBW>1/T but not less than 10Hz, peak detector, linear averaging, auto sweep,max hold 50*1/DC traces (method VB of KDB 789033) |
| Note 5: | Plots of the average and peak bandedge do not account for any duty cycle correction. Refer to the tabular results for final measurements. |



EMC Test Data

| | |
|---------------------------------------|------------------------------------|
| Client: Aruba Networks | Job Number: JD100928 |
| Model: APIN0103 (FCC ID: Q9DAPIN0103) | T-Log Number: T101080 |
| | Project Manager: Christine Krebill |
| Contact: Rob Hastings | Project Coordinator: - |
| Standard: FCC 15.407 | Class: N/A |

Run #1: Radiated Bandedge Measurements, 5725-5850 MHz

Date of Test: 03/07/16
 Test Engineer: Rafael Varelas
 Test Location: FT Chamber #7
 Config. Used: 1
 Config Change: None
 EUT Voltage: 120V/60Hz

Channel: 149 - 5745 MHz
 Tx Chain: 2Tx
 Mode: a
 Data Rate: 12 MBps

5715 MHz Band Edge Signal Radiated Field Strength

| Frequency | Level | Pol | FCC 15.209 | | Detector | Azimuth | Height | Comments |
|-----------|--------------|-----|------------|--------|-----------|---------|--------|--------------------------|
| MHz | dB μ V/m | v/h | Limit | Margin | Pk/QP/Avg | degrees | meters | |
| 5715.000 | 62.6 | V | 68.3 | -5.7 | PK | 146 | 2.0 | POS; RB 1 MHz; VB: 3 MHz |
| 5714.460 | 53.1 | H | 68.3 | -15.2 | PK | 104 | 1.3 | POS; RB 1 MHz; VB: 3 MHz |

5715-5725 MHz Band Edge Signal Radiated Field Strength

| Frequency | Level | Pol | 15.E | | Detector | Azimuth | Height | Comments |
|-----------|--------------|-----|-------|--------|-----------|---------|--------|--------------------------|
| MHz | dB μ V/m | v/h | Limit | Margin | Pk/QP/Avg | degrees | meters | |
| 5724.920 | 78.0 | V | 78.3 | -0.3 | PK | 146 | 2.0 | POS; RB 1 MHz; VB: 3 MHz |
| 5724.880 | 69.7 | H | 78.3 | -8.6 | PK | 104 | 1.3 | POS; RB 1 MHz; VB: 3 MHz |

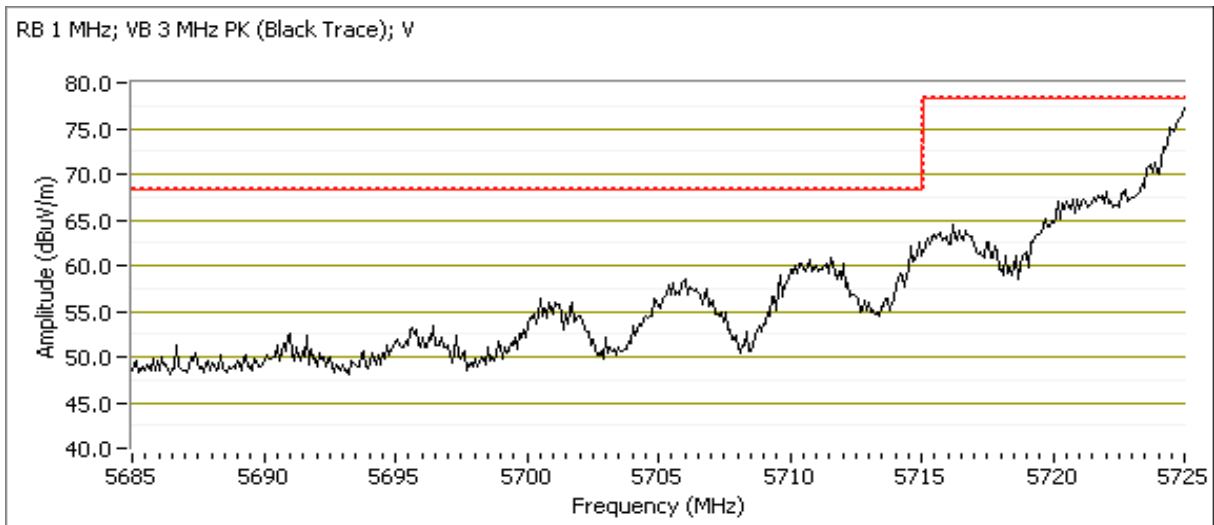



EMC Test Data

| | |
|---------------------------------------|------------------------------------|
| Client: Aruba Networks | Job Number: JD100928 |
| Model: APIN0103 (FCC ID: Q9DAPIN0103) | T-Log Number: T101080 |
| | Project Manager: Christine Krebill |
| Contact: Rob Hastings | Project Coordinator: - |
| Standard: FCC 15.407 | Class: N/A |

Channel: 165 - 5825 MHz
 Tx Chain: 2Tx
 Mode: a
 Data Rate: 12 MBps

5850 MHz Band Edge Signal Radiated Field Strength

| Frequency | Level | Pol | FCC 15.209 | | Detector | Azimuth | Height | Comments |
|-----------|--------------|-----|------------|--------|-----------|---------|--------|--------------------------|
| MHz | dB μ V/m | v/h | Limit | Margin | Pk/QP/Avg | degrees | meters | |
| 5850.760 | 76.1 | V | 78.3 | -2.2 | PK | 8 | 2.6 | POS; RB 1 MHz; VB: 3 MHz |
| 5855.010 | 69.6 | H | 78.3 | -8.7 | PK | 176 | 2.2 | POS; RB 1 MHz; VB: 3 MHz |

5860 MHz Band Edge Signal Radiated Field Strength

| Frequency | Level | Pol | 15.E | | Detector | Azimuth | Height | Comments |
|-----------|--------------|-----|-------|--------|-----------|---------|--------|--------------------------|
| MHz | dB μ V/m | v/h | Limit | Margin | Pk/QP/Avg | degrees | meters | |
| 5860.300 | 65.8 | V | 68.3 | -2.5 | PK | 8 | 2.6 | POS; RB 1 MHz; VB: 3 MHz |
| 5860.120 | 61.1 | H | 68.3 | -7.2 | PK | 176 | 2.2 | POS; RB 1 MHz; VB: 3 MHz |

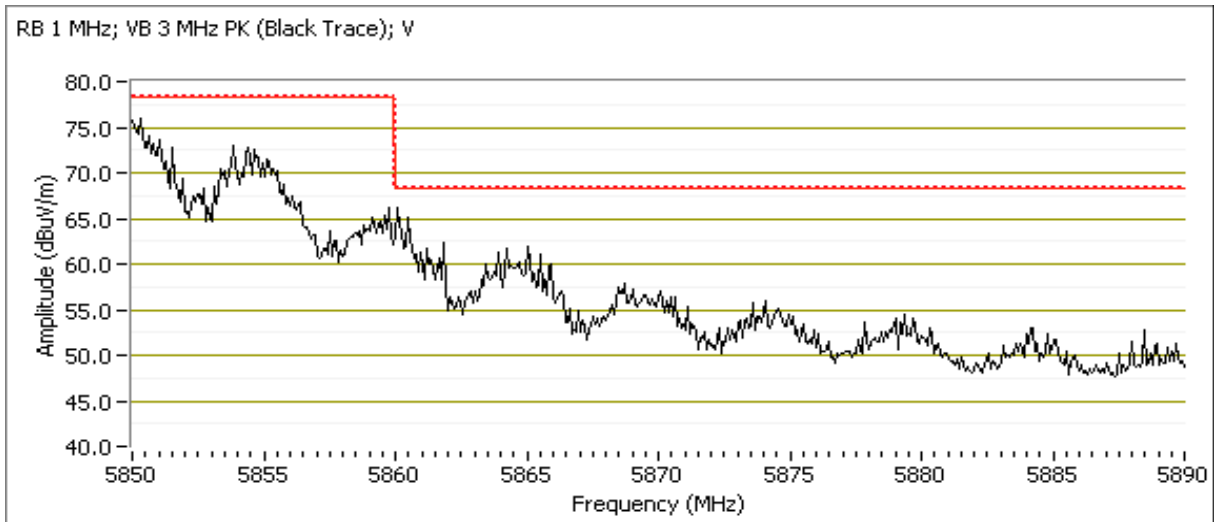



EMC Test Data

| | |
|---------------------------------------|------------------------------------|
| Client: Aruba Networks | Job Number: JD100928 |
| Model: APIN0103 (FCC ID: Q9DAPIN0103) | T-Log Number: T101080 |
| | Project Manager: Christine Krebill |
| Contact: Rob Hastings | Project Coordinator: - |
| Standard: FCC 15.407 | Class: N/A |

Run #2: Radiated Bandedge Measurements, 5725-5850 MHz

Date of Test: 03/07/16
 Test Engineer: Rafael Varelas
 Test Location: FT Chamber #7
 Config. Used: 1
 Config Change: None
 EUT Voltage: 120V/60Hz

Channel: 149 - 5745 MHz
 Tx Chain: 2Tx
 Mode: HT20
 Data Rate: MCS 0

5715 MHz Band Edge Signal Radiated Field Strength

| Frequency | Level | Pol | FCC 15.209 | | Detector | Azimuth | Height | Comments |
|-----------|--------------|-----|------------|--------|-----------|---------|--------|--------------------------|
| MHz | dB μ V/m | v/h | Limit | Margin | Pk/QP/Avg | degrees | meters | |
| 5712.480 | 60.8 | V | 68.3 | -7.5 | PK | 320 | 2.5 | POS; RB 1 MHz; VB: 3 MHz |
| 5713.920 | 56.1 | H | 68.3 | -12.2 | PK | 42 | 2.2 | POS; RB 1 MHz; VB: 3 MHz |

5715-5725 MHz Band Edge Signal Radiated Field Strength

| Frequency | Level | Pol | 15.E | | Detector | Azimuth | Height | Comments |
|-----------|--------------|-----|-------|--------|-----------|---------|--------|--------------------------|
| MHz | dB μ V/m | v/h | Limit | Margin | Pk/QP/Avg | degrees | meters | |
| 5724.960 | 77.6 | V | 78.3 | -0.7 | PK | 0 | 2.3 | POS; RB 1 MHz; VB: 3 MHz |
| 5722.600 | 68.6 | H | 78.3 | -9.7 | PK | 91 | 1.5 | POS; RB 1 MHz; VB: 3 MHz |

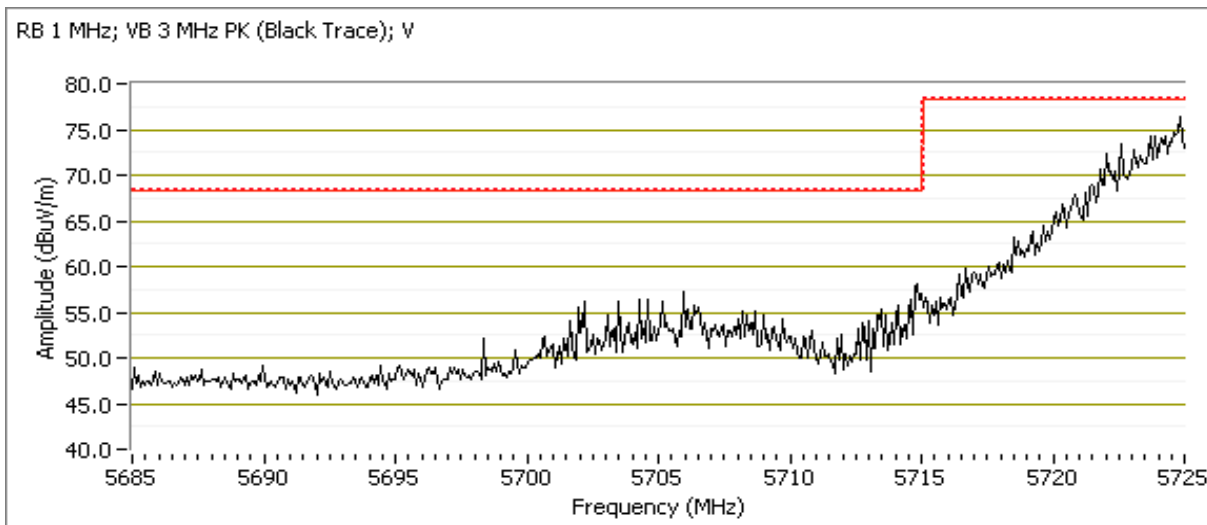



EMC Test Data

| | |
|---------------------------------------|------------------------------------|
| Client: Aruba Networks | Job Number: JD100928 |
| Model: APIN0103 (FCC ID: Q9DAPIN0103) | T-Log Number: T101080 |
| | Project Manager: Christine Krebill |
| Contact: Rob Hastings | Project Coordinator: - |
| Standard: FCC 15.407 | Class: N/A |

Channel: 165 - 5825 MHz
 Tx Chain: 2Tx
 Mode: HT20
 Data Rate: MCS 0

5850 MHz Band Edge Signal Radiated Field Strength

| Frequency | Level | Pol | FCC 15.209 | | Detector | Azimuth | Height | Comments |
|-----------|--------------|-----|------------|--------|-----------|---------|--------|--------------------------|
| MHz | dB μ V/m | v/h | Limit | Margin | Pk/QP/Avg | degrees | meters | |
| 5850.800 | 73.6 | V | 78.3 | -4.7 | PK | 238 | 2.0 | POS; RB 1 MHz; VB: 3 MHz |
| 5850.600 | 61.5 | H | 78.3 | -16.8 | PK | 106 | 1.6 | POS; RB 1 MHz; VB: 3 MHz |

5860 MHz Band Edge Signal Radiated Field Strength

| Frequency | Level | Pol | 15.E | | Detector | Azimuth | Height | Comments |
|-----------|--------------|-----|-------|--------|-----------|---------|--------|--------------------------|
| MHz | dB μ V/m | v/h | Limit | Margin | Pk/QP/Avg | degrees | meters | |
| 5862.580 | 66.9 | V | 68.3 | -1.4 | PK | 197 | 2.2 | POS; RB 1 MHz; VB: 3 MHz |
| 5862.400 | 53.6 | H | 68.3 | -14.7 | PK | 106 | 1.6 | POS; RB 1 MHz; VB: 3 MHz |

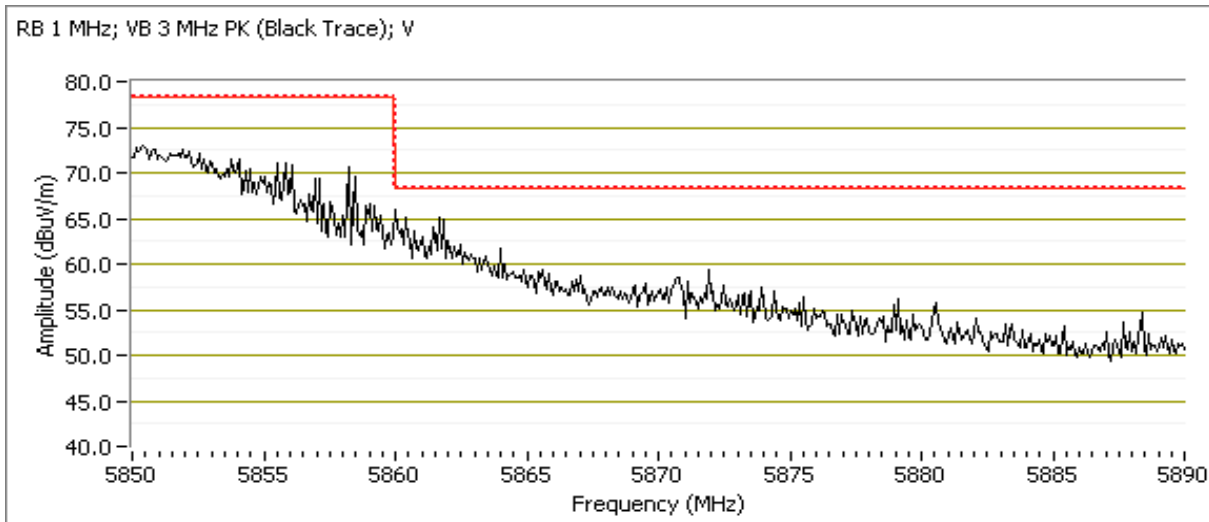



EMC Test Data

| | |
|---------------------------------------|------------------------------------|
| Client: Aruba Networks | Job Number: JD100928 |
| Model: APIN0103 (FCC ID: Q9DAPIN0103) | T-Log Number: T101080 |
| | Project Manager: Christine Krebill |
| Contact: Rob Hastings | Project Coordinator: - |
| Standard: FCC 15.407 | Class: N/A |

Run #3: Radiated Bandedge Measurements, 5725-5850 MHz

Date of Test: 03/07/16
 Test Engineer: Rafael Varelas
 Test Location: FT Chamber #7
 Config. Used: 1
 Config Change: None
 EUT Voltage: 120V/60Hz

Channel: 151 - 5755 MHz
 Tx Chain: 2Tx
 Mode: HT40
 Data Rate: MCS 0

5715 MHz Band Edge Signal Radiated Field Strength

| Frequency | Level | Pol | FCC 15.209 | | Detector | Azimuth | Height | Comments |
|-----------|--------------|-----|------------|--------|-----------|---------|--------|--------------------------|
| MHz | dB μ V/m | v/h | Limit | Margin | Pk/QP/Avg | degrees | meters | |
| 5711.220 | 67.8 | V | 68.3 | -0.5 | PK | 360 | 2.3 | POS; RB 1 MHz; VB: 3 MHz |
| 5712.050 | 66.3 | H | 68.3 | -2.0 | PK | 180 | 1.9 | POS; RB 1 MHz; VB: 3 MHz |

5715-5725 MHz Band Edge Signal Radiated Field Strength

| Frequency | Level | Pol | 15.E | | Detector | Azimuth | Height | Comments |
|-----------|--------------|-----|-------|--------|-----------|---------|--------|--------------------------|
| MHz | dB μ V/m | v/h | Limit | Margin | Pk/QP/Avg | degrees | meters | |
| 5723.200 | 74.0 | V | 78.3 | -4.3 | PK | 146 | 1.8 | POS; RB 1 MHz; VB: 3 MHz |
| 5719.110 | 67.8 | H | 78.3 | -10.5 | PK | 180 | 1.9 | POS; RB 1 MHz; VB: 3 MHz |

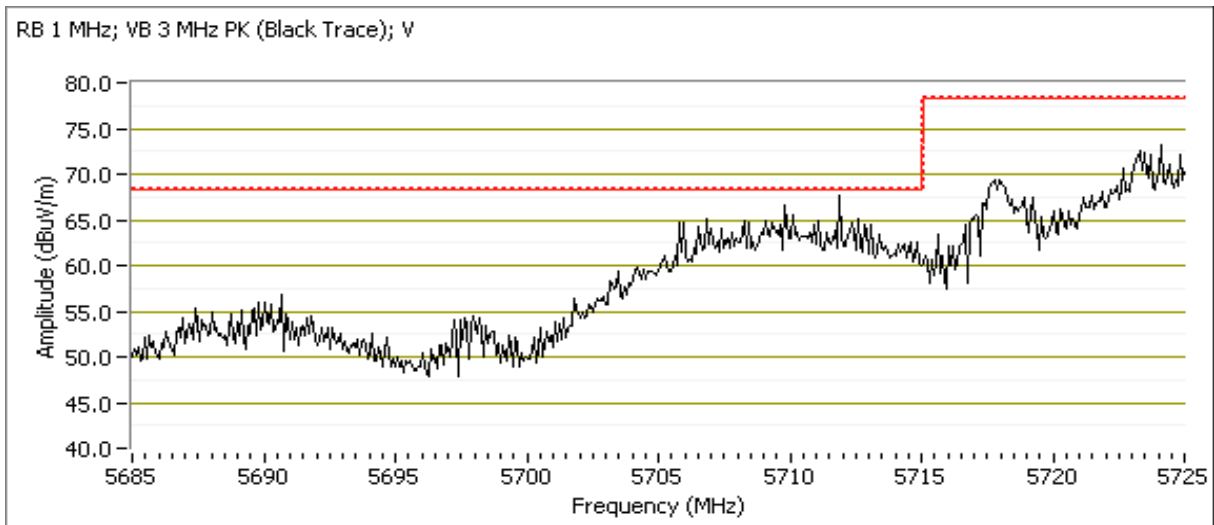



EMC Test Data

| | |
|---------------------------------------|------------------------------------|
| Client: Aruba Networks | Job Number: JD100928 |
| Model: APIN0103 (FCC ID: Q9DAPIN0103) | T-Log Number: T101080 |
| | Project Manager: Christine Krebill |
| Contact: Rob Hastings | Project Coordinator: - |
| Standard: FCC 15.407 | Class: N/A |

Channel: 159 - 5795 MHz
 Tx Chain: 2Tx
 Mode: HT40
 Data Rate: MCS 0

5850 MHz Band Edge Signal Radiated Field Strength

| Frequency MHz | Level dB μ V/m | Pol v/h | FCC 15.209 | | Detector Pk/QP/Avg | Azimuth degrees | Height meters | Comments |
|------------------|-----------------------|------------|------------|--------|-----------------------|--------------------|------------------|--------------------------|
| | | | Limit | Margin | | | | |
| 5854.250 | 72.2 | V | 78.3 | -6.1 | PK | 5 | 2.5 | POS; RB 1 MHz; VB: 3 MHz |
| 5851.800 | 62.9 | H | 78.3 | -15.4 | PK | 54 | 2.8 | POS; RB 1 MHz; VB: 3 MHz |

5860 MHz Band Edge Signal Radiated Field Strength

| Frequency MHz | Level dB μ V/m | Pol v/h | 15.E | | Detector Pk/QP/Avg | Azimuth degrees | Height meters | Comments |
|------------------|-----------------------|------------|-------|--------|-----------------------|--------------------|------------------|--------------------------|
| | | | Limit | Margin | | | | |
| 5860.940 | 66.7 | V | 68.3 | -1.6 | PK | 5 | 2.5 | POS; RB 1 MHz; VB: 3 MHz |
| 5860.600 | 62.0 | H | 68.3 | -6.3 | PK | 54 | 2.8 | POS; RB 1 MHz; VB: 3 MHz |

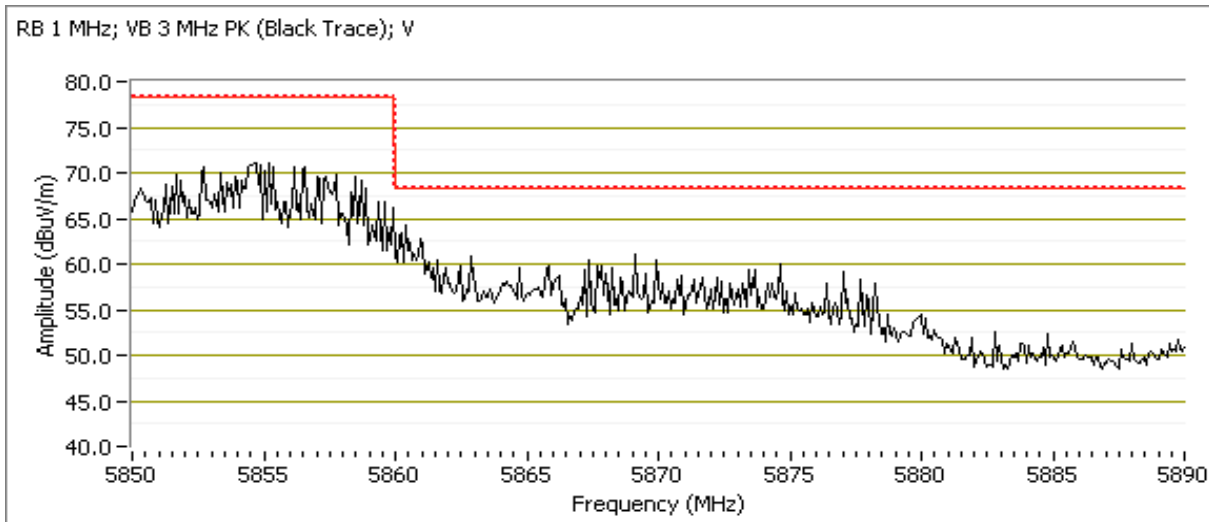

| | | | |
|-----------|--------------------------------|----------------------|-------------------|
| Client: | Aruba Networks | Job Number: | JD100928 |
| Model: | APIN0103 (FCC ID: Q9DAPIN0103) | T-Log Number: | T101080 |
| | | Project Manager: | Christine Krebill |
| Contact: | Rob Hastings | Project Coordinator: | - |
| Standard: | FCC 15.407 | Class: | N/A |

RSS-247 and FCC 15.407 (UNII) Radiated Spurious Emissions

Test Specific Details

Objective: The objective of this test session is to perform final qualification testing of the EUT with respect to the specification listed above.

General Test Configuration

The EUT and all local support equipment were located on the turntable for radiated spurious emissions testing. For radiated emissions testing the measurement antenna was located 3 meters from the EUT, unless otherwise noted.

Ambient Conditions:

Temperature: 21.8 °C
Rel. Humidity: 35 %

Summary of Results

| Run # | Mode | Channel | Target Setting | Final Setting | Test Performed | Limit | Result / Margin |
|---|------|---------------|----------------|---------------|--------------------------------|-------------------|------------------------------------|
| Scans on "center" channel in all OFDM modes to determine the worst case mode. | | | | | | | |
| 1 | a | 157 - 5785MHz | 18 | 23 | Radiated Emissions, 1 - 40 GHz | FCC 15.209 / 15 E | 47.7 dBµV/m @ 1720.1 MHz (-6.3 dB) |
| | n20 | 157 - 5785MHz | 18 | 23 | Radiated Emissions, 1 - 40 GHz | FCC 15.209 / 15 E | 48.0 dBµV/m @ 5400.0 MHz (-6.0 dB) |
| | n40 | 151 - 5755MHz | 18 | 23 | Radiated Emissions, 1 - 40 GHz | FCC 15.209 / 15 E | 48.7 dBµV/m @ 5399.9 MHz (-5.3 dB) |
| High channel for worse case mode | | | | | | | |
| 2 | n40 | 159 - 5795MHz | 18 | 23 | Radiated Emissions, 1 - 40 GHz | FCC 15.209 / 15 E | 50.0 dBµV/m @ 5439.9 MHz (-4.0 dB) |

Modifications Made During Testing

No modifications were made to the EUT during testing

Deviations From The Standard

No deviations were made from the requirements of the standard.

| | | | |
|-----------|--------------------------------|----------------------|-------------------|
| Client: | Aruba Networks | Job Number: | JD100928 |
| Model: | APIN0103 (FCC ID: Q9DAPIN0103) | T-Log Number: | T101080 |
| | | Project Manager: | Christine Krebill |
| Contact: | Rob Hastings | Project Coordinator: | - |
| Standard: | FCC 15.407 | Class: | N/A |

Procedure Comments:

Measurements performed in accordance with FCC KDB 789033

Peak measurements performed with: RBW=1MHz, VBW=3MHz, peak detector, max hold, auto sweep time

Unless otherwise stated/noted, emission has duty cycle $\geq 98\%$ and was measured using RBW=1MHz, VBW=10Hz, peak detector, linear average mode, auto sweep time, max hold 50 traces. (method VB of KDB 789033)

| Mode | Data Rate | Duty Cycle (x) | Constant DC? | T (ms) | Pwr Cor Factor* | Lin Volt Cor Factor** | Min VBW for FS (Hz) |
|------|-----------|----------------|--------------|--------|-----------------|-----------------------|---------------------|
| 11a | 12 MBps | 98.4% | Yes | 2.70 | 0 | 0 | 10 |
| n20 | MCS 0 | 99.0% | Yes | 4.98 | 0 | 0 | 10 |
| n40 | MCS 0 | 98.8% | Yes | 2.41 | 0 | 0 | 10 |

Sample Notes

Sample S/N: CU0006604

Driver: -

Antenna: Internal

Measurement Specific Notes:

| | |
|---------|--|
| Note 1: | For emissions outside of the restricted bands the limit is -27dBm/MHz eirp (68.3dBuV/m). The measurement method required is a peak measurement (RB=1MHz, VB \geq 3MHz, peak detector). Per KDB 789033 2) c) (i), compliance can be demonstrated by meeting the average and peak limits of 15.209, as an alternative. |
| Note 3: | Emission has constant duty cycle < 98%, average measurement performed: RBW=1MHz, VBW>1/T but not less than 10Hz, peak detector, linear averaging, auto sweep,max hold 50*1/DC traces (method VB of KDB 789033) |

Notes:

Original testing showed no radio related emissions below 1GHz.

| | |
|---------------------------------------|------------------------------------|
| Client: Aruba Networks | Job Number: JD100928 |
| Model: APIN0103 (FCC ID: Q9DAPIN0103) | T-Log Number: T101080 |
| | Project Manager: Christine Krebill |
| Contact: Rob Hastings | Project Coordinator: - |
| Standard: FCC 15.407 | Class: N/A |

Run #1, Radiated Spurious Emissions, 1,000 - 40,000 MHz. Operation in the 5725-5850 MHz Band

| | |
|-------------------------------|------------------------|
| Date of Test: 03/07/16 | Config. Used: 1 |
| Test Engineer: Rafael Varelas | Config Change: None |
| Test Location: FT Chamber #7 | EUT Voltage: 120V/60Hz |

Run #1a: Center Channel

Channel: 157 Mode: a
 Tx Chain: 2Tx Data Rate: 12 MBps

| Frequency MHz | Level dB μ V/m | Pol v/h | 15.209 / 15E | | Detector Pk/QP/Avg | Azimuth degrees | Height meters | Comments |
|------------------|-----------------------|------------|--------------|--------|-----------------------|--------------------|------------------|------------------------|
| | | | Limit | Margin | | | | |
| 1720.080 | 47.7 | V | 54.0 | -6.3 | AVG | 261 | 1.3 | RB 1 MHz;VB 10 Hz;Peak |
| 1720.110 | 50.7 | V | 74.0 | -23.3 | PK | 261 | 1.3 | RB 1 MHz;VB 3 MHz;Peak |
| 2150.160 | 49.9 | V | 68.3 | -18.4 | PK | 104 | 2.0 | RB 1 MHz;VB 3 MHz;Peak |
| 5359.770 | 45.8 | V | 54.0 | -8.2 | AVG | 176 | 1.0 | RB 1 MHz;VB 10 Hz;Peak |
| 5358.150 | 57.8 | V | 74.0 | -16.2 | PK | 176 | 1.0 | RB 1 MHz;VB 3 MHz;Peak |
| 6023.530 | 55.1 | V | 68.3 | -13.2 | PK | 184 | 2.4 | RB 1 MHz;VB 3 MHz;Peak |
| 4999.890 | 38.5 | V | 54.0 | -15.5 | AVG | 168 | 2.0 | RB 1 MHz;VB 10 Hz;Peak |
| 4998.130 | 54.7 | V | 74.0 | -19.3 | PK | 168 | 2.0 | RB 1 MHz;VB 3 MHz;Peak |

- Note: Scans made between 18 - 40 GHz with the measurement antenna moved around the card and its antennas 20-50cm from the device indicated there were no significant emissions in this frequency range
- Note 1: For emissions in restricted bands, the limit of 15.209 was used which requires average and peak measurements.
- Note 2: For emissions outside of the restricted bands the limit is -27dBm/MHz eirp (68.3dBuV/m). The measurement method required is a peak measurement (RB=1MHz, VB \geq 3MHz, peak detector).

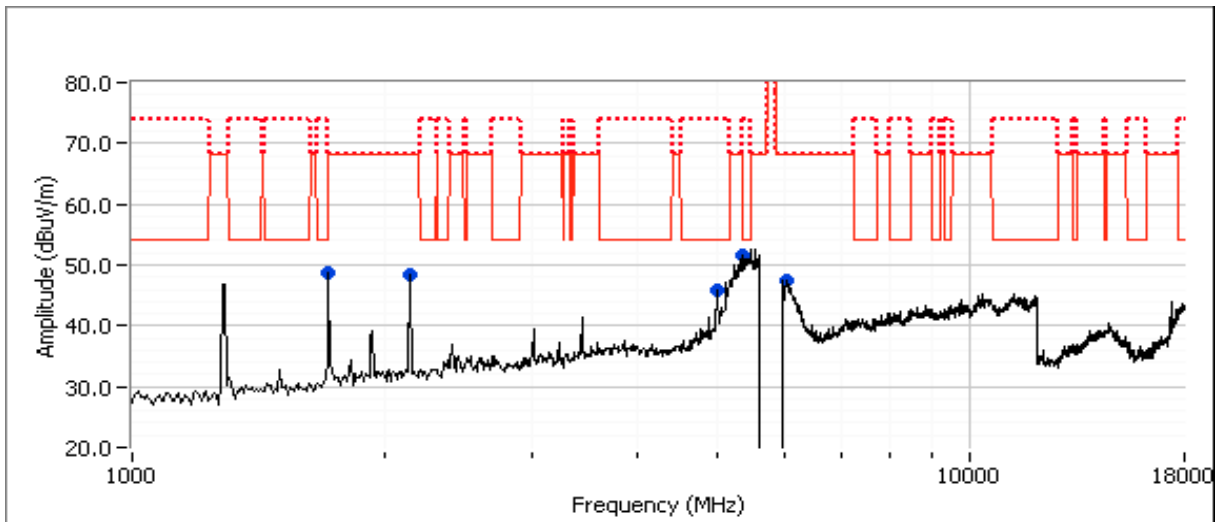

| | |
|---------------------------------------|------------------------------------|
| Client: Aruba Networks | Job Number: JD100928 |
| Model: APIN0103 (FCC ID: Q9DAPIN0103) | T-Log Number: T101080 |
| | Project Manager: Christine Krebill |
| Contact: Rob Hastings | Project Coordinator: - |
| Standard: FCC 15.407 | Class: N/A |

Run #1b: Center Channel

Channel: 157 Mode: 11n20
 Tx Chain: 2Tx Data Rate: MCS 0

| Frequency MHz | Level dB μ V/m | Pol v/h | 15.209 / 15E | | Detector Pk/QP/Avg | Azimuth degrees | Height meters | Comments |
|------------------|-----------------------|------------|--------------|--------|-----------------------|--------------------|------------------|------------------------|
| | | | Limit | Margin | | | | |
| 5400.030 | 48.0 | V | 54.0 | -6.0 | AVG | 180 | 2.4 | RB 1 MHz;VB 10 Hz;Peak |
| 5400.010 | 58.4 | V | 74.0 | -15.6 | PK | 180 | 2.4 | RB 1 MHz;VB 3 MHz;Peak |
| 6083.860 | 55.2 | V | 68.3 | -13.1 | PK | 193 | 2.5 | RB 1 MHz;VB 3 MHz;Peak |
| 4999.550 | 37.8 | V | 54.0 | -16.2 | AVG | 175 | 2.2 | RB 1 MHz;VB 10 Hz;Peak |
| 4999.750 | 53.8 | V | 74.0 | -20.2 | PK | 175 | 2.2 | RB 1 MHz;VB 3 MHz;Peak |
| 1720.050 | 47.9 | V | 54.0 | -6.1 | AVG | 82 | 1.9 | RB 1 MHz;VB 10 Hz;Peak |
| 1720.170 | 50.5 | V | 74.0 | -23.5 | PK | 82 | 1.9 | RB 1 MHz;VB 3 MHz;Peak |
| 2150.180 | 46.2 | V | 68.3 | -22.1 | AVG | 83 | 1.9 | RB 1 MHz;VB 10 Hz;Peak |
| 2150.030 | 49.7 | V | 68.3 | -18.6 | PK | 83 | 1.9 | RB 1 MHz;VB 3 MHz;Peak |

- Note: Scans made between 18 - 40 GHz with the measurement antenna moved around the card and its antennas 20-50cm from the device indicated there were no significant emissions in this frequency range
- Note 1: For emissions in restricted bands, the limit of 15.209 was used which requires average and peak measurements.
- Note 2: For emissions outside of the restricted bands the limit is -27dBm/MHz eirp (68.3dBuV/m). The measurement method required is a peak measurement (RB=1MHz, VB \geq 3MHz, peak detector).

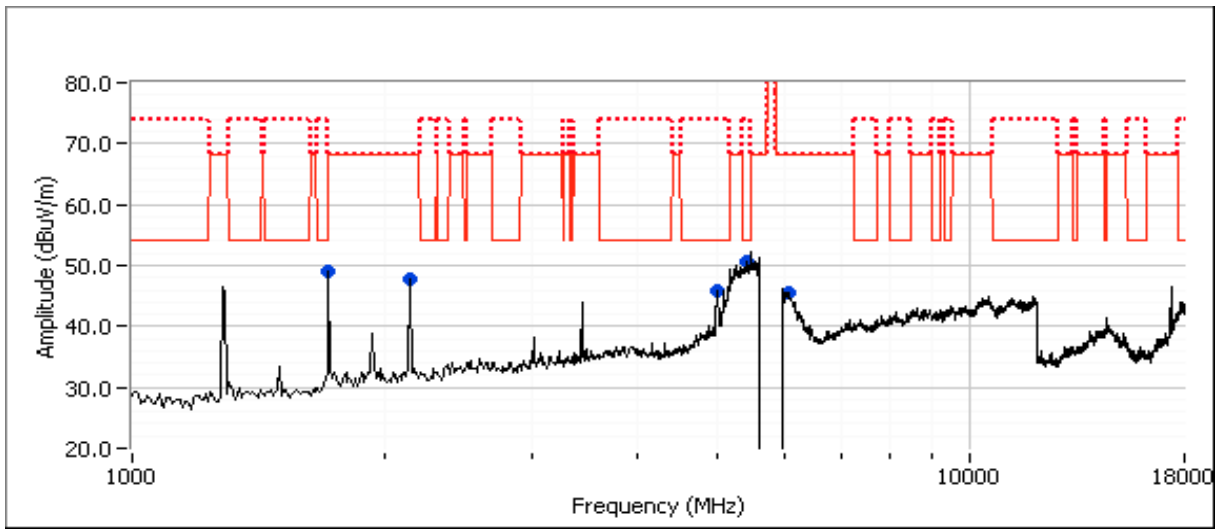

| | |
|---------------------------------------|------------------------------------|
| Client: Aruba Networks | Job Number: JD100928 |
| Model: APIN0103 (FCC ID: Q9DAPIN0103) | T-Log Number: T101080 |
| | Project Manager: Christine Krebill |
| Contact: Rob Hastings | Project Coordinator: - |
| Standard: FCC 15.407 | Class: N/A |

Run #1c: Center Channel

Channel: 151 Mode: 11n40
 Tx Chain: 2Tx Data Rate: MCS 0

| Frequency MHz | Level dB μ V/m | Pol v/h | 15.209 / 15E | | Detector Pk/QP/Avg | Azimuth degrees | Height meters | Comments |
|------------------|-----------------------|------------|--------------|--------|-----------------------|--------------------|------------------|------------------------|
| | | | Limit | Margin | | | | |
| 5399.930 | 48.7 | V | 54.0 | -5.3 | AVG | 192 | 2.0 | RB 1 MHz;VB 10 Hz;Peak |
| 5400.090 | 60.4 | V | 74.0 | -13.6 | PK | 192 | 2.0 | RB 1 MHz;VB 3 MHz;Peak |
| 2150.110 | 49.7 | V | 68.3 | -18.6 | PK | 86 | 1.9 | RB 1 MHz;VB 3 MHz;Peak |
| 1720.100 | 47.8 | V | 54.0 | -6.2 | AVG | 82 | 1.9 | RB 1 MHz;VB 10 Hz;Peak |
| 1719.970 | 50.6 | V | 74.0 | -23.4 | PK | 82 | 1.9 | RB 1 MHz;VB 3 MHz;Peak |
| 4997.270 | 38.8 | V | 54.0 | -15.2 | AVG | 206 | 2.2 | RB 1 MHz;VB 10 Hz;Peak |
| 4999.160 | 55.2 | V | 74.0 | -18.8 | PK | 206 | 2.2 | RB 1 MHz;VB 3 MHz;Peak |
| 6032.560 | 55.2 | V | 68.3 | -13.1 | PK | 203 | 2.4 | RB 1 MHz;VB 3 MHz;Peak |

- Note: Scans made between 18 - 40 GHz with the measurement antenna moved around the card and its antennas 20-50cm from the device indicated there were no significant emissions in this frequency range
- Note 1: For emissions in restricted bands, the limit of 15.209 was used which requires average and peak measurements.
- Note 2: For emissions outside of the restricted bands the limit is -27dBm/MHz eirp (68.3dBuV/m). The measurement method required is a peak measurement (RB=1MHz, VB \geq 3MHz, peak detector).

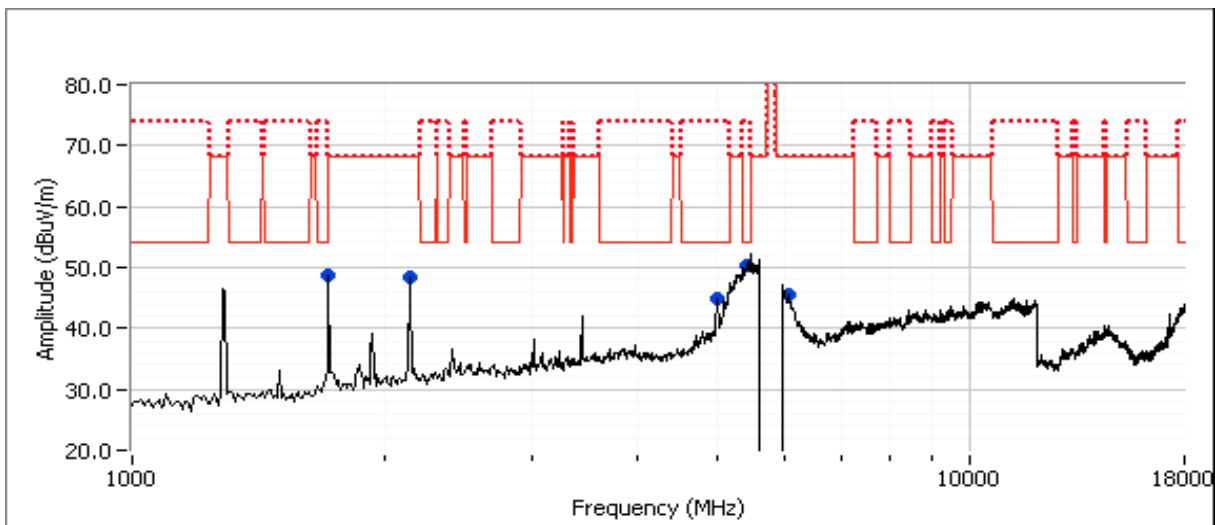

| | |
|---------------------------------------|------------------------------------|
| Client: Aruba Networks | Job Number: JD100928 |
| Model: APIN0103 (FCC ID: Q9DAPIN0103) | T-Log Number: T101080 |
| | Project Manager: Christine Krebill |
| Contact: Rob Hastings | Project Coordinator: - |
| Standard: FCC 15.407 | Class: N/A |

Run #2: Radiated Spurious Emissions, 1,000 - 40000 MHz. Operating Mode: Worse case from Run #1

Date of Test: 03/07/16 Config. Used: 1
 Test Engineer: Rafael Varelas Config Change: None
 Test Location: FT Chamber #7 EUT Voltage: 120V/60Hz

Run #2a: High Channel

Channel: 5795 Mode: 11n40
 Tx Chain: 2x2 Data Rate: MCS 0

| Frequency MHz | Level dB μ V/m | Pol v/h | 15.209 / 15.247 | | Detector Pk/QP/Avg | Azimuth degrees | Height meters | Comments |
|------------------|-----------------------|------------|-----------------|--------|-----------------------|--------------------|------------------|------------------------|
| | | | Limit | Margin | | | | |
| 5439.910 | 50.0 | V | 54.0 | -4.0 | AVG | 188 | 1.9 | RB 1 MHz;VB 10 Hz;Peak |
| 5440.150 | 60.1 | V | 74.0 | -13.9 | PK | 188 | 1.9 | RB 1 MHz;VB 3 MHz;Peak |
| 1720.120 | 48.3 | V | 54.0 | -5.7 | AVG | 256 | 1.3 | RB 1 MHz;VB 10 Hz;Peak |
| 1720.110 | 50.8 | V | 74.0 | -23.2 | PK | 256 | 1.3 | RB 1 MHz;VB 3 MHz;Peak |
| 6072.880 | 54.2 | V | 68.3 | -14.1 | PK | 239 | 2.0 | RB 1 MHz;VB 3 MHz;Peak |
| 4999.760 | 38.8 | V | 54.0 | -15.2 | AVG | 183 | 1.9 | RB 1 MHz;VB 10 Hz;Peak |
| 4999.040 | 55.1 | V | 74.0 | -18.9 | PK | 183 | 1.9 | RB 1 MHz;VB 3 MHz;Peak |
| 2149.990 | 51.5 | V | 68.3 | -16.8 | PK | 72 | 1.9 | RB 1 MHz;VB 3 MHz;Peak |

Note: Scans made between 18 - 40 GHz with the measurement antenna moved around the card and its antennas 20-50cm from the device indicated there were no significant emissions in this frequency range

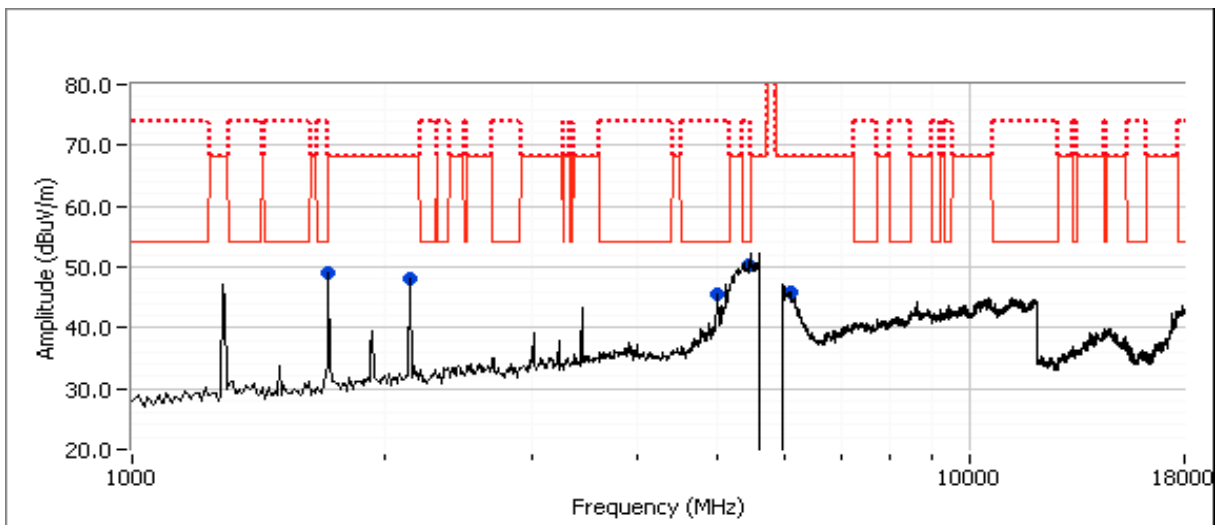

| | | | |
|-----------|--------------------------------|----------------------|-------------------|
| Client: | Aruba Networks | Job Number: | JD100928 |
| Model: | APIN0103 (FCC ID: Q9DAPIN0103) | T-Log Number: | T101080 |
| | | Project Manager: | Christine Krebill |
| Contact: | Rob Hastings | Project Coordinator: | - |
| Standard: | FCC 15.407 | Class: | N/A |

RSS-247 (LELAN) and FCC 15.407(UNII) Antenna Port Measurements Power, PSD, Bandwidth and Spurious Emissions

Test Specific Details

Objective: The objective of this test session is to perform final qualification testing of the EUT with respect to the specification listed above.

General Test Configuration

When measuring the conducted emissions from the EUT's antenna port, the antenna port of the EUT was connected to the spectrum analyzer or power meter via a suitable attenuator to prevent overloading the measurement system. All measurements are corrected to allow for the external attenuators and cables used.

Ambient Conditions:

| | |
|----------------|----------|
| Temperature: | 18-19 °C |
| Rel. Humidity: | 35-40 % |

Modifications Made During Testing

No modifications were made to the EUT during testing

Deviations From The Standard

No deviations were made from the requirements of the standard.

Sample Notes

Sample S/N: CU0005990

Driver: -



EMC Test Data

| | |
|---------------------------------------|------------------------------------|
| Client: Aruba Networks | Job Number: JD100928 |
| Model: APIN0103 (FCC ID: Q9DAPIN0103) | T-Log Number: T101080 |
| | Project Manager: Christine Krebill |
| Contact: Rob Hastings | Project Coordinator: - |
| Standard: FCC 15.407 | Class: N/A |

Summary of Results

| Run # | Test Performed | Limit | Pass / Fail | Result / Margin |
|-------|-----------------------|-------------------------------|-------------|---|
| 1 | Power, 5725 - 5850MHz | 15.407(a) (3) | Pass | a: 22.5dBm (178.3 mW) n20: 21.6dBm (145.0 mW) n40: 20.9dBm (123.6 mW) |
| 1 | PSD, 5725 - 5850MHz | 15.407(a) (3) | Pass | a: 12.1dBm/MHz n20: 10.8dBm/MHz n40: 7.2dBm/MHz |
| 1 | 99% Bandwidth | RSS-GEN (Information only) | N/A | a: 18.4 MHz n20: 19.0 MHz n40: 36.5 MHz |

Procedure Comments:

Measurements performed in accordance with FCC KDB 789033 D01

| Mode | Data Rate | Duty Cycle (x) | Constant DC? | T (ms) | Pwr Cor Factor* | Lin Volt Cor Factor** | Min VBW for FS (Hz) |
|------|-----------|----------------|--------------|--------|-----------------|-----------------------|---------------------|
| 11a | 12 MBps | 98.4% | Yes | 2.70 | 0 | 0 | 10 |
| n20 | MCS 0 | 99.0% | Yes | 4.98 | 0 | 0 | 10 |
| n40 | MCS 0 | 98.8% | Yes | 2.41 | 0 | 0 | 10 |



EMC Test Data

| | |
|---------------------------------------|------------------------------------|
| Client: Aruba Networks | Job Number: JD100928 |
| Model: APIN0103 (FCC ID: Q9DAPIN0103) | T-Log Number: T101080 |
| | Project Manager: Christine Krebill |
| Contact: Rob Hastings | Project Coordinator: - |
| Standard: FCC 15.407 | Class: N/A |

Run #1: Bandwidth, Output Power and Power Spectral Density - MIMO Systems
 Date of Test: 03/08/16 Config. Used: 1
 Test Engineer: Mehran Birgani Config Change: None
 Test Location: Lab 4 EUT Voltage: 120V/60Hz

| | |
|---------|---|
| Note 1: | Duty Cycle \geq 98%. Output power measured using a spectrum analyzer (see plots below). RB=1MHz, VB=3 MHz, Span $>$ OBW, # of points in sweep \geq 2*span/RBW, auto sweep, RMS detector, power averaging on (transmitted signal was continuous, duty cycle \geq 98%) and power integration over the OBW (method SA-1 of ANSI C63.10). |
| Note 2: | Measured using the same analyzer settings used for output power. |
| Note 3: | 99% Bandwidth measured in accordance with C63.10 - RB between 1-5 % of OBW and VB \geq 3*RB, Span between 1.5 and 5 times OBW. |
| Note 4: | For MIMO systems the total output power and total PSD are calculated from the sum of the powers of the individual chains (in linear terms). The antenna gain used to determine the EIRP and limits for PSD/Output power depends on the operating mode of the MIMO device. If the signals on the non-coherent between the transmit chains then the gain used to determine the limits is the highest gain of the individual chains and the EIRP is the sum of the products of gain and power on each chain. If the signals are coherent then the effective antenna gain is the sum (in linear terms) of the gains for each chain and the EIRP is the product of the effective gain and total power. |

Antenna Gain Information

| Freq | Antenna Gain (dBi) / Chain | | | | BF | MultiChain Legacy | CDD | Sectorized / Xpol | Dir G (PWR) | Dir G (PSD) |
|-----------|----------------------------|-----|---|---|----|-------------------|-----|-------------------|-------------|-------------|
| | 1 | 2 | 3 | 4 | | | | | | |
| 5150-5250 | 4.1 | 4.1 | | | No | Yes | Yes | No | 4.10 | 7.1 |
| 5250-5350 | 4.1 | 4.1 | | | No | Yes | Yes | No | 4.10 | 7.1 |
| 5470-5725 | 4.3 | 4.3 | | | No | Yes | Yes | No | 4.30 | 7.3 |
| 5725-5825 | 4.3 | 4.3 | | | No | Yes | Yes | No | 4.30 | 7.3 |

For devices that support CDD modes

Min # of spatial streams: 1
 Max # of spatial streams: 2

| | |
|--------|---|
| Notes: | BF = beamforming mode supported, Multichain Legacy = 802.11 legacy data rates supported for multichain transmissions, CDD = Cyclic Delay Diversity (or Cyclic Shift Diversity) modes supported, Sectorized / Xpol = antennas are sectorized or cross polarized. |
| Notes: | Dir G (PWR) = total gain (Gant + Array Gain) for power calculations; GA (PSD) = total gain for PSD calculations based on FCC KDB 662911. Depending on the modes supported, the Array Gain value for power could be different from the PSD value. |
| Notes: | Array gain for power/psd calculated per KDB 662911 D01. |



EMC Test Data

| | |
|---------------------------------------|------------------------------------|
| Client: Aruba Networks | Job Number: JD100928 |
| Model: APIN0103 (FCC ID: Q9DAPIN0103) | T-Log Number: T101080 |
| | Project Manager: Christine Krebill |
| Contact: Rob Hastings | Project Coordinator: - |
| Standard: FCC 15.407 | Class: N/A |

MIMO Device - 5725-5850 MHz Band - FCC/IC

Mode: 11a

Max EIRP (mW): 479.9

| Frequency (MHz) | Chain | Software Setting | 99% BW (MHz) | Duty Cycle % | Power dBm | Total Power ¹ mW | Total Power ¹ dBm | Limit dBm | Max Power (W) | Result |
|-----------------|-------|------------------|--------------|--------------|-----------|-----------------------------|------------------------------|-----------|---------------|--------|
| 5745 | 1 | 19 | 16.9 | 98.4 | 16.4 | 84.4 | 19.3 | 30.0 | 0.178 | Pass |
| | 3 | | | | | | | | | |
| | 4 | | | | | | | | | |
| | 2 | | | | 16.1 | | | | | |
| 5785 | 1 | 23 | 17.8 | 98.4 | 19.4 | 178.3 | 22.5 | 30.0 | | Pass |
| | 3 | | | | | | | | | |
| | 4 | | | | | | | | | |
| | 2 | | | | 19.6 | | | | | |
| 5825 | 1 | 23 | 18.4 | 98.4 | 19.5 | 178.3 | 22.5 | 30.0 | | Pass |
| | 3 | | | | | | | | | |
| | 4 | | | | | | | | | |
| | 2 | | | | 19.5 | | | | | |

MIMO Device 5725-5850 MHz PSD - FCC/IC

Mode: 11a

| Frequency (MHz) | Chain | Software Setting | 99% BW (MHz) | Duty Cycle % | PSD dBm/MHz | Total PSD ¹ mW/MHz | Total PSD ¹ dBm/MHz | FCC Limit dBm/500kHz | IC Limit dBm/500kHz | Result |
|-----------------|-------|------------------|--------------|--------------|-------------|-------------------------------|--------------------------------|----------------------|---------------------|--------|
| 5745 | 1 | 19 | | 98.4 | 6.0 | 7.7 | 8.9 | 28.7 | 28.7 | Pass |
| | 3 | | | | | | | | | |
| | 4 | | | | | | | | | |
| | 2 | | | | 5.7 | | | | | |
| 5785 | 1 | 23 | | 98.4 | 9.0 | 15.9 | 12.0 | 28.7 | 28.7 | Pass |
| | 3 | | | | | | | | | |
| | 4 | | | | | | | | | |
| | 2 | | | | 9.0 | | | | | |
| 5825 | 1 | 23 | | 98.4 | 9.0 | 16.3 | 12.1 | 28.7 | 28.7 | Pass |
| | 3 | | | | | | | | | |
| | 4 | | | | | | | | | |
| | 2 | | | | 9.2 | | | | | |

| | |
|---------------------------------------|------------------------------------|
| Client: Aruba Networks | Job Number: JD100928 |
| Model: APIN0103 (FCC ID: Q9DAPIN0103) | T-Log Number: T101080 |
| | Project Manager: Christine Krebill |
| Contact: Rob Hastings | Project Coordinator: - |
| Standard: FCC 15.407 | Class: N/A |

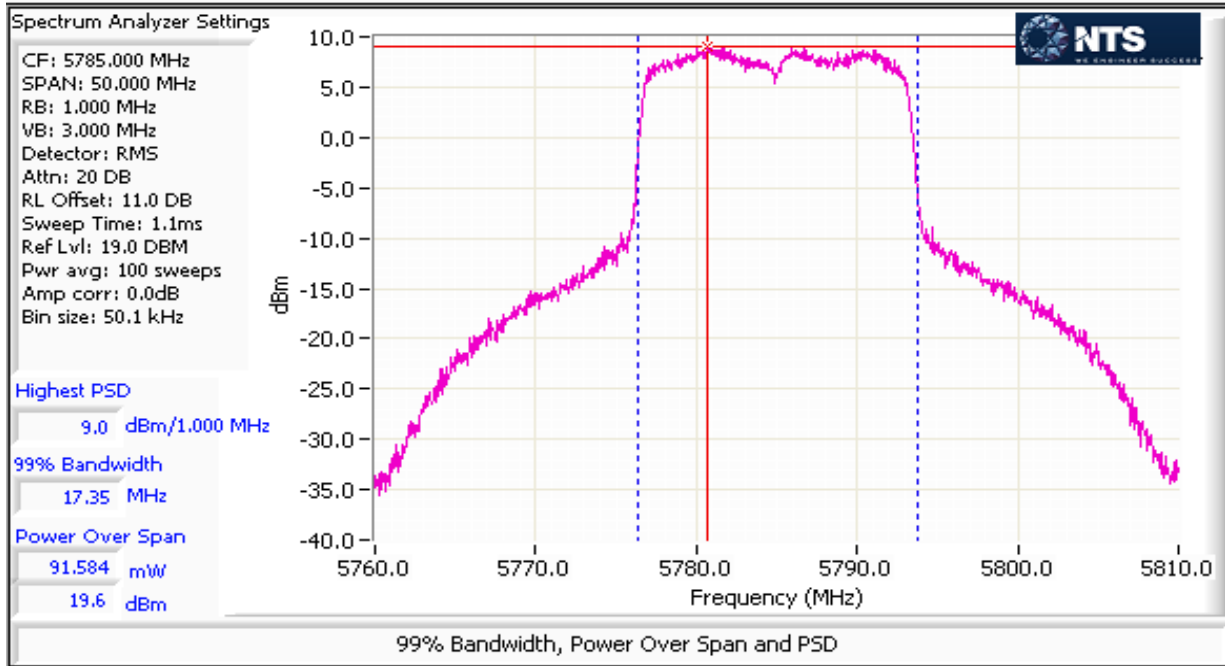



EMC Test Data

| | |
|---------------------------------------|------------------------------------|
| Client: Aruba Networks | Job Number: JD100928 |
| Model: APIN0103 (FCC ID: Q9DAPIN0103) | T-Log Number: T101080 |
| | Project Manager: Christine Krebill |
| Contact: Rob Hastings | Project Coordinator: - |
| Standard: FCC 15.407 | Class: N/A |

MIMO Device - 5725-5850 MHz Band - FCC/IC

Mode: n20

Max EIRP (mW): 390.3

| Frequency (MHz) | Chain | Software Setting | 99% BW (MHz) | Duty Cycle % | Power dBm | Total Power ¹ mW | dBm | FCC Limit dBm | Max Power (W) | Result |
|-----------------|-------|------------------|--------------|--------------|-----------|-----------------------------|------|---------------|---------------|--------|
| 5745 | 1 | 17 | 18.0 | 99.0 | 15.1 | 59.3 | 17.7 | 30.0 | 0.145 | Pass |
| | 3 | | | | | | | | | |
| | 4 | | | | | | | | | |
| | 2 | | | | 14.3 | | | | | |
| 5785 | 1 | 23 | 19.0 | 99.0 | 18.8 | 145.0 | 21.6 | 30.0 | | Pass |
| | 3 | | | | | | | | | |
| | 4 | | | | | | | | | |
| | 2 | | | | 18.4 | | | | | |
| 5825 | 1 | 21 | 18.2 | 99.0 | 17.6 | 112.5 | 20.5 | 30.0 | | Pass |
| | 3 | | | | | | | | | |
| | 4 | | | | | | | | | |
| | 2 | | | | 17.4 | | | | | |

MIMO Device 5725-5850 MHz PSD - FCC/IC

Mode: n20

| Frequency (MHz) | Chain | Software Setting | 99% BW (MHz) | Duty Cycle % | PSD dBm/MHz | Total PSD ¹ mW/MHz | dBm/MHz | FCC Limit dBm/MHz | IC Limit dBm/MHz | Result |
|-----------------|-------|------------------|--------------|--------------|-------------|-------------------------------|---------|-------------------|------------------|--------|
| 5745 | 1 | 17 | | 99.0 | 4.4 | 4.9 | 6.9 | 28.7 | 28.7 | Pass |
| | 3 | | | | | | | | | |
| | 4 | | | | | | | | | |
| | 2 | | | | 3.4 | | | | | |
| 5785 | 1 | 23 | | 99.0 | 8.0 | 12.1 | 10.8 | 28.7 | 28.7 | Pass |
| | 3 | | | | | | | | | |
| | 4 | | | | | | | | | |
| | 2 | | | | 7.6 | | | | | |
| 5825 | 1 | 21 | | 99.0 | 7.0 | 9.7 | 9.9 | 28.7 | 28.7 | Pass |
| | 3 | | | | | | | | | |
| | 4 | | | | | | | | | |
| | 2 | | | | 6.7 | | | | | |

| | |
|---------------------------------------|------------------------------------|
| Client: Aruba Networks | Job Number: JD100928 |
| Model: APIN0103 (FCC ID: Q9DAPIN0103) | T-Log Number: T101080 |
| | Project Manager: Christine Krebill |
| Contact: Rob Hastings | Project Coordinator: - |
| Standard: FCC 15.407 | Class: N/A |

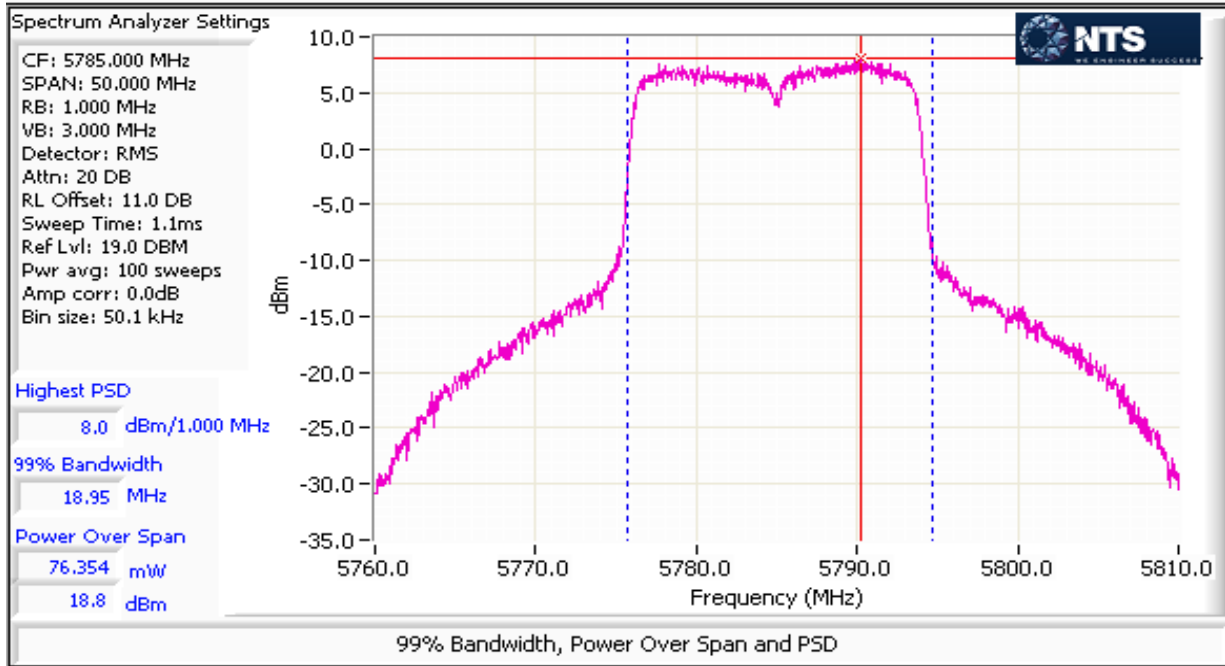



EMC Test Data

| | |
|---------------------------------------|------------------------------------|
| Client: Aruba Networks | Job Number: JD100928 |
| Model: APIN0103 (FCC ID: Q9DAPIN0103) | T-Log Number: T101080 |
| | Project Manager: Christine Krebill |
| Contact: Rob Hastings | Project Coordinator: - |
| Standard: FCC 15.407 | Class: N/A |

MIMO Device - 5725-5850 MHz Band - FCC/IC

Mode: n40

Max EIRP (mW): 332.7

| Frequency (MHz) | Chain | Software Setting | 99% BW (MHz) | Duty Cycle % | Power dBm | Total Power ¹ | | FCC Limit dBm | Max Power (W) | Result | |
|-----------------|-------|------------------|--------------|--------------|-----------|--------------------------|------|---------------|---------------|--------|------|
| | | | | | | mW | dBm | | | | |
| 5755 | 1 | 15 | 36.3 | 98.8 | 12.3 | 34.4 | 15.4 | 30.0 | 0.124 | Pass | |
| | 3 | | | | | | | | | | |
| | 4 | | | | | | | | | | |
| | 2 | | | | | | | | | | |
| 5795 | 1 | 21 | 36.5 | 98.8 | 17.6 | 123.6 | 20.9 | 30.0 | | | Pass |
| | 3 | | | | | | | | | | |
| | 4 | | | | | | | | | | |
| | 2 | | | | 18.2 | | | | | | |

MIMO Device 5725-5850 MHz PSD - FCC/IC

Mode: n40

| Frequency (MHz) | Chain | Software Setting | 99% BW (MHz) | Duty Cycle % | PSD dBm/MHz | Total PSD ¹ | | FCC Limit dBm/MHz | IC Limit dBm/MHz | Result |
|-----------------|-------|------------------|--------------|--------------|-------------|------------------------|---------|-------------------|------------------|--------|
| | | | | | | mW/MHz | dBm/MHz | | | |
| 5755 | 1 | 15 | | 98.8 | -1.5 | 1.5 | 1.8 | 28.7 | 28.7 | Pass |
| | 3 | | | | | | | | | |
| | 4 | | | | | | | | | |
| | 2 | | | | -1.0 | | | | | |
| 5795 | 1 | 21 | | 98.8 | 3.8 | 5.3 | 7.2 | 28.7 | 28.7 | Pass |
| | 3 | | | | | | | | | |
| | 4 | | | | | | | | | |
| | 2 | | | | 4.6 | | | | | |

| | |
|---------------------------------------|------------------------------------|
| Client: Aruba Networks | Job Number: JD100928 |
| Model: APIN0103 (FCC ID: Q9DAPIN0103) | T-Log Number: T101080 |
| | Project Manager: Christine Krebill |
| Contact: Rob Hastings | Project Coordinator: - |
| Standard: FCC 15.407 | Class: N/A |

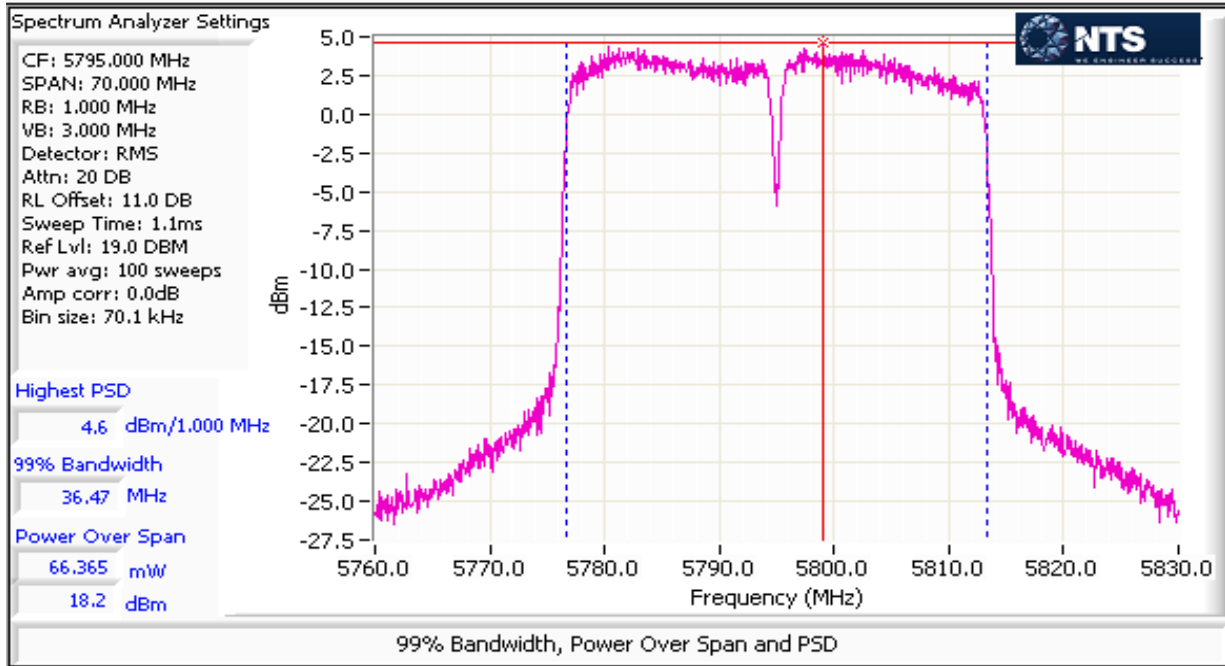



EMC Test Data

| | |
|---------------------------------------|------------------------------------|
| Client: Aruba Networks | Job Number: JD100928 |
| Model: APIN0103 (FCC ID: Q9DAPIN0103) | T-Log Number: T101080 |
| | Project Manager: Christine Krebill |
| Contact: Rob Hastings | Project Coordinator: - |
| Standard: FCC 15.407 | Class: B |

Conducted Emissions

(NTS Silicon Valley, Fremont Facility, Semi-Anechoic Chamber)

Test Specific Details

Objective: The objective of this test session is to perform final qualification testing of the EUT with respect to the specification listed above.

| | |
|-----------------------------------|------------------------|
| Date of Test: 3/8/2016 | Config. Used: 1 |
| Test Engineer: M. Birgani | Config Change: - |
| Test Location: Fremont Chamber #7 | EUT Voltage: 120V/60Hz |

General Test Configuration

The EUT was located on a table inside the semi-anechoic chamber, 40 cm from a vertical coupling plane and 80cm from the LISN. Any cables running to remote support equipment where routed through metal conduit and when possible passed through a ferrite clamp upon exiting the chamber.

| | | |
|----------------------------|----------------|----------|
| Ambient Conditions: | Temperature: | 17-19 °C |
| | Rel. Humidity: | 30-35 % |

Summary of Results

| Run # | Test Performed | Limit | Result | Margin |
|-------|-------------------------|---------|--------|------------------------------|
| 1 | CE, AC Power, 120V/60Hz | Class B | Pass | 34.2dBµV @ 0.36MHz (-14.6dB) |

Modifications Made During Testing

No modifications were made to the EUT during testing

Deviations From The Standard

No deviations were made from the requirements of the standard.

Note: The unit was transmitting at 5745MHz at its maximum power setting.

| | |
|---------------------------------------|------------------------------------|
| Client: Aruba Networks | Job Number: JD100928 |
| Model: APIN0103 (FCC ID: Q9DAPIN0103) | T-Log Number: T101080 |
| | Project Manager: Christine Krebill |
| Contact: Rob Hastings | Project Coordinator: - |
| Standard: FCC 15.407 | Class: B |

Run #1: AC Power Port Conducted Emissions, 0.15 - 30MHz, 120V/60Hz

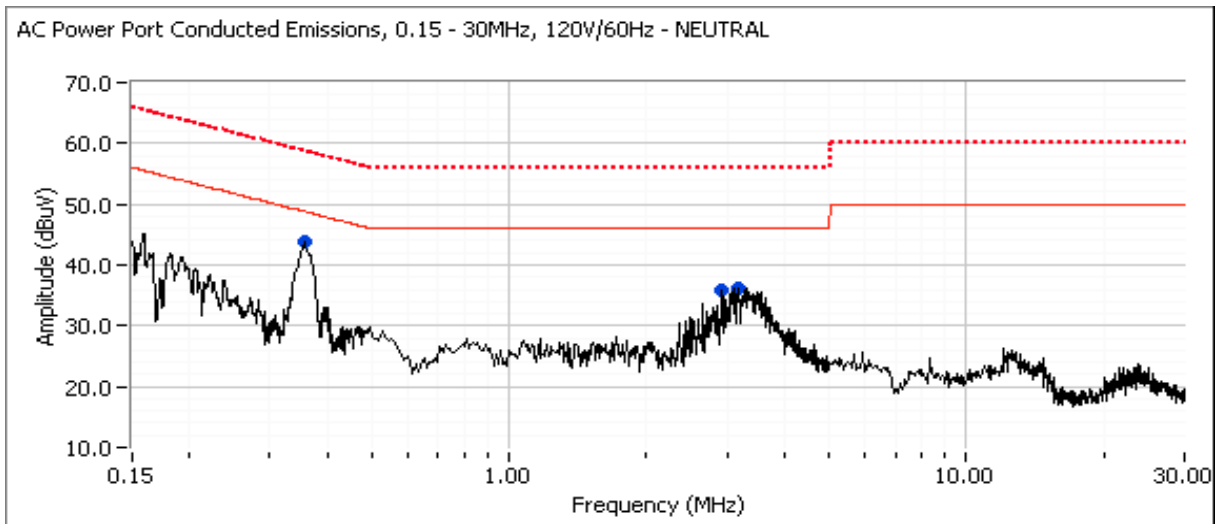
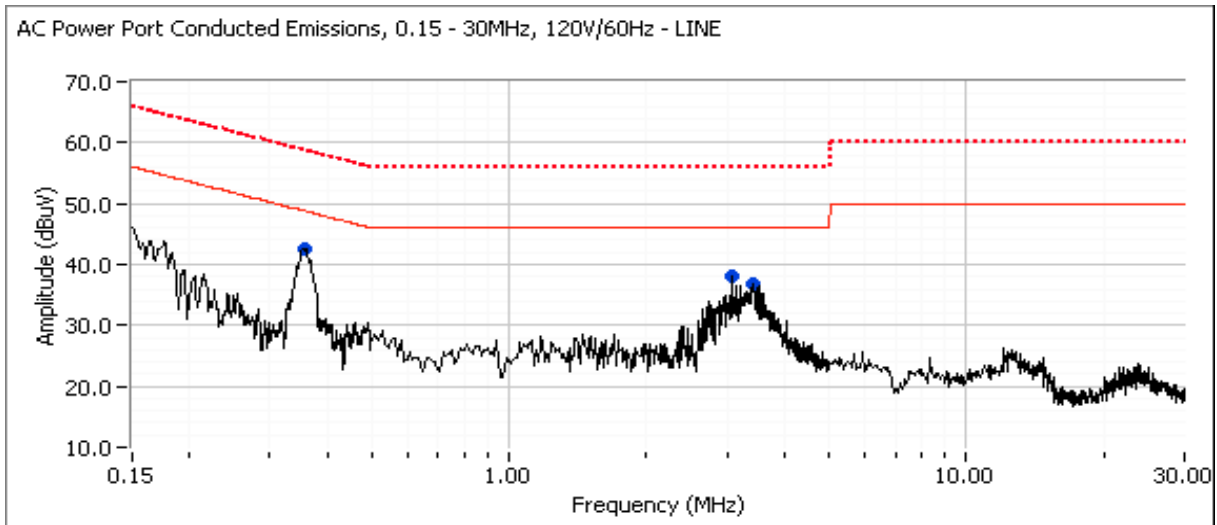



EMC Test Data

| | |
|---------------------------------------|------------------------------------|
| Client: Aruba Networks | Job Number: JD100928 |
| Model: APIN0103 (FCC ID: Q9DAPIN0103) | T-Log Number: T101080 |
| | Project Manager: Christine Krebill |
| Contact: Rob Hastings | Project Coordinator: - |
| Standard: FCC 15.407 | Class: B |

Run #1: AC Power Port Conducted Emissions, 0.15 - 30MHz, 120V/60Hz

Preliminary peak readings captured during pre-scan (peak readings vs. average limit)

| Frequency MHz | Level dB μ V | AC Line | Class B | | Detector QP/Ave | Comments |
|------------------|---------------------|------------|---------|--------|--------------------|----------|
| | | | Limit | Margin | | |
| 0.356 | 43.7 | Neutral | 48.8 | -5.1 | Peak | |
| 0.357 | 42.5 | Line | 48.8 | -6.3 | Peak | |
| 3.101 | 38.1 | Line | 46.0 | -7.9 | Peak | |
| 3.447 | 36.7 | Line | 46.0 | -9.3 | Peak | |
| 3.159 | 36.3 | Neutral | 46.0 | -9.7 | Peak | |
| 2.905 | 36.0 | Neutral | 46.0 | -10.0 | Peak | |

Final quasi-peak and average readings

| Frequency MHz | Level dB μ V | AC Line | Class B | | Detector QP/Ave | Comments |
|------------------|---------------------|------------|---------|--------------|--------------------|-------------|
| | | | Limit | Margin | | |
| 0.356 | 34.2 | Neutral | 48.8 | -14.6 | AVG | AVG (0.10s) |
| 0.357 | 33.0 | Line | 48.8 | -15.8 | AVG | AVG (0.10s) |
| 0.356 | 42.2 | Neutral | 58.8 | -16.6 | QP | QP (1.00s) |
| 0.357 | 41.3 | Line | 58.8 | -17.5 | QP | QP (1.00s) |
| 3.447 | 30.4 | Line | 56.0 | -25.6 | QP | QP (1.00s) |
| 3.159 | 29.0 | Neutral | 56.0 | -27.0 | QP | QP (1.00s) |
| 3.101 | 28.7 | Line | 56.0 | -27.3 | QP | QP (1.00s) |
| 3.447 | 18.3 | Line | 46.0 | -27.7 | AVG | AVG (0.10s) |
| 3.159 | 16.9 | Neutral | 46.0 | -29.1 | AVG | AVG (0.10s) |
| 2.905 | 26.7 | Neutral | 56.0 | -29.3 | QP | QP (1.00s) |
| 3.101 | 16.5 | Line | 46.0 | -29.5 | AVG | AVG (0.10s) |
| 2.905 | 13.9 | Neutral | 46.0 | -32.1 | AVG | AVG (0.10s) |

End of Report

This page is intentionally blank and marks the last page of this test report.