

Company: Aruba Networks

Test of: APEX0104 802.11a/b/g/n/ac Access Point

To: FCC CFR 47 Part 15 Subpart C 15.247

Report No.: ARUB199-U3 Rev A





Test of: Aruba Networks APEX0104 a/b/g/n/ac Access Point
to

To: FCC CFR 47 Part 15 Subpart C 15.247 & IC RSS-247

Test Report Serial No.: ARUB199-U3 Rev A

Note: this report is one of a set of reports that together address the requirements for FCC 15.247, FCC 15.407 and Industry Canada RSS-247 compliance

Report Number	Test Report Type
ARUB199-U3	FCC 15.247 + IC RSS-247 2.4 GHz Test Report
ARUB198-U6	FCC 15.407 Non-DFS Bands Conducted Test Report
ARUB198-U7	IC RSS-247 Non-DFS Bands Conducted Test Report
ARUB199-U9a	FCC 15.247 + IC RSS-247 Conducted & Radiated Test Report (DFS Bands)
ARUB199-U9b	FCC 15.247 + IC RSS-247 DFS Test Report

This report supersedes: NONE

Applicant: Aruba Networks
1344 Crossman Ave.
Sunnyvale, California 94089-1113
USA

Product Function: Wireless Access Point

Issue Date: 27th August 2015

This Test Report is Issued Under the Authority of:

MiCOM Labs, Inc.
575 Boulder Court
Pleasanton California 94566
USA
Phone: +1 (925) 462-0304
Fax: +1 (925) 462-0306
www.micomlabs.com



MiCOM Labs is an ISO 17025 Accredited Testing Laboratory



Table of Contents

1. ACCREDITATION, LISTINGS & RECOGNITION.....	4
1.1. TESTING ACCREDITATION.....	4
1.2. RECOGNITION	5
1.3. PRODUCT CERTIFICATION	6
2. DOCUMENT HISTORY	7
3. TEST RESULT CERTIFICATE.....	8
4. REFERENCES AND MEASUREMENT UNCERTAINTY	9
4.1. Normative References	9
4.2. Test and Uncertainty Procedure.....	10
5. PRODUCT DETAILS AND TEST CONFIGURATIONS.....	11
5.1. Technical Details	11
5.2. Scope Of Test Program.....	12
5.3. Equipment Model(s) and Serial Number(s).....	13
5.4. Antenna Details	13
5.5. Cabling and I/O Ports	13
5.6. Test Configurations.....	14
5.7. Equipment Modifications	14
5.8. Deviations from the Test Standard	14
6. TEST SUMMARY	15
7. TEST EQUIPMENT CONFIGURATION(S)	16
7.1. Conducted	16
7.2. Radiated Emissions.....	18
7.3. ac Wireline Emissions.....	20
8. MEASUREMENT AND PRESENTATION OF TEST DATA	21
9. WORST CASE MEASUREMENT RESULTS.....	22
10. TEST RESULTS	22
10.1. 6 dB & 99% Bandwidth.....	22
10.2. Conducted Output Power	27
10.3. Conducted Spurious Emissions.....	33
10.3.1. <i>Conducted Emissions</i>	33
10.3.1.1. Conducted Spurious Emissions	33
10.3.1.2. Conducted Band-Edge Emissions	38
10.4. Power Spectral Density	47
10.5. Radiated Spurious Emissions.....	52
10.5.1. <i>Restricted Band Emissions</i>	52
10.5.2. <i>Restricted Band-Edge Emissions</i>	58
10.5.3. <i>Digital Emissions (0.03 - 1 GHz)</i>	62
10.6. ac Wireline Emissions	63
A. APPENDIX - GRAPHICAL IMAGES	66
A.1. 6 dB & 99% Bandwidth	67
A.2. Conducted Emissions.....	103
A.2.1. <i>Conducted Spurious Emissions</i>	103
A.2.2. <i>Conducted Band-Edge Emissions</i>	139
A.3. Power Spectral Density	163
A.4. Radiated Spurious Emissions	211
A.5. Restricted Band-Edge Emissions.....	214
A.6. Digital Emissions	222

This test report may be reproduced in full only. The document may only be updated by MiCOM Labs personnel. All changes will be noted in the Document History section of the report.

1. ACCREDITATION, LISTINGS & RECOGNITION

1.1. TESTING ACCREDITATION

MiCOM Labs, Inc. is an accredited Electrical testing laboratory per the international standard ISO/IEC 17025:2005. The company is accredited by the American Association for Laboratory Accreditation (A2LA) www.a2la.org test laboratory number 2381.01. MiCOM Labs test schedule is available at the following URL; <http://www.a2la.org/scopepdf/2381-01.pdf>



This test report may be reproduced in full only. The document may only be updated by MiCOM Labs personnel. All changes will be noted in the Document History section of the report.



1.2. RECOGNITION

MiCOM Labs, Inc has widely recognized wireless testing capabilities. Our international recognition includes Conformity Assessment Body designation by APEC MRA countries. MiCOM Labs test reports are accepted globally.

Country	Recognition Body	Status	Phase	Identification No.
USA	Federal Communications Commission (FCC)	TCB	-	US0159 Listing #: 102167
Canada	Industry Canada (IC)	FCB	APEC MRA 2	US0159 Listing #: 4143A-2 4143A-3
Japan	MIC (Ministry of Internal Affairs and Communication)	CAB	APEC MRA 2	RCB 210
	VCCI	--	--	A-0012
Europe	European Commission	NB	EU MRA	NB 2280
Australia	Australian Communications and Media Authority (ACMA)	CAB	APEC MRA 1	US0159
Hong Kong	Office of the Telecommunication Authority (OFTA)	CAB	APEC MRA 1	
Korea	Ministry of Information and Communication Radio Research Laboratory (RRL)	CAB	APEC MRA 1	
Singapore	Infocomm Development Authority (IDA)	CAB	APEC MRA 1	
Taiwan	National Communications Commission (NCC) Bureau of Standards, Metrology and Inspection (BSMI)	CAB	APEC MRA 1	
Vietnam	Ministry of Communication (MIC)	CAB	APEC MRA 1	

EU MRA – European Union Mutual Recognition Agreement.

NB – Notified Body

APEC MRA – Asia Pacific Economic Community Mutual Recognition Agreement. Recognition agreement under which test lab is accredited to regulatory standards of the APEC member countries.

Phase I - recognition for product testing

Phase II – recognition for both product testing and certification

1.3. PRODUCT CERTIFICATION

MiCOM Labs, Inc. is an accredited Product Certification Body per the international standard ISO/IEC 17065:2012. The company is accredited by the American Association for Laboratory Accreditation (A2LA) www.a2la.org test laboratory number 2381.02. MiCOM Labs test schedule is available at the following URL; <http://www.a2la.org/scopepdf/2381-02.pdf>



United States of America – Telecommunication Certification Body (TCB)
Industry Canada – Certification Body, CAB Identifier – US0159
Europe – Notified Body (NB), NB Identifier - 2280
Japan – Recognized Certification Body (RCB), RCB Identifier - 210

This test report may be reproduced in full only. The document may only be updated by MiCOM Labs personnel. All changes will be noted in the Document History section of the report.



Title: Aruba Networks APEX0104
To: FCC CFR 47 Part 15 Subpart C 15.247 & IC RSS-247
Serial #: ARUB199-U3 Rev A
Issue Date: 27th August 2015
Page: 7 of 223

2. DOCUMENT HISTORY

Document History		
Revision	Date	Comments
Draft	23 rd July 2015	
Draft #2	21 st August 2015	
Draft #3	26 th August 2015	
Rev A	27 th August 2015	Initial Release
.		
.		
.		
.		
.		

In the above table the latest report revision will replace all earlier versions.

This test report may be reproduced in full only. The document may only be updated by MiCOM Labs personnel. All changes will be noted in the Document History section of the report.



Title: Aruba Networks APEX0104
To: FCC CFR 47 Part 15 Subpart C 15.247 & IC RSS-247
Serial #: ARUB199-U3 Rev A
Issue Date: 27th August 2015
Page: 8 of 223

3. TEST RESULT CERTIFICATE

Manufacturer: Aruba Networks 1344 Crossman Ave. Sunnyvale 94089-1113 USA	Tested By: MiCOM Labs, Inc. 575 Boulder Court Pleasanton California 94566 USA
Model: APEX0104	Telephone: +1 925 462 0304 Fax: +1 925 462 0306
Type Of Equipment: Wireless LAN Access Point	
S/N's: 6140570	
Test Date(s): 14 th – 26 th August 2015	Website: www.micomlabs.com

STANDARD(S)	TEST RESULTS
FCC Part 15 Subpart C 15.247 (DTS) + IC RSS-247	EQUIPMENT COMPLIES

MiCOM Labs, Inc. tested the equipment mentioned in accordance with the requirements set forth in the above standards. Test results indicate that the equipment tested is capable of demonstrating compliance with the requirements as documented within this report.

Notes:

1. This document reports conditions under which testing was conducted and the results of testing performed.
2. Details of test methods used have been recorded and kept on file by the laboratory.
3. Test results apply only to the item(s) tested.

Approved & Released for MiCOM Labs, Inc. by:





Graeme Grieve
Quality Manager MiCOM Labs, Inc.



Gordon Hurst
President & CEO MiCOM Labs, Inc.

This test report may be reproduced in full only. The document may only be updated by MiCOM Labs personnel. All changes will be noted in the Document History section of the report.

4. REFERENCES AND MEASUREMENT UNCERTAINTY

4.1. Normative References

REF.	PUBLICATION	YEAR	TITLE
I	KDB 662911	Oct 31 2013	Guidance for measurement of output emission of devices that employ single transmitter with multiple outputs or systems with multiple transmitters operating simultaneously in the same frequency band
II	KDB 558074 D01 v03r03	9th June 2015	Guidance for performing compliance measurements on Digital Transmission Systems (DTS) operating under section 15.247.
III	A2LA	June 2015	R105 - Requirement's When Making Reference to A2LA Accreditation Status
IV	ANSI C63.10	2013	American National Standard for Testing Unlicensed Wireless Devices
V	ANSI C63.4	2014	American National Standards for Methods of Measurement of Radio-Noise Emissions from Low-Voltage Electrical and Electronic Equipment in the Range of 9 kHz to 40 GHz
VI	CISPR 22	2008	Information technology equipment - Radio disturbance characteristics - Limits and methods of measurement
VII	ETSI TR 100 028	2001-12	Parts 1 and 2 Electromagnetic compatibility and Radio Spectrum Matters (ERM); Uncertainties in the measurement of mobile radio equipment characteristics
VIII	FCC 47 CFR Part 15.247	2014	Radio Frequency Devices; Subpart C – Intentional Radiators
IX	ICES-003	Issue 5 2012	Spectrum Management and Telecommunications; Interference-Causing Equipment Standard. Information Technology Equipment (ITE) – Limits and methods of measurement.
X	M 3003	Edition 3 Nov. 2012	Expression of Uncertainty and Confidence in Measurements
XI	RSS-247 Issue 1	May 2015	Digital Transmission Systems (DTSs), Frequency Hopping System (FHSs) and Licence-Exempt Local Area Network (LE-LEN) Devices
XII	RSS-Gen Issue 4	November 2014	General Requirements and Information for the Certification of Radiocommunication Equipment
XIII	KDB 644545 D03 v01	August 14th 2014	Guidance for IEEE 802.11ac New Rules
XIV	FCC 47 CFR Part 2.1033	2014	FCC requirements and rules regarding photographs and test setup diagrams.

This test report may be reproduced in full only. The document may only be updated by MiCOM Labs personnel. All changes will be noted in the Document History section of the report.



Title: Aruba Networks APEX0104
To: FCC CFR 47 Part 15 Subpart C 15.247 & IC RSS-247
Serial #: ARUB199-U3 Rev A
Issue Date: 27th August 2015
Page: 10 of 223

4.2. Test and Uncertainty Procedure

Conducted and radiated emission measurements were conducted in accordance with American National Standards Institute ANSI C63.4, listed in the Normative References section of this report.

Measurement uncertainty figures are calculated in accordance with ETSI TR 100 028 Parts 1 and 2.

Measurement uncertainties stated are based on a standard uncertainty multiplied by a coverage factor $k = 2$, providing a level of confidence of approximately 95 % in accordance with UKAS document M 3003 listed in the Normative References section of this report.

This test report may be reproduced in full only. The document may only be updated by MiCOM Labs personnel. All changes will be noted in the Document History section of the report.



Title: Aruba Networks APEX0104
To: FCC CFR 47 Part 15 Subpart C 15.247 & IC RSS-247
Serial #: ARUB199-U3 Rev A
Issue Date: 27th August 2015
Page: 11 of 223

5. PRODUCT DETAILS AND TEST CONFIGURATIONS

5.1. Technical Details

Details	Description
Purpose:	Test of the Aruba Networks APEX0104 802.11 a/b/g/n/ac Access point to FCC CFR 47 Part 15 Subpart C 15.247 (DTS) & IC RSS-247. Radio Frequency Devices; Subpart C – Intentional Radiators
Applicant:	Aruba Networks 1344 Crossman Ave. Sunnyvale 94089-1113 USA
Manufacturer:	As Applicant
Laboratory performing the tests:	MiCOM Labs, Inc. 575 Boulder Court Pleasanton California 94566 USA
Test report reference number:	ARUB199 - 27x FCC IC New Rules
Date EUT received:	10 th July 2015
Standard(s) applied:	FCC CFR 47 Part 15 Subpart C 15.247 (DTS)
Dates of test (from - to):	14 th – 26 th July 2015
No of Units Tested:	2
Type of Equipment:	802.11a/b/g/n/ac Wireless Access Point 3x3 Spatial Multiplexing MIMO configuration
Product Family Name:	Wireless Access Point
Model(s):	APEX0104
Location for use:	Outdoor only
Declared Frequency Range(s):	2400 - 2483.5 MHz
Primary function of equipment:	Wireless Access Point for transmitting data and voice.
Secondary function of equipment:	None Provided
Type of Modulation:	Per 802.11 –CCK, BPSK, QPSK, DSSS, OFDM
EUT Modes of Operation:	802.11b; 802.11g; 802.11n HT-20; 802.11n HT-40;
Declared Nominal Output Power (Ave):	+30 dBm
Transmit/Receive Operation:	Transceiver - Half Duplex
Rated Input Voltage and Current:	ac Adapter Input 100-240Vac 50-60 Hz, 1A ; Output 12Vdc, 3A POE (POE adaptor NOT sold with unit) 48Vdc
Operating Temperature Range:	Declared Range -40°C to +65°C
ITU Emission Designator:	2400 – 2483.5 MHz 802.11b 11M6G1D 2400 – 2483.5 MHz 802.11g 16M5D1D 2400 – 2483.5 MHz 802.11n – HT-20 17M7D1D 2400 – 2483.5 MHz 802.11n – HT-40 36M2D1D
Equipment Dimensions:	215mm x 295mm x 229mm
Weight:	3.8kg
Hardware Rev:	2.0
Software Rev:	2.0

This test report may be reproduced in full only. The document may only be updated by MiCOM Labs personnel. All changes will be noted in the Document History section of the report.

5.2. Scope Of Test Program

Aruba Networks APEX0104 Wireless LAN Access Point

The scope of the test program was to test the Aruba Networks APEX0104 Wireless LAN Access Point, 3x3 Spatial Multiplexing MIMO configurations in the frequency ranges 2400 - 2483.5 MHz for compliance against the following specification:

FCC CFR 47 Part 15 Subpart C 15.247

Radio Frequency Devices; Subpart C – Intentional Radiators

Industry Canada RSS-247 Issue 1 May 2015

Digital Transmission Systems (DTSS), Frequency Hopping Systems (FHSs) and Licence-Exempt Local Area Network (LE-LAN) Devices

Aruba Networks APEX0104 Wireless LAN Access Point

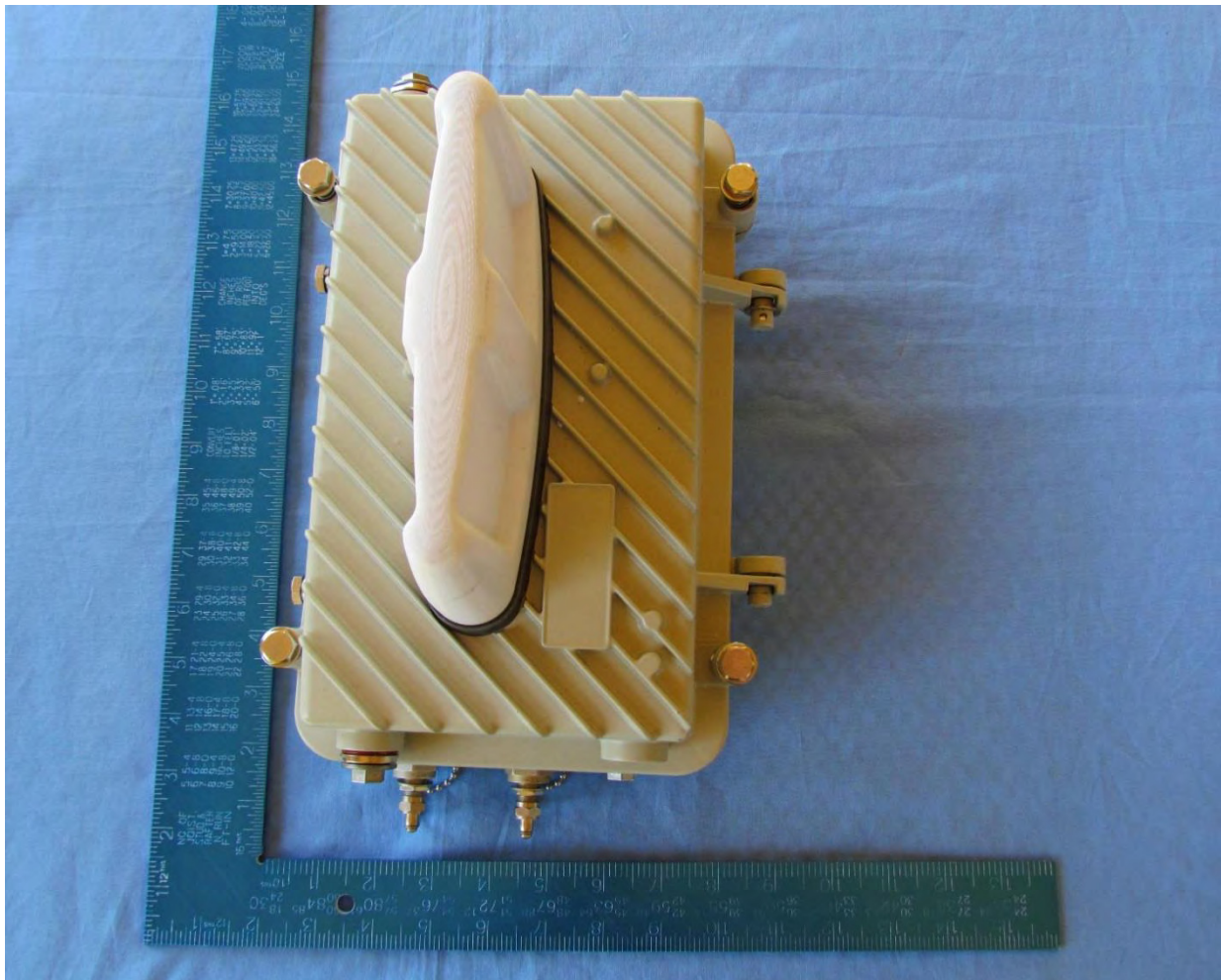

This test report may be reproduced in full only. The document may only be updated by MiCOM Labs personnel. All changes will be noted in the Document History section of the report.



Title: Aruba Networks APEX0104
To: FCC CFR 47 Part 15 Subpart C 15.247 & IC RSS-247
Serial #: ARUB199-U3 Rev A
Issue Date: 27th August 2015
Page: 13 of 223

5.3. Equipment Model(s) and Serial Number(s)

Type	Manufacturer	Model	Family	Serial no.
EUT	Aruba Networks	APEX0104	802.11a/b/g/n Wireless Access Point	6140570
Support	CUI Inc.	ETSA480083U	Ac Adapter	None
Support	Laptop PC with 11ac client PCM CIA	LATITUDE E5440	DELL	None

5.4. Antenna Details

Type	Manufacturer	Model	Family	Gain (dBi)	BF Gain	Dir BW	X-Pol	Frequency Band (MHz)
integral	Aruba Networks	Unknown	Dipole	2.8	-	360	-	2400 - 2483.5
integral	Aruba Networks	Unknown	Dipole	3.6	-	360	-	5725 - 5850

BF Gain - Beamforming Gain
Dir BW - Directional BeamWidth
X-Pol - Cross Polarization

5.5. Cabling and I/O Ports

Port Type	Max Cable Length	# Of Ports	Screened	Conn Type	Data Type
Ethernet	POE 100m	1	N	RJ-45	Packet Data
Ethernet	1	1	N	RJ-45	Packet Data
USB	15m	1	Y	USB	Digital

This test report may be reproduced in full only. The document may only be updated by MiCOM Labs personnel. All changes will be noted in the Document History section of the report.



5.6. Test Configurations

Results for the following configurations are provided in this report:

Operational Mode(s) (802.11a/b/g/n/ac)	Data Rate with Highest Power MBit/s	Channel Frequency (MHz)		
		Low	Mid	High
2400 - 2483.5 MHz				
802.11b	1	2412.00	2437.00	2462.00
802.11g	6	2412.00	2437.00	2462.00
802.11n HT-20	6.5	2412.00	2437.00	2462.00
802.11n HT-40	13.5	2422.00	2442.00	2452.00

5.7. Equipment Modifications

The following modifications were required to bring the equipment into compliance:

1. NONE

5.8. Deviations from the Test Standard

The following deviations from the test standard were required in order to complete the test program:

1. NONE



6. TEST SUMMARY

List of Measurements

Test Header	Result	Data Link
CONDUCTED TEST RESULTS	Complies	
15.247(a)(2) [IC RSS-247 5.2 (1)] 6 dB & 99% Bandwidth	Complies	View Data
15.247(b), 15.31(e) [IC RSS-247 5.4 (4)] Conducted Output Power	Complies	View Data
15.247(d) [IC RSS-247 5.5] Emissions	Complies	
(1) Conducted Emissions	Complies	
(i) Conducted Spurious Emissions	Complies	View Data
(ii) Conducted Band-Edge Emissions	Complies	View Data
15.247(e) [IC RSS-247 5.2 (2)] Power Spectral Density	Complies	View Data
RADIATED EMISSION RESULTS	Complies	
15.247(d) [IC RSS-247 8.9] Emissions	-	-
(2) Radiated Emissions	-	-
(i) 15.205 [IC RSS-247 8.10] Restricted Band Emissions	Complies	View Data
(ii) 15.205 [IC RSS-247 8.10] Restricted Band-Edge Emissions	Complies	View Data
(3) 15.209 [IC RSS-247 8.9] Digital Emissions (0.03 - 1 GHz)	Complies	View Data
ac WIRELINE EMISSION RESULTS		
FCC 17.207 [IC RSS-Gen 8.8] ac Wireline Emissions	Complies	View Data

This test report may be reproduced in full only. The document may only be updated by MiCOM Labs personnel. All changes will be noted in the Document History section of the report.

7. TEST EQUIPMENT CONFIGURATION(S)

7.1. Conducted

Conducted RF Emission Test Set-up(s).

The following tests were performed using the conducted test set-up shown in the diagram below.

1. 6 dB & 99% Bandwidth
2. Conducted Output Power
3. Conducted Spurious Emissions
4. Conducted Band-Edge Spurious Emissions
5. Power Spectral Density

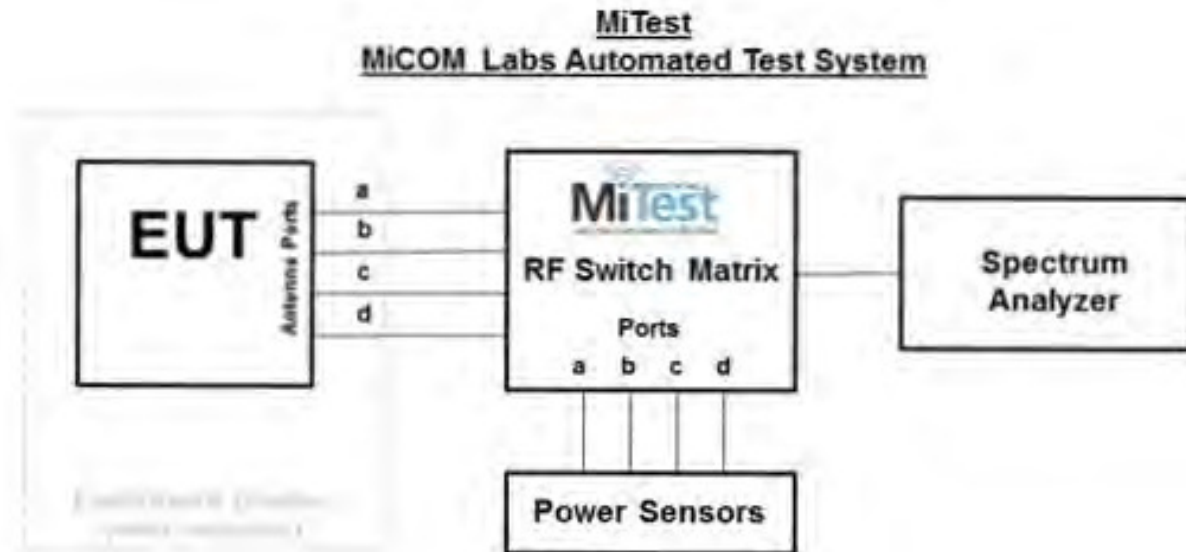

A full system calibration was performed on the test station and any resulting system losses (or gains) were taken into account in the production of all final measurement data.



Title: Aruba Networks APEX0104
To: FCC CFR 47 Part 15 Subpart C 15.247 & IC RSS-247
Serial #: ARUB199-U3 Rev A
Issue Date: 27th August 2015
Page: 17 of 223

Asset#	Description	Manufacturer	Model#	Serial#	Calibration Due Date
127	Power Supply	HP	6674A	US36370530	Cal when used
158	Barometer/Thermometer	Control Company	4196	E2846	04 Dec 2015
248	Resistance Thermometer	Thermotronics	GR2105-02	9340 #1	30 Oct 2015
287	Rohde & Schwarz 40 GHz Receiver	Rhode & Schwarz	ESIB40	100201	31 Aug 2015
376	USB 10MHz - 18GHz Average Power Sensor	Agilent	U2000A	MY51440005	28 Oct 2015
381	4x4 RF Switch Box	MiCOM Labs	MiTest RF Switch Box	MIC002	20 Dec 2015
419	Laptop with Labview Software	Lenova	W520	TS02	Not Required
420	USB to GPIB Interface	National Instruments	GPIB-USB HS	1346738	Not Required
435	USB Wideband Power Sensor	Boonton	55006	8730	31 Jul 2015
440	USB Wideband Power Sensor	Boonton	55006	9178	25 Sep 2015
441	USB Wideband Power Sensor	Boonton	55006	9179	25 Sep 2015
442	USB Wideband Power Sensor	Boonton	55006	9181	25 Sep 2015
460	Dell Computer with installation of MiTest executable.	Dell	Optiplex330	BC944G1	Not Required
74	Environmental Chamber Chamber 3	Tenney	TTC	12808-1	30 Sep 2015
RF#2 GPIB#1	GPIB cable to Power Supply	HP	GPIB	None	Not Required
RF#2 SMA#1	EUT to Mitest box port 1	Flexco	SMA Cable port1	None	20 Dec 2015
RF#2 SMA#2	EUT to Mitest box port 2	Flexco	SMA Cable port2	None	20 Dec 2015
RF#2 SMA#3	EUT to Mitest box port 3	Flexco	SMA Cable port3	None	20 Dec 2015
RF#2 SMA#4	EUT to Mitest box port 3	Flexco	SMA Cable port4	None	20 Dec 2015
RF#2 SMA#SA	Mitest box to SA	Flexco	SMA Cable SA	None	20 Dec 2015
RF#2 USB#1	USB Cable to Mitest Box	Dynex	USB Cable	None	Not Required

This test report may be reproduced in full only. The document may only be updated by MiCOM Labs personnel. All changes will be noted in the Document History section of the report.

7.2. Radiated Emissions

The following tests were performed using the conducted test set-up shown in the diagram below.

1. Section 10.5.1 Spurious Emissions
2. Section 10.5.2 Restricted Band-Edge Emissions
3. Section 10.5.3. Digital Emissions

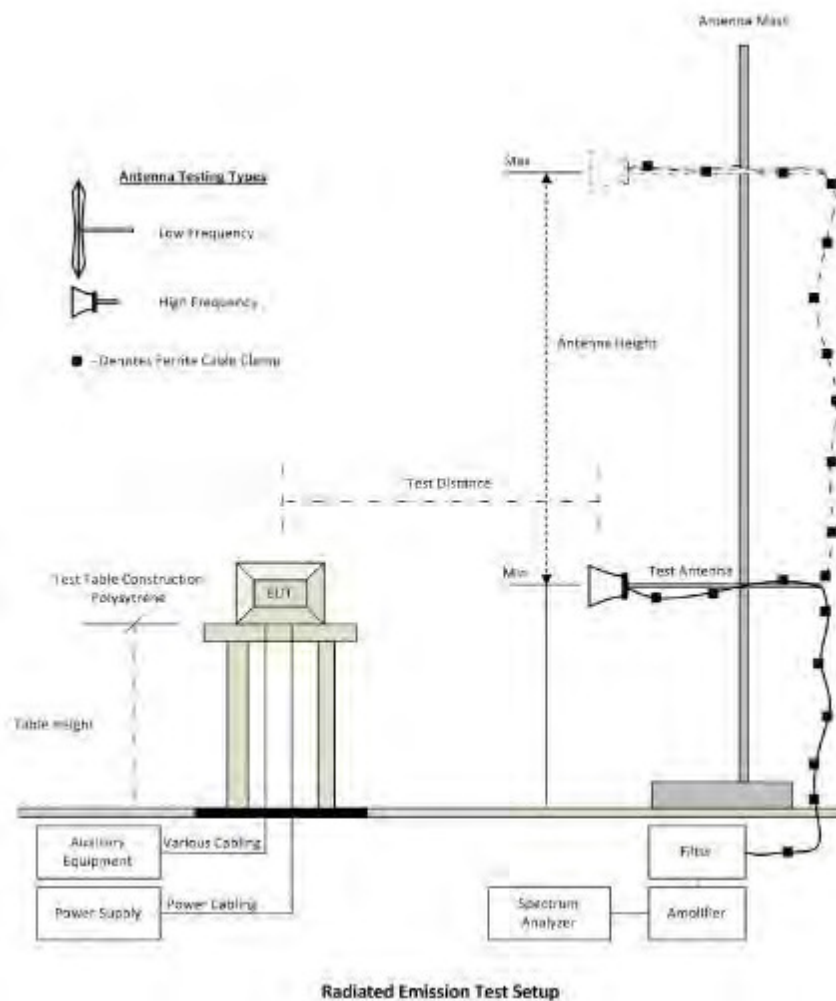

A full system calibration was performed on the test station and any resulting system losses (or gains) were taken into account in the production of all final measurement data.



Title: Aruba Networks APEX0104
To: FCC CFR 47 Part 15 Subpart C 15.247 & IC RSS-247
Serial #: ARUB199-U3 Rev A
Issue Date: 27th August 2015
Page: 19 of 223

Asset#	Description	Manufacturer	Model#	Serial#	Calibration Due Date
158	Barometer/Thermometer	Control Company	4196	E2846	04 Dec 2015
170	Video System Controller for Semi Anechoic Chamber	Panasonic	WV-CY101	04R08507	Not Required
287	Rohde & Schwarz 40 GHz Receiver	Rhode & Schwarz	ESIB40	100201	31 Aug 2015
310	SMA Cable	Micro-Coax	UFA210A-0-0787-3G03G0	209089-001	30 Oct 2015
338	Sunol 30 to 3000 MHz Antenna	Sunol	JB3	A052907	14 Aug 2015
393	DC - 1050 MHz Low Pass Filter	Microcircuits	VLFX-1050	N/A	08 Oct 2015
397	Amp 10 - 2500MHz	MiCOM Labs	Amp 10 - 2500 MHz	NA	23 Oct 2015
399	ETS 1-18 GHz Horn Antenna	ETS	3117	00154575	10 Oct 2015
406	Amplifier for Radiated Emissions	MiCOM Labs	40dB 1 to 18GHz Amp	0406	28 May 2016
410	Desktop Computer	Dell	Inspiron 620	WS38	Not Required
411	Mast/Turntable Controller	Sunol Sciences	SC98V	060199-1D	Not Required
412	USB to GPIB Interface	National Instruments	GPIB-USB HS	11B8DC2	Not Required
413	Mast Controller	Sunol Science	TWR95-4	030801-3	Not Required
415	Turntable Controller	Sunol Sciences	Turntable Controller	None	Not Required
416	Gigabit ethernet filter	ETS-Lingren	Gigafoil 260366	None	Not Required
462	Schwarzbeck cable from Antenna to Amplifier.	Schwarzbeck	AK 9513	462	25 Aug 2015
463	Schwarzbeck cable from Amplifier to Bulkhead.	Schwarzbeck	AK 9513	463	25 Aug 2015
464	Schwarzbeck cable from Bulkhead to Receiver	Schwarzbeck	AK 9513	464	25 Aug 2015
465	Low Pass Filter DC-1000 MHz	Mini-Circuits	NLP-1200+	VUU01901402	25 Aug 2015
468	Low pass filter	Mini Circuits	SLP-550	None	30 Sep 2015
469	Low pass filter	Mini Circuit	SLP-1000	None	30 Sep 2015
470	High Pass filter	Mini Circuits	SHP-700	None	30 Sep 2015
CC05	Confidence Check	MiCOM	CC05	None	1 Aug 2015

This test report may be reproduced in full only. The document may only be updated by MiCOM Labs personnel. All changes will be noted in the Document History section of the report.

7.3. ac Wireline Emissions

The following tests were performed using the conducted test set-up shown in the diagram below.

1. Section 10.6 ac Wireline Conducted Emissions

Test Measurement Set up

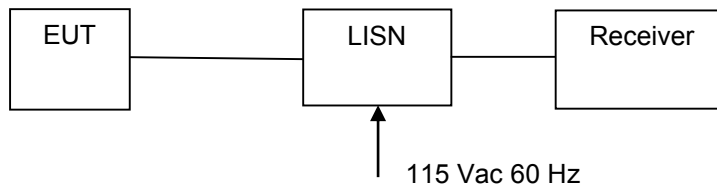

Measurement set up for AC Wireline Conducted Emissions Test

Traceability of Test Equipment Utilized for ac Wireline Emission Testing

Asset#	Description	Manufacturer	Model#	Serial#	Calibration Due Date
158	Barometer/Thermometer	Control Company	4196	E2846	04 Dec 2015
184	Pulse Limiter	Rhode & Schwarz	ESH3Z2	357.8810.52	Cal when used
190	LISN (two-line V-network)	Rhode & Schwarz	ESH3Z5	836679/006	12 Sep 2015
287	Rohde & Schwarz 40 GHz Receiver	Rhode & Schwarz	ESIB40	100201	31 Aug 2015
316	Dell desktop computer workstation with Vasona	Dell	Desktop	WS04	Not Required

This test report may be reproduced in full only. The document may only be updated by MiCOM Labs personnel. All changes will be noted in the Document History section of the report.

8. MEASUREMENT AND PRESENTATION OF TEST DATA

The measurement and graphical data presented in this test report was generated automatically using state-of-the-art technology creating an easy to read report structure. Numerical measurement data is separated from supporting graphical data (plots) through hyperlinks. Numerical measurement data can be reviewed without scrolling through numerous graphical pages to arrive at the next data matrix.

Plots have been relegated into the Appendix 'Graphical Data'.

Test and report automation was performed by [MiTest](#). [MiTest](#) is an automated test system developed by MiCOM Labs. [MiTest](#) is the first cloud based modular test system enabling end-to-end automation of regulatory compliance testing for conducted RF testing.



The MiCOM Labs "[MiTest](#)" Automated Test System" (Patent Pending)

This test report may be reproduced in full only. The document may only be updated by MiCOM Labs personnel. All changes will be noted in the Document History section of the report.



Title: Aruba Networks APEX0104
To: FCC CFR 47 Part 15 Subpart C 15.247 & IC RSS-247
Serial #: ARUB199-U3 Rev A
Issue Date: 27th August 2015
Page: 22 of 223

9. WORST CASE MEASUREMENT RESULTS

10. TEST RESULTS

10.1. 6 dB & 99% Bandwidth

Conducted Test Conditions for 6 dB and 99% Bandwidth			
Standard:	FCC CFR 47:15.247	Ambient Temp. (°C):	24.0 - 27.5
Test Heading:	6 dB and 99 % Bandwidth	Rel. Humidity (%):	32 - 45
Standard Section(s):	15.247 (a)(2)	Pressure (mBars):	999 - 1001
Reference Document(s):	See Normative References		

Test Procedure for 6 dB and 99% Bandwidth Measurement
The bandwidth at 6 dB and 99 % was measured with a spectrum analyzer connected to the antenna terminal, while EUT is operating in transmission mode at the appropriate center frequency.

Testing was performed under ambient conditions at nominal voltage. Where the device operated with multiple antenna ports i.e. MIMO device, each port was measured and reported.

Test configuration and setup used for the measurement was per the Conducted Test Set-up specified in this document.

Limits for 6 dB and 99% Bandwidth
(a) Operation under the provisions of this Section is limited to frequency hopping and digitally modulated intentional radiators that comply with the following provisions:
(2) Systems using digital modulation techniques may operate in the 902-928 MHz and 2400-2483.5 MHz bands. The minimum 6 dB bandwidth shall be at least 500 kHz.

This test report may be reproduced in full only. The document may only be updated by MiCOM Labs personnel. All changes will be noted in the Document History section of the report.



Title: Aruba Networks APEX0104
To: FCC CFR 47 Part 15 Subpart C 15.247 & IC RSS-247
Serial #: ARUB199-U3 Rev A
Issue Date: 27th August 2015
Page: 23 of 223

Equipment Configuration for 6 dB & 99% Bandwidth

Variant:	802.11b	Duty Cycle (%):	99.0
Data Rate:	1.00 MBit/s	Antenna Gain (dBi):	2.80
Modulation:	CCK	Beam Forming Gain (Y)(dB):	Not Applicable
TPC:	Not Applicable	Tested By:	CC
Engineering Test Notes:			

Test Measurement Results

Test Frequency	Measured 6 dB Bandwidth (MHz)				6 dB Bandwidth (MHz)		Limit	Lowest Margin
	Port(s)				Highest	Lowest		
	MHz	a	b	c			d	KHz
2412.0	8.270	8.730	8.200	--	8.730	8.200	≥500.0	-7.70
2437.0	8.470	8.530	8.330	--	8.530	8.330	≥500.0	-7.83
2462.0	8.130	8.270	8.470	--	8.470	8.130	≥500.0	-7.63

Test Frequency	Measured 99% Bandwidth (MHz)				Maximum 99% Bandwidth (MHz)		
	Port(s)						
	MHz	a	b	c	d		
2412.0	11.545	11.526	11.509	--	11.545		
2437.0	11.558	11.586	11.527	--	11.586		
2462.0	11.520	11.566	11.388	--	11.566		

Traceability to Industry Recognized Test Methodologies	
Work Instruction:	WI-03 MEASURING RF SPECTRUM MASK
Measurement Uncertainty:	±2.81 dB

Note: click the links in the above matrix to view the graphical image (plot).

This test report may be reproduced in full only. The document may only be updated by MiCOM Labs personnel. All changes will be noted in the Document History section of the report.



Title: Aruba Networks APEX0104
To: FCC CFR 47 Part 15 Subpart C 15.247 & IC RSS-247
Serial #: ARUB199-U3 Rev A
Issue Date: 27th August 2015
Page: 24 of 223

Equipment Configuration for 6 dB & 99% Bandwidth

Variant:	802.11g	Duty Cycle (%):	99.0
Data Rate:	6.00 MBit/s	Antenna Gain (dBi):	2.80
Modulation:	OFDM	Beam Forming Gain (Y)(dB):	Not Applicable
TPC:	Not Applicable	Tested By:	CC
Engineering Test Notes:			

Test Measurement Results

Test Frequency	Measured 6 dB Bandwidth (MHz)				6 dB Bandwidth (MHz)		Limit	Lowest Margin
	Port(s)				Highest	Lowest		
	MHz	a	b	c			d	KHz
2412.0	16.270	16.200	16.200	--	16.270	16.200	≥500.0	-15.70
2437.0	16.270	16.270	16.200	--	16.270	16.200	≥500.0	-15.70
2462.0	16.270	16.200	16.200	--	16.270	16.200	≥500.0	-15.70

Test Frequency	Measured 99% Bandwidth (MHz)				Maximum 99% Bandwidth (MHz)		
	Port(s)						
	MHz	a	b	c	d		
2412.0	16.489	16.501	16.512	--	16.512		
2437.0	16.508	16.511	16.510	--	16.511		
2462.0	16.466	16.479	16.495	--	16.495		

Traceability to Industry Recognized Test Methodologies	
Work Instruction:	WI-03 MEASURING RF SPECTRUM MASK
Measurement Uncertainty:	±2.81 dB

Note: click the links in the above matrix to view the graphical image (plot).

This test report may be reproduced in full only. The document may only be updated by MiCOM Labs personnel. All changes will be noted in the Document History section of the report.



Title: Aruba Networks APEX0104
To: FCC CFR 47 Part 15 Subpart C 15.247 & IC RSS-247
Serial #: ARUB199-U3 Rev A
Issue Date: 27th August 2015
Page: 25 of 223

Equipment Configuration for 6 dB & 99% Bandwidth

Variant:	802.11n HT-20	Duty Cycle (%):	98.0
Data Rate:	6.50 MBit/s	Antenna Gain (dBi):	2.80
Modulation:	OFDM	Beam Forming Gain (Y)(dB):	Not Applicable
TPC:	Not Applicable	Tested By:	CC
Engineering Test Notes:			

Test Measurement Results

Test Frequency	Measured 6 dB Bandwidth (MHz)				6 dB Bandwidth (MHz)		Limit	Lowest Margin
	Port(s)				Highest	Lowest		
	MHz	a	b	c			d	KHz
2412.0	17.530	17.530	17.530	--	17.530	17.530	≥500.0	-17.03
2437.0	17.530	17.530	17.530	--	17.530	17.530	≥500.0	-17.03
2462.0	17.530	17.530	17.530	--	17.530	17.530	≥500.0	-17.03

Test Frequency	Measured 99% Bandwidth (MHz)				Maximum 99% Bandwidth (MHz)		
	Port(s)						
	MHz	a	b	c	d		
2412.0	17.687	17.675	17.694	--	17.694		
2437.0	17.713	17.705	17.694	--	17.713		
2462.0	17.670	17.661	17.688	--	17.688		

Traceability to Industry Recognized Test Methodologies	
Work Instruction:	WI-03 MEASURING RF SPECTRUM MASK
Measurement Uncertainty:	±2.81 dB

Note: click the links in the above matrix to view the graphical image (plot).

This test report may be reproduced in full only. The document may only be updated by MiCOM Labs personnel. All changes will be noted in the Document History section of the report.



Title: Aruba Networks APEX0104
To: FCC CFR 47 Part 15 Subpart C 15.247 & IC RSS-247
Serial #: ARUB199-U3 Rev A
Issue Date: 27th August 2015
Page: 26 of 223

Equipment Configuration for 6 dB & 99% Bandwidth

Variant:	802.11n HT-40	Duty Cycle (%):	97.0
Data Rate:	13.50 MBit/s	Antenna Gain (dBi):	2.80
Modulation:	OFDM	Beam Forming Gain (Y)(dB):	Not Applicable
TPC:	Not Applicable	Tested By:	CC
Engineering Test Notes:			

Test Measurement Results

Test Frequency	Measured 6 dB Bandwidth (MHz)				6 dB Bandwidth (MHz)		Limit	Lowest Margin
	Port(s)				Highest	Lowest		
	MHz	a	b	c			d	KHz
2422.0	35.870	36.130	36.130	--	36.130	35.870	≥500.0	-35.37
2437.0	36.000	36.130	35.870	--	36.130	35.870	≥500.0	-35.37
2452.0	35.870	36.130	35.870	--	36.130	35.870	≥500.0	-35.37

Test Frequency	Measured 99% Bandwidth (MHz)				Maximum 99% Bandwidth (MHz)		
	Port(s)						
	MHz	a	b	c	d		
2422.0	36.107	36.157	36.176	--	36.176		
2437.0	36.123	36.190	36.081	--	36.190		
2452.0	36.045	36.151	36.026	--	36.151		

Traceability to Industry Recognized Test Methodologies	
Work Instruction:	WI-03 MEASURING RF SPECTRUM MASK
Measurement Uncertainty:	±2.81 dB

Note: click the links in the above matrix to view the graphical image (plot).

This test report may be reproduced in full only. The document may only be updated by MiCOM Labs personnel. All changes will be noted in the Document History section of the report.



10.2. Conducted Output Power

Conducted Test Conditions for Fundamental Emission Output Power			
Standard:	FCC CFR 47:15.247	Ambient Temp. (°C):	24.0 - 27.5
Test Heading:	Output Power	Rel. Humidity (%):	32 - 45
Standard Section(s):	15.247 (b) & (c)	Pressure (mBars):	999 - 1001
Reference Document(s):	See Normative References		

Test Procedure for Fundamental Emission Output Power Measurement
In the case of average power measurements an average power sensor was utilized.

For peak power measurements the spectrum analyzer built-in power function was used to integrate peak power over the 20 dB bandwidth.

Testing was performed under ambient conditions at nominal voltage only. Where the device operated with multiple antenna ports i.e. MIMO device, each port was measured, summed (Σ) and reported.

Test configuration and setup used for the measurement was per the Conducted Test Set-up specified in this document.

Supporting Information

Calculated Power = $A + G + Y + 10 \log(1/x)$ dBm

A = Total Power [$10^a \cdot \text{Log}_{10}(10^{a/10} + 10^{b/10} + 10^{c/10} + 10^{d/10})$]

G = Antenna Gain

Y = Beamforming Gain

x = Duty Cycle (average power measurements only)

Limits for Fundamental Emission Output Power

(b) The maximum peak conducted output power of the intentional radiator shall not exceed the following for non-frequency hopping systems:

(3) For systems using digital modulation in the 902-928 MHz and 2400-2483.5 MHz bands: 1 Watt. As an alternative to a peak power measurement, compliance with the one Watt limit can be based on a measurement of the maximum conducted output power. Maximum Conducted Output Power is defined as the total transmit power delivered to all antennas and antenna elements averaged across all symbols in the signaling alphabet when the transmitter is operating at its maximum power control level. Power must be summed across all antennas and antenna elements. The average must not include any time intervals during which the transmitter is off or is transmitting at a reduced power level. If multiple modes of operation are possible (e.g., alternative modulation methods), the maximum conducted output power is the highest total transmit power occurring in any mode.

(4) The conducted output power limit specified in paragraph (b) of this section is based on the use of antennas with directional gains that do not exceed 6 dBi. Except as shown in paragraph (c) of this section, if transmitting antennas of directional gain greater than 6 dBi are used, the conducted output power from the intentional radiator shall be reduced below the stated values in paragraphs (b)(3) of this section, as appropriate, by the amount in dB that the directional gain of the antenna exceeds 6 dBi.

(c) Operation with directional antenna gains greater than 6 dBi.

(1) Fixed point-to-point operation:

(i) Systems operating in the 2400-2483.5 MHz band that are used exclusively for fixed, point-to-point operations may employ transmitting antennas with directional gain greater than 6 dBi provided the maximum conducted output power of the intentional radiator is reduced by 1 dB for every 3 dB that the directional gain of the antenna exceeds 6 dBi.

(iii) Fixed, point-to-point operation, as used in paragraphs (c)(1)(i) and (c)(1)(ii) of this section, excludes the use of point-to-multipoint systems, omnidirectional applications, and multiple co-located intentional radiators transmitting the same information. The operator of the spread spectrum or digitally modulated intentional radiator or, if the equipment is professionally installed, the installer is responsible for ensuring that the system is used exclusively for fixed, point-to-point operations. The instruction manual furnished with the intentional radiator shall contain language in the installation

This test report may be reproduced in full only. The document may only be updated by MiCOM Labs personnel. All changes will be noted in the Document History section of the report.



Title: Aruba Networks APEX0104
To: FCC CFR 47 Part 15 Subpart C 15.247 & IC RSS-247
Serial #: ARUB199-U3 Rev A
Issue Date: 27th August 2015
Page: 28 of 223

instructions informing the operator and the installer of this responsibility.

(2) In addition to the provisions in paragraphs (b)(3), (b)(4) and (c)(1)(i) of this section, transmitters operating in the 2400-2483.5 MHz band that emit multiple directional beams, simultaneously or sequentially, for the purpose of directing signals to individual receivers or to groups of receivers provided the emissions comply with the following:

(i) Different information must be transmitted to each receiver.

(ii) If the transmitter employs an antenna system that emits multiple directional beams but does not do emit multiple directional beams simultaneously, the total output power conducted to the array or arrays that comprise the device, i.e., the sum of the power supplied to all antennas, antenna elements, staves, etc. and summed across all carriers or frequency channels, shall not exceed the limit specified in paragraph (b)(1) or (b)(3) of this section, as applicable. However, the total conducted output power shall be reduced by 1 dB below the specified limits for each 3 dB that the directional gain of the antenna/antenna array exceeds 6 dBi. The directional antenna gain shall be computed as follows:

(A) The directional gain shall be calculated as the sum of $10 \log$ (number of array elements or staves) plus the directional gain of the element or stave having the highest gain.

(B) A lower value for the directional gain than that calculated in paragraph (c)(2)(ii)(A) of this section will be accepted if sufficient evidence is presented, e.g., due to shading of the array or coherence loss in the beamforming.

(iii) If a transmitter employs an antenna that operates simultaneously on multiple directional beams using the same or different frequency channels, the power supplied to each emission beam is subject to the power limit specified in paragraph (c)(2)(ii) of this section. If transmitted beams overlap, the power shall be reduced to ensure that their aggregate power does not exceed the limit specified in paragraph (c)(2)(ii) of this section. In addition, the aggregate power transmitted simultaneously on all beams shall not exceed the limit specified in paragraph (c)(2)(ii) of this section by more than 8 dB.

(iv) Transmitters that emit a single directional beam shall operate under the provisions of paragraph (c)(1) of this section.

This test report may be reproduced in full only. The document may only be updated by MiCOM Labs personnel. All changes will be noted in the Document History section of the report.



Title: Aruba Networks APEX0104
To: FCC CFR 47 Part 15 Subpart C 15.247 & IC RSS-247
Serial #: ARUB199-U3 Rev A
Issue Date: 27th August 2015
Page: 29 of 223

Equipment Configuration for Average Output Power

Variant:	802.11b	Duty Cycle (%):	99.0
Data Rate:	1 MBit/s	Antenna Gain (dBi):	2.80
Modulation:	CCK	Beam Forming Gain (Y)(dB):	Not Applicable
TPC:	Not Applicable	Tested By:	CC
Engineering Test Notes:			

Test Measurement Results

Test Frequency	Measured Output Power (dBm)				Calculated Total Power Σ Port(s) + DCCF (+0.04 dB)	Limit	Margin	EUT Power Setting
	Port(s)							
MHz	a	b	c	d	dBm	dBm	dB	
2412.0	24.63	25.09	24.80	--	29.66	30.00	-0.34	24.00
2437.0	24.43	25.01	24.59	--	29.50	30.00	-0.50	24.00
2462.0	24.37	24.87	24.46	--	29.39	30.00	-0.61	24.00

Traceability to Industry Recognized Test Methodologies

Work Instruction:	WI-01 MEASURING RF OUTPUT POWER
Measurement Uncertainty:	± 1.33 dB

DCCF - Duty Cycle Correction Factor

This test report may be reproduced in full only. The document may only be updated by MiCOM Labs personnel. All changes will be noted in the Document History section of the report.



Title: Aruba Networks APEX0104
To: FCC CFR 47 Part 15 Subpart C 15.247 & IC RSS-247
Serial #: ARUB199-U3 Rev A
Issue Date: 27th August 2015
Page: 30 of 223

Equipment Configuration for Average Output Power

Variant:	802.11g	Duty Cycle (%):	99.0
Data Rate:	6 MBit/s	Antenna Gain (dBi):	2.80
Modulation:	OFDM	Beam Forming Gain (Y)(dB):	Not Applicable
TPC:	Not Applicable	Tested By:	CC
Engineering Test Notes:			

Test Measurement Results

Test Frequency	Measured Output Power (dBm)				Calculated Total Power Σ Port(s) + DCCF (+0.04 dB)	Limit	Margin	EUT Power Setting
	Port(s)							
MHz	a	b	c	d	dBm	dBm	dB	
2412.0	23.88	24.13	23.96	--	28.81	30.00	-1.19	24.00
2437.0	23.56	24.06	23.69	--	28.59	30.00	-1.41	24.00
2462.0	23.45	23.93	23.68	--	28.51	30.00	-1.49	24.00

Traceability to Industry Recognized Test Methodologies

Work Instruction:	WI-01 MEASURING RF OUTPUT POWER
Measurement Uncertainty:	± 1.33 dB

DCCF - Duty Cycle Correction Factor

This test report may be reproduced in full only. The document may only be updated by MiCOM Labs personnel. All changes will be noted in the Document History section of the report.



Title: Aruba Networks APEX0104
To: FCC CFR 47 Part 15 Subpart C 15.247 & IC RSS-247
Serial #: ARUB199-U3 Rev A
Issue Date: 27th August 2015
Page: 31 of 223

Equipment Configuration for Average Output Power

Variant:	802.11n HT-20	Duty Cycle (%):	98.0
Data Rate:	6.5 MBit/s	Antenna Gain (dBi):	2.80
Modulation:	OFDM	Beam Forming Gain (Y)(dB):	Not Applicable
TPC:	Not Applicable	Tested By:	CC
Engineering Test Notes:			

Test Measurement Results

Test Frequency	Measured Output Power (dBm)				Calculated Total Power Σ Port(s) + DCCF (+0.09 dB)	Limit	Margin	EUT Power Setting
	Port(s)							
MHz	a	b	c	d	dBm	dBm	dB	
2412.0	23.61	23.95	23.77	--	28.64	30.00	-1.36	24.00
2437.0	23.54	23.99	23.71	--	28.61	30.00	-1.39	24.00
2462.0	23.25	23.85	23.48	--	28.39	30.00	-1.61	24.00

Traceability to Industry Recognized Test Methodologies

Work Instruction:	WI-01 MEASURING RF OUTPUT POWER
Measurement Uncertainty:	± 1.33 dB

DCCF - Duty Cycle Correction Factor

This test report may be reproduced in full only. The document may only be updated by MiCOM Labs personnel. All changes will be noted in the Document History section of the report.



Title: Aruba Networks APEX0104
To: FCC CFR 47 Part 15 Subpart C 15.247 & IC RSS-247
Serial #: ARUB199-U3 Rev A
Issue Date: 27th August 2015
Page: 32 of 223

Equipment Configuration for Average Output Power

Variant:	802.11n HT-40	Duty Cycle (%):	97.0
Data Rate:	13.5 MBit/s	Antenna Gain (dBi):	2.80
Modulation:	OFDM	Beam Forming Gain (Y)(dB):	Not Applicable
TPC:	Not Applicable	Tested By:	CC
Engineering Test Notes:			

Test Measurement Results

Test Frequency	Measured Output Power (dBm)				Calculated Total Power Σ Port(s) + DCCF (+0.13 dB)	Limit	Margin	EUT Power Setting
	Port(s)							
MHz	a	b	c	d	dBm	dBm	dB	
2422.0	23.35	23.70	23.52	--	28.43	30.00	-1.57	23.00
2437.0	23.34	23.81	23.21	--	28.36	30.00	-1.64	23.00
2452.0	23.21	23.53	23.17	--	28.21	30.00	-1.79	23.00

Traceability to Industry Recognized Test Methodologies

Work Instruction:	WI-01 MEASURING RF OUTPUT POWER
Measurement Uncertainty:	± 1.33 dB

DCCF - Duty Cycle Correction Factor

This test report may be reproduced in full only. The document may only be updated by MiCOM Labs personnel. All changes will be noted in the Document History section of the report.



Title: Aruba Networks APEX0104
To: FCC CFR 47 Part 15 Subpart C 15.247 & IC RSS-247
Serial #: ARUB199-U3 Rev A
Issue Date: 27th August 2015
Page: 33 of 223

10.3. Conducted Spurious Emissions

10.3.1. Conducted Emissions

10.3.1.1. Conducted Spurious Emissions

Conducted Test Conditions for Transmitter Conducted Spurious and Band-Edge Emissions			
Standard:	FCC CFR 47:15.247	Ambient Temp. (°C):	24.0 - 27.5
Test Heading:	Max Unwanted Emission Levels	Rel. Humidity (%):	32 - 45
Standard Section(s):	15.247 (d)	Pressure (mBars):	999 - 1001
Reference Document(s):	See Normative References		

Test Procedure for Transmitter Conducted Spurious and Band-Edge Emissions Measurement

Transmitter Conducted Spurious and Band-Edge emissions were measured at a limit of 30 dBc (average detector) or 20 dBc (peak detector) below the highest in-band spectral density measured with a spectrum analyzer connected to the antenna terminal. Measurements were made while EUT was operating in transmit mode of operation at the appropriate centre frequency closest to the band-edge. Emissions were maximized during the measurement and limits derived from the peak spectral power and drawn on each plot.

Where the device operated with multiple antenna ports i.e. MIMO device, each port was measured separately. Testing was performed under ambient conditions at nominal voltage only.

Test configuration and setup used for the measurement was per the Conducted Test Set-up specified in this document.

Limits Transmitter Conducted Spurious and Band-Edge Emissions

(d) In any 100 kHz bandwidth outside the frequency band in which the spread spectrum or digitally modulated intentional radiator is operating, the radio frequency power that is produced by the intentional radiator shall be at least 20 dB below that in the 100 kHz bandwidth within the band that contains the highest level of the desired power, based on either an RF conducted or a radiated measurement, provided the transmitter demonstrates compliance with the peak conducted power limits. If the transmitter complies with the conducted power limits based on the use of RMS averaging over a time interval, as permitted under paragraph (b)(3) of this section, the attenuation required under this paragraph shall be 30 dB instead of 20 dB. Attenuation below the general limits specified in §15.209(a) is not required. In addition, radiated emissions which fall in the restricted bands, as defined in §15.205(a), must also comply with the radiated emission limits specified in §15.209(a) (see §15.205(c)).

This test report may be reproduced in full only. The document may only be updated by MiCOM Labs personnel. All changes will be noted in the Document History section of the report.



Title: Aruba Networks APEX0104
To: FCC CFR 47 Part 15 Subpart C 15.247 & IC RSS-247
Serial #: ARUB199-U3 Rev A
Issue Date: 27th August 2015
Page: 34 of 223

Equipment Configuration for Transmitter Conducted Spurious Emissions

Variant:	802.11b	Duty Cycle (%):	99.0
Data Rate:	1.00 MBit/s	Antenna Gain (dBi):	2.80
Modulation:	CCK	Beam Forming Gain (Y):	Not Applicable
TPC:	Not Applicable	Tested By:	CC
Engineering Test Notes:			

Test Measurement Results

Test Frequency	Frequency Range	Transmitter Conducted Spurious Emissions (dBm)							
		Port a		Port b		Port c		Port d	
MHz	MHz	SE	Limit	SE	Limit	SE	Limit	SE	Limit
2412.0	30.0 - 26000.0	-66.603	-31.07	-66.613	-30.79	-66.586	-31.21	--	--
2437.0	30.0 - 26000.0	-66.695	-31.47	-66.779	-31.25	-66.625	-31.59	--	--
2462.0	30.0 - 26000.0	-66.664	-31.65	-66.736	-31.34	-66.597	-31.80	--	--

Traceability to Industry Recognized Test Methodologies

Work Instruction:	WI-05 MEASUREMENT OF SPURIOUS EMISSIONS
Measurement Uncertainty:	<=40 GHz ±2.37 dB, > 40 GHz ±4.6 dB

Note: click the links in the above matrix to view the graphical image (plot).

This test report may be reproduced in full only. The document may only be updated by MiCOM Labs personnel. All changes will be noted in the Document History section of the report.



Title: Aruba Networks APEX0104
To: FCC CFR 47 Part 15 Subpart C 15.247 & IC RSS-247
Serial #: ARUB199-U3 Rev A
Issue Date: 27th August 2015
Page: 35 of 223

Equipment Configuration for Transmitter Conducted Spurious Emissions

Variant:	802.11g	Duty Cycle (%):	99.0
Data Rate:	6.00 MBit/s	Antenna Gain (dBi):	2.80
Modulation:	OFDM	Beam Forming Gain (Y):	Not Applicable
TPC:	Not Applicable	Tested By:	CC
Engineering Test Notes:			

Test Measurement Results

Test Frequency	Frequency Range	Transmitter Conducted Spurious Emissions (dBm)							
		Port a		Port b		Port c		Port d	
MHz	MHz	SE	Limit	SE	Limit	SE	Limit	SE	Limit
2412.0	30.0 - 26000.0	-66.678	-32.22	-66.687	-31.87	-66.552	-32.01	--	--
2437.0	30.0 - 26000.0	-66.695	-33.44	-66.641	-32.81	-66.534	-33.05	--	--
2462.0	30.0 - 26000.0	-66.616	-32.59	-66.676	-32.11	-66.661	-32.30	--	--

Traceability to Industry Recognized Test Methodologies

Work Instruction:	WI-05 MEASUREMENT OF SPURIOUS EMISSIONS
Measurement Uncertainty:	<=40 GHz ±2.37 dB, > 40 GHz ±4.6 dB

Note: click the links in the above matrix to view the graphical image (plot).

This test report may be reproduced in full only. The document may only be updated by MiCOM Labs personnel. All changes will be noted in the Document History section of the report.



Title: Aruba Networks APEX0104
To: FCC CFR 47 Part 15 Subpart C 15.247 & IC RSS-247
Serial #: ARUB199-U3 Rev A
Issue Date: 27th August 2015
Page: 36 of 223

Equipment Configuration for Transmitter Conducted Spurious Emissions

Variant:	802.11n HT-20	Duty Cycle (%):	98.0
Data Rate:	6.50 MBit/s	Antenna Gain (dBi):	2.80
Modulation:	OFDM	Beam Forming Gain (Y):	Not Applicable
TPC:	Not Applicable	Tested By:	CC
Engineering Test Notes:			

Test Measurement Results

Test Frequency	Frequency Range	Transmitter Conducted Spurious Emissions (dBm)							
		Port a		Port b		Port c		Port d	
MHz	MHz	SE	Limit	SE	Limit	SE	Limit	SE	Limit
2412.0	30.0 - 26000.0	-66.579	-32.25	-66.655	-31.67	-66.526	-32.16	--	--
2437.0	30.0 - 26000.0	-66.677	-33.46	-66.680	-32.96	-66.574	-33.09	--	--
2462.0	30.0 - 26000.0	-66.628	-32.71	-66.675	-32.32	-66.573	-32.60	--	--

Traceability to Industry Recognized Test Methodologies

Work Instruction:	WI-05 MEASUREMENT OF SPURIOUS EMISSIONS
Measurement Uncertainty:	<=40 GHz ±2.37 dB, > 40 GHz ±4.6 dB

Note: click the links in the above matrix to view the graphical image (plot).

This test report may be reproduced in full only. The document may only be updated by MiCOM Labs personnel. All changes will be noted in the Document History section of the report.



Title: Aruba Networks APEX0104
To: FCC CFR 47 Part 15 Subpart C 15.247 & IC RSS-247
Serial #: ARUB199-U3 Rev A
Issue Date: 27th August 2015
Page: 37 of 223

Equipment Configuration for Transmitter Conducted Spurious Emissions

Variant:	802.11n HT-40	Duty Cycle (%):	97.0
Data Rate:	13.50 MBit/s	Antenna Gain (dBi):	2.80
Modulation:	OFDM	Beam Forming Gain (Y):	Not Applicable
TPC:	Not Applicable	Tested By:	CC
Engineering Test Notes:			

Test Measurement Results

Test Frequency	Frequency Range	Transmitter Conducted Spurious Emissions (dBm)							
		Port a		Port b		Port c		Port d	
MHz	MHz	SE	Limit	SE	Limit	SE	Limit	SE	Limit
2422.0	30.0 - 26000.0	-66.609	-32.67	-66.532	-33.34	-66.467	-33.52	--	--
2437.0	30.0 - 26000.0	-66.595	-34.52	-66.618	-34.10	-66.489	-34.23	--	--
2452.0	30.0 - 26000.0	-66.607	-32.85	-66.616	-32.56	-66.548	-32.86	--	--

Traceability to Industry Recognized Test Methodologies

Work Instruction:	WI-05 MEASUREMENT OF SPURIOUS EMISSIONS
Measurement Uncertainty:	<=40 GHz ±2.37 dB, > 40 GHz ±4.6 dB

Note: click the links in the above matrix to view the graphical image (plot).

This test report may be reproduced in full only. The document may only be updated by MiCOM Labs personnel. All changes will be noted in the Document History section of the report.



Title: Aruba Networks APEX0104
To: FCC CFR 47 Part 15 Subpart C 15.247 & IC RSS-247
Serial #: ARUB199-U3 Rev A
Issue Date: 27th August 2015
Page: 38 of 223

10.3.1.2. Conducted Band-Edge Emissions

Conducted Test Conditions for Transmitter Conducted Spurious and Band-Edge Emissions			
Standard:	FCC CFR 47:15.247	Ambient Temp. (°C):	24.0 - 27.5
Test Heading:	Max Unwanted Emission Levels	Rel. Humidity (%):	32 - 45
Standard Section(s):	15.247 (d)	Pressure (mBars):	999 - 1001
Reference Document(s):	See Normative References		

Test Procedure for Transmitter Conducted Spurious and Band-Edge Emissions Measurement

Transmitter Conducted Spurious and Band-Edge emissions were measured at a limit of 30 dBc (average detector) or 20 dBc (peak detector) below the highest in-band spectral density measured with a spectrum analyzer connected to the antenna terminal. Measurements were made while EUT was operating in transmit mode of operation at the appropriate centre frequency closest to the band-edge. Emissions were maximized during the measurement and limits derived from the peak spectral power and drawn on each plot.

Where the device operated with multiple antenna ports i.e. MIMO device, each port was measured separately. Testing was performed under ambient conditions at nominal voltage only.

Test configuration and setup used for the measurement was per the Conducted Test Set-up specified in this document.

Limits Transmitter Conducted Spurious and Band-Edge Emissions

(d) In any 100 kHz bandwidth outside the frequency band in which the spread spectrum or digitally modulated intentional radiator is operating, the radio frequency power that is produced by the intentional radiator shall be at least 20 dB below that in the 100 kHz bandwidth within the band that contains the highest level of the desired power, based on either an RF conducted or a radiated measurement, provided the transmitter demonstrates compliance with the peak conducted power limits. If the transmitter complies with the conducted power limits based on the use of RMS averaging over a time interval, as permitted under paragraph (b)(3) of this section, the attenuation required under this paragraph shall be 30 dB instead of 20 dB. Attenuation below the general limits specified in §15.209(a) is not required. In addition, radiated emissions which fall in the restricted bands, as defined in §15.205(a), must also comply with the radiated emission limits specified in §15.209(a) (see §15.205(c)).

This test report may be reproduced in full only. The document may only be updated by MiCOM Labs personnel. All changes will be noted in the Document History section of the report.



Title: Aruba Networks APEX0104
To: FCC CFR 47 Part 15 Subpart C 15.247 & IC RSS-247
Serial #: ARUB199-U3 Rev A
Issue Date: 27th August 2015
Page: 39 of 223

Equipment Configuration for Conducted Low Band-Edge Emissions - Average

Variant:	802.11b	Duty Cycle (%):	99.0
Data Rate:	1.00 MBit/s	Antenna Gain (dBi):	2.80
Modulation:	CCK	Beam Forming Gain (Y)(dB):	Not Applicable
TPC:	Not Applicable	Tested By:	CC
Engineering Test Notes:			

Test Measurement Results

Channel Frequency:	2412.0 MHz					
Band-Edge Frequency:	2400.0 MHz					
Test Frequency Range:	2350.0 - 2422.0 MHz					
Port(s)	Band-Edge Markers and Limit			Revised Limit		Margin
	M1 Amplitude (dBm)	Plot Limit (dBm)	M2 Frequency (MHz)	Amplitude (dBm)	M2A Frequency (MHz)	(MHz)
a	-47.54	-23.18	2404.50	--	--	-4.500
b	-46.53	-22.88	2404.50	--	--	-4.500
c	-47.13	-23.05	2404.50	--	--	-4.500

Traceability to Industry Recognized Test Methodologies	
Work Instruction:	WI-05 MEASUREMENT OF SPURIOUS EMISSIONS
Measurement Uncertainty:	<=40 GHz ±2.37 dB, > 40 GHz ±4.6 dB

Note: click the links in the above matrix to view the graphical image (plot).

This test report may be reproduced in full only. The document may only be updated by MiCOM Labs personnel. All changes will be noted in the Document History section of the report.



Title: Aruba Networks APEX0104
To: FCC CFR 47 Part 15 Subpart C 15.247 & IC RSS-247
Serial #: ARUB199-U3 Rev A
Issue Date: 27th August 2015
Page: 40 of 223

Equipment Configuration for Conducted Low Band-Edge Emissions - Average

Variant:	802.11g	Duty Cycle (%):	99.0
Data Rate:	6.00 MBit/s	Antenna Gain (dBi):	2.80
Modulation:	OFDM	Beam Forming Gain (Y)(dB):	Not Applicable
TPC:	Not Applicable	Tested By:	CC
Engineering Test Notes:			

Test Measurement Results

Channel Frequency:	2412.0 MHz					
Band-Edge Frequency:	2400.0 MHz					
Test Frequency Range:	2350.0 - 2422.0 MHz					
Port(s)	Band-Edge Markers and Limit			Revised Limit		Margin
	M1 Amplitude (dBm)	Plot Limit (dBm)	M2 Frequency (MHz)	Amplitude (dBm)	M2A Frequency (MHz)	(MHz)
a	-29.79	-25.91	2401.60	--	--	-1.600
b	-27.72	-25.62	2401.50	--	--	-1.500
c	-29.23	-25.86	2401.60	--	--	-1.600

Traceability to Industry Recognized Test Methodologies

Work Instruction:	WI-05 MEASUREMENT OF SPURIOUS EMISSIONS
Measurement Uncertainty:	<=40 GHz ±2.37 dB, > 40 GHz ±4.6 dB

Note: click the links in the above matrix to view the graphical image (plot).

This test report may be reproduced in full only. The document may only be updated by MiCOM Labs personnel. All changes will be noted in the Document History section of the report.



Title: Aruba Networks APEX0104
To: FCC CFR 47 Part 15 Subpart C 15.247 & IC RSS-247
Serial #: ARUB199-U3 Rev A
Issue Date: 27th August 2015
Page: 41 of 223

Equipment Configuration for Conducted Low Band-Edge Emissions - Average

Variant:	802.11n HT-20	Duty Cycle (%):	98.0
Data Rate:	6.50 MBit/s	Antenna Gain (dBi):	2.80
Modulation:	OFDM	Beam Forming Gain (Y)(dB):	Not Applicable
TPC:	Not Applicable	Tested By:	CC
Engineering Test Notes:			

Test Measurement Results

Channel Frequency:	2412.0 MHz					
Band-Edge Frequency:	2400.0 MHz					
Test Frequency Range:	2350.0 - 2422.0 MHz					
Port(s)	Band-Edge Markers and Limit			Revised Limit		Margin
	M1 Amplitude (dBm)	Plot Limit (dBm)	M2 Frequency (MHz)	Amplitude (dBm)	M2A Frequency (MHz)	(MHz)
a	-29.43	-26.52	2401.50	--	--	-1.500
b	-27.19	-23.37	2401.60	--	--	-1.600
c	-29.17	-26.54	2401.50	--	--	-1.500

Traceability to Industry Recognized Test Methodologies	
Work Instruction:	WI-05 MEASUREMENT OF SPURIOUS EMISSIONS
Measurement Uncertainty:	<=40 GHz ±2.37 dB, > 40 GHz ±4.6 dB

Note: click the links in the above matrix to view the graphical image (plot).

This test report may be reproduced in full only. The document may only be updated by MiCOM Labs personnel. All changes will be noted in the Document History section of the report.



Title: Aruba Networks APEX0104
To: FCC CFR 47 Part 15 Subpart C 15.247 & IC RSS-247
Serial #: ARUB199-U3 Rev A
Issue Date: 27th August 2015
Page: 42 of 223

Equipment Configuration for Conducted Low Band-Edge Emissions - Average

Variant:	802.11n HT-40	Duty Cycle (%):	97.0
Data Rate:	13.5 MBit/s	Antenna Gain (dBi):	2.80
Modulation:	OFDM	Beam Forming Gain (Y)(dB):	Not Applicable
TPC:	Not Applicable	Tested By:	CC
Engineering Test Notes:			

Test Measurement Results

Channel Frequency:	2422.0 MHz					
Band-Edge Frequency:	2400.0 MHz					
Test Frequency Range:	2292.0 - 2442.0 MHz					
Port(s)	Band-Edge Markers and Limit			Revised Limit		Margin
	M1 Amplitude (dBm)	Plot Limit (dBm)	M2 Frequency (MHz)	Amplitude (dBm)	M2A Frequency (MHz)	(MHz)
a	-32.92	-29.83	2402.00	--	--	-2.000
b	-31.49	-29.66	2401.80	--	--	-1.800
c	-32.65	-29.90	2401.80	--	--	-1.800

Traceability to Industry Recognized Test Methodologies

Work Instruction:	WI-05 MEASUREMENT OF SPURIOUS EMISSIONS
Measurement Uncertainty:	<=40 GHz ±2.37 dB, > 40 GHz ±4.6 dB

Note: click the links in the above matrix to view the graphical image (plot).

This test report may be reproduced in full only. The document may only be updated by MiCOM Labs personnel. All changes will be noted in the Document History section of the report.



Title: Aruba Networks APEX0104
To: FCC CFR 47 Part 15 Subpart C 15.247 & IC RSS-247
Serial #: ARUB199-U3 Rev A
Issue Date: 27th August 2015
Page: 43 of 223

Equipment Configuration for Conducted High Band-Edge Emissions - Average

Variant:	802.11b	Duty Cycle (%):	99.0
Data Rate:	1.00 MBit/s	Antenna Gain (dBi):	2.80
Modulation:	CCK	Beam Forming Gain (Y)(dB):	Not Applicable
TPC:	Not Applicable	Tested By:	CC
Engineering Test Notes:			

Test Measurement Results

Channel Frequency:	2462.0 MHz					
Band-Edge Frequency:	2483.5 MHz					
Test Frequency Range:	2452.0 - 2524.0 MHz					
Port(s)	Band-Edge Markers and Limit			Revised Limit		Margin
	M3 Amplitude (dBm)	Plot Limit (dBm)	M2 Frequency (MHz)	Amplitude (dBm)	M2A Frequency (MHz)	(MHz)
a	-60.34	-23.45	2469.40	--	--	-14.100
b	-59.52	-22.84	2469.40	--	--	-14.100
c	-59.24	-23.11	2469.40	--	--	-14.100

Traceability to Industry Recognized Test Methodologies	
Work Instruction:	WI-05 MEASUREMENT OF SPURIOUS EMISSIONS
Measurement Uncertainty:	<=40 GHz ±2.37 dB, > 40 GHz ±4.6 dB

Note: click the links in the above matrix to view the graphical image (plot).

This test report may be reproduced in full only. The document may only be updated by MiCOM Labs personnel. All changes will be noted in the Document History section of the report.



Title: Aruba Networks APEX0104
To: FCC CFR 47 Part 15 Subpart C 15.247 & IC RSS-247
Serial #: ARUB199-U3 Rev A
Issue Date: 27th August 2015
Page: 44 of 223

Equipment Configuration for Conducted High Band-Edge Emissions - Average

Variant:	802.11g	Duty Cycle (%):	99.0
Data Rate:	6.00 MBit/s	Antenna Gain (dBi):	2.80
Modulation:	OFDM	Beam Forming Gain (Y)(dB):	Not Applicable
TPC:	Not Applicable	Tested By:	CC
Engineering Test Notes:			

Test Measurement Results

Channel Frequency:	2462.0 MHz					
Band-Edge Frequency:	2483.5 MHz					
Test Frequency Range:	2452.0 - 2524.0 MHz					
Port(s)	Band-Edge Markers and Limit			Revised Limit		Margin
	M3 Amplitude (dBm)	Plot Limit (dBm)	M2 Frequency (MHz)	Amplitude (dBm)	M2A Frequency (MHz)	(MHz)
a	-41.00	-26.45	2472.30	--	--	-11.200
b	-39.15	-25.99	2472.60	--	--	-10.900
c	-40.11	-26.30	2472.30	--	--	-11.200

Traceability to Industry Recognized Test Methodologies

Work Instruction:	WI-05 MEASUREMENT OF SPURIOUS EMISSIONS
Measurement Uncertainty:	<=40 GHz ±2.37 dB, > 40 GHz ±4.6 dB

Note: click the links in the above matrix to view the graphical image (plot).

This test report may be reproduced in full only. The document may only be updated by MiCOM Labs personnel. All changes will be noted in the Document History section of the report.



Title: Aruba Networks APEX0104
To: FCC CFR 47 Part 15 Subpart C 15.247 & IC RSS-247
Serial #: ARUB199-U3 Rev A
Issue Date: 27th August 2015
Page: 45 of 223

Equipment Configuration for Conducted High Band-Edge Emissions - Average

Variant:	802.11n HT-20	Duty Cycle (%):	98.0
Data Rate:	6.50 MBit/s	Antenna Gain (dBi):	2.80
Modulation:	OFDM	Beam Forming Gain (Y)(dB):	Not Applicable
TPC:	Not Applicable	Tested By:	CC
Engineering Test Notes:			

Test Measurement Results

Channel Frequency:	2462.0 MHz					
Band-Edge Frequency:	2483.5 MHz					
Test Frequency Range:	2452.0 - 2524.0 MHz					
Port(s)	Band-Edge Markers and Limit			Revised Limit		Margin
	M3 Amplitude (dBm)	Plot Limit (dBm)	M2 Frequency (MHz)	Amplitude (dBm)	M2A Frequency (MHz)	(MHz)
a	-39.09	-26.51	2472.30	--	--	-11.200
b	-36.91	-26.31	2473.20	--	--	-10.300
c	-39.17	-26.58	2472.30	--	--	-11.200

Traceability to Industry Recognized Test Methodologies	
Work Instruction:	WI-05 MEASUREMENT OF SPURIOUS EMISSIONS
Measurement Uncertainty:	<=40 GHz ±2.37 dB, > 40 GHz ±4.6 dB

Note: click the links in the above matrix to view the graphical image (plot).

This test report may be reproduced in full only. The document may only be updated by MiCOM Labs personnel. All changes will be noted in the Document History section of the report.



Title: Aruba Networks APEX0104
To: FCC CFR 47 Part 15 Subpart C 15.247 & IC RSS-247
Serial #: ARUB199-U3 Rev A
Issue Date: 27th August 2015
Page: 46 of 223

Equipment Configuration for Conducted High Band-Edge Emissions - Average

Variant:	802.11n HT-40	Duty Cycle (%):	97.0
Data Rate:	13.50 MBit/s	Antenna Gain (dBi):	2.80
Modulation:	OFDM	Beam Forming Gain (Y)(dB):	Not Applicable
TPC:	Not Applicable	Tested By:	CC
Engineering Test Notes:			

Test Measurement Results

Channel Frequency:	2452.0 MHz					
Band-Edge Frequency:	2483.5 MHz					
Test Frequency Range:	2432.0 - 2582.0 MHz					
Port(s)	Band-Edge Markers and Limit			Revised Limit		Margin
	M3 Amplitude (dBm)	Plot Limit (dBm)	M2 Frequency (MHz)	Amplitude (dBm)	M2A Frequency (MHz)	(MHz)
a	-35.41	-30.07	2472.00	--	--	-11.500
b	-34.04	-29.86	2472.30	--	--	-11.200
c	-36.46	-29.83	2471.80	--	--	-11.700

Traceability to Industry Recognized Test Methodologies

Work Instruction:	WI-05 MEASUREMENT OF SPURIOUS EMISSIONS
Measurement Uncertainty:	<=40 GHz ±2.37 dB, > 40 GHz ±4.6 dB

Note: click the links in the above matrix to view the graphical image (plot).

This test report may be reproduced in full only. The document may only be updated by MiCOM Labs personnel. All changes will be noted in the Document History section of the report.



10.4. Power Spectral Density

Conducted Test Conditions for Power Spectral Density			
Standard:	FCC CFR 47:15.247	Ambient Temp. (°C):	24.0 - 27.5
Test Heading:	Power Spectral Density	Rel. Humidity (%):	32 - 45
Standard Section(s):	15.247 (e)	Pressure (mBars):	999 - 1001
Reference Document(s):	See Normative References		

Test Procedure for Power Spectral Density

The transmitter output was connected to a spectrum analyzer and the measured made in a 3 kHz resolution bandwidth using the analyzer auto-coupled sweep-time. A peak value was found over the full emission bandwidth and the spectrum downloaded for post processing purposes.

Where the device operated with multiple antenna ports i.e. MIMO device, each port was measured separately. The Peak Power Spectral Density is the highest level found across the emission bandwidth. With multiple antenna port measurements the numerical analyzer data from each port is summed (à) and a link to this additional graphic is provided.

Testing was performed under ambient conditions at nominal voltage only.

Test configuration and setup used for the measurement was per the Conducted Test Set-up specified in this document.

Measure and sum the spectra across the outputs. With this technique, spectra are measured at each output of the device at the required resolution bandwidth. The individual spectra are then summed mathematically in linear power units. Unlike in-band power measurements, in which the sum involves a single measured value (output power) from each output, measurements for compliance with PSD limits involve summing entire spectra across corresponding frequency bins on the various outputs. Consistency is maintained for any device with multiple transmitter outputs to be certain the individual outputs are all aligned with the same span and same number of points. In this instance, the linear power spectrum value within the first spectral bin of output 0 is summed with that in the first spectral bin of output 1, and the first spectral bin of output 2, and so on up to the Nth output to obtain the true value for the first frequency bin of the summed spectrum. The summed spectrum value for each frequency bin is computed in this fashion. These summed spectral values were post processed and the resulting numerical and graphical data presented.

NOTE:

It may be observed that the spectrum in some antenna port plots break the limit line however this in itself does NOT constitute a failure. In all cases a spectrum summation plot is provided in order to prove compliance. A failure occurs only after the summation of all spectrum plots have been summed and are found to be greater than the limit line.

Supporting Information

Calculated Power = $A + 10 \log (1/x)$ dBm

A = Total Power Spectral Density [$10 \log_{10} (10^{a/10} + 10^{b/10} + 10^{c/10} + 10^{d/10})$]

x = Duty Cycle

Limits Power Spectral Density

For digitally modulated systems, the power spectral density conducted from the intentional radiator to the antenna shall not be greater than +8 dBm in any 3 kHz band during any time interval of continuous transmission. This power spectral density shall be determined in accordance with the provisions of paragraph (b) of this section. The same method of determining the conducted output power shall be used to determine the power spectral density.



Title: Aruba Networks APEX0104
To: FCC CFR 47 Part 15 Subpart C 15.247 & IC RSS-247
Serial #: ARUB199-U3 Rev A
Issue Date: 27th August 2015
Page: 48 of 223

Equipment Configuration for Power Spectral Density - Average

Variant:	802.11b	Duty Cycle (%):	99.0
Data Rate:	1.00 MBit/s	Antenna Gain (dBi):	2.80
Modulation:	CCK	Beam Forming Gain (Y)(dB):	Not Applicable
TPC:	Not Applicable	Tested By:	CC
Engineering Test Notes:			

Test Measurement Results							
Test Frequency	Measured Power Spectral Density				Amplitude Summation + DCCF (+0.04 dB)	Limit	Margin
	Port(s) (dBm/3KHz)						
MHz	a	b	c	d	dBm/3KHz	dBm/3KHz	dB
2412.0	-7.372	-6.196	-7.143	--	-2.690	8.0	-10.7
2437.0	-7.585	-6.797	-7.653	--	-2.821	8.0	-10.8
2462.0	-7.762	-7.255	-7.485	--	-3.045	8.0	-11.0

Traceability to Industry Recognized Test Methodologies	
Work Instruction:	WI-03 MEASURING RF SPECTRUM MASK
Measurement Uncertainty:	±2.81 dB

DCCF - Duty Cycle Correction Factor

Note: click the links in the above matrix to view the graphical image (plot).

This test report may be reproduced in full only. The document may only be updated by MiCOM Labs personnel. All changes will be noted in the Document History section of the report.



Title: Aruba Networks APEX0104
To: FCC CFR 47 Part 15 Subpart C 15.247 & IC RSS-247
Serial #: ARUB199-U3 Rev A
Issue Date: 27th August 2015
Page: 49 of 223

Equipment Configuration for Power Spectral Density - Average

Variant:	802.11g	Duty Cycle (%):	99.0
Data Rate:	6.00 MBit/s	Antenna Gain (dBi):	2.80
Modulation:	OFDM	Beam Forming Gain (Y)(dB):	Not Applicable
TPC:	Not Applicable	Tested By:	CC
Engineering Test Notes:			

Test Measurement Results							
Test Frequency	Measured Power Spectral Density				Amplitude Summation + DCCF (+0.04 dB)	Limit	Margin
	Port(s) (dBm/3KHz)						
MHz	a	b	c	d	dBm/3KHz	dBm/3KHz	dB
2412.0	-10.450	-9.895	-9.943	--	-5.412	8.0	-13.4
2437.0	-10.201	-9.724	-10.600	--	-5.385	8.0	-13.4
2462.0	-10.654	-9.926	-10.424	--	-5.685	8.0	-13.7

Traceability to Industry Recognized Test Methodologies	
Work Instruction:	WI-03 MEASURING RF SPECTRUM MASK
Measurement Uncertainty:	±2.81 dB

DCCF - Duty Cycle Correction Factor

Note: click the links in the above matrix to view the graphical image (plot).

This test report may be reproduced in full only. The document may only be updated by MiCOM Labs personnel. All changes will be noted in the Document History section of the report.



Title: Aruba Networks APEX0104
To: FCC CFR 47 Part 15 Subpart C 15.247 & IC RSS-247
Serial #: ARUB199-U3 Rev A
Issue Date: 27th August 2015
Page: 50 of 223

Equipment Configuration for Power Spectral Density - Average

Variant:	802.11n HT-20	Duty Cycle (%):	98.0
Data Rate:	6.50 MBit/s	Antenna Gain (dBi):	2.80
Modulation:	OFDM	Beam Forming Gain (Y)(dB):	Not Applicable
TPC:	Not Applicable	Tested By:	CC
Engineering Test Notes:			

Test Measurement Results							
Test Frequency	Measured Power Spectral Density				Amplitude Summation + DCCF (+0.09 dB)	Limit	Margin
	Port(s) (dBm/3KHz)						
MHz	a	b	c	d	dBm/3KHz	dBm/3KHz	dB
2412.0	-10.772	-10.293	-10.755	--	-6.136	8.0	-14.1
2437.0	-10.753	-10.196	-10.717	--	-5.986	8.0	-14.0
2462.0	-10.758	-10.160	-10.874	--	-6.156	8.0	-14.1

Traceability to Industry Recognized Test Methodologies	
Work Instruction:	WI-03 MEASURING RF SPECTRUM MASK
Measurement Uncertainty:	±2.81 dB

DCCF - Duty Cycle Correction Factor

Note: click the links in the above matrix to view the graphical image (plot).

This test report may be reproduced in full only. The document may only be updated by MiCOM Labs personnel. All changes will be noted in the Document History section of the report.



Title: Aruba Networks APEX0104
To: FCC CFR 47 Part 15 Subpart C 15.247 & IC RSS-247
Serial #: ARUB199-U3 Rev A
Issue Date: 27th August 2015
Page: 51 of 223

Equipment Configuration for Power Spectral Density - Average

Variant:	802.11n HT-40	Duty Cycle (%):	97.0
Data Rate:	13.50 MBit/s	Antenna Gain (dBi):	2.80
Modulation:	OFDM	Beam Forming Gain (Y)(dB):	Not Applicable
TPC:	Not Applicable	Tested By:	CC
Engineering Test Notes:			

Test Measurement Results							
Test Frequency	Measured Power Spectral Density				Amplitude Summation + DCCF (+0.13 dB)	Limit	Margin
	Port(s) (dBm/3KHz)						
MHz	a	b	c	d	dBm/3KHz	dBm/3KHz	dB
2422.0	-13.861	-13.558	-13.643	--	-8.858	8.0	-16.8
2437.0	-14.163	-13.319	-13.900	--	-9.014	8.0	-17.0
2452.0	-13.469	-13.602	-14.036	--	-8.798	8.0	-16.8

Traceability to Industry Recognized Test Methodologies	
Work Instruction:	WI-03 MEASURING RF SPECTRUM MASK
Measurement Uncertainty:	±2.81 dB

DCCF - Duty Cycle Correction Factor

Note: click the links in the above matrix to view the graphical image (plot).

This test report may be reproduced in full only. The document may only be updated by MiCOM Labs personnel. All changes will be noted in the Document History section of the report.



10.5. Radiated Spurious Emissions

10.5.1. Restricted Band Emissions

Radiated Test Conditions for Radiated Spurious and Band-Edge Emissions (Restricted Bands)			
Standard:	15.247	Ambient Temp. (°C):	20.0 - 24.5
Test Heading:	Radiated Spurious and Band-Edge Emissions	Rel. Humidity (%):	32 - 45
Standard Section(s):	15.205, 15.209	Pressure (mBars):	999 - 1001
Reference Document(s):	See Normative References		

Test Procedure for Radiated Spurious and Band-Edge Emissions (Restricted Bands)

Radiated emissions for restricted bands above 1 GHz are measured in the anechoic chamber at a 3-meter distance on every azimuth in both horizontal and vertical polarities. The emissions are recorded and maximized as a function of azimuth by rotation through 360° with a spectrum analyzer in peak hold mode. Depending on the frequency band spanned a notch filter and waveguide filter was used to remove the fundamental frequency. The highest emissions relative to the limit are listed for each frequency spanned. Measurements on any restricted band frequency or frequencies above 1 GHz are based on the use of measurement instrumentation employing peak and average detectors. All measurements were performed using a resolution bandwidth of 1 MHz.

Test configuration and setup for Radiated Spurious and Band-Edge Measurement were per the Radiated Test Set-up specified in this document.

Limits for Restricted Bands

Peak emission: 74 dBuV/m

Average emission: 54 dBuV/m

Field Strength Calculation

The field strength is calculated by adding the Antenna Factor and Cable Loss, and subtracting Amplifier Gain from the measured reading. All factors are included in the reported data.

$$FS = R + AF + CORR - FO$$

where:

FS = Field Strength

R = Measured Spectrum analyzer Input Amplitude

AF = Antenna Factor

CORR = Correction Factor = CL – AG + NFL

CL = Cable Loss

AG = Amplifier Gain

FO = Distance Falloff Factor

NFL = Notch Filter Loss or Waveguide Loss

Example:

Given receiver input reading of 51.5 dBmV; Antenna Factor of 8.5 dB; Cable Loss of 1.3 dB; Falloff Factor of 0 dB, an Amplifier Gain of 26 dB and Notch Filter Loss of 1 dB. The Field Strength (FS) of the measured emission is:

$$FS = 51.5 + 8.5 + 1.3 - 26.0 + 1 = 36.3 \text{ dBmV/m}$$

Conversion between dBmV/m (or dBmV) and mV/m (or mV) are as follows:

$$\text{Level (dBmV/m)} = 20 * \text{Log (level (mV/m))}$$

$$40 \text{ dBmV/m} = 100 \text{ mV/m}$$

$$48 \text{ dBmV/m} = 250 \text{ mV/m}$$

This test report may be reproduced in full only. The document may only be updated by MiCOM Labs personnel. All changes will be noted in the Document History section of the report.



Restricted Bands of Operation (15.205)

(a) Except as shown in paragraph (d) of this section, only spurious emissions are permitted in any of the frequency bands listed below:

Restricted Frequency Bands			
MHz	MHz	MHz	GHz
0.090-0.110	16.42-16.423	399.9-410	4.5-5.15
0.495-0.505	16.69475-16.69525	608-614	5.35-5.46
2.1735-2.1905	16.80425-16.80475	960-1240	7.25-7.75
4.125-4.128	25.5-25.67	1300-1427	8.025-8.5
4.17725-4.17775	37.5-38.25	1435-1626.5	9.0-9.2
4.20725-4.20775	73-74.6	1645.5-1646.5	9.3-9.5
6.215-6.218	74.8-75.2	1660-1710	10.6-12.7
6.26775-6.26825	108-121.94	1718.8-1722.2	13.25-13.4
6.31175-6.31225	123-138	2200-2300	14.47-14.5
8.291-8.294	149.9-150.05	2310-2390	15.35-16.2
8.362-8.366	156.52475-156.52525	2483.5-2500	17.7-21.4
8.37625-8.38675	156.7-156.9	2690-2900	22.01-23.12
8.41425-8.41475	162.0125-167.17	3260-3267	23.6-24.0
12.29-12.293	167.72-173.2	3332-3339	31.2-31.8
12.51975-12.52025	240-285	3345.8-3358	36.43-36.5
12.57675-12.57725	322-335.4	3600-4400	Above 38.6
13.36-13.41			

(b) Except as provided in paragraphs (d) and (e) of this section, the field strength of emissions appearing within these frequency bands shall not exceed the limits shown in §15.209. At frequencies equal to or less than 1000 MHz, compliance with the limits in §15.209 shall be demonstrated using measurement instrumentation employing a CISPR quasi-peak detector. Above 1000 MHz, compliance with the emission limits in §15.209 shall be demonstrated based on the average value of the measured emissions. The provisions in §15.35 apply to these measurements.

(c) Except as provided in paragraphs (d) and (e) of this section, regardless of the field strength limits specified elsewhere in this subpart, the provisions of this section apply to emissions from any intentional radiator.

(d) The following devices are exempt from the requirements of this section:

(1) Swept frequency field disturbance sensors operating between 1.705 and 37 MHz provided their emissions only sweep through the bands listed in paragraph (a) of this section, the sweep is never stopped with the fundamental emission within the bands listed in paragraph (a) of this section, and the fundamental emission is outside of the bands listed in paragraph (a) of this section more than 99% of the time the device is actively transmitting, without compensation for duty cycle.

(2) Transmitters used to detect buried electronic markers at 101.4 kHz which are employed by telephone companies.

(3) Cable locating equipment operated pursuant to §15.213.

(4) Any equipment operated under the provisions of §15.253, 15.255, and 15.256 in the frequency band 75-85 GHz, or §15.257 of this part.

This test report may be reproduced in full only. The document may only be updated by MiCOM Labs personnel. All changes will be noted in the Document History section of the report.



Title: Aruba Networks APEX0104
To: FCC CFR 47 Part 15 Subpart C 15.247 & IC RSS-247
Serial #: ARUB199-U3 Rev A
Issue Date: 27th August 2015
Page: 54 of 223

- (5) Biomedical telemetry devices operating under the provisions of §15.242 of this part are not subject to the restricted band 608-614 MHz but are subject to compliance within the other restricted bands.
- (6) Transmitters operating under the provisions of subparts D or F of this part.
- (7) Devices operated pursuant to §15.225 are exempt from complying with this section for the 13.36-13.41 MHz band only.
- (8) Devices operated in the 24.075-24.175 GHz band under §15.245 are exempt from complying with the requirements of this section for the 48.15-48.35 GHz and 72.225-72.525 GHz bands only, and shall not exceed the limits specified in §15.245(b).
- (9) Devices operated in the 24.0-24.25 GHz band under §15.249 are exempt from complying with the requirements of this section for the 48.0-48.5 GHz and 72.0-72.75 GHz bands only, and shall not exceed the limits specified in §15.249(a).
- (e) Harmonic emissions appearing in the restricted bands above 17.7 GHz from field disturbance sensors operating under the provisions of §15.245 shall not exceed the limits specified in §15.245(b).

This test report may be reproduced in full only. The document may only be updated by MiCOM Labs personnel. All changes will be noted in the Document History section of the report.



Title: Aruba Networks APEX0104
To: FCC CFR 47 Part 15 Subpart C 15.247 & IC RSS-247
Serial #: ARUB199-U3 Rev A
Issue Date: 27th August 2015
Page: 55 of 223

Equipment Configuration for Radiated Spurious - Restricted Band Emissions
--

Antenna:	Integral	Variant:	802.11b
Antenna Gain (dBi):	2.80	Modulation:	CCK
Beam Forming Gain (Y):	Not Applicable	Duty Cycle (%):	100
Channel Frequency (MHz):	2412.00	Data Rate:	1.00 MBit/s
Power Setting:	24	Tested By:	JMH

Test Measurement Results

Click here to view measurement data...
--

Test Notes: EUT on table connected via telnet to Laptop outside chamber

This test report may be reproduced in full only. The document may only be updated by MiCOM Labs personnel. All changes will be noted in the Document History section of the report.



Title: Aruba Networks APEX0104
To: FCC CFR 47 Part 15 Subpart C 15.247 & IC RSS-247
Serial #: ARUB199-U3 Rev A
Issue Date: 27th August 2015
Page: 56 of 223

Equipment Configuration for Radiated Spurious - Restricted Band Emissions
--

Antenna:	Integral	Variant:	802.11b
Antenna Gain (dBi):	2.80	Modulation:	CCK
Beam Forming Gain (Y):	Not Applicable	Duty Cycle (%):	100
Channel Frequency (MHz):	2437.00	Data Rate:	1.00 MBit/s
Power Setting:	24	Tested By:	JMH

Test Measurement Results

Click here to view measurement data...
--

Test Notes: EUT on table connected via telnet to Laptop outside chamber

This test report may be reproduced in full only. The document may only be updated by MiCOM Labs personnel. All changes will be noted in the Document History section of the report.



Title: Aruba Networks APEX0104
To: FCC CFR 47 Part 15 Subpart C 15.247 & IC RSS-247
Serial #: ARUB199-U3 Rev A
Issue Date: 27th August 2015
Page: 57 of 223

Equipment Configuration for Radiated Spurious - Restricted Band Emissions

Antenna:	Integral	Variant:	802.11b
Antenna Gain (dBi):	2.80	Modulation:	CCK
Beam Forming Gain (Y):	Not Applicable	Duty Cycle (%):	100
Channel Frequency (MHz):	2462.00	Data Rate:	1.00 MBit/s
Power Setting:	24	Tested By:	JMH

Test Measurement Results

Num	Frequency MHz	Raw dBµV	Cable Loss	AF dB	Level dBµV/m	Measurement Type	Pol	Hgt cm	Azt Deg	Limit dBµV/m	Margin dB	Pass /Fail
#1	2461.44	63.51	4.08	-11.68	55.91	Max Peak	Horizontal	152	35	74.0	-18.1	Pass

Test Notes: EUT on table connected via telnet to Laptop outside chamber

This test report may be reproduced in full only. The document may only be updated by MiCOM Labs personnel. All changes will be noted in the Document History section of the report.



Title: Aruba Networks APEX0104
To: FCC CFR 47 Part 15 Subpart C 15.247 & IC RSS-247
Serial #: ARUB199-U3 Rev A
Issue Date: 27th August 2015
Page: 58 of 223

10.5.2. Restricted Band-Edge Emissions

Equipment Configuration for Radiated - Lower Restricted Band-Edge Emissions

Antenna:	Integral	Variant:	802.11b
Antenna Gain (dBi):	2.80	Modulation:	CCK
Beam Forming Gain (Y):	Not Applicable	Duty Cycle (%):	100
Channel Frequency (MHz):	2412.00	Data Rate:	1.00 MBit/s
Power Setting:	24	Tested By:	JMH

Test Measurement Results

Num	Frequency MHz	Raw dBµV	Cable Loss	AF dB	Level dBµV/m	Measurement Type	Pol	Hgt cm	Azt Deg	Limit dBµV/m	Margin dB	Pass /Fail
#1	2387.11	65.88	4.04	-11.94	57.98	Max Peak	Horizontal	140	261	74.0	-16.0	Pass
#2	2389.10	53.99	4.04	-11.92	46.11	Max Avg	Horizontal	140	261	54.0	-7.9	Pass

Test Notes: EUT on table connected via telnet to Laptop outside chamber

Equipment Configuration for Radiated - Upper Restricted Band-Edge Emissions

Antenna:	Integral	Variant:	802.11b
Antenna Gain (dBi):	2.80	Modulation:	CCK
Beam Forming Gain (Y):	Not Applicable	Duty Cycle (%):	100
Channel Frequency (MHz):	2462.00	Data Rate:	1.00 MBit/s
Power Setting:	24	Tested By:	JMH

Test Measurement Results

Num	Frequency MHz	Raw dBµV	Cable Loss	AF dB	Level dBµV/m	Measurement Type	Pol	Hgt cm	Azt Deg	Limit dBµV/m	Margin dB	Pass /Fail
#1	2484.97	67.76	4.10	-11.64	60.22	Max Peak	Horizontal	190	276	74.0	-13.8	Pass
#2	2485.50	53.01	4.10	-11.64	45.47	Max Avg	Horizontal	190	276	54.0	-8.5	Pass

Test Notes: EUT on table connected via telnet to Laptop outside chamber.

This test report may be reproduced in full only. The document may only be updated by MiCOM Labs personnel. All changes will be noted in the Document History section of the report.



Title: Aruba Networks APEX0104
To: FCC CFR 47 Part 15 Subpart C 15.247 & IC RSS-247
Serial #: ARUB199-U3 Rev A
Issue Date: 27th August 2015
Page: 59 of 223

Equipment Configuration for Radiated - Lower Restricted Band-Edge Emissions

Antenna:	Integral	Variant:	802.11g
Antenna Gain (dBi):	2.80	Modulation:	OFDM
Beam Forming Gain (Y):	Not Applicable	Duty Cycle (%):	100
Channel Frequency (MHz):	2412.00	Data Rate:	6.00 MBit/s
Power Setting:	21	Tested By:	JMH

Test Measurement Results

Num	Frequency MHz	Raw dBµV	Cable Loss	AF dB	Level dBµV/m	Measurement Type	Pol	Hgt cm	Azt Deg	Limit dBµV/m	Margin dB	Pass /Fail
#1	2390.00	61.72	4.04	-11.92	53.84	Max Avg	Horizontal	140	261	54.0	-0.2	Pass
#2	2390.00	81.54	4.04	-11.92	73.66	Max Peak	Horizontal	140	261	74.0	-0.3	Pass

Test Notes: EUT on table connected via telnet to Laptop outside chamber. Power Reduction to 21

Equipment Configuration for Radiated - Upper Restricted Band-Edge Emissions

Antenna:	Integral	Variant:	802.11g
Antenna Gain (dBi):	2.80	Modulation:	OFDM
Beam Forming Gain (Y):	Not Applicable	Duty Cycle (%):	100
Channel Frequency (MHz):	2462.00	Data Rate:	6.00 MBit/s
Power Setting:	20.5	Tested By:	JMH

Test Measurement Results

Num	Frequency MHz	Raw dBµV	Cable Loss	AF dB	Level dBµV/m	Measurement Type	Pol	Hgt cm	Azt Deg	Limit dBµV/m	Margin dB	Pass /Fail
#1	2483.50	81.37	4.10	-11.64	73.83	Max Peak	Horizontal	190	276	74.0	-0.2	Pass
#2	2484.03	61.14	4.10	-11.64	53.60	Max Avg	Horizontal	190	276	54.0	-0.4	Pass

Test Notes: EUT on table connected via telnet to Laptop outside chamber. Power Reduction to 20.5

This test report may be reproduced in full only. The document may only be updated by MiCOM Labs personnel. All changes will be noted in the Document History section of the report.



Title: Aruba Networks APEX0104
To: FCC CFR 47 Part 15 Subpart C 15.247 & IC RSS-247
Serial #: ARUB199-U3 Rev A
Issue Date: 27th August 2015
Page: 60 of 223

Equipment Configuration for Radiated - Lower Restricted Band-Edge Emissions

Antenna:	Integral	Variant:	802.11n HT-20
Antenna Gain (dBi):	2.80	Modulation:	OFDM
Beam Forming Gain (Y):	Not Applicable	Duty Cycle (%):	100
Channel Frequency (MHz):	2412.00	Data Rate:	6.50 MBit/s
Power Setting:	19.75	Tested By:	JMH

Test Measurement Results

Num	Frequency MHz	Raw dBµV	Cable Loss	AF dB	Level dBµV/m	Measurement Type	Pol	Hgt cm	Azt Deg	Limit dBµV/m	Margin dB	Pass /Fail
#1	2390.00	61.55	4.04	-11.92	53.67	Max Avg	Horizontal	140	261	54.0	-0.3	Pass
#2	2390.00	80.68	4.04	-11.92	72.80	Max Peak	Horizontal	140	261	74.0	-1.2	Pass

Test Notes: EUT on table connected via telnet to Laptop outside chamber. Power Reduction to 19.75

Equipment Configuration for Radiated - Upper Restricted Band-Edge Emissions

Antenna:	Integral	Variant:	802.11n HT-20
Antenna Gain (dBi):	2.80	Modulation:	OFDM
Beam Forming Gain (Y):	Not Applicable	Duty Cycle (%):	100
Channel Frequency (MHz):	2462.00	Data Rate:	6.50 MBit/s
Power Setting:	19.25	Tested By:	JMH

Test Measurement Results

Num	Frequency MHz	Raw dBµV	Cable Loss	AF dB	Level dBµV/m	Measurement Type	Pol	Hgt cm	Azt Deg	Limit dBµV/m	Margin dB	Pass /Fail
#1	2483.50	60.39	4.10	-11.64	52.85	Max Avg	Horizontal	190	276	54.0	-1.2	Pass
#2	2483.50	79.86	4.10	-11.64	72.32	Max Peak	Horizontal	190	276	74.0	-1.7	Pass

Test Notes: EUT on table connected via telnet to Laptop outside chamber. Power Reduction to 19.25

This test report may be reproduced in full only. The document may only be updated by MiCOM Labs personnel. All changes will be noted in the Document History section of the report.



Title: Aruba Networks APEX0104
To: FCC CFR 47 Part 15 Subpart C 15.247 & IC RSS-247
Serial #: ARUB199-U3 Rev A
Issue Date: 27th August 2015
Page: 61 of 223

Equipment Configuration for Radiated - Lower Restricted Band-Edge Emissions

Antenna:	Integral	Variant:	802.11n HT-40
Antenna Gain (dBi):	2.80	Modulation:	OFDM
Beam Forming Gain (Y):	Not Applicable	Duty Cycle (%):	100
Channel Frequency (MHz):	2422.00	Data Rate:	13.50 MBit/s
Power Setting:	16.25	Tested By:	JMH

Test Measurement Results

Num	Frequency MHz	Raw dBμV	Cable Loss	AF dB	Level dBμV/m	Measurement Type	Pol	Hgt cm	Azt Deg	Limit dBμV/m	Margin dB	Pass /Fail
#1	2389.46	75.99	4.04	-11.92	68.11	Max Peak	Horizontal	140	261	74.0	-5.9	Pass
#2	2390.00	61.59	4.04	-11.92	53.71	Max Avg	Horizontal	140	261	54.0	-0.3	Pass

Test Notes: EUT on table connected via telnet to Laptop outside chamber. Power Reduction to 16.25

Equipment Configuration for Radiated - Upper Restricted Band-Edge Emissions

Antenna:	Integral	Variant:	802.11n HT-40
Antenna Gain (dBi):	2.80	Modulation:	OFDM
Beam Forming Gain (Y):	Not Applicable	Duty Cycle (%):	100
Channel Frequency (MHz):	2452.00	Data Rate:	13.50 MBit/s
Power Setting:	16.0	Tested By:	JMH

Test Measurement Results

Num	Frequency MHz	Raw dBμV	Cable Loss	AF dB	Level dBμV/m	Measurement Type	Pol	Hgt cm	Azt Deg	Limit dBμV/m	Margin dB	Pass /Fail
#1	2484.43	61.24	4.10	-11.64	53.70	Max Avg	Horizontal	190	276	54.0	-0.3	Pass
#2	2486.83	77.24	4.10	-11.64	69.70	Max Peak	Horizontal	190	276	74.0	-4.3	Pass

Test Notes: EUT on table connected via telnet to Laptop outside chamber. Power Reduction to 16.0

This test report may be reproduced in full only. The document may only be updated by MiCOM Labs personnel. All changes will be noted in the Document History section of the report.



Title: Aruba Networks APEX0104
To: FCC CFR 47 Part 15 Subpart C 15.247 & IC RSS-247
Serial #: ARUB199-U3 Rev A
Issue Date: 27th August 2015
Page: 62 of 223

10.5.3. Digital Emissions (0.03 - 1 GHz)

Equipment Configuration for Digital Emissions (0.03 - 1 GHz)

Antenna: Integral	Variant: 802.11b
Antenna Gain (dBi): 2.80	Modulation: CCK
Beam Forming Gain (Y): Not Applicable	Duty Cycle (%): 100
Channel Frequency (MHz): 2437.00	Data Rate: 1.00 MBit/s
Power Setting: NA	Tested By: JMH

Test Measurement Results

Num	Frequency MHz	Raw dBµV	Cable Loss	AF dB	Level dBµV/m	Measurement Type	Pol	Hgt cm	Azt Deg	Limit dBµV/m	Margin dB	Pass /Fail
#1	36.14	41.87	3.47	-14.37	30.97	MaxQP	Vertical	114	202	40.0	-9.0	Pass
#2	37.79	44.19	3.48	-16.06	31.61	MaxQP	Vertical	123	0	40.0	-8.4	Pass
#3	39.49	47.94	3.49	-16.67	34.76	MaxQP	Vertical	103	358	40.0	-5.2	Pass
#4	213.18	51.70	4.39	-20.00	36.09	MaxQP	Horizontal	119	271	43.0	-6.9	Pass
#5	479.99	44.31	5.28	-12.80	36.79	MaxQP	Horizontal	207	355	46.0	-9.2	Pass
#6	937.50	39.87	6.47	-7.20	39.14	MaxQP	Horizontal	144	52	46.0	-6.9	Pass

Test Notes: EUT on table connected to Laptop outside chamber

This test report may be reproduced in full only. The document may only be updated by MiCOM Labs personnel. All changes will be noted in the Document History section of the report.



Title: Aruba Networks APEX0104
To: FCC CFR 47 Part 15 Subpart C 15.247 & IC RSS-247
Serial #: ARUB199-U3 Rev A
Issue Date: 27th August 2015
Page: 63 of 223

10.6. ac Wireline Emissions

Test Procedure

The EUT is configured in accordance with ANSI C63.4. The conducted emissions are measured in a shielded room with a spectrum analyzer in peak hold in the first instance. Emissions closest to the limit are measured in the quasi-peak mode (QP) with the tuned receiver using a bandwidth of 9 kHz. The emissions are maximized further by cable manipulation. The highest emissions relative to the limit are listed.

This test report may be reproduced in full only. The document may only be updated by MiCOM Labs personnel. All changes will be noted in the Document History section of the report.



Title: Aruba Networks APEX0104
To: FCC CFR 47 Part 15 Subpart C 15.247 & IC RSS-247
Serial #: ARUB199-U3 Rev A
Issue Date: 27th August 2015
Page: 64 of 223

Model Number	APEX0104	Engineer	JMH
Variant	ac Wireline 120V	Temp (°C)	29
Freq. Range	0.150 MHz - 30 MHz	Rel. Hum.(%)	37
Power Setting	N/A	Press. (mBars)	1005
Antenna	Integral		
Test Notes 1	EUT SN#614570, powered by AC/DC Adapter 120V		
Test Notes 2	Class B Limits		

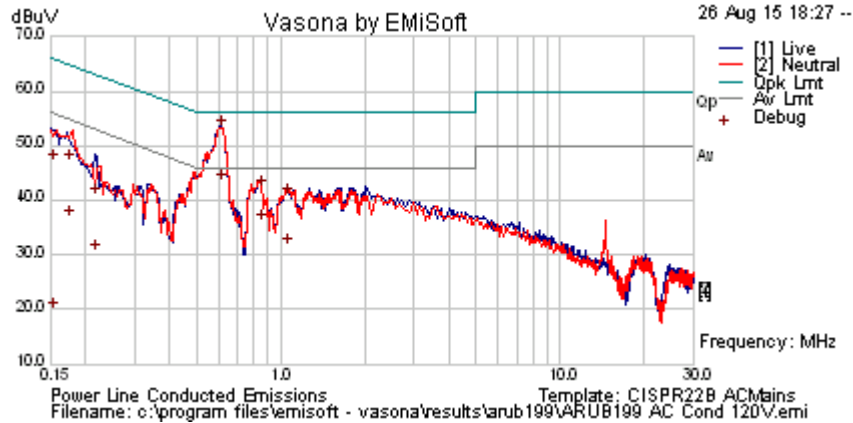

Formally measured emission peaks

Frequency MHz	Raw dBuV	Cable Loss	Factors dB	Level dBuV	Measurement Type	Line	Limit dBuV	Margin dB	Pass /Fail	Comments
0.152	9.70	9.9	0.08	19.67	Average	Live	55.89	-36.2	Pass	
0.152	36.7	9.9	0.08	46.67	Quasi Peak	Live	65.89	-19.2	Pass	
0.175	37.0	9.9	0.08	46.93	Quasi Peak	Neutral	64.72	-17.8	Pass	
0.175	26.6	9.9	0.08	36.54	Average	Neutral	54.72	-18.2	Pass	
0.216	30.4	9.9	0.1	40.4	Quasi Peak	Live	62.97	-22.6	Pass	
0.216	20.4	9.9	0.1	30.4	Average	Live	52.97	-22.6	Pass	
0.605	33.3	9.9	0.1	43.3	Average	Live	46	-2.7	Pass	
0.605	42.9	9.9	0.1	52.9	Quasi Peak	Live	56	-3.1	Pass	
0.846	25.7	9.9	0.1	35.7	Average	Neutral	46	-10.3	Pass	
0.846	32.0	9.9	0.1	42.1	Quasi Peak	Neutral	56	-13.9	Pass	
1.054	21.4	9.9	0.1	31.5	Average	Live	46	-14.6	Pass	
1.054	30.6	9.9	0.1	40.6	Quasi Peak	Live	56	-15.4	Pass	

Legend: DIG = Digital Device Emission; TX = Transmitter Emission; FUND = Fundamental Frequency
 NRB = Non-Restricted Band, Limit is 20 dB below Fundamental; RB = Restricted Band

This test report may be reproduced in full only. The document may only be updated by MiCOM Labs personnel. All changes will be noted in the Document History section of the report.



Specification

Limits

§15.207 (a) Except as shown in paragraphs (b) and (c) of this section, for an intentional radiator that is designed to be connected to the public utility (AC) power line, the radio frequency voltage that is conducted back onto the AC power line on any frequency or frequencies within the band 150 kHz to 30 MHz shall not exceed the limits in the following table, as measured using a 50 $\mu\Omega$ line impedance stabilization network (LISN), see §15.207 (a) matrix below. Compliance with the provisions of this paragraph shall be based on the measurement of the radio frequency voltage between each power line and ground at the power terminal.

§15.207 (a) Limit Matrix

The lower limit applies at the boundary between frequency ranges

Frequency of Emission (MHz)	Conducted Limit (dB μ V)	
	Quasi-peak	Average
0.15-0.5	66 to 56*	56 to 46*
0.5-5	56	46
5-30	60	50

* Decreases with the logarithm of the frequency

Laboratory Measurement Uncertainty for Conducted Emissions

Measurement uncertainty	± 2.64 dB
-------------------------	---------------

This test report may be reproduced in full only. The document may only be updated by MiCOM Labs personnel. All changes will be noted in the Document History section of the report.



Title: Aruba Networks APEX0104
To: FCC CFR 47 Part 15 Subpart C 15.247 & IC RSS-247
Serial #: ARUB199-U3 Rev A
Issue Date: 27th August 2015
Page: 66 of 223

A. APPENDIX - GRAPHICAL IMAGES

This test report may be reproduced in full only. The document may only be updated by MiCOM Labs personnel. All changes will be noted in the Document History section of the report.



A.1. 6 dB & 99% Bandwidth

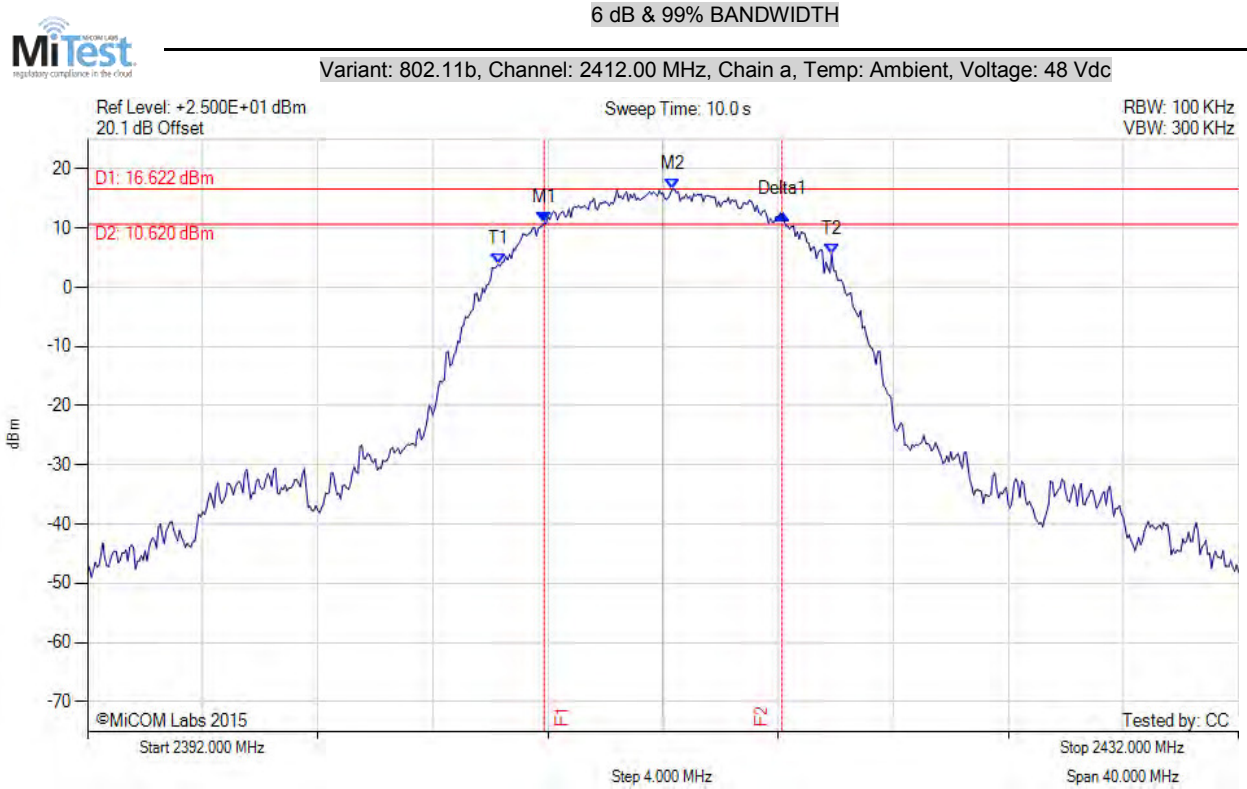

Analyser Setup	Marker:Frequency:Amplitude	Test Results
Detector = POS Sweep Count = 0 RF Atten (dB) = 20 Trace Mode = MAXH	M1 : 2407.870 MHz : 10.885 dBm M2 : 2412.330 MHz : 16.622 dBm Delta1 : 8.270 MHz : 1.473 dB T1 : 2406.267 MHz : 3.868 dBm T2 : 2417.867 MHz : 5.591 dBm OBW : 11.545 MHz	Measured 6 dB Bandwidth: 8.270 MHz Limit: ≥500.0 kHz Margin: -7.77 MHz

[back to matrix](#)

This test report may be reproduced in full only. The document may only be updated by MiCOM Labs personnel. All changes will be noted in the Document History section of the report.



Title: Aruba Networks APEX0104
To: FCC CFR 47 Part 15 Subpart C 15.247 & IC RSS-247
Serial #: ARUB199-U3 Rev A
Issue Date: 27th August 2015
Page: 68 of 223

6 dB & 99% BANDWIDTH



Variant: 802.11b, Channel: 2412.00 MHz, Chain b, Temp: Ambient, Voltage: 48 Vdc

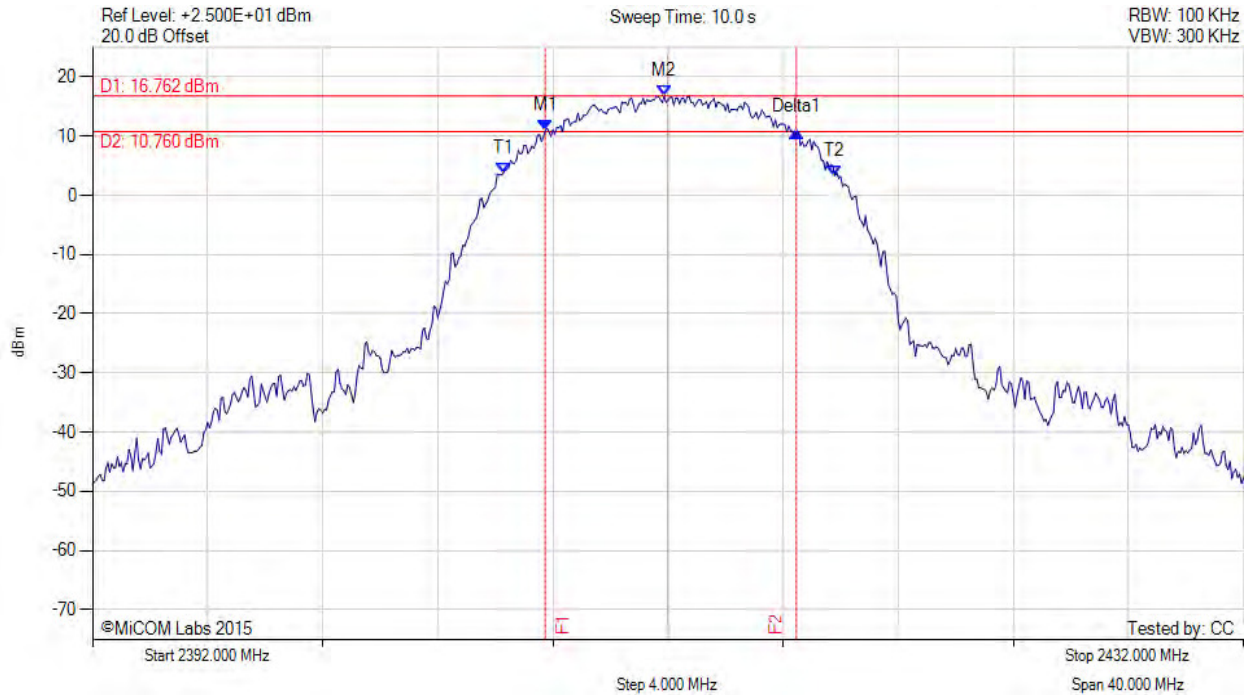

Analyser Setup	Marker:Frequency:Amplitude	Test Results
Detector = POS Sweep Count = 0 RF Atten (dB) = 20 Trace Mode = MAXH	M1 : 2407.730 MHz : 10.860 dBm M2 : 2411.870 MHz : 16.762 dBm Delta1 : 8.730 MHz : -0.245 dB T1 : 2406.267 MHz : 3.675 dBm T2 : 2417.800 MHz : 3.274 dBm OBW : 11.526 MHz	Measured 6 dB Bandwidth: 8.730 MHz Limit: ≥500.0 kHz Margin: -8.23 MHz

[back to matrix](#)

This test report may be reproduced in full only. The document may only be updated by MiCOM Labs personnel. All changes will be noted in the Document History section of the report.



Title: Aruba Networks APEX0104
To: FCC CFR 47 Part 15 Subpart C 15.247 & IC RSS-247
Serial #: ARUB199-U3 Rev A
Issue Date: 27th August 2015
Page: 69 of 223

6 dB & 99% BANDWIDTH



Variant: 802.11b, Channel: 2412.00 MHz, Chain c, Temp: Ambient, Voltage: 48 Vdc

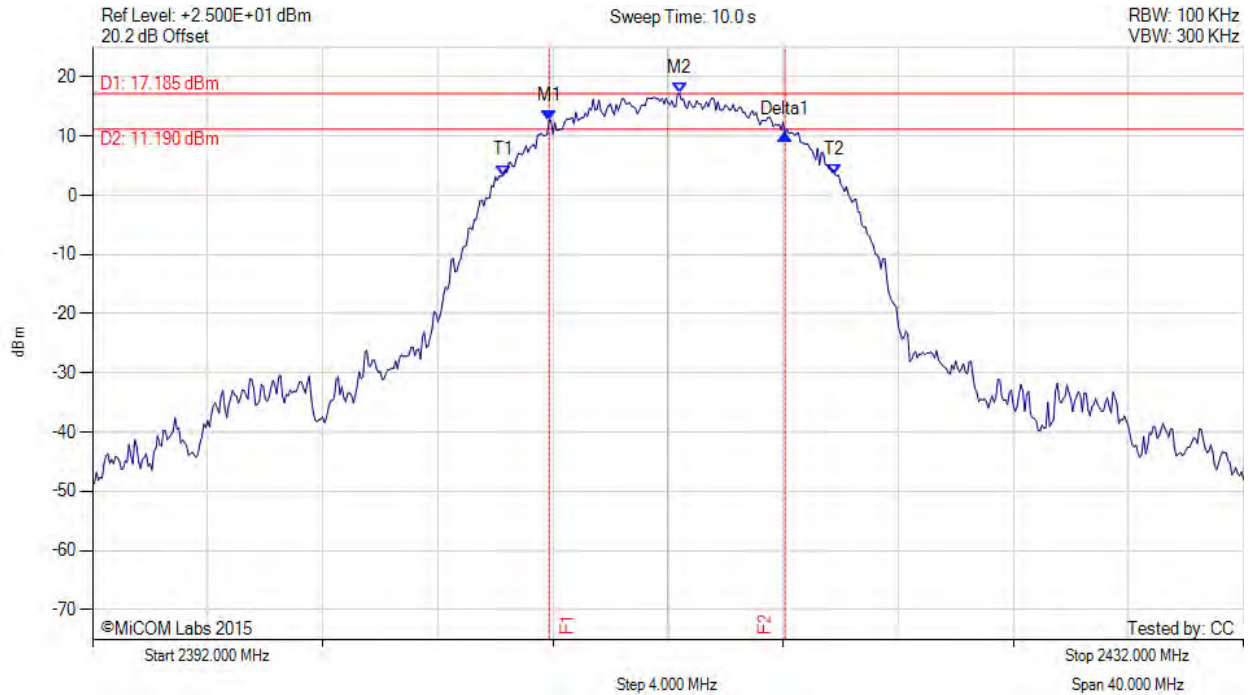

Analyser Setup	Marker:Frequency:Amplitude	Test Results
Detector = POS Sweep Count = 0 RF Atten (dB) = 20 Trace Mode = MAXH	M1 : 2407.870 MHz : 12.683 dBm M2 : 2412.400 MHz : 17.185 dBm Delta1 : 8.200 MHz : -2.433 dB T1 : 2406.267 MHz : 3.354 dBm T2 : 2417.800 MHz : 3.499 dBm OBW : 11.509 MHz	Measured 6 dB Bandwidth: 8.200 MHz Limit: ≥500.0 kHz Margin: -7.70 MHz

[back to matrix](#)

This test report may be reproduced in full only. The document may only be updated by MiCOM Labs personnel. All changes will be noted in the Document History section of the report.



Title: Aruba Networks APEX0104
To: FCC CFR 47 Part 15 Subpart C 15.247 & IC RSS-247
Serial #: ARUB199-U3 Rev A
Issue Date: 27th August 2015
Page: 70 of 223

6 dB & 99% BANDWIDTH



Variant: 802.11b, Channel: 2437.00 MHz, Chain a, Temp: Ambient, Voltage: 48 Vdc

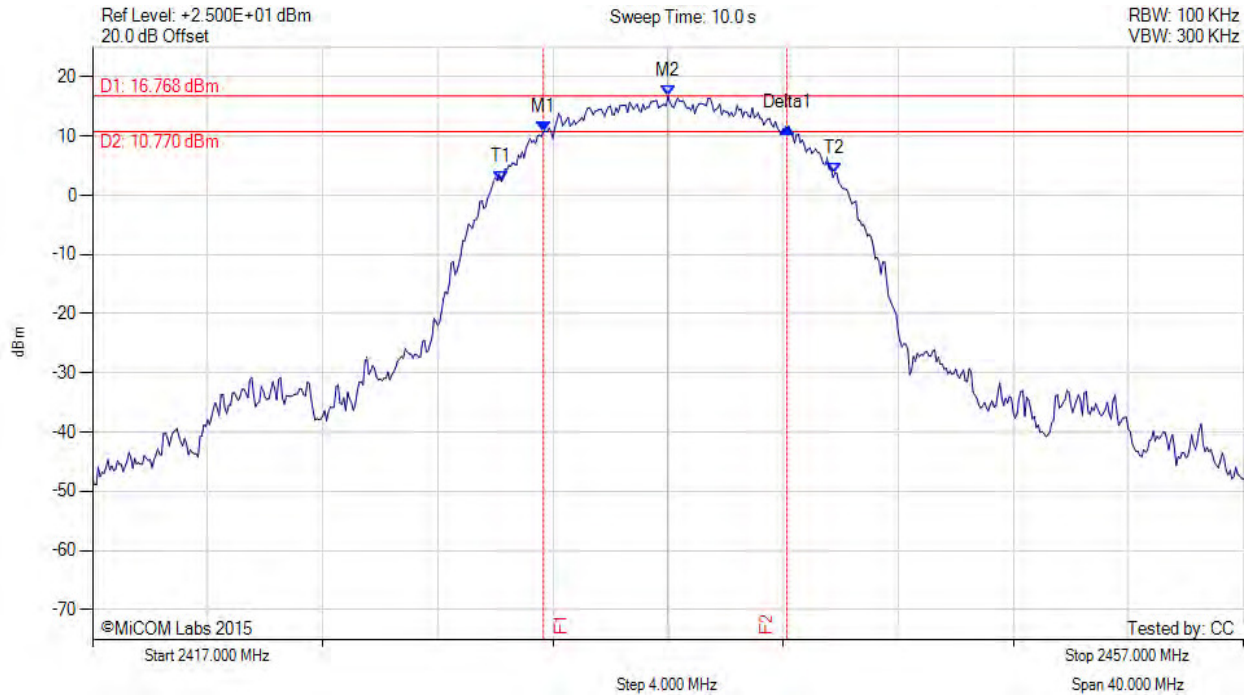

Analyser Setup	Marker:Frequency:Amplitude	Test Results
Detector = POS Sweep Count = 0 RF Atten (dB) = 20 Trace Mode = MAXH	M1 : 2432.670 MHz : 10.778 dBm M2 : 2437.000 MHz : 16.768 dBm Delta1 : 8.470 MHz : 0.675 dB T1 : 2431.200 MHz : 2.351 dBm T2 : 2442.800 MHz : 3.731 dBm OBW : 11.558 MHz	Measured 6 dB Bandwidth: 8.470 MHz Limit: ≥500.0 kHz Margin: -7.97 MHz

[back to matrix](#)

This test report may be reproduced in full only. The document may only be updated by MiCOM Labs personnel. All changes will be noted in the Document History section of the report.



Title: Aruba Networks APEX0104
To: FCC CFR 47 Part 15 Subpart C 15.247 & IC RSS-247
Serial #: ARUB199-U3 Rev A
Issue Date: 27th August 2015
Page: 71 of 223

6 dB & 99% BANDWIDTH



Variant: 802.11b, Channel: 2437.00 MHz, Chain b, Temp: Ambient, Voltage: 48 Vdc

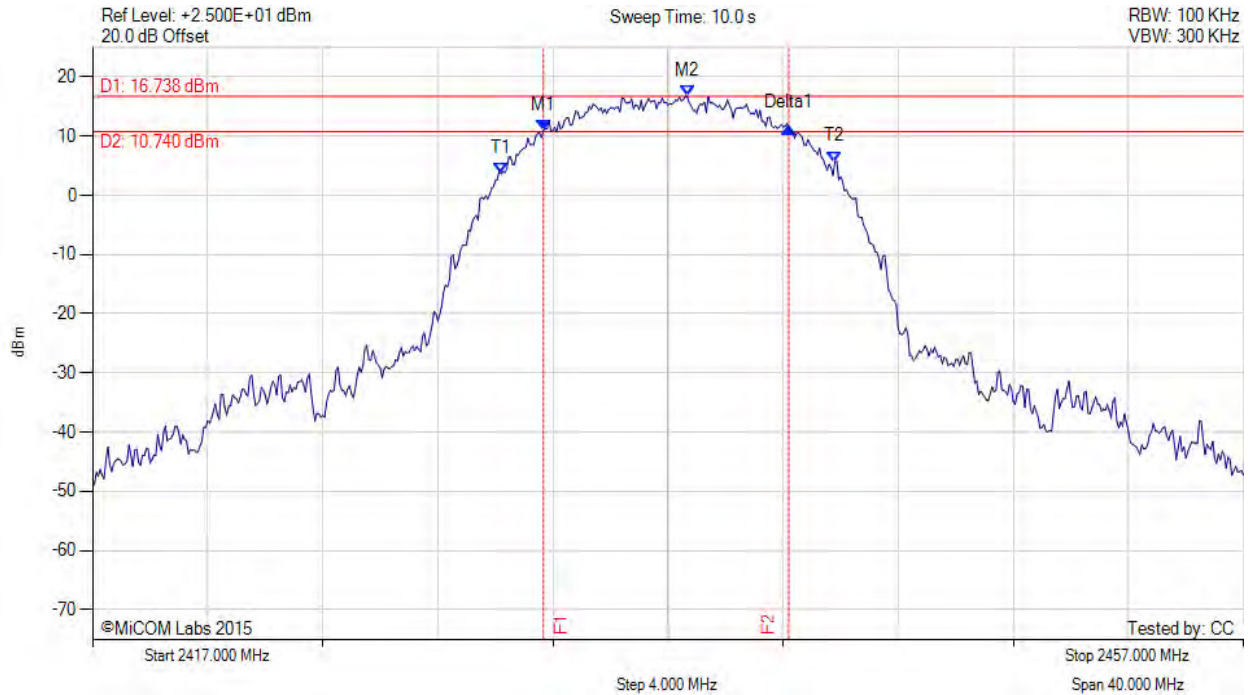

Analyser Setup	Marker:Frequency:Amplitude	Test Results
Detector = POS Sweep Count = 0 RF Atten (dB) = 20 Trace Mode = MAXH	M1 : 2432.670 MHz : 10.957 dBm M2 : 2437.670 MHz : 16.738 dBm Delta1 : 8.530 MHz : 0.494 dB T1 : 2431.200 MHz : 3.617 dBm T2 : 2442.800 MHz : 5.684 dBm OBW : 11.586 MHz	Measured 6 dB Bandwidth: 8.530 MHz Limit: ≥500.0 kHz Margin: -8.03 MHz

[back to matrix](#)

This test report may be reproduced in full only. The document may only be updated by MiCOM Labs personnel. All changes will be noted in the Document History section of the report.



Title: Aruba Networks APEX0104
To: FCC CFR 47 Part 15 Subpart C 15.247 & IC RSS-247
Serial #: ARUB199-U3 Rev A
Issue Date: 27th August 2015
Page: 72 of 223

6 dB & 99% BANDWIDTH



Variant: 802.11b, Channel: 2437.00 MHz, Chain c, Temp: Ambient, Voltage: 48 Vdc

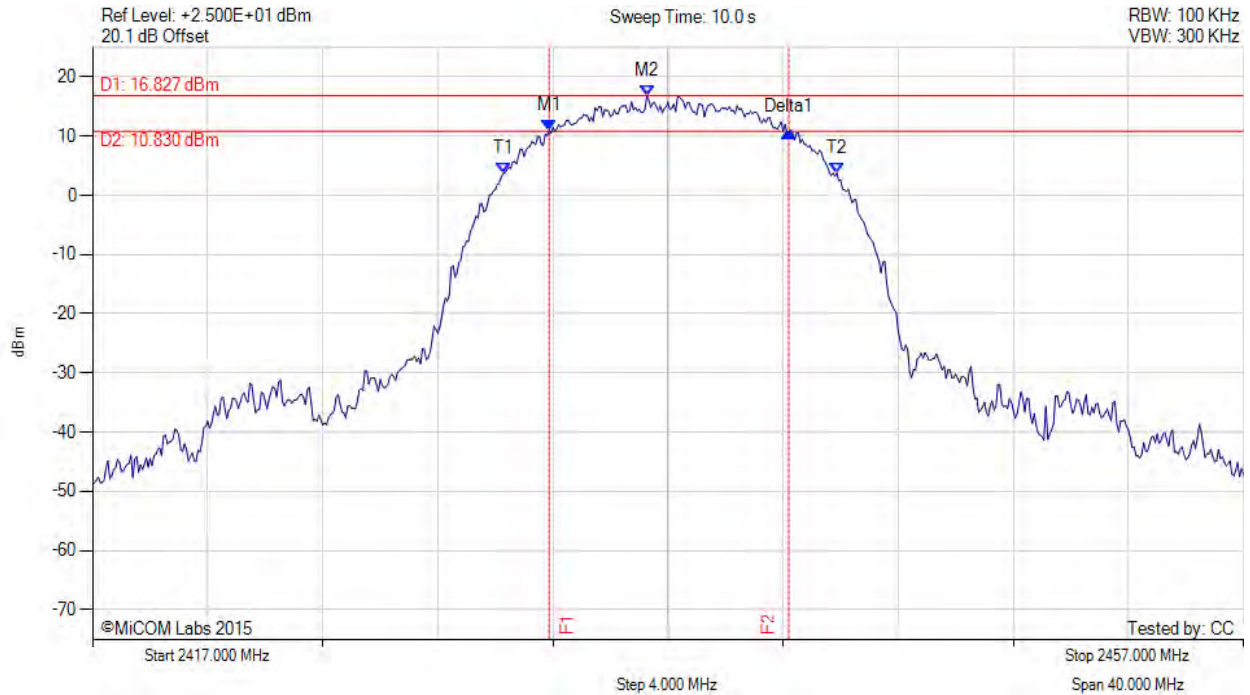

Analyser Setup	Marker:Frequency:Amplitude	Test Results
Detector = POS Sweep Count = 0 RF Atten (dB) = 20 Trace Mode = MAXH	M1 : 2432.870 MHz : 10.939 dBm M2 : 2436.270 MHz : 16.827 dBm Delta1 : 8.330 MHz : -0.326 dB T1 : 2431.267 MHz : 3.632 dBm T2 : 2442.867 MHz : 3.722 dBm OBW : 11.527 MHz	Measured 6 dB Bandwidth: 8.330 MHz Limit: ≥500.0 kHz Margin: -7.83 MHz

[back to matrix](#)

This test report may be reproduced in full only. The document may only be updated by MiCOM Labs personnel. All changes will be noted in the Document History section of the report.



Title: Aruba Networks APEX0104
To: FCC CFR 47 Part 15 Subpart C 15.247 & IC RSS-247
Serial #: ARUB199-U3 Rev A
Issue Date: 27th August 2015
Page: 73 of 223

6 dB & 99% BANDWIDTH



Variant: 802.11b, Channel: 2462.00 MHz, Chain a, Temp: Ambient, Voltage: 48 Vdc

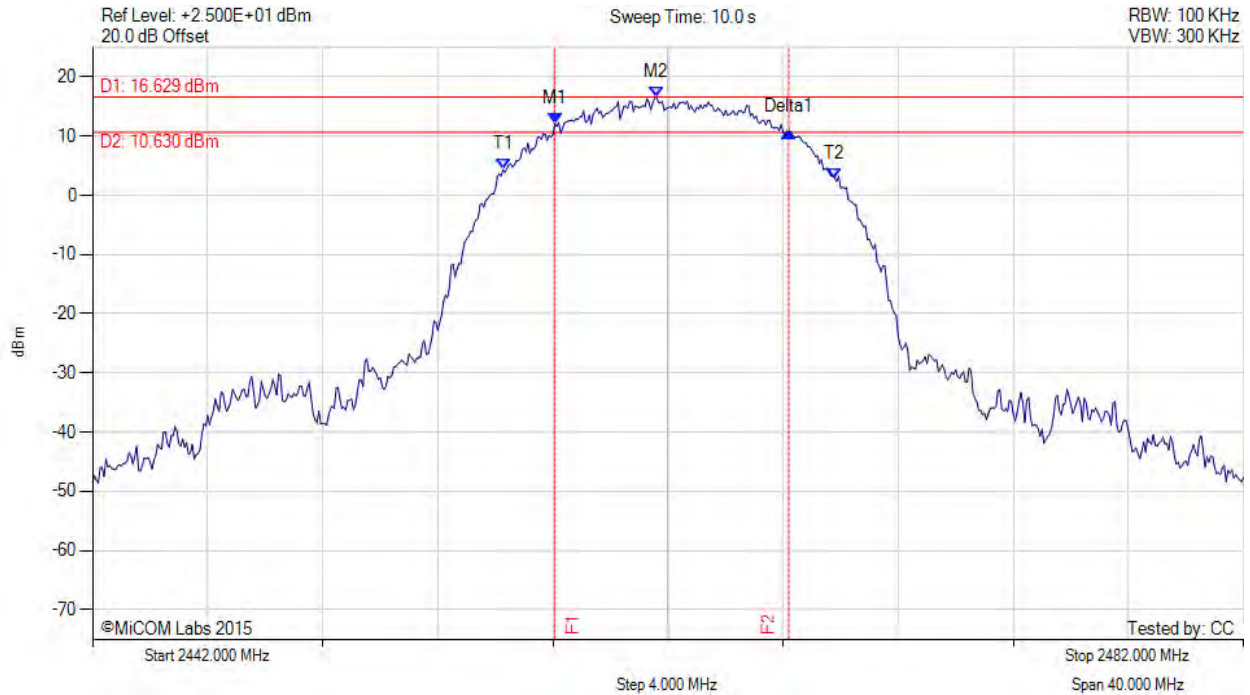

Analyser Setup	Marker:Frequency:Amplitude	Test Results
Detector = POS Sweep Count = 0 RF Atten (dB) = 20 Trace Mode = MAXH	M1 : 2458.070 MHz : 12.063 dBm M2 : 2461.600 MHz : 16.629 dBm Delta1 : 8.130 MHz : -1.283 dB T1 : 2456.267 MHz : 4.346 dBm T2 : 2467.800 MHz : 2.846 dBm OBW : 11.520 MHz	Measured 6 dB Bandwidth: 8.130 MHz Limit: ≥500.0 kHz Margin: -7.63 MHz

[back to matrix](#)

This test report may be reproduced in full only. The document may only be updated by MiCOM Labs personnel. All changes will be noted in the Document History section of the report.



Title: Aruba Networks APEX0104
To: FCC CFR 47 Part 15 Subpart C 15.247 & IC RSS-247
Serial #: ARUB199-U3 Rev A
Issue Date: 27th August 2015
Page: 74 of 223

6 dB & 99% BANDWIDTH



Variant: 802.11b, Channel: 2462.00 MHz, Chain b, Temp: Ambient, Voltage: 48 Vdc

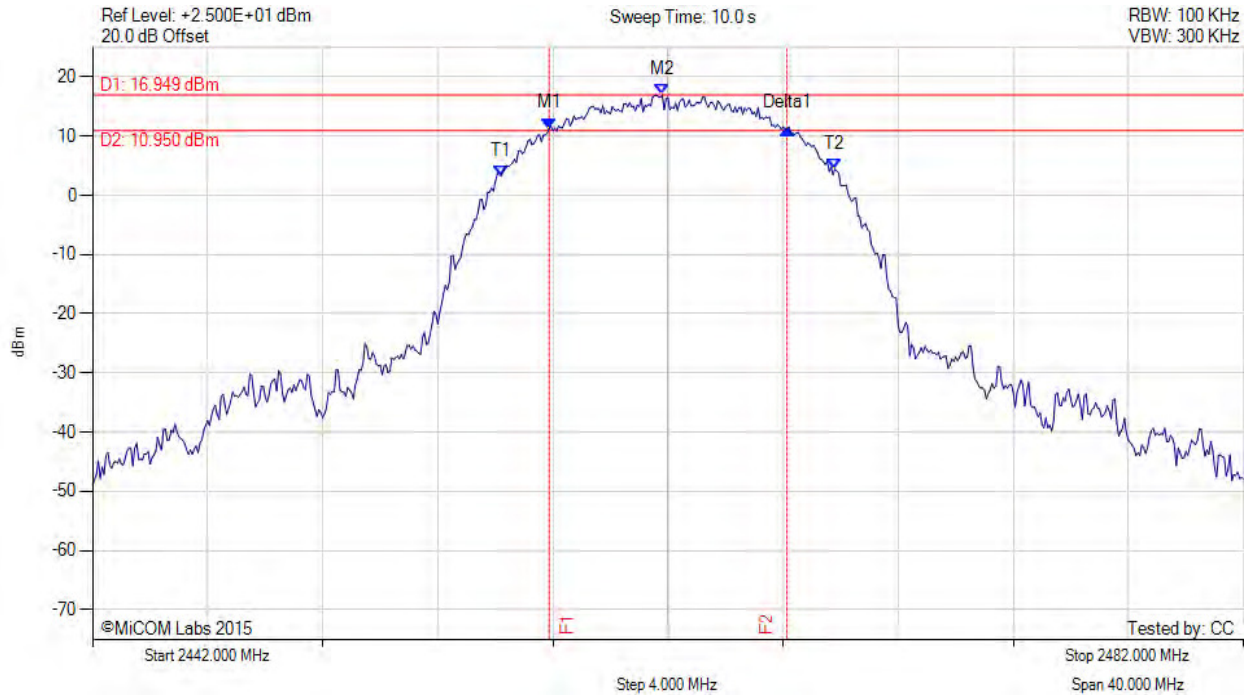

Analyser Setup	Marker:Frequency:Amplitude	Test Results
Detector = POS Sweep Count = 0 RF Atten (dB) = 20 Trace Mode = MAXH	M1 : 2457.870 MHz : 11.298 dBm M2 : 2461.800 MHz : 16.949 dBm Delta1 : 8.270 MHz : -0.011 dB T1 : 2456.200 MHz : 3.223 dBm T2 : 2467.800 MHz : 4.390 dBm OBW : 11.566 MHz	Measured 6 dB Bandwidth: 8.270 MHz Limit: ≥500.0 kHz Margin: -7.77 MHz

[back to matrix](#)

This test report may be reproduced in full only. The document may only be updated by MiCOM Labs personnel. All changes will be noted in the Document History section of the report.



Title: Aruba Networks APEX0104
To: FCC CFR 47 Part 15 Subpart C 15.247 & IC RSS-247
Serial #: ARUB199-U3 Rev A
Issue Date: 27th August 2015
Page: 75 of 223

6 dB & 99% BANDWIDTH



Variant: 802.11b, Channel: 2462.00 MHz, Chain c, Temp: Ambient, Voltage: 48 Vdc

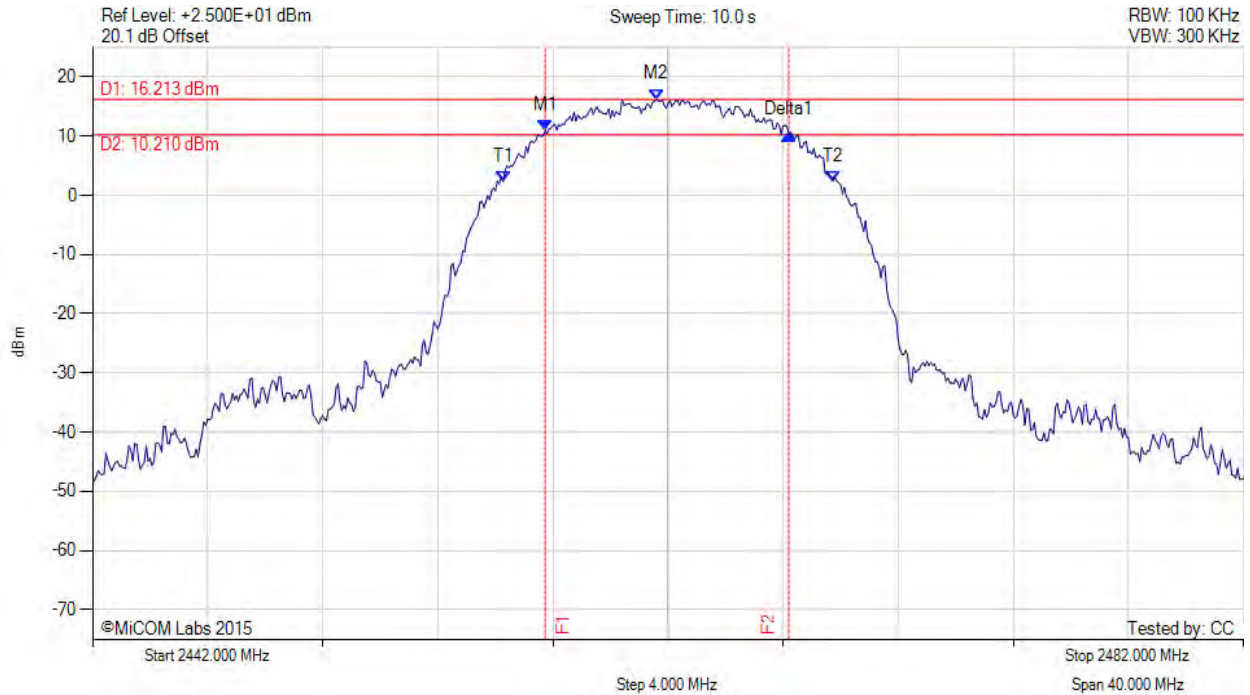

Analyser Setup	Marker:Frequency:Amplitude	Test Results
Detector = POS Sweep Count = 0 RF Atten (dB) = 20 Trace Mode = MAXH	M1 : 2457.730 MHz : 10.986 dBm M2 : 2461.600 MHz : 16.213 dBm Delta1 : 8.470 MHz : -0.672 dB T1 : 2456.267 MHz : 2.286 dBm T2 : 2467.733 MHz : 2.399 dBm OBW : 11.388 MHz	Measured 6 dB Bandwidth: 8.470 MHz Limit: ≥500.0 kHz Margin: -7.97 MHz

[back to matrix](#)

This test report may be reproduced in full only. The document may only be updated by MiCOM Labs personnel. All changes will be noted in the Document History section of the report.



Title: Aruba Networks APEX0104
To: FCC CFR 47 Part 15 Subpart C 15.247 & IC RSS-247
Serial #: ARUB199-U3 Rev A
Issue Date: 27th August 2015
Page: 76 of 223

6 dB & 99% BANDWIDTH



Variant: 802.11g, Channel: 2412.00 MHz, Chain a, Temp: Ambient, Voltage: 48 Vdc

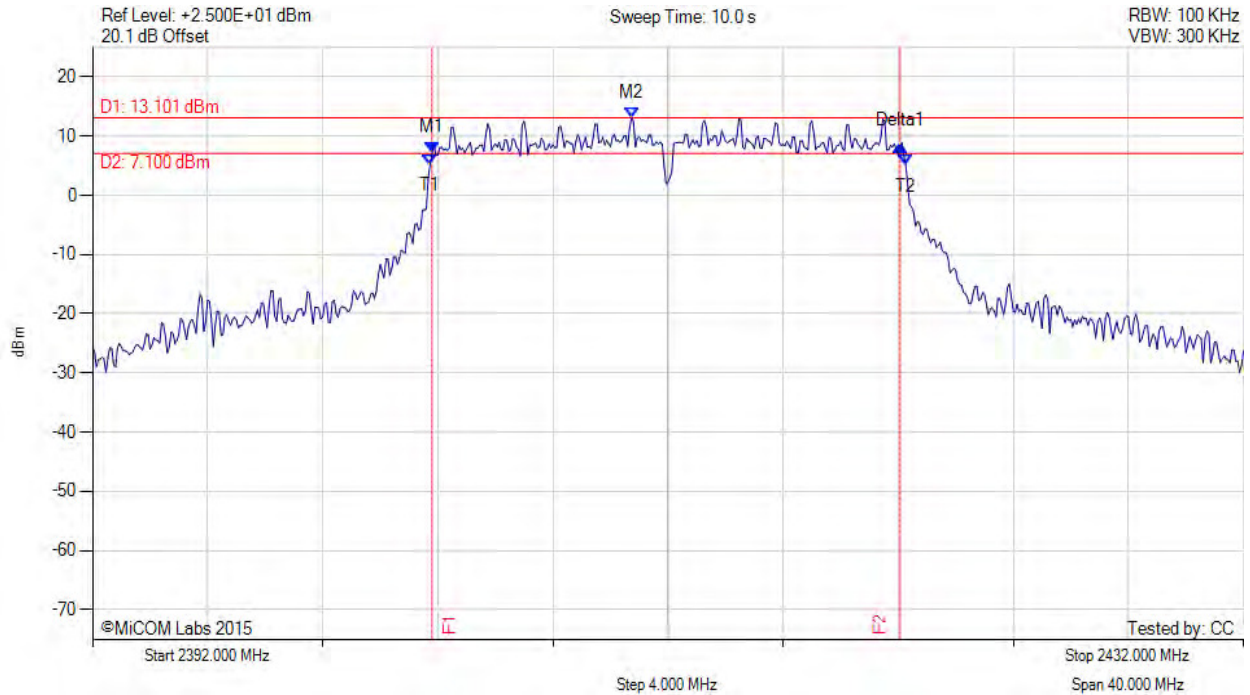

Analyser Setup	Marker:Frequency:Amplitude	Test Results
Detector = POS Sweep Count = 0 RF Atten (dB) = 20 Trace Mode = MAXH	M1 : 2403.800 MHz : 7.135 dBm M2 : 2410.730 MHz : 13.101 dBm Delta1 : 16.270 MHz : 1.292 dB T1 : 2403.733 MHz : 5.235 dBm T2 : 2420.267 MHz : 5.034 dBm OBW : 16.489 MHz	Measured 6 dB Bandwidth: 16.270 MHz Limit: ≥500.0 kHz Margin: -15.77 MHz

[back to matrix](#)

This test report may be reproduced in full only. The document may only be updated by MiCOM Labs personnel. All changes will be noted in the Document History section of the report.



Title: Aruba Networks APEX0104
To: FCC CFR 47 Part 15 Subpart C 15.247 & IC RSS-247
Serial #: ARUB199-U3 Rev A
Issue Date: 27th August 2015
Page: 77 of 223

6 dB & 99% BANDWIDTH



Variant: 802.11g, Channel: 2412.00 MHz, Chain b, Temp: Ambient, Voltage: 48 Vdc

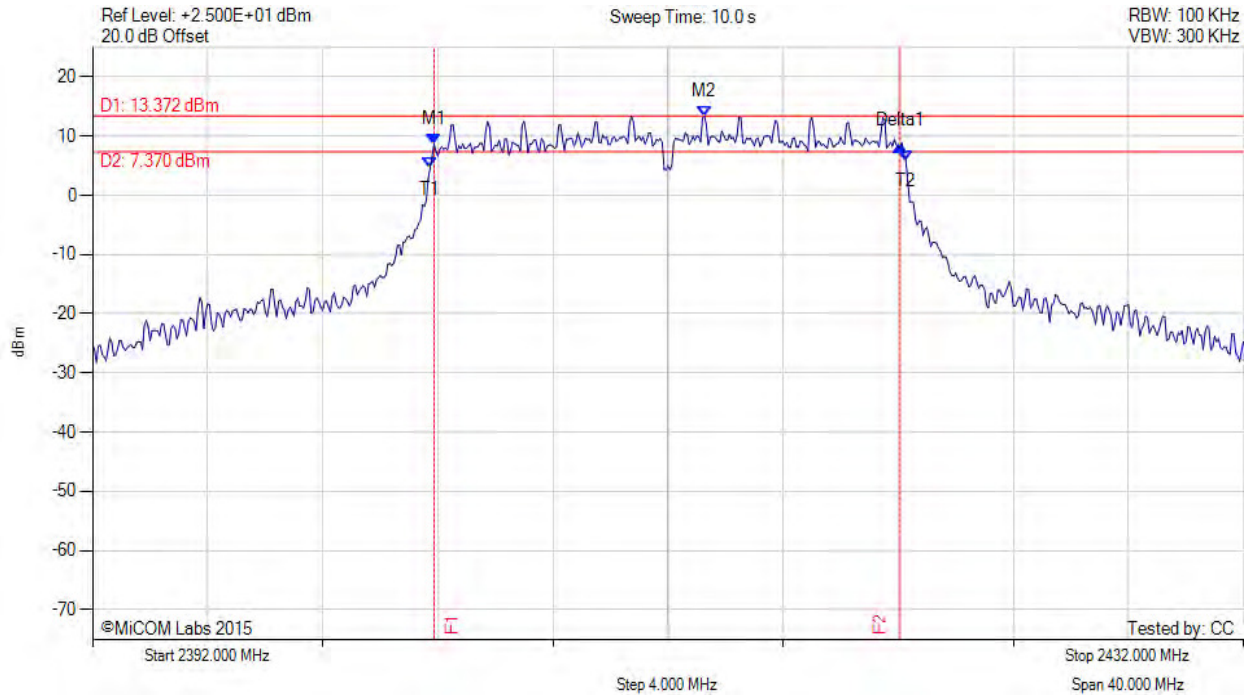

Analyser Setup	Marker:Frequency:Amplitude	Test Results
Detector = POS Sweep Count = 0 RF Atten (dB) = 20 Trace Mode = MAXH	M1 : 2403.870 MHz : 8.627 dBm M2 : 2413.270 MHz : 13.372 dBm Delta1 : 16.200 MHz : -0.303 dB T1 : 2403.733 MHz : 4.607 dBm T2 : 2420.267 MHz : 5.906 dBm OBW : 16.501 MHz	Measured 6 dB Bandwidth: 16.200 MHz Limit: ≥500.0 kHz Margin: -15.70 MHz

[back to matrix](#)

This test report may be reproduced in full only. The document may only be updated by MiCOM Labs personnel. All changes will be noted in the Document History section of the report.



Title: Aruba Networks APEX0104
To: FCC CFR 47 Part 15 Subpart C 15.247 & IC RSS-247
Serial #: ARUB199-U3 Rev A
Issue Date: 27th August 2015
Page: 78 of 223

6 dB & 99% BANDWIDTH



Variant: 802.11g, Channel: 2412.00 MHz, Chain c, Temp: Ambient, Voltage: 48 Vdc

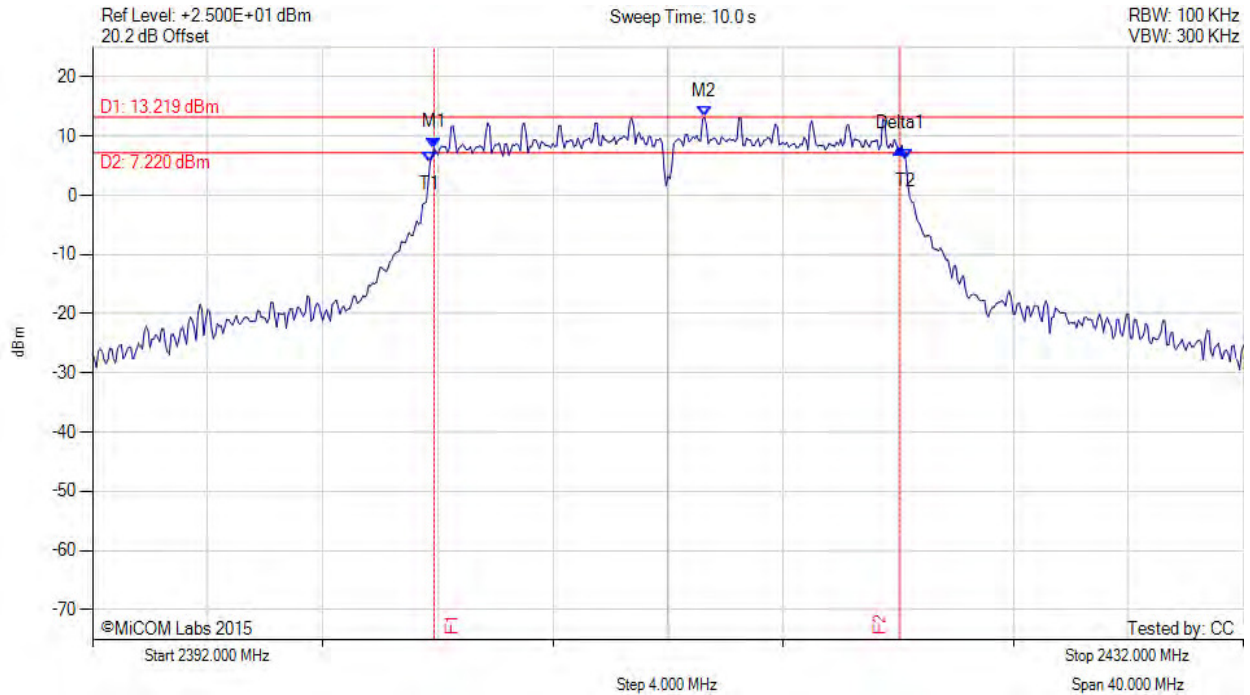

Analyser Setup	Marker:Frequency:Amplitude	Test Results
Detector = POS Sweep Count = 0 RF Atten (dB) = 20 Trace Mode = MAXH	M1 : 2403.870 MHz : 8.027 dBm M2 : 2413.270 MHz : 13.219 dBm Delta1 : 16.200 MHz : -0.178 dB T1 : 2403.733 MHz : 5.592 dBm T2 : 2420.267 MHz : 5.953 dBm OBW : 16.512 MHz	Measured 6 dB Bandwidth: 16.200 MHz Limit: ≥500.0 kHz Margin: -15.70 MHz

[back to matrix](#)

This test report may be reproduced in full only. The document may only be updated by MiCOM Labs personnel. All changes will be noted in the Document History section of the report.



Title: Aruba Networks APEX0104
To: FCC CFR 47 Part 15 Subpart C 15.247 & IC RSS-247
Serial #: ARUB199-U3 Rev A
Issue Date: 27th August 2015
Page: 79 of 223

6 dB & 99% BANDWIDTH



Variant: 802.11g, Channel: 2437.00 MHz, Chain a, Temp: Ambient, Voltage: 48 Vdc

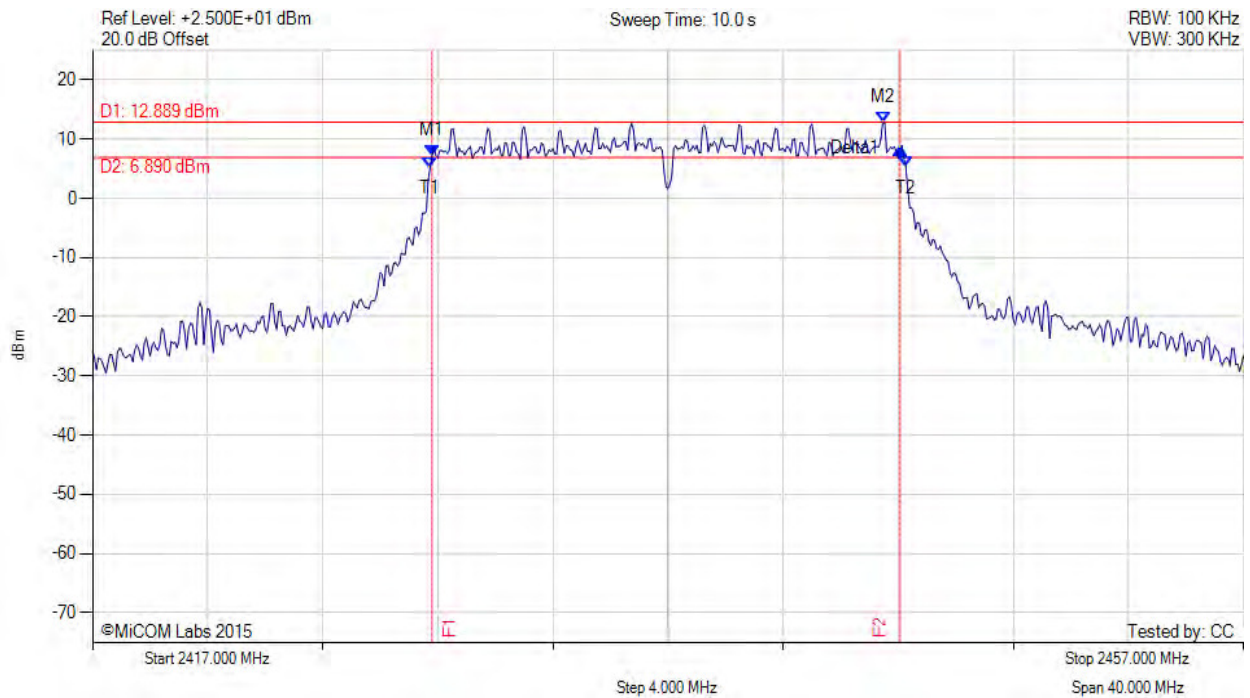

Analyser Setup	Marker:Frequency:Amplitude	Test Results
Detector = POS Sweep Count = 0 RF Atten (dB) = 20 Trace Mode = MAXH	M1 : 2428.800 MHz : 7.227 dBm M2 : 2444.470 MHz : 12.889 dBm Delta1 : 16.270 MHz : 1.195 dB T1 : 2428.733 MHz : 5.154 dBm T2 : 2445.267 MHz : 5.348 dBm OBW : 16.508 MHz	Measured 6 dB Bandwidth: 16.270 MHz Limit: ≥500.0 kHz Margin: -15.77 MHz

[back to matrix](#)

This test report may be reproduced in full only. The document may only be updated by MiCOM Labs personnel. All changes will be noted in the Document History section of the report.



Title: Aruba Networks APEX0104
To: FCC CFR 47 Part 15 Subpart C 15.247 & IC RSS-247
Serial #: ARUB199-U3 Rev A
Issue Date: 27th August 2015
Page: 80 of 223

6 dB & 99% BANDWIDTH



Variant: 802.11g, Channel: 2437.00 MHz, Chain b, Temp: Ambient, Voltage: 48 Vdc

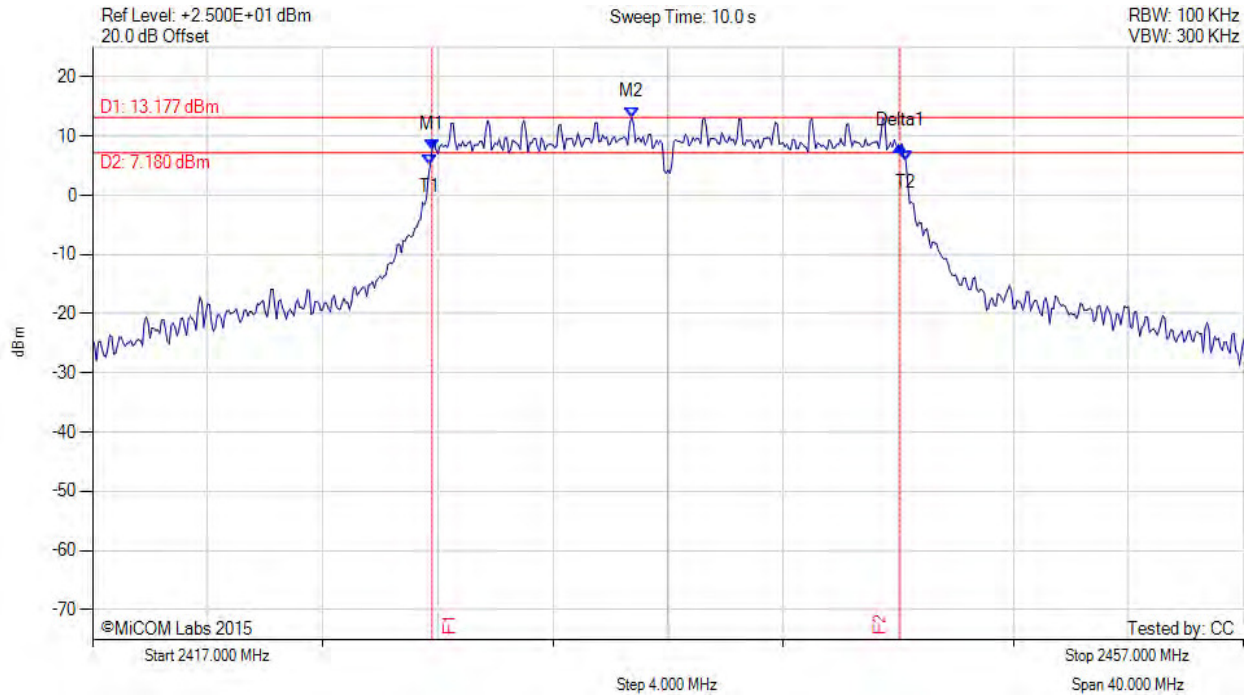

Analyser Setup	Marker:Frequency:Amplitude	Test Results
Detector = POS Sweep Count = 0 RF Atten (dB) = 20 Trace Mode = MAXH	M1 : 2428.800 MHz : 7.711 dBm M2 : 2435.730 MHz : 13.177 dBm Delta1 : 16.270 MHz : 0.566 dB T1 : 2428.733 MHz : 5.036 dBm T2 : 2445.267 MHz : 5.770 dBm OBW : 16.511 MHz	Measured 6 dB Bandwidth: 16.270 MHz Limit: ≥500.0 kHz Margin: -15.77 MHz

[back to matrix](#)

This test report may be reproduced in full only. The document may only be updated by MiCOM Labs personnel. All changes will be noted in the Document History section of the report.



Title: Aruba Networks APEX0104
To: FCC CFR 47 Part 15 Subpart C 15.247 & IC RSS-247
Serial #: ARUB199-U3 Rev A
Issue Date: 27th August 2015
Page: 81 of 223

6 dB & 99% BANDWIDTH



Variant: 802.11g, Channel: 2437.00 MHz, Chain c, Temp: Ambient, Voltage: 48 Vdc

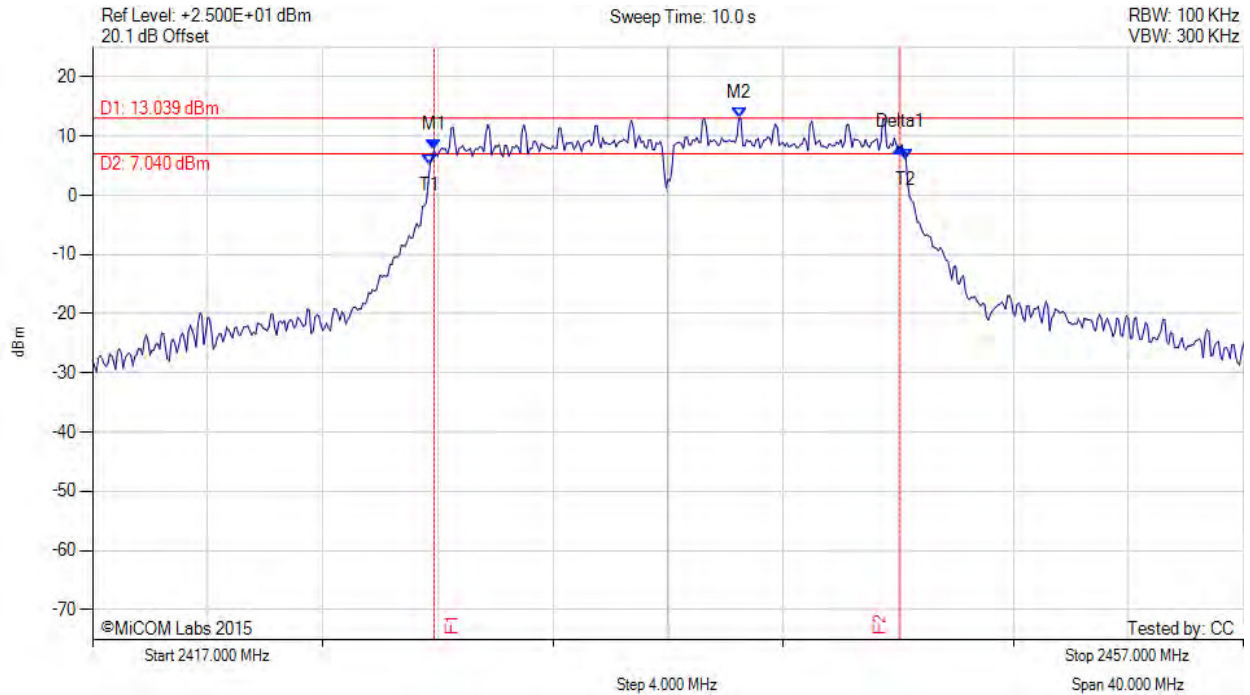

Analyser Setup	Marker:Frequency:Amplitude	Test Results
Detector = POS Sweep Count = 0 RF Atten (dB) = 20 Trace Mode = MAXH	M1 : 2428.870 MHz : 7.668 dBm M2 : 2439.470 MHz : 13.039 dBm Delta1 : 16.200 MHz : 0.461 dB T1 : 2428.733 MHz : 5.223 dBm T2 : 2445.267 MHz : 6.167 dBm OBW : 16.510 MHz	Measured 6 dB Bandwidth: 16.200 MHz Limit: ≥500.0 kHz Margin: -15.70 MHz

[back to matrix](#)

This test report may be reproduced in full only. The document may only be updated by MiCOM Labs personnel. All changes will be noted in the Document History section of the report.



Title: Aruba Networks APEX0104
To: FCC CFR 47 Part 15 Subpart C 15.247 & IC RSS-247
Serial #: ARUB199-U3 Rev A
Issue Date: 27th August 2015
Page: 82 of 223

6 dB & 99% BANDWIDTH



Variant: 802.11g, Channel: 2462.00 MHz, Chain a, Temp: Ambient, Voltage: 48 Vdc

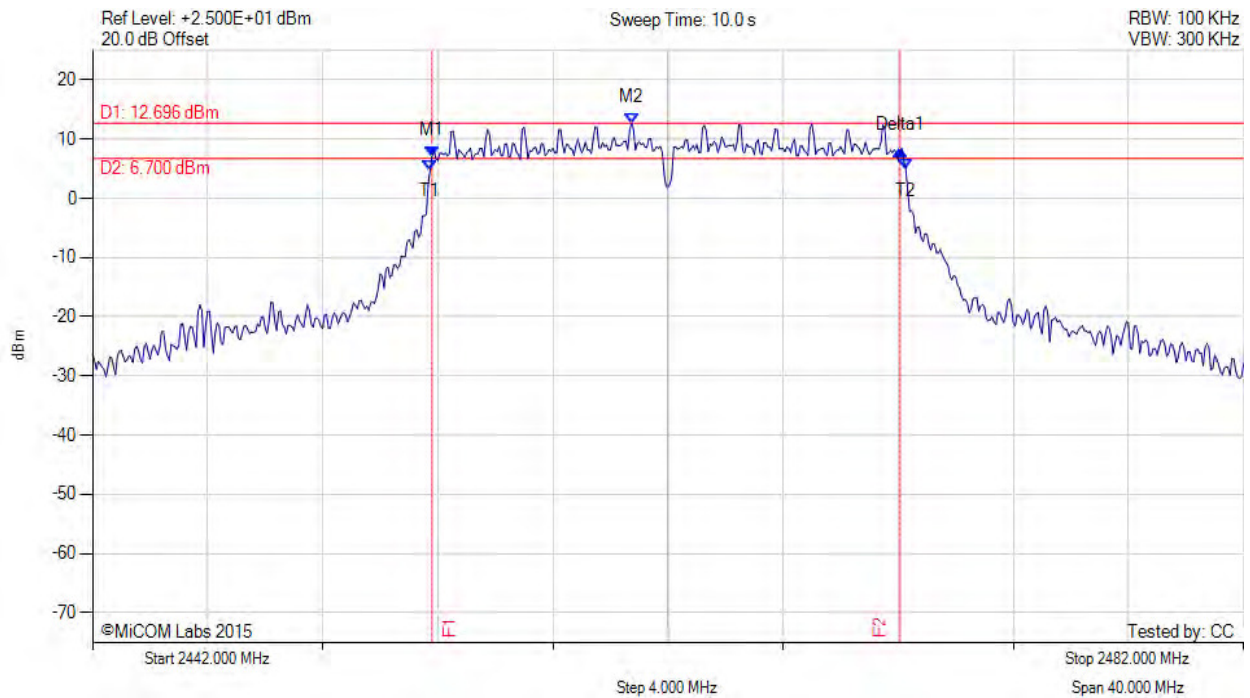

Analyser Setup	Marker:Frequency:Amplitude	Test Results
Detector = POS Sweep Count = 0 RF Atten (dB) = 20 Trace Mode = MAXH	M1 : 2453.800 MHz : 7.086 dBm M2 : 2460.730 MHz : 12.696 dBm Delta1 : 16.270 MHz : 0.980 dB T1 : 2453.733 MHz : 4.744 dBm T2 : 2470.267 MHz : 4.849 dBm OBW : 16.466 MHz	Measured 6 dB Bandwidth: 16.270 MHz Limit: ≥500.0 kHz Margin: -15.77 MHz

[back to matrix](#)

This test report may be reproduced in full only. The document may only be updated by MiCOM Labs personnel. All changes will be noted in the Document History section of the report.



Title: Aruba Networks APEX0104
To: FCC CFR 47 Part 15 Subpart C 15.247 & IC RSS-247
Serial #: ARUB199-U3 Rev A
Issue Date: 27th August 2015
Page: 83 of 223

6 dB & 99% BANDWIDTH



Variant: 802.11g, Channel: 2462.00 MHz, Chain b, Temp: Ambient, Voltage: 48 Vdc

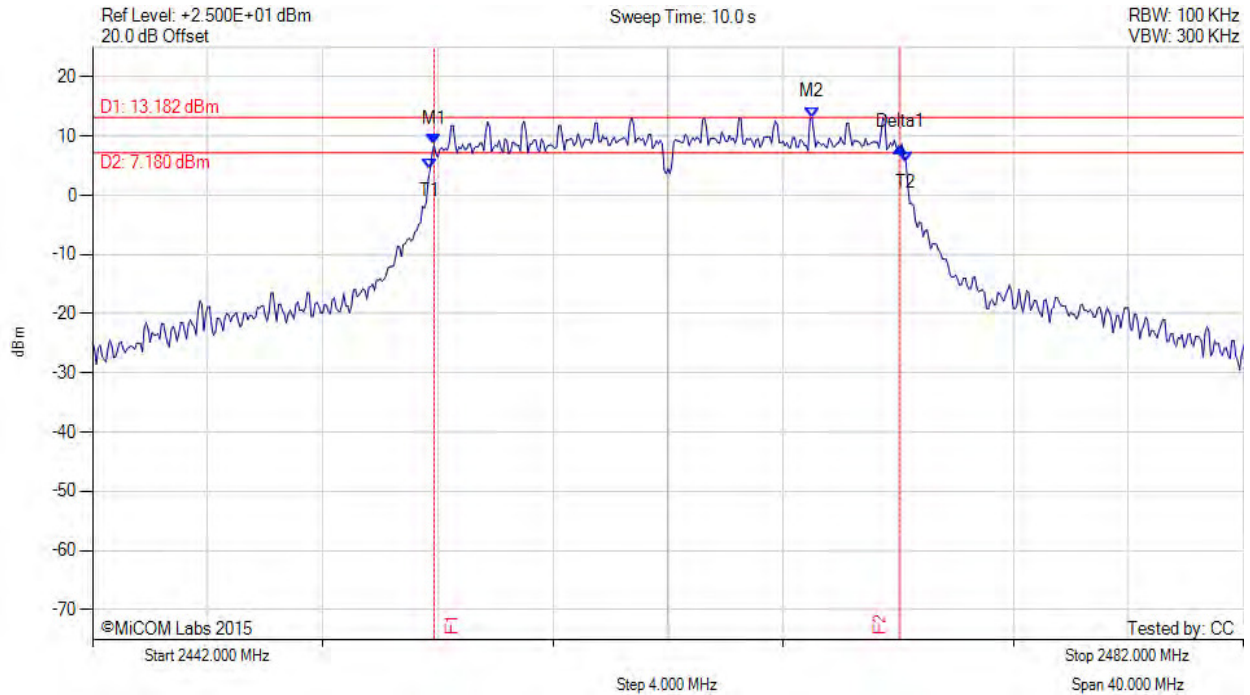

Analyser Setup	Marker:Frequency:Amplitude	Test Results
Detector = POS Sweep Count = 0 RF Atten (dB) = 20 Trace Mode = MAXH	M1 : 2453.870 MHz : 8.512 dBm M2 : 2467.000 MHz : 13.182 dBm Delta1 : 16.200 MHz : -0.315 dB T1 : 2453.733 MHz : 4.402 dBm T2 : 2470.267 MHz : 5.652 dBm OBW : 16.479 MHz	Measured 6 dB Bandwidth: 16.200 MHz Limit: ≥500.0 kHz Margin: -15.70 MHz

[back to matrix](#)

This test report may be reproduced in full only. The document may only be updated by MiCOM Labs personnel. All changes will be noted in the Document History section of the report.



Title: Aruba Networks APEX0104
To: FCC CFR 47 Part 15 Subpart C 15.247 & IC RSS-247
Serial #: ARUB199-U3 Rev A
Issue Date: 27th August 2015
Page: 84 of 223

6 dB & 99% BANDWIDTH



Variant: 802.11g, Channel: 2462.00 MHz, Chain c, Temp: Ambient, Voltage: 48 Vdc

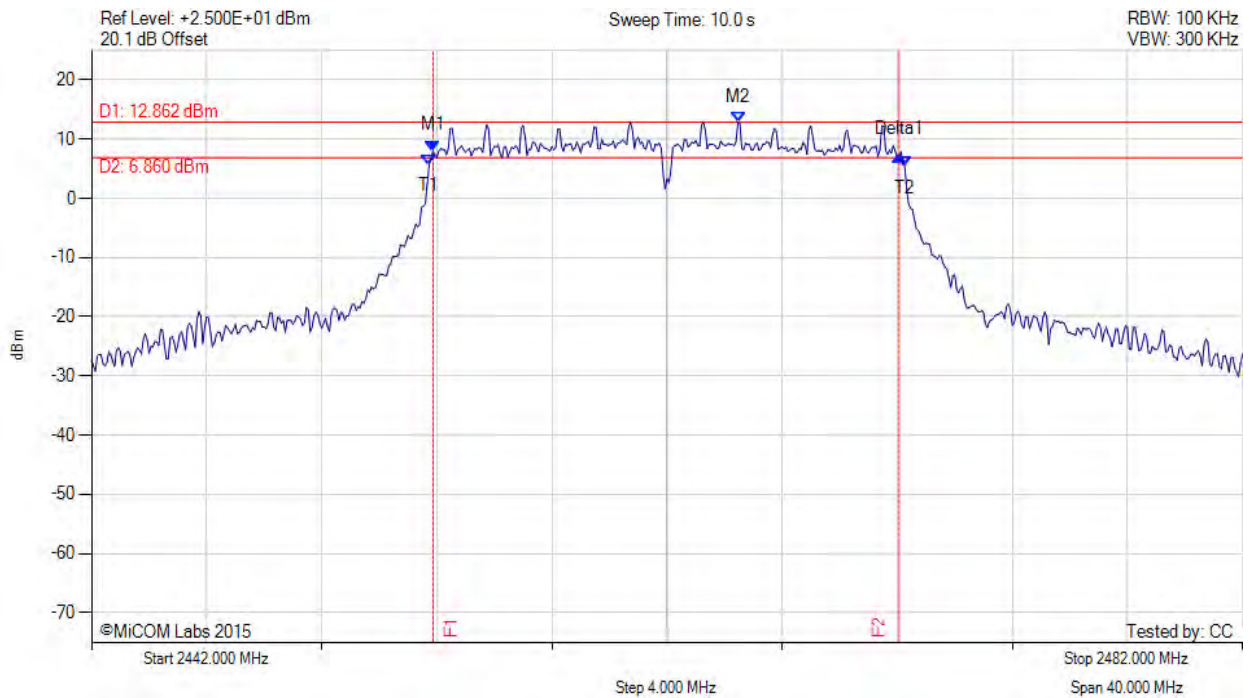

Analyser Setup	Marker:Frequency:Amplitude	Test Results
Detector = POS Sweep Count = 0 RF Atten (dB) = 20 Trace Mode = MAXH	M1 : 2453.870 MHz : 8.032 dBm M2 : 2464.470 MHz : 12.862 dBm Delta1 : 16.200 MHz : -0.696 dB T1 : 2453.733 MHz : 5.616 dBm T2 : 2470.267 MHz : 5.341 dBm OBW : 16.495 MHz	Measured 6 dB Bandwidth: 16.200 MHz Limit: ≥500.0 kHz Margin: -15.70 MHz

[back to matrix](#)

This test report may be reproduced in full only. The document may only be updated by MiCOM Labs personnel. All changes will be noted in the Document History section of the report.



Title: Aruba Networks APEX0104
To: FCC CFR 47 Part 15 Subpart C 15.247 & IC RSS-247
Serial #: ARUB199-U3 Rev A
Issue Date: 27th August 2015
Page: 85 of 223

6 dB & 99% BANDWIDTH



Variant: 802.11n HT-20, Channel: 2412.00 MHz, Chain a, Temp: Ambient, Voltage: 48 Vdc

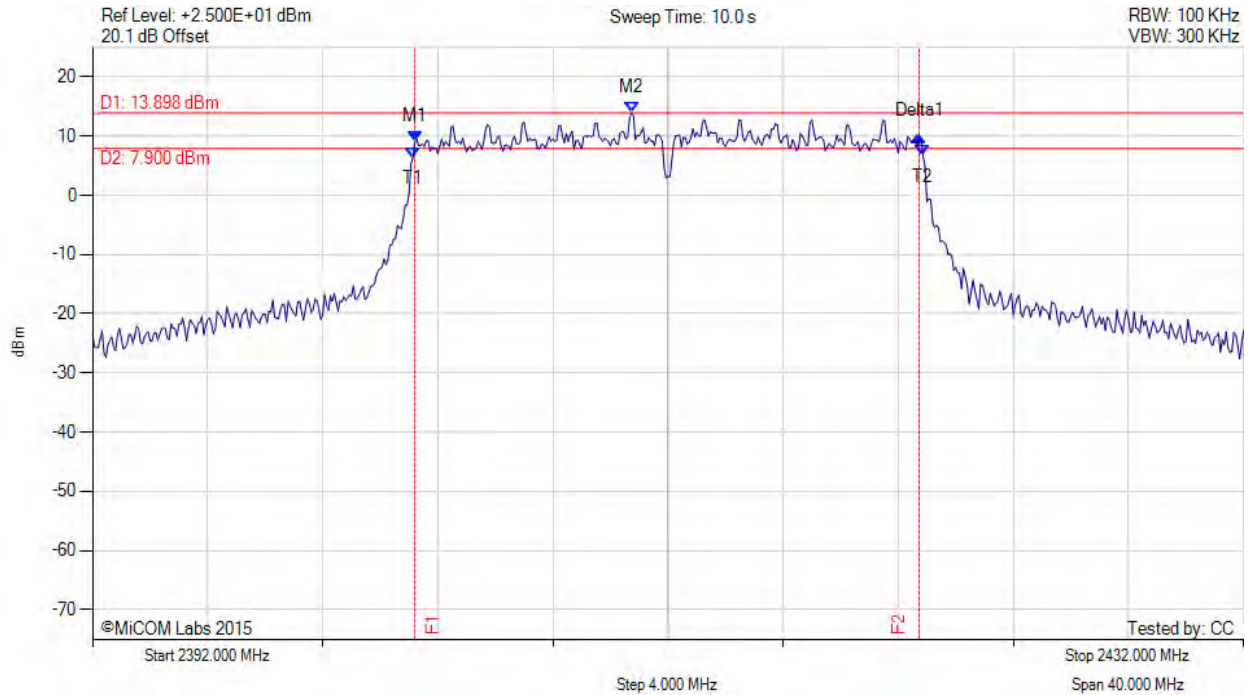

Analyser Setup	Marker:Frequency:Amplitude	Test Results
Detector = POS Sweep Count = 0 RF Atten (dB) = 20 Trace Mode = MAXH	M1 : 2403.200 MHz : 9.027 dBm M2 : 2410.730 MHz : 13.898 dBm Delta1 : 17.530 MHz : 0.992 dB T1 : 2403.133 MHz : 6.337 dBm T2 : 2420.867 MHz : 6.688 dBm OBW : 17.687 MHz	Measured 6 dB Bandwidth: 17.530 MHz Limit: ≥500.0 kHz Margin: -17.03 MHz

[back to matrix](#)

This test report may be reproduced in full only. The document may only be updated by MiCOM Labs personnel. All changes will be noted in the Document History section of the report.



Title: Aruba Networks APEX0104
To: FCC CFR 47 Part 15 Subpart C 15.247 & IC RSS-247
Serial #: ARUB199-U3 Rev A
Issue Date: 27th August 2015
Page: 86 of 223

6 dB & 99% BANDWIDTH



Variant: 802.11n HT-20, Channel: 2412.00 MHz, Chain b, Temp: Ambient, Voltage: 48 Vdc

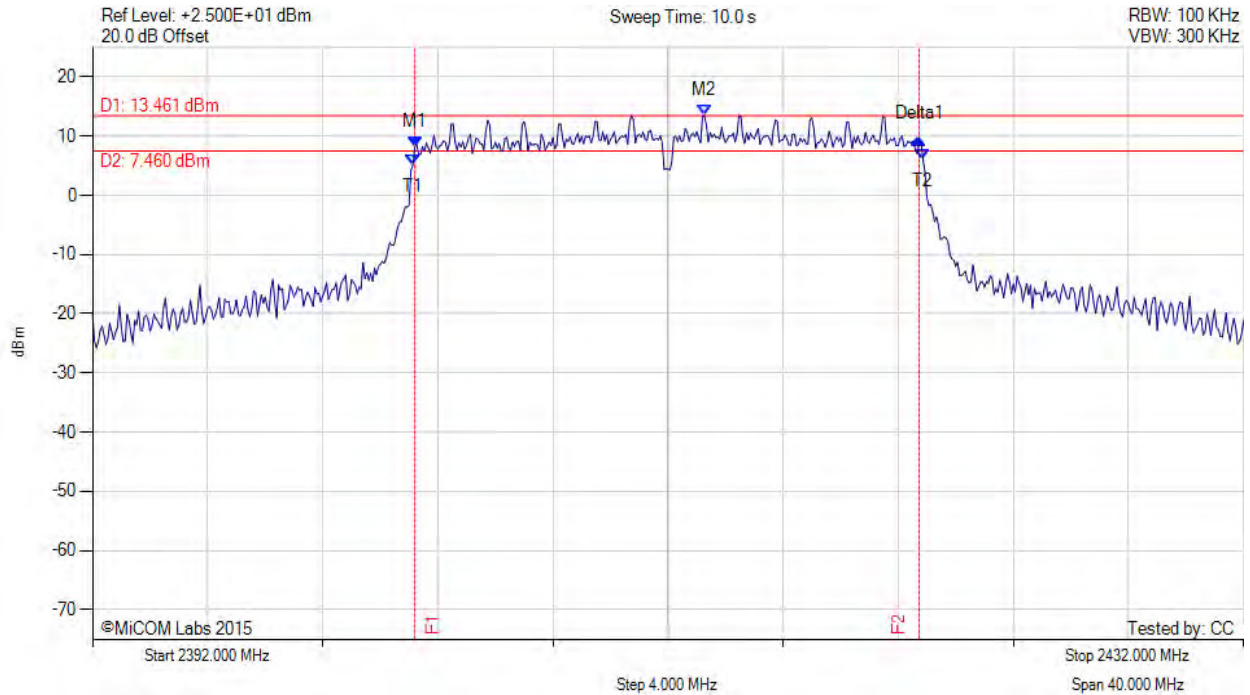

Analyser Setup	Marker:Frequency:Amplitude	Test Results
Detector = POS Sweep Count = 0 RF Atten (dB) = 20 Trace Mode = MAXH	M1 : 2403.200 MHz : 8.205 dBm M2 : 2413.270 MHz : 13.461 dBm Delta1 : 17.530 MHz : 1.257 dB T1 : 2403.133 MHz : 5.050 dBm T2 : 2420.867 MHz : 5.967 dBm OBW : 17.675 MHz	Measured 6 dB Bandwidth: 17.530 MHz Limit: ≥500.0 kHz Margin: -17.03 MHz

[back to matrix](#)

This test report may be reproduced in full only. The document may only be updated by MiCOM Labs personnel. All changes will be noted in the Document History section of the report.



Title: Aruba Networks APEX0104
To: FCC CFR 47 Part 15 Subpart C 15.247 & IC RSS-247
Serial #: ARUB199-U3 Rev A
Issue Date: 27th August 2015
Page: 87 of 223

6 dB & 99% BANDWIDTH



Variant: 802.11n HT-20, Channel: 2412.00 MHz, Chain c, Temp: Ambient, Voltage: 48 Vdc

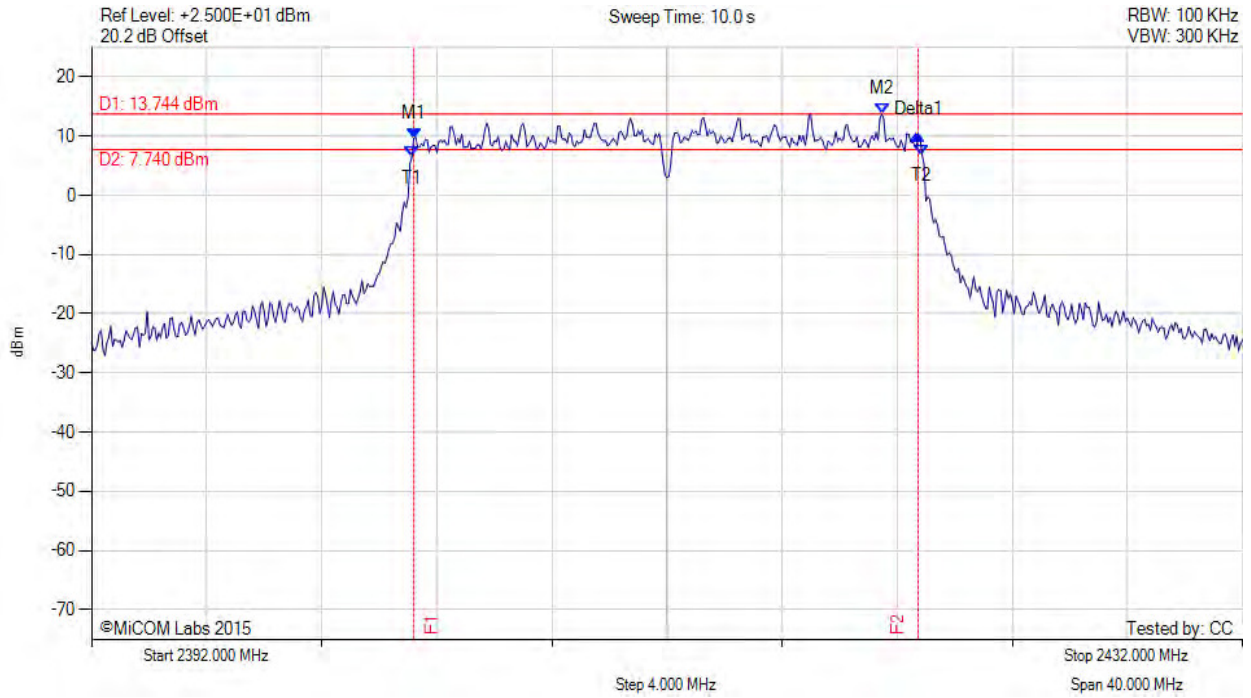

Analyser Setup	Marker:Frequency:Amplitude	Test Results
Detector = POS Sweep Count = 0 RF Atten (dB) = 20 Trace Mode = MAXH	M1 : 2403.200 MHz : 9.611 dBm M2 : 2419.470 MHz : 13.744 dBm Delta1 : 17.530 MHz : 0.575 dB T1 : 2403.133 MHz : 6.417 dBm T2 : 2420.867 MHz : 6.861 dBm OBW : 17.694 MHz	Measured 6 dB Bandwidth: 17.530 MHz Limit: ≥500.0 kHz Margin: -17.03 MHz

[back to matrix](#)

This test report may be reproduced in full only. The document may only be updated by MiCOM Labs personnel. All changes will be noted in the Document History section of the report.



Title: Aruba Networks APEX0104
To: FCC CFR 47 Part 15 Subpart C 15.247 & IC RSS-247
Serial #: ARUB199-U3 Rev A
Issue Date: 27th August 2015
Page: 88 of 223

6 dB & 99% BANDWIDTH



Variant: 802.11n HT-20, Channel: 2437.00 MHz, Chain a, Temp: Ambient, Voltage: 48 Vdc

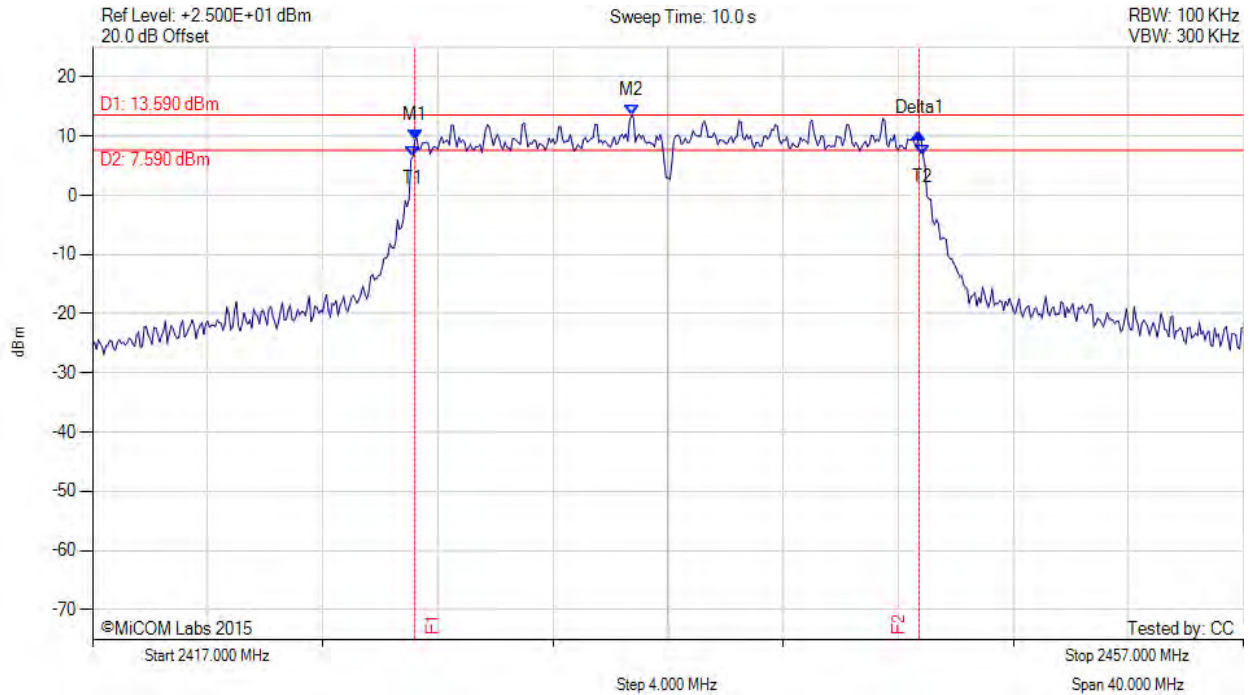

Analyser Setup	Marker:Frequency:Amplitude	Test Results
Detector = POS Sweep Count = 0 RF Atten (dB) = 20 Trace Mode = MAXH	M1 : 2428.200 MHz : 9.370 dBm M2 : 2435.730 MHz : 13.590 dBm Delta1 : 17.530 MHz : 1.090 dB T1 : 2428.133 MHz : 6.501 dBm T2 : 2445.867 MHz : 6.775 dBm OBW : 17.713 MHz	Measured 6 dB Bandwidth: 17.530 MHz Limit: ≥500.0 kHz Margin: -17.03 MHz

[back to matrix](#)

This test report may be reproduced in full only. The document may only be updated by MiCOM Labs personnel. All changes will be noted in the Document History section of the report.



Title: Aruba Networks APEX0104
To: FCC CFR 47 Part 15 Subpart C 15.247 & IC RSS-247
Serial #: ARUB199-U3 Rev A
Issue Date: 27th August 2015
Page: 89 of 223

6 dB & 99% BANDWIDTH



Variant: 802.11n HT-20, Channel: 2437.00 MHz, Chain b, Temp: Ambient, Voltage: 48 Vdc

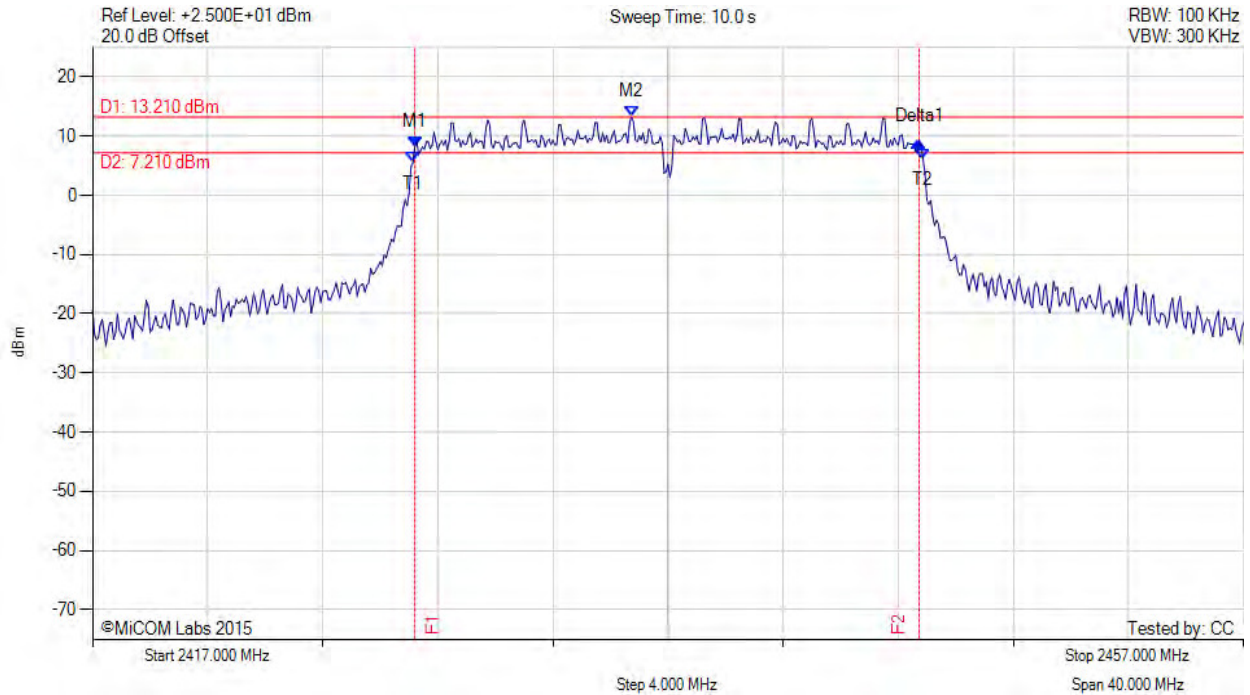

Analyser Setup	Marker:Frequency:Amplitude	Test Results
Detector = POS Sweep Count = 0 RF Atten (dB) = 20 Trace Mode = MAXH	M1 : 2428.200 MHz : 8.136 dBm M2 : 2435.730 MHz : 13.210 dBm Delta1 : 17.530 MHz : 0.961 dB T1 : 2428.133 MHz : 5.497 dBm T2 : 2445.867 MHz : 6.113 dBm OBW : 17.705 MHz	Measured 6 dB Bandwidth: 17.530 MHz Limit: ≥500.0 kHz Margin: -17.03 MHz

[back to matrix](#)

This test report may be reproduced in full only. The document may only be updated by MiCOM Labs personnel. All changes will be noted in the Document History section of the report.



Title: Aruba Networks APEX0104
To: FCC CFR 47 Part 15 Subpart C 15.247 & IC RSS-247
Serial #: ARUB199-U3 Rev A
Issue Date: 27th August 2015
Page: 90 of 223

6 dB & 99% BANDWIDTH



Variant: 802.11n HT-20, Channel: 2437.00 MHz, Chain c, Temp: Ambient, Voltage: 48 Vdc

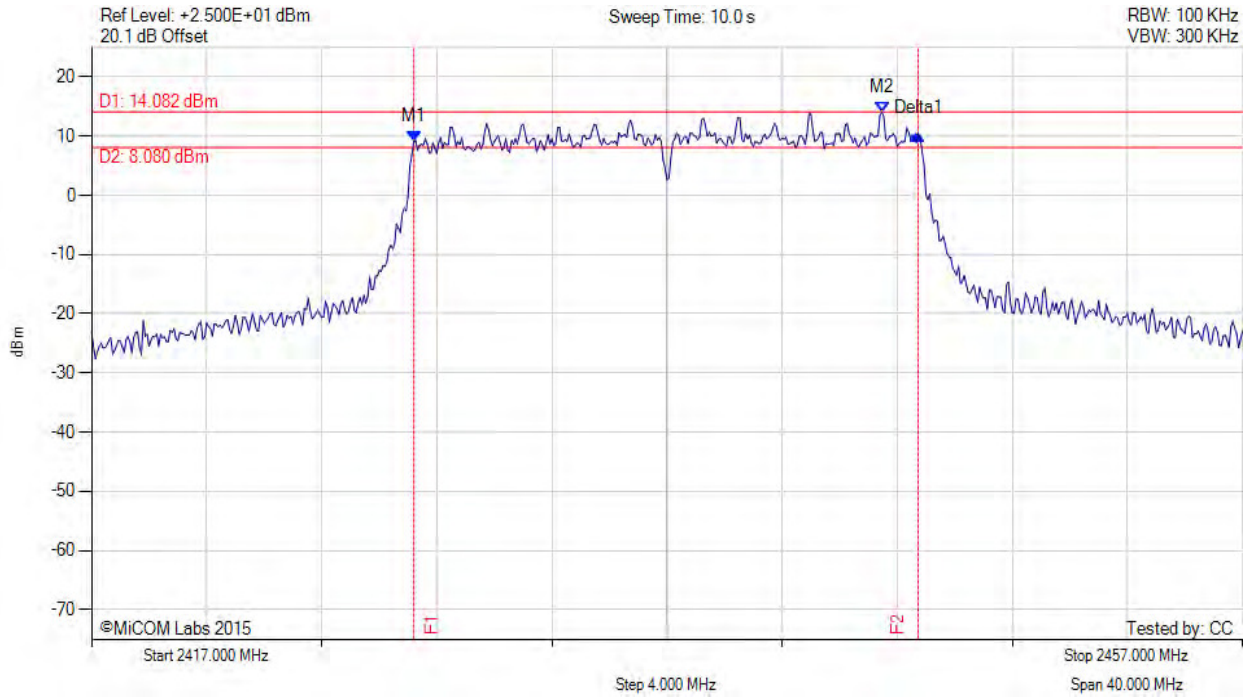

Analyser Setup	Marker:Frequency:Amplitude	Test Results
Detector = POS Sweep Count = 0 RF Atten (dB) = 20 Trace Mode = MAXH	M1 : 2428.200 MHz : 9.169 dBm M2 : 2444.470 MHz : 14.082 dBm Delta1 : 17.530 MHz : 1.185 dB T1 : 0 Hz : 0.000 dBm T2 : 0 Hz : 0.000 dBm OBW : 17.694 MHz	Measured 6 dB Bandwidth: 17.530 MHz Limit: ≥500.0 kHz Margin: -17.03 MHz

[back to matrix](#)

This test report may be reproduced in full only. The document may only be updated by MiCOM Labs personnel. All changes will be noted in the Document History section of the report.



6 dB & 99% BANDWIDTH



Variant: 802.11n HT-20, Channel: 2462.00 MHz, Chain a, Temp: Ambient, Voltage: 48 Vdc

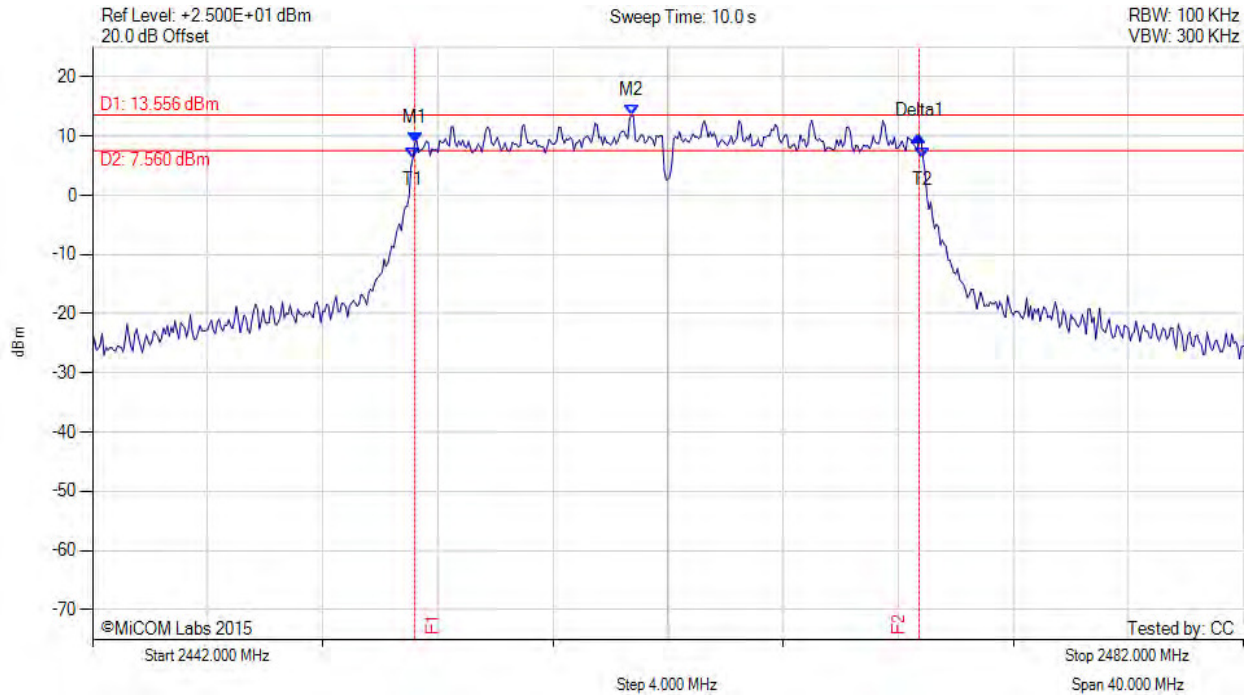

Analyser Setup	Marker:Frequency:Amplitude	Test Results
Detector = POS Sweep Count = 0 RF Atten (dB) = 20 Trace Mode = MAXH	M1 : 2453.200 MHz : 8.946 dBm M2 : 2460.730 MHz : 13.556 dBm Delta1 : 17.530 MHz : 1.095 dB T1 : 2453.133 MHz : 6.274 dBm T2 : 2470.867 MHz : 6.234 dBm OBW : 17.670 MHz	Measured 6 dB Bandwidth: 17.530 MHz Limit: ≥500.0 kHz Margin: -17.03 MHz

[back to matrix](#)

This test report may be reproduced in full only. The document may only be updated by MiCOM Labs personnel. All changes will be noted in the Document History section of the report.



Title: Aruba Networks APEX0104
To: FCC CFR 47 Part 15 Subpart C 15.247 & IC RSS-247
Serial #: ARUB199-U3 Rev A
Issue Date: 27th August 2015
Page: 92 of 223

6 dB & 99% BANDWIDTH



Variant: 802.11n HT-20, Channel: 2462.00 MHz, Chain b, Temp: Ambient, Voltage: 48 Vdc

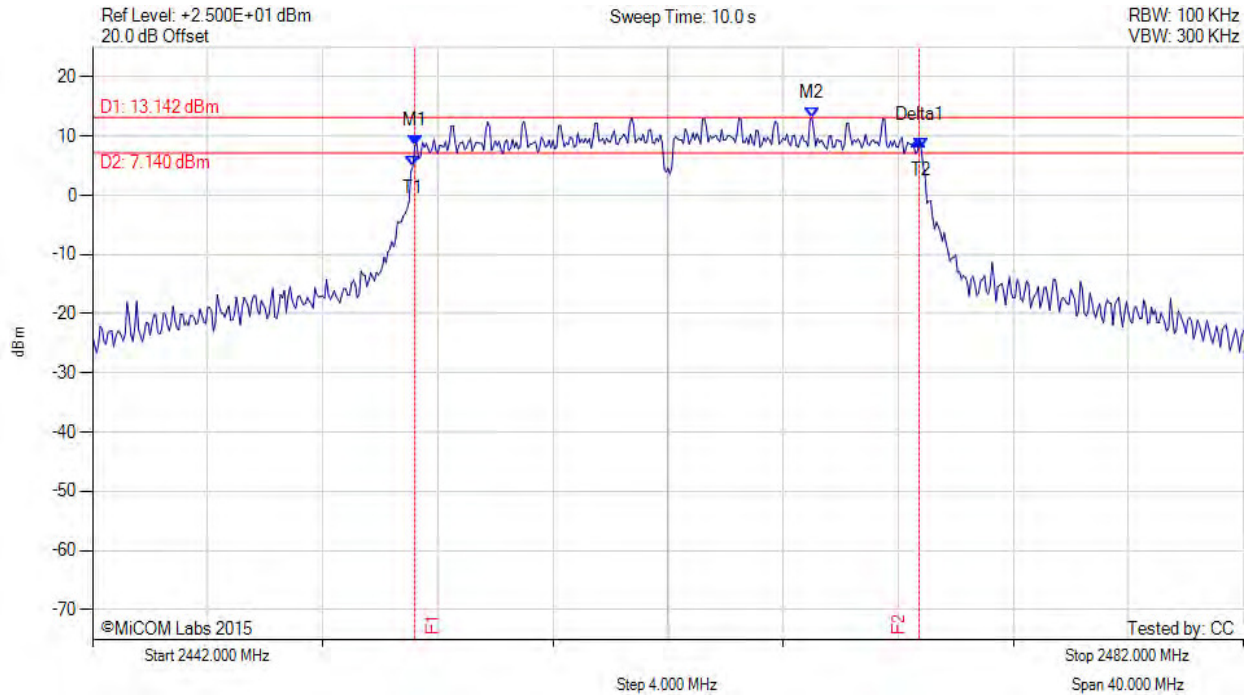

Analyser Setup	Marker:Frequency:Amplitude	Test Results
Detector = POS Sweep Count = 0 RF Atten (dB) = 20 Trace Mode = MAXH	M1 : 2453.200 MHz : 8.293 dBm M2 : 2467.000 MHz : 13.142 dBm Delta1 : 17.530 MHz : 0.977 dB T1 : 2453.133 MHz : 4.889 dBm T2 : 2470.800 MHz : 7.901 dBm OBW : 17.661 MHz	Measured 6 dB Bandwidth: 17.530 MHz Limit: ≥500.0 kHz Margin: -17.03 MHz

[back to matrix](#)

This test report may be reproduced in full only. The document may only be updated by MiCOM Labs personnel. All changes will be noted in the Document History section of the report.



Title: Aruba Networks APEX0104
To: FCC CFR 47 Part 15 Subpart C 15.247 & IC RSS-247
Serial #: ARUB199-U3 Rev A
Issue Date: 27th August 2015
Page: 93 of 223

6 dB & 99% BANDWIDTH



Variant: 802.11n HT-20, Channel: 2462.00 MHz, Chain c, Temp: Ambient, Voltage: 48 Vdc

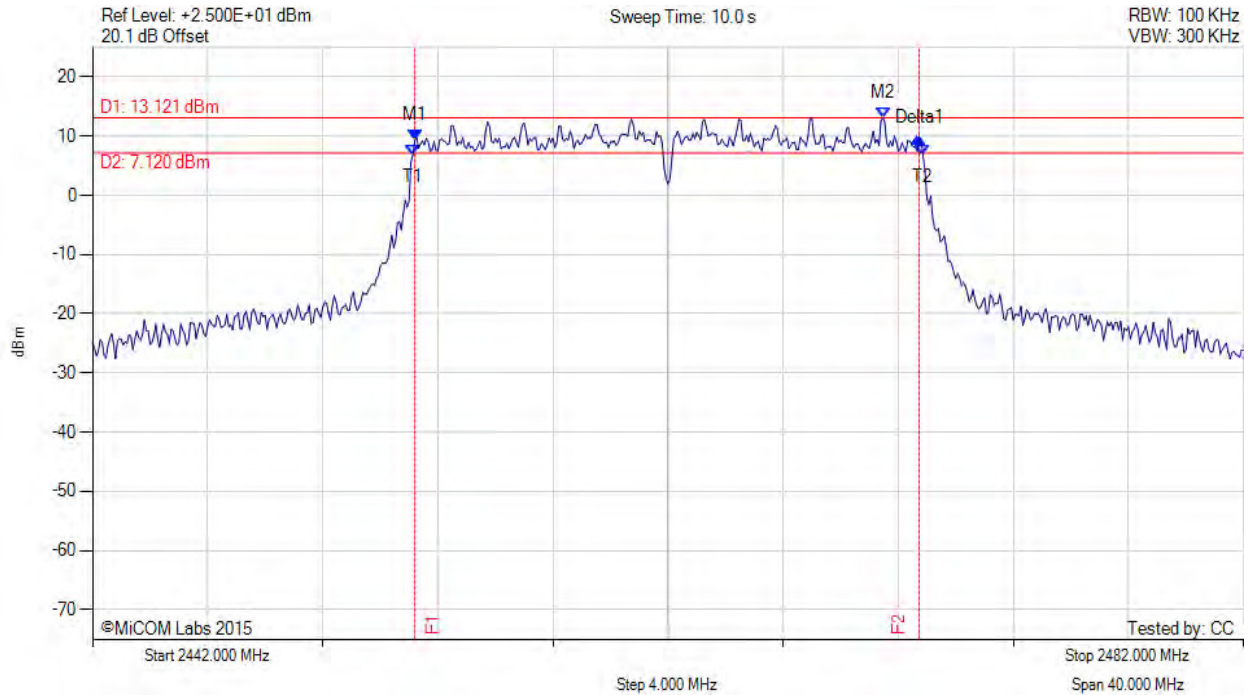

Analyser Setup	Marker:Frequency:Amplitude	Test Results
Detector = POS Sweep Count = 0 RF Atten (dB) = 20 Trace Mode = MAXH	M1 : 2453.200 MHz : 9.339 dBm M2 : 2469.470 MHz : 13.121 dBm Delta1 : 17.530 MHz : 0.368 dB T1 : 2453.133 MHz : 6.778 dBm T2 : 2470.867 MHz : 6.672 dBm OBW : 17.688 MHz	Measured 6 dB Bandwidth: 17.530 MHz Limit: ≥500.0 kHz Margin: -17.03 MHz

[back to matrix](#)

This test report may be reproduced in full only. The document may only be updated by MiCOM Labs personnel. All changes will be noted in the Document History section of the report.



Title: Aruba Networks APEX0104
To: FCC CFR 47 Part 15 Subpart C 15.247 & IC RSS-247
Serial #: ARUB199-U3 Rev A
Issue Date: 27th August 2015
Page: 94 of 223

6 dB & 99% BANDWIDTH



Variant: 802.11n HT-40, Channel: 2422.00 MHz, Chain a, Temp: Ambient, Voltage: 48 Vdc

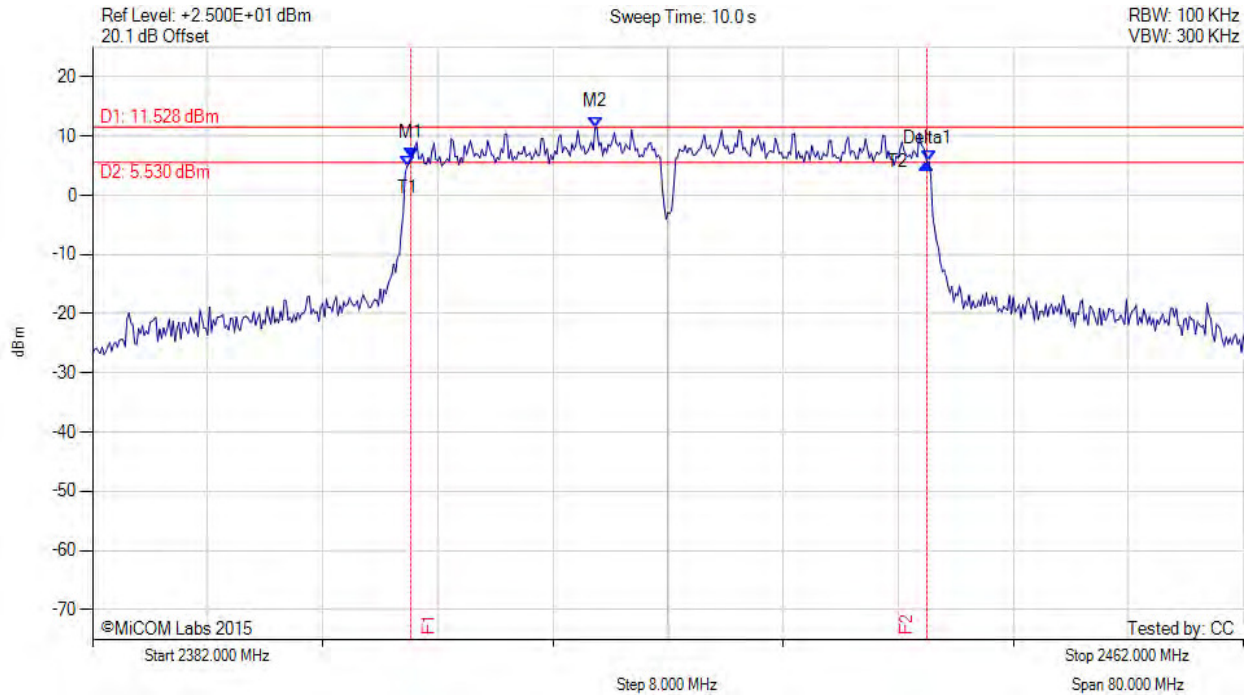

Analyser Setup	Marker:Frequency:Amplitude	Test Results
Detector = POS Sweep Count = 0 RF Atten (dB) = 20 Trace Mode = MAXH	M1 : 2404.130 MHz : 6.326 dBm M2 : 2416.930 MHz : 11.528 dBm Delta1 : 35.870 MHz : -1.016 dB T1 : 2403.867 MHz : 4.873 dBm T2 : 2440.133 MHz : 5.739 dBm OBW : 36.107 MHz	Measured 6 dB Bandwidth: 35.870 MHz Limit: ≥500.0 kHz Margin: -35.37 MHz

[back to matrix](#)

This test report may be reproduced in full only. The document may only be updated by MiCOM Labs personnel. All changes will be noted in the Document History section of the report.



Title: Aruba Networks APEX0104
To: FCC CFR 47 Part 15 Subpart C 15.247 & IC RSS-247
Serial #: ARUB199-U3 Rev A
Issue Date: 27th August 2015
Page: 95 of 223

6 dB & 99% BANDWIDTH



Variant: 802.11n HT-40, Channel: 2422.00 MHz, Chain b, Temp: Ambient, Voltage: 48 Vdc

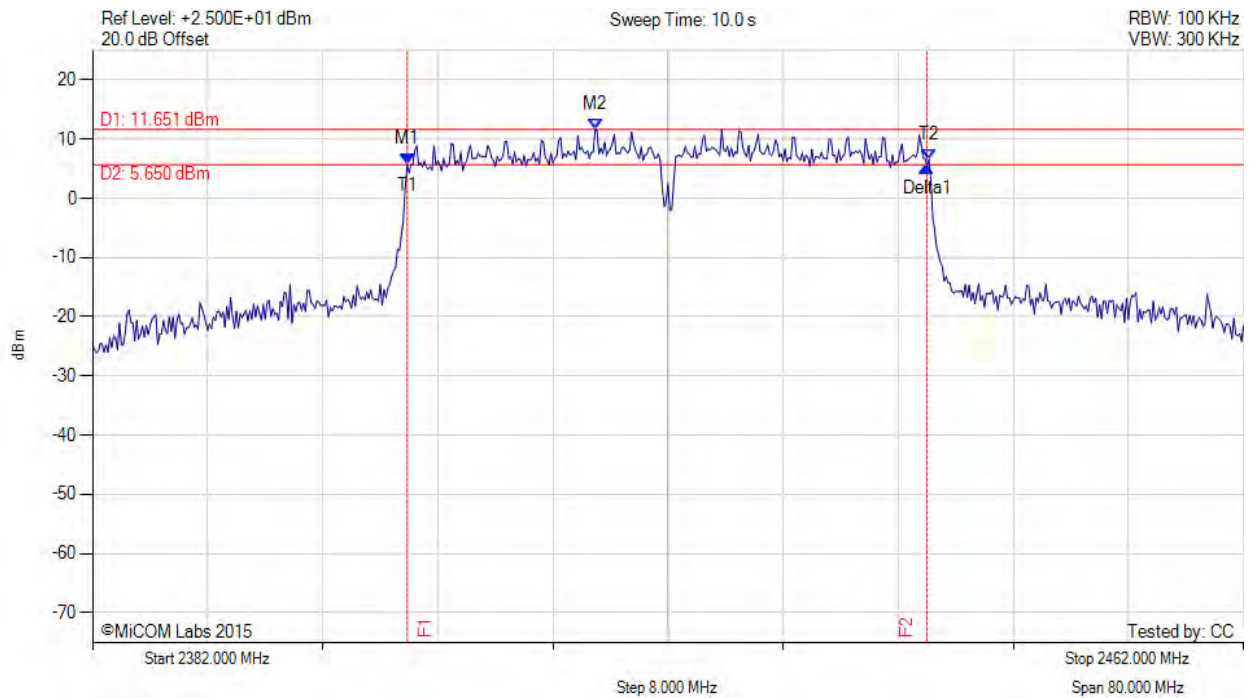

Analyser Setup	Marker:Frequency:Amplitude	Test Results
Detector = POS Sweep Count = 0 RF Atten (dB) = 20 Trace Mode = MAXH	M1 : 2403.870 MHz : 5.743 dBm M2 : 2416.930 MHz : 11.651 dBm Delta1 : 36.130 MHz : -0.402 dB T1 : 2403.867 MHz : 5.743 dBm T2 : 2440.133 MHz : 6.549 dBm OBW : 36.157 MHz	Measured 6 dB Bandwidth: 36.130 MHz Limit: ≥500.0 kHz Margin: -35.63 MHz

[back to matrix](#)

This test report may be reproduced in full only. The document may only be updated by MiCOM Labs personnel. All changes will be noted in the Document History section of the report.



Title: Aruba Networks APEX0104
To: FCC CFR 47 Part 15 Subpart C 15.247 & IC RSS-247
Serial #: ARUB199-U3 Rev A
Issue Date: 27th August 2015
Page: 96 of 223

6 dB & 99% BANDWIDTH



Variant: 802.11n HT-40, Channel: 2422.00 MHz, Chain c, Temp: Ambient, Voltage: 48 Vdc

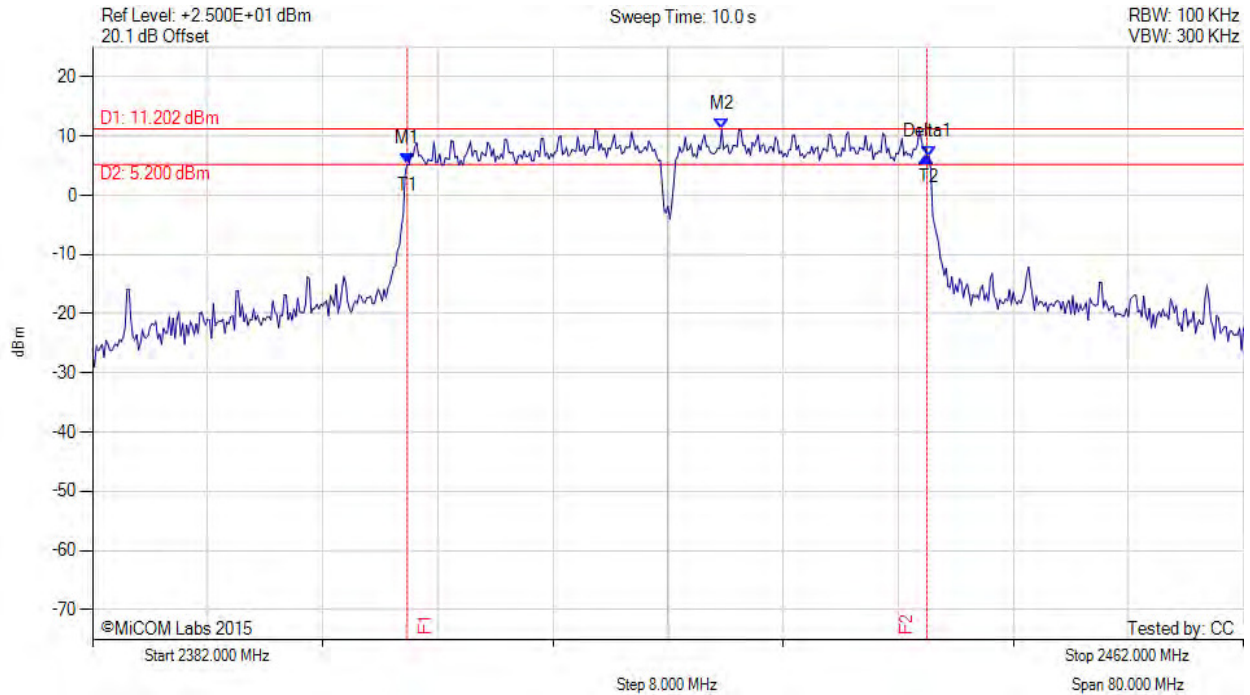

Analyser Setup	Marker:Frequency:Amplitude	Test Results
Detector = POS Sweep Count = 0 RF Atten (dB) = 20 Trace Mode = MAXH	M1 : 2403.870 MHz : 5.264 dBm M2 : 2425.730 MHz : 11.202 dBm Delta1 : 36.130 MHz : 1.183 dB T1 : 2403.867 MHz : 5.264 dBm T2 : 2440.133 MHz : 6.565 dBm OBW : 36.176 MHz	Measured 6 dB Bandwidth: 36.130 MHz Limit: ≥500.0 kHz Margin: -35.63 MHz

[back to matrix](#)

This test report may be reproduced in full only. The document may only be updated by MiCOM Labs personnel. All changes will be noted in the Document History section of the report.



Title: Aruba Networks APEX0104
To: FCC CFR 47 Part 15 Subpart C 15.247 & IC RSS-247
Serial #: ARUB199-U3 Rev A
Issue Date: 27th August 2015
Page: 97 of 223

6 dB & 99% BANDWIDTH



Variant: 802.11n HT-40, Channel: 2437.00 MHz, Chain a, Temp: Ambient, Voltage: 48 Vdc

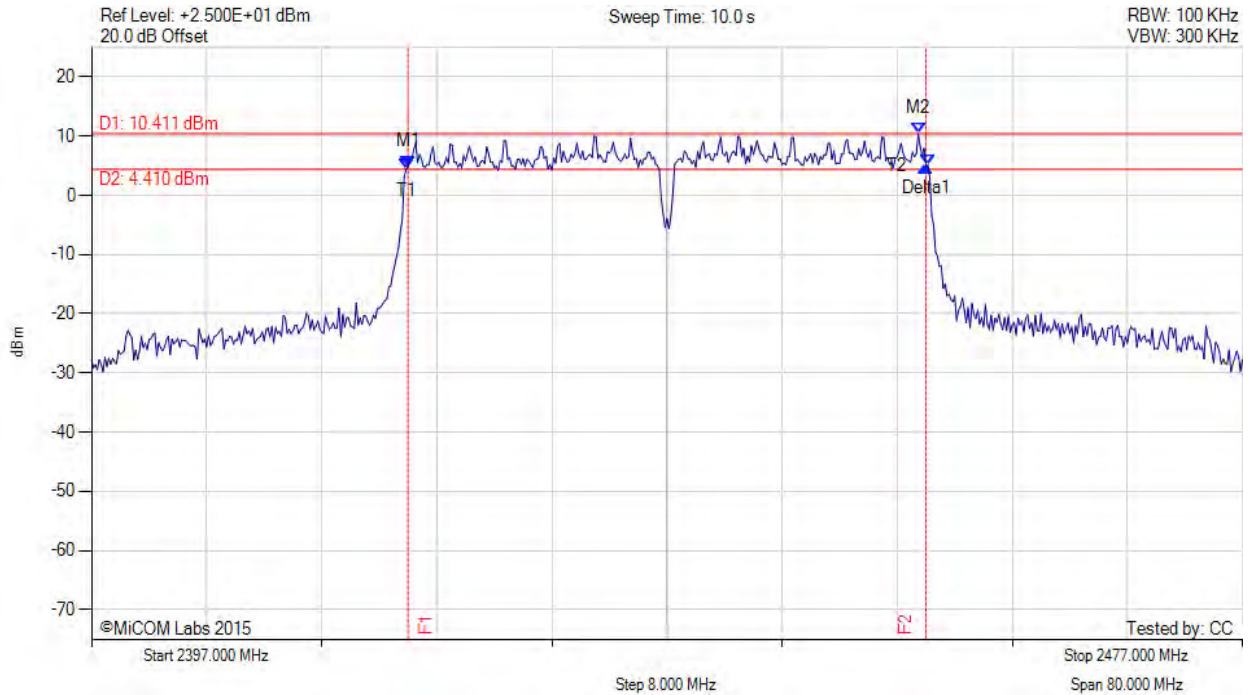

Analyser Setup	Marker:Frequency:Amplitude	Test Results
Detector = POS Sweep Count = 0 RF Atten (dB) = 20 Trace Mode = MAXH	M1 : 2419.000 MHz : 4.870 dBm M2 : 2454.470 MHz : 10.411 dBm Delta1 : 36.000 MHz : -0.056 dB T1 : 2418.867 MHz : 4.312 dBm T2 : 2455.133 MHz : 5.077 dBm OBW : 36.123 MHz	Measured 6 dB Bandwidth: 36.000 MHz Limit: ≥500.0 kHz Margin: -35.50 MHz

[back to matrix](#)

This test report may be reproduced in full only. The document may only be updated by MiCOM Labs personnel. All changes will be noted in the Document History section of the report.



Title: Aruba Networks APEX0104
To: FCC CFR 47 Part 15 Subpart C 15.247 & IC RSS-247
Serial #: ARUB199-U3 Rev A
Issue Date: 27th August 2015
Page: 98 of 223

6 dB & 99% BANDWIDTH



Variant: 802.11n HT-40, Channel: 2437.00 MHz, Chain b, Temp: Ambient, Voltage: 48 Vdc

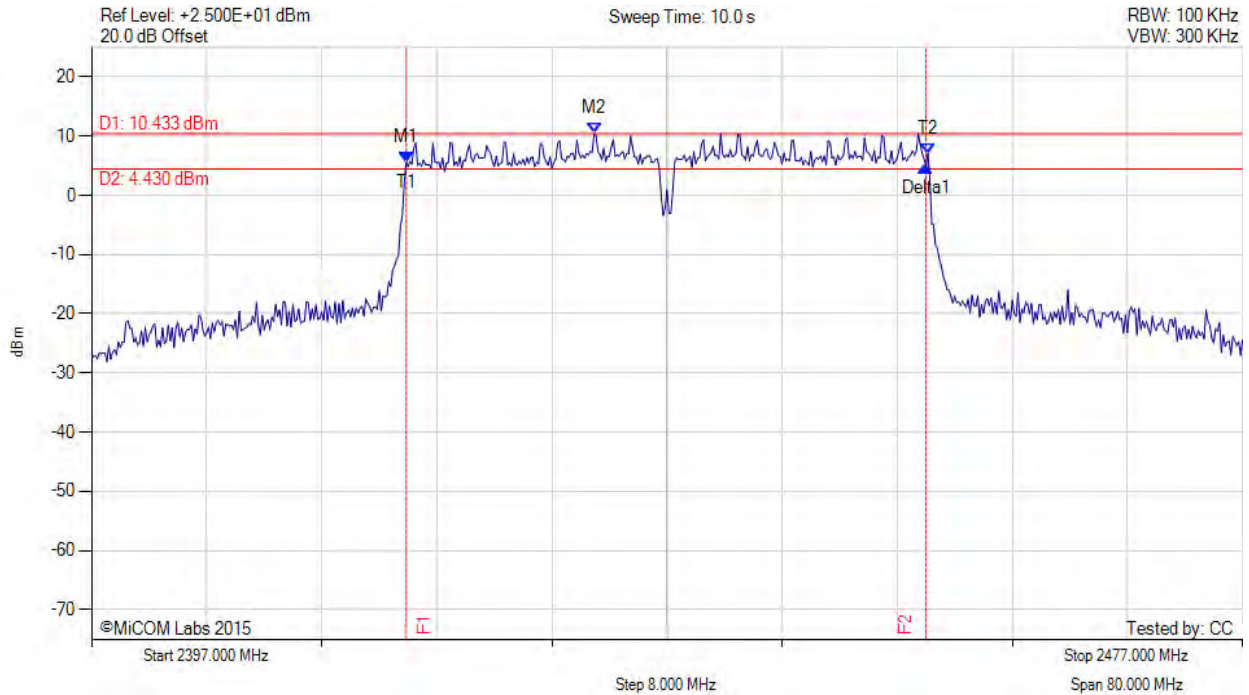

Analyser Setup	Marker:Frequency:Amplitude	Test Results
Detector = POS Sweep Count = 0 RF Atten (dB) = 20 Trace Mode = MAXH	M1 : 2418.870 MHz : 5.617 dBm M2 : 2431.930 MHz : 10.433 dBm Delta1 : 36.130 MHz : -0.748 dB T1 : 2418.867 MHz : 5.617 dBm T2 : 2455.133 MHz : 7.078 dBm OBW : 36.190 MHz	Measured 6 dB Bandwidth: 36.130 MHz Limit: ≥500.0 kHz Margin: -35.63 MHz

[back to matrix](#)

This test report may be reproduced in full only. The document may only be updated by MiCOM Labs personnel. All changes will be noted in the Document History section of the report.



Title: Aruba Networks APEX0104
To: FCC CFR 47 Part 15 Subpart C 15.247 & IC RSS-247
Serial #: ARUB199-U3 Rev A
Issue Date: 27th August 2015
Page: 99 of 223

6 dB & 99% BANDWIDTH



Variant: 802.11n HT-40, Channel: 2437.00 MHz, Chain c, Temp: Ambient, Voltage: 48 Vdc

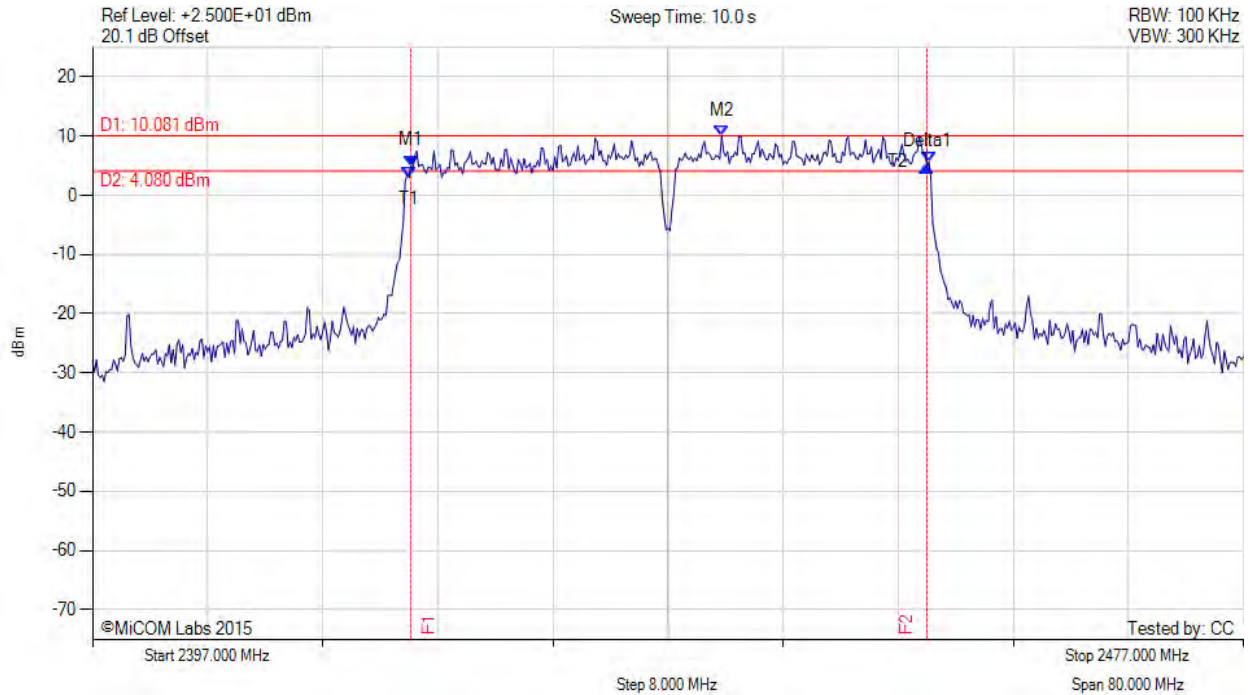

Analyser Setup	Marker:Frequency:Amplitude	Test Results
Detector = POS Sweep Count = 0 RF Atten (dB) = 20 Trace Mode = MAXH	M1 : 2419.130 MHz : 4.977 dBm M2 : 2440.730 MHz : 10.081 dBm Delta1 : 35.870 MHz : -0.180 dB T1 : 2419.000 MHz : 3.038 dBm T2 : 2455.133 MHz : 5.625 dBm OBW : 36.081 MHz	Measured 6 dB Bandwidth: 35.870 MHz Limit: ≥500.0 kHz Margin: -35.37 MHz

[back to matrix](#)

This test report may be reproduced in full only. The document may only be updated by MiCOM Labs personnel. All changes will be noted in the Document History section of the report.



Title: Aruba Networks APEX0104
To: FCC CFR 47 Part 15 Subpart C 15.247 & IC RSS-247
Serial #: ARUB199-U3 Rev A
Issue Date: 27th August 2015
Page: 100 of 223

6 dB & 99% BANDWIDTH



Variant: 802.11n HT-40, Channel: 2452.00 MHz, Chain a, Temp: Ambient, Voltage: 48 Vdc

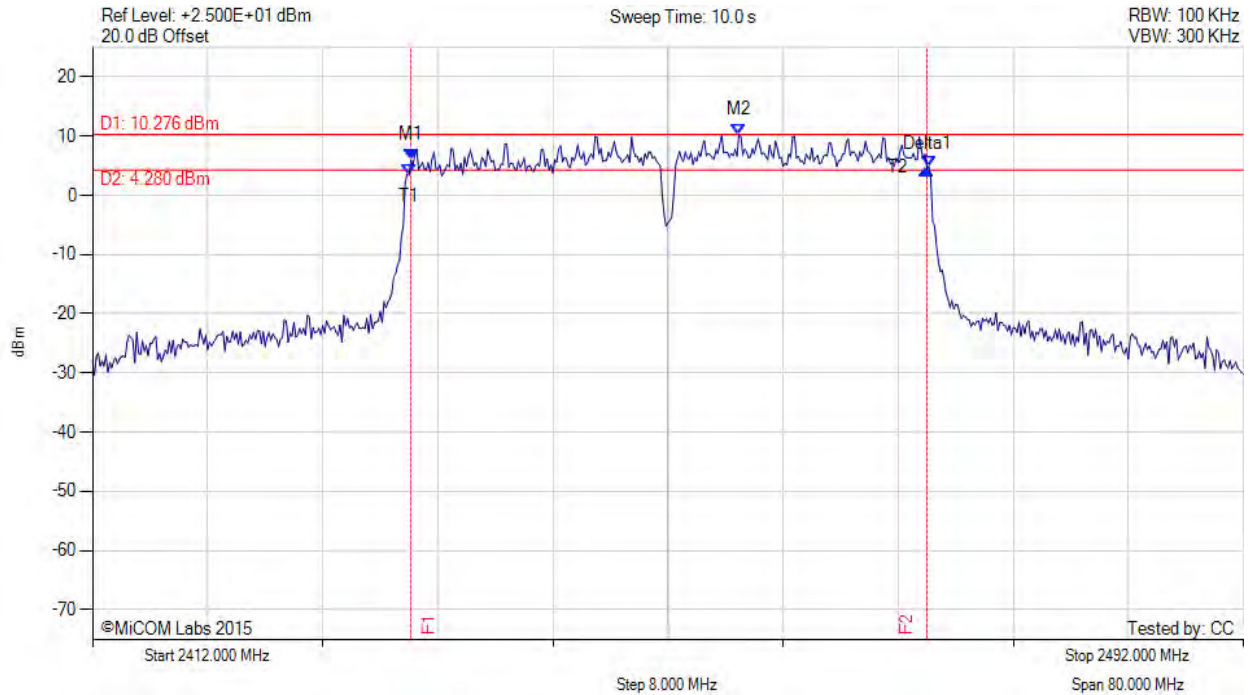

Analyser Setup	Marker:Frequency:Amplitude	Test Results
Detector = POS Sweep Count = 0 RF Atten (dB) = 20 Trace Mode = MAXH	M1 : 2434.130 MHz : 5.949 dBm M2 : 2456.930 MHz : 10.276 dBm Delta1 : 35.870 MHz : -1.527 dB T1 : 2434.000 MHz : 3.404 dBm T2 : 2470.133 MHz : 4.907 dBm OBW : 36.045 MHz	Measured 6 dB Bandwidth: 35.870 MHz Limit: ≥500.0 kHz Margin: -35.37 MHz

[back to matrix](#)

This test report may be reproduced in full only. The document may only be updated by MiCOM Labs personnel. All changes will be noted in the Document History section of the report.



Title: Aruba Networks APEX0104
To: FCC CFR 47 Part 15 Subpart C 15.247 & IC RSS-247
Serial #: ARUB199-U3 Rev A
Issue Date: 27th August 2015
Page: 101 of 223

6 dB & 99% BANDWIDTH



Variant: 802.11n HT-40, Channel: 2452.00 MHz, Chain b, Temp: Ambient, Voltage: 48 Vdc

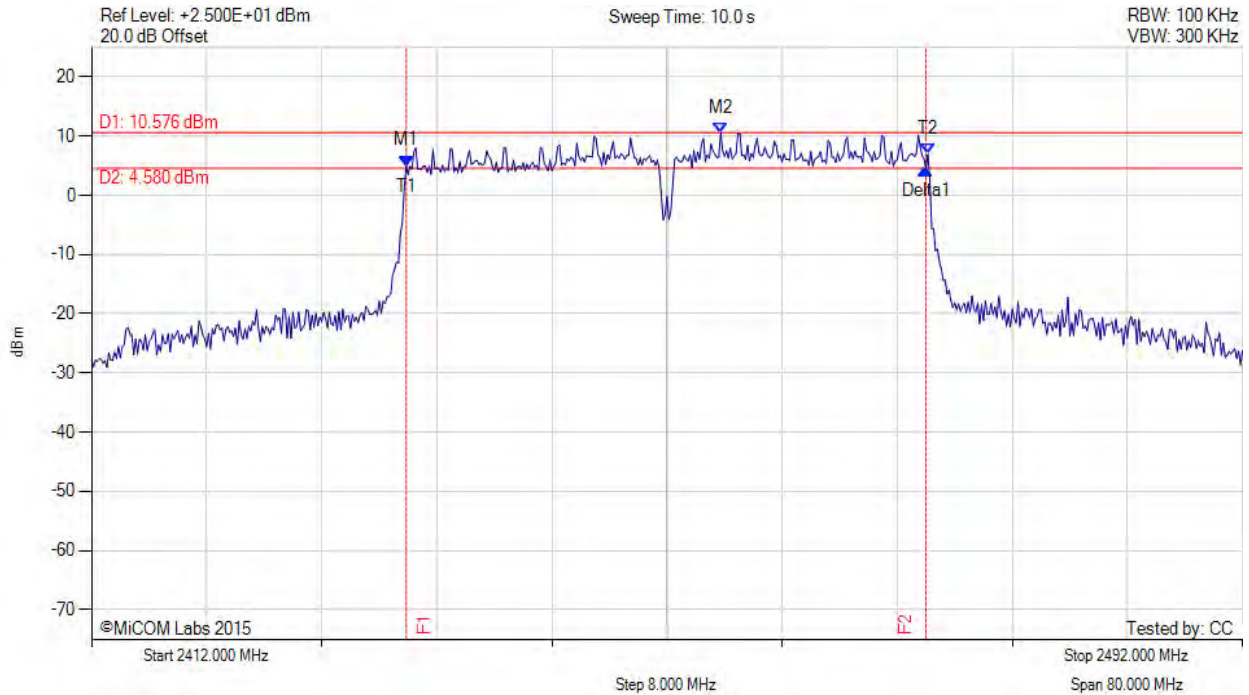

Analyser Setup	Marker:Frequency:Amplitude	Test Results
Detector = POS Sweep Count = 0 RF Atten (dB) = 20 Trace Mode = MAXH	M1 : 2433.870 MHz : 4.997 dBm M2 : 2455.730 MHz : 10.576 dBm Delta1 : 36.130 MHz : -0.604 dB T1 : 2433.867 MHz : 4.997 dBm T2 : 2470.133 MHz : 6.943 dBm OBW : 36.151 MHz	Measured 6 dB Bandwidth: 36.130 MHz Limit: ≥500.0 kHz Margin: -35.63 MHz

[back to matrix](#)

This test report may be reproduced in full only. The document may only be updated by MiCOM Labs personnel. All changes will be noted in the Document History section of the report.



Title: Aruba Networks APEX0104
To: FCC CFR 47 Part 15 Subpart C 15.247 & IC RSS-247
Serial #: ARUB199-U3 Rev A
Issue Date: 27th August 2015
Page: 102 of 223

6 dB & 99% BANDWIDTH



Variant: 802.11n HT-40, Channel: 2452.00 MHz, Chain c, Temp: Ambient, Voltage: 48 Vdc

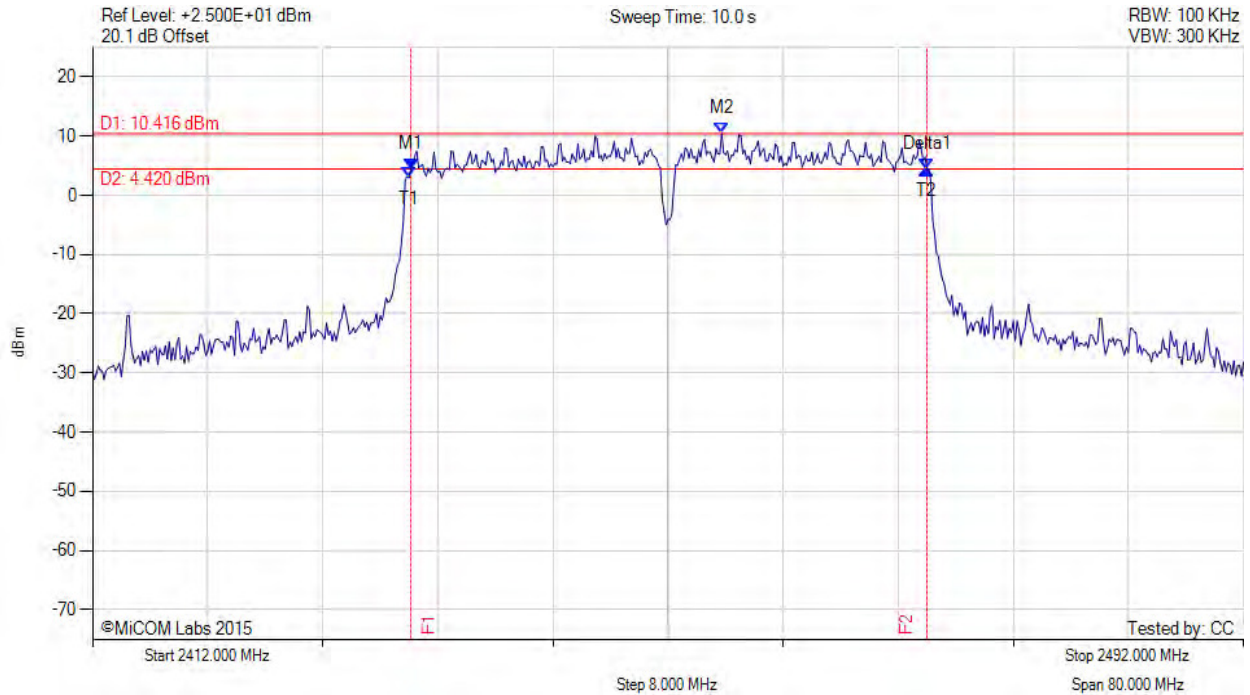

Analyser Setup	Marker:Frequency:Amplitude	Test Results
Detector = POS Sweep Count = 0 RF Atten (dB) = 20 Trace Mode = MAXH	M1 : 2434.130 MHz : 4.504 dBm M2 : 2455.730 MHz : 10.416 dBm Delta1 : 35.870 MHz : -0.144 dB T1 : 2434.000 MHz : 2.991 dBm T2 : 2470.000 MHz : 4.360 dBm OBW : 36.026 MHz	Measured 6 dB Bandwidth: 35.870 MHz Limit: ≥500.0 kHz Margin: -35.37 MHz

[back to matrix](#)

This test report may be reproduced in full only. The document may only be updated by MiCOM Labs personnel. All changes will be noted in the Document History section of the report.



Title: Aruba Networks APEX0104
To: FCC CFR 47 Part 15 Subpart C 15.247 & IC RSS-247
Serial #: ARUB199-U3 Rev A
Issue Date: 27th August 2015
Page: 103 of 223

A.2. Conducted Emissions

A.2.1. Conducted Spurious Emissions

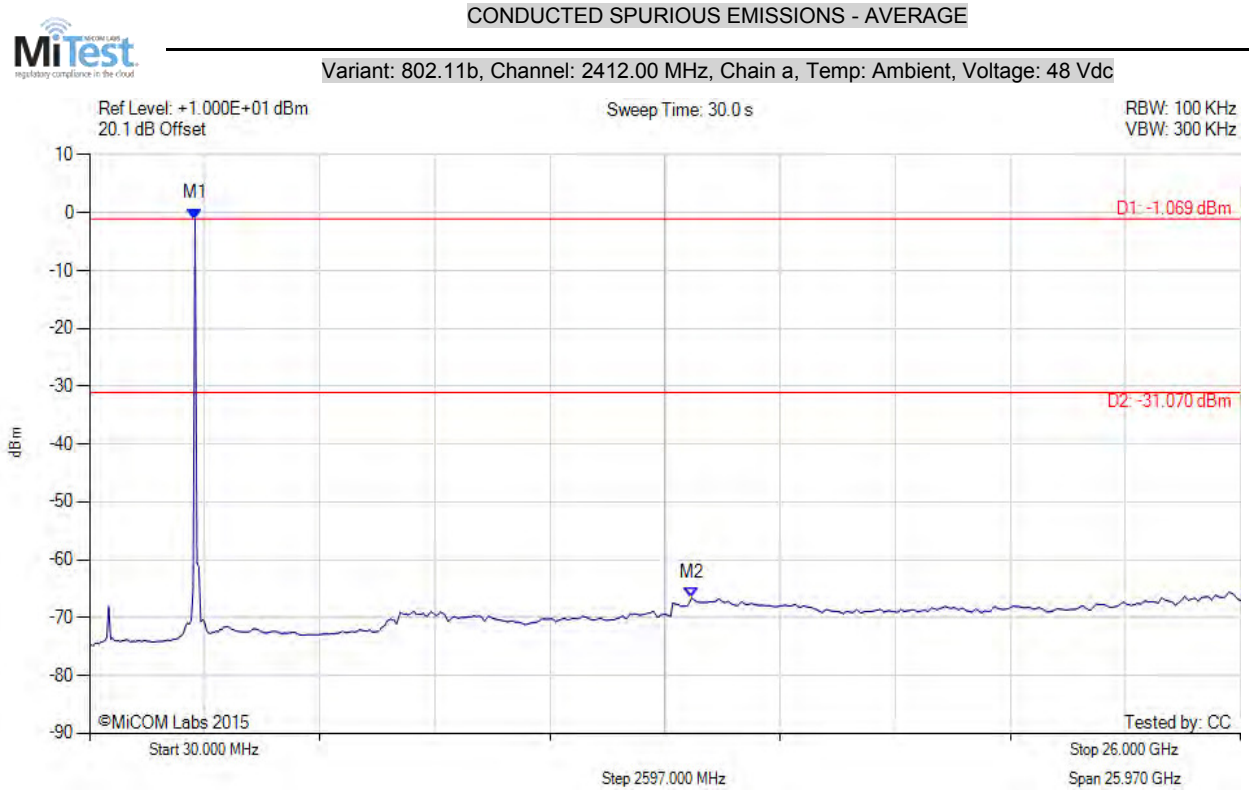

Analyser Setup	Marker:Frequency:Amplitude	Test Results
Detector = AVER Sweep Count = 0 RF Atten (dB) = 10 Trace Mode = VIEW	M1 : 2410.000 MHz : -1.069 dBm M2 : 13.620 GHz : -66.603 dBm	Limit: -31.07 dBm Margin: -35.53 dB

[back to matrix](#)

This test report may be reproduced in full only. The document may only be updated by MiCOM Labs personnel. All changes will be noted in the Document History section of the report.



Title: Aruba Networks APEX0104
To: FCC CFR 47 Part 15 Subpart C 15.247 & IC RSS-247
Serial #: ARUB199-U3 Rev A
Issue Date: 27th August 2015
Page: 104 of 223

CONDUCTED SPURIOUS EMISSIONS - AVERAGE



Variant: 802.11b, Channel: 2412.00 MHz, Chain b, Temp: Ambient, Voltage: 48 Vdc

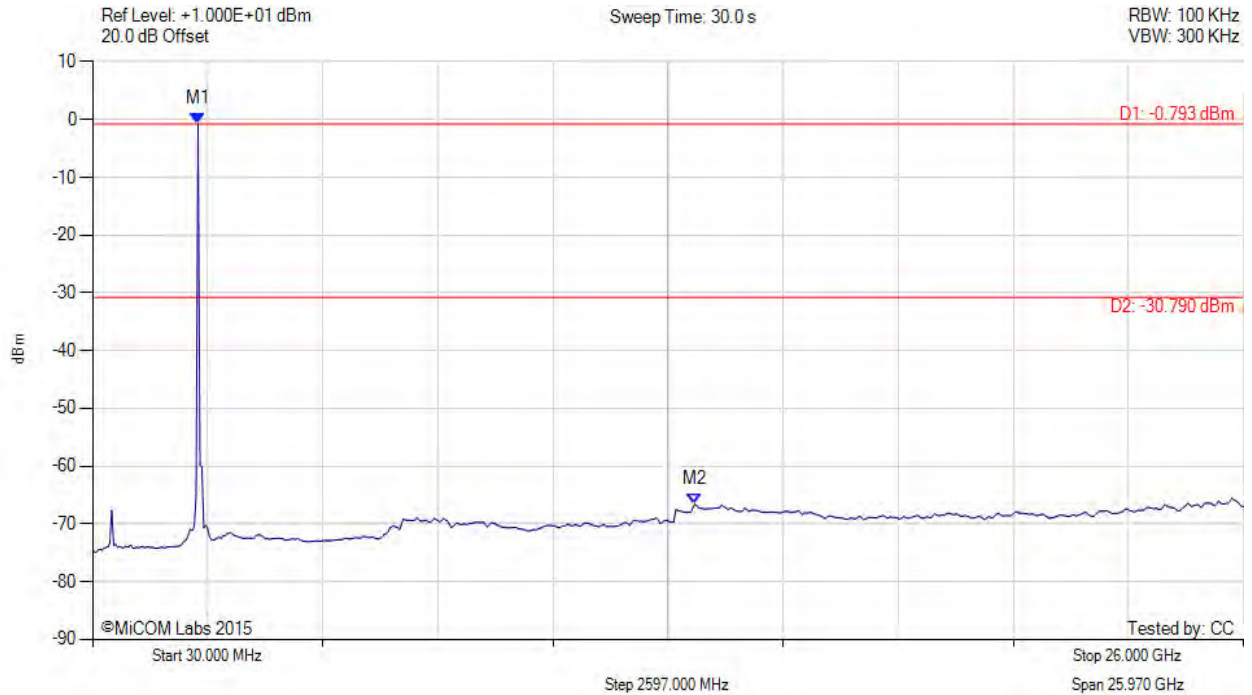

Analyser Setup	Marker:Frequency:Amplitude	Test Results
Detector = AVER Sweep Count = 0 RF Atten (dB) = 10 Trace Mode = VIEW	M1 : 2410.000 MHz : -0.793 dBm M2 : 13.620 GHz : -66.613 dBm	Limit: -30.79 dBm Margin: -35.82 dB

[back to matrix](#)

This test report may be reproduced in full only. The document may only be updated by MiCOM Labs personnel. All changes will be noted in the Document History section of the report.



Title: Aruba Networks APEX0104
To: FCC CFR 47 Part 15 Subpart C 15.247 & IC RSS-247
Serial #: ARUB199-U3 Rev A
Issue Date: 27th August 2015
Page: 105 of 223

CONDUCTED SPURIOUS EMISSIONS - AVERAGE



Variant: 802.11b, Channel: 2412.00 MHz, Chain c, Temp: Ambient, Voltage: 48 Vdc

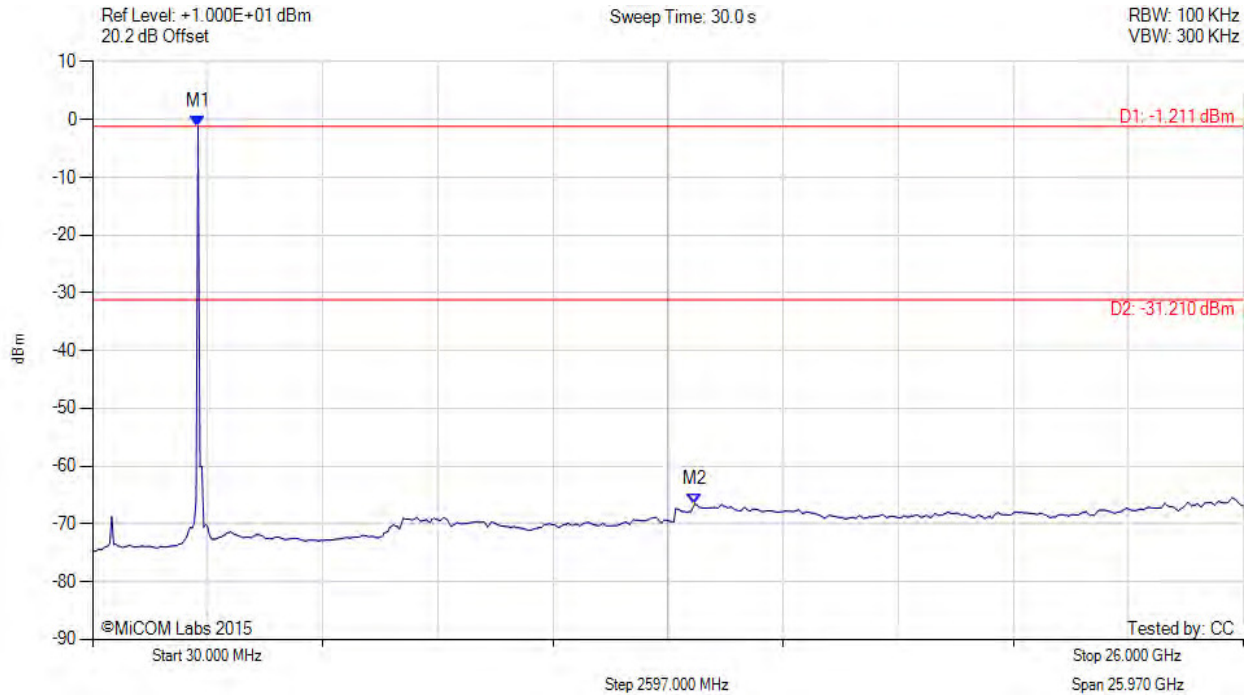

Analyser Setup	Marker:Frequency:Amplitude	Test Results
Detector = AVER Sweep Count = 0 RF Atten (dB) = 10 Trace Mode = VIEW	M1 : 2410.000 MHz : -1.211 dBm M2 : 13.620 GHz : -66.586 dBm	Limit: -31.21 dBm Margin: -35.38 dB

[back to matrix](#)

This test report may be reproduced in full only. The document may only be updated by MiCOM Labs personnel. All changes will be noted in the Document History section of the report.



Title: Aruba Networks APEX0104
To: FCC CFR 47 Part 15 Subpart C 15.247 & IC RSS-247
Serial #: ARUB199-U3 Rev A
Issue Date: 27th August 2015
Page: 106 of 223

CONDUCTED SPURIOUS EMISSIONS - AVERAGE



Variant: 802.11b, Channel: 2437.00 MHz, Chain a, Temp: Ambient, Voltage: 48 Vdc

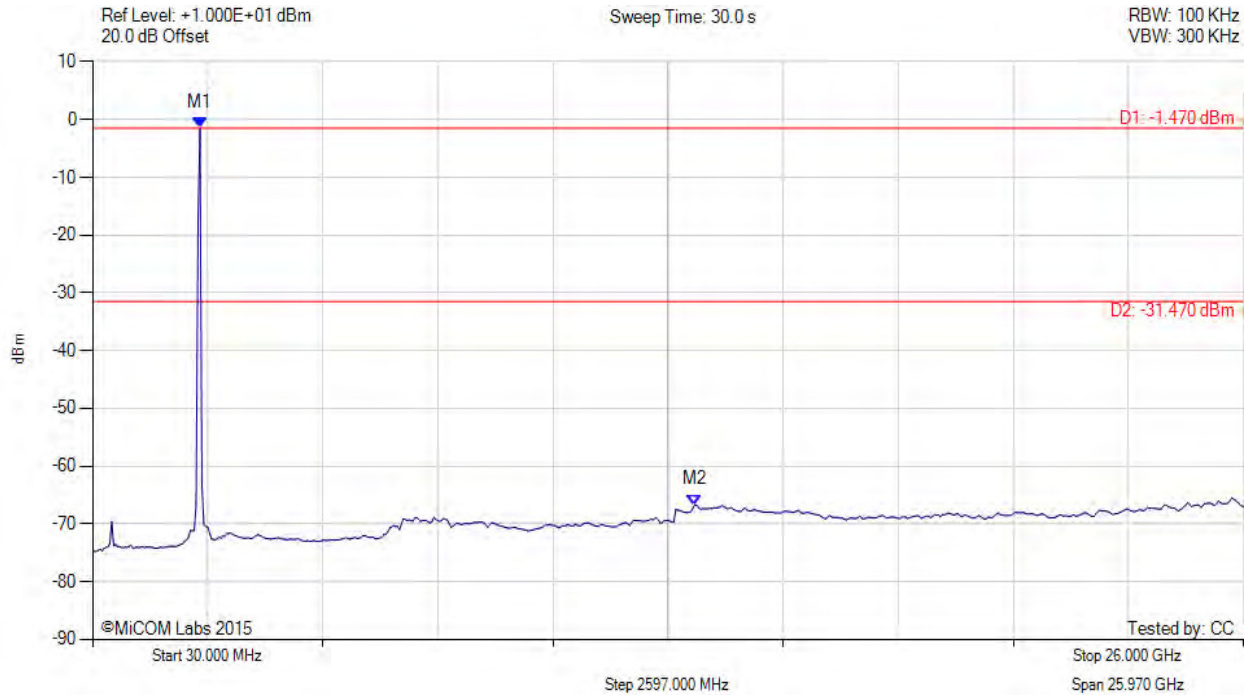

Analyser Setup	Marker:Frequency:Amplitude	Test Results
Detector = AVER Sweep Count = 0 RF Atten (dB) = 10 Trace Mode = VIEW	M1 : 2450.000 MHz : -1.470 dBm M2 : 13.620 GHz : -66.695 dBm	Limit: -31.47 dBm Margin: -35.22 dB

[back to matrix](#)

This test report may be reproduced in full only. The document may only be updated by MiCOM Labs personnel. All changes will be noted in the Document History section of the report.



Title: Aruba Networks APEX0104
To: FCC CFR 47 Part 15 Subpart C 15.247 & IC RSS-247
Serial #: ARUB199-U3 Rev A
Issue Date: 27th August 2015
Page: 107 of 223

CONDUCTED SPURIOUS EMISSIONS - AVERAGE



Variant: 802.11b, Channel: 2437.00 MHz, Chain b, Temp: Ambient, Voltage: 48 Vdc

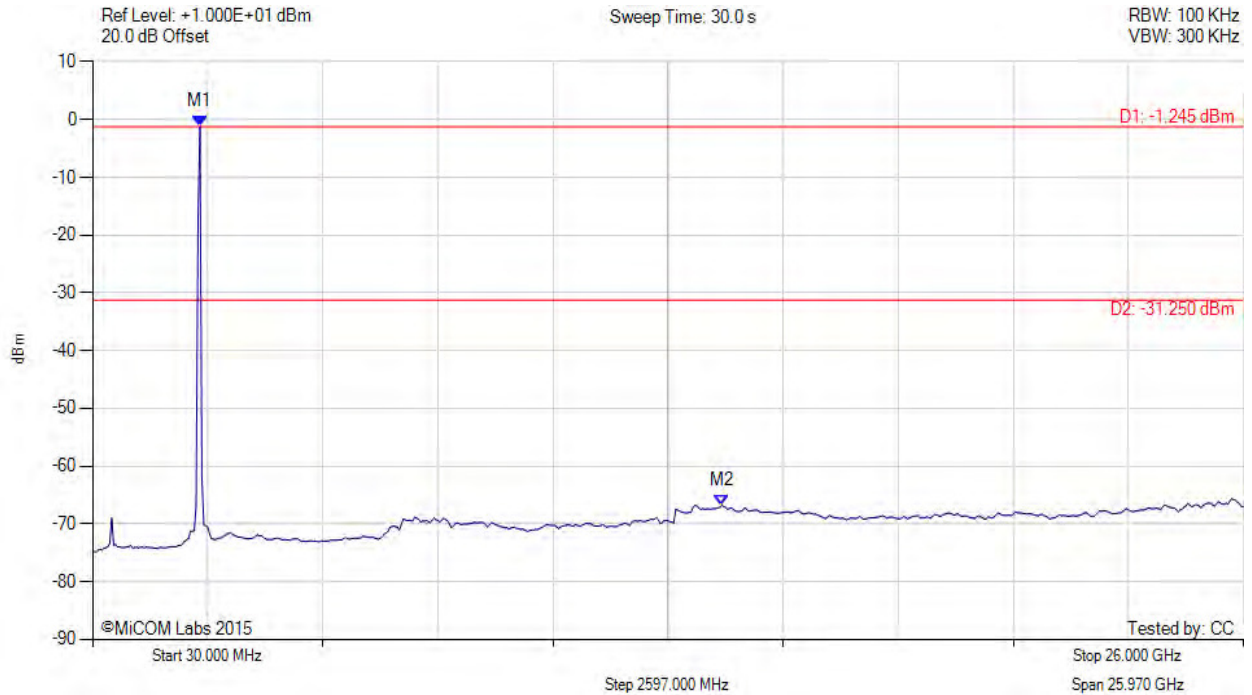

Analyser Setup	Marker:Frequency:Amplitude	Test Results
Detector = AVER Sweep Count = 0 RF Atten (dB) = 10 Trace Mode = VIEW	M1 : 2450.000 MHz : -1.245 dBm M2 : 14.230 GHz : -66.779 dBm	Limit: -31.25 dBm Margin: -35.53 dB

[back to matrix](#)

This test report may be reproduced in full only. The document may only be updated by MiCOM Labs personnel. All changes will be noted in the Document History section of the report.



Title: Aruba Networks APEX0104
To: FCC CFR 47 Part 15 Subpart C 15.247 & IC RSS-247
Serial #: ARUB199-U3 Rev A
Issue Date: 27th August 2015
Page: 108 of 223

CONDUCTED SPURIOUS EMISSIONS - AVERAGE



Variant: 802.11b, Channel: 2437.00 MHz, Chain c, Temp: Ambient, Voltage: 48 Vdc

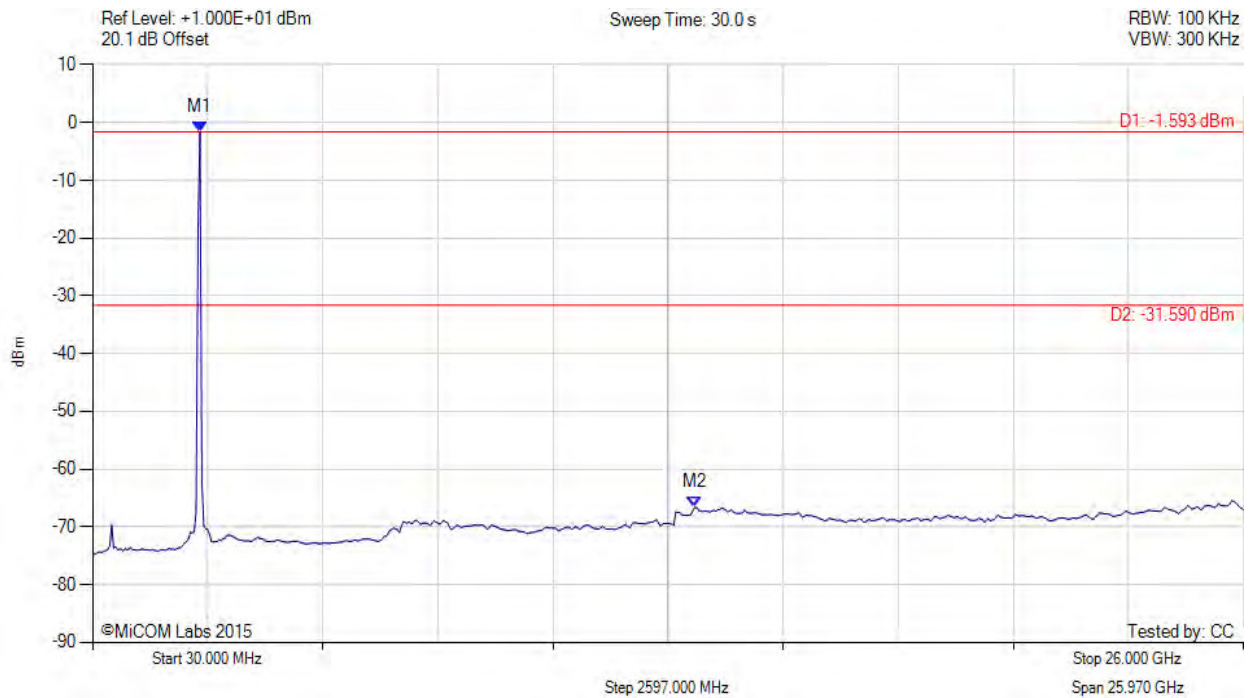

Analyser Setup	Marker:Frequency:Amplitude	Test Results
Detector = AVER Sweep Count = 0 RF Atten (dB) = 10 Trace Mode = VIEW	M1 : 2450.000 MHz : -1.593 dBm M2 : 13.620 GHz : -66.625 dBm	Limit: -31.59 dBm Margin: -35.03 dB

[back to matrix](#)

This test report may be reproduced in full only. The document may only be updated by MiCOM Labs personnel. All changes will be noted in the Document History section of the report.



Title: Aruba Networks APEX0104
To: FCC CFR 47 Part 15 Subpart C 15.247 & IC RSS-247
Serial #: ARUB199-U3 Rev A
Issue Date: 27th August 2015
Page: 109 of 223

CONDUCTED SPURIOUS EMISSIONS - AVERAGE



Variant: 802.11b, Channel: 2462.00 MHz, Chain a, Temp: Ambient, Voltage: 48 Vdc

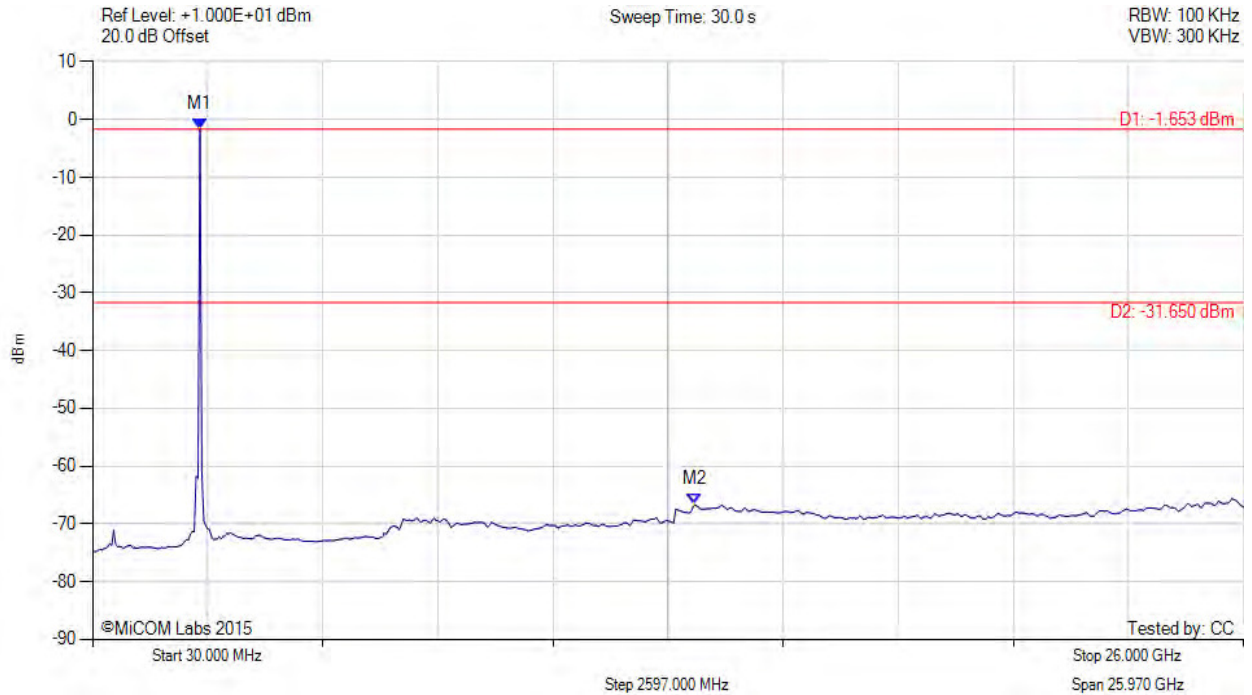

Analyser Setup	Marker:Frequency:Amplitude	Test Results
Detector = AVER Sweep Count = 0 RF Atten (dB) = 10 Trace Mode = VIEW	M1 : 2450.000 MHz : -1.653 dBm M2 : 13.620 GHz : -66.664 dBm	Limit: -31.65 dBm Margin: -35.01 dB

[back to matrix](#)

This test report may be reproduced in full only. The document may only be updated by MiCOM Labs personnel. All changes will be noted in the Document History section of the report.



Title: Aruba Networks APEX0104
To: FCC CFR 47 Part 15 Subpart C 15.247 & IC RSS-247
Serial #: ARUB199-U3 Rev A
Issue Date: 27th August 2015
Page: 110 of 223

CONDUCTED SPURIOUS EMISSIONS - AVERAGE



Variant: 802.11b, Channel: 2462.00 MHz, Chain b, Temp: Ambient, Voltage: 48 Vdc

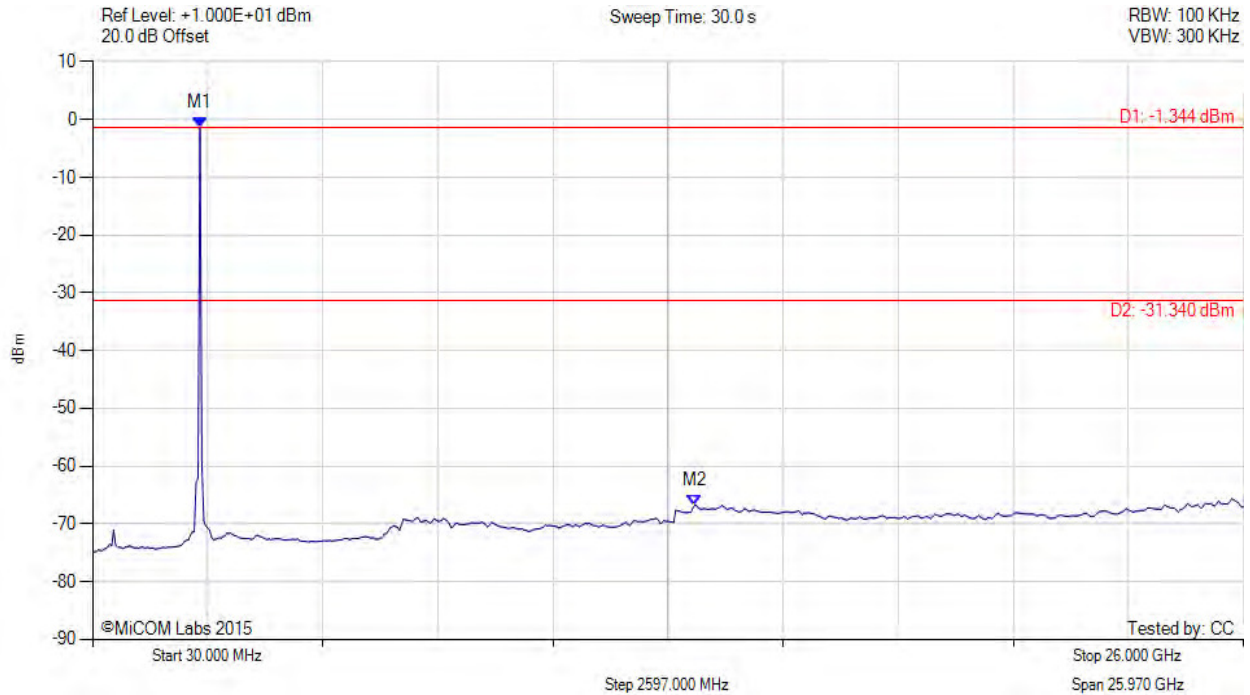

Analyser Setup	Marker:Frequency:Amplitude	Test Results
Detector = AVER Sweep Count = 0 RF Atten (dB) = 10 Trace Mode = VIEW	M1 : 2450.000 MHz : -1.344 dBm M2 : 13.620 GHz : -66.736 dBm	Limit: -31.34 dBm Margin: -35.40 dB

[back to matrix](#)

This test report may be reproduced in full only. The document may only be updated by MiCOM Labs personnel. All changes will be noted in the Document History section of the report.



Title: Aruba Networks APEX0104
To: FCC CFR 47 Part 15 Subpart C 15.247 & IC RSS-247
Serial #: ARUB199-U3 Rev A
Issue Date: 27th August 2015
Page: 111 of 223

CONDUCTED SPURIOUS EMISSIONS - AVERAGE



Variant: 802.11b, Channel: 2462.00 MHz, Chain c, Temp: Ambient, Voltage: 48 Vdc

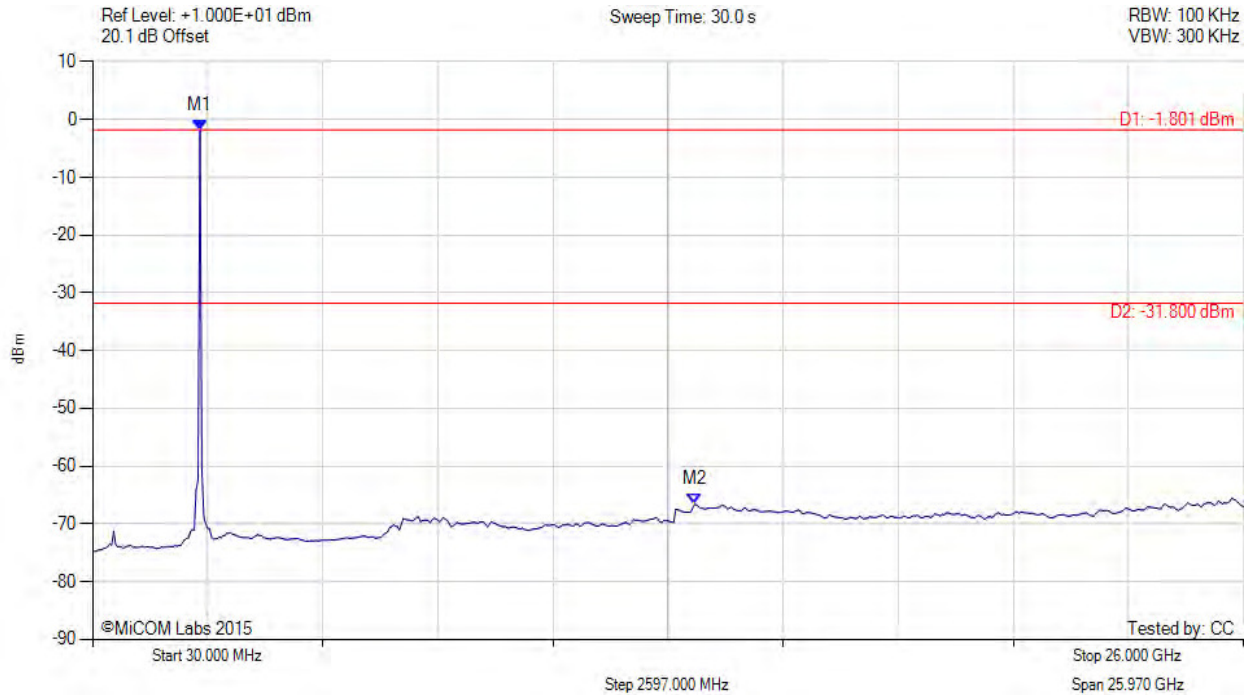

Analyser Setup	Marker:Frequency:Amplitude	Test Results
Detector = AVER Sweep Count = 0 RF Atten (dB) = 10 Trace Mode = VIEW	M1 : 2450.000 MHz : -1.801 dBm M2 : 13.620 GHz : -66.597 dBm	Limit: -31.80 dBm Margin: -34.80 dB

[back to matrix](#)

This test report may be reproduced in full only. The document may only be updated by MiCOM Labs personnel. All changes will be noted in the Document History section of the report.



Title: Aruba Networks APEX0104
To: FCC CFR 47 Part 15 Subpart C 15.247 & IC RSS-247
Serial #: ARUB199-U3 Rev A
Issue Date: 27th August 2015
Page: 112 of 223

CONDUCTED SPURIOUS EMISSIONS - AVERAGE



Variant: 802.11g, Channel: 2412.00 MHz, Chain a, Temp: Ambient, Voltage: 48 Vdc

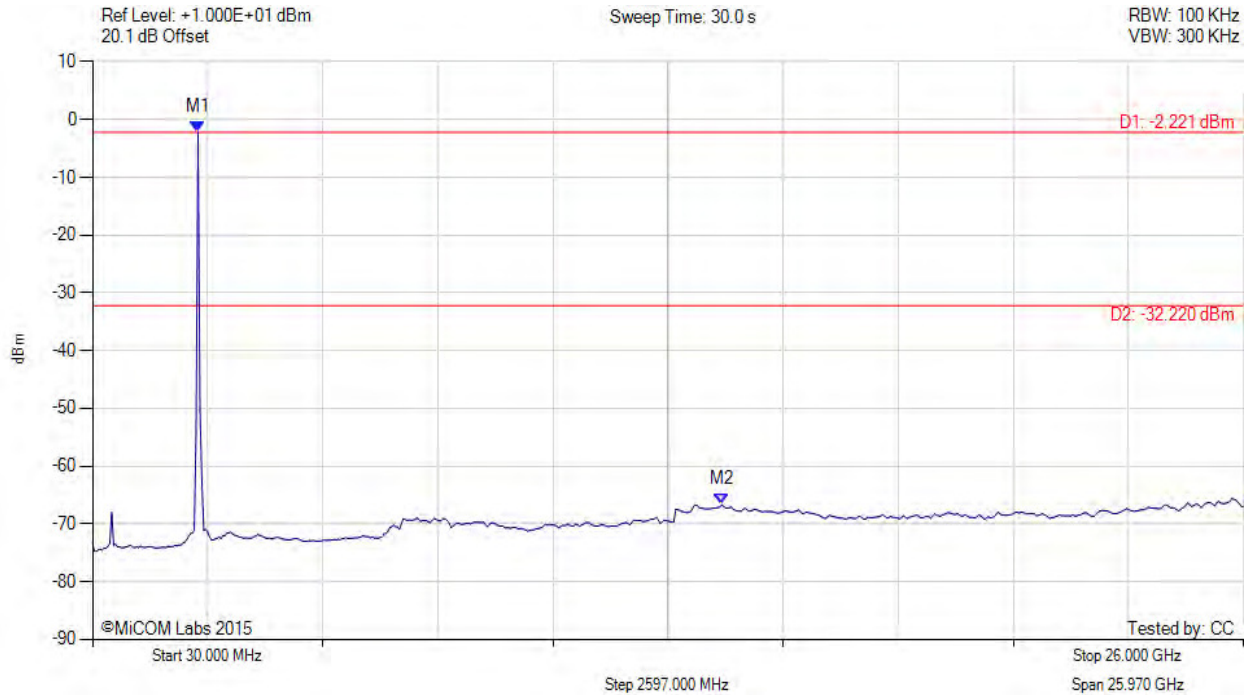

Analyser Setup	Marker:Frequency:Amplitude	Test Results
Detector = AVER Sweep Count = 0 RF Atten (dB) = 10 Trace Mode = VIEW	M1 : 2410.000 MHz : -2.221 dBm M2 : 14.230 GHz : -66.678 dBm	Limit: -32.22 dBm Margin: -34.46 dB

[back to matrix](#)

This test report may be reproduced in full only. The document may only be updated by MiCOM Labs personnel. All changes will be noted in the Document History section of the report.



Title: Aruba Networks APEX0104
To: FCC CFR 47 Part 15 Subpart C 15.247 & IC RSS-247
Serial #: ARUB199-U3 Rev A
Issue Date: 27th August 2015
Page: 113 of 223

CONDUCTED SPURIOUS EMISSIONS - AVERAGE



Variant: 802.11g, Channel: 2412.00 MHz, Chain b, Temp: Ambient, Voltage: 48 Vdc

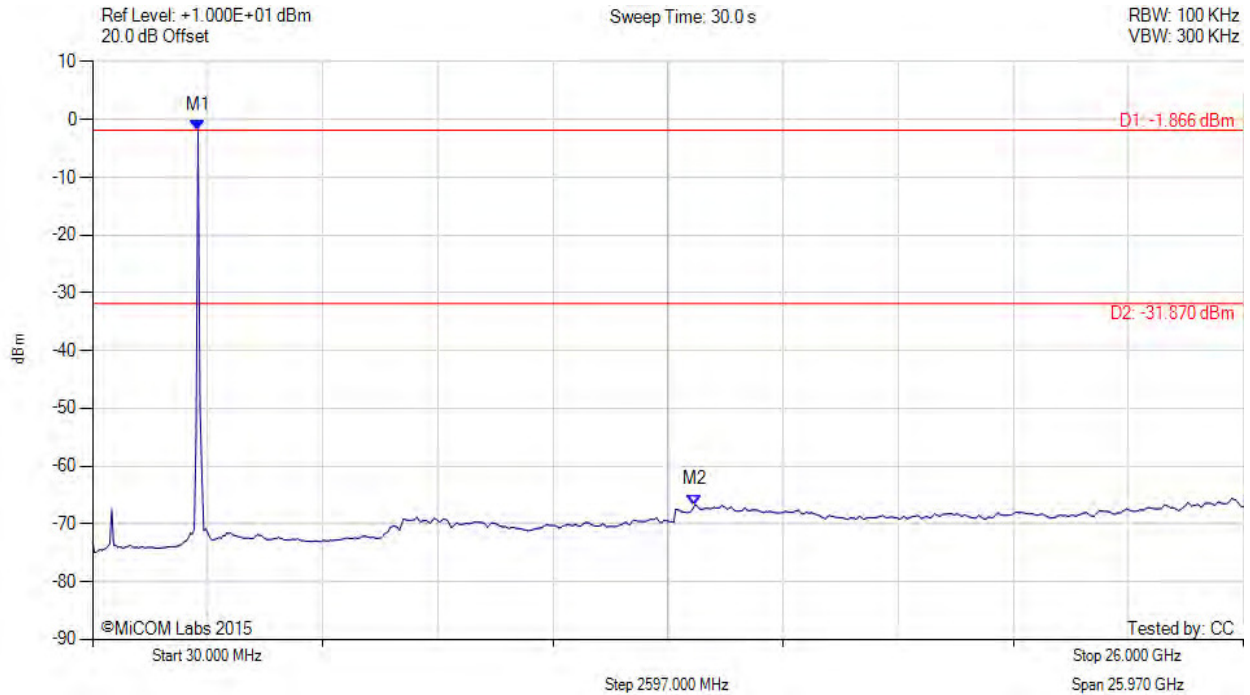

Analyser Setup	Marker:Frequency:Amplitude	Test Results
Detector = AVER Sweep Count = 0 RF Atten (dB) = 10 Trace Mode = VIEW	M1 : 2410.000 MHz : -1.866 dBm M2 : 13.620 GHz : -66.687 dBm	Limit: -31.87 dBm Margin: -34.82 dB

[back to matrix](#)

This test report may be reproduced in full only. The document may only be updated by MiCOM Labs personnel. All changes will be noted in the Document History section of the report.



Title: Aruba Networks APEX0104
To: FCC CFR 47 Part 15 Subpart C 15.247 & IC RSS-247
Serial #: ARUB199-U3 Rev A
Issue Date: 27th August 2015
Page: 114 of 223

CONDUCTED SPURIOUS EMISSIONS - AVERAGE



Variant: 802.11g, Channel: 2412.00 MHz, Chain c, Temp: Ambient, Voltage: 48 Vdc

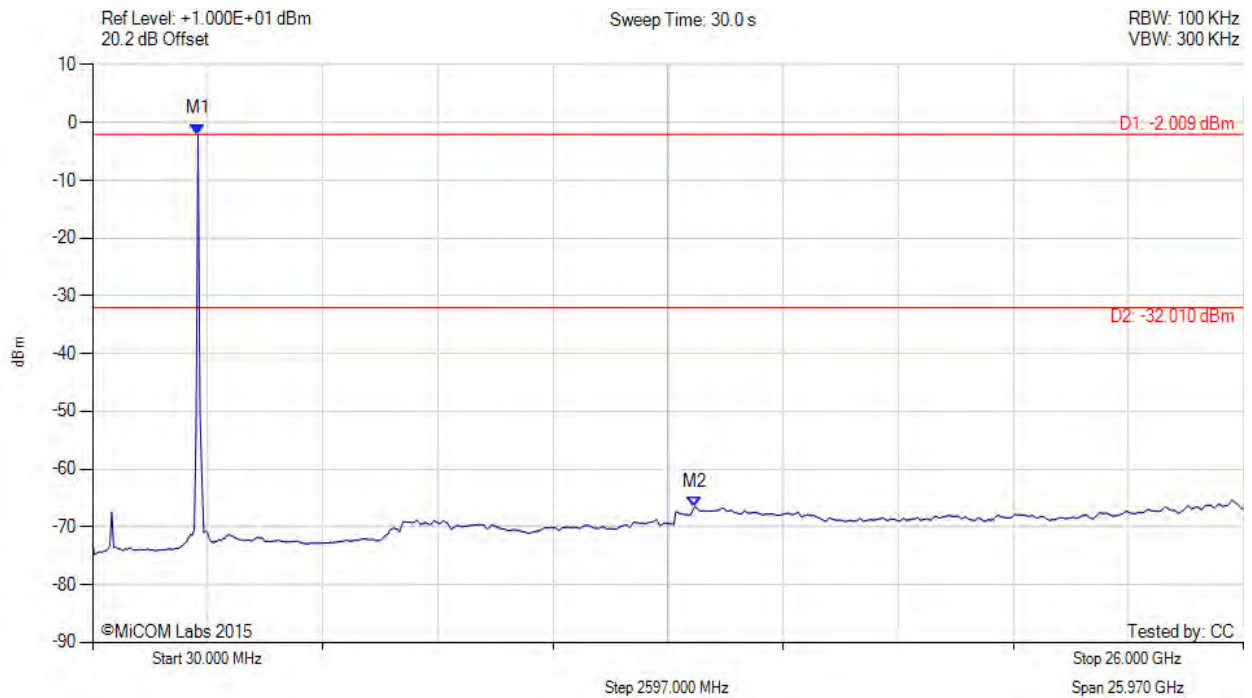

Analyser Setup	Marker:Frequency:Amplitude	Test Results
Detector = AVER Sweep Count = 0 RF Atten (dB) = 10 Trace Mode = VIEW	M1 : 2410.000 MHz : -2.009 dBm M2 : 13.620 GHz : -66.552 dBm	Limit: -32.01 dBm Margin: -34.54 dB

[back to matrix](#)

This test report may be reproduced in full only. The document may only be updated by MiCOM Labs personnel. All changes will be noted in the Document History section of the report.



Title: Aruba Networks APEX0104
To: FCC CFR 47 Part 15 Subpart C 15.247 & IC RSS-247
Serial #: ARUB199-U3 Rev A
Issue Date: 27th August 2015
Page: 115 of 223

CONDUCTED SPURIOUS EMISSIONS - AVERAGE



Variant: 802.11g, Channel: 2437.00 MHz, Chain a, Temp: Ambient, Voltage: 48 Vdc

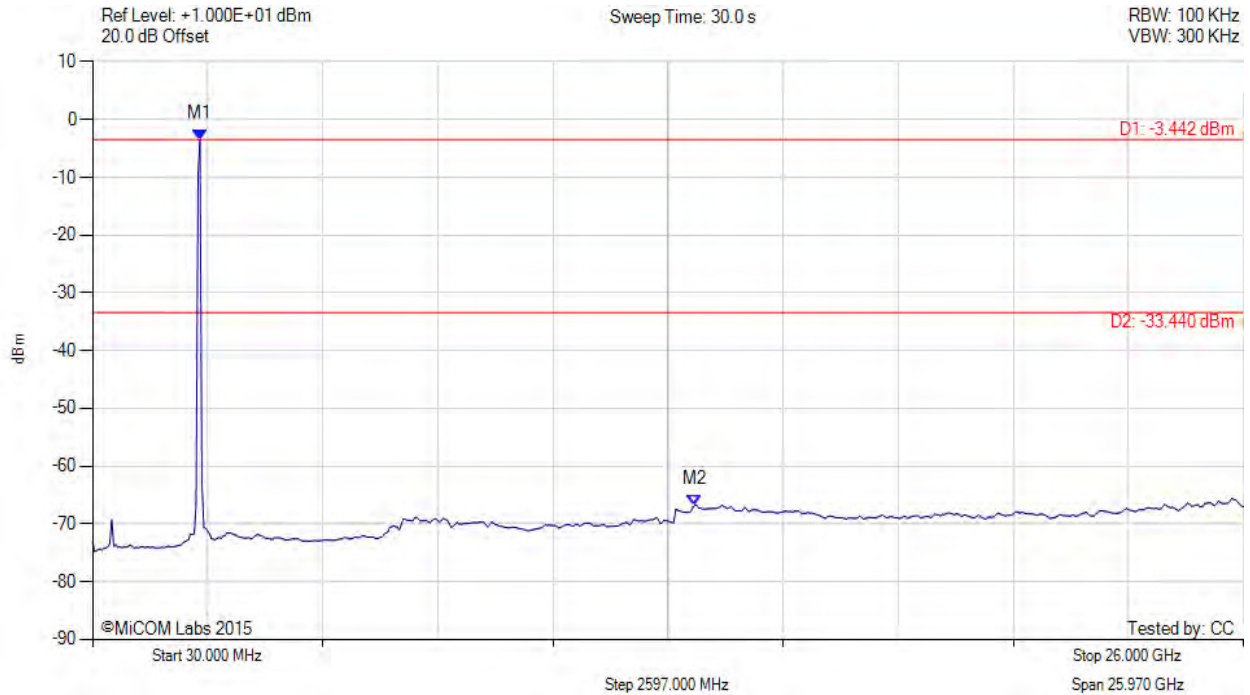

Analyser Setup	Marker:Frequency:Amplitude	Test Results
Detector = AVER Sweep Count = 0 RF Atten (dB) = 10 Trace Mode = VIEW	M1 : 2450.000 MHz : -3.442 dBm M2 : 13.620 GHz : -66.695 dBm	Limit: -33.44 dBm Margin: -33.25 dB

[back to matrix](#)

This test report may be reproduced in full only. The document may only be updated by MiCOM Labs personnel. All changes will be noted in the Document History section of the report.



Title: Aruba Networks APEX0104
To: FCC CFR 47 Part 15 Subpart C 15.247 & IC RSS-247
Serial #: ARUB199-U3 Rev A
Issue Date: 27th August 2015
Page: 116 of 223

CONDUCTED SPURIOUS EMISSIONS - AVERAGE



Variant: 802.11g, Channel: 2437.00 MHz, Chain b, Temp: Ambient, Voltage: 48 Vdc

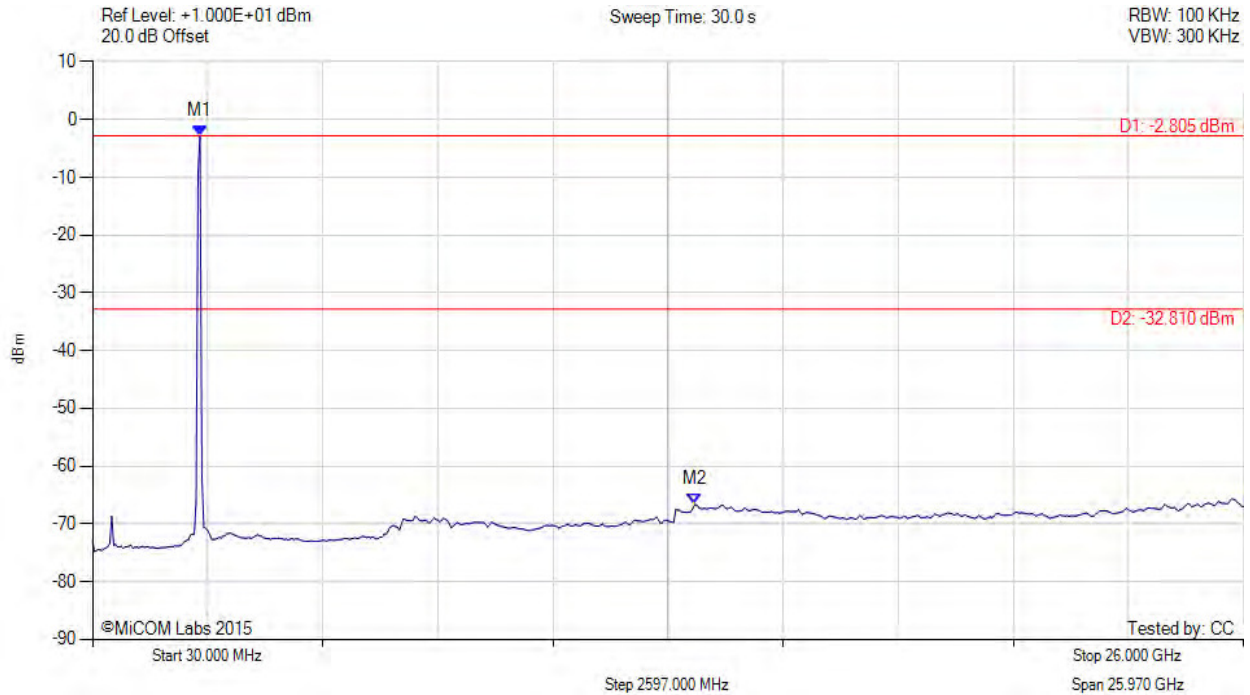

Analyser Setup	Marker:Frequency:Amplitude	Test Results
Detector = AVER Sweep Count = 0 RF Atten (dB) = 10 Trace Mode = VIEW	M1 : 2450.000 MHz : -2.805 dBm M2 : 13.620 GHz : -66.641 dBm	Limit: -32.81 dBm Margin: -33.83 dB

[back to matrix](#)

This test report may be reproduced in full only. The document may only be updated by MiCOM Labs personnel. All changes will be noted in the Document History section of the report.



Title: Aruba Networks APEX0104
To: FCC CFR 47 Part 15 Subpart C 15.247 & IC RSS-247
Serial #: ARUB199-U3 Rev A
Issue Date: 27th August 2015
Page: 117 of 223

CONDUCTED SPURIOUS EMISSIONS - AVERAGE



Variant: 802.11g, Channel: 2437.00 MHz, Chain c, Temp: Ambient, Voltage: 48 Vdc

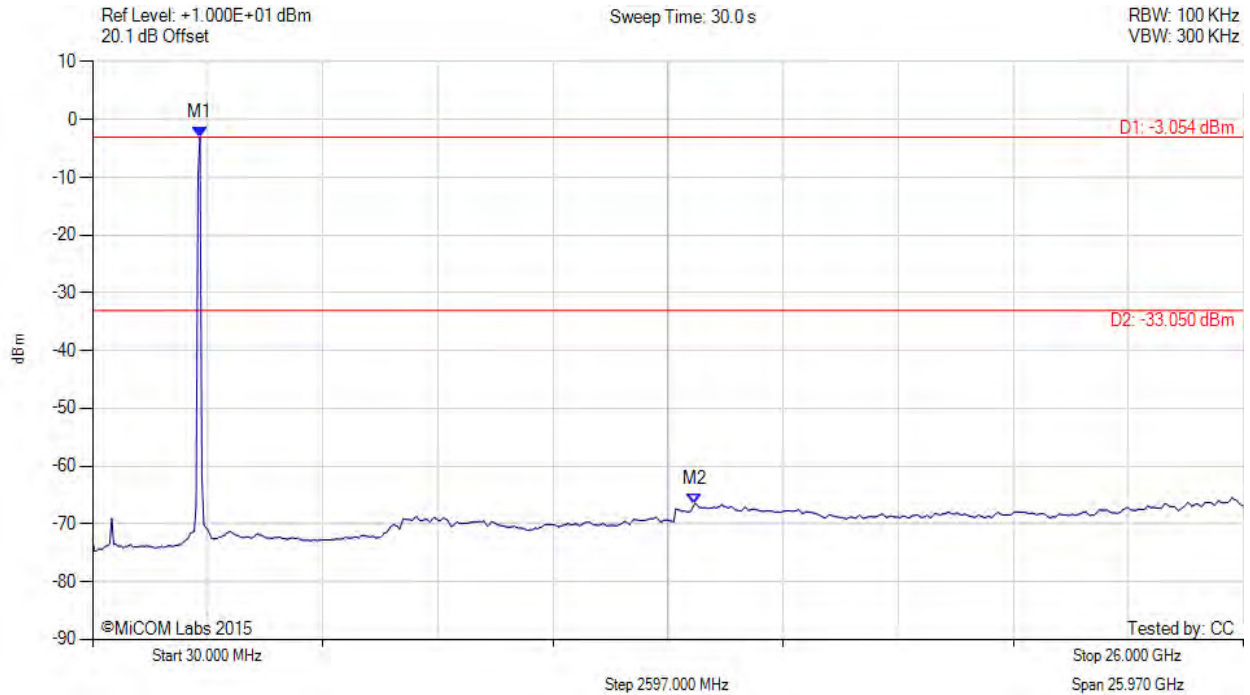

Analyser Setup	Marker:Frequency:Amplitude	Test Results
Detector = AVER Sweep Count = 0 RF Atten (dB) = 10 Trace Mode = VIEW	M1 : 2450.000 MHz : -3.054 dBm M2 : 13.620 GHz : -66.534 dBm	Limit: -33.05 dBm Margin: -33.48 dB

[back to matrix](#)

This test report may be reproduced in full only. The document may only be updated by MiCOM Labs personnel. All changes will be noted in the Document History section of the report.



Title: Aruba Networks APEX0104
To: FCC CFR 47 Part 15 Subpart C 15.247 & IC RSS-247
Serial #: ARUB199-U3 Rev A
Issue Date: 27th August 2015
Page: 118 of 223

CONDUCTED SPURIOUS EMISSIONS - AVERAGE



Variant: 802.11g, Channel: 2462.00 MHz, Chain a, Temp: Ambient, Voltage: 48 Vdc

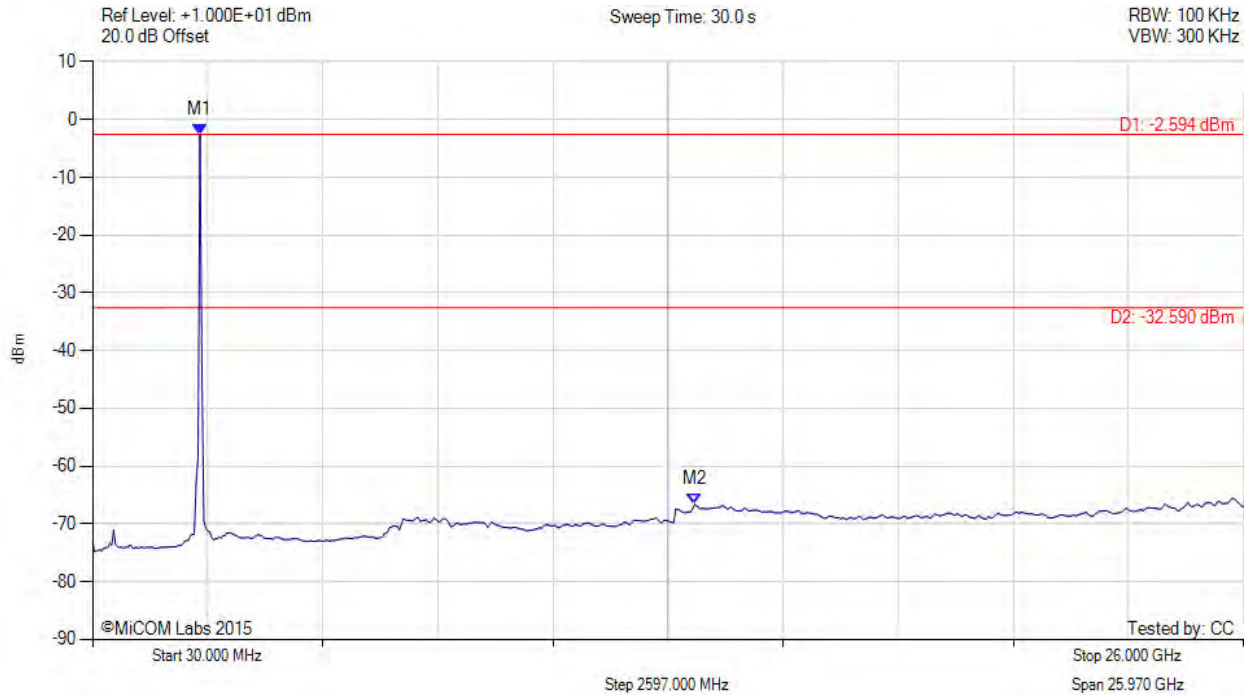

Analyser Setup	Marker:Frequency:Amplitude	Test Results
Detector = AVER Sweep Count = 0 RF Atten (dB) = 10 Trace Mode = VIEW	M1 : 2450.000 MHz : -2.594 dBm M2 : 13.620 GHz : -66.616 dBm	Limit: -32.59 dBm Margin: -34.03 dB

[back to matrix](#)

This test report may be reproduced in full only. The document may only be updated by MiCOM Labs personnel. All changes will be noted in the Document History section of the report.



Title: Aruba Networks APEX0104
To: FCC CFR 47 Part 15 Subpart C 15.247 & IC RSS-247
Serial #: ARUB199-U3 Rev A
Issue Date: 27th August 2015
Page: 119 of 223

CONDUCTED SPURIOUS EMISSIONS - AVERAGE



Variant: 802.11g, Channel: 2462.00 MHz, Chain b, Temp: Ambient, Voltage: 48 Vdc

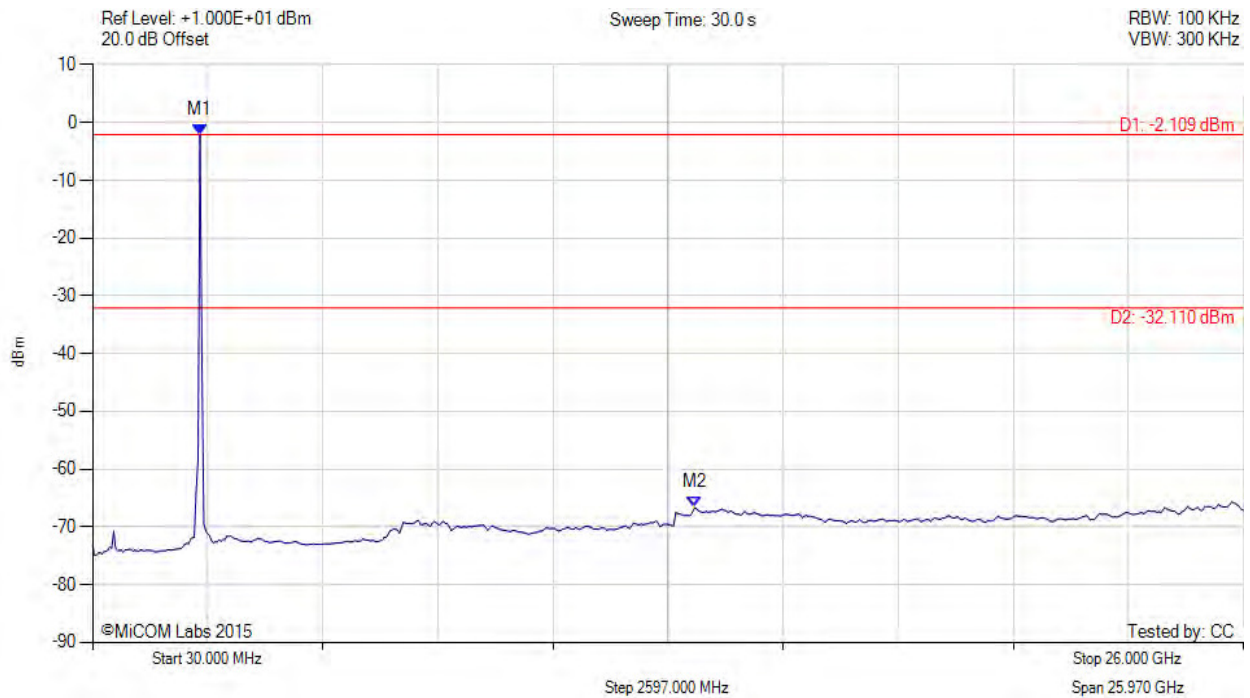

Analyser Setup	Marker:Frequency:Amplitude	Test Results
Detector = AVER Sweep Count = 0 RF Atten (dB) = 10 Trace Mode = VIEW	M1 : 2450.000 MHz : -2.109 dBm M2 : 13.620 GHz : -66.676 dBm	Limit: -32.11 dBm Margin: -34.57 dB

[back to matrix](#)

This test report may be reproduced in full only. The document may only be updated by MiCOM Labs personnel. All changes will be noted in the Document History section of the report.



Title: Aruba Networks APEX0104
To: FCC CFR 47 Part 15 Subpart C 15.247 & IC RSS-247
Serial #: ARUB199-U3 Rev A
Issue Date: 27th August 2015
Page: 120 of 223

CONDUCTED SPURIOUS EMISSIONS - AVERAGE



Variant: 802.11g, Channel: 2462.00 MHz, Chain c, Temp: Ambient, Voltage: 48 Vdc

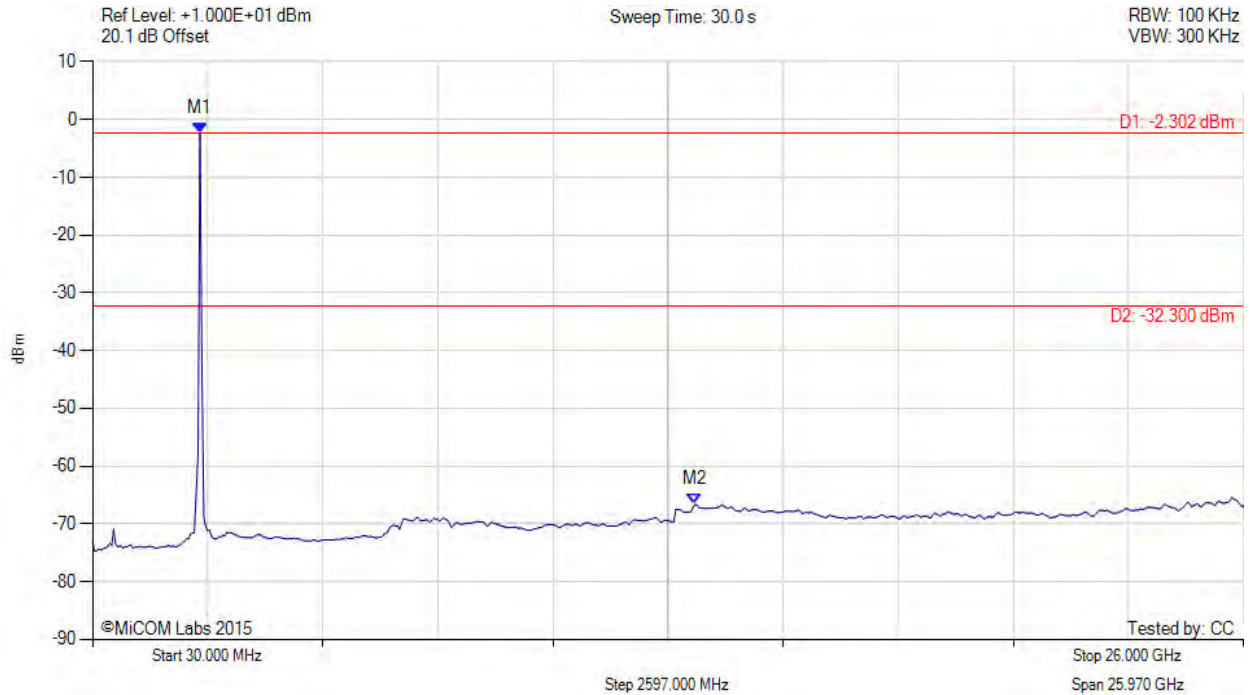

Analyser Setup	Marker:Frequency:Amplitude	Test Results
Detector = AVER Sweep Count = 0 RF Atten (dB) = 10 Trace Mode = VIEW	M1 : 2450.000 MHz : -2.302 dBm M2 : 13.620 GHz : -66.661 dBm	Limit: -32.30 dBm Margin: -34.36 dB

[back to matrix](#)

This test report may be reproduced in full only. The document may only be updated by MiCOM Labs personnel. All changes will be noted in the Document History section of the report.



Title: Aruba Networks APEX0104
To: FCC CFR 47 Part 15 Subpart C 15.247 & IC RSS-247
Serial #: ARUB199-U3 Rev A
Issue Date: 27th August 2015
Page: 121 of 223

CONDUCTED SPURIOUS EMISSIONS - AVERAGE



Variant: 802.11n HT-20, Channel: 2412.00 MHz, Chain a, Temp: Ambient, Voltage: 48 Vdc

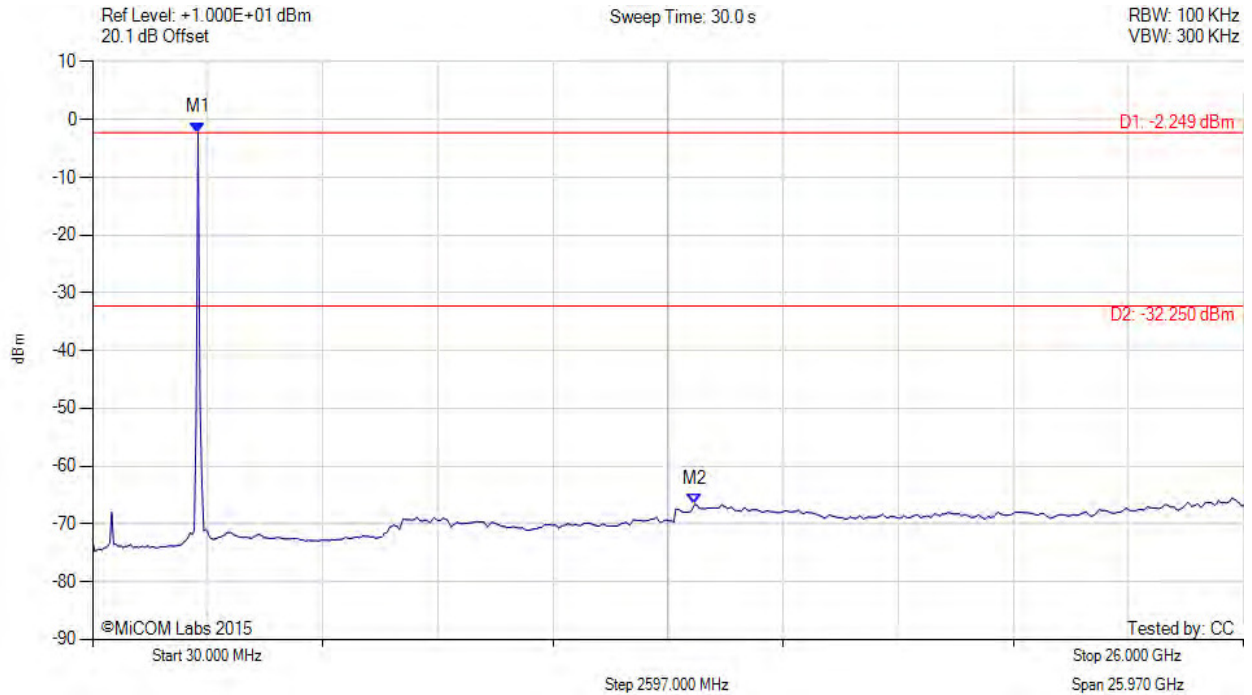

Analyser Setup	Marker:Frequency:Amplitude	Test Results
Detector = AVER Sweep Count = 0 RF Atten (dB) = 10 Trace Mode = VIEW	M1 : 2410.000 MHz : -2.249 dBm M2 : 13.620 GHz : -66.579 dBm	Limit: -32.25 dBm Margin: -34.33 dB

[back to matrix](#)

This test report may be reproduced in full only. The document may only be updated by MiCOM Labs personnel. All changes will be noted in the Document History section of the report.



Title: Aruba Networks APEX0104
To: FCC CFR 47 Part 15 Subpart C 15.247 & IC RSS-247
Serial #: ARUB199-U3 Rev A
Issue Date: 27th August 2015
Page: 122 of 223

CONDUCTED SPURIOUS EMISSIONS - AVERAGE



Variant: 802.11n HT-20, Channel: 2412.00 MHz, Chain b, Temp: Ambient, Voltage: 48 Vdc

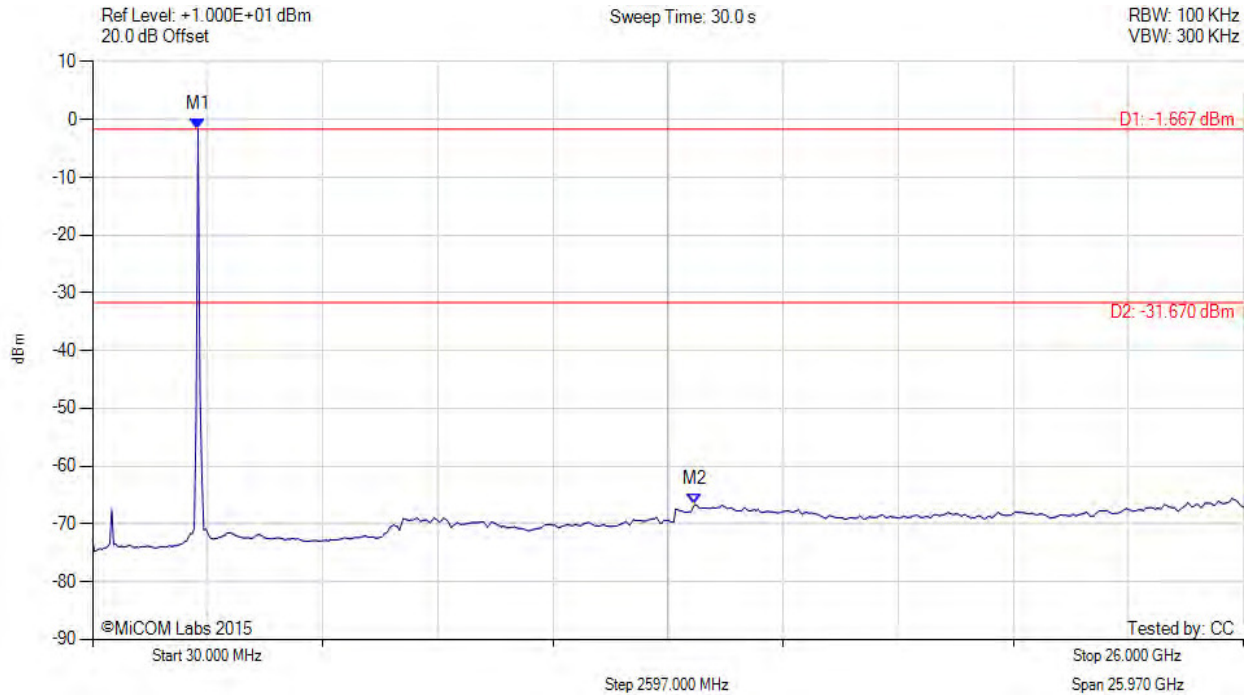

Analyser Setup	Marker:Frequency:Amplitude	Test Results
Detector = AVER Sweep Count = 0 RF Atten (dB) = 10 Trace Mode = VIEW	M1 : 2410.000 MHz : -1.667 dBm M2 : 13.620 GHz : -66.655 dBm	Limit: -31.67 dBm Margin: -34.98 dB

[back to matrix](#)

This test report may be reproduced in full only. The document may only be updated by MiCOM Labs personnel. All changes will be noted in the Document History section of the report.



Title: Aruba Networks APEX0104
To: FCC CFR 47 Part 15 Subpart C 15.247 & IC RSS-247
Serial #: ARUB199-U3 Rev A
Issue Date: 27th August 2015
Page: 123 of 223

CONDUCTED SPURIOUS EMISSIONS - AVERAGE



Variant: 802.11n HT-20, Channel: 2412.00 MHz, Chain c, Temp: Ambient, Voltage: 48 Vdc

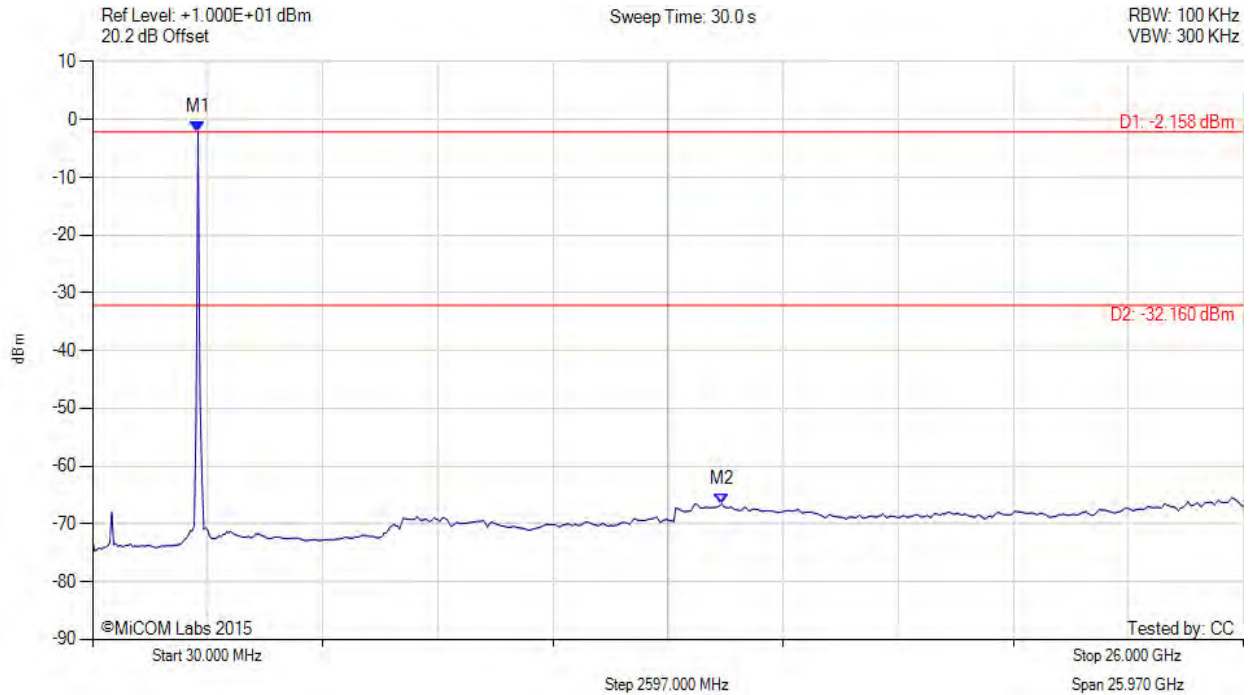

Analyser Setup	Marker:Frequency:Amplitude	Test Results
Detector = AVER Sweep Count = 0 RF Atten (dB) = 10 Trace Mode = VIEW	M1 : 2410.000 MHz : -2.158 dBm M2 : 14.230 GHz : -66.526 dBm	Limit: -32.16 dBm Margin: -34.37 dB

[back to matrix](#)

This test report may be reproduced in full only. The document may only be updated by MiCOM Labs personnel. All changes will be noted in the Document History section of the report.



Title: Aruba Networks APEX0104
To: FCC CFR 47 Part 15 Subpart C 15.247 & IC RSS-247
Serial #: ARUB199-U3 Rev A
Issue Date: 27th August 2015
Page: 124 of 223

CONDUCTED SPURIOUS EMISSIONS - AVERAGE



Variant: 802.11n HT-20, Channel: 2437.00 MHz, Chain a, Temp: Ambient, Voltage: 48 Vdc

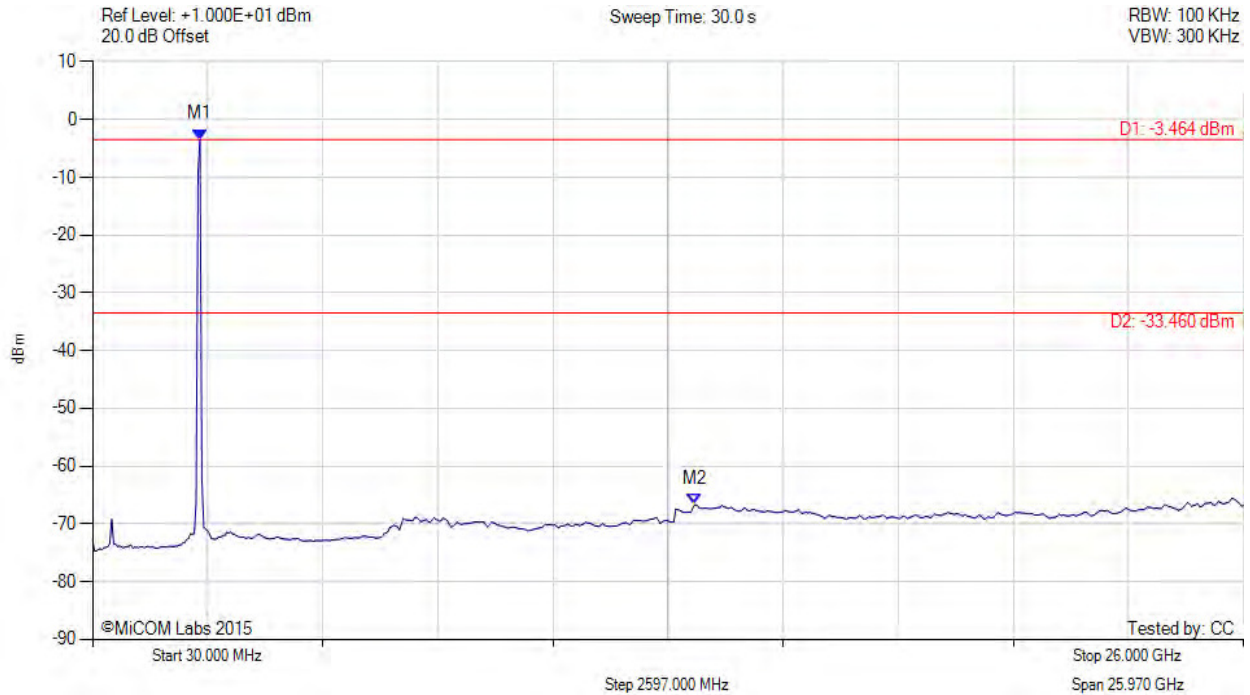

Analyser Setup	Marker:Frequency:Amplitude	Test Results
Detector = AVER Sweep Count = 0 RF Atten (dB) = 10 Trace Mode = VIEW	M1 : 2450.000 MHz : -3.464 dBm M2 : 13.620 GHz : -66.677 dBm	Limit: -33.46 dBm Margin: -33.22 dB

[back to matrix](#)

This test report may be reproduced in full only. The document may only be updated by MiCOM Labs personnel. All changes will be noted in the Document History section of the report.



Title: Aruba Networks APEX0104
To: FCC CFR 47 Part 15 Subpart C 15.247 & IC RSS-247
Serial #: ARUB199-U3 Rev A
Issue Date: 27th August 2015
Page: 125 of 223

CONDUCTED SPURIOUS EMISSIONS - AVERAGE



Variant: 802.11n HT-20, Channel: 2437.00 MHz, Chain b, Temp: Ambient, Voltage: 48 Vdc

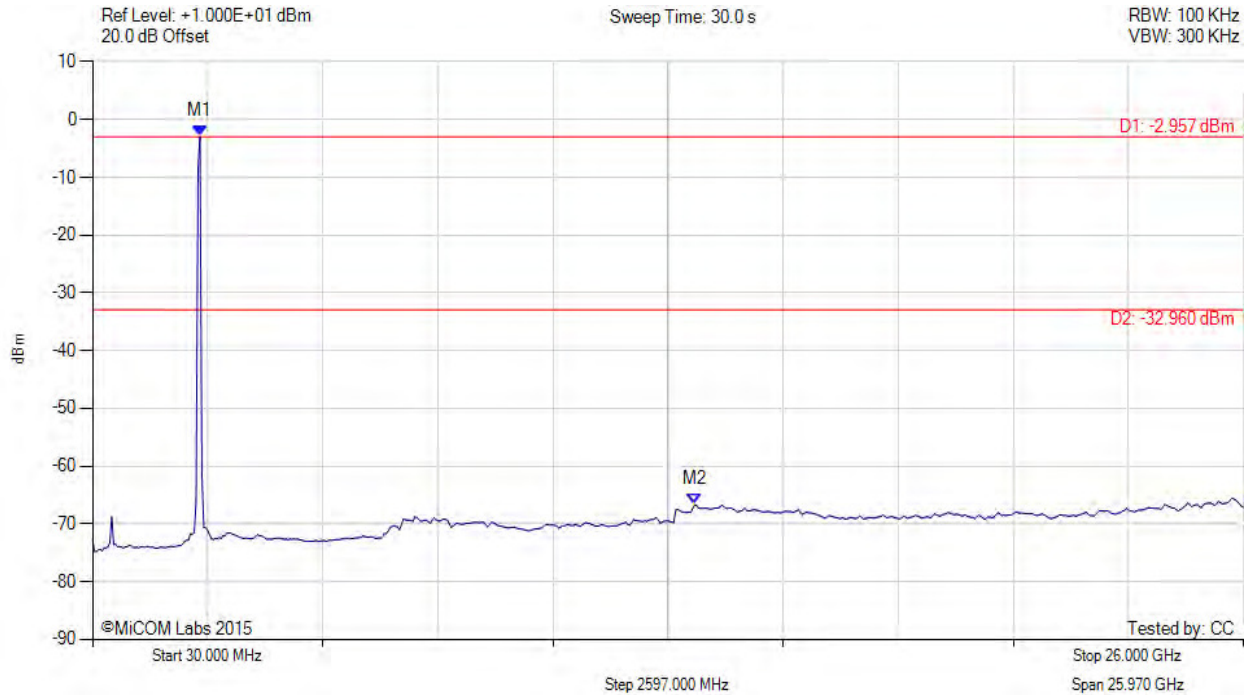

Analyser Setup	Marker:Frequency:Amplitude	Test Results
Detector = AVER Sweep Count = 0 RF Atten (dB) = 10 Trace Mode = VIEW	M1 : 2450.000 MHz : -2.957 dBm M2 : 13.620 GHz : -66.680 dBm	Limit: -32.96 dBm Margin: -33.72 dB

[back to matrix](#)

This test report may be reproduced in full only. The document may only be updated by MiCOM Labs personnel. All changes will be noted in the Document History section of the report.



Title: Aruba Networks APEX0104
To: FCC CFR 47 Part 15 Subpart C 15.247 & IC RSS-247
Serial #: ARUB199-U3 Rev A
Issue Date: 27th August 2015
Page: 126 of 223

CONDUCTED SPURIOUS EMISSIONS - AVERAGE



Variant: 802.11n HT-20, Channel: 2437.00 MHz, Chain c, Temp: Ambient, Voltage: 48 Vdc

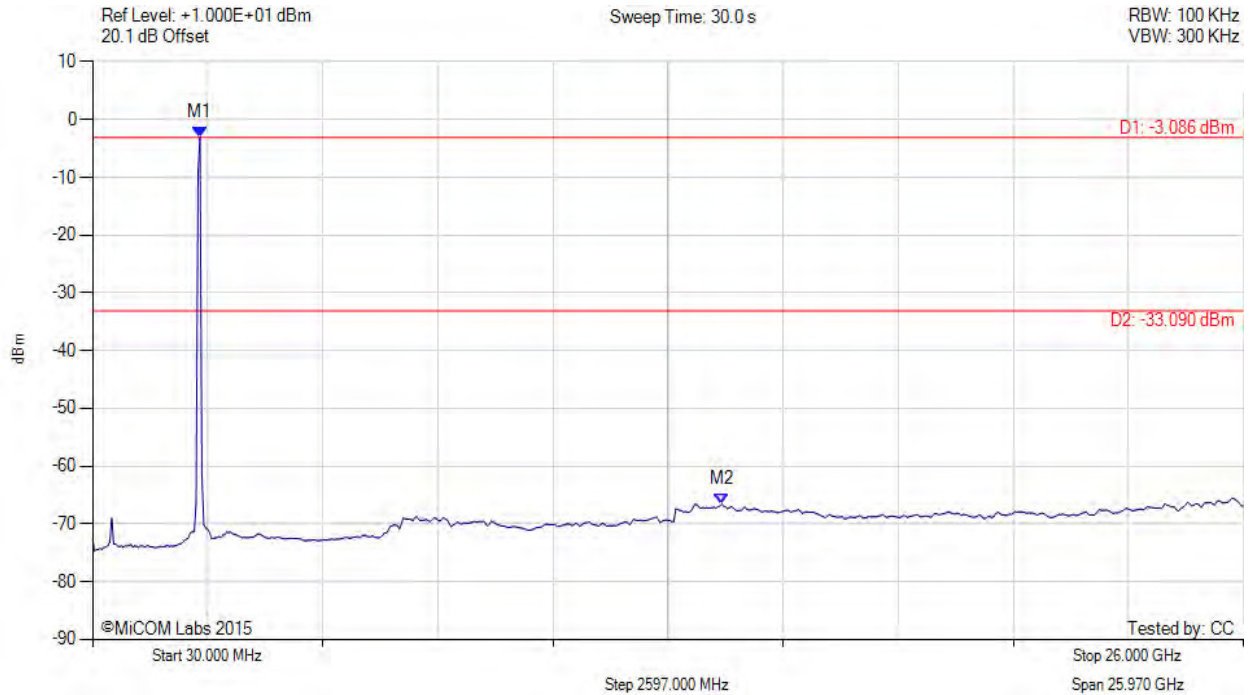

Analyser Setup	Marker:Frequency:Amplitude	Test Results
Detector = AVER Sweep Count = 0 RF Atten (dB) = 10 Trace Mode = VIEW	M1 : 2450.000 MHz : -3.086 dBm M2 : 14.230 GHz : -66.574 dBm	Limit: -33.09 dBm Margin: -33.48 dB

[back to matrix](#)

This test report may be reproduced in full only. The document may only be updated by MiCOM Labs personnel. All changes will be noted in the Document History section of the report.



Title: Aruba Networks APEX0104
To: FCC CFR 47 Part 15 Subpart C 15.247 & IC RSS-247
Serial #: ARUB199-U3 Rev A
Issue Date: 27th August 2015
Page: 127 of 223

CONDUCTED SPURIOUS EMISSIONS - AVERAGE



Variant: 802.11n HT-20, Channel: 2462.00 MHz, Chain a, Temp: Ambient, Voltage: 48 Vdc

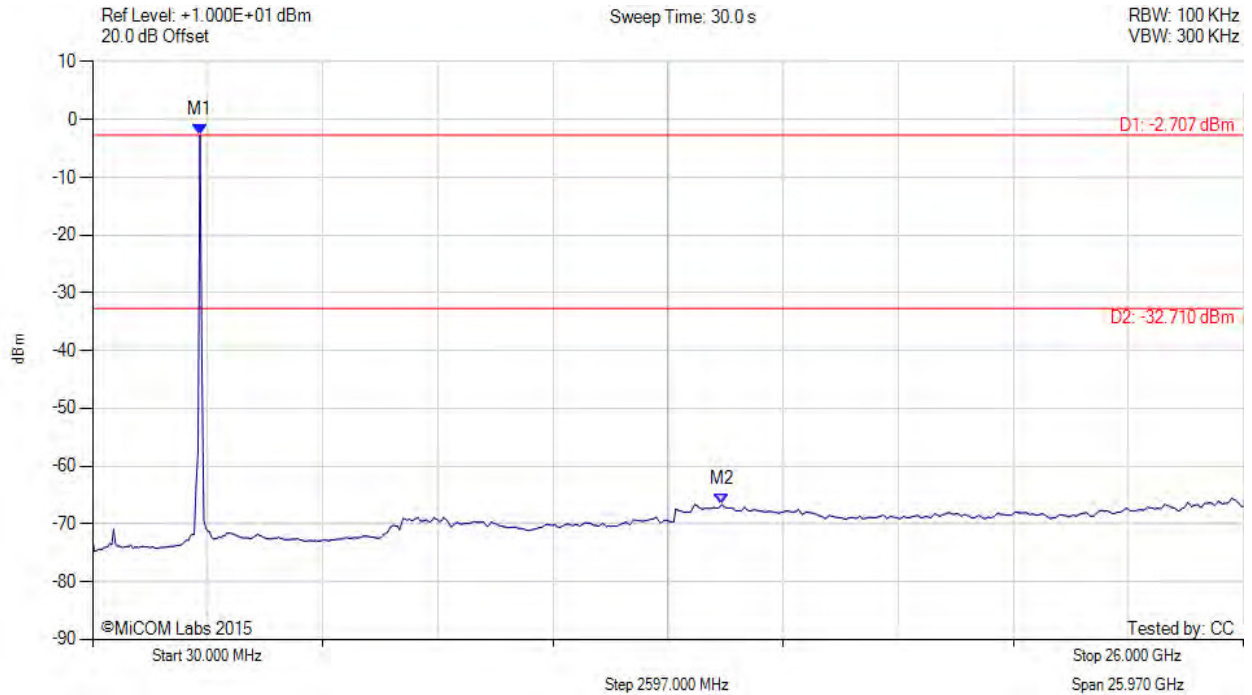

Analyser Setup	Marker:Frequency:Amplitude	Test Results
Detector = AVER Sweep Count = 0 RF Atten (dB) = 10 Trace Mode = VIEW	M1 : 2450.000 MHz : -2.707 dBm M2 : 14.230 GHz : -66.628 dBm	Limit: -32.71 dBm Margin: -33.92 dB

[back to matrix](#)

This test report may be reproduced in full only. The document may only be updated by MiCOM Labs personnel. All changes will be noted in the Document History section of the report.



Title: Aruba Networks APEX0104
To: FCC CFR 47 Part 15 Subpart C 15.247 & IC RSS-247
Serial #: ARUB199-U3 Rev A
Issue Date: 27th August 2015
Page: 128 of 223

CONDUCTED SPURIOUS EMISSIONS - AVERAGE



Variant: 802.11n HT-20, Channel: 2462.00 MHz, Chain b, Temp: Ambient, Voltage: 48 Vdc

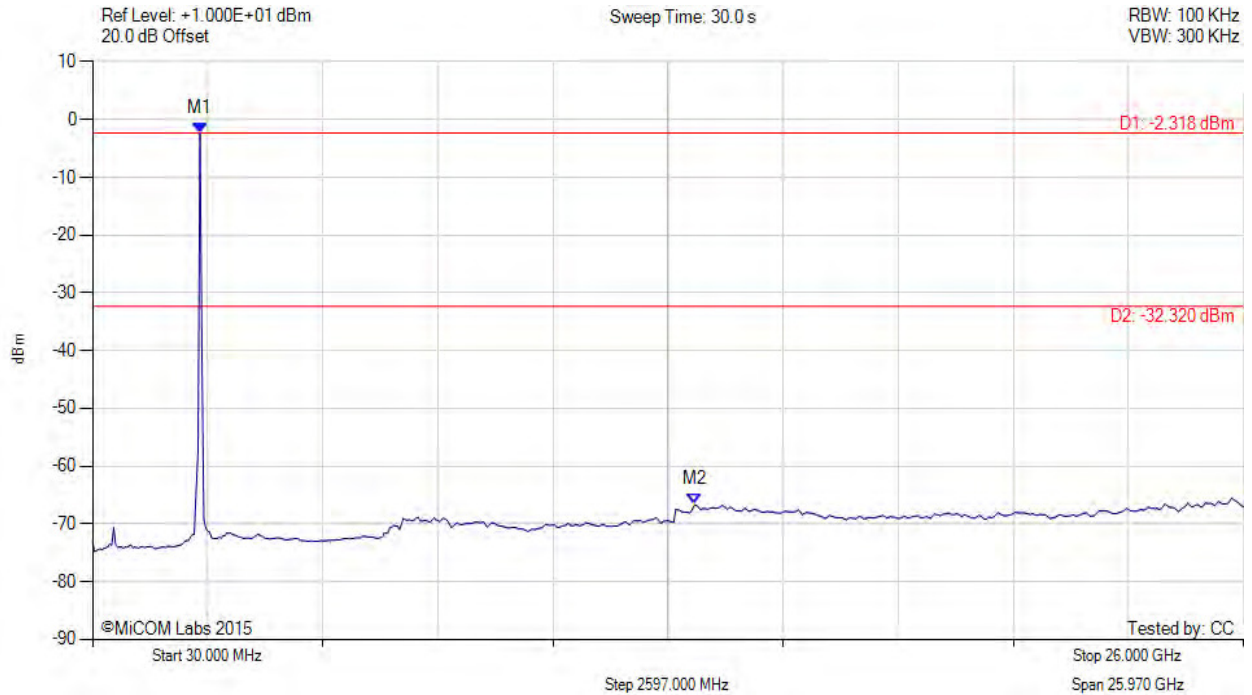

Analyser Setup	Marker:Frequency:Amplitude	Test Results
Detector = AVER Sweep Count = 0 RF Atten (dB) = 10 Trace Mode = VIEW	M1 : 2450.000 MHz : -2.318 dBm M2 : 13.620 GHz : -66.675 dBm	Limit: -32.32 dBm Margin: -34.35 dB

[back to matrix](#)

This test report may be reproduced in full only. The document may only be updated by MiCOM Labs personnel. All changes will be noted in the Document History section of the report.



Title: Aruba Networks APEX0104
To: FCC CFR 47 Part 15 Subpart C 15.247 & IC RSS-247
Serial #: ARUB199-U3 Rev A
Issue Date: 27th August 2015
Page: 129 of 223

CONDUCTED SPURIOUS EMISSIONS - AVERAGE



Variant: 802.11n HT-20, Channel: 2462.00 MHz, Chain c, Temp: Ambient, Voltage: 48 Vdc

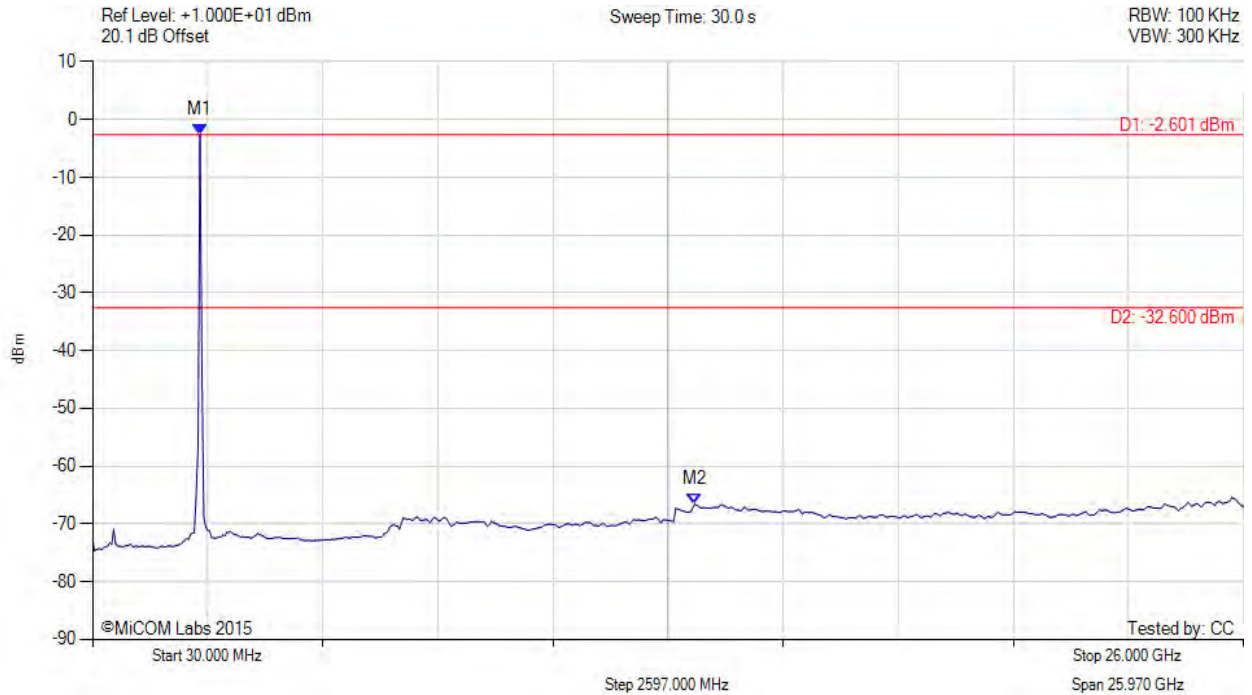

Analyser Setup	Marker:Frequency:Amplitude	Test Results
Detector = AVER Sweep Count = 0 RF Atten (dB) = 10 Trace Mode = VIEW	M1 : 2450.000 MHz : -2.601 dBm M2 : 13.620 GHz : -66.573 dBm	Limit: -32.60 dBm Margin: -33.97 dB

[back to matrix](#)

This test report may be reproduced in full only. The document may only be updated by MiCOM Labs personnel. All changes will be noted in the Document History section of the report.



Title: Aruba Networks APEX0104
To: FCC CFR 47 Part 15 Subpart C 15.247 & IC RSS-247
Serial #: ARUB199-U3 Rev A
Issue Date: 27th August 2015
Page: 130 of 223

CONDUCTED SPURIOUS EMISSIONS - AVERAGE



Variant: 802.11n HT-40, Channel: 2422.00 MHz, Chain a, Temp: Ambient, Voltage: 48 Vdc

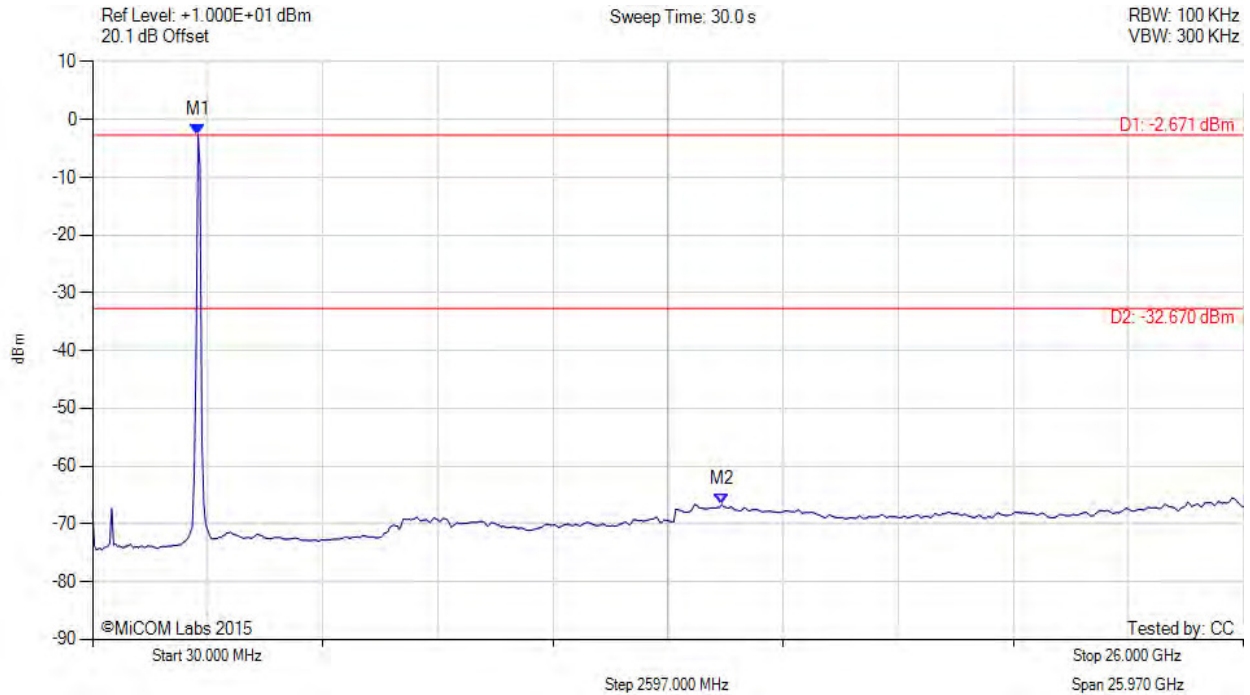

Analyser Setup	Marker:Frequency:Amplitude	Test Results
Detector = AVER Sweep Count = 0 RF Atten (dB) = 10 Trace Mode = VIEW	M1 : 2410.000 MHz : -2.671 dBm M2 : 14.230 GHz : -66.609 dBm	Limit: -32.67 dBm Margin: -33.94 dB

[back to matrix](#)

This test report may be reproduced in full only. The document may only be updated by MiCOM Labs personnel. All changes will be noted in the Document History section of the report.



Title: Aruba Networks APEX0104
To: FCC CFR 47 Part 15 Subpart C 15.247 & IC RSS-247
Serial #: ARUB199-U3 Rev A
Issue Date: 27th August 2015
Page: 131 of 223

CONDUCTED SPURIOUS EMISSIONS - AVERAGE



Variant: 802.11n HT-40, Channel: 2422.00 MHz, Chain b, Temp: Ambient, Voltage: 48 Vdc

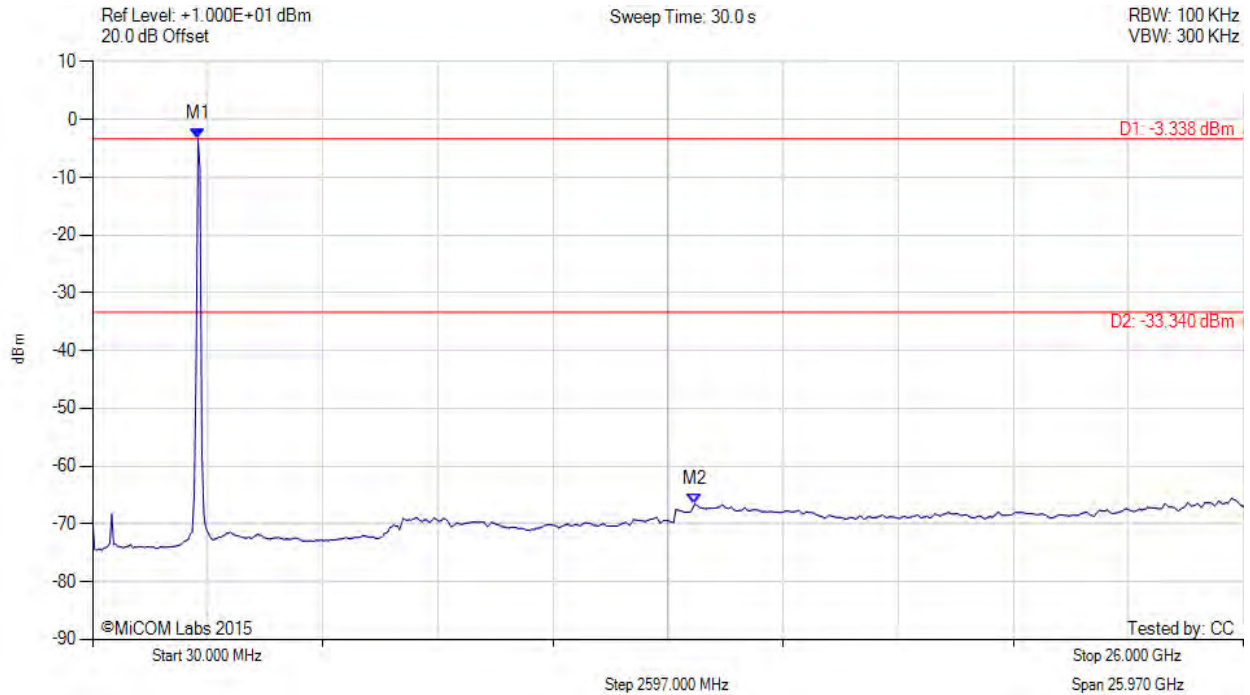

Analyser Setup	Marker:Frequency:Amplitude	Test Results
Detector = AVER Sweep Count = 0 RF Atten (dB) = 10 Trace Mode = VIEW	M1 : 2410.000 MHz : -3.338 dBm M2 : 13.620 GHz : -66.532 dBm	Limit: -33.34 dBm Margin: -33.19 dB

[back to matrix](#)

This test report may be reproduced in full only. The document may only be updated by MiCOM Labs personnel. All changes will be noted in the Document History section of the report.



Title: Aruba Networks APEX0104
To: FCC CFR 47 Part 15 Subpart C 15.247 & IC RSS-247
Serial #: ARUB199-U3 Rev A
Issue Date: 27th August 2015
Page: 132 of 223

CONDUCTED SPURIOUS EMISSIONS - AVERAGE



Variant: 802.11n HT-40, Channel: 2422.00 MHz, Chain c, Temp: Ambient, Voltage: 48 Vdc

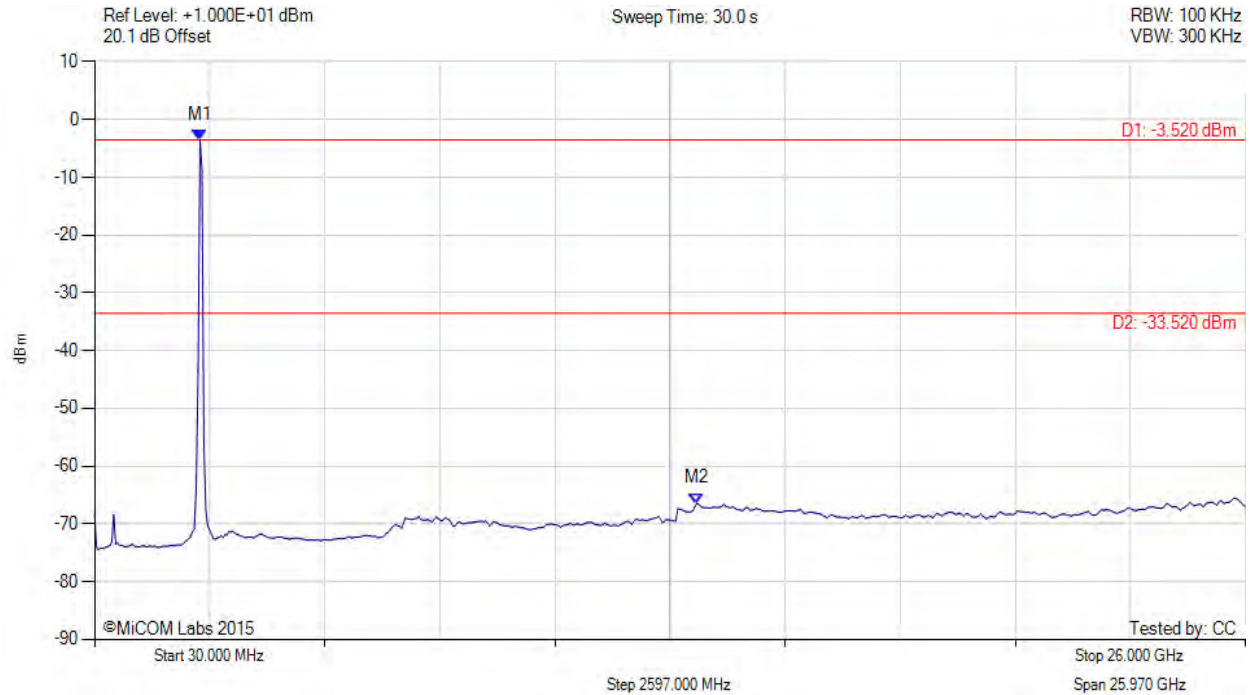

Analyser Setup	Marker:Frequency:Amplitude	Test Results
Detector = AVER Sweep Count = 0 RF Atten (dB) = 10 Trace Mode = VIEW	M1 : 2410.000 MHz : -3.520 dBm M2 : 13.620 GHz : -66.467 dBm	Limit: -33.52 dBm Margin: -32.95 dB

[back to matrix](#)

This test report may be reproduced in full only. The document may only be updated by MiCOM Labs personnel. All changes will be noted in the Document History section of the report.



Title: Aruba Networks APEX0104
To: FCC CFR 47 Part 15 Subpart C 15.247 & IC RSS-247
Serial #: ARUB199-U3 Rev A
Issue Date: 27th August 2015
Page: 133 of 223

CONDUCTED SPURIOUS EMISSIONS - AVERAGE



Variant: 802.11n HT-40, Channel: 2437.00 MHz, Chain a, Temp: Ambient, Voltage: 48 Vdc

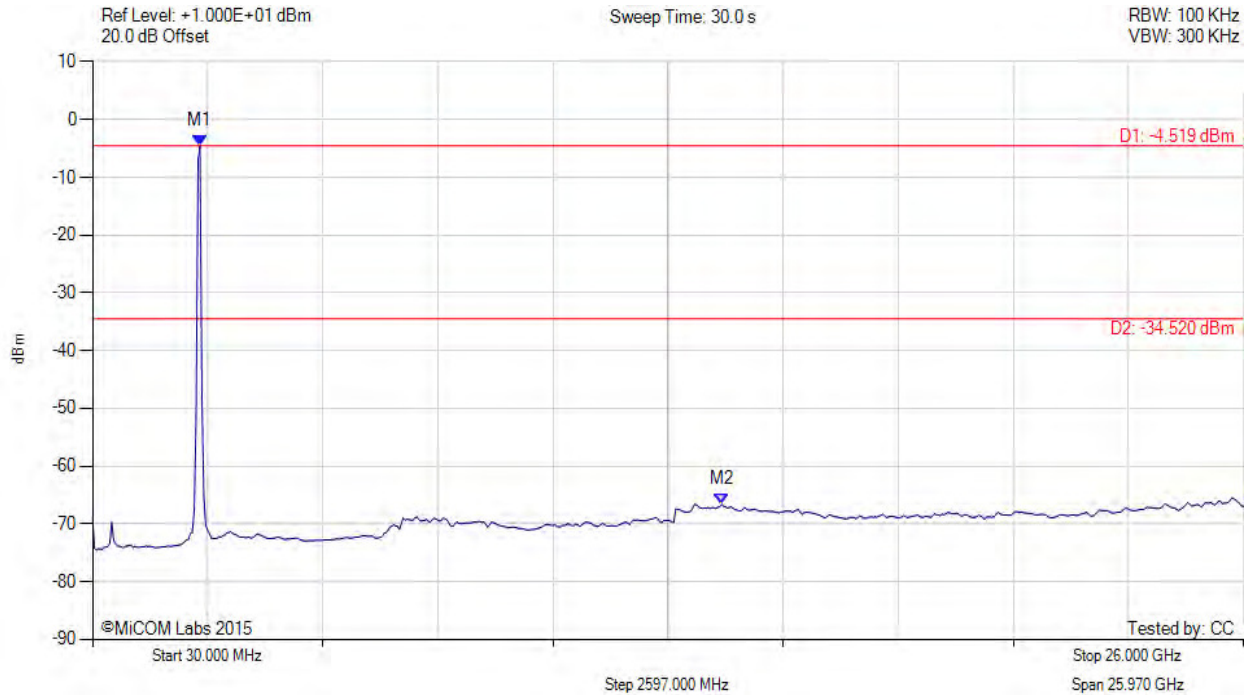

Analyser Setup	Marker:Frequency:Amplitude	Test Results
Detector = AVER Sweep Count = 0 RF Atten (dB) = 10 Trace Mode = VIEW	M1 : 2450.000 MHz : -4.519 dBm M2 : 14.230 GHz : -66.595 dBm	Limit: -34.52 dBm Margin: -32.07 dB

[back to matrix](#)

This test report may be reproduced in full only. The document may only be updated by MiCOM Labs personnel. All changes will be noted in the Document History section of the report.



Title: Aruba Networks APEX0104
To: FCC CFR 47 Part 15 Subpart C 15.247 & IC RSS-247
Serial #: ARUB199-U3 Rev A
Issue Date: 27th August 2015
Page: 134 of 223

CONDUCTED SPURIOUS EMISSIONS - AVERAGE



Variant: 802.11n HT-40, Channel: 2437.00 MHz, Chain b, Temp: Ambient, Voltage: 48 Vdc

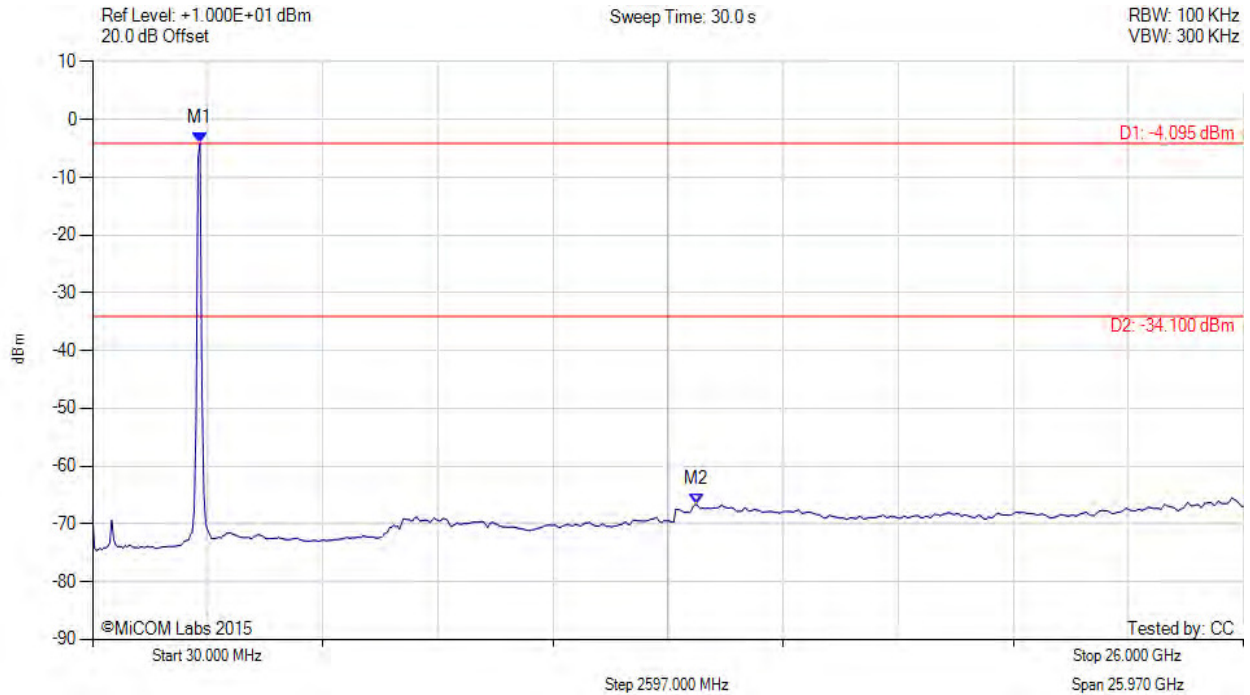

Analyser Setup	Marker:Frequency:Amplitude	Test Results
Detector = AVER Sweep Count = 0 RF Atten (dB) = 10 Trace Mode = VIEW	M1 : 2450.000 MHz : -4.095 dBm M2 : 13.660 GHz : -66.618 dBm	Limit: -34.10 dBm Margin: -32.52 dB

[back to matrix](#)

This test report may be reproduced in full only. The document may only be updated by MiCOM Labs personnel. All changes will be noted in the Document History section of the report.



Title: Aruba Networks APEX0104
To: FCC CFR 47 Part 15 Subpart C 15.247 & IC RSS-247
Serial #: ARUB199-U3 Rev A
Issue Date: 27th August 2015
Page: 135 of 223

CONDUCTED SPURIOUS EMISSIONS - AVERAGE



Variant: 802.11n HT-40, Channel: 2437.00 MHz, Chain c, Temp: Ambient, Voltage: 48 Vdc

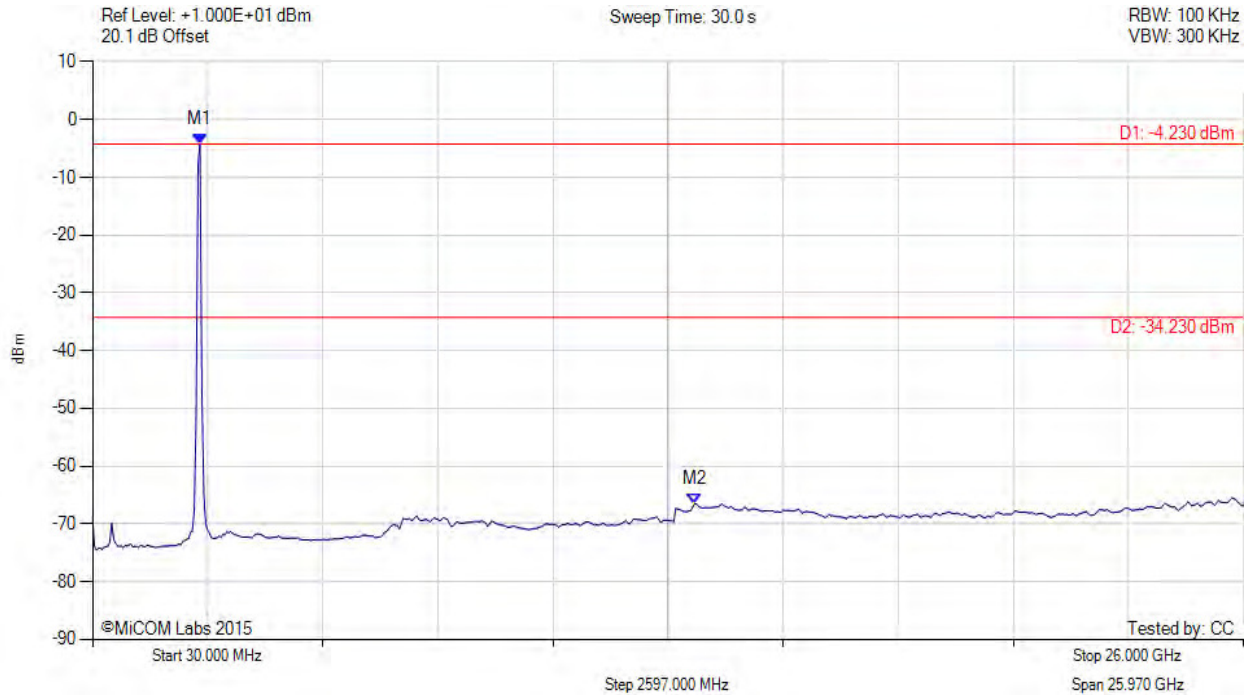

Analyser Setup	Marker:Frequency:Amplitude	Test Results
Detector = AVER Sweep Count = 0 RF Atten (dB) = 10 Trace Mode = VIEW	M1 : 2450.000 MHz : -4.230 dBm M2 : 13.620 GHz : -66.489 dBm	Limit: -34.23 dBm Margin: -32.26 dB

[back to matrix](#)

This test report may be reproduced in full only. The document may only be updated by MiCOM Labs personnel. All changes will be noted in the Document History section of the report.



Title: Aruba Networks APEX0104
To: FCC CFR 47 Part 15 Subpart C 15.247 & IC RSS-247
Serial #: ARUB199-U3 Rev A
Issue Date: 27th August 2015
Page: 136 of 223

CONDUCTED SPURIOUS EMISSIONS - AVERAGE



Variant: 802.11n HT-40, Channel: 2452.00 MHz, Chain a, Temp: Ambient, Voltage: 48 Vdc

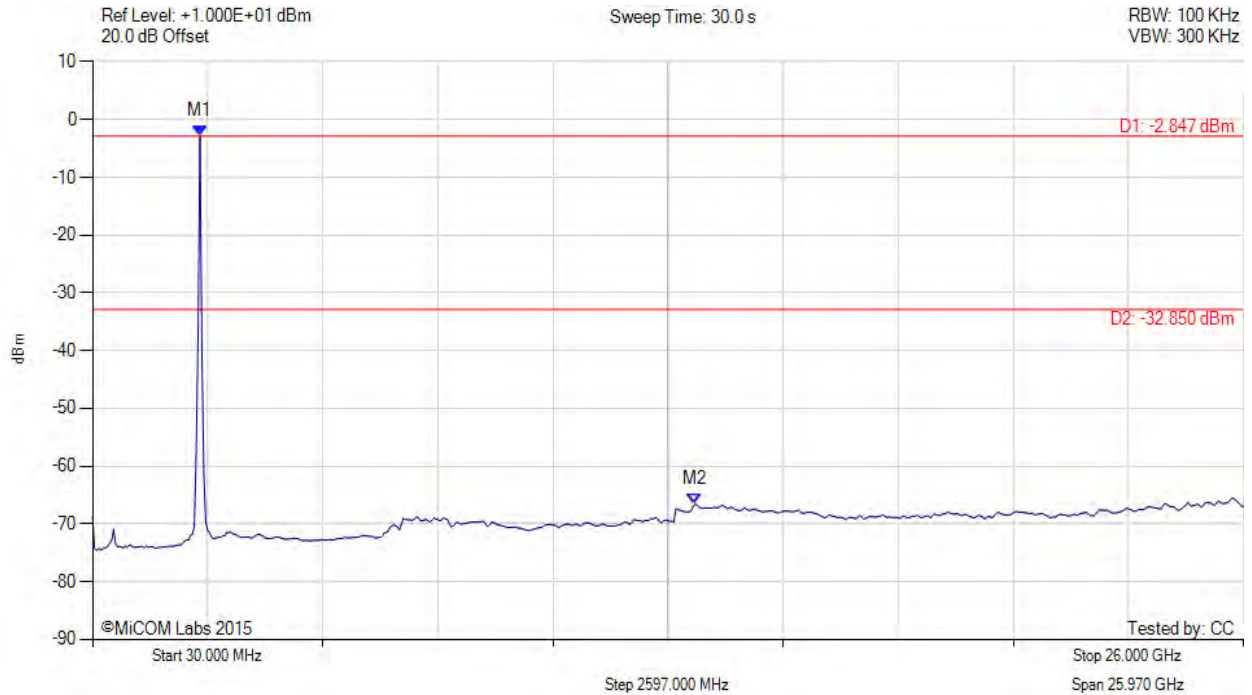

Analyser Setup	Marker:Frequency:Amplitude	Test Results
Detector = AVER Sweep Count = 0 RF Atten (dB) = 10 Trace Mode = VIEW	M1 : 2450.000 MHz : -2.847 dBm M2 : 13.620 GHz : -66.607 dBm	Limit: -32.85 dBm Margin: -33.76 dB

[back to matrix](#)

This test report may be reproduced in full only. The document may only be updated by MiCOM Labs personnel. All changes will be noted in the Document History section of the report.



Title: Aruba Networks APEX0104
To: FCC CFR 47 Part 15 Subpart C 15.247 & IC RSS-247
Serial #: ARUB199-U3 Rev A
Issue Date: 27th August 2015
Page: 137 of 223

CONDUCTED SPURIOUS EMISSIONS - AVERAGE



Variant: 802.11n HT-40, Channel: 2452.00 MHz, Chain b, Temp: Ambient, Voltage: 48 Vdc

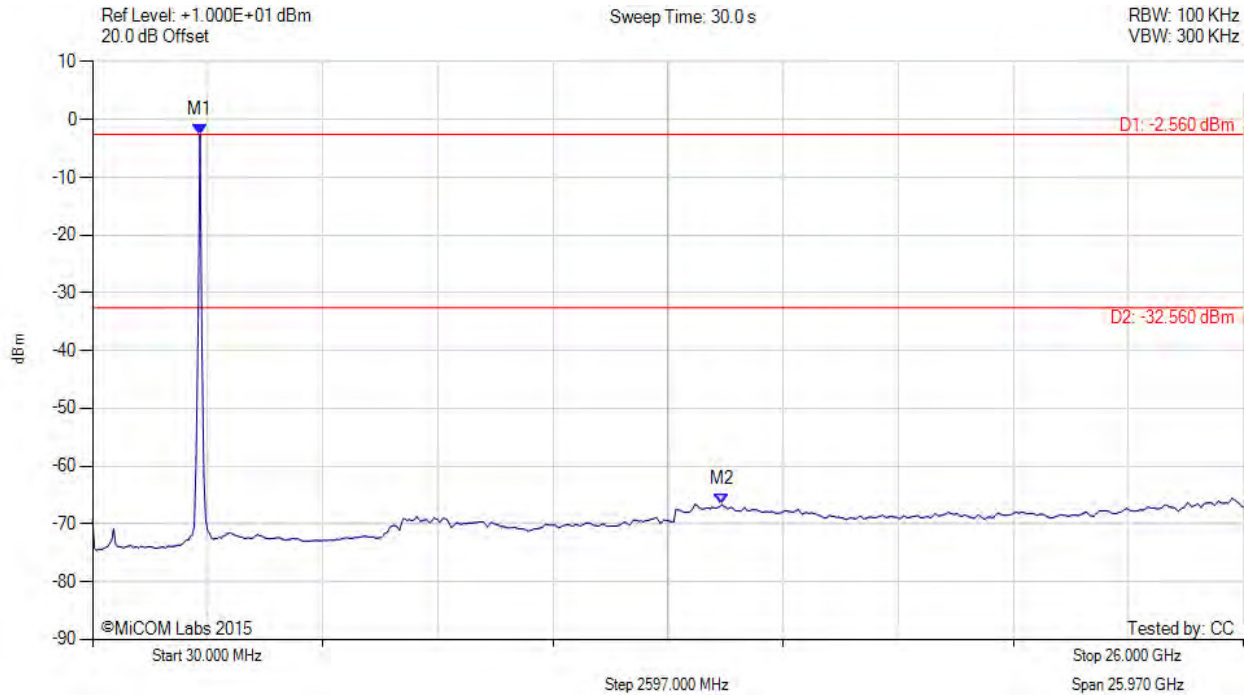

Analyser Setup	Marker:Frequency:Amplitude	Test Results
Detector = AVER Sweep Count = 0 RF Atten (dB) = 10 Trace Mode = VIEW	M1 : 2450.000 MHz : -2.560 dBm M2 : 14.230 GHz : -66.616 dBm	Limit: -32.56 dBm Margin: -34.06 dB

[back to matrix](#)

This test report may be reproduced in full only. The document may only be updated by MiCOM Labs personnel. All changes will be noted in the Document History section of the report.



Title: Aruba Networks APEX0104
To: FCC CFR 47 Part 15 Subpart C 15.247 & IC RSS-247
Serial #: ARUB199-U3 Rev A
Issue Date: 27th August 2015
Page: 138 of 223

CONDUCTED SPURIOUS EMISSIONS - AVERAGE



Variant: 802.11n HT-40, Channel: 2452.00 MHz, Chain c, Temp: Ambient, Voltage: 48 Vdc

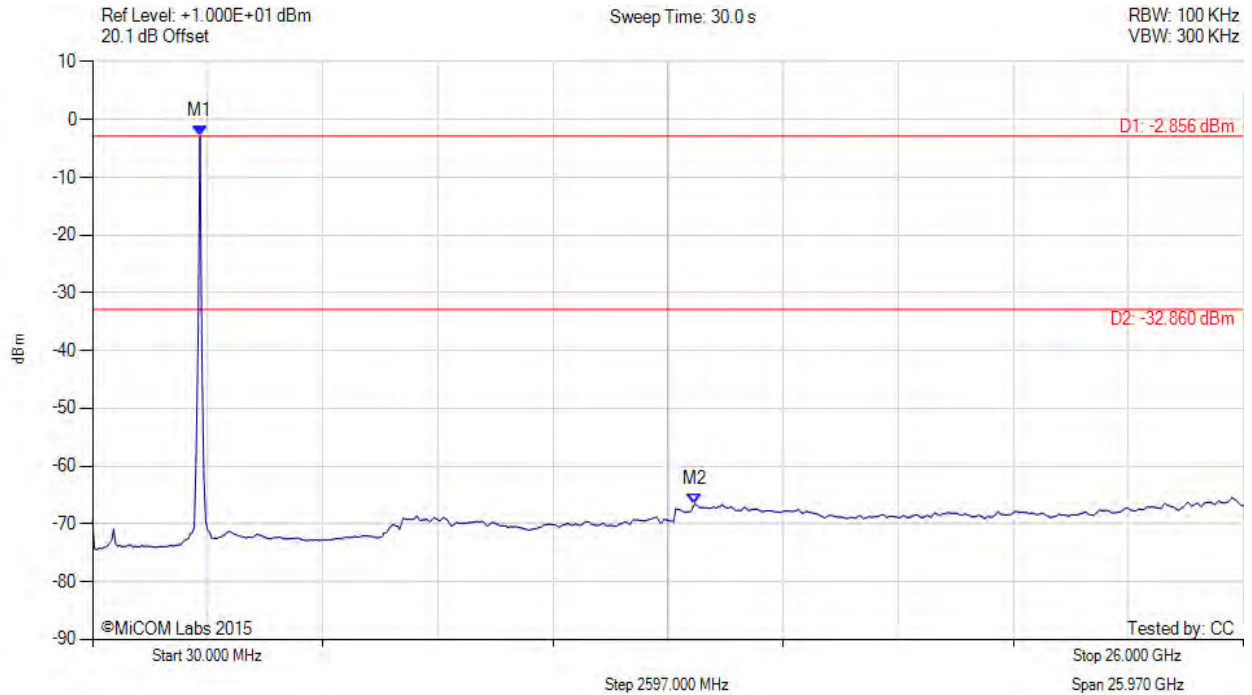

Analyser Setup	Marker:Frequency:Amplitude	Test Results
Detector = AVER Sweep Count = 0 RF Atten (dB) = 10 Trace Mode = VIEW	M1 : 2450.000 MHz : -2.856 dBm M2 : 13.620 GHz : -66.548 dBm	Limit: -32.86 dBm Margin: -33.69 dB

[back to matrix](#)

This test report may be reproduced in full only. The document may only be updated by MiCOM Labs personnel. All changes will be noted in the Document History section of the report.



A.2.2. Conducted Band-Edge Emissions

CONDUCTED LOW BAND-EDGE EMISSIONS - AVERAGE



Variant: 802.11b, Channel: 2412.00 MHz, Chain a, Temp: Ambient, Voltage: 48 Vdc

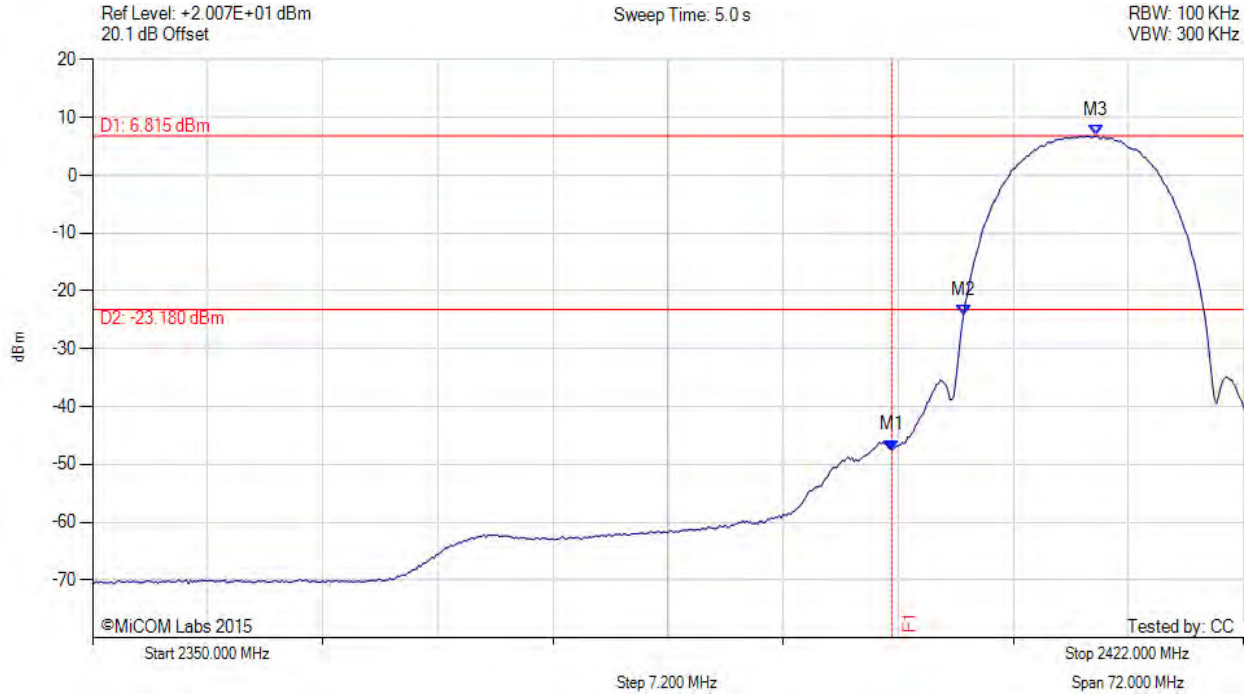

Analyser Setup	Marker:Frequency:Amplitude	Test Results
Detector = AVER Sweep Count = 0 RF Atten (dB) = 10 Trace Mode = VIEW	M1 : 2400.000 MHz : -47.536 dBm M2 : 2404.480 MHz : -24.255 dBm M3 : 2412.760 MHz : 6.815 dBm	Channel Frequency: 2412.00 MHz

[back to matrix](#)

This test report may be reproduced in full only. The document may only be updated by MiCOM Labs personnel. All changes will be noted in the Document History section of the report.



Title: Aruba Networks APEX0104
To: FCC CFR 47 Part 15 Subpart C 15.247 & IC RSS-247
Serial #: ARUB199-U3 Rev A
Issue Date: 27th August 2015
Page: 140 of 223

CONDUCTED LOW BAND-EDGE EMISSIONS - AVERAGE



Variant: 802.11b, Channel: 2412.00 MHz, Chain b, Temp: Ambient, Voltage: 48 Vdc

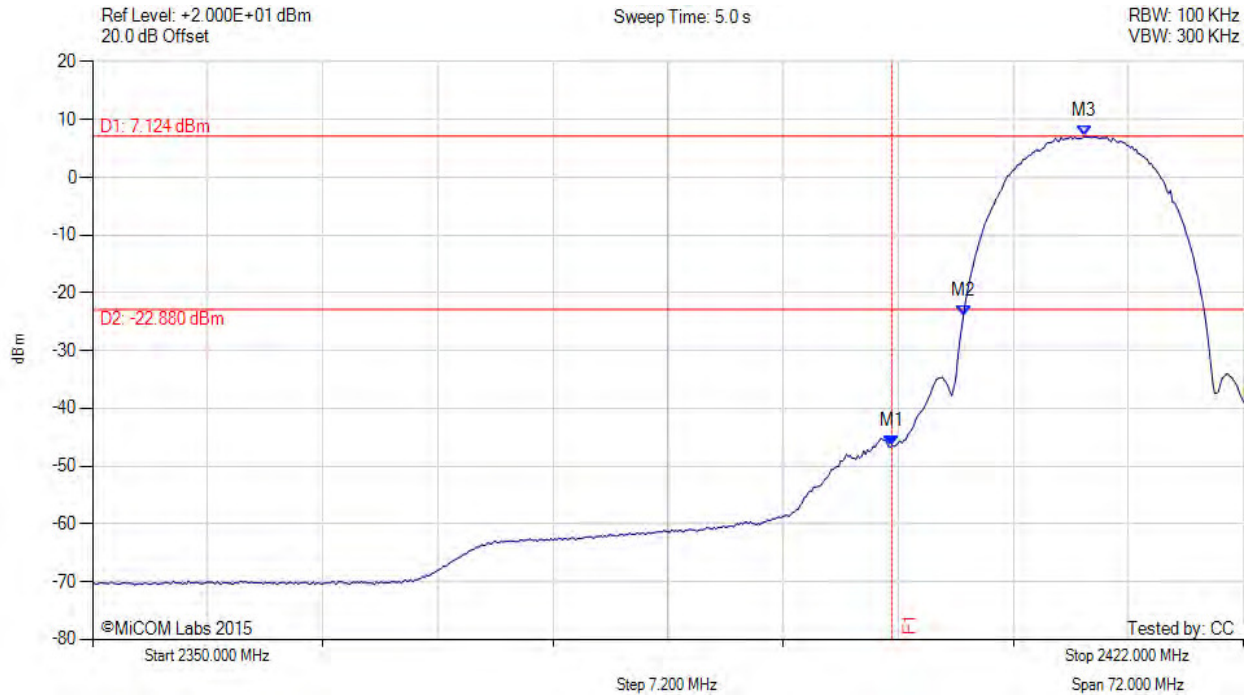

Analyser Setup	Marker:Frequency:Amplitude	Test Results
Detector = AVER Sweep Count = 0 RF Atten (dB) = 10 Trace Mode = VIEW	M1 : 2400.000 MHz : -46.531 dBm M2 : 2404.480 MHz : -23.959 dBm M3 : 2412.040 MHz : 7.124 dBm	Channel Frequency: 2412.00 MHz

[back to matrix](#)

This test report may be reproduced in full only. The document may only be updated by MiCOM Labs personnel. All changes will be noted in the Document History section of the report.



Title: Aruba Networks APEX0104
To: FCC CFR 47 Part 15 Subpart C 15.247 & IC RSS-247
Serial #: ARUB199-U3 Rev A
Issue Date: 27th August 2015
Page: 141 of 223

CONDUCTED LOW BAND-EDGE EMISSIONS - AVERAGE



Variant: 802.11b, Channel: 2412.00 MHz, Chain c, Temp: Ambient, Voltage: 48 Vdc

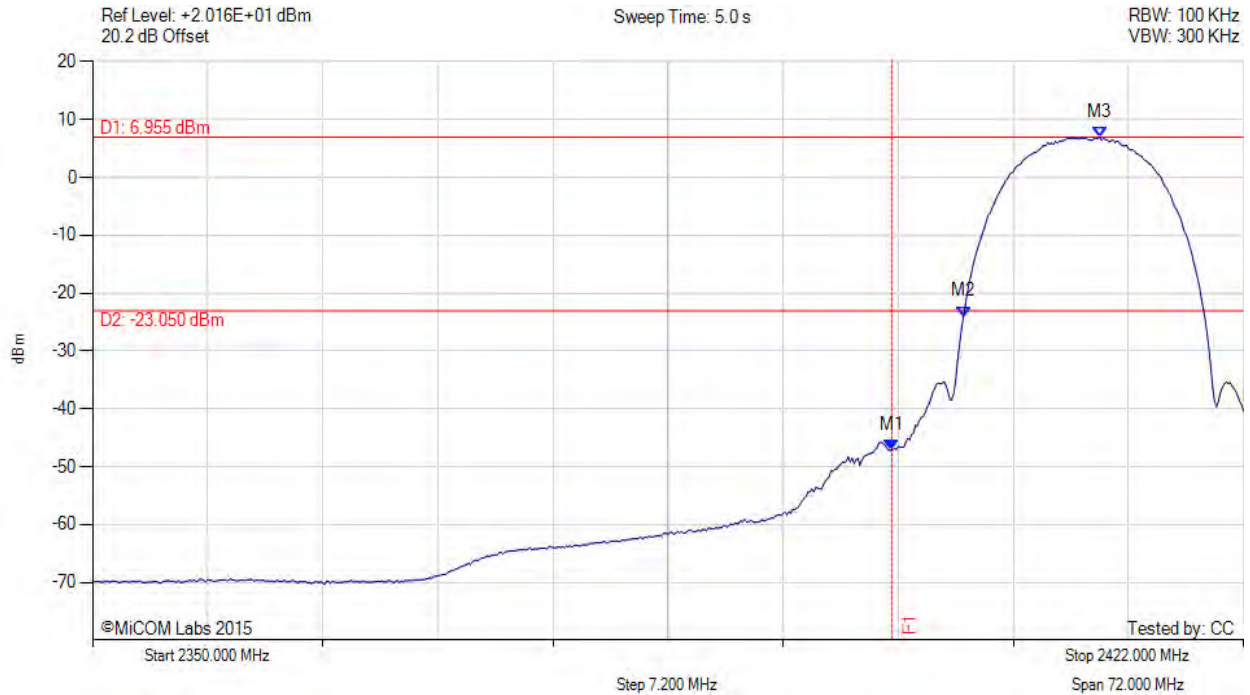

Analyser Setup	Marker:Frequency:Amplitude	Test Results
Detector = AVER Sweep Count = 0 RF Atten (dB) = 10 Trace Mode = VIEW	M1 : 2400.000 MHz : -47.134 dBm M2 : 2404.480 MHz : -24.047 dBm M3 : 2413.000 MHz : 6.955 dBm	Channel Frequency: 2412.00 MHz

[back to matrix](#)

This test report may be reproduced in full only. The document may only be updated by MiCOM Labs personnel. All changes will be noted in the Document History section of the report.



Title: Aruba Networks APEX0104
To: FCC CFR 47 Part 15 Subpart C 15.247 & IC RSS-247
Serial #: ARUB199-U3 Rev A
Issue Date: 27th August 2015
Page: 142 of 223

CONDUCTED LOW BAND-EDGE EMISSIONS - AVERAGE



Variant: 802.11g, Channel: 2412.00 MHz, Chain a, Temp: Ambient, Voltage: 48 Vdc

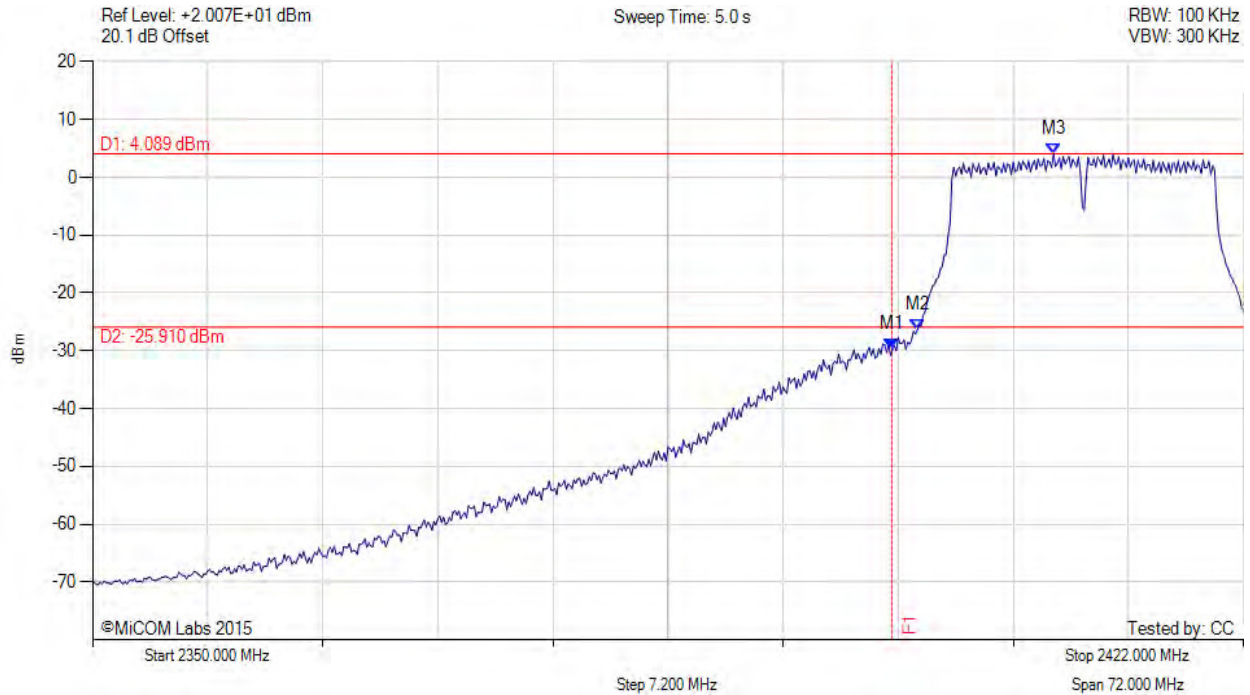

Analyser Setup	Marker:Frequency:Amplitude	Test Results
Detector = AVER Sweep Count = 0 RF Atten (dB) = 10 Trace Mode = VIEW	M1 : 2400.000 MHz : -29.790 dBm M2 : 2401.600 MHz : -26.400 dBm M3 : 2410.120 MHz : 4.089 dBm	Channel Frequency: 2412.00 MHz

[back to matrix](#)

This test report may be reproduced in full only. The document may only be updated by MiCOM Labs personnel. All changes will be noted in the Document History section of the report.



Title: Aruba Networks APEX0104
To: FCC CFR 47 Part 15 Subpart C 15.247 & IC RSS-247
Serial #: ARUB199-U3 Rev A
Issue Date: 27th August 2015
Page: 143 of 223

CONDUCTED LOW BAND-EDGE EMISSIONS - AVERAGE



Variant: 802.11g, Channel: 2412.00 MHz, Chain b, Temp: Ambient, Voltage: 48 Vdc

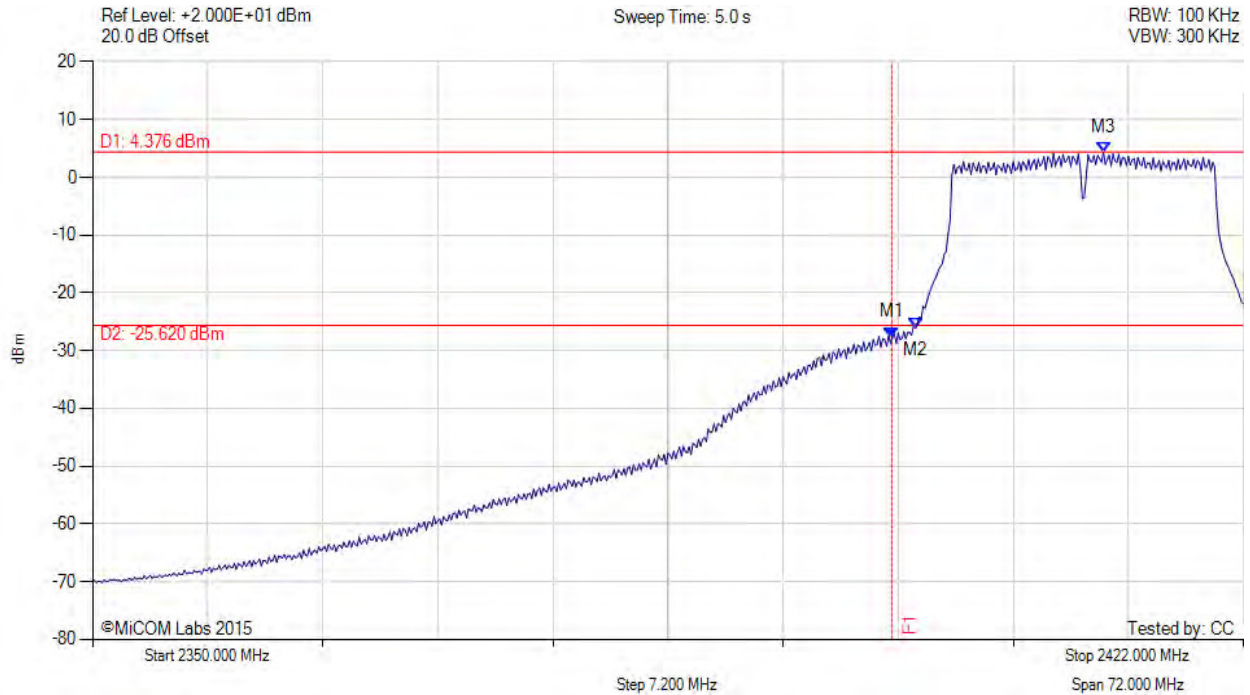

Analyser Setup	Marker:Frequency:Amplitude	Test Results
Detector = AVER Sweep Count = 0 RF Atten (dB) = 10 Trace Mode = VIEW	M1 : 2400.000 MHz : -27.724 dBm M2 : 2401.480 MHz : -26.140 dBm M3 : 2413.240 MHz : 4.376 dBm	Channel Frequency: 2412.00 MHz

[back to matrix](#)

This test report may be reproduced in full only. The document may only be updated by MiCOM Labs personnel. All changes will be noted in the Document History section of the report.



Title: Aruba Networks APEX0104
To: FCC CFR 47 Part 15 Subpart C 15.247 & IC RSS-247
Serial #: ARUB199-U3 Rev A
Issue Date: 27th August 2015
Page: 144 of 223

CONDUCTED LOW BAND-EDGE EMISSIONS - AVERAGE



Variant: 802.11g, Channel: 2412.00 MHz, Chain c, Temp: Ambient, Voltage: 48 Vdc

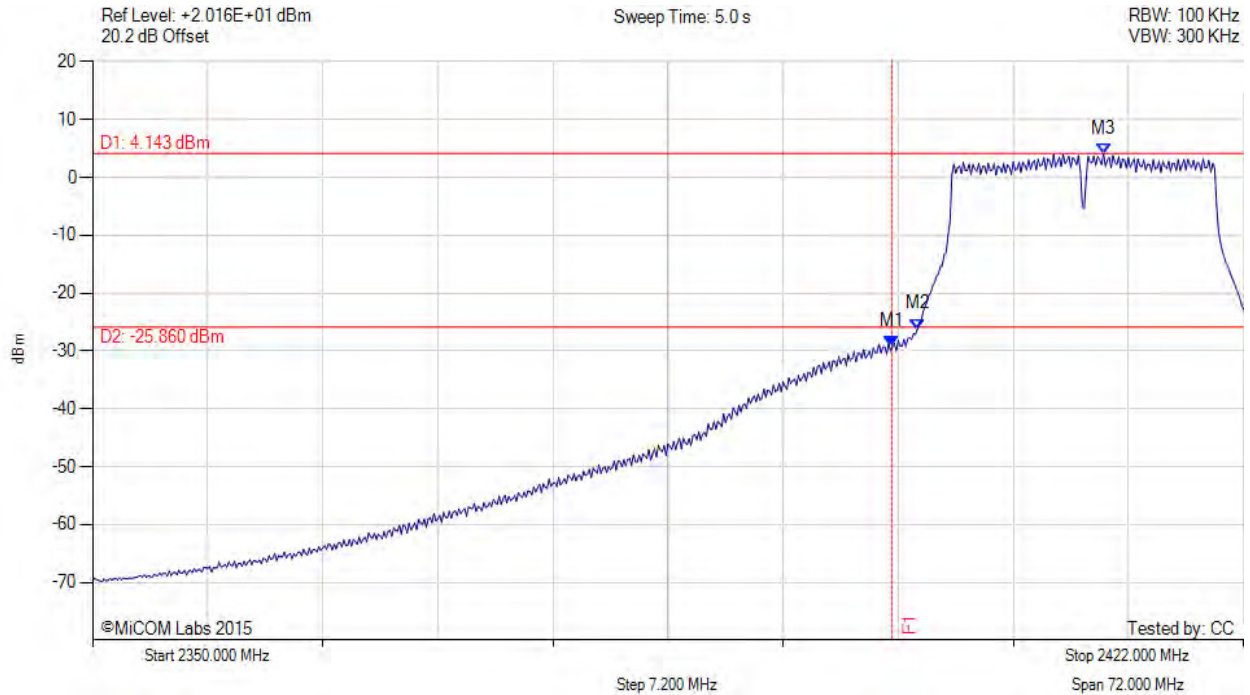

Analyser Setup	Marker:Frequency:Amplitude	Test Results
Detector = AVER Sweep Count = 0 RF Atten (dB) = 10 Trace Mode = VIEW	M1 : 2400.000 MHz : -29.228 dBm M2 : 2401.600 MHz : -26.214 dBm M3 : 2413.240 MHz : 4.143 dBm	Channel Frequency: 2412.00 MHz

[back to matrix](#)

This test report may be reproduced in full only. The document may only be updated by MiCOM Labs personnel. All changes will be noted in the Document History section of the report.



Title: Aruba Networks APEX0104
To: FCC CFR 47 Part 15 Subpart C 15.247 & IC RSS-247
Serial #: ARUB199-U3 Rev A
Issue Date: 27th August 2015
Page: 145 of 223

CONDUCTED LOW BAND-EDGE EMISSIONS - AVERAGE



Variant: 802.11n HT-20, Channel: 2412.00 MHz, Chain a, Temp: Ambient, Voltage: 48 Vdc

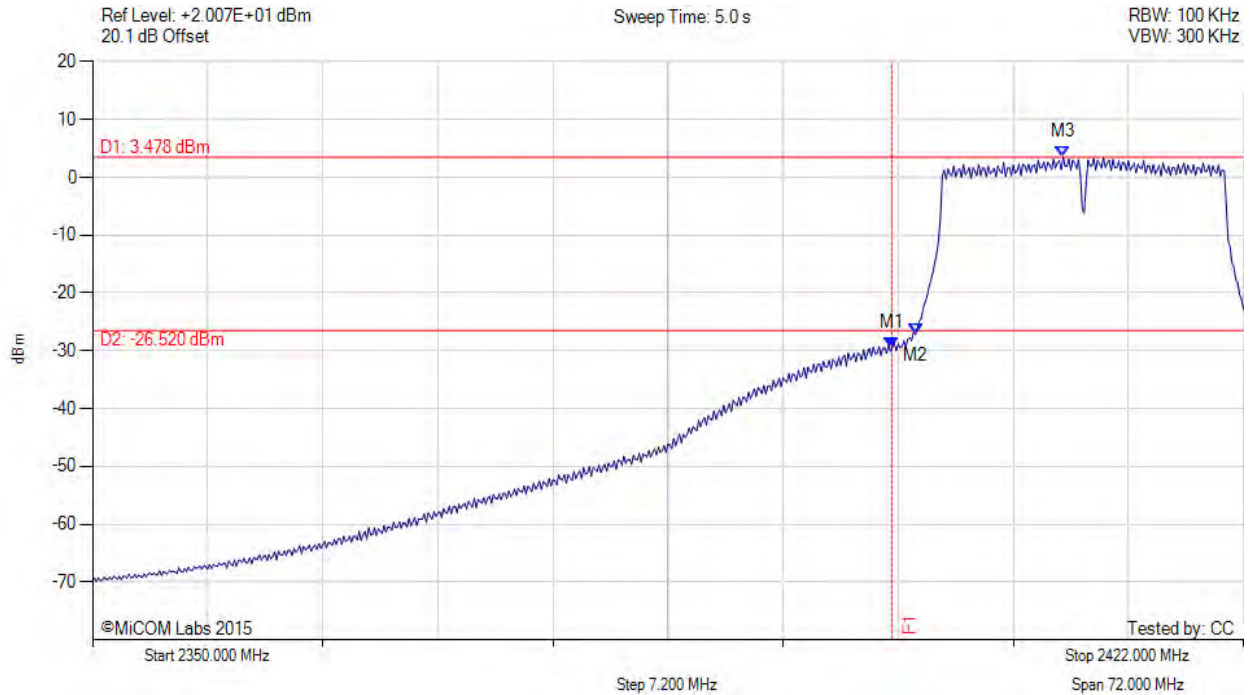

Analyser Setup	Marker:Frequency:Amplitude	Test Results
Detector = AVER Sweep Count = 0 RF Atten (dB) = 10 Trace Mode = VIEW	M1 : 2400.000 MHz : -29.426 dBm M2 : 2401.480 MHz : -27.144 dBm M3 : 2410.720 MHz : 3.478 dBm	Channel Frequency: 2412.00 MHz

[back to matrix](#)

This test report may be reproduced in full only. The document may only be updated by MiCOM Labs personnel. All changes will be noted in the Document History section of the report.



Title: Aruba Networks APEX0104
To: FCC CFR 47 Part 15 Subpart C 15.247 & IC RSS-247
Serial #: ARUB199-U3 Rev A
Issue Date: 27th August 2015
Page: 146 of 223

CONDUCTED LOW BAND-EDGE EMISSIONS - AVERAGE



Variant: 802.11n HT-20, Channel: 2412.00 MHz, Chain b, Temp: Ambient, Voltage: 48 Vdc

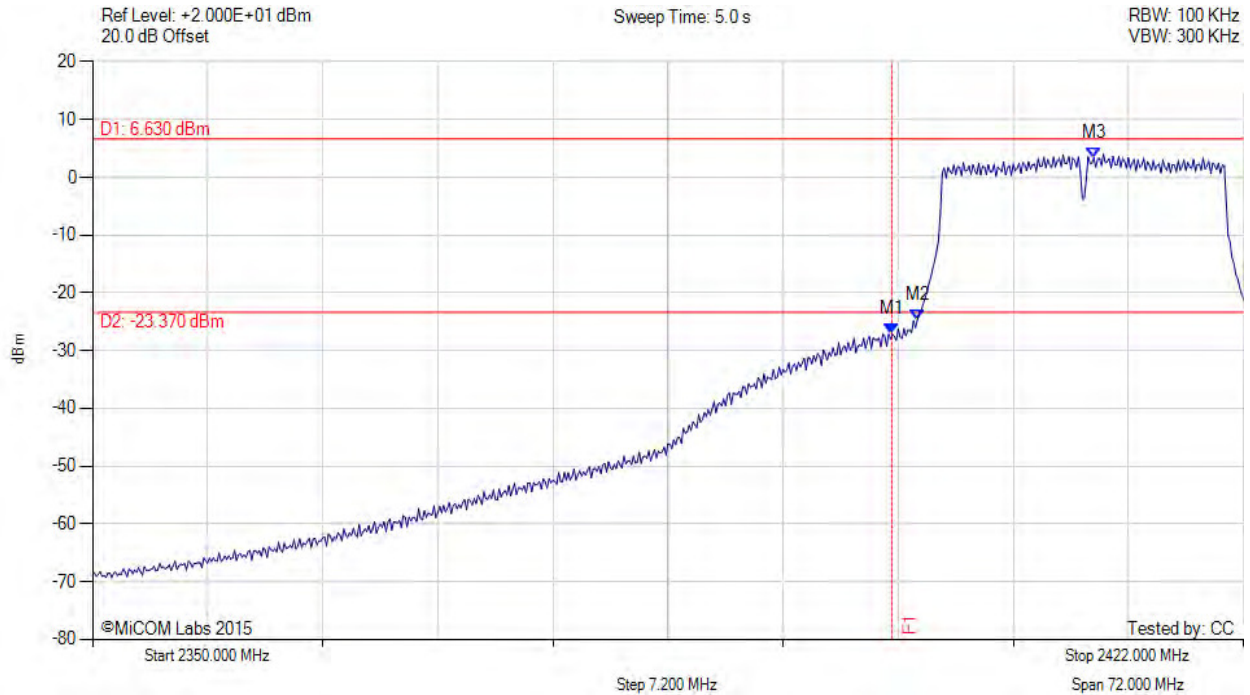

Analyser Setup	Marker:Frequency:Amplitude	Test Results
Detector = AVER Sweep Count = 0 RF Atten (dB) = 10 Trace Mode = VIEW	M1 : 2400.000 MHz : -27.193 dBm M2 : 2401.600 MHz : -24.769 dBm M3 : 2412.640 MHz : 3.4 dBm	Channel Frequency: 2412.00 MHz

[back to matrix](#)

This test report may be reproduced in full only. The document may only be updated by MiCOM Labs personnel. All changes will be noted in the Document History section of the report.



Title: Aruba Networks APEX0104
To: FCC CFR 47 Part 15 Subpart C 15.247 & IC RSS-247
Serial #: ARUB199-U3 Rev A
Issue Date: 27th August 2015
Page: 147 of 223

CONDUCTED LOW BAND-EDGE EMISSIONS - AVERAGE



Variant: 802.11n HT-20, Channel: 2412.00 MHz, Chain c, Temp: Ambient, Voltage: 48 Vdc

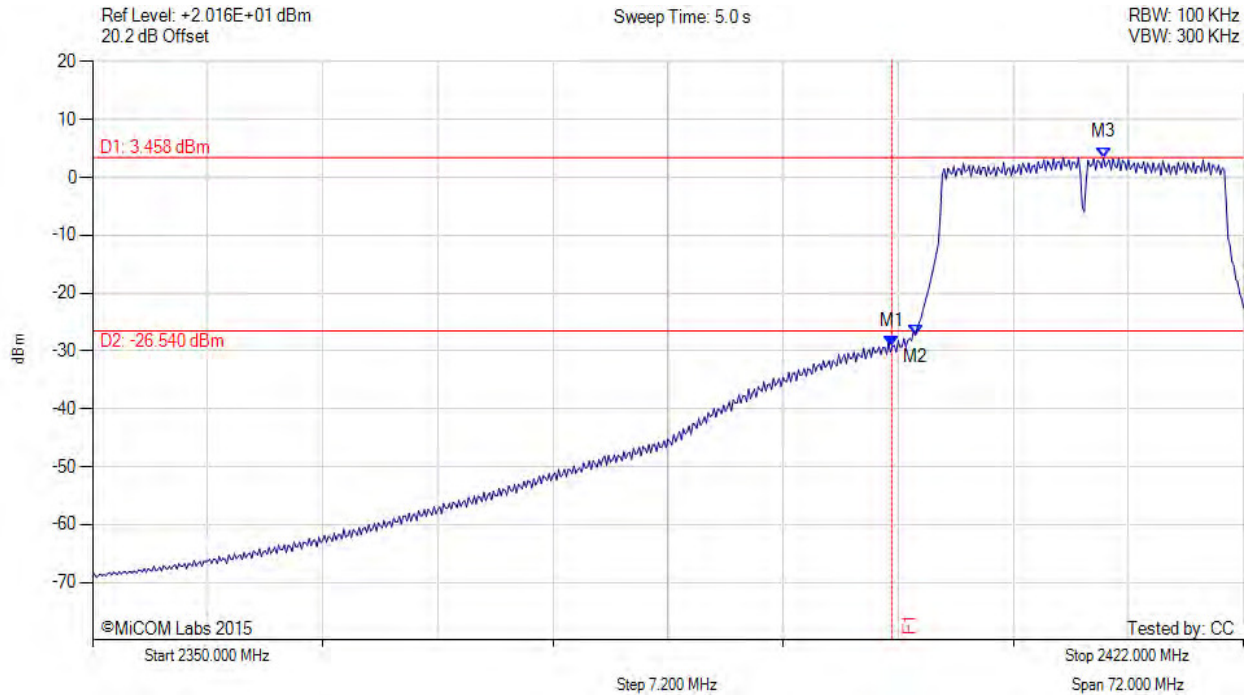

Analyser Setup	Marker:Frequency:Amplitude	Test Results
Detector = AVER Sweep Count = 0 RF Atten (dB) = 10 Trace Mode = VIEW	M1 : 2400.000 MHz : -29.173 dBm M2 : 2401.480 MHz : -27.282 dBm M3 : 2413.240 MHz : 3.458 dBm	Channel Frequency: 2412.00 MHz

[back to matrix](#)

This test report may be reproduced in full only. The document may only be updated by MiCOM Labs personnel. All changes will be noted in the Document History section of the report.



CONDUCTED LOW BAND-EDGE EMISSIONS - AVERAGE



Variant: 802.11n HT-40, Channel: 2422.00 MHz, Chain a, Temp: Ambient, Voltage: 48 Vdc

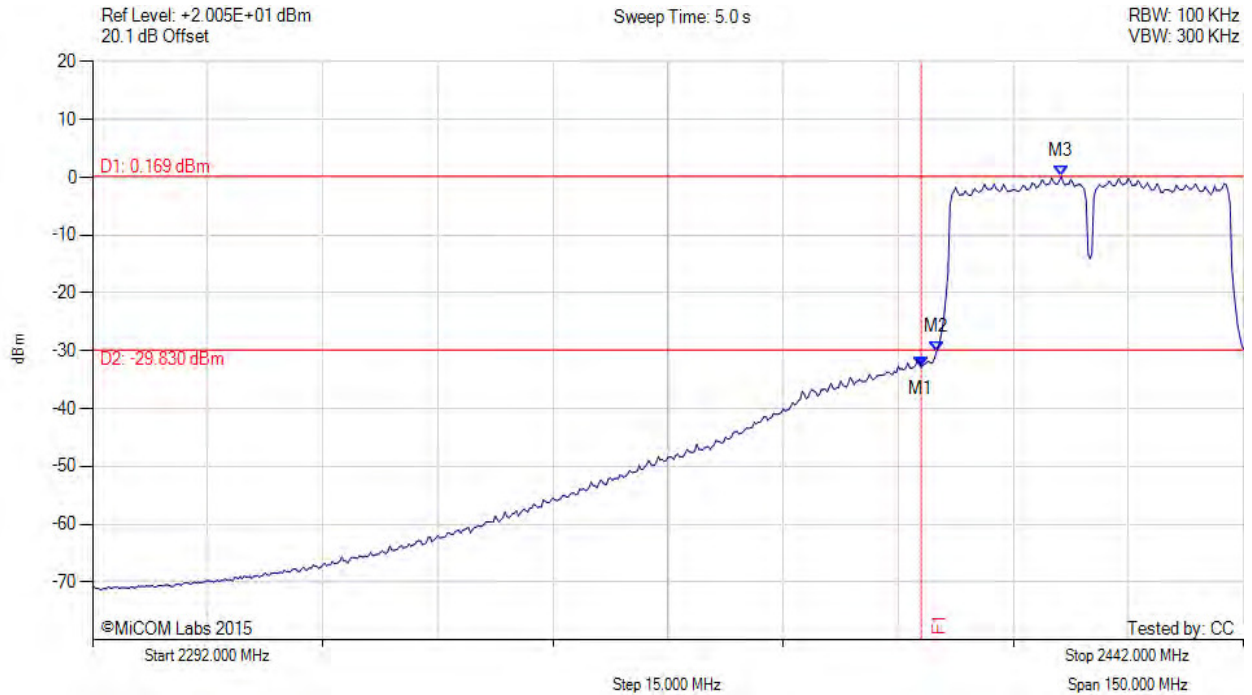

Analyser Setup	Marker:Frequency:Amplitude	Test Results
Detector = AVER Sweep Count = 0 RF Atten (dB) = 10 Trace Mode = VIEW	M1 : 2400.000 MHz : -32.919 dBm M2 : 2402.000 MHz : -30.125 dBm M3 : 2418.250 MHz : 0.169 dBm	Channel Frequency: 2422.00 MHz

[back to matrix](#)

This test report may be reproduced in full only. The document may only be updated by MiCOM Labs personnel. All changes will be noted in the Document History section of the report.



Title: Aruba Networks APEX0104
To: FCC CFR 47 Part 15 Subpart C 15.247 & IC RSS-247
Serial #: ARUB199-U3 Rev A
Issue Date: 27th August 2015
Page: 149 of 223

CONDUCTED LOW BAND-EDGE EMISSIONS - AVERAGE



Variant: 802.11n HT-40, Channel: 2422.00 MHz, Chain b, Temp: Ambient, Voltage: 48 Vdc

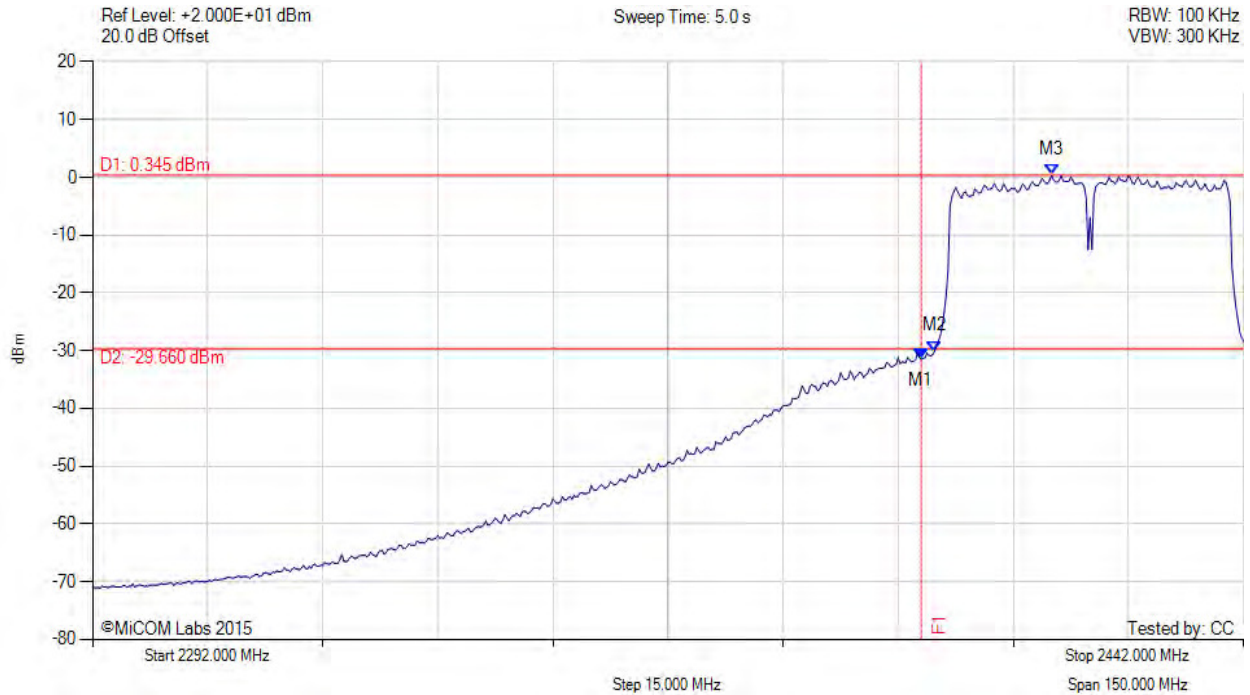

Analyser Setup	Marker:Frequency:Amplitude	Test Results
Detector = AVER Sweep Count = 0 RF Atten (dB) = 10 Trace Mode = VIEW	M1 : 2400.000 MHz : -31.485 dBm M2 : 2401.750 MHz : -30.093 dBm M3 : 2417.000 MHz : 0.345 dBm	Channel Frequency: 2422.00 MHz

[back to matrix](#)

This test report may be reproduced in full only. The document may only be updated by MiCOM Labs personnel. All changes will be noted in the Document History section of the report.



Title: Aruba Networks APEX0104
To: FCC CFR 47 Part 15 Subpart C 15.247 & IC RSS-247
Serial #: ARUB199-U3 Rev A
Issue Date: 27th August 2015
Page: 150 of 223

CONDUCTED LOW BAND-EDGE EMISSIONS - AVERAGE



Variant: 802.11n HT-40, Channel: 2422.00 MHz, Chain c, Temp: Ambient, Voltage: 48 Vdc

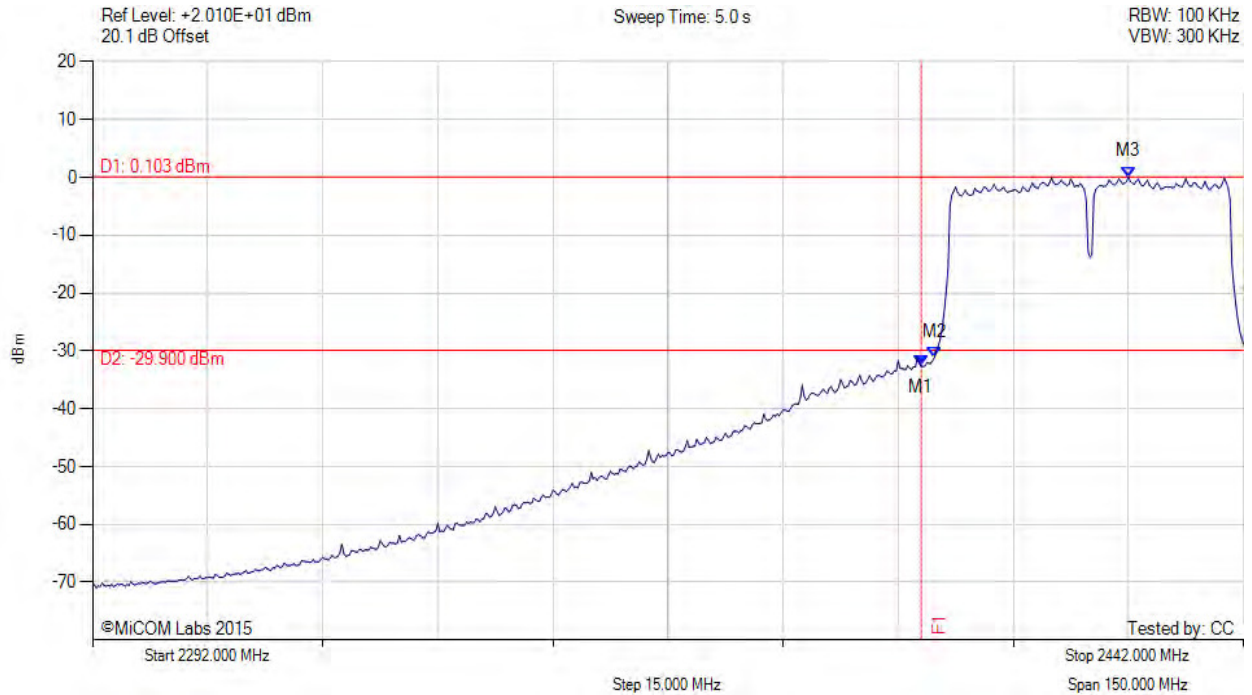

Analyser Setup	Marker:Frequency:Amplitude	Test Results
Detector = AVER Sweep Count = 0 RF Atten (dB) = 10 Trace Mode = VIEW	M1 : 2400.000 MHz : -32.653 dBm M2 : 2401.750 MHz : -31.095 dBm M3 : 2427.000 MHz : 0.103 dBm	Channel Frequency: 2422.00 MHz

[back to matrix](#)

This test report may be reproduced in full only. The document may only be updated by MiCOM Labs personnel. All changes will be noted in the Document History section of the report.



Title: Aruba Networks APEX0104
To: FCC CFR 47 Part 15 Subpart C 15.247 & IC RSS-247
Serial #: ARUB199-U3 Rev A
Issue Date: 27th August 2015
Page: 151 of 223

CONDUCTED HIGH BAND-EDGE EMISSIONS - AVERAGE



Variant: 802.11b, Channel: 2462.00 MHz, Chain a, Temp: Ambient, Voltage: 48 Vdc

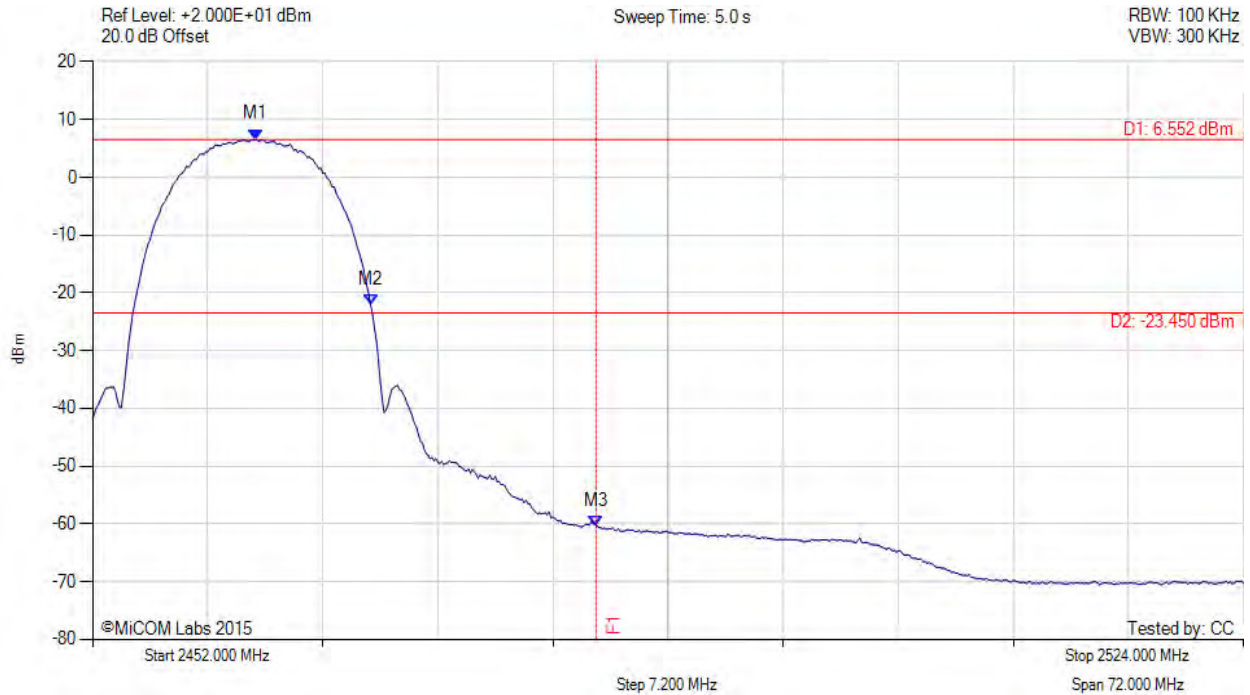

Analyser Setup	Marker:Frequency:Amplitude	Test Results
Detector = AVER Sweep Count = 0 RF Atten (dB) = 10 Trace Mode = VIEW	M1 : 2462.200 MHz : 6.552 dBm M2 : 2469.400 MHz : -22.078 dBm M3 : 2483.500 MHz : -60.342 dBm	Channel Frequency: 2462.00 MHz

[back to matrix](#)

This test report may be reproduced in full only. The document may only be updated by MiCOM Labs personnel. All changes will be noted in the Document History section of the report.



Title: Aruba Networks APEX0104
To: FCC CFR 47 Part 15 Subpart C 15.247 & IC RSS-247
Serial #: ARUB199-U3 Rev A
Issue Date: 27th August 2015
Page: 152 of 223

CONDUCTED HIGH BAND-EDGE EMISSIONS - AVERAGE



Variant: 802.11b, Channel: 2462.00 MHz, Chain b, Temp: Ambient, Voltage: 48 Vdc

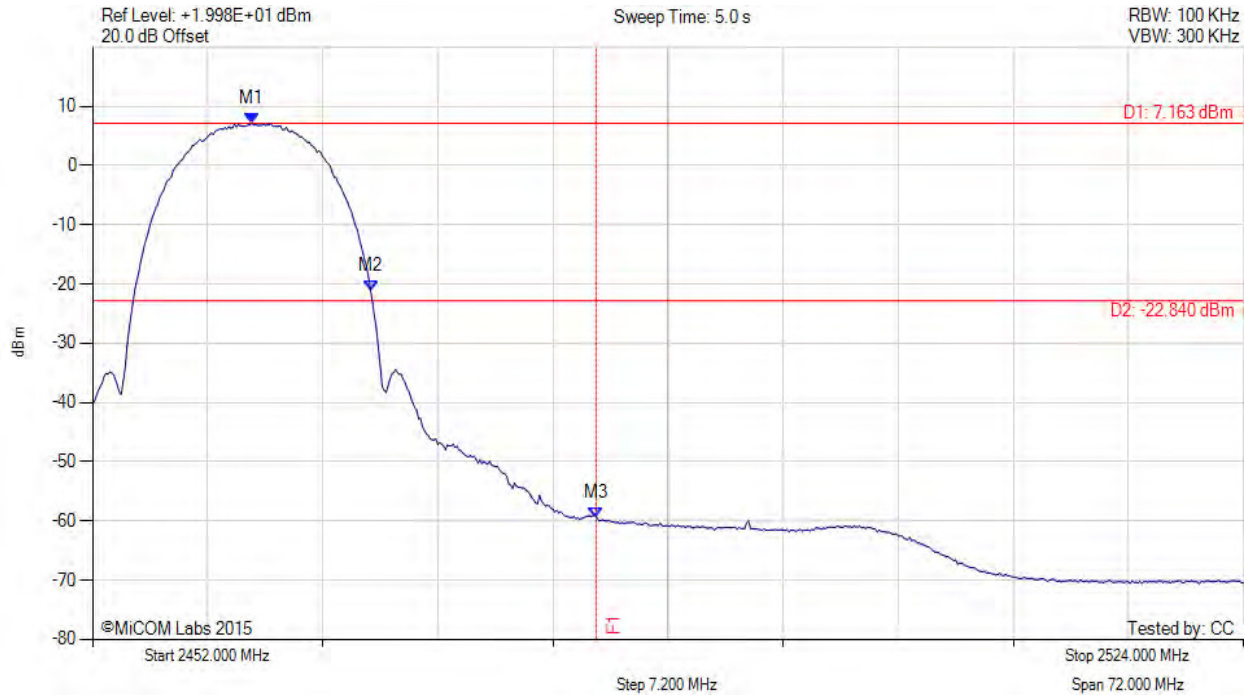

Analyser Setup	Marker:Frequency:Amplitude	Test Results
Detector = AVER Sweep Count = 0 RF Atten (dB) = 10 Trace Mode = VIEW	M1 : 2461.960 MHz : 7.163 dBm M2 : 2469.400 MHz : -21.161 dBm M3 : 2483.500 MHz : -59.519 dBm	Channel Frequency: 2462.00 MHz

[back to matrix](#)

This test report may be reproduced in full only. The document may only be updated by MiCOM Labs personnel. All changes will be noted in the Document History section of the report.



Title: Aruba Networks APEX0104
To: FCC CFR 47 Part 15 Subpart C 15.247 & IC RSS-247
Serial #: ARUB199-U3 Rev A
Issue Date: 27th August 2015
Page: 153 of 223

CONDUCTED HIGH BAND-EDGE EMISSIONS - AVERAGE



Variant: 802.11b, Channel: 2462.00 MHz, Chain c, Temp: Ambient, Voltage: 48 Vdc

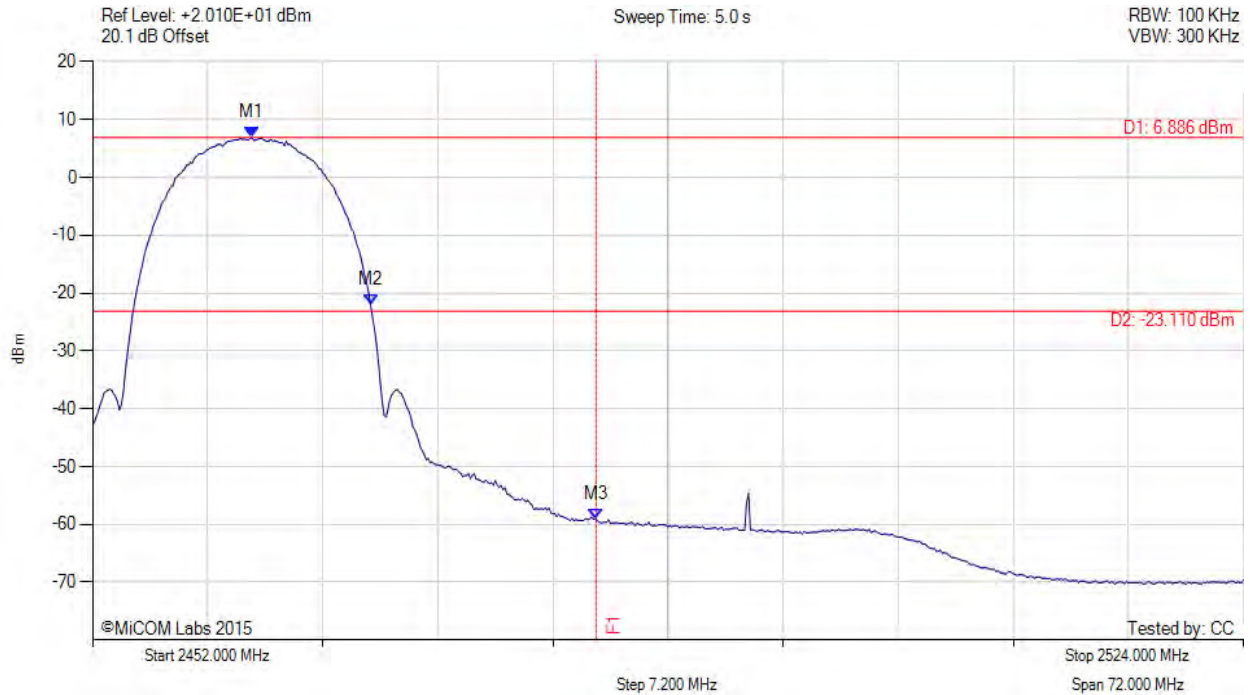

Analyser Setup	Marker:Frequency:Amplitude	Test Results
Detector = AVER Sweep Count = 0 RF Atten (dB) = 10 Trace Mode = VIEW	M1 : 2461.960 MHz : 6.886 dBm M2 : 2469.400 MHz : -22.052 dBm M3 : 2483.500 MHz : -59.237 dBm	Channel Frequency: 2462.00 MHz

[back to matrix](#)

This test report may be reproduced in full only. The document may only be updated by MiCOM Labs personnel. All changes will be noted in the Document History section of the report.



Title: Aruba Networks APEX0104
To: FCC CFR 47 Part 15 Subpart C 15.247 & IC RSS-247
Serial #: ARUB199-U3 Rev A
Issue Date: 27th August 2015
Page: 154 of 223

CONDUCTED HIGH BAND-EDGE EMISSIONS - AVERAGE



Variant: 802.11g, Channel: 2462.00 MHz, Chain a, Temp: Ambient, Voltage: 48 Vdc

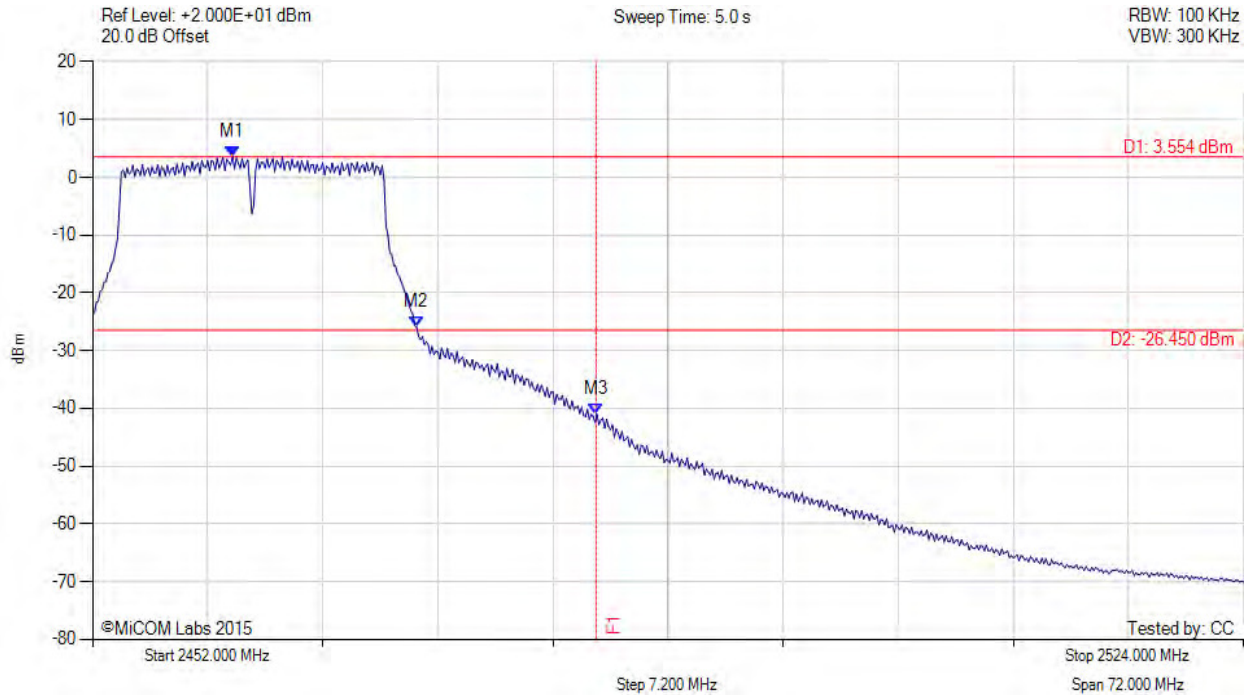

Analyser Setup	Marker:Frequency:Amplitude	Test Results
Detector = AVER Sweep Count = 0 RF Atten (dB) = 10 Trace Mode = VIEW	M1 : 2460.760 MHz : 3.554 dBm M2 : 2472.280 MHz : -25.951 dBm M3 : 2483.500 MHz : -41.004 dBm	Channel Frequency: 2462.00 MHz

[back to matrix](#)

This test report may be reproduced in full only. The document may only be updated by MiCOM Labs personnel. All changes will be noted in the Document History section of the report.



Title: Aruba Networks APEX0104
To: FCC CFR 47 Part 15 Subpart C 15.247 & IC RSS-247
Serial #: ARUB199-U3 Rev A
Issue Date: 27th August 2015
Page: 155 of 223

CONDUCTED HIGH BAND-EDGE EMISSIONS - AVERAGE



Variant: 802.11g, Channel: 2462.00 MHz, Chain b, Temp: Ambient, Voltage: 48 Vdc

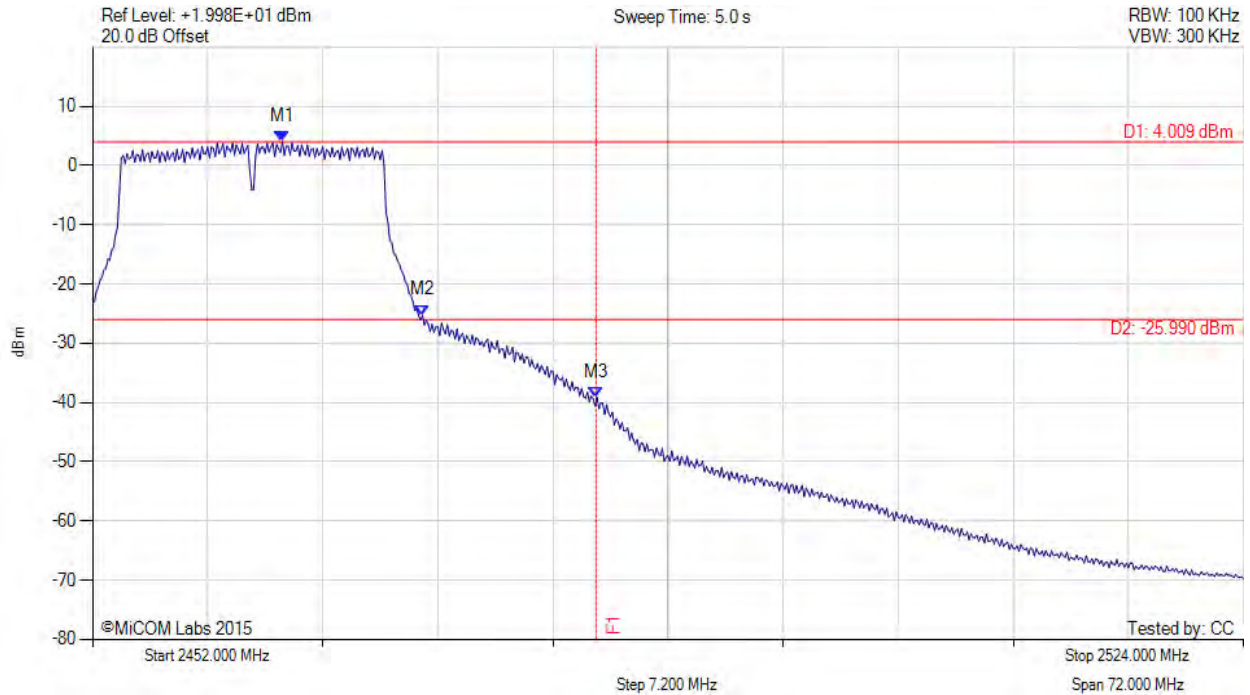

Analyser Setup	Marker:Frequency:Amplitude	Test Results
Detector = AVER Sweep Count = 0 RF Atten (dB) = 10 Trace Mode = VIEW	M1 : 2463.880 MHz : 4.009 dBm M2 : 2472.640 MHz : -25.273 dBm M3 : 2483.500 MHz : -39.147 dBm	Channel Frequency: 2462.00 MHz

[back to matrix](#)

This test report may be reproduced in full only. The document may only be updated by MiCOM Labs personnel. All changes will be noted in the Document History section of the report.



Title: Aruba Networks APEX0104
To: FCC CFR 47 Part 15 Subpart C 15.247 & IC RSS-247
Serial #: ARUB199-U3 Rev A
Issue Date: 27th August 2015
Page: 156 of 223

CONDUCTED HIGH BAND-EDGE EMISSIONS - AVERAGE



Variant: 802.11g, Channel: 2462.00 MHz, Chain c, Temp: Ambient, Voltage: 48 Vdc

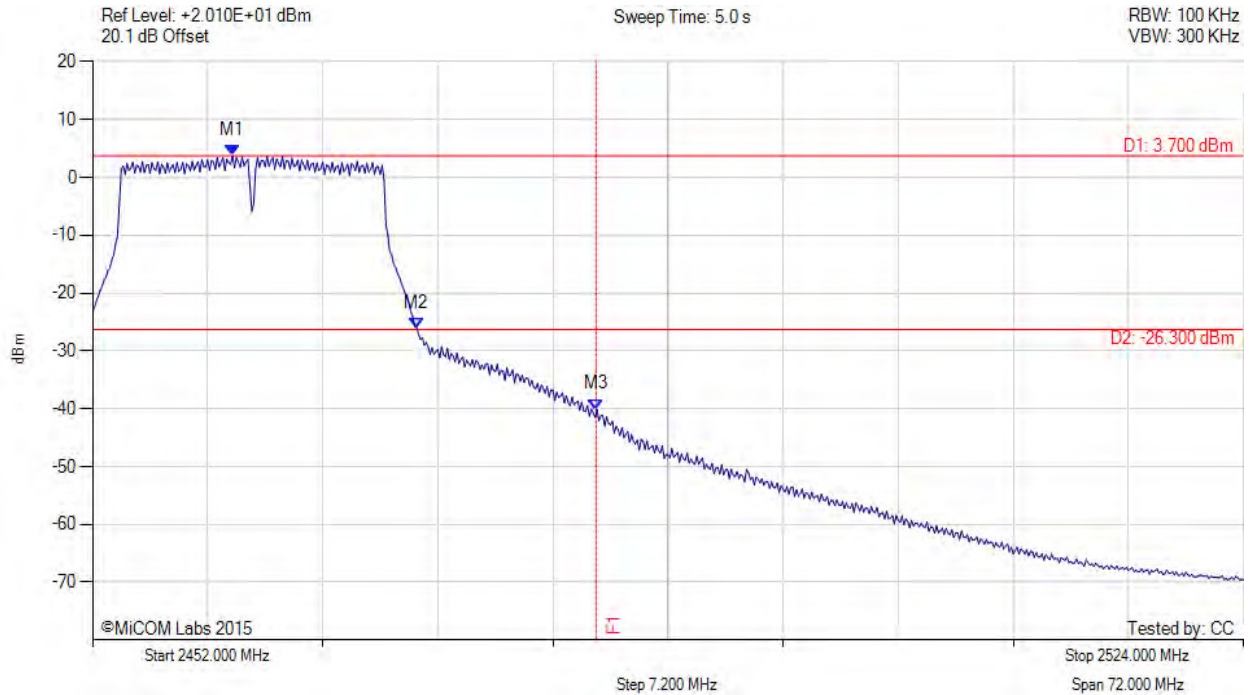

Analyser Setup	Marker:Frequency:Amplitude	Test Results
Detector = AVER Sweep Count = 0 RF Atten (dB) = 10 Trace Mode = VIEW	M1 : 2460.760 MHz : 3.700 dBm M2 : 2472.280 MHz : -26.019 dBm M3 : 2483.500 MHz : -40.112 dBm	Channel Frequency: 2462.00 MHz

[back to matrix](#)

This test report may be reproduced in full only. The document may only be updated by MiCOM Labs personnel. All changes will be noted in the Document History section of the report.



Title: Aruba Networks APEX0104
To: FCC CFR 47 Part 15 Subpart C 15.247 & IC RSS-247
Serial #: ARUB199-U3 Rev A
Issue Date: 27th August 2015
Page: 157 of 223

CONDUCTED HIGH BAND-EDGE EMISSIONS - AVERAGE



Variant: 802.11n HT-20, Channel: 2462.00 MHz, Chain a, Temp: Ambient, Voltage: 48 Vdc

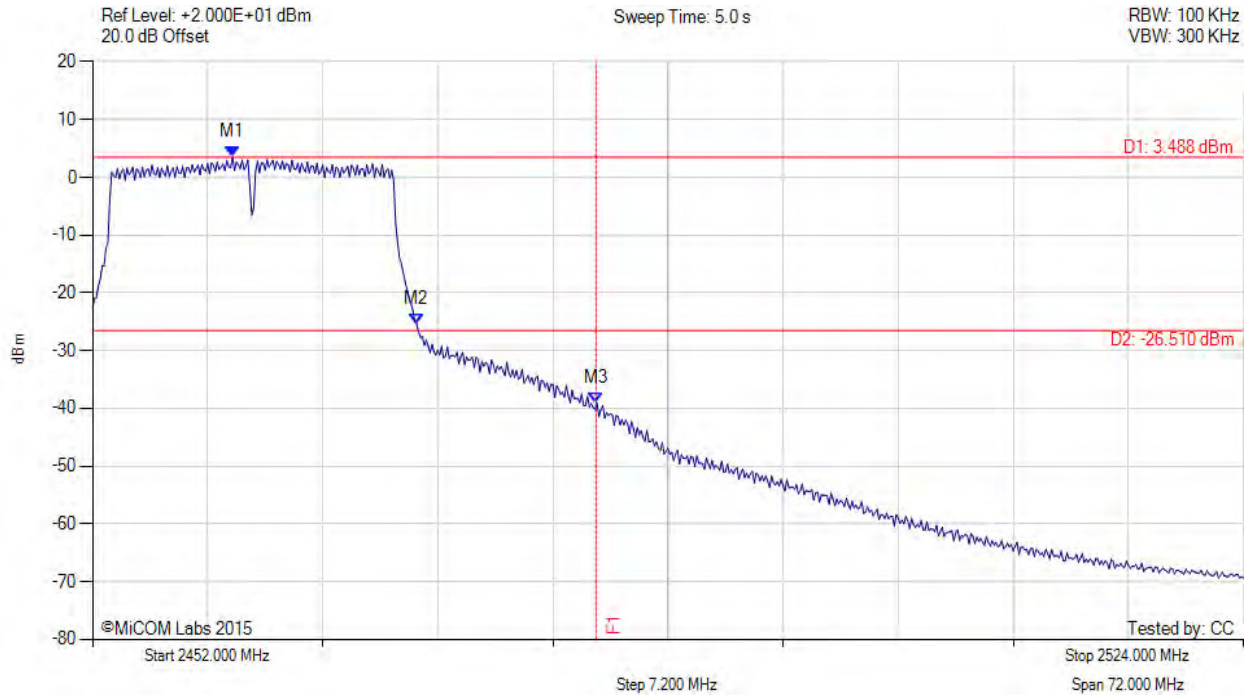

Analyser Setup	Marker:Frequency:Amplitude	Test Results
Detector = AVER Sweep Count = 0 RF Atten (dB) = 10 Trace Mode = VIEW	M1 : 2460.760 MHz : 3.488 dBm M2 : 2472.280 MHz : -25.436 dBm M3 : 2483.500 MHz : -39.090 dBm	Channel Frequency: 2462.00 MHz

[back to matrix](#)

This test report may be reproduced in full only. The document may only be updated by MiCOM Labs personnel. All changes will be noted in the Document History section of the report.



Title: Aruba Networks APEX0104
To: FCC CFR 47 Part 15 Subpart C 15.247 & IC RSS-247
Serial #: ARUB199-U3 Rev A
Issue Date: 27th August 2015
Page: 158 of 223

CONDUCTED HIGH BAND-EDGE EMISSIONS - AVERAGE



Variant: 802.11n HT-20, Channel: 2462.00 MHz, Chain b, Temp: Ambient, Voltage: 48 Vdc

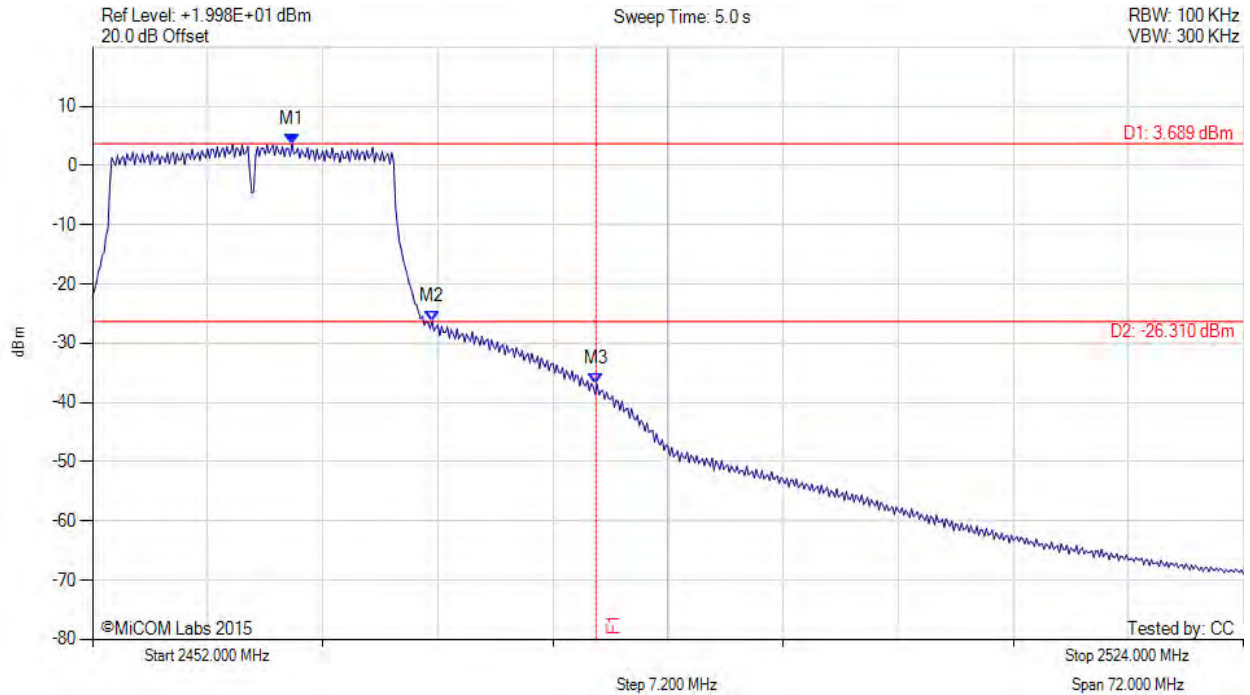

Analyser Setup	Marker:Frequency:Amplitude	Test Results
Detector = AVER Sweep Count = 0 RF Atten (dB) = 10 Trace Mode = VIEW	M1 : 2464.480 MHz : 3.689 dBm M2 : 2473.240 MHz : -26.294 dBm M3 : 2483.500 MHz : -36.911 dBm	Channel Frequency: 2462.00 MHz

[back to matrix](#)

This test report may be reproduced in full only. The document may only be updated by MiCOM Labs personnel. All changes will be noted in the Document History section of the report.



Title: Aruba Networks APEX0104
To: FCC CFR 47 Part 15 Subpart C 15.247 & IC RSS-247
Serial #: ARUB199-U3 Rev A
Issue Date: 27th August 2015
Page: 159 of 223

CONDUCTED HIGH BAND-EDGE EMISSIONS - AVERAGE



Variant: 802.11n HT-20, Channel: 2462.00 MHz, Chain c, Temp: Ambient, Voltage: 48 Vdc

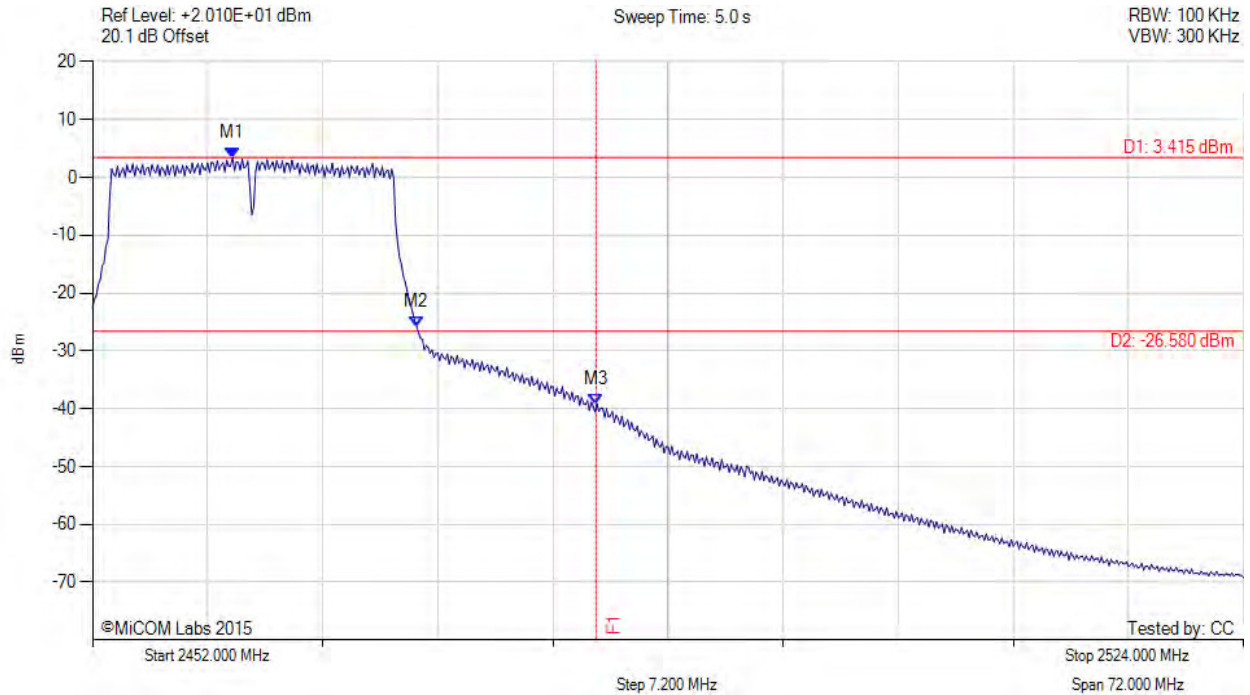

Analyser Setup	Marker:Frequency:Amplitude	Test Results
Detector = AVER Sweep Count = 0 RF Atten (dB) = 10 Trace Mode = VIEW	M1 : 2460.760 MHz : 3.415 dBm M2 : 2472.280 MHz : -25.816 dBm M3 : 2483.500 MHz : -39.173 dBm	Channel Frequency: 2462.00 MHz

[back to matrix](#)

This test report may be reproduced in full only. The document may only be updated by MiCOM Labs personnel. All changes will be noted in the Document History section of the report.



Title: Aruba Networks APEX0104
To: FCC CFR 47 Part 15 Subpart C 15.247 & IC RSS-247
Serial #: ARUB199-U3 Rev A
Issue Date: 27th August 2015
Page: 160 of 223

CONDUCTED HIGH BAND-EDGE EMISSIONS - AVERAGE



Variant: 802.11n HT-40, Channel: 2452.00 MHz, Chain a, Temp: Ambient, Voltage: 48 Vdc

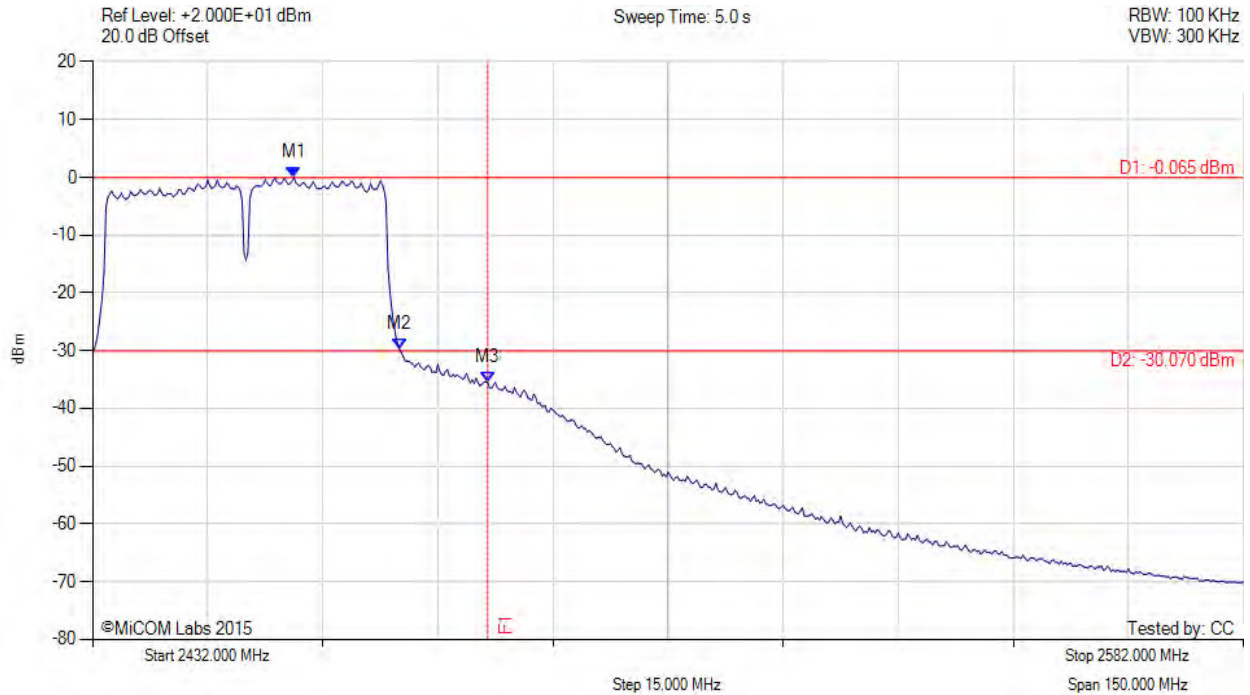

Analyser Setup	Marker:Frequency:Amplitude	Test Results
Detector = AVER Sweep Count = 0 RF Atten (dB) = 10 Trace Mode = VIEW	M1 : 2458.250 MHz : -0.065 dBm M2 : 2472.000 MHz : -29.765 dBm M3 : 2483.500 MHz : -35.409 dBm	Channel Frequency: 2452.00 MHz

[back to matrix](#)

This test report may be reproduced in full only. The document may only be updated by MiCOM Labs personnel. All changes will be noted in the Document History section of the report.



CONDUCTED HIGH BAND-EDGE EMISSIONS - AVERAGE



Variant: 802.11n HT-40, Channel: 2452.00 MHz, Chain b, Temp: Ambient, Voltage: 48 Vdc

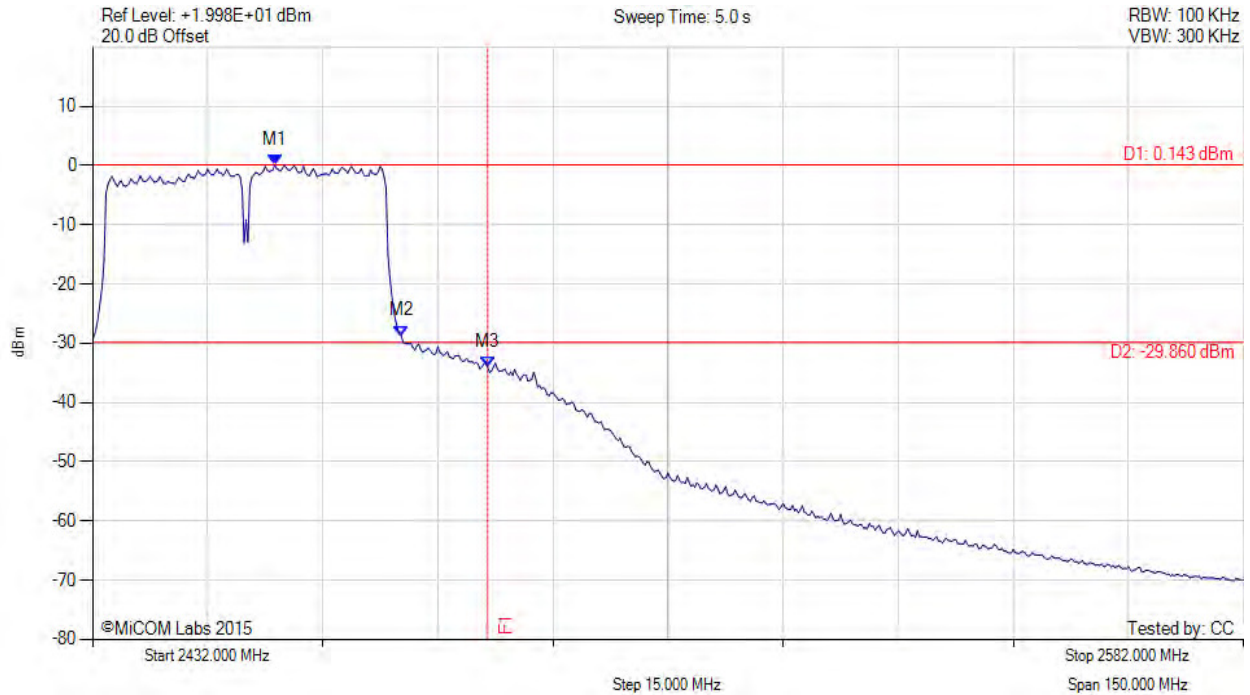

Analyser Setup	Marker:Frequency:Amplitude	Test Results
Detector = AVER Sweep Count = 0 RF Atten (dB) = 10 Trace Mode = VIEW	M1 : 2455.750 MHz : 0.143 dBm M2 : 2472.250 MHz : -28.787 dBm M3 : 2483.500 MHz : -34.036 dBm	Channel Frequency: 2452.00 MHz

[back to matrix](#)

This test report may be reproduced in full only. The document may only be updated by MiCOM Labs personnel. All changes will be noted in the Document History section of the report.



Title: Aruba Networks APEX0104
To: FCC CFR 47 Part 15 Subpart C 15.247 & IC RSS-247
Serial #: ARUB199-U3 Rev A
Issue Date: 27th August 2015
Page: 162 of 223

CONDUCTED HIGH BAND-EDGE EMISSIONS - AVERAGE



Variant: 802.11n HT-40, Channel: 2452.00 MHz, Chain c, Temp: Ambient, Voltage: 48 Vdc

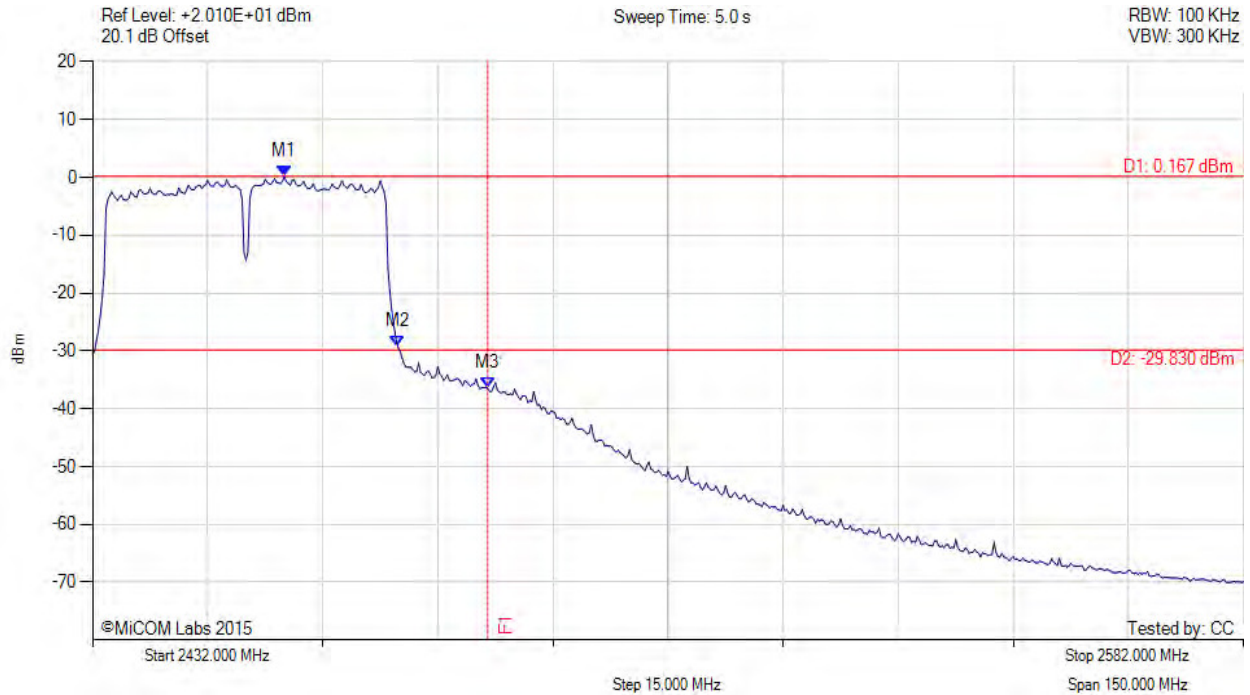

Analyser Setup	Marker:Frequency:Amplitude	Test Results
Detector = AVER Sweep Count = 0 RF Atten (dB) = 10 Trace Mode = VIEW	M1 : 2457.000 MHz : 0.167 dBm M2 : 2471.750 MHz : -29.178 dBm M3 : 2483.500 MHz : -36.463 dBm	Channel Frequency: 2452.00 MHz

[back to matrix](#)

This test report may be reproduced in full only. The document may only be updated by MiCOM Labs personnel. All changes will be noted in the Document History section of the report.



A.3. Power Spectral Density

POWER SPECTRAL DENSITY - AVERAGE



Variant: 802.11b, Channel: 2412.00 MHz, Chain a, Temp: Ambient, Voltage: 48 Vdc

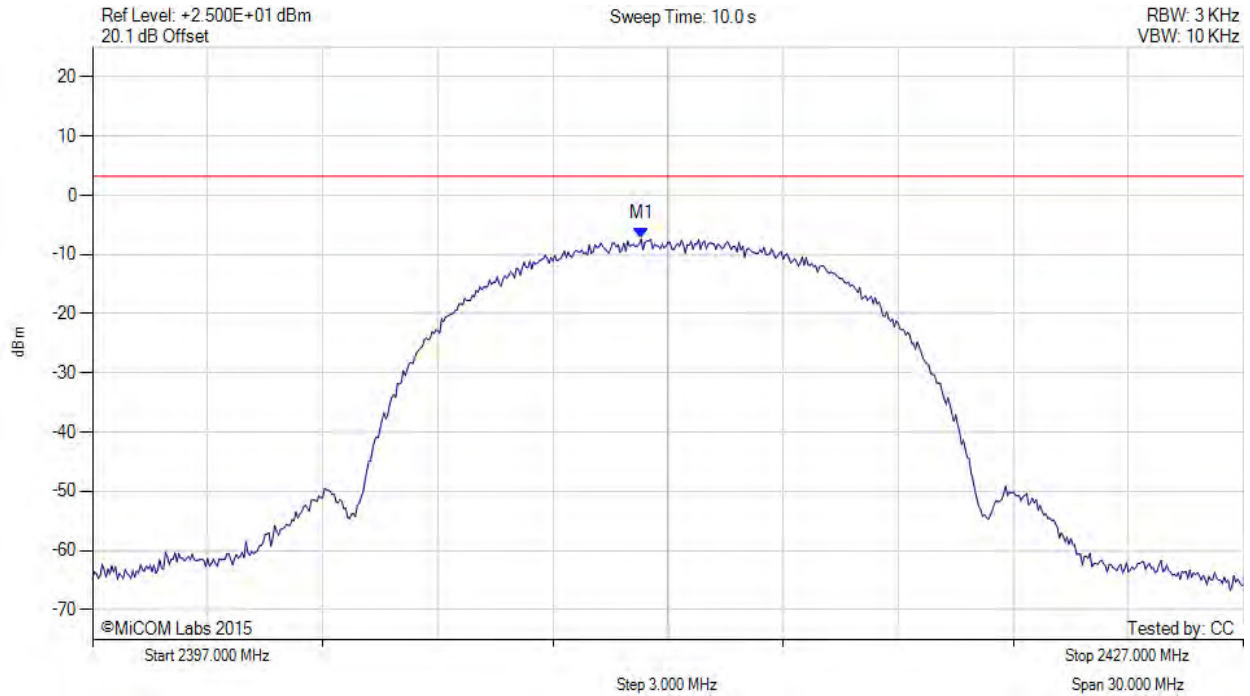

Analyser Setup	Marker:Frequency:Amplitude	Test Results
Detector = AVER Sweep Count = 0 RF Atten (dB) = 20 Trace Mode = VIEW	M1 : 2411.300 MHz : -7.372 dBm	Limit: ≤ 3.230 dBm

[back to matrix](#)

This test report may be reproduced in full only. The document may only be updated by MiCOM Labs personnel. All changes will be noted in the Document History section of the report.



Title: Aruba Networks APEX0104
To: FCC CFR 47 Part 15 Subpart C 15.247 & IC RSS-247
Serial #: ARUB199-U3 Rev A
Issue Date: 27th August 2015
Page: 164 of 223

POWER SPECTRAL DENSITY - AVERAGE



Variant: 802.11b, Channel: 2412.00 MHz, Chain b, Temp: Ambient, Voltage: 48 Vdc

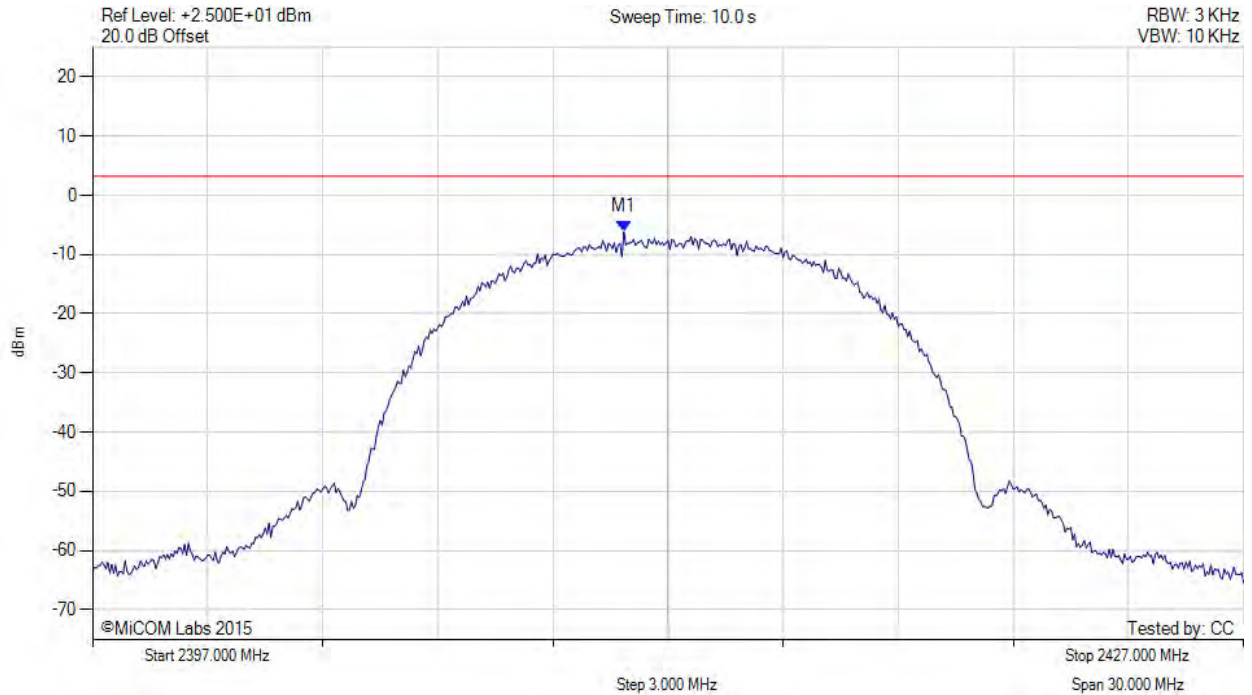

Analyser Setup	Marker:Frequency:Amplitude	Test Results
Detector = AVER Sweep Count = 0 RF Atten (dB) = 20 Trace Mode = VIEW	M1 : 2410.850 MHz : -6.196 dBm	Limit: ≤ 3.230 dBm

[back to matrix](#)

This test report may be reproduced in full only. The document may only be updated by MiCOM Labs personnel. All changes will be noted in the Document History section of the report.



Title: Aruba Networks APEX0104
To: FCC CFR 47 Part 15 Subpart C 15.247 & IC RSS-247
Serial #: ARUB199-U3 Rev A
Issue Date: 27th August 2015
Page: 165 of 223

POWER SPECTRAL DENSITY - AVERAGE



Variant: 802.11b, Channel: 2412.00 MHz, Chain c, Temp: Ambient, Voltage: 48 Vdc

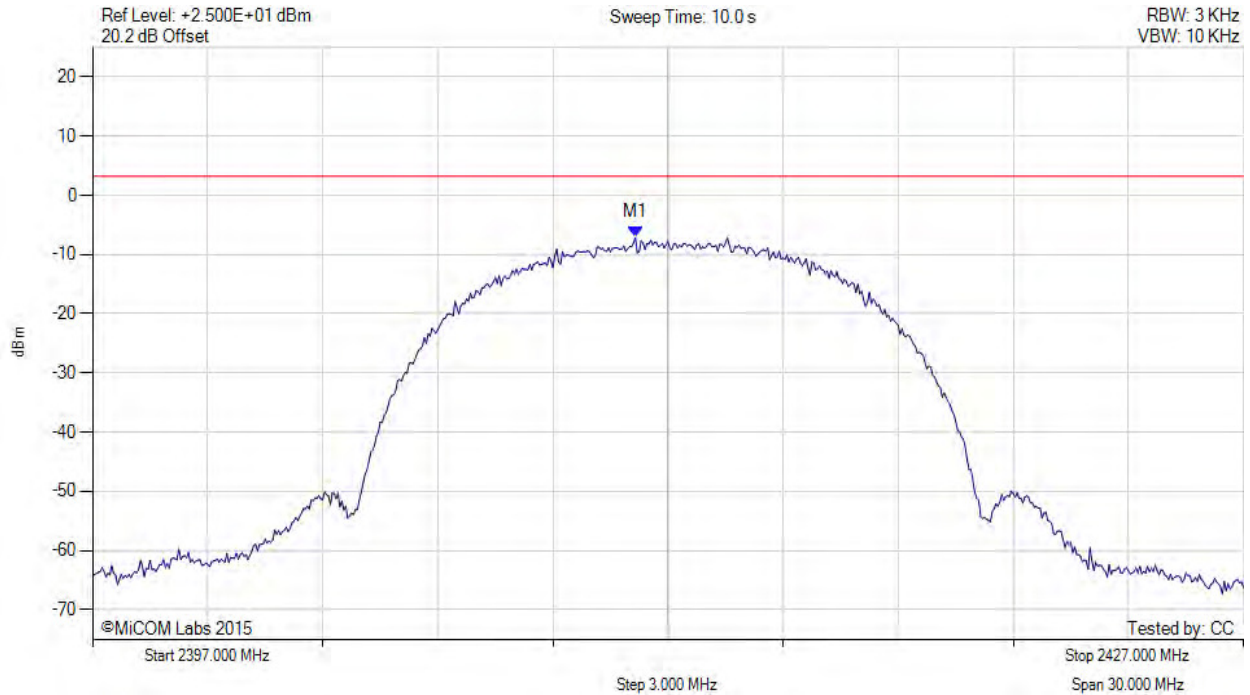

Analyser Setup	Marker:Frequency:Amplitude	Test Results
Detector = AVER Sweep Count = 0 RF Atten (dB) = 20 Trace Mode = VIEW	M1 : 2411.150 MHz : -7.143 dBm	Limit: ≤ 3.230 dBm

[back to matrix](#)

This test report may be reproduced in full only. The document may only be updated by MiCOM Labs personnel. All changes will be noted in the Document History section of the report.



Title: Aruba Networks APEX0104
To: FCC CFR 47 Part 15 Subpart C 15.247 & IC RSS-247
Serial #: ARUB199-U3 Rev A
Issue Date: 27th August 2015
Page: 166 of 223

POWER SPECTRAL DENSITY - AVERAGE



Variant: 802.11b, Channel: 2412.00 MHz, SUM, Temp: Ambient, Voltage: 48 Vdc

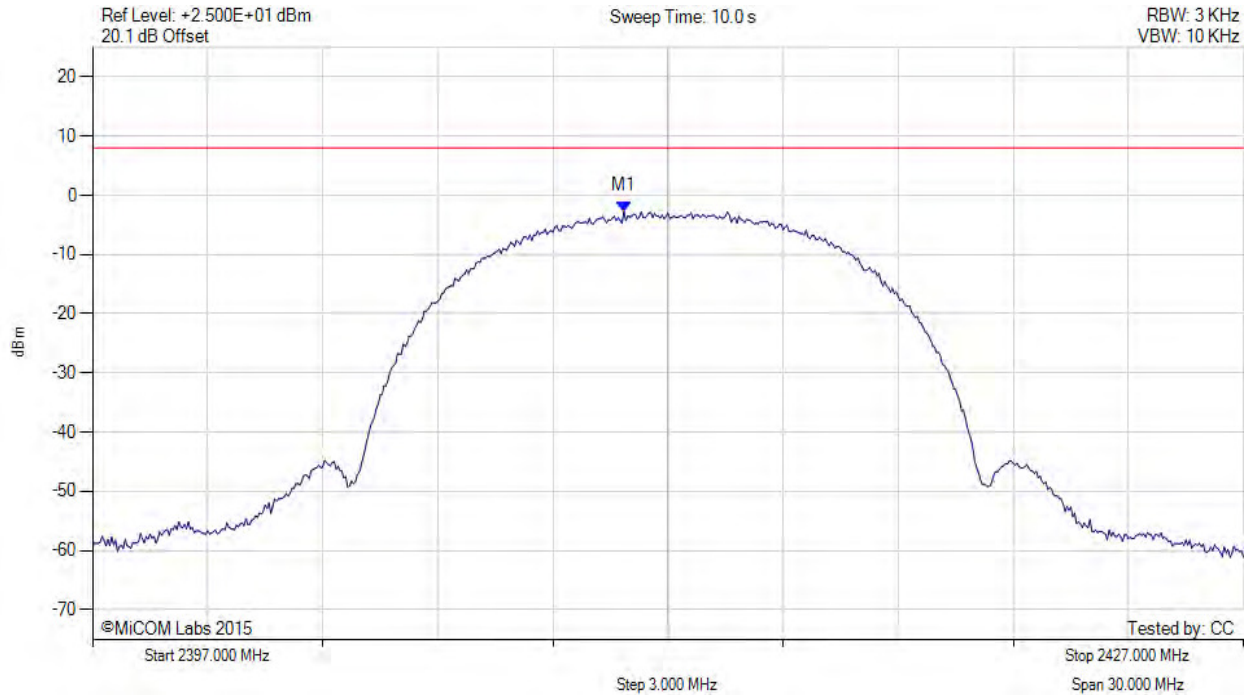

Analyser Setup	Marker:Frequency:Amplitude	Test Results
Detector = AVER Sweep Count = 0 RF Atten (dB) = 20 Trace Mode = VIEW	M1 : 2410.900 MHz : -2.734 dBm M1 + DCCF : 2410.900 MHz : -2.690 dBm Duty Cycle Correction Factor : +0.04 dB	Limit: ≤ 8.0 dBm Margin: -10.7 dB

[back to matrix](#)

This test report may be reproduced in full only. The document may only be updated by MiCOM Labs personnel. All changes will be noted in the Document History section of the report.



Title: Aruba Networks APEX0104
To: FCC CFR 47 Part 15 Subpart C 15.247 & IC RSS-247
Serial #: ARUB199-U3 Rev A
Issue Date: 27th August 2015
Page: 167 of 223

POWER SPECTRAL DENSITY - AVERAGE



Variant: 802.11b, Channel: 2437.00 MHz, Chain a, Temp: Ambient, Voltage: 48 Vdc

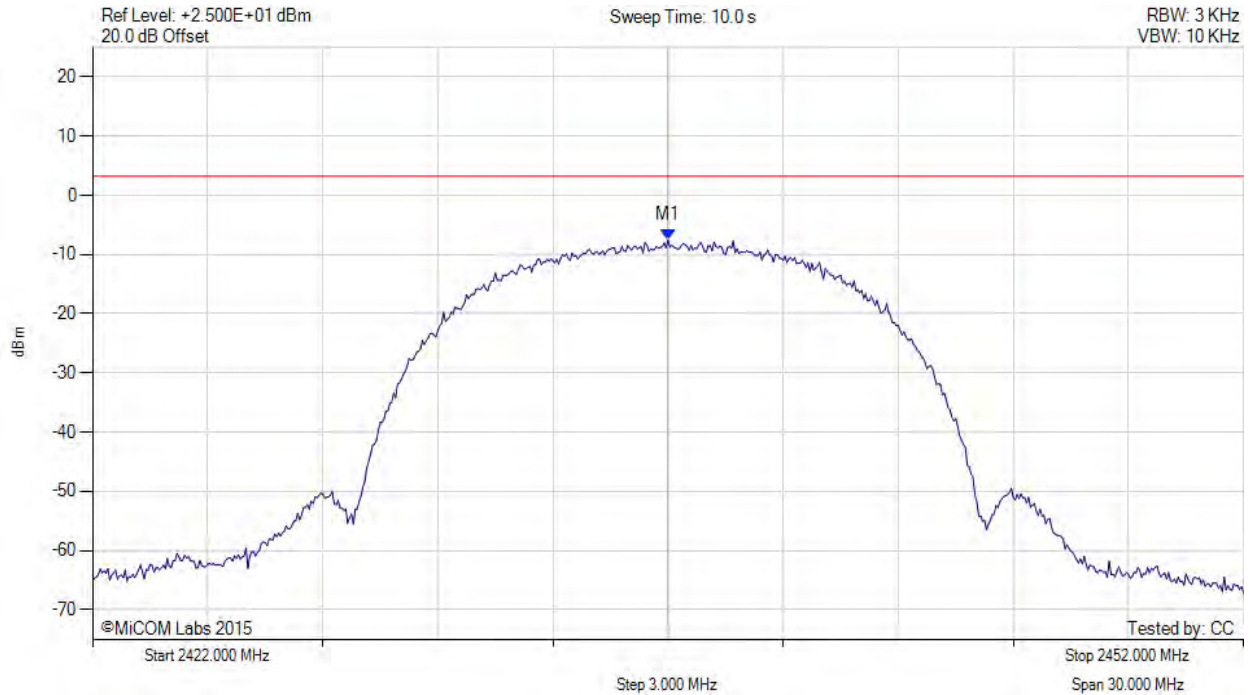

Analyser Setup	Marker:Frequency:Amplitude	Test Results
Detector = AVER Sweep Count = 0 RF Atten (dB) = 20 Trace Mode = VIEW	M1 : 2437.000 MHz : -7.585 dBm	Limit: ≤ 3.230 dBm

[back to matrix](#)

This test report may be reproduced in full only. The document may only be updated by MiCOM Labs personnel. All changes will be noted in the Document History section of the report.



Title: Aruba Networks APEX0104
To: FCC CFR 47 Part 15 Subpart C 15.247 & IC RSS-247
Serial #: ARUB199-U3 Rev A
Issue Date: 27th August 2015
Page: 168 of 223

POWER SPECTRAL DENSITY - AVERAGE



Variant: 802.11b, Channel: 2437.00 MHz, Chain b, Temp: Ambient, Voltage: 48 Vdc

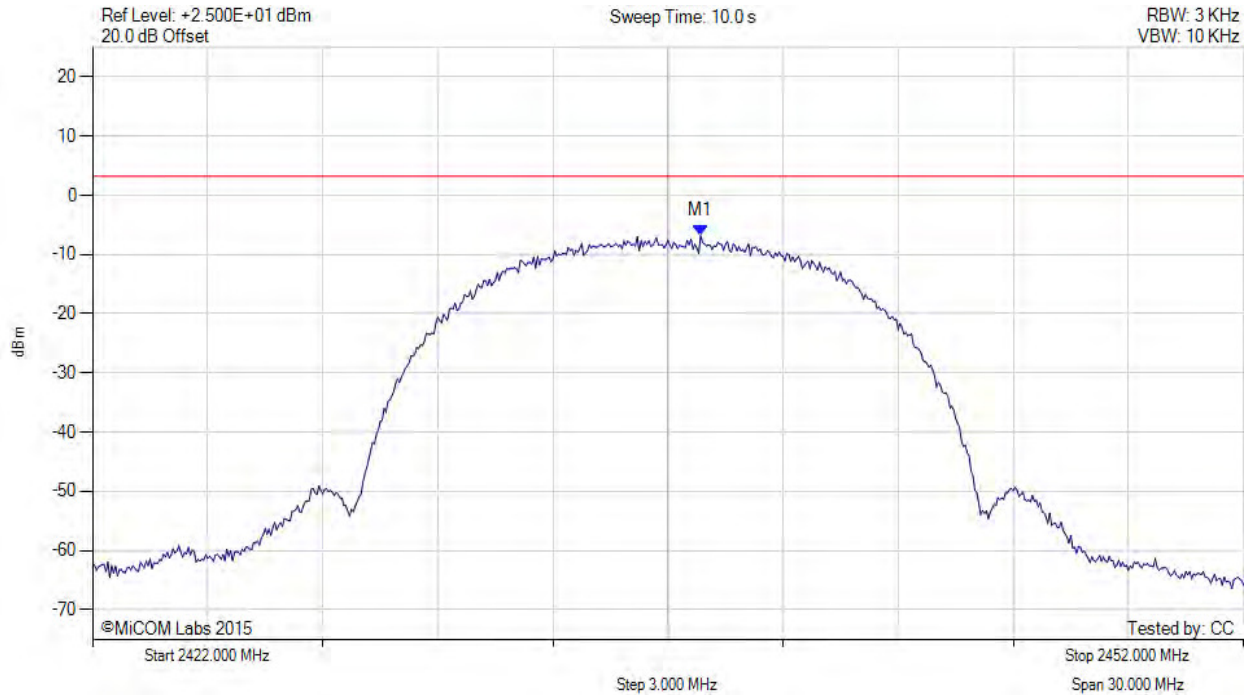

Analyser Setup	Marker:Frequency:Amplitude	Test Results
Detector = AVER Sweep Count = 0 RF Atten (dB) = 20 Trace Mode = VIEW	M1 : 2437.850 MHz : -6.797 dBm	Limit: ≤ 3.230 dBm

[back to matrix](#)

This test report may be reproduced in full only. The document may only be updated by MiCOM Labs personnel. All changes will be noted in the Document History section of the report.



Title: Aruba Networks APEX0104
To: FCC CFR 47 Part 15 Subpart C 15.247 & IC RSS-247
Serial #: ARUB199-U3 Rev A
Issue Date: 27th August 2015
Page: 169 of 223

POWER SPECTRAL DENSITY - AVERAGE



Variant: 802.11b, Channel: 2437.00 MHz, Chain c, Temp: Ambient, Voltage: 48 Vdc

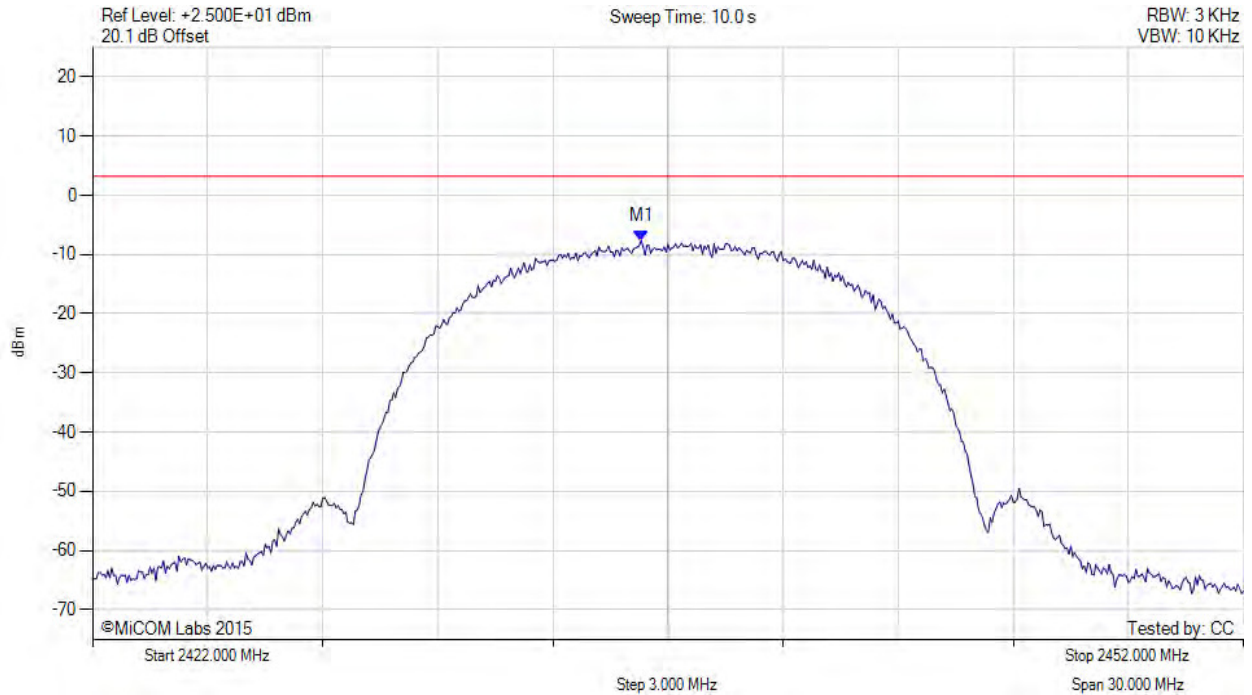

Analyser Setup	Marker:Frequency:Amplitude	Test Results
Detector = AVER Sweep Count = 0 RF Atten (dB) = 20 Trace Mode = VIEW	M1 : 2436.300 MHz : -7.653 dBm	Limit: ≤ 3.230 dBm

[back to matrix](#)

This test report may be reproduced in full only. The document may only be updated by MiCOM Labs personnel. All changes will be noted in the Document History section of the report.



Title: Aruba Networks APEX0104
To: FCC CFR 47 Part 15 Subpart C 15.247 & IC RSS-247
Serial #: ARUB199-U3 Rev A
Issue Date: 27th August 2015
Page: 170 of 223

POWER SPECTRAL DENSITY - AVERAGE



Variant: 802.11b, Channel: 2437.00 MHz, SUM, Temp: Ambient, Voltage: 48 Vdc

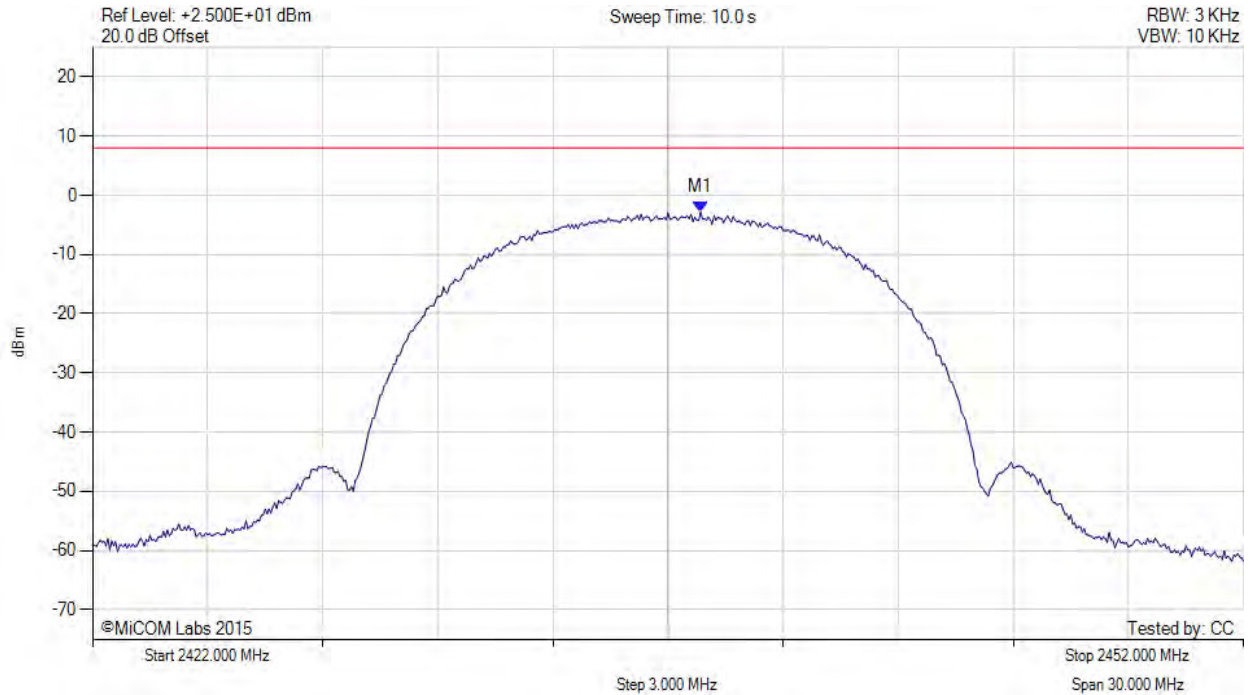

Analyser Setup	Marker:Frequency:Amplitude	Test Results
Detector = AVER Sweep Count = 0 RF Atten (dB) = 20 Trace Mode = VIEW	M1 : 2437.900 MHz : -2.865 dBm M1 + DCCF : 2437.900 MHz : -2.821 dBm Duty Cycle Correction Factor : +0.04 dB	Limit: ≤ 8.0 dBm Margin: -10.8 dB

[back to matrix](#)

This test report may be reproduced in full only. The document may only be updated by MiCOM Labs personnel. All changes will be noted in the Document History section of the report.



Title: Aruba Networks APEX0104
To: FCC CFR 47 Part 15 Subpart C 15.247 & IC RSS-247
Serial #: ARUB199-U3 Rev A
Issue Date: 27th August 2015
Page: 171 of 223

POWER SPECTRAL DENSITY - AVERAGE



Variant: 802.11b, Channel: 2462.00 MHz, Chain a, Temp: Ambient, Voltage: 48 Vdc

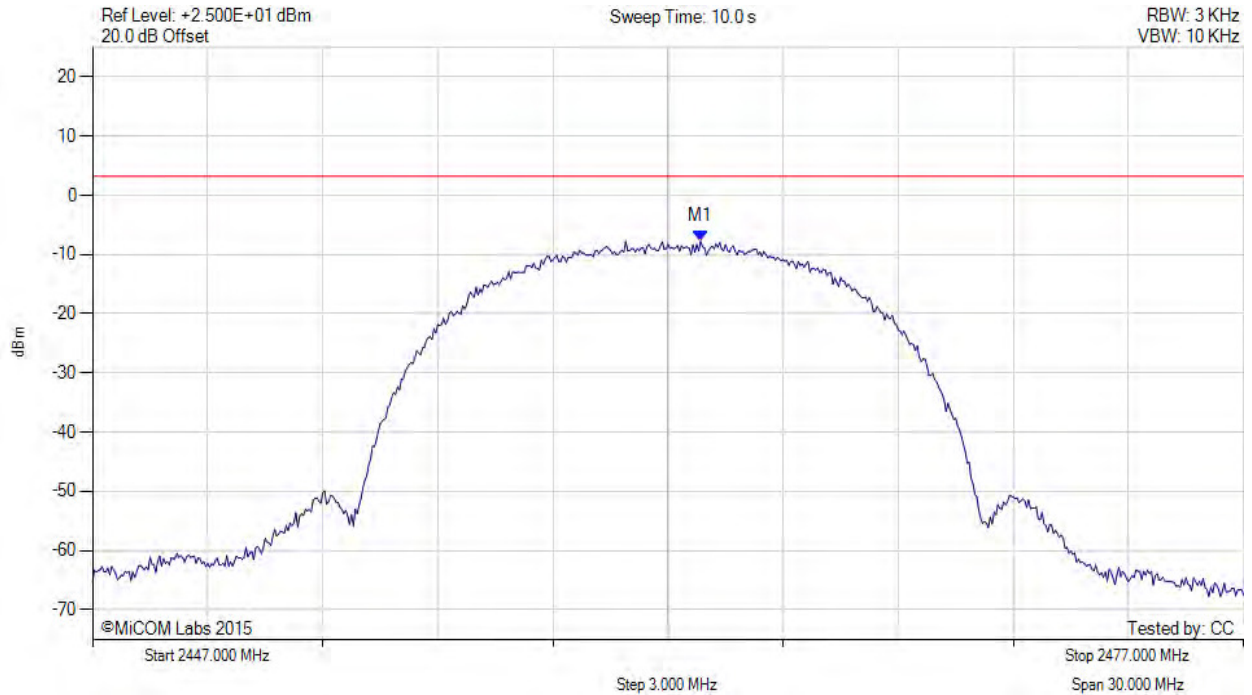

Analyser Setup	Marker:Frequency:Amplitude	Test Results
Detector = AVER Sweep Count = 0 RF Atten (dB) = 20 Trace Mode = VIEW	M1 : 2462.850 MHz : -7.762 dBm	Limit: ≤ 3.230 dBm

[back to matrix](#)

This test report may be reproduced in full only. The document may only be updated by MiCOM Labs personnel. All changes will be noted in the Document History section of the report.



Title: Aruba Networks APEX0104
To: FCC CFR 47 Part 15 Subpart C 15.247 & IC RSS-247
Serial #: ARUB199-U3 Rev A
Issue Date: 27th August 2015
Page: 172 of 223

POWER SPECTRAL DENSITY - AVERAGE



Variant: 802.11b, Channel: 2462.00 MHz, Chain b, Temp: Ambient, Voltage: 48 Vdc

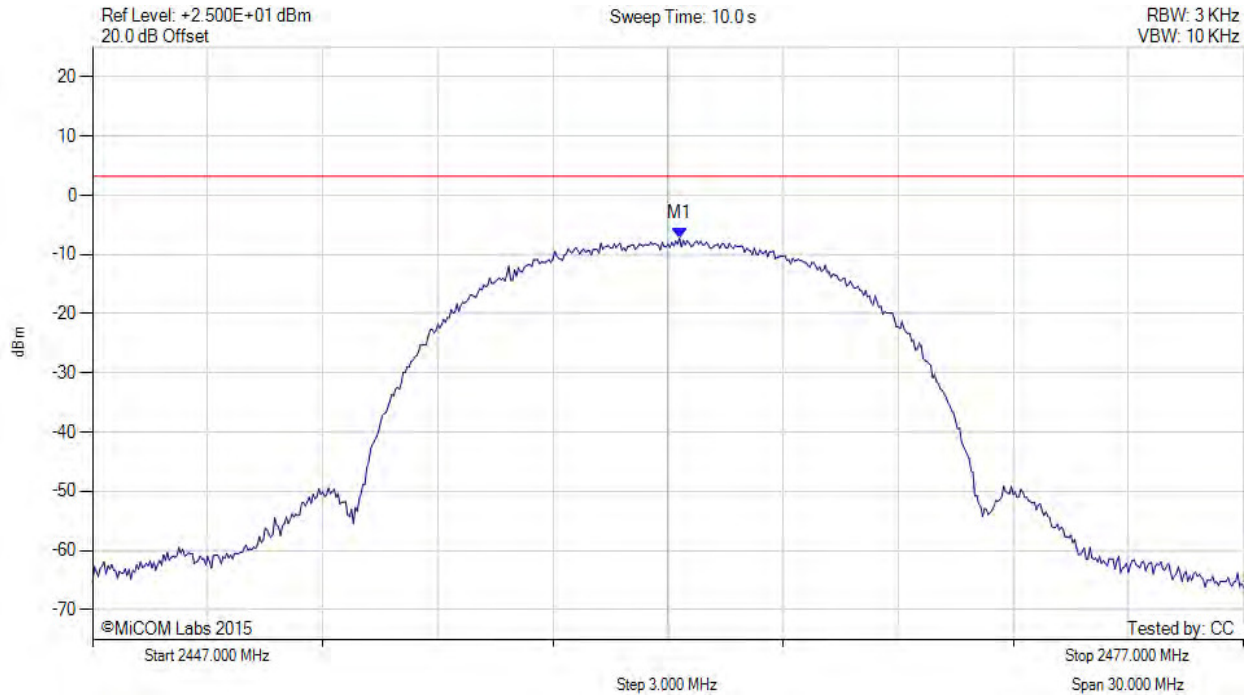

Analyser Setup	Marker:Frequency:Amplitude	Test Results
Detector = AVER Sweep Count = 0 RF Atten (dB) = 20 Trace Mode = VIEW	M1 : 2462.300 MHz : -7.255 dBm	Limit: ≤ 3.230 dBm

[back to matrix](#)

This test report may be reproduced in full only. The document may only be updated by MiCOM Labs personnel. All changes will be noted in the Document History section of the report.



Title: Aruba Networks APEX0104
To: FCC CFR 47 Part 15 Subpart C 15.247 & IC RSS-247
Serial #: ARUB199-U3 Rev A
Issue Date: 27th August 2015
Page: 173 of 223

POWER SPECTRAL DENSITY - AVERAGE



Variant: 802.11b, Channel: 2462.00 MHz, Chain c, Temp: Ambient, Voltage: 48 Vdc

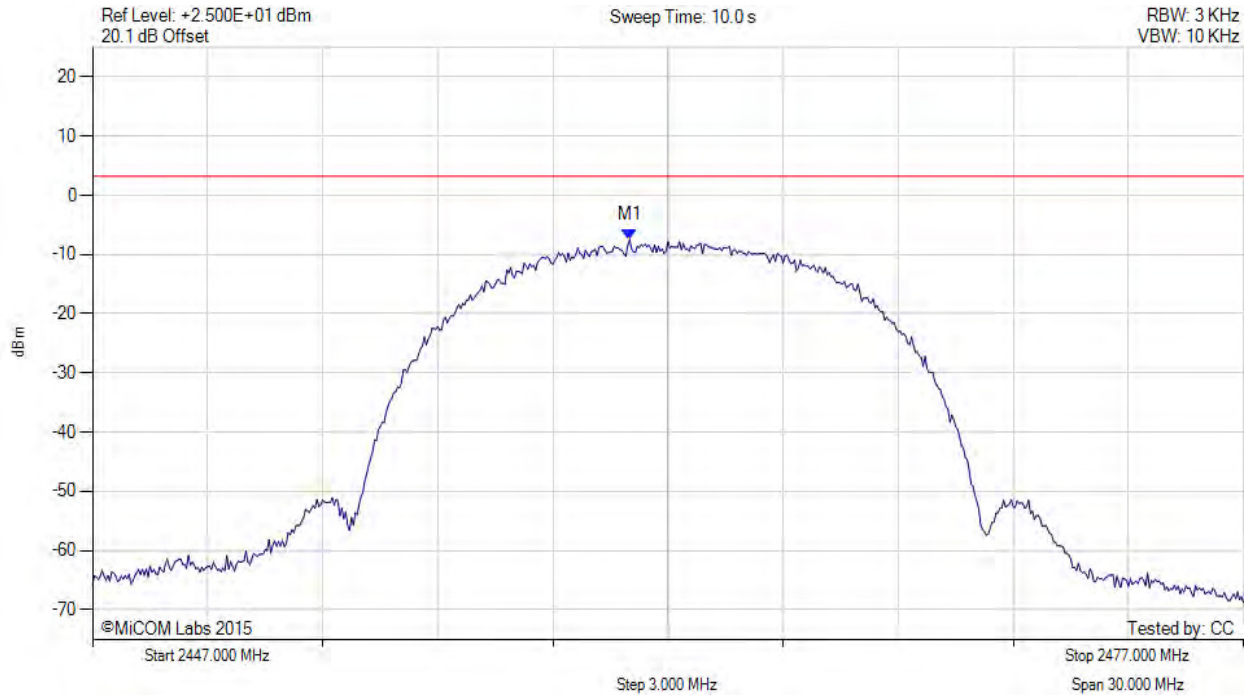

Analyser Setup	Marker:Frequency:Amplitude	Test Results
Detector = AVER Sweep Count = 0 RF Atten (dB) = 20 Trace Mode = VIEW	M1 : 2461.000 MHz : -7.485 dBm	Limit: ≤ 3.230 dBm

[back to matrix](#)

This test report may be reproduced in full only. The document may only be updated by MiCOM Labs personnel. All changes will be noted in the Document History section of the report.



Title: Aruba Networks APEX0104
To: FCC CFR 47 Part 15 Subpart C 15.247 & IC RSS-247
Serial #: ARUB199-U3 Rev A
Issue Date: 27th August 2015
Page: 174 of 223

POWER SPECTRAL DENSITY - AVERAGE



Variant: 802.11b, Channel: 2462.00 MHz, SUM, Temp: Ambient, Voltage: 48 Vdc

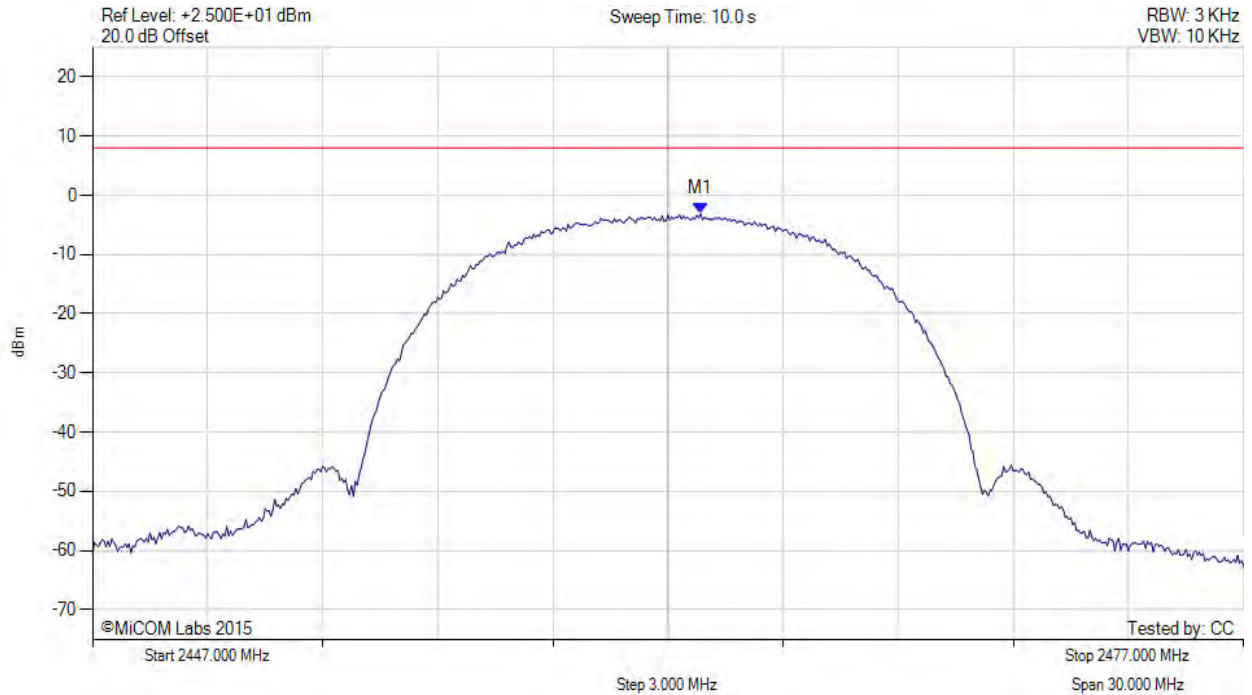

Analyser Setup	Marker:Frequency:Amplitude	Test Results
Detector = AVER Sweep Count = 0 RF Atten (dB) = 20 Trace Mode = VIEW	M1 : 2462.900 MHz : -3.089 dBm M1 + DCCF : 2462.900 MHz : -3.045 dBm Duty Cycle Correction Factor : +0.04 dB	Limit: ≤ 8.0 dBm Margin: -11.0 dB

[back to matrix](#)

This test report may be reproduced in full only. The document may only be updated by MiCOM Labs personnel. All changes will be noted in the Document History section of the report.



Title: Aruba Networks APEX0104
To: FCC CFR 47 Part 15 Subpart C 15.247 & IC RSS-247
Serial #: ARUB199-U3 Rev A
Issue Date: 27th August 2015
Page: 175 of 223

POWER SPECTRAL DENSITY - AVERAGE



Variant: 802.11g, Channel: 2412.00 MHz, Chain a, Temp: Ambient, Voltage: 48 Vdc

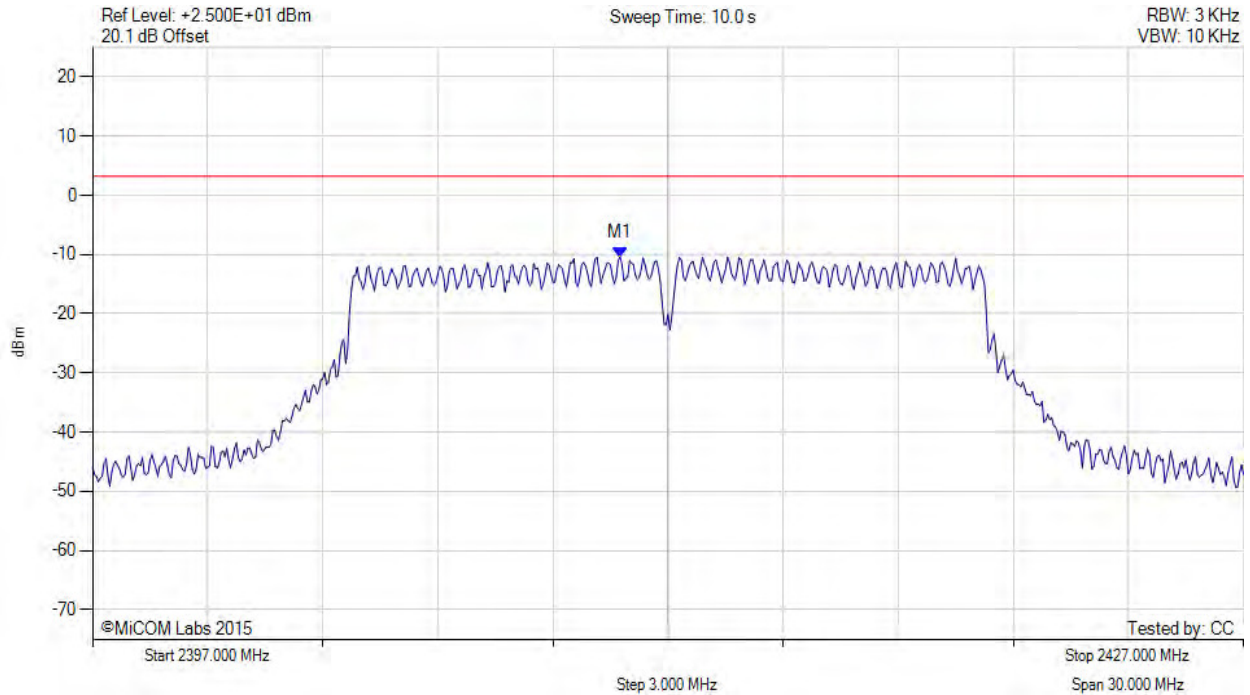

Analyser Setup	Marker:Frequency:Amplitude	Test Results
Detector = AVER Sweep Count = 0 RF Atten (dB) = 20 Trace Mode = VIEW	M1 : 2410.750 MHz : -10.450 dBm	Limit: ≤ 3.230 dBm

[back to matrix](#)

This test report may be reproduced in full only. The document may only be updated by MiCOM Labs personnel. All changes will be noted in the Document History section of the report.



Title: Aruba Networks APEX0104
To: FCC CFR 47 Part 15 Subpart C 15.247 & IC RSS-247
Serial #: ARUB199-U3 Rev A
Issue Date: 27th August 2015
Page: 176 of 223

POWER SPECTRAL DENSITY - AVERAGE



Variant: 802.11g, Channel: 2412.00 MHz, Chain b, Temp: Ambient, Voltage: 48 Vdc

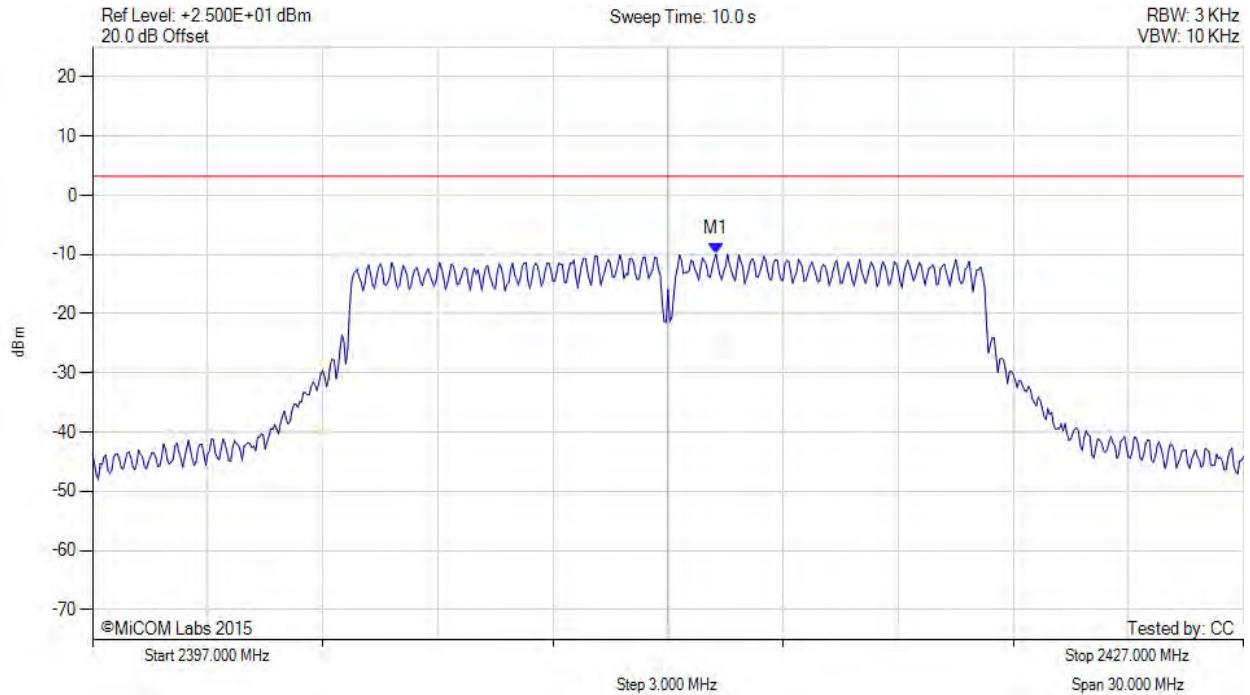

Analyser Setup	Marker:Frequency:Amplitude	Test Results
Detector = AVER Sweep Count = 0 RF Atten (dB) = 20 Trace Mode = VIEW	M1 : 2413.250 MHz : -9.895 dBm	Limit: ≤ 3.230 dBm

[back to matrix](#)

This test report may be reproduced in full only. The document may only be updated by MiCOM Labs personnel. All changes will be noted in the Document History section of the report.



Title: Aruba Networks APEX0104
To: FCC CFR 47 Part 15 Subpart C 15.247 & IC RSS-247
Serial #: ARUB199-U3 Rev A
Issue Date: 27th August 2015
Page: 177 of 223

POWER SPECTRAL DENSITY - AVERAGE



Variant: 802.11g, Channel: 2412.00 MHz, Chain c, Temp: Ambient, Voltage: 48 Vdc

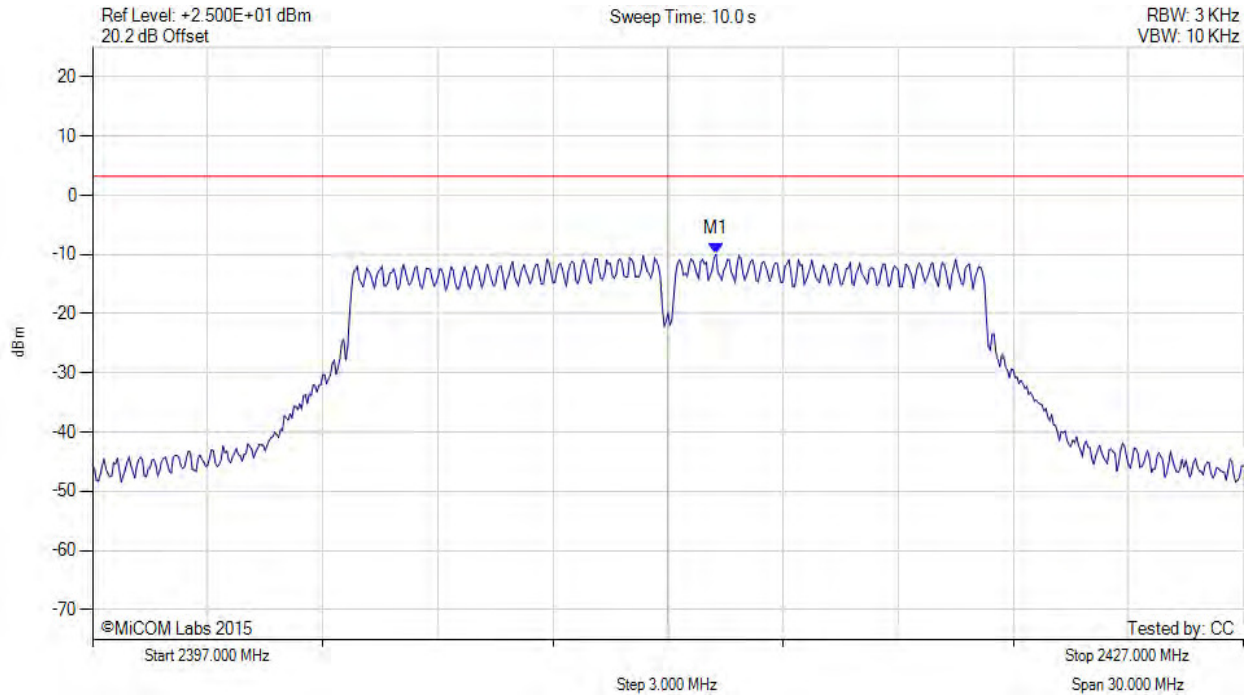

Analyser Setup	Marker:Frequency:Amplitude	Test Results
Detector = AVER Sweep Count = 0 RF Atten (dB) = 20 Trace Mode = VIEW	M1 : 2413.250 MHz : -9.943 dBm	Limit: ≤ 3.230 dBm

[back to matrix](#)

This test report may be reproduced in full only. The document may only be updated by MiCOM Labs personnel. All changes will be noted in the Document History section of the report.



Title: Aruba Networks APEX0104
To: FCC CFR 47 Part 15 Subpart C 15.247 & IC RSS-247
Serial #: ARUB199-U3 Rev A
Issue Date: 27th August 2015
Page: 178 of 223

POWER SPECTRAL DENSITY - AVERAGE



Variant: 802.11g, Channel: 2412.00 MHz, SUM, Temp: Ambient, Voltage: 48 Vdc

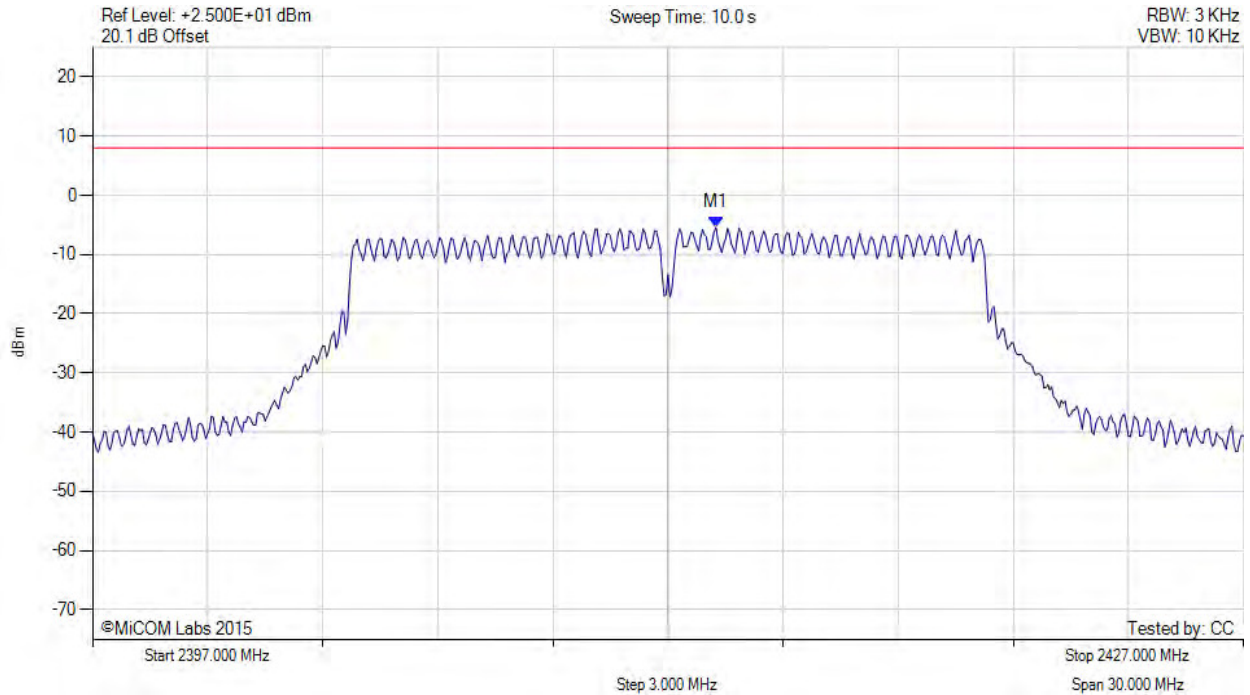

Analyser Setup	Marker:Frequency:Amplitude	Test Results
Detector = AVER Sweep Count = 0 RF Atten (dB) = 20 Trace Mode = VIEW	M1 : 2413.300 MHz : -5.456 dBm M1 + DCCF : 2413.300 MHz : -5.412 dBm Duty Cycle Correction Factor : +0.04 dB	Limit: ≤ 8.0 dBm Margin: -13.4 dB

[back to matrix](#)

This test report may be reproduced in full only. The document may only be updated by MiCOM Labs personnel. All changes will be noted in the Document History section of the report.



Title: Aruba Networks APEX0104
To: FCC CFR 47 Part 15 Subpart C 15.247 & IC RSS-247
Serial #: ARUB199-U3 Rev A
Issue Date: 27th August 2015
Page: 179 of 223

POWER SPECTRAL DENSITY - AVERAGE



Variant: 802.11g, Channel: 2437.00 MHz, Chain a, Temp: Ambient, Voltage: 48 Vdc

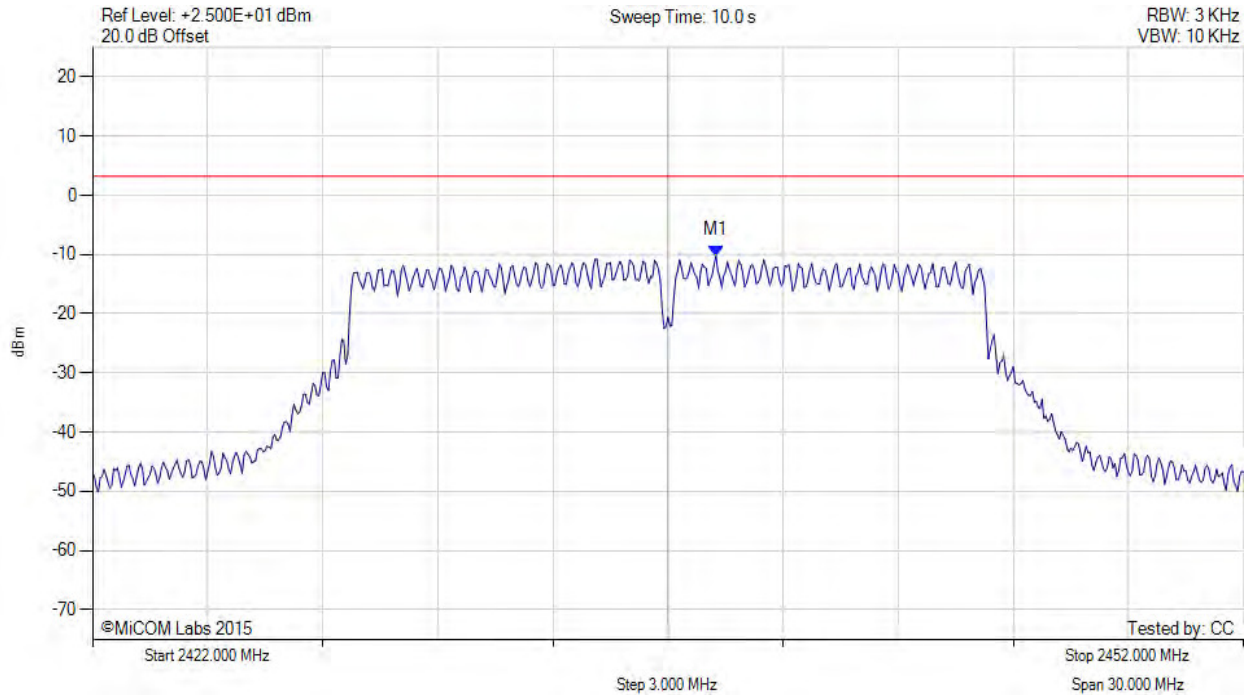

Analyser Setup	Marker:Frequency:Amplitude	Test Results
Detector = AVER Sweep Count = 0 RF Atten (dB) = 20 Trace Mode = VIEW	M1 : 2438.250 MHz : -10.201 dBm	Limit: ≤ 3.230 dBm

[back to matrix](#)

This test report may be reproduced in full only. The document may only be updated by MiCOM Labs personnel. All changes will be noted in the Document History section of the report.



Title: Aruba Networks APEX0104
To: FCC CFR 47 Part 15 Subpart C 15.247 & IC RSS-247
Serial #: ARUB199-U3 Rev A
Issue Date: 27th August 2015
Page: 180 of 223

POWER SPECTRAL DENSITY - AVERAGE



Variant: 802.11g, Channel: 2437.00 MHz, Chain b, Temp: Ambient, Voltage: 48 Vdc

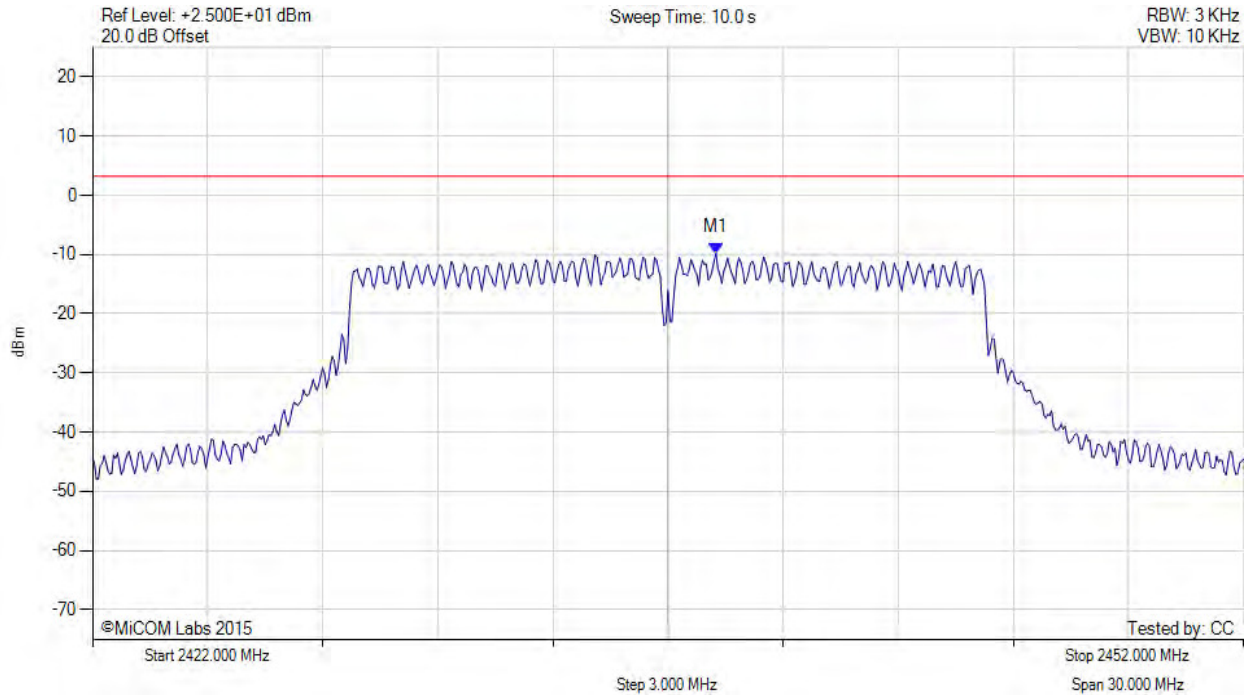

Analyser Setup	Marker:Frequency:Amplitude	Test Results
Detector = AVER Sweep Count = 0 RF Atten (dB) = 20 Trace Mode = VIEW	M1 : 2438.250 MHz : -9.724 dBm	Limit: ≤ 3.230 dBm

[back to matrix](#)

This test report may be reproduced in full only. The document may only be updated by MiCOM Labs personnel. All changes will be noted in the Document History section of the report.



Title: Aruba Networks APEX0104
To: FCC CFR 47 Part 15 Subpart C 15.247 & IC RSS-247
Serial #: ARUB199-U3 Rev A
Issue Date: 27th August 2015
Page: 181 of 223

POWER SPECTRAL DENSITY - AVERAGE



Variant: 802.11g, Channel: 2437.00 MHz, Chain c, Temp: Ambient, Voltage: 48 Vdc

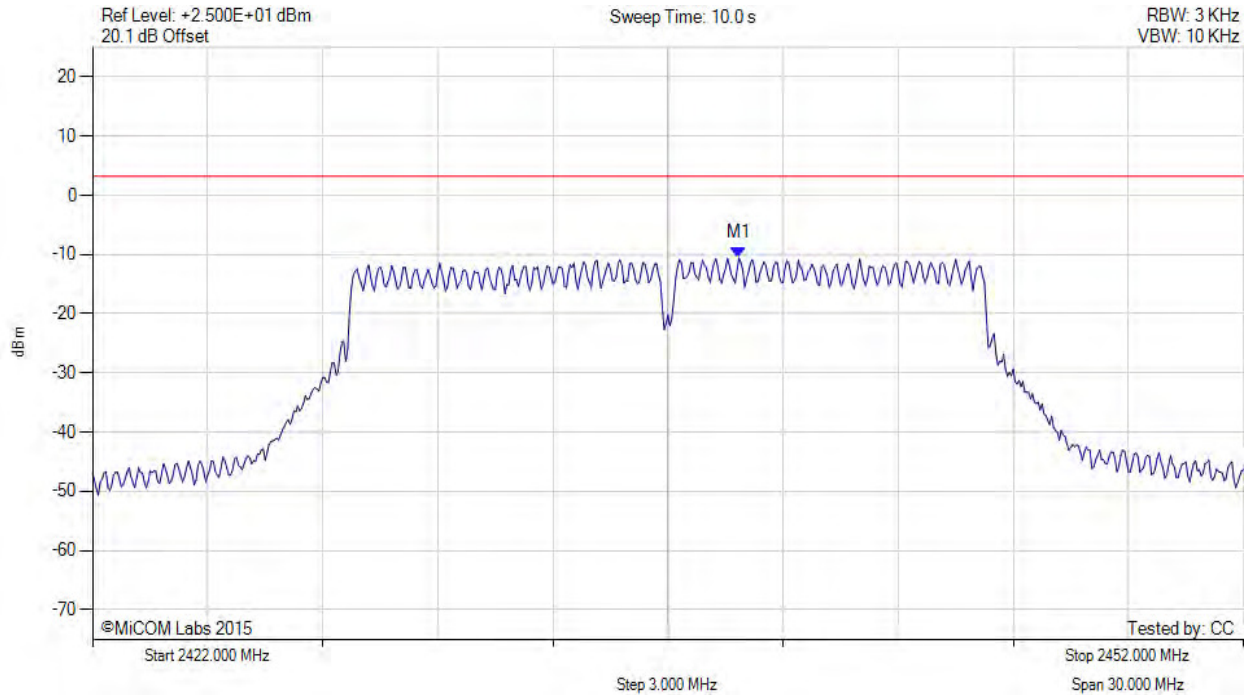

Analyser Setup	Marker:Frequency:Amplitude	Test Results
Detector = AVER Sweep Count = 0 RF Atten (dB) = 20 Trace Mode = VIEW	M1 : 2438.850 MHz : -10.600 dBm	Limit: ≤ 3.230 dBm

[back to matrix](#)

This test report may be reproduced in full only. The document may only be updated by MiCOM Labs personnel. All changes will be noted in the Document History section of the report.



Title: Aruba Networks APEX0104
To: FCC CFR 47 Part 15 Subpart C 15.247 & IC RSS-247
Serial #: ARUB199-U3 Rev A
Issue Date: 27th August 2015
Page: 182 of 223

POWER SPECTRAL DENSITY - AVERAGE



Variant: 802.11g, Channel: 2437.00 MHz, SUM, Temp: Ambient, Voltage: 48 Vdc

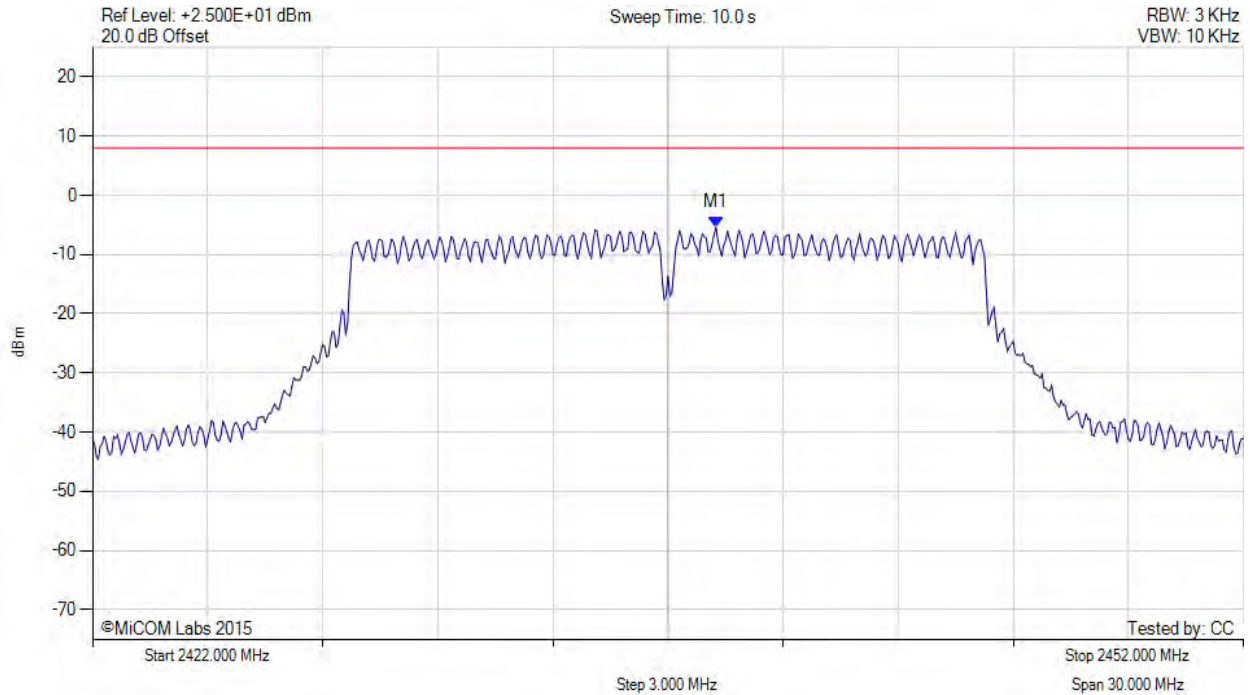

Analyser Setup	Marker:Frequency:Amplitude	Test Results
Detector = AVER Sweep Count = 0 RF Atten (dB) = 20 Trace Mode = VIEW	M1 : 2438.300 MHz : -5.429 dBm M1 + DCCF : 2438.300 MHz : -5.385 dBm Duty Cycle Correction Factor : +0.04 dB	Limit: ≤ 8.0 dBm Margin: -13.4 dB

[back to matrix](#)

This test report may be reproduced in full only. The document may only be updated by MiCOM Labs personnel. All changes will be noted in the Document History section of the report.



Title: Aruba Networks APEX0104
To: FCC CFR 47 Part 15 Subpart C 15.247 & IC RSS-247
Serial #: ARUB199-U3 Rev A
Issue Date: 27th August 2015
Page: 183 of 223

POWER SPECTRAL DENSITY - AVERAGE



Variant: 802.11g, Channel: 2462.00 MHz, Chain a, Temp: Ambient, Voltage: 48 Vdc

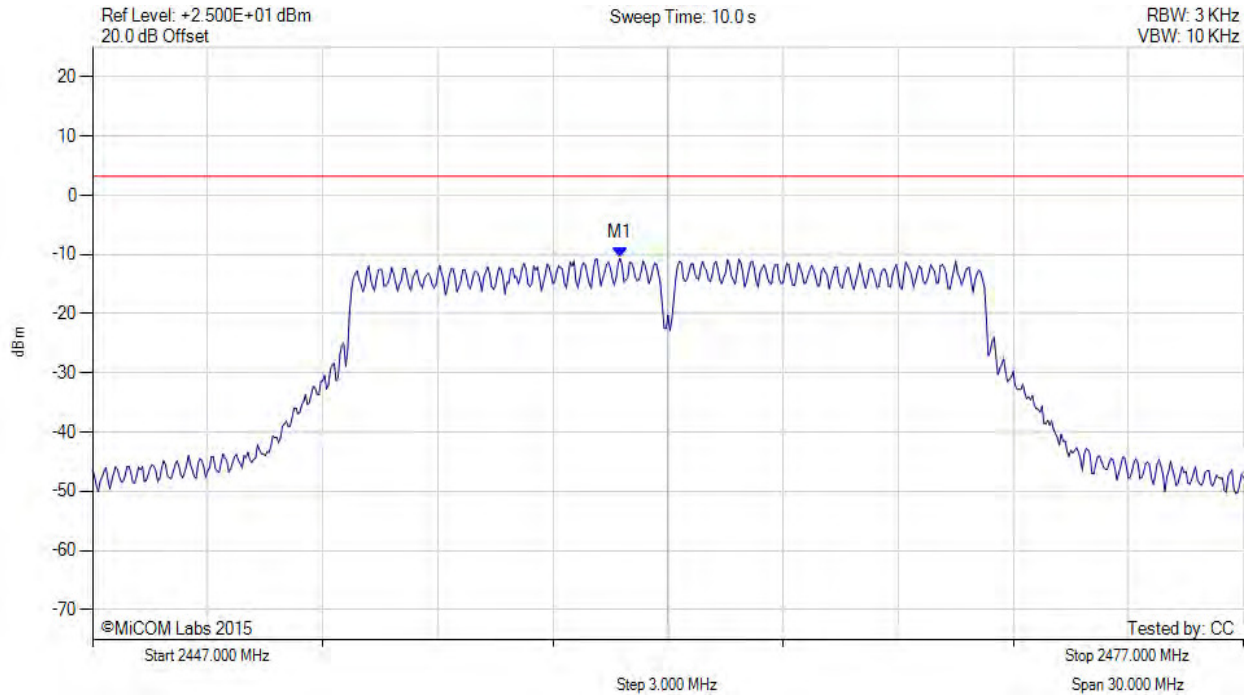

Analyser Setup	Marker:Frequency:Amplitude	Test Results
Detector = AVER Sweep Count = 0 RF Atten (dB) = 20 Trace Mode = VIEW	M1 : 2460.750 MHz : -10.654 dBm	Limit: ≤ 3.230 dBm

[back to matrix](#)

This test report may be reproduced in full only. The document may only be updated by MiCOM Labs personnel. All changes will be noted in the Document History section of the report.



Title: Aruba Networks APEX0104
To: FCC CFR 47 Part 15 Subpart C 15.247 & IC RSS-247
Serial #: ARUB199-U3 Rev A
Issue Date: 27th August 2015
Page: 184 of 223

POWER SPECTRAL DENSITY - AVERAGE



Variant: 802.11g, Channel: 2462.00 MHz, Chain b, Temp: Ambient, Voltage: 48 Vdc

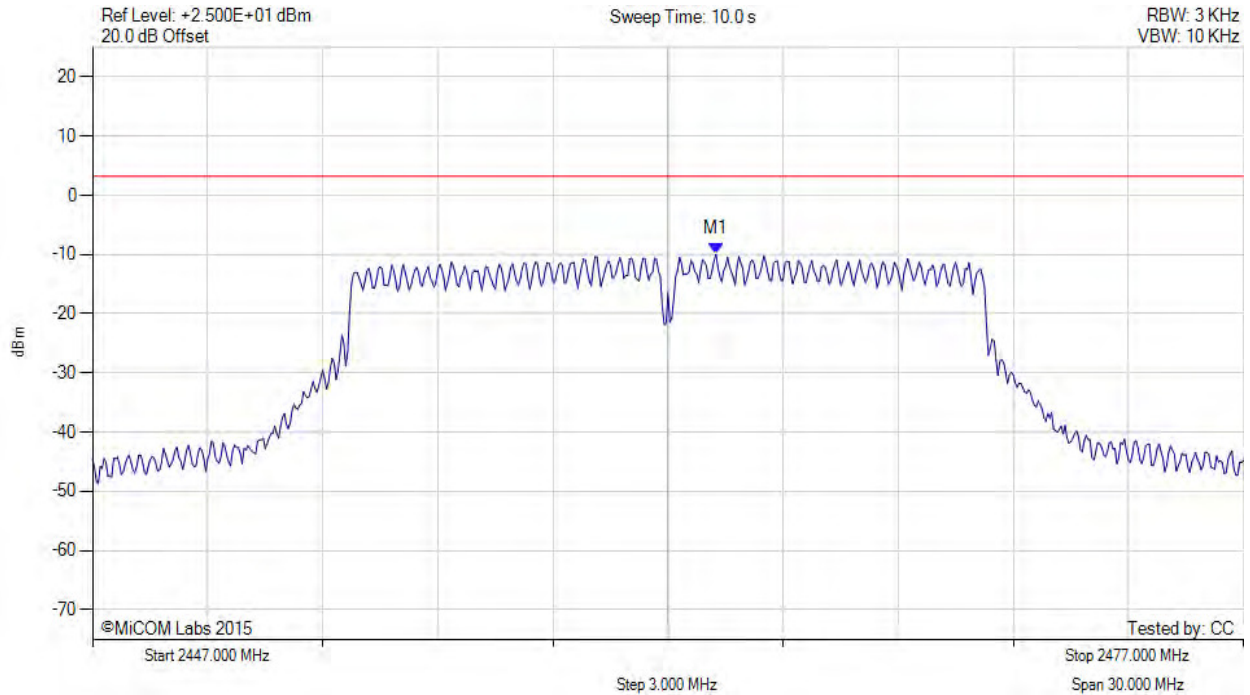

Analyser Setup	Marker:Frequency:Amplitude	Test Results
Detector = AVER Sweep Count = 0 RF Atten (dB) = 20 Trace Mode = VIEW	M1 : 2463.250 MHz : -9.926 dBm	Limit: ≤ 3.230 dBm

[back to matrix](#)

This test report may be reproduced in full only. The document may only be updated by MiCOM Labs personnel. All changes will be noted in the Document History section of the report.



Title: Aruba Networks APEX0104
To: FCC CFR 47 Part 15 Subpart C 15.247 & IC RSS-247
Serial #: ARUB199-U3 Rev A
Issue Date: 27th August 2015
Page: 185 of 223

POWER SPECTRAL DENSITY - AVERAGE



Variant: 802.11g, Channel: 2462.00 MHz, Chain c, Temp: Ambient, Voltage: 48 Vdc

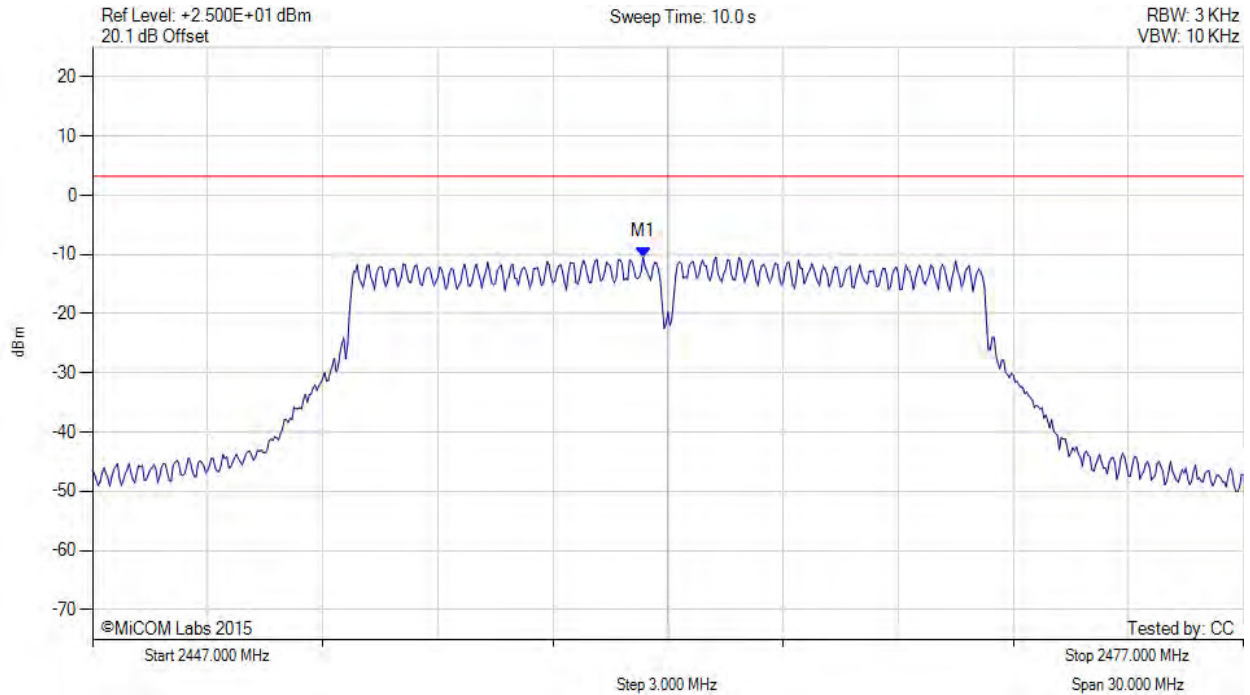

Analyser Setup	Marker:Frequency:Amplitude	Test Results
Detector = AVER Sweep Count = 0 RF Atten (dB) = 20 Trace Mode = VIEW	M1 : 2461.350 MHz : -10.424 dBm	Limit: ≤ 3.230 dBm

[back to matrix](#)

This test report may be reproduced in full only. The document may only be updated by MiCOM Labs personnel. All changes will be noted in the Document History section of the report.



Title: Aruba Networks APEX0104
To: FCC CFR 47 Part 15 Subpart C 15.247 & IC RSS-247
Serial #: ARUB199-U3 Rev A
Issue Date: 27th August 2015
Page: 186 of 223

POWER SPECTRAL DENSITY - AVERAGE



Variant: 802.11g, Channel: 2462.00 MHz, SUM, Temp: Ambient, Voltage: 48 Vdc

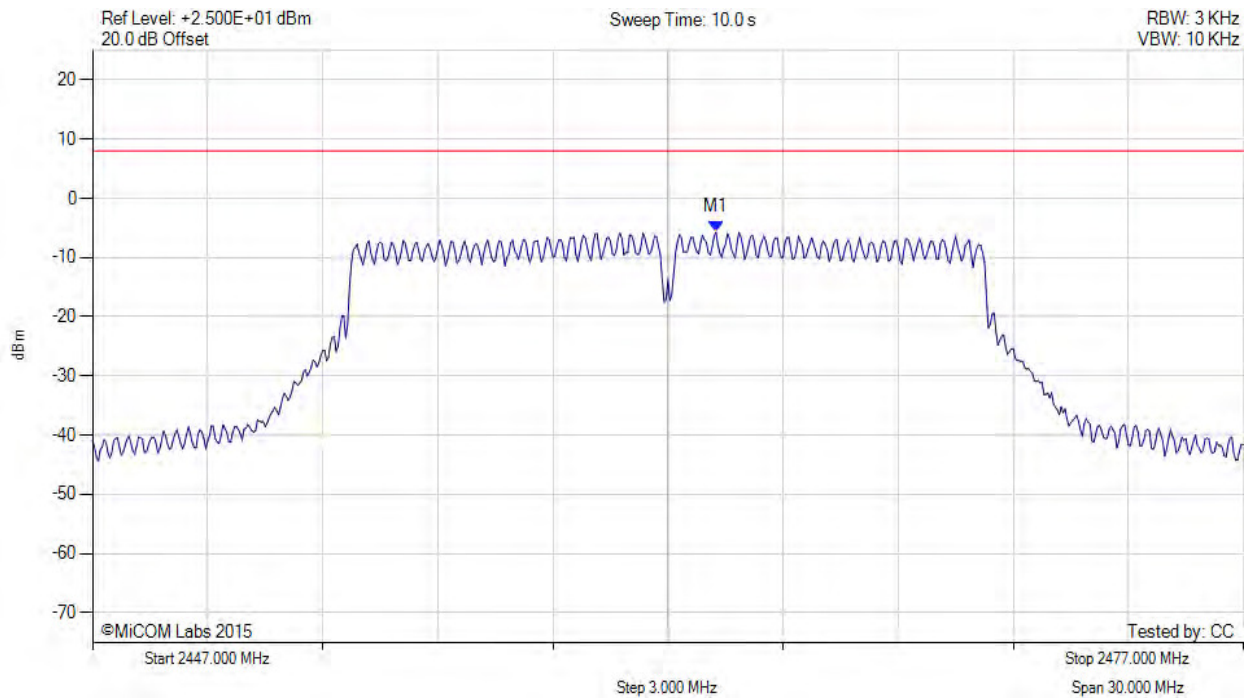

Analyser Setup	Marker:Frequency:Amplitude	Test Results
Detector = AVER Sweep Count = 0 RF Atten (dB) = 20 Trace Mode = VIEW	M1 : 2463.300 MHz : -5.729 dBm M1 + DCCF : 2463.300 MHz : -5.685 dBm Duty Cycle Correction Factor : +0.04 dB	Limit: ≤ 8.0 dBm Margin: -13.7 dB

[back to matrix](#)

This test report may be reproduced in full only. The document may only be updated by MiCOM Labs personnel. All changes will be noted in the Document History section of the report.



Title: Aruba Networks APEX0104
To: FCC CFR 47 Part 15 Subpart C 15.247 & IC RSS-247
Serial #: ARUB199-U3 Rev A
Issue Date: 27th August 2015
Page: 187 of 223

POWER SPECTRAL DENSITY - AVERAGE



Variant: 802.11n HT-20, Channel: 2412.00 MHz, Chain a, Temp: Ambient, Voltage: 48 Vdc

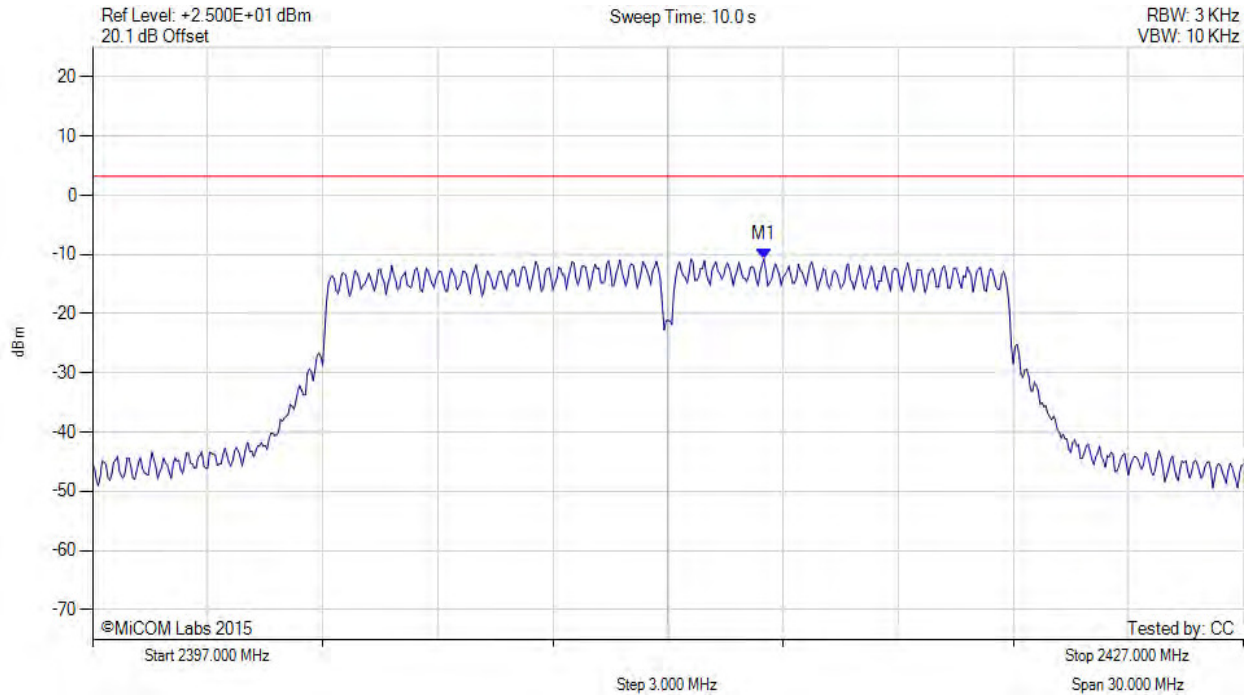

Analyser Setup	Marker:Frequency:Amplitude	Test Results
Detector = AVER Sweep Count = 0 RF Atten (dB) = 20 Trace Mode = VIEW	M1 : 2414.500 MHz : -10.772 dBm	Limit: ≤ 3.230 dBm

[back to matrix](#)

This test report may be reproduced in full only. The document may only be updated by MiCOM Labs personnel. All changes will be noted in the Document History section of the report.



Title: Aruba Networks APEX0104
To: FCC CFR 47 Part 15 Subpart C 15.247 & IC RSS-247
Serial #: ARUB199-U3 Rev A
Issue Date: 27th August 2015
Page: 188 of 223

POWER SPECTRAL DENSITY - AVERAGE



Variant: 802.11n HT-20, Channel: 2412.00 MHz, Chain b, Temp: Ambient, Voltage: 48 Vdc

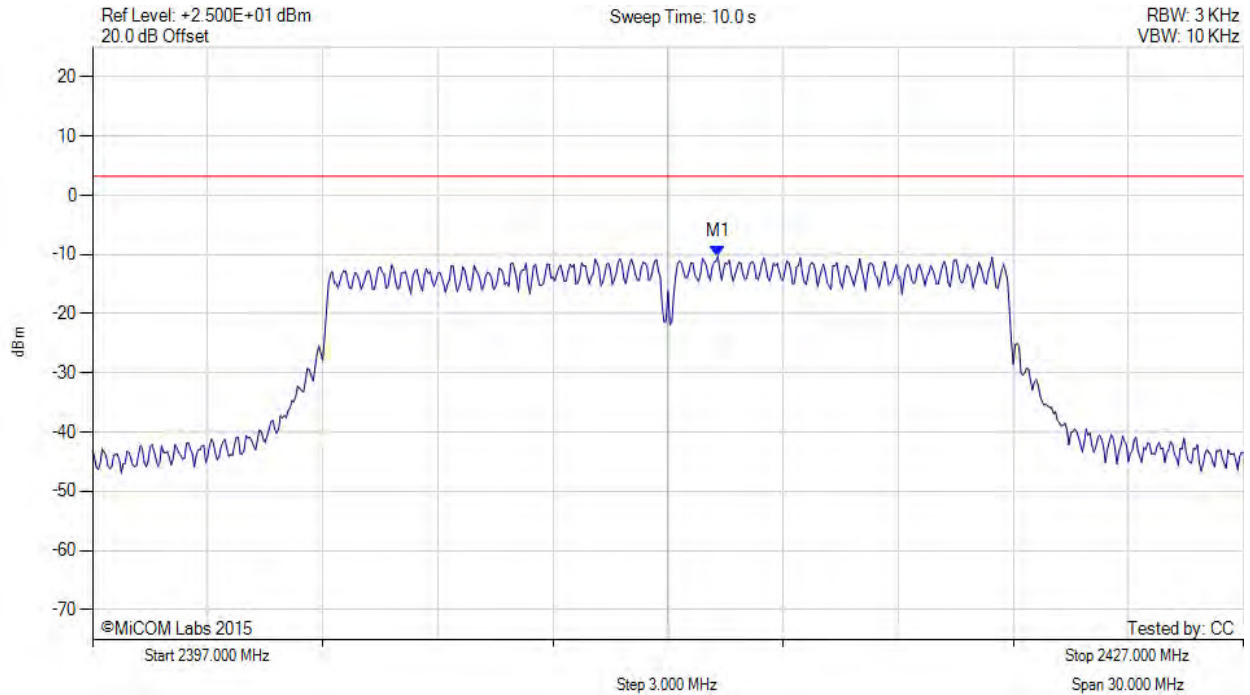

Analyser Setup	Marker:Frequency:Amplitude	Test Results
Detector = AVER Sweep Count = 0 RF Atten (dB) = 20 Trace Mode = MAXH	M1 : 2413.300 MHz : -10.293 dBm	Limit: ≤ 3.230 dBm

[back to matrix](#)

This test report may be reproduced in full only. The document may only be updated by MiCOM Labs personnel. All changes will be noted in the Document History section of the report.



Title: Aruba Networks APEX0104
To: FCC CFR 47 Part 15 Subpart C 15.247 & IC RSS-247
Serial #: ARUB199-U3 Rev A
Issue Date: 27th August 2015
Page: 189 of 223

POWER SPECTRAL DENSITY - AVERAGE



Variant: 802.11n HT-20, Channel: 2412.00 MHz, Chain c, Temp: Ambient, Voltage: 48 Vdc

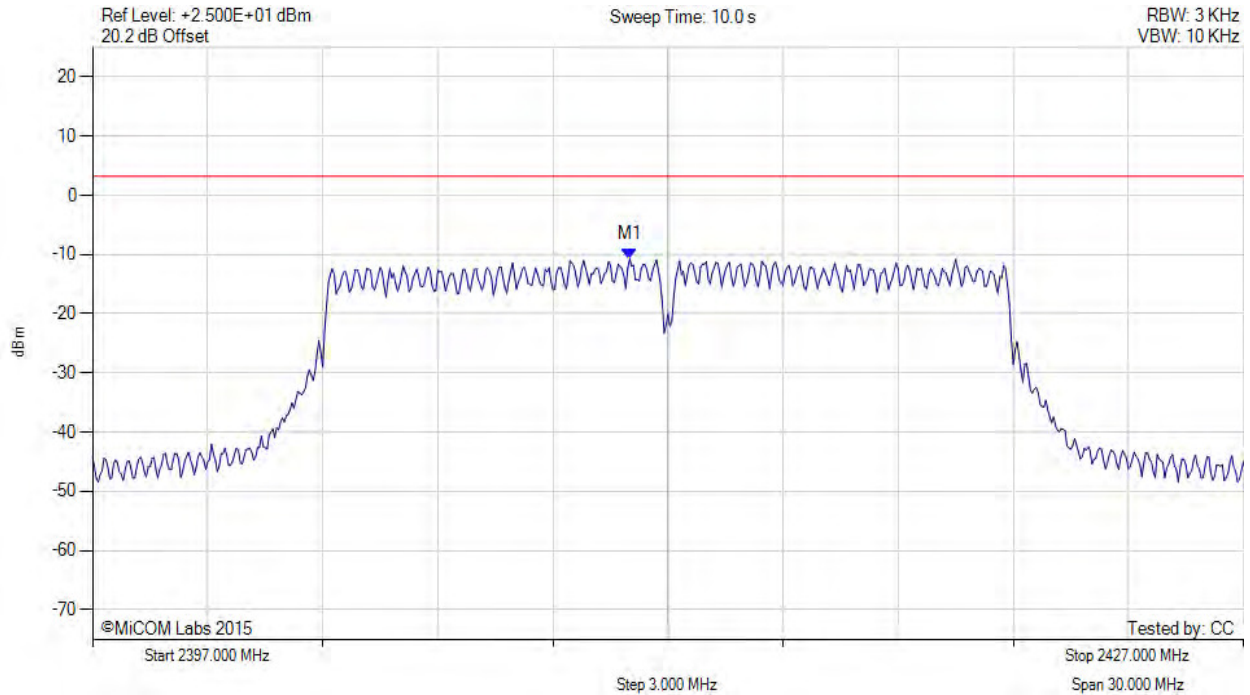

Analyser Setup	Marker:Frequency:Amplitude	Test Results
Detector = AVER Sweep Count = 0 RF Atten (dB) = 20 Trace Mode = VIEW	M1 : 2411.000 MHz : -10.755 dBm	Limit: ≤ 3.230 dBm

[back to matrix](#)

This test report may be reproduced in full only. The document may only be updated by MiCOM Labs personnel. All changes will be noted in the Document History section of the report.



Title: Aruba Networks APEX0104
To: FCC CFR 47 Part 15 Subpart C 15.247 & IC RSS-247
Serial #: ARUB199-U3 Rev A
Issue Date: 27th August 2015
Page: 190 of 223

POWER SPECTRAL DENSITY - AVERAGE



Variant: 802.11n HT-20, Channel: 2412.00 MHz, SUM, Temp: Ambient, Voltage: 48 Vdc

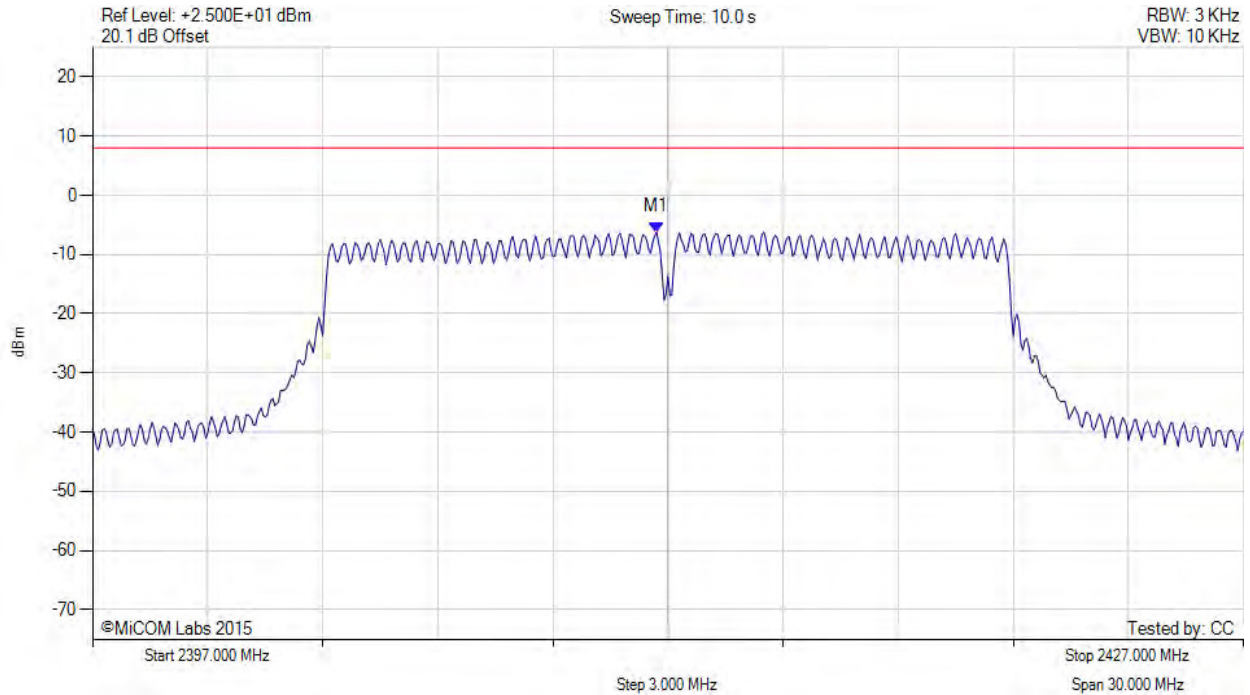

Analyser Setup	Marker:Frequency:Amplitude	Test Results
Detector = AVER Sweep Count = 0 RF Atten (dB) = 20 Trace Mode = VIEW	M1 : 2411.700 MHz : -6.224 dBm M1 + DCCF : 2411.700 MHz : -6.136 dBm Duty Cycle Correction Factor : +0.09 dB	Limit: ≤ 8.0 dBm Margin: -14.1 dB

[back to matrix](#)

This test report may be reproduced in full only. The document may only be updated by MiCOM Labs personnel. All changes will be noted in the Document History section of the report.



Title: Aruba Networks APEX0104
To: FCC CFR 47 Part 15 Subpart C 15.247 & IC RSS-247
Serial #: ARUB199-U3 Rev A
Issue Date: 27th August 2015
Page: 191 of 223

POWER SPECTRAL DENSITY - AVERAGE



Variant: 802.11n HT-20, Channel: 2437.00 MHz, Chain a, Temp: Ambient, Voltage: 48 Vdc

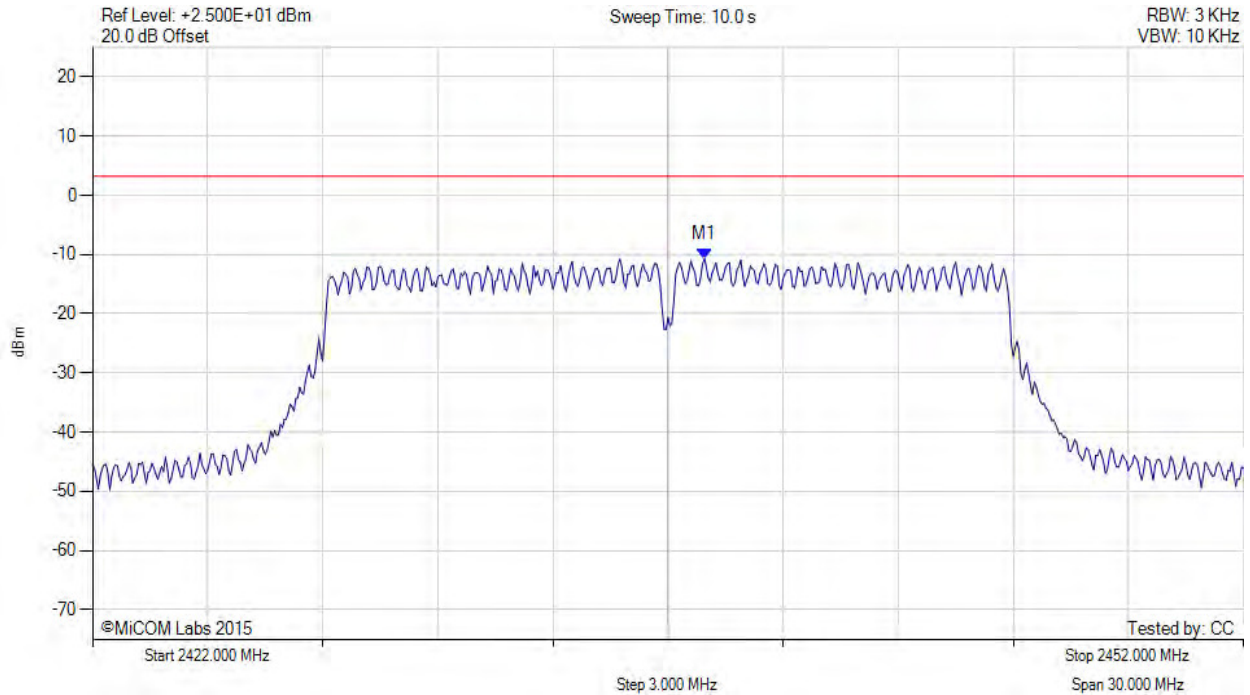

Analyser Setup	Marker:Frequency:Amplitude	Test Results
Detector = AVER Sweep Count = 0 RF Atten (dB) = 20 Trace Mode = VIEW	M1 : 2437.950 MHz : -10.753 dBm	Limit: ≤ 3.230 dBm

[back to matrix](#)

This test report may be reproduced in full only. The document may only be updated by MiCOM Labs personnel. All changes will be noted in the Document History section of the report.



Title: Aruba Networks APEX0104
To: FCC CFR 47 Part 15 Subpart C 15.247 & IC RSS-247
Serial #: ARUB199-U3 Rev A
Issue Date: 27th August 2015
Page: 192 of 223

POWER SPECTRAL DENSITY - AVERAGE



Variant: 802.11n HT-20, Channel: 2437.00 MHz, Chain b, Temp: Ambient, Voltage: 48 Vdc

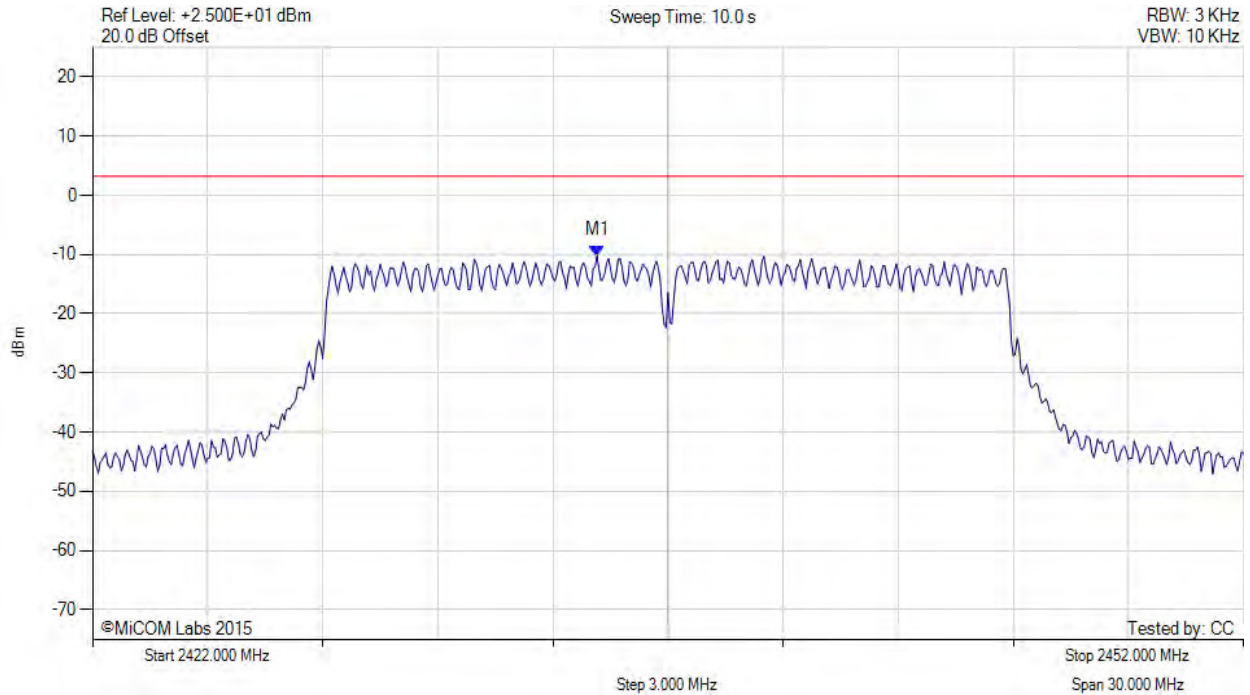

Analyser Setup	Marker:Frequency:Amplitude	Test Results
Detector = AVER Sweep Count = 0 RF Atten (dB) = 20 Trace Mode = VIEW	M1 : 2435.150 MHz : -10.196 dBm	Limit: ≤ 3.230 dBm

[back to matrix](#)

This test report may be reproduced in full only. The document may only be updated by MiCOM Labs personnel. All changes will be noted in the Document History section of the report.



Title: Aruba Networks APEX0104
To: FCC CFR 47 Part 15 Subpart C 15.247 & IC RSS-247
Serial #: ARUB199-U3 Rev A
Issue Date: 27th August 2015
Page: 193 of 223

POWER SPECTRAL DENSITY - AVERAGE



Variant: 802.11n HT-20, Channel: 2437.00 MHz, Chain c, Temp: Ambient, Voltage: 48 Vdc

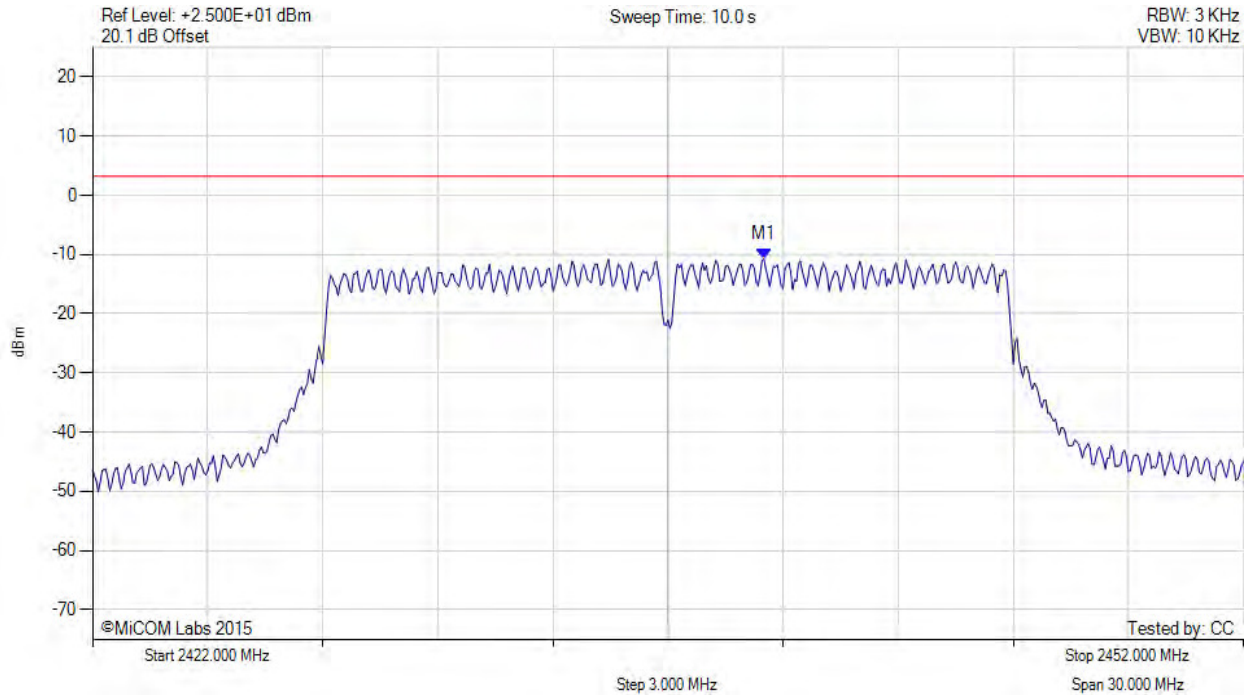

Analyser Setup	Marker:Frequency:Amplitude	Test Results
Detector = AVER Sweep Count = 0 RF Atten (dB) = 20 Trace Mode = VIEW	M1 : 2439.500 MHz : -10.717 dBm	Limit: ≤ 3.230 dBm

[back to matrix](#)

This test report may be reproduced in full only. The document may only be updated by MiCOM Labs personnel. All changes will be noted in the Document History section of the report.



Title: Aruba Networks APEX0104
To: FCC CFR 47 Part 15 Subpart C 15.247 & IC RSS-247
Serial #: ARUB199-U3 Rev A
Issue Date: 27th August 2015
Page: 194 of 223

POWER SPECTRAL DENSITY - AVERAGE



Variante: 802.11n HT-20, Channel: 2437.00 MHz, SUM, Temp: Ambient, Voltage: 48 Vdc

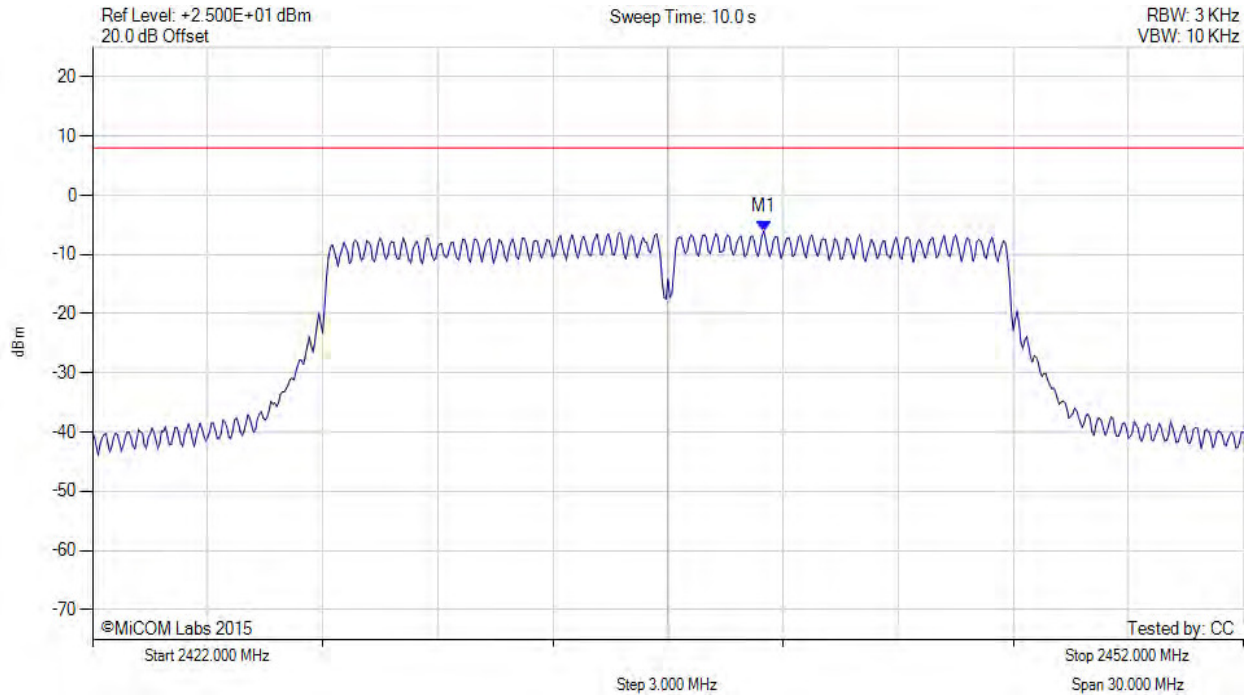

Analyser Setup	Marker:Frequency:Amplitude	Test Results
Detector = AVER Sweep Count = 0 RF Atten (dB) = 20 Trace Mode = VIEW	M1 : 2439.500 MHz : -6.074 dBm M1 + DCCF : 2439.500 MHz : -5.986 dBm Duty Cycle Correction Factor : +0.09 dB	Limit: ≤ 8.0 dBm Margin: -14.0 dB

[back to matrix](#)

This test report may be reproduced in full only. The document may only be updated by MiCOM Labs personnel. All changes will be noted in the Document History section of the report.



Title: Aruba Networks APEX0104
To: FCC CFR 47 Part 15 Subpart C 15.247 & IC RSS-247
Serial #: ARUB199-U3 Rev A
Issue Date: 27th August 2015
Page: 195 of 223

POWER SPECTRAL DENSITY - AVERAGE



Variant: 802.11n HT-20, Channel: 2462.00 MHz, Chain a, Temp: Ambient, Voltage: 48 Vdc

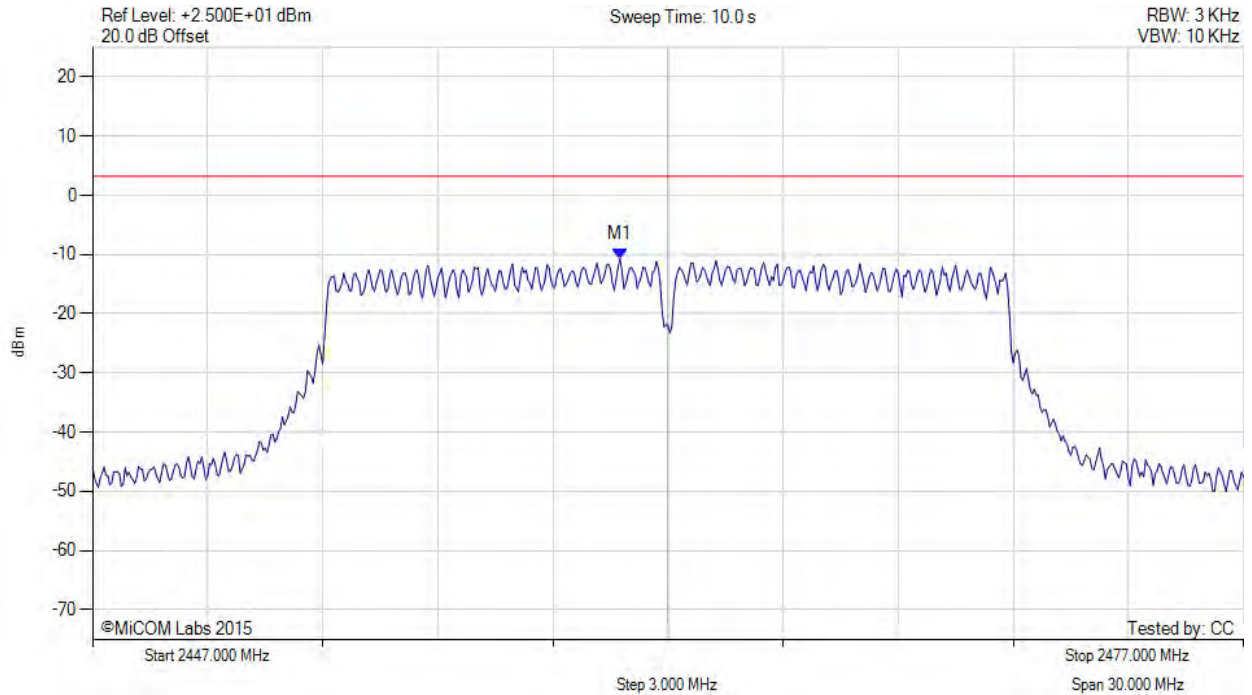

Analyser Setup	Marker:Frequency:Amplitude	Test Results
Detector = AVER Sweep Count = 0 RF Atten (dB) = 20 Trace Mode = VIEW	M1 : 2460.750 MHz : -10.758 dBm	Limit: ≤ 3.230 dBm

[back to matrix](#)

This test report may be reproduced in full only. The document may only be updated by MiCOM Labs personnel. All changes will be noted in the Document History section of the report.



Title: Aruba Networks APEX0104
To: FCC CFR 47 Part 15 Subpart C 15.247 & IC RSS-247
Serial #: ARUB199-U3 Rev A
Issue Date: 27th August 2015
Page: 196 of 223

POWER SPECTRAL DENSITY - AVERAGE



Variant: 802.11n HT-20, Channel: 2462.00 MHz, Chain b, Temp: Ambient, Voltage: 48 Vdc

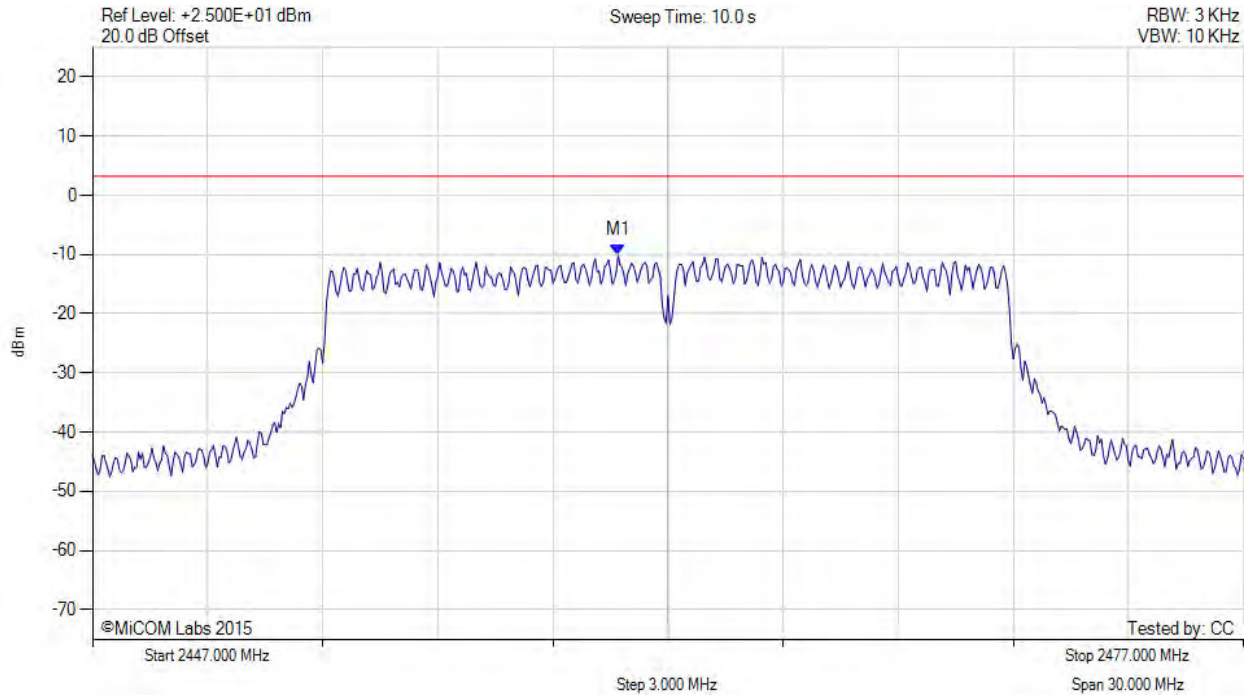

Analyser Setup	Marker:Frequency:Amplitude	Test Results
Detector = AVER Sweep Count = 0 RF Atten (dB) = 20 Trace Mode = VIEW	M1 : 2460.700 MHz : -10.160 dBm	Limit: ≤ 3.230 dBm

[back to matrix](#)

This test report may be reproduced in full only. The document may only be updated by MiCOM Labs personnel. All changes will be noted in the Document History section of the report.



Title: Aruba Networks APEX0104
To: FCC CFR 47 Part 15 Subpart C 15.247 & IC RSS-247
Serial #: ARUB199-U3 Rev A
Issue Date: 27th August 2015
Page: 197 of 223

POWER SPECTRAL DENSITY - AVERAGE



Variant: 802.11n HT-20, Channel: 2462.00 MHz, Chain c, Temp: Ambient, Voltage: 48 Vdc

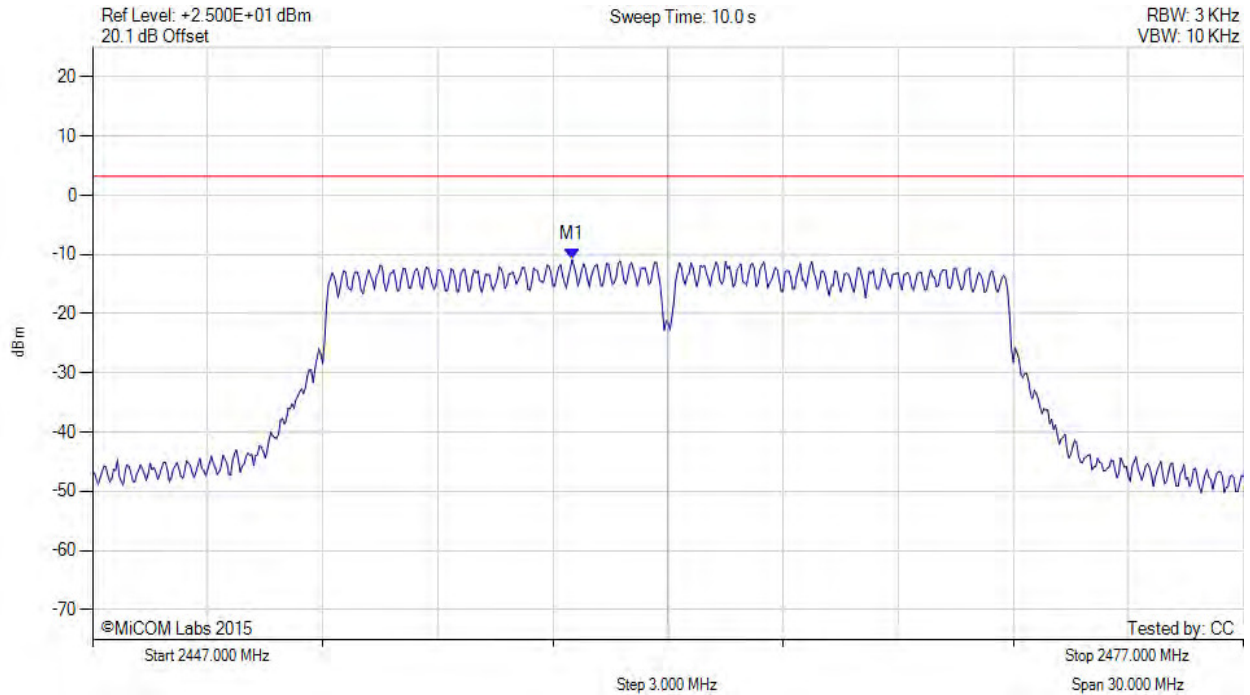

Analyser Setup	Marker:Frequency:Amplitude	Test Results
Detector = AVER Sweep Count = 0 RF Atten (dB) = 20 Trace Mode = VIEW	M1 : 2459.500 MHz : -10.874 dBm	Limit: ≤ 3.230 dBm

[back to matrix](#)

This test report may be reproduced in full only. The document may only be updated by MiCOM Labs personnel. All changes will be noted in the Document History section of the report.



Title: Aruba Networks APEX0104
To: FCC CFR 47 Part 15 Subpart C 15.247 & IC RSS-247
Serial #: ARUB199-U3 Rev A
Issue Date: 27th August 2015
Page: 198 of 223

POWER SPECTRAL DENSITY - AVERAGE



Variant: 802.11n HT-20, Channel: 2462.00 MHz, SUM, Temp: Ambient, Voltage: 48 Vdc

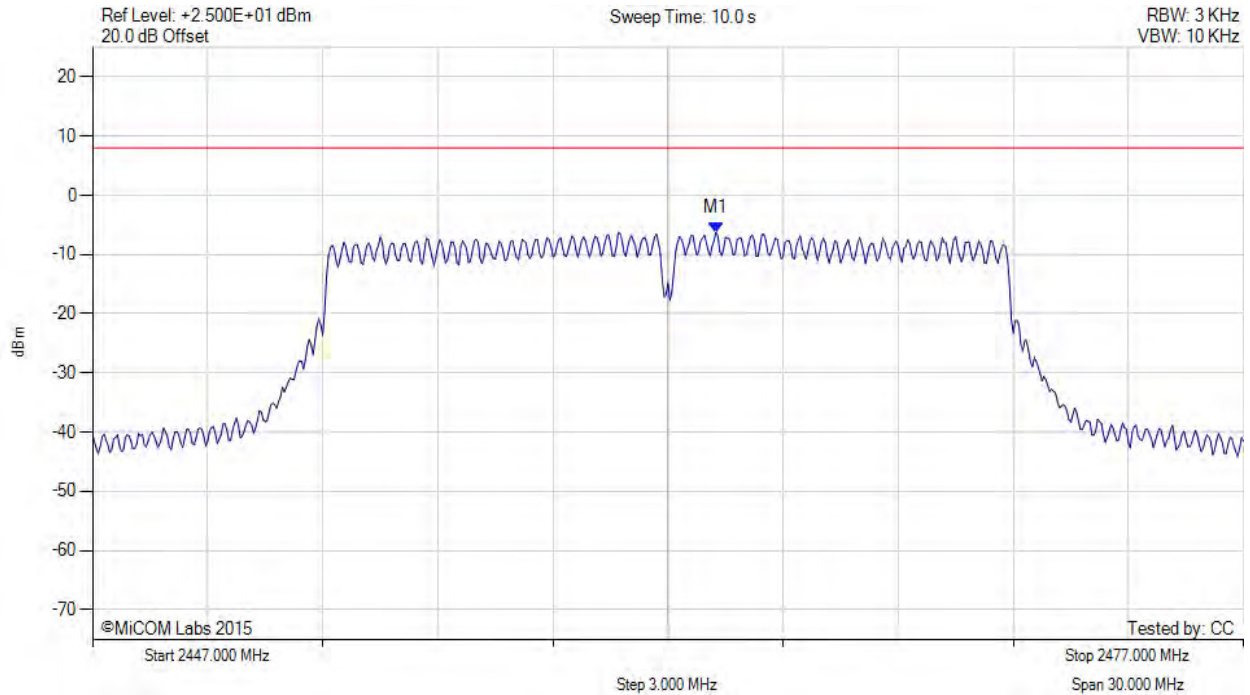

Analyser Setup	Marker:Frequency:Amplitude	Test Results
Detector = AVER Sweep Count = 0 RF Atten (dB) = 20 Trace Mode = VIEW	M1 : 2463.300 MHz : -6.244 dBm M1 + DCCF : 2463.300 MHz : -6.156 dBm Duty Cycle Correction Factor : +0.09 dB	Limit: ≤ 8.0 dBm Margin: -14.1 dB

[back to matrix](#)

This test report may be reproduced in full only. The document may only be updated by MiCOM Labs personnel. All changes will be noted in the Document History section of the report.



Title: Aruba Networks APEX0104
To: FCC CFR 47 Part 15 Subpart C 15.247 & IC RSS-247
Serial #: ARUB199-U3 Rev A
Issue Date: 27th August 2015
Page: 199 of 223

POWER SPECTRAL DENSITY - AVERAGE



Variant: 802.11n HT-40, Channel: 2422.00 MHz, Chain a, Temp: Ambient, Voltage: 48 Vdc

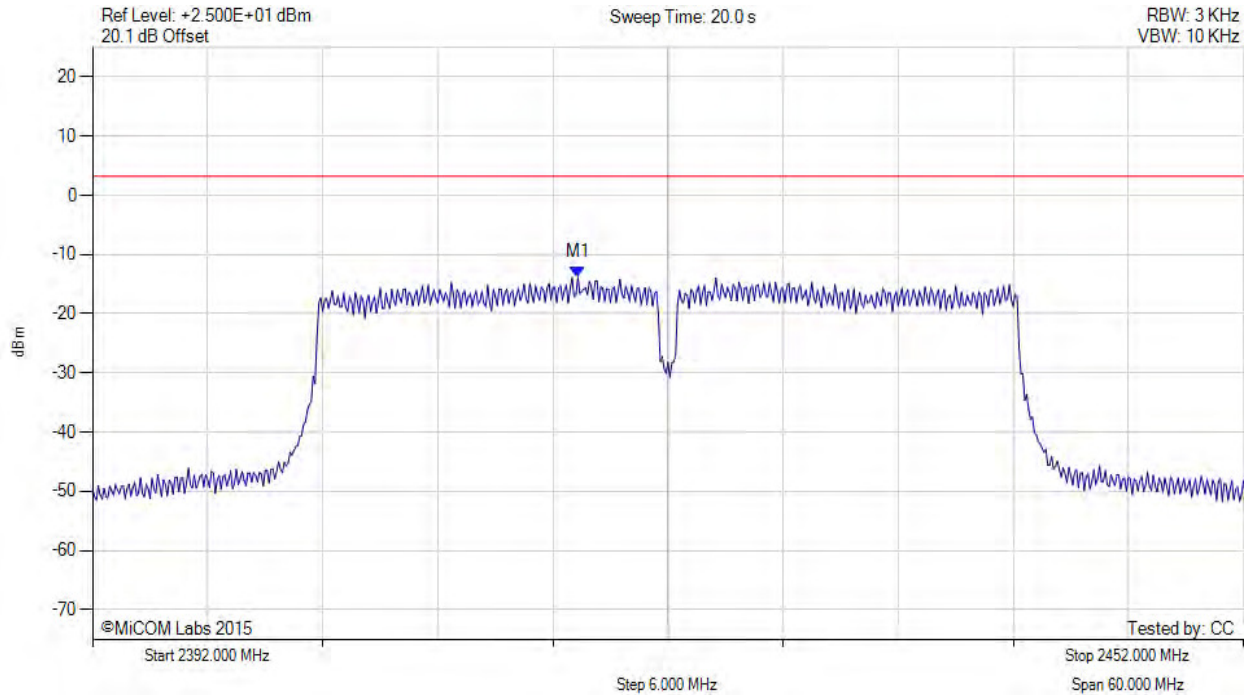

Analyser Setup	Marker:Frequency:Amplitude	Test Results
Detector = AVER Sweep Count = 0 RF Atten (dB) = 20 Trace Mode = VIEW	M1 : 2417.300 MHz : -13.861 dBm	Limit: ≤ 3.230 dBm

[back to matrix](#)

This test report may be reproduced in full only. The document may only be updated by MiCOM Labs personnel. All changes will be noted in the Document History section of the report.



Title: Aruba Networks APEX0104
To: FCC CFR 47 Part 15 Subpart C 15.247 & IC RSS-247
Serial #: ARUB199-U3 Rev A
Issue Date: 27th August 2015
Page: 200 of 223

POWER SPECTRAL DENSITY - AVERAGE



Variant: 802.11n HT-40, Channel: 2422.00 MHz, Chain b, Temp: Ambient, Voltage: 48 Vdc

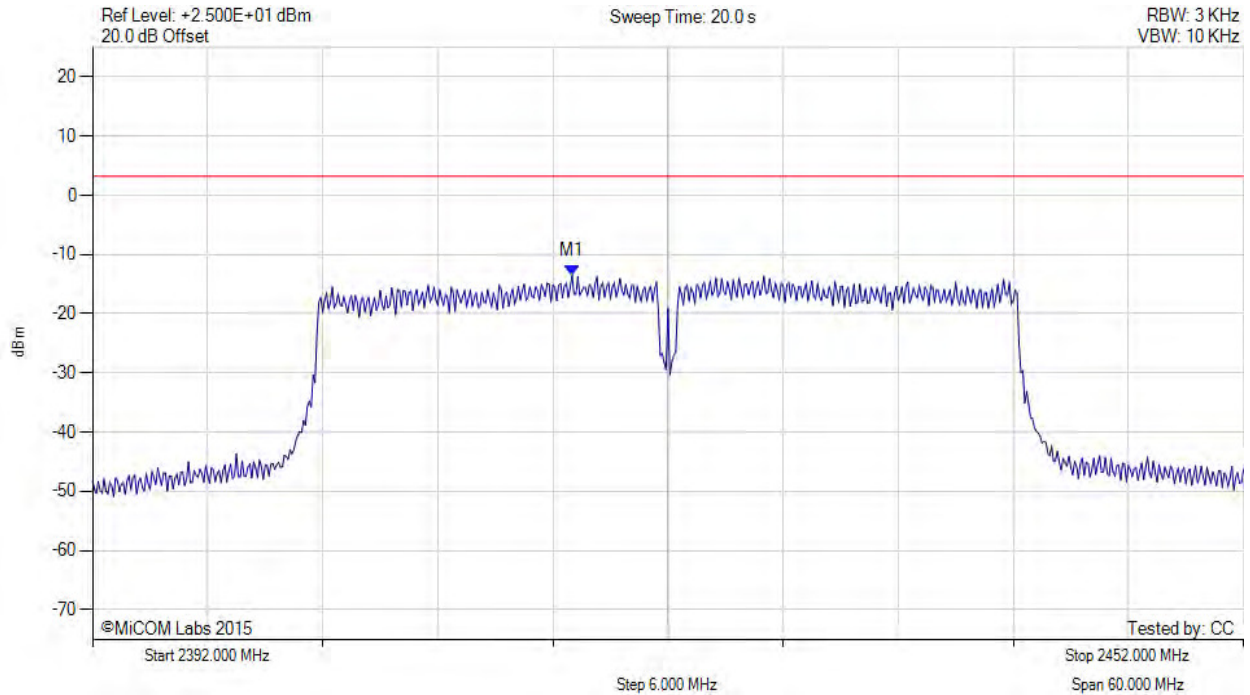

Analyser Setup	Marker:Frequency:Amplitude	Test Results
Detector = AVER Sweep Count = 0 RF Atten (dB) = 20 Trace Mode = VIEW	M1 : 2417.000 MHz : -13.558 dBm	Limit: ≤ 3.230 dBm

[back to matrix](#)

This test report may be reproduced in full only. The document may only be updated by MiCOM Labs personnel. All changes will be noted in the Document History section of the report.



Title: Aruba Networks APEX0104
To: FCC CFR 47 Part 15 Subpart C 15.247 & IC RSS-247
Serial #: ARUB199-U3 Rev A
Issue Date: 27th August 2015
Page: 201 of 223

POWER SPECTRAL DENSITY - AVERAGE



Variant: 802.11n HT-40, Channel: 2422.00 MHz, Chain c, Temp: Ambient, Voltage: 48 Vdc

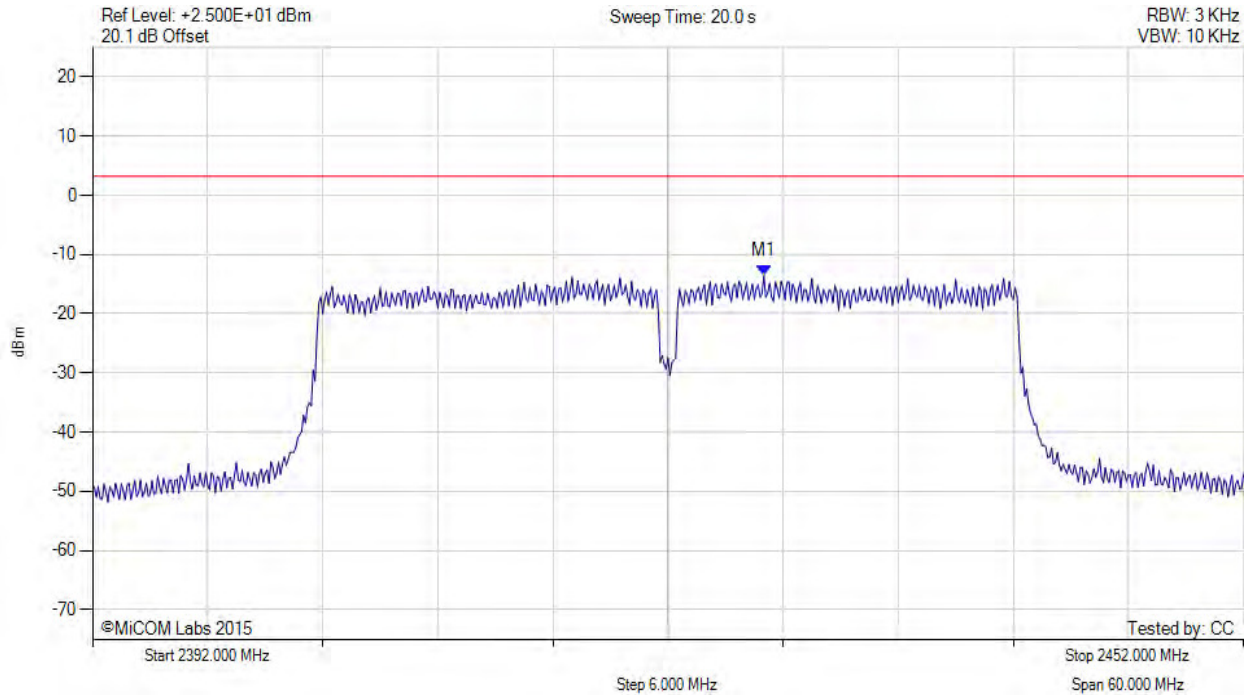

Analyser Setup	Marker:Frequency:Amplitude	Test Results
Detector = AVER Sweep Count = 0 RF Atten (dB) = 20 Trace Mode = VIEW	M1 : 2427.000 MHz : -13.643 dBm	Limit: ≤ 3.230 dBm

[back to matrix](#)

This test report may be reproduced in full only. The document may only be updated by MiCOM Labs personnel. All changes will be noted in the Document History section of the report.



Title: Aruba Networks APEX0104
To: FCC CFR 47 Part 15 Subpart C 15.247 & IC RSS-247
Serial #: ARUB199-U3 Rev A
Issue Date: 27th August 2015
Page: 202 of 223

POWER SPECTRAL DENSITY - AVERAGE



Variant: 802.11n HT-40, Channel: 2422.00 MHz, SUM, Temp: Ambient, Voltage: 48 Vdc

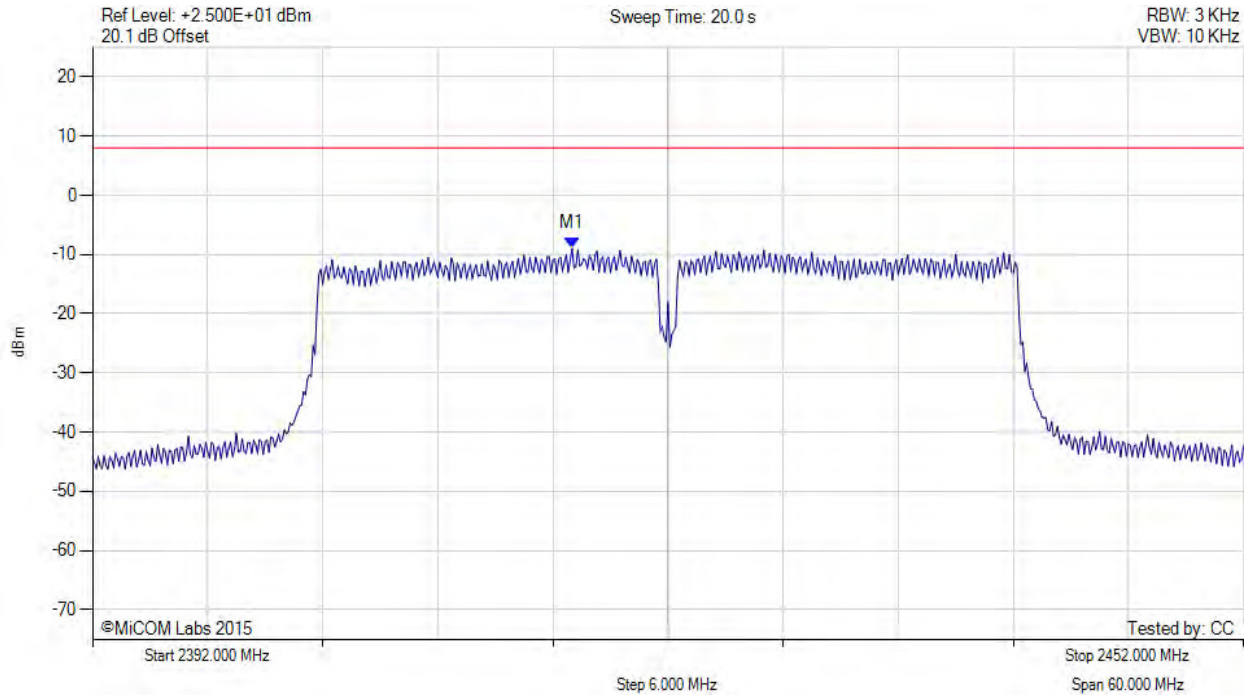

Analyser Setup	Marker:Frequency:Amplitude	Test Results
Detector = AVER Sweep Count = 0 RF Atten (dB) = 20 Trace Mode = VIEW	M1 : 2417.000 MHz : -8.990 dBm M1 + DCCF : 2417.000 MHz : -8.858 dBm Duty Cycle Correction Factor : +0.13 dB	Limit: ≤ 8.0 dBm Margin: -16.8 dB

[back to matrix](#)

This test report may be reproduced in full only. The document may only be updated by MiCOM Labs personnel. All changes will be noted in the Document History section of the report.



Title: Aruba Networks APEX0104
To: FCC CFR 47 Part 15 Subpart C 15.247 & IC RSS-247
Serial #: ARUB199-U3 Rev A
Issue Date: 27th August 2015
Page: 203 of 223

POWER SPECTRAL DENSITY - AVERAGE



Variant: 802.11n HT-40, Channel: 2437.00 MHz, Chain a, Temp: Ambient, Voltage: 48 Vdc

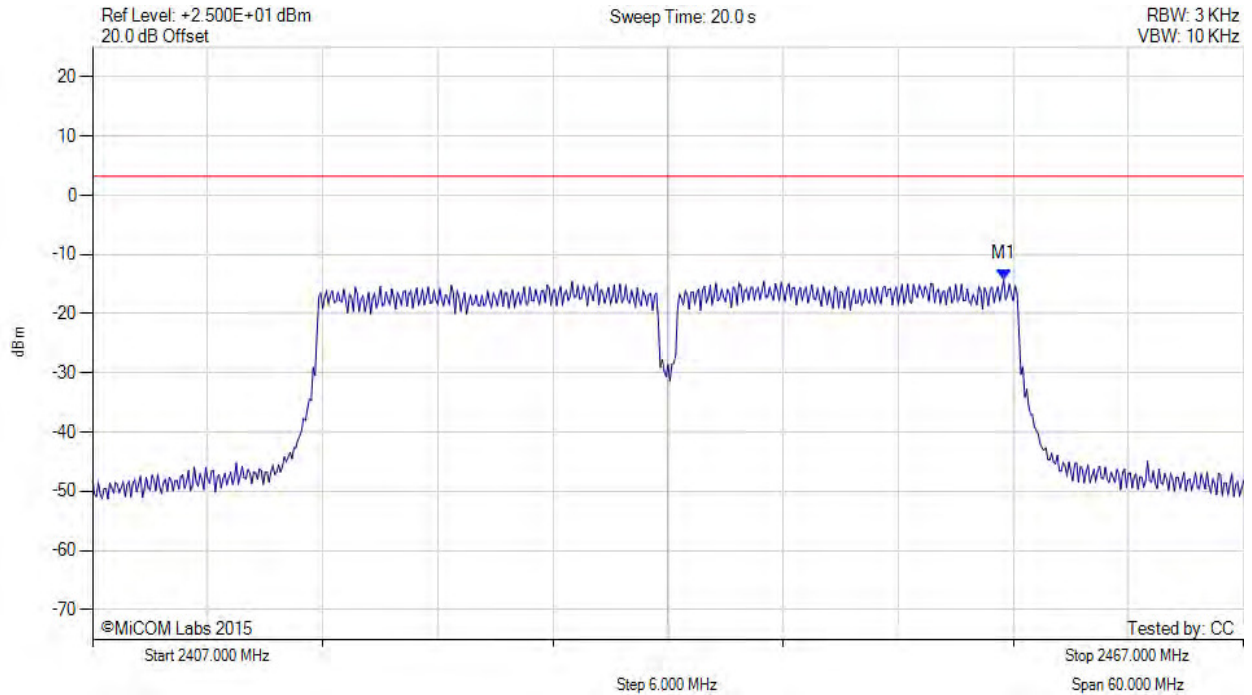

Analyser Setup	Marker:Frequency:Amplitude	Test Results
Detector = AVER Sweep Count = 0 RF Atten (dB) = 20 Trace Mode = VIEW	M1 : 2454.500 MHz : -14.163 dBm	Limit: ≤ 3.230 dBm

[back to matrix](#)

This test report may be reproduced in full only. The document may only be updated by MiCOM Labs personnel. All changes will be noted in the Document History section of the report.



Title: Aruba Networks APEX0104
To: FCC CFR 47 Part 15 Subpart C 15.247 & IC RSS-247
Serial #: ARUB199-U3 Rev A
Issue Date: 27th August 2015
Page: 204 of 223

POWER SPECTRAL DENSITY - AVERAGE



Variant: 802.11n HT-40, Channel: 2437.00 MHz, Chain b, Temp: Ambient, Voltage: 48 Vdc



Analyser Setup	Marker:Frequency:Amplitude	Test Results
Detector = AVER Sweep Count = 0 RF Atten (dB) = 20 Trace Mode = VIEW	M1 : 2432.000 MHz : -13.319 dBm	Limit: ≤ 3.230 dBm

[back to matrix](#)

This test report may be reproduced in full only. The document may only be updated by MiCOM Labs personnel. All changes will be noted in the Document History section of the report.



Title: Aruba Networks APEX0104
To: FCC CFR 47 Part 15 Subpart C 15.247 & IC RSS-247
Serial #: ARUB199-U3 Rev A
Issue Date: 27th August 2015
Page: 205 of 223

POWER SPECTRAL DENSITY - AVERAGE



Variant: 802.11n HT-40, Channel: 2437.00 MHz, Chain c, Temp: Ambient, Voltage: 48 Vdc

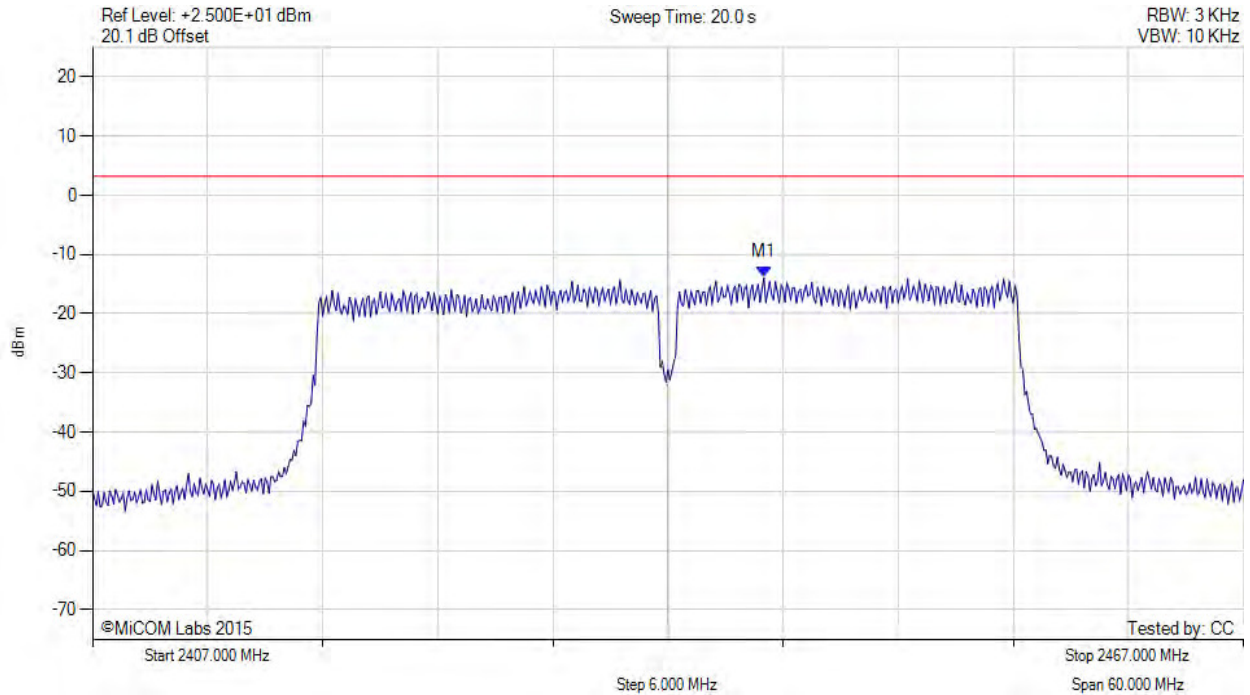

Analyser Setup	Marker:Frequency:Amplitude	Test Results
Detector = AVER Sweep Count = 0 RF Atten (dB) = 20 Trace Mode = VIEW	M1 : 2442.000 MHz : -13.900 dBm	Limit: ≤ 3.230 dBm

[back to matrix](#)

This test report may be reproduced in full only. The document may only be updated by MiCOM Labs personnel. All changes will be noted in the Document History section of the report.



Title: Aruba Networks APEX0104
To: FCC CFR 47 Part 15 Subpart C 15.247 & IC RSS-247
Serial #: ARUB199-U3 Rev A
Issue Date: 27th August 2015
Page: 206 of 223

POWER SPECTRAL DENSITY - AVERAGE



Variant: 802.11n HT-40, Channel: 2437.00 MHz, SUM, Temp: Ambient, Voltage: 48 Vdc

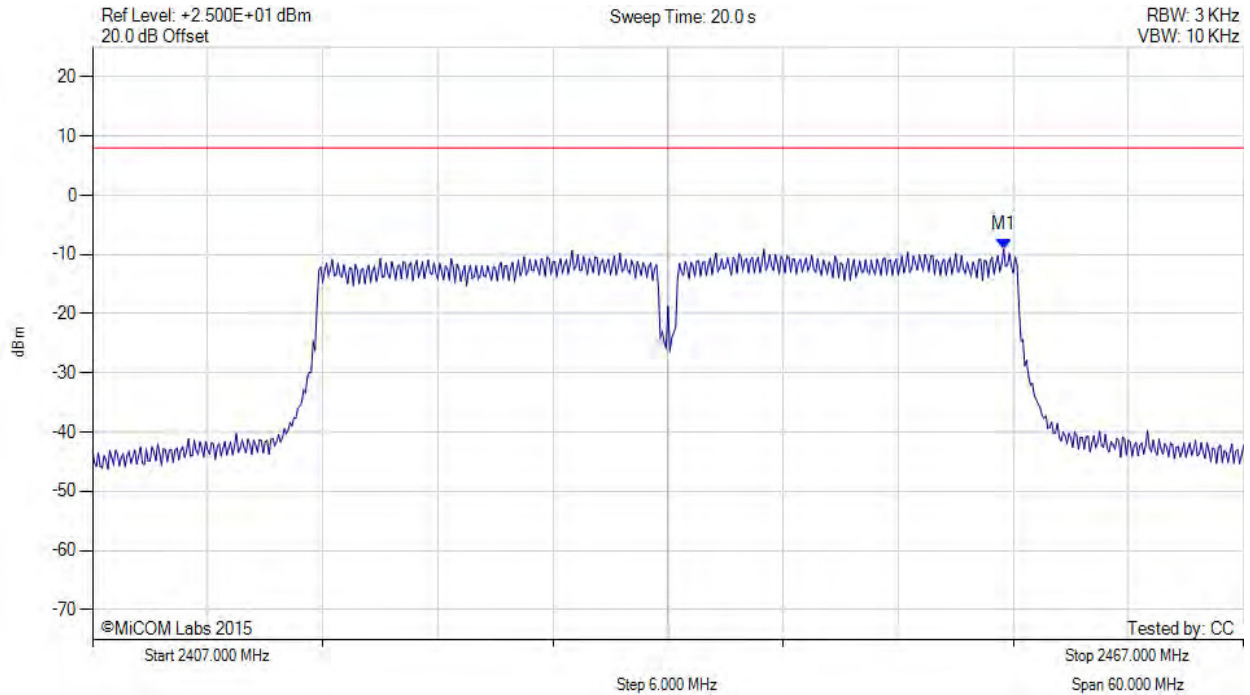

Analyser Setup	Marker:Frequency:Amplitude	Test Results
Detector = AVER Sweep Count = 0 RF Atten (dB) = 20 Trace Mode = VIEW	M1 : 2454.500 MHz : -9.146 dBm M1 + DCCF : 2454.500 MHz : -9.014 dBm Duty Cycle Correction Factor : +0.13 dB	Limit: ≤ 8.0 dBm Margin: -17.0 dB

[back to matrix](#)

This test report may be reproduced in full only. The document may only be updated by MiCOM Labs personnel. All changes will be noted in the Document History section of the report.



Title: Aruba Networks APEX0104
To: FCC CFR 47 Part 15 Subpart C 15.247 & IC RSS-247
Serial #: ARUB199-U3 Rev A
Issue Date: 27th August 2015
Page: 207 of 223

POWER SPECTRAL DENSITY - AVERAGE



Variant: 802.11n HT-40, Channel: 2452.00 MHz, Chain a, Temp: Ambient, Voltage: 48 Vdc

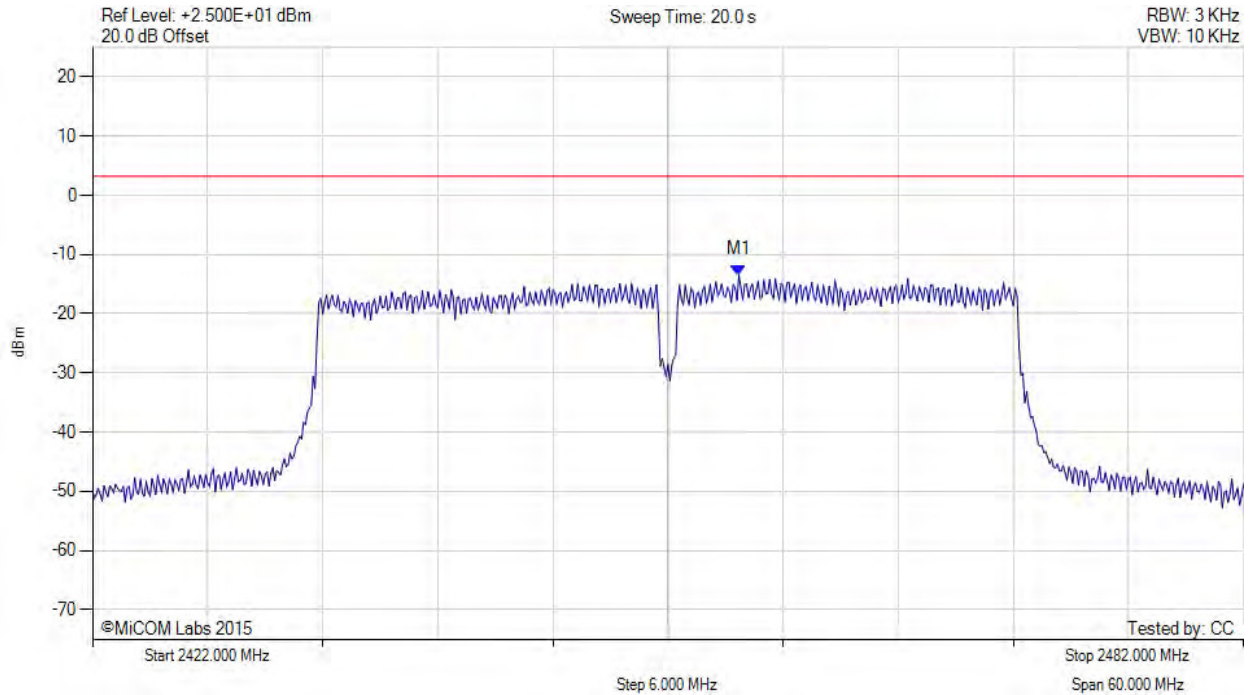

Analyser Setup	Marker:Frequency:Amplitude	Test Results
Detector = AVER Sweep Count = 0 RF Atten (dB) = 20 Trace Mode = VIEW	M1 : 2455.700 MHz : -13.469 dBm	Limit: ≤ 3.230 dBm

[back to matrix](#)

This test report may be reproduced in full only. The document may only be updated by MiCOM Labs personnel. All changes will be noted in the Document History section of the report.



Title: Aruba Networks APEX0104
To: FCC CFR 47 Part 15 Subpart C 15.247 & IC RSS-247
Serial #: ARUB199-U3 Rev A
Issue Date: 27th August 2015
Page: 208 of 223

POWER SPECTRAL DENSITY - AVERAGE



Variant: 802.11n HT-40, Channel: 2452.00 MHz, Chain b, Temp: Ambient, Voltage: 48 Vdc

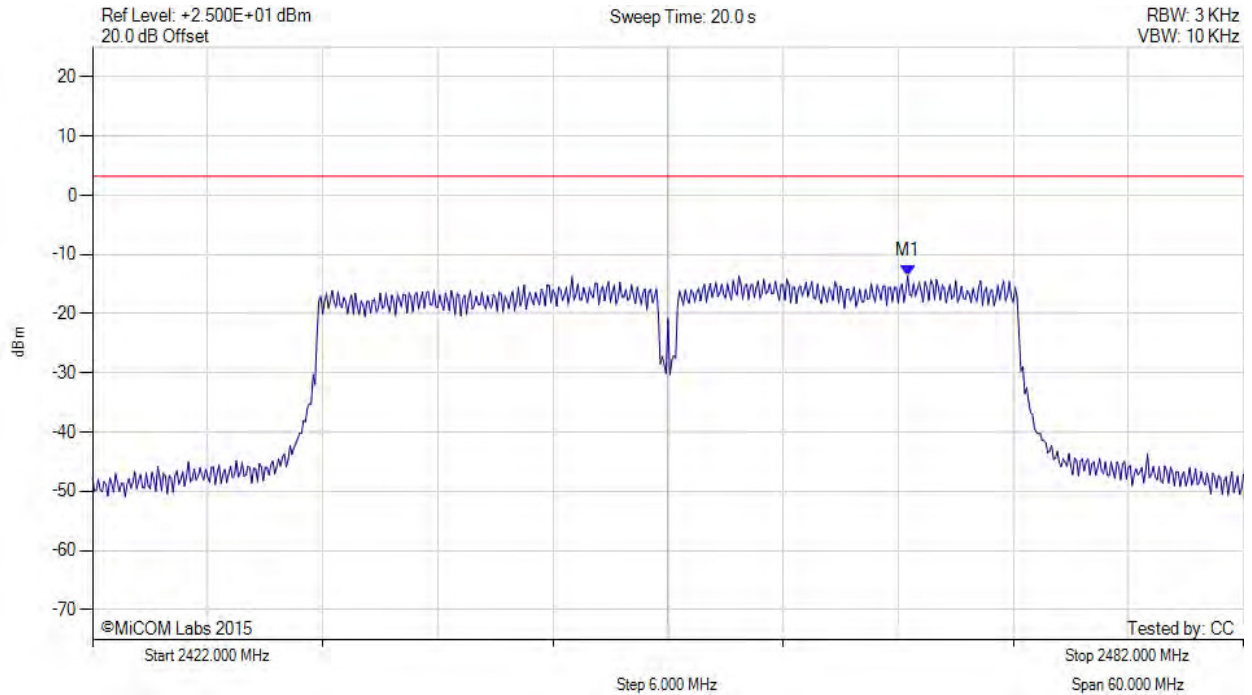

Analyser Setup	Marker:Frequency:Amplitude	Test Results
Detector = AVER Sweep Count = 0 RF Atten (dB) = 20 Trace Mode = VIEW	M1 : 2464.500 MHz : -13.602 dBm	Limit: ≤ 3.230 dBm

[back to matrix](#)

This test report may be reproduced in full only. The document may only be updated by MiCOM Labs personnel. All changes will be noted in the Document History section of the report.



Title: Aruba Networks APEX0104
To: FCC CFR 47 Part 15 Subpart C 15.247 & IC RSS-247
Serial #: ARUB199-U3 Rev A
Issue Date: 27th August 2015
Page: 209 of 223

POWER SPECTRAL DENSITY - AVERAGE



Variant: 802.11n HT-40, Channel: 2452.00 MHz, Chain c, Temp: Ambient, Voltage: 48 Vdc

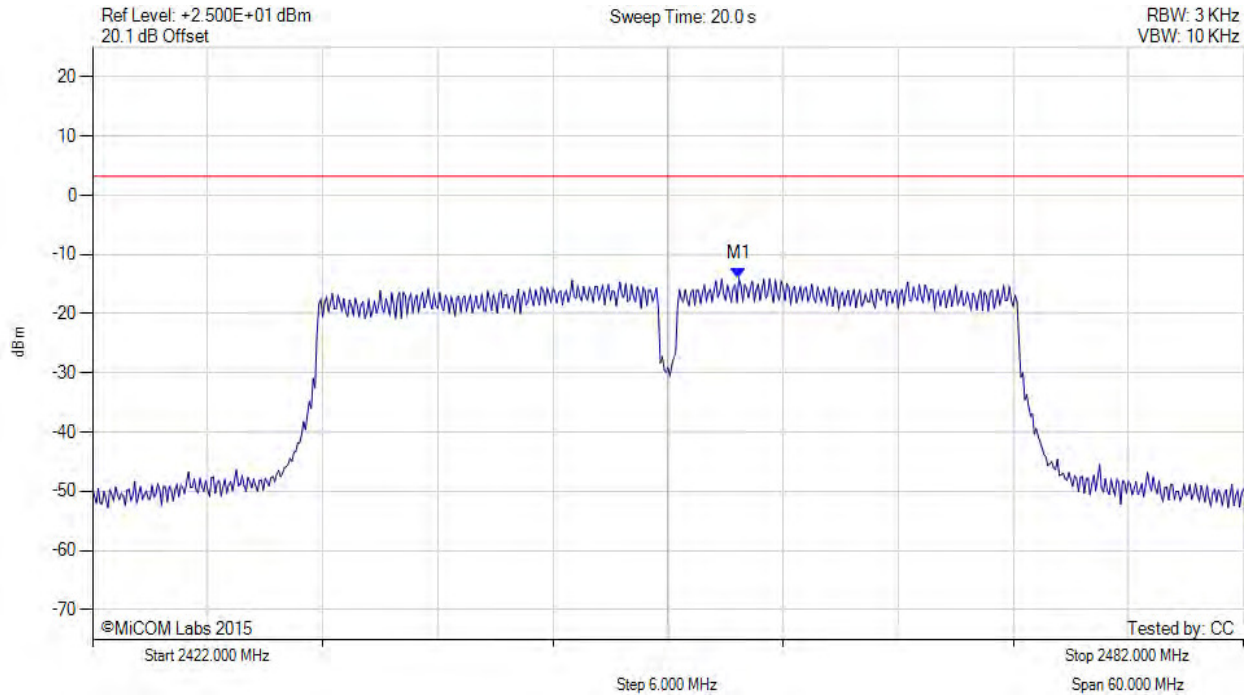

Analyser Setup	Marker:Frequency:Amplitude	Test Results
Detector = AVER Sweep Count = 0 RF Atten (dB) = 20 Trace Mode = VIEW	M1 : 2455.700 MHz : -14.036 dBm	Limit: ≤ 3.230 dBm

[back to matrix](#)

This test report may be reproduced in full only. The document may only be updated by MiCOM Labs personnel. All changes will be noted in the Document History section of the report.



Title: Aruba Networks APEX0104
To: FCC CFR 47 Part 15 Subpart C 15.247 & IC RSS-247
Serial #: ARUB199-U3 Rev A
Issue Date: 27th August 2015
Page: 210 of 223

POWER SPECTRAL DENSITY - AVERAGE



Variant: 802.11n HT-40, Channel: 2452.00 MHz, SUM, Temp: Ambient, Voltage: 48 Vdc

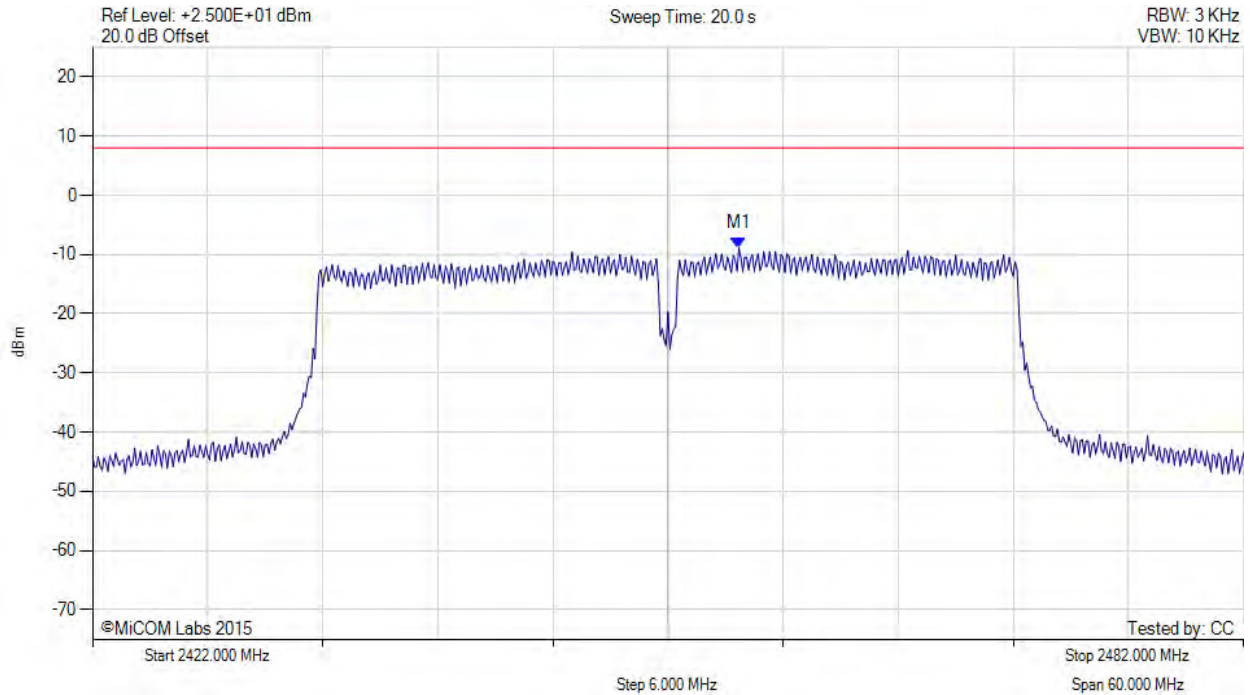

Analyser Setup	Marker:Frequency:Amplitude	Test Results
Detector = AVER Sweep Count = 0 RF Atten (dB) = 20 Trace Mode = VIEW	M1 : 2455.700 MHz : -8.930 dBm M1 + DCCF : 2455.700 MHz : -8.798 dBm Duty Cycle Correction Factor : +0.13 dB	Limit: ≤ 8.0 dBm Margin: -16.8 dB

[back to matrix](#)

This test report may be reproduced in full only. The document may only be updated by MiCOM Labs personnel. All changes will be noted in the Document History section of the report.



Title: Aruba Networks APEX0104
To: FCC CFR 47 Part 15 Subpart C 15.247 & IC RSS-247
Serial #: ARUB199-U3 Rev A
Issue Date: 27th August 2015
Page: 211 of 223

A.4. Radiated Spurious Emissions



RADIATED SPURIOUS - RESTRICTED BAND EMISSIONS

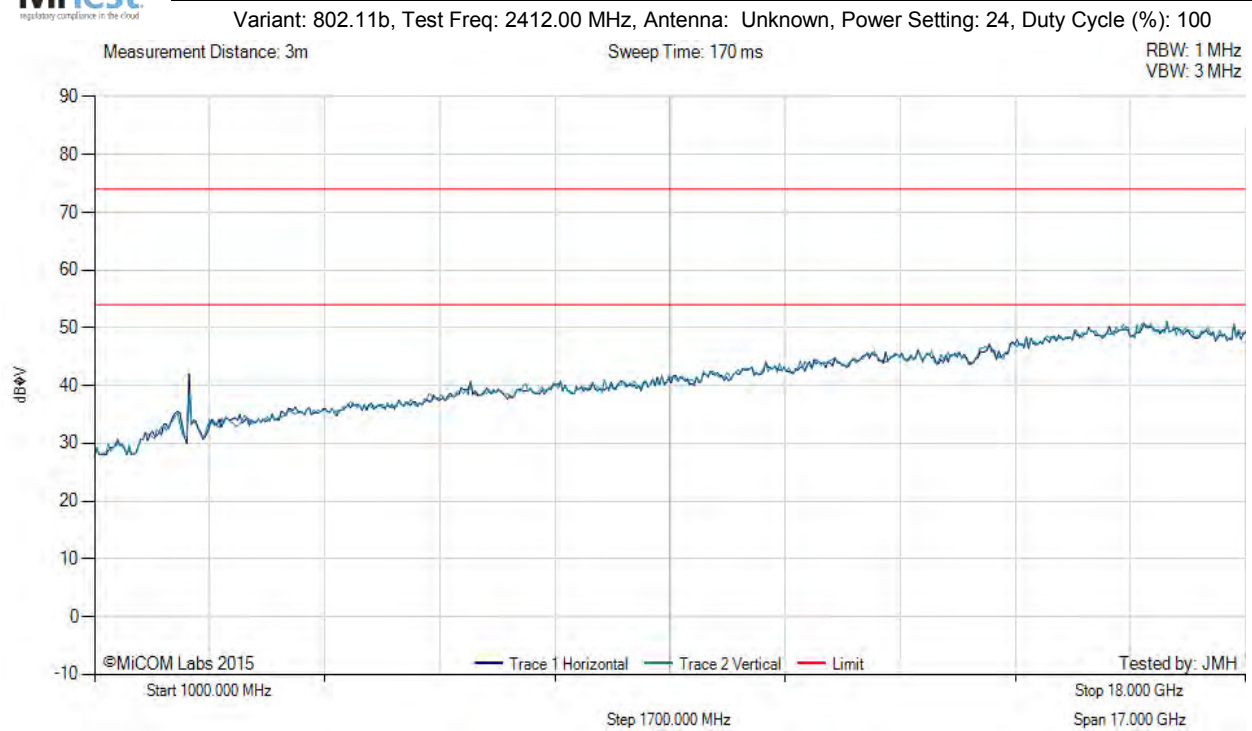

There are no emissions found within 6dB of the limit line.

Test Notes: EUT on table connected via telnet to Laptop outside chamber

[back to matrix](#)

This test report may be reproduced in full only. The document may only be updated by MiCOM Labs personnel. All changes will be noted in the Document History section of the report.



Title: Aruba Networks APEX0104
To: FCC CFR 47 Part 15 Subpart C 15.247 & IC RSS-247
Serial #: ARUB199-U3 Rev A
Issue Date: 27th August 2015
Page: 212 of 223



RADIATED SPURIOUS - RESTRICTED BAND EMISSIONS

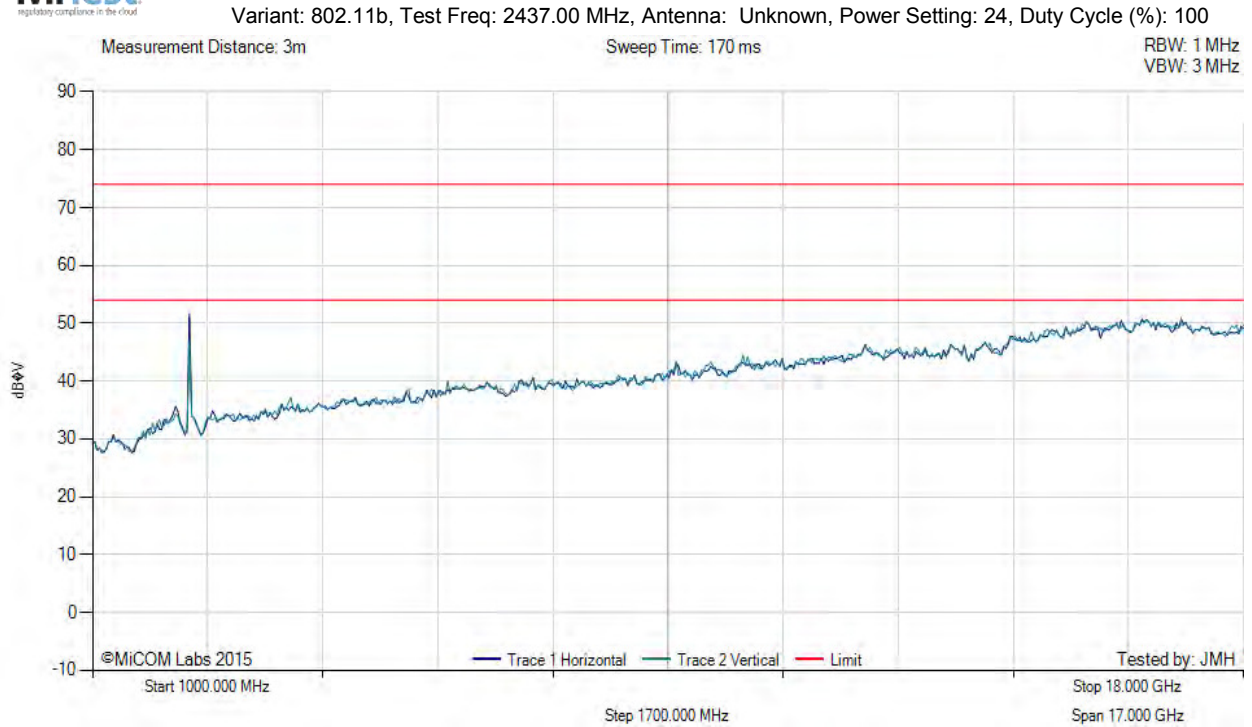

There are no emissions found within 6dB of the limit line.

Test Notes: EUT on table connected via telnet to Laptop outside chamber

[back to matrix](#)

This test report may be reproduced in full only. The document may only be updated by MiCOM Labs personnel. All changes will be noted in the Document History section of the report.



Title: Aruba Networks APEX0104
To: FCC CFR 47 Part 15 Subpart C 15.247 & IC RSS-247
Serial #: ARUB199-U3 Rev A
Issue Date: 27th August 2015
Page: 213 of 223



RADIATED SPURIOUS - RESTRICTED BAND EMISSIONS

Variant: 802.11b, Test Freq: 2462.00 MHz, Antenna: Unknown, Power Setting: 24, Duty Cycle (%): 100

Measurement Distance: 3m

Sweep Time: 170 ms

RBW: 1 MHz
VBW: 3 MHz

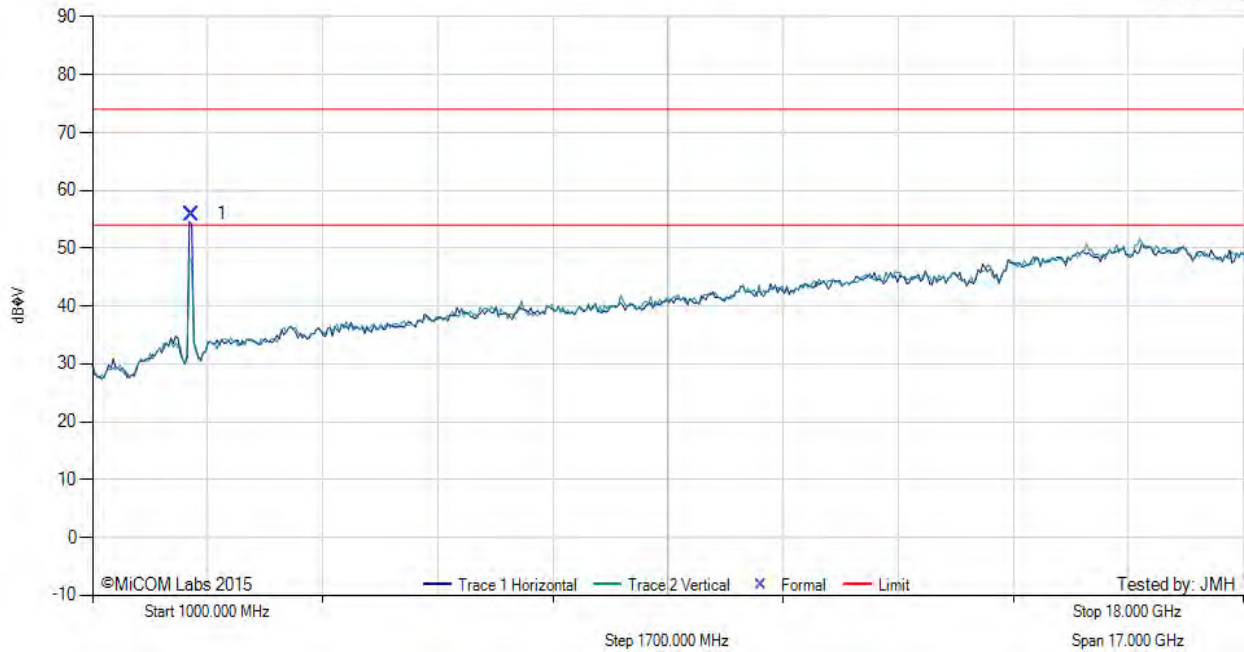

Num	Frequency MHz	Raw dBµV	Cable Loss	AF dB	Level dBµV/m	Measurement Type	Pol	Hgt cm	Azt Deg	Limit dBµV/m	Margin dB	Pass /Fail
1	2461.44	63.51	4.08	-11.68	55.91	Max Peak	Horizontal	152	35	74.0	-18.1	Pass

Test Notes: EUT on table connected via telnet to Laptop outside chamber

[back to matrix](#)

This test report may be reproduced in full only. The document may only be updated by MiCOM Labs personnel. All changes will be noted in the Document History section of the report.



A.5. Restricted Band-Edge Emissions



RADIATED - LOWER RESTRICTED BAND-EDGE EMISSIONS

Variant: 802.11b, Test Freq: 2412.00 MHz, Antenna: Unknown, Power Setting: 24, Duty Cycle (%): 100

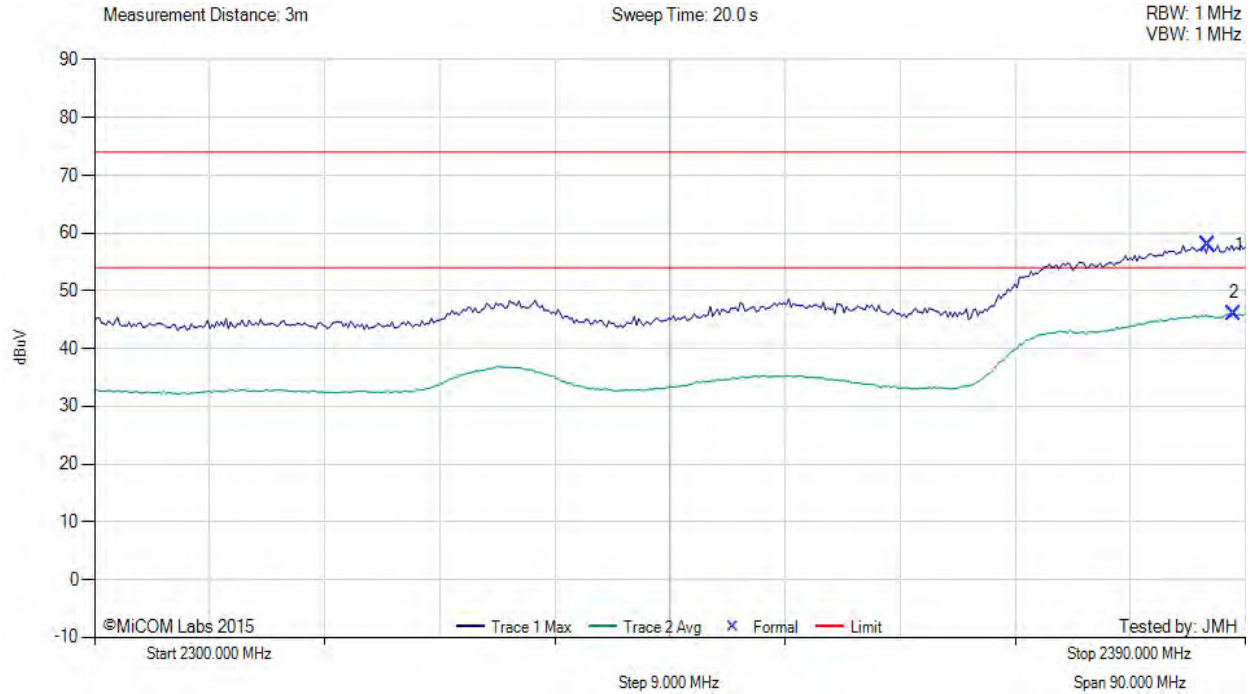

Num	Frequency MHz	Raw dBμV	Cable Loss	AF dB	Level dBμV/m	Measurement Type	Pol	Hgt cm	Azt Deg	Limit dBμV/m	Margin dB	Pass /Fail
1	2387.11	65.88	4.04	-11.94	57.98	Max Peak	Horizontal	140	261	74.0	-16.0	Pass
2	2389.10	53.99	4.04	-11.92	46.11	Max Avg	Horizontal	140	261	54.0	-7.9	Pass

Test Notes: EUT on table connected via telnet to Laptop outside chamber

[back to matrix](#)

This test report may be reproduced in full only. The document may only be updated by MiCOM Labs personnel. All changes will be noted in the Document History section of the report.



Title: Aruba Networks APEX0104
To: FCC CFR 47 Part 15 Subpart C 15.247 & IC RSS-247
Serial #: ARUB199-U3 Rev A
Issue Date: 27th August 2015
Page: 215 of 223



RADIATED - LOWER RESTRICTED BAND-EDGE EMISSIONS

Variant: 802.11g, Test Freq: 2412.00 MHz, Antenna: Unknown, Power Setting: 21, Duty Cycle (%): 100

Measurement Distance: 3m

Sweep Time: 20.0 s

RBW: 1 MHz
VBW: 1 MHz

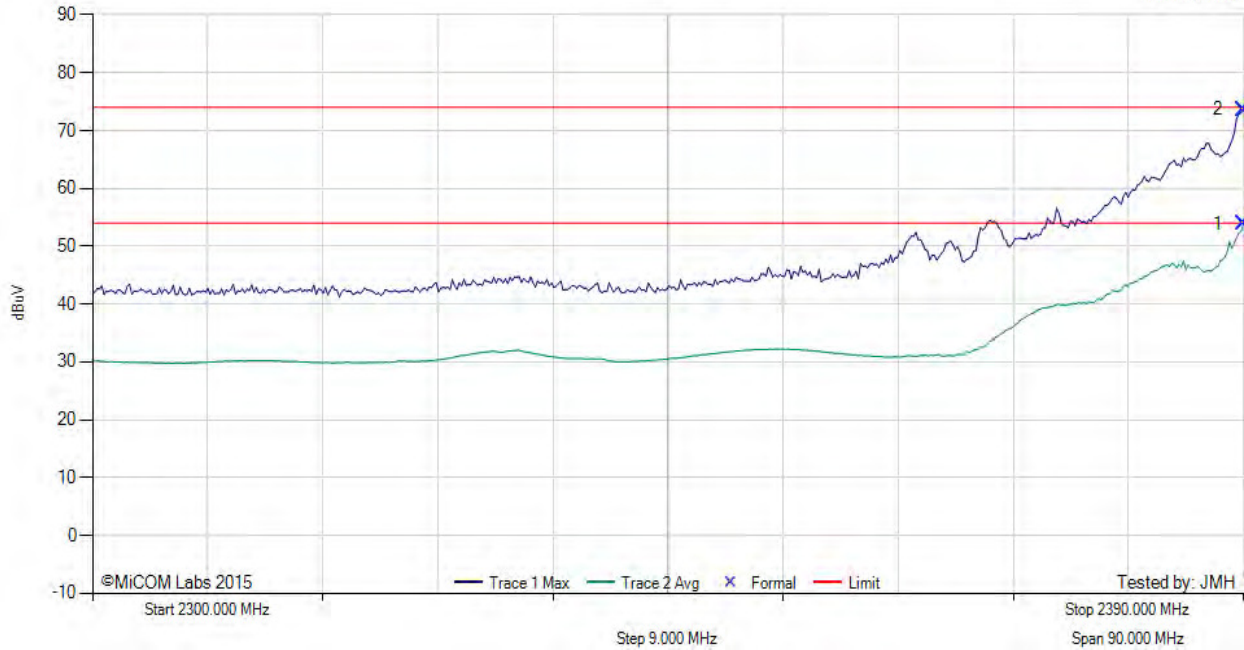

Num	Frequency MHz	Raw dBµV	Cable Loss	AF dB	Level dBµV/m	Measurement Type	Pol	Hgt cm	Azt Deg	Limit dBµV/m	Margin dB	Pass /Fail
1	2390.00	61.72	4.04	-11.92	53.84	Max Avg	Horizontal	140	261	54.0	-0.2	Pass
2	2390.00	81.54	4.04	-11.92	73.66	Max Peak	Horizontal	140	261	74.0	-0.3	Pass

Test Notes: EUT on table connected via telnet to Laptop outside chamber. Power Reduction to 21

[back to matrix](#)

This test report may be reproduced in full only. The document may only be updated by MiCOM Labs personnel. All changes will be noted in the Document History section of the report.



Title: Aruba Networks APEX0104
To: FCC CFR 47 Part 15 Subpart C 15.247 & IC RSS-247
Serial #: ARUB199-U3 Rev A
Issue Date: 27th August 2015
Page: 216 of 223



RADIATED - LOWER RESTRICTED BAND-EDGE EMISSIONS

Variant: 802.11n HT-20, Test Freq: 2412.00 MHz, Antenna: Unknown, Power Setting: 19.75, Duty Cycle (%): 100

Measurement Distance: 3m

Sweep Time: 20.0 s

RBW: 1 MHz
VBW: 1 MHz

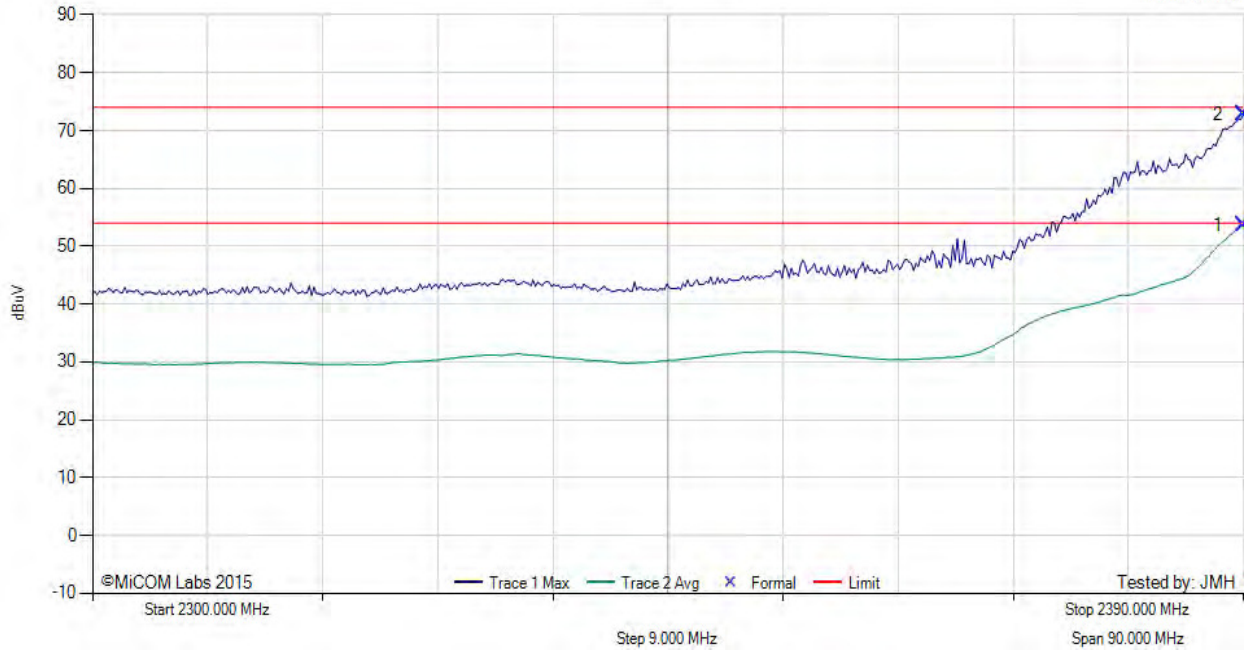

Num	Frequency MHz	Raw dBµV	Cable Loss	AF dB	Level dBµV/m	Measurement Type	Pol	Hgt cm	Azt Deg	Limit dBµV/m	Margin dB	Pass /Fail
1	2390.00	61.55	4.04	-11.92	53.67	Max Avg	Horizontal	140	261	54.0	-0.3	Pass
2	2390.00	80.68	4.04	-11.92	72.80	Max Peak	Horizontal	140	261	74.0	-1.2	Pass

Test Notes: EUT on table connected via telnet to Laptop outside chamber. Power Reduction to 19.75

[back to matrix](#)

This test report may be reproduced in full only. The document may only be updated by MiCOM Labs personnel. All changes will be noted in the Document History section of the report.



Title: Aruba Networks APEX0104
To: FCC CFR 47 Part 15 Subpart C 15.247 & IC RSS-247
Serial #: ARUB199-U3 Rev A
Issue Date: 27th August 2015
Page: 217 of 223



RADIATED - LOWER RESTRICTED BAND-EDGE EMISSIONS

Variant: 802.11n HT-40, Test Freq: 2422.00 MHz, Antenna: Unknown, Power Setting: 16.25, Duty Cycle (%): 100

Measurement Distance: 3m

Sweep Time: 20.0 s

RBW: 1 MHz
VBW: 1 MHz

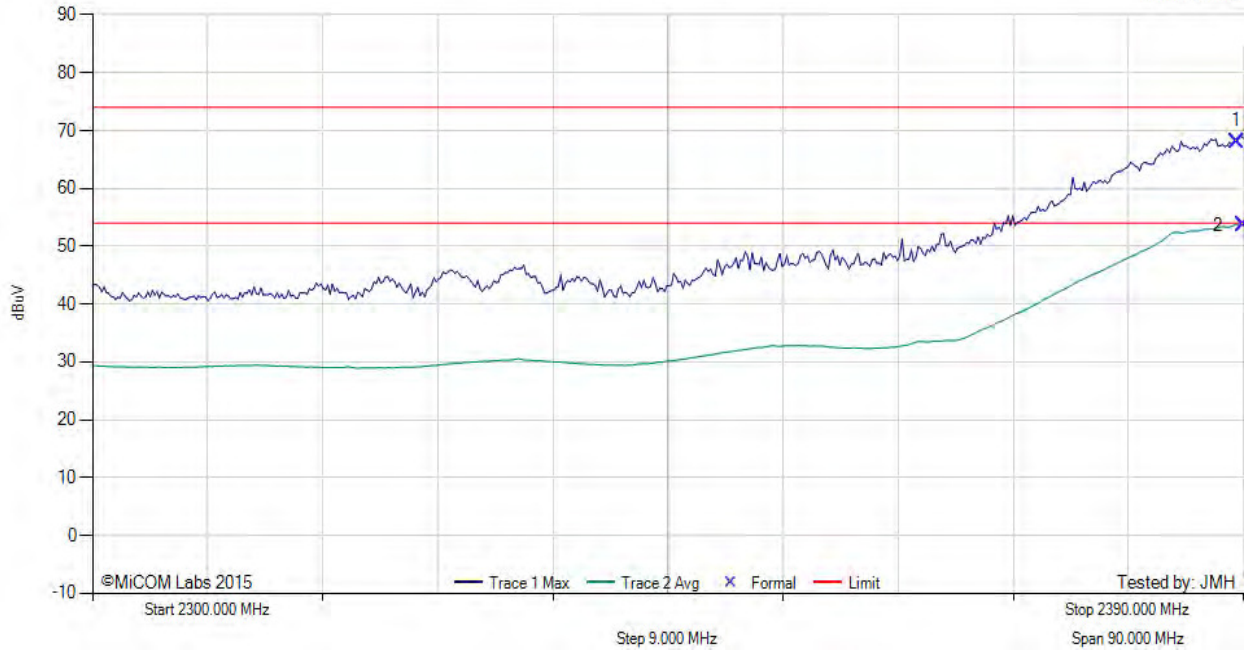

Num	Frequency MHz	Raw dBµV	Cable Loss	AF dB	Level dBµV/m	Measurement Type	Pol	Hgt cm	Azt Deg	Limit dBµV/m	Margin dB	Pass /Fail
1	2389.46	75.99	4.04	-11.92	68.11	Max Peak	Horizontal	140	261	74.0	-5.9	Pass
2	2390.00	61.59	4.04	-11.92	53.71	Max Avg	Horizontal	140	261	54.0	-0.3	Pass

Test Notes: EUT on table connected via telnet to Laptop outside chamber. Power Reduction to 16.25

[back to matrix](#)

This test report may be reproduced in full only. The document may only be updated by MiCOM Labs personnel. All changes will be noted in the Document History section of the report.



Title: Aruba Networks APEX0104
To: FCC CFR 47 Part 15 Subpart C 15.247 & IC RSS-247
Serial #: ARUB199-U3 Rev A
Issue Date: 27th August 2015
Page: 218 of 223



RADIATED - UPPER RESTRICTED BAND-EDGE EMISSIONS

Variant: 802.11b, Test Freq: 2462.00 MHz, Antenna: Unknown, Power Setting: 24, Duty Cycle (%): 100

Measurement Distance: 3m

Sweep Time: 20.0 s

RBW: 1 MHz
VBW: 1 MHz

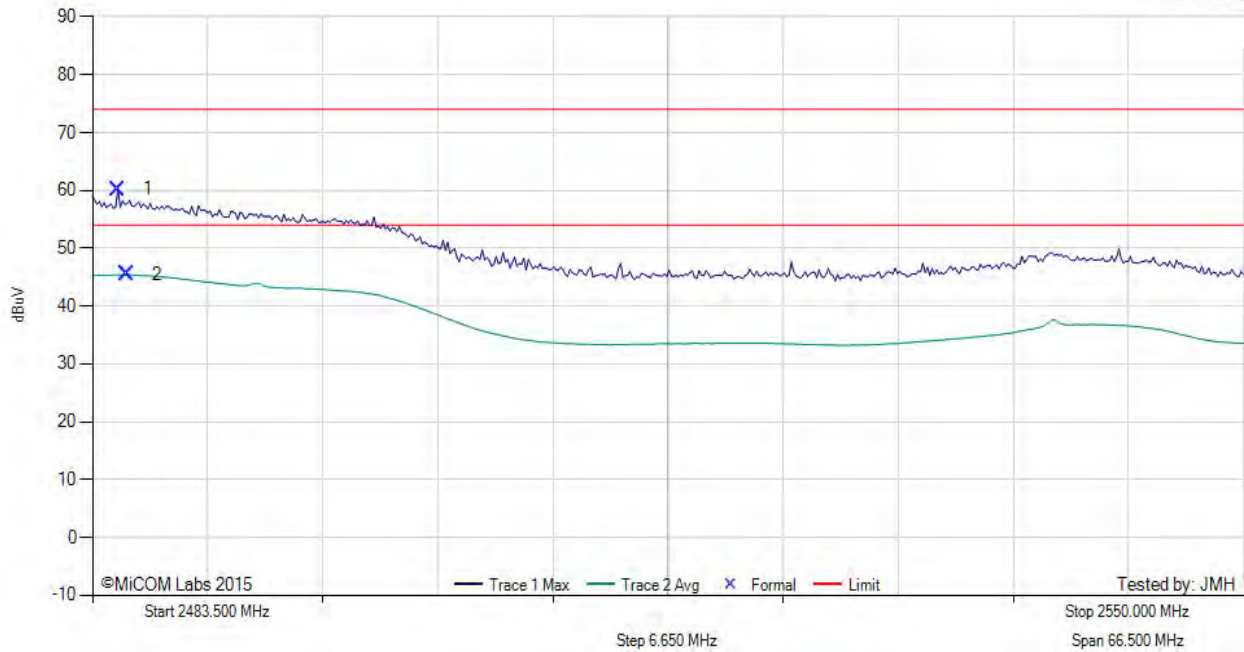

Num	Frequency MHz	Raw dBµV	Cable Loss	AF dB	Level dBµV/m	Measurement Type	Pol	Hgt cm	Azt Deg	Limit dBµV/m	Margin dB	Pass /Fail
1	2484.97	67.76	4.10	-11.64	60.22	Max Peak	Horizontal	190	276	74.0	-13.8	Pass
2	2485.50	53.01	4.10	-11.64	45.47	Max Avg	Horizontal	190	276	54.0	-8.5	Pass

Test Notes: EUT on table connected via telnet to Laptop outside chamber.

[back to matrix](#)

This test report may be reproduced in full only. The document may only be updated by MiCOM Labs personnel. All changes will be noted in the Document History section of the report.



Title: Aruba Networks APEX0104
To: FCC CFR 47 Part 15 Subpart C 15.247 & IC RSS-247
Serial #: ARUB199-U3 Rev A
Issue Date: 27th August 2015
Page: 219 of 223



RADIATED - UPPER RESTRICTED BAND-EDGE EMISSIONS

Variant: 802.11g, Test Freq: 2462.00 MHz, Antenna: Unknown, Power Setting: 20.5, Duty Cycle (%): 100

Measurement Distance: 3m

Sweep Time: 20.0 s

RBW: 1 MHz
VBW: 1 MHz

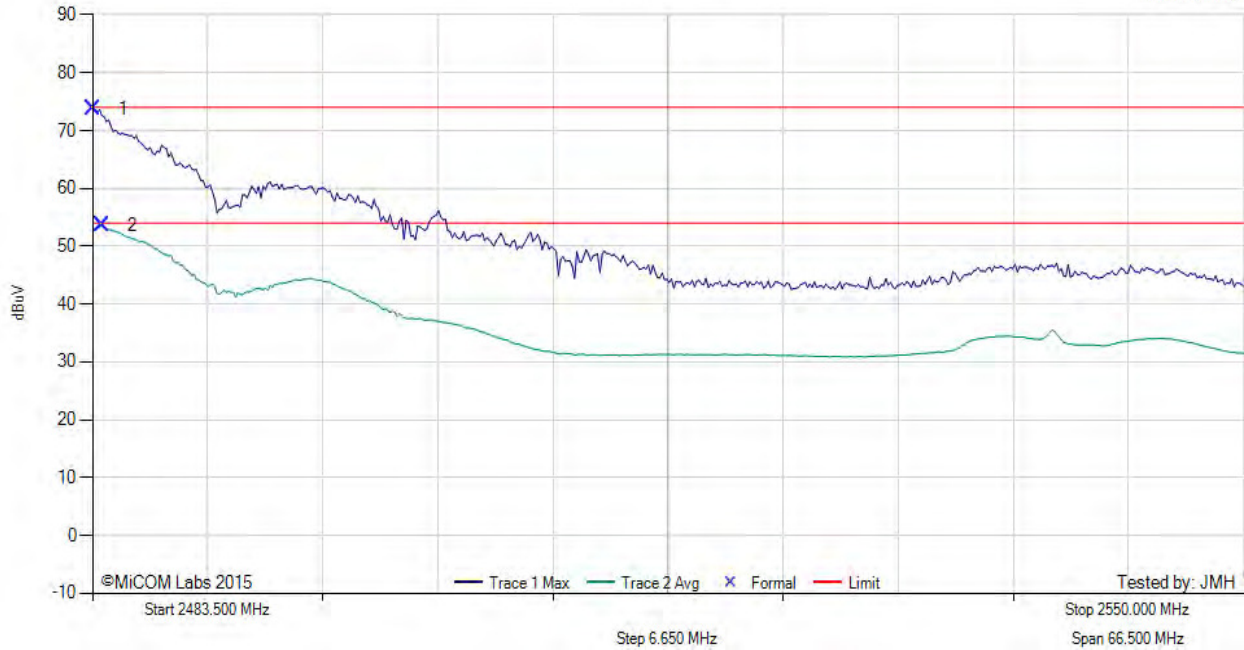

Num	Frequency MHz	Raw dBµV	Cable Loss	AF dB	Level dBµV/m	Measurement Type	Pol	Hgt cm	Azt Deg	Limit dBµV/m	Margin dB	Pass /Fail
1	2483.50	81.37	4.10	-11.64	73.83	Max Peak	Horizontal	190	276	74.0	-0.2	Pass
2	2484.03	61.14	4.10	-11.64	53.60	Max Avg	Horizontal	190	276	54.0	-0.4	Pass

Test Notes: EUT on table connected via telnet to Laptop outside chamber. Power Reduction to 20.5

[back to matrix](#)

This test report may be reproduced in full only. The document may only be updated by MiCOM Labs personnel. All changes will be noted in the Document History section of the report.



Title: Aruba Networks APEX0104
To: FCC CFR 47 Part 15 Subpart C 15.247 & IC RSS-247
Serial #: ARUB199-U3 Rev A
Issue Date: 27th August 2015
Page: 220 of 223

RADIATED - UPPER RESTRICTED BAND-EDGE EMISSIONS



Variant: 802.11n HT-20, Test Freq: 2462.00 MHz, Antenna: Unknown, Power Setting: 19.25, Duty Cycle (%): 100

Measurement Distance: 3m

Sweep Time: 20.0 s

RBW: 1 MHz
VBW: 1 MHz

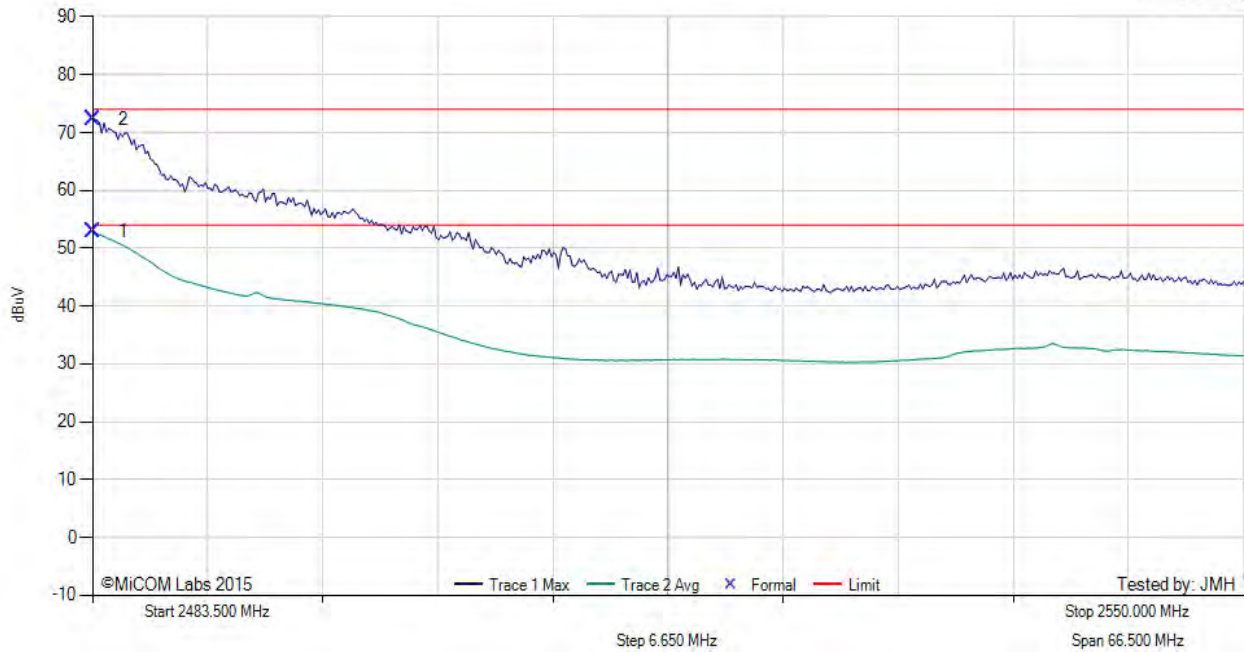

Num	Frequency MHz	Raw dBµV	Cable Loss	AF dB	Level dBµV/m	Measurement Type	Pol	Hgt cm	Azt Deg	Limit dBµV/m	Margin dB	Pass /Fail
1	2483.50	60.39	4.10	-11.64	52.85	Max Avg	Horizontal	190	276	54.0	-1.2	Pass
2	2483.50	79.86	4.10	-11.64	72.32	Max Peak	Horizontal	190	276	74.0	-1.7	Pass

Test Notes: EUT on table connected via telnet to Laptop outside chamber. Power Reduction to 19.25

[back to matrix](#)

This test report may be reproduced in full only. The document may only be updated by MiCOM Labs personnel. All changes will be noted in the Document History section of the report.



Title: Aruba Networks APEX0104
To: FCC CFR 47 Part 15 Subpart C 15.247 & IC RSS-247
Serial #: ARUB199-U3 Rev A
Issue Date: 27th August 2015
Page: 221 of 223



RADIATED - UPPER RESTRICTED BAND-EDGE EMISSIONS

Variant: 802.11n HT-40, Test Freq: 2452.00 MHz, Antenna: Unknown, Power Setting: 16.0, Duty Cycle (%): 100

Measurement Distance: 3m

Sweep Time: 20.0 s

RBW: 1 MHz
VBW: 1 MHz

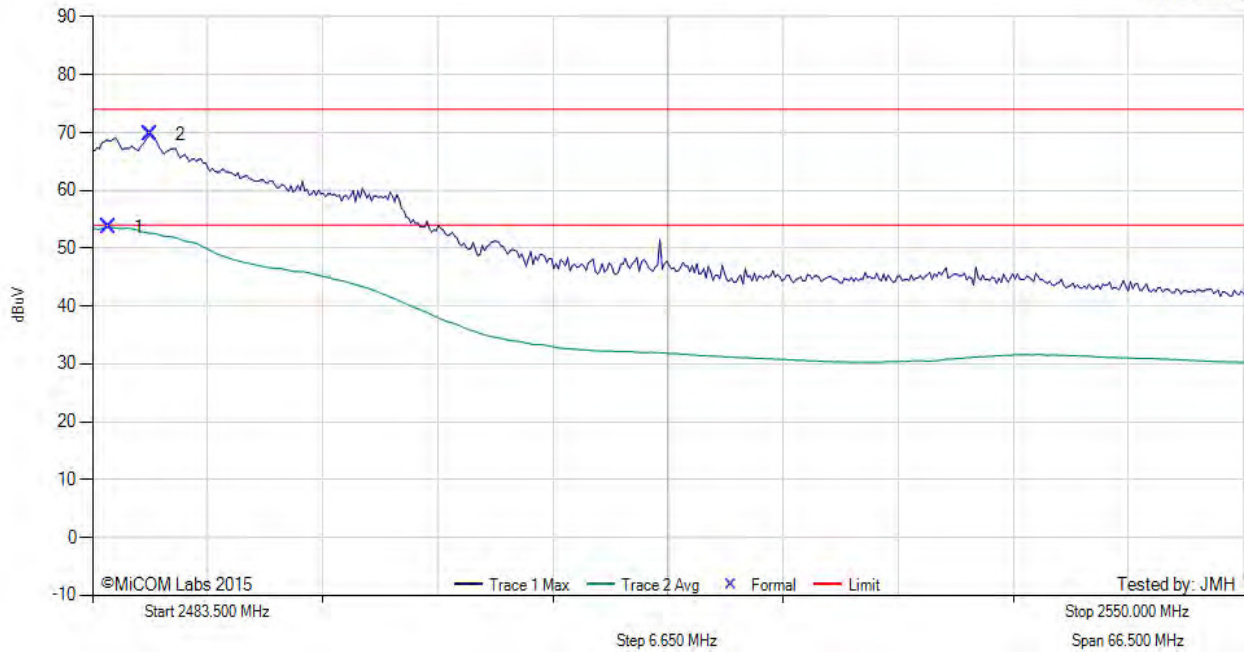

Num	Frequency MHz	Raw dBµV	Cable Loss	AF dB	Level dBµV/m	Measurement Type	Pol	Hgt cm	Azt Deg	Limit dBµV/m	Margin dB	Pass /Fail
1	2484.43	61.24	4.10	-11.64	53.70	Max Avg	Horizontal	190	276	54.0	-0.3	Pass
2	2486.83	77.24	4.10	-11.64	69.70	Max Peak	Horizontal	190	276	74.0	-4.3	Pass

Test Notes: EUT on table connected via telnet to Laptop outside chamber. Power Reduction to 16.0

[back to matrix](#)

This test report may be reproduced in full only. The document may only be updated by MiCOM Labs personnel. All changes will be noted in the Document History section of the report.



A.6. Digital Emissions



DIGITAL EMISSIONS (0.03 - 1 GHz)

Variant: 802.11b, Test Freq: 2437.00 MHz, Antenna: Unknown, Power Setting: NA, Duty Cycle (%): 100

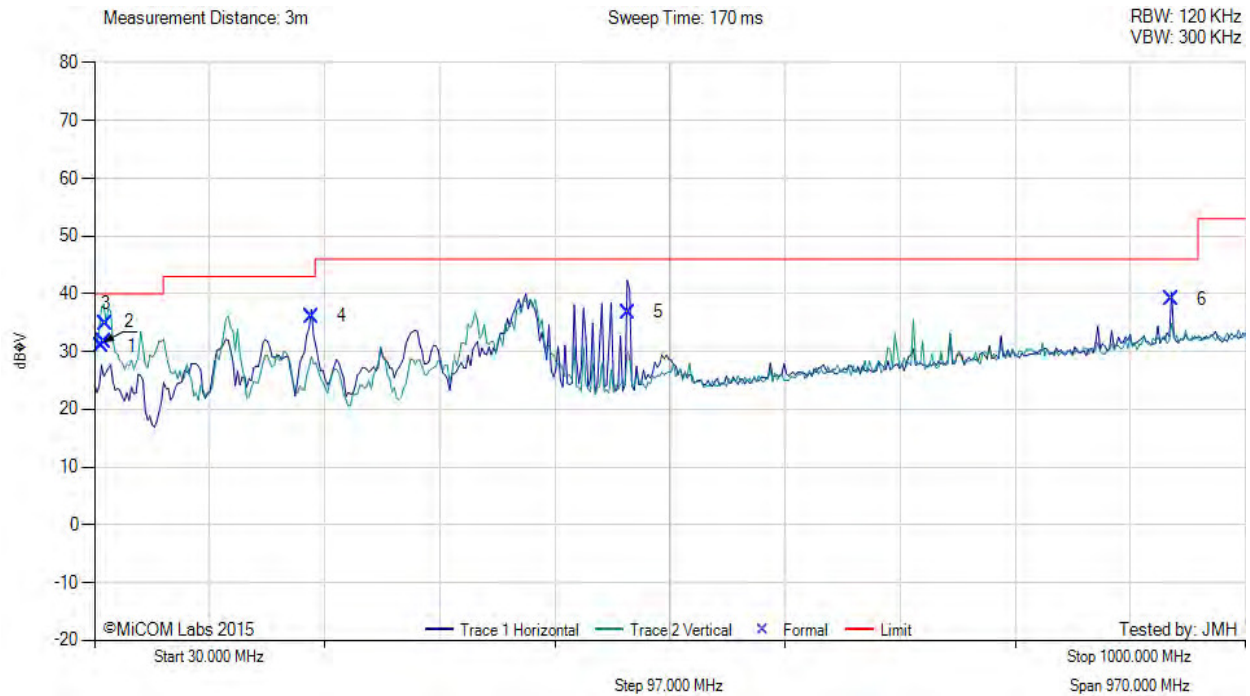

Num	Frequency MHz	Raw dBµV	Cable Loss	AF dB	Level dBµV/m	Measurement Type	Pol	Hgt cm	Azt Deg	Limit dBµV/m	Margin dB	Pass /Fail
1	36.14	41.87	3.47	-14.37	30.97	MaxQP	Vertical	114	202	40.0	-9.0	Pass
2	37.79	44.19	3.48	-16.06	31.61	MaxQP	Vertical	123	0	40.0	-8.4	Pass
3	39.49	47.94	3.49	-16.67	34.76	MaxQP	Vertical	103	358	40.0	-5.2	Pass
4	213.18	51.70	4.39	-20.00	36.09	MaxQP	Horizontal	119	271	43.0	-6.9	Pass
5	479.99	44.31	5.28	-12.80	36.79	MaxQP	Horizontal	207	355	46.0	-9.2	Pass
6	937.50	39.87	6.47	-7.20	39.14	MaxQP	Horizontal	144	52	46.0	-6.9	Pass

Test Notes: EUT on table connected to Laptop outside chamber

[back to matrix](#)

This test report may be reproduced in full only. The document may only be updated by MiCOM Labs personnel. All changes will be noted in the Document History section of the report.



575 Boulder Court
Pleasanton, California 94566, USA
Tel: +1 (925) 462 0304
Fax: +1 (925) 462 0306
www.micomlabs.com