

Test of Aruba AP-70 802.11 a/b/g Wireless AP

To: FCC 47 CFR Part 15.407

Test Report Serial No.: ARUB13-A4 Rev A



TEST REPORT

FROM



Test of Aruba AP-70 802.11 a/b/g Wireless AP
to
To: FCC 47 CFR Part 15.407

Test Report Serial No.: ARUB13-A4 Rev A

Note: this report only contains data with regard to the 5,150 to 5,350 MHz, and 5,470 to 5,725 MHz operational modes of the Aruba Wireless Access Point. 2.4 and 5.8 GHz test data are reported in MiCOM Labs test report ARUB13-A2.

This report supersedes None

Manufacturer: Aruba Networks
1322 Crossman Avenue
Sunnyvale
CA 94089, USA

Product Function: 802.11a/b/g Wireless Access Point

Copy No: pdf **Issue Date:** 20th July 2007

This Test Report is Issued Under the Authority of:

MiCOM Labs, Inc.
440 Boulder Court, Suite 200
Pleasanton, CA 94566 USA
Phone: +1 (925) 462-0304
Fax: +1 (925) 462-0306
www.micomlabs.com



CERTIFICATE #2381.01

MiCOM Labs is an ISO 17025 Accredited Testing Laboratory



Title: Aruba AP-70 802.11 a/b/g Wireless AP
To: FCC 47 CFR Part 15.407
Serial #: ARUB13-A4 Rev A
Issue Date: 20th July 2007
Page: 3 of 130

This page has been left intentionally blank



TABLE OF CONTENTS

ACCREDITATION & LISTINGS.....	6
1. TEST RESULT CERTIFICATE	9
2. REFERENCES AND MEASUREMENT UNCERTAINTY	10
2.1. Normative References	10
2.2. Test and Uncertainty Procedures	11
3. PRODUCT DETAILS AND TEST CONFIGURATIONS	12
3.1. Technical Details	12
3.2. Scope of Test Program.....	13
3.3. Equipment Model(s) and Serial Number(s)	16
3.4. Antenna Details	16
3.5. Cabling and I/O Ports	16
3.6. Test Configurations.....	17
3.7. Equipment Modifications.....	17
3.8. Deviations from the Test Standard	17
4. TEST SUMMARY	18
5. TEST RESULTS.....	21
5.1. Device Characteristics	21
5.1.1. 26 dB and 99 % Bandwidth	21
5.1.2. Transmit Output Power.....	29
5.1.3. Peak Power Spectral Density	33
5.1.4. Peak Excursion Ratio	41
5.1.5. Frequency Stability.....	49
5.1.6. Maximum Permissible Exposure	50
5.1.7. Radiated Emissions.....	51
5.1.8. AC Wireline Conducted Emissions (150 kHz – 30 MHz).....	88
6. Dynamic Frequency Selection (DFS).....	91
6.1. Test Procedure and Setup.....	91
6.1.1. Interference Threshold values, Master or Client incorporating In-Service Monitoring.....	91
6.1.2. DFS Response requirement values.....	91
6.1.3. Radar Test Waveforms.....	92
6.1.4. Frequency Hopping Radar Test Waveform	95
6.1.5. Radar Waveform Calibration	95
6.1.6. Radar Waveform Calibration Plots	96
6.1.7. Test Set Up:.....	102

This test report may be reproduced in full only. The document may only be updated by MiCOM Labs personnel. Any changes will be noted in the Document History section of the report.



Title: Aruba AP-70 802.11 a/b/g Wireless AP
To: FCC 47 CFR Part 15.407
Serial #: ARUB13-A4 Rev A
Issue Date: 20th July 2007
Page: 5 of 130

6.2. Dynamic Frequency Selection (DFS) Test Results	104
6.2.1. <i>UNII Detection Bandwidth:</i>	104
6.2.2. <i>Initial Channel Availability Check Time:</i>	106
6.2.3. <i>Radar Burst at the Beginning of the Channel Availability Check Time:</i>	108
6.2.4. <i>Radar Burst at the End of the Channel Availability Check Time:</i>	110
6.2.5. <i>In-Service Monitoring for Channel Move Time, Channel Closing Transmission Time and Non-Occupancy Period</i>	112
6.2.6. <i>Statistical Performance Check</i>	119
7. PHOTOGRAPHS.....	124
7.1. Radiated Spurious Emissions	124
All ports had appropriate cables connected	124
7.2. AC Wireline Emissions (150 kHz - 30 MHz)	125
7.3. General Measurement Test Set-Up	126
7.4. Dynamic Frequency Selection Test Set-Up	127
8. TEST EQUIPMENT DETAILS.....	129

This test report may be reproduced in full only. The document may only be updated by MiCOM Labs personnel. Any changes will be noted in the Document History section of the report.



Title: Aruba AP-70 802.11 a/b/g Wireless AP
To: FCC 47 CFR Part 15.407
Serial #: ARUB13-A4 Rev A
Issue Date: 20th July 2007
Page: 6 of 130

ACCREDITATION & LISTINGS

MiCOM Labs, Inc. an accredited laboratory complies with the international standard BS EN ISO/IEC 17025. The company is accredited by the American Association for Laboratory Accreditation (A2LA) www.a2la.org test laboratory number 2381.01. MiCOM Labs test schedule is available at the following URL; <http://www.a2la.org/scopepdf/2381-01.pdf>



**THE AMERICAN
ASSOCIATION
FOR LABORATORY
ACCREDITATION**

ACCREDITED LABORATORY

A2LA has accredited

MICOM LABS
Pleasanton, CA

for technical competence in the field of

Electrical Testing

The accreditation covers the specific tests and types of tests listed on the agreed scope of accreditation. This laboratory meets the requirements of ISO/IEC 17025 - 1999 "General Requirements for the Competence of Testing and Calibration Laboratories" and any additional program requirements in the identified field of testing.

Presented this 14th day of September 2005.



Peter Almy
President
For the Accreditation Council
Certificate Number 2381.01
Valid to: November 30, 2007

For tests or types of tests to which this accreditation applies,
please refer to the laboratory's Electrical Scope of Accreditation.

This test report may be reproduced in full only. The document may only be updated by MiCOM Labs personnel. Any changes will be noted in the Document History section of the report.



Title: Aruba AP-70 802.11 a/b/g Wireless AP
To: FCC 47 CFR Part 15.407
Serial #: ARUB13-A4 Rev A
Issue Date: 20th July 2007
Page: 7 of 130

LISTINGS

MiCOM Labs test facilities are listed by the following organizations;

North America

United States of America

Federal Communications Commission (FCC) Listing #: 102167

RECOGNITION

APEC MRA (Asia-Pacific Economic Community Mutual Recognition Agreement)

Conformity Assessment Body (CAB) – MiCOM Labs

Test data generated by MiCOM Labs is accepted in the following countries under the APEC MRA.

Country	Recognition Body	Phase	CAB Identification No.
Australia	Australian Communications and Media Authority (ACMA)	I	US0159
Hong Kong	Office of the Telecommunication Authority (OFTA)	I	
Korea	Ministry of Information and Communication Radio Research Laboratory (RRL)	I	
Singapore	Infocomm Development Authority (IDA)	I	
Taiwan	Directorate General of Telecommunications (DGT)	I	
	Bureau of Standards, Metrology and Inspection (BSMI)	I	

This test report may be reproduced in full only. The document may only be updated by MiCOM Labs personnel. Any changes will be noted in the Document History section of the report.



Title: Aruba AP-70 802.11 a/b/g Wireless AP
To: FCC 47 CFR Part 15.407
Serial #: ARUB13-A4 Rev A
Issue Date: 20th July 2007
Page: 8 of 130

DOCUMENT HISTORY

Document History		
Revision	Date	Comments
Draft		
Rev A	20 th July 2007	Initial Release

This test report may be reproduced in full only. The document may only be updated by MiCOM Labs personnel. Any changes will be noted in the Document History section of the report.



Title: Aruba AP-70 802.11 a/b/g Wireless AP
To: FCC 47 CFR Part 15.407
Serial #: ARUB13-A4 Rev A
Issue Date: 20th July 2007
Page: 9 of 130

1. TEST RESULT CERTIFICATE

Manufacturer:	Aruba Networks 1322 Crossman Avenue Sunnyvale CA 94089, USA	Tested By:	MiCOM Labs, Inc. 440 Boulder Court Suite 200 Pleasanton California, 94566, USA
EUT:	Wireless Access Point	Telephone:	+1 925 462 0304
Model:	AP-70	Fax:	+1 925 462 0306
S/N:	A50137434 (conducted) A50137415 (radiated)		
Test Date(s):	6th to 15th July 2007	Website:	www.micomlabs.com

STANDARD(S)	TEST RESULTS
FCC 47 CFR Part 15.407	EQUIPMENT COMPLIES

MiCOM Labs, Inc. tested the equipment mentioned in accordance with the requirements set forth in the above standards. Test results indicate that the equipment tested is capable of demonstrating compliance with the requirements as documented within this report.

Notes:

1. This document reports conditions under which testing was conducted and the results of testing performed.
2. Details of test methods used have been recorded and kept on file by the laboratory.
3. Test results apply only to the item(s) tested.

Approved & Released for MiCOM Labs, Inc. by:



CERTIFICATE #2381.01

Graeme Grieve
Quality Manager MiCOM Labs,

Gordon Hurst
President & CEO MiCOM Labs, Inc.

This test report may be reproduced in full only. The document may only be updated by MiCOM Labs personnel. Any changes will be noted in the Document History section of the report.



Title: Aruba AP-70 802.11 a/b/g Wireless AP
To: FCC 47 CFR Part 15.407
Serial #: ARUB13-A4 Rev A
Issue Date: 20th July 2007
Page: 10 of 130

2. REFERENCES AND MEASUREMENT UNCERTAINTY

2.1. Normative References

Ref.	Publication	Year	Title
(i)	FCC 47 CFR Part 15.407	Feb 2006	Code of Federal Regulations
(ii)	FCC 06-96	June 2006	Memorandum Opinion and Order
(iii)	ANSI C63.4	2003	American National Standards for Methods of Measurement of Radio-Noise Emissions from Low-Voltage Electrical and Electronic Equipment in the Range of 9 kHz to 40 GHz
(iv)	CISPR 22/ EN 55022	1997 1998	Limits and Methods of Measurements of Radio Disturbance Characteristics of Information Technology Equipment
(v)	M 3003	Edition 1 Dec. 1997	Expression of Uncertainty and Confidence in Measurements
(vi)	LAB34	Edition 1 Aug 2002	The expression of uncertainty in EMC Testing
(vii)	ETSI TR 100 028	2001	Parts 1 and 2 Electromagnetic compatibility and Radio Spectrum Matters (ERM); Uncertainties in the measurement of mobile radio equipment characteristics
(viii)	A2LA	14 th September 2005	Reference to A2LA Accreditation Status – A2LA Advertising Policy
(ix)	FCC Public Notice – DA 02-2138	2002	Guidelines for Assessing Unlicensed National Information Infrastructure (U-NII) Devices

This test report may be reproduced in full only. The document may only be updated by MiCOM Labs personnel. Any changes will be noted in the Document History section of the report.



Title: Aruba AP-70 802.11 a/b/g Wireless AP
To: FCC 47 CFR Part 15.407
Serial #: ARUB13-A4 Rev A
Issue Date: 20th July 2007
Page: 11 of 130

2.2. Test and Uncertainty Procedures

Conducted and radiated emission measurements were conducted in accordance with American National Standards Institute ANSI C63.4, listed in the Normative References section of this report.

Measurement uncertainty figures are calculated in accordance with ETSI TR 100 028 Parts 1 and 2.

Measurement uncertainties stated are based on a standard uncertainty multiplied by a coverage factor $k = 2$, providing a level of confidence of approximately 95 % in accordance with UKAS document M 3003 listed in the Normative References section of this report.

This test report may be reproduced in full only. The document may only be updated by MiCOM Labs personnel. Any changes will be noted in the Document History section of the report.



Title: Aruba AP-70 802.11 a/b/g Wireless AP
To: FCC 47 CFR Part 15.407
Serial #: ARUB13-A4 Rev A
Issue Date: 20th July 2007
Page: 12 of 130

3. PRODUCT DETAILS AND TEST CONFIGURATIONS

3.1. Technical Details

Details	Description
Purpose:	Test of the Aruba AP-70 802.11 a/b/g Wireless AP in the frequency ranges 5150 to 5350 MHz, and 5470 to 5,725 MHz to FCC Part 15.407 regulations.
Applicant:	As Manufacturer
Manufacturer:	Aruba Networks 1322 Crossman Avenue Sunnyvale CA 94089, USA
Laboratory performing the tests:	MiCOM Labs, Inc. 440 Boulder Court, Suite 200 Pleasanton, California 94566 USA
Test report reference number:	ARUB13-A4 Rev A
Date EUT received:	6 TH July 2006
Standard(s) applied:	FCC 47 CFR Part 15.407
Dates of test (from - to):	6 th to 15 th July 2007
No of Units Tested:	2
Type of Equipment:	802.11a/b/g Wireless Access Point
Manufacturers Trade Name:	Wireless Access Point
Model:	AP-70
Software Release	ARUBA05 3.1.1.0
Location for use:	Indoor
Declared Frequency Range(s):	5,150 to 5,350 MHz 5,470 to 5,725 MHz
Type of Modulation:	Per 802.11a – OFDM
Declared Nominal Output Power: (Average Power)	5,150-5,350 MHz: +16 dBm 5,470-5,725 MHz: +16 dBm
EUT Modes of Operation:	802.11a/b/g
Transmit/Receive Operation:	Time Division Duplex
Rated Input Voltage and Current:	5 Vdc, 3 A
Operating Temperature Range:	Declared range 0 to +50°C
ITU Emission Designator:	802.11a – 17M4W7D
Frequency Stability:	±20 ppm max
Equipment Dimensions:	Antenna; Retracted 167x190x30mm (6.57x7.48x1.18 in.) Extended 293x190x30mm (11.54x7.48x1.18 in.)
Weight:	18oz (510 grams)
Primary function of equipment:	Wireless Access Point

This test report may be reproduced in full only. The document may only be updated by MiCOM Labs personnel. Any changes will be noted in the Document History section of the report.



Title: Aruba AP-70 802.11 a/b/g Wireless AP
To: FCC 47 CFR Part 15.407
Serial #: ARUB13-A4 Rev A
Issue Date: 20th July 2007
Page: 13 of 130

3.2. Scope of Test Program

RF Testing

The scope of the compliance program was to test the Aruba AP-70 wireless AP in the frequency ranges 5150 - 5350 MHz and 5470 – 5725 MHz for compliance against FCC 47 CFR Part 15.407 specifications including Dynamic Frequency Selection (DFS) requirements.

The Aruba Networks AP-70 access point has two independent transmitters. System identifies antennas as primary and secondary devices.

Dynamic Frequency Selection

The scope of the test program was to test the Aruba AP-70 Systems wireless access point in the frequency ranges 5,250 – 5,350 and 5,470 to 5,725 MHz as a Master device for compliance against DFS requirements of FCC 47 CFR Part 15.407 and the FCC specification Memorandum Opinion and Order FCC 06-96.

One frequency was chosen (5,300 MHz) from the operating channels of the UUT within the 5,250 – 5,350 MHz and 5,470 – 5,725 MHz bands for DFS testing per the requirements of FCC specification "Memorandum Opinion and Order FCC 06-96", Section 7.8 "DFS Conformance Test Procedures".

U-NII devices operating in the 5,250 – 5,350 MHz and 5,470 - 5,725 MHz bands shall employ a DFS radar detection mechanism to detect the presence of radar systems and to avoid co-channel operation with radar systems.

The Aruba AP-70 product operates as a Master device with full radar detection and Dynamic Frequency Selection (DFS) capability.

The Master device provides, on aggregate, uniform loading of the spectrum across all devices by selecting an operating channel among the available channels using a random algorithm.

This test report may be reproduced in full only. The document may only be updated by MiCOM Labs personnel. Any changes will be noted in the Document History section of the report.

**Aruba Networks
AP-70 Wireless Access Point**

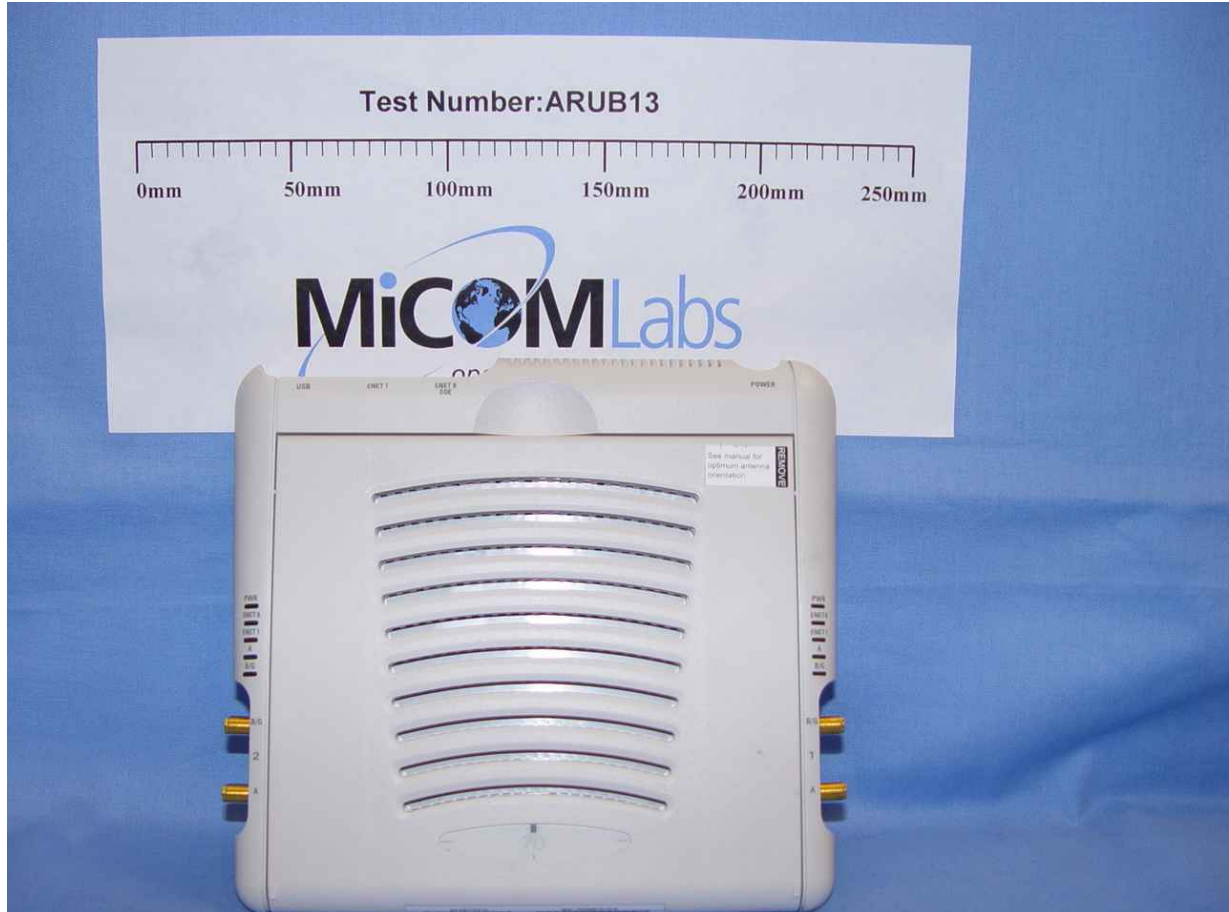

This test report may be reproduced in full only. The document may only be updated by MiCOM Labs personnel. Any changes will be noted in the Document History section of the report.

**Aruba Networks
AP-70 Wireless Access Point
Position of Integral Antenna**



Position of Integral Antenna



3.3. Equipment Model(s) and Serial Number(s)

Type (EUT/Support)	Equipment Description (Including Brand Name)	Mfr	Model No.	Serial No.
EUT	Wireless AP	Aruba Networks	AP-70	A50137434
EUT	Power Supply	CUI Inc	A1-15S05	R00042200045
EUT	Power Over LAN Hub	Power Dsine	6001	I041760400073 331B03
Support	Laptop PC	IBM	Thinkpad	None

3.4. Antenna Details

1. 5150 – 57250 MHz
 - a. Integral
 - 2.4 – 2.5 GHz Gain: 4.46 dBi
 - 5.15 GHz Gain: 7.21 dBi
 - 5.35 GHz Gain: 6.49 dBi
 - 5.725 GHz Gain: 5.23 dBi
 - b. Cushcraft AP-ANT-10, 6 dBi OMNI (Cushcraft P/N: S5153WBPX)
 - c. Cushcraft AP-ANT-12, 14 dBi Directional (Cushcraft P/N: S51514WP)

3.5. Cabling and I/O Ports

Number and type of I/O ports

1. 2 X 10/100 Ethernet Ports
2. USB
3. 5 Vdc, 4mm supply connector



3.6. Test Configurations

Testing was performed to determine the highest power level versus bit rate. 6 MB/s 802.11a was found to provide the highest power level. This data rate were used to exercise the product throughout the entire test program except for DFS.

Matrix of test configurations

Operational Mode (802.11)	Frequencies (MHz)	Maximum Data Rates (MBit/s)	Data Rate(s) Selected for Test Purposes (Mbit/s)	
			Conducted	Radiated
a	5,180 5,260 5,320	54	6 ¹	6 ¹
a	5,500 5,600 5,700	54	6 ¹	6 ¹

¹ – Except for DFS these data rates were used to test and exercise the EUT at all times

Antenna Test Configurations for Radiated Emissions

Freq Band (GHz)	802.11 Mode	Integral	ANT-10 6 dBi Omni	ANT-12 14 dBi Panel
5	a	X	X	X

3.7. Equipment Modifications

The following modifications were required to bring the equipment into compliance:

1. None

3.8. Deviations from the Test Standard

The following deviations from the test standard were required in order to complete the test program:

1. None



4. TEST SUMMARY

List of Measurements

The following table represents the list of measurements required under the **FCC CFR47 Part 15.407**.

Section(s)	Test Items	Description	Condition	Result	Test Report Section
15.407(a)	26dB and 99% Emission BW	Emission bandwidth measurement	Conducted	Complies	5.1.1
15.407(a)	Transmit Output Power	Power Measurement	Conducted	Complies	5.1.2
15.407(a)	Peak Power Spectral Density	PPSD	Conducted	Complies	5.1.3
15.407(a)(6)	Peak Excursion Ratio	<13dB in any 1MHz bandwidth	Conducted	Complies	5.1.4
15.407(g) 15.31	Frequency Stability	Limits: contained within band of operation at all times.	Manufacturer declaration	Complies	5.1.5
15.407(f)	Maximum Permissible Exposure (MPE)	Exposure to radio frequency energy levels.	Conducted	Complies	5.1.6

This test report may be reproduced in full only. The document may only be updated by MiCOM Labs personnel. Any changes will be noted in the Document History section of the report.



List of Measurements (continued)

The following table represents the list of measurements required under the **FCC CFR47 Part 15.407**.

Section(s)	Test Items	Description	Condition	Result	Test Report Section
15.407(b)(2) 15.205(a) 15.209(a)	Radiated Emissions		Radiated		5.1.7
	Transmitter Radiated Spurious Emissions	Emissions above 1 GHz		Complies	5.1.7.1
	Radiated Band Edge	Band edge results		Complies	5.1.7.2
15.407(b)(6) 15.205(a) 15.209(a)	Radiated Emissions	Emissions <1 GHz (30M-1 GHz)		Complies	5.1.7.3
15.407(b)(6) 15.207	AC Wireline Conducted Emissions 150 kHz–30 MHz	Conducted Emissions	Conducted	Complies	5.1.8

This test report may be reproduced in full only. The document may only be updated by MiCOM Labs personnel. Any changes will be noted in the Document History section of the report.



List of Measurements (cont'd)

Dynamic Frequency Selection (DFS)

The following table represents the list of measurements required under the **FCC CFR47 Part 15.407(h)(2)** and **FCC Memorandum Opinion and Order FCC 06-96 (Compliance Measurement procedures for Unlicensed National Information Infrastructure devices operating in the 5250-5350 MHz and 5470-5725 MHz bands incorporating dynamic frequency selection).**

Tests performed on Master Device

Section	Test Items	Description	Condition	Result	Test Report Section
7.8.1	Detection Bandwidth	UNII Detection Bandwidth	Conducted	Complies	6.2.1
7.8.2.1	Performance Requirements Check	Initial Channel Availability Check Time	Conducted	Complies	6.2.2
7.8.2.2		Radar Burst at the Beginning of the Channel Availability Check Time	Conducted	Complies	6.2.3
7.8.2.3		Radar Burst at the End of the Channel Availability Check Time	Conducted	Complies	6.2.4
7.8.3	In-Service Monitoring	In-Service Monitoring for Channel Move Time, Channel Closing Transmission Time and Non-Occupancy Period	Conducted	Complies	6.2.5
7.8.4	Radar Detection	Statistical Performance Check	Conducted	Complies	6.2.6

Note 1: Test results reported in this document relate only to the items tested

Note 2: The required tests demonstrated compliance as per client declaration of test configuration, monitoring methodology and associated pass/fail criteria

5. TEST RESULTS

5.1. Device Characteristics

5.1.1. 26 dB and 99 % Bandwidth

FCC, Part 15 Subpart C §15.407(a)

Test Procedure

The bandwidth at 26 dB and 99 % is measured with a spectrum analyzer connected to the antenna terminal, while EUT is operating in transmission mode at the appropriate center frequency. The spectrum analyzer utilized the 6 dB resolution bandwidth filter for all measurements.

Test Measurement Set up

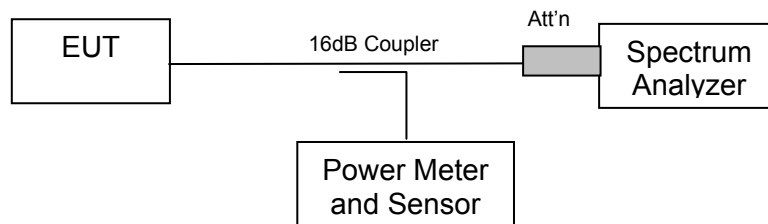

Measurement set up for 6 dB and 99 % bandwidth test

EUT parameters.

Data Rate(s): 802.11a 6 MBit/s,

Duty Cycle: 100%

Power Level: Maximum



Measurement Results for 26 dB and 99 % Operational Bandwidth(s)

Ambient conditions.

Temperature: 17 to 23 °C Relative humidity: 31 to 57 % Pressure: 999 to 1012 mbar

TABLE OF RESULTS – 802.11a

Center Frequency (MHz)	26 dB Bandwidth (MHz)	99 % BW (MHz)
5,180	33.768	17.335
5,260	36.172	17.234
5,320	34.770	17.134

5,180 MHz 802.11a 26 dB and 99 % Bandwidth

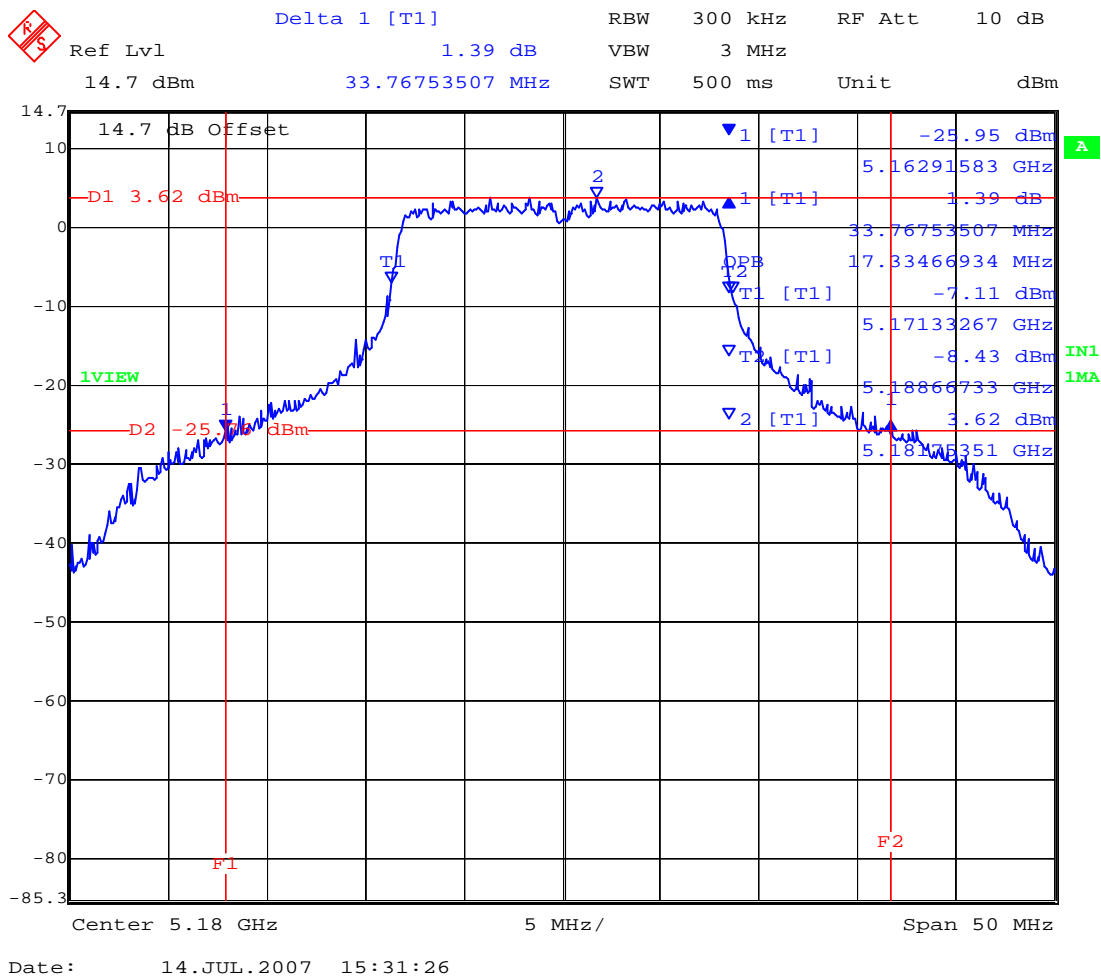

This test report may be reproduced in full only. The document may only be updated by MiCOM Labs personnel. Any changes will be noted in the Document History section of the report.



5,260 MHz 802.11a 26 dB and 99 % Bandwidth

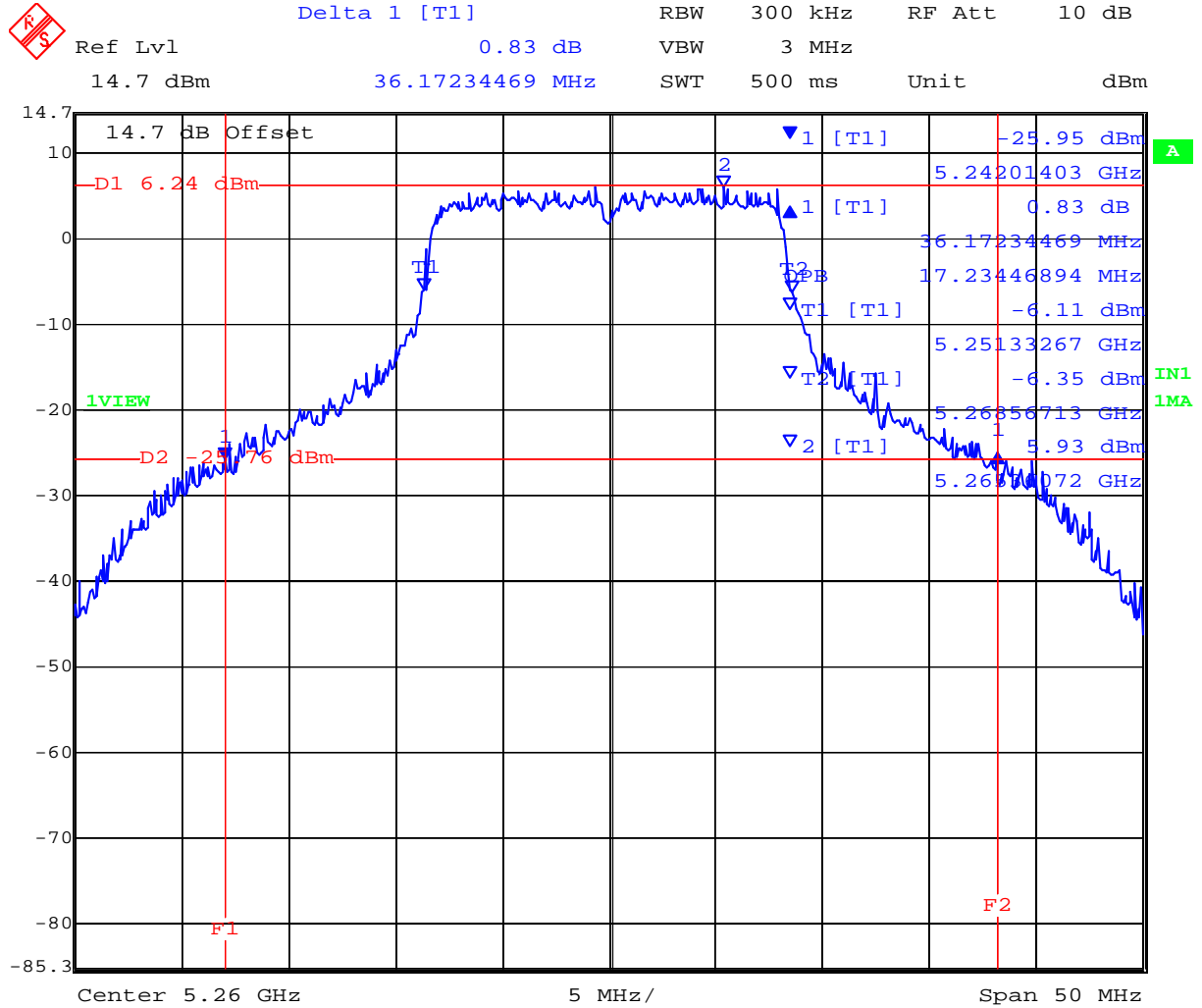

Date: 14.JUL.2007 15:28:19

This test report may be reproduced in full only. The document may only be updated by MiCOM Labs personnel. Any changes will be noted in the Document History section of the report.



5,320 MHz 802.11a 26 dB and 99 % Bandwidth

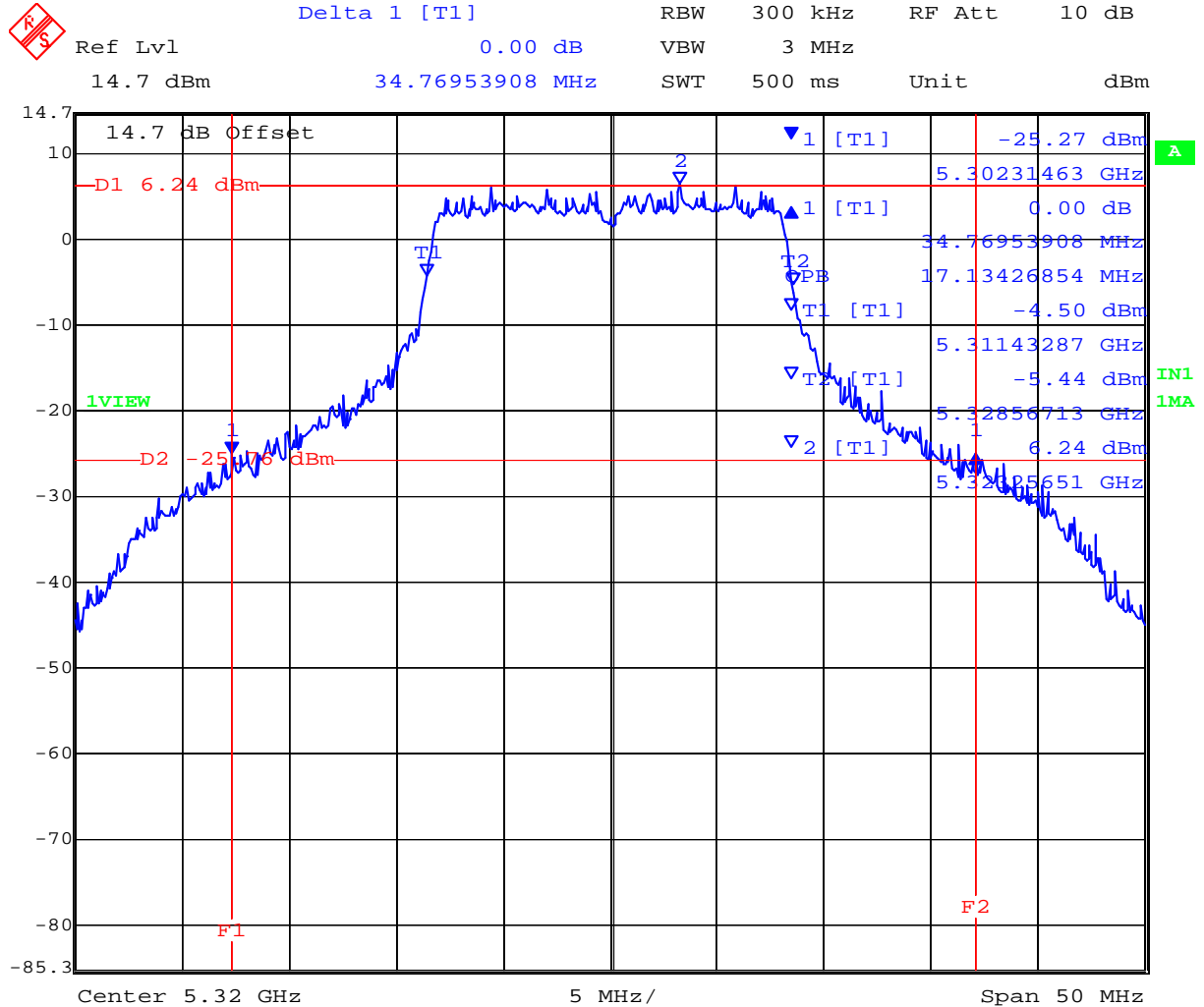

Date: 14.JUL.2007 15:25:54

This test report may be reproduced in full only. The document may only be updated by MiCOM Labs personnel. Any changes will be noted in the Document History section of the report.



TABLE OF RESULTS – 802.11a

Center Frequency (MHz)	26 dB Bandwidth (MHz)	99 % BW (MHz)
5,500	26.152	17.234
5,600	25.050	17.234
5,700	23.848	17.134

5,500 MHz 802.11a 26 dB and 99 % Bandwidth

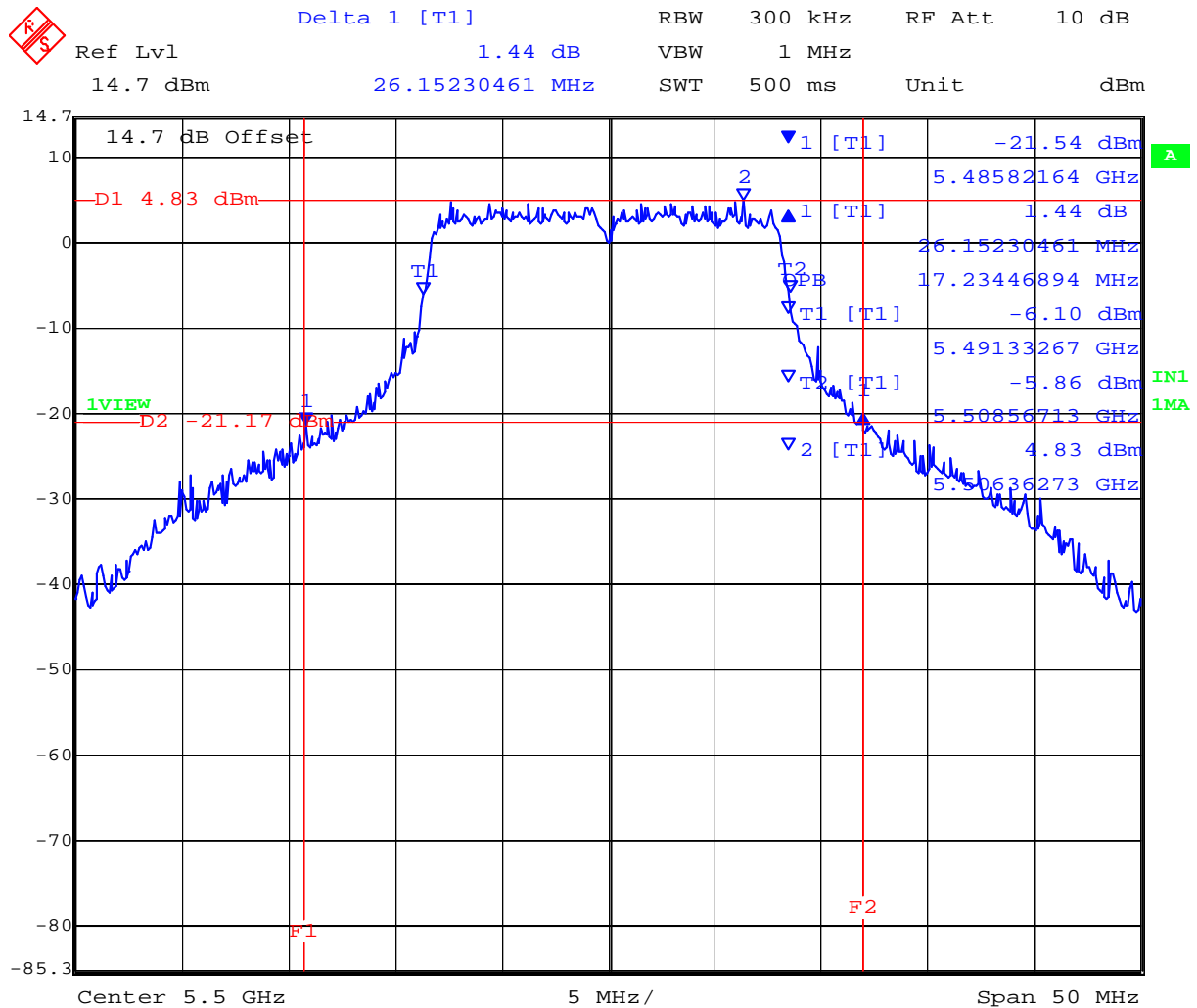

Date: 14.JUL.2007 14:32:34

This test report may be reproduced in full only. The document may only be updated by MiCOM Labs personnel. Any changes will be noted in the Document History section of the report.



5,600 MHz 802.11a 26 dB and 99 % Bandwidth

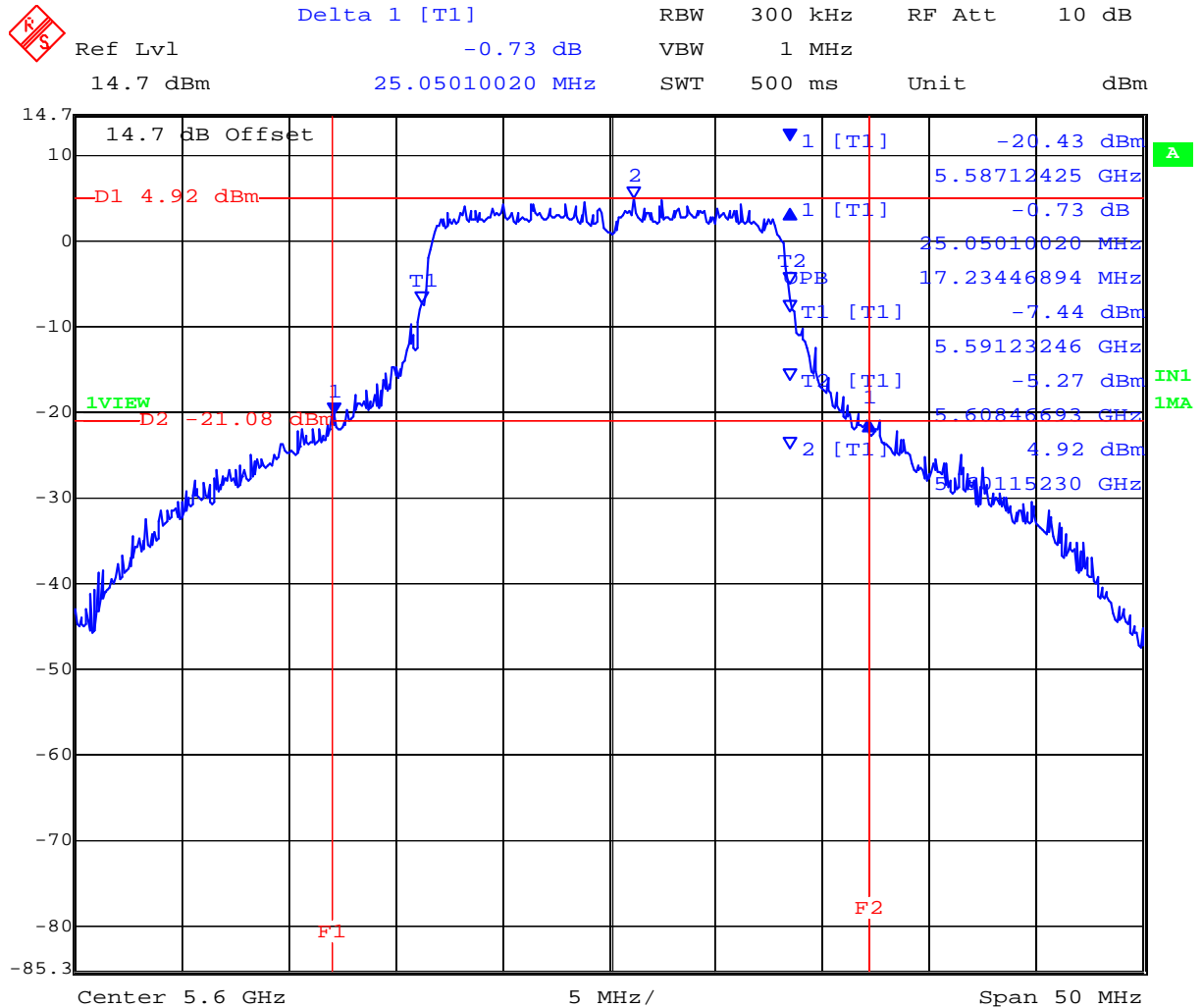

Date: 14.JUL.2007 14:29:18

This test report may be reproduced in full only. The document may only be updated by MiCOM Labs personnel. Any changes will be noted in the Document History section of the report.



5,700 MHz 802.11a 26 dB and 99 % Bandwidth

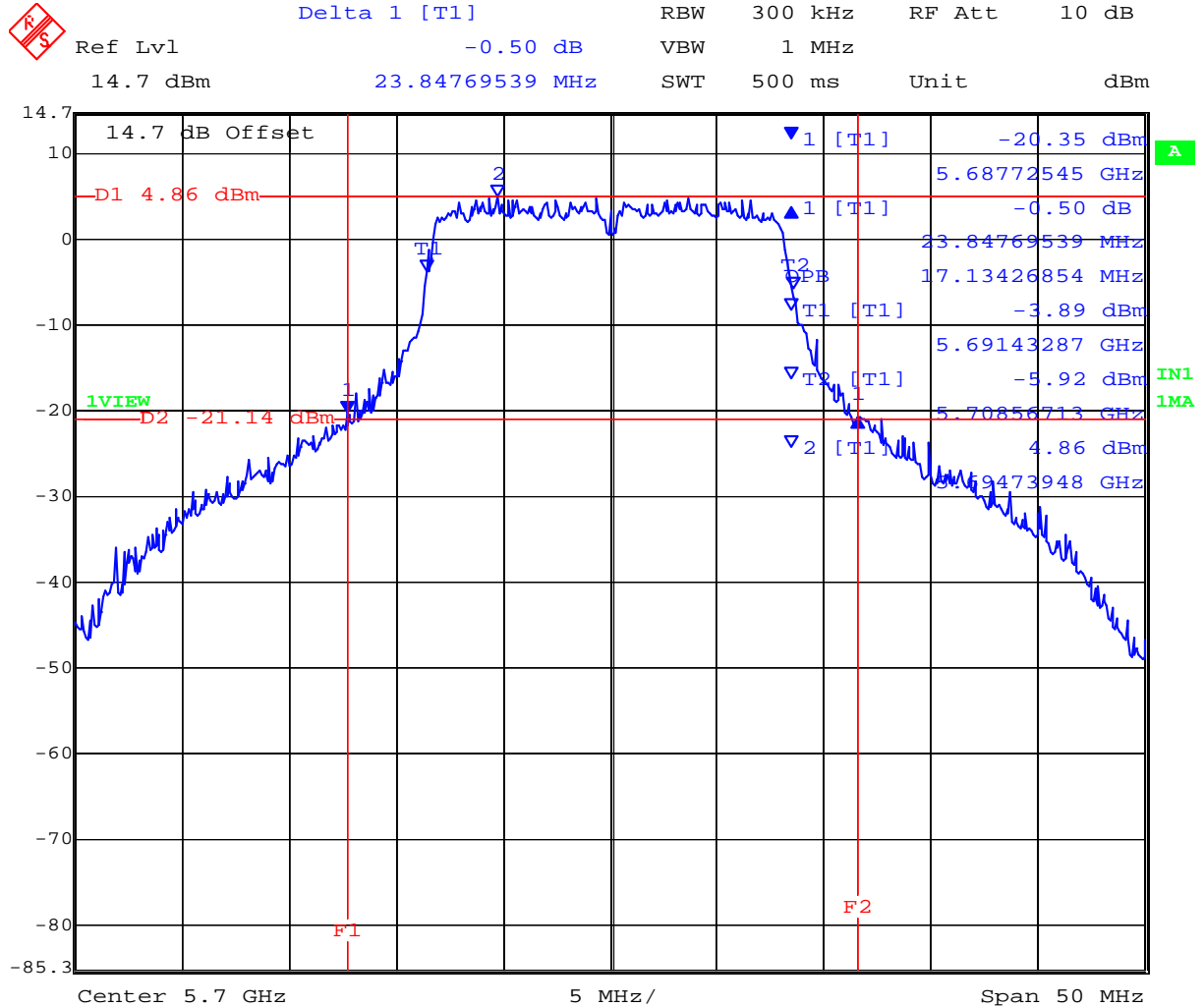

Date: 14.JUL.2007 14:25:57

This test report may be reproduced in full only. The document may only be updated by MiCOM Labs personnel. Any changes will be noted in the Document History section of the report.



Title: Aruba AP-70 802.11 a/b/g Wireless AP
To: FCC 47 CFR Part 15.407
Serial #: ARUB13-A4 Rev A
Issue Date: 20th July 2007
Page: 28 of 130

Specification

Limits

FCC, Part 15 §15.407 (a)(1), (a)(2)

(a)(1) For the band 5.15-5.25 GHz the maximum conducted output power over the frequency band of operation shall not exceed the lesser of 50 mW or +4 dBm + 10 log B, where B is the 26 dB emission bandwidth in megahertz. In addition, the peak power spectral density shall not exceed +4 dBm in any 1 megahertz band.

(a)(2) For the 5.25-5.35 GHz band the maximum conducted output power over the frequency band of operation shall not exceed the lesser of 250 mW or +11 dBm + 10 log B, where B is the 26 dB emission bandwidth in megahertz. In addition, the peak power spectral density shall not exceed +11 dBm in any 1 megahertz band.

Laboratory Measurement Uncertainty for Spectrum Measurement

Measurement uncertainty	±2.81 dB
-------------------------	----------

Traceability

Method	Test Equipment Used
Measurements were made per work instruction WI-03 'Measurement of RF Spectrum Mask'	0158, 0193, 0252, 0313, 0314, 0070, 0116, 0117

This test report may be reproduced in full only. The document may only be updated by MiCOM Labs personnel. Any changes will be noted in the Document History section of the report.

5.1.2. Transmit Output Power

FCC, Part 15 Subpart C §15.407(a)

Test Procedure

The transmitter terminal of EUT was connected to the input of an average power meter. Measurements were made while EUT was operating in a continuous transmission mode i.e. 100 % duty cycle at the appropriate center frequency. All cable losses and offsets were taken into consideration in the measured result.

Test Measurement Set up

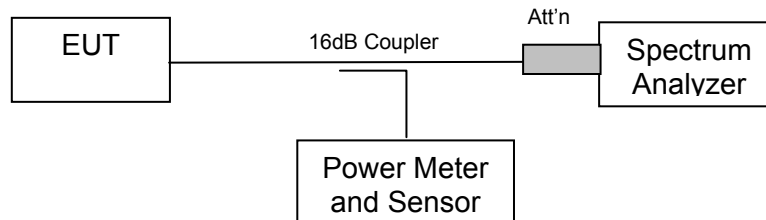

Measurement set up for Transmitter Output Power



Antenna Gain - Maximum Permissible Peak Transmit Power

If transmitting antennas of directional gain greater than 6 dBi are used, the maximum conducted output power shall be reduced by the amount in dB that the directional gain of the antenna exceeds 6 dBi.

The maximum allowable peak power in the 5150 – 5250 MHz frequency band is +17 dBm.

The maximum allowable peak power in the 5250 – 5350 MHz, and 5470 – 5725 MHz frequency band is + 24 dBm.

Antenna Type	Freq Band (MHz)	Gain (dBi)	Antenna Gain >6dBi (dB)	Max. Allowable Peak Power (dBm)	Max. EIRP (dBm)
ANT-12 Panel	5150-5250	14	8	17 – 8 = 9	23.0
ANT-12 Panel	5250-5350 5470-5725	14	8	24 – 8 = 16	30.0

Maximum Transmit Power, FCC Limits

Limit 5150 – 5250 MHz: Lesser of 50 mW (+17dBm) or $4 + 10 \text{ Log (B) dBm}$

Frequency Range (MHz)	Maximum 26 dB Bandwidth (MHz)	$4 + 10 \text{ Log (B) (dBm)}$	Limit (dBm)
5150 – 5250	33.768	+19.29	+17.0

Limit 5250 – 5350 and 5470 – 5725; Lesser of 250 mW (+24dBm) or $11 + 10 \text{ Log (B) dBm}$

Frequency Range (MHz)	Maximum 26 dB Bandwidth (MHz)	$11 + 10 \text{ Log (B) (dBm)}$	Limit (dBm)
5250 - 5350	36.172	+26.59	+24.0
5470 - 5725	26.152	+25.18	+24.0

This test report may be reproduced in full only. The document may only be updated by MiCOM Labs personnel. Any changes will be noted in the Document History section of the report.



Title: Aruba AP-70 802.11 a/b/g Wireless AP
To: FCC 47 CFR Part 15.407
Serial #: ARUB13-A4 Rev A
Issue Date: 20th July 2007
Page: 31 of 130

Measurement Results for Transmit Output Power

Ambient conditions.

Temperature: 17 to 23 °C Relative humidity: 31 to 57 % Pressure: 999 to 1012 mbar

EUT parameters.

Data Rate(s): 802.11a 6 MBit/s,

Power Level: Maximum

Duty Cycle: 100%

TABLE OF RESULTS – 802.11a

Center Frequency (MHz)	Maximum Conducted Power (dBm)
5,180	+14.04
5,260	+15.12
5,320	+14.29

TABLE OF RESULTS – 802.11a

Center Frequency (MHz)	Maximum Conducted Power (dBm)
5,500	+13.80
5,600	+14.05
5,700	+14.29

This test report may be reproduced in full only. The document may only be updated by MiCOM Labs personnel. Any changes will be noted in the Document History section of the report.



Specification

Limits

FCC, Part 15 §15.407 (a)(1), (a)(2) and Industry Canada RSS-210 § A9.2(2)

(a)(1) For the band 5.15-5.25 GHz the maximum conducted output power over the frequency band of operation shall not exceed the lesser of 50 mW or $+4 \text{ dBm} + 10 \log B$, where B is the 26 dB emission bandwidth in megahertz. In addition, the peak power spectral density shall not exceed +4 dBm in any 1 megahertz band.

(a)(2) For the 5.25-5.35 GHz band the maximum conducted output power over the frequency band of operation shall not exceed the lesser of 250 mW or $+11 \text{ dBm} + 10 \log B$, where B is the 26 dB emission bandwidth in megahertz. In addition, the peak power spectral density shall not exceed +11 dBm in any 1 megahertz band.

Laboratory Measurement Uncertainty for Power Measurements

Measurement uncertainty	$\pm 1.33 \text{ dB}$
-------------------------	-----------------------

Traceability

Method	Test Equipment Used
Measurements were made per work instruction WI-01 'Measuring RF Output Power'	0158, 0193, 0252, 0313, 0314, 0070, 0116, 0117

This test report may be reproduced in full only. The document may only be updated by MiCOM Labs personnel. Any changes will be noted in the Document History section of the report.

5.1.3. Peak Power Spectral Density

FCC, Part 15 Subpart C §15.407(a)

Test Procedure

The transmitter output was connected to a spectrum analyzer and the peak power spectral density measured. Method 2 Sample Detection and power averaging, specified in FCC document DA 02-2138 (Normative Reference (ix) Section 2.1 “Guidelines for Assessing Unlicensed National Information Infrastructure (U-NII) Devices”) was used to determine the peak power spectral density of the emission. The Peak Power Spectral Density is the highest level found across the emission in a 1 MHz resolution bandwidth.

Test Measurement Set up

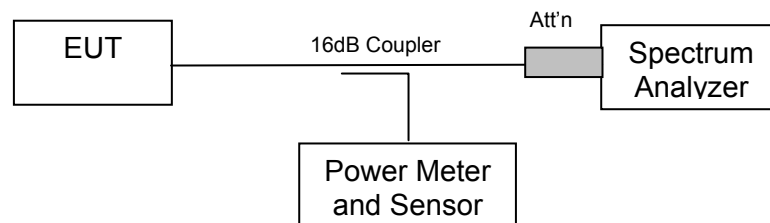

Measurement set up for Peak Power Spectral Density

Measurement Results for Peak Power Spectral Density

Ambient conditions.

Temperature: 17 to 23 °C Relative humidity: 31 to 57 % Pressure: 999 to 1012 mbar

EUT parameters.

Data Rate(s): 802.11a 6 MBit/s,

Power Level: Maximum

Duty Cycle: 100%



TABLE OF RESULTS – 802.11a

Center Frequency (MHz)	Peak Frequency (MHz)	PPSD (dBm)
5,180	5181.15230	-3.05
5,260	5264.95992	-0.60
5,320	5326.96393	-0.20

5,180 MHz 802.11a Peak Power Spectral Density

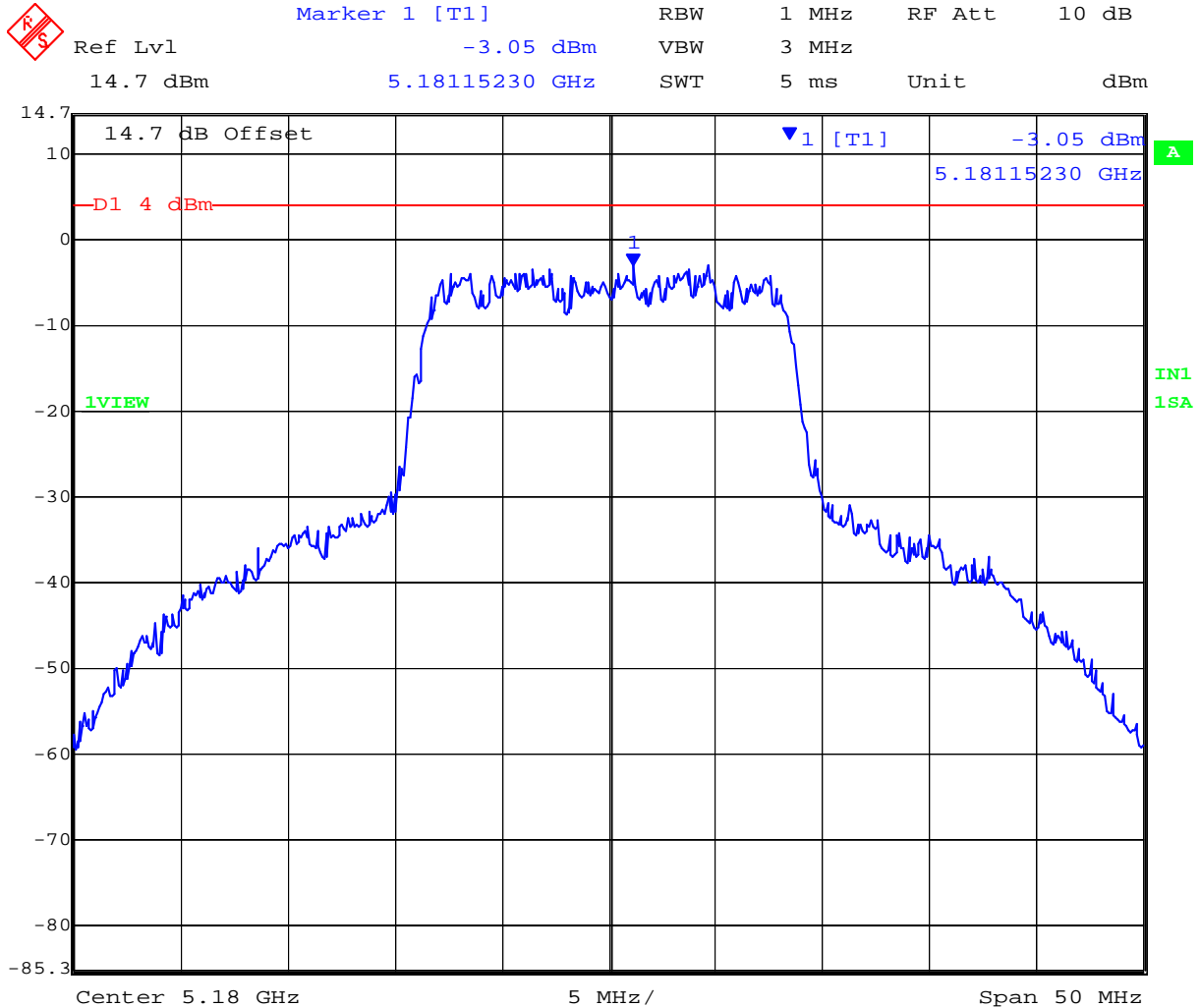

Date: 14.JUL.2007 13:49:28

This test report may be reproduced in full only. The document may only be updated by MiCOM Labs personnel. Any changes will be noted in the Document History section of the report.



5,260 MHz 802.11a Peak Power Spectral Density

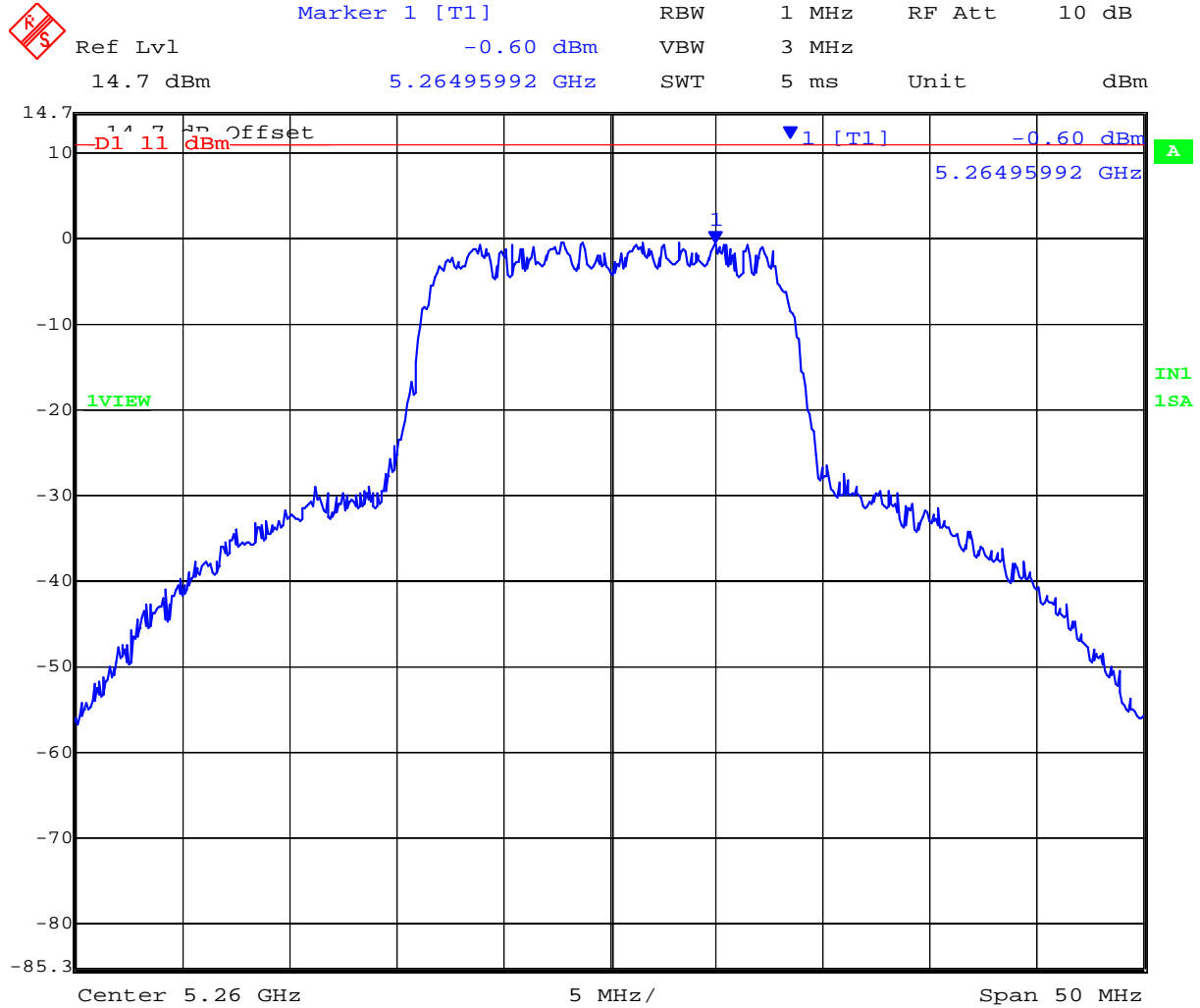

Date: 14.JUL.2007 14:03:14

This test report may be reproduced in full only. The document may only be updated by MiCOM Labs personnel. Any changes will be noted in the Document History section of the report.



5,320 MHz 802.11a Peak Power Spectral Density

	Marker 1 [T1]	RBW 1 MHz	RF Att 10 dB
	Ref Lvl 14.7 dBm	-0.20 dBm	VBW 3 MHz
	5.32696393 GHz	SWT 5 ms	Unit dBm

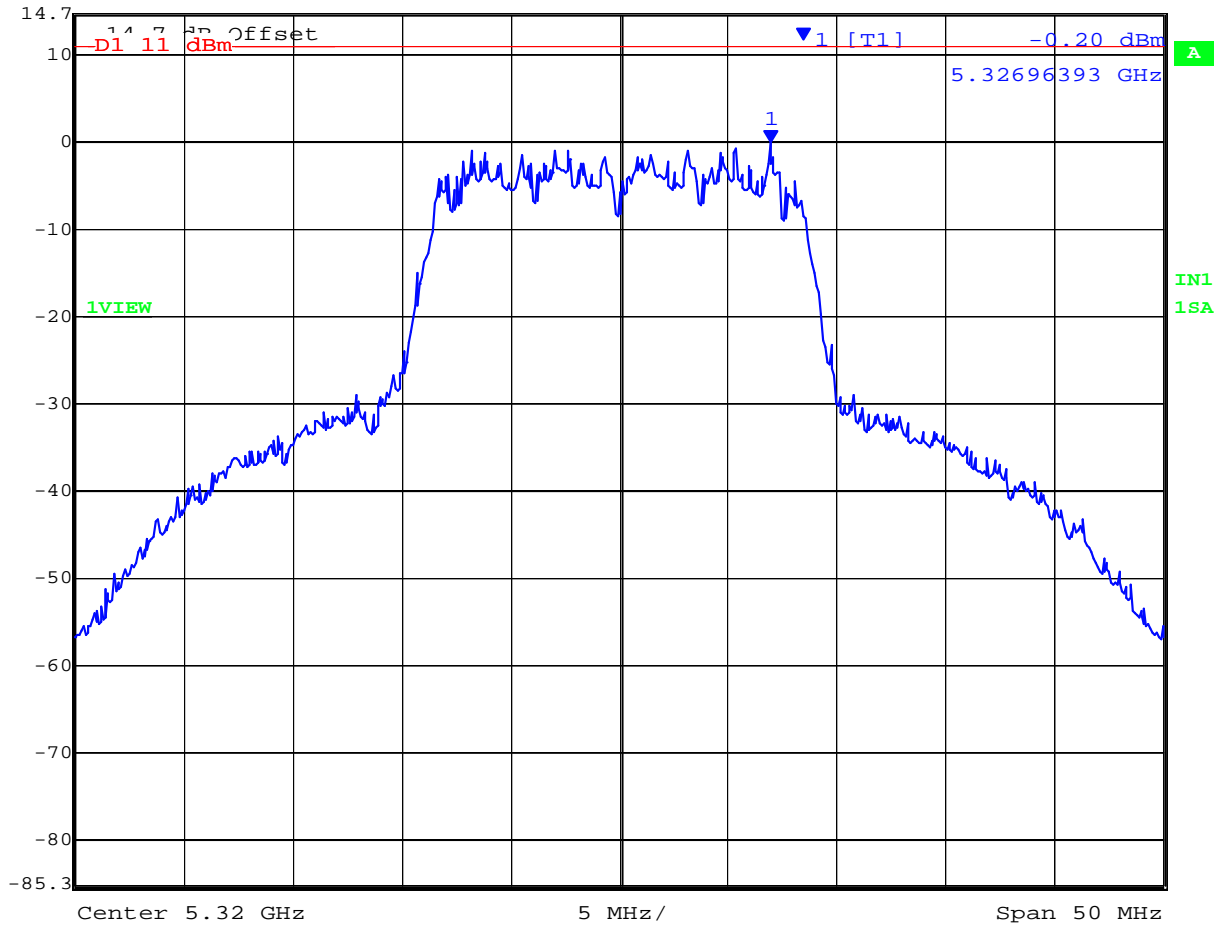

Date: 14.JUL.2007 14:07:46

This test report may be reproduced in full only. The document may only be updated by MiCOM Labs personnel. Any changes will be noted in the Document History section of the report.

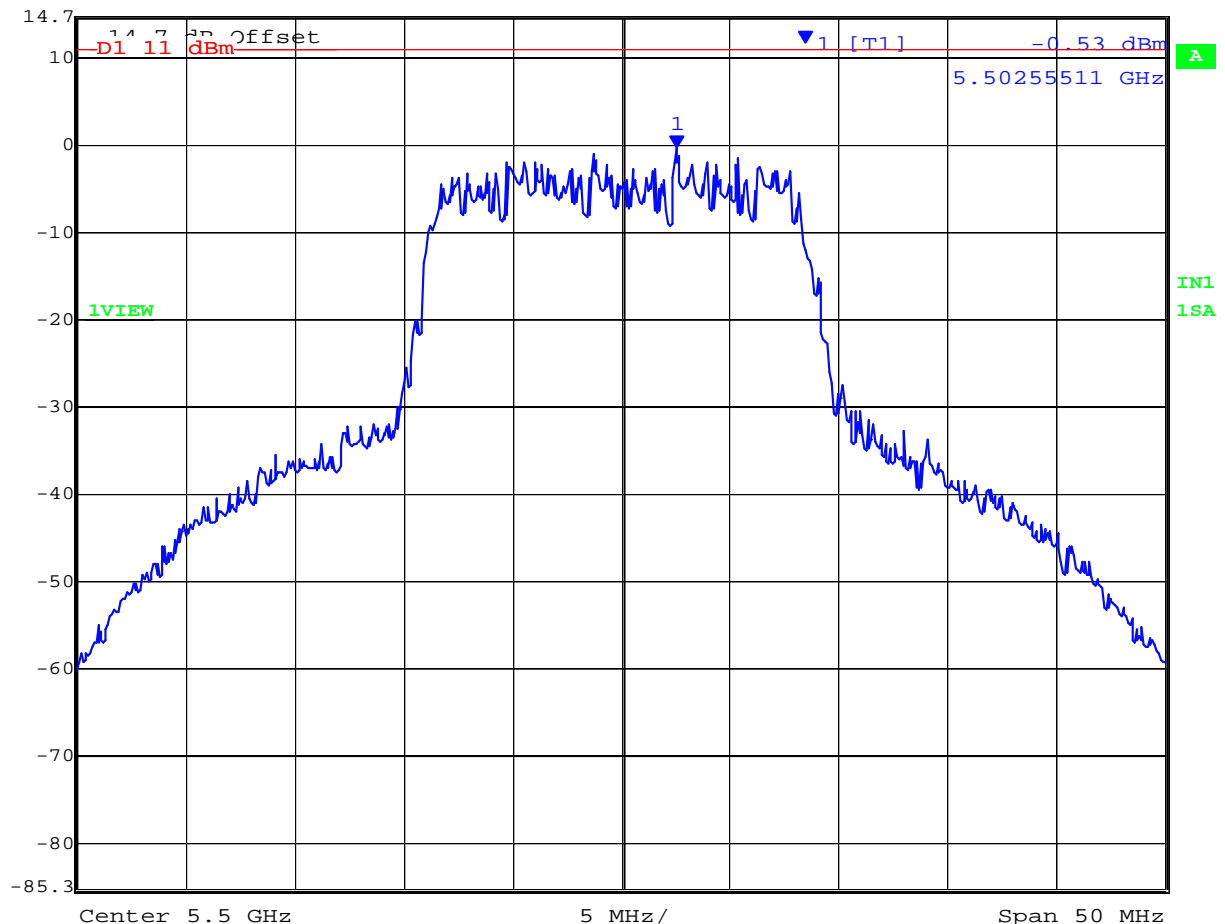

TABLE OF RESULTS – 802.11a

Center Frequency (MHz)	Peak Frequency (MHz)	PPSD (dBm)
5,500	5502.55511	-0.53
5,600	5593.43687	-1.73
5,700	5704.45892	-0.34

5,500 MHz 802.11a Peak Power Spectral Density

Marker 1 [T1] RBW 1 MHz RF Att 10 dB
 Ref Lvl 14.7 dBm -0.53 dBm VBW 3 MHz
 5.50255511 GHz SWT 5 ms Unit dBm



Date: 14.JUL.2007 14:16:46

This test report may be reproduced in full only. The document may only be updated by MiCOM Labs personnel. Any changes will be noted in the Document History section of the report.



Title: Aruba AP-70 802.11 a/b/g Wireless AP
To: FCC 47 CFR Part 15.407
Serial #: ARUB13-A4 Rev A
Issue Date: 20th July 2007
Page: 38 of 130

5,600 MHz 802.11a Peak Power Spectral Density

Marker 1 [T1] RBW 1 MHz RF Att 10 dB
Ref Lvl 14.7 dBm Offset -1.73 dBm VBW 3 MHz
14.7 dBm 5.59343687 GHz SWT 5 ms Unit dBm

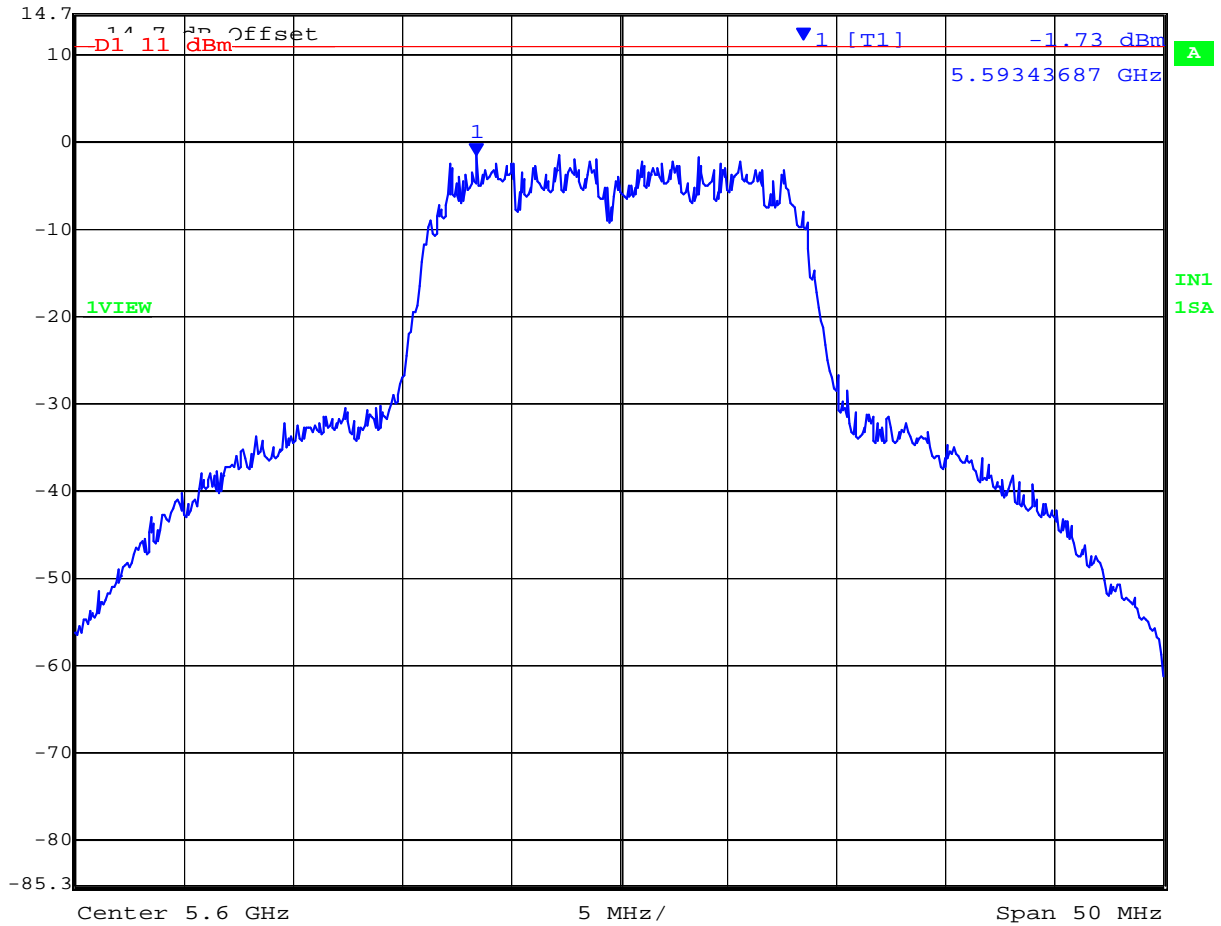

Date: 14.JUL.2007 14:18:23

This test report may be reproduced in full only. The document may only be updated by MiCOM Labs personnel. Any changes will be noted in the Document History section of the report.



5,700 MHz 802.11a Peak Power Spectral Density

 Ref Lvl 14.7 dBm Marker 1 [T1] RBW 1 MHz RF Att 10 dB
-0.34 dBm VBW 3 MHz
5.70445892 GHz SWT 5 ms Unit dBm

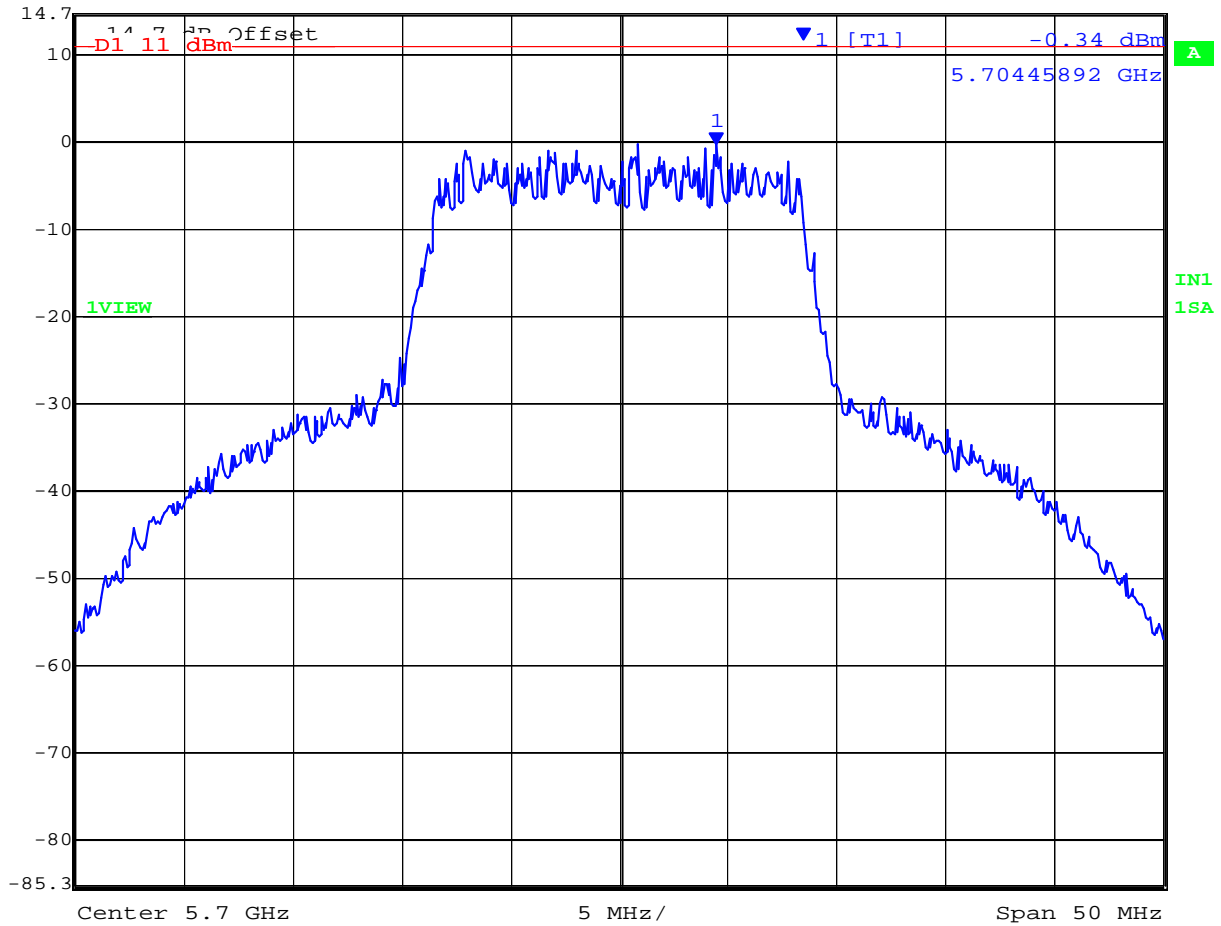

Date: 14.JUL.2007 14:20:09

This test report may be reproduced in full only. The document may only be updated by MiCOM Labs personnel. Any changes will be noted in the Document History section of the report.



Title: Aruba AP-70 802.11 a/b/g Wireless AP
To: FCC 47 CFR Part 15.407
Serial #: ARUB13-A4 Rev A
Issue Date: 20th July 2007
Page: 40 of 130

Specification

FCC, Part 15 §15.407 (a)(1), (a)(2)

(a)(1) The peak power spectral density shall not exceed +4 dBm in any 1 megahertz band.

(a)(2) The peak power spectral density shall not exceed +11 dBm in any 1 megahertz band.

Laboratory Measurement Uncertainty for Spectral Density

Measurement uncertainty	± 1.33 dB
-------------------------	---------------

Traceability

Method	Test Equipment Used
Measurements were made per work instruction WI-01 'Measuring RF Output Power'	0158, 0193, 0252, 0313, 0314, 0070, 0116, 0117

This test report may be reproduced in full only. The document may only be updated by MiCOM Labs personnel. Any changes will be noted in the Document History section of the report.

5.1.4. Peak Excursion Ratio

FCC, Part 15 Subpart C §15.407(a)(6)

Test Procedure

Normative Reference (xi) Section 2.1 Measurement Procedure DA 02-2138 “Measurement Procedure Updated for Peak Transmit Power in the UNII Bands” was implemented to determine the Peak Excursion Ratio. This is a conducted measurement using a spectrum analyzer. The Peak Excursion Ratio is the difference in amplitude (dB) between the two traces.

Test Measurement Set up

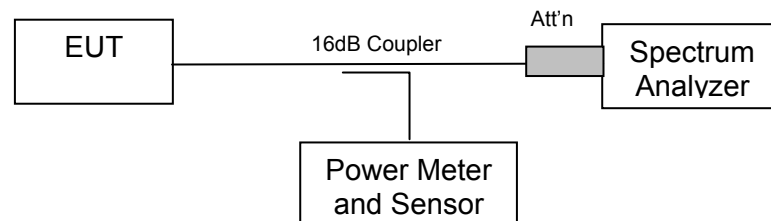

Measurement set up for Peak Excursion Ratio

Measurement Results for Peak Excursion Ratio

Ambient conditions.

Temperature: 17 to 23 °C Relative humidity: 31 to 57% Pressure: 999 to 1012 mbar

EUT parameters

Data Rate(s): 802.11a 6 MBit/s,

Power Level: Maximum



TABLE OF RESULTS – 802.11a

Centre Frequency (MHz)	Peak Excursion Ratio (dB)
5,180	11.12
5,260	11.28
5,320	10.42

5,180 MHz 802.11a - Peak Excursion Ratio

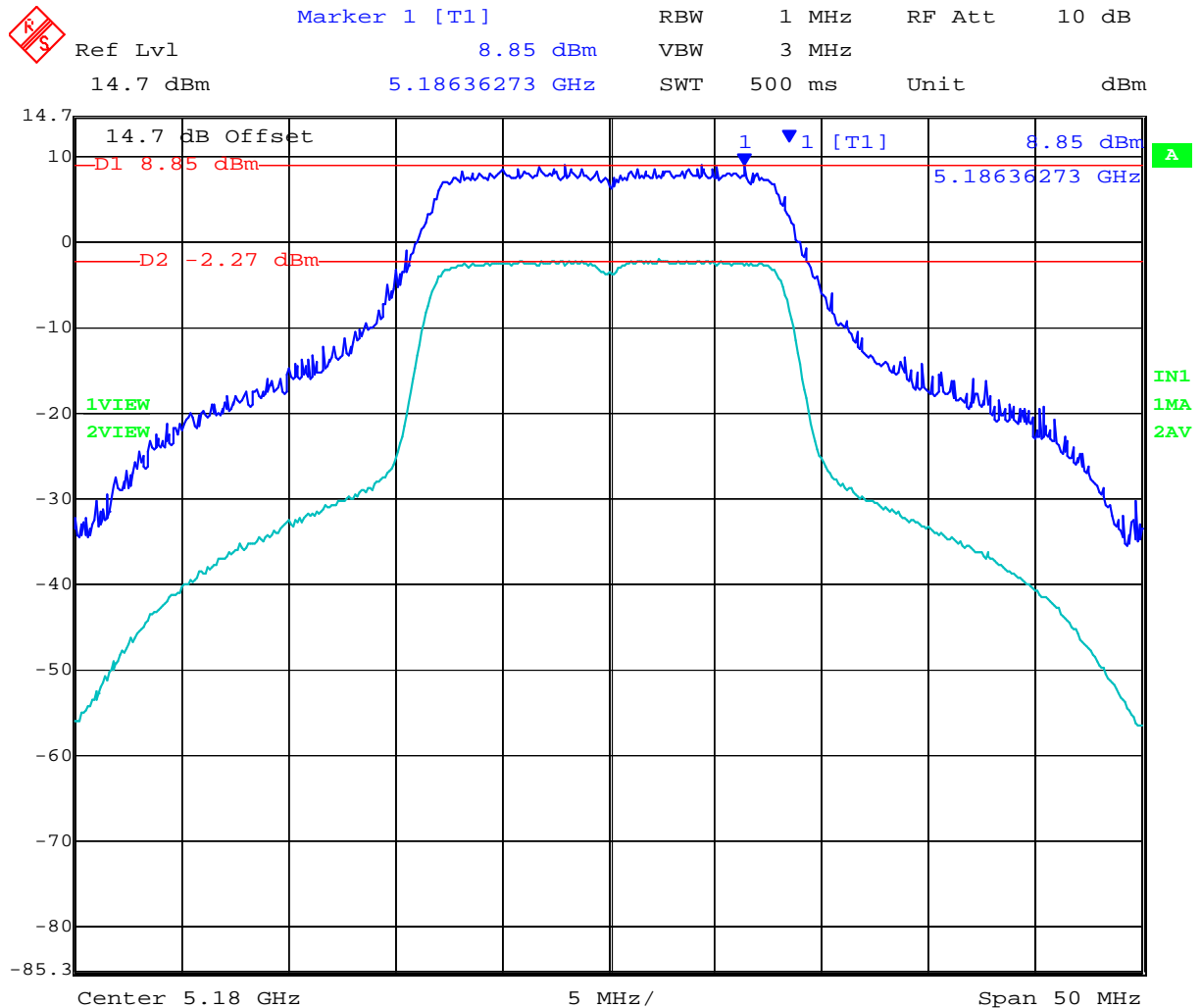

Date: 14.JUL.2007 14:57:47

This test report may be reproduced in full only. The document may only be updated by MiCOM Labs personnel. Any changes will be noted in the Document History section of the report.



5,260 MHz 802.11a - Peak Excursion Ratio

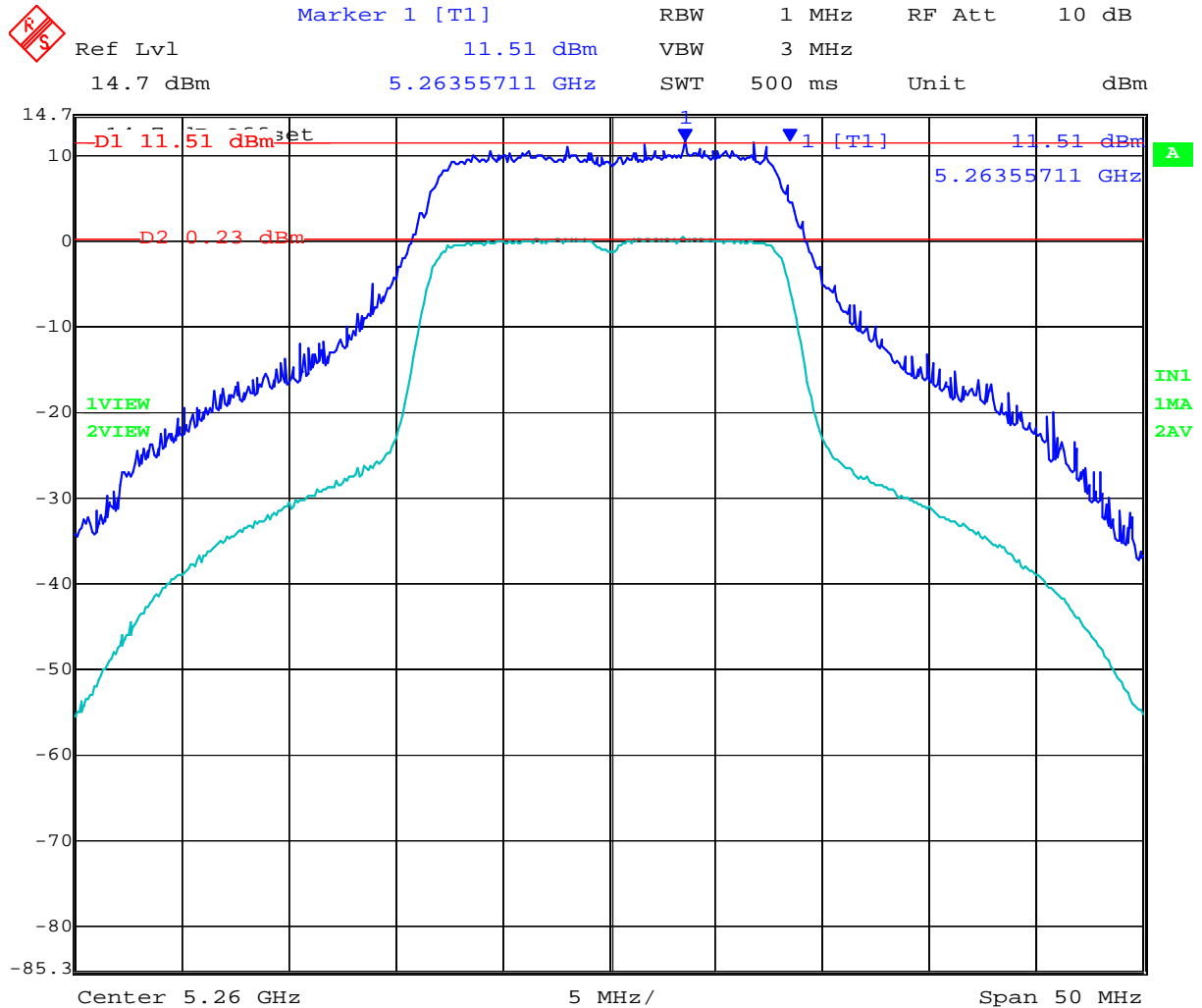

Date: 14.JUL.2007 14:59:47

This test report may be reproduced in full only. The document may only be updated by MiCOM Labs personnel. Any changes will be noted in the Document History section of the report.



5,320 MHz 802.11a - Peak Excursion Ratio

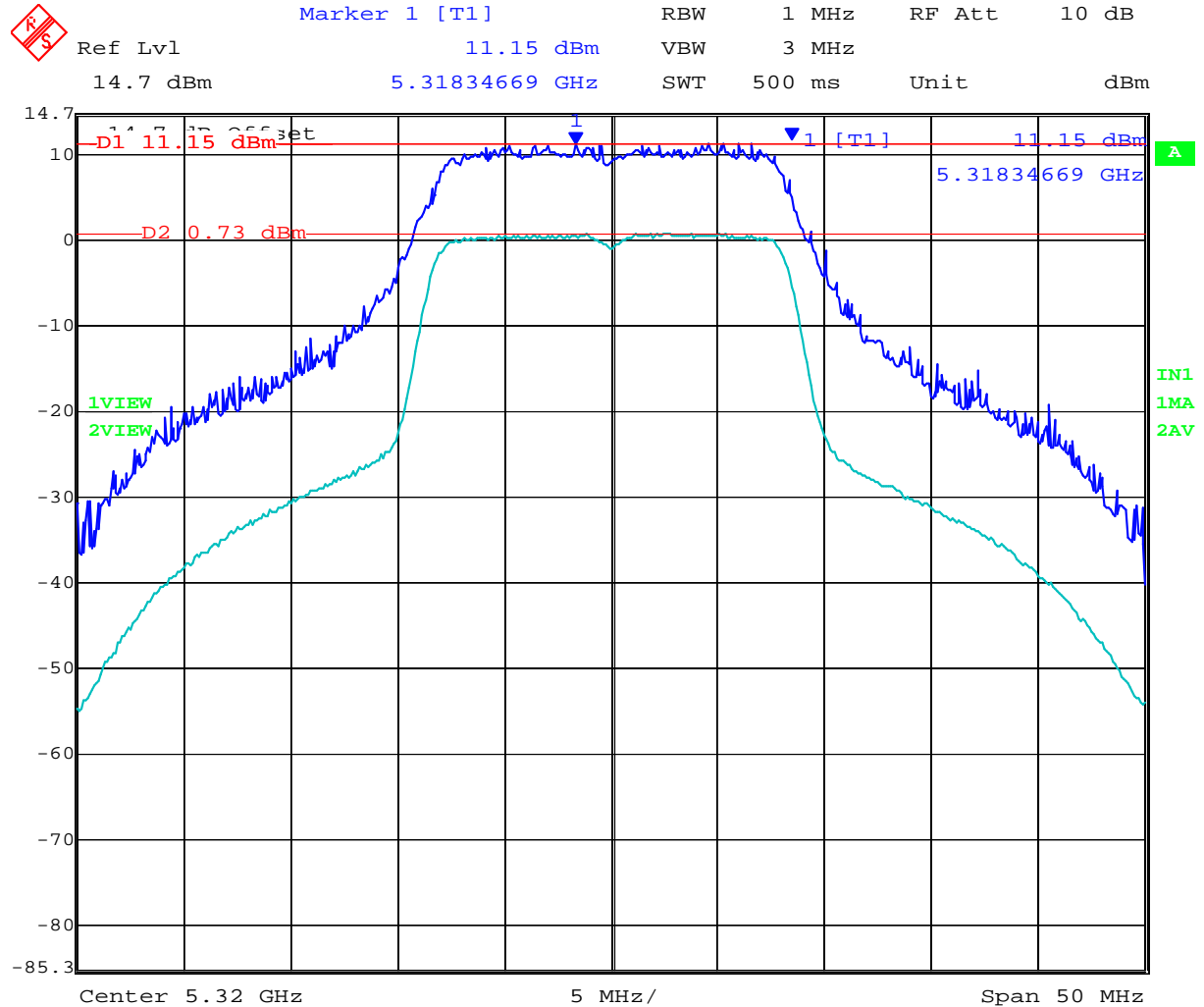

Date: 14.JUL.2007 15:09:56

This test report may be reproduced in full only. The document may only be updated by MiCOM Labs personnel. Any changes will be noted in the Document History section of the report.



TABLE OF RESULTS – 802.11a

Centre Frequency (MHz)	Peak Excursion Ratio (dB)
5,500	10.86
5,600	11.09
5,700	10.17

5,500 MHz 802.11a - Peak Excursion Ratio

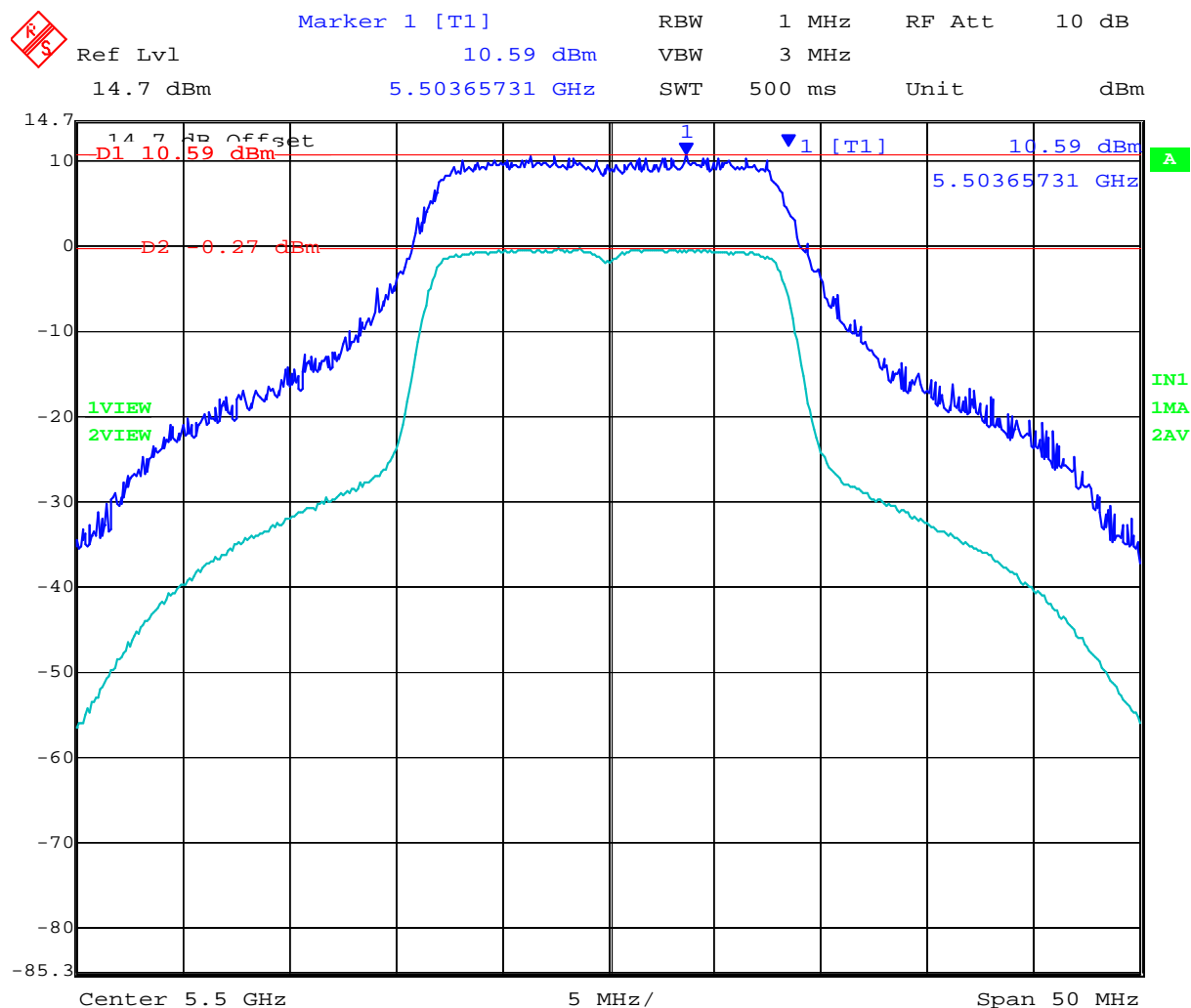

Date: 14.JUL.2007 14:41:24

This test report may be reproduced in full only. The document may only be updated by MiCOM Labs personnel. Any changes will be noted in the Document History section of the report.



5,600 MHz 802.11a - Peak Excursion Ratio

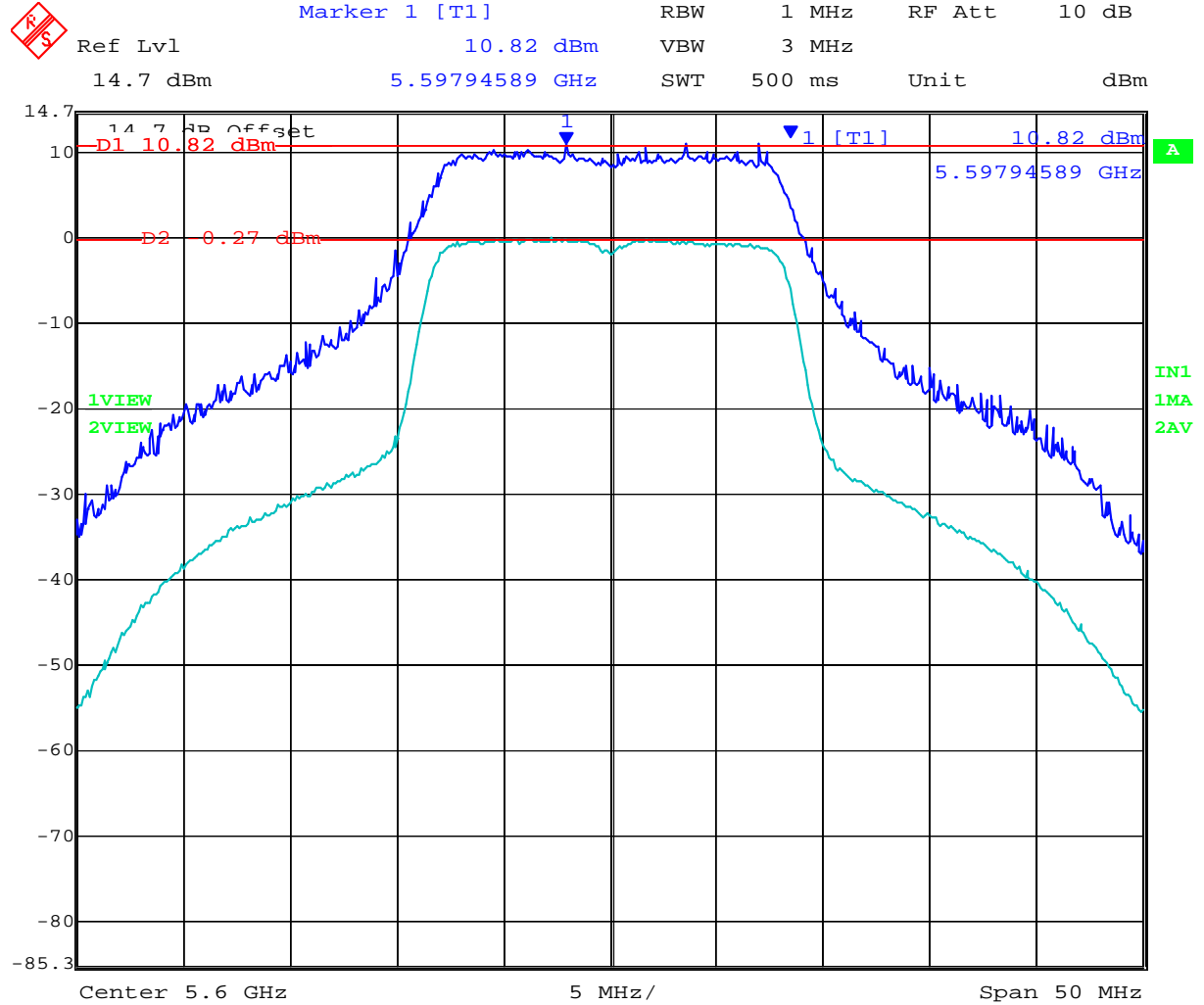

Date: 14.JUL.2007 14:43:33

This test report may be reproduced in full only. The document may only be updated by MiCOM Labs personnel. Any changes will be noted in the Document History section of the report.



5,700 MHz 802.11a - Peak Excursion Ratio

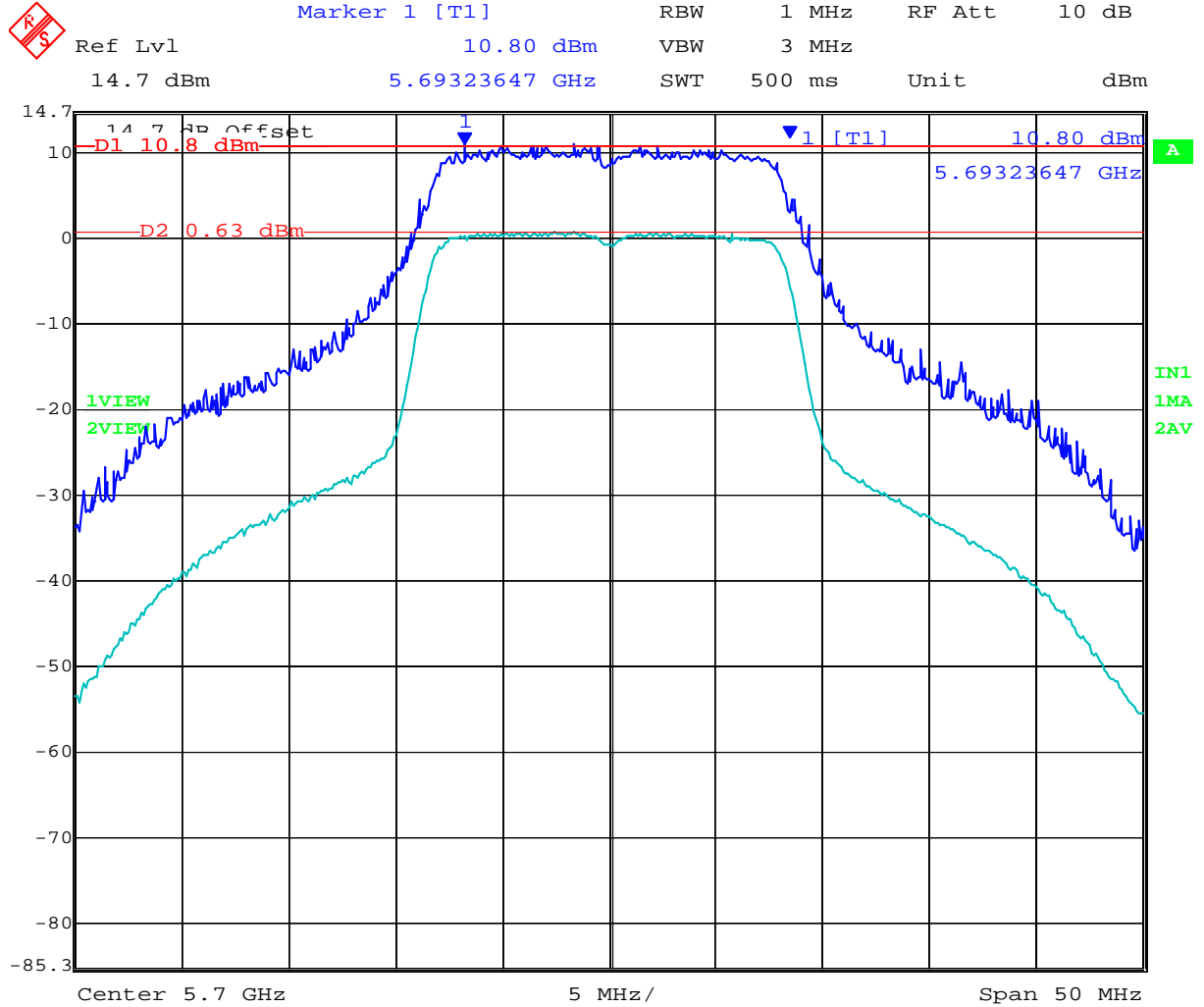

Date: 14.JUL.2007 14:48:45

This test report may be reproduced in full only. The document may only be updated by MiCOM Labs personnel. Any changes will be noted in the Document History section of the report.



Title: Aruba AP-70 802.11 a/b/g Wireless AP
To: FCC 47 CFR Part 15.407
Serial #: ARUB13-A4 Rev A
Issue Date: 20th July 2007
Page: 48 of 130

Specification

Limits

§15.407 (a)(6) The ratio of the peak excursion of the modulation envelope (measured using a peak hold function) to the peak transmit power (measured as specified in this paragraph) shall not exceed 13dB across any 1MHz bandwidth or the emission bandwidth whichever is less

Laboratory Measurement Uncertainty for Spectrum Measurement

Measurement uncertainty	$\pm 2.81\text{dB}$
-------------------------	---------------------

Traceability

Method	Test Equipment Used
Measurements were made per work instruction WI-03 'Measurement of RF Spectrum Mask'	0158, 0193, 0252, 0313, 0314, 0070, 0116, 0117

This test report may be reproduced in full only. The document may only be updated by MiCOM Labs personnel. Any changes will be noted in the Document History section of the report.



Title: Aruba AP-70 802.11 a/b/g Wireless AP
To: FCC 47 CFR Part 15.407
Serial #: ARUB13-A4 Rev A
Issue Date: 20th July 2007
Page: 49 of 130

5.1.5. Frequency Stability

FCC, Part 15 Subpart C §15.407(g)

Test Procedure

The manufacturer of the equipment is responsible for ensuring that the frequency stability is such that emissions are always maintained within the band of operation under all conditions.

Manufacturer Declaration

The frequency stability of the reference oscillator sets the frequency stability of the RF transceiver signals. Therefore all of the RF signals should have ± 20 ppm stability.

This stability accounts for room temp tolerance of the crystal oscillator circuit, frequency variation across temperature, and crystal ageing.

± 20 ppm at 5.250 GHz translates to a maximum frequency shift of ± 105 KHz. As the edge of the channels is at least one MHz from either of the band edges, ± 105 KHz is more than sufficient to guarantee that the intentional emission will remain in the band over the entire operating range of the EUT.

Specification

Limits

§15.407 (g) Manufacturers of U-NII devices are responsible for ensuring frequency stability such that an emission is maintained within the band of operation under all conditions of normal operation as specified in the user's manual.

This test report may be reproduced in full only. The document may only be updated by MiCOM Labs personnel. Any changes will be noted in the Document History section of the report.



5.1.6. Maximum Permissible Exposure

FCC, Part 15 Subpart C §15.407(f)

Calculations for Maximum Permissible Exposure Levels

$$\text{Power Density} = P_d \text{ (mW/cm}^2\text{)} = \text{EIRP}/(4\pi d^2)$$

$$\text{EIRP} = P * G$$

P = Peak output power (mW)

G = Antenna numeric gain (numeric)

d = Separation distance (cm)

$$\text{Numeric Gain} = 10 ^ (G \text{ (dBi)}/10)$$

Because the EUT belongs to the General Population/Uncontrolled Exposure the limit of power density is 1.0 mW/cm²

Antenna Gain (dBi)	Numeric Gain (numeric)	Peak Output Power (dBm)	Peak Output Power (mW)	Calculated safe distance @ max limit 1mW/ cm ² (d=cm)
14	25.12	15.12	32.51	8.1

Specification

Maximum Permissible Exposure Limits

§15.247 (f) U-NII devices are subject to the radio frequency radiation exposure requirements specified in §1.1307 (b), 2.1091 and 2.1093 as appropriate. All equipment shall be considered to operate in a “general population/uncontrolled” environment.

Limit S = 1mW / cm² from 1.310 Table 1

Note: for mobile or fixed location transmitters the minimum separation distance is 20cm, even if calculations indicate the MPE distance to be less.

Laboratory Measurement Uncertainty for Power Measurements

Measurement uncertainty	±1.33 dB
-------------------------	----------

5.1.7. Radiated Emissions

5.1.7.1. Transmitter Radiated Spurious Emissions (above 1 GHz)

FCC, Part 15 Subpart C §15.407(b)(2), §15.205(a)/15.209(a)

Test Procedure

Radiated emissions above 1 GHz are measured in the anechoic chamber at a 3-meter distance on every azimuth in both horizontal and vertical polarities. The emissions are recorded and maximized as a function of azimuth by rotation through 360° with a spectrum analyzer in peak hold mode. Depending on the frequency band spanned a notch filter and waveguide filter was used to remove the fundamental frequency. The highest emissions relative to the limit are listed for each frequency spanned.

All measurements on any frequency or frequencies over 1 MHz are based on the use of measurement instrumentation employing an average detector function. All measurements above 1 GHz were performed using a minimum resolution bandwidth of 1 MHz.

Test Measurement Set up

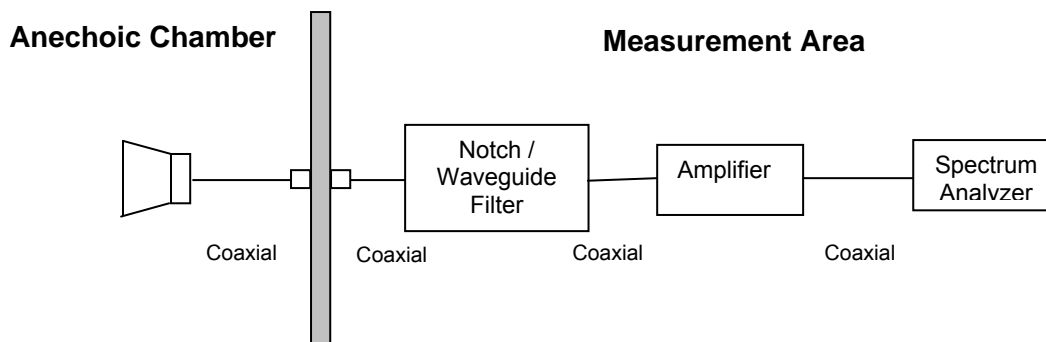

Measurement set up for Radiated Emission Test

Field Strength Calculation

The field strength is calculated by adding the Antenna Factor and Cable Loss, and subtracting Amplifier Gain from the measured reading. All factors are included in the reported data.

$$FS = R + AF + CORR - FO$$

where: FS = Field Strength

R = Measured Spectrum analyzer Input Amplitude

AF = Antenna Factor

CORR = Correction Factor = CL – AG + NFL

CL = Cable Loss

AG = Amplifier Gain

FO = Distance Falloff Factor

NFL = Notch Filter Loss or Waveguide Loss



Title: Aruba AP-70 802.11 a/b/g Wireless AP
To: FCC 47 CFR Part 15.407
Serial #: ARUB13-A4 Rev A
Issue Date: 20th July 2007
Page: 52 of 130

For example:

Given receiver input reading of 51.5 dB μ V; Antenna Factor of 8.5 dB; Cable Loss of 1.3 dB; Falloff Factor of 0 dB, an Amplifier Gain of 26 dB and Notch Filter Loss of 1 dB. The Field Strength of the measured emission is:

$$FS = 51.5 + 8.5 + 1.3 - 26.0 + 1 = 36.3 \text{ dB}\mu\text{V/m}$$

Conversion between dB μ V/m (or dB μ V) and μ V/m (or μ V) are done as:

$$\text{Level (dB}\mu\text{V/m)} = 20 * \text{Log (level (\mu\text{V/m}))}$$

$$40 \text{ dB}\mu\text{V/m} = 100 \mu\text{V/m}$$

$$48 \text{ dB}\mu\text{V/m} = 250 \mu\text{V/m}$$

The following formula is used to convert the equipment isotropic radiated power (eirp) to field strength (dB μ V/m);

$$E = 1000000 \times \sqrt{30P} / 3 \mu\text{V/m}$$

where P is the EIRP in Watts

$$\text{Therefore: } -27 \text{ dBm/MHz} = 68.23 \text{ dB}\mu\text{V/m}$$

Note: The data in this Section identifies that the EUT is in compliance with the -27dBm/MHz EIRP limit (68.23 dB μ V/m) for out of band emissions. All peak emissions are less than 68.23 dB μ V/m.

This test report may be reproduced in full only. The document may only be updated by MiCOM Labs personnel. Any changes will be noted in the Document History section of the report.



Measurement Results Transmitter Radiated Spurious Emissions above 1 GHz

Ambient conditions.

Temperature: 17 to 23°C Relative humidity: 31 to 57 % Pressure: 999 to 1012 mbar

TABLE OF RESULTS – 802.11a 5,180 MHz Integral Antenna

PEAK

Freq. (MHz)	Pol. (H/V)	Raw Reading (dBμV)	Correction Factor (dB)	Corrected Field Strength (dBμV/m)	Peak Limit (dBμV/m)	Margin (dB)
10363.33	V	43.64	5.89	49.53	74	-24.47

AVERAGE

Freq. (MHz)	Pol. (H/V)	Raw Reading (dBμV)	Correction Factor (dB)	Corrected Field Strength (dBμV/m)	Average Limit (dBμV/m)	Margin (dB)
10363.33	V	40.67	5.89	46.56	54	-7.44

Radiated Emissions for 5,180 MHz

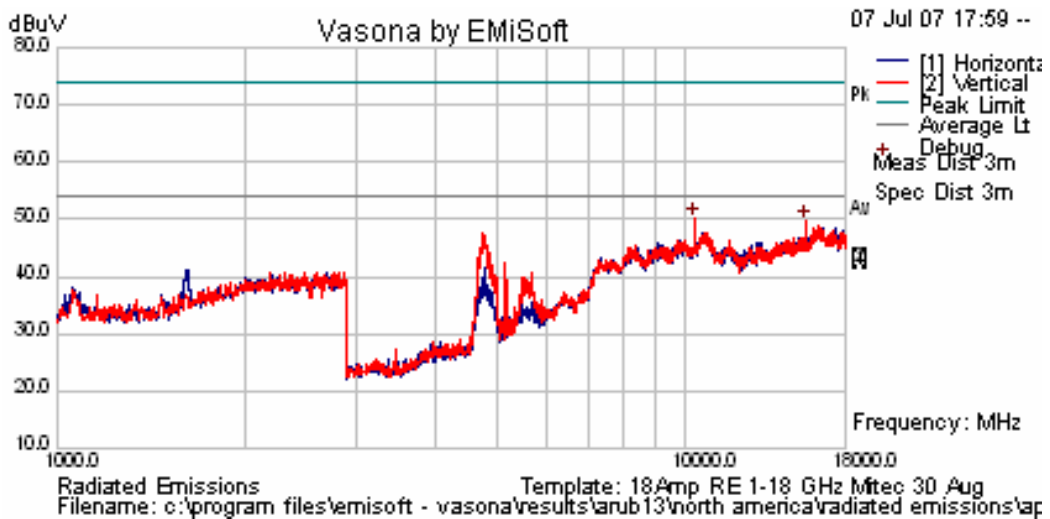

This test report may be reproduced in full only. The document may only be updated by MiCOM Labs personnel. Any changes will be noted in the Document History section of the report.



TABLE OF RESULTS – 802.11a 5,260 MHz Integral Antenna

PEAK

Freq. (MHz)	Pol. (H/V)	Raw Reading (dB μ V)	Correction Factor (dB)	Corrected Field Strength (dB μ V/m)	Peak Limit (dB μ V/m)	Margin (dB)
15791.67	V	56.18	+8.91	65.09	74	-8.91
10515.00	V	46.04	+6.13	52.17	74	-21.83

AVERAGE

Freq. (MHz)	Pol. (H/V)	Raw Reading (dB μ V)	Correction Factor (dB)	Corrected Field Strength (dB μ V/m)	Average Limit (dB μ V/m)	Margin (dB)
15791.67	V	39.07	+8.91	47.98	54	-6.02
10515.00	V	42.19	+6.13	48.32	54	-5.68

Radiated Emissions for 5,260 MHz

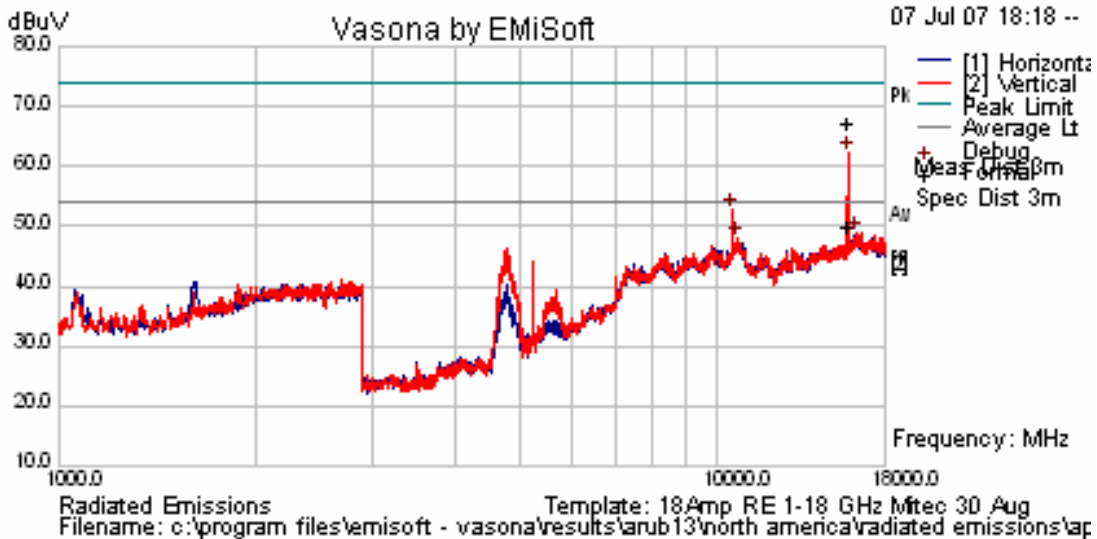

This test report may be reproduced in full only. The document may only be updated by MiCOM Labs personnel. Any changes will be noted in the Document History section of the report.



TABLE OF RESULTS – 802.11a 5,320 MHz Integral Antenna

PEAK

Freq. (MHz)	Pol. (H/V)	Raw Reading (dB μ V)	Correction Factor (dB)	Corrected Field Strength (dB μ V/m)	Peak Limit (dB μ V/m)	Margin (dB)
15960.832	V	56.53	+8.95	65.48	74	-8.52

AVERAGE

Freq. (MHz)	Pol. (H/V)	Raw Reading (dB μ V)	Correction Factor (dB)	Corrected Field Strength (dB μ V/m)	Average Limit (dB μ V/m)	Margin (dB)
15960.832	V	38.10	+8.95	47.05	54	-6.95

Radiated Emissions for 5,320 MHz

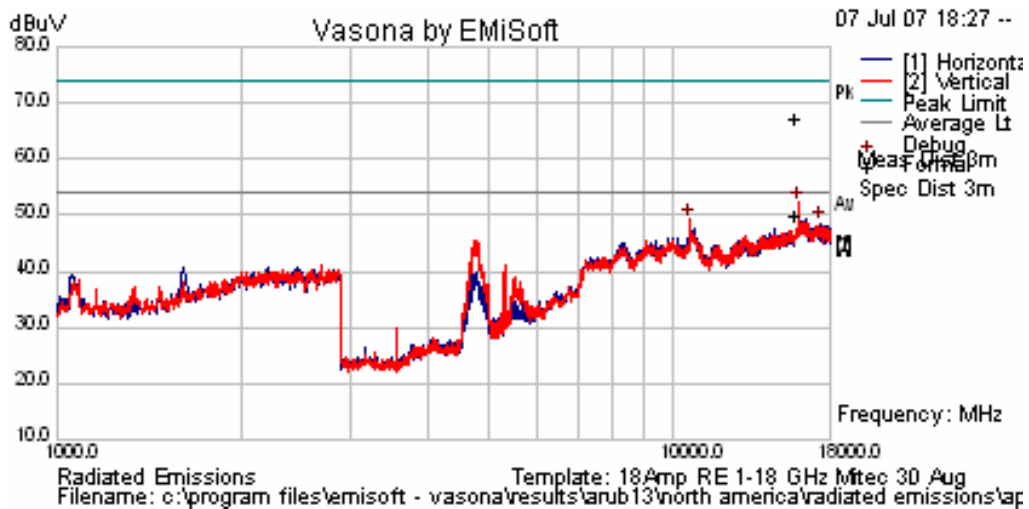

This test report may be reproduced in full only. The document may only be updated by MiCOM Labs personnel. Any changes will be noted in the Document History section of the report.

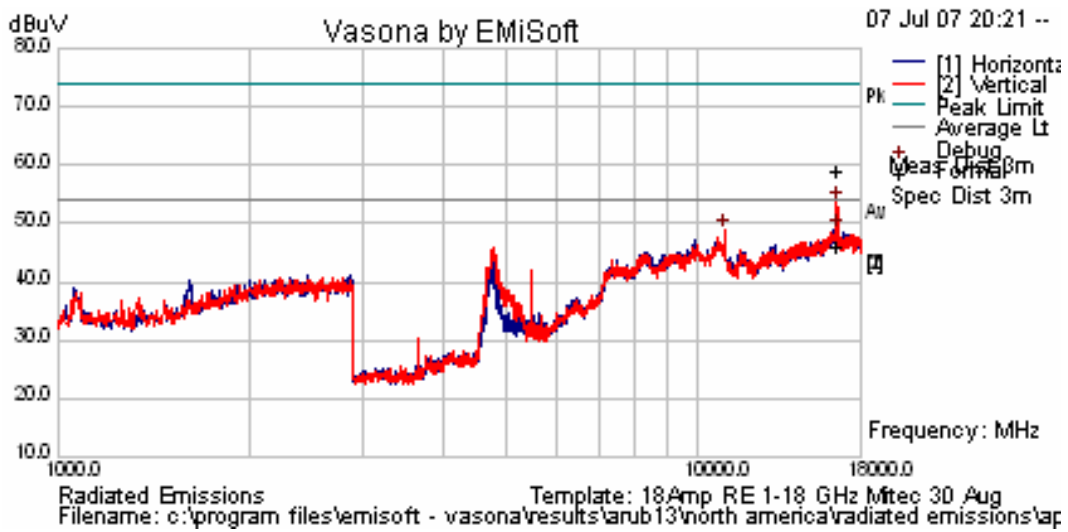

TABLE OF RESULTS – 802.11a 5,500 MHz Integral Antenna

Freq. (MHz)	Pol. (H/V)	Raw Reading (dB μ V)	Correction Factor (dB)	Corrected Field Strength (dB μ V/m)	Peak Limit (dB μ V/m)	Margin (dB)
16501.67	V	46.48	+10.35	56.83	74	-17.17

Freq. (MHz)	Pol. (H/V)	Raw Reading (dB μ V)	Correction Factor (dB)	Corrected Field Strength (dB μ V/m)	Average Limit (dB μ V/m)	Margin (dB)
16501.67	V	33.65	+10.35	44.00	54	-10.00

Radiated Emissions for 5,500 MHz



This test report may be reproduced in full only. The document may only be updated by MiCOM Labs personnel. Any changes will be noted in the Document History section of the report.



TABLE OF RESULTS – 802.11a 5,600 MHz Integral Antenna

Freq. (MHz)	Pol. (H/V)	Raw Reading (dB μ V)	Correction Factor (dB)	Corrected Field Strength (dB μ V/m)	Limit (dB μ V/m)	Margin (dB)
					74	
					74	

Freq. (MHz)	Pol. (H/V)	Raw Reading (dB μ V)	Correction Factor (dB)	Corrected Field Strength (dB μ V/m)	Limit (dB μ V/m)	Margin (dB)
					54	
					54	

No peak emissions were found to break the average limit line (54 dB μ V/m). No additional investigation was required.

Radiated Emissions for 5,600 MHz

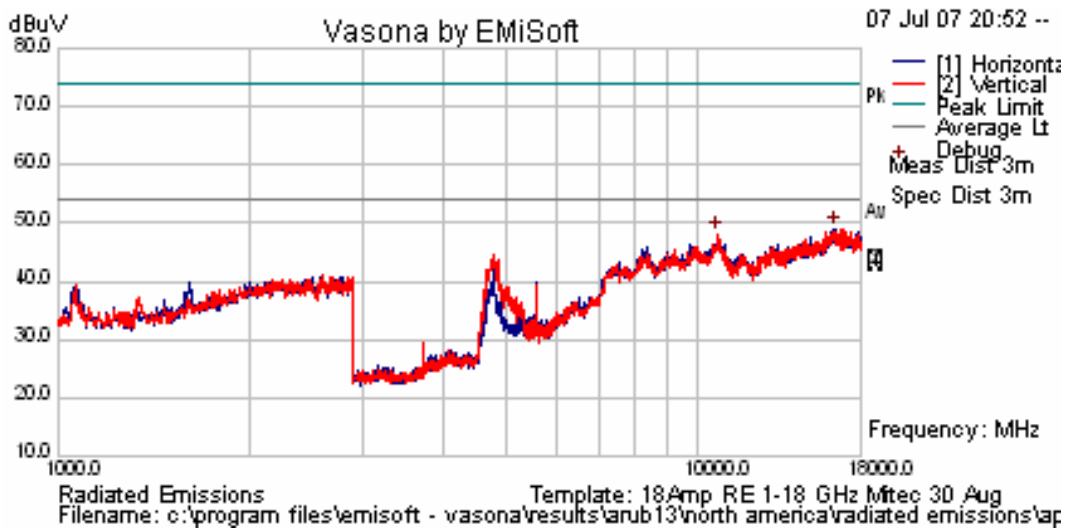

This test report may be reproduced in full only. The document may only be updated by MiCOM Labs personnel. Any changes will be noted in the Document History section of the report.



TABLE OF RESULTS – 802.11a 5,700 MHz Integral Antenna

Freq. (MHz)	Pol. (H/V)	Raw Reading (dB μ V)	Correction Factor (dB)	Corrected Field Strength (dB μ V/m)	Peak Limit (dB μ V/m)	Margin (dB)
					54	
					54	

Freq. (MHz)	Pol. (H/V)	Raw Reading (dB μ V)	Correction Factor (dB)	Corrected Field Strength (dB μ V/m)	Average Limit (dB μ V/m)	Margin (dB)
					54	
					54	

No peak emissions were found to break the average limit line (54 dB μ V/m). No additional investigation was required.

Radiated Emissions for 5,700 MHz

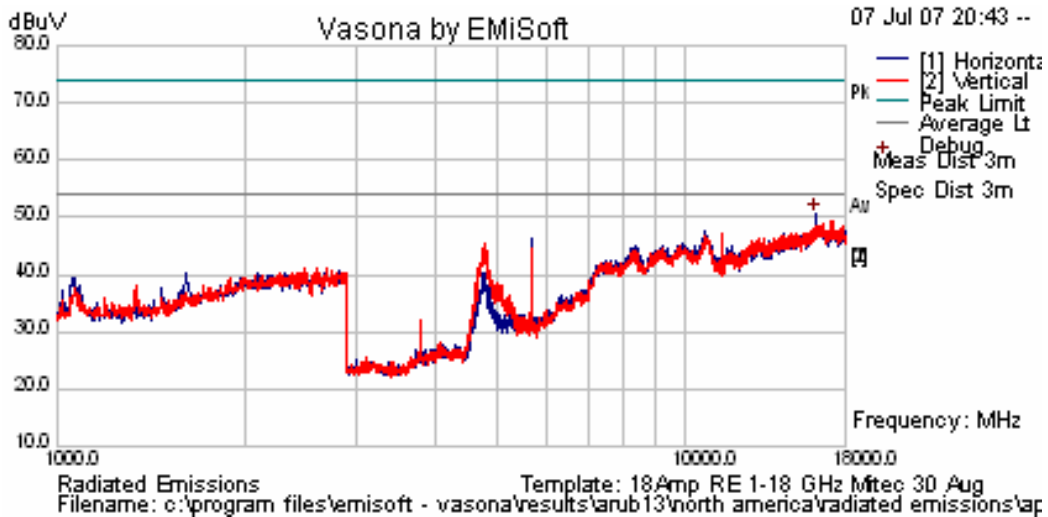

This test report may be reproduced in full only. The document may only be updated by MiCOM Labs personnel. Any changes will be noted in the Document History section of the report.



TABLE OF RESULTS – 802.11a 5,180 MHz ANT-10, 6 dBi Antenna

Freq. (MHz)	Pol. (H/V)	Raw Reading (dB μ V)	Correction Factor (dB)	Corrected Field Strength (dB μ V/m)	Peak Limit (dB μ V/m)	Margin (dB)
					74	
					74	
					74	

Freq. (MHz)	Pol. (H/V)	Raw Reading (dB μ V)	Correction Factor (dB)	Corrected Field Strength (dB μ V/m)	Average Limit (dB μ V/m)	Margin (dB)
					54	
					54	
					54	

No peak emissions were found to break the average limit line (54 dB μ V/m). No additional investigation was required.

Radiated Emissions for 5,180 MHz

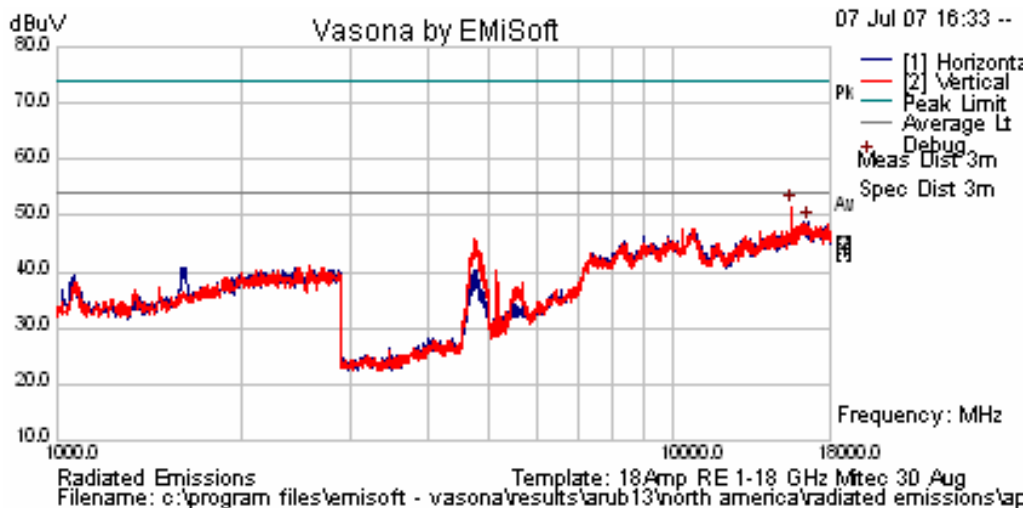

This test report may be reproduced in full only. The document may only be updated by MiCOM Labs personnel. Any changes will be noted in the Document History section of the report.

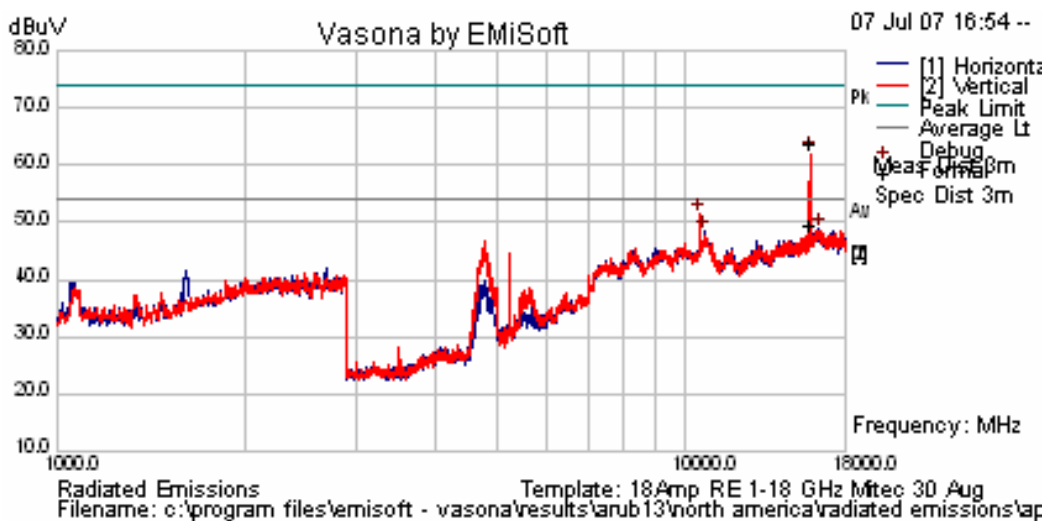

TABLE OF RESULTS – 802.11a 5,260 MHz ANT-10, 6 dBi Antenna

Freq. (MHz)	Pol. (H/V)	Raw Reading (dB μ V)	Correction Factor (dB)	Corrected Field Strength (dB μ V/m)	Peak Limit (dB μ V/m)	Margin (dB)
15782.42	V	53.04	+8.86	61.9	74	-12.1

Freq. (MHz)	Pol. (H/V)	Raw Reading (dB μ V)	Correction Factor (dB)	Corrected Field Strength (dB μ V/m)	Average Limit (dB μ V/m)	Margin (dB)
15782.42	V	38.69	+8.86	47.55	54	-6.45

Radiated Emissions for 5,260 MHz



This test report may be reproduced in full only. The document may only be updated by MiCOM Labs personnel. Any changes will be noted in the Document History section of the report.

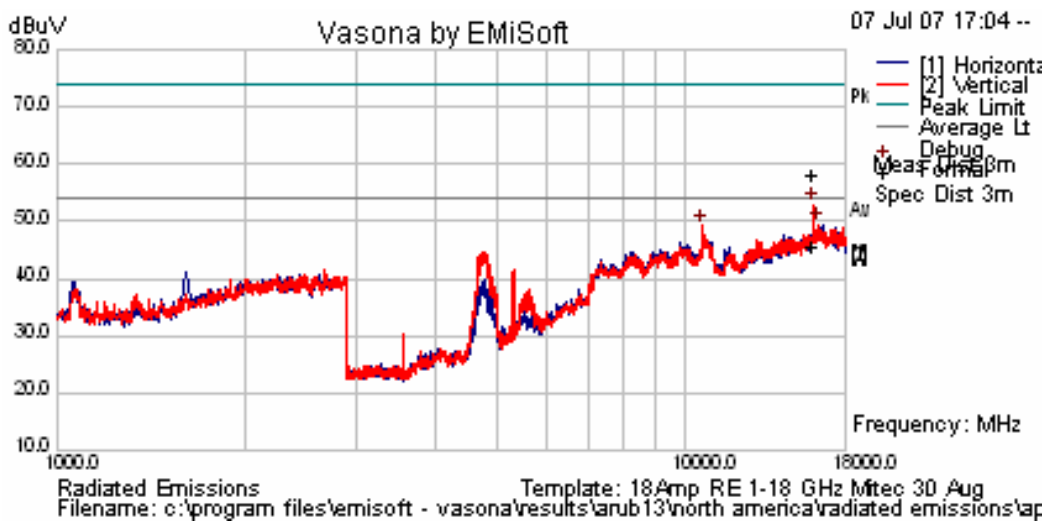

TABLE OF RESULTS – 802.11a 5,320 MHz ANT-10, 6 dBi Antenna

Freq. (MHz)	Pol. (H/V)	Raw Reading (dB μ V)	Correction Factor (dB)	Corrected Field Strength (dB μ V/m)	Peak Limit (dB μ V/m)	Margin (dB)
15974.11	V	46.69	+9.62	56.31	74	-17.69

Freq. (MHz)	Pol. (H/V)	Raw Reading (dB μ V)	Correction Factor (dB)	Corrected Field Strength (dB μ V/m)	Average Limit (dB μ V/m)	Margin (dB)
15974.11	V	33.85	+9.62	43.47	54	-10.53

Radiated Emissions for 5,320 MHz



This test report may be reproduced in full only. The document may only be updated by MiCOM Labs personnel. Any changes will be noted in the Document History section of the report.



TABLE OF RESULTS – 802.11a 5,500 MHz ANT-10, 6 dBi Antenna

Freq. (MHz)	Pol. (H/V)	Raw Reading (dB μ V)	Correction Factor (dB)	Corrected Field Strength (dB μ V/m)	Peak Limit (dB μ V/m)	Margin (dB)
					74	
					74	

Freq. (MHz)	Pol. (H/V)	Raw Reading (dB μ V)	Correction Factor (dB)	Corrected Field Strength (dB μ V/m)	Average Limit (dB μ V/m)	Margin (dB)
					54	
					54	

No peak emissions were found to break the average limit line (54 dB μ V/m). No additional investigation was required.

Radiated Emissions for 5,500 MHz

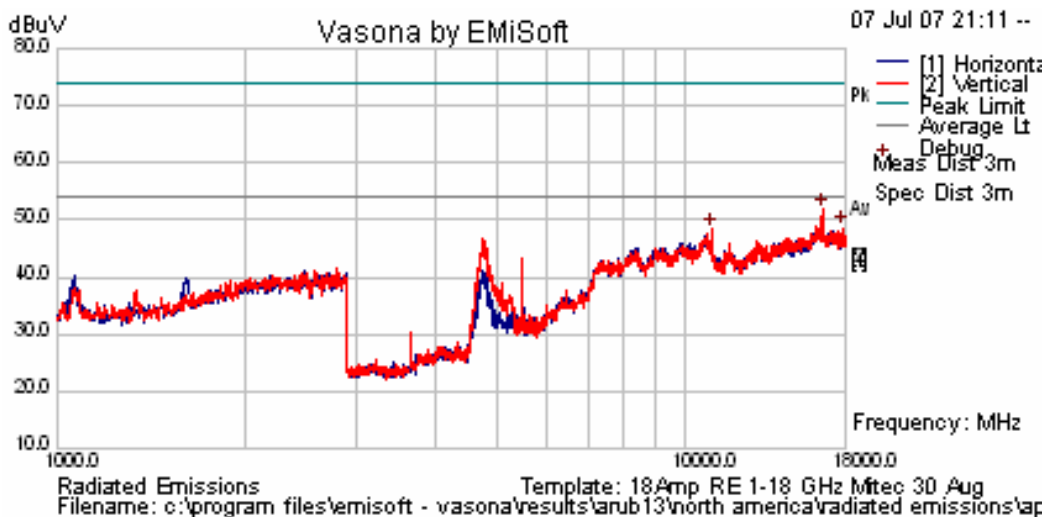

This test report may be reproduced in full only. The document may only be updated by MiCOM Labs personnel. Any changes will be noted in the Document History section of the report.



TABLE OF RESULTS – 802.11a 5,600 MHz ANT-10, 6 dBi Antenna

Freq. (MHz)	Pol. (H/V)	Raw Reading (dB μ V)	Correction Factor (dB)	Corrected Field Strength (dB μ V/m)	Limit (dB μ V/m)	Margin (dB)
					74	
					74	

Freq. (MHz)	Pol. (H/V)	Raw Reading (dB μ V)	Correction Factor (dB)	Corrected Field Strength (dB μ V/m)	Limit (dB μ V/m)	Margin (dB)
					54	
					54	

No peak emissions were found to break the average limit line (54 dB μ V/m). No additional investigation was required.

Radiated Emissions for 5,600 MHz

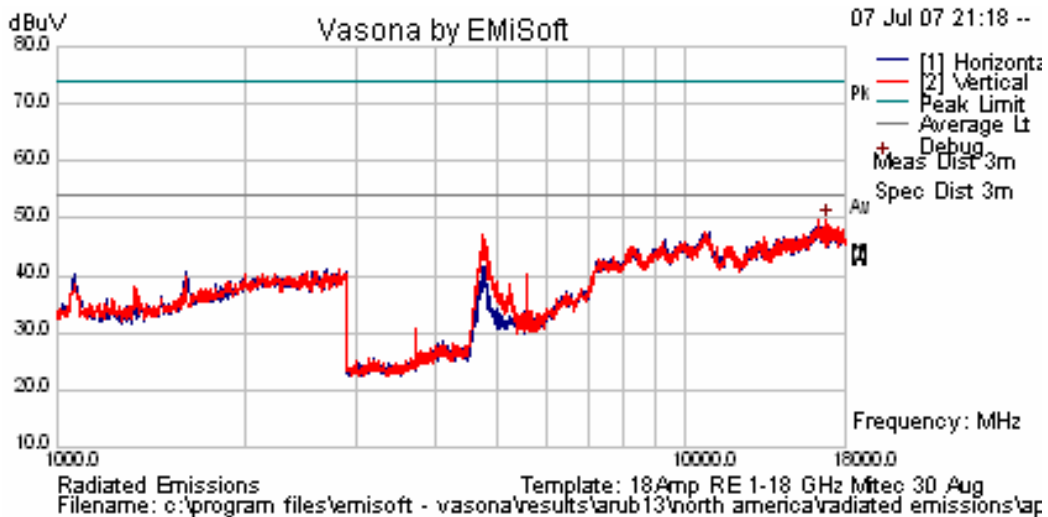

This test report may be reproduced in full only. The document may only be updated by MiCOM Labs personnel. Any changes will be noted in the Document History section of the report.



TABLE OF RESULTS – 802.11a 5,700 MHz ANT-10, 6 dBi Antenna

Freq. (MHz)	Pol. (H/V)	Raw Reading (dB μ V)	Correction Factor (dB)	Corrected Field Strength (dB μ V/m)	Peak Limit (dB μ V/m)	Margin (dB)
					74	
					74	

Freq. (MHz)	Pol. (H/V)	Raw Reading (dB μ V)	Correction Factor (dB)	Corrected Field Strength (dB μ V/m)	Average Limit (dB μ V/m)	Margin (dB)
					54	
					54	

No peak emissions were found to break the average limit line (54 dB μ V/m). No additional investigation was required.

Radiated Emissions for 5,700 MHz

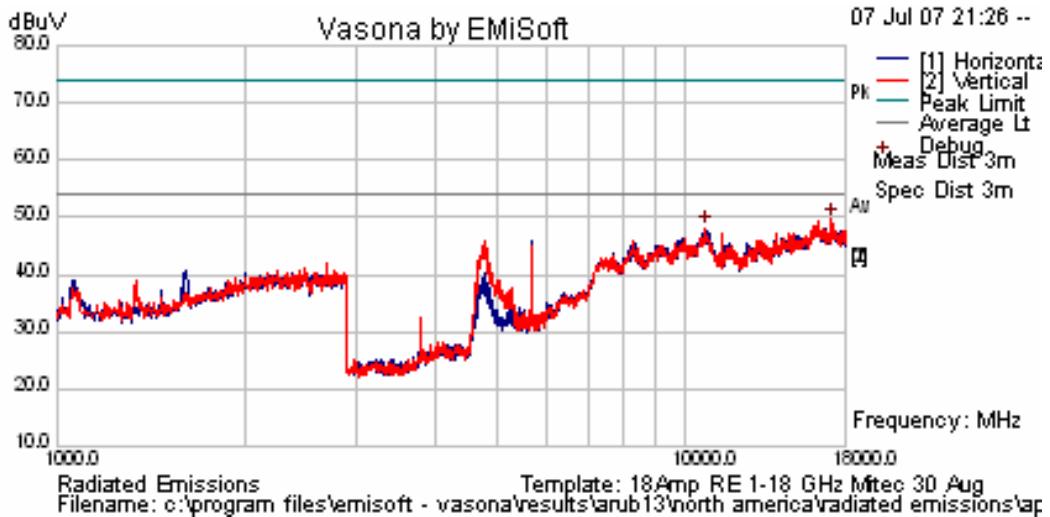

This test report may be reproduced in full only. The document may only be updated by MiCOM Labs personnel. Any changes will be noted in the Document History section of the report.



Measurement Results Transmitter Radiated Spurious Emissions above 1 GHz

Ambient conditions.

Temperature: 17 to 23°C Relative humidity: 31 to 57 % Pressure: 999 to 1012 mbar

TABLE OF RESULTS – 802.11a 5,180 MHz ANT-12, 14 dBi Antenna

Freq. (MHz)	Pol. (H/V)	Raw Reading (dBμV)	Correction Factor (dB)	Corrected Field Strength (dBμV/m)	Peak Limit (dBμV/m)	Margin (dB)
					74	

Freq. (MHz)	Pol. (H/V)	Raw Reading (dBμV)	Correction Factor (dB)	Corrected Field Strength (dBμV/m)	Average Limit (dBμV/m)	Margin (dB)
					54	

No peak emissions were found to break the average limit line (54 dBμV/m). No additional investigation was required.

Radiated Emissions for 5,180 MHz

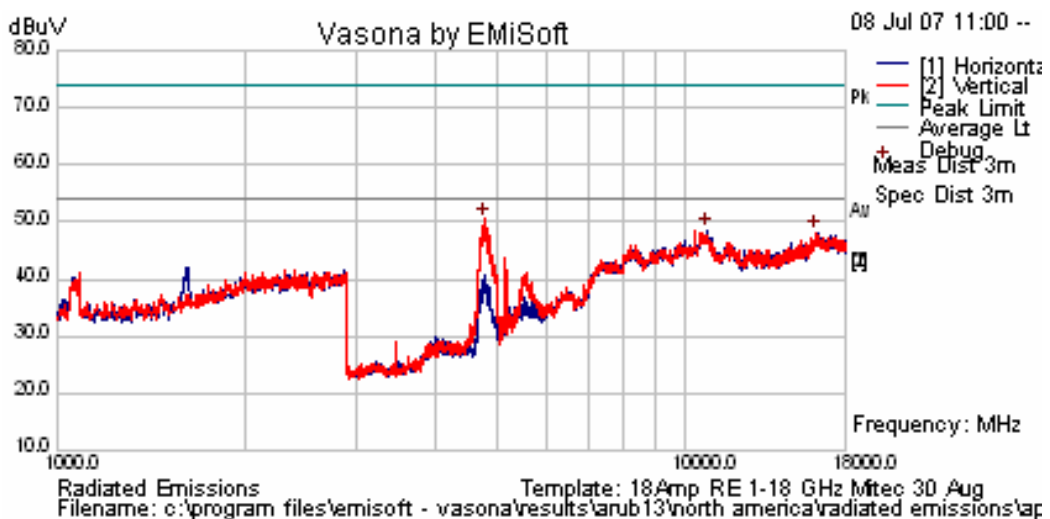

This test report may be reproduced in full only. The document may only be updated by MiCOM Labs personnel. Any changes will be noted in the Document History section of the report.

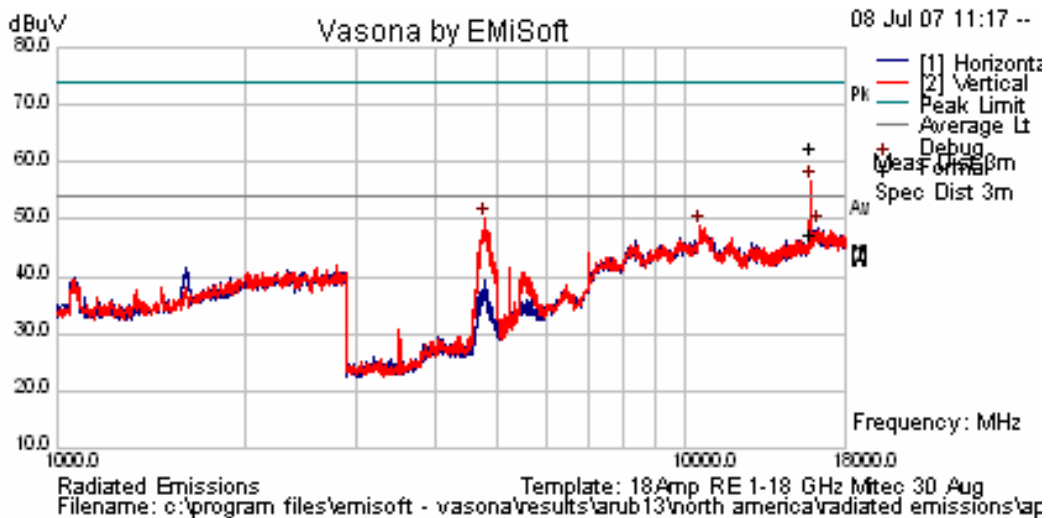

TABLE OF RESULTS – 802.11a 5,260 MHz ANT-12, 14 dBi Antenna

Freq. (MHz)	Pol. (H/V)	Raw Reading (dBμV)	Correction Factor (dB)	Corrected Field Strength (dBμV/m)	Peak Limit (dBμV/m)	Margin (dB)
15783.2	V	51.68	+8.87	60.55	74	-13.45

Freq. (MHz)	Pol. (H/V)	Raw Reading (dBμV)	Correction Factor (dB)	Corrected Field Strength (dBμV/m)	Average Limit (dBμV/m)	Margin (dB)
15783.2	V	36.27	+8.87	45.14	54	-8.86

Radiated Emissions for 5,260 MHz



This test report may be reproduced in full only. The document may only be updated by MiCOM Labs personnel. Any changes will be noted in the Document History section of the report.



TABLE OF RESULTS – 802.11a 5,320 MHz ANT-12, 14 dBi Antenna

Freq. (MHz)	Pol. (H/V)	Raw Reading (dB μ V)	Correction Factor (dB)	Corrected Field Strength (dB μ V/m)	Peak Limit (dB μ V/m)	Margin (dB)
					74	
					74	

Freq. (MHz)	Pol. (H/V)	Raw Reading (dB μ V)	Correction Factor (dB)	Corrected Field Strength (dB μ V/m)	Average Limit (dB μ V/m)	Margin (dB)
					54	
					54	

No peak emissions were found to break the average limit line (54 dB μ V/m). No additional investigation was required.

Radiated Emissions for 5,320 MHz

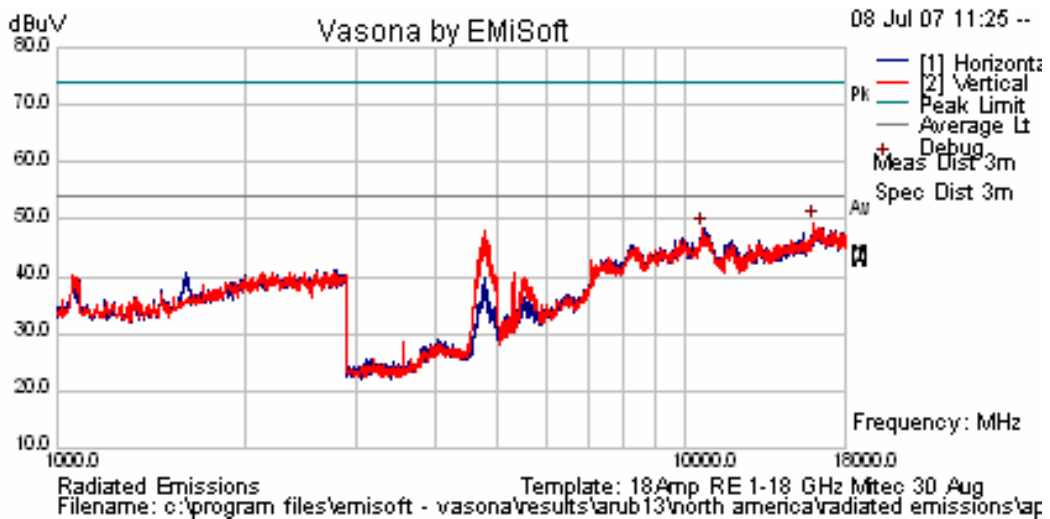

This test report may be reproduced in full only. The document may only be updated by MiCOM Labs personnel. Any changes will be noted in the Document History section of the report.



TABLE OF RESULTS – 802.11a 5,500 MHz ANT-12, 14 dBi Antenna

Freq. (MHz)	Pol. (H/V)	Raw Reading (dB μ V)	Correction Factor (dB)	Corrected Field Strength (dB μ V/m)	Peak Limit (dB μ V/m)	Margin (dB)
					74	
					74	

Freq. (MHz)	Pol. (H/V)	Raw Reading (dB μ V)	Correction Factor (dB)	Corrected Field Strength (dB μ V/m)	Average Limit (dB μ V/m)	Margin (dB)
					54	
					54	

No peak emissions were found to break the average limit line (54 dB μ V/m). No additional investigation was required.

Radiated Emissions for 5,500 MHz

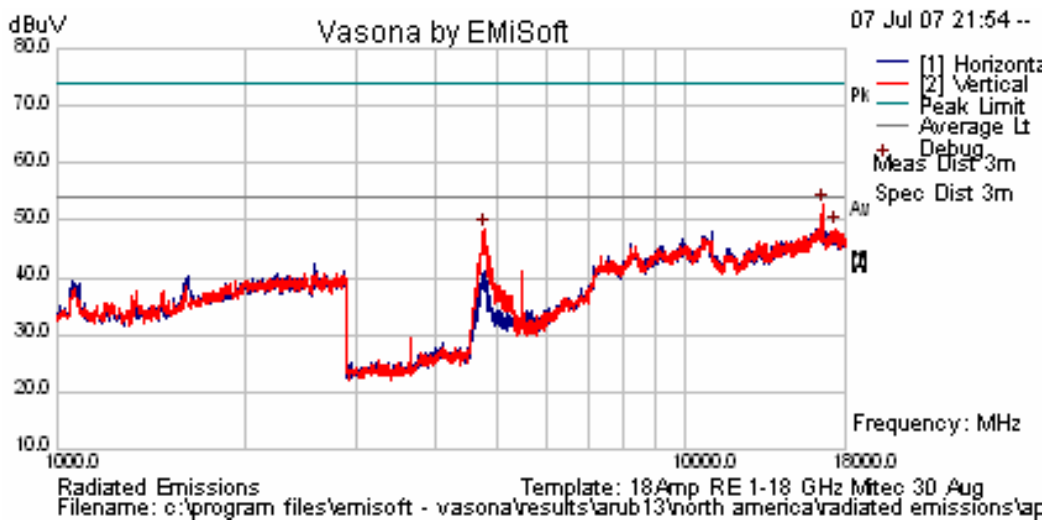

This test report may be reproduced in full only. The document may only be updated by MiCOM Labs personnel. Any changes will be noted in the Document History section of the report.



TABLE OF RESULTS – 802.11a 5,600 MHz ANT-12, 14 dBi Antenna

Freq. (MHz)	Pol. (H/V)	Raw Reading (dB μ V)	Correction Factor (dB)	Corrected Field Strength (dB μ V/m)	Limit (dB μ V/m)	Margin (dB)
					74	
					74	

Freq. (MHz)	Pol. (H/V)	Raw Reading (dB μ V)	Correction Factor (dB)	Corrected Field Strength (dB μ V/m)	Limit (dB μ V/m)	Margin (dB)
					54	
					54	

No peak emissions were found to break the average limit line (54 dB μ V/m). No additional investigation was required.

Radiated Emissions for 5,600 MHz

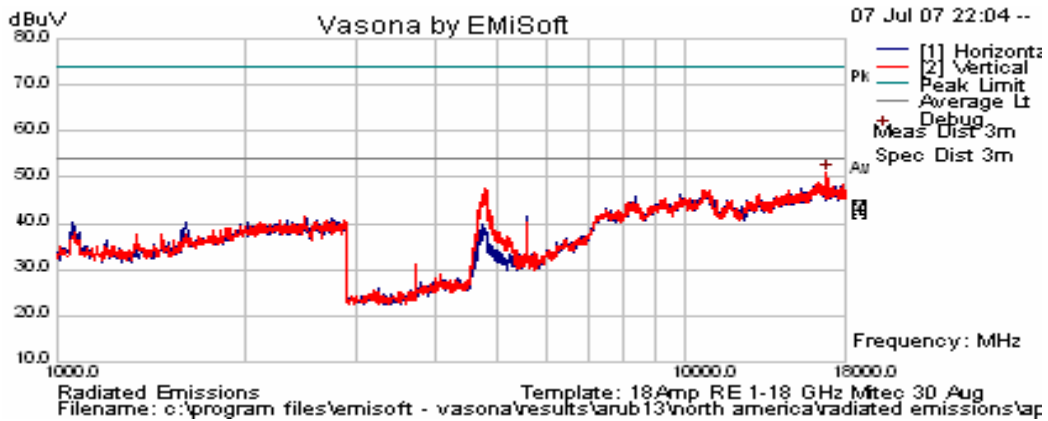

This test report may be reproduced in full only. The document may only be updated by MiCOM Labs personnel. Any changes will be noted in the Document History section of the report.



TABLE OF RESULTS – 802.11a 5,700 MHz ANT-12, 14 dBi Antenna

Freq. (MHz)	Pol. (H/V)	Raw Reading (dB μ V)	Correction Factor (dB)	Corrected Field Strength (dB μ V/m)	Peak Limit (dB μ V/m)	Margin (dB)
					54	
					54	

Freq. (MHz)	Pol. (H/V)	Raw Reading (dB μ V)	Correction Factor (dB)	Corrected Field Strength (dB μ V/m)	Average Limit (dB μ V/m)	Margin (dB)
					54	
					54	

No peak emissions were found to break the average limit line (54 dB μ V/m). No additional investigation was required.

Radiated Emissions for 5,700 MHz

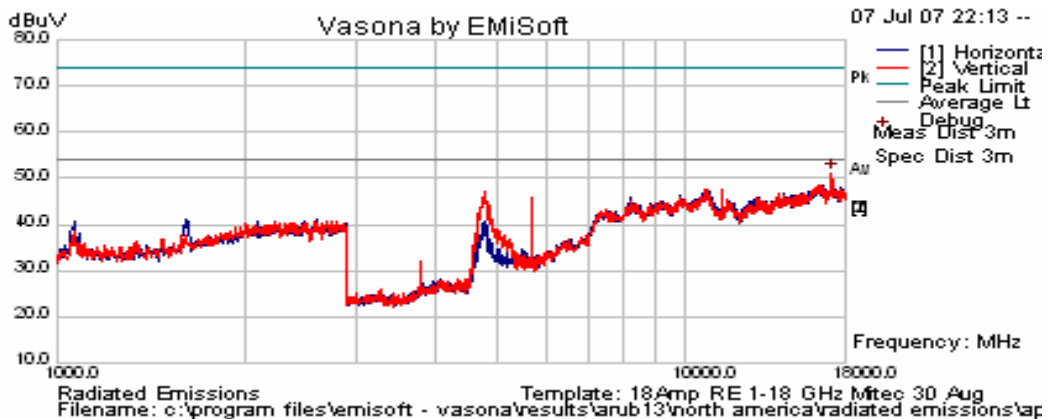

This test report may be reproduced in full only. The document may only be updated by MiCOM Labs personnel. Any changes will be noted in the Document History section of the report.



5.1.7.2. Radiated Band-Edge – Restricted Bands

Lower sub-band 5,150 MHz to 5,350 MHz

TABLE OF RESULTS - 802.11a - Integral Antenna

Tx Freq. (MHz)	Restricted Band Frequency (MHz)	Measured (dBuV/m)	Limit (dBuV/m)	Margin (dB)
5,180 _{PEAK}	5,150	62.94	74.00	-11.06
5,180 _{Ave}	5,150	49.70	54.00	-4.30

802.11a – 5,180 MHz

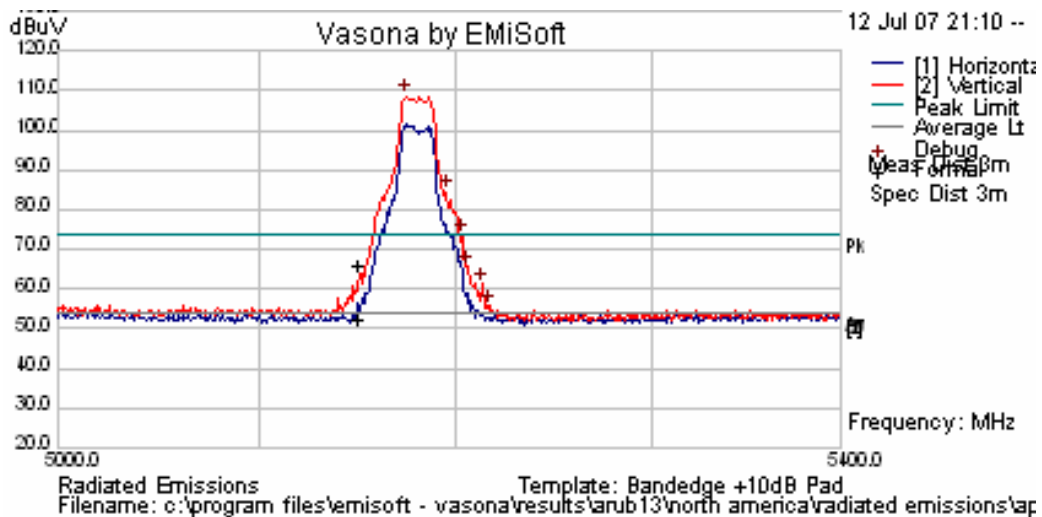

This test report may be reproduced in full only. The document may only be updated by MiCOM Labs personnel. Any changes will be noted in the Document History section of the report.



TABLE OF RESULTS - 802.11a - Integral Antenna

Tx Freq. (MHz)	Restricted Band Frequency (MHz)	Measured (dBuV/m)	Limit (dBuV/m)	Margin (dB)
5,320 _{PEAK}	5,350	62.96	74.00	-11.04
5,320 _{AVE}	5,350	49.76	54.00	-4.24

802.11a – 5,320 MHz

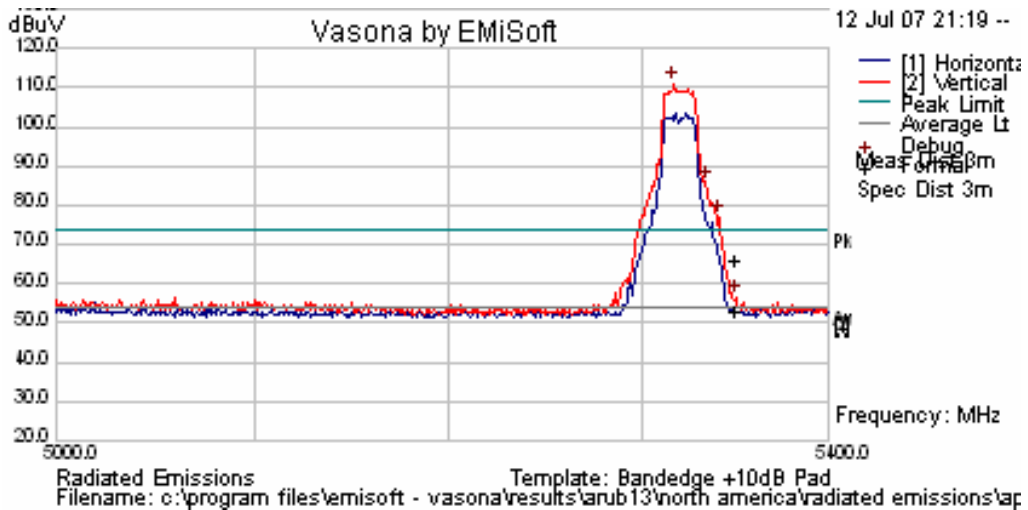

This test report may be reproduced in full only. The document may only be updated by MiCOM Labs personnel. Any changes will be noted in the Document History section of the report.



Lower sub-band 5,470 MHz to 5,725 MHz

TABLE OF RESULTS - 802.11a - Integral Antenna

Tx Freq. (MHz)	Restricted Band Frequency (MHz)	Measured (dBuV/m)	Limit (dBuV/m)	Margin (dB)
5,500 _{PEAK}	5,460	63.18	74.00	-10.82
5,500 _{AVE}	5,460	50.27	54.00	-3.73

802.11a – 5,500 MHz

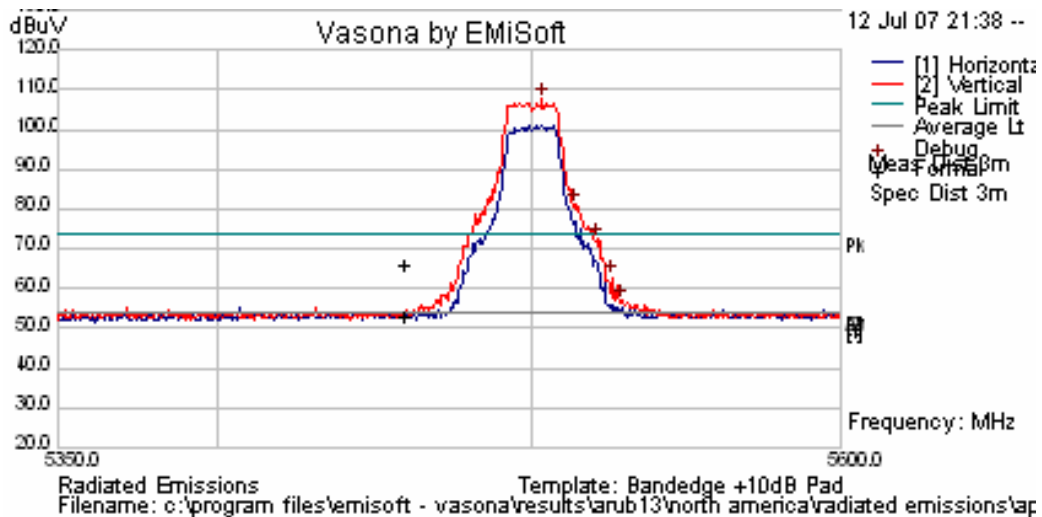

Note; No band edge measurements are required at the upper end of the 5,470 – 5,725 band.



Lower sub-band 5,150 MHz to 5,350 MHz

TABLE OF RESULTS - 802.11a - ANT-10, 6 dBi Antenna

Tx Freq. (MHz)	Restricted Band Frequency (MHz)	Measured (dBuV/m)	Limit (dBuV/m)	Margin (dB)
5,180 _{PEAK}	5,150	64.63	74.00	-9.37
5,180 _{Ave}	5,150	49.80	54.00	-4.20

802.11a – 5,180 MHz

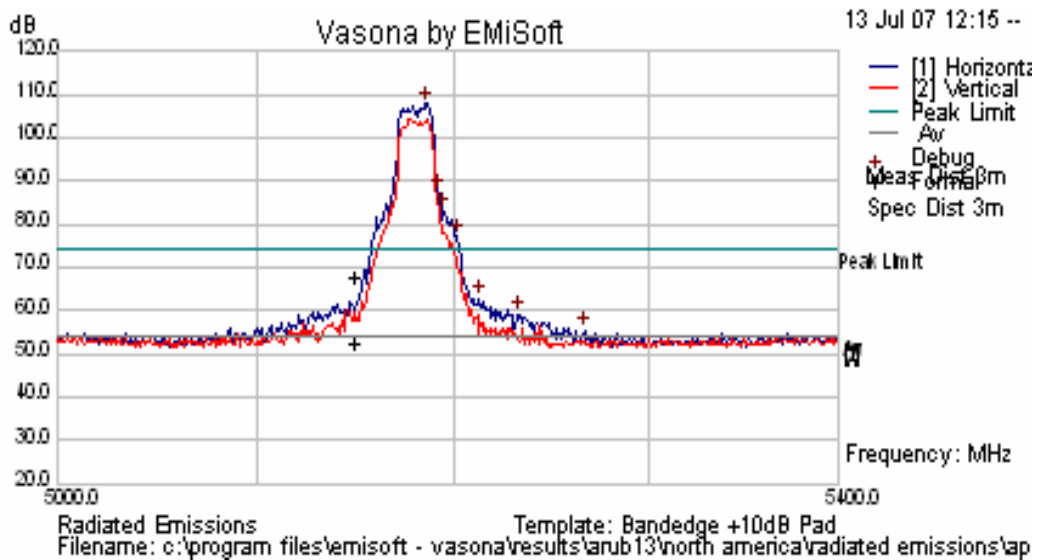

This test report may be reproduced in full only. The document may only be updated by MiCOM Labs personnel. Any changes will be noted in the Document History section of the report.



TABLE OF RESULTS - 802.11a - ANT-10, 6 dBi Antenna

Tx Freq. (MHz)	Restricted Band Frequency (MHz)	Measured (dBuV/m)	Limit (dBuV/m)	Margin (dB)
5,320 _{PEAK}	5,350	62.83	74.00	-11.17
5,320 _{AVE}	5,350	49.66	54.00	-4.34

802.11a – 5,320 MHz

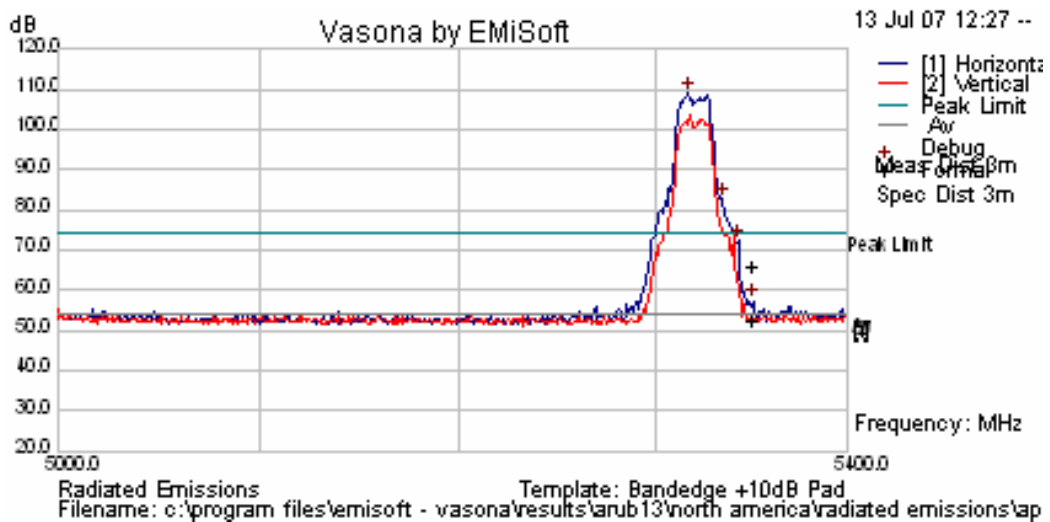

This test report may be reproduced in full only. The document may only be updated by MiCOM Labs personnel. Any changes will be noted in the Document History section of the report.



Lower sub-band 5,470 MHz to 5,725 MHz

TABLE OF RESULTS - 802.11a - ANT-10, 6 dBi Antenna

Tx Freq. (MHz)	Restricted Band Frequency (MHz)	Measured (dBuV/m)	Limit (dBuV/m)	Margin (dB)
5,500 _{PEAK}	5,460	63.59	74.00	-10.41
5,500 _{Ave}	5,460	50.33	54.00	-3.67

802.11a – 5,500 MHz

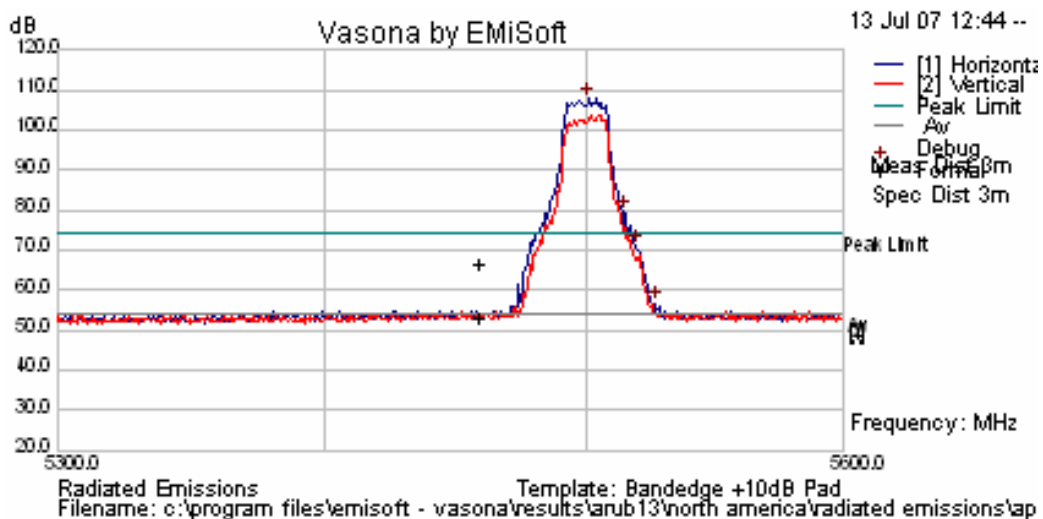

Note; No band edge measurements are required at the upper end of the 5,470 – 5,725 band.

This test report may be reproduced in full only. The document may only be updated by MiCOM Labs personnel. Any changes will be noted in the Document History section of the report.



Lower sub-band 5,150 MHz to 5,350 MHz

TABLE OF RESULTS - 802.11a - ANT-12, 14 dBi Antenna

Tx Freq. (MHz)	Restricted Band Frequency (MHz)	Measured (dBuV/m)	Limit (dBuV/m)	Margin (dB)
5,180 _{PEAK}	5,150	63.63	74.00	-10.37
5,180 _{Ave}	5,150	49.75	54.00	-4.25

802.11a – 5,180 MHz

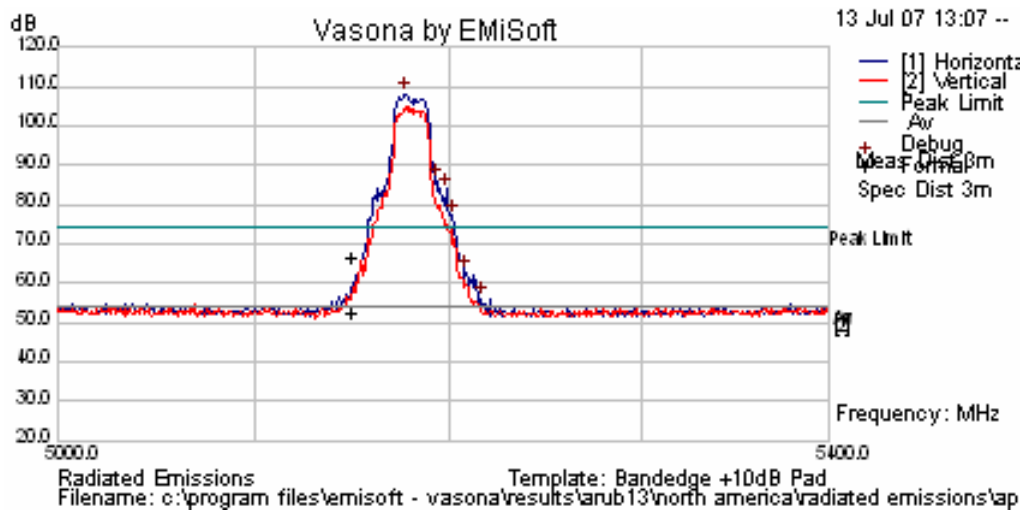

This test report may be reproduced in full only. The document may only be updated by MiCOM Labs personnel. Any changes will be noted in the Document History section of the report.



TABLE OF RESULTS - 802.11a - ANT-12, 14 dBi Antenna

Tx Freq. (MHz)	Restricted Band Frequency (MHz)	Measured (dBuV/m)	Limit (dBuV/m)	Margin (dB)
5,320 _{PEAK}	5,350	63.51	74.00	-10.49
5,320 _{AVE}	5,350	49.64	54.00	-4.36

802.11a – 5,320 MHz

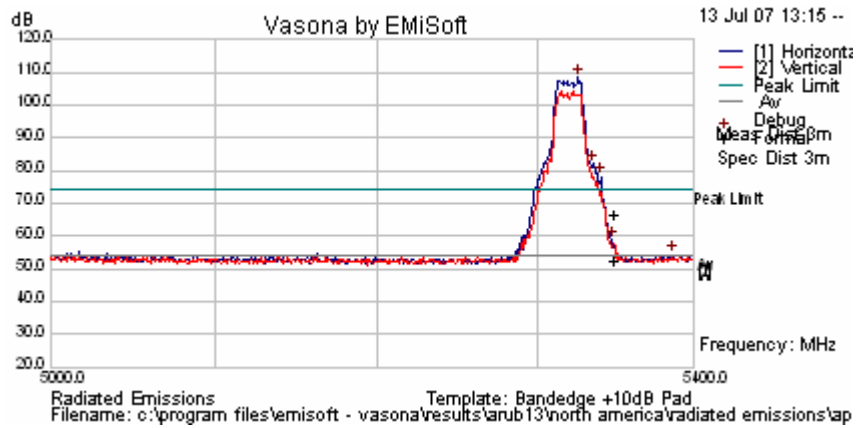

This test report may be reproduced in full only. The document may only be updated by MiCOM Labs personnel. Any changes will be noted in the Document History section of the report.



Lower sub-band 5,470 MHz to 5,725 MHz

TABLE OF RESULTS - 802.11a - ANT-12, 14 dBi Antenna

Tx Freq. (MHz)	Restricted Band Frequency (MHz)	Measured (dBuV/m)	Limit (dBuV/m)	Margin (dB)
5,500 _{PEAK}	5,460	63.32	74.00	-10.68
5,500 _{Ave}	5,460	50.34	54.00	-3.66

802.11a – 5,500 MHz

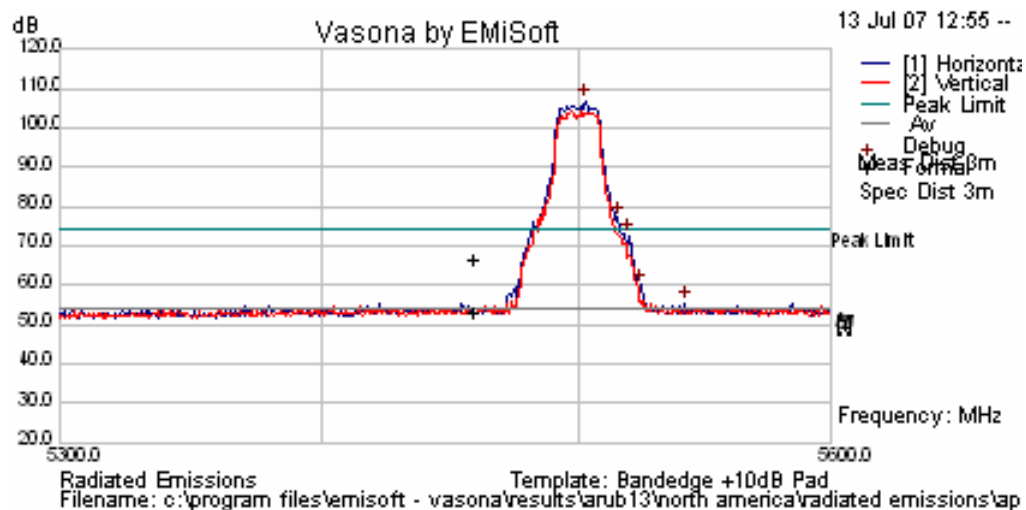

Note; No band edge measurements are required at the upper end of the 5,470 – 5,725 band.

This test report may be reproduced in full only. The document may only be updated by MiCOM Labs personnel. Any changes will be noted in the Document History section of the report.



Specification

Limits

15.407 (b)(2). All emissions outside of the 5,150-5,350MHz band shall not exceed an EIRP of -27dBm/MHz.

§15.205 (a) Except as shown in paragraph (d) of 15.205 (a), only spurious emissions are permitted in any of the frequency bands listed.

§15.205 (a) Except as shown in paragraphs (d) and (e) of this section, the field strength of emissions appearing within these frequency bands shall not exceed the limits shown in Section §15.209. At frequencies equal to or less than 1000 MHz, compliance with the limits in Section 15.209 shall be demonstrated using measurement instrumentation employing a CISPR quasi-peak detector. Above 1000 MHz, compliance with the emission limits in Section 15.209 shall be demonstrated based on the average value of the measured emissions. The provisions in Section 15.35 apply to these measurements.

§15.209 (a) Except as provided elsewhere in this subpart, the emissions from an intentional radiator shall not exceed the field strength levels specified in the following table.

§15.209 (a) Limit Matrix

Frequency(MHz)	Field Strength ($\mu\text{V}/\text{m}$)	Field Strength ($\text{dB}\mu\text{V}/\text{m}$)	Measurement Distance (meters)
30-88	100	40.0	3
88-216	150	43.5	3
216-960	200	46.0	3
Above 960	500	54.0	3



Title: Aruba AP-70 802.11 a/b/g Wireless AP
To: FCC 47 CFR Part 15.407
Serial #: ARUB13-A4 Rev A
Issue Date: 20th July 2007
Page: 81 of 130

Laboratory Measurement Uncertainty for Radiated Emissions

Measurement uncertainty	+5.6/ -4.5 dB
-------------------------	---------------

Traceability

Method	Test Equipment Used
Measurements were made per work instruction WI-03 'Measurement of Radiated Emissions'	0088, 0158, 0134, 0304, 0311, 0315, 0310, 0312

This test report may be reproduced in full only. The document may only be updated by MiCOM Labs personnel. Any changes will be noted in the Document History section of the report.

5.1.7.3. Radiated Spurious Emissions (30M-1 GHz)

FCC, Part 15 Subpart C §15.407(b)(6); §15.205(a); §15.209(a)

Test Procedure

Preliminary radiated emissions are measured in the anechoic chamber at a 10-meter distance on every azimuth in both horizontal and vertical polarity. The emissions are recorded with a spectrum analyzer in peak hold mode. Emissions closest to the limits are measured in the quasi-peak mode with the tuned receiver using a bandwidth of 120 kHz. Only the highest emissions relative to the limit are listed. The anechoic chamber test set-up is identified in Section 6 Test Set-Up Photographs.

The EUT had two methods of powering on ac/dc converter and Power over Ethernet, Both modes were tested.

Test Measurement Set up

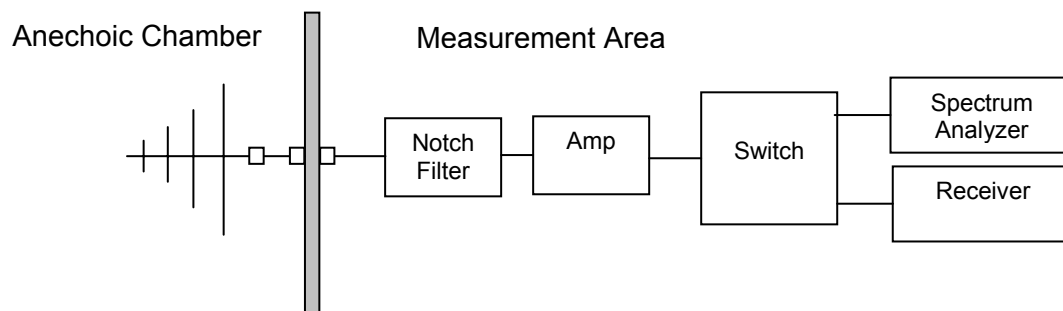

Field Strength Calculation

The field strength is calculated by adding the Antenna Factor and Cable Loss, and subtracting Amplifier Gain from the measured reading. In this test facility, the Antenna Factor, Cable Loss, and Amplifier Gains are loaded into the Rohde & Schwarz Receiver and the corrected field strength can be read directly on the receiver.

$$FS = R + AF + CORR$$

where:

FS = Field Strength

R = Measured Receiver Input Amplitude

AF = Antenna Factor

CORR = Correction Factor = CL – AG + NFL

CL = Cable Loss

AG = Amplifier Gain



Title: Aruba AP-70 802.11 a/b/g Wireless AP
To: FCC 47 CFR Part 15.407
Serial #: ARUB13-A4 Rev A
Issue Date: 20th July 2007
Page: 83 of 130

For example:

Given a Receiver input reading of 51.5dB μ V; Antenna Factor of 8.5dB; Cable Loss of 1.3dB; Falloff Factor of 0dB, an Amplifier Gain of 26dB and Notch Filter Loss of 1dB. The Field Strength of the measured emission is:

$$FS = 51.5 + 8.5 + 1.3 - 26.0 + 1 = 36.3\text{dB}\mu\text{V/m}$$

Conversion between dB μ V/m (or dB μ V) and μ V/m (or μ V) are done as:

$$\text{Level (dB}\mu\text{V/m)} = 20 * \text{Log (level (\mu\text{V/m}))}$$

$$40 \text{ dB}\mu\text{V/m} = 100\mu\text{V/m}$$

$$48 \text{ dB}\mu\text{V/m} = 250\mu\text{V/m}$$

Measurement Results for Spurious Emissions (30 MHz – 1 GHz)

Ambient conditions.

Temperature: 17 to 23 °C Relative humidity: 31 to 57 % Pressure: 999 to 1012 mbar

EUT parameters.

Transmitter operation: 802.11b

Data Rate(s): 1 Mb/s

Frequency: 2437 MHz

Power Level: Maximum

This test report may be reproduced in full only. The document may only be updated by MiCOM Labs personnel. Any changes will be noted in the Document History section of the report.



TABLE OF RESULTS

Test Configuration - POE Converter, External Antennas Connected

Freq. (MHz)	Peak (dBuV/m)	QP (dBuV/m)	QP Lmt (dBuV/m)	QP Margin (dB)	Angle (deg)	Height (cm)	Polarity
43.502	40.95	34.39	40	-5.61	216	114	V
53.859	40.88	34.93	40	-5.07	179	110	V
500.027	36.32	38.36	46	-7.64	140	107	V

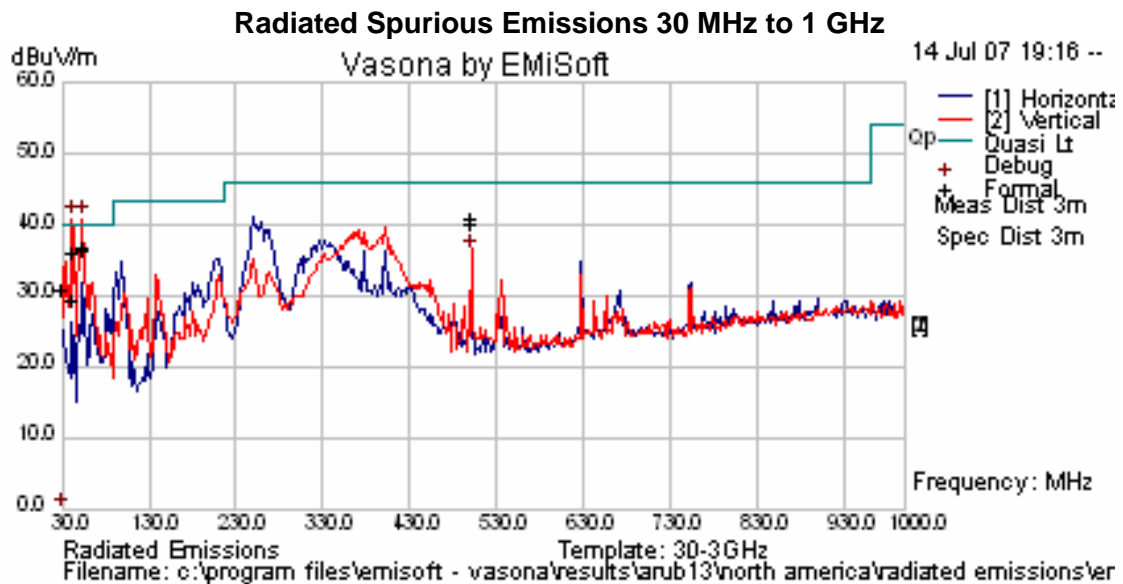

This test report may be reproduced in full only. The document may only be updated by MiCOM Labs personnel. Any changes will be noted in the Document History section of the report.



TABLE OF RESULTS

Test Configuration - ac/dc Converter, Integral Antennas Connected

Freq. (MHz)	Peak (dBuV/m)	QP (dBuV/m)	QP Lmt (dBuV/m)	QP Margin (dB)	Angle (deg)	Height (cm)	Polarity
500.04	38.92	36.63	46	-9.37	292	100	V
375.013	37.84	36.74	46	-9.26	59	101	H
50.444	32.92	31.11	40	-8.89	174	100	V

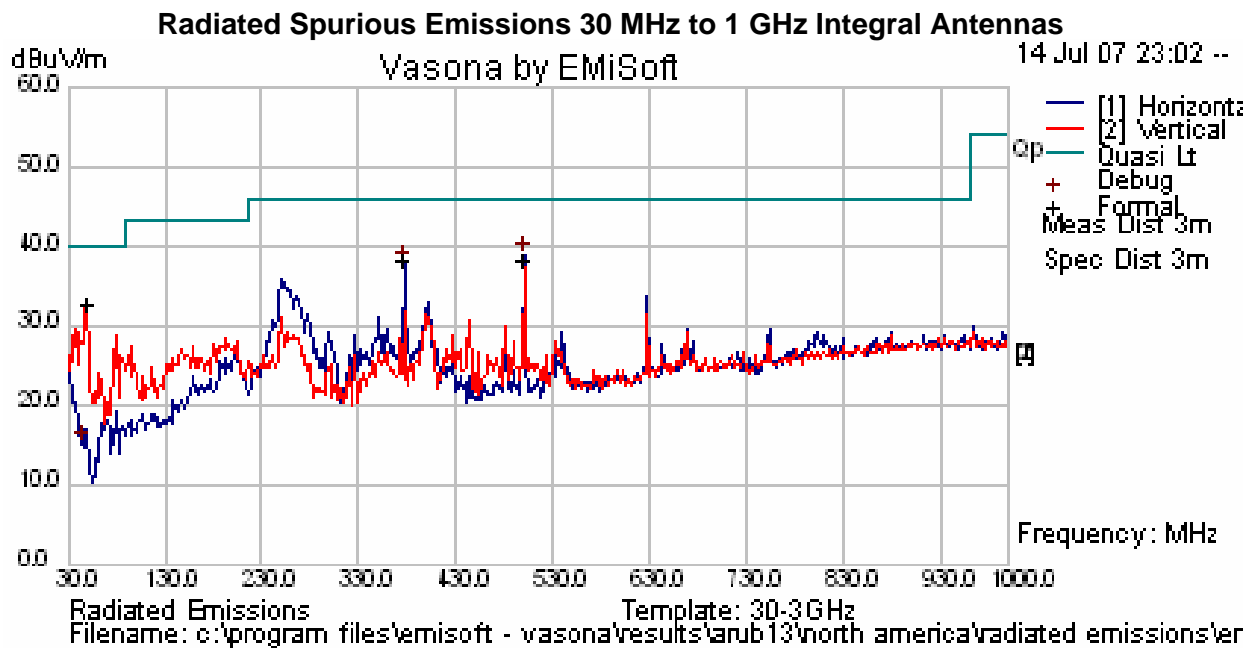

This test report may be reproduced in full only. The document may only be updated by MiCOM Labs personnel. Any changes will be noted in the Document History section of the report.



Title: Aruba AP-70 802.11 a/b/g Wireless AP
To: FCC 47 CFR Part 15.407
Serial #: ARUB13-A4 Rev A
Issue Date: 20th July 2007
Page: 86 of 130

TABLE OF RESULTS

Test Configuration - ac/dc Converter, External Antennas Connected

Freq. (MHz)	Peak (dBuV/m)	QP (dBuV/m)	QP Lmt (dBuV/m)	QP Margin (dB)	Angle (deg)	Height (cm)	Polarity

There were no emissions within 6 dB of the limit line therefore no further detailed investigation was required.

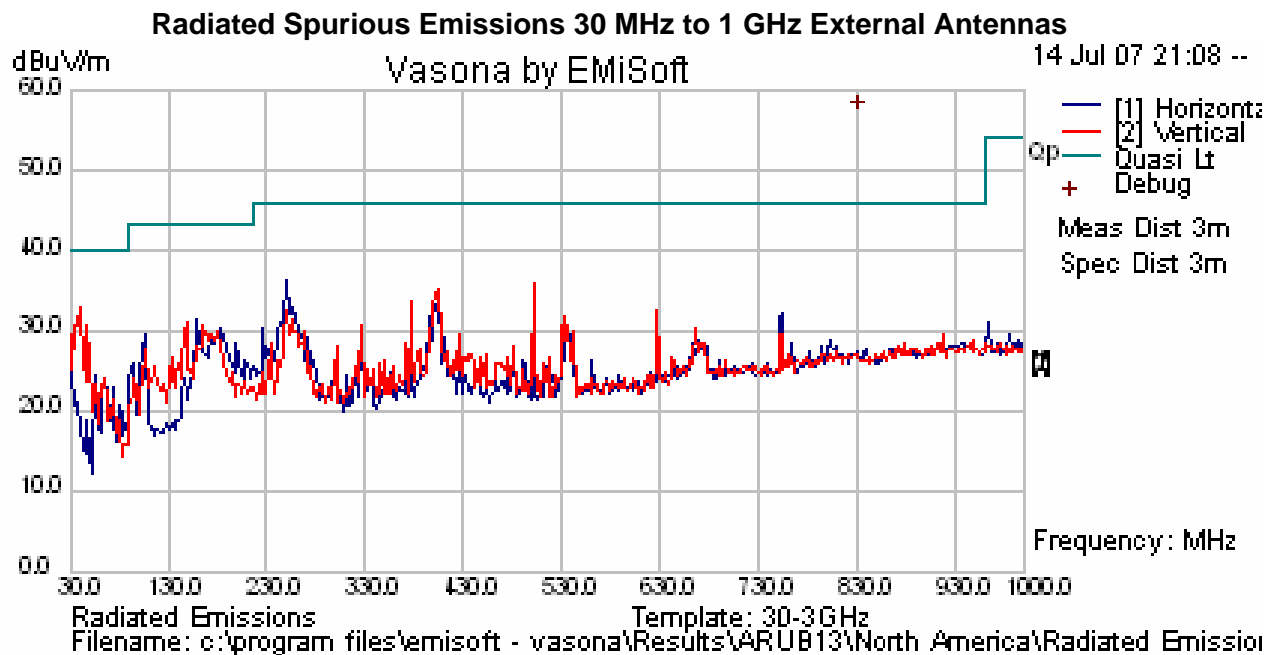

This test report may be reproduced in full only. The document may only be updated by MiCOM Labs personnel. Any changes will be noted in the Document History section of the report.



Specification

Limits

§15.407(b)(6) Unwanted emissions below 1 GHz must comply with the general field strength limits set forth in Section 15.209.

§15.205 (a) Except as shown in paragraph (d) of 15.205 (a), only spurious emissions are permitted in any of the frequency bands listed.

§15.205 (a) Except as shown in paragraphs (d) and (e) of this section, the field strength of emissions appearing within these frequency bands shall not exceed the limits shown in Section §15.209. At frequencies equal to or less than 1000 MHz, compliance with the limits in Section 15.209 shall be demonstrated using measurement instrumentation employing a CISPR quasi-peak detector. Above 1000 MHz, compliance with the emission limits in Section 15.209 shall be demonstrated based on the average value of the measured emissions. The provisions in Section 15.35 apply to these measurements.

§15.209 (a) Except as provided elsewhere in this subpart, the emissions from an intentional radiator shall not exceed the field strength levels specified in the following table.

Frequency(MHz)	Field Strength ($\mu\text{V}/\text{m}$)	Field Strength ($\text{dB}\mu\text{V}/\text{m}$)	Measurement Distance (meters)
30-88	100	40.0	3
88-216	150	43.5	3
216-960	200	46.0	3
Above 960	500	54.0	3

Laboratory Measurement Uncertainty for Radiated Emissions

Measurement uncertainty	+5.6/ -4.5 dB
-------------------------	---------------

Traceability

Method	Test Equipment Used
Measurements were made per work instruction WI-03 'Measurement of Radiated Emissions'	0088, 0158, 0134, 0304, 0311, 0315, 0310, 0312

This test report may be reproduced in full only. The document may only be updated by MiCOM Labs personnel. Any changes will be noted in the Document History section of the report.

5.1.8. AC Wireline Conducted Emissions (150 kHz – 30 MHz)

FCC, Part 15 Subpart C §15.407(b)(6)/15.207

Test Procedure

The EUT is configured in accordance with ANSI C63.4. The conducted emissions are measured in a shielded room with a spectrum analyzer in peak hold in the first instance. Emissions closest to the limit are measured in the quasi-peak mode (QP) with the tuned receiver using a bandwidth of 9 kHz. The emissions are maximized further by cable manipulation. The highest emissions relative to the limit are listed.

Test Measurement Set up

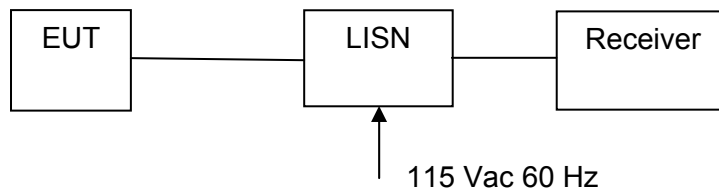

Measurement set up for AC Wireline Conducted Emissions Test

Measurement Results for AC Wireline Conducted Emissions (150 kHz – 30 MHz)

Ambient conditions.

Temperature: 17 to 23 °C Relative humidity: 31 to 57 % Pressure: 999 to 1012 mbar

AC Wireline Emissions 115Vac 60Hz
Transmitter Power Level: Maximum



TABLE OF RESULTS –

Freq (MHz)	Line	Peak (dB μ V)	QP (dB μ V)	QP Limit (dB μ V)	QP Margin (dB)	Ave. (dB μ V)	Ave. Limit (dB μ V)	Ave. Margin (dB)
0.150	Line	52.17	48.93	66	-17.07	38.88	56.00	-17.12
0.165	Line	43.57	37.84	65.21	-27.36	20.09	55.21	-35.12
0.221	Line	37.87	37.02	62.78	-25.76	16.11	52.78	-36.67
0.346	Line	36.72	30.32	59.06	-28.74	23.49	49.06	-25.57
11.804	Line	32.58	34.72	60	-25.28	30.23	50.00	-19.77
21.260	Line	32.21	37.24	60	-22.76	31.15	50.00	-18.85

AC Wireline Conducted Emissions –150 kHz – 30 MHz)

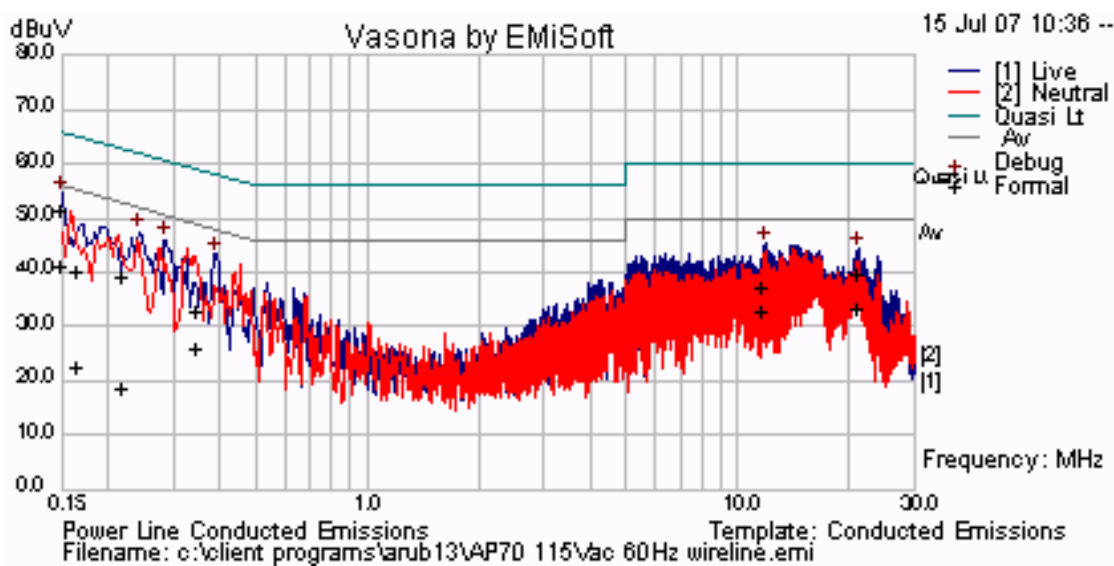

This test report may be reproduced in full only. The document may only be updated by MiCOM Labs personnel. Any changes will be noted in the Document History section of the report.



Specification

Limit

§15.407 (b)(6); Any U-NII devices using an AC power line are required to comply also with the limits set forth in Section 15.207.

§15.207 (a) Except as shown in paragraphs (b) and (c) of this section, for an intentional radiator that is designed to be connected to the public utility (AC) power line, the radio frequency voltage that is conducted back onto the AC power line on any frequency or frequencies within the band 150 kHz to 30 MHz shall not exceed the limits in the following table, as measured using a 50 $\mu\Omega$ line impedance stabilization network (LISN), see §15.207 (a) matrix below. Compliance with the provisions of this paragraph shall be based on the measurement of the radio frequency voltage between each power line and ground at the power terminal.

§15.207 (a) Limit Matrix

The lower limit applies at the boundary between frequency ranges

Frequency of Emission (MHz)	Conducted Limit (dB μ V)	
	Quasi-peak	Average
0.15-0.5	66 to 56*	56 to 46*
0.5-5	56	46
5-30	60	50

* Decreases with the logarithm of the frequency

Laboratory Measurement Uncertainty for Conducted Emissions

Measurement uncertainty	± 2.64 dB
-------------------------	---------------

Traceability

Method	Test Equipment Used
Measurements were made per work instruction WI-EMC-01 'Measurement of Conducted Emissions'	0158, 0184, 0193, 0190, 0293, 0307

This test report may be reproduced in full only. The document may only be updated by MiCOM Labs personnel. Any changes will be noted in the Document History section of the report.



6. Dynamic Frequency Selection (DFS)

6.1. Test Procedure and Setup

FCC, Part 15 Subpart C §15.407(h)
FCC 06-96 Memorandum Opinion and Order

6.1.1. Interference Threshold values, Master or Client incorporating In-Service Monitoring

Maximum Transmit Power	Value (see note)
≥ 200 milliwatt	-64 dBm
< 200 milliwatt	-62 dBm
Note 1: This is the level at the input of the receiver assuming a 0 dBi receive antenna	

6.1.2. DFS Response requirement values

Parameter	Value
<i>Non-occupancy period</i>	Minimum 30 minutes
<i>Channel Availability Check Time</i>	60 seconds
<i>Channel Move Time</i>	10 seconds See Note 1.
<i>Channel Closing Transmission Time</i>	200 milliseconds + an aggregate of 60 milliseconds over remaining 10 second period. See Notes 1 and 2.
<i>U-NII Detection Bandwidth</i>	Minimum 80% of the 99% power bandwidth See Note 3.

Note 1: The instant that the *Channel Move Time* and the *Channel Closing Transmission Time* begins is as follows:

- For the Short pulse radar Test Signals this instant is the end of the *Burst*.
- For the Frequency Hopping radar Test Signal, this instant is the end of the last radar *Burst* generated.
- For the Long Pulse radar Test Signal this instant is the end of the 12 second period defining the radar transmission.

Note 2: The *Channel Closing Transmission Time* is comprised of 200 milliseconds starting at the beginning of the *Channel Move Time* plus any additional intermittent control signals required to facilitate *Channel* changes (an aggregate of 60 milliseconds) during the remainder of the 10 second period. The aggregate duration of control signals will not count quiet periods in between transmissions.

Note 3: During the *U-NII Detection Bandwidth* detection test, radar type 1 is used and for each frequency step the minimum percentage of detection is 90%. Measurements are performed with no data traffic.



6.1.3. Radar Test Waveforms

This section provides the parameters for required test waveforms, minimum percentage of successful detections, and the minimum number of trials that must be used for determining DFS conformance. Step intervals of 0.1 microsecond for Pulse Width, 1 microsecond for PRI, 1 MHz for chirp width and 1 for the number of pulses will be utilized for the random determination of specific test waveforms.

Short Pulse Radar Test Waveforms

Radar Type	Pulse Width (μsec)	PRI (μsec)	Number of Pulses	Minimum Percentage of Successful Detection	Minimum Trials
1	1	1428	18	60%	30
2	1-5	150-230	23-29	60%	30
3	6-10	200-500	16-18	60%	30
4	11-20	200-500	12-16	60%	30
Aggregate (Radar Types 1-4)				80%	120

A minimum of 30 unique waveforms are required for each of the short pulse radar types 2 through 4. For short pulse radar type 1, the same waveform is used a minimum of 30 times. If more than 30 waveforms are used for short pulse radar types 2 through 4, then each additional waveform must also be unique and not repeated from the previous waveforms. The aggregate is the average of the percentage of successful detections of short pulse radar types 1-4.

Long Pulse Radar Test Waveform

Radar Type	Pulse Width (μsec)	Chirp Width (MHz)	PRI (μsec)	Number of Pulses per Burst	Number of Bursts	Minimum Percentage of Successful Detection	Minimum Trials
5	50-100	5-20	1000-2000	1-3	8-20	80%	30

The parameters for this waveform are randomly chosen. Thirty unique waveforms are required for the Long Pulse radar test signal. If more than 30 waveforms are used for the Long Pulse radar test signal, then each additional waveform must also be unique and not repeated from the previous waveforms.



Title: Aruba AP-70 802.11 a/b/g Wireless AP
To: FCC 47 CFR Part 15.407
Serial #: ARUB13-A4 Rev A
Issue Date: 20th July 2007
Page: 93 of 130

Each waveform is defined as follows:

- 1) The transmission period for the Long Pulse Radar test signal is 12 seconds.
- 2) There are a total of 8 to 20 *Bursts* in the 12 second period, with the number of *Bursts* being randomly chosen. This number is *Burst Count*.
- 3) Each *Burst* consists of 1 to 3 pulses, with the number of pulses being randomly chosen. Each *Burst* within the 12 second sequence may have a different number of pulses.
- 4) The pulse width is between 50 and 100 microseconds, with the pulse width being randomly chosen. Each pulse within a *Burst* will have the same pulse width. Pulses in different *Bursts* may have different pulse widths.
- 5) Each pulse has a linear FM chirp between 5 and 20 MHz, with the chirp width being randomly chosen. Each pulse within a *Burst* will have the same chirp width. Pulses in different *Bursts* may have different chirp widths. The chirp is centered on the pulse. For example, with a radar frequency of 5300 MHz and a 20 MHz chirped signal, the chirp starts at 5290 MHz and ends at 5310 MHz.
- 6) If more than one pulse is present in a *Burst*, the time between the pulses will be between 1000 and 2000 microseconds, with the time being randomly chosen. If three pulses are present in a *Burst*, the time between the first and second pulses is chosen independently of the time between the second and third pulses.
- 7) The 12 second transmission period is divided into even intervals. The number of intervals is equal to *Burst_Count*. Each interval is of length $(12,000,000 / \textit{Burst_Count})$ microseconds. Each interval contains one *Burst*. The start time for the *Burst*, relative to the beginning of the interval, is between 1 and $[(12,000,000 / \textit{Burst_Count}) - (\textit{Total Burst Length}) + (\textit{One Random PRI Interval})]$ microseconds, with the start time being randomly chosen. The step interval for the start time is 1 microsecond. The start time for each *Burst* is chosen independently.

This test report may be reproduced in full only. The document may only be updated by MiCOM Labs personnel. Any changes will be noted in the Document History section of the report.

A representative example of a Long Pulse radar test waveform:

- 1) The total test signal length is 12 seconds.
- 2) 8 *Bursts* are randomly generated for the *Burst_Count*.
- 3) *Burst 1* has 2 randomly generated pulses.
- 4) The pulse width (for both pulses) is randomly selected to be 75 microseconds.
- 5) The PRI is randomly selected to be at 1213 microseconds.
- 6) *Bursts 2* through 8 are generated using steps 3 – 5.
- 7) Each *Burst* is contained in even intervals of 1,500,000 microseconds. The starting location for Pulse 1, *Burst 1* is randomly generated (1 to 1,500,000 minus the total *Burst 1* length + 1 random PRI interval) at the 325,001 microsecond step. *Bursts 2* through 8 randomly fall in successive 1,500,000 microsecond intervals (i.e. *Burst 2* falls in the 1,500,001 – 3,000,000 microsecond range).

Graphical representation of the Long Pulse radar Test Waveform.

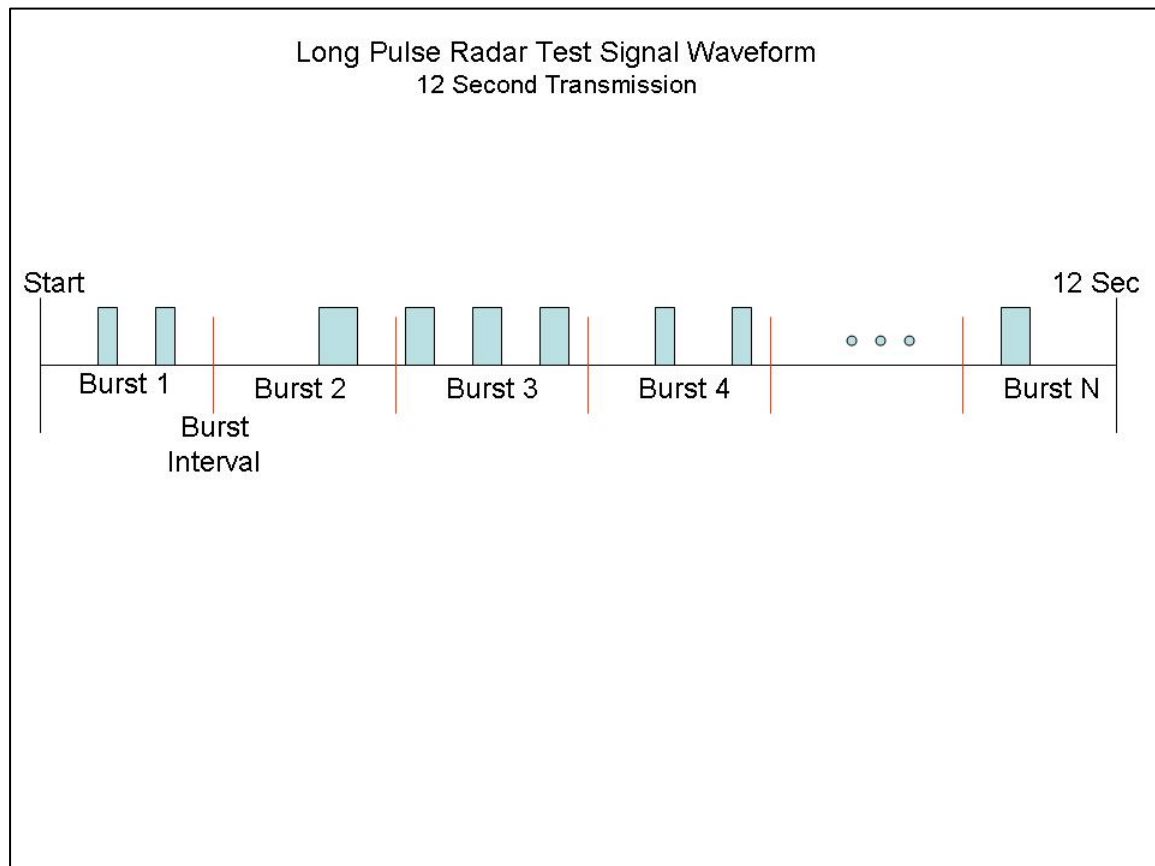

6.1.4. Frequency Hopping Radar Test Waveform

Frequency Hopping Radar Test Waveform

Radar Type	Pulse Width (µsec)	PRI (µsec)	Pulses per Hop	Hopping Rate (kHz)	Hopping Sequence Length (msec)	Minimum Percentage of Successful Detection	Minimum Trials
6	1	333	9	.333	300	70%	30

For the Frequency Hopping Radar Type, the same *Burst* parameters are used for each waveform. The hopping sequence is different for each waveform and a 100-length segment is selected from the hopping sequence defined by the following algorithm:

The first frequency in a hopping sequence is selected randomly from the group of 475 integer frequencies from 5250 – 5724 MHz. Next, the frequency that was just chosen is removed from the group and a frequency is randomly selected from the remaining 474 frequencies in the group. This process continues until all 475 frequencies are chosen for the set. For selection of a random frequency, the frequencies remaining within the group are always treated as equally likely.

6.1.5. Radar Waveform Calibration

The following equipment setup was used to calibrate the conducted Radar Waveform. A spectrum analyzer was used to establish the test signal level for each radar type. During this process there were no transmissions by either the Master or Client Device. The spectrum analyzer was switched to the zero span (Time Domain) mode at the frequency of the Radar Waveform generator. Peak detection was utilized. The spectrum analyzer resolution bandwidth (RBW) and video bandwidth (VBW) were set to 3 MHz.

The signal generator amplitude was set so that the power level measured at the spectrum analyzer was -61dBm (Ref Section 5.1). The 30dB amplifier gain was entered as an amplitude offset on the spectrum analyzer.

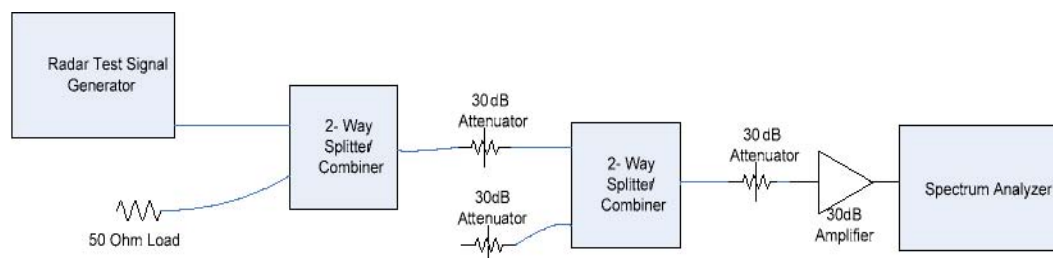

Conducted Calibration Setup



6.1.6. Radar Waveform Calibration Plots

The following are the calibration plots for required radar waveforms

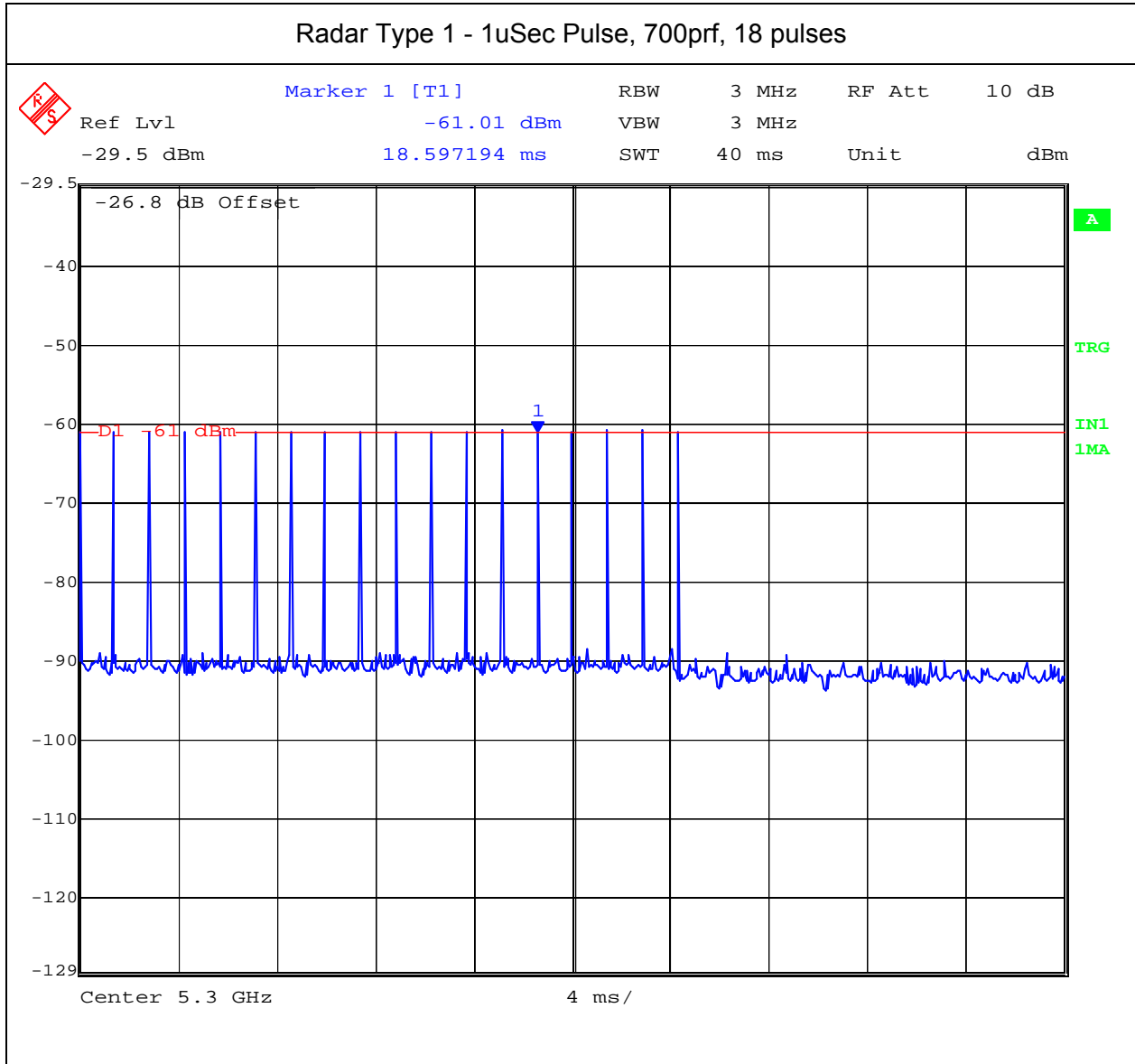

This test report may be reproduced in full only. The document may only be updated by MiCOM Labs personnel. Any changes will be noted in the Document History section of the report.



Radar Type 2 - 2.1uSec Pulse Width, 170prf, 25 pulses

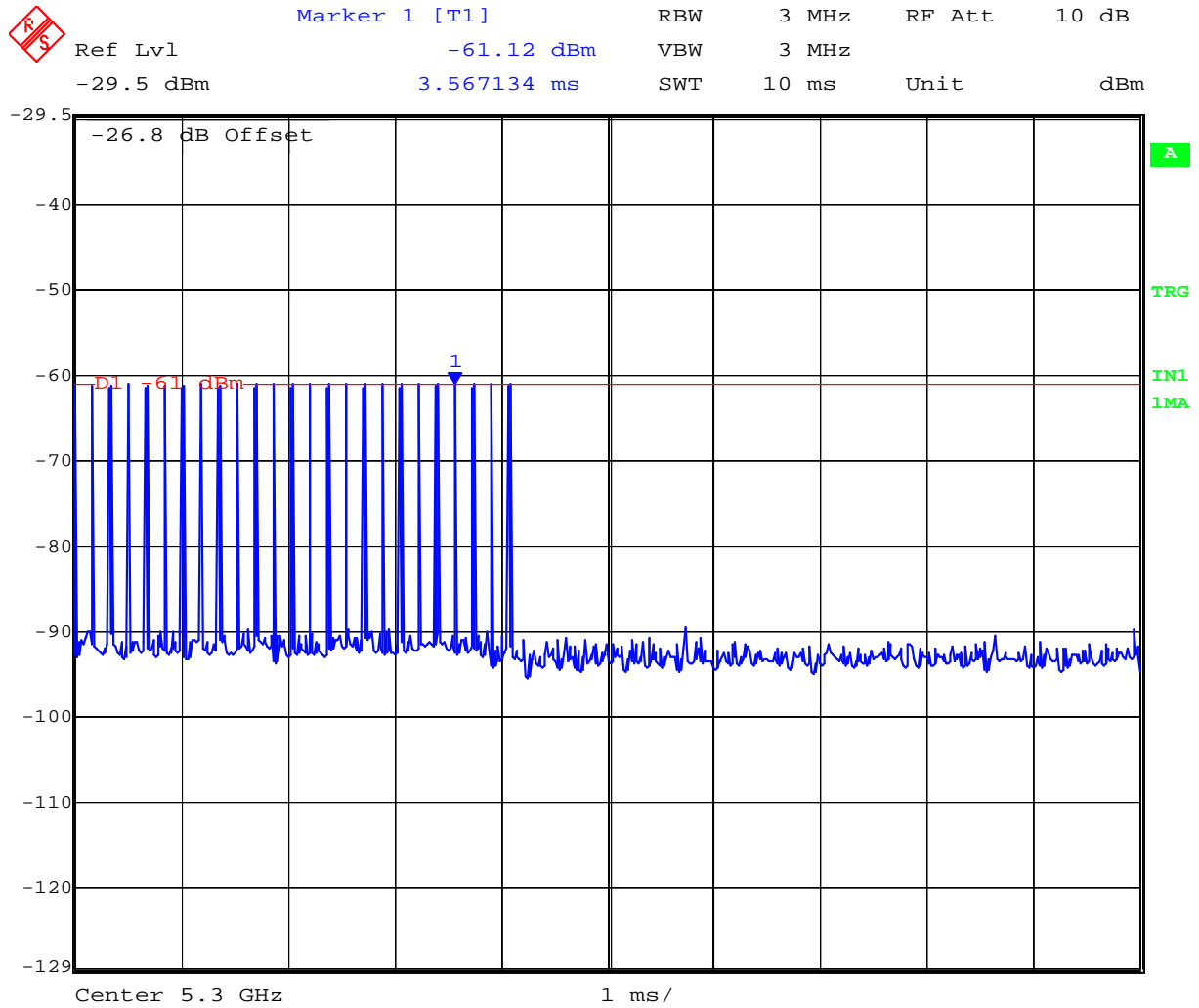

This test report may be reproduced in full only. The document may only be updated by MiCOM Labs personnel. Any changes will be noted in the Document History section of the report.



Radar Type 3 - 7.5uSec Pulse Width, 309prf, 17 pulses

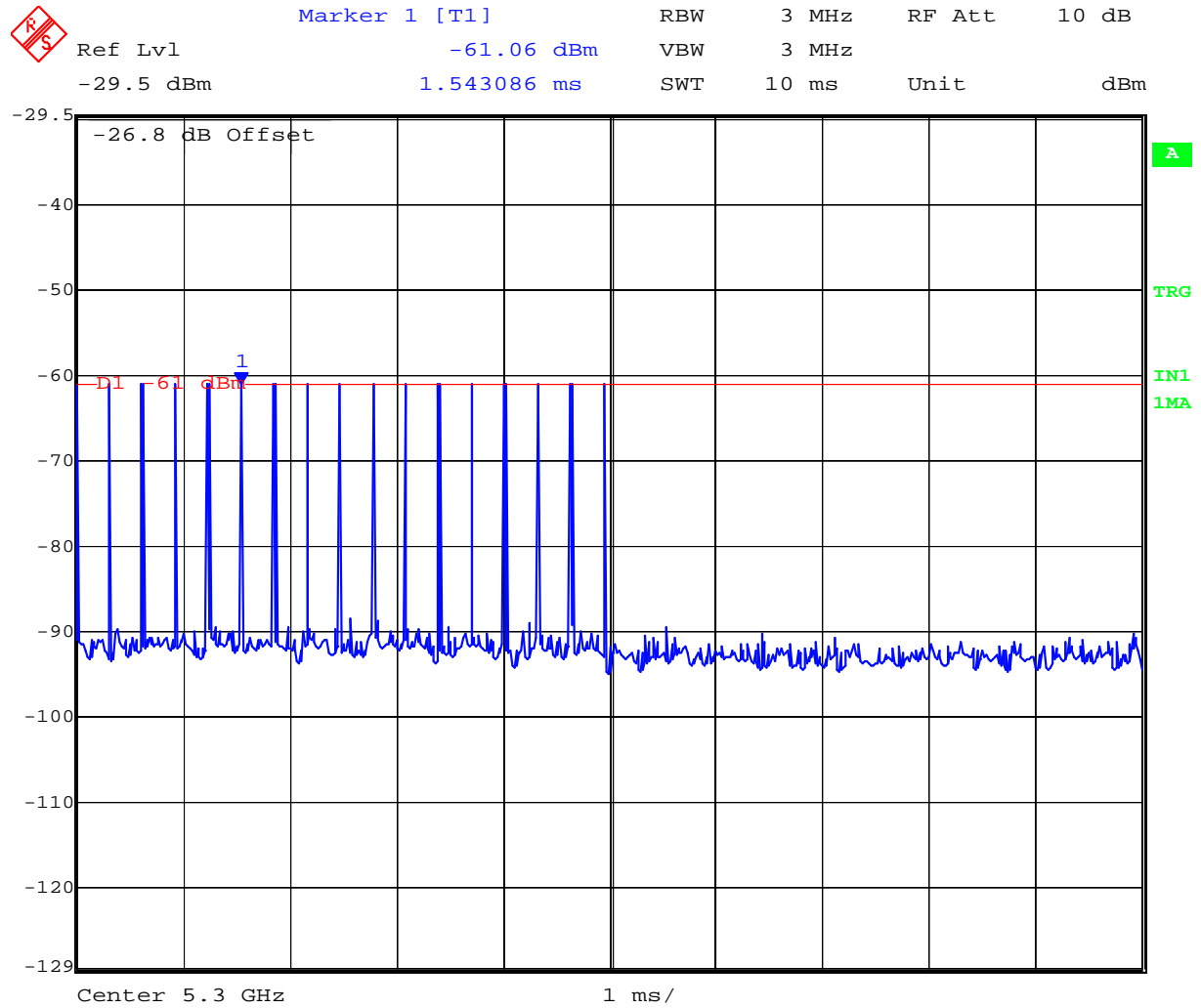

This test report may be reproduced in full only. The document may only be updated by MiCOM Labs personnel. Any changes will be noted in the Document History section of the report.



Radar Type 4 - 17.9uSec Pulse Width, 383prf, 16 pulses

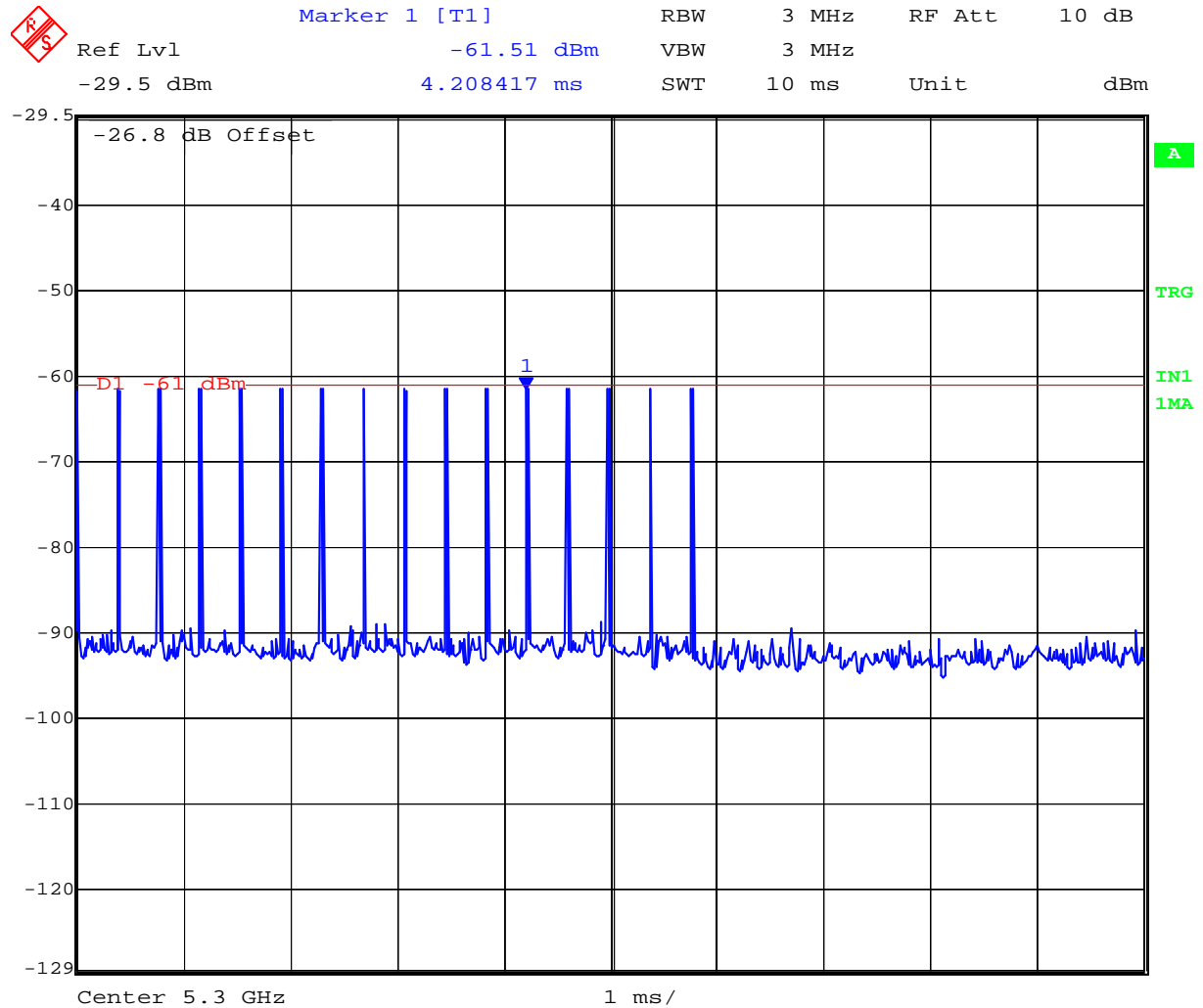

This test report may be reproduced in full only. The document may only be updated by MiCOM Labs personnel. Any changes will be noted in the Document History section of the report.

Radar Type 5

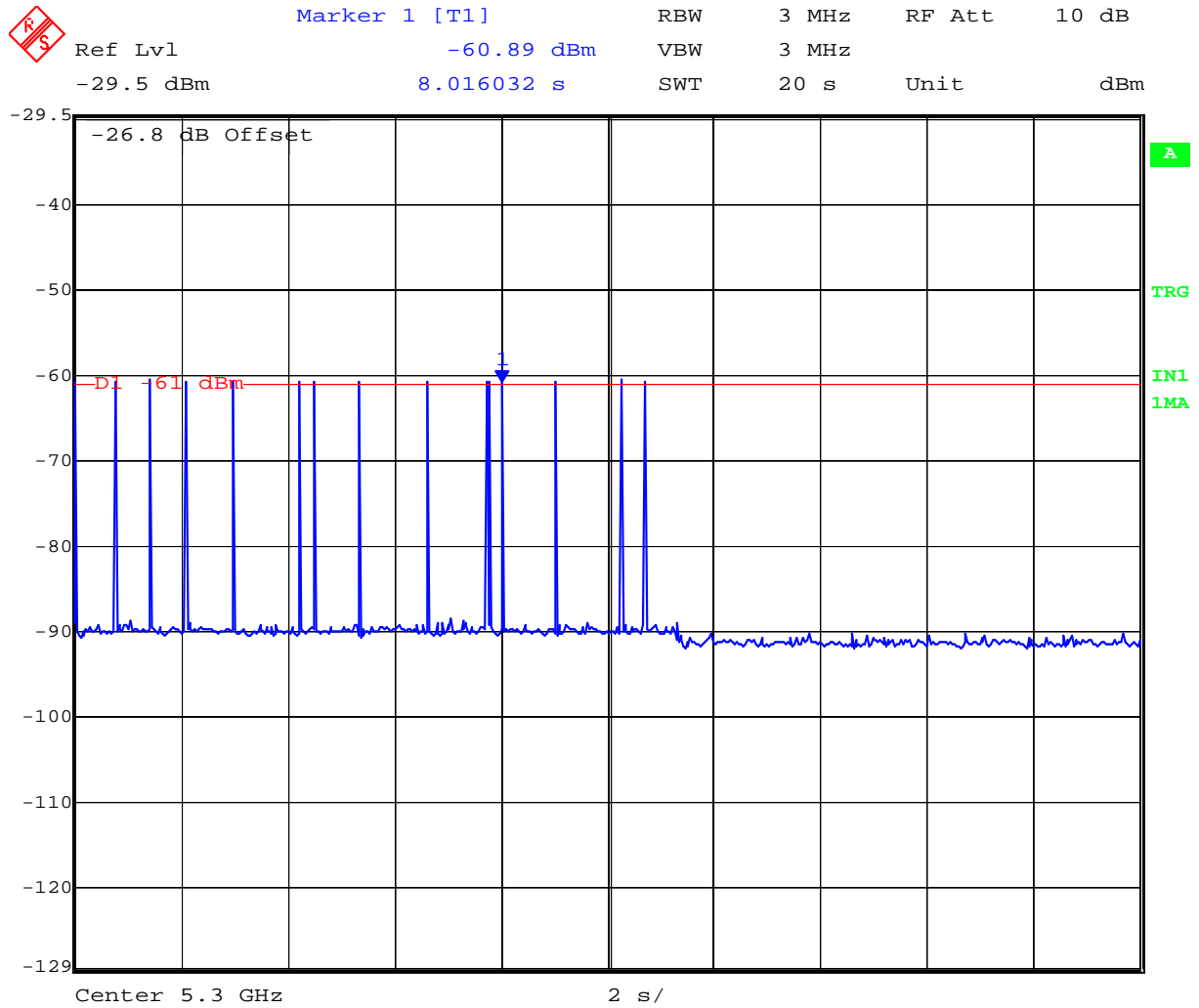

This test report may be reproduced in full only. The document may only be updated by MiCOM Labs personnel. Any changes will be noted in the Document History section of the report.



Radar Type 6

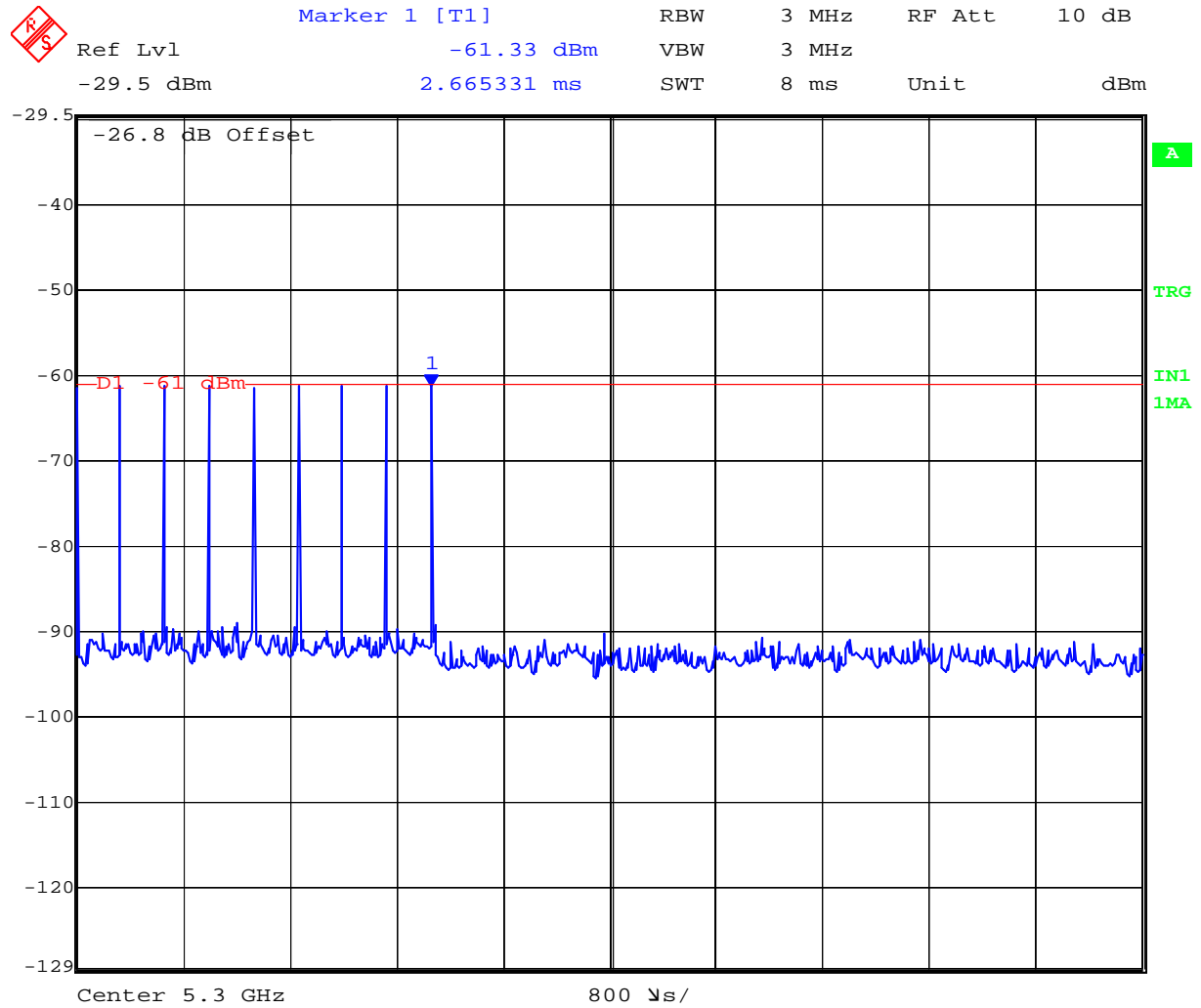

This test report may be reproduced in full only. The document may only be updated by MiCOM Labs personnel. Any changes will be noted in the Document History section of the report.

6.1.7. Test Set Up:

Block Diagram(s) of Test Setup

Setup for Conducted Measurements where the EUT is the Master with injection of Radar Test Waveforms at the Master.

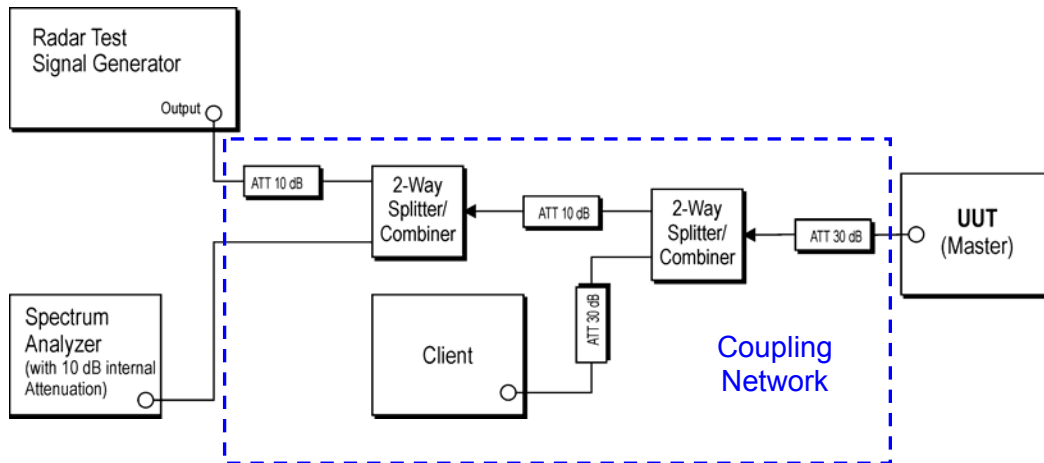

Support Equipment Configuration

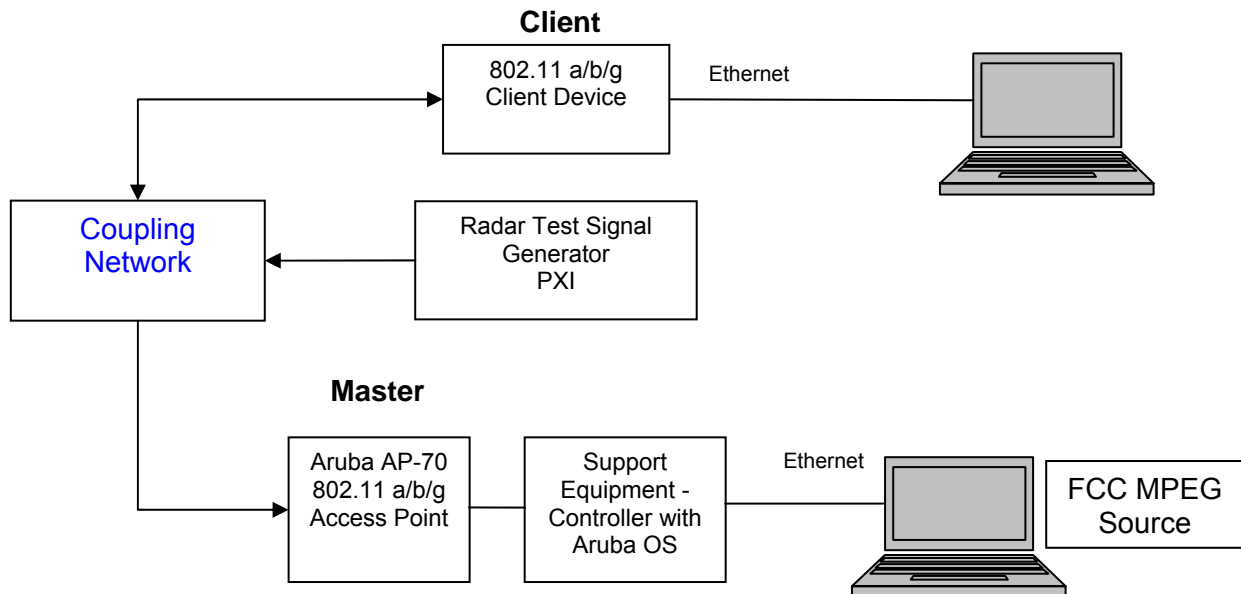

This test report may be reproduced in full only. The document may only be updated by MiCOM Labs personnel. Any changes will be noted in the Document History section of the report.



Title: Aruba AP-70 802.11 a/b/g Wireless AP
To: FCC 47 CFR Part 15.407
Serial #: ARUB13-A4 Rev A
Issue Date: 20th July 2007
Page: 103 of 130

For the frequency band 5,250 – 5,350 MHz, the Master device provides, on aggregate, uniform loading of the spectrum across all devices by selecting an operating channel among the available channels using a random algorithm.

Declared minimum antenna gain 3 dBi. ;

Radar receive signal level = -62 dBm + minimum antenna gain + 1 dB

$$= -62 + 3 + 1$$

Radar receive signal level = -58 dBm

Measurement Results - Dynamic Frequency Selection (DFS)

Ambient conditions.

Temperature: 17 to 23 °C Relative humidity: 31 to 57% Pressure: 999 to 1012 mbar

Radio parameters.

Test methodology: Conducted

Device Type: Master

Transmit Power: Maximum

This test report may be reproduced in full only. The document may only be updated by MiCOM Labs personnel. Any changes will be noted in the Document History section of the report.



Title: Aruba AP-70 802.11 a/b/g Wireless AP
To: FCC 47 CFR Part 15.407
Serial #: ARUB13-A4 Rev A
Issue Date: 20th July 2007
Page: 104 of 130

6.2. Dynamic Frequency Selection (DFS) Test Results

6.2.1. UNII Detection Bandwidth:

All UNII channels for this device have identical channel bandwidths and DFS testing was completed on channel 5,300 MHz.

The generating equipment is configured as shown in the Conducted Test Setup above. A single Burst of the short pulse radar Type 1 through 6 was produced at 5300 MHz at a level of -58 dBm (Ref Section 5.1). The EUT is set up as a standalone device (no associated Client and no traffic).

A single radar Burst is generated for a minimum of 10 trials, and the response of the EUT is noted. The EUT must detect the Radar Waveform 90% or more of the time.

The radar frequency is increased in 1 MHz steps, repeating the above test sequence, until the detection rate falls below 90%. The highest frequency at which detection is greater than or equal to 90% is denoted as F_H .

The radar frequency is decreased in 1 MHz steps, repeating the above test sequence, until the detection rate falls below 90%. The lowest frequency at which detection is greater than or equal to 90% is denoted as F_L .

The U-NII Detection Bandwidth is calculated as follows:

$$\text{U-NII Detection Bandwidth} = F_H - F_L$$

The U-NII Detection Bandwidth must be at least 80% of the EUT transmitter 99% power, otherwise, the EUT does not comply with DFS requirements.

This test report may be reproduced in full only. The document may only be updated by MiCOM Labs personnel. Any changes will be noted in the Document History section of the report.



Title: Aruba AP-70 802.11 a/b/g Wireless AP
To: FCC 47 CFR Part 15.407
Serial #: ARUB13-A4 Rev A
Issue Date: 20th July 2007
Page: 106 of 130

6.2.2. Initial Channel Availability Check Time

This test verifies that the EUT does not emit pulse, control, or data signals on the test Channel until the power-up sequence has been completed and the U-NII device checks for Radar Waveforms for one minute on the test Channel. This test does not use any Radar Waveforms.

The U-NII device is powered on and be instructed to operate at 5300 MHz. At the same time the EUT is powered on, the spectrum analyzer is set for zero span with a 1 MHz resolution bandwidth at 5300 MHz with a 210 second sweep time. The analyzer's sweep will be started the same time power is applied to the U-NII device.

The EUT should not transmit any pulse or data transmissions until at least 1 minute after the completion of the power-on cycle.

The first red frequency line T_1 shown on the following plot denotes the instant when the EUT has completed its power-up sequence i.e. T_0 (as defined within the FCC's MO&O 06-96 Normative Reference 2). The power-up reference T_0 is determined by the time it takes for the EUT to start "beaconing" i.e. initial beacon – 60 secs = end of power-up.

The Channel Availability Check Time commences at instant T_0 and will end no sooner than $T_0 + 60$ seconds.

The Master requires 31.6 seconds to complete its power-on cycle.



Initial Channel Availability Check Time during power up of EUT
Ch 5300 MHz

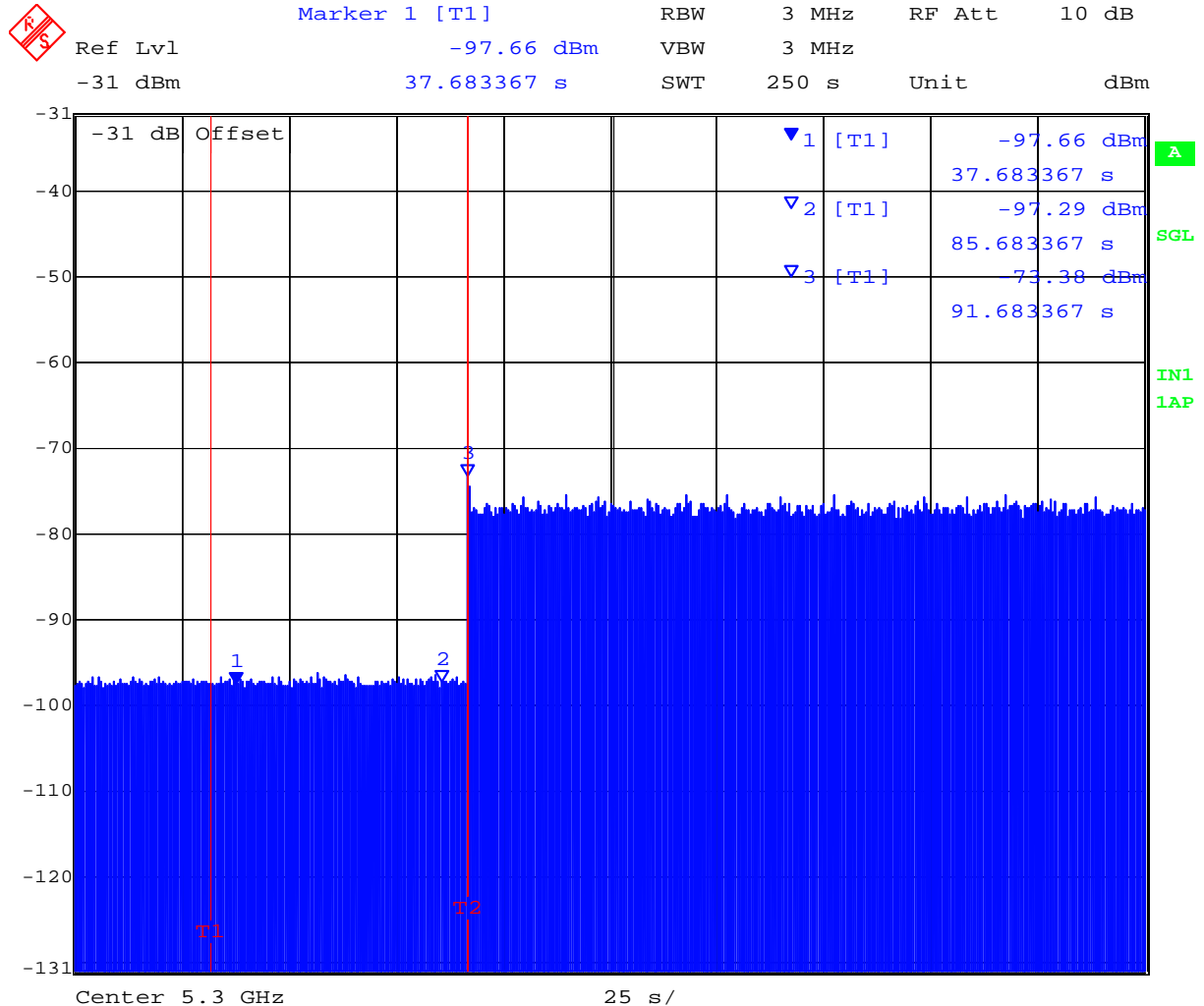

Date: 6.JUL.2007 11:00:39

This test report may be reproduced in full only. The document may only be updated by MiCOM Labs personnel. Any changes will be noted in the Document History section of the report.



Title: Aruba AP-70 802.11 a/b/g Wireless AP
To: FCC 47 CFR Part 15.407
Serial #: ARUB13-A4 Rev A
Issue Date: 20th July 2007
Page: 108 of 130

6.2.3. Radar Burst at the Beginning of the Channel Availability Check Time:

The steps below define the procedure to verify successful radar detection on the selected Channel during a period equal to the Channel Availability Check Time and avoidance of operation on that Channel when a radar Burst with a level equal to the DFS Detection Threshold +6 dB (-58 dBm Ref Section 6.1.7) occurs at the beginning of the Channel Availability Check Time.

A single Burst of short pulse of radar Type 1 will commence within a 6 second window starting at T_0 (frequency line T1 on the following plot).

Visual indication on the EUT of successful detection of the radar Burst will be recorded and reported. Observation of emissions at 5300MHz will continue for 2.5 minutes after the radar burst has been generated.

Verify that during the 2.5 minute measurement window no EUT transmissions have occurred at 5300MHz.

This test report may be reproduced in full only. The document may only be updated by MiCOM Labs personnel. Any changes will be noted in the Document History section of the report.



Channel Availability Check Time at the start of the 60 second Check Time
Ch 5300 MHz



Marker 1 [T1] RBW 3 MHz RF Att 10 dB
 Ref Lvl -31 dBm Offset -97.37 dBm VBW 3 MHz
 -31 dBm 37.683367 s SWT 250 s Unit dBm

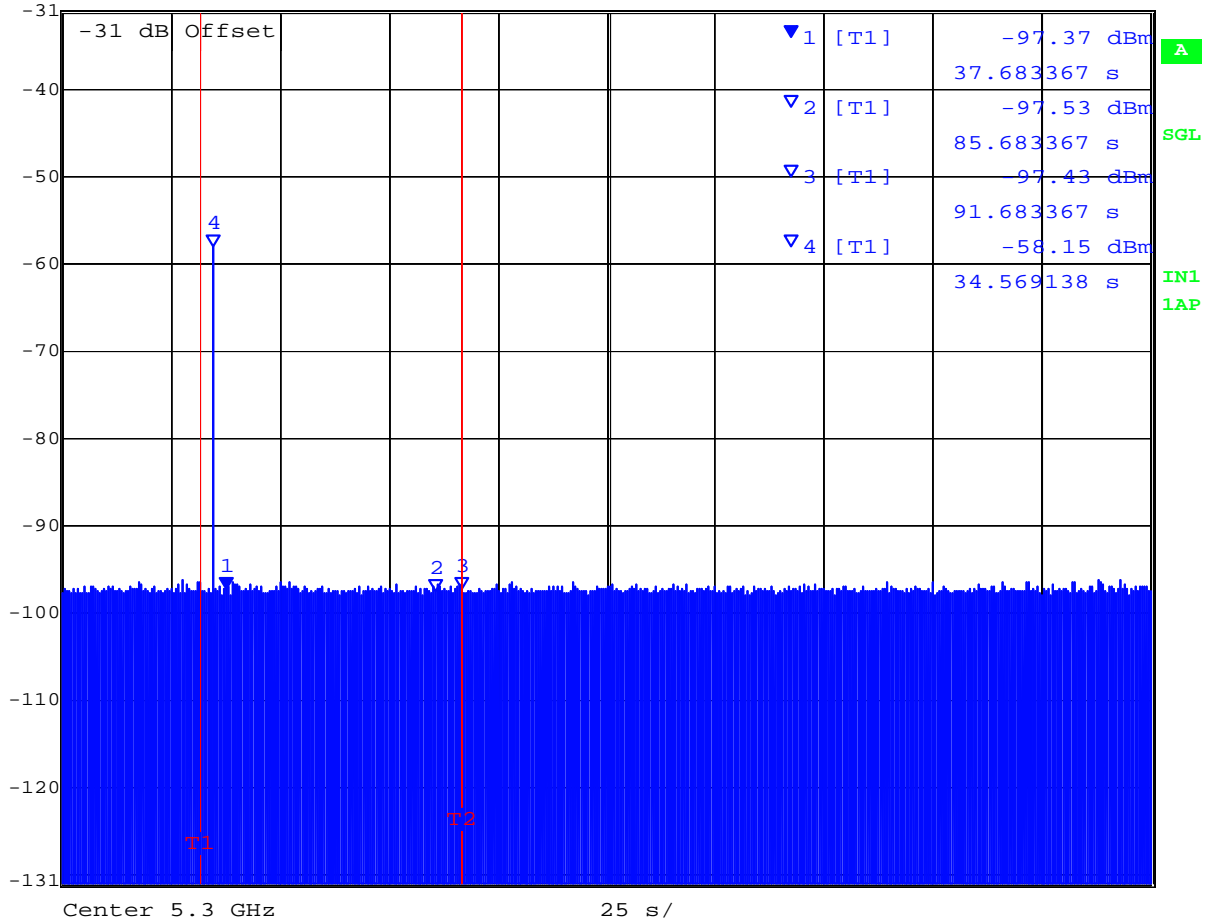

Date: 6.JUL.2007 11:07:32

This test report may be reproduced in full only. The document may only be updated by MiCOM Labs personnel. Any changes will be noted in the Document History section of the report.



Title: Aruba AP-70 802.11 a/b/g Wireless AP
To: FCC 47 CFR Part 15.407
Serial #: ARUB13-A4 Rev A
Issue Date: 20th July 2007
Page: 110 of 130

6.2.4. Radar Burst at the End of the Channel Availability Check Time:

The steps below define the procedure to verify successful radar detection on the selected Channel during a period equal to the Channel Availability Check Time and avoidance of operation on that Channel when a radar Burst with a level equal to the DFS Detection Threshold occurs at the end of the Channel Availability Check Time.

A single Burst of short pulse of radar type 1 will commence within a 6 second window starting at $T_0 + 54$ seconds. The window will commence at marker 2 and end at the red frequency line T_2 .

Visual indication on the EUT of successful detection of the radar Burst will be recorded and reported. Observation of emissions at 5300MHz will continue for 2.5 minutes after the radar burst has been generated.

Verify that during the 2.5 minute measurement window no EUT transmissions occurred on 5300MHz.

This test report may be reproduced in full only. The document may only be updated by MiCOM Labs personnel. Any changes will be noted in the Document History section of the report.



Channel Availability Check Time at the end of the 60 second Check Time
Ch 5300 MHz

	Marker 1 [T1]	RBW	3 MHz	RF Att	10 dB
Ref Lvl	-97.80 dBm	VBW	3 MHz		
-31 dBm	37.683367 s	SWT	250 s	Unit	dBm

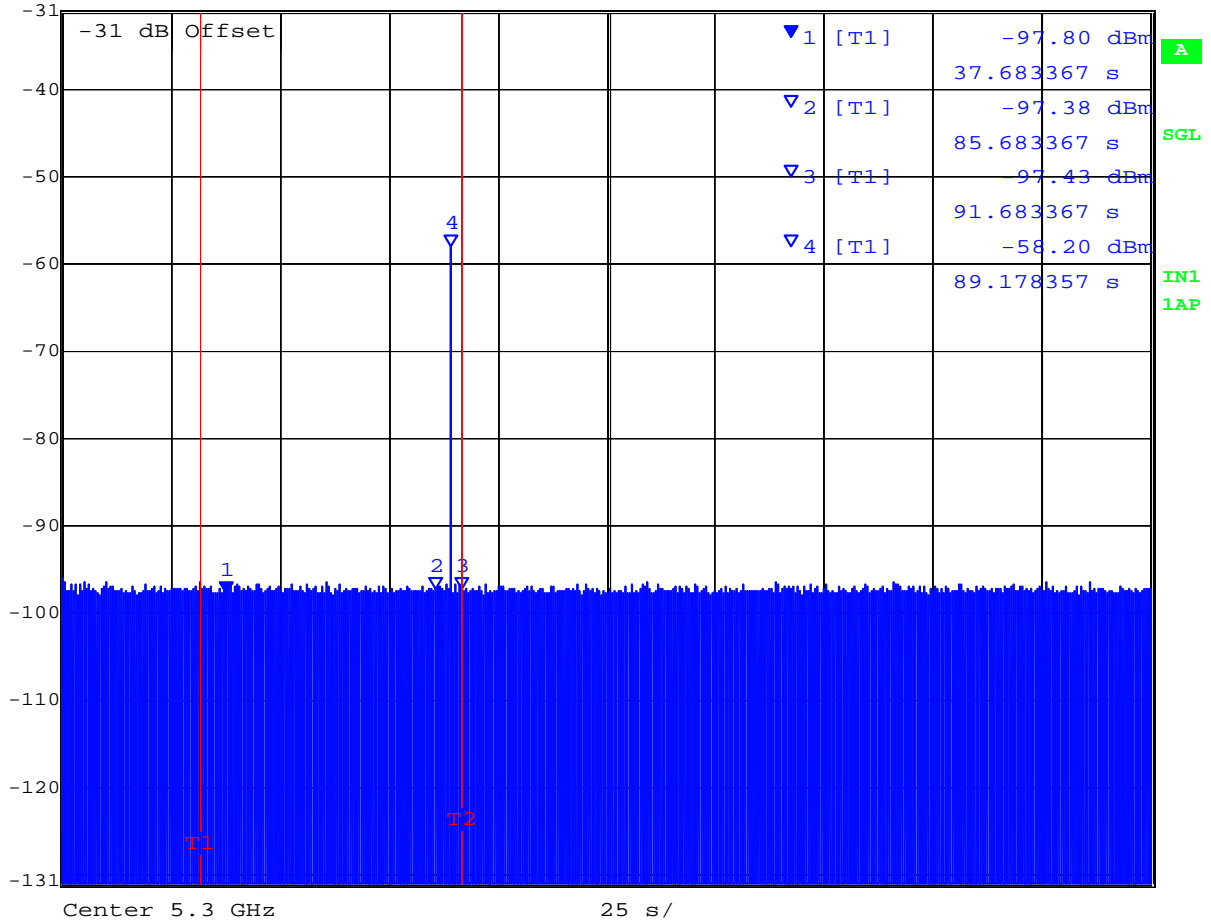

Date: 6.JUL.2007 11:20:08

This test report may be reproduced in full only. The document may only be updated by MiCOM Labs personnel. Any changes will be noted in the Document History section of the report.



Title: Aruba AP-70 802.11 a/b/g Wireless AP
To: FCC 47 CFR Part 15.407
Serial #: ARUB13-A4 Rev A
Issue Date: 20th July 2007
Page: 112 of 130

6.2.5. In-Service Monitoring for Channel Move Time, Channel Closing Transmission Time and Non-Occupancy Period
FCC §15.407(h)(2)(iii)

The steps below define the procedure to determine the above mentioned parameters when a radar Burst with a level equal to the DFS Detection Threshold is generated on the Operating Channel of the U-NII device.

A U-NII device operating as a Client Device will associate with the EUT (Master). The requisite MPEG video file ("TestFile.mpg" available on the NTIA website at the following link <http://ntiacsd.ntia.doc.gov/dfs/>) is streamed from the master device (AP) to the client.

Channel Closing Transmission Time - Measurement

A Type 1 waveform was introduced to the EUT, from which a 12 second transmission record was captured, collecting nearly 250M samples of data, which included 60ms of pre-trigger data. This Type 1 waveform had an integral marker built into its construction, marking the start of the waveform play, which directly triggered the PXI digitizer's data capture via the PXI backplane trigger bus.

The test system was setup to capture data for all transmission events above a threshold level of -61dBm. The test equipment time stamps all captured events with respect to T_0 (zero time indicating the start of the measurements sequence) starting the 60 ms pre-trigger period followed by the radar type 1 burst period.

Radar (Type 1) Pre-trigger period 60ms

Type 1 burst period 24.277ms

(The period of the 18 pulse burst includes [17 pulses * 1.428mS PRI] = 24.276ms. Then add 1 μ s pulse width for the final pulse.)

Channel Closing Transmission Time starts immediately after the last radar pulse is transmitted i.e. 84.277ms after the start of the trace capture period.



Title: Aruba AP-70 802.11 a/b/g Wireless AP
To: FCC 47 CFR Part 15.407
Serial #: ARUB13-A4 Rev A
Issue Date: 20th July 2007
Page: 113 of 130

Therefore, pulses seen after this 84.277ms boundary are identified and totaled to provide an aggregate total of transmissions in order to determine whether the EUT is compliant with the Channel Closing Transmission Time requirements as described in MO&O FCC 06-96. In this case, it was found that an aggregate total of 1.416 ms of transmission time accrued.

Channel Closing Transmission Time = 1.416 mSecs (limit 260 mSecs)

Channel Move Time, Channel Closing Time for Type 1 Radar

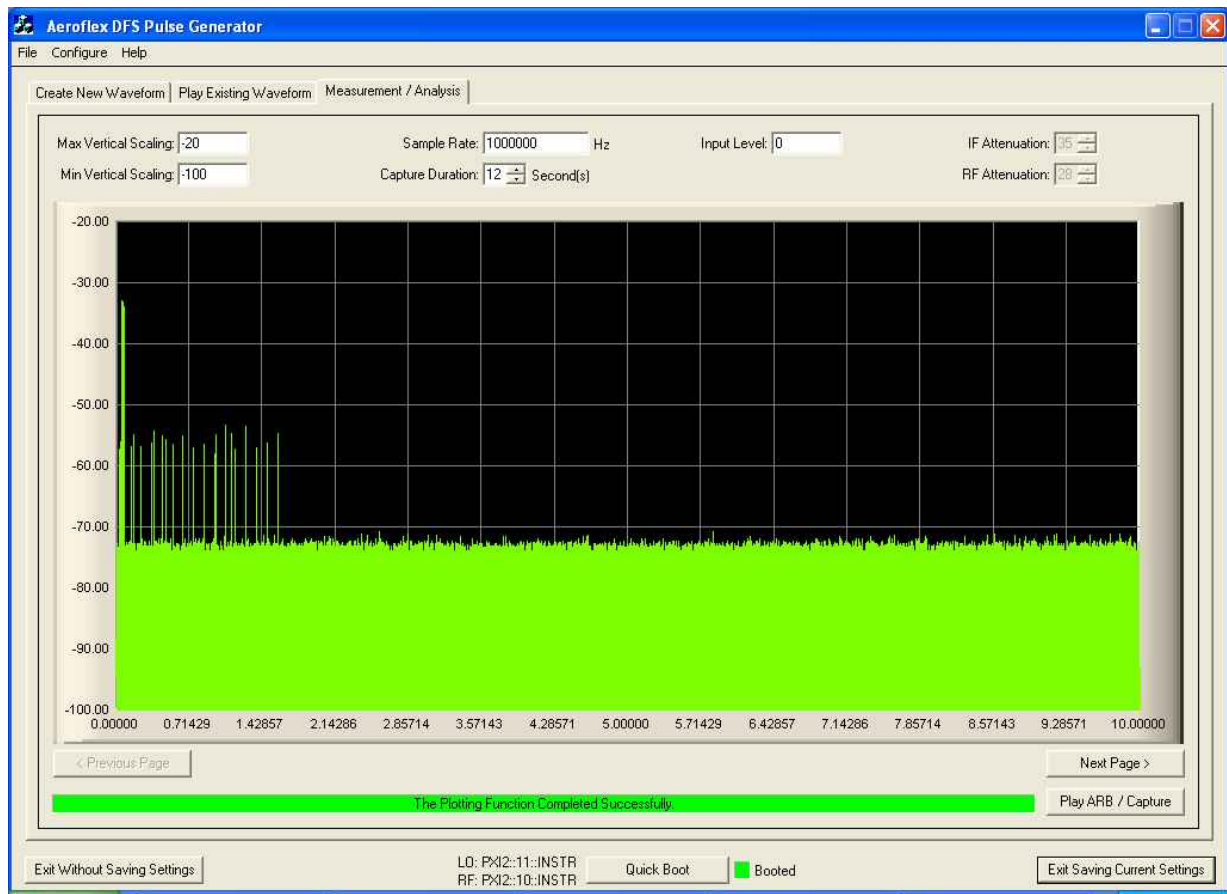

This test report may be reproduced in full only. The document may only be updated by MiCOM Labs personnel. Any changes will be noted in the Document History section of the report.



Title: Aruba AP-70 802.11 a/b/g Wireless AP
To: FCC 47 CFR Part 15.407
Serial #: ARUB13-A4 Rev A
Issue Date: 20th July 2007
Page: 114 of 130

The following data was captured by the Aeroflex PXI test System and is used to calculate the Channel Closing Transmission Time for the EUT with the intervention of Radar Type 1.

Only the "Start" and "End" data captured by the Aeroflex PXI system is shown for the sake of brevity in reporting the results.

Sample Number: 84270 Rising Edge,	Sample Time Stamp	0.084277	
Sample Number: 84278 Falling Edge,	Sample Time Stamp	0.084278	1E-06
Sample Number: 85698 Rising Edge,	Sample Time Stamp	0.085698	
Sample Number: 85705 Falling Edge,	Sample Time Stamp	0.085705	7E-06
Sample Number: 151426 Rising Edge,	Sample Time Stamp	0.151426	
Sample Number: 151428 Falling Edge,	Sample Time Stamp	0.151428	2E-06
Sample Number: 151429 Rising Edge,	Sample Time Stamp	0.151429	
Sample Number: 151431 Falling Edge,	Sample Time Stamp	0.151431	2E-06
Sample Number: 151432 Rising Edge,	Sample Time Stamp	0.151432	
Sample Number: 151433 Falling Edge,	Sample Time Stamp	0.151433	1E-06
Sample Number: 151435 Rising Edge,	Sample Time Stamp	0.151435	
Sample Number: 151436 Falling Edge,	Sample Time Stamp	0.151436	1E-06
Sample Number: 151438 Rising Edge,	Sample Time Stamp	0.151438	
Sample Number: 151439 Falling Edge,	Sample Time Stamp	0.151439	1E-06
Sample Number: 151440 Rising Edge,	Sample Time Stamp	0.15144	
Sample Number: 151444 Falling Edge,	Sample Time Stamp	0.151444	4E-06
Sample Number: 151445 Rising Edge,	Sample Time Stamp	0.151445	
Sample Number: 151447 Falling Edge,	Sample Time Stamp	0.151447	2E-06
Sample Number: 151448 Rising Edge,	Sample Time Stamp	0.151448	
Sample Number: 151451 Falling Edge,	Sample Time Stamp	0.151451	3E-06
Sample Number: 151452 Rising Edge,	Sample Time Stamp	0.151452	
Sample Number: 151453 Falling Edge,	Sample Time Stamp	0.151453	1E-06
Sample Number: 151454 Rising Edge,	Sample Time Stamp	0.151454	
Sample Number: 151455 Falling Edge,	Sample Time Stamp	0.151455	1E-06

This test report may be reproduced in full only. The document may only be updated by MiCOM Labs personnel. Any changes will be noted in the Document History section of the report.



Title: Aruba AP-70 802.11 a/b/g Wireless AP
To: FCC 47 CFR Part 15.407
Serial #: ARUB13-A4 Rev A
Issue Date: 20th July 2007
Page: 115 of 130

Sample Number: 1585143 Rising Edge,	Sample Time Stamp	1.585143	
Sample Number: 1585147 Falling Edge,	Sample Time Stamp	1.585147	4E-06
Sample Number: 1585148 Rising Edge,	Sample Time Stamp	1.585148	
Sample Number: 1585152 Falling Edge,	Sample Time Stamp	1.585152	4E-06
Sample Number: 1585153 Rising Edge,	Sample Time Stamp	1.585153	
Sample Number: 1585156 Falling Edge,	Sample Time Stamp	1.585156	3E-06
Sample Number: 1585157 Rising Edge,	Sample Time Stamp	1.585157	
Sample Number: 1585160 Falling Edge,	Sample Time Stamp	1.58516	3E-06
Sample Number: 1585162 Rising Edge,	Sample Time Stamp	1.585162	
Sample Number: 1585164 Falling Edge,	Sample Time Stamp	1.585164	2E-06
Sample Number: 1586598 Rising Edge,	Sample Time Stamp	1.586598	
Sample Number: 1586599 Falling Edge,	Sample Time Stamp	1.586599	1E-06
Sample Number: 1586600 Rising Edge,	Sample Time Stamp	1.5866	
Sample Number: 1586602 Falling Edge,	Sample Time Stamp	1.586602	2E-06
Sample Number: 1586603 Rising Edge,	Sample Time Stamp	1.586603	
Sample Number: 1586604 Falling Edge,	Sample Time Stamp	1.586604	1E-06
Sample Number: 1586605 Rising Edge,	Sample Time Stamp	1.586605	
Sample Number: 1586607 Falling Edge,	Sample Time Stamp	1.586607	2E-06
Sample Number: 1586608 Rising Edge,	Sample Time Stamp	1.586608	
Sample Number: 1586611 Falling Edge,	Sample Time Stamp	1.586611	3E-06
Sample Number: 1586612 Rising Edge,	Sample Time Stamp	1.586612	
Sample Number: 1586615 Falling Edge,	Sample Time Stamp	1.586615	3E-06
Sample Number: 1586617 Rising Edge,	Sample Time Stamp	1.586617	
Sample Number: 1586618 Falling Edge,	Sample Time Stamp	1.586618*	1E-06

Aggregate Closing Transmission Time = 0.001416

* Represents the last transmission activity of the EUT. The 1.586618* second time stamp is used to calculate Channel Move Time.

This test report may be reproduced in full only. The document may only be updated by MiCOM Labs personnel. Any changes will be noted in the Document History section of the report.



Title: Aruba AP-70 802.11 a/b/g Wireless AP
To: FCC 47 CFR Part 15.407
Serial #: ARUB13-A4 Rev A
Issue Date: 20th July 2007
Page: 116 of 130

Channel Move Time – Measurement & Calculation Type 1 Radar

The Channel Move Time is calculated using the data captured for the Channel Closing time as follows;-

$$\text{Channel Move Time} = Ft - Pt - Rt$$

Where;-

Ft = Final transmission activity occurred at 1.586618 Seconds

Pt = Pre-trigger information 60 mS

Rt = Type 1 burst period 24.277 mS

(Rt is the period of the 18 pulse burst includes [17 pulses *1.428mS PRI] = 24.276ms. Then add 1µs pulse width for the final pulse.)

$$\text{Channel Move Time} = 1.586618 - 0.060 - 0.024277 = \underline{\underline{1.502341 \text{ secs (Limit 10 secs)}}}$$

This test report may be reproduced in full only. The document may only be updated by MiCOM Labs personnel. Any changes will be noted in the Document History section of the report.

Channel Move Time, Channel Closing Transmission Time for Type 5 Radar

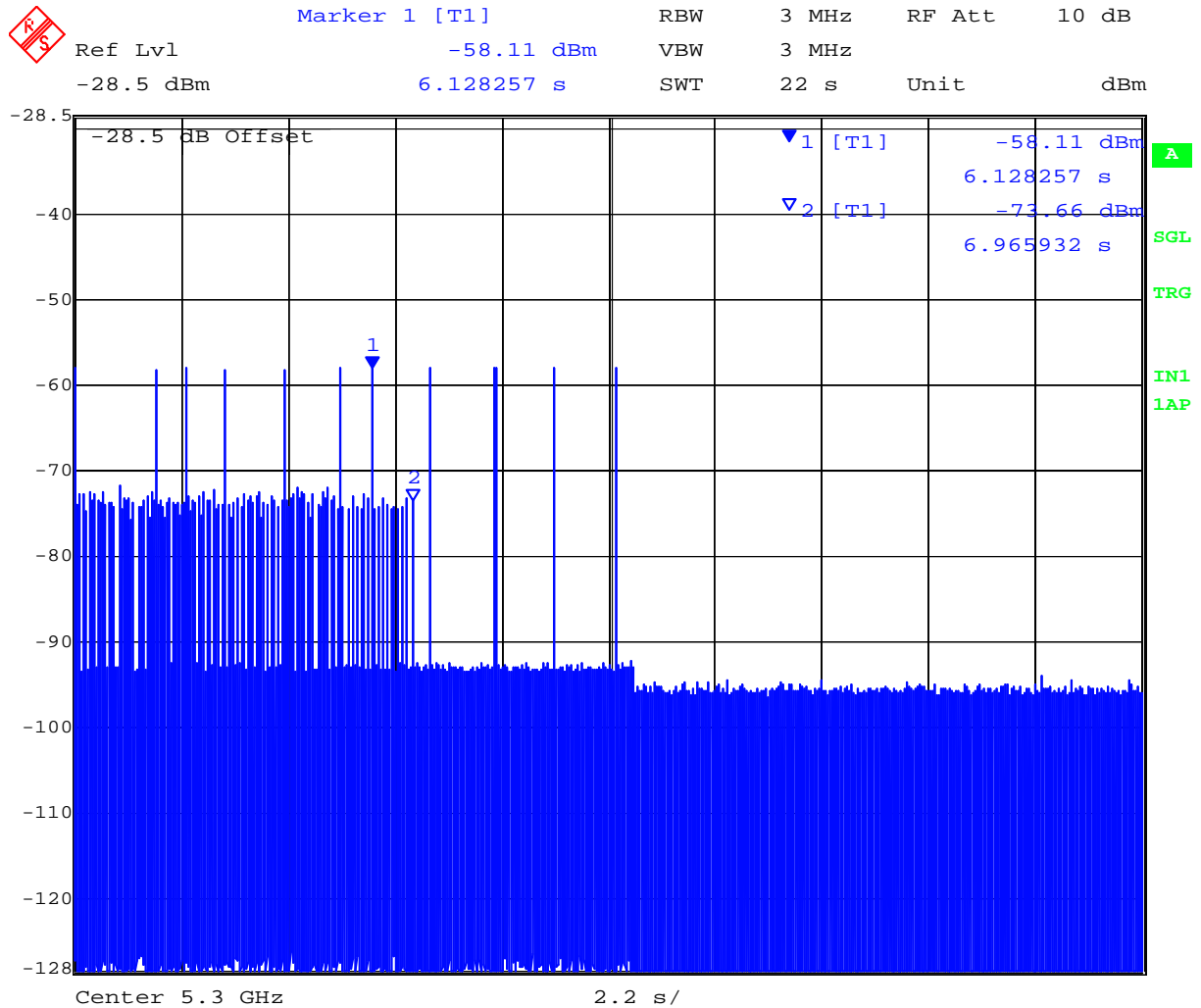

Date: 6.JUL.2007 18:40:14

With reference to the requirements of FCC MO & O 06-96;- The instant that the Chanel Move Time and Channel Closing Time begins for the long Pulse Radar Test Signal is the instant at the end of the 12 Second period defining the Radar Waveform. From the above plot is can be seen that the EUT stopped transmitting data before completion of the Radar Test Signal, therefore the Channel Closing Time and Channel Move time complies with the requirements.

By definition Channel Closing Transmission Time for Type 5 (Long Pulse) commences after the falling edge of the last radar pulse. Channel Closing Transmission Time = 0 secs.



30 Minute Non-Occupancy Period

The EUT is monitored for more than 30 minutes following the channel close/move time to verify no transmissions resume on this Channel.

30 Minute Non-Occupancy Period Type 1 Radar Ch 5300 MHz

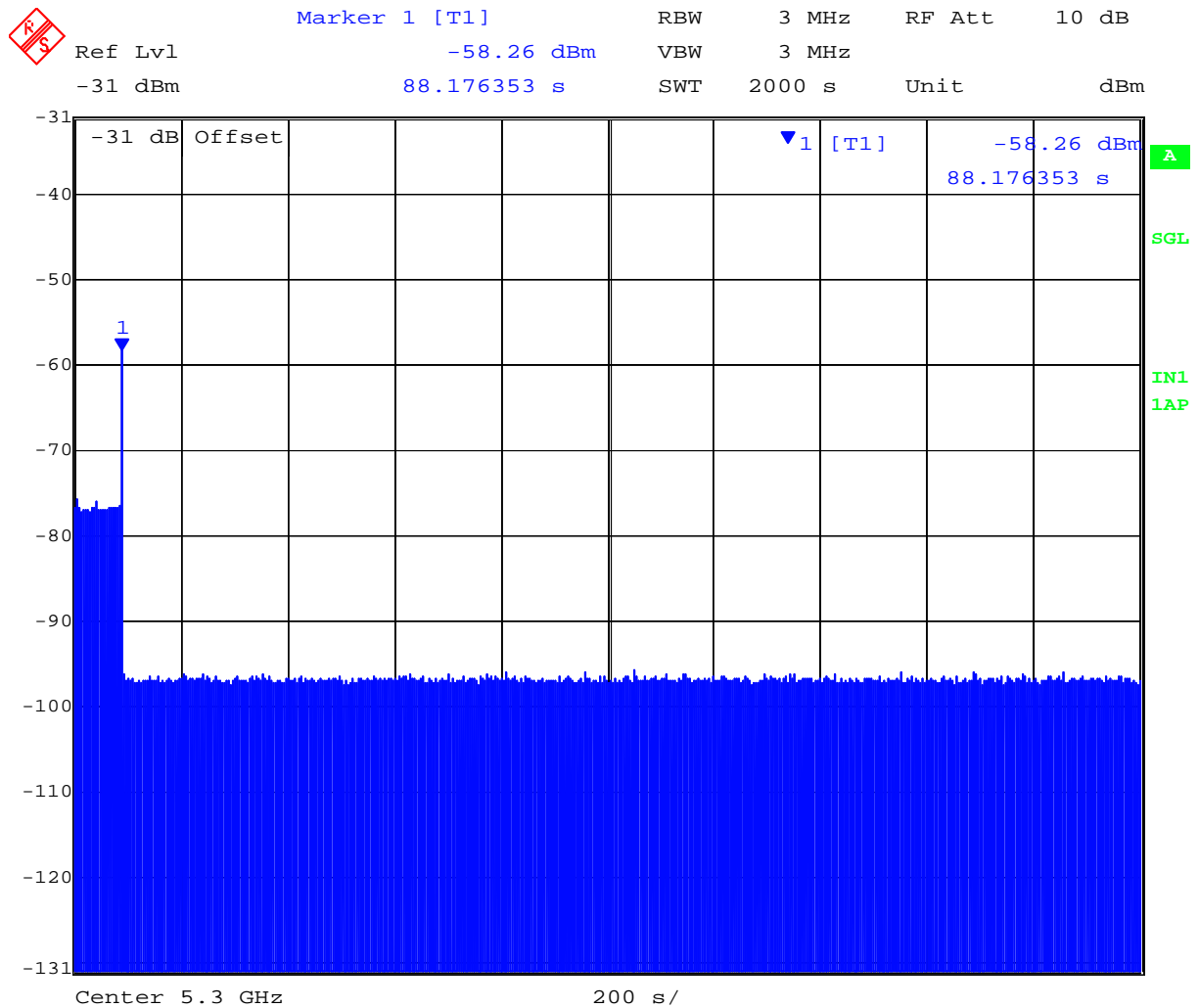

Date: 6.JUL.2007 19:48:29

This test report may be reproduced in full only. The document may only be updated by MiCOM Labs personnel. Any changes will be noted in the Document History section of the report.



Title: Aruba AP-70 802.11 a/b/g Wireless AP
To: FCC 47 CFR Part 15.407
Serial #: ARUB13-A4 Rev A
Issue Date: 20th July 2007
Page: 119 of 130

6.2.6. Statistical Performance Check

The steps below define the procedure to determine the minimum percentage of detection when a radar burst with a level equal to the DFS Detection Threshold is generated on the Operating Channel of the U-NII device.

A U-NII device operating as a Client Device will associate with the UUT (Master) at 5300 MHz. Stream the MPEG test file from the Master Device to the Client Device on the selected Channel for the entire period of the test.

The Radar Waveform generator sends the individual waveform for each of the radar types 1-6. Statistical data will be gathered to determine the ability of the device to detect the radar test waveforms. The device can utilize a test mode to demonstrate when detection occurs to prevent the need to reset the device between trial runs. The percentage of successful detection is calculated by:

Total # of detections ÷ Total # of Trials × 100 = Probability of Detection

The Minimum number of trails, minimum percentage of successful detection and the average minimum percentage of successful detection are found in the Radar Test Waveforms section.

This test report may be reproduced in full only. The document may only be updated by MiCOM Labs personnel. Any changes will be noted in the Document History section of the report.



Radar Type 2 - Verification of Detection

Trail #	Detection = 1, No Detection = 0			
	Type 1	Type 2	Type 3	Type 4
1	1	1	1	1
2	1	1	1	0
3	1	1	1	1
4	1	1	0	1
5	1	1	1	1
6	0	0	1	1
7	1	1	1	1
8	1	1	1	1
9	1	1	1	1
10	0	1	1	1
11	1	1	1	1
12	1	1	1	1
13	1	1	1	1
14	0	1	1	1
15	1	1	1	1
16	1	1	0	1
17	1	1	1	1
18	1	1	1	1
19	1	1	1	0
20	1	1	1	1
21	1	1	1	1
22	1	1	1	1
23	0	1	1	1
24	1	1	0	1
25	1	1	1	1
26	0	1	1	1
27	1	1	1	0
28	1	1	1	1
29	1	0	1	1
30	1	1	1	1
Detection Percentage	83.3% (>60%)	93.3% (>60%)	90% (>60%)	90% (>60%)

In addition an average minimum percentage of successful detection across all four Short pulse radar test waveforms is required and calculated as follows;

$$(P_{d1} + P_{d2} + P_{d3} + P_{d4}) / 4 = (83.3\% + 93.3\% + 90\% + 90\%) / 4 = 89.15\% (> 80\%)$$

This test report may be reproduced in full only. The document may only be updated by MiCOM Labs personnel. Any changes will be noted in the Document History section of the report.



Title: Aruba AP-70 802.11 a/b/g Wireless AP
To: FCC 47 CFR Part 15.407
Serial #: ARUB13-A4 Rev A
Issue Date: 20th July 2007
Page: 121 of 130

Radar Type 5 - Verification of Detection

Trail #	Detection = 1 No Detection = 0
1	1
2	1
3	1
4	1
5	1
6	1
7	1
8	1
9	1
10	1
11	1
12	1
13	1
14	1
15	1
16	1
17	1
18	1
19	1
20	1
21	1
22	1
23	1
24	1
25	1
26	1
27	1
28	1
29	1
30	1
Detection Percentage	100% (>60%)

This test report may be reproduced in full only. The document may only be updated by MiCOM Labs personnel. Any changes will be noted in the Document History section of the report.



Title: Aruba AP-70 802.11 a/b/g Wireless AP
To: FCC 47 CFR Part 15.407
Serial #: ARUB13-A4 Rev A
Issue Date: 20th July 2007
Page: 122 of 130

Radar Type 6 - Verification of Detection

Trail #	Detection = 1 No Detection = 0
1	1
2	1
3	1
4	1
5	0
6	1
7	1
8	1
9	0
10	1
11	1
12	1
13	0
14	1
15	1
16	1
17	1
18	1
19	1
20	1
21	1
22	0
23	1
24	0
25	0
26	1
27	1
28	1
29	1
30	1
Detection Percentage	80% (>60%)

This test report may be reproduced in full only. The document may only be updated by MiCOM Labs personnel. Any changes will be noted in the Document History section of the report.



Title: Aruba AP-70 802.11 a/b/g Wireless AP
To: FCC 47 CFR Part 15.407
Serial #: ARUB13-A4 Rev A
Issue Date: 20th July 2007
Page: 123 of 130

Measurement Uncertainty Time/Power

Measurement uncertainty	
- Time	4%
- Power	1.33dB

Traceability

Test Equipment Used

0072, 0083, 0098, 0116, 0132, 0158, 0313, 0314, 0193, 0223, 0252, 0253, 0251, 0256, 0328, 0329

This test report may be reproduced in full only. The document may only be updated by MiCOM Labs personnel. Any changes will be noted in the Document History section of the report.

7. PHOTOGRAPHS

7.1. Radiated Spurious Emissions



All ports had appropriate cables connected

7.2. AC Wireline Emissions (150 kHz - 30 MHz)

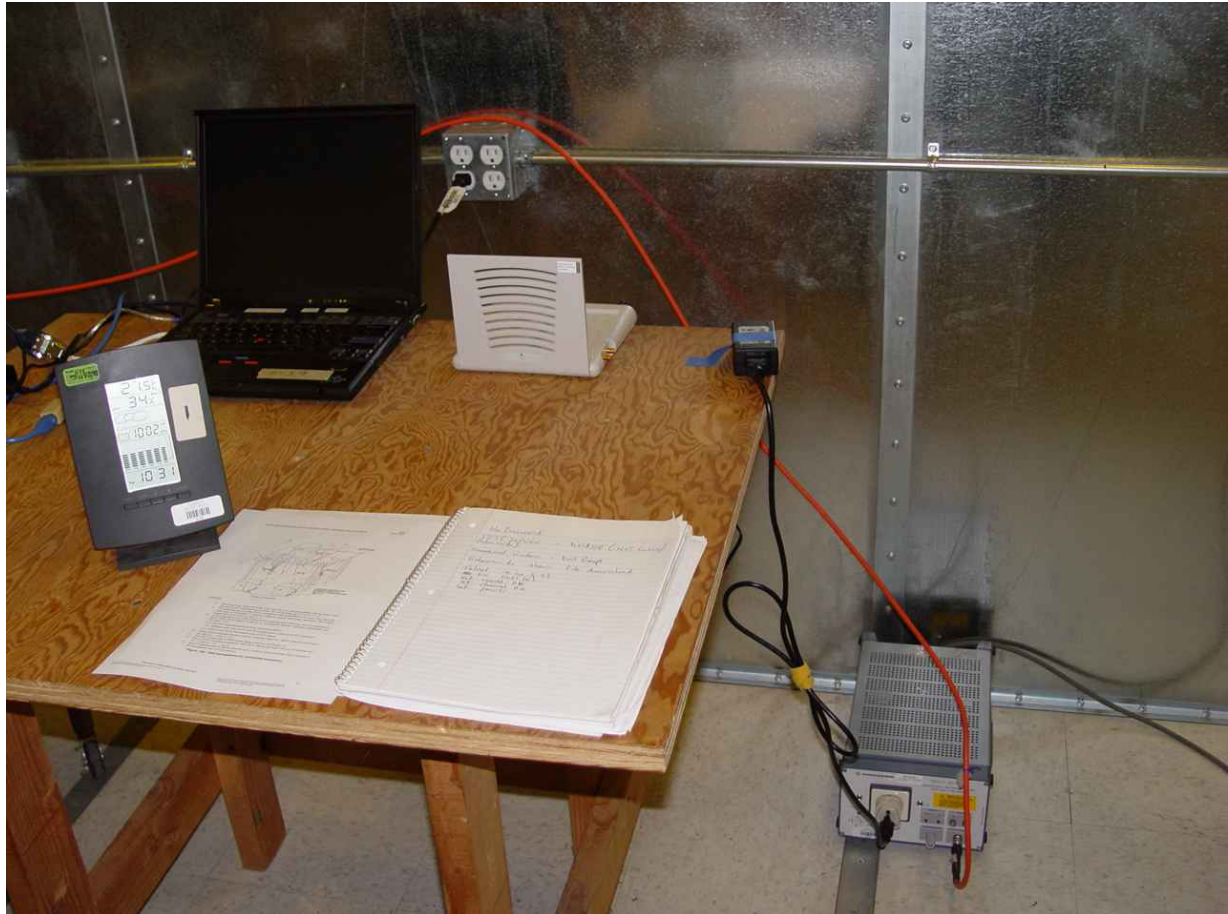

This test report may be reproduced in full only. The document may only be updated by MiCOM Labs personnel. Any changes will be noted in the Document History section of the report.

7.3. General Measurement Test Set-Up



This test report may be reproduced in full only. The document may only be updated by MiCOM Labs personnel. Any changes will be noted in the Document History section of the report.

7.4. Dynamic Frequency Selection Test Set-Up

General DFS Test Setup

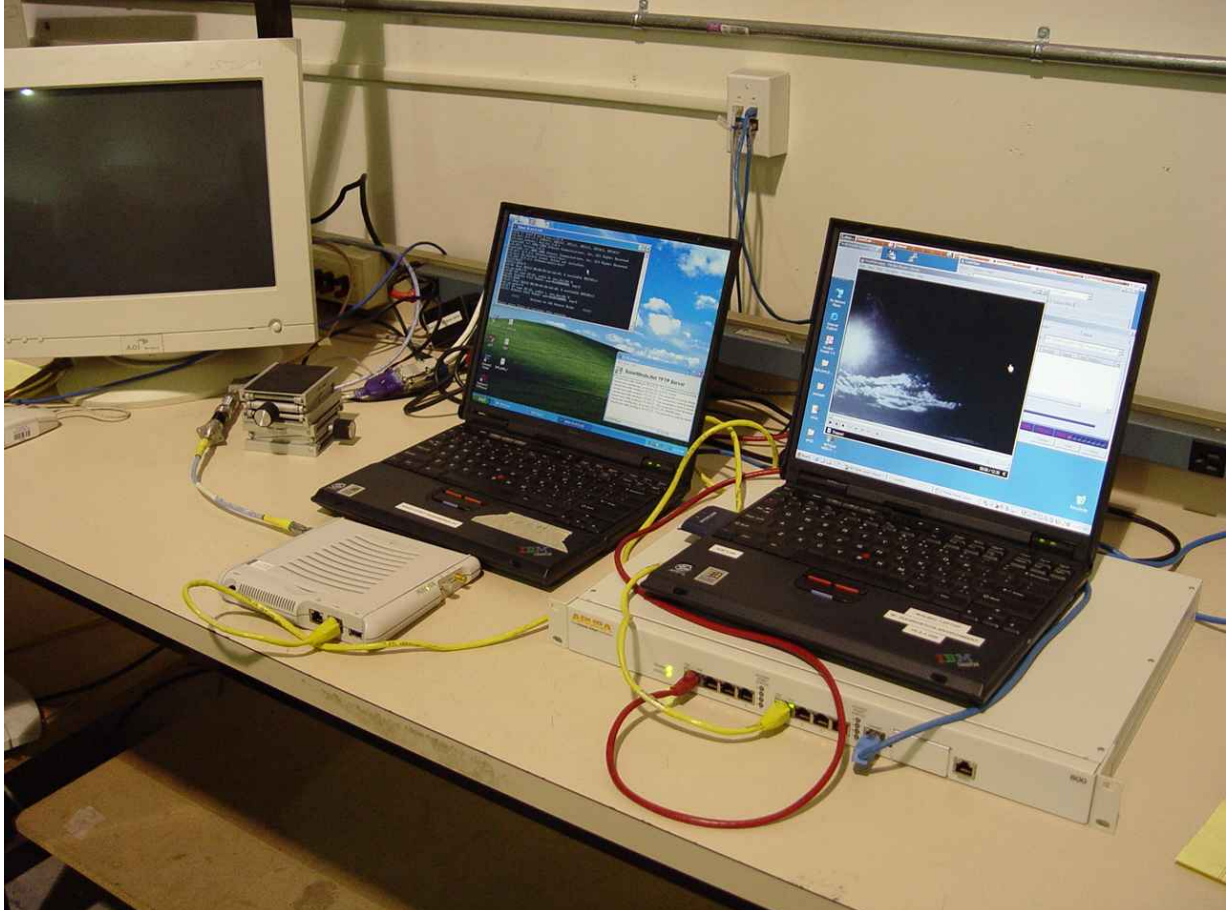

This test report may be reproduced in full only. The document may only be updated by MiCOM Labs personnel. Any changes will be noted in the Document History section of the report.

DFS Test Equipment

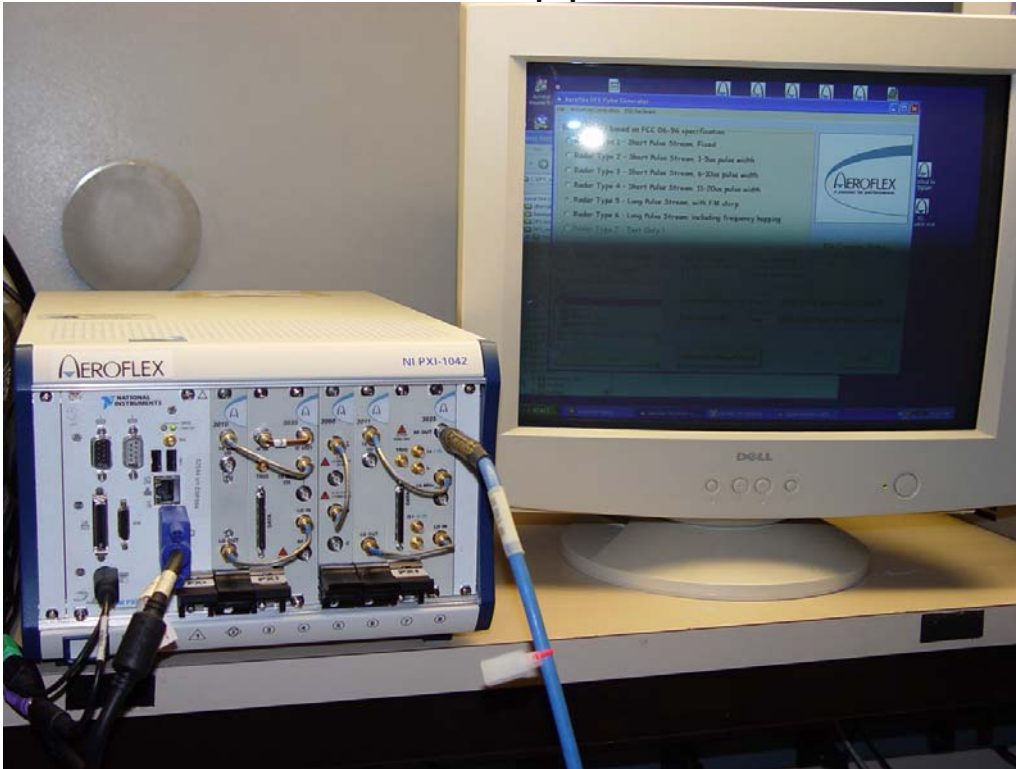

DFS Test Equipment



This test report may be reproduced in full only. The document may only be updated by MiCOM Labs personnel. Any changes will be noted in the Document History section of the report.



Title: Aruba AP-70 802.11 a/b/g Wireless AP
To: FCC 47 CFR Part 15.407
Serial #: ARUB13-A4 Rev A
Issue Date: 20th July 2007
Page: 129 of 130

8. TEST EQUIPMENT DETAILS

Asset #	Instrument	Manufacturer	Part #	Serial #
0088	Spectrum Analyzer	Hewlett Packard	8564E	3410A00141
0134	Amplifier	Com Power	PA 122	181910
0158	Barometer /Thermometer	Control Co.	4196	E2846
0193	EMI Receiver	Rhode & Schwartz	ESI 7	838496/007
0252	SMA Cable	Megaphase	Sucoflex 104	None
0310	2m SMA Cable	Micro-Coax	UFA210A-0-0787-3G03G0	209089-001
0312	3m SMA Cable	Micro-Coax	UFA210A-1-1181-3G0300	209092-001
0313	Coupler	Hewlett Packard	86205A	3140A01285
0314	30dB N-Type Attenuator	ARRA	N9444-30	1623
0070	Power Meter	Hewlett Packard	437B	3125U11552
0116	Power Sensor	Hewlett Packard	8485A	3318A19694
0117	Power Sensor	Hewlett Packard	8487D	3318A00371
0184	Pulse Limiter	Rhode & Schwartz	ESH3Z2	357.8810.52
0190	LISN	Rhode & Schwartz	ESH3Z5	836679/006
0293	BNC Cable	Megaphase	1689 1GVT4	15F50B001
0301	5.6 GHz Notch Filter	Micro-Tronics	RBC50704	001
0302	5.25 GHz Notch Filter	Micro-Tronics	BRC50703	002
0303	5.8 GHz Notch Filter	Micro-Tronics	BRC50705	003
0304	2.4GHzHz Notch Filter	Micro-Tronics	--	001
0307	BNC Cable	Megaphase	1689 1GVT4	15F50B002
0335	1-18GHz Horn Antenna	ETS- Lindgren	3117	00066580
0337	Amplifier	MiCOM Labs	--	--
0338	Antenna	Sunol Sciences	JB-3	A052907

This test report may be reproduced in full only. The document may only be updated by MiCOM Labs personnel. Any changes will be noted in the Document History section of the report.



440 Boulder Court, Suite 200
Pleasanton, CA 94566, USA
Tel: 1.925.462.0304
Fax: 1.925.462.0306
www.micomlabs.com