



RF MEASUREMENT REPORT

FCC ID: Q9DAPIN0503
Applicant: Hewlett Packard Enterprise Company
Product: ACCESS POINT
Model No.: APIN0503
Trademark:  
FCC Classification: Unlicensed National Information Infrastructure (NII)
FCC Rule Part(s): Part 15 Subpart E (Section 15.407)
Result: Complies
Received Date: 2022-12-19
Test Date: 2022-12-19 ~ 2023-04-03

Reviewed By:

Jame Yuan

Approved By:

Robin Wu



The test results relate only to the samples tested.

This equipment has been shown to be capable of compliance with the applicable technical standards as indicated in the measurement report and was tested in accordance with the measurement procedures specified in KDB789033. Test results reported herein relate only to the item(s) tested.

The test report shall not be reproduced except in full without the written approval of MRT Technology (Suzhou) Co., Ltd.

Revision History

Report No.	Version	Description	Issue Date	Note
2212RSU034-U2	V01	Initial Report	2023-04-03	Valid

CONTENTS

Description	Page
1. General Information	6
1.1. Applicant	6
1.2. Manufacturer.....	6
1.3. Testing Facility	6
1.4. Product Information	7
1.5. Radio Specification under Test.....	7
1.6. Working Frequencies.....	8
1.7. Antenna Details	9
2. Test Configuration	10
2.1. Test Mode	10
2.2. Test System Connection Diagram	11
2.3. Applied Standards	11
2.4. Test Environment Condition.....	12
3. Antenna Requirements	13
4. Measuring Instrument	14
5. Decision Rules and Measurement Uncertainty	15
5.1. Decision Rules.....	15
5.2. Measurement Uncertainty	15
6. Test Result.....	16
6.1. Summary	16
6.2. 26dB & 99% Bandwidth Measurement.....	17
6.2.1. Test Limit.....	17
6.2.2. Test Procedure	17
6.2.3. Test Setting	17
6.2.4. Test Setup.....	18
6.2.5. Test Result	18
6.3. 6dB Bandwidth Measurement	19
6.3.1. Test Limit.....	19
6.3.2. Test Procedure	19
6.3.3. Test Setting	19
6.3.4. Test Setup.....	19
6.3.5. Test Result	19
6.4. Output Power Measurement.....	20
6.4.1. Test Limit.....	20
6.4.2. Test Procedure	20

6.4.3.	Test Setting	20
6.4.4.	Test Setup	20
6.4.5.	Test Result	20
6.5.	Transmit Power Control Measurement	21
6.5.1.	Test Limit.....	21
6.5.2.	Test Procedure	21
6.5.3.	Test Setting	21
6.5.4.	Test Setup.....	21
6.5.5.	Test Result	21
6.6.	Power Spectral Density Measurement	22
6.6.1.	Test Limit.....	22
6.6.2.	Test Procedure	22
6.6.3.	Test Setting	22
6.6.4.	Test Setup.....	23
6.6.5.	Test Result	23
6.7.	Frequency Stability Measurement	24
6.7.1.	Test Limit.....	24
6.7.2.	Test Procedure	24
6.7.3.	Test Setup.....	24
6.7.4.	Test Result	25
6.8.	Radiated Spurious Emission Measurement	26
6.8.1.	Test Limit.....	26
6.8.2.	Test Procedure	26
6.8.3.	Test Setting	26
6.8.4.	Test Setup.....	28
6.8.5.	Test Result	29
6.9.	Radiated Restricted Band Edge Measurement	30
6.9.1.	Test Limit.....	30
6.9.2.	Test Procedure	32
6.9.3.	Test Setting	32
6.9.4.	Test Setup.....	33
6.9.5.	Test Result	33
6.10.	AC Conducted Emissions Measurement.....	34
6.10.1.	Test Limit.....	34
6.10.2.	Test Setup.....	34
6.10.3.	Test Result	34
Appendix A – Test Result		35
A.1	Duty Cycle Test Result	35
A.2	26dB Bandwidth Test Result	37

A.3	6dB Bandwidth Test Result	53
A.4	Output Power Test Result	59
A.5	Power Spectral Density Test Result.....	62
A.6	Frequency Stability Test Result.....	89
A.7	Radiated Spurious Emission Test Result	90
A.8	Radiated Restricted Band Edge Test Result.....	171
A.9	AC Conducted Emissions Test Result	293
Appendix B – Test Setup Photograph		295
Appendix C – EUT Photograph		296

1. General Information

1.1. Applicant

Hewlett Packard Enterprise Company
6280 America Center Drive, San Jose CA 95002, United States

1.2. Manufacturer

Hewlett Packard Enterprise Company
6280 America Center Drive, San Jose CA 95002, United States

1.3. Testing Facility

<input checked="" type="checkbox"/>	Test Site – MRT Suzhou Laboratory
	Laboratory Location (Suzhou - Wuzhong) D8 Building, No.2 Tian'edang Rd., Wuzhong Economic Development Zone, Suzhou, China
	Laboratory Location (Suzhou - SIP) 4b Building, Liando U Valley, No.200 Xingpu Rd., Shengpu Town, Suzhou Industrial Park, China
	Laboratory Accreditations
	A2LA: 3628.01 CNAS: L10551
	FCC: CN1166 ISED: CN0001
	VCCI: <input type="checkbox"/> R-20025 <input type="checkbox"/> G-20034 <input type="checkbox"/> C-20020 <input type="checkbox"/> T-20020 <input type="checkbox"/> R-20141 <input type="checkbox"/> G-20134 <input type="checkbox"/> C-20103 <input type="checkbox"/> T-20104
<input type="checkbox"/>	Test Site – MRT Shenzhen Laboratory
	Laboratory Location (Shenzhen) 1G, Building A, Junxiangda Building, Zhongshanyuan Road West, Nanshan District, Shenzhen, China
	Laboratory Accreditations
	A2LA: 3628.02 CNAS: L10551
	FCC: CN1284 ISED: CN0105
<input type="checkbox"/>	Test Site – MRT Taiwan Laboratory
	Laboratory Location (Taiwan) No. 38, Fuxing 2nd Rd., Guishan Dist., Taoyuan City 333, Taiwan (R.O.C.)
	Laboratory Accreditations
	TAF: L3261-190725
	FCC: 291082, TW3261 ISED: TW3261

1.4. Product Information

Product Name	ACCESS POINT
Model No.	APIN0503
Serial No.	CNPMLGQ02T
Software Version	v0.1.8
Wi-Fi Specification	802.11a/b/g/n/ac/ax
Antenna Information	Refer to Clause 1.7
Working Voltage	PoE Input
Operating Temp.	0 ~ 40 °C
Operating Environment	Indoor Use
Accessory	
PoE Injector	Model: ADH-15CR BA Input: 100-240V ~ 0.6A 50/60Hz Output: 55.0V==0.28A 15.4W
Note 1: The information of EUT was provided by the manufacturer, and the accuracy of the information shall be the responsibility of the manufacturer. Note 2: PoE Injector are not sold with the product.	

1.5. Radio Specification under Test

Frequency Range	For 802.11a/n-HT20/ac-VHT20/ax-HE20: 5180~5240MHz, 5260~5320MHz, 5500~5720MHz, 5745~5825MHz For 802.11n-HT40/ac-VHT40/ax-HE40: 5190~5230MHz, 5270~5310MHz, 5510~5710MHz, 5755~5795MHz For 802.11ac-VHT80/ax-HE80: 5210MHz, 5290MHz, 5530MHz, 5610 MHz, 5690MHz, 5775MHz	
Type of Modulation	802.11a/n/ac: OFDM 802.11ax: OFDMA	
Data Rate	802.11a: 6/9/12/18/24/36/48/54Mbps 802.11n: up to 300Mbps 802.11ac: up to 866.7Mbps 802.11ax: up to 1201Mbps	
Channel Puncturing Function	<input type="checkbox"/> Supported	<input checked="" type="checkbox"/> Unsupported
Support RU	<input checked="" type="checkbox"/> Full RU	<input type="checkbox"/> Partial RU

1.6. Working Frequencies

802.11a/n-HT20/ac-VHT20/ax-HE20

Channel	Frequency	Channel	Frequency	Channel	Frequency
36	5180 MHz	40	5200 MHz	44	5220 MHz
48	5240 MHz	52	5260 MHz	56	5280 MHz
60	5300 MHz	64	5320 MHz	100	5500 MHz
104	5520 MHz	108	5540 MHz	112	5560 MHz
116	5580 MHz	120	5600 MHz	124	5620 MHz
128	5640 MHz	132	5660 MHz	136	5680 MHz
140	5700 MHz	144	5720 MHz	149	5745 MHz
153	5765 MHz	157	5785 MHz	161	5805 MHz
165	5825 MHz	--	--	--	--

802.11n-HT40/ac-VHT40/ax-HE40

Channel	Frequency	Channel	Frequency	Channel	Frequency
38	5190 MHz	46	5230 MHz	54	5270 MHz
62	5310 MHz	102	5510 MHz	110	5550MHz
118	5590 MHz	126	5630 MHz	134	5670 MHz
142	5710 MHz	151	5755 MHz	159	5795 MHz

802.11ac-VHT80/ax-HE80

Channel	Frequency	Channel	Frequency	Channel	Frequency
42	5210 MHz	58	5290 MHz	106	5530 MHz
122	5610 MHz	138	5690 MHz	155	5775 MHz

1.7. Antenna Details

Antenna Type	Frequency Band (MHz)	Tx Paths	Max Antenna Gain (dBi)	CDD Directional Gain (dBi)	
				For Power	For PSD
PIFA Antenna	2412 ~ 2462	2	1.5	1.5	4.5
	5150 ~ 5895	2	3.9	3.9	6.9

Note:

- 1, The EUT supports Cyclic Delay Diversity (CDD) mode, and CDD signals are correlated.
- 2, The EUT also supports Beam Forming mode, and the Beam Forming support 802.11n/ac/ax, not include 802.11a/b/g.
3. For beamforming operation, Aruba OS automatically backs power down based on a $10\log(N)$ factor based on CDD power.
4. Refer to antenna specification for the detail calculation method of directional gain.

2. Test Configuration

2.1. Test Mode

Mode 1: Transmit by 802.11a_N _{ss} =1 (6Mbps)
Mode 2: Transmit by 802.11ac-VHT20_N _{ss} =1 (MCS0)
Mode 3: Transmit by 802.11ac-VHT40_N _{ss} =1 (MCS0)
Mode 4: Transmit by 802.11ac-VHT80_N _{ss} =1 (MCS0)
Mode 5: Transmit by 802.11ax-HE20_N _{ss} =1 (MCS0)
Mode 6: Transmit by 802.11ax-HE40_N _{ss} =1 (MCS0)
Mode 7: Transmit by 802.11ax-HE80_N _{ss} =1 (MCS0)
Remark: <ol style="list-style-type: none">1. All modes of operation and data rates were investigated, so all RF test requirements shall be executed at the worst data rate.2. For beamforming operation, manufacturer automatically backs power down based on a $10\log(N_{ANT})$ factor based on CDD power. Therefore, only the CDD mode was evaluated in this report.

2.2. Test System Connection Diagram

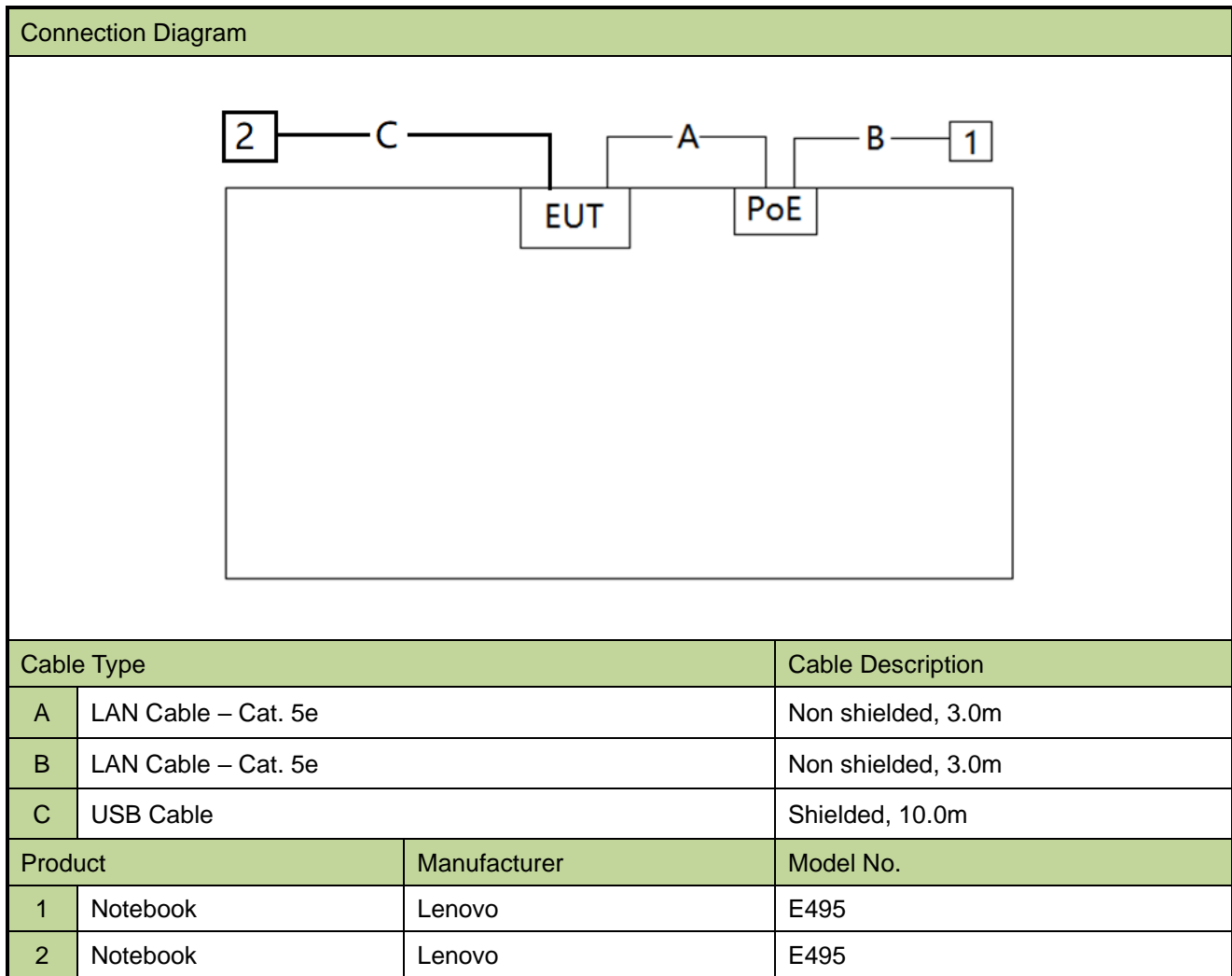

Note 1: The test utility software used during testing was “accessMTool.exe”, and the version was 3.2.1.4.

Note 2: Detail power setting refer to operation description.

2.3. Applied Standards

According to the specifications of the manufacturer, the EUT must comply with the requirements of the following standards:

- FCC Part 15.407
- KDB 789033 D02v02r01
- KDB 662911 D01v02r01
- ANSI C63.10-2013

2.4. Test Environment Condition

Ambient Temperature	15 ~ 35°C
Relative Humidity	20 ~ 75%RH

3. Antenna Requirements

Excerpt from §15.203 of the FCC Rules/Regulations:

“An intentional radiator antenna shall be designed to ensure that no antenna other than that furnished by the responsible party can be used with the device. The use of a permanently attached antenna or of an antenna that uses a unique coupling to the intentional radiator shall be considered sufficient to comply with the provisions of this section.”

- The antenna of the device is **permanently attached**.
- There are no provisions for connection to an external antenna.

Conclusion:

The unit complies with the requirement of §15.203.

4. Measuring Instrument

Instrument	Manufacturer	Model No.	Asset No.	Cali. Interval	Cali. Due Date	Test Site
EMI Test Receiver	R&S	ESR3	MRTSUE06185	1 year	2023-12-28	SIP-AC2
Preamplifier	EMCI	EMC184045SE	MRTSUE06602	1 year	2023-10-10	SIP-AC2
Loop Antenna	Schwarzbeck	FMZB 1519 B	MRTSUE06937	1 year	2023-03-14	SIP-AC2
				1 year	2024-02-26	SIP-AC2
Signal Analyzer	Keysight	N9010B	MRTSUE06559	1 year	2023-06-01	SIP-AC2
Horn Antenna	Schwarzbeck	BBHA 9170	MRTSUE06598	1 year	2023-11-05	SIP-AC2
Thermohygrometer	testo	608-H1	MRTSUE06623	1 year	2023-11-27	SIP-AC2
Thermohygrometer	testo	608-H1	MRTSUE06624	1 year	2023-11-27	SIP-AC2
TRILOG Antenna	Schwarzbeck	VULB 9168	MRTSUE06647	1 year	2023-07-13	SIP-AC2
Anechoic Chamber	RIKEN	SIP-AC2	MRTSUE06781	1 year	2023-12-22	SIP-AC2
Signal Analyzer	Keysight	N9010B	MRTSUE06603	1 year	2023-10-25	SIP-AC3
Horn Antenna	R&S	HF907	MRTSUE06611	1 year	2023-07-30	SIP-AC3
Thermohygrometer	testo	608-H1	MRTSUE06619	1 year	2023-11-01	SIP-AC3
Thermohygrometer	testo	608-H1	MRTSUE06622	1 year	2023-11-27	SIP-AC3
Preamplifier	EMCI	EMC012645SE	MRTSUE06642	1 year	2023-01-13	SIP-AC3
Anechoic Chamber	RIKEN	SIP-AC3	MRTSUE06782	1 year	2023-12-22	SIP-AC3
Two-Line V-Network	R&S	ENV216	MRTSUE06003	1 year	2023-06-01	SIP-SR2
EMI Test Receiver	R&S	ESR3	MRTSUE06612	1 year	2023-06-01	SIP-SR2
Thermohygrometer	testo	608-H1	MRTSUE06621	1 year	2023-11-27	SIP-SR2
Shielding Room	MIX-BEP	SIP-SR2	MRTSUE06949	5 years	2024-10-23	SIP-SR2
Signal Analyzer	Keysight	N9010B	MRTSUE06558	1 year	2023-06-01	SIP-TR1
Thermohygrometer	testo	608-H1	MRTSUE11022	1 year	2023-11-01	SIP-TR1
USB Power Sensor	Keysight	U2021XA	MRTSUE06596	1 year	2023-08-23	SIP-TR1

Software	Version	Function
EMI V3	V3.0.0	EMI Test Software
Controller_MF 7802BS	1.02	RE Antenna & Turntable
Agilent Power Analyzer/Agilent Power Panel	V R03.09.00	Power

5. Decision Rules and Measurement Uncertainty

5.1. Decision Rules

The Decision Rule is based on Simple Acceptance in accordance with ISO Guide 98-4: 2012 Clause 8.2. (Measurement uncertainty is not taken into account when stating conformity with a specified requirement.)

5.2. Measurement Uncertainty

Where relevant, the following test uncertainty levels have been estimated for tests performed on the EUT as specified in CISPR 16-4-2. This uncertainty represents an expanded uncertainty expressed at approximately the 95% confidence level using a coverage factor of $k = 2$.

AC Conducted Emission Measurement
Measurement Uncertainty for a Level of Confidence of 95% ($U=2Uc(y)$): 9kHz~150kHz: 3.58dB 150kHz~30MHz: 3.20dB
Radiated Disturbance
Measurement Uncertainty for a Level of Confidence of 95% ($U=2Uc(y)$): Coaxial: 9kHz~30MHz: 2.59dB Coplanar: 9kHz~30MHz: 2.60dB Horizontal: 30MHz~300MHz: 3.85dB 300MHz~1GHz: 4.36dB 1GHz~40GHz: 4.98dB Vertical: 30MHz~300MHz: 4.06dB 300MHz~1GHz: 5.28dB 1GHz~40GHz: 4.91dB
Spurious Emissions, Conducted
Measuring Uncertainty for a Level of Confidence of 95% ($U=2Uc(y)$): 2.3dB
Output Power
Measuring Uncertainty for a Level of Confidence of 95% ($U=2Uc(y)$): 1.5dB
Power Spectrum Density
Measuring Uncertainty for a Level of Confidence of 95% ($U=2Uc(y)$): 2.3dB
Occupied Bandwidth
Measuring Uncertainty for a Level of Confidence of 95% ($U=2Uc(y)$): 3.2%

6. Test Result

6.1. Summary

FCC Section(s)	Test Description	Test Condition	Verdict
15.407(a)	26dB Bandwidth	Conducted	Pass
15.407(e)	6dB Bandwidth		Pass
15.407(a)(1)(ii), (2), (3)(i)	Maximum Conducted Output Power		Pass
15.407(h)(1)	Transmit Power Control		Pass
15.407(a)(1)(ii), (2), (3)(i), (12)	Peak Power Spectral Density		Pass
15.407(b)(1), (2), (3), (4)(i)	Undesirable Emissions		Pass
15.205, 15.209 15.407(b)(8), (9), (10)	General Field Strength Limits (Restricted Bands and Radiated Emission Limits)	Radiated	Pass
15.207	AC Conducted Emissions 150kHz - 30MHz	Line Conducted	Pass

Remark:

- The analyzer plots shown in this section were all taken with a correction table loaded into the analyzer. The correction table was used to account for the losses of the cables and attenuators used as part of the system to connect the EUT to the analyzer at all frequencies of interest.
- For radiated emission test, every axis (X, Y, Z) was also verified. The test results shown in the following sections represent the worst-case emissions.

6.2. 26dB & 99% Bandwidth Measurement

6.2.1. Test Limit

N/A

6.2.2. Test Procedure

KDB 789033 D02v02r01- Section II)C)1) (26dB Bandwidth)

KDB 789033 D02v02r01- Section II)D) (99% Bandwidth)

6.2.3. Test Setting

26dB Bandwidth

1. The analyzers' automatic bandwidth measurement capability was used to perform the 26dB bandwidth
2. RBW = approximately 1% of the emission bandwidth.
3. VBW > RBW
4. Detector = Peak.
5. Trace mode = max hold.
6. Measure the maximum width of the emission that is 26 dB down from the maximum of the emission.
Compare this with the RBW setting of the analyzer. Readjust RBW and repeat measurement as needed until the RBW/EBW ratio is approximately 1%.

99% Bandwidth

1. Set center frequency to the nominal EUT channel center frequency.
2. RBW = 1% to 5% of the OBW
3. VBW $\geq 3 \times$ RBW
4. Span = 1.5 times to 5 times the OBW
5. Detector = peak
6. Trace mode = max hold
7. Allow the trace to stabilize
8. Use the 99% power bandwidth function of the instrument.

6.2.4. Test Setup

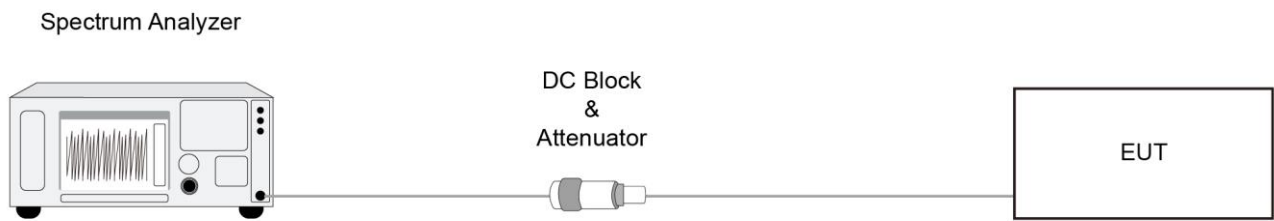

6.2.5. Test Result

Refer to Appendix A.2.

6.3. 6dB Bandwidth Measurement

6.3.1. Test Limit

The minimum 6dB bandwidth shall be at least 500 kHz.

6.3.2. Test Procedure

KDB 789033 D02v02r01- Section II)C)2)

6.3.3. Test Setting

1. Set center frequency to the nominal EUT channel center frequency.
2. RBW = 100 kHz.
3. VBW $\geq 3 \times$ RBW.
4. Detector = Peak.
5. Trace mode = max hold.
6. Sweep = auto couple.
7. Allow the trace to stabilize.
8. Measure the maximum width of the emission that is constrained by the frequencies associated with the two outermost amplitude points (upper and lower frequencies) that are attenuated by 6 dB relative to the maximum level measured in the fundamental emission.

6.3.4. Test Setup

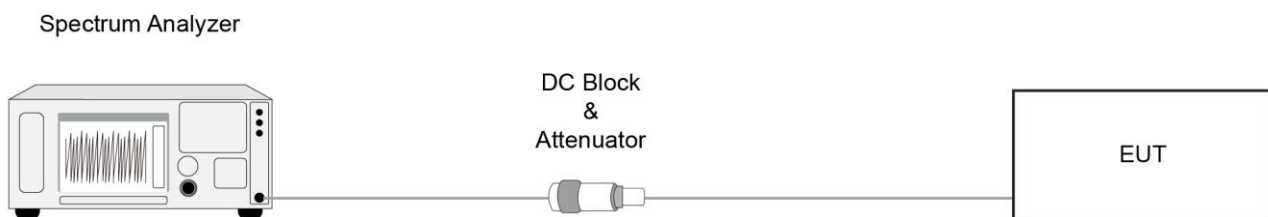

6.3.5. Test Result

Refer to Appendix A.3.

6.4. Output Power Measurement

6.4.1. Test Limit

For the band 5.15-5.25 GHz, the maximum conducted output power over the frequency band of operation shall not exceed 1 W provided the maximum antenna gain does not exceed 6 dBi.

For the 5.25-5.35 GHz and 5.47-5.725 GHz bands, the maximum conducted output power over the frequency bands of operation shall not exceed the lesser of 250 mW or $11 \text{ dBm} + 10 \log B$, where B is the 26 dB emission bandwidth in megahertz.

For the band 5.725-5.85 GHz, the maximum conducted output power over the frequency band of operation shall not exceed 1 W (30dBm).

If transmitting antennas of directional gain greater than 6dBi are used, the maximum conducted output power shall be reduced by the amount in dB that the directional gain of the antenna exceeds 6dBi.

6.4.2. Test Procedure

KDB 789033D02v02r01- Section II)E)3)b) Method PM-G

6.4.3. Test Setting

Average Power Measurement

Average power measurements were performed only when the EUT was transmitting at its maximum power control level using a broadband power meter with a pulse sensor. The power meter implemented triggering and gating capabilities which were set up such that power measurements were recorded only during the ON time of the transmitter.

6.4.4. Test Setup

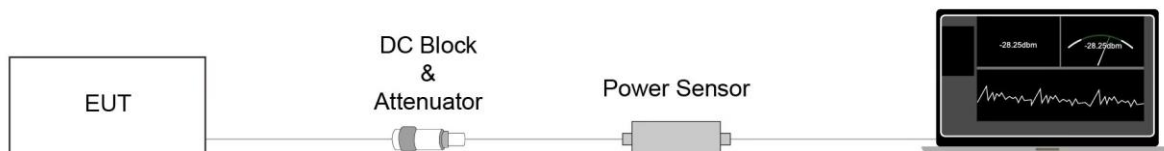

6.4.5. Test Result

Refer to Appendix A.4.

6.5. Transmit Power Control Measurement

6.5.1. Test Limit

The U-NII device is required to have the capability to operate at least 6 dB below the mean EIRP value of 30 dBm.

6.5.2. Test Procedure

KDB 789033 D02v01- Section II)E)3)b) Method PM-G

6.5.3. Test Setting

Average power measurements were performed only when the EUT was transmitting at its maximum power control level using a broadband power meter with a pulse sensor. The power meter implemented triggering and gating capabilities which were set up such that power measurements were recorded only during the ON time of the transmitter. The trace was averaged over 100 traces to obtain the final measured average power.

6.5.4. Test Setup

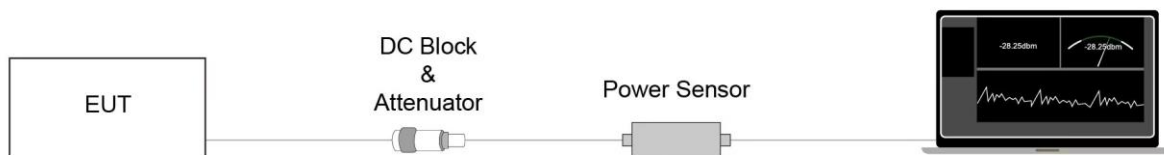

6.5.5. Test Result

Device supports TPC mechanism, details refer to the operational description.

6.6. Power Spectral Density Measurement

6.6.1. Test Limit

For the band 5.15-5.25 GHz, the maximum power spectral density shall not exceed 17 dBm in any 1 megahertz band.

For the 5.25-5.35 GHz and 5.47-5.725 GHz bands, the maximum power spectral density shall not exceed 11 dBm in any 1 megahertz band.

For the band 5.725-5.85 GHz, the maximum power spectral density shall not exceed 30 dBm in any 500-kHz band.

If transmitting antennas of directional gain greater than 6dBi are used, the peak power spectral density shall be reduced by the amount in dB that the directional gain of the antenna exceeds 6dBi.

6.6.2. Test Procedure

KDB 789033 D02v02r01-Section II)F)

6.6.3. Test Setting

1. Analyzer was set to the center frequency of the UNII channel under investigation
2. Span was set to encompass the entire 26dB EBW of the signal.
3. RBW = 1MHz (510kHz, if measurement bandwidth of Maximum PSD is specified in 500 kHz)
4. VBW = 3 × RBW
5. Number of sweep points $\geq 2 \times (\text{span} / \text{RBW})$
6. Detector = power averaging (Average)
7. Sweep time = auto
8. Trigger = free run
9. Trace average at least 100 traces in power averaging (rms) mode; however, the number of traces to be averaged shall be increased above 100 as needed to ensure that the average accurately represents the true average over the on and off periods of the transmitter.
10. Use the peak search function on the instrument to find the peak of the spectrum and record its value.
11. Add $10 \cdot \log(1/x)$, where x is the duty cycle, to the measured power in order to compute the average power during the actual transmission times (because the measurement represents an average over both the on and off times of the transmission). For example, add $10 \cdot \log(1/0.25) = 6$ dB if the duty cycle is 25 percent.

6.6.4. Test Setup

Spectrum Analyzer

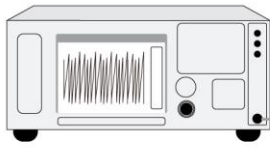

DC Block
&
Attenuator



6.6.5. Test Result

Refer to Appendix A.5.

6.7. Frequency Stability Measurement

6.7.1. Test Limit

Manufactures of U-NII devices are responsible for ensuring frequency stability such that an emission is maintained within the band of operation under all conditions of normal operation as specified in the user's manual.

6.7.2. Test Procedure

Frequency Stability Under Temperature Variations:

The equipment under test was connected to an external AC or DC power supply and input rated voltage. RF output was connected to a frequency counter or spectrum analyzer via feed through attenuators. The EUT was placed inside the temperature chamber. Set the spectrum analyzer RBW low enough to obtain the desired frequency resolution and measure EUT 20°C operating frequency as reference frequency. Turn EUT off and set the chamber temperature to highest. After the temperature stabilized for approximately 30 minutes recorded the frequency. Repeat step measure with 10°C decreased per stage until the lowest temperature reached.

Frequency Stability Under Voltage Variations:

Set chamber temperature to 20°C. Use a variable AC power supply / DC power source to power the EUT and set the voltage to rated voltage. Set the spectrum analyzer RBW low enough to obtain the desired frequency resolution and recorded the frequency.

Reduce the input voltage to specify extreme voltage variation ($\pm 15\%$) and endpoint, record the maximum frequency change.

6.7.3. Test Setup

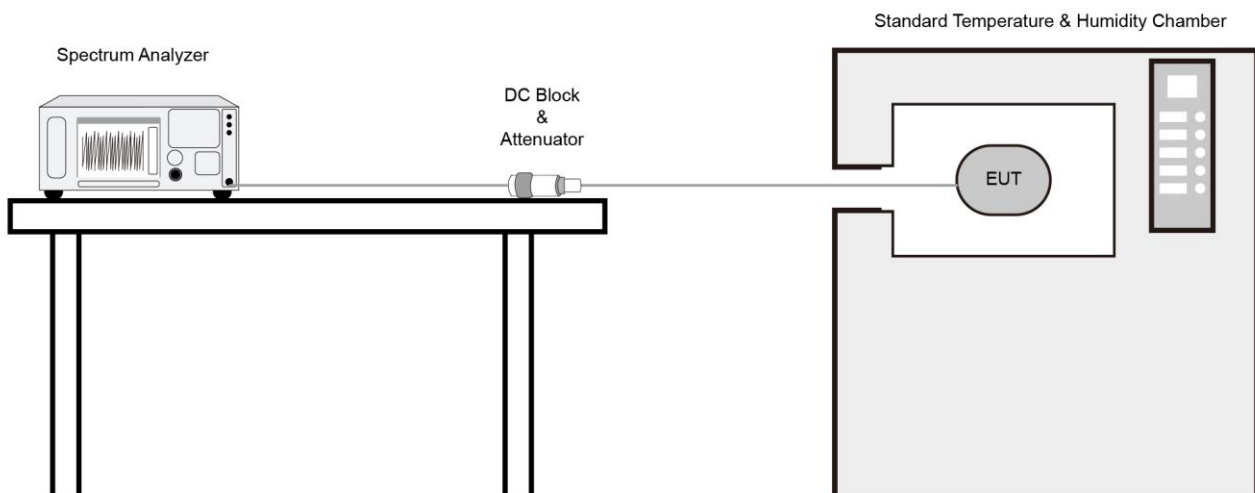

6.7.4. Test Result

Refer to Appendix A.6.

6.8. Radiated Spurious Emission Measurement

6.8.1. Test Limit

All out of band emissions appearing in a restricted band as specified in Section 15.205 of the Title 47 CFR must not exceed the limits shown in Table per Section 15.209.

FCC Part 15 Subpart C Paragraph 15.209		
Frequency [MHz]	Field Strength [uV/m]	Measured Distance [Meters]
0.009 - 0.490	2400/F (kHz)	300
0.490 - 1.705	24000/F (kHz)	30
1.705 - 30	30	30
30 - 88	100	3
88 - 216	150	3
216 - 960	200	3
Above 960	500	3

6.8.2. Test Procedure

KDB 789033 D02v02r01- Section II)G)

6.8.3. Test Setting

Table 1 - RBW as a function of frequency

Frequency	RBW
9 ~ 150 kHz	200 ~ 300 Hz
0.15 ~ 30 MHz	9 ~ 10 kHz
30 ~ 1000 MHz	100 ~ 120 kHz
> 1000MHz	1MHz

Quasi-Peak Measurements below 1GHz

1. Analyzer center frequency was set to the frequency of the radiated spurious emission of interest
2. Span was set greater than 1MHz
3. RBW = as specified in Table 1
4. Detector = CISPR quasi-peak
5. Sweep time = auto couple
6. Trace was allowed to stabilize

Peak Measurements above 1GHz

1. Analyzer center frequency was set to the frequency of the radiated spurious emission of interest
2. RBW = 1MHz
3. VBW = 3MHz
4. Detector = peak
5. Sweep time = auto couple
6. Trace mode = max hold
7. Trace was allowed to stabilize

Average Measurements above 1GHz (Method VB)

1. Analyzer center frequency was set to the frequency of the radiated spurious emission of interest
2. RBW = 1MHz
3. VBW; If the EUT is configured to transmit with duty cycle $\geq 98\%$, set VBW = 10 Hz.
If the EUT duty cycle is $< 98\%$, set VBW $\geq 1/T$. T is the minimum transmission duration.

802.11a	VBW = 470Hz	802.11ax-HE20	VBW = 680Hz
802.11ac-VHT20	VBW = 510Hz	802.11ax-HE40	VBW = 1.3kHz
802.11ac-VHT40	VBW = 1.1kHz	802.11ax-HE80	VBW = 2.4kHz
802.11ac-VHT80	VBW = 2.4kHz	N/A	N/A

4. Detector = Peak
5. Sweep time = auto
6. Trace mode = max hold
7. Trace was allowed to stabilize

6.8.4. Test Setup

Below 1GHz Test Setup:

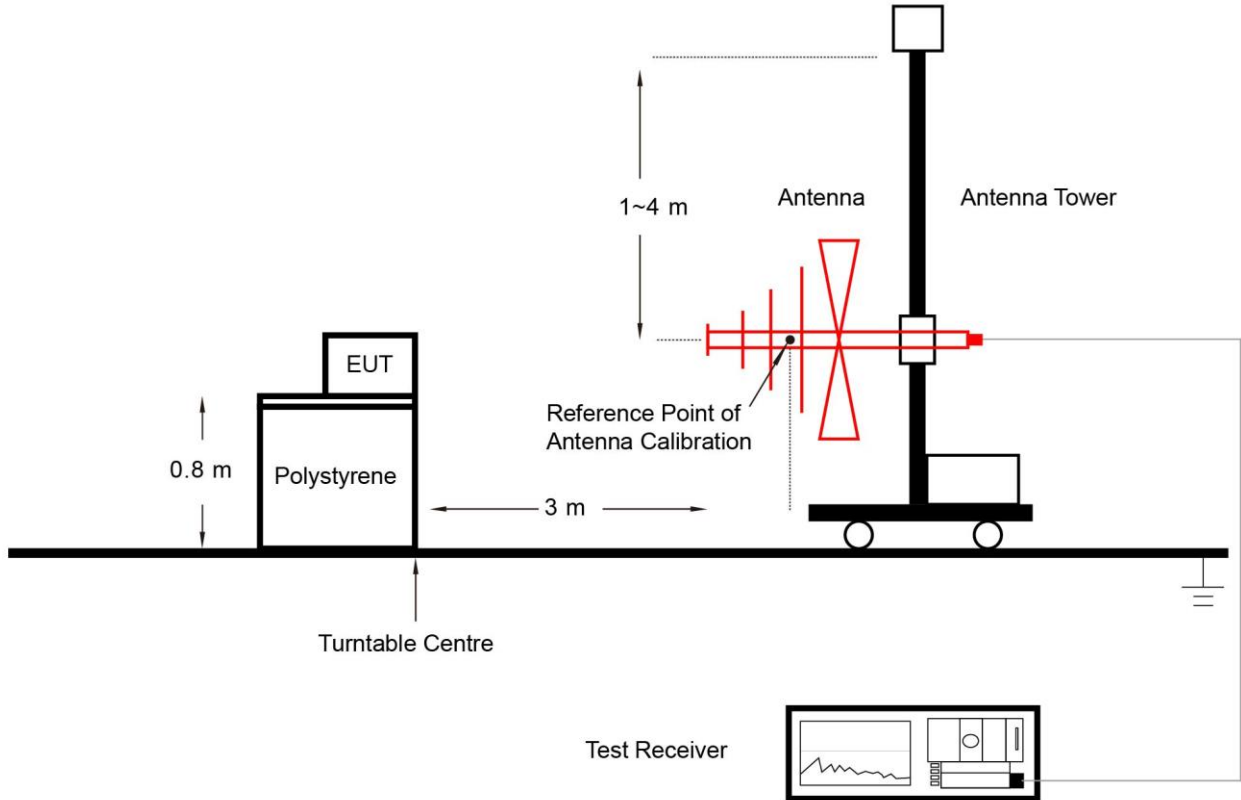

Above 1GHz Test Setup:

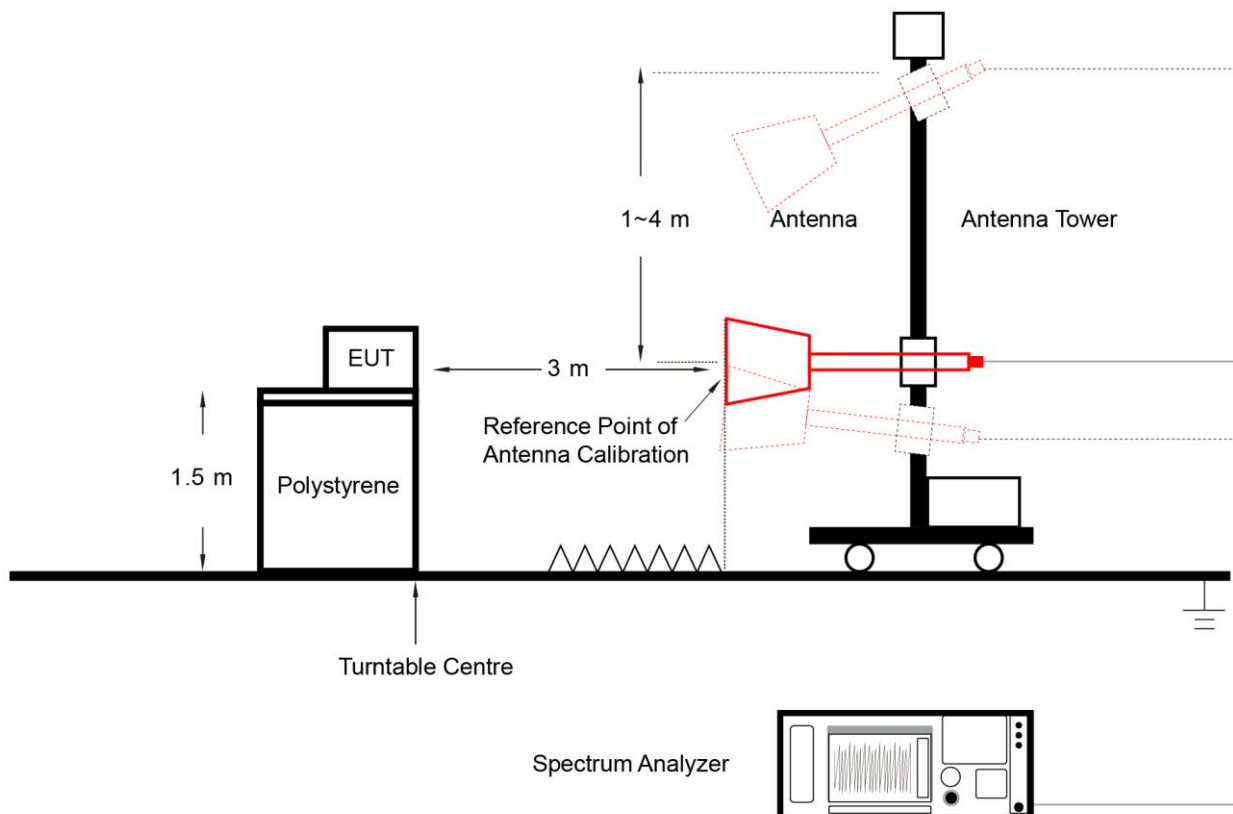

6.8.5. Test Result

Refer to Appendix A.7.

6.9. Radiated Restricted Band Edge Measurement

6.9.1. Test Limit

For 15.205 requirement:

Radiated emissions which fall in the restricted bands, as defined in Section 15.205(a) of FCC part 15, must also comply with the radiated emission limits specified in Section 15.209(a).

Frequency (MHz)	Frequency (MHz)	Frequency (MHz)	Frequency (GHz)
0.090 - 0.110	16.42 - 16.423	399.9 - 410	4.5 - 5.15
¹ 0.495 - 0.505	16.69475 - 16.69525	608 - 614	5.35 - 5.46
2.1735 - 2.1905	16.80425 - 16.80475	960 - 1240	7.25 - 7.75
4.125 - 4.128	25.5 - 25.67	1300 - 1427	8.025 - 8.5
4.17725 - 4.17775	37.5 - 38.25	1435 - 1626.5	9.0 - 9.2
4.20725 - 4.20775	73 - 74.6	1645.5 - 1646.5	9.3 - 9.5
6.215 - 6.218	74.8 - 75.2	1660 - 1710	10.6 - 12.7
6.26775 - 6.26825	108 - 121.94	1718.8 - 1722.2	13.25 - 13.4
6.31175 - 6.31225	123 - 138	2200 - 2300	14.47 - 14.5
8.291 - 8.294	149.9 - 150.05	2310 - 2390	15.35 - 16.2
8.362 - 8.366	156.52475 - 156.52525	2483.5 - 2500	17.7 - 21.4
8.37625 - 8.38675	156.7 - 156.9	2690 - 2900	22.01 - 23.12
8.41425 - 8.41475	162.0125 - 167.17	3260 - 3267	23.6 - 24.0
12.29 - 12.293	167.72 - 173.2	3332 - 3339	31.2 - 31.8
12.51975 - 12.52025	240 - 285	3345.8 - 3358	36.43 - 36.5
12.57675 - 12.57725	322 - 335.4	3600 - 4400	(²)
13.36 - 13.41	--	--	--

For 15.407(b) requirement:

For transmitters operating in the 5.15-5.25 GHz band: All emissions outside of the 5.15-5.35 GHz band shall not exceed an e.i.r.p. of -27 dBm/MHz.

For transmitters operating in the 5.25-5.35 GHz band: All emissions outside of the 5.15-5.35 GHz band shall not exceed an e.i.r.p. of -27 dBm/MHz.

For transmitters operating in the 5.47-5.725 GHz band: All emissions outside of the 5.47-5.725 GHz band shall not exceed an e.i.r.p. of -27 dBm/MHz.

For transmitters operating in the 5.725-5.85 GHz band: All emissions shall be limited to a level of -27 dBm/MHz at 75 MHz or more above or below the band edge increasing linearly to 10 dBm/MHz at 25 MHz above or below the band edge, and from 25 MHz above or below the band edge increasing linearly to a level of 15.6 dBm/MHz at 5 MHz above or below the band edge, and from 5 MHz above or below the band edge increasing linearly to a level of 27 dBm/MHz at the band edge.

Refer to KDB 789033 D02v02r01 G)2)c), as specified in § 15.407(b), emissions above 1000 MHz that are outside of the restricted bands are subject to a maximum emission limit of -27 dBm/MHz (or -17 dBm/MHz as specified in § 15.407(b)(4)). However, an out-of-band emission that complies with both the peak and average limits of § 15.209 is not required to satisfy the -27 dBm/MHz or -17 dBm/MHz maximum emission limit.

All out of band emissions appearing in a restricted band as specified in Section 15.205 of the Title 47CFR must not exceed the limits shown in Table per Section 15.209.

FCC Part 15 Subpart C Paragraph 15.209		
Frequency [MHz]	Field Strength [uV/m]	Measured Distance [Meters]
0.009 - 0.490	2400/F (kHz)	300
0.490 - 1.705	24000/F (kHz)	30
1.705 - 30	30	30
30 - 88	100	3
88 - 216	150	3
216 - 960	200	3
Above 960	500	3

6.9.2. Test Procedure

KDB 789033 D02v02r01- Section II)G)

6.9.3. Test Setting

Peak Measurements above 1GHz

1. Analyzer center frequency was set to the frequency of the radiated spurious emission of interest
2. RBW = 1MHz
3. VBW = 3MHz
4. Detector = Peak
5. Sweep time = Auto couple
6. Trace mode = Max hold
7. Trace was allowed to stabilize

Average Measurements above 1GHz (Method VB)

1. Analyzer center frequency was set to the frequency of the radiated spurious emission of interest
2. RBW = 1MHz
3. VBW; if the EUT is configured to transmit with duty cycle $\geq 98\%$, set VBW = 10Hz

If the EUT duty cycle is $< 98\%$, set $VBW \geq 1/T$. T is the minimum transmission duration

802.11a	VBW = 470Hz	802.11ax-HE20	VBW = 680Hz
802.11ac-VHT20	VBW = 510Hz	802.11ax-HE40	VBW = 1.3kHz
802.11ac-VHT40	VBW = 1.1kHz	802.11ax-HE80	VBW = 2.4kHz
802.11ac-VHT80	VBW = 2.4kHz	N/A	N/A

4. Detector = Peak
5. Sweep time = Auto
6. Trace mode = Max hold
7. Trace was allowed to stabilize

6.9.4. Test Setup

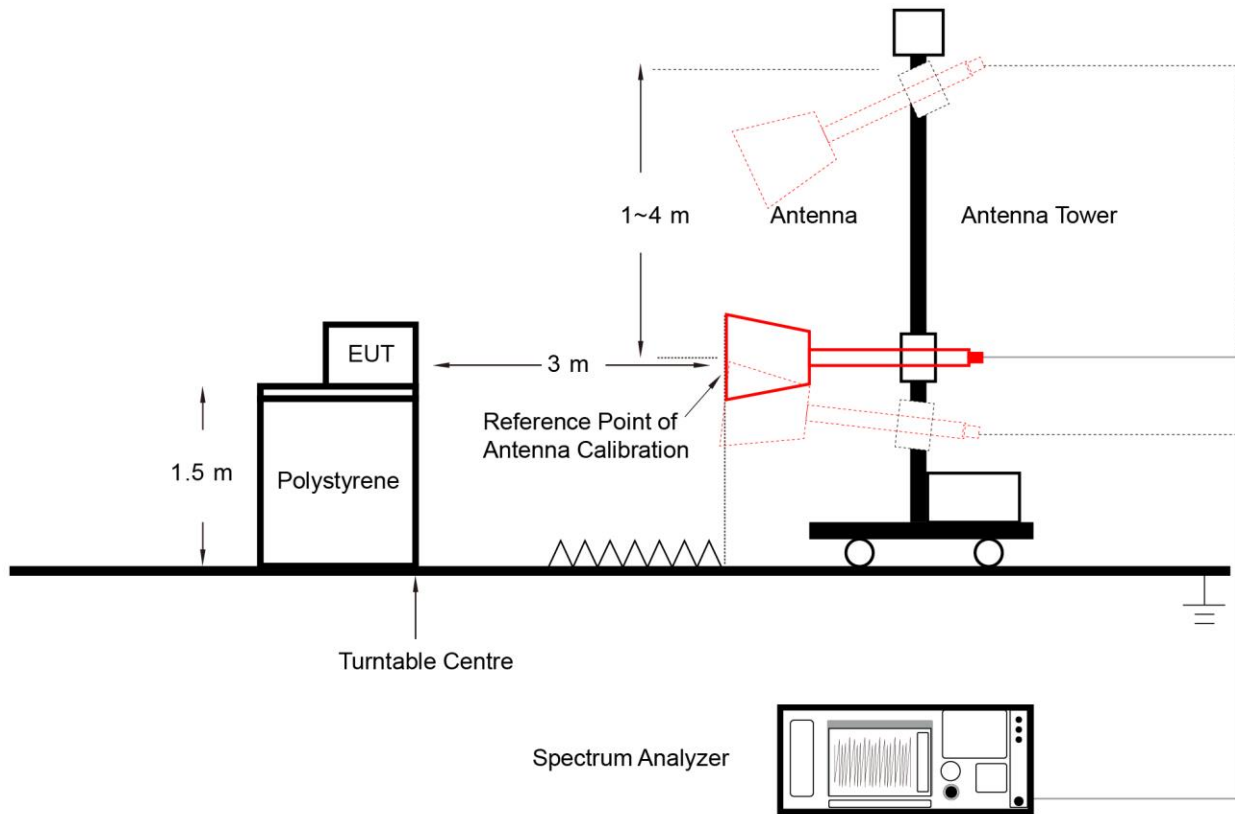

6.9.5. Test Result

Refer to Appendix A.8.

6.10. AC Conducted Emissions Measurement

6.10.1. Test Limit

FCC Part 15.207 Limits		
Frequency (MHz)	QP (dBuV)	AV (dBuV)
0.15 - 0.50	66 - 56	56 - 46
0.50 - 5.0	56	46
5.0 - 30	60	50

Note 1: The lower limit shall apply at the transition frequencies.

Note 2: The limit decreases linearly with the logarithm of the frequency in the range 0.15MHz to 0.5MHz.

6.10.2. Test Setup

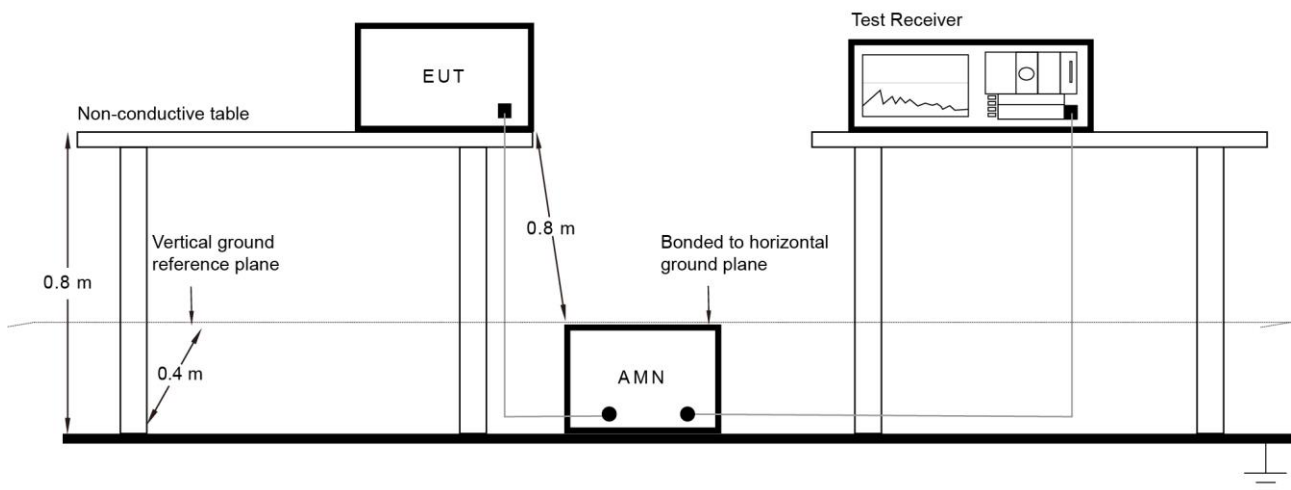

6.10.3. Test Result

Refer to Appendix A.9.

Appendix A – Test Result

A.1 Duty Cycle Test Result

Test Site	SIP-TR1	Test Engineer	Alisa Deng
Test Date	2022-12-19		

Test Mode	Duty Cycle
802.11a	94.71%
802.11ac-VHT20	98.21%
802.11ac-VHT40	96.65%
802.11ac-VHT80	93.74%
802.11ax-HE20	97.76%
802.11ax-HE40	95.93%
802.11ax-HE80	92.45%

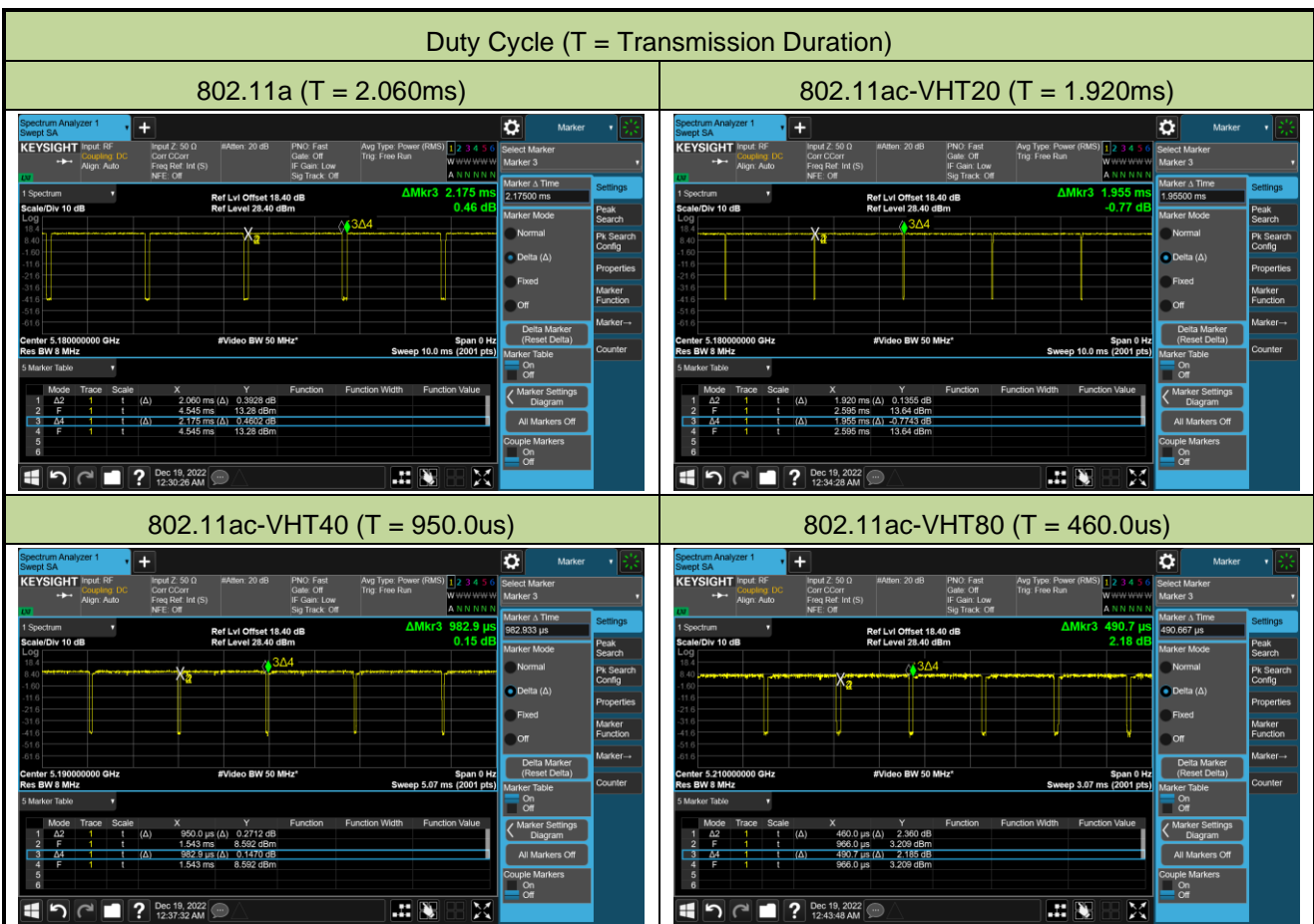

Duty Cycle (T = Transmission Duration)

802.11ax-HE20 (T = 1.486ms)

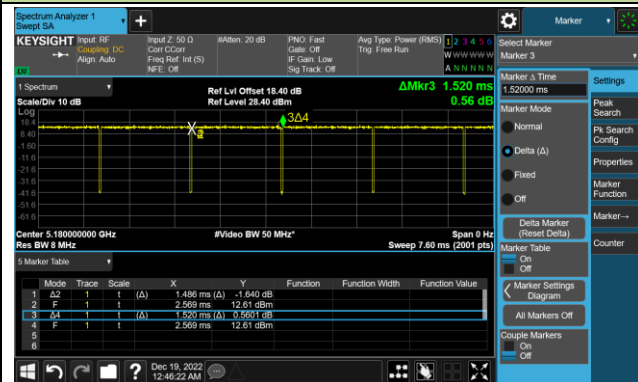

802.11ax-HE40 (T = 777.7us)

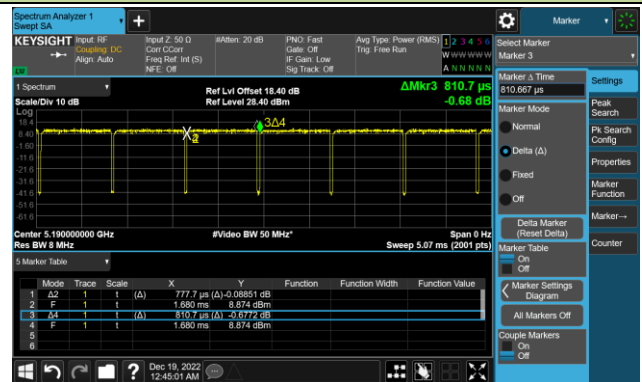

802.11ax-HE80 (T = 412.5us)

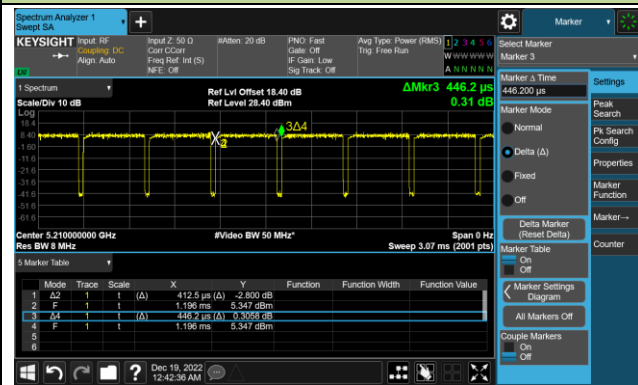

A.2 26dB Bandwidth Test Result

Test Site	SIP-TR1	Test Engineer	Alisa Deng
Test Date	2022-12-27		

Test Mode	Data Rate/ MCS	Channel No.	Frequency (MHz)	99% Bandwidth (MHz)	26dB Bandwidth (MHz)
11a	6Mbps	36	5180	16.801	21.30
11a	6Mbps	44	5220	16.773	21.56
11a	6Mbps	48	5240	16.818	21.57
11a	6Mbps	52	5260	16.820	21.71
11a	6Mbps	60	5300	16.830	21.57
11a	6Mbps	64	5320	16.817	21.33
11a	6Mbps	100	5500	16.803	21.28
11a	6Mbps	116	5580	16.790	21.27
11a	6Mbps	140	5700	16.795	21.30
11a	6Mbps	144	5720	16.783	21.30
11a	6Mbps	149	5745	16.777	21.37
11a	6Mbps	157	5785	16.754	21.25
11a	6Mbps	165	5825	16.802	21.24
11ac-VHT20	MCS0	36	5180	17.919	21.50
11ac-VHT20	MCS0	44	5220	17.957	21.63
11ac-VHT20	MCS0	48	5240	17.959	21.65
11ac-VHT20	MCS0	52	5260	17.936	21.63
11ac-VHT20	MCS0	60	5300	17.931	21.66
11ac-VHT20	MCS0	64	5320	17.960	21.70
11ac-VHT20	MCS0	100	5500	17.928	21.61
11ac-VHT20	MCS0	116	5580	17.926	21.61
11ac-VHT20	MCS0	140	5700	17.905	21.48
11ac-VHT20	MCS0	144	5720	17.919	21.65
11ac-VHT20	MCS0	149	5745	17.917	21.56
11ac-VHT20	MCS0	157	5785	17.926	21.62
11ac-VHT20	MCS0	165	5825	17.939	21.73

Test Mode	Data Rate/ MCS	Channel No.	Frequency (MHz)	99% Bandwidth (MHz)	26dB Bandwidth (MHz)
11ac-VHT40	MCS0	38	5190	36.308	39.76
11ac-VHT40	MCS0	46	5230	36.415	42.82
11ac-VHT40	MCS0	54	5270	36.421	41.43
11ac-VHT40	MCS0	62	5310	36.260	39.79
11ac-VHT40	MCS0	102	5510	36.371	39.73
11ac-VHT40	MCS0	110	5550	36.332	40.06
11ac-VHT40	MCS0	134	5670	36.317	39.85
11ac-VHT40	MCS0	142	5710	36.410	39.85
11ac-VHT40	MCS0	151	5755	36.368	39.85
11ac-VHT40	MCS0	159	5795	36.367	40.13
11ac-VHT80	MCS0	42	5210	75.739	81.35
11ac-VHT80	MCS0	58	5290	75.695	81.46
11ac-VHT80	MCS0	106	5530	75.758	81.99
11ac-VHT80	MCS0	122	5610	75.845	81.26
11ac-VHT80	MCS0	138	5690	75.826	81.40
11ac-VHT80	MCS0	155	5775	75.846	81.83
11ax-HE20	MCS0	36	5180	19.071	21.40
11ax-HE20	MCS0	44	5220	19.064	22.81
11ax-HE20	MCS0	48	5240	19.077	22.83
11ax-HE20	MCS0	52	5260	19.079	22.42
11ax-HE20	MCS0	60	5300	19.092	22.65
11ax-HE20	MCS0	64	5320	19.032	21.26
11ax-HE20	MCS0	100	5500	19.048	21.47
11ax-HE20	MCS0	116	5580	19.072	21.35
11ax-HE20	MCS0	140	5700	19.066	21.28
11ax-HE20	MCS0	144	5720	19.038	21.48
11ax-HE20	MCS0	149	5745	19.056	21.50
11ax-HE20	MCS0	157	5785	19.055	21.39
11ax-HE20	MCS0	165	5825	19.080	21.43

Test Mode	Data Rate/ MCS	Channel No.	Frequency (MHz)	99% Bandwidth (MHz)	26dB Bandwidth (MHz)
11ax-HE40	MCS0	38	5190	37.629	39.99
11ax-HE40	MCS0	46	5230	37.582	40.10
11ax-HE40	MCS0	54	5270	37.605	39.97
11ax-HE40	MCS0	62	5310	37.565	40.09
11ax-HE40	MCS0	102	5510	37.505	39.83
11ax-HE40	MCS0	110	5550	37.603	40.09
11ax-HE40	MCS0	134	5670	37.573	39.91
11ax-HE40	MCS0	142	5710	37.628	40.01
11ax-HE40	MCS0	151	5755	37.541	39.93
11ax-HE40	MCS0	159	5795	37.593	39.93
11ax-HE80	MCS0	42	5210	76.918	81.06
11ax-HE80	MCS0	58	5290	76.912	81.06
11ax-HE80	MCS0	106	5530	76.887	80.80
11ax-HE80	MCS0	122	5610	76.841	81.01
11ax-HE80	MCS0	138	5690	76.892	80.88
11ax-HE80	MCS0	155	5775	76.855	81.13

Test Mode	Data Rate/ MCS	Channel No.	Frequency (MHz)	F _H (MHz)	Limit (MHz)
802.11a	6Mbps	48	5240	5248.41	< 5250
802.11ac-VHT20	MCS0	48	5240	5248.98	< 5250
802.11ac-VHT40	MCS0	46	5230	5248.21	< 5250
802.11ac-VHT80	MCS0	42	5210	5247.87	< 5250
802.11ax-HE20	MCS0	48	5240	5249.54	< 5250
802.11ax-HE40	MCS0	46	5230	5248.79	< 5250
802.11ax-HE80	MCS0	42	5210	5248.46	< 5250

Note: $F_H = \text{Centre frequency} + 99\% \text{ OBW} / 2$

For example, 802.11a 5240MHz, $F_H = 5240 \text{ MHz} + 16.818 \text{ MHz} / 2 = 5248.41 \text{ MHz}$

Test Mode	Data Rate/ MCS	Channel No.	Frequency (MHz)	Total EBW 26dB Bandwidth (MHz)	26dB Bandwidth Fall within U-NII 2C (MHz)
Straddle Channel					
11a	6Mbps	144	5720	21.30	15.65
11ac-VHT20	MCS0	144	5720	21.65	15.83
11ac-VHT40	MCS0	142	5710	39.85	34.93
11ac-VHT80	MCS0	138	5690	81.40	75.70
11ax-HE20	MCS0	144	5720	21.48	15.74
11ax-HE40	MCS0	142	5710	40.01	35.01
11ax-HE80	MCS0	138	5690	80.88	75.44

Note:

20MHz BW, Straddle Channel EBW fall within U-NII 2C = Total EBW / 2 + (5725 - 5720) MHz

40MHz BW, Straddle Channel EBW fall within U-NII 2C = Total EBW / 2 + (5725 - 5710) MHz

80MHz BW, Straddle Channel EBW fall within U-NII 2C = Total EBW / 2 + (5725 - 5690) MHz

802.11a 26dB Bandwidth

Channel 36 (5180MHz)

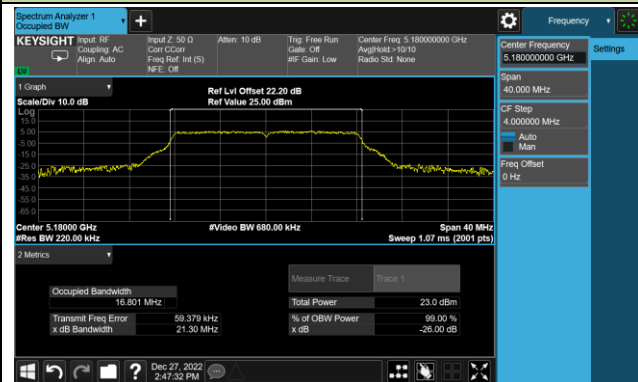

Channel 44 (5220MHz)

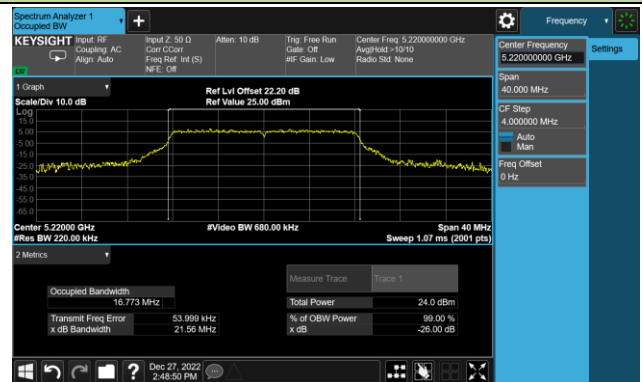

Channel 48 (5240MHz)

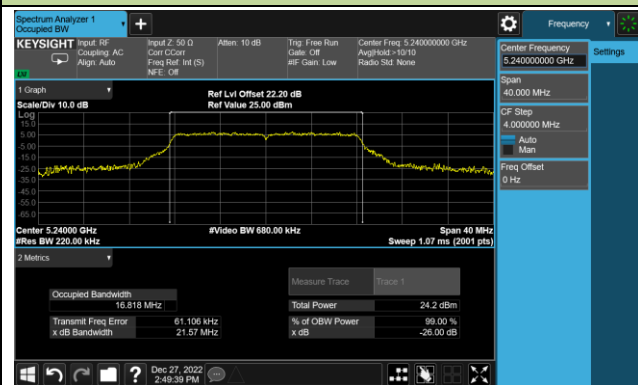

Channel 52 (5260MHz)

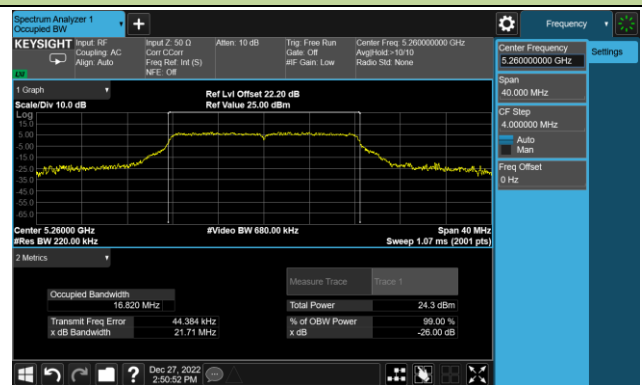

Channel 60 (5300MHz)

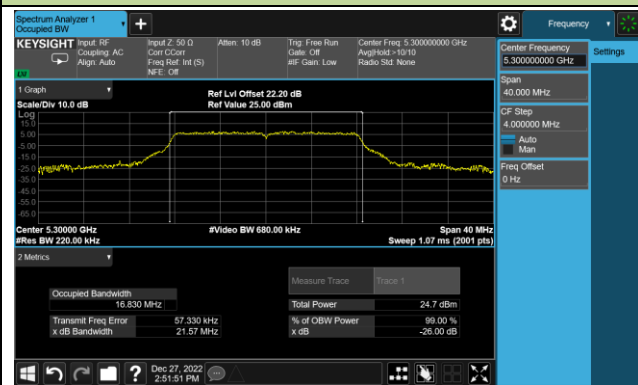

Channel 64 (5320MHz)

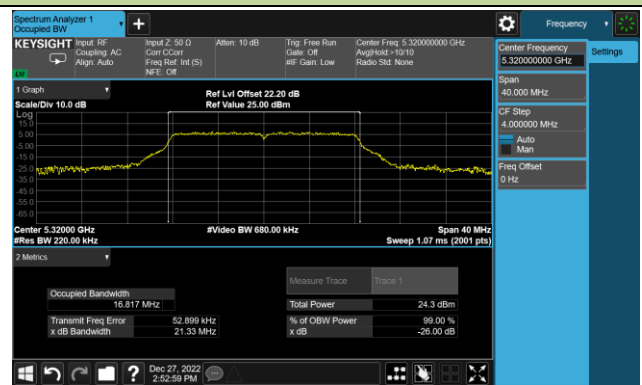

802.11a 26dB Bandwidth

Channel 100 (5500MHz)

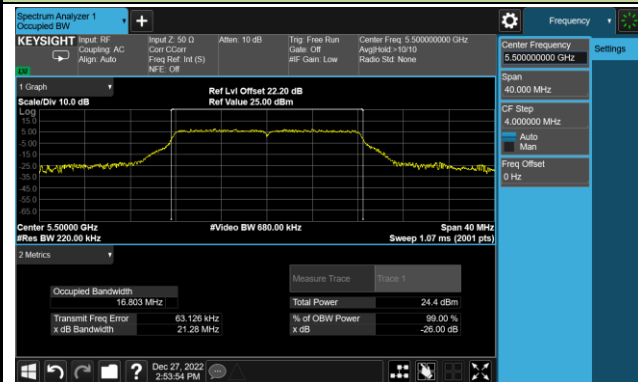

Channel 116 (5580MHz)

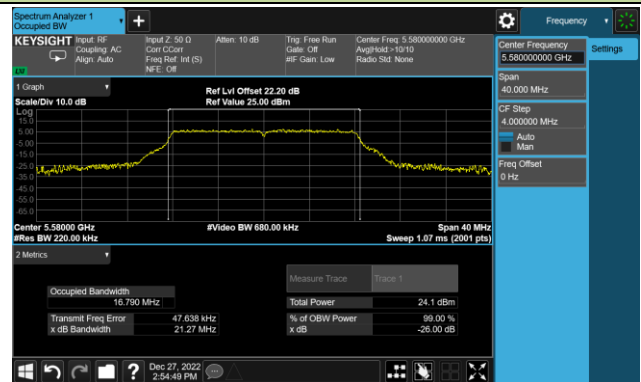

Channel 140 (5700MHz)

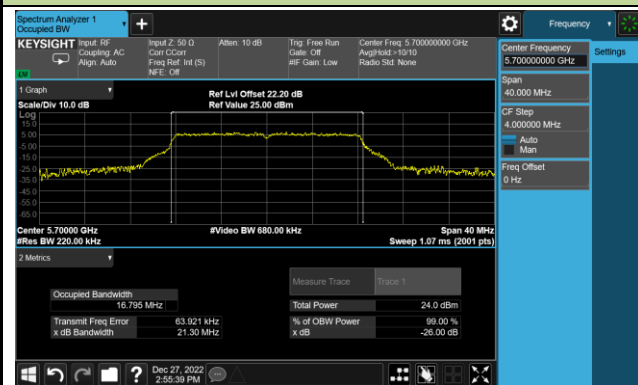

Channel 144(5720MHz)

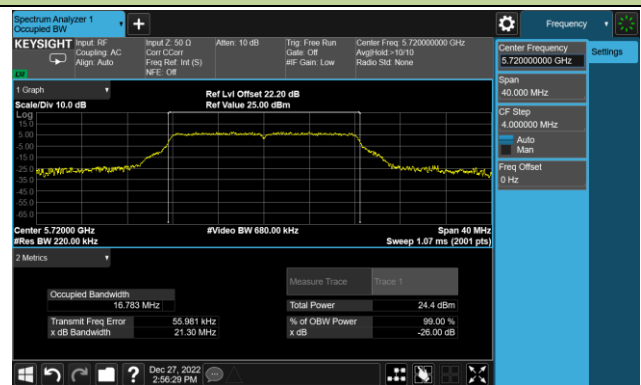

Channel 149 (5745MHz)

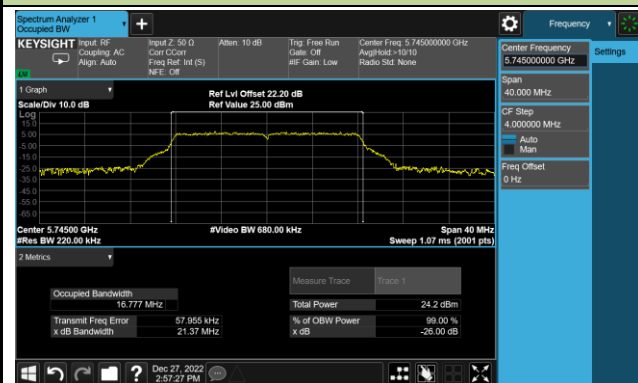

Channel 157 (5785MHz)

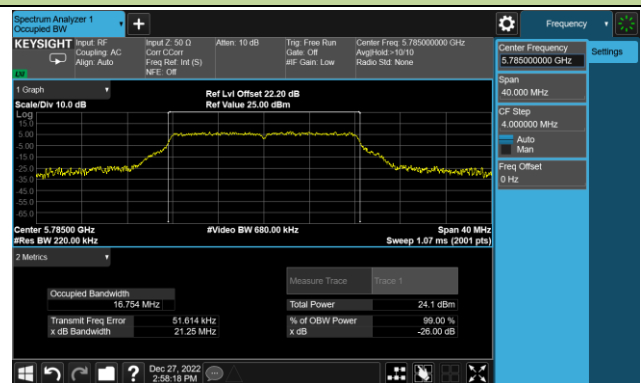

Channel 165 (5825MHz)

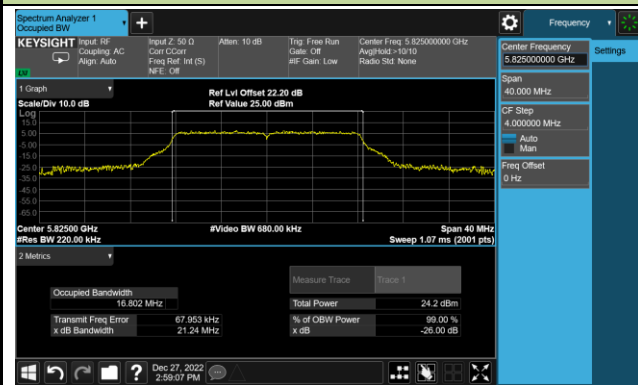

802.11ac-VHT20 26dB Bandwidth

Channel 36 (5180MHz)

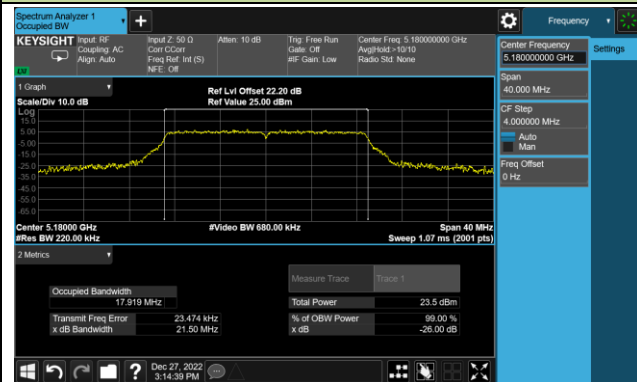

Channel 44 (5220MHz)

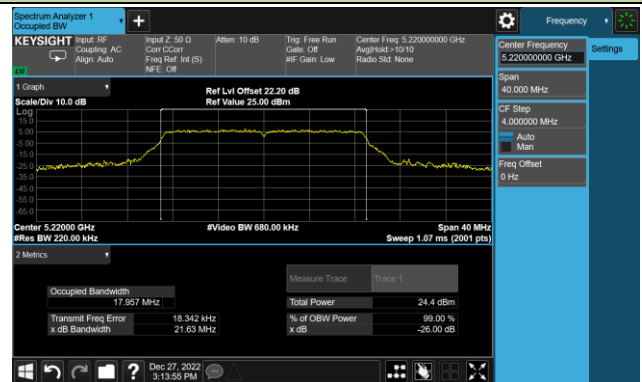

Channel 48 (5240MHz)

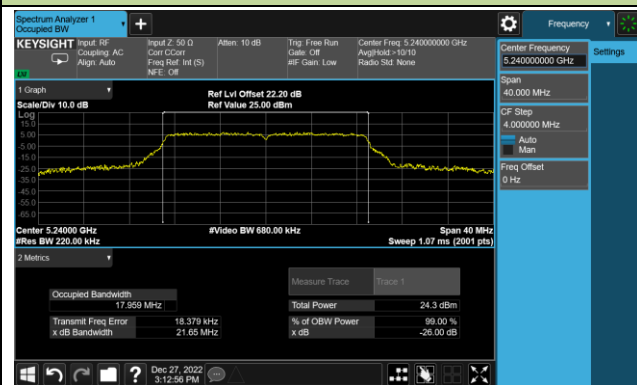

Channel 52 (5260MHz)

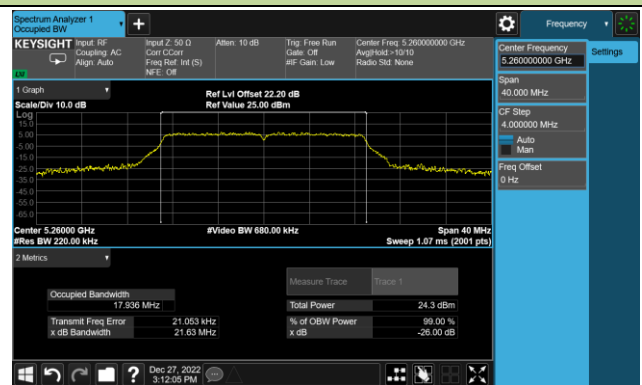

Channel 60 (5300MHz)

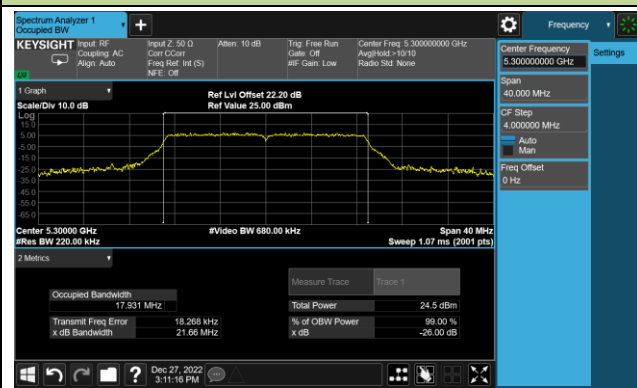

Channel 64 (5320MHz)

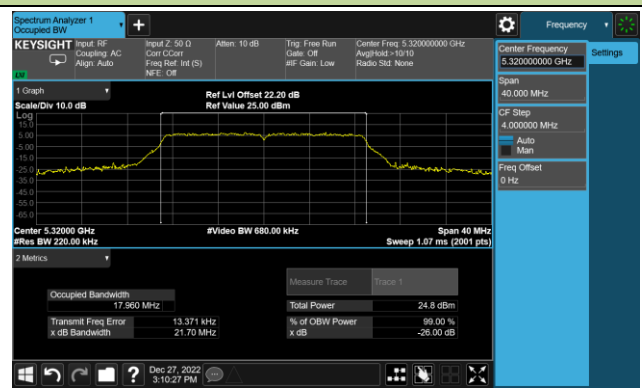

802.11ac-VHT20 26dB Bandwidth

Channel 100 (5500MHz)

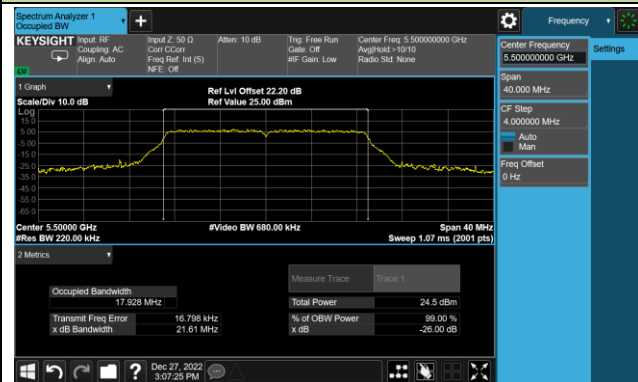

Channel 116 (5580MHz)

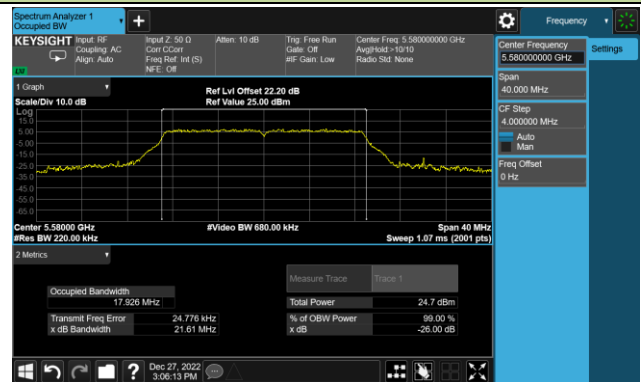

Channel 140 (5700MHz)

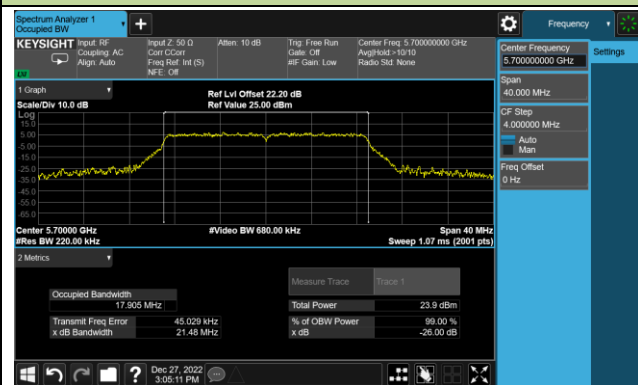

Channel 144(5720MHz)

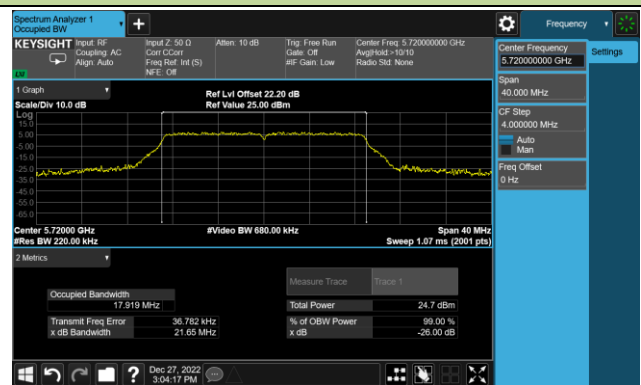

Channel 149 (5745MHz)

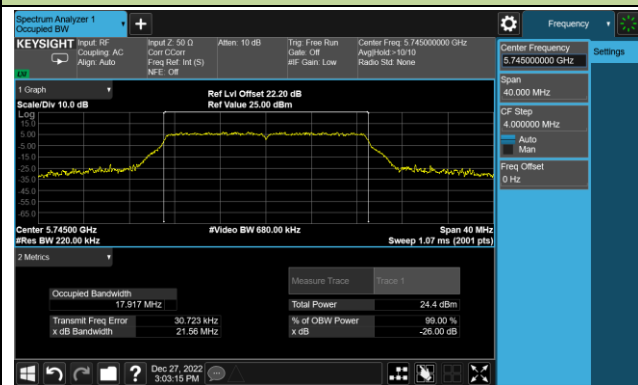

Channel 157 (5785MHz)

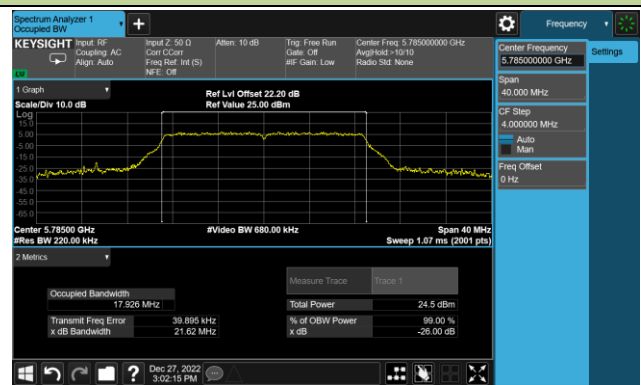

Channel 165 (5825MHz)

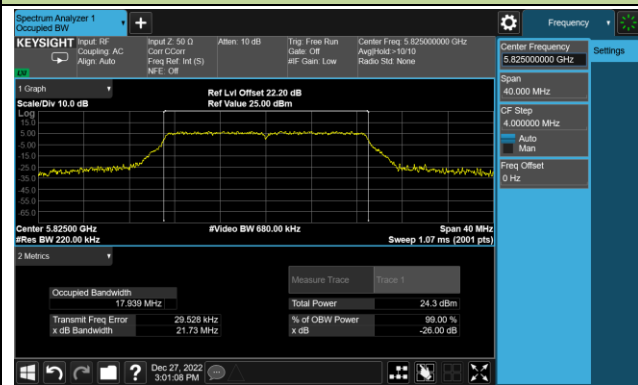

802.11ac-VHT40 26dB Bandwidth

Channel 38 (5190MHz)

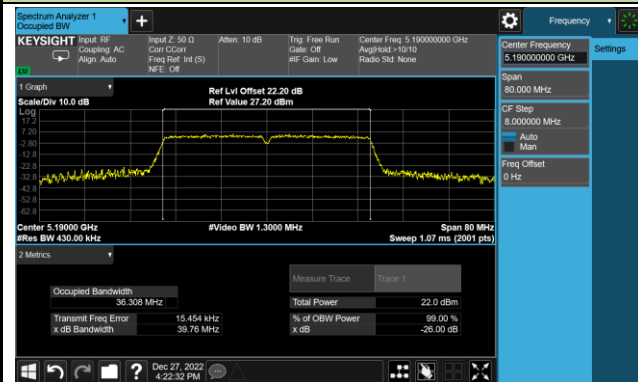

Channel 46 (5230MHz)

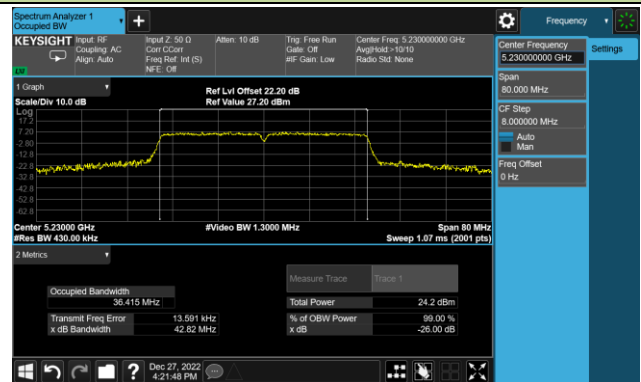

Channel 54 (5270MHz)

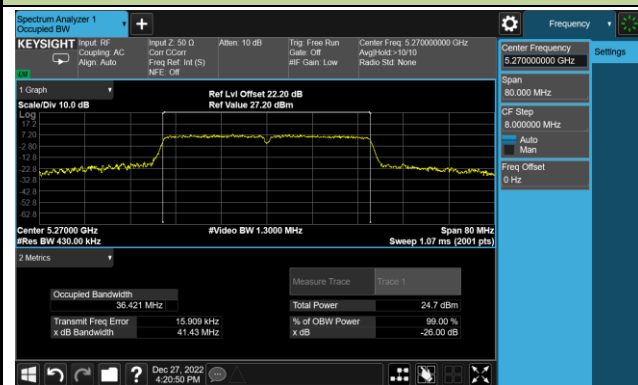

Channel 62 (5310MHz)

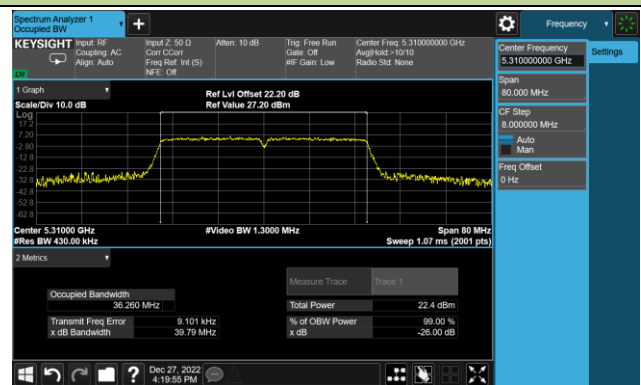

Channel 102 (5510MHz)

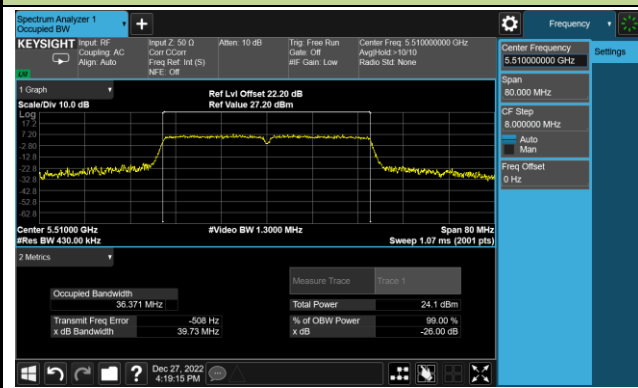

Channel 110 (5550MHz)

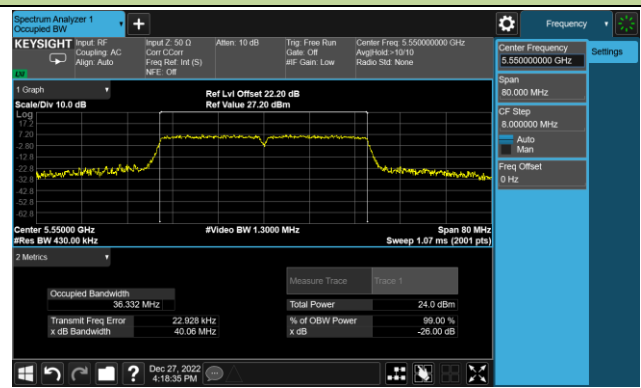

802.11ac-VHT40 26dB Bandwidth

Channel 134 (5670MHz)

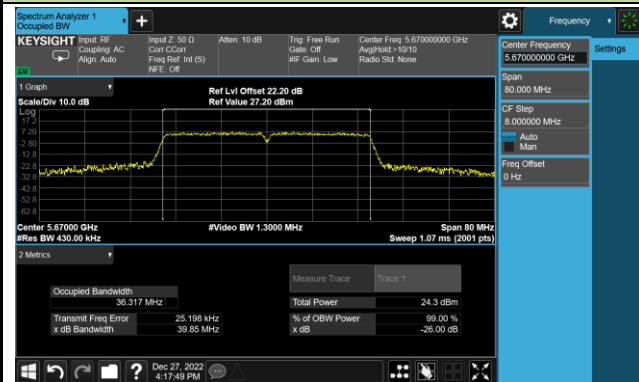

Channel 142(5710MHz)

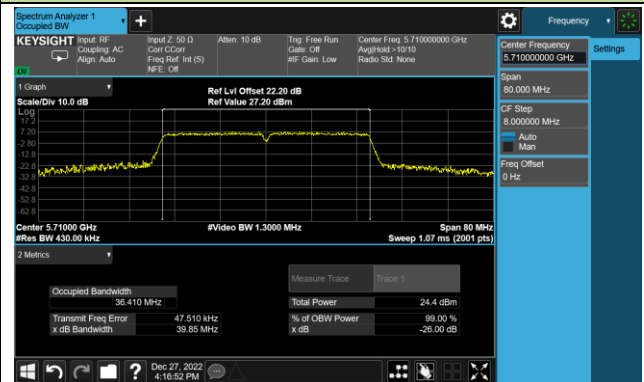

Channel 151 (5755MHz)

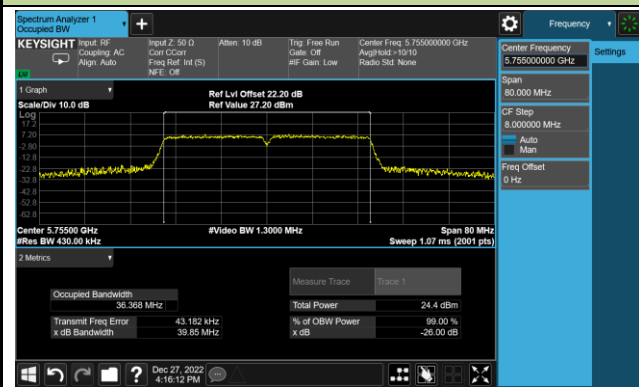

Channel 159 (5795MHz)

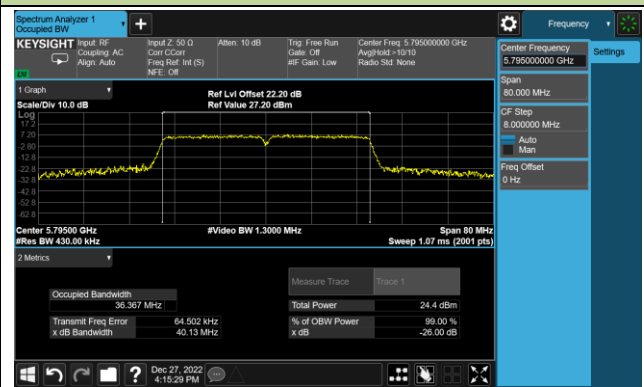

802.11ac-VHT80 26dB Bandwidth

Channel 42 (5210MHz)

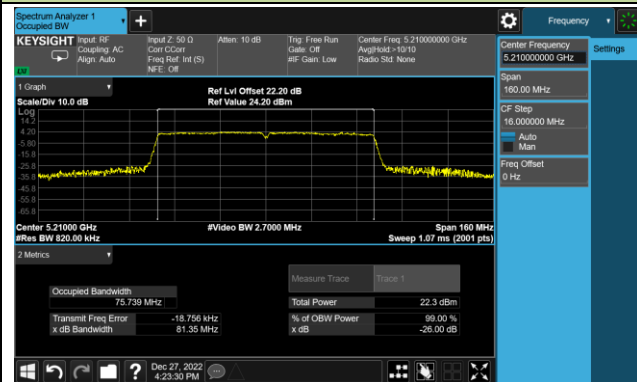

Channel 58 (5290MHz)

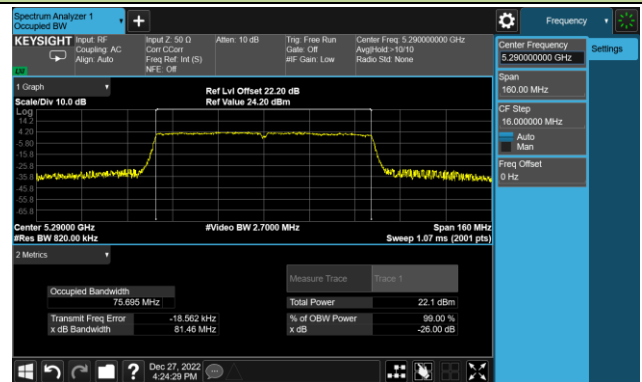

Channel 106 (5530MHz)

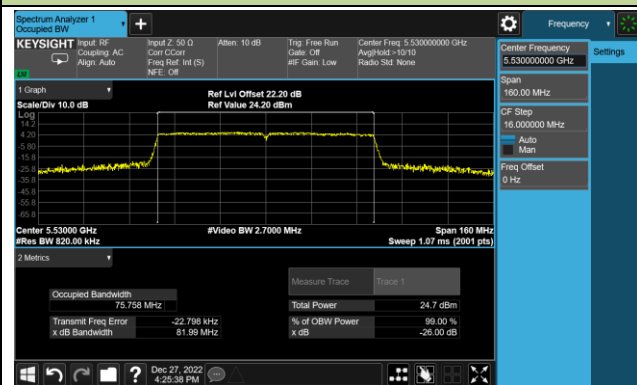

Channel 122 (5610MHz)

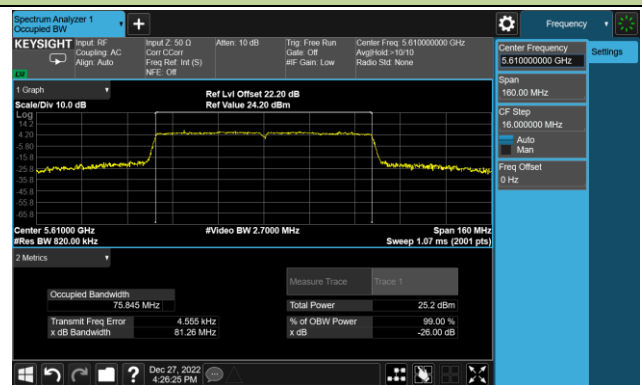

Channel 138 (5690MHz)

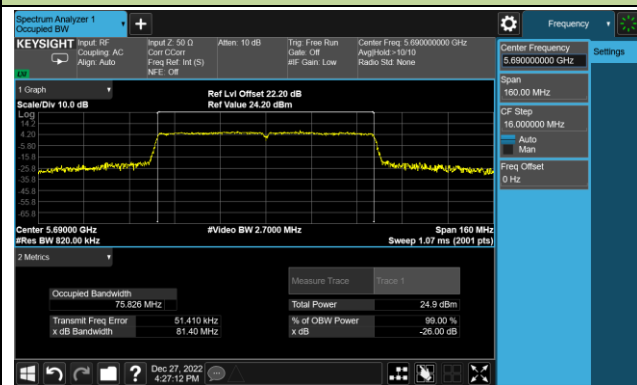

Channel 155 (5775MHz)

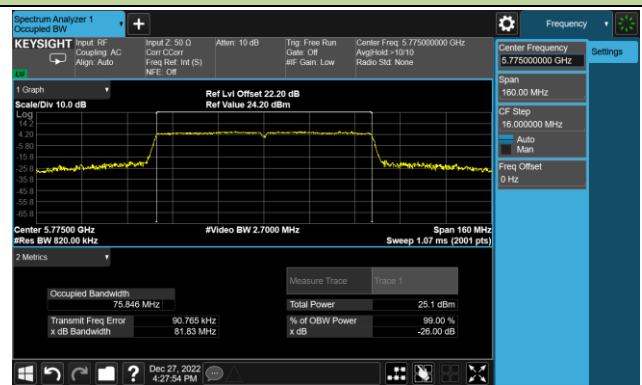

802.11ax-HE20 26dB Bandwidth

Channel 36 (5180MHz)

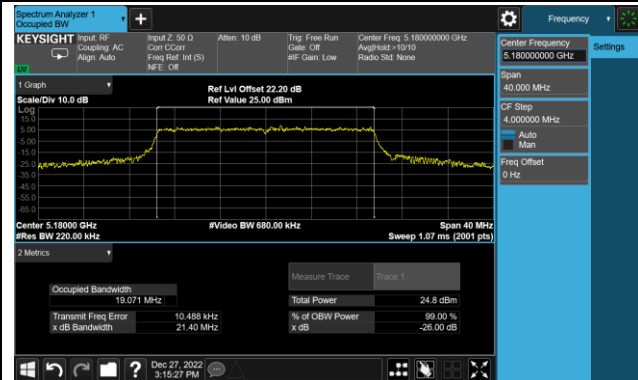

Channel 44 (5220MHz)

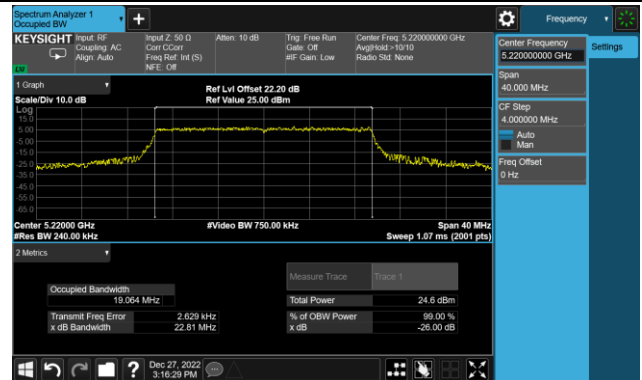

Channel 48 (5240MHz)

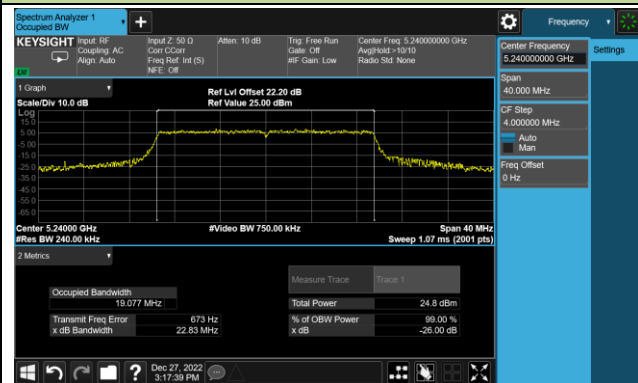

Channel 52 (5260MHz)

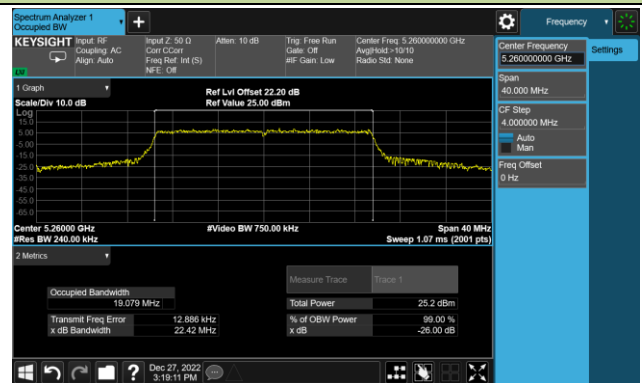

Channel 60 (5300MHz)

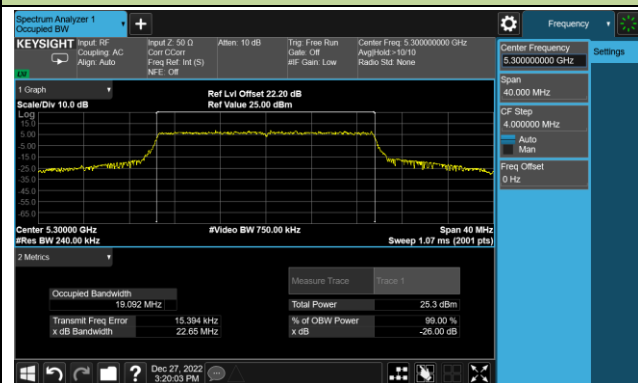

Channel 64 (5320MHz)

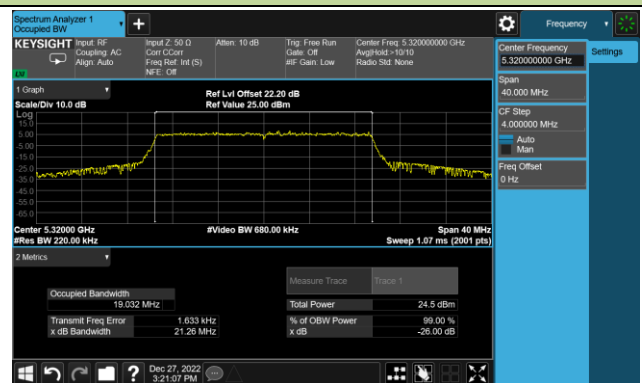

802.11ax-HE20 26dB Bandwidth

Channel 100 (5500MHz)

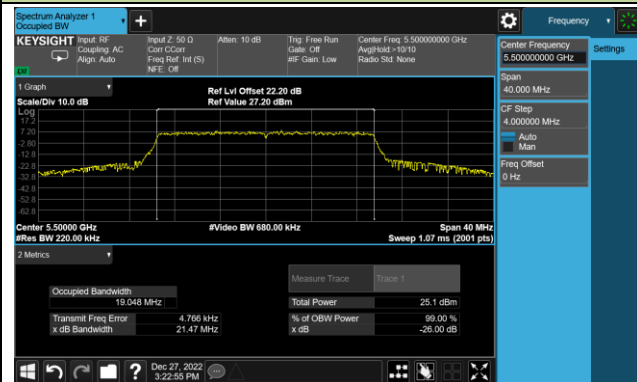

Channel 116 (5580MHz)

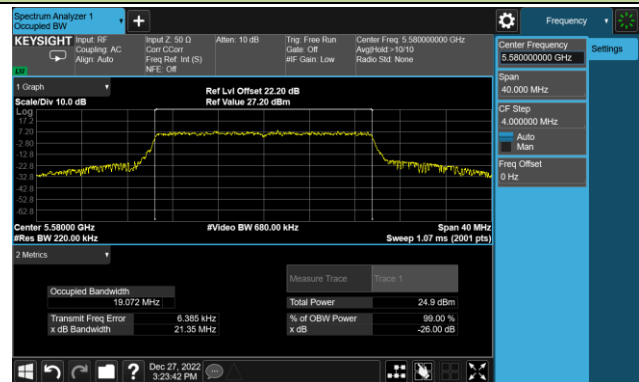

Channel 140 (5700MHz)

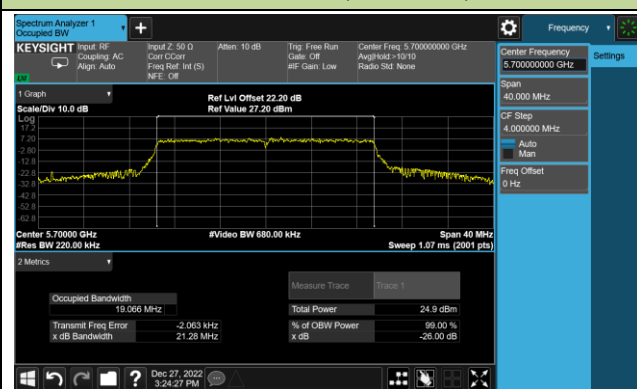

Channel 144 (5720MHz)

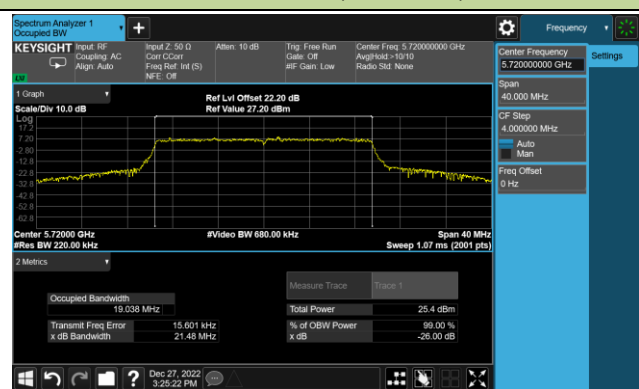

Channel 149 (5745MHz)

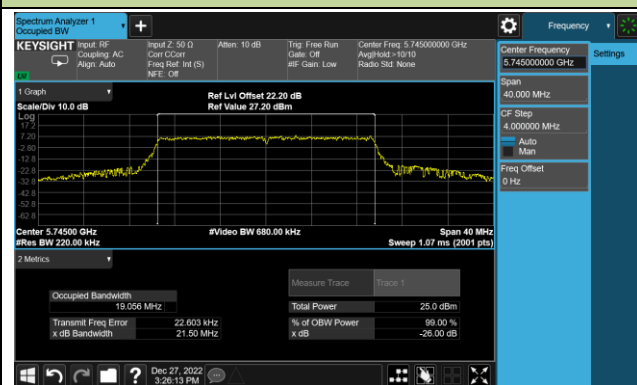

Channel 157 (5785MHz)

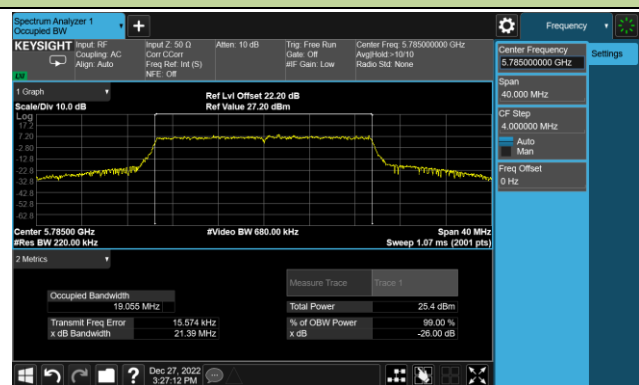

Channel 165 (5825MHz)

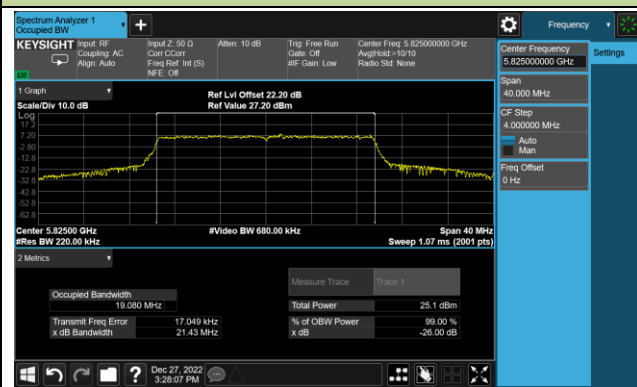

802.11ax-HE40 26dB Bandwidth

Channel 38 (5190MHz)

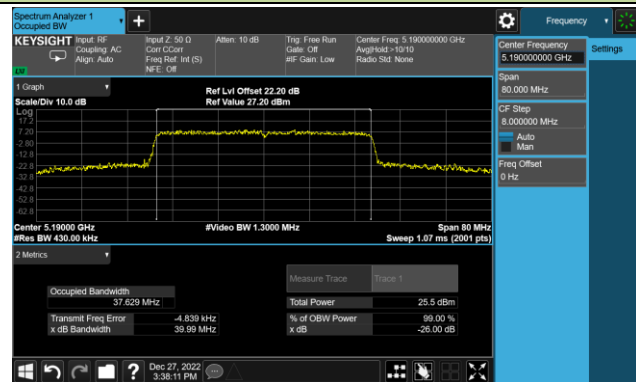

Channel 46 (5230MHz)

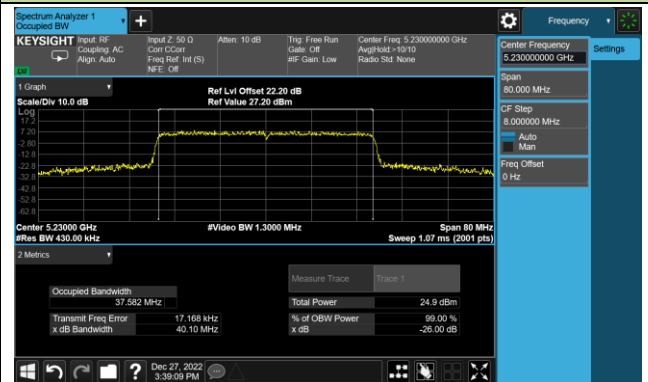

Channel 54 (5270MHz)

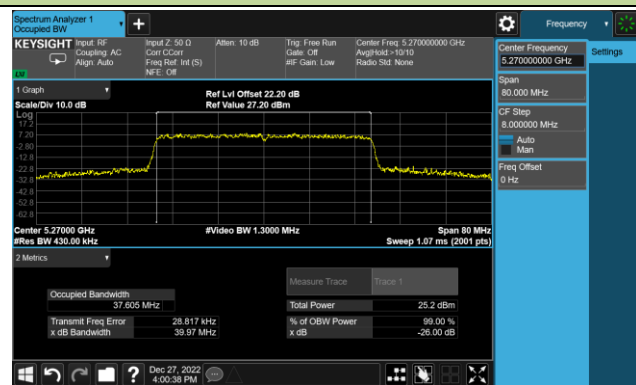

Channel 62 (5310MHz)

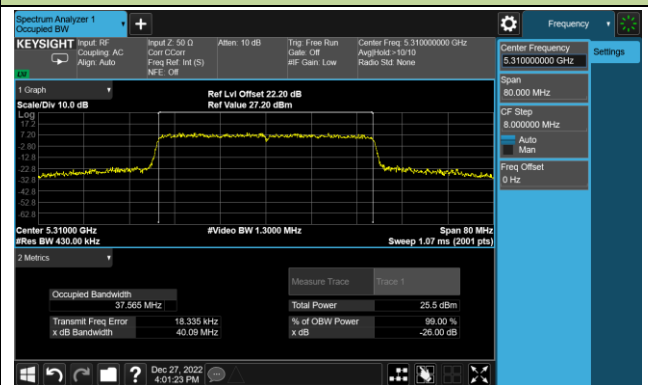

Channel 102 (5510MHz)

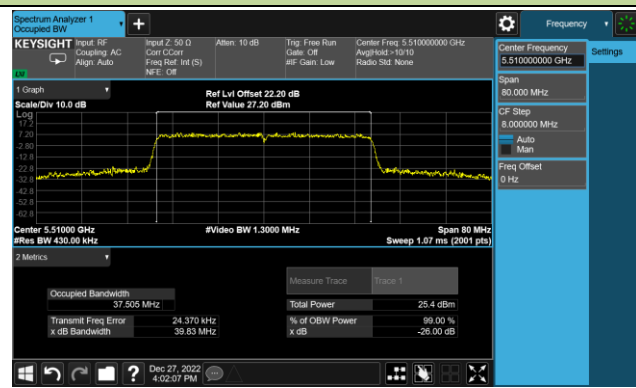

Channel 110 (5550MHz)

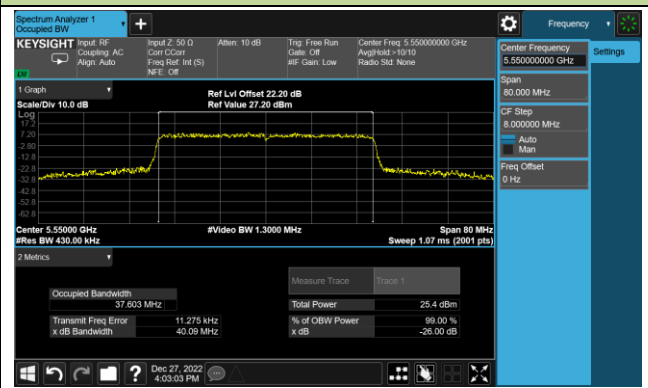

802.11ax-HE40 26dB Bandwidth

Channel 134 (5670MHz)

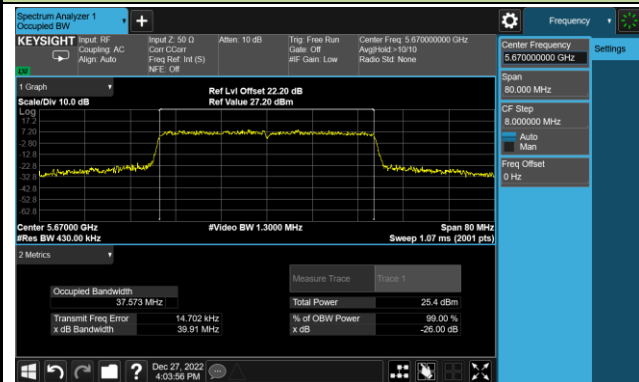

Channel 142(5710MHz)

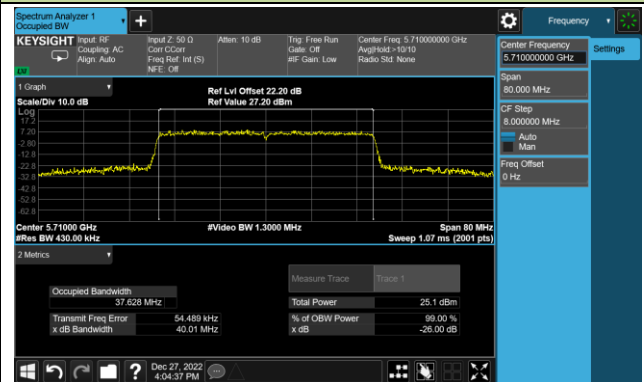

Channel 151 (5755MHz)

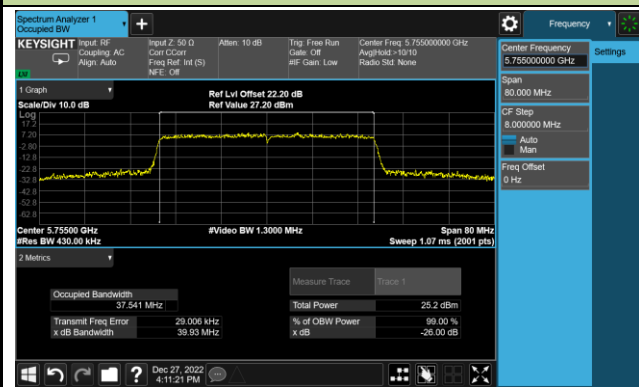

Channel 159 (5795MHz)

