

Test of Aruba AP-175 802.11a/b/g/n Wireless AP

To: FCC 47 CFR Part 15.407 & IC RSS-210

Test Report Serial No.: ARUB111-U1 Rev B



# TEST REPORT

FROM



Test of Aruba AP-175 802.11a/b/g/n Wireless AP  
to

To: FCC 47 CFR Part 15.407 & IC RSS-210

Test Report Serial No.: ARUB111-U1 Rev B

Note: this report contains data with regard to the 5,250 to 5,350 and 5,470 – 5,725 MHz DFS bands for the Aruba Networks, Inc AP-175 Wireless LAN Access Point. 2.4 and 5.8 GHz test data are reported in MiCOM Labs test report ARUB61-U1, and the results for DFS testing are reported in MiCOM Labs test report ARUB111-U2.

This report supersedes ARUB111-U1 Rev A

Applicant: Aruba Networks, Inc  
1344 Crossman Avenue  
Sunnyvale  
CA 94089, USA

Product Function: Wireless LAN Access Point

Copy No: pdf Issue Date: 12th August 2013

**This Test Report is Issued Under the Authority of:**

**MiCOM Labs, Inc.**

440 Boulder Court, Suite 200

Pleasanton, CA 94566 USA

Phone: +1 (925) 462-0304

Fax: +1 (925) 462-0306

[www.micomlabs.com](http://www.micomlabs.com)



TESTING CERTIFICATE #2381.01

**MiCOM Labs is an ISO 17025 Accredited Testing Laboratory**



**Title:** Aruba AP-175 802.11a/b/g/n Wireless AP  
**To:** FCC 47 CFR Part 15.407 & IC RSS-210  
**Serial #:** ARUB111-U1 Rev B  
**Issue Date:** 12th August 2013  
**Page:** 3 of 185

---

This page has been left intentionally blank

---

This test report may be reproduced in full only. The document may only be updated by MiCOM Labs personnel. Any changes will be noted in the Document History section of the report.



## TABLE OF CONTENTS

|   |            |
|---|------------|
| <b>ACCREDITATION, LISTINGS &amp; RECOGNITION .....</b>  | <b>5</b>   |
| ACCREDITATION - TESTING .....                           | 5          |
| RECOGNITION.....  | 6          |
| PRODUCT CERTIFICATION.....                              | 7          |
| <b>1. TEST RESULT CERTIFICATE .....</b>                 | <b>9</b>   |
| <b>2. REFERENCES AND MEASUREMENT UNCERTAINTY .....</b>  | <b>10</b>  |
| 2.1. Normative References .....                         | 10         |
| 2.2. Test and Uncertainty Procedures .....              | 11         |
| <b>3. PRODUCT DETAILS AND TEST CONFIGURATIONS .....</b> | <b>12</b>  |
| 3.1. Technical Details .....                            | 12         |
| 3.2. Scope of Test Program.....                         | 13         |
| 3.3. Equipment Model(s) and Serial Number(s) .....      | 14         |
| 3.4. Antenna Details .....                              | 14         |
| 3.5. Cabling and I/O Ports .....                        | 14         |
| 3.6. Test Configurations.....                           | 15         |
| 3.7. Equipment Modifications.....                       | 16         |
| 3.8. Deviations from the Test Standard .....            | 16         |
| 3.9. Subcontracted Testing or Third Party Data .....    | 16         |
| <b>4. TEST SUMMARY .....</b>                            | <b>17</b>  |
| <b>5. TEST RESULTS .....</b>                            | <b>19</b>  |
| 5.1. Device Characteristics .....                       | 19         |
| 5.1.1. <i>26 dB and 99 % Bandwidth</i> .....            | 19         |
| 5.1.2. <i>Transmit Output Power</i> .....               | 44         |
| 5.1.3. <i>Peak Power Spectral Density</i> .....         | 51         |
| 5.1.4. <i>Peak Excursion Ratio</i> .....                | 76         |
| 5.1.5. <i>Frequency Stability</i> .....                 | 101        |
| 5.1.6. <i>Maximum Permissible Exposure</i> .....        | 102        |
| 5.1.7. <i>Radiated Emissions</i> .....                  | 104        |
| <b>6. PHOTOGRAPHS.....</b>                              | <b>183</b> |
| 6.1. Radiated Emissions < 1GHz.....                     | 183        |
| <b>7. TEST EQUIPMENT DETAILS.....</b>                   | <b>184</b> |

---

This test report may be reproduced in full only. The document may only be updated by MiCOM Labs personnel. Any changes will be noted in the Document History section of the report.



**Title:** Aruba AP-175 802.11a/b/g/n Wireless AP  
**To:** FCC 47 CFR Part 15.407 & IC RSS-210  
**Serial #:** ARUB111-U1 Rev B  
**Issue Date:** 12th August 2013  
**Page:** 5 of 185

## **ACCREDITATION, LISTINGS & RECOGNITION**

### **ACCREDITATION - TESTING**

MiCOM Labs, Inc. is an accredited Electrical testing laboratory per the international standard EN ISO/IEC 17025. The company is accredited by the American Association for Laboratory Accreditation (A2LA) [www.a2la.org](http://www.a2la.org) test laboratory number 2381.01. MiCOM Labs test schedule is available at the following URL; <http://www.a2la.org/scopepdf/2381-01.pdf>



The American Association for Laboratory Accreditation

World Class Accreditation

## *Accredited Laboratory*

A2LA has accredited

**MICOM LABS**

*Pleasanton, CA*

for technical competence in the field of

**Electrical Testing**

This laboratory is accredited in accordance with the recognized International Standard ISO/IEC 17025:2005 *General Requirements for the Competence of Testing and Calibration Laboratories*. This accreditation demonstrates technical competence for a defined scope and the operation of a laboratory quality management system (refer to joint ISO-ILAC-IAF Communiqué dated 8 January 2009).

Presented this 27<sup>th</sup> day of March 2012.



President & CEO  
For the Accreditation Council  
Certificate Number 2381.01  
Valid to November 30, 2013

*For the tests or types of tests to which this accreditation applies, please refer to the laboratory's Electrical Scope of Accreditation.*

This test report may be reproduced in full only. The document may only be updated by MiCOM Labs personnel. Any changes will be noted in the Document History section of the report.



## **RECOGNITION**

MiCOM Labs, Inc has widely recognized Electrical testing capabilities. Our international recognition includes Conformity Assessment Body designation by APEC MRA\*\* countries. Our test reports are widely accepted for global type approvals.

| <b>Country</b> | <b>Recognition Body</b>  | <b>Status</b> | <b>Phase</b> | <b>Identification No.</b>    |
|----------------|--|---------------|--------------|------------------------------|
| USA            | Federal Communications Commission (FCC)  | TCB           | -            | US0159<br>Listing #: 102167  |
| Canada         | Industry Canada (IC)   | FCB           | APEC MRA 2   | US0159<br>Listing #: 4143A-2 |
| Japan          | MIC (Ministry of Internal Affairs and Communication)   | CAB           | APEC MRA 2   | RCB 210                      |
|                | VCCI   | --            | --           | A-0012                       |
| Europe         | European Commission  | NB            | EU MRA       | NB 2280                      |
| Australia      | Australian Communications and Media Authority (ACMA)   | CAB           | APEC MRA 1   | US0159                       |
| Hong Kong      | Office of the Telecommunication Authority (OFTA)   | CAB           | APEC MRA 1   |                              |
| Korea          | Ministry of Information and Communication Radio Research Laboratory (RRL)                        | CAB           | APEC MRA 1   |                              |
| Singapore      | Infocomm Development Authority (IDA)   | CAB           | APEC MRA 1   |                              |
| Taiwan         | National Communications Commission (NCC)<br>Bureau of Standards, Metrology and Inspection (BSMI) | CAB           | APEC MRA 1   |                              |
| Vietnam        | Ministry of Communication (MIC)  | CAB           | APEC MRA 1   |                              |

\*\*APEC MRA – Asia Pacific Economic Community Mutual Recognition Agreement.

Is a recognition agreement under which test lab is accredited to regulatory standards of the APEC member countries.

Phase I - recognition for product testing

Phase II – recognition for both product testing and certification

N/A – Not Applicable

\*\*EU MRA – European Union Mutual Recognition Agreement.

Is a recognition agreement under which test lab is accredited to regulatory standards of the EU member countries.

\*\*NB – Notified Body

This test report may be reproduced in full only. The document may only be updated by MiCOM Labs personnel. Any changes will be noted in the Document History section of the report.



**Title:** Aruba AP-175 802.11a/b/g/n Wireless AP  
**To:** FCC 47 CFR Part 15.407 & IC RSS-210  
**Serial #:** ARUB111-U1 Rev B  
**Issue Date:** 12th August 2013  
**Page:** 7 of 185

## **PRODUCT CERTIFICATION**

MiCOM Labs, Inc. is an accredited Product Certification Body per the international standard EN ISO/IEC Guide 65. The company is accredited by the American Association for Laboratory Accreditation (A2LA) [www.a2la.org](http://www.a2la.org) test laboratory number 2381.02. MiCOM Labs test schedule is available at the following URL; <http://www.a2la.org/scopepdf/2381-02.pdf>



The American Association for Laboratory Accreditation

"World Class Accreditation"

### *Accredited Product Certification Body*

A2LA has accredited

**MICOM LABS**

*Pleasanton, CA*

for technical competence as a

**Product Certification Body**

This product certification body is accredited in accordance with the recognized International Standard ISO/IEC Guide 65:1996 *General requirements for bodies operating product certification systems*. This accreditation demonstrates technical competence for a defined scope and the operation of a quality management system.

Presented this 27<sup>th</sup> day of March 2012.



President & CEO  
For the Accreditation Council  
Certificate Number 2381.02  
Valid to November 30, 2013

*For the product certification schemes to which this accreditation applies, please refer to the organization's Product Certification Scope of Accreditation*

### **United States of America – Telecommunication Certification Body (TCB)**

TCB Identifier – US0159

### **Industry Canada – Certification Body**

CAB Identifier – US0159

### **Europe – Notified Body**

Notified Body Identifier - 2280

### **Japan – Recognized Certification Body (RCB)**

RCB Identifier - 210

This test report may be reproduced in full only. The document may only be updated by MiCOM Labs personnel. Any changes will be noted in the Document History section of the report.



**Title:** Aruba AP-175 802.11a/b/g/n Wireless AP  
**To:** FCC 47 CFR Part 15.407 & IC RSS-210  
**Serial #:** ARUB111-U1 Rev B  
**Issue Date:** 12th August 2013  
**Page:** 8 of 185

---

## DOCUMENT HISTORY

| Document History |                                |                       |
|------------------|--------------------------------|-----------------------|
| Revision         | Date                           | Comments              |
| Draft            |                                |                       |
| Rev A            | 17 <sup>th</sup> December 2012 | Initial Release       |
| Rev B            | 12 <sup>th</sup> August 2013   | Update to add antenna |
|                  |                                |                       |

---

This test report may be reproduced in full only. The document may only be updated by MiCOM Labs personnel. Any changes will be noted in the Document History section of the report.





**Title:** Aruba AP-175 802.11a/b/g/n Wireless AP  
**To:** FCC 47 CFR Part 15.407 & IC RSS-210  
**Serial #:** ARUB111-U1 Rev B  
**Issue Date:** 12th August 2013  
**Page:** 9 of 185

## 1. TEST RESULT CERTIFICATE

|               |   |            |  |
|---------------|---|------------|--|
| Applicant:    | Aruba Networks, Inc<br>1344 Crossman Avenue<br>Sunnyvale<br>CA 94089, USA | Tested By: | MiCOM Labs, Inc.<br>440 Boulder Court<br>Suite 200<br>Pleasanton<br>California, 94566, USA |
| EUT:          | 802.11a/b/g/n Wireless Access Point                                       | Tel:       | +1 925 462 0304  |
| Model:        | AP-175  | Fax:       | +1 925 462 0306  |
| S/N:          | AY0009995   |            |  |
| Test Date(s): | 27th June - 18th July 2012  | Website:   | www.micomlabs.com  |

| STANDARD(S)                         | TEST RESULTS       |
|-------------------------------------|--------------------|
| FCC 47 CFR Part 15.407 & IC RSS-210 | EQUIPMENT COMPLIES |

MiCOM Labs, Inc. tested the equipment mentioned in accordance with the requirements set forth in the above standards. Test results indicate that the equipment tested is capable of demonstrating compliance with the requirements as documented within this report.

### Notes:

1. This document reports conditions under which testing was conducted and the results of testing performed.
2. Details of test methods used have been recorded and kept on file by the laboratory.
3. Test results apply only to the item(s) tested.

Approved & Released for MiCOM Labs, Inc. by:



TESTING CERTIFICATE #2381.01

  
\_\_\_\_\_  
Graeme Grieve  
Quality Manager MiCOM Labs,

  
\_\_\_\_\_  
Gordon Hurst  
President & CEO MiCOM Labs, Inc.

This test report may be reproduced in full only. The document may only be updated by MiCOM Labs personnel. Any changes will be noted in the Document History section of the report.

## **2. REFERENCES AND MEASUREMENT UNCERTAINTY**

### **2.1. Normative References**

| <b>Ref.</b>   | <b>Publication</b>             | <b>Year</b>            | <b>Title</b>   |
|---------------|--------------------------------|------------------------|--|
| <b>(i)</b>    | FCC 47 CFR Part 15.407         | 2012                   | Code of Federal Regulations  |
| <b>(ii)</b>   | FCC 06-96                      | June 2006              | Memorandum Opinion and Order   |
| <b>(iii)</b>  | Industry Canada RSS-210        | Issue 7<br>June 2007   | Low Power License-Exempt Radiocommunication Devices (All Frequency Bands): Category 1 Equipment  |
| <b>(iv)</b>   | Industry Canada RSS-Gen        | Issue 2<br>June 2007   | General Requirements and Information for the Certification of Radiocommunication Equipment   |
| <b>(v)</b>    | ANSI C63.4                     | 2003                   | American National Standards for Methods of Measurement of Radio-Noise Emissions from Low-Voltage Electrical and Electronic Equipment in the Range of 9 kHz to 40 GHz |
| <b>(vi)</b>   | CISPR 22/<br>EN 55022          | 1997<br>1998           | Limits and Methods of Measurements of Radio Disturbance Characteristics of Information Technology Equipment  |
| <b>(vii)</b>  | M 3003                         | Edition 1<br>Dec. 1997 | Expression of Uncertainty and Confidence in Measurements   |
| <b>(viii)</b> | LAB34                          | Edition 1<br>Aug 2002  | The expression of uncertainty in EMC Testing   |
| <b>(ix)</b>   | ETSI TR 100 028                | 2001                   | Parts 1 and 2<br>Electromagnetic compatibility and Radio Spectrum Matters (ERM); Uncertainties in the measurement of mobile radio equipment characteristics          |
| <b>(x)</b>    | A2LA                           | July 2012              | Reference to A2LA Accreditation Status – A2LA Advertising Policy   |
| <b>(xi)</b>   | FCC Public Notice – DA 02-2138 | 2002                   | Guidelines for Assessing Unlicensed National Information Infrastructure (U-NII) Devices  |



**Title:** Aruba AP-175 802.11a/b/g/n Wireless AP  
**To:** FCC 47 CFR Part 15.407 & IC RSS-210  
**Serial #:** ARUB111-U1 Rev B  
**Issue Date:** 12th August 2013  
**Page:** 11 of 185

---

## **2.2. Test and Uncertainty Procedures**

Conducted and radiated emission measurements were conducted in accordance with American National Standards Institute ANSI C63.4, listed in the Normative References section of this report.

Measurement uncertainty figures are calculated in accordance with ETSI TR 100 028 Parts 1 and 2.

Measurement uncertainties stated are based on a standard uncertainty multiplied by a coverage factor  $k = 2$ , providing a level of confidence of approximately 95 % in accordance with UKAS document M 3003 listed in the Normative References section of this report.

---

This test report may be reproduced in full only. The document may only be updated by MiCOM Labs personnel. Any changes will be noted in the Document History section of the report.



**Title:** Aruba AP-175 802.11a/b/g/n Wireless AP  
**To:** FCC 47 CFR Part 15.407 & IC RSS-210  
**Serial #:** ARUB111-U1 Rev B  
**Issue Date:** 12th August 2013  
**Page:** 12 of 185

### 3. PRODUCT DETAILS AND TEST CONFIGURATIONS

#### 3.1. Technical Details

| Details   | Description   |                 |         |         |               |         |               |         |                 |         |         |               |         |               |         |
|---|---|-----------------|---------|---------|---------------|---------|---------------|---------|-----------------|---------|---------|---------------|---------|---------------|---------|
| Purpose:  | Test of the Aruba AP-175 802.11a/b/g/n Wireless AP in the frequency ranges 5250 to 5350 MHz and 5470 – 5725MHz to FCC Part 15.407 and Industry Canada RSS-210 regulations.  |                 |         |         |               |         |               |         |                 |         |         |               |         |               |         |
| Applicant:  | Aruba Networks, Inc<br>1344 Crossman Avenue<br>Sunnyvale<br>CA 94089, USA   |                 |         |         |               |         |               |         |                 |         |         |               |         |               |         |
| Manufacturer:                                     | As applicant  |                 |         |         |               |         |               |         |                 |         |         |               |         |               |         |
| Laboratory performing the tests:                  | MiCOM Labs, Inc.<br>440 Boulder Court, Suite 200<br>Pleasanton, California 94566 USA  |                 |         |         |               |         |               |         |                 |         |         |               |         |               |         |
| Test report reference number:                     | ARUB111-U1 Rev B  |                 |         |         |               |         |               |         |                 |         |         |               |         |               |         |
| Date EUT received:                                | 6 <sup>th</sup> June 2012   |                 |         |         |               |         |               |         |                 |         |         |               |         |               |         |
| Standard(s) applied:                              | FCC 47 CFR Part 15.407 & IC RSS-210   |                 |         |         |               |         |               |         |                 |         |         |               |         |               |         |
| Dates of test (from - to):                        | 27th June - 18th July 2012<br>27th June - 18th July 2012  |                 |         |         |               |         |               |         |                 |         |         |               |         |               |         |
| No of Units Tested:                               | 1   |                 |         |         |               |         |               |         |                 |         |         |               |         |               |         |
| Type of Equipment:                                | 802.11a/b/g/n Wireless Access Point, 2x2 Spatial Multiplexing MIMO configuration  |                 |         |         |               |         |               |         |                 |         |         |               |         |               |         |
| Applicants Trade Name:                            | Aruba Networks, Inc   |                 |         |         |               |         |               |         |                 |         |         |               |         |               |         |
| Model(s):   | AP-175  |                 |         |         |               |         |               |         |                 |         |         |               |         |               |         |
| Software Release                                  | AOS Rev 6.2.0.0   |                 |         |         |               |         |               |         |                 |         |         |               |         |               |         |
| Location for use:                                 | Outdoor   |                 |         |         |               |         |               |         |                 |         |         |               |         |               |         |
| Declared Frequency Range(s):                      | 5,250 to 5,350 and 5,470 – 5,725 MHz  |                 |         |         |               |         |               |         |                 |         |         |               |         |               |         |
| Type of Modulation:                               | Per 802.11 –CCK, BPSK, QPSK, DSSS, OFDM   |                 |         |         |               |         |               |         |                 |         |         |               |         |               |         |
| Declared Nominal Output Power:<br>(Average Power) | 802.11a: Legacy +17 dBm<br>802.11n: HT-20 +17 dBm<br>802.11n: HT-40 +17 dBm   |                 |         |         |               |         |               |         |                 |         |         |               |         |               |         |
| EUT Modes of Operation:                           | Legacy 802.11a/b/g, 802.11n HT-20, HT-40  |                 |         |         |               |         |               |         |                 |         |         |               |         |               |         |
| Transmit/Receive Operation:                       | Time Division Duplex  |                 |         |         |               |         |               |         |                 |         |         |               |         |               |         |
| Rated Input Voltage and Current:                  | DC: Nominal: 12V DC Current: 1.25 A   |                 |         |         |               |         |               |         |                 |         |         |               |         |               |         |
| Operating Temperature Range:                      | Nominal: 20 °C Max: 50 °C Min: 0 °C   |                 |         |         |               |         |               |         |                 |         |         |               |         |               |         |
| ITU Emission Designator:                          | <table border="0"> <tr> <td rowspan="3">5250 – 5350 MHz</td> <td>802.11a</td> <td>17M3D1D</td> </tr> <tr> <td>802.11n HT-20</td> <td>18M5D1D</td> </tr> <tr> <td>802.11n HT-40</td> <td>47M0D1D</td> </tr> <tr> <td rowspan="3">5470 – 5725 MHz</td> <td>802.11a</td> <td>18M0D1D</td> </tr> <tr> <td>802.11n HT-20</td> <td>19M1D1D</td> </tr> <tr> <td>802.11n HT-40</td> <td>54M0D1D</td> </tr> </table> | 5250 – 5350 MHz | 802.11a | 17M3D1D | 802.11n HT-20 | 18M5D1D | 802.11n HT-40 | 47M0D1D | 5470 – 5725 MHz | 802.11a | 18M0D1D | 802.11n HT-20 | 19M1D1D | 802.11n HT-40 | 54M0D1D |
| 5250 – 5350 MHz                                   | 802.11a   |                 | 17M3D1D |         |               |         |               |         |                 |         |         |               |         |               |         |
|   | 802.11n HT-20   |                 | 18M5D1D |         |               |         |               |         |                 |         |         |               |         |               |         |
|   | 802.11n HT-40   | 47M0D1D         |         |         |               |         |               |         |                 |         |         |               |         |               |         |
| 5470 – 5725 MHz                                   | 802.11a   | 18M0D1D         |         |         |               |         |               |         |                 |         |         |               |         |               |         |
|   | 802.11n HT-20   | 19M1D1D         |         |         |               |         |               |         |                 |         |         |               |         |               |         |
|   | 802.11n HT-40   | 54M0D1D         |         |         |               |         |               |         |                 |         |         |               |         |               |         |
| Frequency Stability:                              | ±20 ppm   |                 |         |         |               |         |               |         |                 |         |         |               |         |               |         |
| Equipment Dimensions:                             | 10.2" x 10.2" x 4.0" (25.9cm x 25.9cm x 10.2cm)   |                 |         |         |               |         |               |         |                 |         |         |               |         |               |         |
| Weight:   | 7lbs (3.25 kgs)   |                 |         |         |               |         |               |         |                 |         |         |               |         |               |         |
| Primary function of equipment:                    | Wireless Access Point for transmitting data and voice   |                 |         |         |               |         |               |         |                 |         |         |               |         |               |         |

This test report may be reproduced in full only. The document may only be updated by MiCOM Labs personnel. Any changes will be noted in the Document History section of the report.



**Title:** Aruba AP-175 802.11a/b/g/n Wireless AP  
**To:** FCC 47 CFR Part 15.407 & IC RSS-210  
**Serial #:** ARUB111-U1 Rev B  
**Issue Date:** 12th August 2013  
**Page:** 13 of 185

---

### **3.2. Scope of Test Program**

#### **Testing**

The scope of the compliance program was to test the Aruba Networks Inc AP-175P 802.11 a/b/g/n AP wireless Access Point, 2x2 Spatial Multiplexing MIMO configurations in the frequency ranges in the frequency ranges 5,250 – 5,350 and 5,470 – 5,725 MHz for compliance against FCC 47 CFR Part 15.407 and Industry Canada RSS-210 specifications.

The Aruba Networks AP-175P has external antennas with N-type connectors. The device has two radios with two transmit and receive antennae. The antennas used with the AP-175P are detailed in section 3.4 "Antenna Details".

---

This test report may be reproduced in full only. The document may only be updated by MiCOM Labs personnel. Any changes will be noted in the Document History section of the report.



### 3.3. Equipment Model(s) and Serial Number(s)

| Type (EUT/Support) | Equipment Description (Including Brand Name) | Mfr                 | Model No. | Serial No. |
|--------------------|--|---------------------|-----------|------------|
| EUT                | 802.11a/b/g/n Wireless Access Point          | Aruba Networks, Inc | AP-175    | AY0009995  |
| Support            | Laptop PC                                    | IBM                 | Thinkpad  | None       |

### 3.4. Antenna Details

The following is a description of the EUT antennas.

| Antenna Type: | Manufacturer | Model      | Gain (dBi) | Frequency Range (MHz) |
|---------------|--------------|------------|------------|-----------------------|
| Dipole        | Aruba        | AP-ANT-1B  | 5.8        | 4900 – 5875           |
| Dipole        | Aruba        | AP-ANT-10  | 6          | 5150 – 5875           |
| Dipole        | Aruba        | AP-ANT-86D | 9          | 5150 – 5875           |
| Directional   | Aruba        | AP-ANT-89  | 14.0       | 5150 - 5350           |
|               |              |            | 13.25      | 5470 – 5875           |

### 3.5. Cabling and I/O Ports

Number and type of I/O ports

1. 1000/100/10 Ethernet with POE x 1.
2. USB Local maintenance terminal (LMT) x 1.



### 3.6. Test Configurations

Testing was performed to determine the highest power level versus bit rate. The variant with the highest power was used to exercise the product.

Matrix of test configurations

| Operational Mode(s)<br>(802.11) | Variant | Data Rates with Highest<br>Power | Frequencies<br>(MHz)           |
|---------------------------------|---------|----------------------------------|--------------------------------|
| a,n                             | Legacy  | 6 MBit/s                         | 5260, 5300, 5320               |
|                                 | HT-20   | 6.5 MCS                          | 5500, 5580, 5700               |
|                                 | HT-40   | 13.5 MCS                         | 5270, 5310<br>5510, 5550, 5670 |

### Antenna Test Configurations for Radiated Emissions and Band-Edge

The following measurements were performed on all antenna configurations identified in Section 3.4 Antenna Details.

### Spurious Emission and Band-Edge Test Strategy

| 11a     | 11n HT-20 | 11n HT-40 |
|---------|-----------|-----------|
| SE 5260 | SE 5260   | SE 5270   |
| SE 5300 | SE 5300   |           |
| SE 5320 | SE 5320   | SE 5310   |
| BE 5350 | BE 5350   | BE 5350   |
| BE 5460 | BE 5460   | BE 5460   |
| SE 5500 | SE 5500   | SE 5510   |
| SE 5580 | SE 5580   | SE 5550   |
| SE 5700 | SE 5700   | SE 5670   |

KEY:-

SE – Spurious Emissions

BE – Band-Edge



### 3.7. Equipment Modifications

The following modifications were required to bring the equipment into compliance:

#### EUT Software Power Settings - Radiated Testing

1. Measurements were made using the highest gain antenna used with the AP-104, Antenna(s): AP-ANT-18; 7.5 dBi, AP-ANT-19; 6.0 dBi, 5150 – 5875 MHz band.

#### Configured Power Settings for Radiated Tests

| Band/Mode        | Antenna AP-ANT-10       | Antenna AP-ANT-86D | Antenna AP-ANT-89 |
|------------------|-------------------------|--------------------|-------------------|
|                  | ART Power Setting (dBm) |                    |                   |
| <b>5250-5350</b> |                         |                    |                   |
| 802.11a          | 21                      | 19                 | 19.0              |
| 802.11n HT20     | 21                      | 19                 | 18.5              |
| 802.11n HT40     | 17                      | 16                 | 20.5              |
| <b>5470-5725</b> |                         |                    |                   |
| 802.11a          | 21                      | 21                 | 20                |
| 802.11n HT20     | 21                      | 21                 | 20                |
| 802.11n HT40     | 17                      | 21                 | 20                |

### 3.8. Deviations from the Test Standard

The following deviations from the test standard were required in order to complete the test program:

1. NONE

### 3.9. Subcontracted Testing or Third Party Data

1. NONE





## 4. TEST SUMMARY

### List of Measurements

The following table represents the list of measurements required under the **FCC CFR47 Part 15.407** and **Industry Canada RSS-210** and **Industry Canada RSS-Gen**.

| Section(s)                       | Test Items                         | Description   | Condition             | Result   | Test Report Section |
|----------------------------------|------------------------------------|---|-----------------------|----------|---------------------|
| 15.407(a)<br>A9.2(2)<br>4.4      | 26dB and 99% Emission BW           | Emission bandwidth measurement  | Conducted             | Complies | 5.1.1               |
| 15.407(a)<br>A9.2(2)<br>4.6      | Transmit Output Power              | Power Measurement   | Conducted             | Complies | 5.1.2               |
| 15.407(a)<br>A9.2(2)             | Peak Power Spectral Density        | PPSD  | Conducted             | Complies | 5.1.3               |
| 15.407(a)(6)                     | Peak Excursion Ratio               | <13dB in any 1MHz bandwidth   | Conducted             | Complies | 5.1.4               |
| 15.407(g)<br>15.31<br>2.1<br>4.5 | Frequency Stability                | Limits: contained within band of operation at all times.                      | Applicant declaration | Complies | 5.1.5               |
| 15.407(f)<br>5.5                 | Radio Frequency Radiation Exposure | Exposure to radio frequency energy levels, Maximum Permissible Exposure (MPE) | Conducted             | Complies | 5.1.6               |

This test report may be reproduced in full only. The document may only be updated by MiCOM Labs personnel. Any changes will be noted in the Document History section of the report.



**List of Measurements (continued)**

The following table represents the list of measurements required under the **FCC CFR47 Part 15.407** and **Industry Canada RSS-210** and **Industry Canada RSS-Gen**.

| Section(s)  | Test Items                                     | Description                  | Condition | Result                              | Test Report Section |
|---|--|------------------------------|-----------|-------------------------------------|---------------------|
| <b>15.407(b)(2)</b><br><b>15.205(a)</b><br><b>15.209(a)</b><br><b>2.2</b><br><b>2.6</b><br><b>A9.3(2)</b><br><b>4.7</b> | Radiated Emissions                             |                              | Radiated  |                                     | 5.1.7               |
|   | Transmitter Radiated Spurious Emissions        | Emissions above 1 GHz        |           | Complies                            | 5.1.7.1             |
|   | Radiated Band Edge                             | Band edge results            |           | Complies                            | 5.1.7.1             |
| Industry Canada only<br><b>RSS-Gen §4.10, §6</b>  | Receiver Radiated Spurious Emissions           | Emissions above 1 GHz        |           | Complies                            | 5.1.7.2             |
| <b>15.407(b)(6)</b><br><b>15.205(a)</b><br><b>15.209(a)</b><br><b>2.2</b>   | Radiated Emissions                             | Emissions <1 GHz (30M-1 GHz) |           | Complies                            | 5.1.7.3             |
| <b>15.407(b)(6)</b><br><b>15.207</b><br><b>7.2.2</b>  | AC Wireline Conducted Emissions 150 kHz–30 MHz | Conducted Emissions          | Conducted | Not Applicable<br>EUT is DC powered | N/A                 |

This test report may be reproduced in full only. The document may only be updated by MiCOM Labs personnel. Any changes will be noted in the Document History section of the report.

## 5. TEST RESULTS

### 5.1. Device Characteristics

#### 5.1.1. 26 dB and 99 % Bandwidth

**FCC, Part 15 Subpart C §15.407(a)**  
**Industry Canada RSS-210 § A9.2(2)**  
**Industry Canada RSS-Gen 4.4**

#### Test Procedure

The bandwidth at 26 dB and 99 % is measured with a spectrum analyzer connected to the antenna terminal, while EUT is operating in transmission mode at the appropriate center frequency.

#### Test Measurement Set up

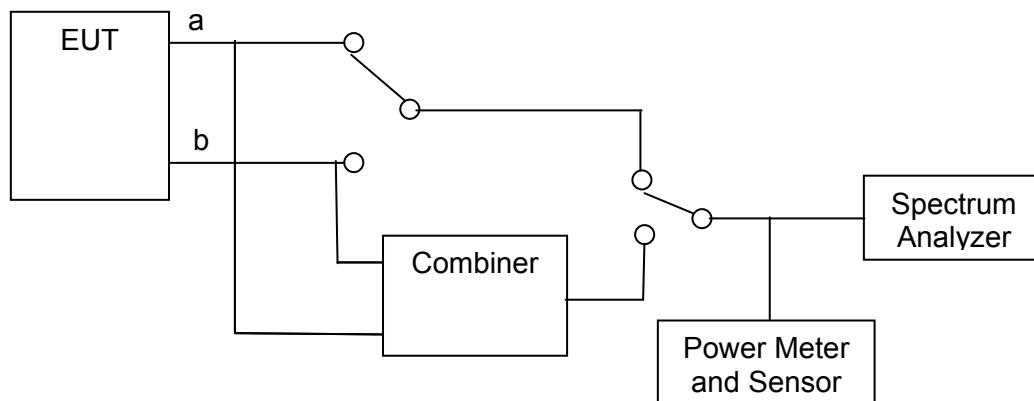

Measurement set up for 26 dB and 99 % bandwidth test

#### Radio Parameters

Duty Cycle: 100%

Output: Modulated Carrier

Power: Maximum Default Power



**Measurement Results for 26 dB and 99 % Operational Bandwidth(s)**

Ambient conditions.

Temperature: 17 to 23 °C    Relative humidity: 31 to 57 %    Pressure: 999 to 1012 mbar

**TABLE OF RESULTS – 802.11a Legacy (5,250 – 5,350 MHz)**

|                               |                   |                            |             |
|-------------------------------|-------------------|----------------------------|-------------|
| <b>Test Conditions:</b>       | 15.247 (a)(2)     | <b>Rel. Humidity (%):</b>  | 35 to 42    |
| <b>Variant:</b>               | 802.11a           | <b>Ambient Temp. (°C):</b> | 19 to 22    |
| <b>TPC:</b>                   | HIGH              | <b>Pressure (mBars):</b>   | 998 to 1003 |
| <b>Modulation:</b>            | ON                | <b>Duty Cycle (x):</b>     | 100         |
| <b>Beam Forming Gain (Y):</b> | N/A          dB   | <b>Antenna Gain:</b>       | 6 dBi       |
| <b>Applied Voltage:</b>       | 12.0          Vdc |                            |             |
| <b>Notes 1:</b>               |                   |                            |             |
| <b>Notes 2:</b>               |                   |                            |             |

**26 dB Bandwidth**

| Test Frequency | 26 dB Bandwidth |           |    |    | Minimum 6dB Bandwidth Limit |     | Margin     |
|----------------|-----------------|-----------|----|----|-----------------------------|-----|------------|
|                | MHz             |           |    |    | kHz                         | MHz |            |
| MHz            | a               | b         | c  | d  |                             |     |            |
| 5260           | 24.148000       | 27.355000 | -- | -- | 500                         | 0.5 | -23.648000 |
| 5300           | 25.150000       | 29.058000 | -- | -- |                             |     | -24.650000 |
| 5320           | 24.048000       | 26.453000 | -- | -- |                             |     | -23.548000 |

**99% Bandwidth**

| Test Frequency | 99 % Bandwidth |           |    |    |  |  |  |
|----------------|----------------|-----------|----|----|--|--|--|
|                | MHz            |           |    |    |  |  |  |
| MHz            | a              | b         | c  | d  |  |  |  |
| 5260           | 16.934000      | 17.134000 | -- | -- |  |  |  |
| 5300           | 16.934000      | 17.234000 | -- | -- |  |  |  |
| 5320           | 16.834000      | 17.134000 | -- | -- |  |  |  |

|                                 |          |
|---------------------------------|----------|
| <b>Measurement uncertainty:</b> | ±2.81 dB |
|---------------------------------|----------|

This test report may be reproduced in full only. The document may only be updated by MiCOM Labs personnel. Any changes will be noted in the Document History section of the report.



### CHAIN A 5,260 MHz 802.11a Legacy 26 dB and 99 % Bandwidth

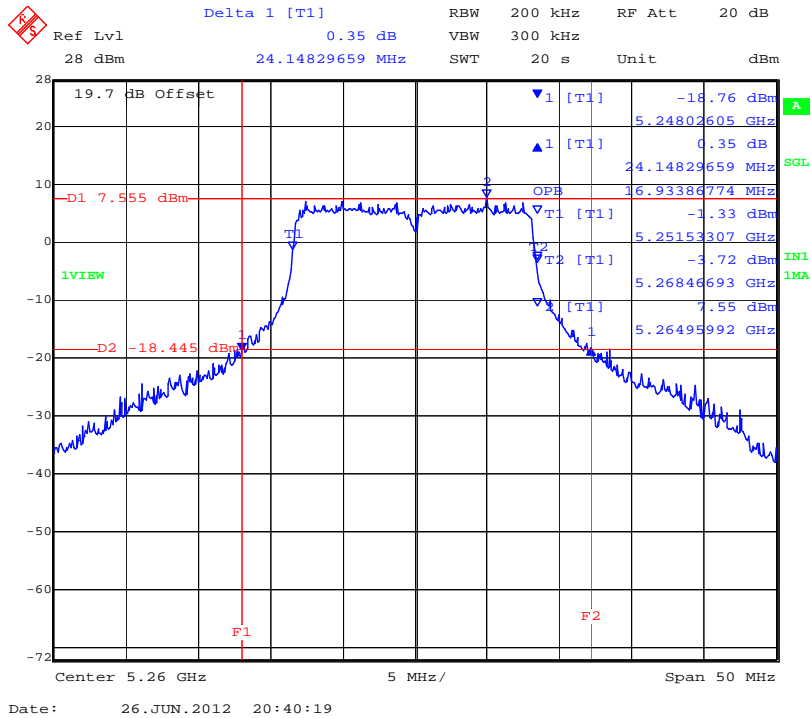

### CHAIN B 5,260 MHz 802.11a Legacy 26 dB and 99 % Bandwidth

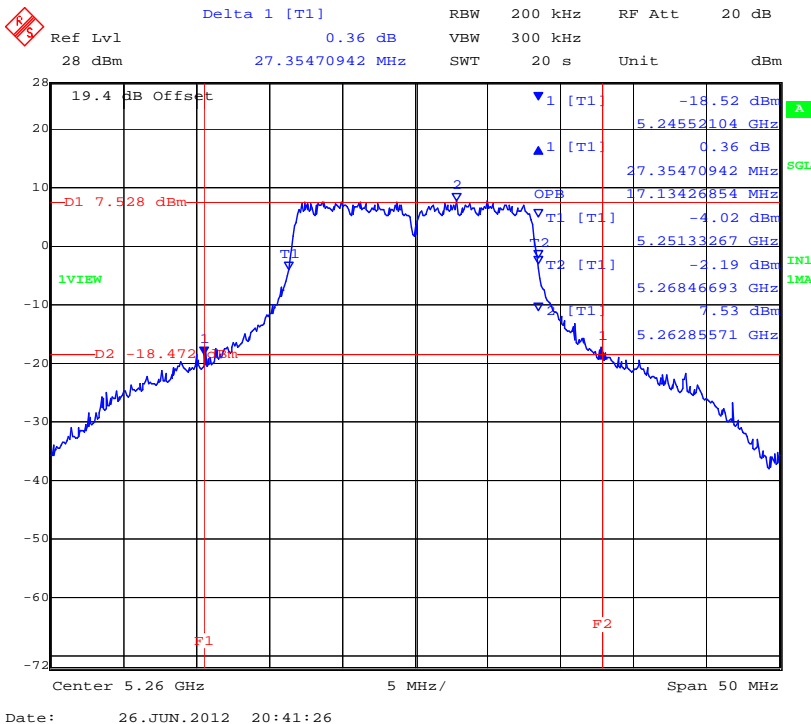

This test report may be reproduced in full only. The document may only be updated by MiCOM Labs personnel. Any changes will be noted in the Document History section of the report.



### CHAIN A 5,300 MHz 802.11a Legacy 26 dB and 99 % Bandwidth

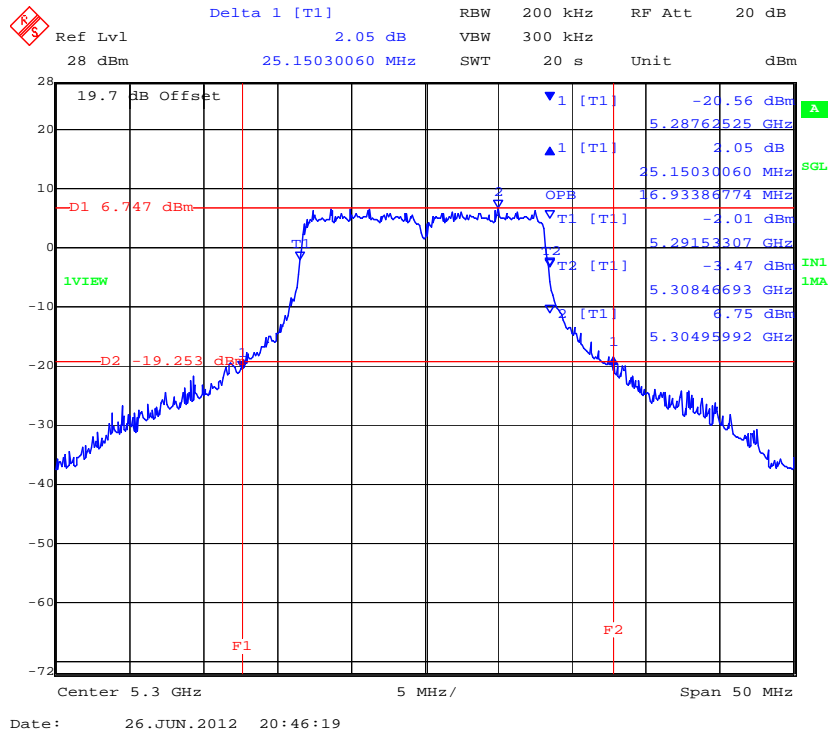

### CHAIN B 5,300 MHz 802.11a Legacy 26 dB and 99 % Bandwidth

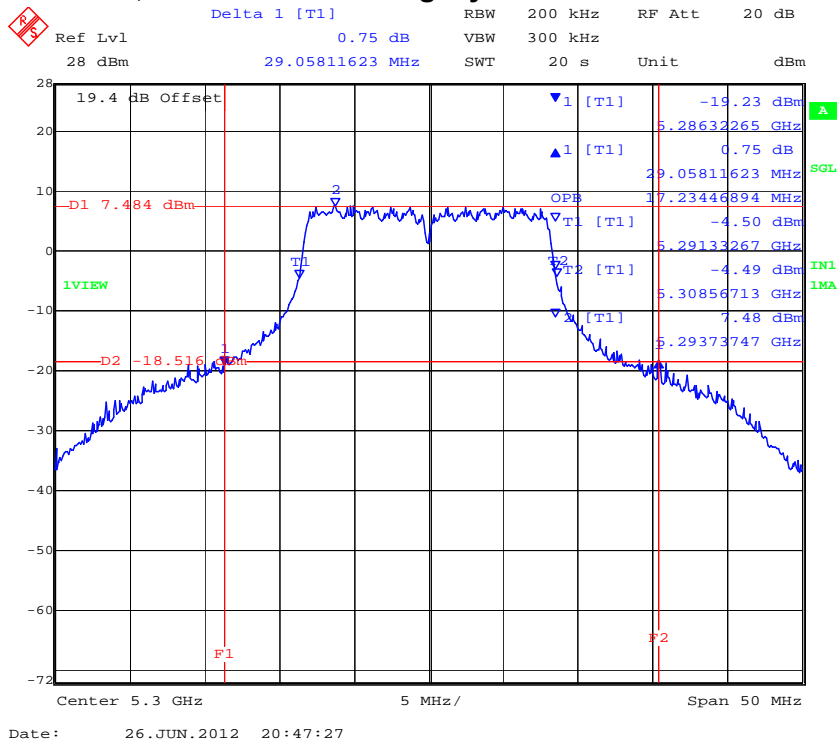

This test report may be reproduced in full only. The document may only be updated by MiCOM Labs personnel. Any changes will be noted in the Document History section of the report.



### CHAIN A 5,320 MHz 802.11a Legacy 26 dB and 99 % Bandwidth

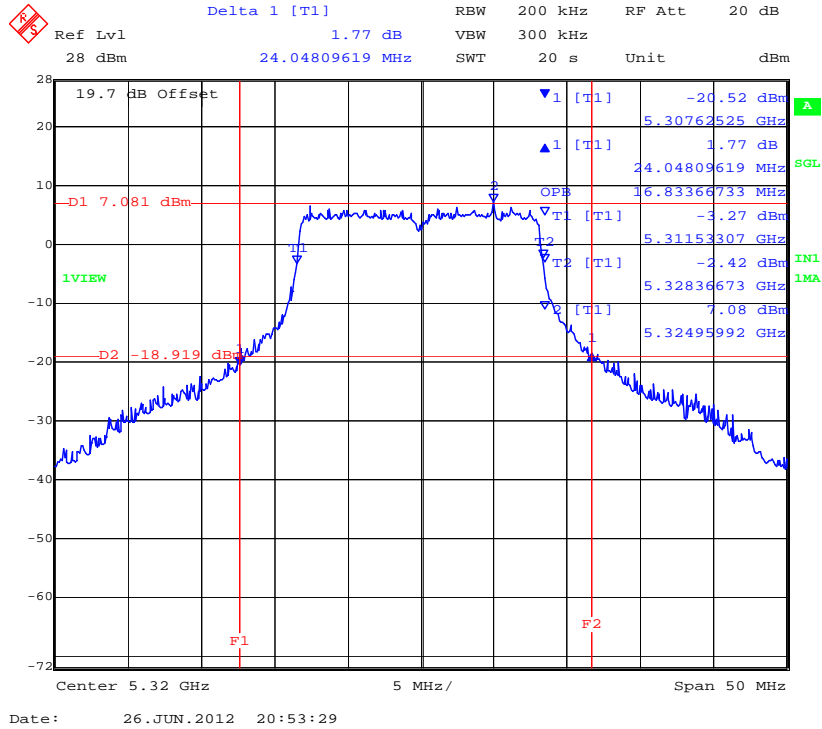

### CHAIN B 5,320 MHz 802.11a Legacy 26 dB and 99 % Bandwidth

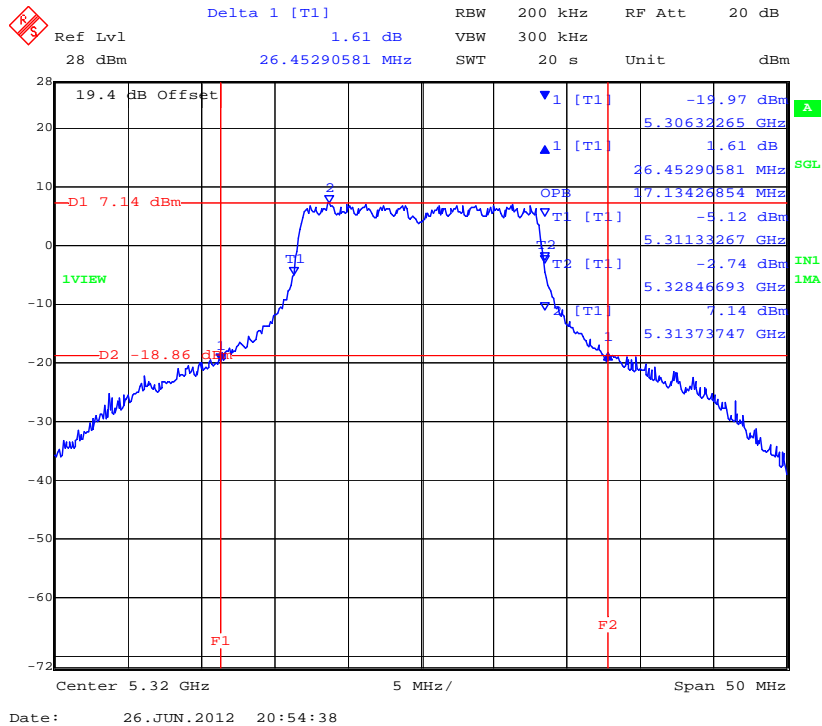

This test report may be reproduced in full only. The document may only be updated by MiCOM Labs personnel. Any changes will be noted in the Document History section of the report.



**TABLE OF RESULTS – 802.11a Legacy (5,470 – 5,725 MHz)**

|                               |               |                            |             |
|-------------------------------|---------------|----------------------------|-------------|
| <b>Test Conditions:</b>       | 15.247 (a)(2) | <b>Rel. Humidity (%):</b>  | 35 to 42    |
| <b>Variant:</b>               | 802.11a       | <b>Ambient Temp. (°C):</b> | 19 to 22    |
| <b>TPC:</b>                   | HIGH          | <b>Pressure (mBars):</b>   | 998 to 1003 |
| <b>Modulation:</b>            | ON            | <b>Duty Cycle (x):</b>     | 100         |
| <b>Beam Forming Gain (Y):</b> | N/A dB        | <b>Antenna Gain:</b>       | 6 dBi       |
| <b>Applied Voltage:</b>       | 12.0 Vdc      |                            |             |
| <b>Notes 1:</b>               |               |                            |             |
| <b>Notes 2:</b>               |               |                            |             |

**26 dB Bandwidth**

| Test Frequency | 26 dB Bandwidth |           |    |    | Minimum 6dB Bandwidth Limit |     | Margin     |
|----------------|-----------------|-----------|----|----|-----------------------------|-----|------------|
|                | MHz             |           |    |    | kHz                         | MHz |            |
| MHz            | a               | b         | c  | d  |                             |     |            |
| 5500           | 26.954000       | 31.263000 | -- | -- | 500                         | 0.5 | -26.454000 |
| 5580           | 25.551000       | 31.363000 | -- | -- |                             |     | -25.051000 |
| 5700           | 25.150000       | 25.752000 | -- | -- |                             |     | -24.650000 |

**99% Bandwidth**

| Test Frequency | 99 % Bandwidth |           |    |    |  |  |  |
|----------------|----------------|-----------|----|----|--|--|--|
|                | MHz            |           |    |    |  |  |  |
| MHz            | a              | b         | c  | d  |  |  |  |
| 5500           | 17.034000      | 17.535000 | -- | -- |  |  |  |
| 5580           | 16.934000      | 17.735000 | -- | -- |  |  |  |
| 5700           | 16.834000      | 17.234000 | -- | -- |  |  |  |

|                                 |          |
|---------------------------------|----------|
| <b>Measurement uncertainty:</b> | ±2.81 dB |
|---------------------------------|----------|

This test report may be reproduced in full only. The document may only be updated by MiCOM Labs personnel. Any changes will be noted in the Document History section of the report.





### CHAIN A 5,500 MHz 802.11a Legacy 26 dB and 99 % Bandwidth

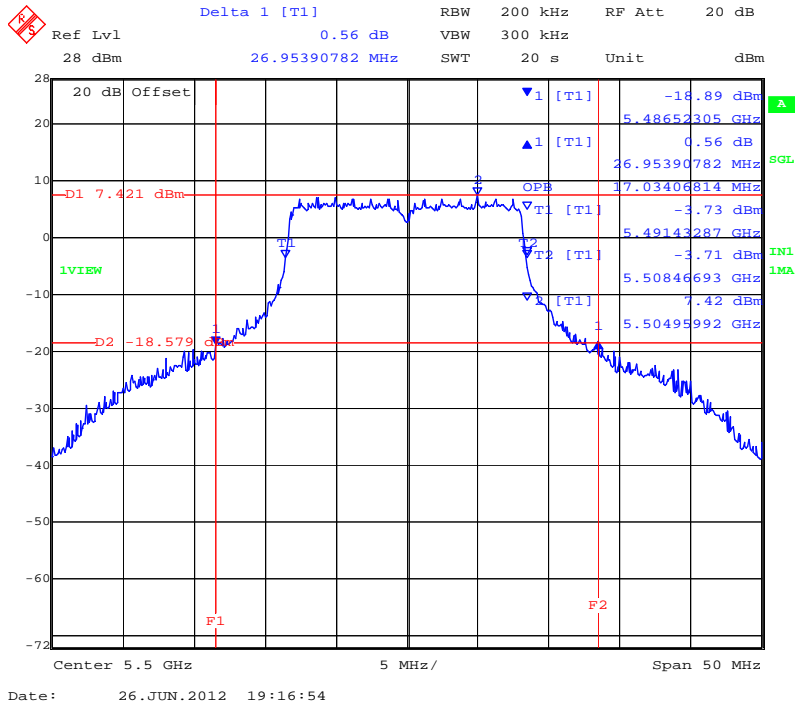

### CHAIN B 5,500 MHz 802.11a Legacy 26 dB and 99 % Bandwidth

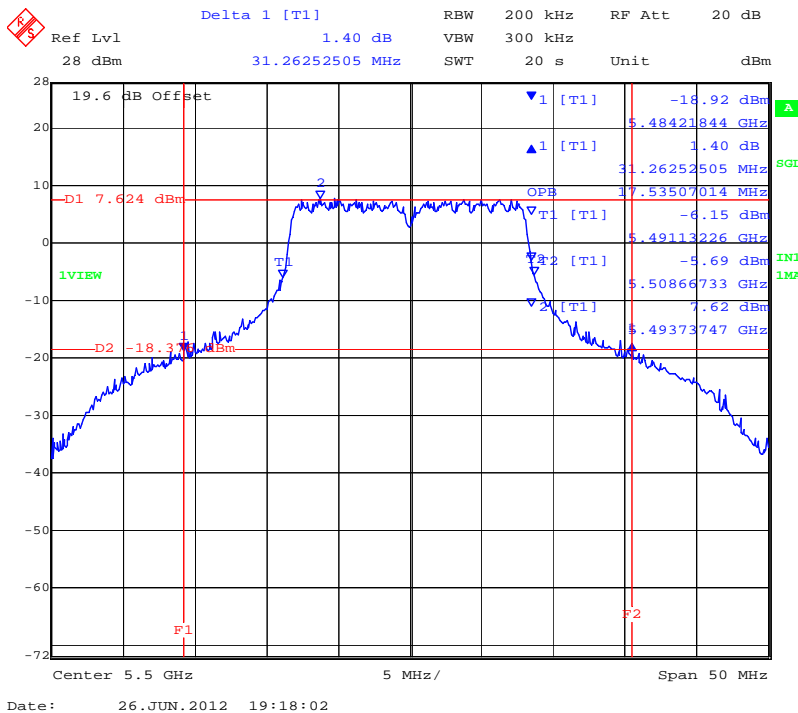

This test report may be reproduced in full only. The document may only be updated by MiCOM Labs personnel. Any changes will be noted in the Document History section of the report.



**CHAIN A 5,580 MHz 802.11a Legacy 26 dB and 99 % Bandwidth**

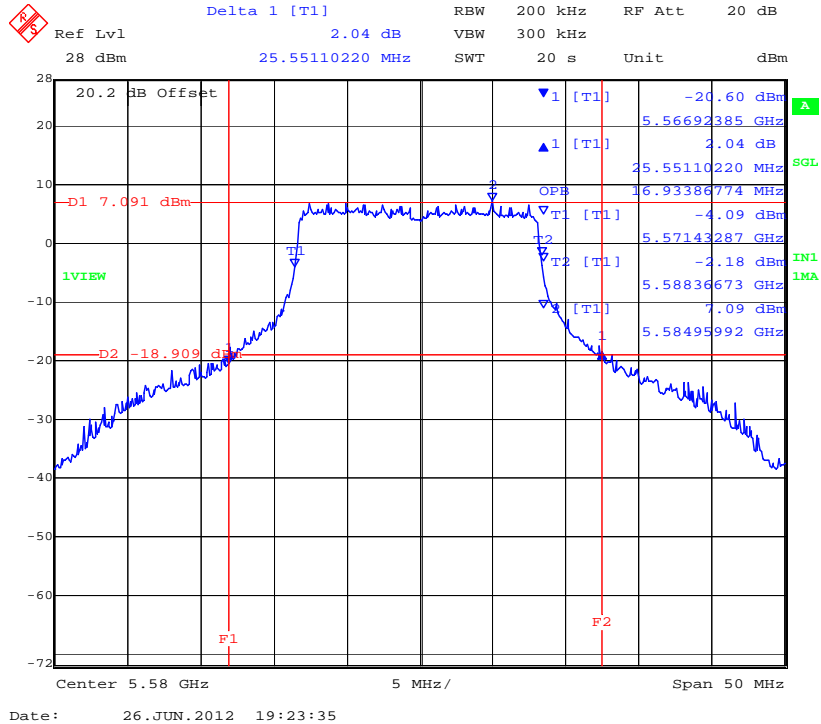

**CHAIN B 5,580 MHz 802.11a Legacy 26 dB and 99 % Bandwidth**

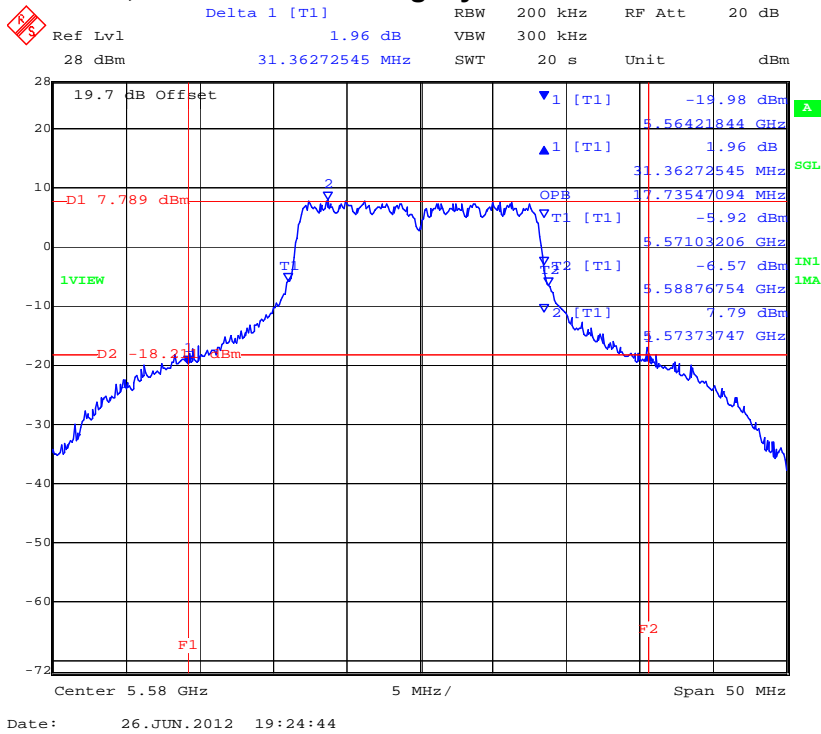

This test report may be reproduced in full only. The document may only be updated by MiCOM Labs personnel. Any changes will be noted in the Document History section of the report.



### CHAIN A 5,700 MHz 802.11a Legacy 26 dB and 99 % Bandwidth

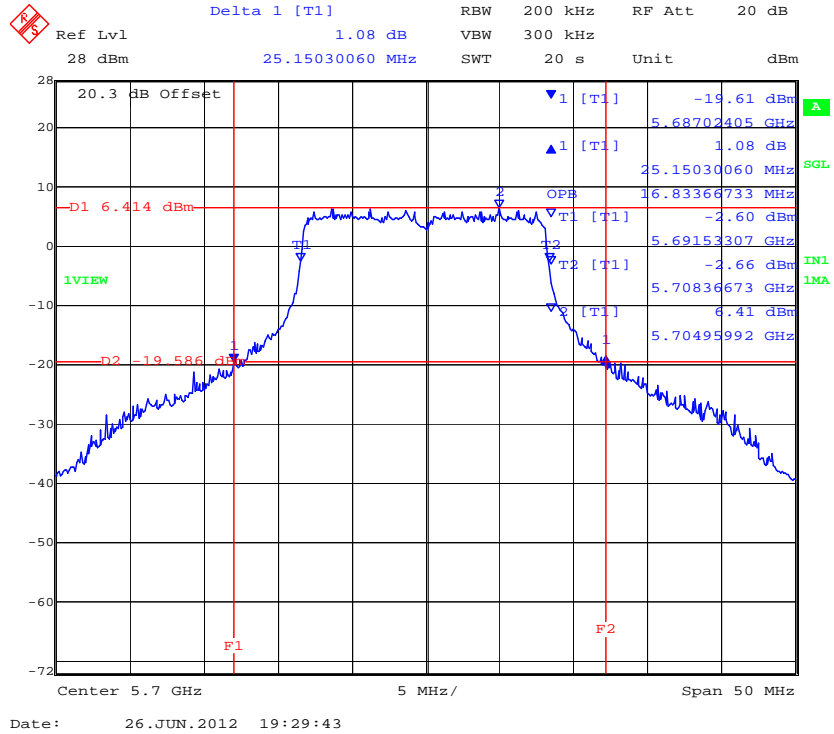

### CHAIN B 5,700 MHz 802.11a Legacy 26 dB and 99 % Bandwidth

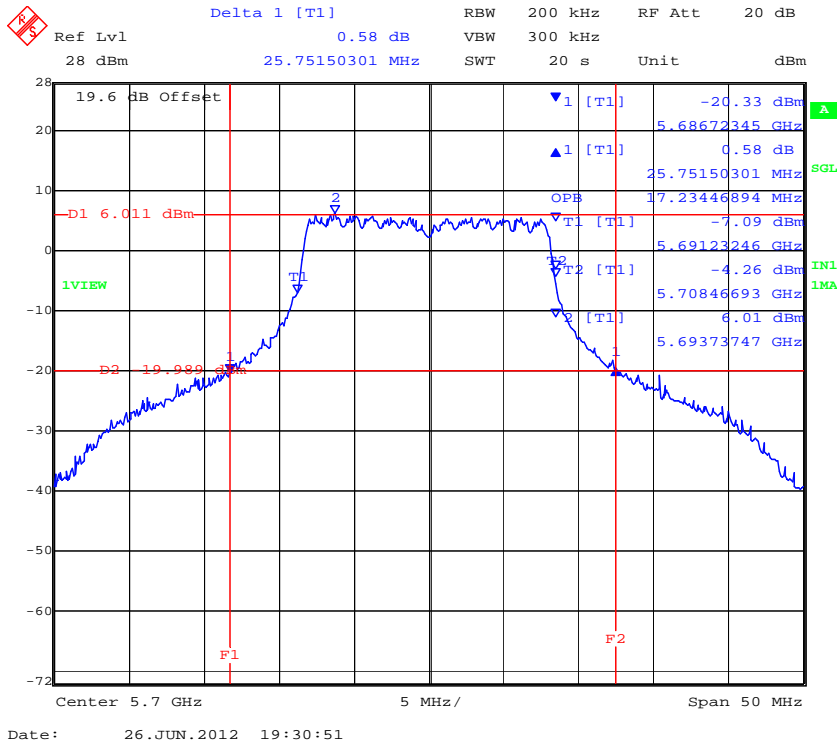

This test report may be reproduced in full only. The document may only be updated by MiCOM Labs personnel. Any changes will be noted in the Document History section of the report.



**Measurement Results for 26 dB and 99 % Operational Bandwidth(s) -Continue**

TABLE OF RESULTS – 802.11n HT-20 (5,250 – 5,350 MHz)

|                               |               |                            |             |
|-------------------------------|---------------|----------------------------|-------------|
| <b>Test Conditions:</b>       | 15.247 (a)(2) | <b>Rel. Humidity (%):</b>  | 35 to 42    |
| <b>Variant:</b>               | 802.11n HT-20 | <b>Ambient Temp. (°C):</b> | 19 to 22    |
| <b>TPC:</b>                   | HIGH          | <b>Pressure (mBars):</b>   | 998 to 1003 |
| <b>Modulation:</b>            | ON            | <b>Duty Cycle (x):</b>     | 100         |
| <b>Beam Forming Gain (Y):</b> | N/A dB        | <b>Antenna Gain:</b>       | 6 dBi       |
| <b>Applied Voltage:</b>       | 12.0 Vdc      |                            |             |
| <b>Notes 1:</b>               |               |                            |             |
| <b>Notes 2:</b>               |               |                            |             |

**26 dB Bandwidth**

| Test Frequency | 26 dB Bandwidth |           |    |    | Minimum 6dB Bandwidth Limit |     | Margin     |
|----------------|-----------------|-----------|----|----|-----------------------------|-----|------------|
|                | MHz             |           |    |    | kHz                         | MHz |            |
| MHz            | a               | b         | c  | d  |                             |     |            |
| 5260           | 27.455000       | 30.361000 | -- | -- | 500                         | 0.5 | -26.955000 |
| 5300           | 26.353000       | 29.058000 | -- | -- |                             |     | -25.853000 |
| 5320           | 25.752000       | 30.661000 | -- | -- |                             |     | -25.252000 |

**99% Bandwidth**

| Test Frequency | 99 % Bandwidth |           |    |    |  |  |
|----------------|----------------|-----------|----|----|--|--|
|                | MHz            |           |    |    |  |  |
| MHz            | a              | b         | c  | d  |  |  |
| 5260           | 18.136000      | 18.337000 | -- | -- |  |  |
| 5300           | 18.136000      | 18.337000 | -- | -- |  |  |
| 5320           | 18.036000      | 18.437000 | -- | -- |  |  |

|                                 |          |
|---------------------------------|----------|
| <b>Measurement uncertainty:</b> | ±2.81 dB |
|---------------------------------|----------|

This test report may be reproduced in full only. The document may only be updated by MiCOM Labs personnel. Any changes will be noted in the Document History section of the report.



### CHAIN A 5,260 MHz 802.11N HT-20 26 dB and 99 % Bandwidth

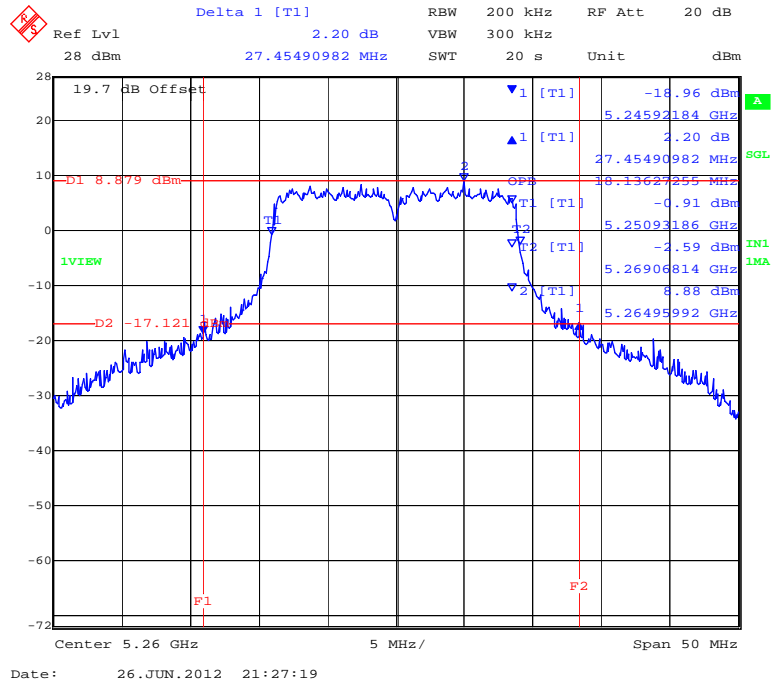

### CHAIN B 5,260 MHz 802.11N HT-20 26 dB and 99 % Bandwidth

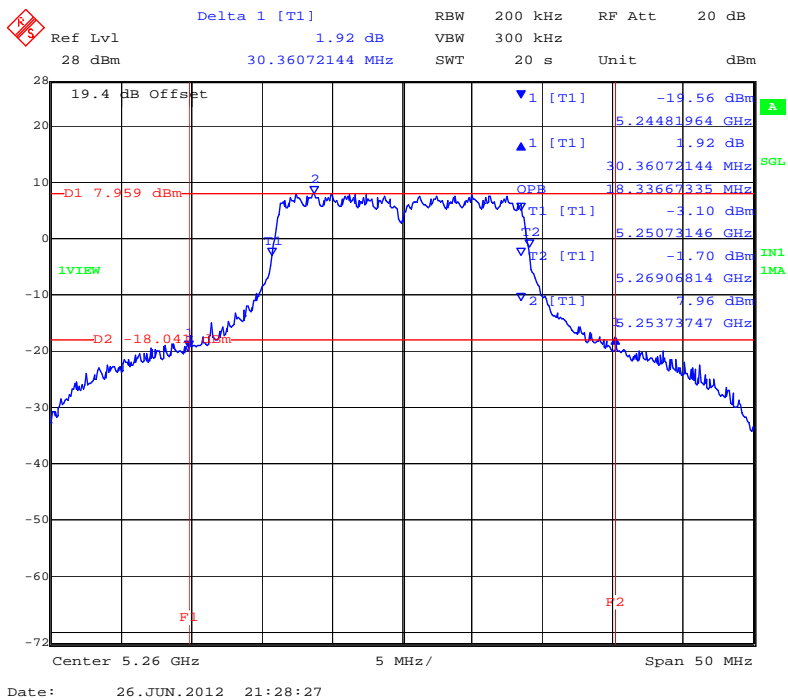

This test report may be reproduced in full only. The document may only be updated by MiCOM Labs personnel. Any changes will be noted in the Document History section of the report.



**CHAIN A 5,300 MHz 802.11N HT-20 26 dB and 99 % Bandwidth**

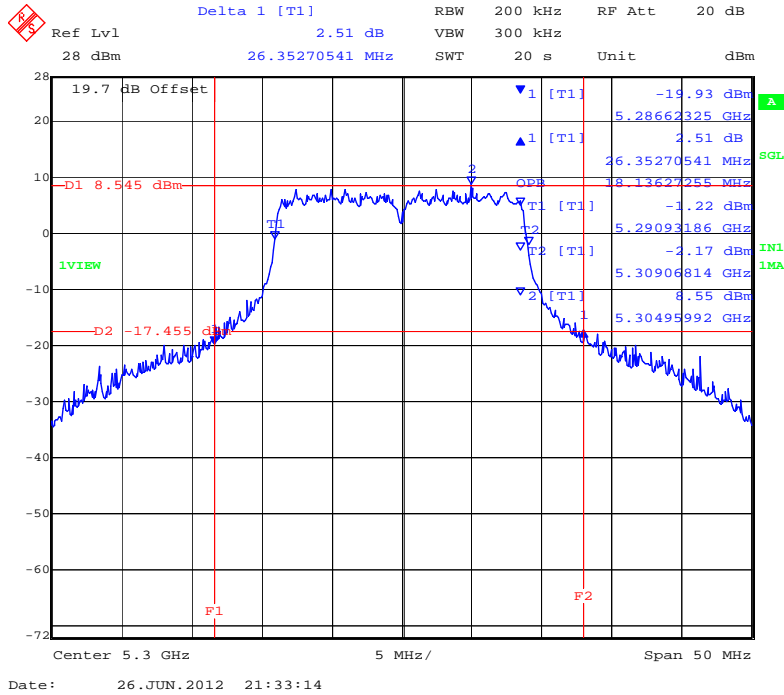

**CHAIN B 5,300 MHz 802.11N HT-20 26 dB and 99 % Bandwidth**

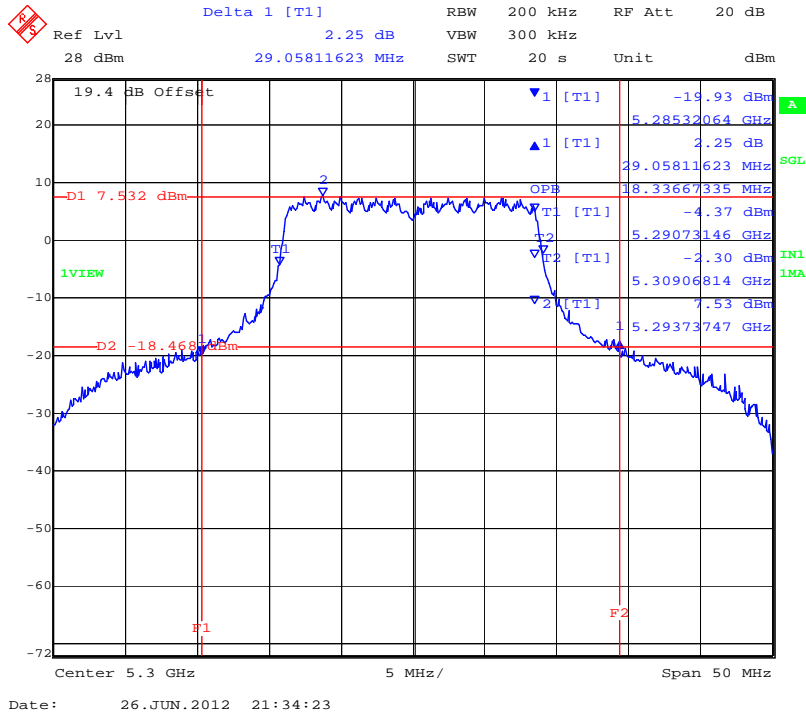

This test report may be reproduced in full only. The document may only be updated by MiCOM Labs personnel. Any changes will be noted in the Document History section of the report.



### CHAIN A 5,320 MHz 802.11N HT-20 26 dB and 99 % Bandwidth

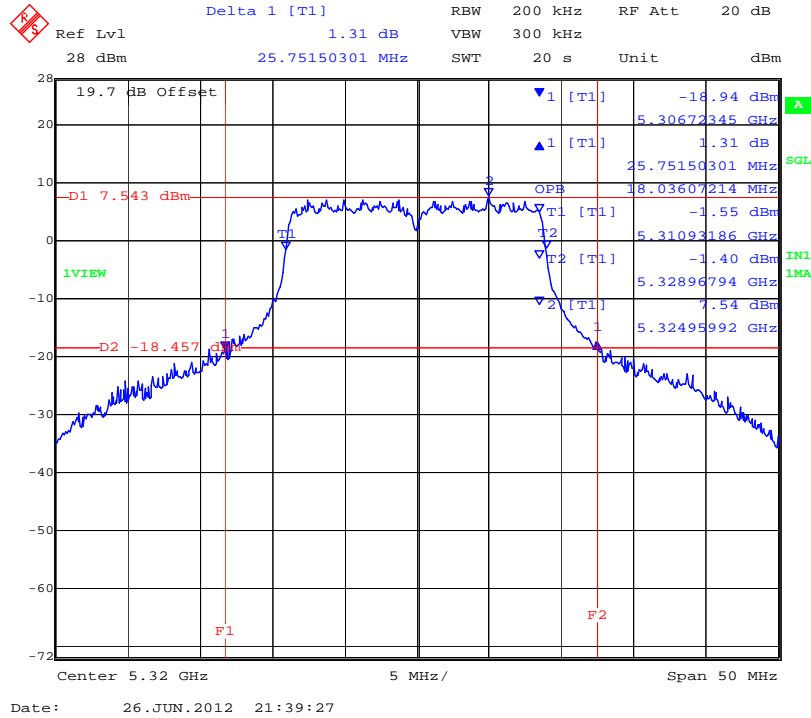

### CHAIN B 5,320 MHz 802.11N HT-20 26 dB and 99 % Bandwidth

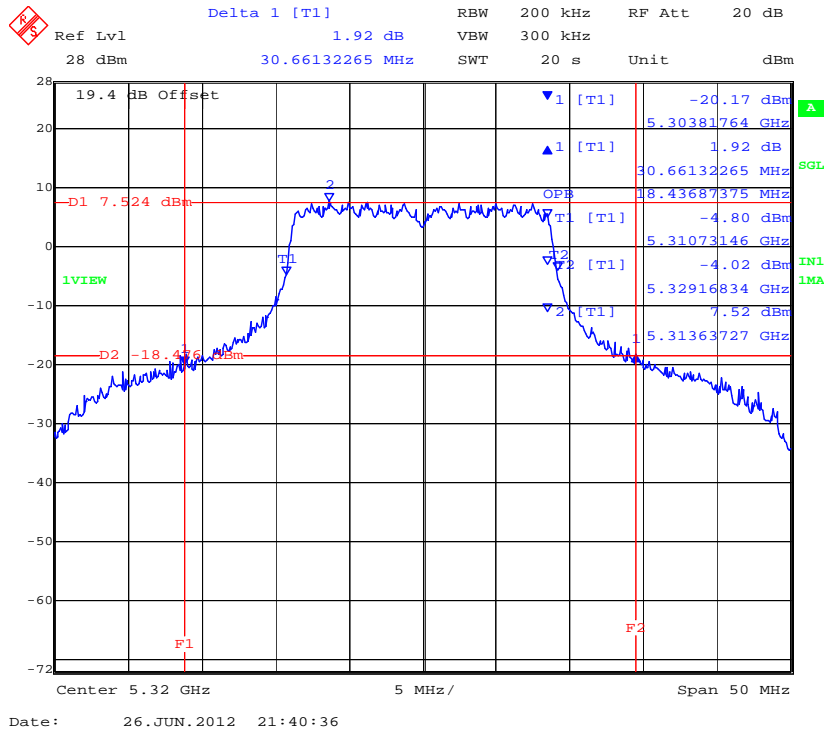

This test report may be reproduced in full only. The document may only be updated by MiCOM Labs personnel. Any changes will be noted in the Document History section of the report.



**Title:** Aruba AP-175 802.11a/b/g/n Wireless AP  
**To:** FCC 47 CFR Part 15.407 & IC RSS-210  
**Serial #:** ARUB111-U1 Rev B  
**Issue Date:** 12th August 2013  
**Page:** 32 of 185

**TABLE OF RESULTS – 802.11n HT-20 (5,470 – 5,725 MHz)**

|                               |               |                            |             |
|-------------------------------|---------------|----------------------------|-------------|
| <b>Test Conditions:</b>       | 15.247 (a)(2) | <b>Rel. Humidity (%):</b>  | 35 to 42    |
| <b>Variant:</b>               | 802.11n HT-20 | <b>Ambient Temp. (°C):</b> | 19 to 22    |
| <b>TPC:</b>                   | HIGH          | <b>Pressure (mBars):</b>   | 998 to 1003 |
| <b>Modulation:</b>            | ON            | <b>Duty Cycle (x):</b>     | 100         |
| <b>Beam Forming Gain (Y):</b> | N/A dB        | <b>Antenna Gain:</b>       | 6 dBi       |
| <b>Applied Voltage:</b>       | 12.0 Vdc      |                            |             |
| <b>Notes 1:</b>               |               |                            |             |
| <b>Notes 2:</b>               |               |                            |             |

**26 dB Bandwidth**

| Test Frequency | 26 dB Bandwidth |           |    |    | Minimum 6dB Bandwidth Limit |     | Margin     |
|----------------|-----------------|-----------|----|----|-----------------------------|-----|------------|
|                | MHz             |           |    |    | kHz                         | MHz | MHz        |
| MHz            | a               | b         | c  | d  |                             |     |            |
| 5500           | 27.255000       | 31.964000 | -- | -- | 500                         | 0.5 | -26.755000 |
| 5580           | 26.754000       | 35.170000 | -- | -- |                             |     | -26.254000 |
| 5700           | 26.754000       | 30.461000 | -- | -- |                             |     | -26.254000 |

**99% Bandwidth**

| Test Frequency | 99 % Bandwidth |           |    |    |  |  |  |
|----------------|----------------|-----------|----|----|--|--|--|
|                | MHz            |           |    |    |  |  |  |
| MHz            | a              | b         | c  | d  |  |  |  |
| 5500           | 18.236000      | 18.737000 | -- | -- |  |  |  |
| 5580           | 18.136000      | 19.038000 | -- | -- |  |  |  |
| 5700           | 18.036000      | 18.537000 | -- | -- |  |  |  |

|                                 |          |
|---------------------------------|----------|
| <b>Measurement uncertainty:</b> | ±2.81 dB |
|---------------------------------|----------|

This test report may be reproduced in full only. The document may only be updated by MiCOM Labs personnel. Any changes will be noted in the Document History section of the report.





### CHAIN A 5,500 MHz 802.11n HT-20 26 dB and 99 % Bandwidth

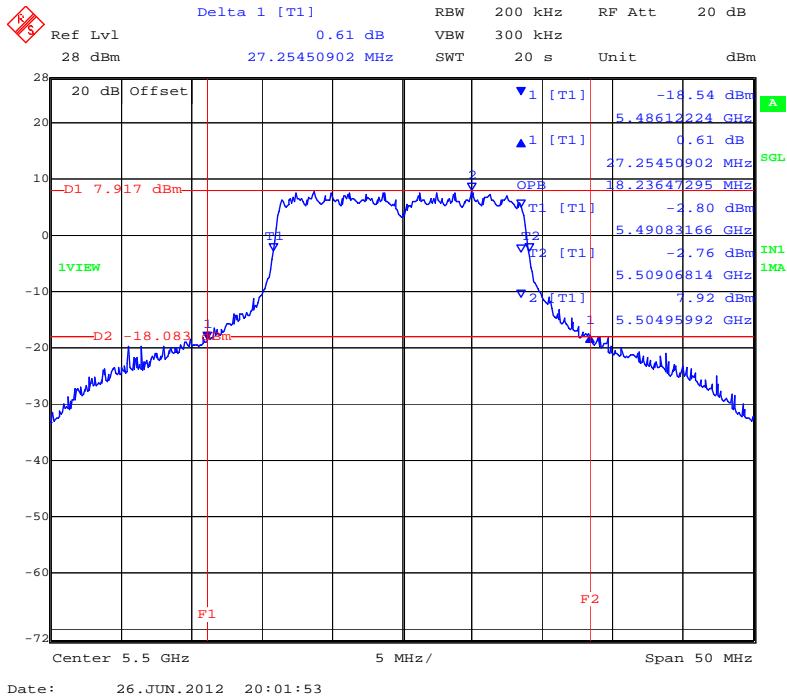

### CHAIN B 5,500 MHz 802.11n HT-20 26 dB and 99 % Bandwidth

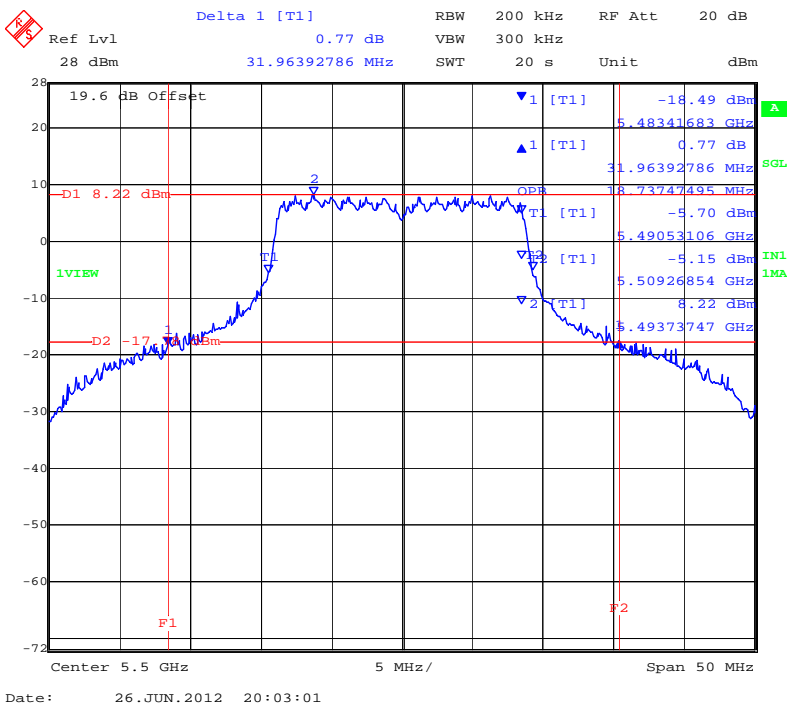

This test report may be reproduced in full only. The document may only be updated by MiCOM Labs personnel. Any changes will be noted in the Document History section of the report.



**CHAIN A 5,580 MHz 802.11n HT-20 26 dB and 99 % Bandwidth**

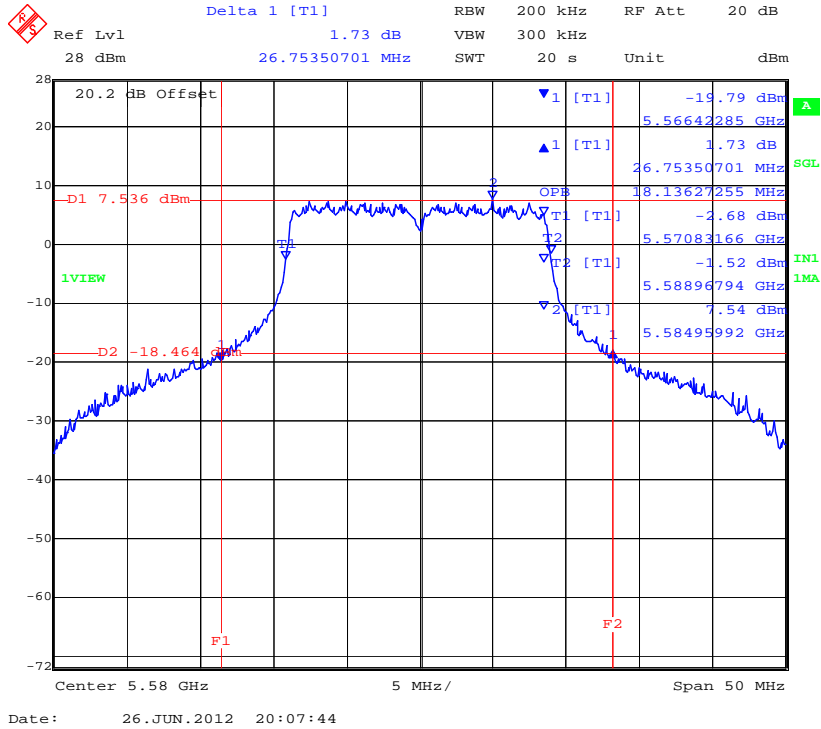

**CHAIN B 5,580 MHz 802.11n HT-20 26 dB and 99 % Bandwidth**

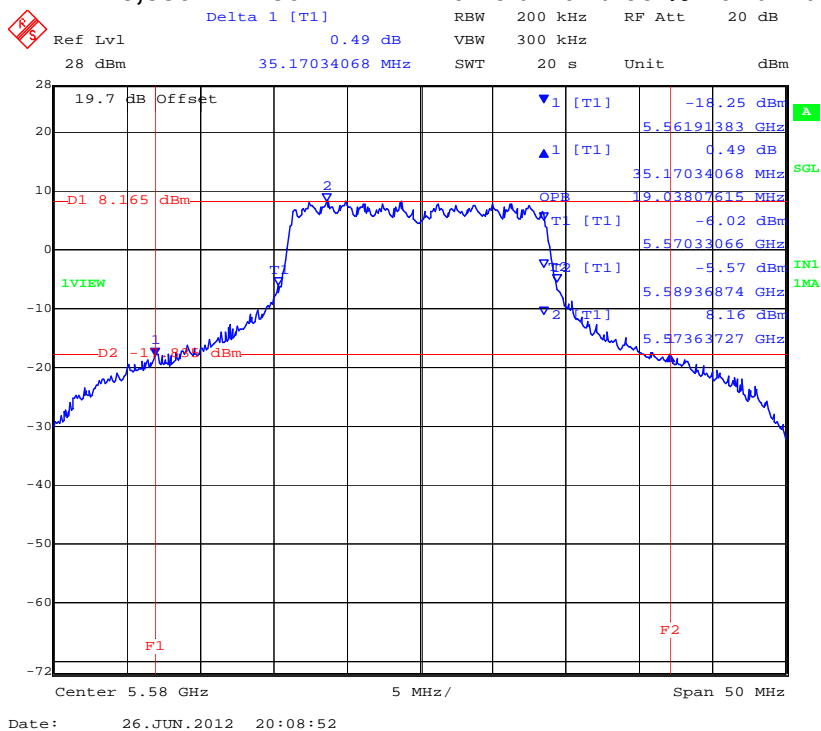

This test report may be reproduced in full only. The document may only be updated by MiCOM Labs personnel. Any changes will be noted in the Document History section of the report.



**CHAIN A 5,700 MHz 802.11n HT-20 26 dB and 99 % Bandwidth**

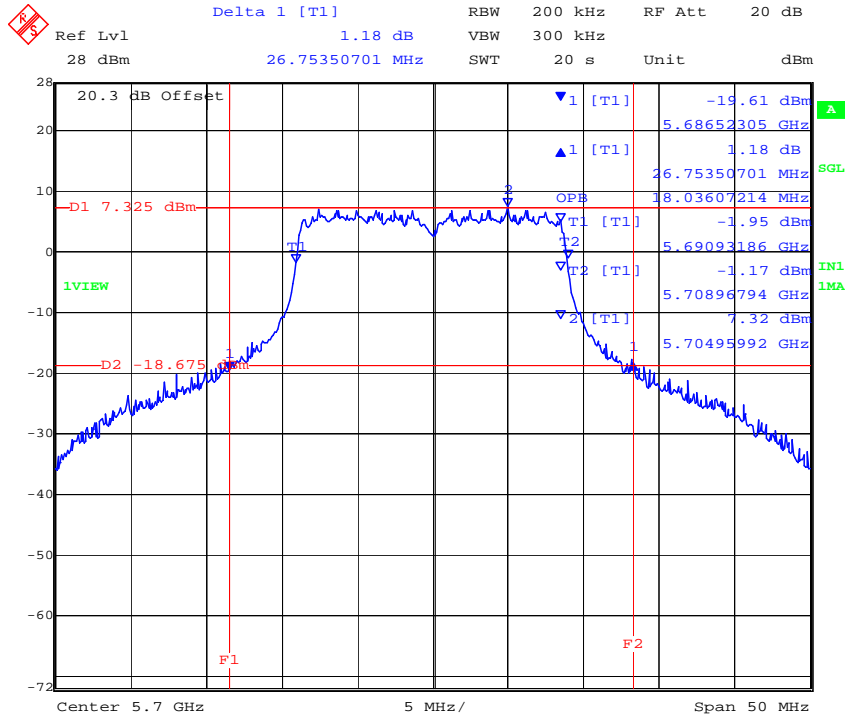

**CHAIN B 5,700 MHz 802.11n HT-20 26 dB and 99 % Bandwidth**

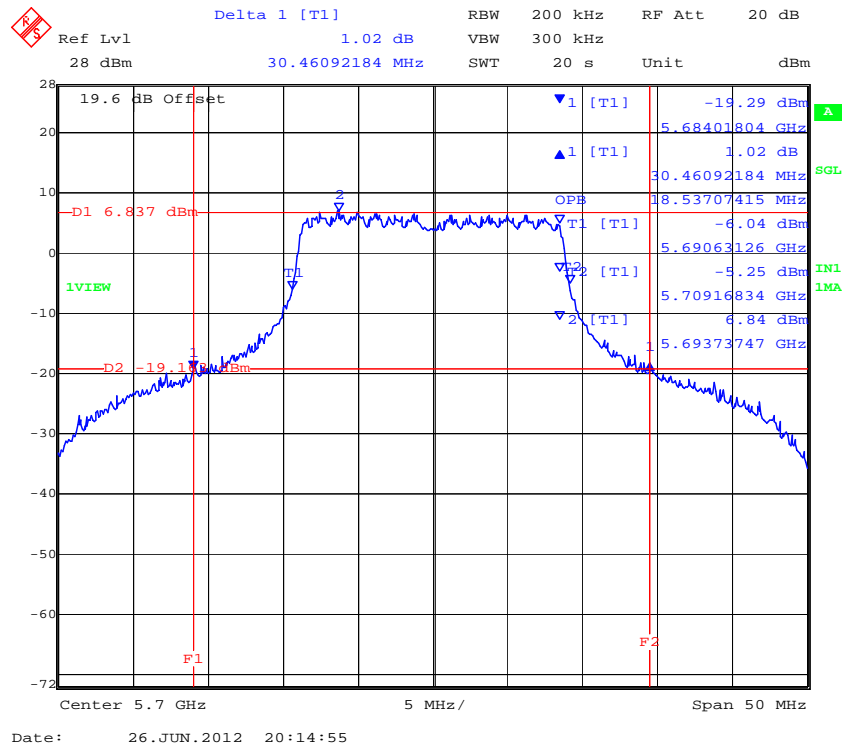

This test report may be reproduced in full only. The document may only be updated by MiCOM Labs personnel. Any changes will be noted in the Document History section of the report.



**Measurement Results for 26 dB and 99 % Operational Bandwidth(s) -Continued**

TABLE OF RESULTS – 802.11n HT-40

|                               |               |                            |             |
|-------------------------------|---------------|----------------------------|-------------|
| <b>Test Conditions:</b>       | 15.247 (a)(2) | <b>Rel. Humidity (%):</b>  | 35 to 42    |
| <b>Variant:</b>               | 802.11n HT-40 | <b>Ambient Temp. (°C):</b> | 19 to 22    |
| <b>TPC:</b>                   | HIGH          | <b>Pressure (mBars):</b>   | 998 to 1003 |
| <b>Modulation:</b>            | ON            | <b>Duty Cycle (x):</b>     | 100         |
| <b>Beam Forming Gain (Y):</b> | N/A dB        | <b>Antenna Gain:</b>       | 6 dBi       |
| <b>Applied Voltage:</b>       | 12.0 Vdc      |                            |             |
| <b>Notes 1:</b>               |               |                            |             |
| <b>Notes 2:</b>               |               |                            |             |

**26 dB Bandwidth**

| Test Frequency | 26 dB Bandwidth |           |    |    | Minimum 6dB Bandwidth Limit |     | Margin     |
|----------------|-----------------|-----------|----|----|-----------------------------|-----|------------|
|                | MHz             |           |    |    | kHz                         | MHz |            |
| MHz            | a               | b         | c  | d  |                             |     |            |
| 5270           | 65.531000       | 84.569000 | -- | -- | 500                         | 0.5 | -65.031000 |
| 5310           | 66.132000       | 85.972000 | -- | -- |                             |     | -65.632000 |

**99% Bandwidth**

| Test Frequency | 99 % Bandwidth |           |    |    |  |  |  |
|----------------|----------------|-----------|----|----|--|--|--|
|                | MHz            |           |    |    |  |  |  |
| MHz            | a              | b         | c  | d  |  |  |  |
| 5270           | 37.074000      | 44.088000 | -- | -- |  |  |  |
| 5310           | 36.874000      | 46.894000 | -- | -- |  |  |  |

|                                 |          |
|---------------------------------|----------|
| <b>Measurement uncertainty:</b> | ±2.81 dB |
|---------------------------------|----------|

This test report may be reproduced in full only. The document may only be updated by MiCOM Labs personnel. Any changes will be noted in the Document History section of the report.



**Chain A 5,270 MHz 802.11n HT-40 26 dB and 99 % Bandwidth**

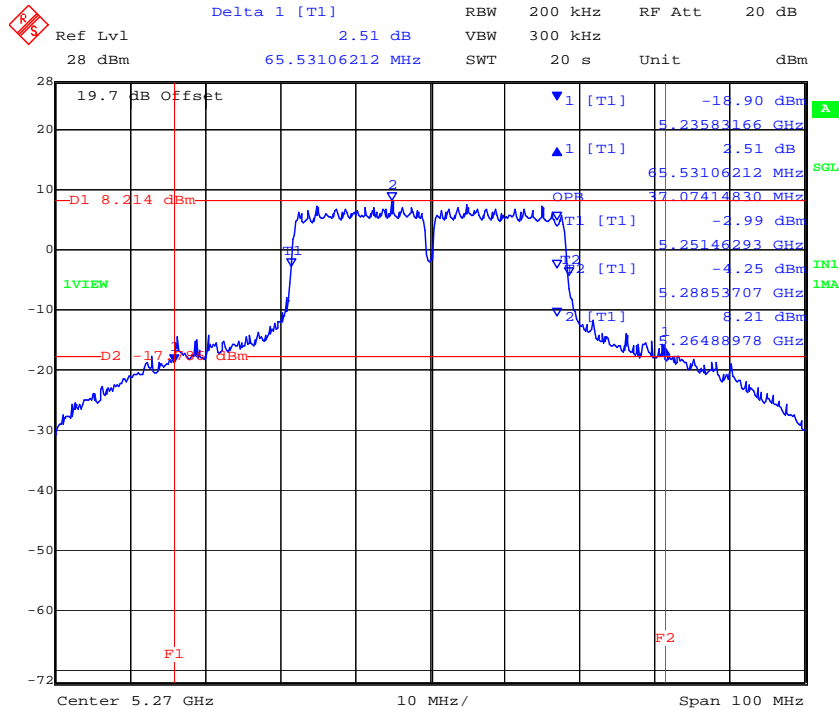

Date: 26.JUN.2012 22:01:49

**Chain B 5,270 MHz 802.11n HT-40 26 dB and 99 % Bandwidth**

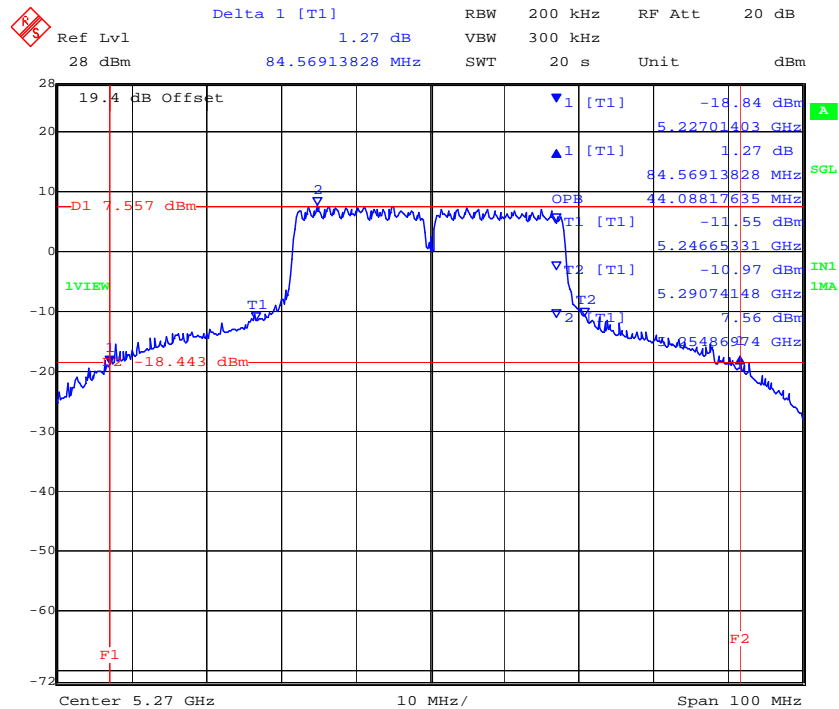

Date: 26.JUN.2012 22:02:57

This test report may be reproduced in full only. The document may only be updated by MiCOM Labs personnel. Any changes will be noted in the Document History section of the report.



### Chain A 5,310 MHz 802.11n HT-40 26 dB and 99 % Bandwidth

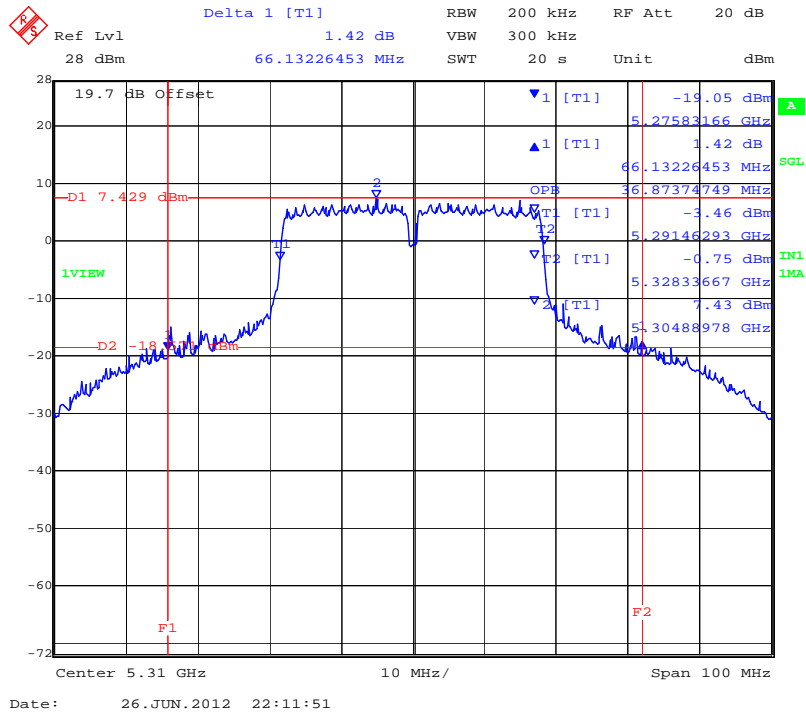

### Chain B 5,310 MHz 802.11n HT-40 26 dB and 99 % Bandwidth

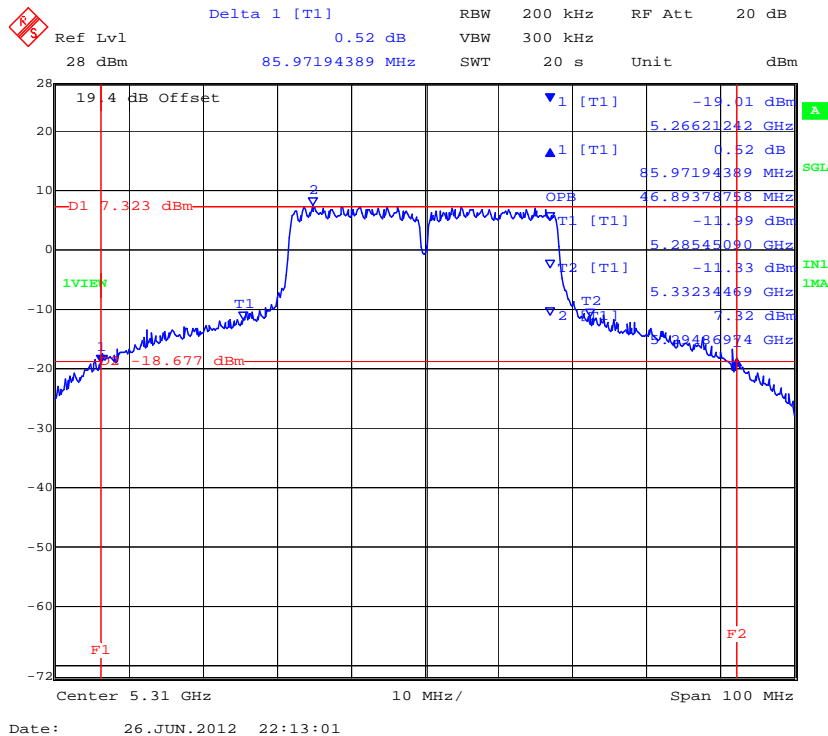

This test report may be reproduced in full only. The document may only be updated by MiCOM Labs personnel. Any changes will be noted in the Document History section of the report.



**Measurement Results for 26 dB and 99 % Operational Bandwidth(s)**

**TABLE OF RESULTS – 802.11n HT-40 (5470 – 5725 MHz)**

|                               |               |                            |             |
|-------------------------------|---------------|----------------------------|-------------|
| <b>Test Conditions:</b>       | 15.247 (a)(2) | <b>Rel. Humidity (%):</b>  | 35 to 42    |
| <b>Variant:</b>               | 802.11n HT-40 | <b>Ambient Temp. (°C):</b> | 19 to 22    |
| <b>TPC:</b>                   | HIGH          | <b>Pressure (mBars):</b>   | 998 to 1003 |
| <b>Modulation:</b>            | ON            | <b>Duty Cycle (x):</b>     | 100         |
| <b>Beam Forming Gain (Y):</b> | N/A dB        | <b>Antenna Gain:</b>       | 6 dBi       |
| <b>Applied Voltage:</b>       | 12.0 Vdc      |                            |             |
| <b>Notes 1:</b>               |               |                            |             |
| <b>Notes 2:</b>               |               |                            |             |

**26 dB Bandwidth**

| Test Frequency | 26 dB Bandwidth |           |    |    | Minimum 6dB Bandwidth Limit |     | Margin     |
|----------------|-----------------|-----------|----|----|-----------------------------|-----|------------|
|                | MHz             |           |    |    | kHz                         | MHz |            |
| MHz            | a               | b         | c  | d  |                             |     |            |
| 5510           | 72.745000       | 87.174000 | -- | -- | 500                         | 0.5 | -72.245000 |
| 5550           | 76.353000       | 90.381000 | -- | -- |                             |     | -75.853000 |
| 5670           | 70.341000       | 87.575000 | -- | -- |                             |     | -69.841000 |

**99% Bandwidth**

| Test Frequency | 99 % Bandwidth |           |    |    |  |  |  |
|----------------|----------------|-----------|----|----|--|--|--|
|                | MHz            |           |    |    |  |  |  |
| MHz            | a              | b         | c  | d  |  |  |  |
| 5510           | 38.277000      | 49.098000 | -- | -- |  |  |  |
| 5550           | 39.679000      | 53.908000 | -- | -- |  |  |  |
| 5670           | 37.475000      | 49.900000 | -- | -- |  |  |  |

|                                 |          |
|---------------------------------|----------|
| <b>Measurement uncertainty:</b> | ±2.81 dB |
|---------------------------------|----------|

This test report may be reproduced in full only. The document may only be updated by MiCOM Labs personnel. Any changes will be noted in the Document History section of the report.



**Chain A 5,510 MHz 802.11n HT-40 26 dB and 99 % Bandwidth**

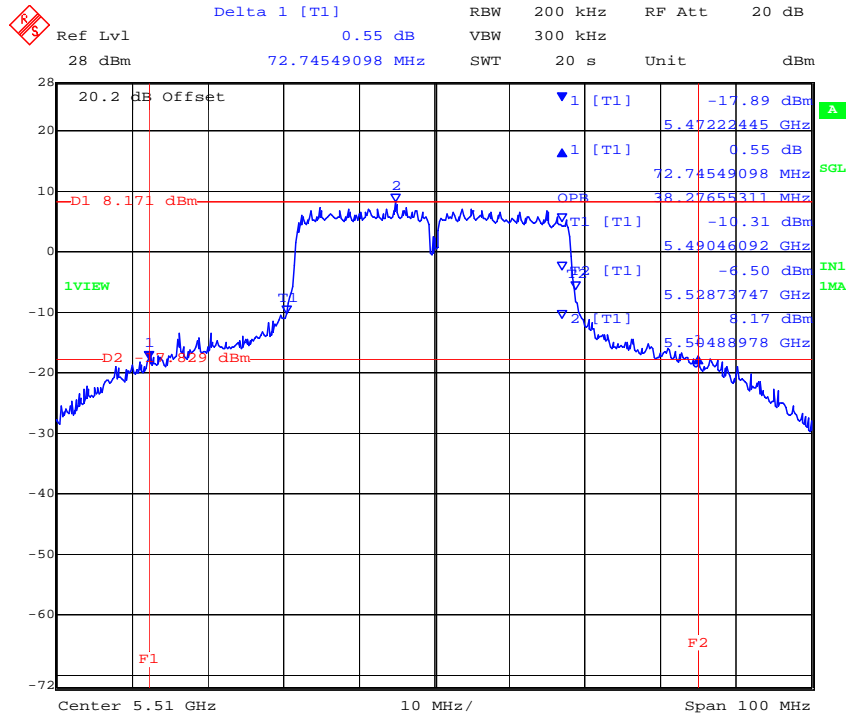

**Chain B 5,510 MHz 802.11n HT-40 26 dB and 99 % Bandwidth**

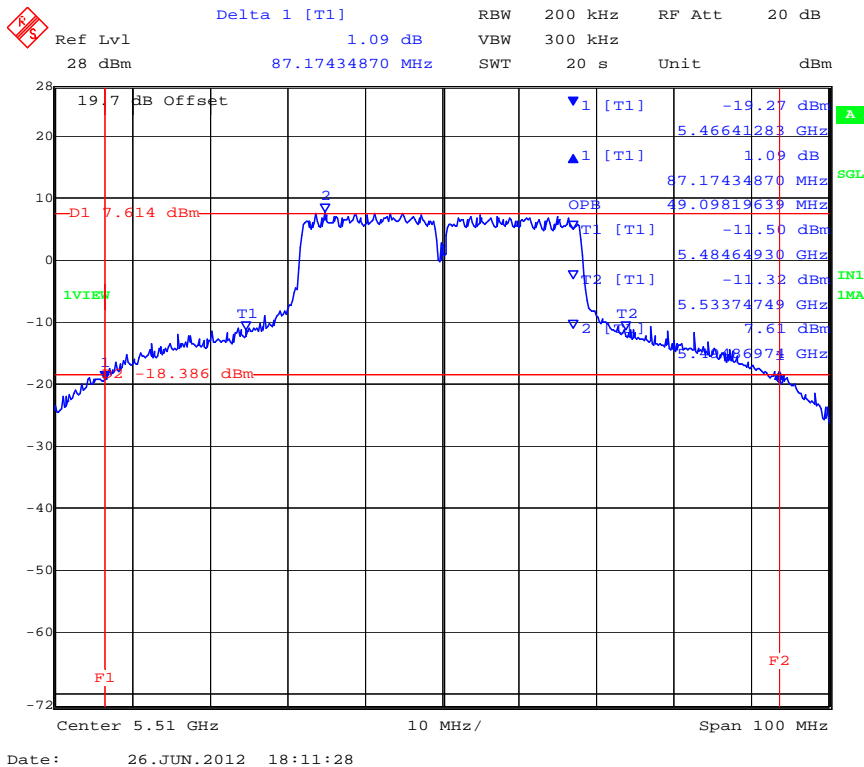

This test report may be reproduced in full only. The document may only be updated by MiCOM Labs personnel. Any changes will be noted in the Document History section of the report.





**Chain A 5,550 MHz 802.11n HT-40 26 dB and 99 % Bandwidth**

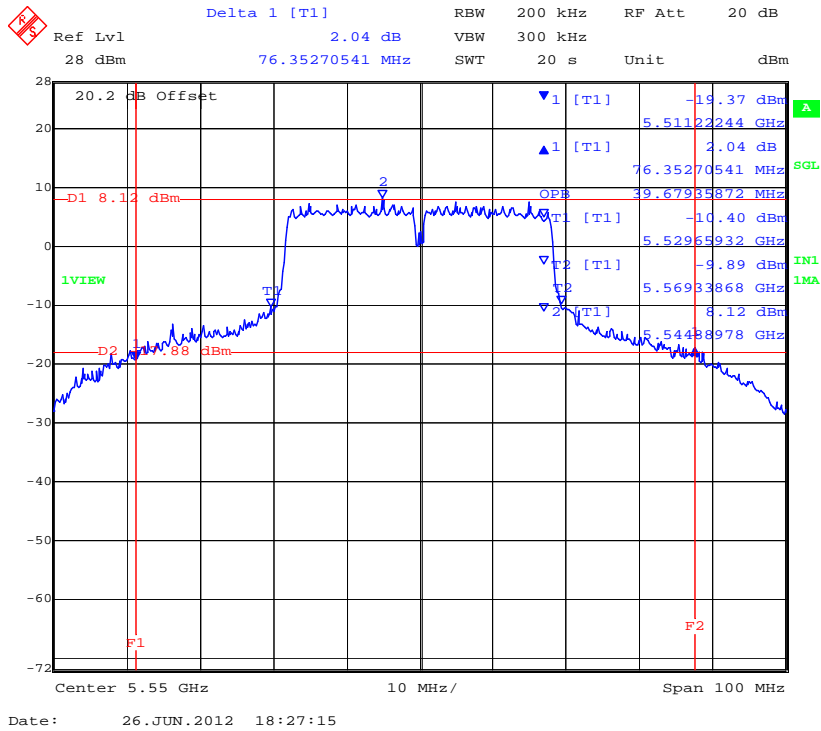

**Chain B 5,550 MHz 802.11n HT-40 26 dB and 99 % Bandwidth**

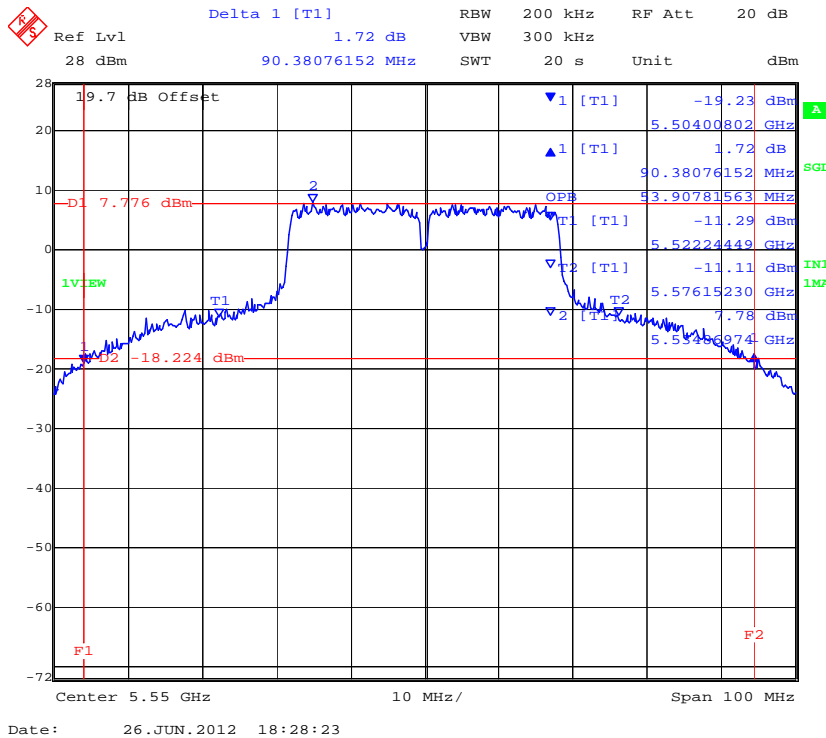

This test report may be reproduced in full only. The document may only be updated by MiCOM Labs personnel. Any changes will be noted in the Document History section of the report.



### Chain A 5,670 MHz 802.11n HT-40 26 dB and 99 % Bandwidth

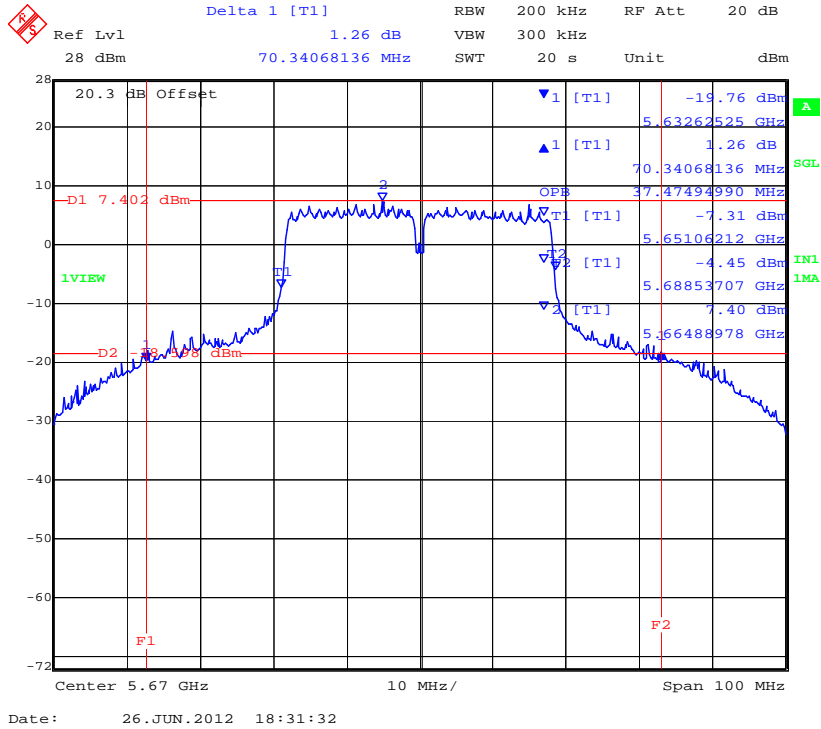

### Chain B 5,670 MHz 802.11n HT-40 26 dB and 99 % Bandwidth

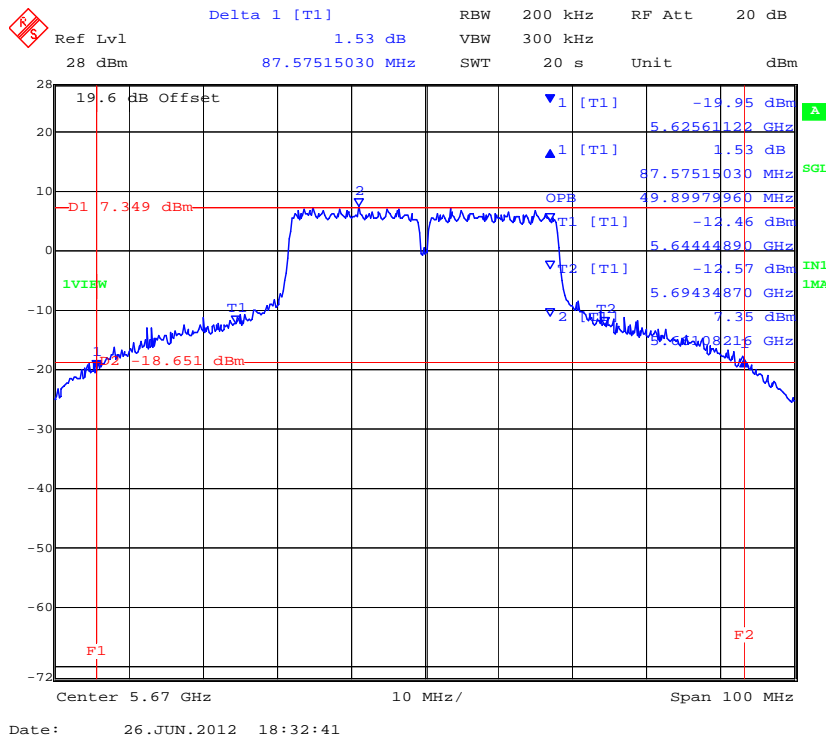

This test report may be reproduced in full only. The document may only be updated by MiCOM Labs personnel. Any changes will be noted in the Document History section of the report.



**Title:** Aruba AP-175 802.11a/b/g/n Wireless AP  
**To:** FCC 47 CFR Part 15.407 & IC RSS-210  
**Serial #:** ARUB111-U1 Rev B  
**Issue Date:** 12th August 2013  
**Page:** 43 of 185

## Specification

### Limits

#### FCC, Part 15 §15.407 (a)(1), (a)(2) and Industry Canada RSS-210 § A9.2(2)

**(a)(1)** For the band 5.15-5.25 GHz the maximum conducted output power over the frequency band of operation shall not exceed the lesser of 50 mW or +4 dBm + 10 log B, where B is the 26 dB emission bandwidth in megahertz. In addition, the peak power spectral density shall not exceed +4 dBm in any 1 megahertz band.

**(a)(2)** For the 5.25-5.35 GHz band the maximum conducted output power over the frequency band of operation shall not exceed the lesser of 250 mW or +11 dBm + 10 log B, where B is the 26 dB emission bandwidth in megahertz. In addition, the peak power spectral density shall not exceed +11 dBm in any 1 megahertz band.

#### Industry Canada RSS-Gen 4.4

When an occupied bandwidth value is not specified in the applicable RSS, the transmitted signal bandwidth to be reported is to be its 99% emission bandwidth, as calculated or measured.

## Laboratory Measurement Uncertainty for Spectrum Measurement

|                         |          |
|-------------------------|----------|
| Measurement uncertainty | ±2.81 dB |
|-------------------------|----------|

## Traceability

| Method  | Test Equipment Used                            |
|---|--|
| Measurements were made per work instruction WI-03 'Measurement of RF Spectrum Mask' | 0158, 0287, 0252, 0313, 0314, 0070, 0116, 0117 |

This test report may be reproduced in full only. The document may only be updated by MiCOM Labs personnel. Any changes will be noted in the Document History section of the report.

### 5.1.2. Transmit Output Power

**FCC, Part 15 Subpart C §15.407(a)**  
**Industry Canada RSS-210 §9.9(2)**  
**Industry Canada RSS-Gen 4.6**

#### Test Procedure

The transmitter terminal of EUT was connected to the input of an average power meter. Measurements were made while EUT was operating in a continuous transmission mode i.e. 100 % duty cycle at the appropriate center frequency. All cable losses and offsets were taken into consideration in the measured result.

#### Test Measurement Set up

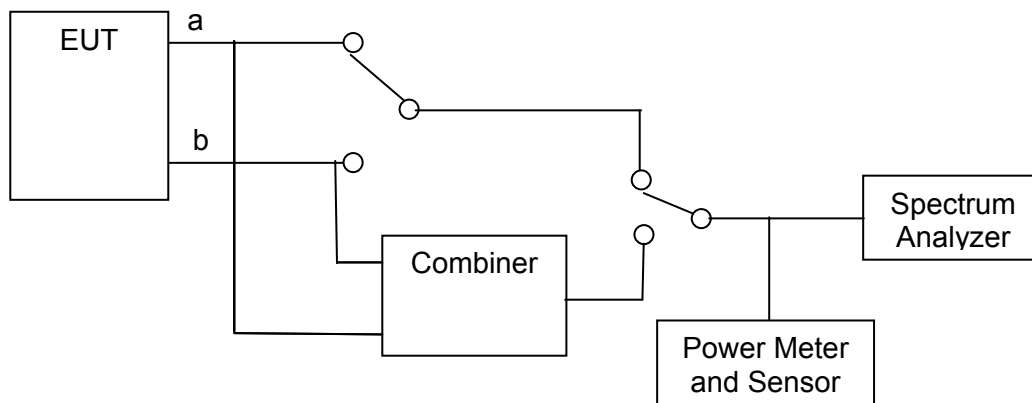

Measurement set up for Transmitter Output Power

Ambient conditions.

Temperature: 17 to 23 °C      Relative humidity: 31 to 57 %      Pressure: 999 to 1012 mbar

EUT parameters.

Power Level: Maximum

Duty Cycle: 100%

Temperature: Ambient



**Maximum Permissible Transmit Power**

**FCC Limits Limits**

**Bands 5250 – 5350 and 5470 – 5725 MHz**

Limit lesser of: 250 mW or 11 dBm + 10 log (B) dBm

| Mode  | Frequency Range (MHz)      | Maximum 26 dB Bandwidth (MHz) | 11 + 10 Log (B) (dBm) | Limit (dBm) |
|-------|----------------------------|-------------------------------|-----------------------|-------------|
| a     | 5250 – 5350<br>5470 – 5725 | 31.363                        | +25.96                | +24.00      |
| HT-20 |                            | 35.170                        | +26.45                | +24.00      |
| HT-40 |                            | 90.381                        | +30.56                | +24.00      |

**Industry Canada Limits**

**Bands 5250 – 5350 and 5470 – 5725 MHz**

Limit lesser of: 250 mW or 11 dBm + 10 log (B) dBm

| Mode  | Frequency Range (MHz)      | Maximum 99% Bandwidth (MHz) | 11 + 10 Log (B) (dBm) | Limit (dBm) |
|-------|----------------------------|-----------------------------|-----------------------|-------------|
| a     | 5250 – 5350<br>5470 – 5725 | 17.735                      | +23.49                | +24.00      |
| HT-20 |                            | 19.038                      | +23.80                | +24.00      |
| HT-40 |                            | 53.908                      | +28.32                | +24.00      |

This test report may be reproduced in full only. The document may only be updated by MiCOM Labs personnel. Any changes will be noted in the Document History section of the report.



**MIMO Operation 5250-5350 MHz**

| Antenna    | Gain | Max. Allowable Conducted Peak Power (dBm) |       | Maximum EIRP |
|------------|------|---|-------|--------------|
|            |      | (dB)                                      | (dBi) |              |
| AP-ANT-1B  | 5.8  |   |       | +30.0        |
| AP-ANT-10  | 6.0  |   |       | +30.0        |
| AP-ANT-86D | 9.0  |   |       | +30.0        |
| AP-ANT-89  | 14.0 |   |       | +30.0        |

**Non-MIMO Operation (Legacy) 5250-5350 MHz**

| Antenna    | Gain dBi | Increased Gain V's No. Antenna Ports |      | Total Gain dBi | Max. Allowable Conducted Peak Power (dBm) | Maximum EIRP (dBm) |
|------------|----------|--------------------------------------|------|----------------|---|--------------------|
|            |          | Ports                                | dB   |                |   |                    |
| AP-ANT-1B  | 5.8      | 2                                    | 3.01 | 8.81           | +21.19                                    | +30.0              |
| AP-ANT-10  | 6.0      | 2                                    | 3.01 | 9.01           | +20.99                                    | +30.0              |
| AP-ANT-86D | 9.0      | 2                                    | 3.01 | 12.01          | +17.99                                    | +30.0              |
| AP-ANT-89  | 14.0     | 2                                    | 3.01 | 17.01          | +12.99                                    | +30.0              |

**MIMO Operation 5470 – 5725 MHz**

| Antenna    | Gain  | Max. Allowable Conducted Peak Power (dBm) |       | Maximum EIRP |
|------------|-------|---|-------|--------------|
|            |       | (dB)                                      | (dBi) |              |
| AP-ANT-1B  | 5.8   |   |       | +30.0        |
| AP-ANT-10  | 6.0   |   |       | +30.0        |
| AP-ANT-86D | 9.0   |   |       | +30.0        |
| AP-ANT-89  | 13.25 |   |       | +30.0        |

**Non-MIMO Operation (Legacy) 5470 – 5725 MHz**

| Antenna    | Gain dBi | Increased Gain V's No. Antenna Ports |      | Total Gain dBi | Max. Allowable Conducted Peak Power (dBm) | Maximum EIRP (dBm) |
|------------|----------|--------------------------------------|------|----------------|---|--------------------|
|            |          | Ports                                | dB   |                |   |                    |
| AP-ANT-1B  | 5.8      | 2                                    | 3.01 | 8.81           | +21.19                                    | +30.0              |
| AP-ANT-10  | 6.0      | 2                                    | 3.01 | 9.01           | +20.99                                    | +30.0              |
| AP-ANT-86D | 9.0      | 2                                    | 3.01 | 12.01          | +17.99                                    | +30.0              |
| AP-ANT-89  | 13.25    | 2                                    | 3.01 | 16.26          | +13.74                                    | +30.0              |

This test report may be reproduced in full only. The document may only be updated by MiCOM Labs personnel. Any changes will be noted in the Document History section of the report.



**Measurement Results for Transmit Output Power**

Ambient conditions.

Temperature: 17 to 23 °C    Relative humidity: 31 to 57 %    Pressure: 999 to 1012 mbar

**Measurement Results for Transmit Output Power**

**TABLE OF RESULTS – 802.11a Legacy**

|                               |               |                            |       |    |      |
|-------------------------------|---------------|----------------------------|-------|----|------|
| <b>Test Conditions:</b>       | 15.407 (a)(1) | <b>Rel. Humidity (%):</b>  | 35    | to | 42   |
| <b>Variant:</b>               | 802.11a       | <b>Ambient Temp. (°C):</b> | 19    | to | 22   |
| <b>TPC:</b>                   | HIGH          | <b>Pressure (mBars):</b>   | 998   | to | 1003 |
| <b>Modulation:</b>            | ON            | <b>Duty Cycle (x):</b>     | 100   |    |      |
| <b>Beam Forming Gain (Y):</b> | N/A    dB     | <b>Antenna Gain:</b>       | 6 dBi |    |      |
| <b>Applied Voltage:</b>       | 12.0    Vdc   |                            |       |    |      |
| <b>Notes 1:</b>               |               |                            |       |    |      |
| <b>Notes 2:</b>               |               |                            |       |    |      |

| Test Frequency | Measured Peak Power |       |    |    | Total Power (dBm) |            | Limit | Margin |
|----------------|---------------------|-------|----|----|-------------------|------------|-------|--------|
|                | RF Port (dBm)       |       |    |    | Combined          | Calculated |       |        |
| MHz            | a                   | b     | c  | d  |                   |            |       |        |
| 5260           | 16.84               | 17.33 | -- | -- | N/A               | 20.10      | 24.00 | -3.90  |
| 5300           | 16.35               | 17.16 | -- | -- | N/A               | 19.78      | 24.00 | -4.22  |
| 5320           | 16.13               | 16.84 | -- | -- | N/A               | 19.51      | 24.00 | -4.49  |

|                                 |          |
|---------------------------------|----------|
| <b>Measurement uncertainty:</b> | ±1.33 dB |
|---------------------------------|----------|

|                               |               |                            |       |    |      |
|-------------------------------|---------------|----------------------------|-------|----|------|
| <b>Test Conditions:</b>       | 15.407 (a)(1) | <b>Rel. Humidity (%):</b>  | 35    | to | 42   |
| <b>Variant:</b>               | 802.11a       | <b>Ambient Temp. (°C):</b> | 19    | to | 22   |
| <b>TPC:</b>                   | HIGH          | <b>Pressure (mBars):</b>   | 998   | to | 1003 |
| <b>Modulation:</b>            | ON            | <b>Duty Cycle (x):</b>     | 100   |    |      |
| <b>Beam Forming Gain (Y):</b> | N/A    dB     | <b>Antenna Gain:</b>       | 6 dBi |    |      |
| <b>Applied Voltage:</b>       | 12.0    Vdc   |                            |       |    |      |
| <b>Notes 1:</b>               |               |                            |       |    |      |
| <b>Notes 2:</b>               |               |                            |       |    |      |

| Test Frequency | Measured Peak Power |       |    |    | Total Power (dBm) |            | Limit | Margin |
|----------------|---------------------|-------|----|----|-------------------|------------|-------|--------|
|                | RF Port (dBm)       |       |    |    | Combined          | Calculated |       |        |
| MHz            | a                   | b     | c  | d  |                   |            |       |        |
| 5500           | 16.87               | 17.21 | -- | -- | N/A               | 20.05      | 24.00 | -3.95  |
| 5580           | 16.64               | 17.72 | -- | -- | N/A               | 20.22      | 24.00 | -3.78  |
| 5700           | 16.24               | 15.86 | -- | -- | N/A               | 19.06      | 24.00 | -4.94  |

|                                 |          |
|---------------------------------|----------|
| <b>Measurement uncertainty:</b> | ±1.33 dB |
|---------------------------------|----------|

This test report may be reproduced in full only. The document may only be updated by MiCOM Labs personnel. Any changes will be noted in the Document History section of the report.



**TABLE OF RESULTS – 802.11n HT20**

|                               |               |                            |       |    |      |
|-------------------------------|---------------|----------------------------|-------|----|------|
| <b>Test Conditions:</b>       | 15.407 (a)(1) | <b>Rel. Humidity (%):</b>  | 35    | to | 42   |
| <b>Variant:</b>               | 802.11n HT-20 | <b>Ambient Temp. (°C):</b> | 19    | to | 22   |
| <b>TPC:</b>                   | HIGH          | <b>Pressure (mBars):</b>   | 998   | to | 1003 |
| <b>Modulation:</b>            | ON            | <b>Duty Cycle (x):</b>     | 100   |    |      |
| <b>Beam Forming Gain (Y):</b> | N/A dB        | <b>Antenna Gain:</b>       | 6 dBi |    |      |
| <b>Applied Voltage:</b>       | 12.0 Vdc      |                            |       |    |      |
| <b>Notes 1:</b>               |               |                            |       |    |      |
| <b>Notes 2:</b>               |               |                            |       |    |      |

| Test Frequency | Measured Peak Power |       |    |    | Total Power (dBm) |            | Limit | Margin |
|----------------|---------------------|-------|----|----|-------------------|------------|-------|--------|
|                | RF Port (dBm)       |       |    |    | Combined          | Calculated |       |        |
| MHz            | a                   | b     | c  | d  |                   |            |       |        |
| 5260           | 17.25               | 17.76 | -- | -- | N/A               | 20.52      | 24.00 | -3.48  |
| 5300           | 17.08               | 17.38 | -- | -- | N/A               | 20.24      | 24.00 | -3.76  |
| 5320           | 16.83               | 17.29 | -- | -- | N/A               | 20.08      | 24.00 | -3.92  |

|                                 |          |
|---------------------------------|----------|
| <b>Measurement uncertainty:</b> | ±1.33 dB |
|---------------------------------|----------|

|                               |               |                            |       |    |      |
|-------------------------------|---------------|----------------------------|-------|----|------|
| <b>Test Conditions:</b>       | 15.407 (a)(1) | <b>Rel. Humidity (%):</b>  | 35    | to | 42   |
| <b>Variant:</b>               | 802.11n HT-20 | <b>Ambient Temp. (°C):</b> | 19    | to | 22   |
| <b>TPC:</b>                   | HIGH          | <b>Pressure (mBars):</b>   | 998   | to | 1003 |
| <b>Modulation:</b>            | ON            | <b>Duty Cycle (x):</b>     | 100   |    |      |
| <b>Beam Forming Gain (Y):</b> | N/A dB        | <b>Antenna Gain:</b>       | 6 dBi |    |      |
| <b>Applied Voltage:</b>       | 12.0 Vdc      |                            |       |    |      |
| <b>Notes 1:</b>               |               |                            |       |    |      |
| <b>Notes 2:</b>               |               |                            |       |    |      |

| Test Frequency | Measured Peak Power |       |    |    | Total Power (dBm) |            | Limit | Margin |
|----------------|---------------------|-------|----|----|-------------------|------------|-------|--------|
|                | RF Port (dBm)       |       |    |    | Combined          | Calculated |       |        |
| MHz            | a                   | b     | c  | d  |                   |            |       |        |
| 5500           | 17.36               | 17.71 | -- | -- | N/A               | 20.55      | 24.00 | -3.45  |
| 5580           | 17.11               | 18.17 | -- | -- | N/A               | 20.68      | 24.00 | -3.32  |
| 5700           | 16.69               | 16.66 | -- | -- | N/A               | 19.69      | 24.00 | -4.31  |

|                                 |          |
|---------------------------------|----------|
| <b>Measurement uncertainty:</b> | ±1.33 dB |
|---------------------------------|----------|

This test report may be reproduced in full only. The document may only be updated by MiCOM Labs personnel. Any changes will be noted in the Document History section of the report.





**TABLE OF RESULTS – 802.11n HT-40**

|                               |               |                            |       |    |      |
|-------------------------------|---------------|----------------------------|-------|----|------|
| <b>Test Conditions:</b>       | 15.407 (a)(1) | <b>Rel. Humidity (%):</b>  | 35    | to | 42   |
| <b>Variant:</b>               | 802.11n HT-40 | <b>Ambient Temp. (°C):</b> | 19    | to | 22   |
| <b>TPC:</b>                   | HIGH          | <b>Pressure (mBars):</b>   | 998   | to | 1003 |
| <b>Modulation:</b>            | ON            | <b>Duty Cycle (x):</b>     | 100   |    |      |
| <b>Beam Forming Gain (Y):</b> | N/A dB        | <b>Antenna Gain:</b>       | 6 dBi |    |      |
| <b>Applied Voltage:</b>       | 12.0 Vdc      |                            |       |    |      |
| <b>Notes 1:</b>               |               |                            |       |    |      |
| <b>Notes 2:</b>               |               |                            |       |    |      |

| Test Frequency | Measured Peak Power |       |    |    | Total Power (dBm) |            | Limit | Margin |
|----------------|---------------------|-------|----|----|-------------------|------------|-------|--------|
|                | RF Port (dBm)       |       |    |    | Combined          | Calculated |       |        |
| MHz            | a                   | b     | c  | d  |                   |            |       |        |
| 5270           | 20.06               | 20.49 | -- | -- | N/A               | 23.29      | 24.00 | -0.71  |
| 5310           | 19.37               | 20.09 | -- | -- | N/A               | 22.76      | 24.00 | -1.24  |

|                                 |          |
|---------------------------------|----------|
| <b>Measurement uncertainty:</b> | ±1.33 dB |
|---------------------------------|----------|

|                               |               |                            |       |    |      |
|-------------------------------|---------------|----------------------------|-------|----|------|
| <b>Test Conditions:</b>       | 15.407 (a)(1) | <b>Rel. Humidity (%):</b>  | 35    | to | 42   |
| <b>Variant:</b>               | 802.11n HT-40 | <b>Ambient Temp. (°C):</b> | 19    | to | 22   |
| <b>TPC:</b>                   | HIGH          | <b>Pressure (mBars):</b>   | 998   | to | 1003 |
| <b>Modulation:</b>            | ON            | <b>Duty Cycle (x):</b>     | 100   |    |      |
| <b>Beam Forming Gain (Y):</b> | N/A dB        | <b>Antenna Gain:</b>       | 6 dBi |    |      |
| <b>Applied Voltage:</b>       | 12.0 Vdc      |                            |       |    |      |
| <b>Notes 1:</b>               |               |                            |       |    |      |
| <b>Notes 2:</b>               |               |                            |       |    |      |

| Test Frequency | Measured Peak Power |       |    |    | Total Power (dBm) |            | Limit | Margin |
|----------------|---------------------|-------|----|----|-------------------|------------|-------|--------|
|                | RF Port (dBm)       |       |    |    | Combined          | Calculated |       |        |
| MHz            | a                   | b     | c  | d  |                   |            |       |        |
| 5510           | 19.74               | 20.42 | -- | -- | N/A               | 23.10      | 24.00 | -0.90  |
| 5550           | 19.91               | 20.77 | -- | -- | N/A               | 23.37      | 24.00 | -0.63  |
| 5670           | 19.17               | 19.82 | -- | -- | N/A               | 22.52      | 24.00 | -1.48  |

|                                 |          |
|---------------------------------|----------|
| <b>Measurement uncertainty:</b> | ±1.33 dB |
|---------------------------------|----------|

This test report may be reproduced in full only. The document may only be updated by MiCOM Labs personnel. Any changes will be noted in the Document History section of the report.



## Specification

### Limits

#### **FCC, Part 15 §15.407 (a)(1), (a)(2) and Industry Canada RSS-210 § A9.2(2)**

**(a)(1)** For the band 5.15-5.25 GHz the maximum conducted output power over the frequency band of operation shall not exceed the lesser of 50 mW or  $+4 \text{ dBm} + 10 \log B$ , where B is the 26 dB emission bandwidth in megahertz. In addition, the peak power spectral density shall not exceed +4 dBm in any 1 megahertz band.

**(a)(2)** For the 5.25-5.35 and 5470-5725 MHz GHz band the maximum conducted output power over the frequency band of operation shall not exceed the lesser of 250 mW or  $+11 \text{ dBm} + 10 \log B$ , where B is the 26 dB emission bandwidth in megahertz. In addition, the peak power spectral density shall not exceed +11 dBm in any 1 megahertz band.

#### **Industry Canada RSS-210 §A9.2(2)**

For the band 5150-5250 MHz, the maximum equivalent isotropically radiated power (e.i.r.p.) shall not exceed 200 mW or  $10 + 10 \log_{10} B$ , dBm, whichever power is less. B is the 99% emission bandwidth in MHz. The e.i.r.p. spectral density shall not exceed 10 dBm in any 1.0 MHz band.

For the band 5250-5350 MHz and 5470-5725 MHz, the maximum conducted output power shall not exceed 250 mW or  $11 + 10 \log_{10} B$ , dBm, whichever power is less. The power spectral density shall not exceed 11 dBm in any 1.0 MHz band. The maximum e.i.r.p. shall not exceed 1.0 W or  $17 + 10 \log_{10} B$ , dBm, whichever power is less. B is the 99% emission bandwidth in MHz.

#### **Industry Canada RSS-Gen 4.4**

When an occupied bandwidth value is not specified in the applicable RSS, the transmitted signal bandwidth to be reported is to be its 99% emission bandwidth, as calculated or measured.

## Laboratory Measurement Uncertainty for Power Measurements

|                         |                       |
|-------------------------|-----------------------|
| Measurement uncertainty | $\pm 1.33 \text{ dB}$ |
|-------------------------|-----------------------|

## Traceability

| Method  | Test Equipment Used                            |
|---|--|
| Measurements were made per work instruction WI-01 'Measuring RF Output Power' | 0158, 0287, 0252, 0313, 0314, 0070, 0116, 0117 |

This test report may be reproduced in full only. The document may only be updated by MiCOM Labs personnel. Any changes will be noted in the Document History section of the report.

### 5.1.3. Peak Power Spectral Density

**FCC, Part 15 Subpart C §15.407(a)**  
**Industry Canada RSS-210 § A9.2(2)**

#### **Test Procedure**

The transmitter output was connected to a spectrum analyzer and the peak power spectral density measured. Method 2 Sample Detection and power averaging, specified in FCC document DA 02-2138 (Normative Reference (ix) Section 2.1 “Guidelines for Assessing Unlicensed National Information Infrastructure (U-NII) Devices”) was used to determine the peak power spectral density of the emission. The Peak Power Spectral Density is the highest level found across the emission in a 1 MHz resolution bandwidth.

#### **Test Measurement Set up**

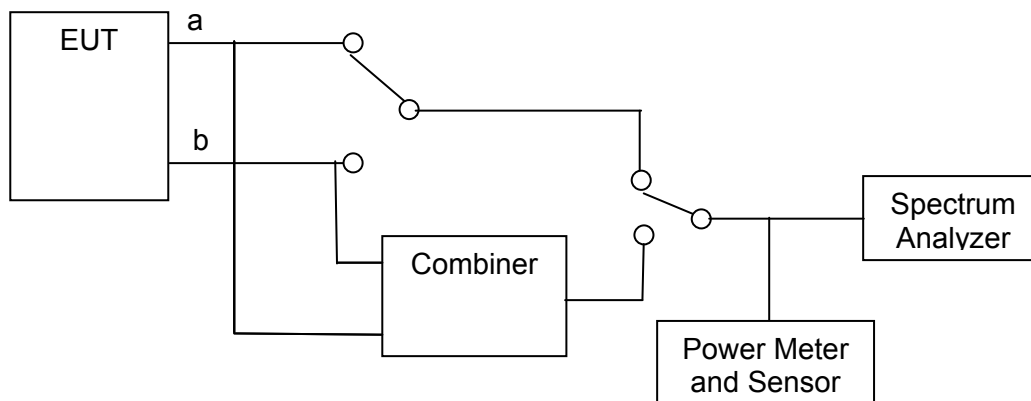

Measurement set up for Peak Power Spectral Density

#### **Measurement Results for Peak Power Spectral Density**

Ambient conditions.

Temperature: 17 to 23 °C      Relative humidity: 31 to 57 %      Pressure: 999 to 1012 mbar

Radio Parameters

Duty Cycle: 100%

Output: Modulated Carrier

Power: Maximum Default Power

This test report may be reproduced in full only. The document may only be updated by MiCOM Labs personnel. Any changes will be noted in the Document History section of the report.



**Title:** Aruba AP-175 802.11a/b/g/n Wireless AP  
**To:** FCC 47 CFR Part 15.407 & IC RSS-210  
**Serial #:** ARUB111-U1 Rev B  
**Issue Date:** 12th August 2013  
**Page:** 52 of 185

**TABLE OF RESULTS – 802.11a Legacy (5250 – 5350 MHz)**

|                               |            |                            |       |    |      |
|-------------------------------|------------|----------------------------|-------|----|------|
| <b>Test Conditions:</b>       | 15.407 (a) | <b>Rel. Humidity (%):</b>  | 35    | to | 42   |
| <b>Variant:</b>               | 802.11a    | <b>Ambient Temp. (°C):</b> | 19    | to | 22   |
| <b>TPC:</b>                   | HIGH       | <b>Pressure (mBars):</b>   | 998   | to | 1003 |
| <b>Modulation:</b>            | ON         | <b>Duty Cycle (%):</b>     | 100   |    |      |
| <b>Beam Forming Gain (Y):</b> | N/A dB     | <b>Antenna Gain:</b>       | 6 dBi |    |      |
| <b>Applied Voltage:</b>       | 12.0 Vdc   | <b>Antenna Ports (N):</b>  | 2     |    |      |
| <b>Notes 1:</b>               |            |                            |       |    |      |
| <b>Notes 2:</b>               |            |                            |       |    |      |

| Test Frequency | Measured Peak Power |      |    |    | Correction factor | Peak Power Spectral Density | Limit | Margin |
|----------------|---------------------|------|----|----|-------------------|-----------------------------|-------|--------|
|                | RF Port (dBm)       |      |    |    |                   |                             |       |        |
| MHz            | a                   | b    | c  | d  | 10Log(N)          | dBm                         | dBm   | dB     |
| 5260           | 5.10                | 5.97 | -- | -- | 3.01              | 8.98                        | 11.00 | -2.02  |
| 5300           | 4.52                | 5.41 | -- | -- | 3.01              | 8.42                        | 11.00 | -2.58  |
| 5320           | 4.44                | 5.10 | -- | -- | 3.01              | 8.11                        | 11.00 | -2.89  |

|                                 |          |
|---------------------------------|----------|
| <b>Measurement uncertainty:</b> | ±1.33 dB |
|---------------------------------|----------|

This test report may be reproduced in full only. The document may only be updated by MiCOM Labs personnel. Any changes will be noted in the Document History section of the report.



### CHAIN A 5,260 MHz 802.11a Legacy Peak Power Spectral Density

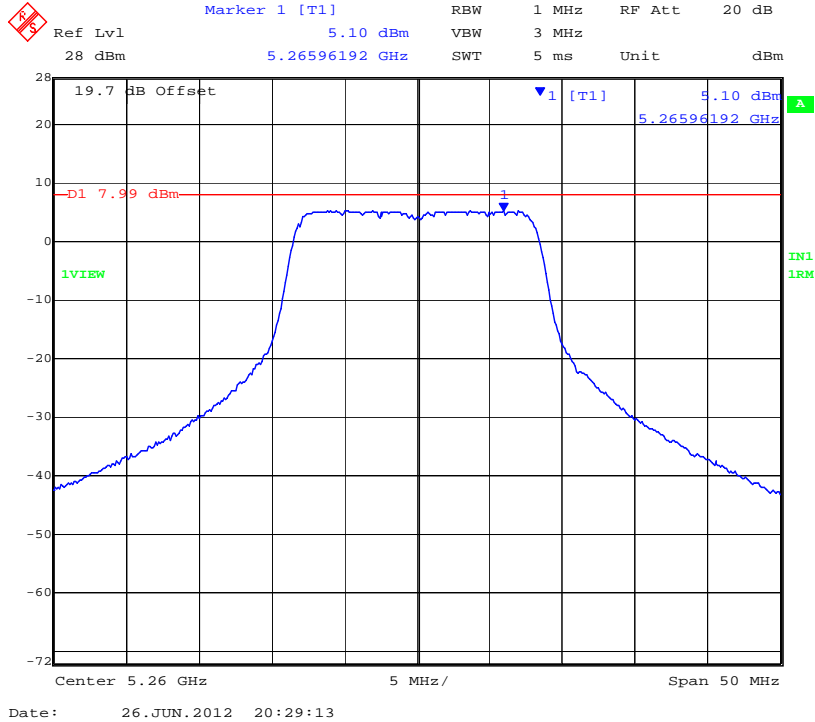

### CHAIN B 5,260 MHz 802.11a Legacy Peak Power Spectral Density

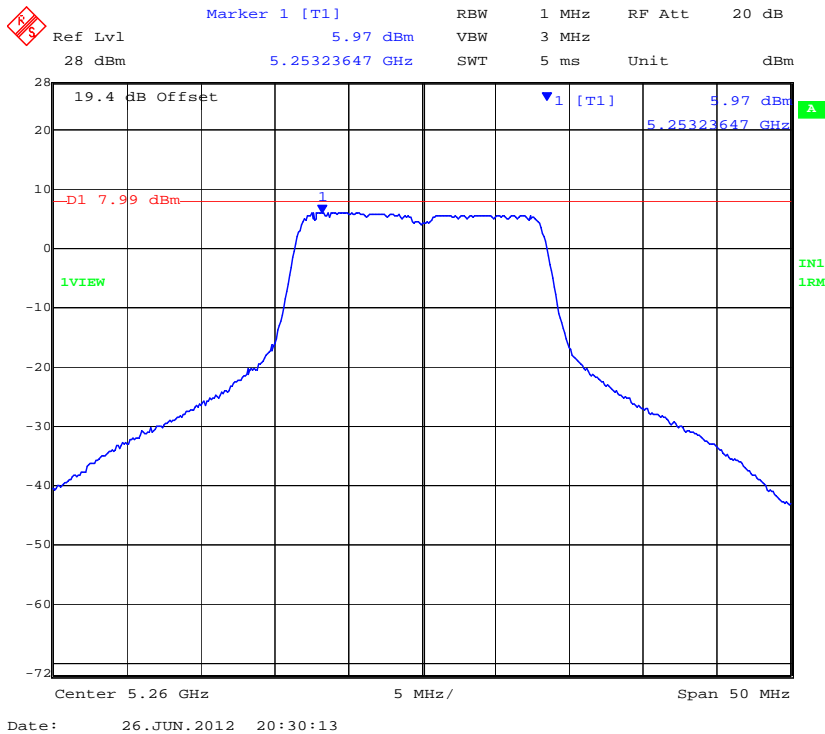

This test report may be reproduced in full only. The document may only be updated by MiCOM Labs personnel. Any changes will be noted in the Document History section of the report.



### CHAIN A 5,300 MHz 802.11a Legacy Peak Power Spectral Density

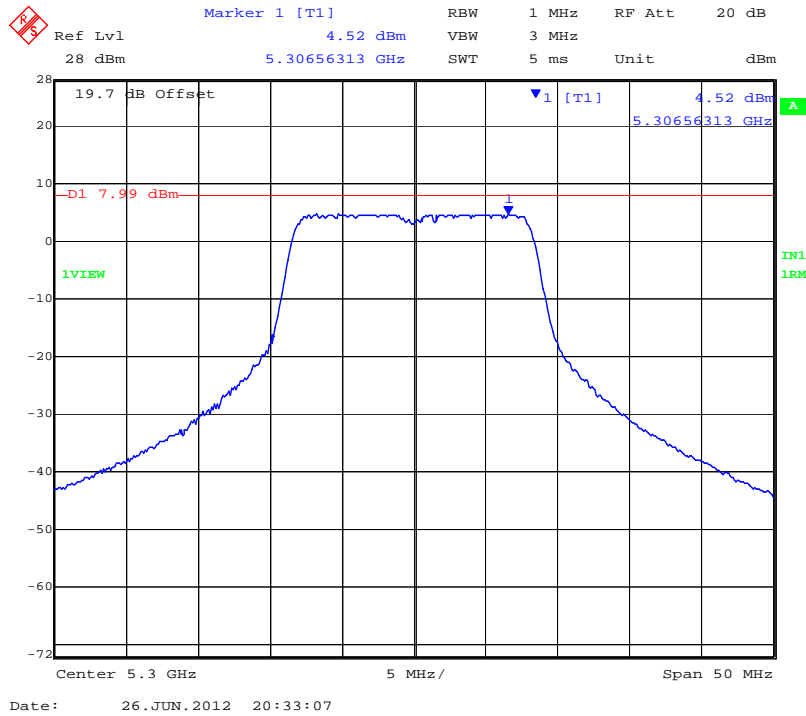

### CHAIN B 5,300 MHz 802.11a Legacy Peak Power Spectral Density

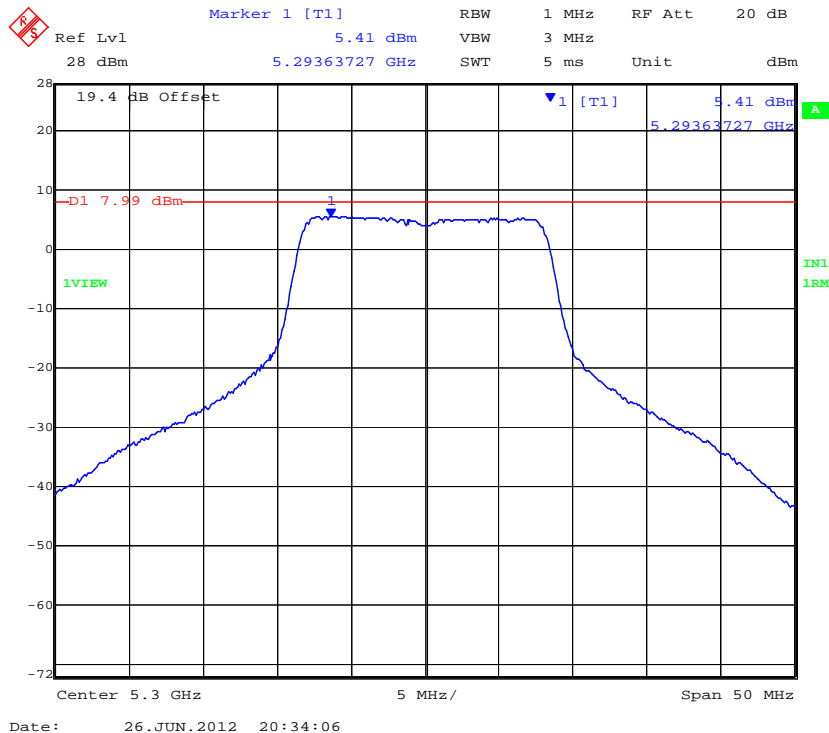

This test report may be reproduced in full only. The document may only be updated by MiCOM Labs personnel. Any changes will be noted in the Document History section of the report.



### Chain A 5,320 MHz 802.11a Legacy Peak Power Spectral Density

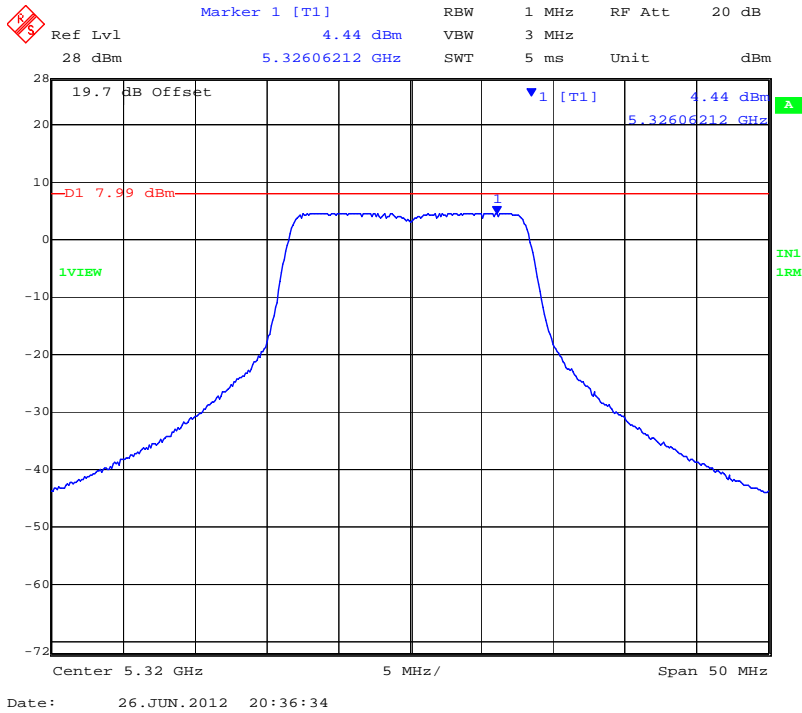

### Chain B 5,320 MHz 802.11a Legacy Peak Power Spectral Density

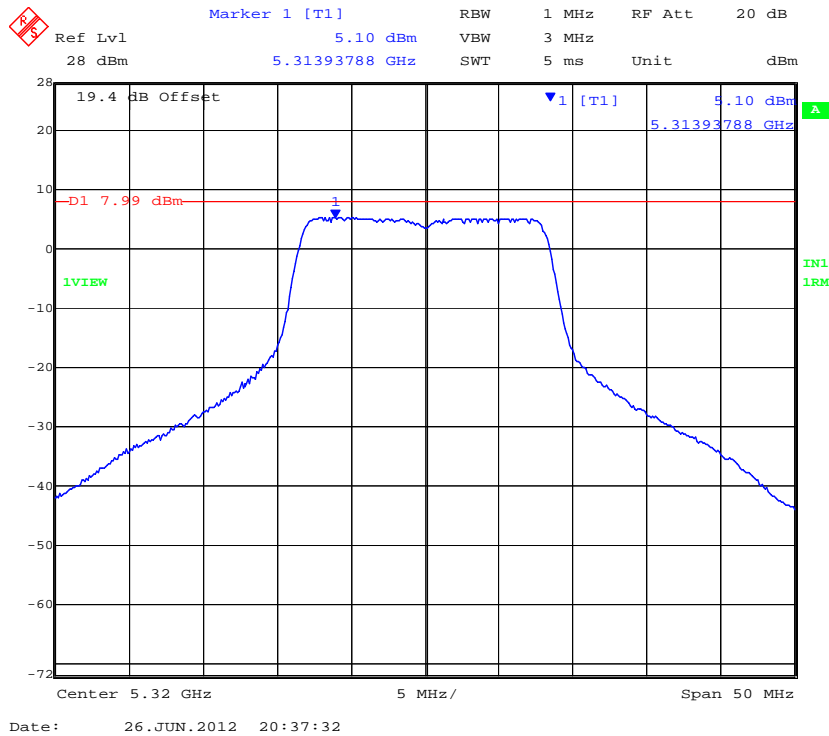

This test report may be reproduced in full only. The document may only be updated by MiCOM Labs personnel. Any changes will be noted in the Document History section of the report.



**Title:** Aruba AP-175 802.11a/b/g/n Wireless AP  
**To:** FCC 47 CFR Part 15.407 & IC RSS-210  
**Serial #:** ARUB111-U1 Rev B  
**Issue Date:** 12th August 2013  
**Page:** 56 of 185

**TABLE OF RESULTS – 802.11a Legacy (5470 – 5725 MHz)**

|                               |            |                            |       |    |      |
|-------------------------------|------------|----------------------------|-------|----|------|
| <b>Test Conditions:</b>       | 15.407 (a) | <b>Rel. Humidity (%):</b>  | 35    | to | 42   |
| <b>Variant:</b>               | 802.11a    | <b>Ambient Temp. (°C):</b> | 19    | to | 22   |
| <b>TPC:</b>                   | HIGH       | <b>Pressure (mBars):</b>   | 998   | to | 1003 |
| <b>Modulation:</b>            | ON         | <b>Duty Cycle (%):</b>     | 100   |    |      |
| <b>Beam Forming Gain (Y):</b> | N/A        | <b>Antenna Gain:</b>       | 6 dBi |    |      |
| <b>Applied Voltage:</b>       | 12.0 Vdc   | <b>Antenna Ports (N):</b>  | 2     |    |      |
| <b>Notes 1:</b>               |            |                            |       |    |      |
| <b>Notes 2:</b>               |            |                            |       |    |      |

| Test Frequency | Measured Peak Power |      |    |    | Correction factor | Peak Power Spectral Density | Limit | Margin |
|----------------|---------------------|------|----|----|-------------------|-----------------------------|-------|--------|
|                | RF Port (dBm)       |      |    |    |                   |                             |       |        |
| MHz            | a                   | b    | c  | d  | 10Log(N)          | dBm                         | dBm   | dB     |
| 5500           | 5.21                | 5.67 | -- | -- | 3.01              | 8.68                        | 11.00 | -2.32  |
| 5580           | 4.92                | 5.81 | -- | -- | 3.01              | 8.82                        | 11.00 | -2.18  |
| 5700           | 4.46                | 4.21 | -- | -- | 3.01              | 7.47                        | 11.00 | -3.53  |

|                                 |          |
|---------------------------------|----------|
| <b>Measurement uncertainty:</b> | ±1.33 dB |
|---------------------------------|----------|

This test report may be reproduced in full only. The document may only be updated by MiCOM Labs personnel. Any changes will be noted in the Document History section of the report.





### CHAIN A 5,500 MHz 802.11a Legacy Peak Power Spectral Density

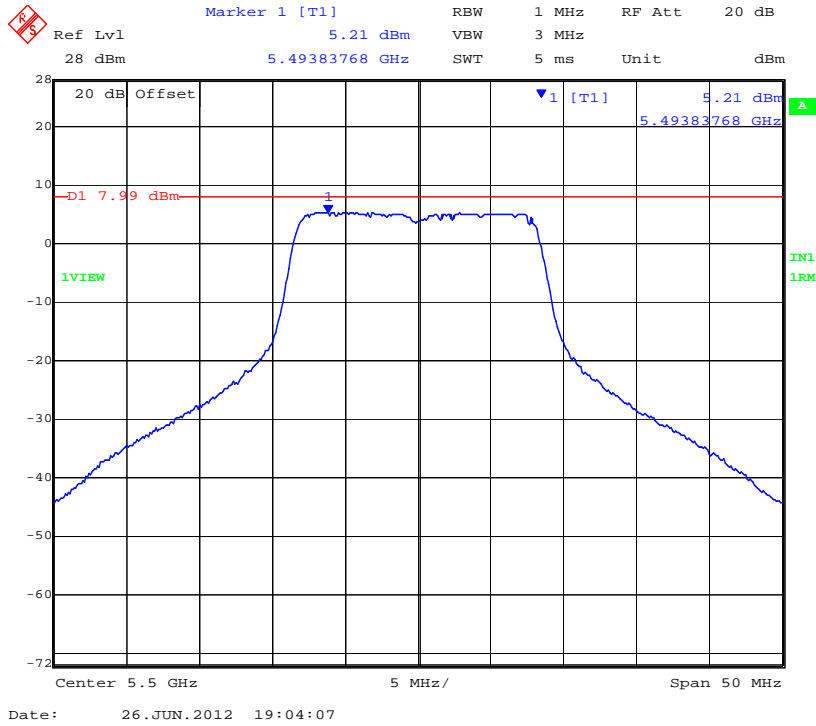

### CHAIN B 5,500 MHz 802.11a Legacy Peak Power Spectral Density

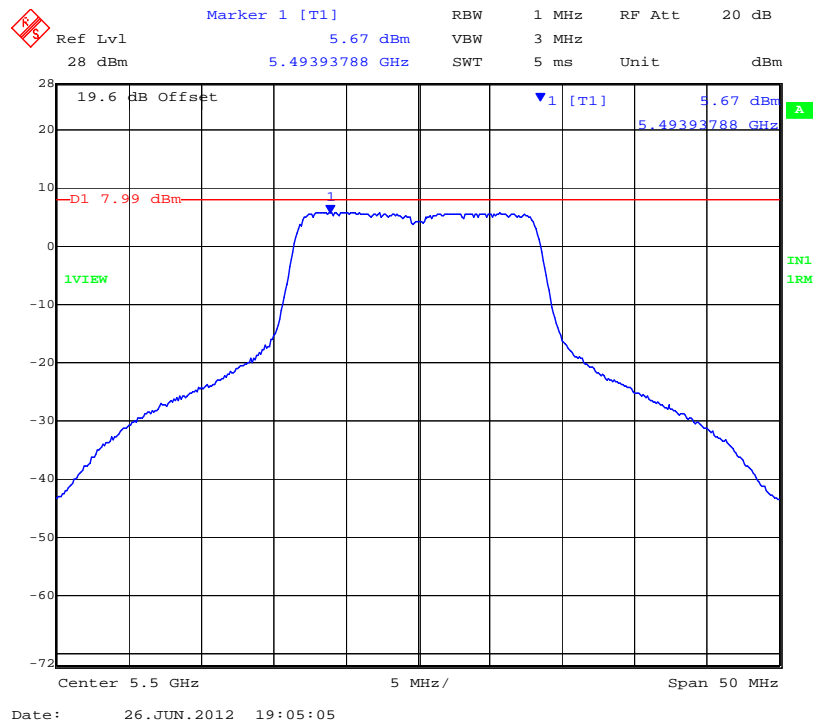

This test report may be reproduced in full only. The document may only be updated by MiCOM Labs personnel. Any changes will be noted in the Document History section of the report.



### CHAIN A 5,580 MHz 802.11a Legacy Peak Power Spectral Density

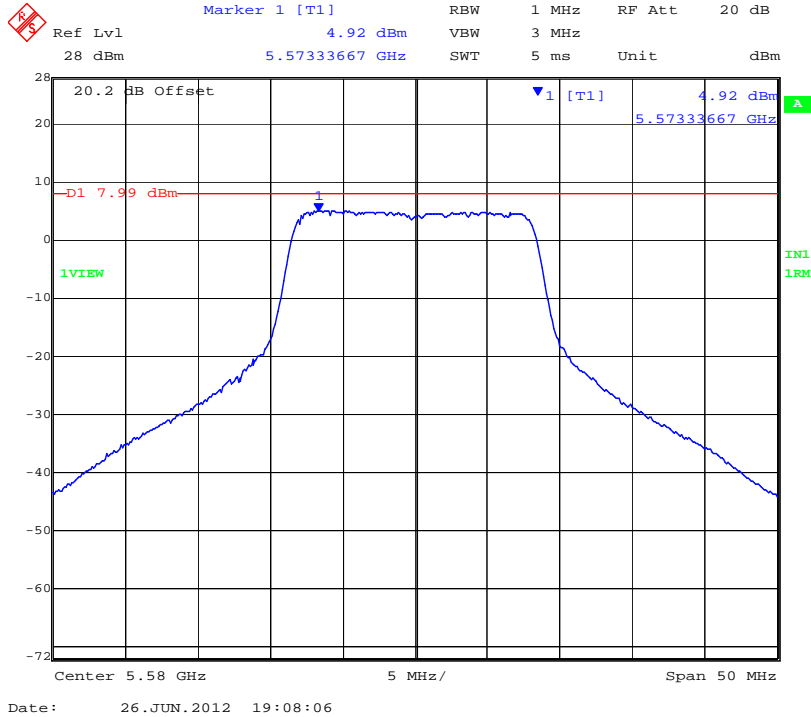

### CHAIN B 5,580 MHz 802.11a Legacy Peak Power Spectral Density

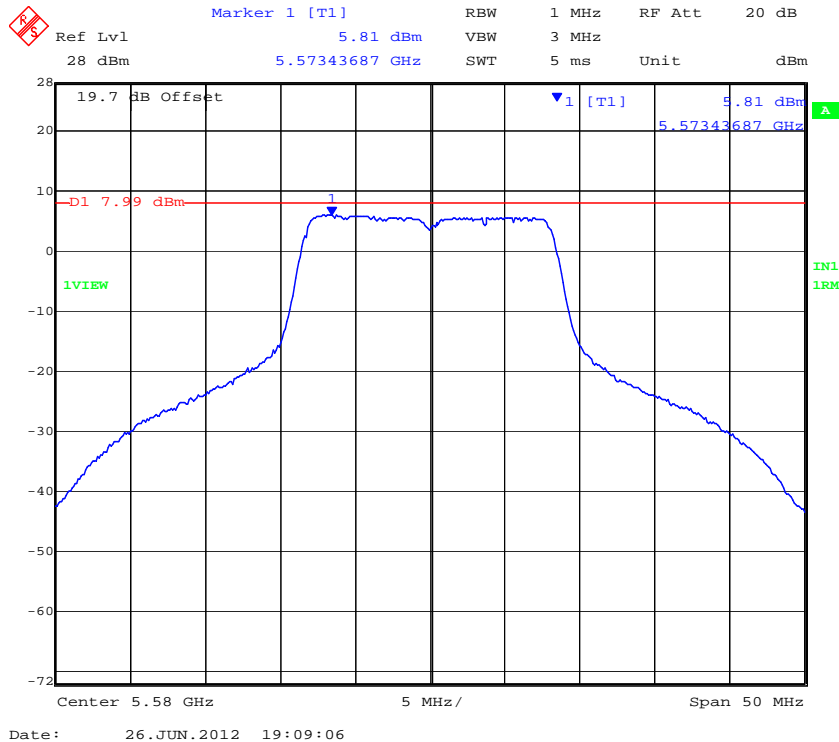

This test report may be reproduced in full only. The document may only be updated by MiCOM Labs personnel. Any changes will be noted in the Document History section of the report.



### Chain A 5,700 MHz 802.11a Legacy Peak Power Spectral Density

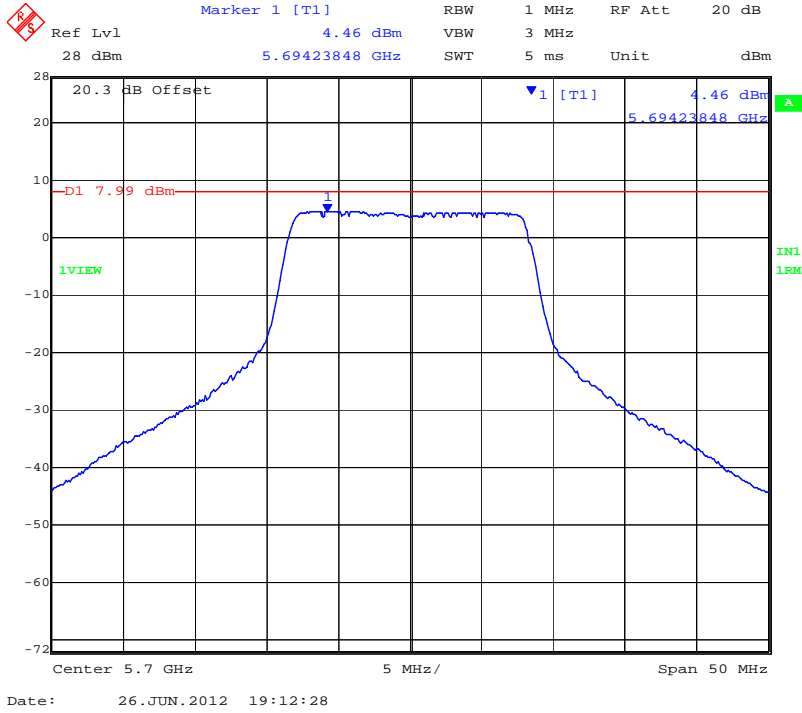

### Chain B 5,700 MHz 802.11a Legacy Peak Power Spectral Density

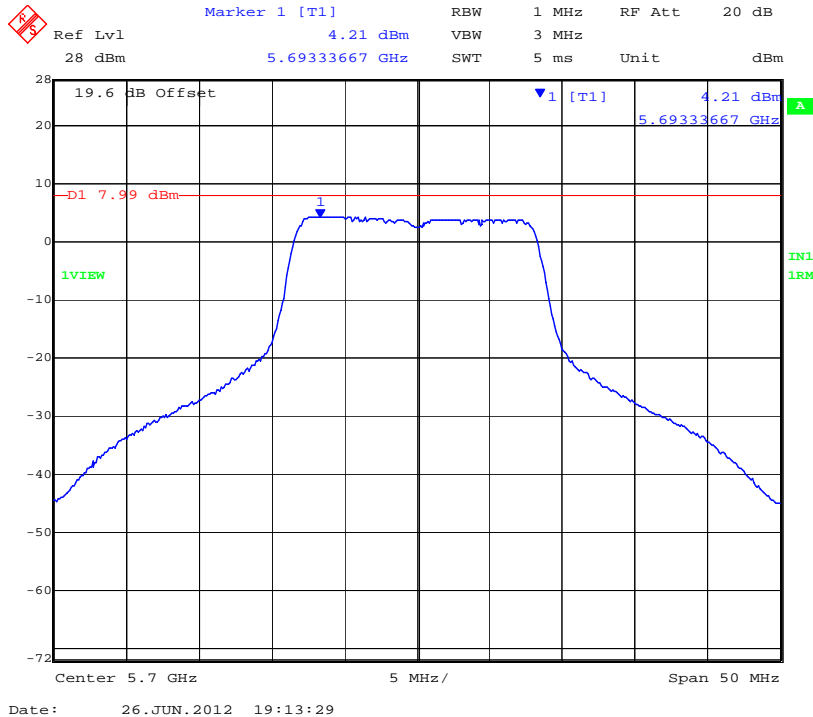

This test report may be reproduced in full only. The document may only be updated by MiCOM Labs personnel. Any changes will be noted in the Document History section of the report.



**Title:** Aruba AP-175 802.11a/b/g/n Wireless AP  
**To:** FCC 47 CFR Part 15.407 & IC RSS-210  
**Serial #:** ARUB111-U1 Rev B  
**Issue Date:** 12th August 2013  
**Page:** 60 of 185

**TABLE OF RESULTS – 802. 11n HT-20 (5250 – 5350 MHz)**

|                               |               |                            |       |    |      |
|-------------------------------|---------------|----------------------------|-------|----|------|
| <b>Test Conditions:</b>       | 15.407 (a)    | <b>Rel. Humidity (%):</b>  | 35    | to | 42   |
| <b>Variant:</b>               | 802.11n HT-20 | <b>Ambient Temp. (°C):</b> | 19    | to | 22   |
| <b>TPC:</b>                   | HIGH          | <b>Pressure (mBars):</b>   | 998   | to | 1003 |
| <b>Modulation:</b>            | ON            | <b>Duty Cycle (%):</b>     | 100   |    |      |
| <b>Beam Forming Gain (Y):</b> | N/A dB        | <b>Antenna Gain:</b>       | 6 dBi |    |      |
| <b>Applied Voltage:</b>       | 12.0 Vdc      | <b>Antenna Ports (N):</b>  | 2     |    |      |
| <b>Notes 1:</b>               |               |                            |       |    |      |
| <b>Notes 2:</b>               |               |                            |       |    |      |

| Test Frequency | Measured Peak Power |      |    |    | Correction factor | Peak Power Spectral Density | Limit | Margin |
|----------------|---------------------|------|----|----|-------------------|-----------------------------|-------|--------|
|                | RF Port (dBm)       |      |    |    |                   |                             |       |        |
| MHz            | a                   | b    | c  | d  | 10Log(N)          | dBm                         | dBm   | dB     |
| 5260           | 5.39                | 5.93 | -- | -- | 3.01              | 8.94                        | 11.00 | -2.06  |
| 5300           | 5.00                | 5.33 | -- | -- | 3.01              | 8.34                        | 11.00 | -2.66  |
| 5320           | 4.82                | 5.24 | -- | -- | 3.01              | 8.25                        | 11.00 | -2.75  |

|                                 |          |
|---------------------------------|----------|
| <b>Measurement uncertainty:</b> | ±1.33 dB |
|---------------------------------|----------|

This test report may be reproduced in full only. The document may only be updated by MiCOM Labs personnel. Any changes will be noted in the Document History section of the report.



### CHAIN A 5,260 MHz 802.11n HT-20 Peak Power Spectral Density

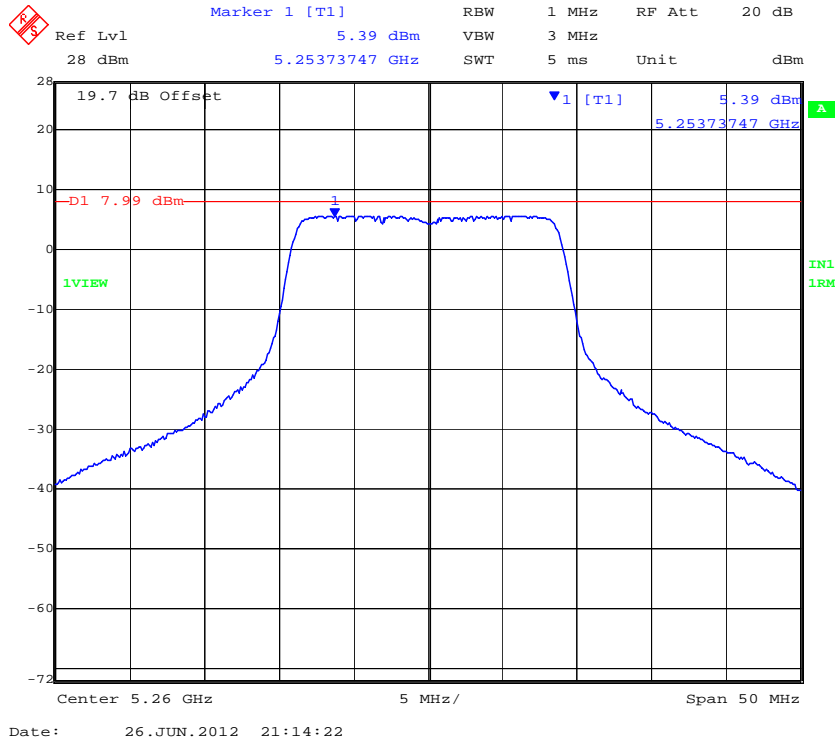

### CHAIN B 5,260 MHz 802.11n HT-20 Peak Power Spectral Density

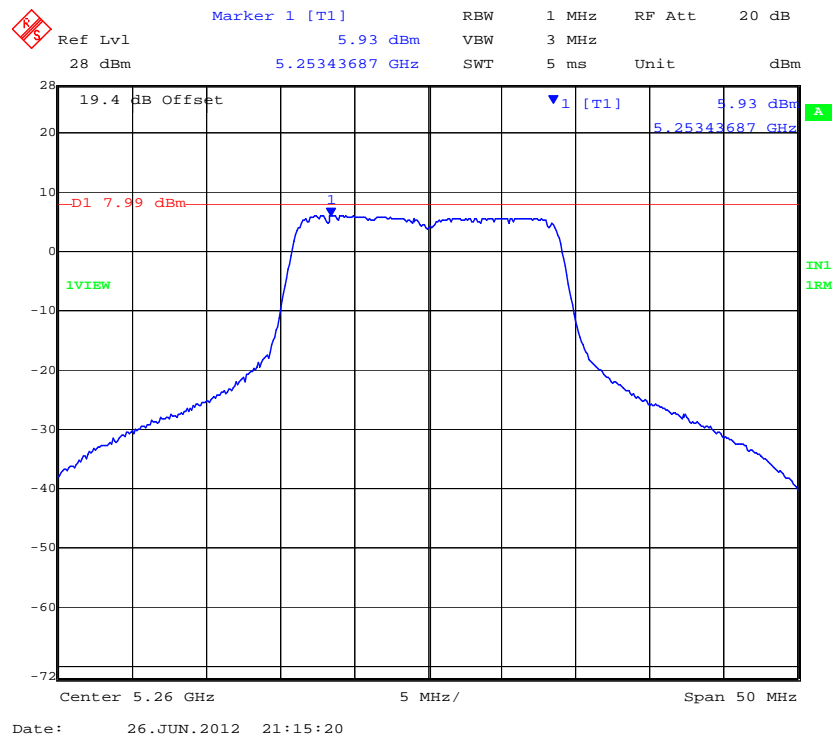

This test report may be reproduced in full only. The document may only be updated by MiCOM Labs personnel. Any changes will be noted in the Document History section of the report.



### CHAIN A 5,300 MHz 802.11n HT-20 Peak Power Spectral Density

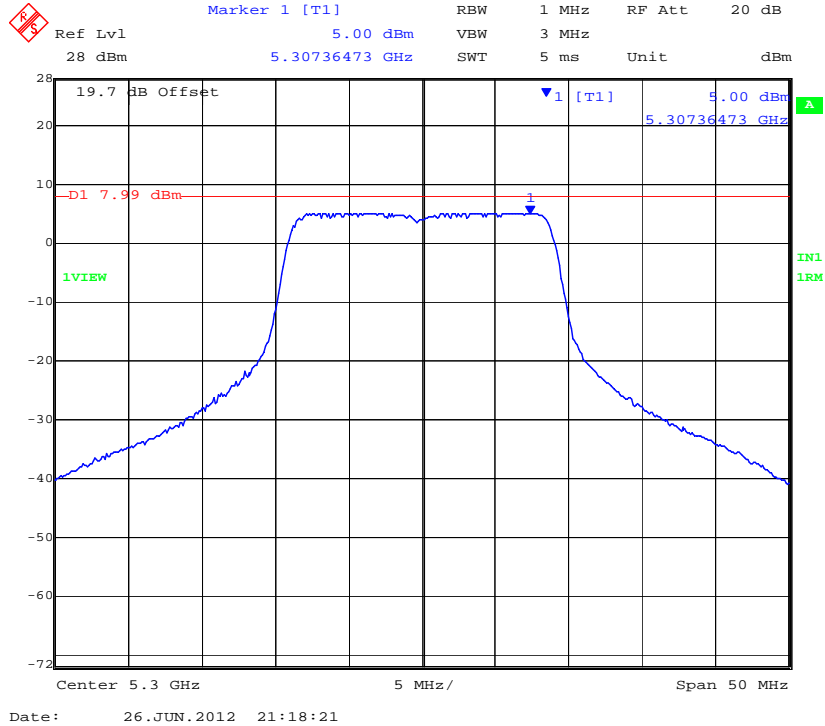

### CHAIN B 5,300 MHz 802.11n HT-20 Peak Power Spectral Density

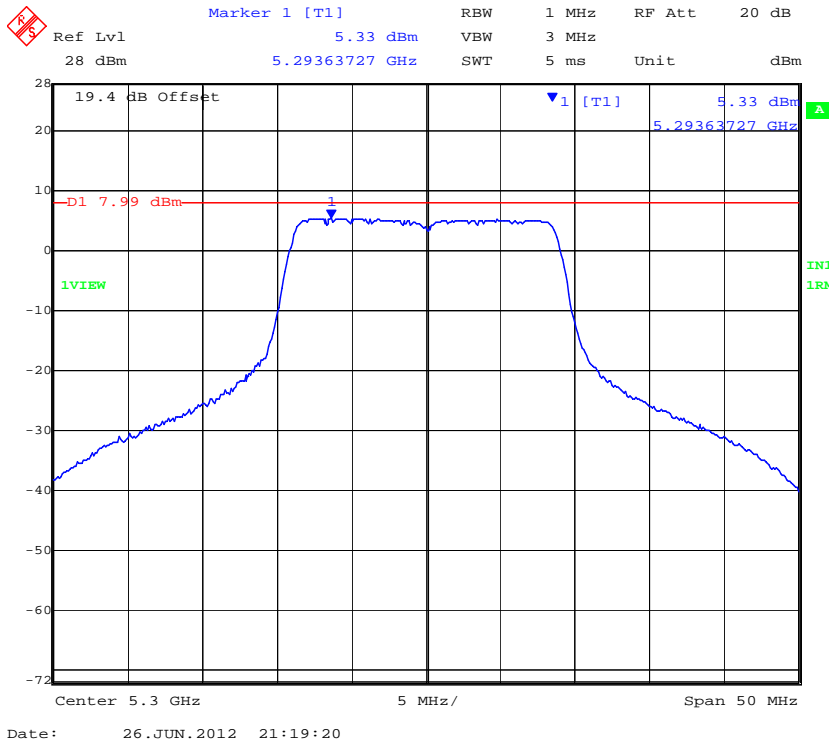

This test report may be reproduced in full only. The document may only be updated by MiCOM Labs personnel. Any changes will be noted in the Document History section of the report.



### Chain A 5,320 MHz 802.11n HT-20 Peak Power Spectral Density

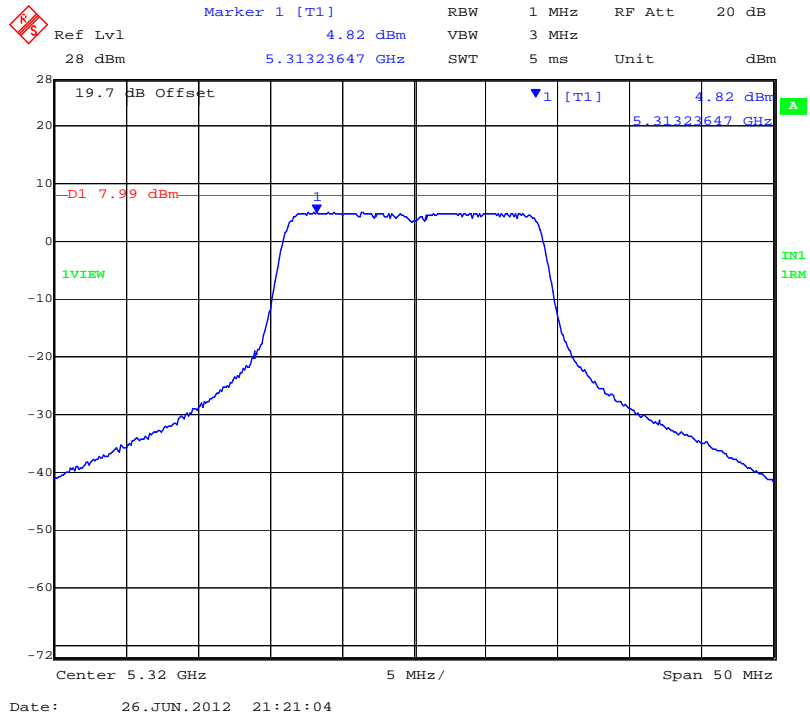

### Chain B 5,320 MHz 802.11n HT-20 Peak Power Spectral Density

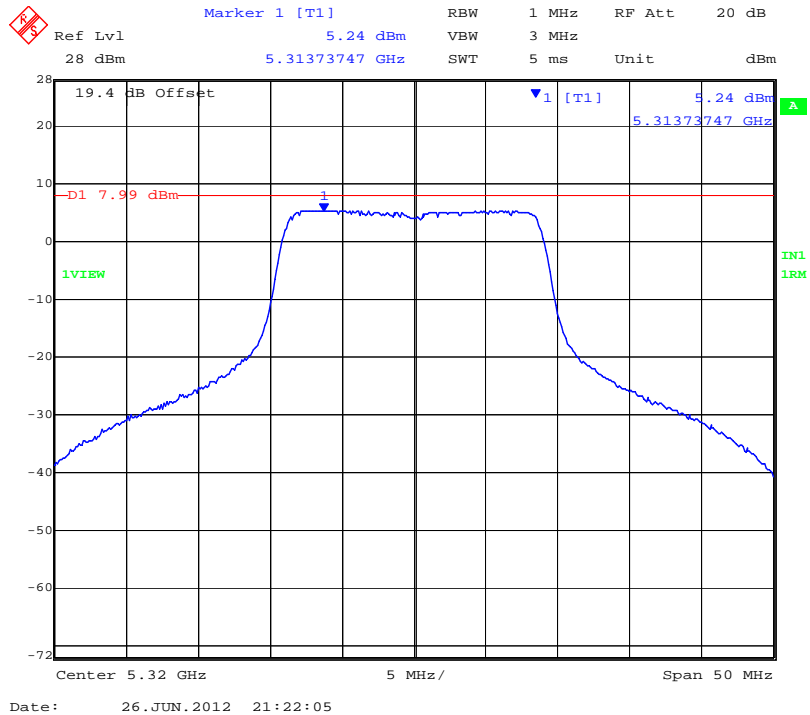

This test report may be reproduced in full only. The document may only be updated by MiCOM Labs personnel. Any changes will be noted in the Document History section of the report.



**Title:** Aruba AP-175 802.11a/b/g/n Wireless AP  
**To:** FCC 47 CFR Part 15.407 & IC RSS-210  
**Serial #:** ARUB111-U1 Rev B  
**Issue Date:** 12th August 2013  
**Page:** 64 of 185

**TABLE OF RESULTS – 802.11n HT-20 (5470 – 5725 MHz)**

|                               |               |                            |       |    |      |
|-------------------------------|---------------|----------------------------|-------|----|------|
| <b>Test Conditions:</b>       | 15.407 (a)    | <b>Rel. Humidity (%):</b>  | 35    | to | 42   |
| <b>Variant:</b>               | 802.11n HT-20 | <b>Ambient Temp. (°C):</b> | 19    | to | 22   |
| <b>TPC:</b>                   | HIGH          | <b>Pressure (mBars):</b>   | 998   | to | 1003 |
| <b>Modulation:</b>            | ON            | <b>Duty Cycle (%):</b>     | 100   |    |      |
| <b>Beam Forming Gain (Y):</b> | N/A           | <b>Antenna Gain:</b>       | 6 dBi |    |      |
| <b>Applied Voltage:</b>       | 12.0 Vdc      | <b>Antenna Ports (N):</b>  | 2     |    |      |
| <b>Notes 1:</b>               |               |                            |       |    |      |
| <b>Notes 2:</b>               |               |                            |       |    |      |

| Test Frequency | Measured Peak Power |      |    |    | Correction factor | Peak Power Spectral Density | Limit | Margin |
|----------------|---------------------|------|----|----|-------------------|-----------------------------|-------|--------|
|                | RF Port (dBm)       |      |    |    |                   |                             |       |        |
| MHz            | a                   | b    | c  | d  | 10Log(N)          | dBm                         | dBm   | dB     |
| 5500           | 5.36                | 5.73 | -- | -- | 3.01              | 8.74                        | 11.00 | -2.26  |
| 5580           | 5.18                | 6.09 | -- | -- | 3.01              | 9.10                        | 11.00 | -1.90  |
| 5700           | 4.56                | 4.73 | -- | -- | 3.01              | 7.74                        | 11.00 | -3.26  |

|                                 |          |
|---------------------------------|----------|
| <b>Measurement uncertainty:</b> | ±1.33 dB |
|---------------------------------|----------|

This test report may be reproduced in full only. The document may only be updated by MiCOM Labs personnel. Any changes will be noted in the Document History section of the report.





### CHAIN A 5,500 MHz 802.11n HT-20 Peak Power Spectral Density

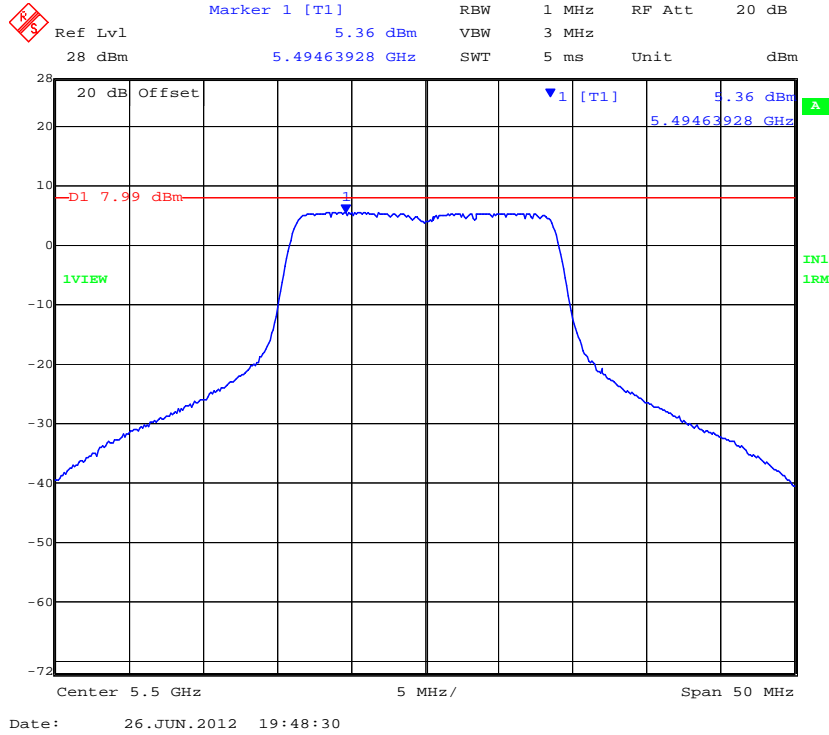

### CHAIN B 5,500 MHz 802.11n HT-20 Peak Power Spectral Density

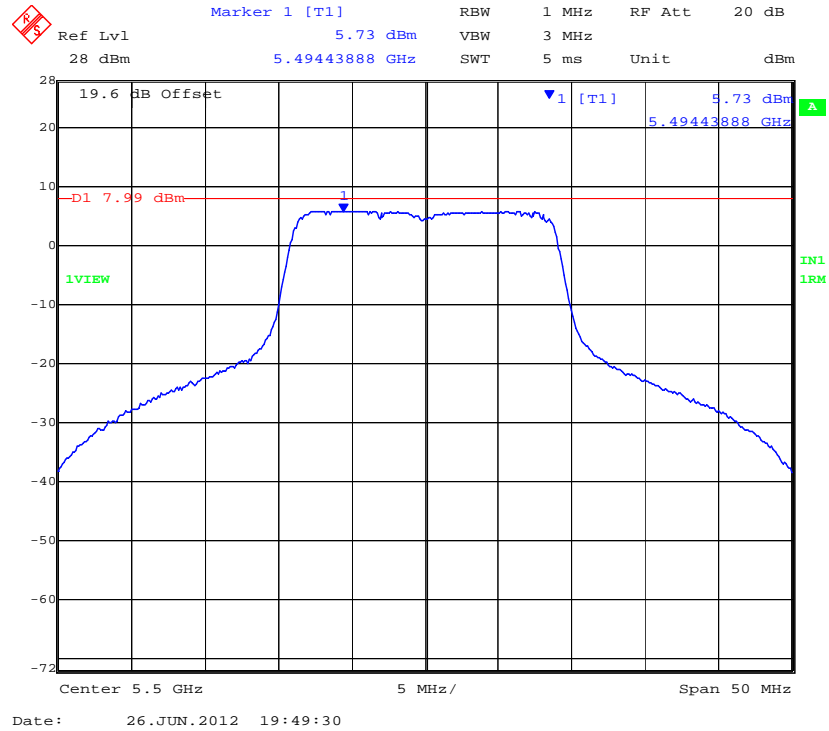

This test report may be reproduced in full only. The document may only be updated by MiCOM Labs personnel. Any changes will be noted in the Document History section of the report.



### CHAIN A 5,580 MHz 802.11n HT-20 Peak Power Spectral Density

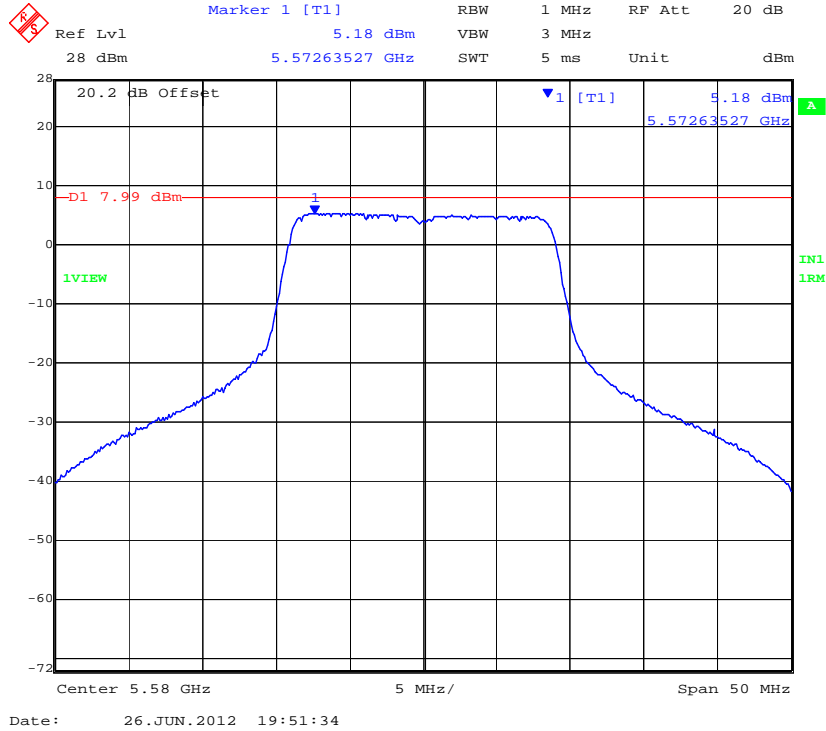

### CHAIN B 5,580 MHz 802.11n HT-20 Peak Power Spectral Density

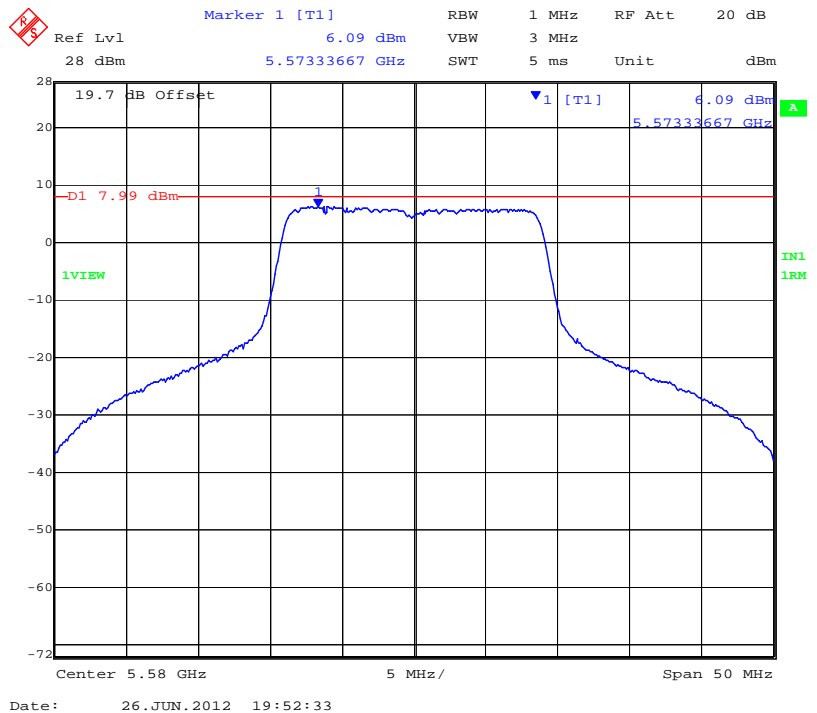

This test report may be reproduced in full only. The document may only be updated by MiCOM Labs personnel. Any changes will be noted in the Document History section of the report.



### Chain A 5,700 MHz 802.11n HT-20 Peak Power Spectral Density

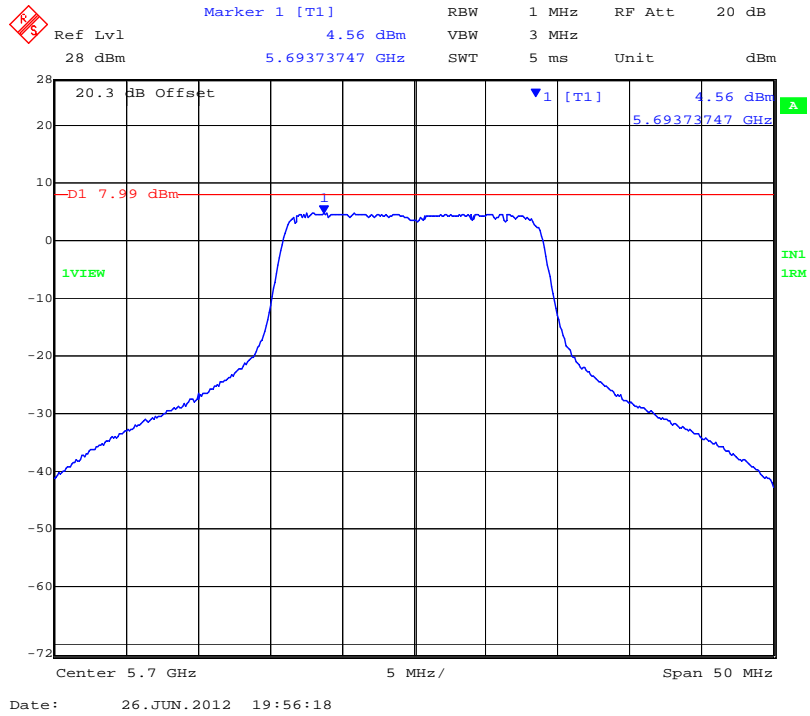

### Chain B 5,700 MHz 802.11n HT-20 Peak Power Spectral Density

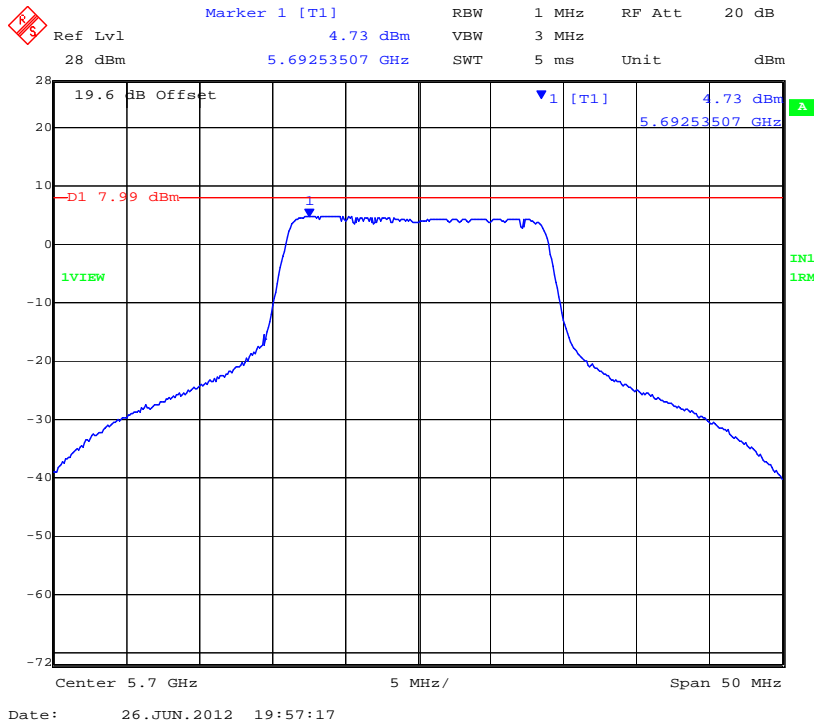

This test report may be reproduced in full only. The document may only be updated by MiCOM Labs personnel. Any changes will be noted in the Document History section of the report.



**Title:** Aruba AP-175 802.11a/b/g/n Wireless AP  
**To:** FCC 47 CFR Part 15.407 & IC RSS-210  
**Serial #:** ARUB111-U1 Rev B  
**Issue Date:** 12th August 2013  
**Page:** 68 of 185

**TABLE OF RESULTS – 802.11n HT-40 (5250 – 5350 MHz)**

|                               |               |                            |       |    |      |
|-------------------------------|---------------|----------------------------|-------|----|------|
| <b>Test Conditions:</b>       | 15.407 (a)    | <b>Rel. Humidity (%):</b>  | 35    | to | 42   |
| <b>Variant:</b>               | 802.11n HT-40 | <b>Ambient Temp. (°C):</b> | 19    | to | 22   |
| <b>TPC:</b>                   | HIGH          | <b>Pressure (mBars):</b>   | 998   | to | 1003 |
| <b>Modulation:</b>            | ON            | <b>Duty Cycle (%):</b>     | 100   |    |      |
| <b>Beam Forming Gain (Y):</b> | N/A           | <b>Antenna Gain:</b>       | 6 dBi |    |      |
| <b>Applied Voltage:</b>       | 12.0 Vdc      | <b>Antenna Ports (N):</b>  | 2     |    |      |
| <b>Notes 1:</b>               |               |                            |       |    |      |
| <b>Notes 2:</b>               |               |                            |       |    |      |

| Test Frequency | Measured Peak Power |      |    |    | Correction factor | Peak Power Spectral Density | Limit | Margin |
|----------------|---------------------|------|----|----|-------------------|-----------------------------|-------|--------|
|                | RF Port (dBm)       |      |    |    |                   |                             |       |        |
| MHz            | a                   | b    | c  | d  | 10Log(N)          | dBm                         | dBm   | dB     |
| 5270           | 4.86                | 5.57 | -- | -- | 3.01              | 8.58                        | 11.00 | -2.42  |
| 5310           | 4.41                | 4.91 | -- | -- | 3.01              | 7.92                        | 11.00 | -3.08  |

|                                 |          |
|---------------------------------|----------|
| <b>Measurement uncertainty:</b> | ±1.33 dB |
|---------------------------------|----------|

This test report may be reproduced in full only. The document may only be updated by MiCOM Labs personnel. Any changes will be noted in the Document History section of the report.



### CHAIN A 5,270 MHz 802.11n HT-40 Peak Power Spectral Density

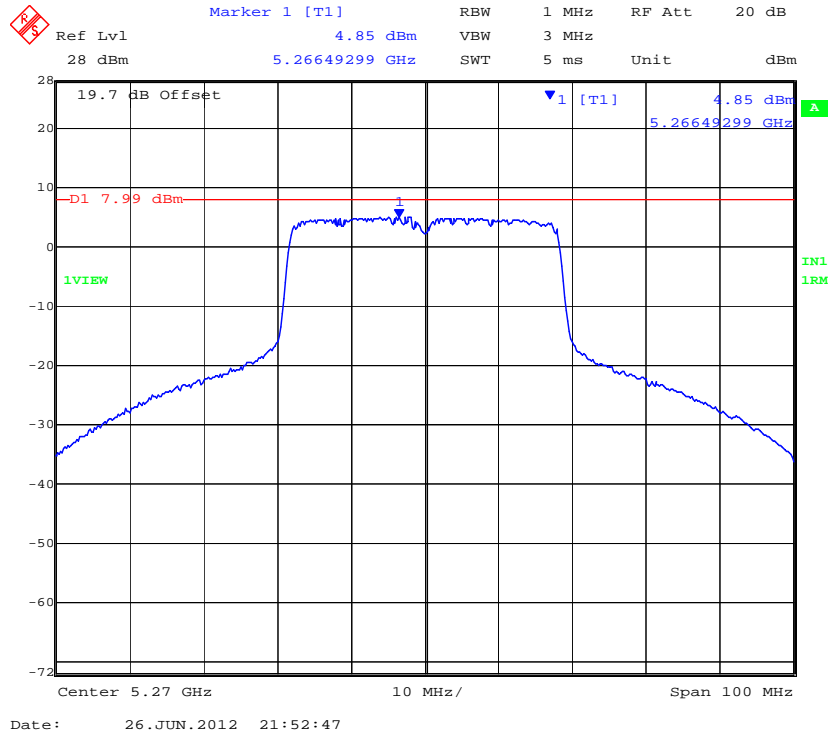

### CHAIN B 5,270 MHz 802.11n HT-40 Peak Power Spectral Density

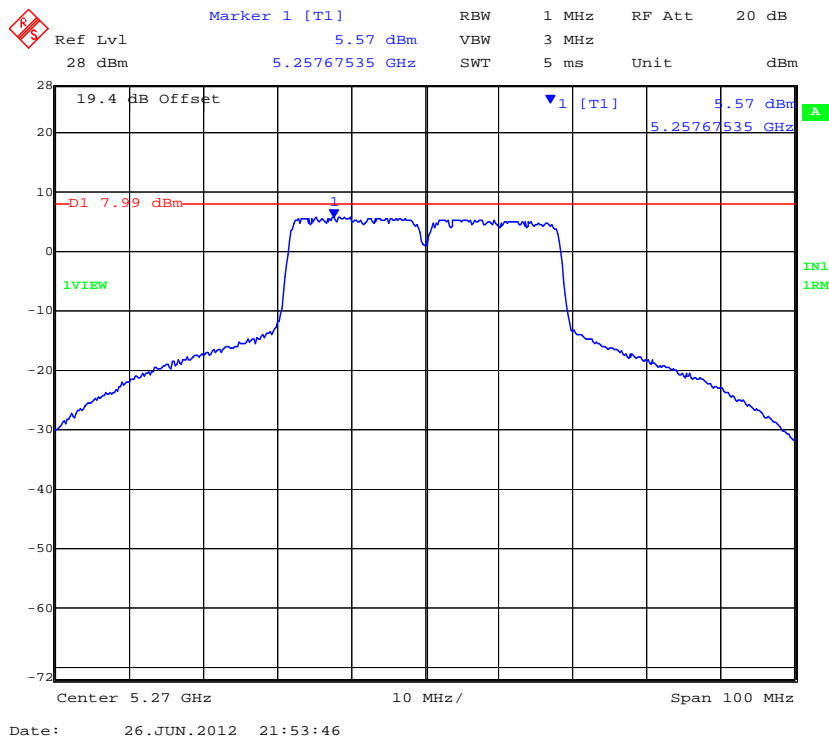

This test report may be reproduced in full only. The document may only be updated by MiCOM Labs personnel. Any changes will be noted in the Document History section of the report.



### Chain A 5,310 MHz 802.11n HT-40 Peak Power Spectral Density

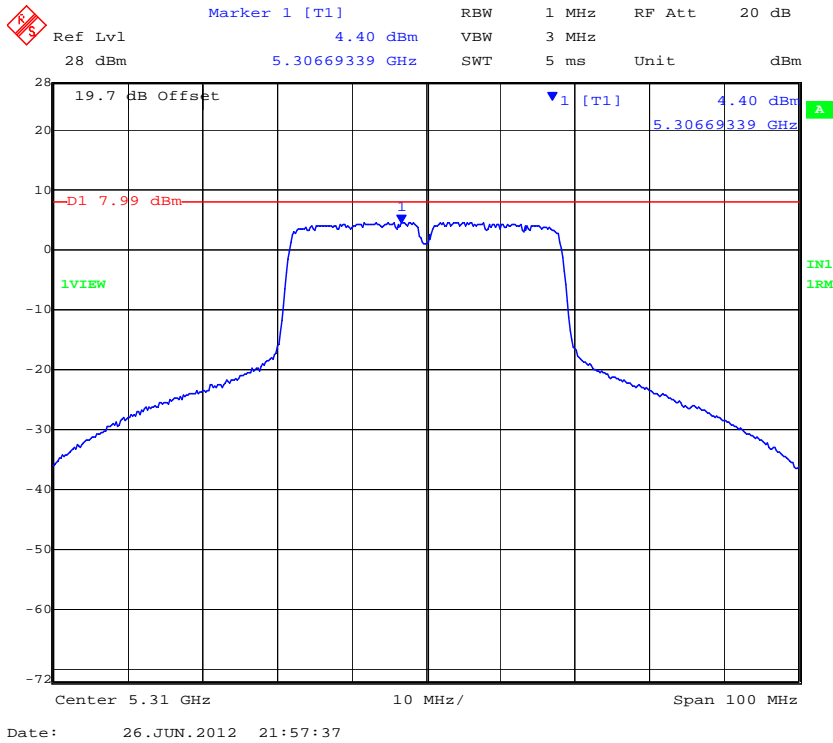

### Chain B 5,310 MHz 802.11n HT-40 Peak Power Spectral Density

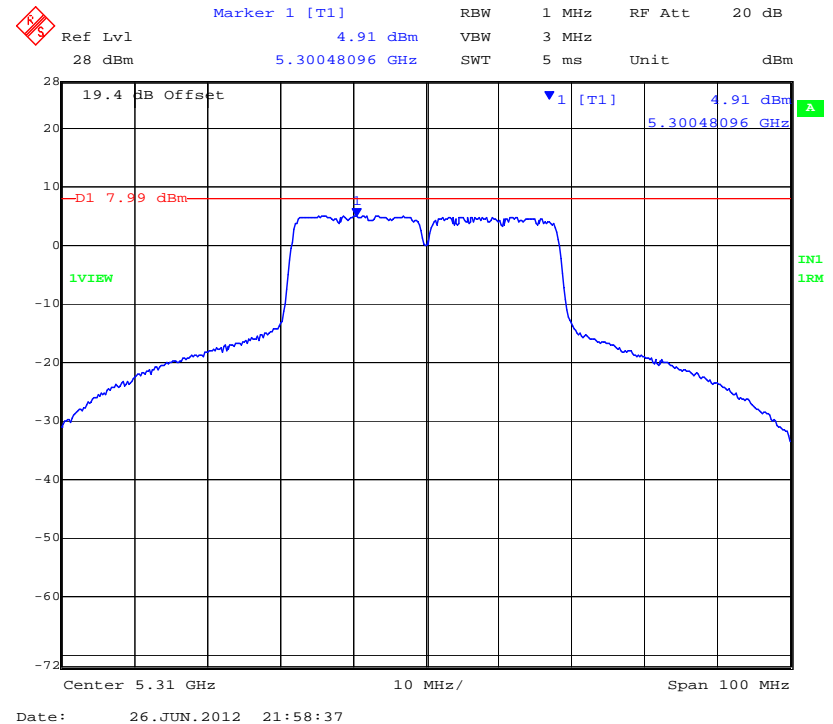

This test report may be reproduced in full only. The document may only be updated by MiCOM Labs personnel. Any changes will be noted in the Document History section of the report.



**TABLE OF RESULTS – 802.11n HT-40 (5470 – 5725 MHz)**

|                               |               |                            |       |    |      |
|-------------------------------|---------------|----------------------------|-------|----|------|
| <b>Test Conditions:</b>       | 15.407 (a)    | <b>Rel. Humidity (%):</b>  | 35    | to | 42   |
| <b>Variant:</b>               | 802.11n HT-40 | <b>Ambient Temp. (°C):</b> | 19    | to | 22   |
| <b>TPC:</b>                   | HIGH          | <b>Pressure (mBars):</b>   | 998   | to | 1003 |
| <b>Modulation:</b>            | ON            | <b>Duty Cycle (%):</b>     | 100   |    |      |
| <b>Beam Forming Gain (Y):</b> | N/A           | <b>Antenna Gain:</b>       | 6 dBi |    |      |
| <b>Applied Voltage:</b>       | 12.0 Vdc      | <b>Antenna Ports (N):</b>  | 2     |    |      |
| <b>Notes 1:</b>               |               |                            |       |    |      |
| <b>Notes 2:</b>               |               |                            |       |    |      |

| Test Frequency | Measured Peak Power |      |    |    | Correction factor | Peak Power Spectral Density | Limit | Margin |
|----------------|---------------------|------|----|----|-------------------|-----------------------------|-------|--------|
|                | RF Port (dBm)       |      |    |    |                   |                             |       |        |
| MHz            | a                   | b    | c  | d  | 10Log(N)          | dBm                         | dBm   | dB     |
| 5510           | 4.86                | 5.21 | -- | -- | 3.01              | 8.22                        | 11.00 | -2.78  |
| 5550           | 4.87                | 5.64 | -- | -- | 3.01              | 8.65                        | 11.00 | -2.35  |
| 5670           | 4.20                | 4.89 | -- | -- | 3.01              | 7.90                        | 11.00 | -3.10  |

|                                 |          |
|---------------------------------|----------|
| <b>Measurement uncertainty:</b> | ±1.33 dB |
|---------------------------------|----------|

This test report may be reproduced in full only. The document may only be updated by MiCOM Labs personnel. Any changes will be noted in the Document History section of the report.



### CHAIN A 5,510 MHz 802.11n HT-40 Peak Power Spectral Density

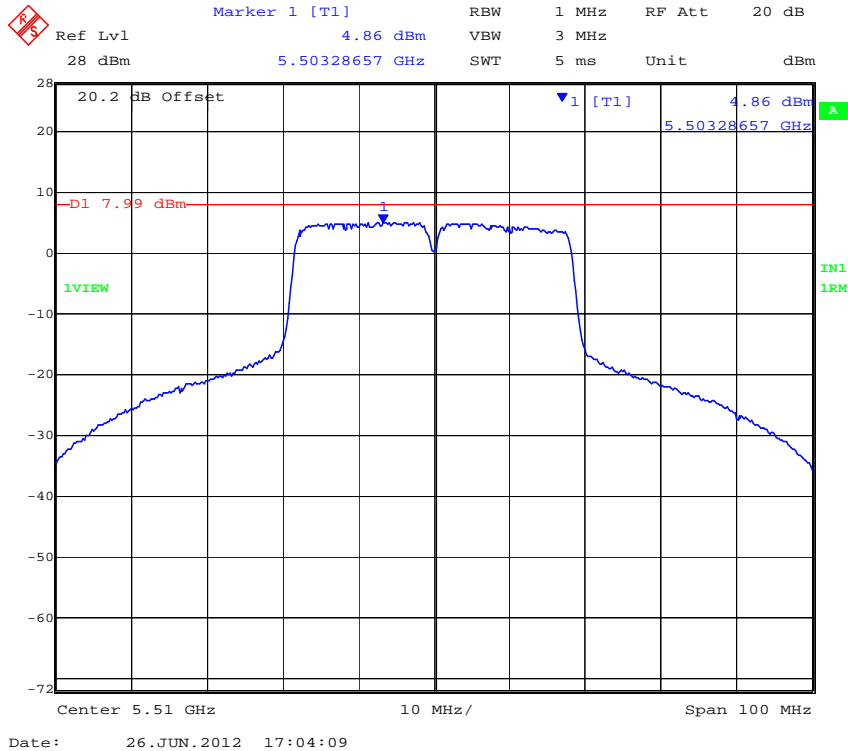

### CHAIN B 5,510 MHz 802.11n HT-40 Peak Power Spectral Density

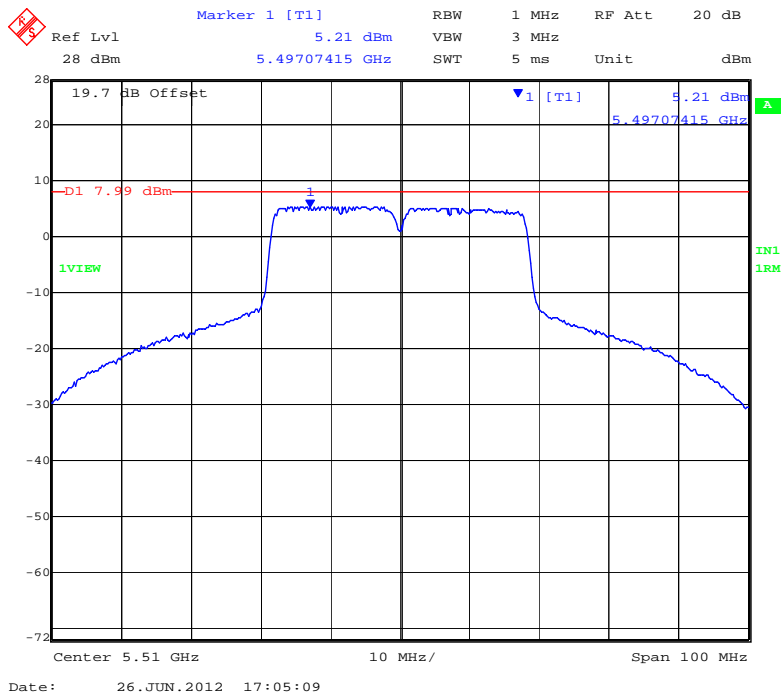

This test report may be reproduced in full only. The document may only be updated by MiCOM Labs personnel. Any changes will be noted in the Document History section of the report.





### CHAIN A 5,550 MHz 802.11n HT-40 Peak Power Spectral Density

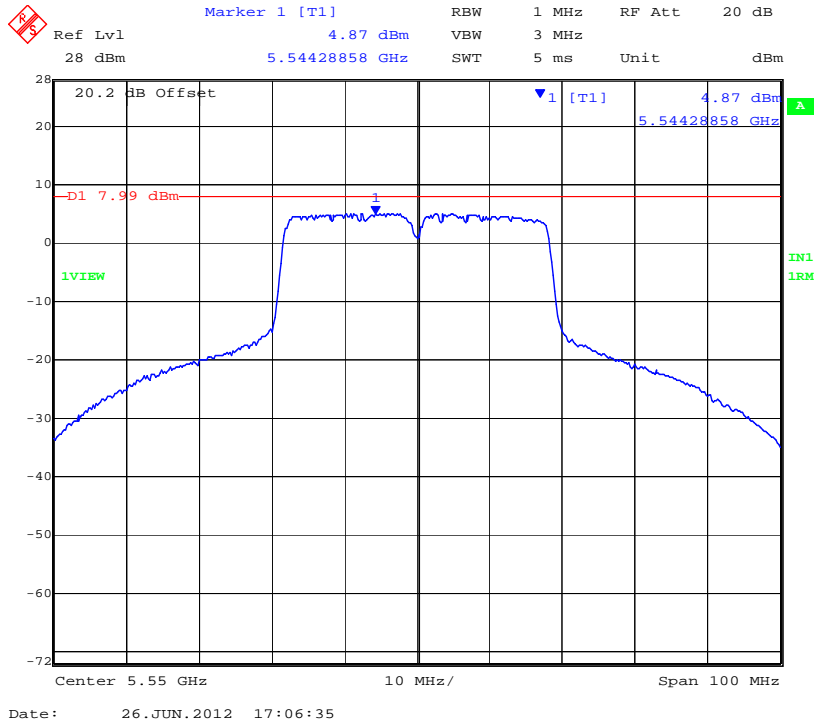

### CHAIN B 5,550 MHz 802.11n HT-40 Peak Power Spectral Density

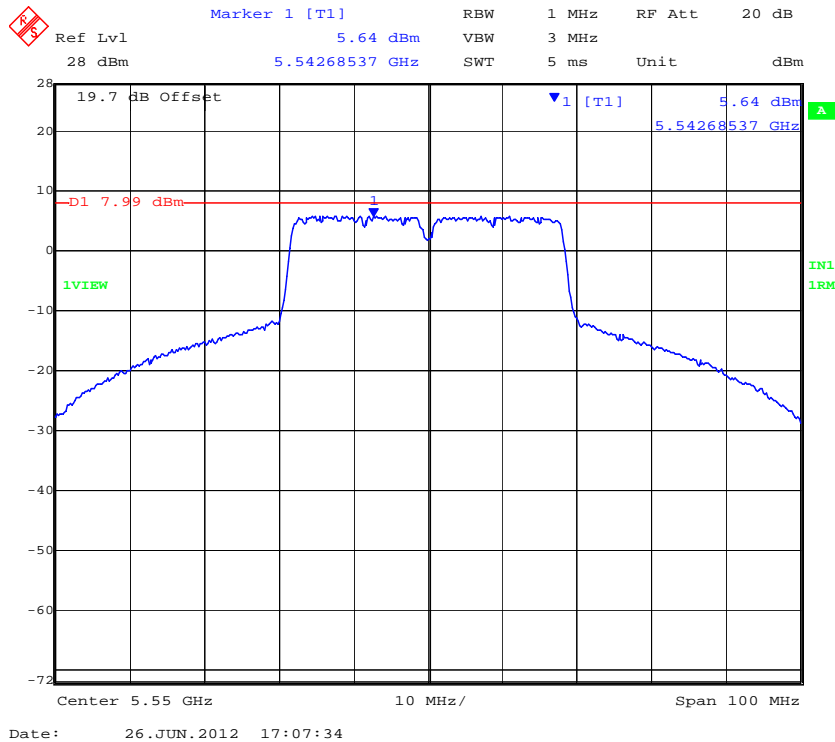

This test report may be reproduced in full only. The document may only be updated by MiCOM Labs personnel. Any changes will be noted in the Document History section of the report.



### Chain A 5,670 MHz 802.11n HT-40 Peak Power Spectral Density

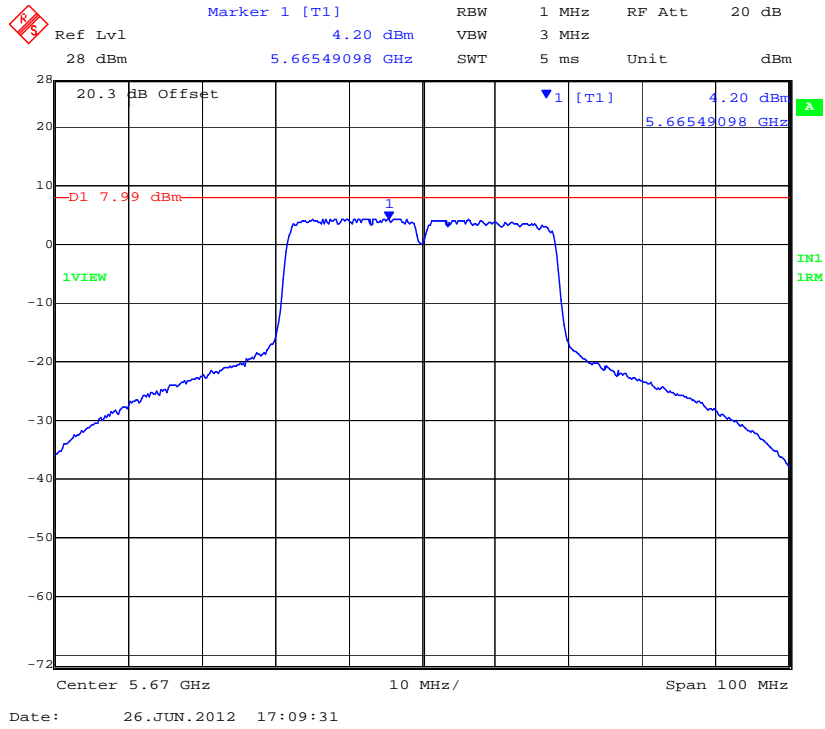

### Chain B 5,670 MHz 802.11n HT-40 Peak Power Spectral Density

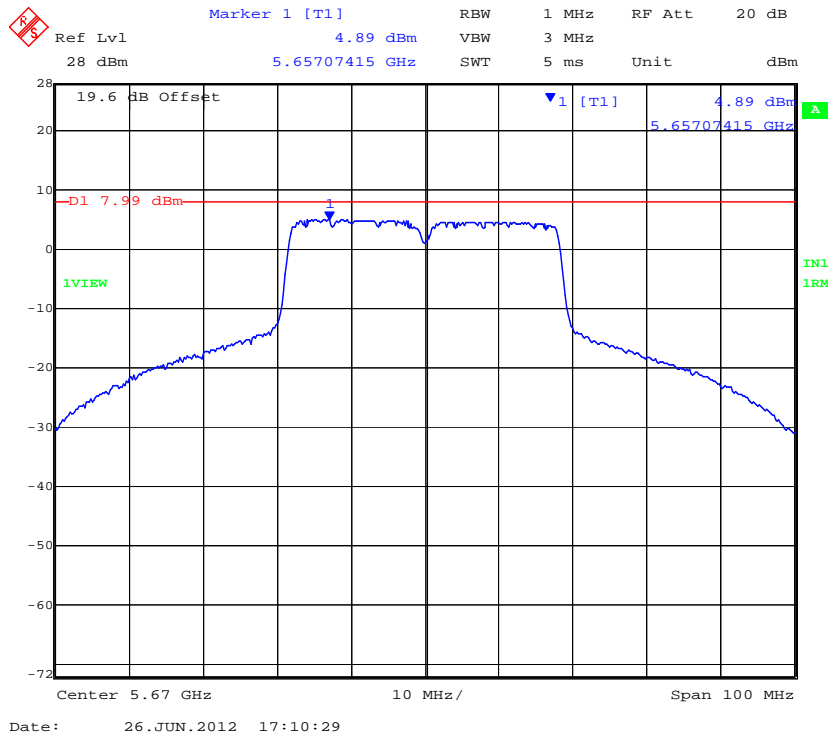

This test report may be reproduced in full only. The document may only be updated by MiCOM Labs personnel. Any changes will be noted in the Document History section of the report.



**Title:** Aruba AP-175 802.11a/b/g/n Wireless AP  
**To:** FCC 47 CFR Part 15.407 & IC RSS-210  
**Serial #:** ARUB111-U1 Rev B  
**Issue Date:** 12th August 2013  
**Page:** 75 of 185

## Specification

### FCC, Part 15 §15.407 (a)(1), (a)(2)

#### 5150 – 5250 MHz

(a)(1) The peak power spectral density shall not exceed +4 dBm in any 1 megahertz band.

#### 5250 – 5350 MHz & 5470 – 5725 MHz

(a)(2) The peak power spectral density shall not exceed +11 dBm in any 1 megahertz band.

### Industry Canada RSS-210 § A9.2(1), A9.2(2)

#### 5150 – 5250 MHz

§ A9.2(1) The eirp spectral density shall not exceed +10 dBm in any 1 MHz band

#### 5250 – 5350 MHz & 5470 – 5725 MHz

§ A9.2(2) The power spectral density shall not exceed +11 dBm in any 1 MHz band

## Laboratory Measurement Uncertainty for Spectral Density

|                         |          |
|-------------------------|----------|
| Measurement uncertainty | ±1.33 dB |
|-------------------------|----------|

## Traceability

| Method  | Test Equipment Used                            |
|---|--|
| Measurements were made per work instruction WI-01 'Measuring RF Output Power' | 0158, 0287, 0252, 0313, 0314, 0070, 0116, 0117 |

This test report may be reproduced in full only. The document may only be updated by MiCOM Labs personnel. Any changes will be noted in the Document History section of the report.

#### 5.1.4. Peak Excursion Ratio

##### FCC, Part 15 Subpart C §15.407(a)(6)

##### Test Procedure

Normative Reference (xi) Section 2.1 Measurement Procedure DA 02-2138 “Measurement Procedure Updated for Peak Transmit Power in the UNII Bands” was implemented to determine the Peak Excursion Ratio. This is a conducted measurement using a spectrum analyzer. The Peak Excursion Ratio is the difference in amplitude (dB) between the two traces.

##### Test Measurement Set up

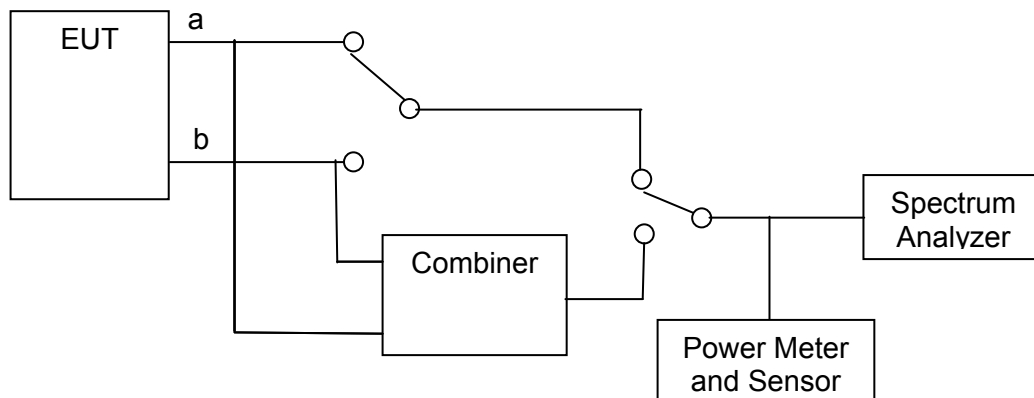

Measurement set up for Peak Excursion Ratio

##### Measurement Results for Peak Excursion Ratio

Ambient conditions.

Temperature: 17 to 23 °C Relative humidity: 31 to 57% Pressure: 999 to 1012 mbar

Radio Parameters

Duty Cycle: 100%

Output: Modulated Carrier

Power: Maximum Default Power



**TABLE OF RESULTS – 802.11a Legacy (5250 – 5350 MHz)**

|                               |            |                            |       |    |      |
|-------------------------------|------------|----------------------------|-------|----|------|
| <b>Test Conditions:</b>       | 15.407 (a) | <b>Rel. Humidity (%):</b>  | 35    | to | 42   |
| <b>Variant:</b>               | 802.11a    | <b>Ambient Temp. (°C):</b> | 19    | to | 22   |
| <b>TPC:</b>                   | HIGH       | <b>Pressure (mBars):</b>   | 998   | to | 1003 |
| <b>Modulation:</b>            | ON         | <b>Duty Cycle (%):</b>     | 100   |    |      |
| <b>Beam Forming Gain (Y):</b> | N/A dB     | <b>Antenna Gain:</b>       | 6 dBi |    |      |
| <b>Applied Voltage:</b>       | 12.0 Vdc   |                            |       |    |      |
| <b>Notes 1:</b>               |            |                            |       |    |      |
| <b>Notes 2:</b>               |            |                            |       |    |      |

| Test Frequency | Trace Δ Marker |        |        |        | Limit  | Margin |
|----------------|----------------|--------|--------|--------|--------|--------|
|                | Port A         | Port B | Port C | Port D |        |        |
| MHz            | dB             | dB     | dB     | dB     | dB     | dB     |
| 5260           | -10.48         | -8.63  | --     | --     | -13.00 | -2.52  |
| 5300           | -10.34         | -9.04  | --     | --     |        | -2.67  |
| 5320           | -10.55         | -9.40  | --     | --     |        | -2.45  |

|                                 |          |
|---------------------------------|----------|
| <b>Measurement uncertainty:</b> | ±1.33 dB |
|---------------------------------|----------|

This test report may be reproduced in full only. The document may only be updated by MiCOM Labs personnel. Any changes will be noted in the Document History section of the report.



### CHAIN A 5,260 MHz 802.11a Legacy - Peak Excursion Ratio

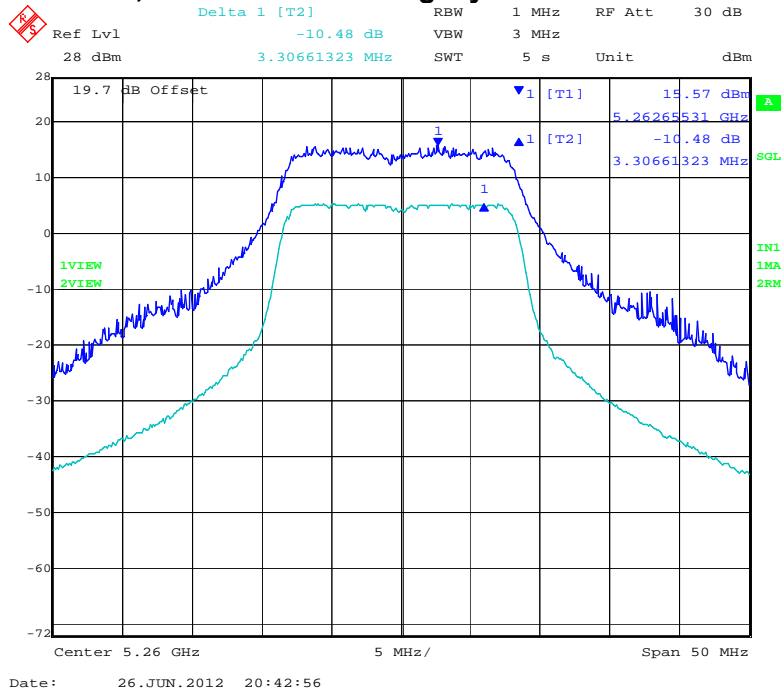

### CHAIN B 5,260 MHz 802.11a Legacy - Peak Excursion Ratio

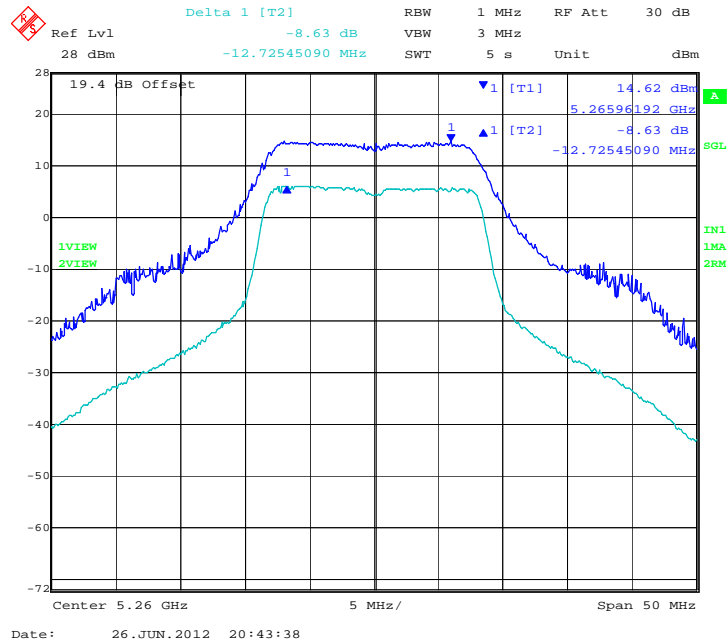

This test report may be reproduced in full only. The document may only be updated by MiCOM Labs personnel. Any changes will be noted in the Document History section of the report.



### CHAIN A 5,300 MHz 802.11a Legacy - Peak Excursion Ratio

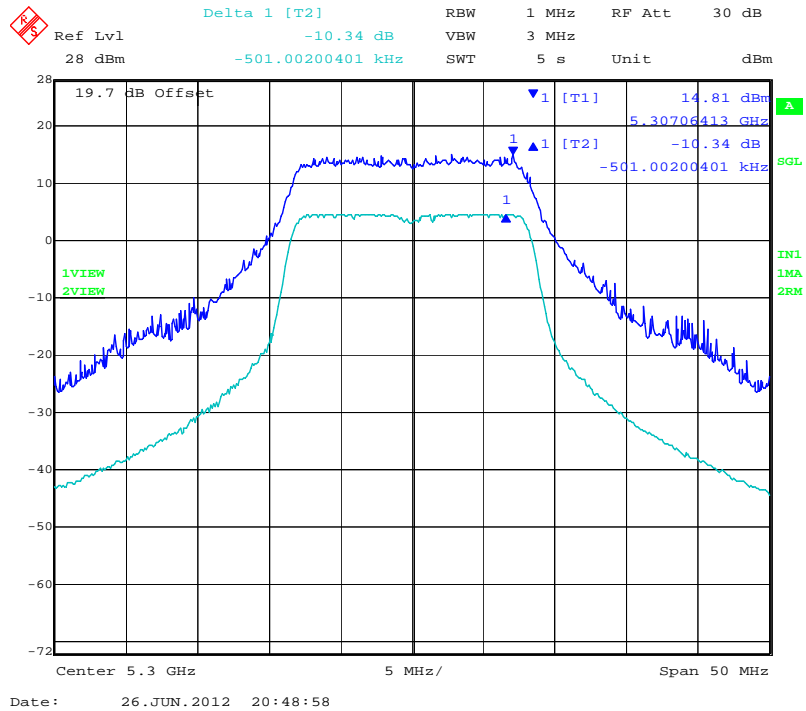

### CHAIN B 5,300 MHz 802.11a Legacy - Peak Excursion Ratio

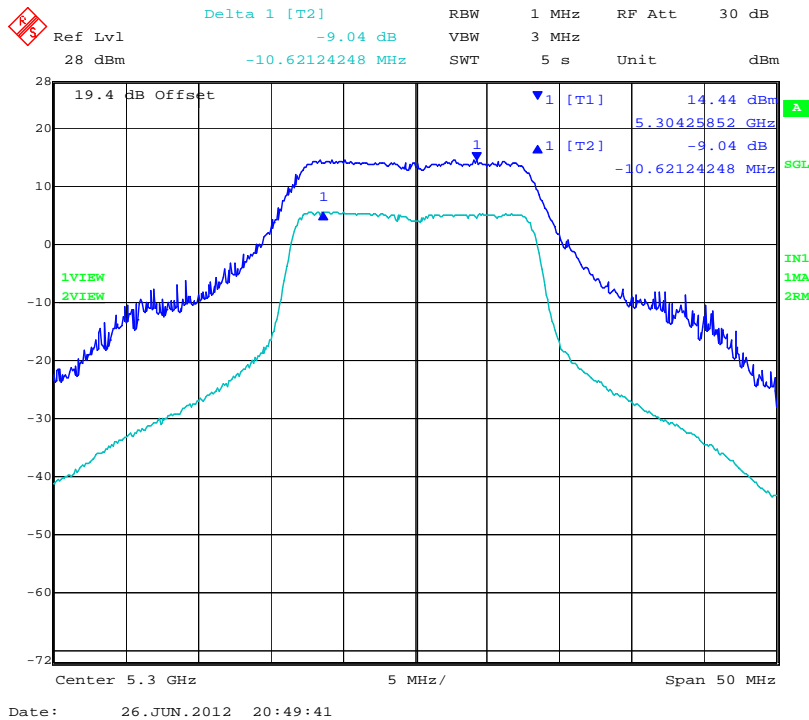

This test report may be reproduced in full only. The document may only be updated by MiCOM Labs personnel. Any changes will be noted in the Document History section of the report.



### CHAIN A 5,320 MHz 802.11a Legacy - Peak Excursion Ratio

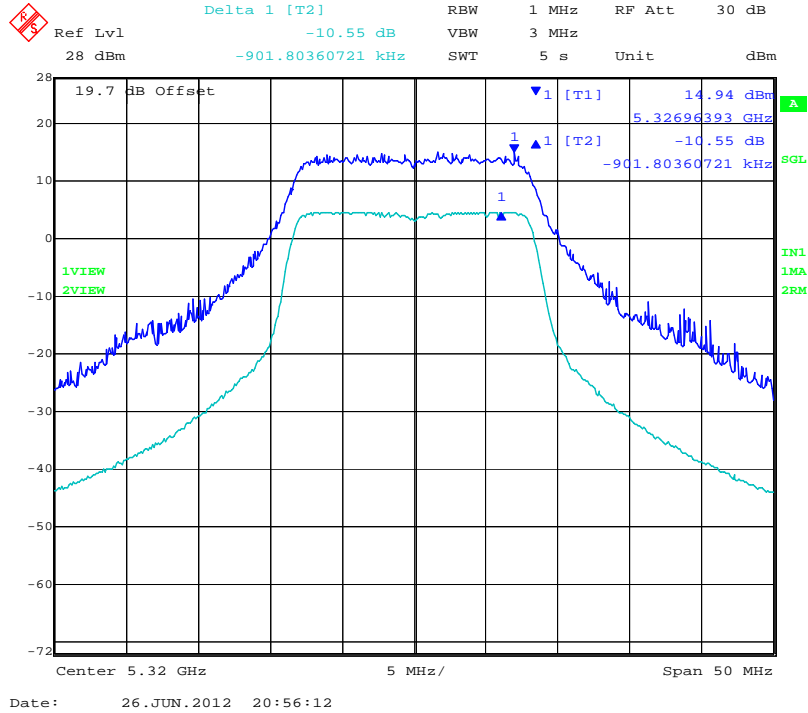

### CHAIN B 5,320 MHz 802.11a Legacy - Peak Excursion Ratio

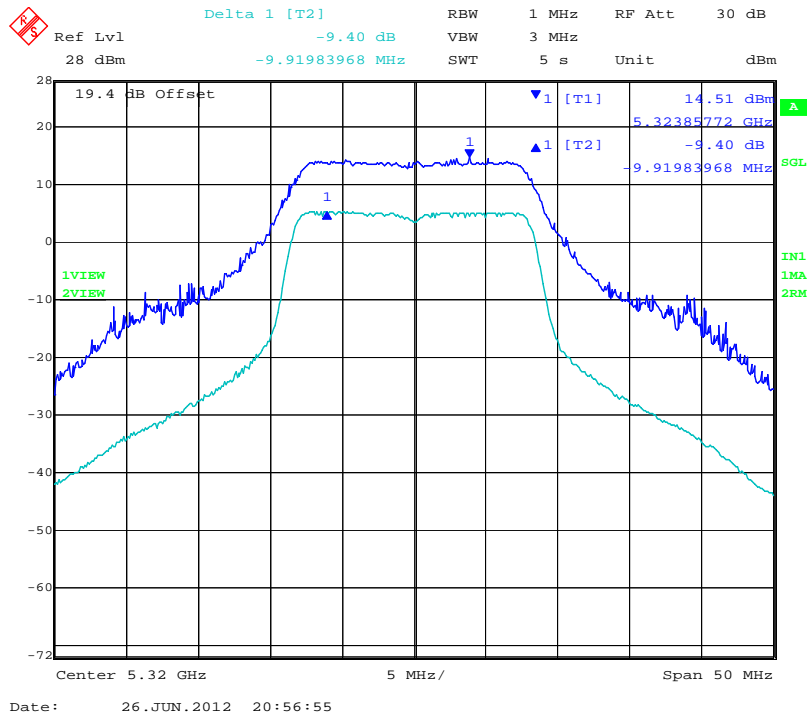

This test report may be reproduced in full only. The document may only be updated by MiCOM Labs personnel. Any changes will be noted in the Document History section of the report.





**Title:** Aruba AP-175 802.11a/b/g/n Wireless AP  
**To:** FCC 47 CFR Part 15.407 & IC RSS-210  
**Serial #:** ARUB111-U1 Rev B  
**Issue Date:** 12th August 2013  
**Page:** 81 of 185

**TABLE OF RESULTS – 802.11a Legacy (5470 – 5725 MHz)**

|                               |            |                            |       |    |      |
|-------------------------------|------------|----------------------------|-------|----|------|
| <b>Test Conditions:</b>       | 15.407 (a) | <b>Rel. Humidity (%):</b>  | 35    | to | 42   |
| <b>Variant:</b>               | 802.11a    | <b>Ambient Temp. (°C):</b> | 19    | to | 22   |
| <b>TPC:</b>                   | HIGH       | <b>Pressure (mBars):</b>   | 998   | to | 1003 |
| <b>Modulation:</b>            | ON         | <b>Duty Cycle (%):</b>     | 100   |    |      |
| <b>Beam Forming Gain (Y):</b> | N/A dB     | <b>Antenna Gain:</b>       | 6 dBi |    |      |
| <b>Applied Voltage:</b>       | 12.0 Vdc   |                            |       |    |      |
| <b>Notes 1:</b>               |            |                            |       |    |      |
| <b>Notes 2:</b>               |            |                            |       |    |      |

| Test Frequency | Trace Δ Marker |        |        |        | Limit  | Margin |
|----------------|----------------|--------|--------|--------|--------|--------|
|                | Port A         | Port B | Port C | Port D |        |        |
| MHz            | dB             | dB     | dB     | dB     | dB     | dB     |
| 5500           | -10.24         | -9.07  | --     | --     | -13.00 | -2.76  |
| 5580           | -10.26         | -9.06  | --     | --     |        | -2.74  |
| 5700           | -10.70         | -9.18  | --     | --     |        | -2.30  |

|                                 |          |
|---------------------------------|----------|
| <b>Measurement uncertainty:</b> | ±1.33 dB |
|---------------------------------|----------|

This test report may be reproduced in full only. The document may only be updated by MiCOM Labs personnel. Any changes will be noted in the Document History section of the report.



### CHAIN A 5,500 MHz 802.11a Legacy - Peak Excursion Ratio

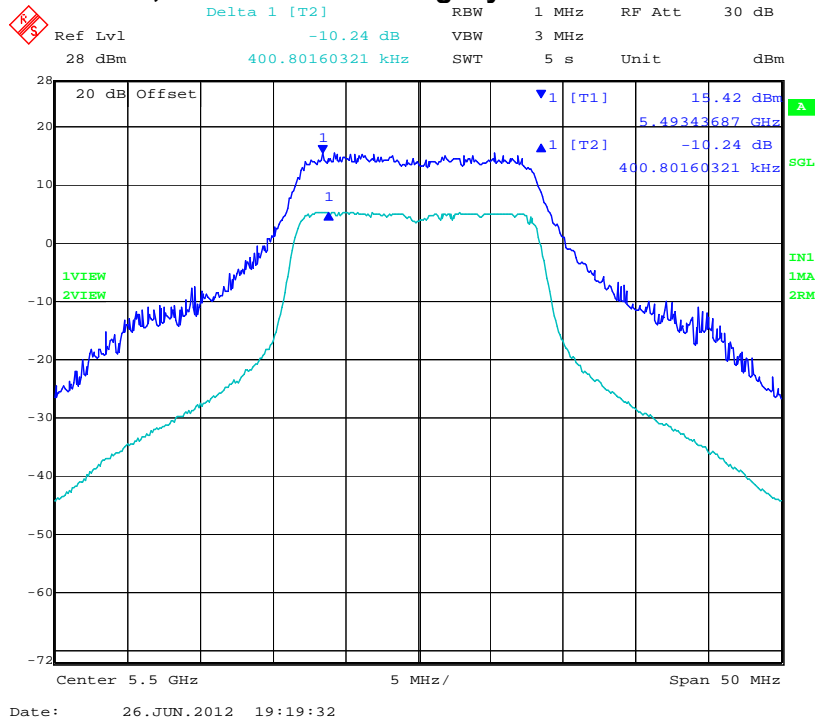

### CHAIN B 5,500 MHz 802.11a Legacy - Peak Excursion Ratio

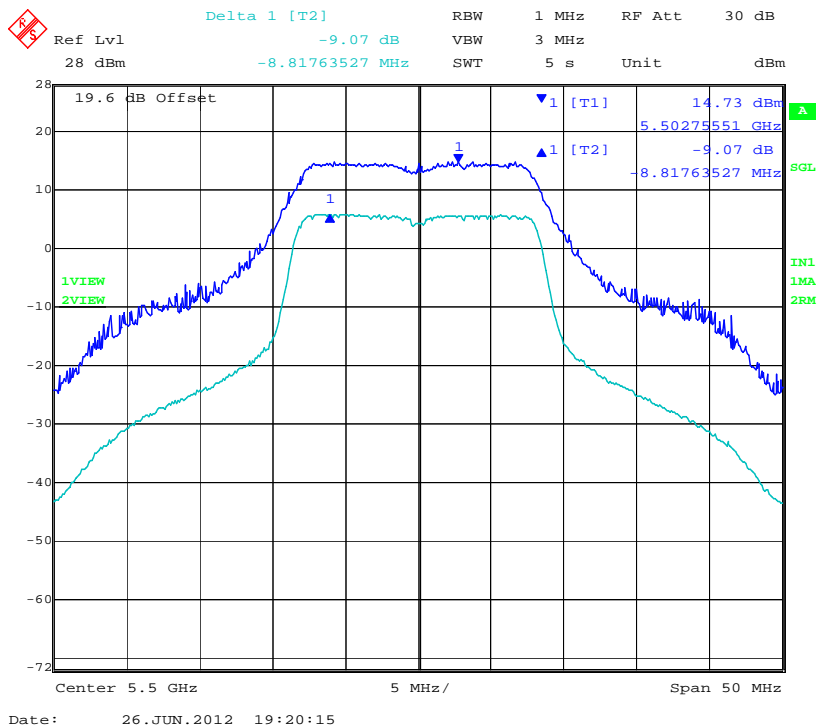

This test report may be reproduced in full only. The document may only be updated by MiCOM Labs personnel. Any changes will be noted in the Document History section of the report.



### CHAIN A 5,580 MHz 802.11a Legacy - Peak Excursion Ratio

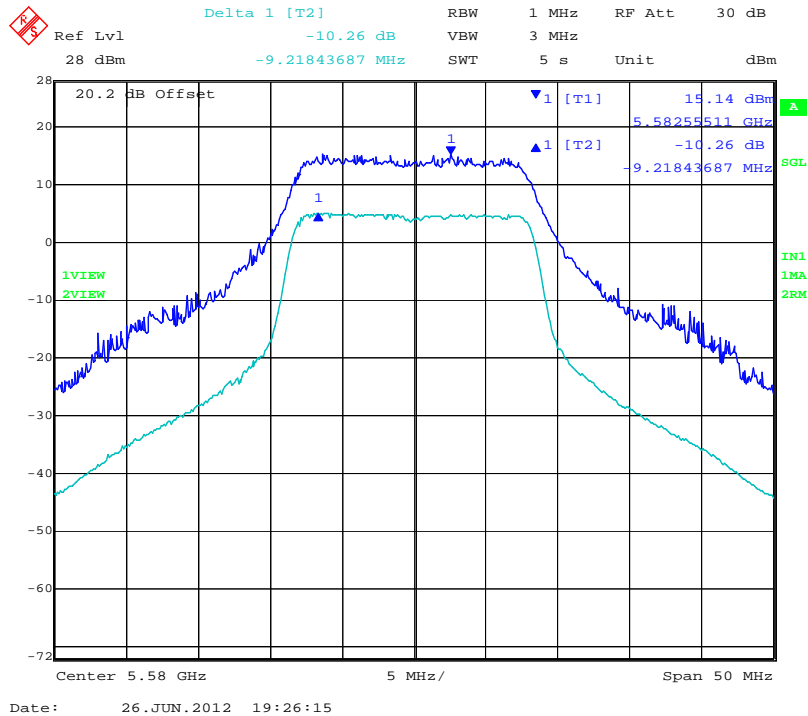

### CHAIN B 5,580 MHz 802.11a Legacy - Peak Excursion Ratio

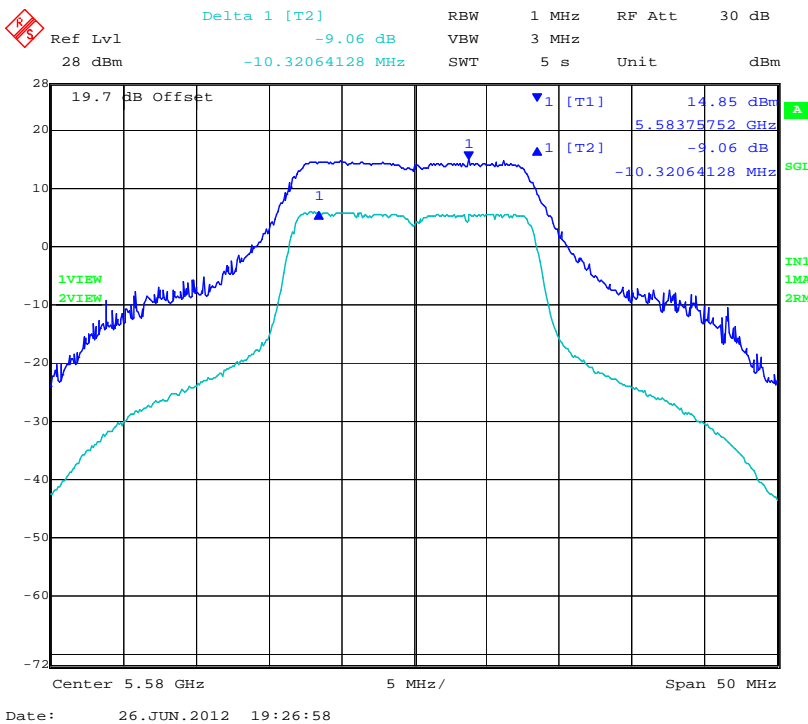

This test report may be reproduced in full only. The document may only be updated by MiCOM Labs personnel. Any changes will be noted in the Document History section of the report.



### CHAIN A 5,700 MHz 802.11a Legacy - Peak Excursion Ratio

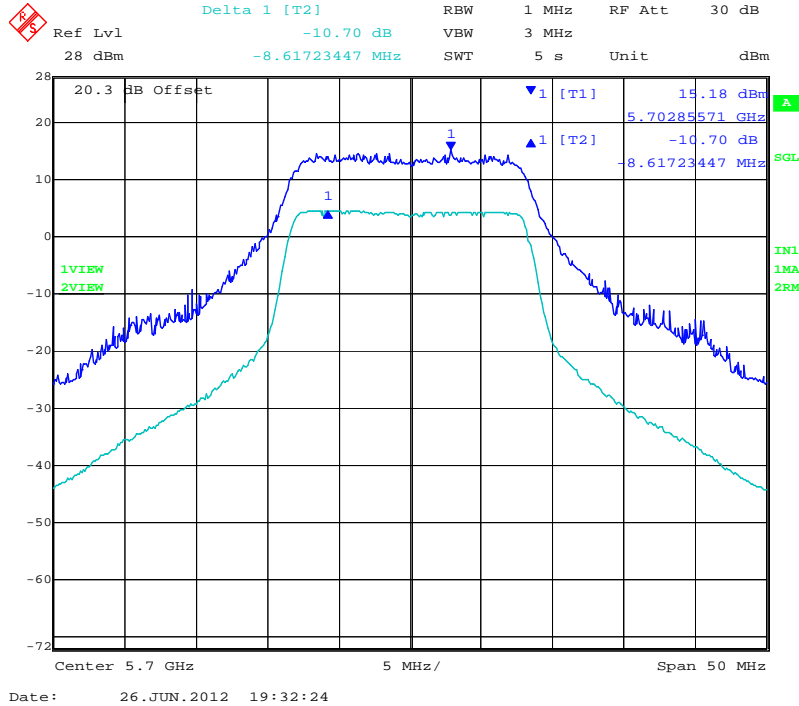

### CHAIN B 5,700 MHz 802.11a Legacy - Peak Excursion Ratio

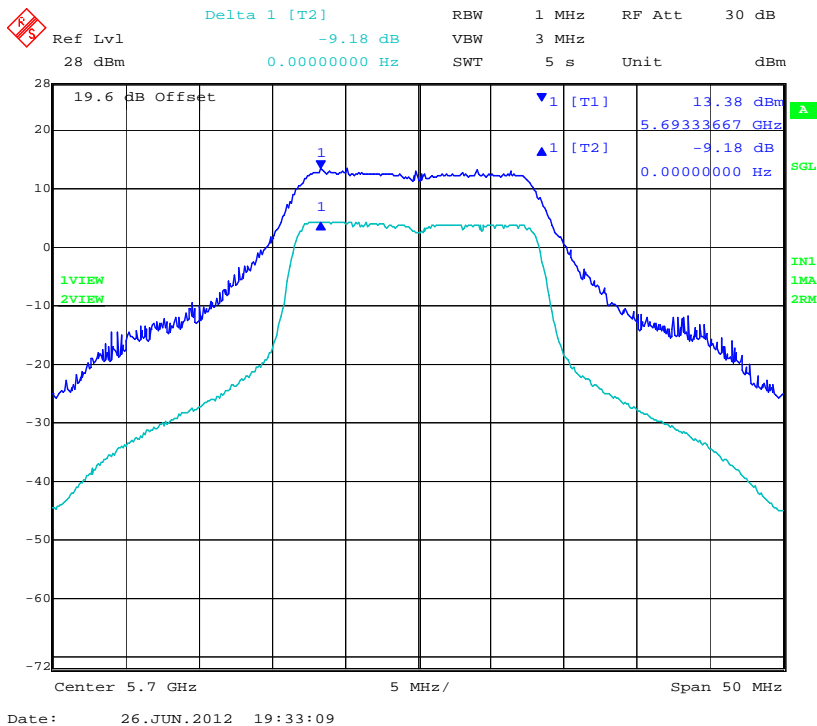

This test report may be reproduced in full only. The document may only be updated by MiCOM Labs personnel. Any changes will be noted in the Document History section of the report.



**TABLE OF RESULTS – 802. 11n HT-20 (5250 – 5350 MHz)**

|                               |               |                            |       |    |      |
|-------------------------------|---------------|----------------------------|-------|----|------|
| <b>Test Conditions:</b>       | 15.407 (a)    | <b>Rel. Humidity (%):</b>  | 35    | to | 42   |
| <b>Variant:</b>               | 802.11n HT-20 | <b>Ambient Temp. (°C):</b> | 19    | to | 22   |
| <b>TPC:</b>                   | HIGH          | <b>Pressure (mBars):</b>   | 998   | to | 1003 |
| <b>Modulation:</b>            | ON            | <b>Duty Cycle (%):</b>     | 100   |    |      |
| <b>Beam Forming Gain (Y):</b> | N/A dB        | <b>Antenna Gain:</b>       | 6 dBi |    |      |
| <b>Applied Voltage:</b>       | 12.0 Vdc      |                            |       |    |      |
| <b>Notes 1:</b>               |               |                            |       |    |      |
| <b>Notes 2:</b>               |               |                            |       |    |      |

| Test Frequency | Trace Δ Marker |        |        |        | Limit  | Margin |
|----------------|----------------|--------|--------|--------|--------|--------|
|                | Port A         | Port B | Port C | Port D |        |        |
| MHz            | dB             | dB     | dB     | dB     | dB     | dB     |
| 5260           | -10.09         | -8.88  | --     | --     | -13.00 | -2.91  |
| 5300           | -10.36         | -8.95  | --     | --     |        | -2.64  |
| 5320           | -9.71          | -9.61  | --     | --     |        | -3.29  |

|                                 |          |
|---------------------------------|----------|
| <b>Measurement uncertainty:</b> | ±1.33 dB |
|---------------------------------|----------|

This test report may be reproduced in full only. The document may only be updated by MiCOM Labs personnel. Any changes will be noted in the Document History section of the report.



### CHAIN A 5,260 MHz 802.11n HT-20 - Peak Excursion Ratio

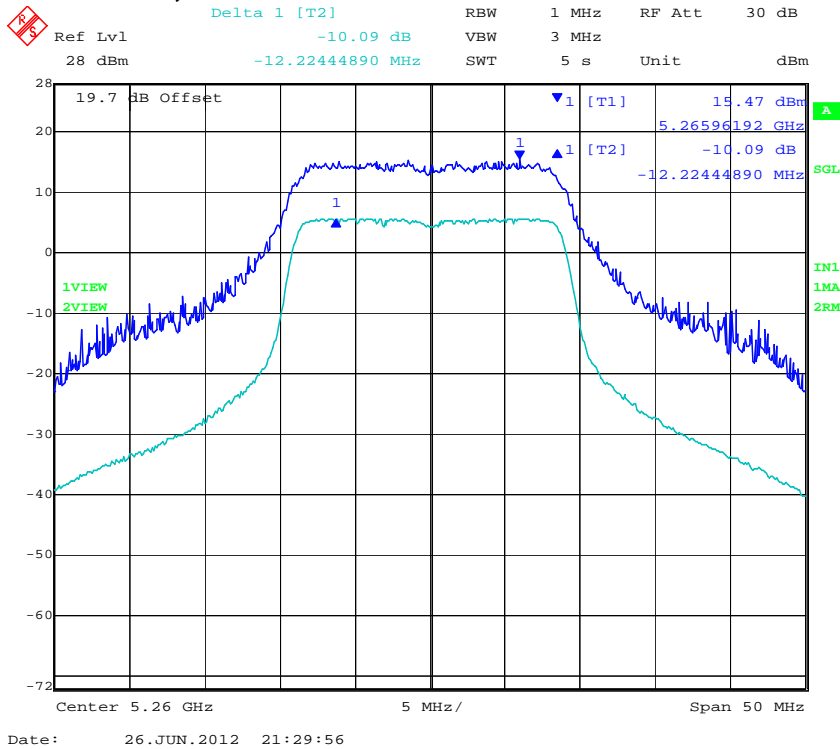

### CHAIN B 5,260 MHz 802.11n HT-20 - Peak Excursion Ratio

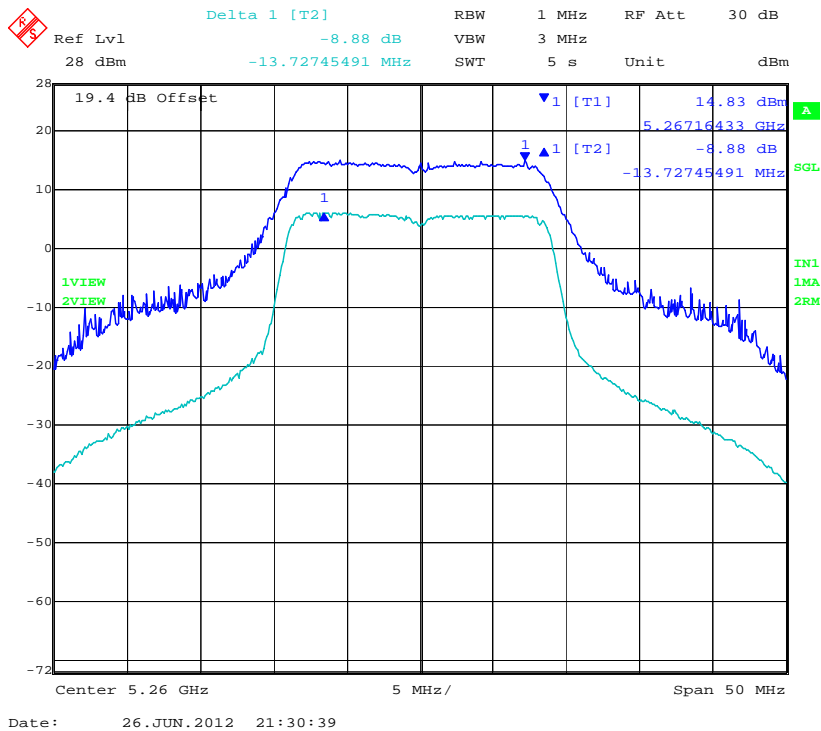

This test report may be reproduced in full only. The document may only be updated by MiCOM Labs personnel. Any changes will be noted in the Document History section of the report.



### CHAIN A 5,300 MHz 802.11n HT-20 - Peak Excursion Ratio

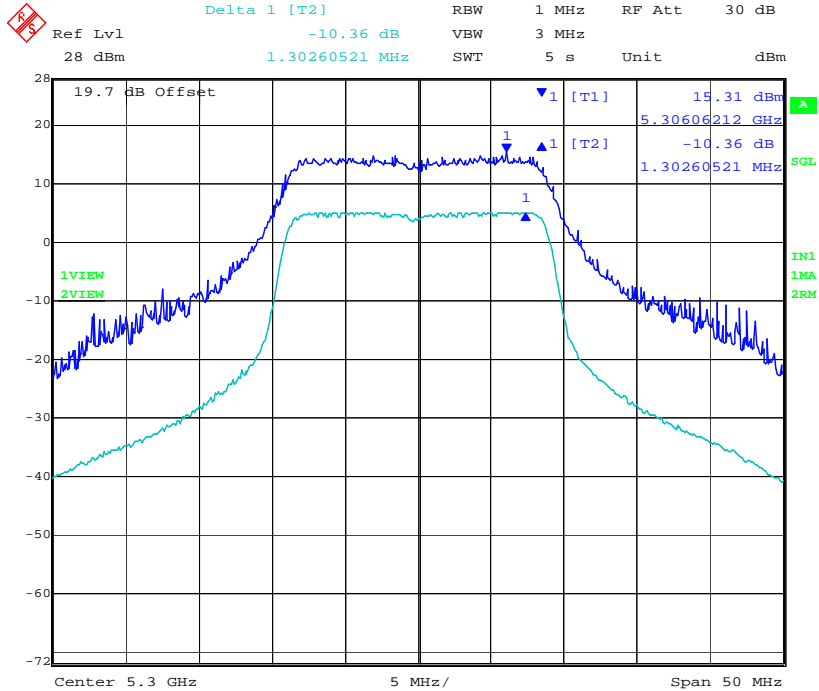

Date: 26.JUN.2012 21:35:56

### CHAIN B 5,300 MHz 802.11n HT-20 - Peak Excursion Ratio

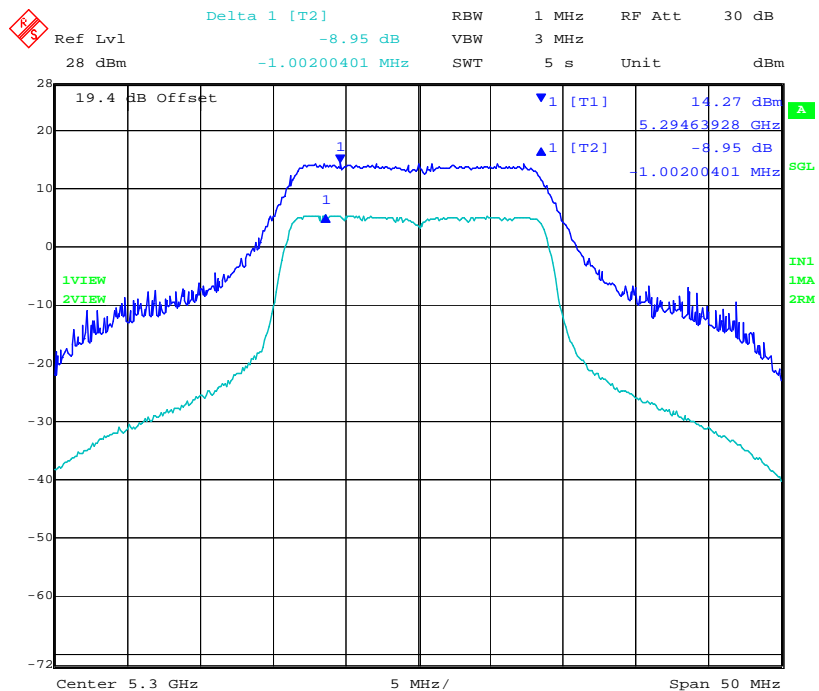

Date: 26.JUN.2012 21:36:38

This test report may be reproduced in full only. The document may only be updated by MiCOM Labs personnel. Any changes will be noted in the Document History section of the report.



### CHAIN A 5,320 MHz 802.11n HT-20 - Peak Excursion Ratio

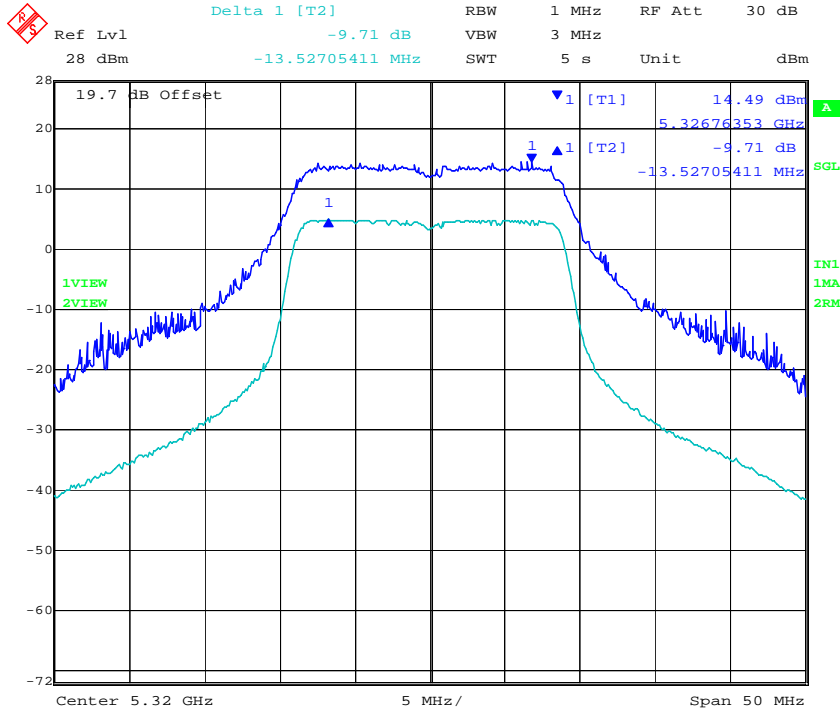

Date: 26.JUN.2012 21:42:09

### CHAIN B 5,320 MHz 802.11n HT-20 - Peak Excursion Ratio

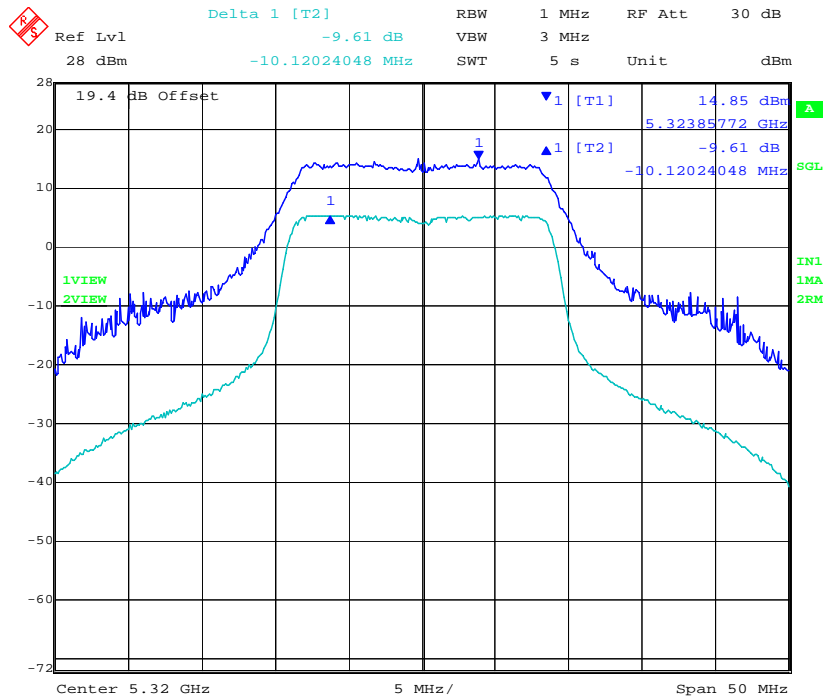

Date: 26.JUN.2012 21:42:52

This test report may be reproduced in full only. The document may only be updated by MiCOM Labs personnel. Any changes will be noted in the Document History section of the report.





**Title:** Aruba AP-175 802.11a/b/g/n Wireless AP  
**To:** FCC 47 CFR Part 15.407 & IC RSS-210  
**Serial #:** ARUB111-U1 Rev B  
**Issue Date:** 12th August 2013  
**Page:** 89 of 185

**TABLE OF RESULTS – 802.11n HT-20 (5470 – 5725 MHz)**

|                               |               |                            |       |    |      |
|-------------------------------|---------------|----------------------------|-------|----|------|
| <b>Test Conditions:</b>       | 15.407 (a)    | <b>Rel. Humidity (%):</b>  | 35    | to | 42   |
| <b>Variant:</b>               | 802.11n HT-20 | <b>Ambient Temp. (°C):</b> | 19    | to | 22   |
| <b>TPC:</b>                   | HIGH          | <b>Pressure (mBars):</b>   | 998   | to | 1003 |
| <b>Modulation:</b>            | ON            | <b>Duty Cycle (%):</b>     | 100   |    |      |
| <b>Beam Forming Gain (Y):</b> | N/A dB        | <b>Antenna Gain:</b>       | 6 dBi |    |      |
| <b>Applied Voltage:</b>       | 12.0 Vdc      |                            |       |    |      |
| <b>Notes 1:</b>               |               |                            |       |    |      |
| <b>Notes 2:</b>               |               |                            |       |    |      |

| Test Frequency | Trace Δ Marker |        |        |        | Limit  | Margin |
|----------------|----------------|--------|--------|--------|--------|--------|
|                | Port A         | Port B | Port C | Port D |        |        |
| MHz            | dB             | dB     | dB     | dB     | dB     | dB     |
| 5500           | -9.58          | -9.54  | --     | --     | -13.00 | -3.42  |
| 5580           | -9.77          | -9.23  | --     | --     |        | -3.23  |
| 5700           | -9.76          | -9.22  | --     | --     |        | -3.24  |

|                                 |          |
|---------------------------------|----------|
| <b>Measurement uncertainty:</b> | ±1.33 dB |
|---------------------------------|----------|

This test report may be reproduced in full only. The document may only be updated by MiCOM Labs personnel. Any changes will be noted in the Document History section of the report.



### CHAIN A 5,500 MHz 802.11n HT-20 - Peak Excursion Ratio

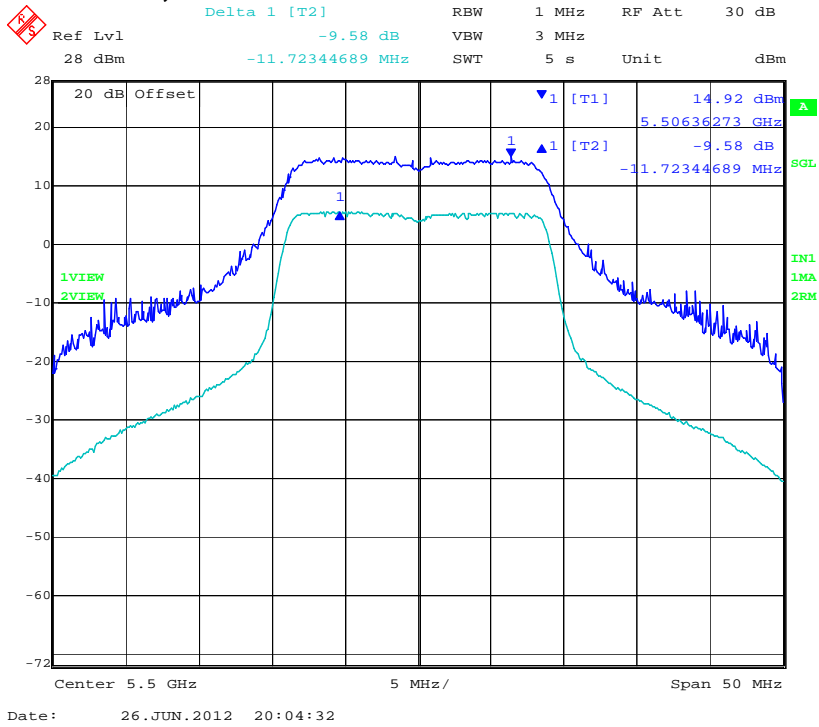

### CHAIN B 5,500 MHz 802.11n HT-20 - Peak Excursion Ratio

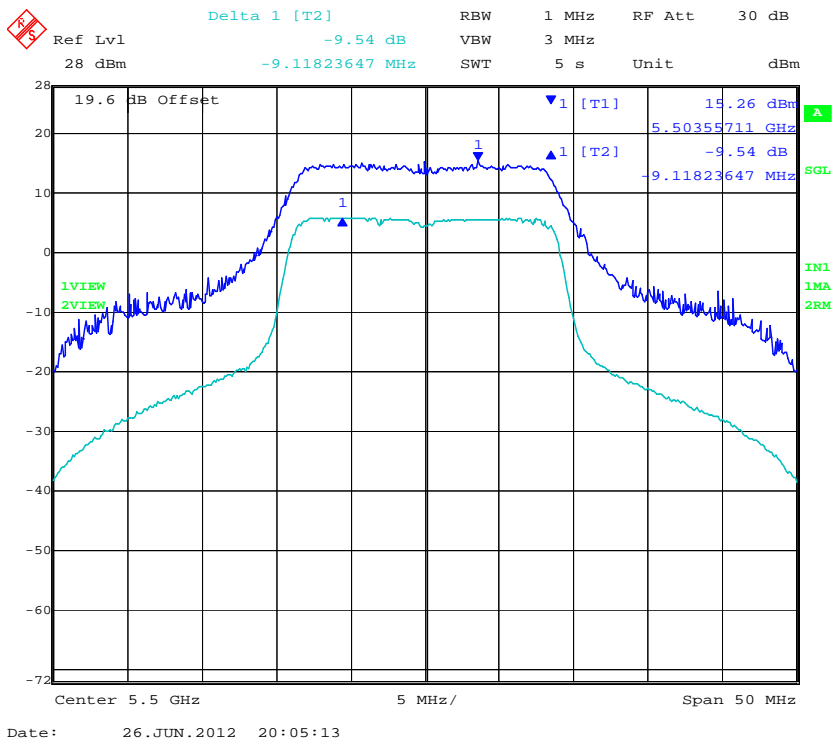

This test report may be reproduced in full only. The document may only be updated by MiCOM Labs personnel. Any changes will be noted in the Document History section of the report.



### CHAIN A 5,580 MHz 802.11n HT-20 - Peak Excursion Ratio

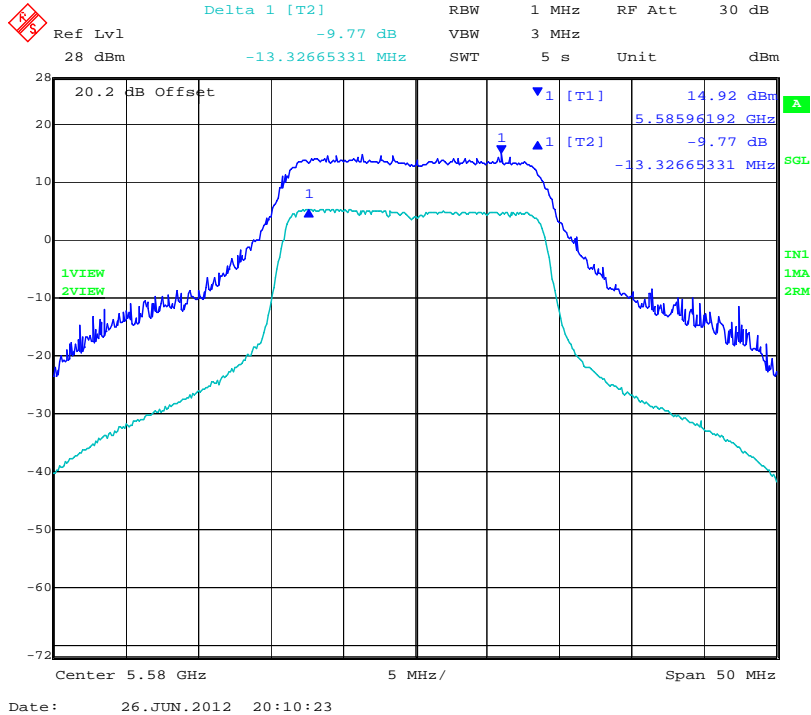

### CHAIN B 5,580 MHz 802.11n HT-20 - Peak Excursion Ratio

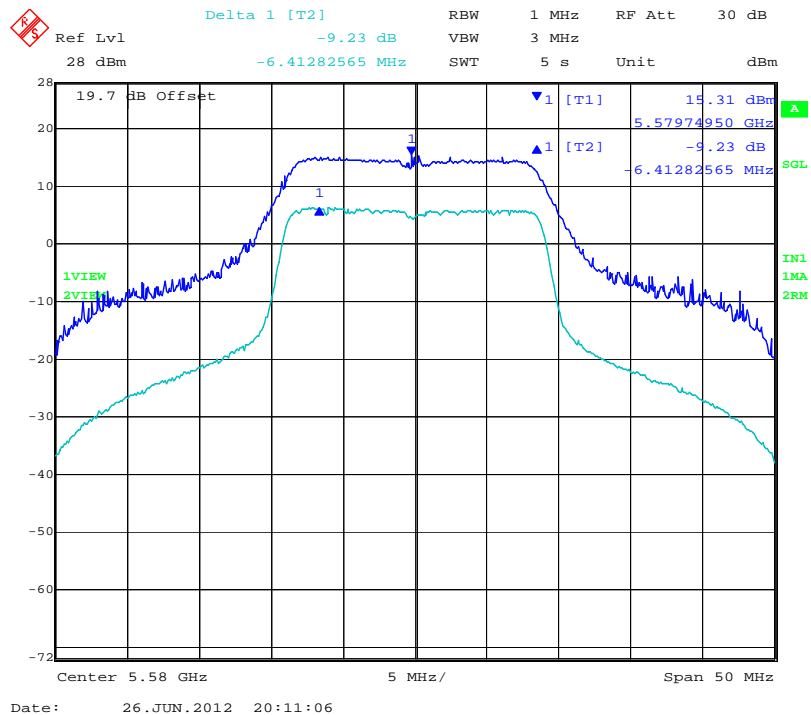

This test report may be reproduced in full only. The document may only be updated by MiCOM Labs personnel. Any changes will be noted in the Document History section of the report.



### CHAIN A 5,700 MHz 802.11n HT-20 - Peak Excursion Ratio

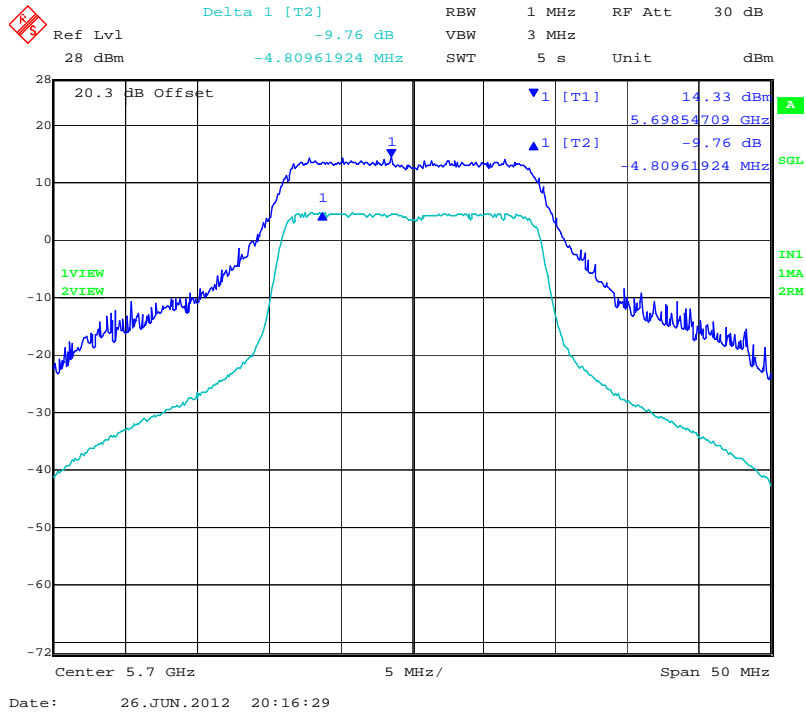

### CHAIN B 5,700 MHz 802.11n HT-20 - Peak Excursion Ratio

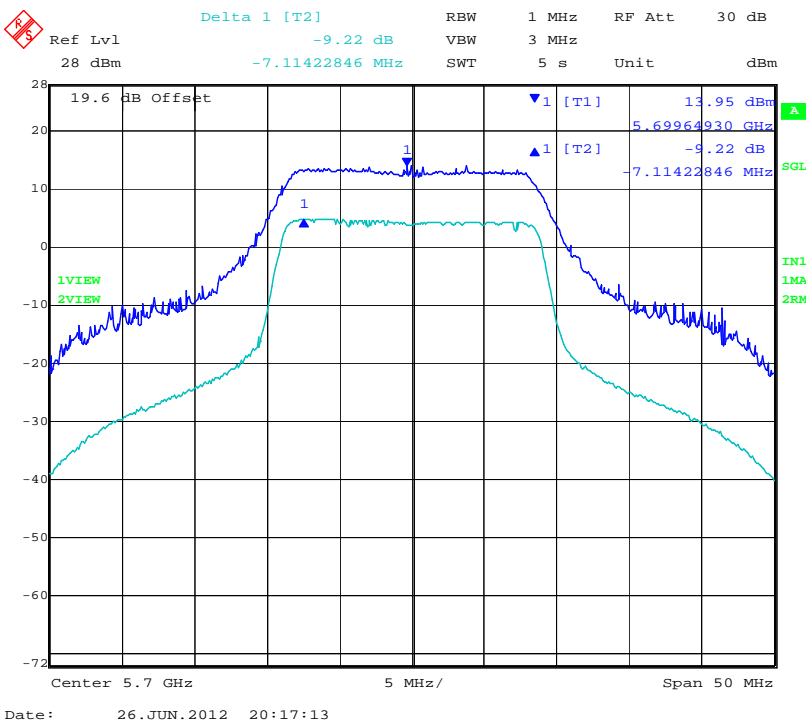

This test report may be reproduced in full only. The document may only be updated by MiCOM Labs personnel. Any changes will be noted in the Document History section of the report.



**Title:** Aruba AP-175 802.11a/b/g/n Wireless AP  
**To:** FCC 47 CFR Part 15.407 & IC RSS-210  
**Serial #:** ARUB111-U1 Rev B  
**Issue Date:** 12th August 2013  
**Page:** 93 of 185

**TABLE OF RESULTS – 802.11n HT-40 (5250 – 5350 MHz)**

|                               |               |                            |       |    |      |
|-------------------------------|---------------|----------------------------|-------|----|------|
| <b>Test Conditions:</b>       | 15.407 (a)    | <b>Rel. Humidity (%):</b>  | 35    | to | 42   |
| <b>Variant:</b>               | 802.11n HT-40 | <b>Ambient Temp. (°C):</b> | 19    | to | 22   |
| <b>TPC:</b>                   | HIGH          | <b>Pressure (mBars):</b>   | 998   | to | 1003 |
| <b>Modulation:</b>            | ON            | <b>Duty Cycle (%):</b>     | 100   |    |      |
| <b>Beam Forming Gain (Y):</b> | N/A dB        | <b>Antenna Gain:</b>       | 6 dBi |    |      |
| <b>Applied Voltage:</b>       | 12.0 Vdc      |                            |       |    |      |
| <b>Notes 1:</b>               |               |                            |       |    |      |
| <b>Notes 2:</b>               |               |                            |       |    |      |

| Test Frequency | Trace Δ Marker |        |        |        | Limit  | Margin |
|----------------|----------------|--------|--------|--------|--------|--------|
|                | Port A         | Port B | Port C | Port D |        |        |
| MHz            | dB             | dB     | dB     | dB     | dB     | dB     |
| 5270           | -9.78          | -9.36  | --     | --     | -13.00 | -3.22  |
| 5310           | -9.96          | -9.59  | --     | --     |        | -3.04  |

|                                 |          |
|---------------------------------|----------|
| <b>Measurement uncertainty:</b> | ±1.33 dB |
|---------------------------------|----------|

This test report may be reproduced in full only. The document may only be updated by MiCOM Labs personnel. Any changes will be noted in the Document History section of the report.



### CHAIN A 5,270 MHz 802.11n HT-40 - Peak Excursion Ratio

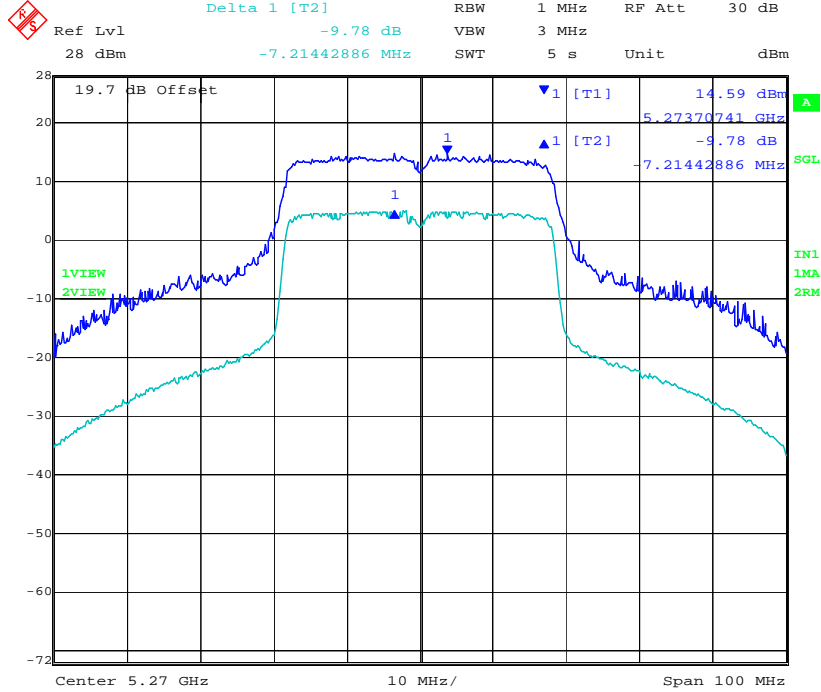

Date: 26.JUN.2012 22:04:27

### CHAIN B 5,270 MHz 802.11n HT-40 - Peak Excursion Ratio

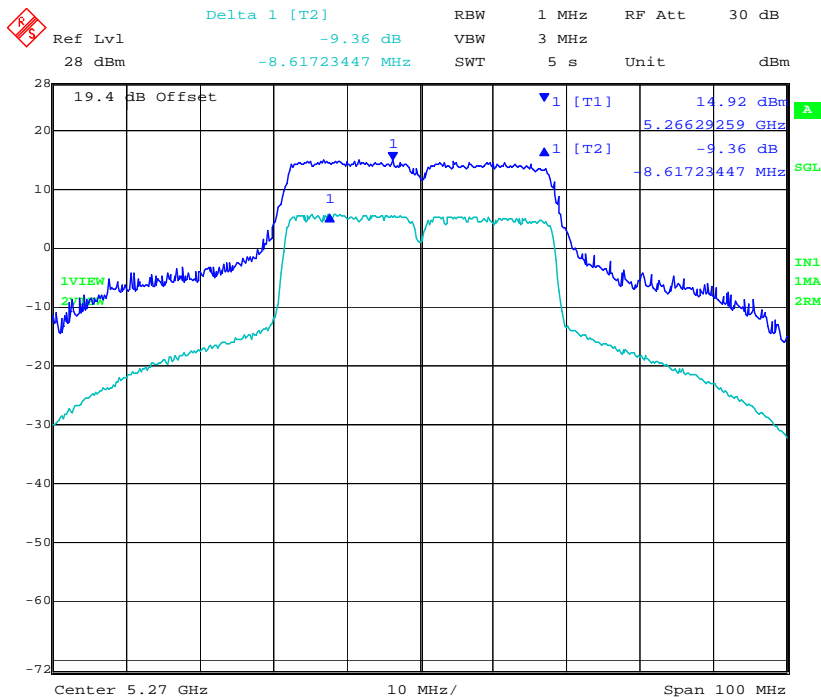

Date: 26.JUN.2012 22:08:51

This test report may be reproduced in full only. The document may only be updated by MiCOM Labs personnel. Any changes will be noted in the Document History section of the report.



### CHAIN A 5,310 MHz 802.11n HT-40 - Peak Excursion Ratio

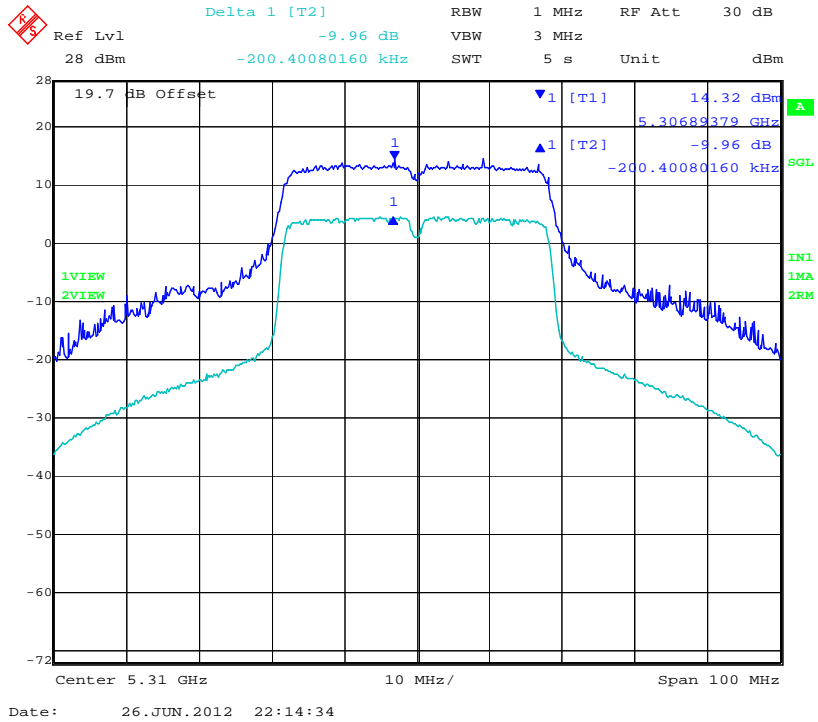

### CHAIN B 5,310 MHz 802.11n HT-40 - Peak Excursion Ratio

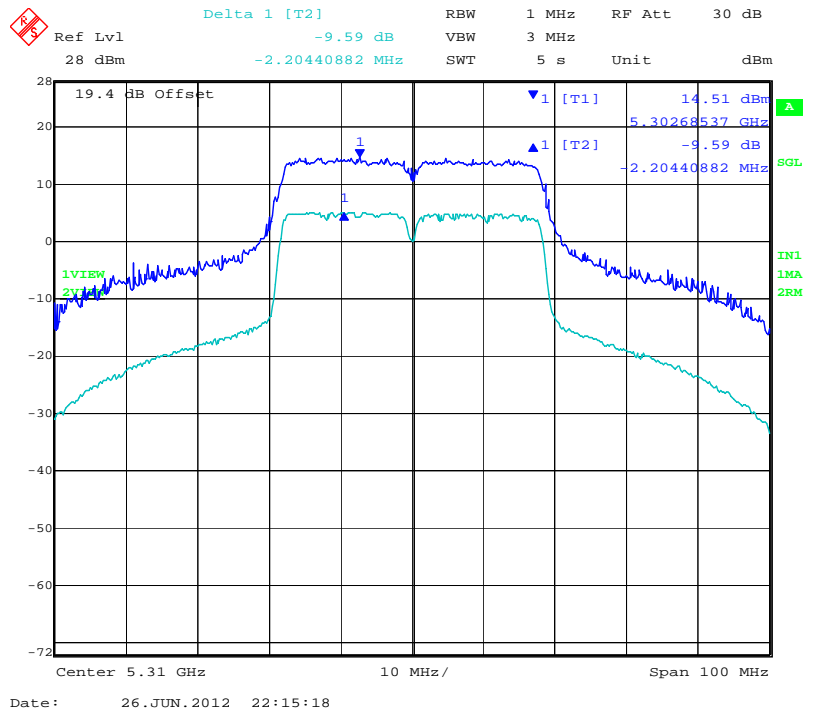

This test report may be reproduced in full only. The document may only be updated by MiCOM Labs personnel. Any changes will be noted in the Document History section of the report.



**TABLE OF RESULTS – 802.11n HT-40 (5470 – 5725 MHz)**

|                               |               |                            |       |    |      |
|-------------------------------|---------------|----------------------------|-------|----|------|
| <b>Test Conditions:</b>       | 15.407 (a)    | <b>Rel. Humidity (%):</b>  | 35    | to | 42   |
| <b>Variant:</b>               | 802.11n HT-40 | <b>Ambient Temp. (°C):</b> | 19    | to | 22   |
| <b>TPC:</b>                   | HIGH          | <b>Pressure (mBars):</b>   | 998   | to | 1003 |
| <b>Modulation:</b>            | ON            | <b>Duty Cycle (%):</b>     | 100   |    |      |
| <b>Beam Forming Gain (Y):</b> | N/A dB        | <b>Antenna Gain:</b>       | 6 dBi |    |      |
| <b>Applied Voltage:</b>       | 12.0 Vdc      |                            |       |    |      |
| <b>Notes 1:</b>               |               |                            |       |    |      |
| <b>Notes 2:</b>               |               |                            |       |    |      |

| Test Frequency | Trace Δ Marker |        |        |        | Limit  | Margin |
|----------------|----------------|--------|--------|--------|--------|--------|
|                | Port A         | Port B | Port C | Port D |        |        |
| MHz            | dB             | dB     | dB     | dB     | dB     | dB     |
| 5510           | -9.96          | -9.31  | --     | --     | -13.00 | -3.04  |
| 5550           | -9.94          | -9.68  | --     | --     |        | -3.06  |
| 5670           | -9.54          | -9.49  | --     | --     |        | -3.46  |

|                                 |          |
|---------------------------------|----------|
| <b>Measurement uncertainty:</b> | ±1.33 dB |
|---------------------------------|----------|

This test report may be reproduced in full only. The document may only be updated by MiCOM Labs personnel. Any changes will be noted in the Document History section of the report.





### CHAIN A 5,510 MHz 802.11n HT-40 - Peak Excursion Ratio

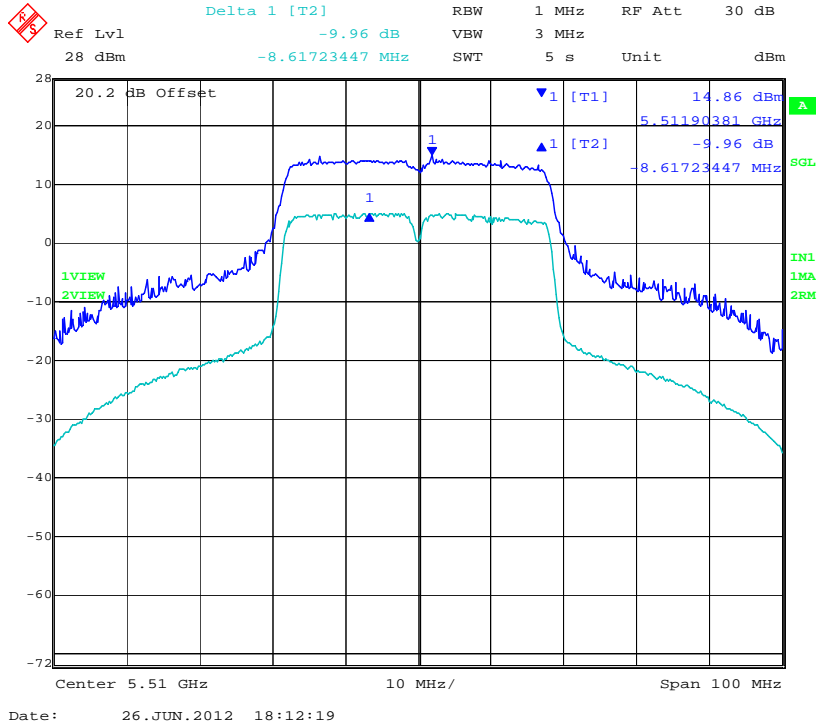

### CHAIN B 5,510 MHz 802.11n HT-40 - Peak Excursion Ratio

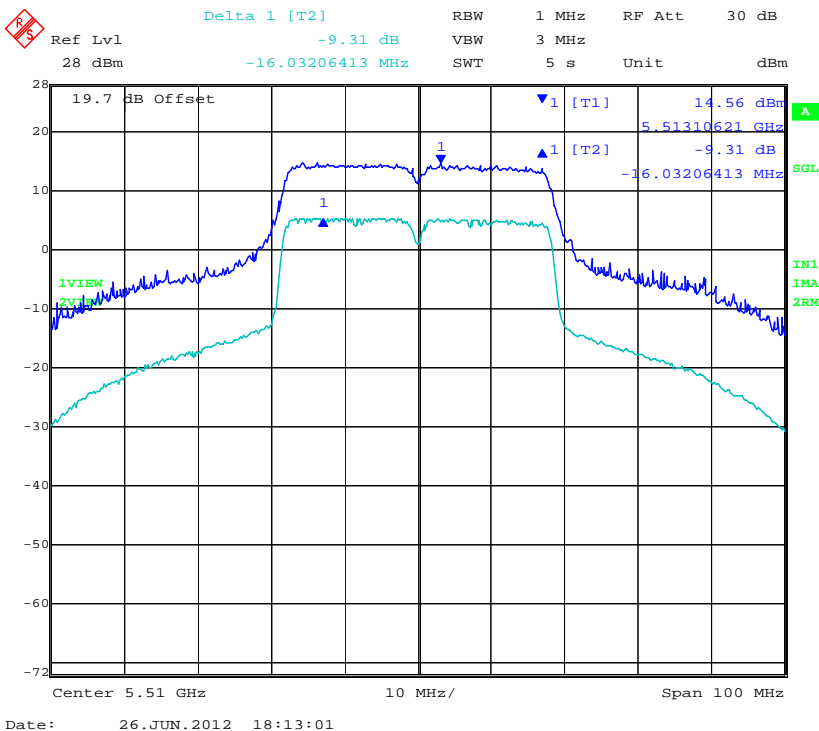

This test report may be reproduced in full only. The document may only be updated by MiCOM Labs personnel. Any changes will be noted in the Document History section of the report.



### CHAIN A 5,550 MHz 802.11n HT-40 - Peak Excursion Ratio

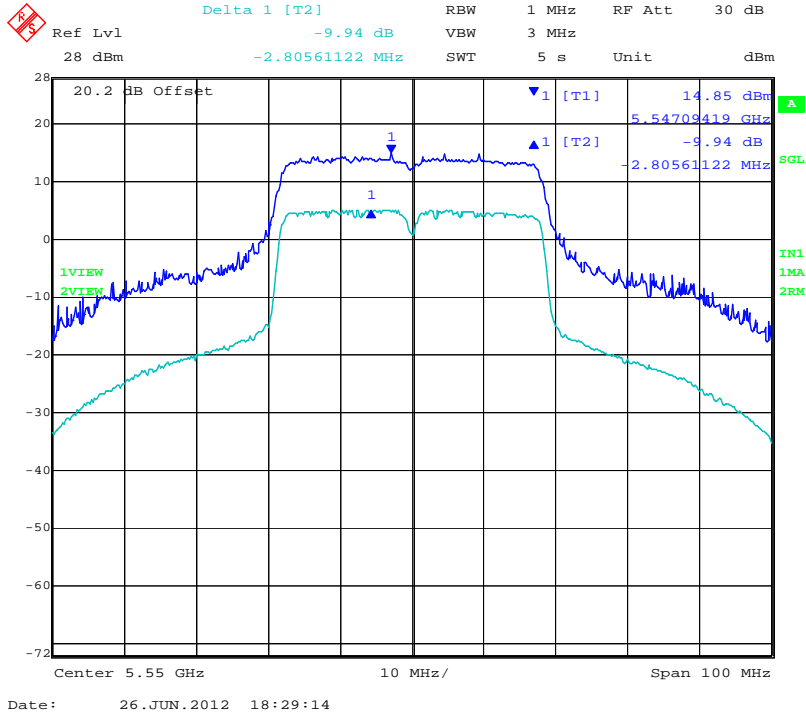

### CHAIN B 5,550 MHz 802.11n HT-40 - Peak Excursion Ratio

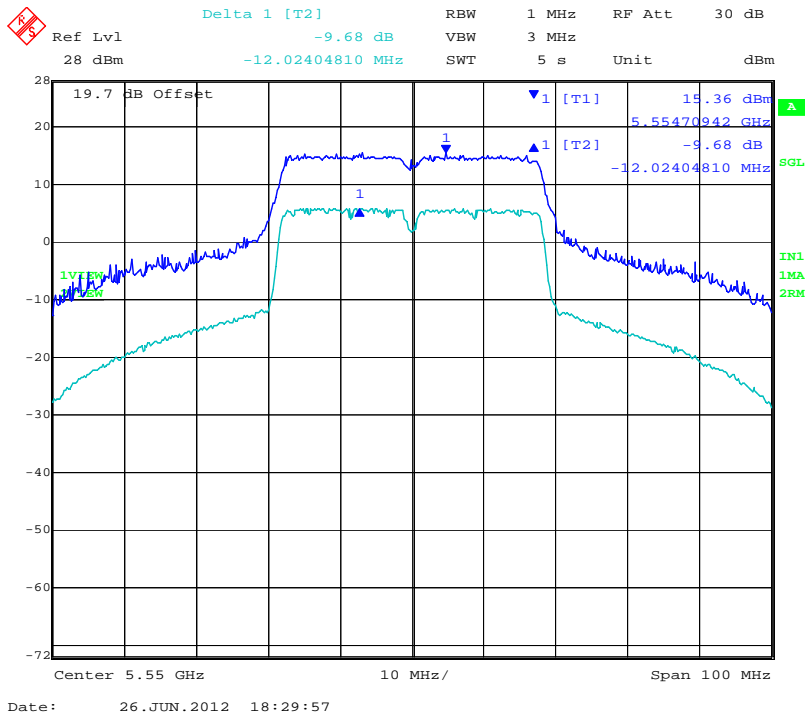

This test report may be reproduced in full only. The document may only be updated by MiCOM Labs personnel. Any changes will be noted in the Document History section of the report.



### CHAIN A 5,670 MHz 802.11n HT-40 - Peak Excursion Ratio

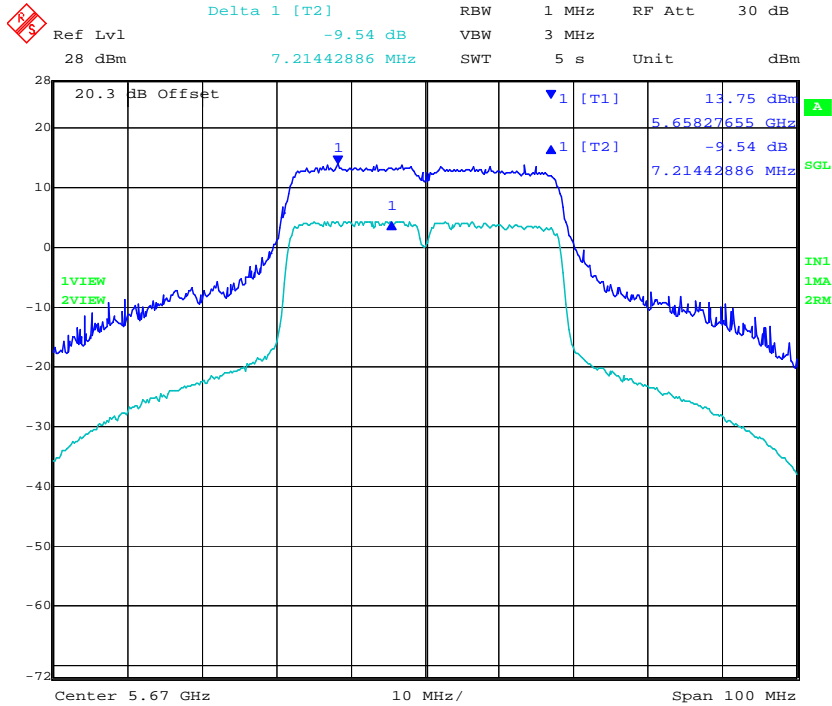

Date: 26.JUN.2012 18:33:32

### CHAIN B 5,670 MHz 802.11n HT-40 - Peak Excursion Ratio

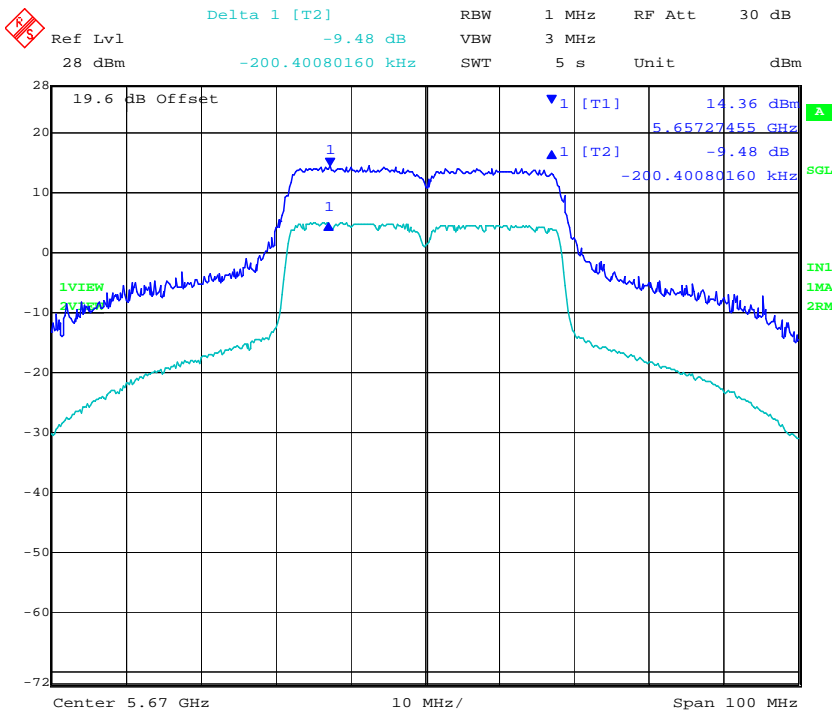

Date: 26.JUN.2012 18:34:15

This test report may be reproduced in full only. The document may only be updated by MiCOM Labs personnel. Any changes will be noted in the Document History section of the report.



**Title:** Aruba AP-175 802.11a/b/g/n Wireless AP  
**To:** FCC 47 CFR Part 15.407 & IC RSS-210  
**Serial #:** ARUB111-U1 Rev B  
**Issue Date:** 12th August 2013  
**Page:** 100 of 185

## Specification

### Limits

**§15.407 (a)(6)** The ratio of the peak excursion of the modulation envelope (measured using a peak hold function) to the peak transmit power (measured as specified in this paragraph) shall not exceed 13dB across any 1MHz bandwidth or the emission bandwidth whichever is less

## Laboratory Measurement Uncertainty for Spectrum Measurement

|                         |                     |
|-------------------------|---------------------|
| Measurement uncertainty | $\pm 2.81\text{dB}$ |
|-------------------------|---------------------|

## Traceability

| Method  | Test Equipment Used                            |
|---|--|
| Measurements were made per work instruction WI-03 'Measurement of RF Spectrum Mask' | 0158, 0287, 0252, 0313, 0314, 0070, 0116, 0117 |

This test report may be reproduced in full only. The document may only be updated by MiCOM Labs personnel. Any changes will be noted in the Document History section of the report.



**Title:** Aruba AP-175 802.11a/b/g/n Wireless AP  
**To:** FCC 47 CFR Part 15.407 & IC RSS-210  
**Serial #:** ARUB111-U1 Rev B  
**Issue Date:** 12th August 2013  
**Page:** 101 of 185

---

### **5.1.5. Frequency Stability**

**FCC, Part 15 Subpart C §15.407(g)**  
**Industry Canada RSS-210 §2.1**

#### **Test Procedure**

The manufacturer of the equipment is responsible for ensuring that the frequency stability is such that emissions are always maintained within the band of operation under all conditions.

#### **Manufacturer Declaration**

The frequency stability of the reference oscillator sets the frequency stability of the RF transceiver signals. Therefore all of the RF signals should have  $\pm 20$ ppm stability.

This stability accounts for room temp tolerance of the crystal oscillator circuit, frequency variation across temperature, and crystal ageing.

$\pm 20$ ppm at 5.250 GHz translates to a maximum frequency shift of  $\pm 105$  KHz. As the edge of the channels is at least one MHz from either of the band edges,  $\pm 105$  KHz is more than sufficient to guarantee that the intentional emission will remain in the band over the entire operating range of the EUT.

#### **Specification**

##### **Limits**

**§15.407 (g)** Manufacturers of U-NII devices are responsible for ensuring frequency stability such that an emission is maintained within the band of operation under all conditions of normal operation as specified in the user's manual.

---

This test report may be reproduced in full only. The document may only be updated by MiCOM Labs personnel. Any changes will be noted in the Document History section of the report.



### 5.1.6. Maximum Permissible Exposure

**FCC, Part 15 Subpart C §15.407(f)**  
**Industry Canada RSS-Gen §5.6**

#### **Calculations for Maximum Permissible Exposure Levels**

$$\text{Power Density} = P_d \text{ (mW/cm}^2\text{)} = \text{EIRP}/(4\pi d^2)$$

$$\text{EIRP} = P * G$$

P = Peak output power (mW)

G = Antenna numeric gain (numeric)

d = Separation distance (cm)

$$\text{Numeric Gain} = 10 ^ (G \text{ (dBi)}/10)$$

Because the EUT belongs to the General Population/Uncontrolled Exposure the limit of power density is 1.0 mW/cm<sup>2</sup>

Note: for mobile or fixed location transmitters the minimum separation distance is 20cm, even if calculations indicate the MPE distance to be less.

#### **Specification**

##### **Maximum Permissible Exposure Limits**

**FCC §1.1310** Limit = 1mW / cm<sup>2</sup> from 1.310 Table 1

**RSS-Gen §5.6** Category I and Category II equipment shall comply with the applicable requirements of RSS-102.

#### **Laboratory Measurement Uncertainty for Power Measurements**

|                         |
|-------------------------|
| Measurement uncertainty |
|-------------------------|

|          |
|----------|
| ±1.33 dB |
|----------|



**Title:** Aruba AP-175 802.11a/b/g/n Wireless AP  
**To:** FCC 47 CFR Part 15.407 & IC RSS-210  
**Serial #:** ARUB111-U1 Rev B  
**Issue Date:** 12th August 2013  
**Page:** 103 of 185

### 5250 – 5350 MHz

| Antenna Model | Type        | Ant Gain (dBi) | Numeric Gain (numeric) | Peak Output Power (dBm) | Peak Output Power (mW) | Calculated Safe Distance @ 1mW/cm <sup>2</sup> Limit(cm) | Power Density @ 20cm (mW/cm <sup>2</sup> ) |
|---------------|-------------|----------------|------------------------|-------------------------|------------------------|--|--|
| AP-ANT-10     | Dipole      | 6              | 4                      | 23.29                   | 213.30                 | 8.22   | 0.17                                       |
| AP-ANT-86D    | Dipole      | 9              | 8                      | 21                      | 125.89                 | 8.92   | 0.20                                       |
| AP-ANT-89     | Directional | 14.0           | 25                     | 16                      | 39.81                  | 8.92   | 0.20                                       |

### 5470 – 5725 MHz

| Antenna Model | Type        | Ant Gain (dBi) | Numeric Gain (numeric) | Peak Output Power (dBm) | Peak Output Power (mW) | Calculated Safe Distance @ 1mW/cm <sup>2</sup> Limit(cm) | Power Density @ 20cm (mW/cm <sup>2</sup> ) |
|---------------|-------------|----------------|------------------------|-------------------------|------------------------|--|--|
| AP-ANT-10     | Dipole      | 6              | 4                      | 23.37                   | 217.27                 | 8.30   | 0.17                                       |
| AP-ANT-86D    | Dipole      | 9              | 8                      | 21                      | 125.89                 | 8.92   | 0.20                                       |
| AP-ANT-89     | Directional | 13.25          | 21                     | 16.75                   | 47.32                  | 8.92   | 0.20                                       |

This test report may be reproduced in full only. The document may only be updated by MiCOM Labs personnel. Any changes will be noted in the Document History section of the report.



### 5.1.7. Radiated Emissions

**FCC, Part 15 Subpart C §15.407(b)(2), §15.205(a)/15.209(a)**  
**Industry Canada RSS-210 §A9.3(2); §2.2; §2.6; RSS-Gen §4.7**

#### Test Procedure

Testing was performed in a 3-meter anechoic chamber. Preliminary radiated emissions were measured on every azimuth and with the receiving antenna in both horizontal and vertical polarizations. Preliminary emissions were recorded with in Spectrum Analyzer mode, using a maximum peak detector while in peak hold mode. Depending on the frequency band spanned a notch filter and/or waveguide filter was used to remove the fundamental frequency.

Emissions nearest the limits were chosen for maximization and formal measurement using a CISPR compliant receiver. Emissions above 1000 MHz are measured utilizing a CISPR compliant average detector with a tuned receiver, using a bandwidth of 1 MHz. Emissions from 30 MHz – 1000 MHz are measured utilizing a CISPR compliant quasi-peak detector with a tuned receiver, using a bandwidth of 120 kHz. Only the highest emissions relative to the limit are listed.

#### Field Strength Calculation

The field strength is calculated by adding the Antenna Factor and Cable Loss, and subtracting Amplifier Gain from the measured reading. All factors are included in the reported data.

$$FS = R + AF + CORR - FO$$

FS = Field Strength

R = Measured Spectrum analyzer Input Amplitude

AF = Antenna Factor

$$CORR = \text{Correction Factor} = CL - AG + NFL$$

CL = Cable Loss

AG = Amplifier Gain

FO = Distance Falloff Factor

NFL = Notch Filter Loss or Waveguide Loss

Field Strength Calculation Example:

Given receiver input reading of 51.5 dB $\mu$ V; Antenna Factor of 8.5 dB; Cable Loss of 1.3 dB; Falloff Factor of 0 dB, an Amplifier Gain of 26 dB and Notch Filter Loss of 1 dB. The Field Strength of the measured emission is:

$$FS = 51.5 + 8.5 + 1.3 - 26.0 + 1 = 36.3 \text{ dB}\mu\text{V/m}$$

Conversion between dB $\mu$ V/m (or dB $\mu$ V) and  $\mu$ V/m (or  $\mu$ V) are done as:

$$\text{Level (dB}\mu\text{V/m)} = 20 * \text{Log (level (\mu\text{V/m}))}$$

$$40 \text{ dB}\mu\text{V/m} = 100 \mu\text{V/m}$$

$$48 \text{ dB}\mu\text{V/m} = 250 \mu\text{V/m}$$

This test report may be reproduced in full only. The document may only be updated by MiCOM Labs personnel. Any changes will be noted in the Document History section of the report.





**Title:** Aruba AP-175 802.11a/b/g/n Wireless AP  
**To:** FCC 47 CFR Part 15.407 & IC RSS-210  
**Serial #:** ARUB111-U1 Rev B  
**Issue Date:** 12th August 2013  
**Page:** 105 of 185

---

The following formula is used to convert the equipment isotropic radiated power (eirp) to field strength (dB $\mu$ V/m);

$$E = 1000000 \times \sqrt{30P} / 3 \mu\text{V/m}$$

where P is the EIRP in Watts

Therefore: -27 dBm/MHz = 68.23 dB $\mu$ V/m

**Note:** The data in this Section identifies that the EUT is in compliance with the -27dBm/MHz EIRP limit (68.23 dB $\mu$ V/m) for out of band emissions. All out of band emissions are less than 68.23 dB  $\mu$ V/m.

---

This test report may be reproduced in full only. The document may only be updated by MiCOM Labs personnel. Any changes will be noted in the Document History section of the report.

### Radiated Emission Measurement Setup – Above 1 GHz

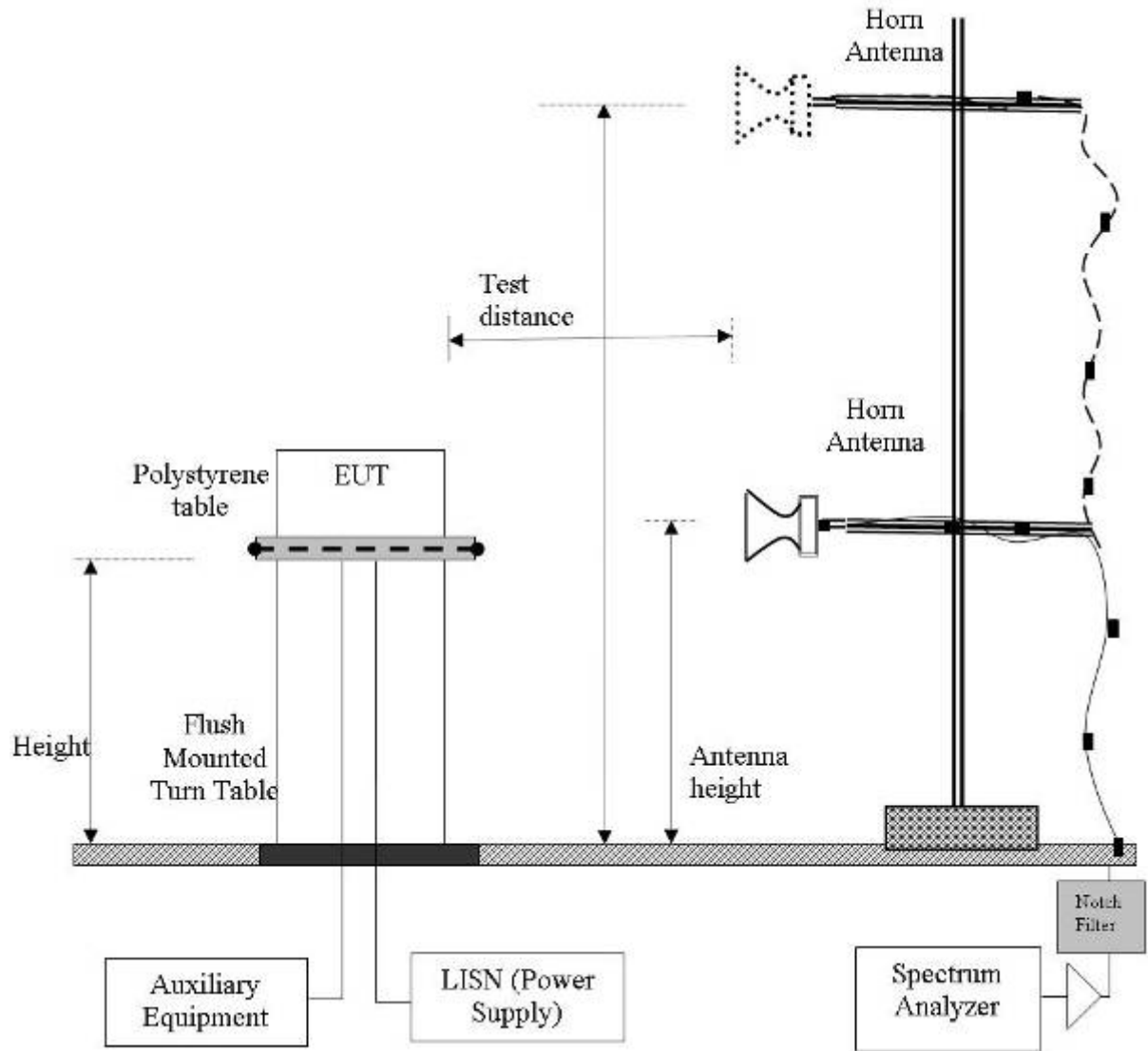

**NOTE: KDB 662911 was implemented for Out-of-Band measurements. Where necessary Option (2) Measure and add  $10 \log(N)$  dB was implemented**



**Title:** Aruba AP-175 802.11a/b/g/n Wireless AP  
**To:** FCC 47 CFR Part 15.407 & IC RSS-210  
**Serial #:** ARUB111-U1 Rev B  
**Issue Date:** 12th August 2013  
**Page:** 107 of 185

---

## Specification

### Radiated Spurious Emissions

**15.407 (b)(2).** All emissions outside of the 5,150-5,350MHz band shall not exceed an EIRP of -27dBm/MHz.

**FCC §15.205 (a)** Except as shown in paragraph (d) of 15.205 (a), only spurious emissions are permitted in any of the frequency bands listed.

**FCC §15.205 (a)** Except as shown in paragraphs (d) and (e) of this section, the field strength of emissions appearing within these frequency bands shall not exceed the limits shown in Section §15.209. At frequencies equal to or less than 1000 MHz, compliance with the limits in Section 15.209 shall be demonstrated using measurement instrumentation employing a CISPR quasi-peak detector. Above 1000 MHz, compliance with the emission limits in Section 15.209 shall be demonstrated based on the average value of the measured emissions. The provisions in Section 15.35 apply to these measurements.

**FCC §15.209 (a)** Except as provided elsewhere in this subpart, the emissions from an intentional radiator shall not exceed the field strength levels specified in the following table.

**RSS-210 §A9.3(2)** For transmitters operating in the 5250-5350 MHz band, all emissions outside the 5150-5350 MHz band shall not exceed -27 dBm/MHz e.i.r.p. Devices operating in the 5250-5350 MHz band that generate emissions in the 5150-5250 MHz band shall not exceed out of band emission limit of 27 dBm/MHz e.i.r.p. in the 5150-5250 MHz band in order to operate indoor/outdoor, or alternatively shall comply with the spectral power density for operation within the 5150-5250 MHz band and shall be labeled "for indoor use only".

**RSS-Gen §4.7** The search for unwanted emissions shall be from the lowest frequency internally generated or used in the device (local oscillator, intermediate of carrier frequency), or from 30 MHz, whichever is the lowest frequency, to the 5<sup>th</sup> harmonic of the highest frequency generated without exceeding 40 GHz.

#### **RSS-Gen §6** Receiver Spurious Emission Standard

If a radiated measurement is made, all spurious emissions shall comply with the limits of the following Table. The resolution bandwidth of the spectrum analyzer shall be 100 kHz for spurious emission measurements below 1.0 GHz and 1.0 MHz for measurements above 1.0 GHz

---

This test report may be reproduced in full only. The document may only be updated by MiCOM Labs personnel. Any changes will be noted in the Document History section of the report.



**Title:** Aruba AP-175 802.11a/b/g/n Wireless AP  
**To:** FCC 47 CFR Part 15.407 & IC RSS-210  
**Serial #:** ARUB111-U1 Rev B  
**Issue Date:** 12th August 2013  
**Page:** 108 of 185

**Table 1: FCC 15.209 Spurious Emissions Limits**

| Frequency (MHz) | Field Strength ( $\mu\text{V/m}$ ) | Field Strength ( $\text{dB}\mu\text{V/m}$ ) | Measurement Distance (meters) |
|-----------------|------------------------------------|---|-------------------------------|
| 30-88           | 100                                | 40.0  | 3                             |
| 88-216          | 150                                | 43.5  | 3                             |
| 216-960         | 200                                | 46.0  | 3                             |
| Above 960       | 500                                | 54.0  | 3                             |

**Laboratory Measurement Uncertainty for Spectrum Measurement**

|                                |               |
|--------------------------------|---------------|
| <b>Measurement Uncertainty</b> | +5.6/ -4.5 dB |
|--------------------------------|---------------|

**Traceability:**

| Method                 | Test Equipment Used                            |
|------------------------|--|
| Work instruction WI-03 | 0088, 0158, 0134, 0304, 0311, 0315, 0310, 0312 |

This test report may be reproduced in full only. The document may only be updated by MiCOM Labs personnel. Any changes will be noted in the Document History section of the report.



**Title:** Aruba AP-175 802.11a/b/g/n Wireless AP  
**To:** FCC 47 CFR Part 15.407 & IC RSS-210  
**Serial #:** ARUB111-U1 Rev B  
**Issue Date:** 12th August 2013  
**Page:** 109 of 185

### 5.1.7.1. Radiated Spurious Emissions – Above 1 GHz

Antenna AP-ANT-10

5250 – 5350 MHz, 802.11a Legacy

|                      |                      |                       |      |
|----------------------|----------------------|-----------------------|------|
| <b>Test Freq.</b>    | 5260 MHz             | <b>Engineer</b>       | JMH  |
| <b>Variant</b>       | 802.11a; 6 Mbs       | <b>Temp (°C)</b>      | 24   |
| <b>Freq. Range</b>   | 1000 MHz - 18000 MHz | <b>Rel. Hum.(%)</b>   | 31   |
| <b>Power Setting</b> | 21                   | <b>Press. (mBars)</b> | 1008 |
| <b>Antenna</b>       | AP-ANT10             | <b>Duty Cycle (%)</b> | 100  |
| <b>Test Notes 1</b>  |                      |                       |      |
| <b>Test Notes 2</b>  |                      |                       |      |

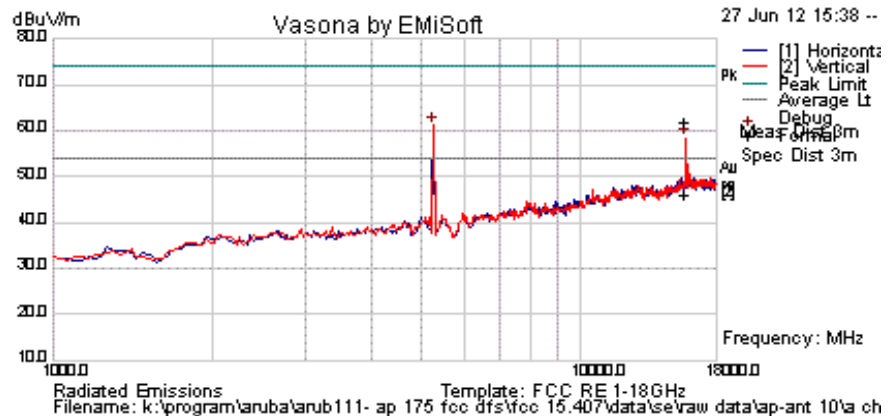

#### Formally measured emission peaks

| Frequency MHz | Raw dBuV | Cable Loss | AF dB | Level dBuV/m | Measurement Type | Pol | Hgt cm | Azt Deg | Limit dBuV/m | Margin dB | Pass /Fail | Comments |
|---------------|----------|------------|-------|--------------|------------------|-----|--------|---------|--------------|-----------|------------|----------|
| 5258.517      | 63.4     | 4.6        | -9.7  | 58.3         | Peak [Scan]      |     |        |         |              |           |            | FUND     |
| 16773.547     | 41.1     | 8.6        | 0.9   | 50.7         | Peak [Scan]      | V   | 200    | 0       | 54.0         | -3.3      | Pass       | Noise    |

**Legend:** TX = Transmitter Emissions; DIG = Digital Emissions; FUND = Fundamental; WB = Wideband Emission  
 NRB = Non-Restricted Band. Limit = 68.23 dBuV/m; RB = Restricted Band. Limits per 15.205

This test report may be reproduced in full only. The document may only be updated by MiCOM Labs personnel. Any changes will be noted in the Document History section of the report.



**Title:** Aruba AP-175 802.11a/b/g/n Wireless AP  
**To:** FCC 47 CFR Part 15.407 & IC RSS-210  
**Serial #:** ARUB111-U1 Rev B  
**Issue Date:** 12th August 2013  
**Page:** 110 of 185

|                      |                      |                       |      |
|----------------------|----------------------|-----------------------|------|
| <b>Test Freq.</b>    | 5300 MHz             | <b>Engineer</b>       | JMH  |
| <b>Variant</b>       | 802.11a; 6 Mbs       | <b>Temp (°C)</b>      | 24   |
| <b>Freq. Range</b>   | 1000 MHz - 18000 MHz | <b>Rel. Hum.(%)</b>   | 31   |
| <b>Power Setting</b> | 21                   | <b>Press. (mBars)</b> | 1008 |
| <b>Antenna</b>       | AP-ANT10             | <b>Duty Cycle (%)</b> | 100  |
| <b>Test Notes 1</b>  |                      |                       |      |
| <b>Test Notes 2</b>  |                      |                       |      |

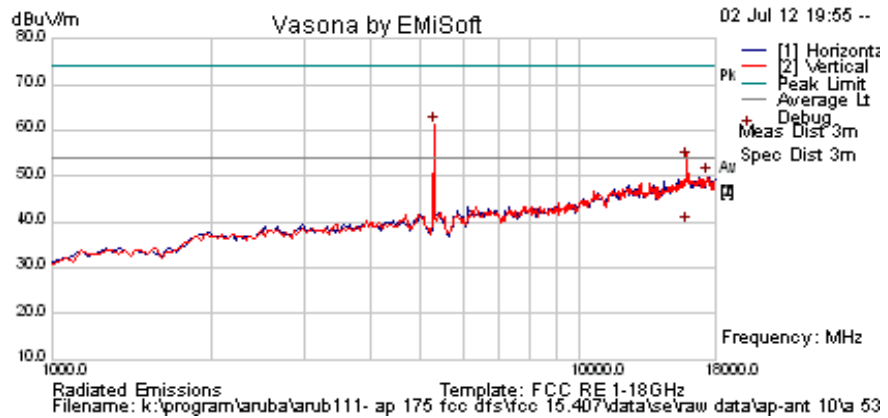

**Formally measured emission peaks**

| Frequency MHz | Raw dBuV | Cable Loss | AF dB | Level dBuV/m | Measurement Type | Pol | Hgt cm | Azt Deg | Limit dBuV/m | Margin dB | Pass /Fail | Comments |
|---------------|----------|------------|-------|--------------|------------------|-----|--------|---------|--------------|-----------|------------|----------|
| 5292.585      | 66.2     | 4.6        | -9.6  | 61.3         | Peak [Scan]      |     |        |         |              |           |            | FUND     |
| 17352.705     | 39.9     | 8.7        | 1.3   | 49.9         | Peak [Scan]      | V   | 100    | 0       | 54.0         | -4.1      | Pass       | Noise    |
| 15920.164     | 44.4     | 8.9        | -0.1  | 53.2         | Peak Max         | V   | 98     | 203     | 74           | -20.8     | Pass       |          |
| 15920.164     | 30.6     | 8.9        | -0.1  | 39.4         | Average Max      | V   | 98     | 203     | 54           | -14.7     | Pass       |          |

Legend: TX = Transmitter Emissions; DIG = Digital Emissions; FUND = Fundamental; WB = Wideband Emission  
 NRB = Non-Restricted Band. Limit = 68.23 dBuV/m; RB = Restricted Band. Limits per 15.205

This test report may be reproduced in full only. The document may only be updated by MiCOM Labs personnel. Any changes will be noted in the Document History section of the report.



**Title:** Aruba AP-175 802.11a/b/g/n Wireless AP  
**To:** FCC 47 CFR Part 15.407 & IC RSS-210  
**Serial #:** ARUB111-U1 Rev B  
**Issue Date:** 12th August 2013  
**Page:** 111 of 185

|                      |                      |                       |      |
|----------------------|----------------------|-----------------------|------|
| <b>Test Freq.</b>    | 5320 MHz             | <b>Engineer</b>       | JMH  |
| <b>Variant</b>       | 802.11a; 6 Mbs       | <b>Temp (°C)</b>      | 24   |
| <b>Freq. Range</b>   | 1000 MHz - 18000 MHz | <b>Rel. Hum.(%)</b>   | 31   |
| <b>Power Setting</b> | 21                   | <b>Press. (mBars)</b> | 1008 |
| <b>Antenna</b>       | AP-ANT10             | <b>Duty Cycle (%)</b> | 100  |
| <b>Test Notes 1</b>  |                      |                       |      |
| <b>Test Notes 2</b>  |                      |                       |      |

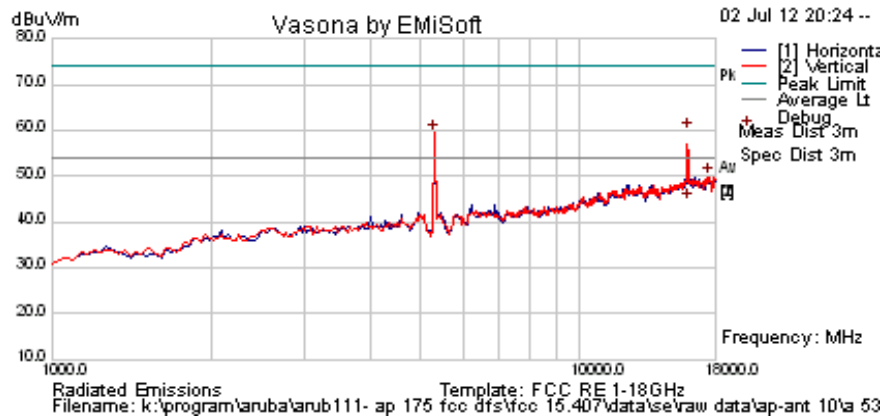

**Formally measured emission peaks**

| Frequency MHz   | Raw dBuV | Cable Loss | AF dB | Level dBuV/m | Measurement Type | Pol | Hgt cm | Azt Deg | Limit dBuV/m | Margin dB | Pass /Fail | Comments |
|---|----------|------------|-------|--------------|------------------|-----|--------|---------|--------------|-----------|------------|----------|
| 5292.585  | 64.5     | 4.6        | -9.6  | 59.5         | Peak [Scan]      |     |        |         |              |           |            | FUND     |
| 17523.046   | 40.1     | 8.8        | 0.9   | 49.8         | Peak [Scan]      | V   | 200    | 0       | 54.0         | -4.2      | Pass       | Noise    |
| 15960.321   | 50.7     | 9.0        | 0.0   | 59.7         | Peak Max         | V   | 98     | 284     | 74           | -14.3     | Pass       |          |
| 15960.321   | 35.2     | 9.0        | 0.0   | 44.2         | Average Max      | V   | 98     | 284     | 54           | -9.8      | Pass       |          |
| Legend: TX = Transmitter Emissions; DIG = Digital Emissions; FUND = Fundamental; WB = Wideband Emission<br>NRB = Non-Restricted Band. Limit = 68.23 dBuV/m; RB = Restricted Band. Limits per 15.205 |          |            |       |              |                  |     |        |         |              |           |            |          |

This test report may be reproduced in full only. The document may only be updated by MiCOM Labs personnel. Any changes will be noted in the Document History section of the report.



**Title:** Aruba AP-175 802.11a/b/g/n Wireless AP  
**To:** FCC 47 CFR Part 15.407 & IC RSS-210  
**Serial #:** ARUB111-U1 Rev B  
**Issue Date:** 12th August 2013  
**Page:** 112 of 185

**5470 – 5725 MHz, 802.11a Legacy**

|                      |                      |                       |      |
|----------------------|----------------------|-----------------------|------|
| <b>Test Freq.</b>    | 5500 MHz             | <b>Engineer</b>       | JMH  |
| <b>Variant</b>       | 802.11a; 6 Mbs       | <b>Temp (°C)</b>      | 24   |
| <b>Freq. Range</b>   | 1000 MHz - 18000 MHz | <b>Rel. Hum.(%)</b>   | 31   |
| <b>Power Setting</b> | 21                   | <b>Press. (mBars)</b> | 1008 |
| <b>Antenna</b>       | AP-ANT10             | <b>Duty Cycle (%)</b> | 100  |
| <b>Test Notes 1</b>  |                      |                       |      |
| <b>Test Notes 2</b>  |                      |                       |      |

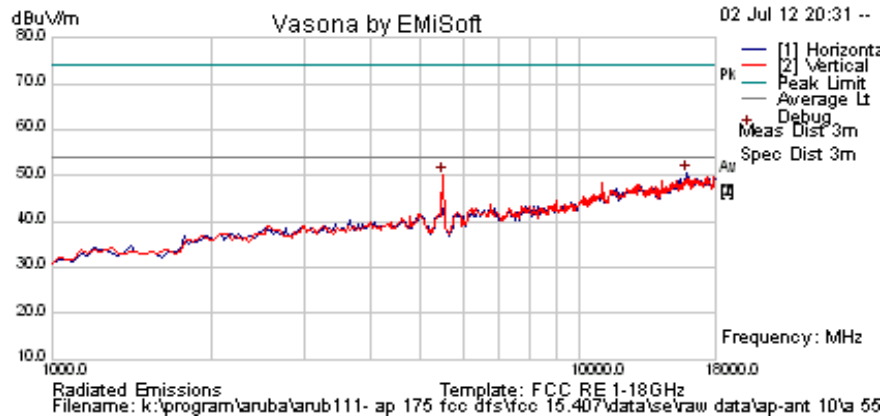

**Formally measured emission peaks**

| Frequency MHz   | Raw dBuV | Cable Loss | AF dB | Level dBuV/m | Measurement Type | Pol | Hgt cm | Azt Deg | Limit dBuV/m | Margin dB | Pass /Fail | Comments |
|---|----------|------------|-------|--------------|------------------|-----|--------|---------|--------------|-----------|------------|----------|
| 15921.844   | 41.6     | 8.9        | -0.1  | 50.4         | Peak [Scan]      | H   | 150    | 0       | 54.0         | -3.6      | Pass       | Noise    |
| 5496.993988   | 55.1     | 4.6        | -9.6  | 50.1         | Peak [Scan]      |     |        |         |              |           |            | FUND     |
| Legend: TX = Transmitter Emissions; DIG = Digital Emissions; FUND = Fundamental; WB = Wideband Emission<br>NRB = Non-Restricted Band. Limit = 68.23 dBuV/m; RB = Restricted Band. Limits per 15.205 |          |            |       |              |                  |     |        |         |              |           |            |          |

This test report may be reproduced in full only. The document may only be updated by MiCOM Labs personnel. Any changes will be noted in the Document History section of the report.





**Title:** Aruba AP-175 802.11a/b/g/n Wireless AP  
**To:** FCC 47 CFR Part 15.407 & IC RSS-210  
**Serial #:** ARUB111-U1 Rev B  
**Issue Date:** 12th August 2013  
**Page:** 113 of 185

|                      |                      |                       |      |
|----------------------|----------------------|-----------------------|------|
| <b>Test Freq.</b>    | 5580 MHz             | <b>Engineer</b>       | JMH  |
| <b>Variant</b>       | 802.11a; 6 Mbs       | <b>Temp (°C)</b>      | 24   |
| <b>Freq. Range</b>   | 1000 MHz - 18000 MHz | <b>Rel. Hum.(%)</b>   | 31   |
| <b>Power Setting</b> | 21                   | <b>Press. (mBars)</b> | 1008 |
| <b>Antenna</b>       | AP-ANT10             | <b>Duty Cycle (%)</b> | 100  |
| <b>Test Notes 1</b>  |                      |                       |      |
| <b>Test Notes 2</b>  |                      |                       |      |

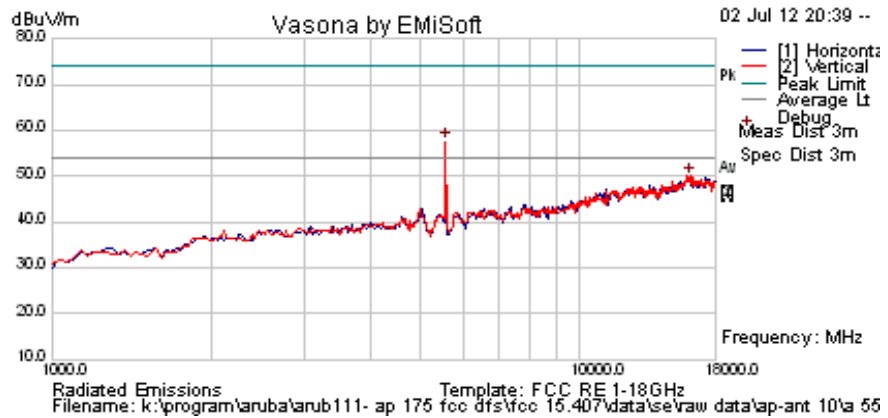

**Formally measured emission peaks**

| Frequency MHz | Raw dBuV | Cable Loss | AF dB | Level dBuV/m | Measurement Type | Pol | Hgt cm | Azt Deg | Limit dBuV/m | Margin dB | Pass /Fail | Comments |
|---------------|----------|------------|-------|--------------|------------------|-----|--------|---------|--------------|-----------|------------|----------|
| 5565.130      | 62.6     | 4.7        | -9.7  | 57.6         | Peak [Scan]      |     |        |         |              |           |            | FUND     |
| 16160.321     | 40.9     | 9.0        | 0.2   | 50.0         | Peak [Scan]      | V   | 200    | 0       | 54.0         | -4.0      | Pass       | Noise    |

Legend: TX = Transmitter Emissions; DIG = Digital Emissions; FUND = Fundamental; WB = Wideband Emission  
 NRB = Non-Restricted Band. Limit = 68.23 dBuV/m; RB = Restricted Band. Limits per 15.205

This test report may be reproduced in full only. The document may only be updated by MiCOM Labs personnel. Any changes will be noted in the Document History section of the report.



**Title:** Aruba AP-175 802.11a/b/g/n Wireless AP  
**To:** FCC 47 CFR Part 15.407 & IC RSS-210  
**Serial #:** ARUB111-U1 Rev B  
**Issue Date:** 12th August 2013  
**Page:** 114 of 185

|                      |                      |                       |      |
|----------------------|----------------------|-----------------------|------|
| <b>Test Freq.</b>    | 5700 MHz             | <b>Engineer</b>       | JMH  |
| <b>Variant</b>       | 802.11a; 6 Mbs       | <b>Temp (°C)</b>      | 24   |
| <b>Freq. Range</b>   | 1000 MHz - 18000 MHz | <b>Rel. Hum.(%)</b>   | 31   |
| <b>Power Setting</b> | 21                   | <b>Press. (mBars)</b> | 1008 |
| <b>Antenna</b>       | AP-ANT10             | <b>Duty Cycle (%)</b> | 100  |
| <b>Test Notes 1</b>  |                      |                       |      |
| <b>Test Notes 2</b>  |                      |                       |      |

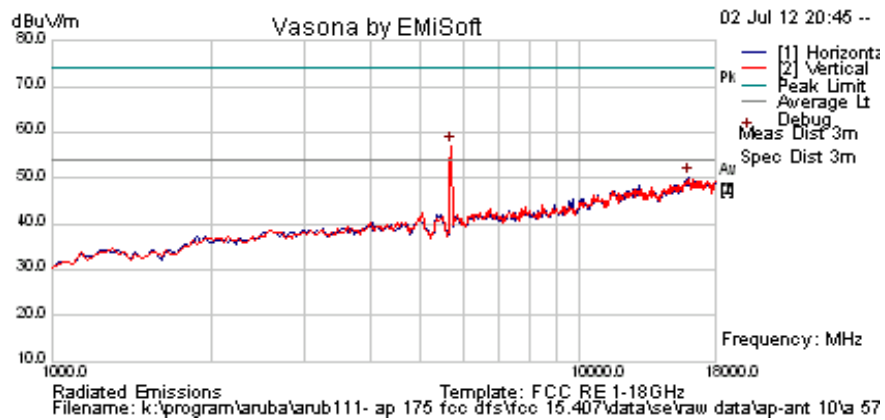

### Formally measured emission peaks

| Frequency MHz | Raw dBuV | Cable Loss | AF dB | Level dBuV/m | Measurement Type | Pol | Hgt cm | Azt Deg | Limit dBuV/m | Margin dB | Pass /Fail | Comments |
|---------------|----------|------------|-------|--------------|------------------|-----|--------|---------|--------------|-----------|------------|----------|
| 5701.403      | 62.0     | 4.7        | -9.6  | 57.2         | Peak [Scan]      |     |        |         |              |           |            | FUND     |
| 16024.048     | 40.9     | 9.0        | 0.2   | 50.2         | Peak [Scan]      | H   | 100    | 0       | 54.0         | -3.8      | Pass       | Noise    |

Legend: TX = Transmitter Emissions; DIG = Digital Emissions; FUND = Fundamental; WB = Wideband Emission  
 NRB = Non-Restricted Band. Limit = 68.23 dBuV/m; RB = Restricted Band. Limits per 15.205

This test report may be reproduced in full only. The document may only be updated by MiCOM Labs personnel. Any changes will be noted in the Document History section of the report.



**Title:** Aruba AP-175 802.11a/b/g/n Wireless AP  
**To:** FCC 47 CFR Part 15.407 & IC RSS-210  
**Serial #:** ARUB111-U1 Rev B  
**Issue Date:** 12th August 2013  
**Page:** 115 of 185

**5250 – 5350 MHz, 802.11n HT-20**

|                      |                        |                       |      |
|----------------------|------------------------|-----------------------|------|
| <b>Test Freq.</b>    | 5260 MHz               | <b>Engineer</b>       | JMH  |
| <b>Variant</b>       | 802.11n HT-20; 6.5 MCS | <b>Temp (°C)</b>      | 25   |
| <b>Freq. Range</b>   | 1000 MHz - 18000 MHz   | <b>Rel. Hum.(%)</b>   | 31   |
| <b>Power Setting</b> | 21                     | <b>Press. (mBars)</b> | 1008 |
| <b>Antenna</b>       | AP-ANT10               | <b>Duty Cycle (%)</b> | 100  |
| <b>Test Notes 1</b>  |                        |                       |      |
| <b>Test Notes 2</b>  |                        |                       |      |

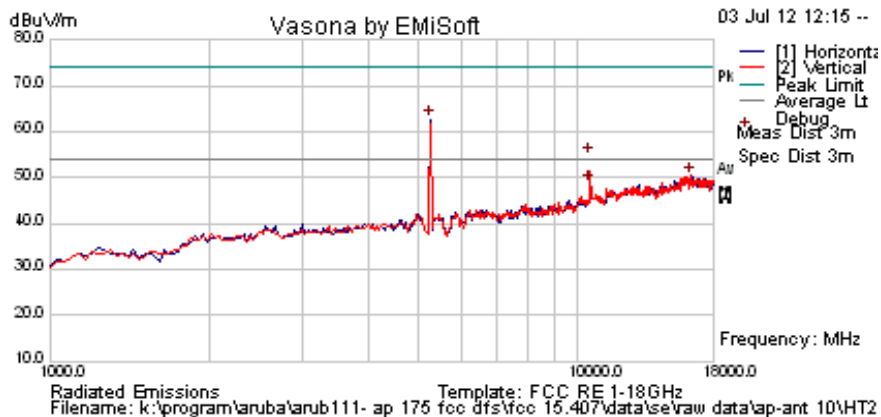

**Formally measured emission peaks**

| Frequency MHz   | Raw dBuV | Cable Loss | AF dB | Level dBuV/m | Measurement Type | Pol | Hgt cm | Azt Deg | Limit dBuV/m | Margin dB | Pass /Fail | Comments |
|---|----------|------------|-------|--------------|------------------|-----|--------|---------|--------------|-----------|------------|----------|
| 5258.517  | 67.9     | 4.6        | -9.7  | 62.8         | Peak [Scan]      |     |        |         |              |           |            | Fund     |
| 16364.729   | 41.3     | 8.9        | 0.2   | 50.4         | Peak [Scan]      | V   | 200    | 0       | 54.0         | -3.6      | Pass       | Noise    |
| 10520.000   | 50.2     | 6.8        | -2.4  | 54.5         | Peak Max         | V   | 98     | 309     | 74           | -19.5     | Pass       |          |
| 10520.000   | 44.5     | 6.8        | -2.4  | 48.8         | Average Max      | V   | 98     | 309     | 54           | -5.2      | Pass       |          |
| Legend: TX = Transmitter Emissions; DIG = Digital Emissions; FUND = Fundamental; WB = Wideband Emission<br>NRB = Non-Restricted Band. Limit = 68.23 dBuV/m; RB = Restricted Band. Limits per 15.205 |          |            |       |              |                  |     |        |         |              |           |            |          |

This test report may be reproduced in full only. The document may only be updated by MiCOM Labs personnel. Any changes will be noted in the Document History section of the report.



**Title:** Aruba AP-175 802.11a/b/g/n Wireless AP  
**To:** FCC 47 CFR Part 15.407 & IC RSS-210  
**Serial #:** ARUB111-U1 Rev B  
**Issue Date:** 12th August 2013  
**Page:** 116 of 185

|                      |                        |                       |      |
|----------------------|------------------------|-----------------------|------|
| <b>Test Freq.</b>    | 5300 MHz               | <b>Engineer</b>       | JMH  |
| <b>Variant</b>       | 802.11n HT-20; 6.5 MCS | <b>Temp (°C)</b>      | 25   |
| <b>Freq. Range</b>   | 1000 MHz - 18000 MHz   | <b>Rel. Hum.(%)</b>   | 31   |
| <b>Power Setting</b> | 21                     | <b>Press. (mBars)</b> | 1008 |
| <b>Antenna</b>       | AP-ANT10               | <b>Duty Cycle (%)</b> | 100  |
| <b>Test Notes 1</b>  |                        |                       |      |
| <b>Test Notes 2</b>  |                        |                       |      |

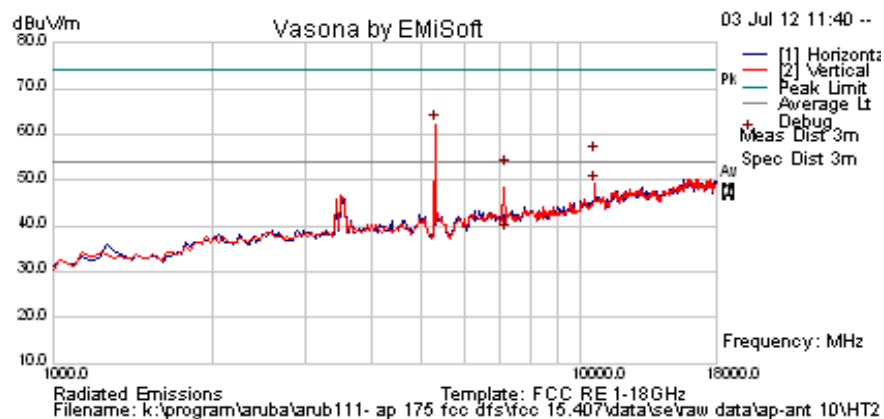

### Formally measured emission peaks

| Frequency MHz | Raw dBuV | Cable Loss | AF dB | Level dBuV/m | Measurement Type | Pol | Hgt cm | Azt Deg | Limit dBuV/m | Margin dB | Pass /Fail | Comments |
|---------------|----------|------------|-------|--------------|------------------|-----|--------|---------|--------------|-----------|------------|----------|
| 5292.585      | 67.1     | 4.6        | -9.6  | 62.2         | Peak [Scan]      |     |        |         |              |           |            | Fund     |
| 7161.372      | 38.9     | 5.4        | -6.0  | 38.3         | Average Max      | V   | 98     | 278     | 54.0         | -15.7     | Pass       |          |
| 7161.372      | 53.3     | 5.4        | -6.0  | 52.7         | Peak Max         | V   | 98     | 278     | 74           | -21.3     | Pass       |          |
| 10600.077     | 51.2     | 6.8        | -2.4  | 55.5         | Peak Max         | V   | 98     | 278     | 74           | -18.5     | Pass       |          |
| 10600.077     | 44.7     | 6.8        | -2.4  | 49.1         | Average Max      | V   | 98     | 278     | 54           | -5.0      | Pass       |          |

Legend: TX = Transmitter Emissions; DIG = Digital Emissions; FUND = Fundamental; WB = Wideband Emission  
 NRB = Non-Restricted Band. Limit = 68.23 dBuV/m; RB = Restricted Band. Limits per 15.205

This test report may be reproduced in full only. The document may only be updated by MiCOM Labs personnel. Any changes will be noted in the Document History section of the report.



**Title:** Aruba AP-175 802.11a/b/g/n Wireless AP  
**To:** FCC 47 CFR Part 15.407 & IC RSS-210  
**Serial #:** ARUB111-U1 Rev B  
**Issue Date:** 12th August 2013  
**Page:** 117 of 185

|                      |                        |                       |      |
|----------------------|------------------------|-----------------------|------|
| <b>Test Freq.</b>    | 5320 MHz               | <b>Engineer</b>       | JMH  |
| <b>Variant</b>       | 802.11n HT-20; 6.5 MCS | <b>Temp (°C)</b>      | 25   |
| <b>Freq. Range</b>   | 1000 MHz - 18000 MHz   | <b>Rel. Hum.(%)</b>   | 31   |
| <b>Power Setting</b> | 21                     | <b>Press. (mBars)</b> | 1008 |
| <b>Antenna</b>       | AP-ANT10               | <b>Duty Cycle (%)</b> | 100  |
| <b>Test Notes 1</b>  |                        |                       |      |
| <b>Test Notes 2</b>  |                        |                       |      |

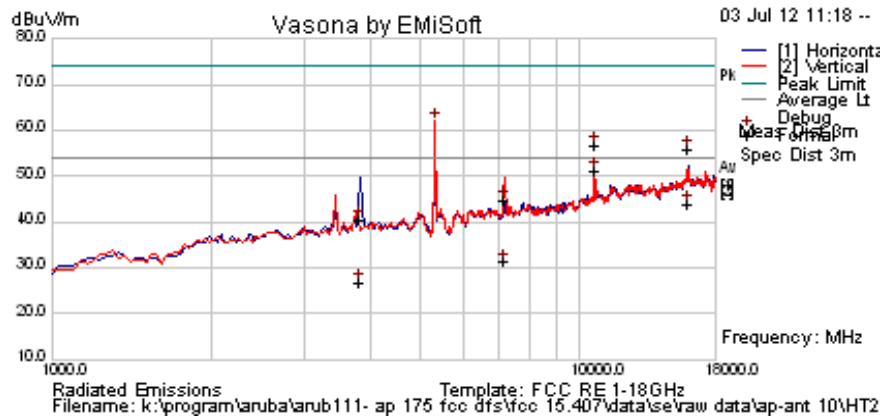

**Formally measured emission peaks**

| Frequency MHz | Raw dBuV | Cable Loss | AF dB | Level dBuV/m | Measurement Type | Pol | Hgt cm | Azt Deg | Limit dBuV/m | Margin dB | Pass /Fail | Comments |
|---------------|----------|------------|-------|--------------|------------------|-----|--------|---------|--------------|-----------|------------|----------|
| 5326.653      | 67.1     | 4.6        | -9.5  | 62.2         | Peak [Scan]      |     |        |         |              |           |            | Fund     |
| 3827.655311   | 47.5     | 3.8        | -10.9 | 40.4         | Peak Max         | H   | 155    | 42      | 74.0         | -33.6     | Pass       |          |
| 3827.655      | 34.0     | 3.8        | -10.9 | 26.9         | Average Max      | H   | 155    | 42      | 54           | -27.1     | Pass       |          |
| 7200.401      | 45.1     | 5.4        | -5.9  | 44.7         | Peak Max         | V   | 123    | 229     | 74           | -29.3     | Pass       |          |
| 7200.401      | 31.7     | 5.4        | -5.9  | 31.3         | Average Max      | V   | 123    | 229     | 54           | -22.7     | Pass       |          |
| 10639.840     | 46.8     | 6.8        | -2.4  | 51.3         | Average Max      | V   | 100    | 281     | 54           | -2.7      | Pass       |          |
| 10639.840     | 52.5     | 6.8        | -2.4  | 56.9         | Peak Max         | V   | 100    | 281     | 74           | -17.1     | Pass       |          |
| 15960.000     | 34.9     | 9.0        | 0.0   | 43.9         | Average Max      | H   | 116    | 267     | 54           | -10.1     | Pass       |          |
| 15960.000     | 46.9     | 9.0        | 0.0   | 55.9         | Peak Max         | H   | 116    | 267     | 74           | -18.1     | Pass       |          |

Legend: TX = Transmitter Emissions; DIG = Digital Emissions; FUND = Fundamental; WB = Wideband Emission  
 NRB = Non-Restricted Band. Limit = 68.23 dBuV/m; RB = Restricted Band. Limits per 15.205

This test report may be reproduced in full only. The document may only be updated by MiCOM Labs personnel. Any changes will be noted in the Document History section of the report.



**Title:** Aruba AP-175 802.11a/b/g/n Wireless AP  
**To:** FCC 47 CFR Part 15.407 & IC RSS-210  
**Serial #:** ARUB111-U1 Rev B  
**Issue Date:** 12th August 2013  
**Page:** 118 of 185

**5470 – 5725 MHz, 802.11n HT-20**

|                      |                        |                       |      |
|----------------------|------------------------|-----------------------|------|
| <b>Test Freq.</b>    | 5500 MHz               | <b>Engineer</b>       | JMH  |
| <b>Variant</b>       | 802.11n HT-20; 6.5 MCS | <b>Temp (°C)</b>      | 25   |
| <b>Freq. Range</b>   | 1000 MHz - 18000 MHz   | <b>Rel. Hum.(%)</b>   | 31   |
| <b>Power Setting</b> | 21                     | <b>Press. (mBars)</b> | 1008 |
| <b>Antenna</b>       | AP-ANT10               | <b>Duty Cycle (%)</b> | 100  |
| <b>Test Notes 1</b>  |                        |                       |      |
| <b>Test Notes 2</b>  |                        |                       |      |

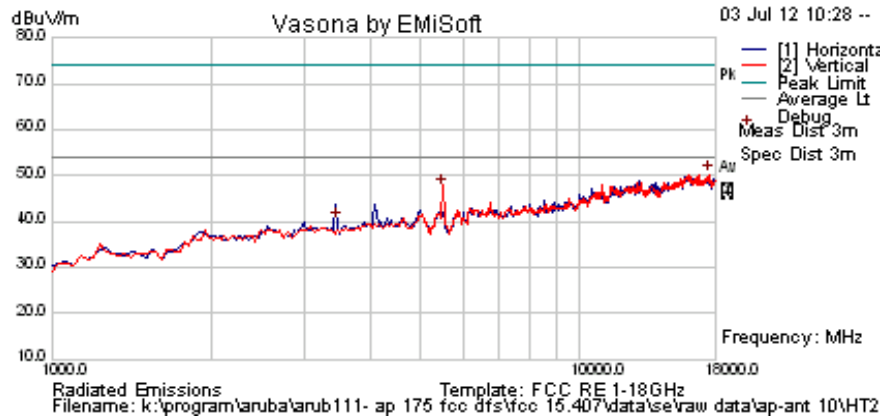

**Formally measured emission peaks**

| Frequency MHz | Raw dBuV | Cable Loss | AF dB | Level dBuV/m | Measurement Type | Pol | Hgt cm | Azt Deg | Limit dBuV/m | Margin dB | Pass /Fail | Comments |
|---------------|----------|------------|-------|--------------|------------------|-----|--------|---------|--------------|-----------|------------|----------|
| 17523.046     | 40.6     | 8.8        | 0.9   | 50.3         | Peak [Scan]      | V   | 100    | 0       | 54.0         | -3.7      | Pass       | Noise    |
| 5495.195      | 52.5     | 4.6        | -9.6  | 47.5         | Peak [Scan]      |     |        |         |              |           |            | Fund     |
| 3475.541      | 48.5     | 3.6        | -11.8 | 40.3         | Peak [Scan]      | V   | 98     | 360     | 54           | -13.7     | Pass       |          |

Legend: TX = Transmitter Emissions; DIG = Digital Emissions; FUND = Fundamental; WB = Wideband Emission  
 NRB = Non-Restricted Band. Limit = 68.23 dBuV/m; RB = Restricted Band. Limits per 15.205

This test report may be reproduced in full only. The document may only be updated by MiCOM Labs personnel. Any changes will be noted in the Document History section of the report.



**Title:** Aruba AP-175 802.11a/b/g/n Wireless AP  
**To:** FCC 47 CFR Part 15.407 & IC RSS-210  
**Serial #:** ARUB111-U1 Rev B  
**Issue Date:** 12th August 2013  
**Page:** 119 of 185

|                      |                        |                       |      |
|----------------------|------------------------|-----------------------|------|
| <b>Test Freq.</b>    | 5580 MHz               | <b>Engineer</b>       | JMH  |
| <b>Variant</b>       | 802.11n HT-20; 6.5 MCS | <b>Temp (°C)</b>      | 25   |
| <b>Freq. Range</b>   | 1000 MHz - 18000 MHz   | <b>Rel. Hum.(%)</b>   | 31   |
| <b>Power Setting</b> | 21                     | <b>Press. (mBars)</b> | 1008 |
| <b>Antenna</b>       | ANT 10                 | <b>Duty Cycle (%)</b> | 100  |
| <b>Test Notes 1</b>  |                        |                       |      |
| <b>Test Notes 2</b>  |                        |                       |      |

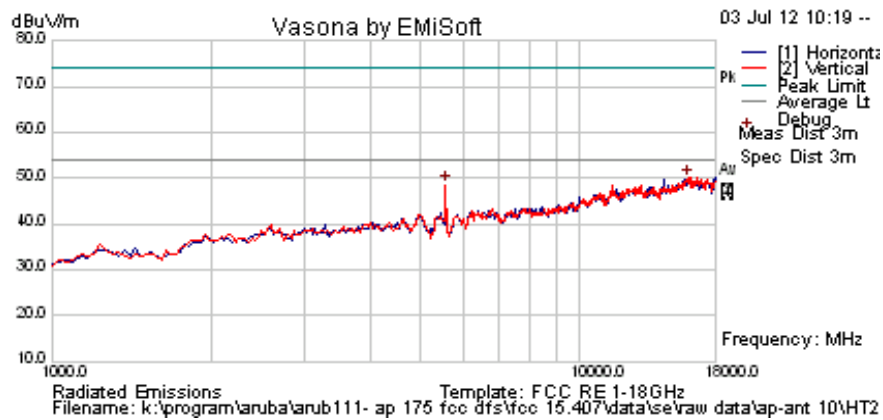

**Formally measured emission peaks**

| Frequency MHz | Raw dBuV | Cable Loss | AF dB | Level dBuV/m | Measurement Type | Pol | Hgt cm | Azt Deg | Limit dBuV/m | Margin dB | Pass /Fail | Comments |
|---------------|----------|------------|-------|--------------|------------------|-----|--------|---------|--------------|-----------|------------|----------|
| 16058.116     | 40.8     | 9.0        | 0.3   | 50.0         | Peak [Scan]      | V   | 200    | 0       | 54.0         | -4.0      | Pass       | Noise    |
| 5565.130261   | 53.6     | 4.7        | -9.7  | 48.6         | Peak [Scan]      |     |        |         |              |           |            | Fund     |

Legend: TX = Transmitter Emissions; DIG = Digital Emissions; FUND = Fundamental; WB = Wideband Emission  
 NRB = Non-Restricted Band. Limit = 68.23 dBuV/m; RB = Restricted Band. Limits per 15.205

This test report may be reproduced in full only. The document may only be updated by MiCOM Labs personnel. Any changes will be noted in the Document History section of the report.



**Title:** Aruba AP-175 802.11a/b/g/n Wireless AP  
**To:** FCC 47 CFR Part 15.407 & IC RSS-210  
**Serial #:** ARUB111-U1 Rev B  
**Issue Date:** 12th August 2013  
**Page:** 120 of 185

|                      |                        |                       |      |
|----------------------|------------------------|-----------------------|------|
| <b>Test Freq.</b>    | 5700 MHz               | <b>Engineer</b>       | JMH  |
| <b>Variant</b>       | 802.11n HT-20; 6.5 MCS | <b>Temp (°C)</b>      | 25   |
| <b>Freq. Range</b>   | 1000 MHz - 18000 MHz   | <b>Rel. Hum.(%)</b>   | 31   |
| <b>Power Setting</b> | 21                     | <b>Press. (mBars)</b> | 1008 |
| <b>Antenna</b>       |                        | <b>Duty Cycle (%)</b> | 100  |
| <b>Test Notes 1</b>  |                        |                       |      |
| <b>Test Notes 2</b>  |                        |                       |      |

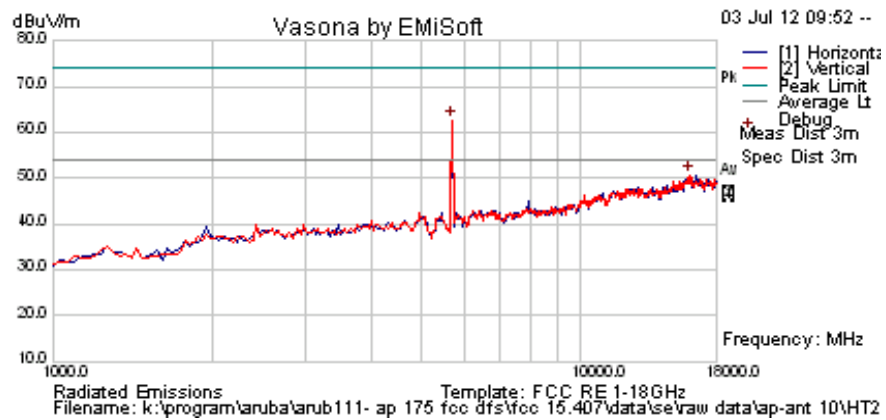

### Formally measured emission peaks

| Frequency MHz | Raw dBuV | Cable Loss | AF dB | Level dBuV/m | Measurement Type | Pol | Hgt cm | Azt Deg | Limit dBuV/m | Margin dB | Pass /Fail | Comments |
|---------------|----------|------------|-------|--------------|------------------|-----|--------|---------|--------------|-----------|------------|----------|
| 5701.403      | 67.6     | 4.7        | -9.6  | 62.8         | Peak [Scan]      |     |        |         |              |           |            | Fund     |
| 15989.98      | 41.6     | 9.0        | 0.1   | 50.7         | Peak [Scan]      | V   | 100    | 0       | 54.0         | -3.3      | Pass       | Noise    |

Legend: TX = Transmitter Emissions; DIG = Digital Emissions; FUND = Fundamental; WB = Wideband Emission  
 NRB = Non-Restricted Band. Limit = 68.23 dBuV/m; RB = Restricted Band. Limits per 15.205

This test report may be reproduced in full only. The document may only be updated by MiCOM Labs personnel. Any changes will be noted in the Document History section of the report.





**Title:** Aruba AP-175 802.11a/b/g/n Wireless AP  
**To:** FCC 47 CFR Part 15.407 & IC RSS-210  
**Serial #:** ARUB111-U1 Rev B  
**Issue Date:** 12th August 2013  
**Page:** 121 of 185

**5250 – 5350 MHz, 802.11n HT-40**

|                      |                         |                       |      |
|----------------------|-------------------------|-----------------------|------|
| <b>Test Freq.</b>    | 5270 MHz                | <b>Engineer</b>       | JMH  |
| <b>Variant</b>       | 802.11n HT-40; 13.5 MCS | <b>Temp (°C)</b>      | 25   |
| <b>Freq. Range</b>   | 1000 MHz - 18000 MHz    | <b>Rel. Hum.(%)</b>   | 31   |
| <b>Power Setting</b> | 17                      | <b>Press. (mBars)</b> | 1008 |
| <b>Antenna</b>       | AP-ANT10                | <b>Duty Cycle (%)</b> | 100  |
| <b>Test Notes 1</b>  |                         |                       |      |
| <b>Test Notes 2</b>  |                         |                       |      |

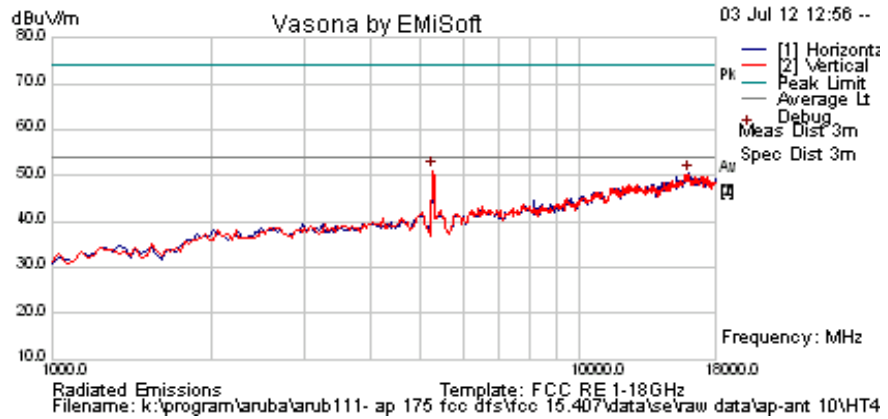

**Formally measured emission peaks**

| Frequency MHz   | Raw dBuV | Cable Loss | AF dB | Level dBuV/m | Measurement Type | Pol | Hgt cm | Azt Deg | Limit dBuV/m | Margin dB | Pass /Fail | Comments |
|---|----------|------------|-------|--------------|------------------|-----|--------|---------|--------------|-----------|------------|----------|
| 5258.517  | 56.3     | 4.6        | -9.7  | 51.2         | Peak [Scan]      |     |        |         |              |           |            | FUND     |
| 15989.98  | 41.4     | 9.0        | 0.1   | 50.5         | Peak [Scan]      | H   | 150    | 0       | 54.0         | -3.5      | Pass       | Noise    |
| Legend: TX = Transmitter Emissions; DIG = Digital Emissions; FUND = Fundamental; WB = Wideband Emission<br>NRB = Non-Restricted Band. Limit = 68.23 dBuV/m; RB = Restricted Band. Limits per 15.205 |          |            |       |              |                  |     |        |         |              |           |            |          |

This test report may be reproduced in full only. The document may only be updated by MiCOM Labs personnel. Any changes will be noted in the Document History section of the report.



**Title:** Aruba AP-175 802.11a/b/g/n Wireless AP  
**To:** FCC 47 CFR Part 15.407 & IC RSS-210  
**Serial #:** ARUB111-U1 Rev B  
**Issue Date:** 12th August 2013  
**Page:** 122 of 185

|                      |                         |                       |      |
|----------------------|-------------------------|-----------------------|------|
| <b>Test Freq.</b>    | 5310 MHz                | <b>Engineer</b>       | JMH  |
| <b>Variant</b>       | 802.11n HT-40; 13.5 MCS | <b>Temp (°C)</b>      | 25   |
| <b>Freq. Range</b>   | 1000 MHz - 18000 MHz    | <b>Rel. Hum.(%)</b>   | 31   |
| <b>Power Setting</b> | 17                      | <b>Press. (mBars)</b> | 1008 |
| <b>Antenna</b>       | AP-ANT10                | <b>Duty Cycle (%)</b> | 100  |
| <b>Test Notes 1</b>  |                         |                       |      |
| <b>Test Notes 2</b>  |                         |                       |      |

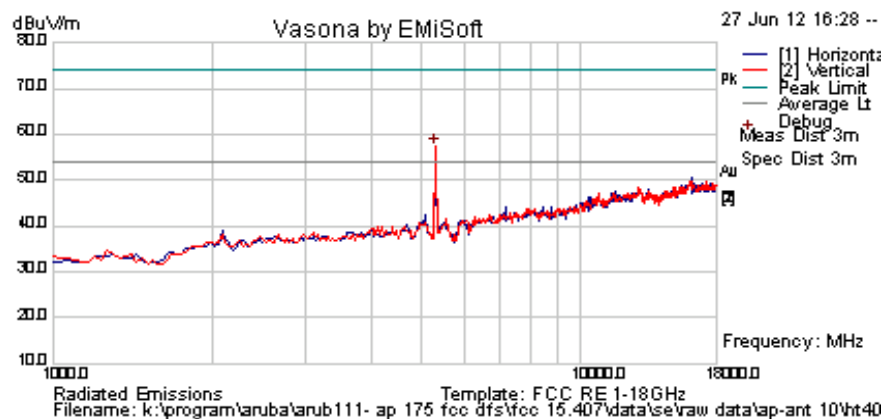

### Formally measured emission peaks

| Frequency MHz  | Raw dBuV | Cable Loss | AF dB | Level dBuV/m | Measurement Type | Pol | Hgt cm | Azt Deg | Limit dBuV/m | Margin dB | Pass /Fail | Comments |
|--|----------|------------|-------|--------------|------------------|-----|--------|---------|--------------|-----------|------------|----------|
| 5292.585   | 57.5     | 4.6        | -9.6  | 52.5         | Peak [Scan]      |     |        |         |              |           |            | FUND     |
| 15921.844  | 49.1     | 8.9        | -0.1  | 57.9         | Peak Max         | V   | 98     | 258     | 74.0         | -16.1     | Pass       |          |
| 15921.844  | 33.2     | 8.9        | -0.1  | 42.0         | Average Max      | V   | 98     | 258     | 54           | -12.0     | Pass       |          |
| Legend: TX = Transmitter Emissions; DIG = Digital Emissions; FUND = Fundamental; WB = Wideband Emission<br>NR = Non-Restricted Band. Limit = 68.23 dBuV/m; RB = Restricted Band. Limits per 15.205 |          |            |       |              |                  |     |        |         |              |           |            |          |

This test report may be reproduced in full only. The document may only be updated by MiCOM Labs personnel. Any changes will be noted in the Document History section of the report.



**Title:** Aruba AP-175 802.11a/b/g/n Wireless AP  
**To:** FCC 47 CFR Part 15.407 & IC RSS-210  
**Serial #:** ARUB111-U1 Rev B  
**Issue Date:** 12th August 2013  
**Page:** 123 of 185

**5470 – 5725 MHz, 802.11n HT-40**

|                      |                         |                       |      |
|----------------------|-------------------------|-----------------------|------|
| <b>Test Freq.</b>    | 5510 MHz                | <b>Engineer</b>       | SB   |
| <b>Variant</b>       | 802.11n HT-40; 13.5 MCS | <b>Temp (°C)</b>      | 26.6 |
| <b>Freq. Range</b>   | 1000 MHz - 18000 MHz    | <b>Rel. Hum.(%)</b>   | 31   |
| <b>Power Setting</b> | 21                      | <b>Press. (mBars)</b> | 1008 |
| <b>Antenna</b>       | AP-ANT10                | <b>Duty Cycle (%)</b> | 100  |
| <b>Test Notes 1</b>  |                         |                       |      |
| <b>Test Notes 2</b>  |                         |                       |      |

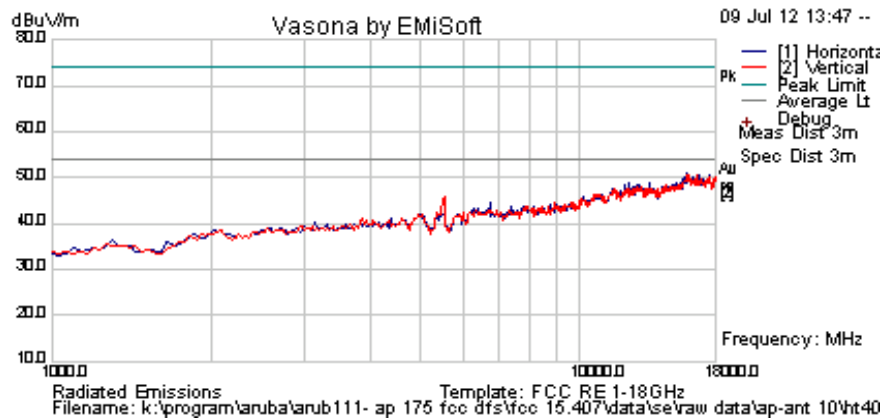

**Formally measured emission peaks**

| Frequency MHz   | Raw dBuV | Cable Loss | AF dB | Level dBuV/m | Measurement Type | Pol | Hgt cm | Azt Deg | Limit dBuV/m | Margin dB | Pass /Fail | Comments |
|---|----------|------------|-------|--------------|------------------|-----|--------|---------|--------------|-----------|------------|----------|
| Legend: TX = Transmitter Emissions; DIG = Digital Emissions; FUND = Fundamental; WB = Wideband Emission<br>NRB = Non-Restricted Band. Limit = 68.23 dBuV/m; RB = Restricted Band. Limits per 15.205 |          |            |       |              |                  |     |        |         |              |           |            |          |

This test report may be reproduced in full only. The document may only be updated by MiCOM Labs personnel. Any changes will be noted in the Document History section of the report.



**Title:** Aruba AP-175 802.11a/b/g/n Wireless AP  
**To:** FCC 47 CFR Part 15.407 & IC RSS-210  
**Serial #:** ARUB111-U1 Rev B  
**Issue Date:** 12th August 2013  
**Page:** 124 of 185

|                      |                         |                       |      |
|----------------------|-------------------------|-----------------------|------|
| <b>Test Freq.</b>    | 5550 MHz                | <b>Engineer</b>       | SB   |
| <b>Variant</b>       | 802.11n HT-40; 13.5 MCS | <b>Temp (°C)</b>      | 26.6 |
| <b>Freq. Range</b>   | 1000 MHz - 18000 MHz    | <b>Rel. Hum.(%)</b>   | 31   |
| <b>Power Setting</b> | 21                      | <b>Press. (mBars)</b> | 1008 |
| <b>Antenna</b>       | AP-ANT10                | <b>Duty Cycle (%)</b> | 100  |
| <b>Test Notes 1</b>  |                         |                       |      |
| <b>Test Notes 2</b>  |                         |                       |      |

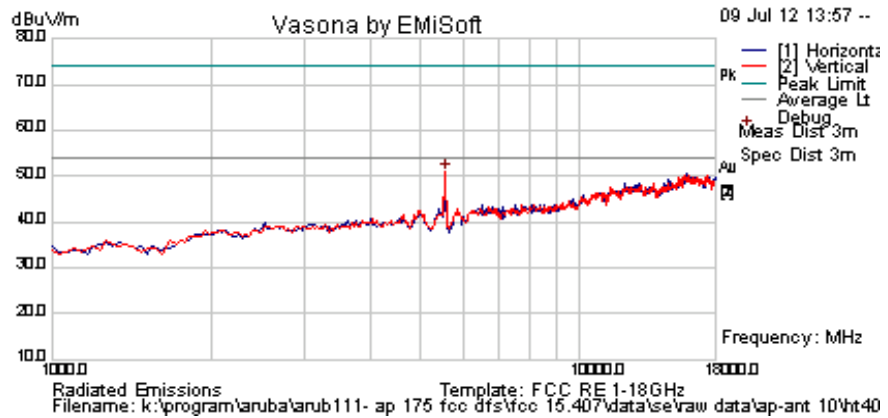

### Formally measured emission peaks

| Frequency MHz | Raw dBuV | Cable Loss | AF dB | Level dBuV/m | Measurement Type | Pol | Hgt cm | Azt Deg | Limit dBuV/m | Margin dB | Pass /Fail | Comments |
|---------------|----------|------------|-------|--------------|------------------|-----|--------|---------|--------------|-----------|------------|----------|
| 5565.130      | 56.0     | 4.7        | -9.7  | 50.9         | Peak [Scan]      | V   | 100    | 0       |              |           |            | FUND     |

Legend: TX = Transmitter Emissions; DIG = Digital Emissions; FUND = Fundamental; WB = Wideband Emission  
 NRB = Non-Restricted Band. Limit = 68.23 dBuV/m; RB = Restricted Band. Limits per 15.205

This test report may be reproduced in full only. The document may only be updated by MiCOM Labs personnel. Any changes will be noted in the Document History section of the report.



**Title:** Aruba AP-175 802.11a/b/g/n Wireless AP  
**To:** FCC 47 CFR Part 15.407 & IC RSS-210  
**Serial #:** ARUB111-U1 Rev B  
**Issue Date:** 12th August 2013  
**Page:** 125 of 185

|                      |                         |                       |      |
|----------------------|-------------------------|-----------------------|------|
| <b>Test Freq.</b>    | 5670 MHz                | <b>Engineer</b>       | SB   |
| <b>Variant</b>       | 802.11n HT-40; 13.5 MCS | <b>Temp (°C)</b>      | 26.6 |
| <b>Freq. Range</b>   | 1000 MHz - 18000 MHz    | <b>Rel. Hum.(%)</b>   | 31   |
| <b>Power Setting</b> | 21                      | <b>Press. (mBars)</b> | 1008 |
| <b>Antenna</b>       | AP-ANT10                | <b>Duty Cycle (%)</b> | 100  |
| <b>Test Notes 1</b>  |                         |                       |      |
| <b>Test Notes 2</b>  |                         |                       |      |

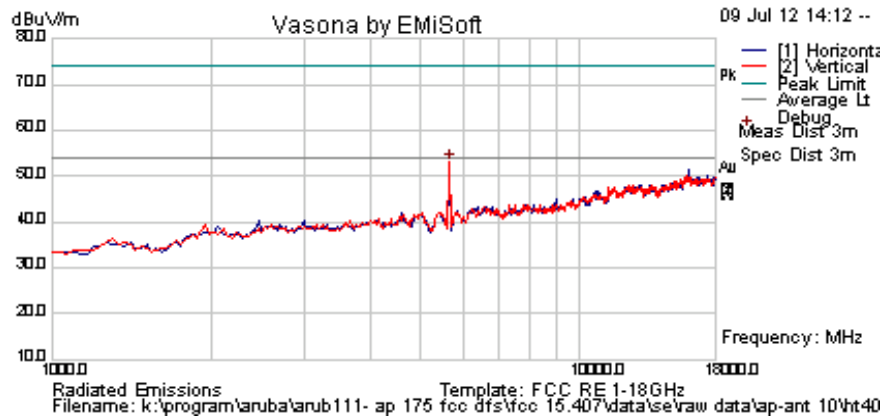

**Formally measured emission peaks**

| Frequency MHz | Raw dBuV | Cable Loss | AF dB | Level dBuV/m | Measurement Type | Pol | Hgt cm | Azt Deg | Limit dBuV/m | Margin dB | Pass /Fail | Comments |
|---------------|----------|------------|-------|--------------|------------------|-----|--------|---------|--------------|-----------|------------|----------|
| 5667.335      | 58.1     | 4.7        | -9.7  | 53.1         | Peak [Scan]      | V   | 100    | 0       |              |           |            | FUND     |

Legend: TX = Transmitter Emissions; DIG = Digital Emissions; FUND = Fundamental; WB = Wideband Emission  
 NRB = Non-Restricted Band. Limit = 68.23 dBuV/m; RB = Restricted Band. Limits per 15.205

This test report may be reproduced in full only. The document may only be updated by MiCOM Labs personnel. Any changes will be noted in the Document History section of the report.



Radiated Band-Edge spurious emissions Antenna AP-ANT-10

5320 MHz - 802.11a Legacy 5350 - 5460 MHz



Date: 27.JUN.2012 15:01:38

This test report may be reproduced in full only. The document may only be updated by MiCOM Labs personnel. Any changes will be noted in the Document History section of the report.



5320 MHz - 802.11n HT-20 5350 - 5460 MHz

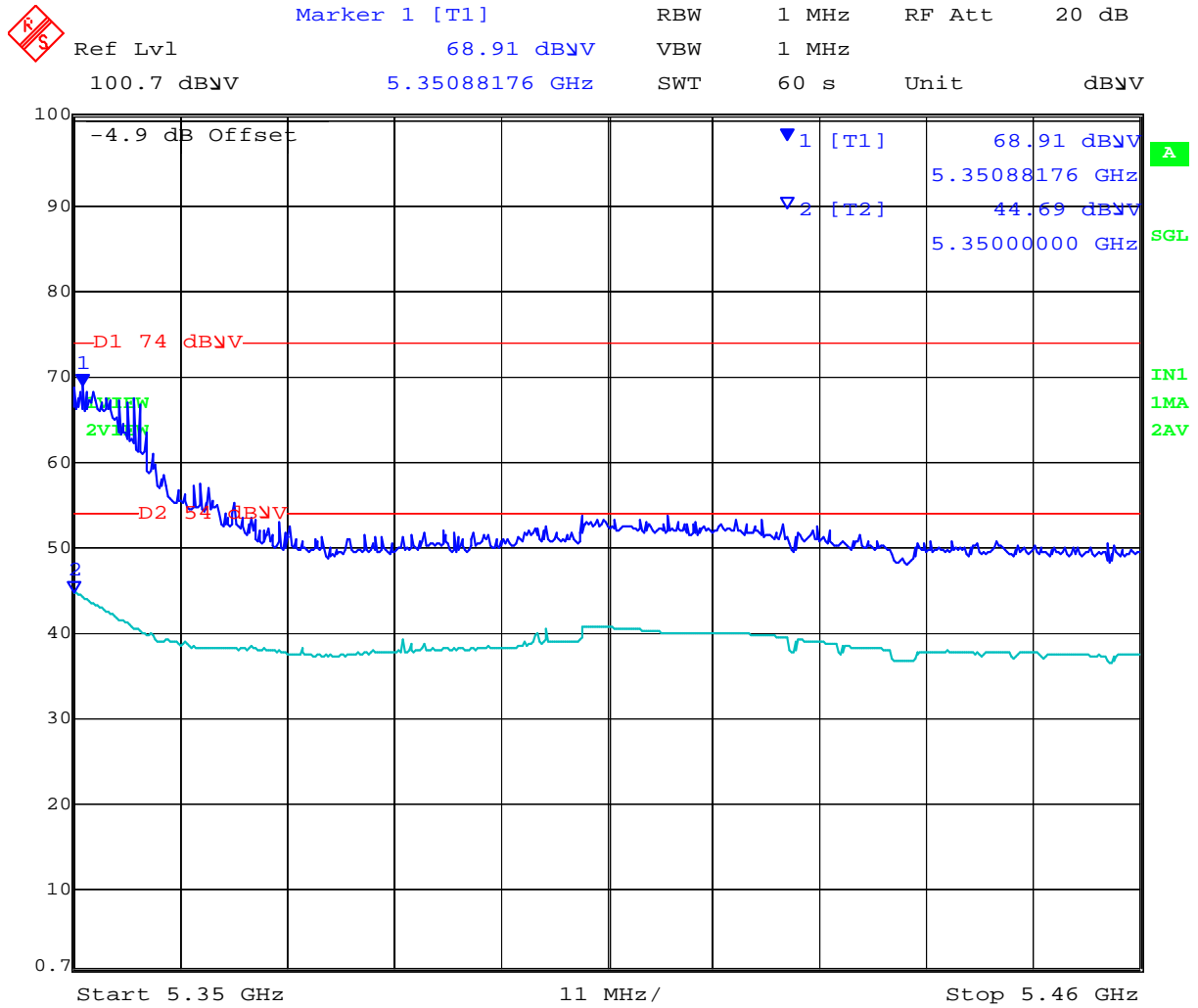

Date: 27.JUN.2012 15:03:12

This test report may be reproduced in full only. The document may only be updated by MiCOM Labs personnel. Any changes will be noted in the Document History section of the report.



5310 MHz - 802.11n HT-40 5350 - 5460 MHz

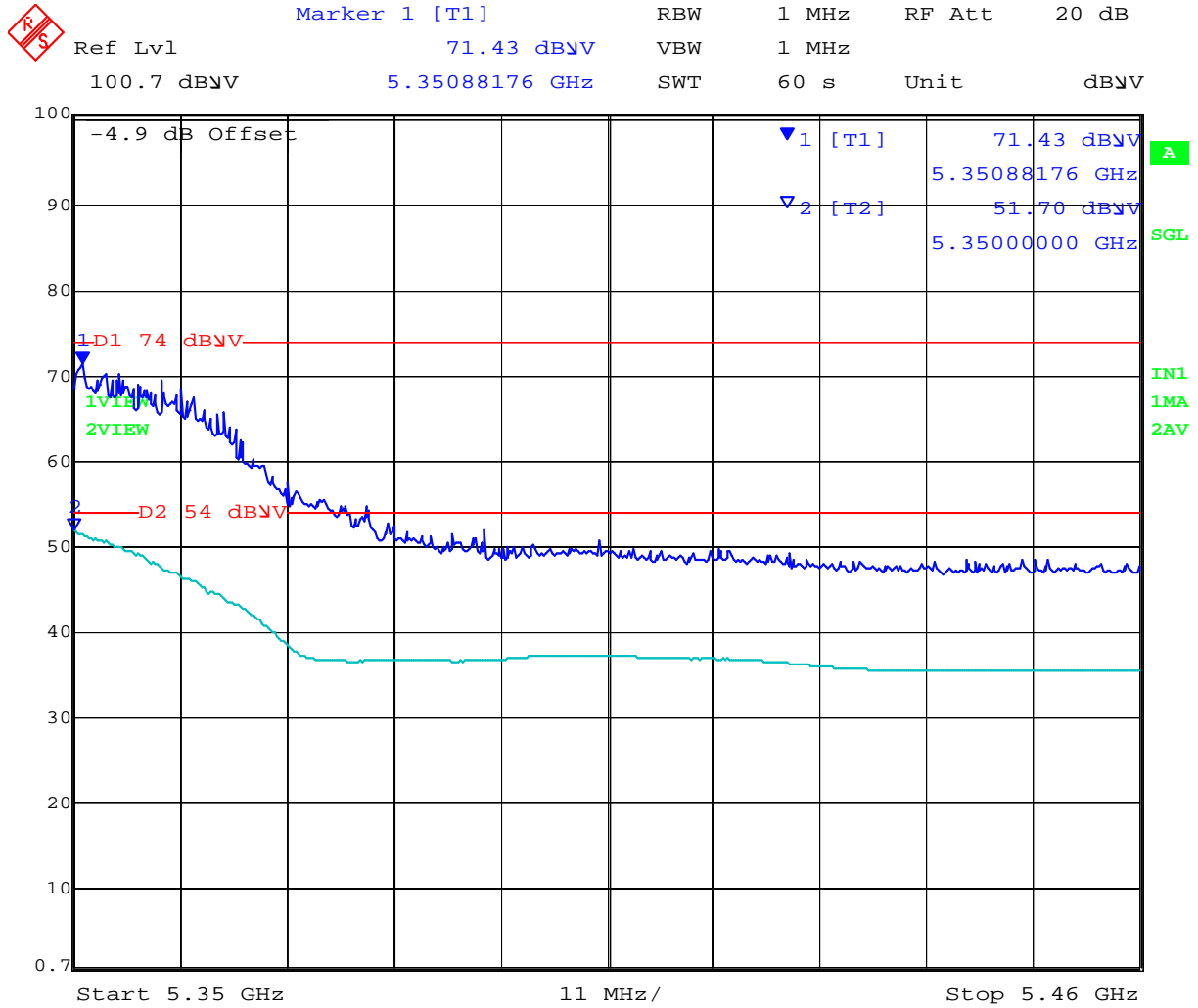

Date: 27.JUN.2012 15:05:32

NOTE: Power Reduction Required ART = 17

This test report may be reproduced in full only. The document may only be updated by MiCOM Labs personnel. Any changes will be noted in the Document History section of the report.





5500 MHz - 802.11a Legacy 5350 - 5460 MHz

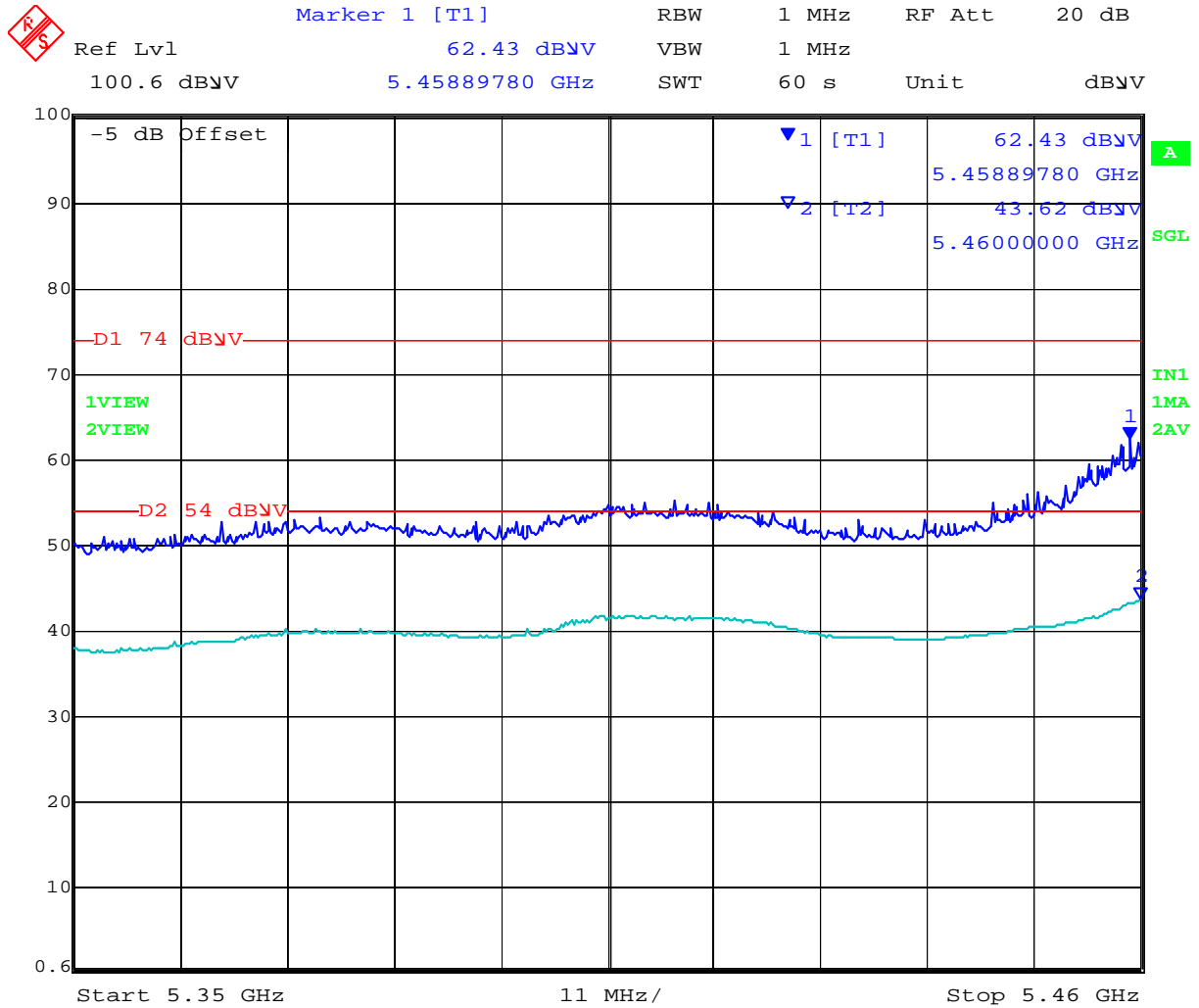

Date: 27.JUN.2012 15:14:56

This test report may be reproduced in full only. The document may only be updated by MiCOM Labs personnel. Any changes will be noted in the Document History section of the report.



5500 MHz - 802.11n HT-20 5350 - 5460 MHz

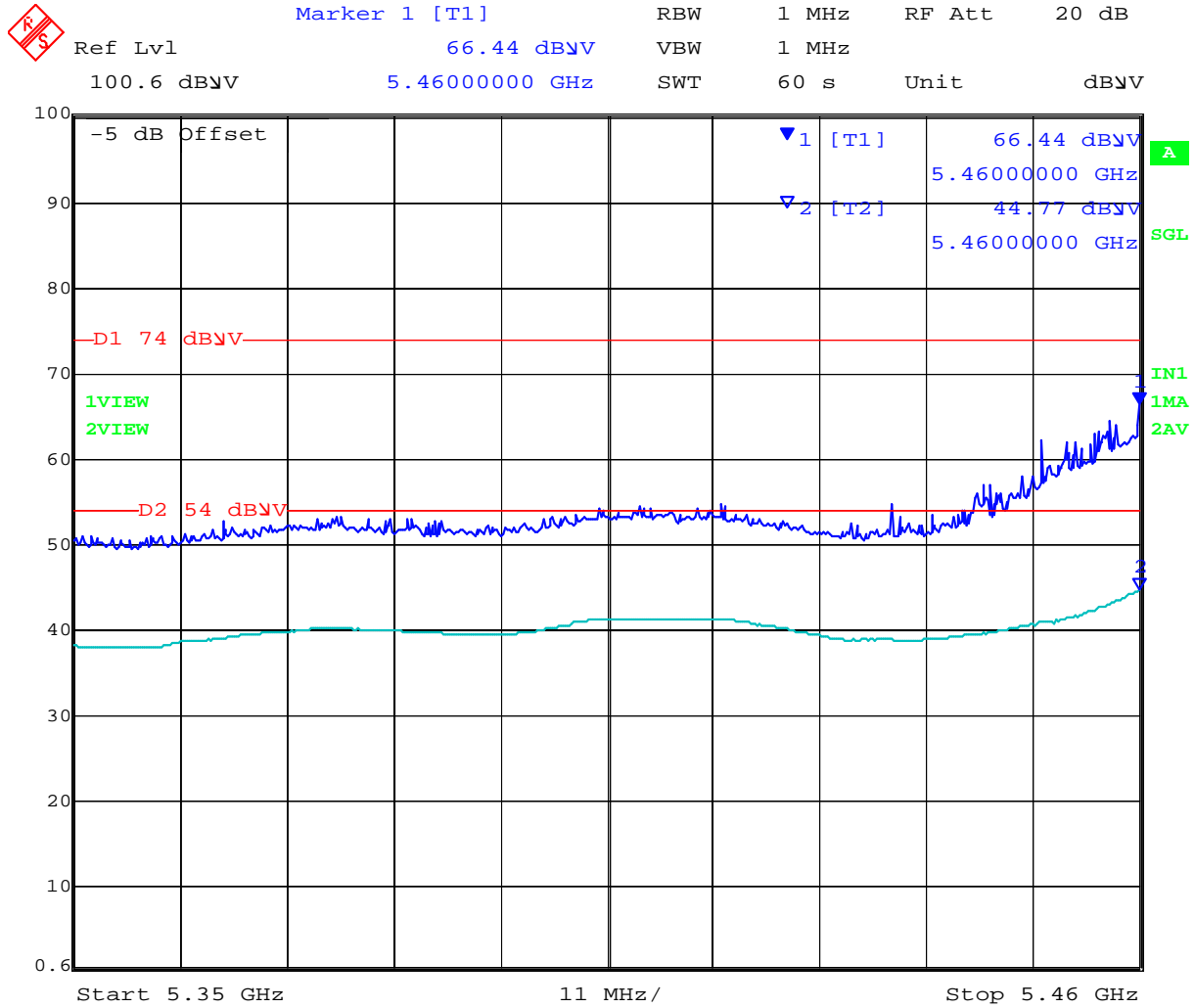

Date: 27.JUN.2012 15:18:29

This test report may be reproduced in full only. The document may only be updated by MiCOM Labs personnel. Any changes will be noted in the Document History section of the report.



5510 MHz - 802.11n HT-40 5350 - 5460 MHz

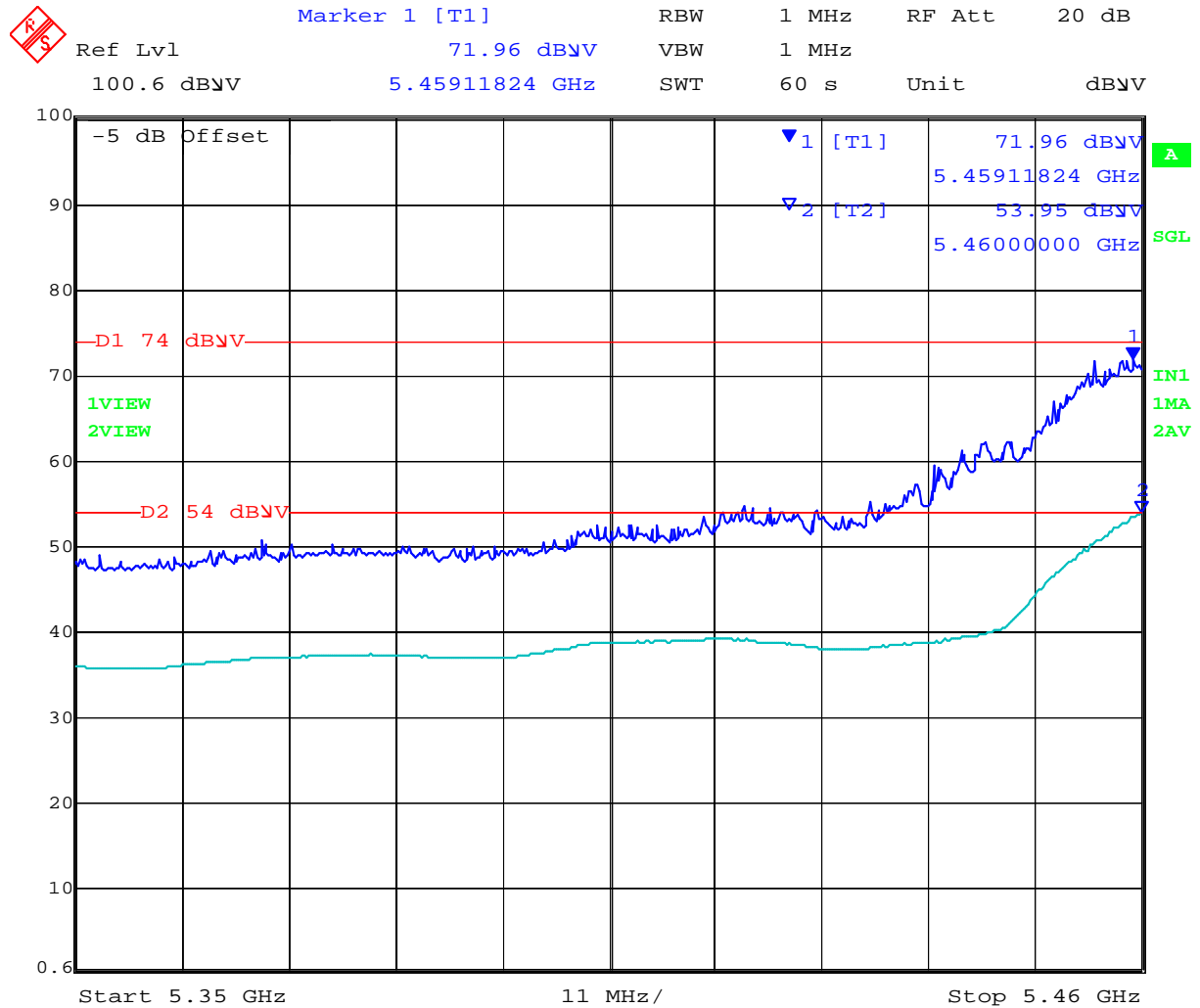

Date: 27.JUN.2012 15:26:43

NOTE: Power Reduction Required ART = 17

This test report may be reproduced in full only. The document may only be updated by MiCOM Labs personnel. Any changes will be noted in the Document History section of the report.



### Radiated Spurious Emissions – Above 1 GHz

Antenna AP-ANT-86D

#### 5250 – 5350 MHz, 802.11a Legacy

|                      |                      |                       |      |
|----------------------|----------------------|-----------------------|------|
| <b>Test Freq.</b>    | 5260 MHz             | <b>Engineer</b>       | SB   |
| <b>Variant</b>       | 802.11a; 6 Mbs       | <b>Temp (°C)</b>      | 26.6 |
| <b>Freq. Range</b>   | 1000 MHz - 18000 MHz | <b>Rel. Hum.(%)</b>   | 31   |
| <b>Power Setting</b> | 19                   | <b>Press. (mBars)</b> | 1008 |
| <b>Antenna</b>       | AP-ANT86D            | <b>Duty Cycle (%)</b> | 100  |
| <b>Test Notes 1</b>  |                      |                       |      |
| <b>Test Notes 2</b>  |                      |                       |      |

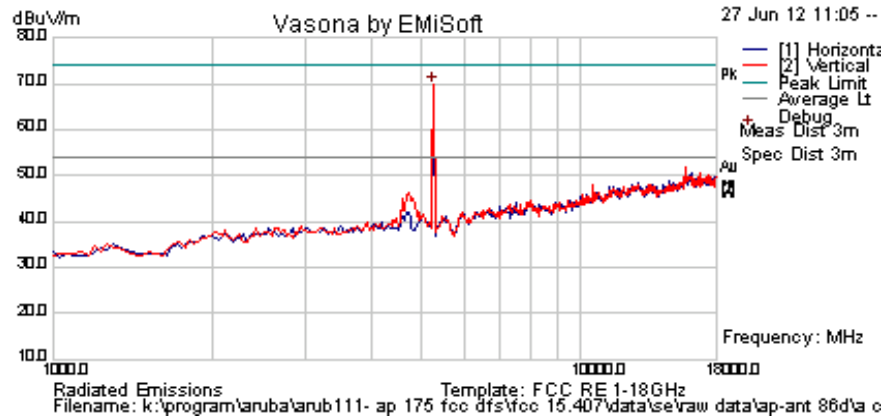

#### Formally measured emission peaks

| Frequency MHz | Raw dBuV | Cable Loss | AF dB | Level dBuV/m | Measurement Type | PoI | Hgt cm | Azt Deg | Limit dBuV/m | Margin dB | Pass /Fail | Comments |
|---------------|----------|------------|-------|--------------|------------------|-----|--------|---------|--------------|-----------|------------|----------|
| 5258.517      | 74.8     | 4.6        | -9.7  | 69.7         | Peak [Scan]      | V   | 150    |         |              |           |            | FUND     |

Legend: TX = Transmitter Emissions; DIG = Digital Emissions; FUND = Fundamental; WB = Wideband Emission  
 NRB = Non-Restricted Band. Limit = 68.23 dBuV/m; RB = Restricted Band. Limits per 15.205

This test report may be reproduced in full only. The document may only be updated by MiCOM Labs personnel. Any changes will be noted in the Document History section of the report.



**Title:** Aruba AP-175 802.11a/b/g/n Wireless AP  
**To:** FCC 47 CFR Part 15.407 & IC RSS-210  
**Serial #:** ARUB111-U1 Rev B  
**Issue Date:** 12th August 2013  
**Page:** 133 of 185

|                      |                      |                       |      |
|----------------------|----------------------|-----------------------|------|
| <b>Test Freq.</b>    | 5300 MHz             | <b>Engineer</b>       | SB   |
| <b>Variant</b>       | 802.11a; 6 Mbs       | <b>Temp (°C)</b>      | 26.6 |
| <b>Freq. Range</b>   | 1000 MHz - 18000 MHz | <b>Rel. Hum.(%)</b>   | 31   |
| <b>Power Setting</b> | 19                   | <b>Press. (mBars)</b> | 1008 |
| <b>Antenna</b>       | AP-ANT86D            | <b>Duty Cycle (%)</b> | 100  |
| <b>Test Notes 1</b>  |                      |                       |      |
| <b>Test Notes 2</b>  |                      |                       |      |

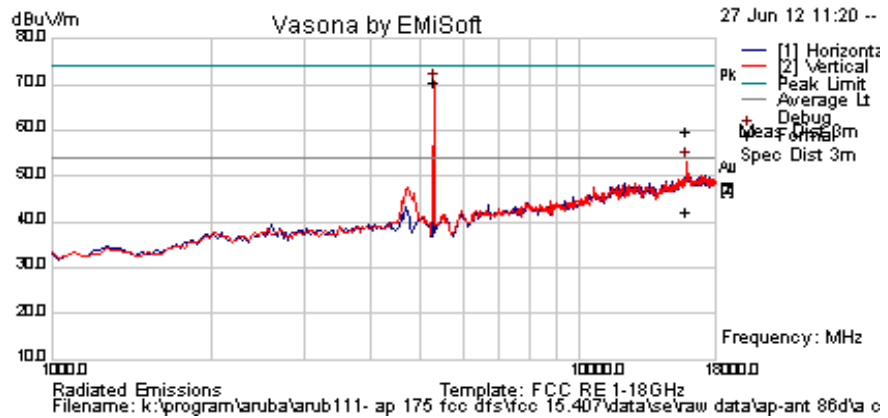

### Formally measured emission peaks

| Frequency MHz   | Raw dBuV | Cable Loss | AF dB | Level dBuV/m | Measurement Type | Pol | Hgt cm | Azt Deg | Limit dBuV/m | Margin dB | Pass /Fail | Comments |
|---|----------|------------|-------|--------------|------------------|-----|--------|---------|--------------|-----------|------------|----------|
| 15898.037   | 51.1     | 8.9        | -0.2  | 59.8         | Peak Max         | V   | 139    | 74      | 74.0         | -14.2     | Pass       |          |
| 15898.037   | 33.4     | 8.9        | -0.2  | 42.1         | Average Max      | V   | 139    | 74      | 54.0         | -11.9     | Pass       |          |
| 5292.585  | 75.5     | 4.6        | -9.6  | 70.5         | Peak [Scan]      | V   | 150    |         |              |           |            | FUND     |
| Legend: TX = Transmitter Emissions; DIG = Digital Emissions; FUND = Fundamental; WB = Wideband Emission<br>NRB = Non-Restricted Band. Limit = 68.23 dBuV/m; RB = Restricted Band. Limits per 15.205 |          |            |       |              |                  |     |        |         |              |           |            |          |

This test report may be reproduced in full only. The document may only be updated by MiCOM Labs personnel. Any changes will be noted in the Document History section of the report.



**Title:** Aruba AP-175 802.11a/b/g/n Wireless AP  
**To:** FCC 47 CFR Part 15.407 & IC RSS-210  
**Serial #:** ARUB111-U1 Rev B  
**Issue Date:** 12th August 2013  
**Page:** 134 of 185

|                      |                      |                       |      |
|----------------------|----------------------|-----------------------|------|
| <b>Test Freq.</b>    | 5320 MHz             | <b>Engineer</b>       | SB   |
| <b>Variant</b>       | 802.11a; 6 Mbs       | <b>Temp (°C)</b>      | 26.6 |
| <b>Freq. Range</b>   | 1000 MHz - 18000 MHz | <b>Rel. Hum.(%)</b>   | 31   |
| <b>Power Setting</b> | 19                   | <b>Press. (mBars)</b> | 1008 |
| <b>Antenna</b>       | AP-ANT86D            | <b>Duty Cycle (%)</b> | 100  |
| <b>Test Notes 1</b>  |                      |                       |      |
| <b>Test Notes 2</b>  |                      |                       |      |

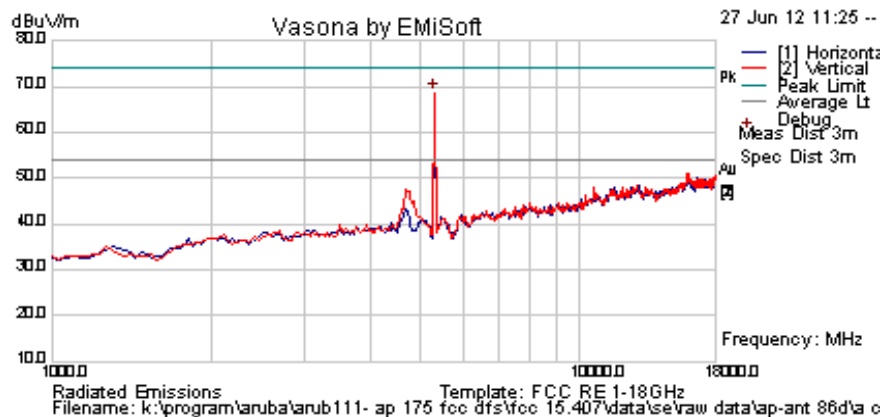

### Formally measured emission peaks

| Frequency MHz   | Raw dBuV | Cable Loss | AF dB | Level dBuV/m | Measurement Type | Pol | Hgt cm | Azt Deg | Limit dBuV/m | Margin dB | Pass /Fail | Comments |
|---|----------|------------|-------|--------------|------------------|-----|--------|---------|--------------|-----------|------------|----------|
| 5292.585  | 73.6     | 4.6        | -9.6  | 68.7         | Peak [Scan]      | V   | 150    |         |              |           |            | FUND     |
| Legend: TX = Transmitter Emissions; DIG = Digital Emissions; FUND = Fundamental; WB = Wideband Emission<br>NRB = Non-Restricted Band. Limit = 68.23 dBuV/m; RB = Restricted Band. Limits per 15.205 |          |            |       |              |                  |     |        |         |              |           |            |          |

This test report may be reproduced in full only. The document may only be updated by MiCOM Labs personnel. Any changes will be noted in the Document History section of the report.



**Title:** Aruba AP-175 802.11a/b/g/n Wireless AP  
**To:** FCC 47 CFR Part 15.407 & IC RSS-210  
**Serial #:** ARUB111-U1 Rev B  
**Issue Date:** 12th August 2013  
**Page:** 135 of 185

**5470 – 5725 MHz, 802.11a Legacy**

|                      |                      |                       |      |
|----------------------|----------------------|-----------------------|------|
| <b>Test Freq.</b>    | 5500 MHz             | <b>Engineer</b>       | SB   |
| <b>Variant</b>       | 802.11a; 6 Mbs       | <b>Temp (°C)</b>      | 26.6 |
| <b>Freq. Range</b>   | 1000 MHz - 18000 MHz | <b>Rel. Hum.(%)</b>   | 31   |
| <b>Power Setting</b> | 21                   | <b>Press. (mBars)</b> | 1008 |
| <b>Antenna</b>       | AP-ANT86D            | <b>Duty Cycle (%)</b> | 100  |
| <b>Test Notes 1</b>  |                      |                       |      |
| <b>Test Notes 2</b>  |                      |                       |      |

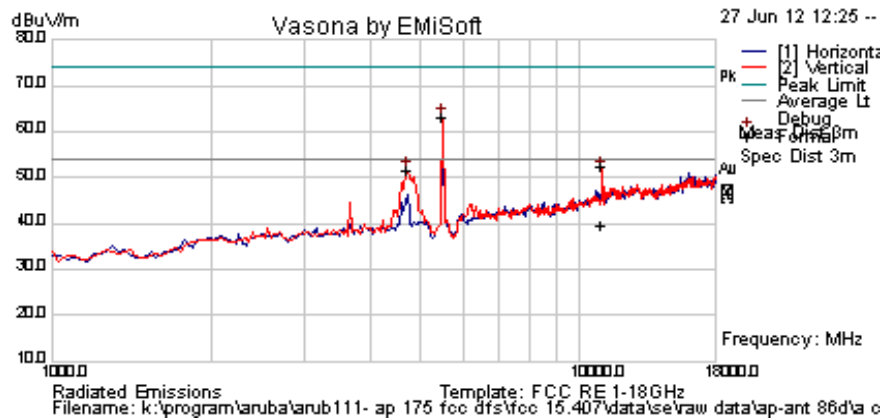

**Formally measured emission peaks**

| Frequency MHz   | Raw dBuV | Cable Loss | AF dB | Level dBuV/m | Measurement Type | Pol | Hgt cm | Azt Deg | Limit dBuV/m | Margin dB | Pass /Fail | Comments |
|---|----------|------------|-------|--------------|------------------|-----|--------|---------|--------------|-----------|------------|----------|
| 10997.755   | 48.7     | 7.0        | -3.1  | 52.6         | Peak Max         | V   | 141    | 319     | 74.0         | -21.5     | Pass       |          |
| 10997.755   | 35.8     | 7.0        | -3.1  | 39.7         | Average Max      | V   | 141    | 319     | 54.0         | -14.3     | Pass       |          |
| 5496.994  | 68.1     | 4.6        | -9.6  | 63.1         | Peak [Scan]      | V   | 150    |         |              |           |            | FUND     |
| 4713.427  | 56.9     | 4.4        | -9.8  | 51.5         | Peak [Scan]      | V   | 150    |         |              |           |            | BE       |
| Legend: TX = Transmitter Emissions; DIG = Digital Emissions; FUND = Fundamental; WB = Wideband Emission<br>NRB = Non-Restricted Band. Limit = 68.23 dBuV/m; RB = Restricted Band. Limits per 15.205 |          |            |       |              |                  |     |        |         |              |           |            |          |

This test report may be reproduced in full only. The document may only be updated by MiCOM Labs personnel. Any changes will be noted in the Document History section of the report.



**Title:** Aruba AP-175 802.11a/b/g/n Wireless AP  
**To:** FCC 47 CFR Part 15.407 & IC RSS-210  
**Serial #:** ARUB111-U1 Rev B  
**Issue Date:** 12th August 2013  
**Page:** 136 of 185

|                      |                      |                       |      |
|----------------------|----------------------|-----------------------|------|
| <b>Test Freq.</b>    | 5580 MHz             | <b>Engineer</b>       | SB   |
| <b>Variant</b>       | 802.11a; 6 Mbs       | <b>Temp (°C)</b>      | 26.6 |
| <b>Freq. Range</b>   | 1000 MHz - 18000 MHz | <b>Rel. Hum.(%)</b>   | 31   |
| <b>Power Setting</b> | 21                   | <b>Press. (mBars)</b> | 1008 |
| <b>Antenna</b>       | AP-ANT86D            | <b>Duty Cycle (%)</b> | 100  |
| <b>Test Notes 1</b>  |                      |                       |      |
| <b>Test Notes 2</b>  |                      |                       |      |

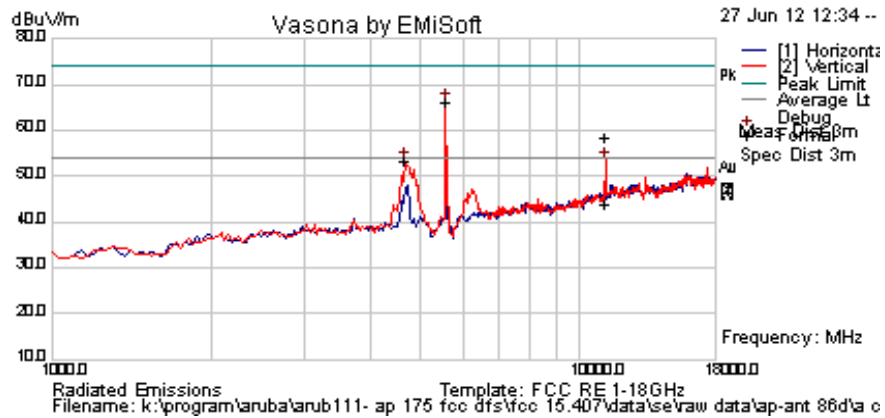

**Formally measured emission peaks**

| Frequency MHz   | Raw dBuV | Cable Loss | AF dB | Level dBuV/m | Measurement Type | Pol | Hgt cm | Azt Deg | Limit dBuV/m | Margin dB | Pass /Fail | Comments |
|---|----------|------------|-------|--------------|------------------|-----|--------|---------|--------------|-----------|------------|----------|
| 11162.245   | 54.3     | 6.9        | -3.0  | 58.3         | Peak Max         | V   | 132    | 271     | 74.0         | -15.7     | Pass       |          |
| 11162.245   | 40.0     | 6.9        | -3.0  | 43.9         | Average Max      | V   | 132    | 271     | 54.0         | -10.1     | Pass       |          |
| 5565.130  | 71.2     | 4.7        | -9.7  | 66.2         | Peak [Scan]      | V   | 150    |         |              |           |            | FUND     |
| 4679.359  | 58.7     | 4.3        | -9.9  | 53.2         | Peak [Scan]      | V   | 150    |         |              |           |            | BE       |
| Legend: TX = Transmitter Emissions; DIG = Digital Emissions; FUND = Fundamental; WB = Wideband Emission<br>NRB = Non-Restricted Band. Limit = 68.23 dBuV/m; RB = Restricted Band. Limits per 15.205 |          |            |       |              |                  |     |        |         |              |           |            |          |

This test report may be reproduced in full only. The document may only be updated by MiCOM Labs personnel. Any changes will be noted in the Document History section of the report.





**Title:** Aruba AP-175 802.11a/b/g/n Wireless AP  
**To:** FCC 47 CFR Part 15.407 & IC RSS-210  
**Serial #:** ARUB111-U1 Rev B  
**Issue Date:** 12th August 2013  
**Page:** 137 of 185

|                      |                      |                       |      |
|----------------------|----------------------|-----------------------|------|
| <b>Test Freq.</b>    | 5700 MHz             | <b>Engineer</b>       | SB   |
| <b>Variant</b>       | 802.11a; 6 Mbs       | <b>Temp (°C)</b>      | 26.6 |
| <b>Freq. Range</b>   | 1000 MHz - 18000 MHz | <b>Rel. Hum.(%)</b>   | 31   |
| <b>Power Setting</b> | 21                   | <b>Press. (mBars)</b> | 1008 |
| <b>Antenna</b>       | AP-ANT86D            | <b>Duty Cycle (%)</b> | 100  |
| <b>Test Notes 1</b>  |                      |                       |      |
| <b>Test Notes 2</b>  |                      |                       |      |

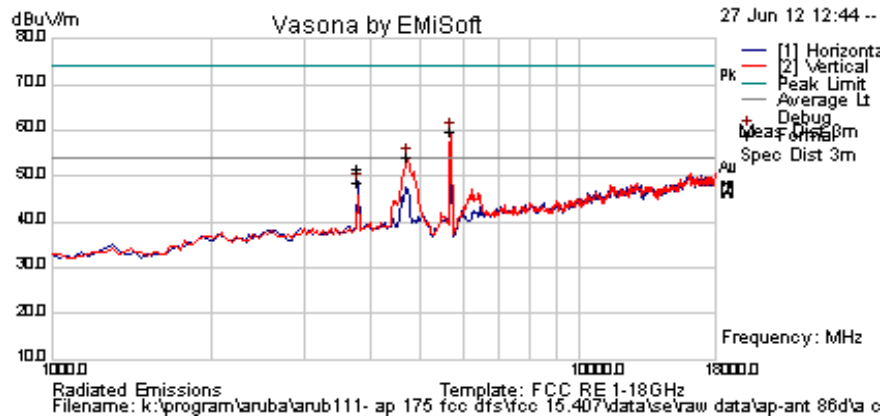

### Formally measured emission peaks

| Frequency MHz   | Raw dBuV | Cable Loss | AF dB | Level dBuV/m | Measurement Type | Pol | Hgt cm | Azt Deg | Limit dBuV/m | Margin dB | Pass /Fail | Comments |
|---|----------|------------|-------|--------------|------------------|-----|--------|---------|--------------|-----------|------------|----------|
| 3799.948  | 58.9     | 3.8        | -10.9 | 51.8         | Peak Max         | H   | 101    | 347     | 74.0         | -22.3     | Pass       |          |
| 3799.947976   | 55.7     | 3.8        | -10.9 | 48.5         | Average Max      | H   | 101    | 347     | 54.0         | -5.5      | Pass       |          |
| 5701.403  | 64.6     | 4.7        | -9.6  | 59.7         | Peak [Scan]      | V   | 150    |         |              |           |            | FUND     |
| 4713.427  | 59.5     | 4.4        | -9.8  | 54.1         | Peak [Scan]      | V   | 150    |         |              |           |            | BE       |
| Legend: TX = Transmitter Emissions; DIG = Digital Emissions; FUND = Fundamental; WB = Wideband Emission<br>NRB = Non-Restricted Band. Limit = 68.23 dBuV/m; RB = Restricted Band. Limits per 15.205 |          |            |       |              |                  |     |        |         |              |           |            |          |

This test report may be reproduced in full only. The document may only be updated by MiCOM Labs personnel. Any changes will be noted in the Document History section of the report.



**Title:** Aruba AP-175 802.11a/b/g/n Wireless AP  
**To:** FCC 47 CFR Part 15.407 & IC RSS-210  
**Serial #:** ARUB111-U1 Rev B  
**Issue Date:** 12th August 2013  
**Page:** 138 of 185

**5250 – 5350 MHz, 802.11n HT-20**

|                      |                        |                       |      |
|----------------------|------------------------|-----------------------|------|
| <b>Test Freq.</b>    | 5260 MHz               | <b>Engineer</b>       | SB   |
| <b>Variant</b>       | 802.11n HT-20; 6.5 MCS | <b>Temp (°C)</b>      | 26.6 |
| <b>Freq. Range</b>   | 1000 MHz - 18000 MHz   | <b>Rel. Hum.(%)</b>   | 31   |
| <b>Power Setting</b> | 19                     | <b>Press. (mBars)</b> | 1008 |
| <b>Antenna</b>       | AP-ANT86D              | <b>Duty Cycle (%)</b> | 100  |
| <b>Test Notes 1</b>  |                        |                       |      |
| <b>Test Notes 2</b>  |                        |                       |      |

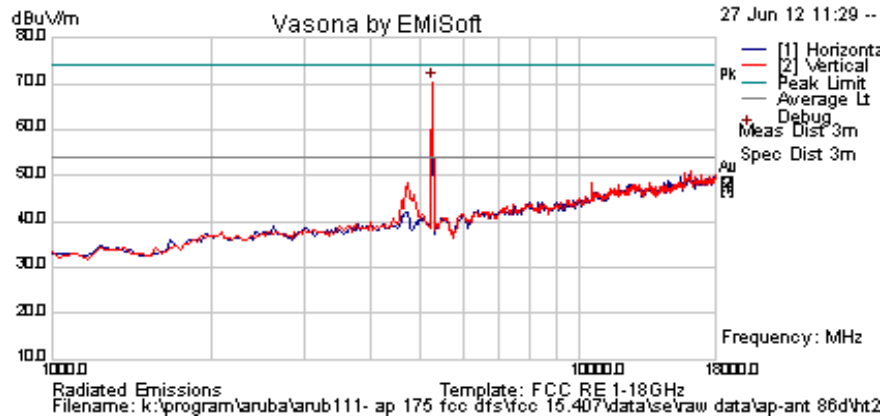

**Formally measured emission peaks**

| Frequency MHz | Raw dBuV | Cable Loss | AF dB | Level dBuV/m | Measurement Type | Pol | Hgt cm | Azt Deg | Limit dBuV/m | Margin dB | Pass /Fail | Comments |
|---------------|----------|------------|-------|--------------|------------------|-----|--------|---------|--------------|-----------|------------|----------|
| 5258.517      | 75.5     | 4.6        | -9.7  | 70.3         | Peak [Scan]      | V   | 150    |         |              |           |            | FUND     |

Legend: TX = Transmitter Emissions; DIG = Digital Emissions; FUND = Fundamental; WB = Wideband Emission  
 NRB = Non-Restricted Band. Limit = 68.23 dBuV/m; RB = Restricted Band. Limits per 15.205

This test report may be reproduced in full only. The document may only be updated by MiCOM Labs personnel. Any changes will be noted in the Document History section of the report.



**Title:** Aruba AP-175 802.11a/b/g/n Wireless AP  
**To:** FCC 47 CFR Part 15.407 & IC RSS-210  
**Serial #:** ARUB111-U1 Rev B  
**Issue Date:** 12th August 2013  
**Page:** 139 of 185

|                      |                        |                       |      |
|----------------------|------------------------|-----------------------|------|
| <b>Test Freq.</b>    | 5300 MHz               | <b>Engineer</b>       | SB   |
| <b>Variant</b>       | 802.11n HT-20; 6.5 MCS | <b>Temp (°C)</b>      | 26.6 |
| <b>Freq. Range</b>   | 1000 MHz - 18000 MHz   | <b>Rel. Hum.(%)</b>   | 31   |
| <b>Power Setting</b> | 19                     | <b>Press. (mBars)</b> | 1008 |
| <b>Antenna</b>       | AP-ANT86D              | <b>Duty Cycle (%)</b> | 100  |
| <b>Test Notes 1</b>  |                        |                       |      |
| <b>Test Notes 2</b>  |                        |                       |      |

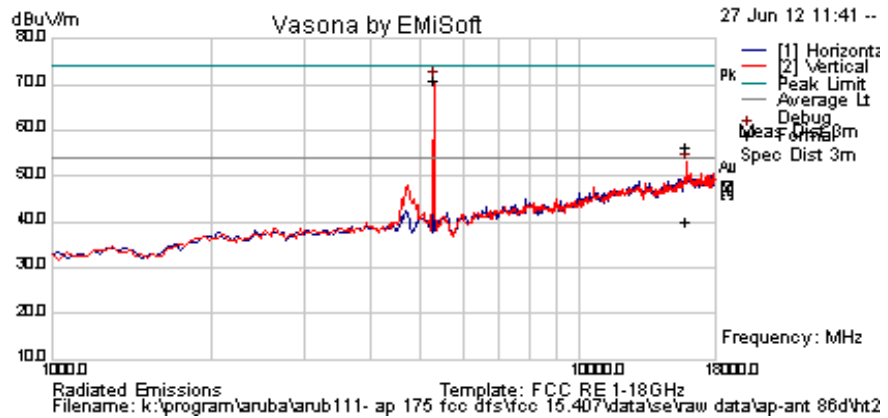

### Formally measured emission peaks

| Frequency MHz   | Raw dBuV | Cable Loss | AF dB | Level dBuV/m | Measurement Type | Pol | Hgt cm | Azt Deg | Limit dBuV/m | Margin dB | Pass /Fail | Comments |
|---|----------|------------|-------|--------------|------------------|-----|--------|---------|--------------|-----------|------------|----------|
| 15891.383   | 47.6     | 8.9        | -0.2  | 56.3         | Peak Max         | V   | 105    | 202     | 74.0         | -17.7     | Pass       |          |
| 15891.383   | 31.3     | 8.9        | -0.2  | 40.0         | Average Max      | V   | 105    | 202     | 54.0         | -14.0     | Pass       |          |
| 5292.585  | 75.8     | 4.6        | -9.6  | 70.8         | Peak [Scan]      | V   | 150    |         |              |           |            | FUND     |
| Legend: TX = Transmitter Emissions; DIG = Digital Emissions; FUND = Fundamental; WB = Wideband Emission<br>NRB = Non-Restricted Band. Limit = 68.23 dBuV/m; RB = Restricted Band. Limits per 15.205 |          |            |       |              |                  |     |        |         |              |           |            |          |

This test report may be reproduced in full only. The document may only be updated by MiCOM Labs personnel. Any changes will be noted in the Document History section of the report.



**Title:** Aruba AP-175 802.11a/b/g/n Wireless AP  
**To:** FCC 47 CFR Part 15.407 & IC RSS-210  
**Serial #:** ARUB111-U1 Rev B  
**Issue Date:** 12th August 2013  
**Page:** 140 of 185

|                      |                        |                       |      |
|----------------------|------------------------|-----------------------|------|
| <b>Test Freq.</b>    | 5320 MHz               | <b>Engineer</b>       | SB   |
| <b>Variant</b>       | 802.11n HT-20; 6.5 MCS | <b>Temp (°C)</b>      | 26.6 |
| <b>Freq. Range</b>   | 1000 MHz - 18000 MHz   | <b>Rel. Hum.(%)</b>   | 31   |
| <b>Power Setting</b> | 19                     | <b>Press. (mBars)</b> | 1008 |
| <b>Antenna</b>       | AP-ANT86D              | <b>Duty Cycle (%)</b> | 100  |
| <b>Test Notes 1</b>  |                        |                       |      |
| <b>Test Notes 2</b>  |                        |                       |      |

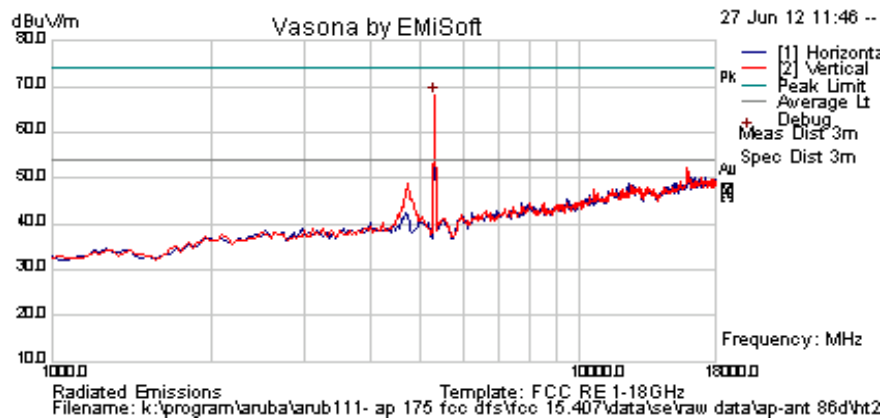

### Formally measured emission peaks

| Frequency MHz | Raw dBuV | Cable Loss | AF dB | Level dBuV/m | Measurement Type | Pol | Hgt cm | Azt Deg | Limit dBuV/m | Margin dB | Pass /Fail | Comments |
|---------------|----------|------------|-------|--------------|------------------|-----|--------|---------|--------------|-----------|------------|----------|
| 5292.585      | 73.1     | 4.6        | -9.6  | 68.1         | Peak [Scan]      | V   | 150    |         |              |           |            | FUND     |

Legend: TX = Transmitter Emissions; DIG = Digital Emissions; FUND = Fundamental; WB = Wideband Emission  
 NRB = Non-Restricted Band. Limit = 68.23 dBuV/m; RB = Restricted Band. Limits per 15.205

This test report may be reproduced in full only. The document may only be updated by MiCOM Labs personnel. Any changes will be noted in the Document History section of the report.



**Title:** Aruba AP-175 802.11a/b/g/n Wireless AP  
**To:** FCC 47 CFR Part 15.407 & IC RSS-210  
**Serial #:** ARUB111-U1 Rev B  
**Issue Date:** 12th August 2013  
**Page:** 141 of 185

**5470 – 5725 MHz, 802.11n HT-20**

|                      |                        |                       |      |
|----------------------|------------------------|-----------------------|------|
| <b>Test Freq.</b>    | 5500 MHz               | <b>Engineer</b>       | SB   |
| <b>Variant</b>       | 802.11n HT-20; 6.5 MCS | <b>Temp (°C)</b>      | 26.6 |
| <b>Freq. Range</b>   | 1000 MHz - 18000 MHz   | <b>Rel. Hum.(%)</b>   | 31   |
| <b>Power Setting</b> | 21                     | <b>Press. (mBars)</b> | 1008 |
| <b>Antenna</b>       | AP-ANT86D              | <b>Duty Cycle (%)</b> | 100  |
| <b>Test Notes 1</b>  |                        |                       |      |
| <b>Test Notes 2</b>  |                        |                       |      |

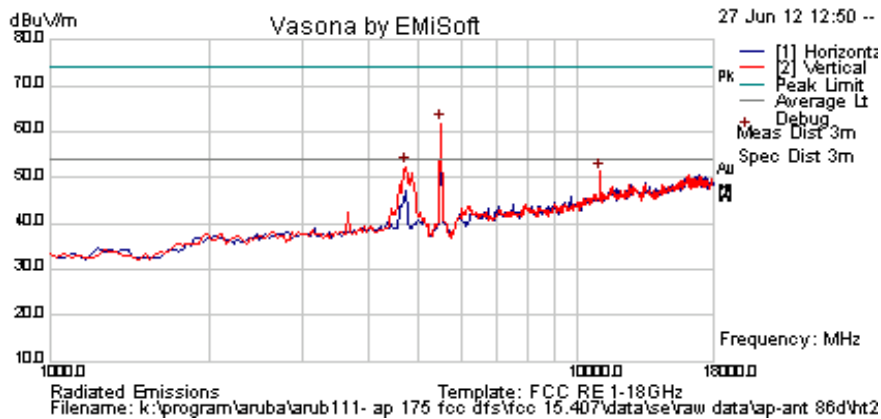

**Formally measured emission peaks**

| Frequency MHz   | Raw dBuV | Cable Loss | AF dB | Level dBuV/m | Measurement Type | Pol | Hgt cm | Azt Deg | Limit dBuV/m | Margin dB | Pass /Fail | Comments |
|---|----------|------------|-------|--------------|------------------|-----|--------|---------|--------------|-----------|------------|----------|
| 10981.964   | 48.7     | 7.0        | -3.1  | 52.6         | Peak Max         | V   | 141    | 319     | 74.0         | -21.5     | Pass       |          |
| 10981.964   | 35.8     | 7.0        | -3.1  | 39.7         | Average Max      | V   | 141    | 319     | 54.0         | -14.3     | Pass       |          |
| 5496.994  | 66.9     | 4.6        | -9.6  | 61.9         | Peak [Scan]      | V   | 150    |         |              |           |            | FUND     |
| 4713.426854   | 57.9     | 4.4        | -9.8  | 52.5         | Peak [Scan]      | V   | 150    |         |              |           |            | BE       |
| Legend: TX = Transmitter Emissions; DIG = Digital Emissions; FUND = Fundamental; WB = Wideband Emission<br>NRB = Non-Restricted Band. Limit = 68.23 dBuV/m; RB = Restricted Band. Limits per 15.205 |          |            |       |              |                  |     |        |         |              |           |            |          |

This test report may be reproduced in full only. The document may only be updated by MiCOM Labs personnel. Any changes will be noted in the Document History section of the report.



**Title:** Aruba AP-175 802.11a/b/g/n Wireless AP  
**To:** FCC 47 CFR Part 15.407 & IC RSS-210  
**Serial #:** ARUB111-U1 Rev B  
**Issue Date:** 12th August 2013  
**Page:** 142 of 185

|                      |                        |                       |      |
|----------------------|------------------------|-----------------------|------|
| <b>Test Freq.</b>    | 5580 MHz               | <b>Engineer</b>       | SB   |
| <b>Variant</b>       | 802.11n HT-20; 6.5 MCS | <b>Temp (°C)</b>      | 26.6 |
| <b>Freq. Range</b>   | 1000 MHz - 18000 MHz   | <b>Rel. Hum.(%)</b>   | 31   |
| <b>Power Setting</b> | 21                     | <b>Press. (mBars)</b> | 1008 |
| <b>Antenna</b>       | AP-ANT86D              | <b>Duty Cycle (%)</b> | 100  |
| <b>Test Notes 1</b>  |                        |                       |      |
| <b>Test Notes 2</b>  |                        |                       |      |

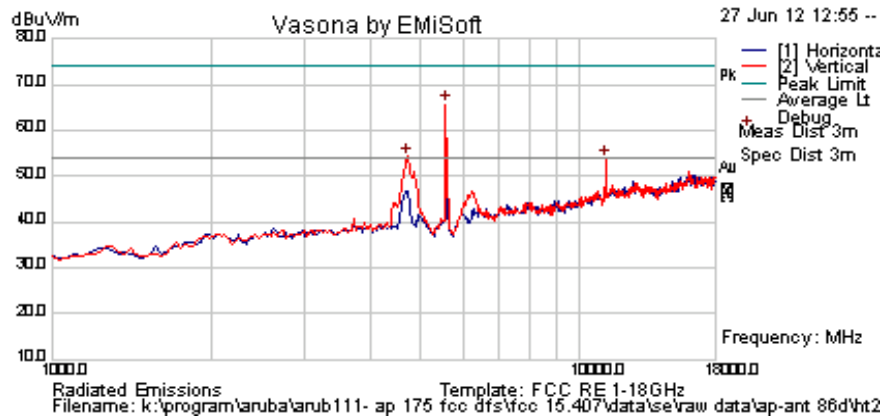

**Formally measured emission peaks**

| Frequency MHz   | Raw dBuV | Cable Loss | AF dB | Level dBuV/m | Measurement Type | Pol | Hgt cm | Azt Deg | Limit dBuV/m | Margin dB | Pass /Fail | Comments |
|---|----------|------------|-------|--------------|------------------|-----|--------|---------|--------------|-----------|------------|----------|
| 11186.373   | 54.3     | 6.9        | -3.0  | 58.3         | Peak Max         | V   | 132    | 271     | 74.0         | -15.7     | Pass       |          |
| 11186.373   | 40.0     | 6.9        | -3.0  | 43.9         | Average Max      | V   | 132    | 271     | 54.0         | -10.1     | Pass       |          |
| 5565.130  | 70.8     | 4.7        | -9.7  | 65.7         | Peak [Scan]      | V   | 150    |         |              |           |            | FUND     |
| 4713.427  | 59.8     | 4.4        | -9.8  | 54.4         | Peak [Scan]      | V   | 150    |         |              |           |            | BE       |
| Legend: TX = Transmitter Emissions; DIG = Digital Emissions; FUND = Fundamental; WB = Wideband Emission<br>NRB = Non-Restricted Band. Limit = 68.23 dBuV/m; RB = Restricted Band. Limits per 15.205 |          |            |       |              |                  |     |        |         |              |           |            |          |

This test report may be reproduced in full only. The document may only be updated by MiCOM Labs personnel. Any changes will be noted in the Document History section of the report.



**Title:** Aruba AP-175 802.11a/b/g/n Wireless AP  
**To:** FCC 47 CFR Part 15.407 & IC RSS-210  
**Serial #:** ARUB111-U1 Rev B  
**Issue Date:** 12th August 2013  
**Page:** 143 of 185

|                      |                        |                       |      |
|----------------------|------------------------|-----------------------|------|
| <b>Test Freq.</b>    | 5700 MHz               | <b>Engineer</b>       | SB   |
| <b>Variant</b>       | 802.11n HT-20; 6.5 MCS | <b>Temp (°C)</b>      | 26.6 |
| <b>Freq. Range</b>   | 1000 MHz - 18000 MHz   | <b>Rel. Hum.(%)</b>   | 31   |
| <b>Power Setting</b> | 21                     | <b>Press. (mBars)</b> | 1008 |
| <b>Antenna</b>       | AP-ANT86D              | <b>Duty Cycle (%)</b> | 100  |
| <b>Test Notes 1</b>  |                        |                       |      |
| <b>Test Notes 2</b>  |                        |                       |      |

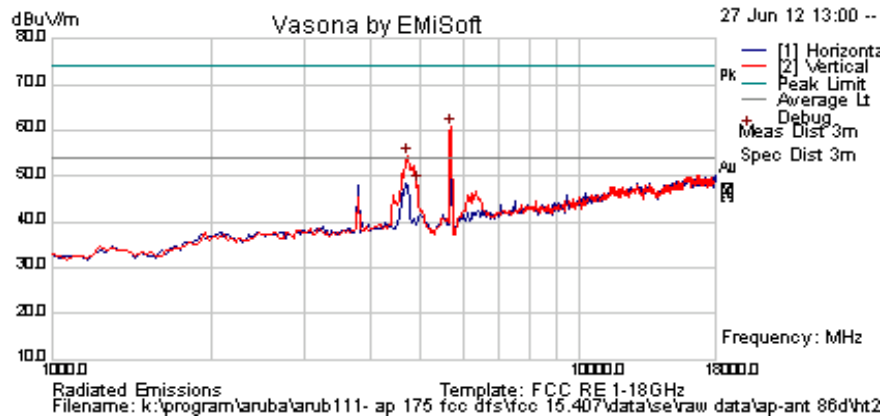

**Formally measured emission peaks**

| Frequency MHz | Raw dBuV | Cable Loss | AF dB | Level dBuV/m | Measurement Type | Pol | Hgt cm | Azt Deg | Limit dBuV/m | Margin dB | Pass /Fail | Comments |
|---------------|----------|------------|-------|--------------|------------------|-----|--------|---------|--------------|-----------|------------|----------|
| 5701.403      | 65.5     | 4.7        | -9.6  | 60.7         | Peak [Scan]      | V   | 150    |         |              |           |            | FUND     |
| 4713.426854   | 59.8     | 4.4        | -9.8  | 54.4         | Peak [Scan]      | V   | 150    |         |              |           |            | BE       |

|         |   |
|---------|---|
| Legend: | TX = Transmitter Emissions; DIG = Digital Emissions; FUND = Fundamental; WB = Wideband Emission |
|         | NRB = Non-Restricted Band. Limit = 68.23 dBuV/m; RB = Restricted Band. Limits per 15.205        |

This test report may be reproduced in full only. The document may only be updated by MiCOM Labs personnel. Any changes will be noted in the Document History section of the report.



**5250 – 5350 MHz, 802.11n HT-40**

|                      |                         |                       |      |
|----------------------|-------------------------|-----------------------|------|
| <b>Test Freq.</b>    | 5270 MHz                | <b>Engineer</b>       | SB   |
| <b>Variant</b>       | 802.11n HT-40; 13.5 MCS | <b>Temp (°C)</b>      | 26.6 |
| <b>Freq. Range</b>   | 1000 MHz - 18000 MHz    | <b>Rel. Hum.(%)</b>   | 31   |
| <b>Power Setting</b> | 16                      | <b>Press. (mBars)</b> | 1008 |
| <b>Antenna</b>       | AP-ANT86D               | <b>Duty Cycle (%)</b> | 100  |
| <b>Test Notes 1</b>  |                         |                       |      |
| <b>Test Notes 2</b>  |                         |                       |      |

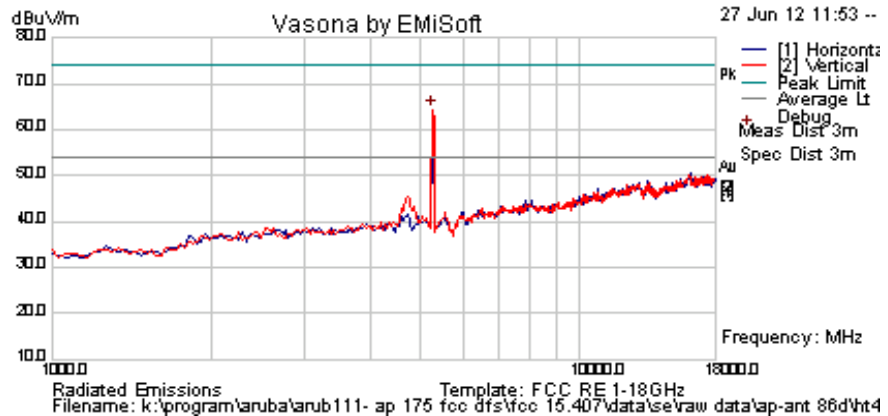

**Formally measured emission peaks**

| Frequency MHz   | Raw dBuV | Cable Loss | AF dB | Level dBuV/m | Measurement Type | Pol | Hgt cm | Azt Deg | Limit dBuV/m | Margin dB | Pass /Fail | Comments |
|---|----------|------------|-------|--------------|------------------|-----|--------|---------|--------------|-----------|------------|----------|
| 5258.517  | 69.6     | 4.6        | -9.7  | 64.5         | Peak [Scan]      | V   | 150    |         |              |           |            | FUND     |
| Legend: TX = Transmitter Emissions; DIG = Digital Emissions; FUND = Fundamental; WB = Wideband Emission<br>NRB = Non-Restricted Band. Limit = 68.23 dBuV/m; RB = Restricted Band. Limits per 15.205 |          |            |       |              |                  |     |        |         |              |           |            |          |

This test report may be reproduced in full only. The document may only be updated by MiCOM Labs personnel. Any changes will be noted in the Document History section of the report.





**Title:** Aruba AP-175 802.11a/b/g/n Wireless AP  
**To:** FCC 47 CFR Part 15.407 & IC RSS-210  
**Serial #:** ARUB111-U1 Rev B  
**Issue Date:** 12th August 2013  
**Page:** 145 of 185

|                      |                         |                       |      |
|----------------------|-------------------------|-----------------------|------|
| <b>Test Freq.</b>    | 5310 MHz                | <b>Engineer</b>       | SB   |
| <b>Variant</b>       | 802.11n HT-40; 13.5 MCS | <b>Temp (°C)</b>      | 26.6 |
| <b>Freq. Range</b>   | 1000 MHz - 18000 MHz    | <b>Rel. Hum.(%)</b>   | 31   |
| <b>Power Setting</b> | 16                      | <b>Press. (mBars)</b> | 1008 |
| <b>Antenna</b>       |                         | <b>Duty Cycle (%)</b> | 100  |
| <b>Test Notes 1</b>  |                         |                       |      |
| <b>Test Notes 2</b>  |                         |                       |      |

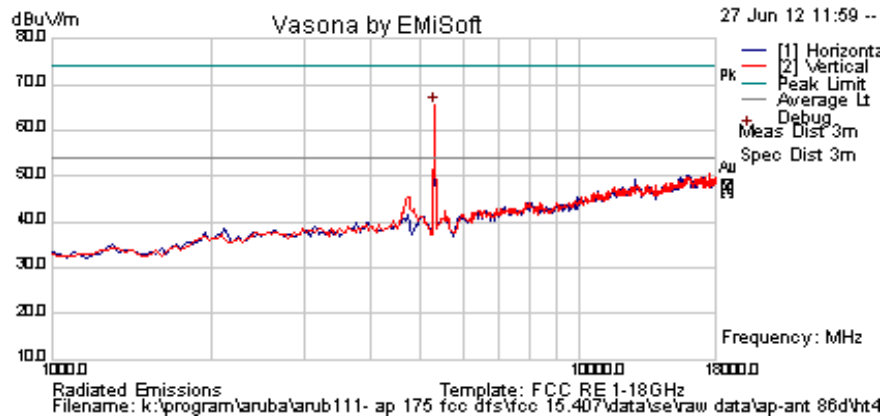

**Formally measured emission peaks**

| Frequency MHz | Raw dBuV | Cable Loss | AF dB | Level dBuV/m | Measurement Type | Pol | Hgt cm | Azt Deg | Limit dBuV/m | Margin dB | Pass /Fail | Comments |
|---------------|----------|------------|-------|--------------|------------------|-----|--------|---------|--------------|-----------|------------|----------|
| 5292.585      | 70.4     | 4.6        | -9.6  | 65.4         | Peak [Scan]      | V   | 150    |         |              |           |            | FUND     |

Legend: TX = Transmitter Emissions; DIG = Digital Emissions; FUND = Fundamental; WB = Wideband Emission  
 NRB = Non-Restricted Band. Limit = 68.23 dBuV/m; RB = Restricted Band. Limits per 15.205

This test report may be reproduced in full only. The document may only be updated by MiCOM Labs personnel. Any changes will be noted in the Document History section of the report.



**Title:** Aruba AP-175 802.11a/b/g/n Wireless AP  
**To:** FCC 47 CFR Part 15.407 & IC RSS-210  
**Serial #:** ARUB111-U1 Rev B  
**Issue Date:** 12th August 2013  
**Page:** 146 of 185

**5470 – 5725 MHz, 802.11n HT-40**

|                      |                         |                       |      |
|----------------------|-------------------------|-----------------------|------|
| <b>Test Freq.</b>    | 5510 MHz                | <b>Engineer</b>       | SB   |
| <b>Variant</b>       | 802.11n HT-40; 13.5 MCS | <b>Temp (°C)</b>      | 26.6 |
| <b>Freq. Range</b>   | 1000 MHz - 18000 MHz    | <b>Rel. Hum.(%)</b>   | 31   |
| <b>Power Setting</b> | 21                      | <b>Press. (mBars)</b> | 1008 |
| <b>Antenna</b>       | AP-ANT86D               | <b>Duty Cycle (%)</b> | 100  |
| <b>Test Notes 1</b>  |                         |                       |      |
| <b>Test Notes 2</b>  |                         |                       |      |

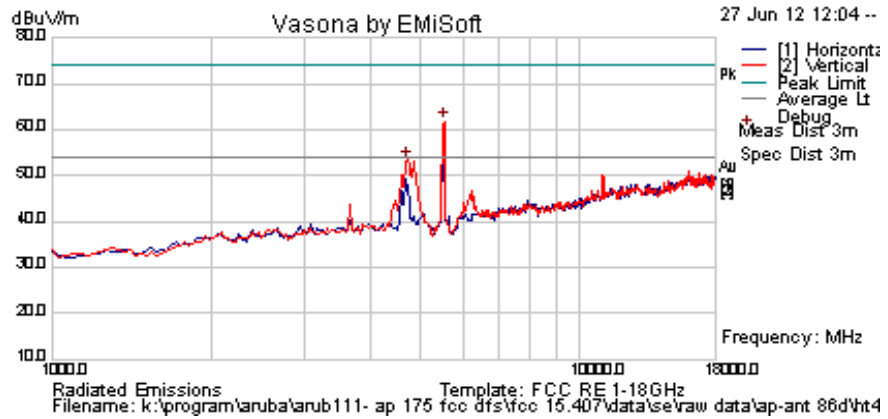

**Formally measured emission peaks**

| Frequency MHz   | Raw dBuV | Cable Loss | AF dB | Level dBuV/m | Measurement Type | Pol | Hgt cm | Azt Deg | Limit dBuV/m | Margin dB | Pass /Fail | Comments |
|---|----------|------------|-------|--------------|------------------|-----|--------|---------|--------------|-----------|------------|----------|
| 5531.062  | 66.8     | 4.6        | -9.7  | 61.8         | Peak [Scan]      | V   | 150    |         |              |           |            | FUND     |
| 4713.426854   | 58.9     | 4.4        | -9.8  | 53.4         | Peak [Scan]      | V   | 150    |         |              |           |            | BE       |
| Legend: TX = Transmitter Emissions; DIG = Digital Emissions; FUND = Fundamental; WB = Wideband Emission<br>NRB = Non-Restricted Band. Limit = 68.23 dBuV/m; RB = Restricted Band. Limits per 15.205 |          |            |       |              |                  |     |        |         |              |           |            |          |

This test report may be reproduced in full only. The document may only be updated by MiCOM Labs personnel. Any changes will be noted in the Document History section of the report.



**Title:** Aruba AP-175 802.11a/b/g/n Wireless AP  
**To:** FCC 47 CFR Part 15.407 & IC RSS-210  
**Serial #:** ARUB111-U1 Rev B  
**Issue Date:** 12th August 2013  
**Page:** 147 of 185

|                      |                         |                       |      |
|----------------------|-------------------------|-----------------------|------|
| <b>Test Freq.</b>    | 5550 MHz                | <b>Engineer</b>       | SB   |
| <b>Variant</b>       | 802.11n HT-40; 13.5 MCS | <b>Temp (°C)</b>      | 26.6 |
| <b>Freq. Range</b>   | 1000 MHz - 18000 MHz    | <b>Rel. Hum.(%)</b>   | 31   |
| <b>Power Setting</b> | 21                      | <b>Press. (mBars)</b> | 1008 |
| <b>Antenna</b>       | AP-ANT86D               | <b>Duty Cycle (%)</b> | 100  |
| <b>Test Notes 1</b>  |                         |                       |      |
| <b>Test Notes 2</b>  |                         |                       |      |

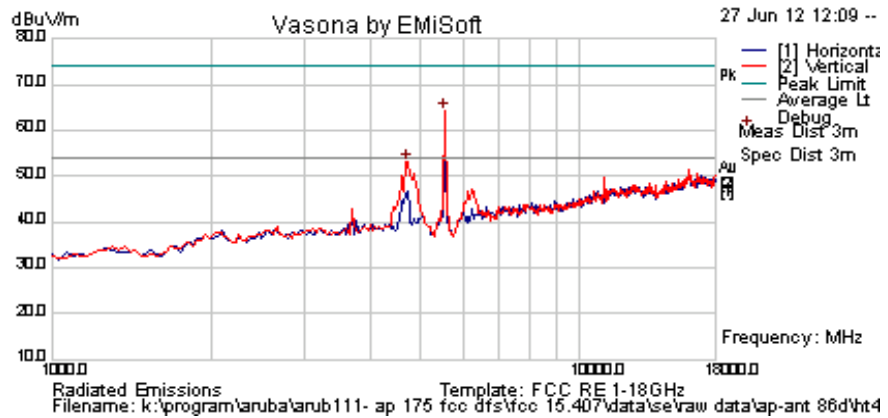

### Formally measured emission peaks

| Frequency MHz | Raw dBuV | Cable Loss | AF dB | Level dBuV/m | Measurement Type | Pol | Hgt cm | Azt Deg | Limit dBuV/m | Margin dB | Pass /Fail | Comments |
|---------------|----------|------------|-------|--------------|------------------|-----|--------|---------|--------------|-----------|------------|----------|
| 5531.062      | 69.3     | 4.6        | -9.7  | 64.3         | Peak [Scan]      | V   | 150    |         |              |           |            | FUND     |
| 4713.426854   | 58.6     | 4.4        | -9.8  | 53.2         | Peak [Scan]      | V   | 150    |         |              |           |            | BE       |

**Legend:** TX = Transmitter Emissions; DIG = Digital Emissions; FUND = Fundamental; WB = Wideband Emission  
 NRB = Non-Restricted Band. Limit = 68.23 dBuV/m; RB = Restricted Band. Limits per 15.205

This test report may be reproduced in full only. The document may only be updated by MiCOM Labs personnel. Any changes will be noted in the Document History section of the report.



**Title:** Aruba AP-175 802.11a/b/g/n Wireless AP  
**To:** FCC 47 CFR Part 15.407 & IC RSS-210  
**Serial #:** ARUB111-U1 Rev B  
**Issue Date:** 12th August 2013  
**Page:** 148 of 185

|                      |                         |                       |      |
|----------------------|-------------------------|-----------------------|------|
| <b>Test Freq.</b>    | 5670 MHz                | <b>Engineer</b>       | SB   |
| <b>Variant</b>       | 802.11n HT-40; 13.5 MCS | <b>Temp (°C)</b>      | 26.6 |
| <b>Freq. Range</b>   | 1000 MHz - 18000 MHz    | <b>Rel. Hum.(%)</b>   | 31   |
| <b>Power Setting</b> | 21                      | <b>Press. (mBars)</b> | 1008 |
| <b>Antenna</b>       | AP-ANT86D               | <b>Duty Cycle (%)</b> | 100  |
| <b>Test Notes 1</b>  |                         |                       |      |
| <b>Test Notes 2</b>  |                         |                       |      |

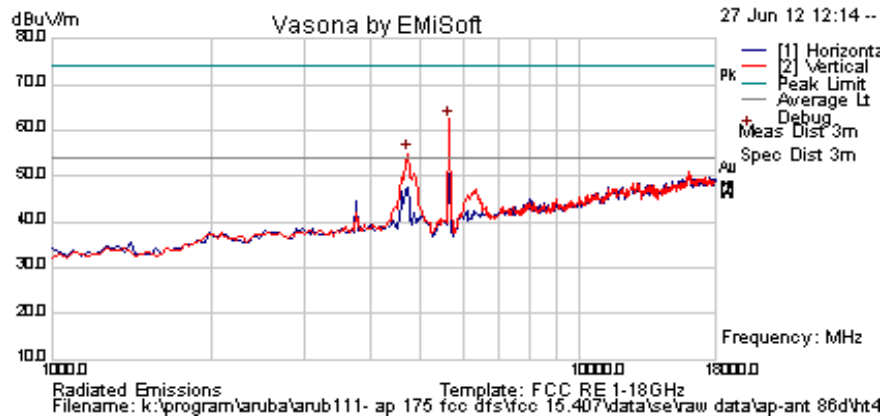

**Formally measured emission peaks**

| Frequency MHz | Raw dBuV | Cable Loss | AF dB | Level dBuV/m | Measurement Type | Pol | Hgt cm | Azt Deg | Limit dBuV/m | Margin dB | Pass /Fail | Comments |
|---------------|----------|------------|-------|--------------|------------------|-----|--------|---------|--------------|-----------|------------|----------|
| 5633.267      | 67.6     | 4.7        | -9.7  | 62.5         | Peak [Scan]      | V   | 150    |         |              |           |            | FUND     |
| 4713.426854   | 60.4     | 4.4        | -9.8  | 55.0         | Peak [Scan]      | V   | 150    |         |              |           |            | BE       |

Legend: TX = Transmitter Emissions; DIG = Digital Emissions; FUND = Fundamental; WB = Wideband Emission  
 NRB = Non-Restricted Band. Limit = 68.23 dBuV/m; RB = Restricted Band. Limits per 15.205

This test report may be reproduced in full only. The document may only be updated by MiCOM Labs personnel. Any changes will be noted in the Document History section of the report.



### 5.1.7.2. Radiated Band-Edge spurious emissions

#### 5320 MHz - 802.11a Legacy 5350 - 5460 MHz

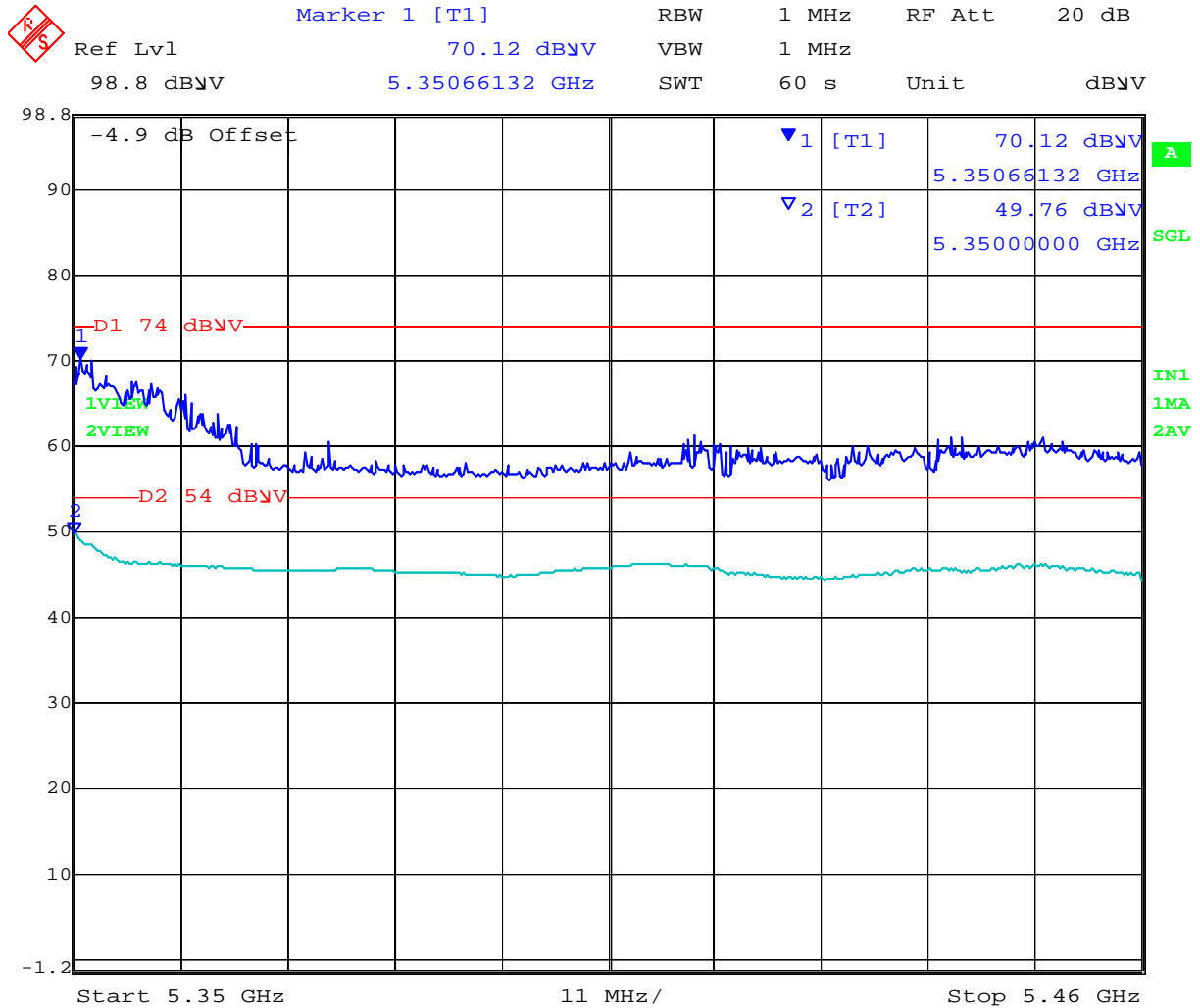

Date: 27.JUN.2012 11:20:12

NOTE: Power Reduction Required ART = 19

This test report may be reproduced in full only. The document may only be updated by MiCOM Labs personnel. Any changes will be noted in the Document History section of the report.



5320 MHz - 802.11n HT-20 5350 - 5460 MHz

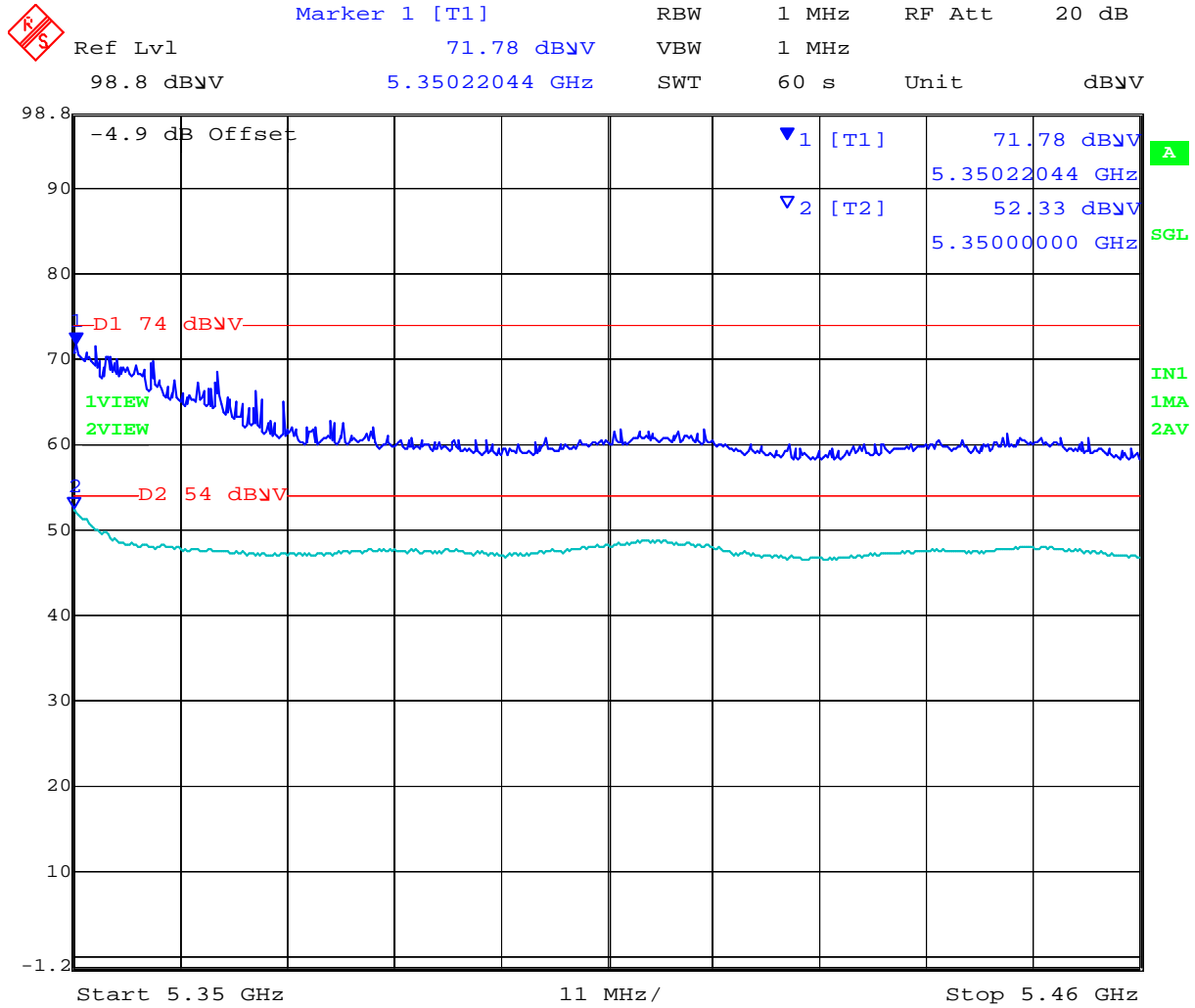

Date: 27.JUN.2012 11:22:30

NOTE: Power Reduction Required ART = 19

This test report may be reproduced in full only. The document may only be updated by MiCOM Labs personnel. Any changes will be noted in the Document History section of the report.



5310 MHz - 802.11n HT-40 5350 - 5460 MHz

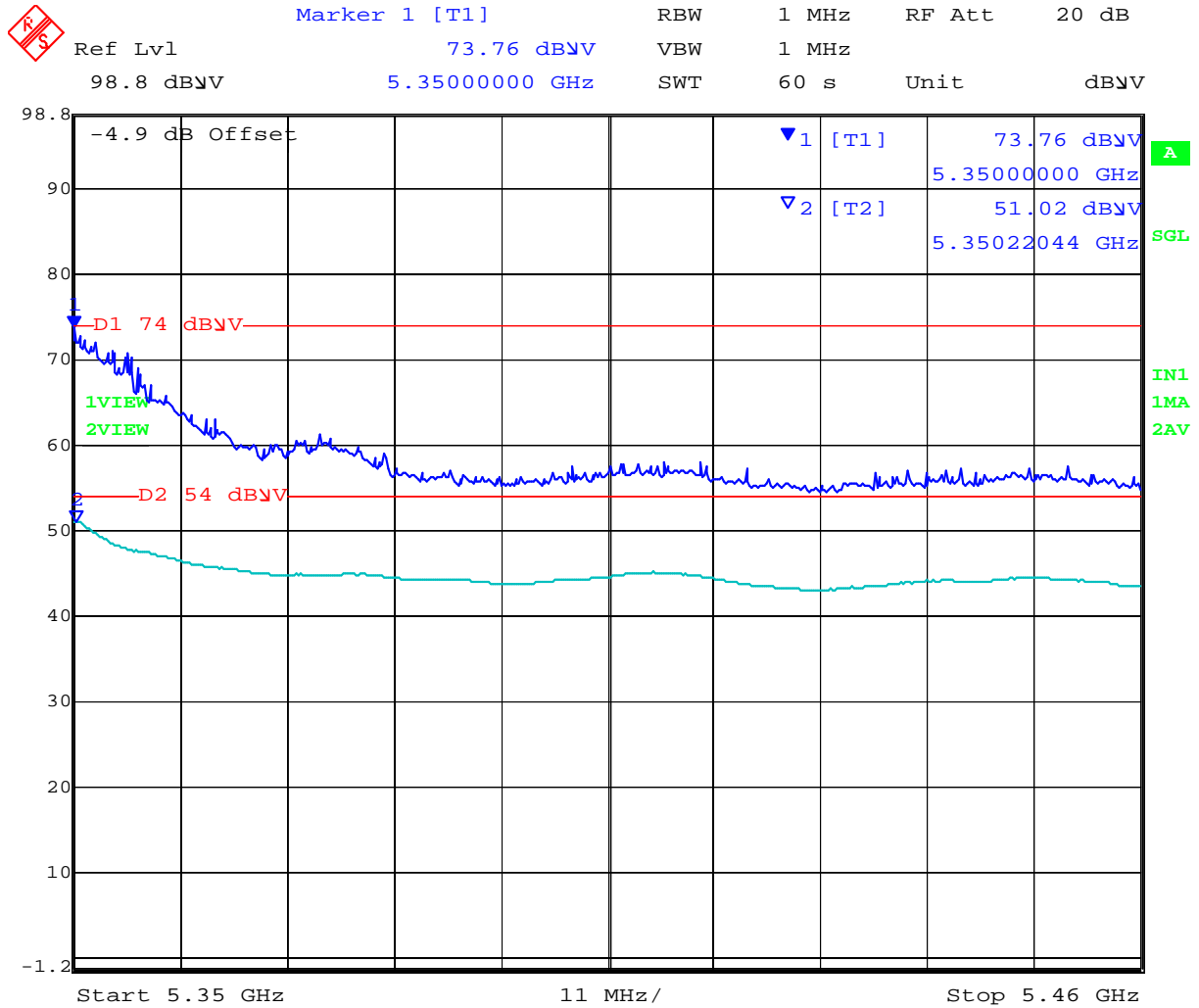

Date: 27.JUN.2012 11:28:02

NOTE: Power Reduction Required ART = 16

This test report may be reproduced in full only. The document may only be updated by MiCOM Labs personnel. Any changes will be noted in the Document History section of the report.



### 5500 MHz - 802.11a Legacy 5350 - 5460 MHz

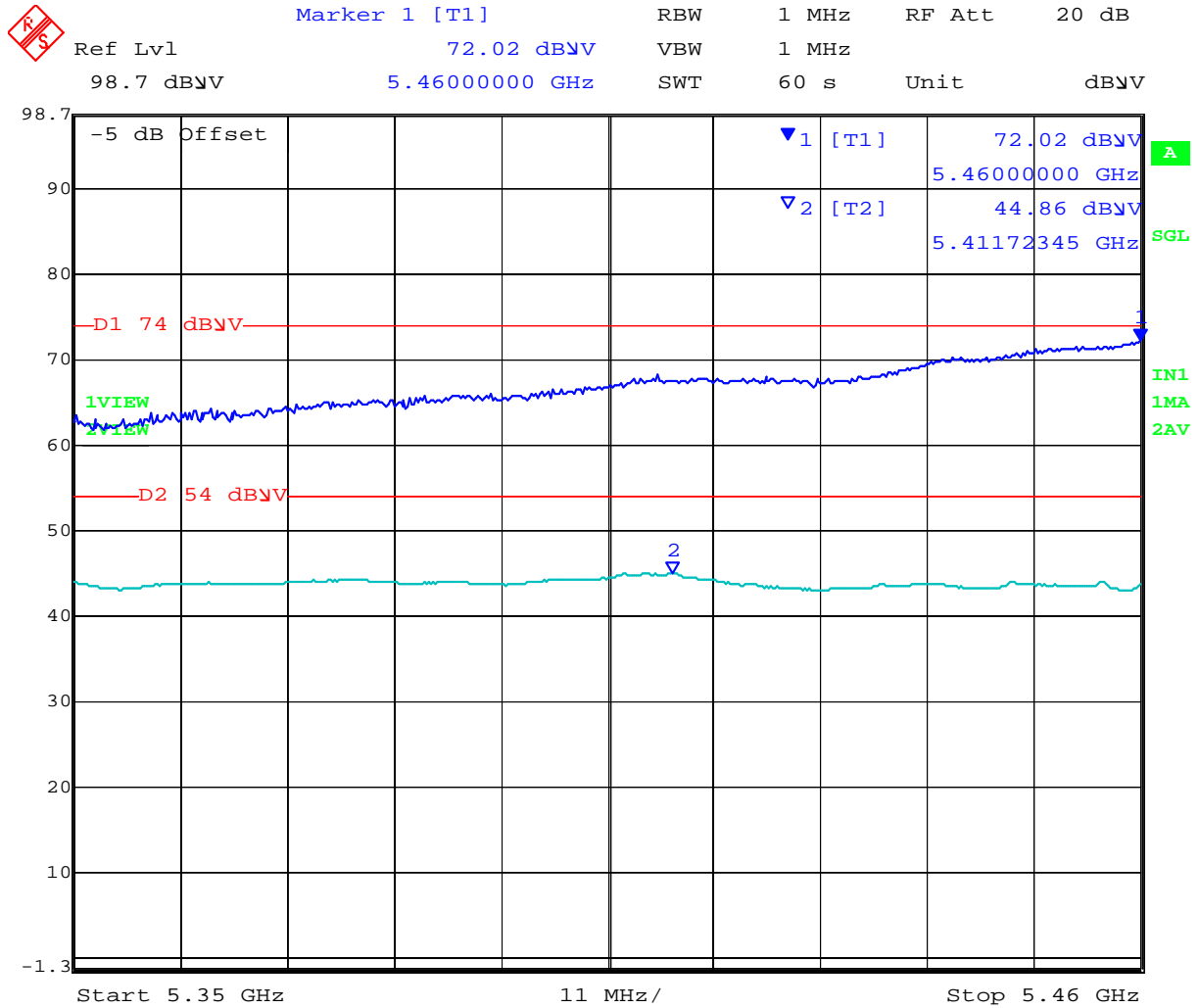

Date: 27.JUN.2012 11:04:02

This test report may be reproduced in full only. The document may only be updated by MiCOM Labs personnel. Any changes will be noted in the Document History section of the report.





5500 MHz - 802.11n HT-20 5350 - 5460 MHz

 Marker 1 [T1] RBW 1 MHz RF Att 20 dB  
Ref Lvl 72.86 dBμV VBW 1 MHz  
98.7 dBμV 5.45911824 GHz SWT 60 s Unit dBμV

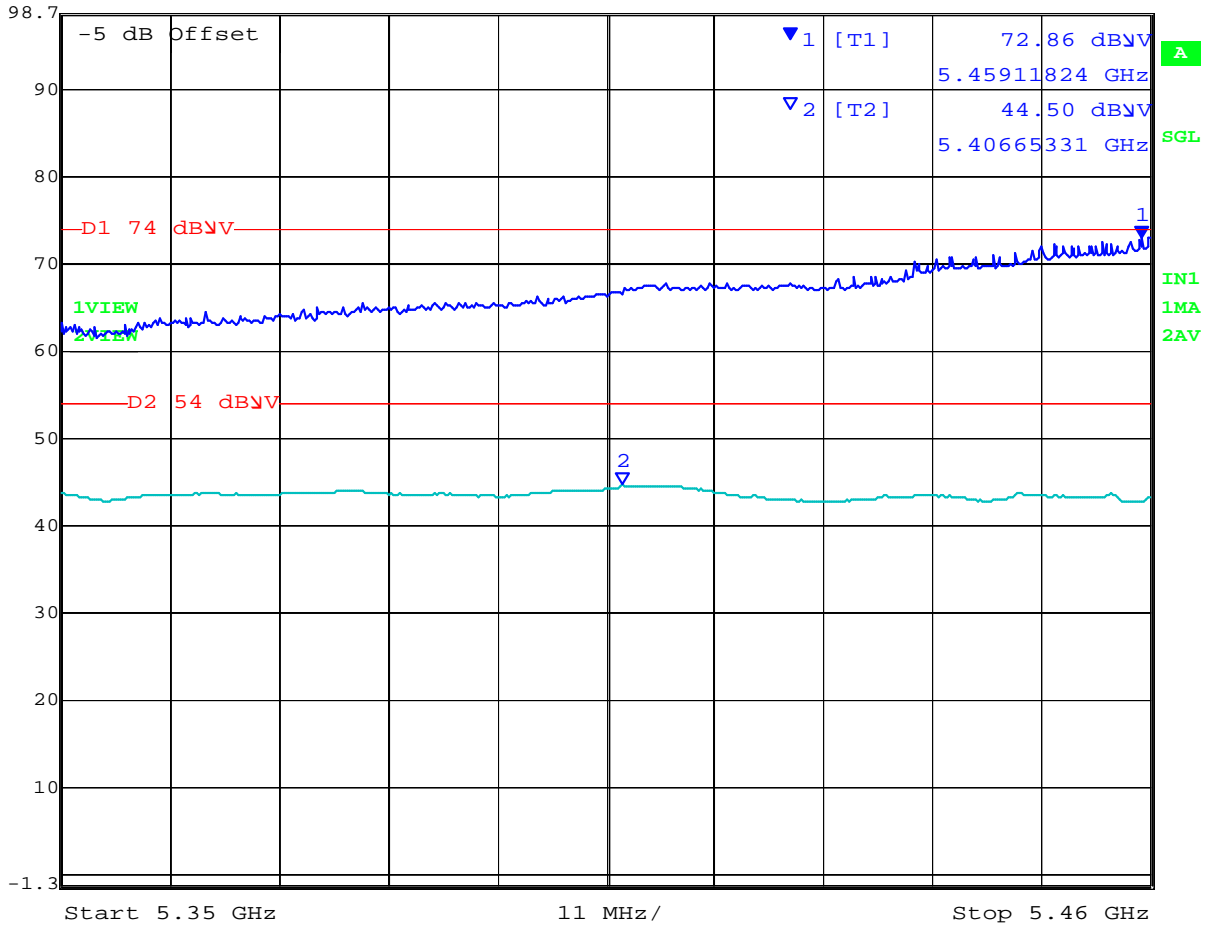

Date: 27.JUN.2012 11:10:15

This test report may be reproduced in full only. The document may only be updated by MiCOM Labs personnel. Any changes will be noted in the Document History section of the report.



5510 MHz - 802.11n HT-40 5350 - 5460 MHz

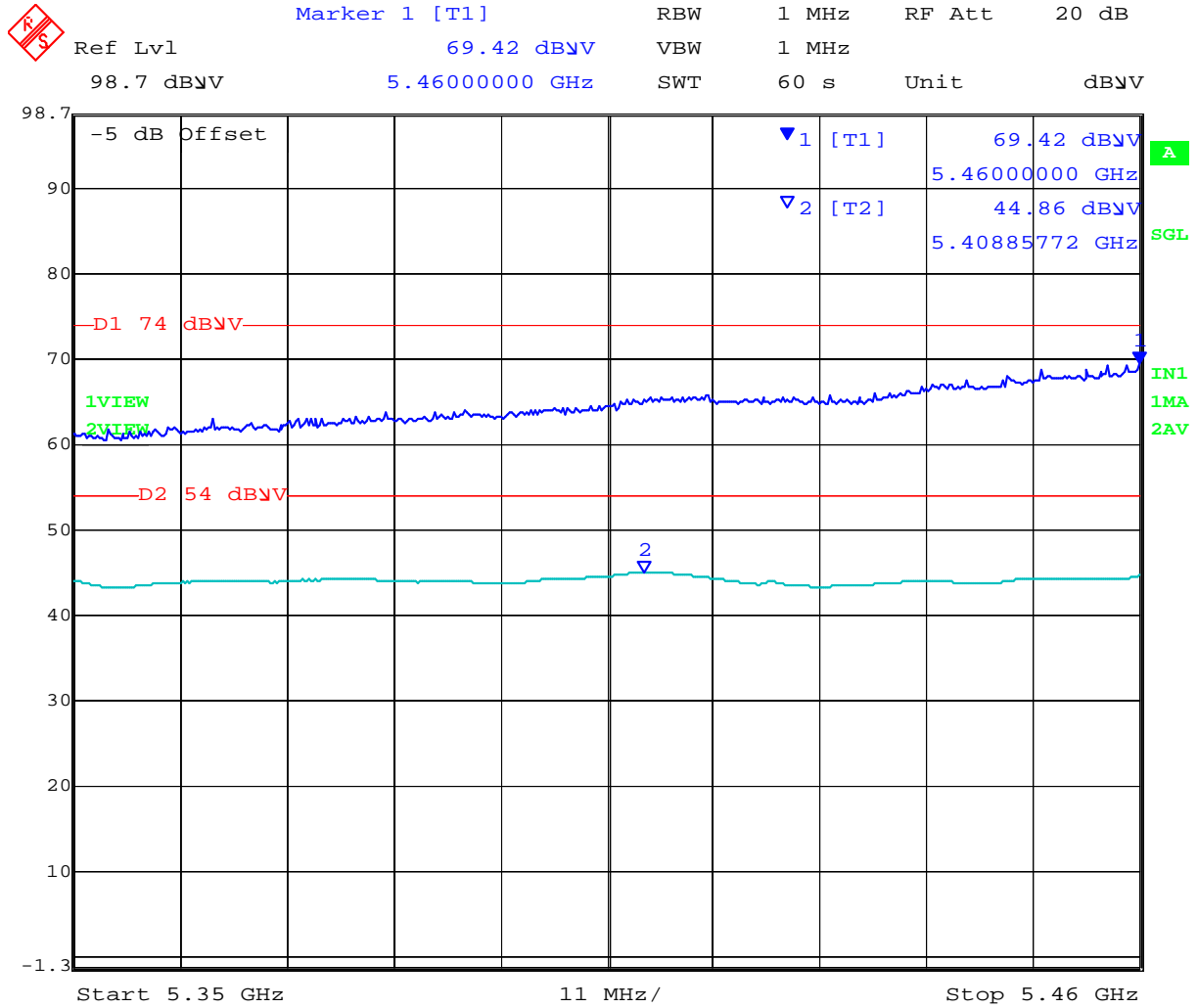

Date: 27.JUN.2012 11:15:47

This test report may be reproduced in full only. The document may only be updated by MiCOM Labs personnel. Any changes will be noted in the Document History section of the report.



Antenna AP-ANT-89

**5250 – 5350 MHz, 802.11a Legacy**

|                      |                      |                       |      |
|----------------------|----------------------|-----------------------|------|
| <b>Test Freq.</b>    | 5260 MHz             | <b>Engineer</b>       | SB   |
| <b>Variant</b>       | 802.11a; 6 Mbs       | <b>Temp (°C)</b>      | 26.6 |
| <b>Freq. Range</b>   | 1000 MHz - 18000 MHz | <b>Rel. Hum.(%)</b>   | 31   |
| <b>Power Setting</b> | 21                   | <b>Press. (mBars)</b> | 1008 |
| <b>Antenna</b>       | AP-ANT89             | <b>Duty Cycle (%)</b> | 100  |
| <b>Test Notes 1</b>  |                      |                       |      |
| <b>Test Notes 2</b>  |                      |                       |      |

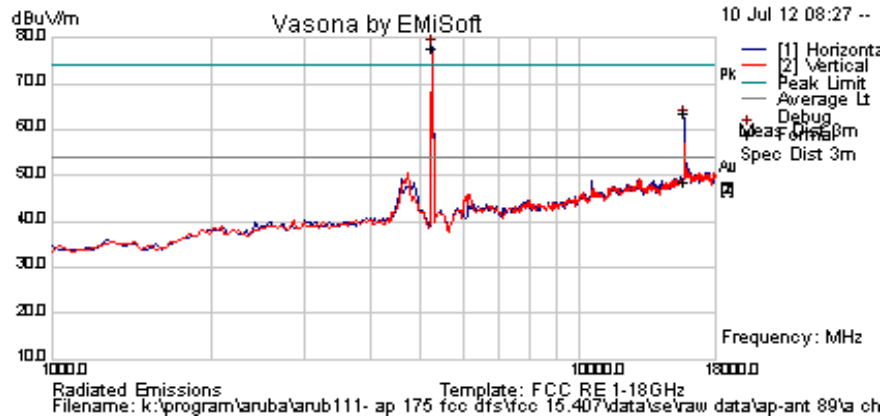

**Formally measured emission peaks**

| Frequency MHz | Raw dBuV | Cable Loss | AF dB | Level dBuV/m | Measurement Type | Pol | Hgt cm | Azt Deg | Limit dBuV/m | Margin dB | Pass /Fail | Comments |
|---------------|----------|------------|-------|--------------|------------------|-----|--------|---------|--------------|-----------|------------|----------|
| 5258.517      | 83.0     | 4.6        | -9.7  | 77.9         | Peak [Scan]      | H   | 150    |         |              |           |            | FUND     |
| 15772.906     | 40.3     | 8.7        | -0.3  | 48.6         | Average Max      | H   | 118    | 330     | 54.0         | -5.4      | Pass       |          |
| 15772.906     | 55.2     | 8.7        | -0.3  | 63.6         | Peak Max         | H   | 118    | 330     | 74           | -10.4     | Pass       |          |

Legend: TX = Transmitter Emissions; DIG = Digital Emissions; FUND = Fundamental; WB = Wideband Emission  
 NRB = Non-Restricted Band. Limit = 68.23 dBuV/m; RB = Restricted Band. Limits per 15.205

This test report may be reproduced in full only. The document may only be updated by MiCOM Labs personnel. Any changes will be noted in the Document History section of the report.



**Title:** Aruba AP-175 802.11a/b/g/n Wireless AP  
**To:** FCC 47 CFR Part 15.407 & IC RSS-210  
**Serial #:** ARUB111-U1 Rev B  
**Issue Date:** 12th August 2013  
**Page:** 156 of 185

|                      |                      |                       |      |
|----------------------|----------------------|-----------------------|------|
| <b>Test Freq.</b>    | 5300 MHz             | <b>Engineer</b>       | SB   |
| <b>Variant</b>       | 802.11a; 6 Mbs       | <b>Temp (°C)</b>      | 26.6 |
| <b>Freq. Range</b>   | 1000 MHz - 18000 MHz | <b>Rel. Hum.(%)</b>   | 31   |
| <b>Power Setting</b> | 21                   | <b>Press. (mBars)</b> | 1008 |
| <b>Antenna</b>       | AP-ANT89             | <b>Duty Cycle (%)</b> | 100  |
| <b>Test Notes 1</b>  |                      |                       |      |
| <b>Test Notes 2</b>  |                      |                       |      |

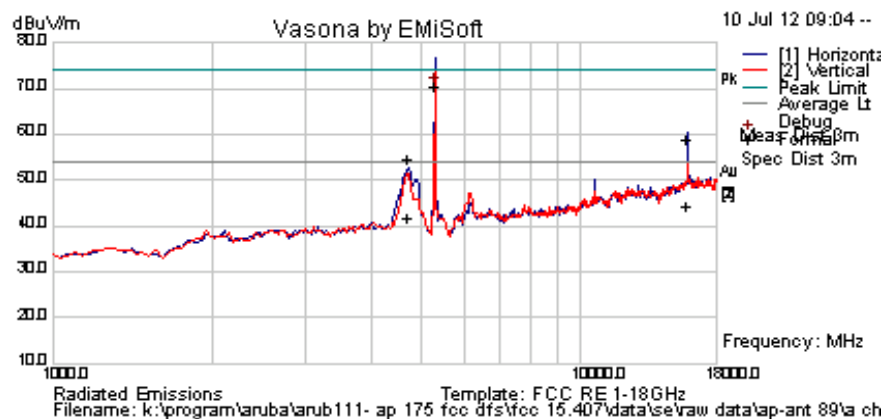

### Formally measured emission peaks

| Frequency MHz | Raw dBuV | Cable Loss | AF dB | Level dBuV/m | Measurement Type | Pol | Hgt cm | Azt Deg | Limit dBuV/m | Margin dB | Pass /Fail | Comments |
|---------------|----------|------------|-------|--------------|------------------|-----|--------|---------|--------------|-----------|------------|----------|
| 15891.784     | 50.3     | 8.9        | -0.2  | 59.0         | Peak Max         | H   | 125    | 3       | 74.0         | -15.0     | Pass       |          |
| 4705.09       | 60.3     | 4.4        | -9.8  | 54.8         | Peak Max         | H   | 98     | 354     | 74.0         | -19.2     | Pass       |          |
| 15891.784     | 35.5     | 8.9        | -0.2  | 44.2         | Average Max      | H   | 125    | 3       | 54           | -9.8      | Pass       |          |
| 4705.090      | 47.1     | 4.4        | -9.8  | 41.7         | Average Max      | H   | 98     | 354     | 54           | -12.3     | Pass       |          |
| 5300.200      | 75.6     | 4.6        | -9.6  | 70.7         | Peak [Scan]      | V   | 98     |         |              |           |            | FUND     |

**Legend:** TX = Transmitter Emissions; DIG = Digital Emissions; FUND = Fundamental; WB = Wideband Emission  
 NRB = Non-Restricted Band. Limit = 68.23 dBuV/m; RB = Restricted Band. Limits per 15.205

This test report may be reproduced in full only. The document may only be updated by MiCOM Labs personnel. Any changes will be noted in the Document History section of the report.



**Title:** Aruba AP-175 802.11a/b/g/n Wireless AP  
**To:** FCC 47 CFR Part 15.407 & IC RSS-210  
**Serial #:** ARUB111-U1 Rev B  
**Issue Date:** 12th August 2013  
**Page:** 157 of 185

|                      |                      |                       |      |
|----------------------|----------------------|-----------------------|------|
| <b>Test Freq.</b>    | 5320 MHz             | <b>Engineer</b>       | SB   |
| <b>Variant</b>       | 802.11a; 6 Mbs       | <b>Temp (°C)</b>      | 26.6 |
| <b>Freq. Range</b>   | 1000 MHz - 18000 MHz | <b>Rel. Hum.(%)</b>   | 31   |
| <b>Power Setting</b> | 21                   | <b>Press. (mBars)</b> | 1008 |
| <b>Antenna</b>       | AP-ANT89             | <b>Duty Cycle (%)</b> | 100  |
| <b>Test Notes 1</b>  |                      |                       |      |
| <b>Test Notes 2</b>  |                      |                       |      |

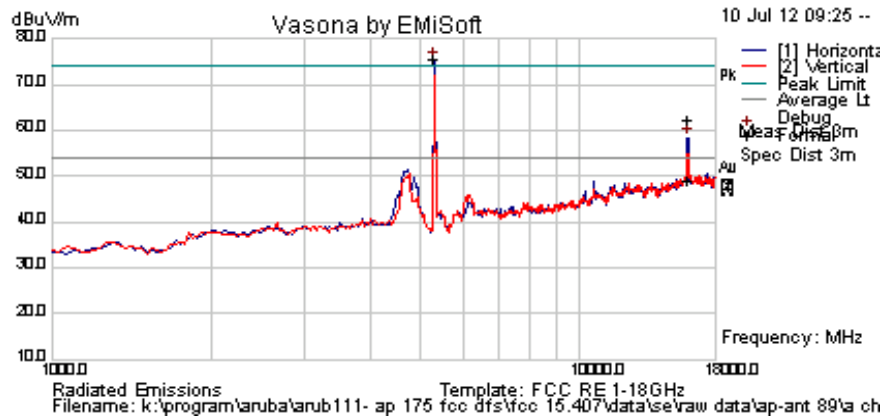

**Formally measured emission peaks**

| Frequency MHz  | Raw dBuV | Cable Loss | AF dB | Level dBuV/m | Measurement Type | Pol | Hgt cm | Azt Deg | Limit dBuV/m | Margin dB | Pass /Fail | Comments |
|--|----------|------------|-------|--------------|------------------|-----|--------|---------|--------------|-----------|------------|----------|
| 15956.633  | 53.2     | 9.0        | 0.0   | 62.2         | Peak Max         | H   | 109    | 330     | 74.0         | -11.9     | Pass       |          |
| 15956.633  | 40.0     | 9.0        | 0.0   | 49.0         | Average Max      | H   | 109    | 330     | 54.0         | -5.1      | Pass       |          |
| 5292.585   | 80.4     | 4.6        | -9.6  | 75.4         | Peak [Scan]      | H   | 150    |         |              |           |            | FUND     |
| Legend: TX = Transmitter Emissions; DIG = Digital Emissions; FUND = Fundamental; WB = Wideband Emission<br>NR = Non-Restricted Band. Limit = 68.23 dBuV/m; RB = Restricted Band. Limits per 15.205 |          |            |       |              |                  |     |        |         |              |           |            |          |

This test report may be reproduced in full only. The document may only be updated by MiCOM Labs personnel. Any changes will be noted in the Document History section of the report.



**Title:** Aruba AP-175 802.11a/b/g/n Wireless AP  
**To:** FCC 47 CFR Part 15.407 & IC RSS-210  
**Serial #:** ARUB111-U1 Rev B  
**Issue Date:** 12th August 2013  
**Page:** 158 of 185

**5470 – 5725 MHz, 802.11a Legacy**

|                      |                      |                       |      |
|----------------------|----------------------|-----------------------|------|
| <b>Test Freq.</b>    | 5500 MHz             | <b>Engineer</b>       | SB   |
| <b>Variant</b>       | 802.11a; 6 Mbs       | <b>Temp (°C)</b>      | 26.6 |
| <b>Freq. Range</b>   | 1000 MHz - 18000 MHz | <b>Rel. Hum.(%)</b>   | 31   |
| <b>Power Setting</b> | 21                   | <b>Press. (mBars)</b> | 1008 |
| <b>Antenna</b>       | AP-ANT89             | <b>Duty Cycle (%)</b> | 100  |
| <b>Test Notes 1</b>  |                      |                       |      |
| <b>Test Notes 2</b>  |                      |                       |      |

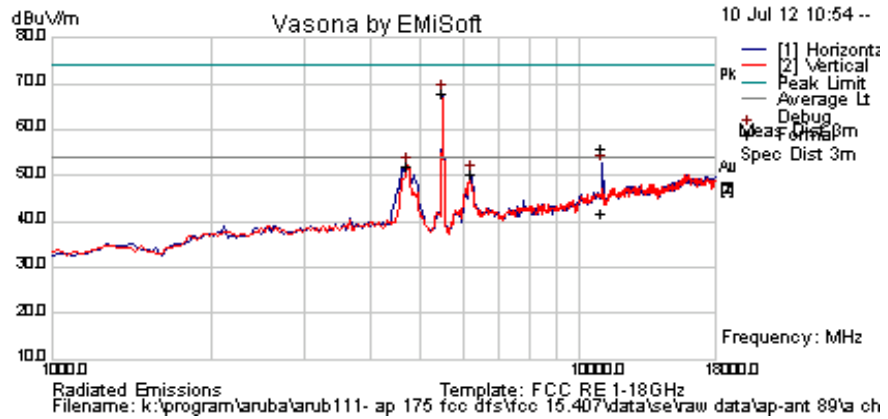

**Formally measured emission peaks**

| Frequency MHz | Raw dBuV | Cable Loss | AF dB | Level dBuV/m | Measurement Type | Pol | Hgt cm | Azt Deg | Limit dBuV/m | Margin dB | Pass /Fail | Comments |
|---------------|----------|------------|-------|--------------|------------------|-----|--------|---------|--------------|-----------|------------|----------|
| 10994.790     | 51.9     | 7.0        | -3.1  | 55.8         | Peak Max         | H   | 101    | 346     | 74.0         | -18.3     | Pass       |          |
| 10994.79      | 38.0     | 7.0        | -3.1  | 41.9         | Average Max      | H   | 101    | 346     | 54.0         | -12.1     | Pass       |          |
| 5496.994      | 72.8     | 4.6        | -9.6  | 67.8         | Peak [Scan]      | H   | 150    |         |              |           |            | FUND     |
| 4713.427      | 57.5     | 4.4        | -9.8  | 52.1         | Peak [Scan]      | V   | 100    | 0       | 54           | -1.9      | Pass       | BE       |
| 6212.425      | 53.1     | 5.0        | -7.8  | 50.3         | Peak [Scan]      | H   | 100    | 0       | 54           | -3.7      | Pass       | NRB      |

Legend: TX = Transmitter Emissions; DIG = Digital Emissions; FUND = Fundamental; WB = Wideband Emission  
 NRB = Non-Restricted Band. Limit = 68.23 dBuV/m; RB = Restricted Band. Limits per 15.205

This test report may be reproduced in full only. The document may only be updated by MiCOM Labs personnel. Any changes will be noted in the Document History section of the report.



**Title:** Aruba AP-175 802.11a/b/g/n Wireless AP  
**To:** FCC 47 CFR Part 15.407 & IC RSS-210  
**Serial #:** ARUB111-U1 Rev B  
**Issue Date:** 12th August 2013  
**Page:** 159 of 185

|                      |                      |                       |      |
|----------------------|----------------------|-----------------------|------|
| <b>Test Freq.</b>    | 5580 MHz             | <b>Engineer</b>       | SB   |
| <b>Variant</b>       | 802.11a; 6 Mbs       | <b>Temp (°C)</b>      | 26.6 |
| <b>Freq. Range</b>   | 1000 MHz - 18000 MHz | <b>Rel. Hum.(%)</b>   | 31   |
| <b>Power Setting</b> | 21                   | <b>Press. (mBars)</b> | 1008 |
| <b>Antenna</b>       | AP-ANT89             | <b>Duty Cycle (%)</b> | 100  |
| <b>Test Notes 1</b>  |                      |                       |      |
| <b>Test Notes 2</b>  |                      |                       |      |

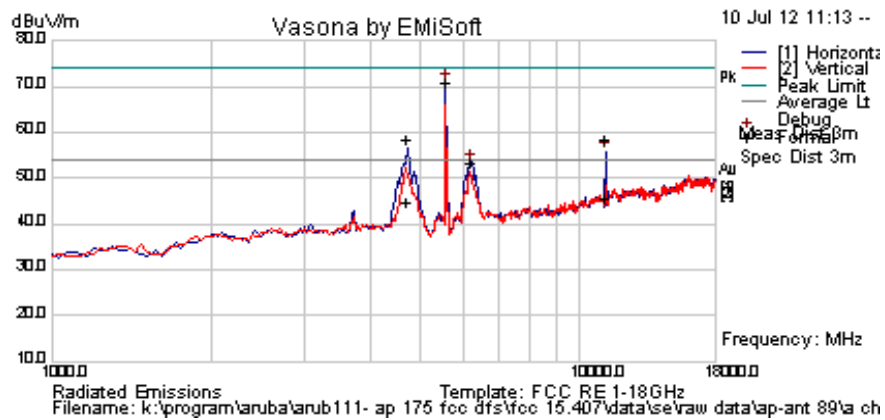

### Formally measured emission peaks

| Frequency MHz | Raw dBuV | Cable Loss | AF dB | Level dBuV/m | Measurement Type | Pol | Hgt cm | Azt Deg | Limit dBuV/m | Margin dB | Pass /Fail | Comments |
|---------------|----------|------------|-------|--------------|------------------|-----|--------|---------|--------------|-----------|------------|----------|
| 4708.938      | 64.0     | 4.4        | -9.8  | 58.6         | Peak Max         | H   | 102    | 350     | 74.0         | -15.4     | Pass       | BE       |
| 4708.938      | 50.3     | 4.4        | -9.8  | 44.8         | Average Max      | H   | 102    | 350     | 54.0         | -9.2      | Pass       | BE       |
| 11160.000     | 54.4     | 6.9        | -3.0  | 58.4         | Peak Max         | H   | 98     | 325     | 74           | -15.6     | Pass       |          |
| 11160.000     | 41.6     | 6.9        | -3.0  | 45.6         | Average Max      | H   | 98     | 325     | 54           | -8.5      | Pass       |          |
| 5565.130      | 76.1     | 4.7        | -9.7  | 71.0         | Peak [Scan]      | H   | 150    |         |              |           |            | FUND     |
| 6212.425      | 56.3     | 5.0        | -7.8  | 53.5         | Peak [Scan]      | H   | 100    | 0       | 54           | -0.5      | Pass       | NRB      |

Legend: TX = Transmitter Emissions; DIG = Digital Emissions; FUND = Fundamental; WB = Wideband Emission  
 NRB = Non-Restricted Band. Limit = 68.23 dBuV/m; RB = Restricted Band. Limits per 15.205

This test report may be reproduced in full only. The document may only be updated by MiCOM Labs personnel. Any changes will be noted in the Document History section of the report.



**Title:** Aruba AP-175 802.11a/b/g/n Wireless AP  
**To:** FCC 47 CFR Part 15.407 & IC RSS-210  
**Serial #:** ARUB111-U1 Rev B  
**Issue Date:** 12th August 2013  
**Page:** 160 of 185

|                      |                      |                       |      |
|----------------------|----------------------|-----------------------|------|
| <b>Test Freq.</b>    | 5700 MHz             | <b>Engineer</b>       | SB   |
| <b>Variant</b>       | 802.11a; 6 Mbs       | <b>Temp (°C)</b>      | 26.6 |
| <b>Freq. Range</b>   | 1000 MHz - 18000 MHz | <b>Rel. Hum.(%)</b>   | 31   |
| <b>Power Setting</b> | 21                   | <b>Press. (mBars)</b> | 1008 |
| <b>Antenna</b>       | AP-ANT89             | <b>Duty Cycle (%)</b> | 100  |
| <b>Test Notes 1</b>  |                      |                       |      |
| <b>Test Notes 2</b>  |                      |                       |      |

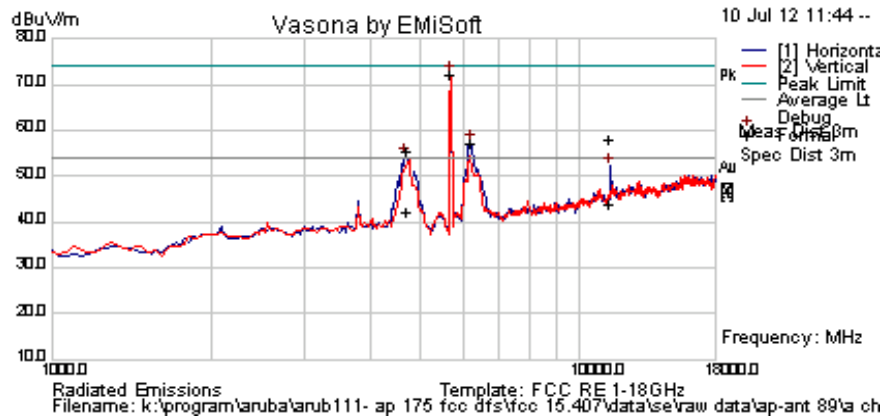

### Formally measured emission peaks

| Frequency MHz | Raw dBuV | Cable Loss | AF dB | Level dBuV/m | Measurement Type | Pol | Hgt cm | Azt Deg | Limit dBuV/m | Margin dB | Pass /Fail | Comments |
|---------------|----------|------------|-------|--------------|------------------|-----|--------|---------|--------------|-----------|------------|----------|
| 4708.858      | 60.8     | 4.4        | -9.8  | 55.4         | Peak Max         | H   | 130    | 360     | 74.0         | -18.6     | Pass       | BE       |
| 11399.359     | 53.3     | 6.8        | -2.3  | 57.9         | Peak Max         | H   | 98     | 323     | 74.0         | -16.1     | Pass       |          |
| 4708.858      | 47.4     | 4.4        | -9.8  | 42.0         | Average Max      | H   | 130    | 360     | 54           | -12.0     | Pass       | BE       |
| 11399.359     | 39.5     | 6.8        | -2.3  | 44.0         | Average Max      | H   | 98     | 323     | 54           | -10.0     | Pass       |          |
| 5701.403      | 77.0     | 4.7        | -9.6  | 72.1         | Peak [Scan]      | V   | 100    | 0       |              |           |            | FUND     |
| 6246.493      | 59.7     | 5.0        | -7.6  | 57.1         | Peak [Scan]      | H   | 100    | 0       |              |           |            | NRB      |

Legend: TX = Transmitter Emissions; DIG = Digital Emissions; FUND = Fundamental; WB = Wideband Emission  
 NRB = Non-Restricted Band. Limit = 68.23 dBuV/m; RB = Restricted Band. Limits per 15.205

This test report may be reproduced in full only. The document may only be updated by MiCOM Labs personnel. Any changes will be noted in the Document History section of the report.





**Title:** Aruba AP-175 802.11a/b/g/n Wireless AP  
**To:** FCC 47 CFR Part 15.407 & IC RSS-210  
**Serial #:** ARUB111-U1 Rev B  
**Issue Date:** 12th August 2013  
**Page:** 161 of 185

**5250 – 5350 MHz, 802.11n HT-20**

|                      |                        |                       |      |
|----------------------|------------------------|-----------------------|------|
| <b>Test Freq.</b>    | 5260 MHz               | <b>Engineer</b>       | SB   |
| <b>Variant</b>       | 802.11n HT-20; 6.5 MCS | <b>Temp (°C)</b>      | 26.6 |
| <b>Freq. Range</b>   | 1000 MHz - 18000 MHz   | <b>Rel. Hum.(%)</b>   | 31   |
| <b>Power Setting</b> | 21                     | <b>Press. (mBars)</b> | 1008 |
| <b>Antenna</b>       | AP-ANT89               | <b>Duty Cycle (%)</b> | 100  |
| <b>Test Notes 1</b>  |                        |                       |      |
| <b>Test Notes 2</b>  |                        |                       |      |

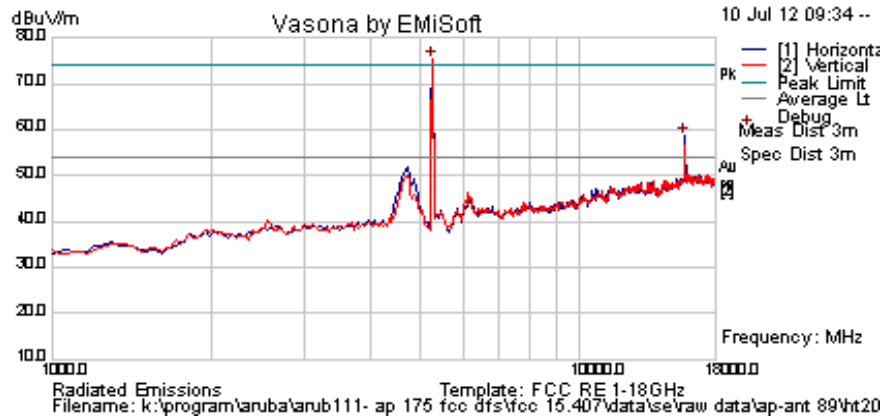

**Formally measured emission peaks**

| Frequency MHz   | Raw dBuV | Cable Loss | AF dB | Level dBuV/m | Measurement Type | Pol | Hgt cm | Azt Deg | Limit dBuV/m | Margin dB | Pass /Fail | Comments |
|---|----------|------------|-------|--------------|------------------|-----|--------|---------|--------------|-----------|------------|----------|
| 5258.517  | 80.5     | 4.6        | -9.7  | 75.4         | Peak [Scan]      | H   | 150    |         |              |           |            | FUND     |
| 15785.571   | 40.3     | 8.7        | -0.3  | 48.6         | Average Max      | H   | 118    | 330     | 54.0         | -5.4      | Pass       |          |
| 15785.571   | 55.2     | 8.7        | -0.3  | 63.6         | Peak Max         | H   | 118    | 330     | 74           | -10.4     | Pass       |          |
| Legend: TX = Transmitter Emissions; DIG = Digital Emissions; FUND = Fundamental; WB = Wideband Emission<br>NRB = Non-Restricted Band. Limit = 68.23 dBuV/m; RB = Restricted Band. Limits per 15.205 |          |            |       |              |                  |     |        |         |              |           |            |          |

This test report may be reproduced in full only. The document may only be updated by MiCOM Labs personnel. Any changes will be noted in the Document History section of the report.



**Title:** Aruba AP-175 802.11a/b/g/n Wireless AP  
**To:** FCC 47 CFR Part 15.407 & IC RSS-210  
**Serial #:** ARUB111-U1 Rev B  
**Issue Date:** 12th August 2013  
**Page:** 162 of 185

|                      |                        |                       |      |
|----------------------|------------------------|-----------------------|------|
| <b>Test Freq.</b>    | 5300 MHz               | <b>Engineer</b>       | SB   |
| <b>Variant</b>       | 802.11n HT-20; 6.5 MCS | <b>Temp (°C)</b>      | 26.6 |
| <b>Freq. Range</b>   | 1000 MHz - 18000 MHz   | <b>Rel. Hum.(%)</b>   | 31   |
| <b>Power Setting</b> | 21                     | <b>Press. (mBars)</b> | 1008 |
| <b>Antenna</b>       | AP-ANT89               | <b>Duty Cycle (%)</b> | 100  |
| <b>Test Notes 1</b>  |                        |                       |      |
| <b>Test Notes 2</b>  |                        |                       |      |

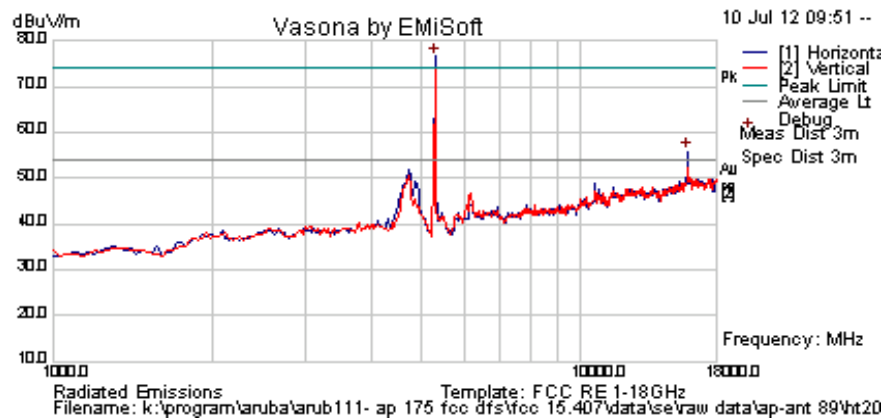

### Formally measured emission peaks

| Frequency MHz   | Raw dBuV | Cable Loss | AF dB | Level dBuV/m | Measurement Type | Pol | Hgt cm | Azt Deg | Limit dBuV/m | Margin dB | Pass /Fail | Comments |
|---|----------|------------|-------|--------------|------------------|-----|--------|---------|--------------|-----------|------------|----------|
| 5292.585  | 81.6     | 4.6        | -9.6  | 76.6         | Peak [Scan]      | H   | 150    |         |              |           |            | FUND     |
| 15887.776   | 50.3     | 8.9        | -0.2  | 59.0         | Peak Max         | H   | 125    | 3       | 74.0         | -15.0     | Pass       |          |
| 15887.776   | 38.1     | 8.8        | -0.2  | 46.6         | Average Max      | H   | 121    | 328     | 54.0         | -7.4      | Pass       |          |
| Legend: TX = Transmitter Emissions; DIG = Digital Emissions; FUND = Fundamental; WB = Wideband Emission<br>NRB = Non-Restricted Band. Limit = 68.23 dBuV/m; RB = Restricted Band. Limits per 15.205 |          |            |       |              |                  |     |        |         |              |           |            |          |

This test report may be reproduced in full only. The document may only be updated by MiCOM Labs personnel. Any changes will be noted in the Document History section of the report.



**Title:** Aruba AP-175 802.11a/b/g/n Wireless AP  
**To:** FCC 47 CFR Part 15.407 & IC RSS-210  
**Serial #:** ARUB111-U1 Rev B  
**Issue Date:** 12th August 2013  
**Page:** 163 of 185

|                      |                        |                       |      |
|----------------------|------------------------|-----------------------|------|
| <b>Test Freq.</b>    | 5320 MHz               | <b>Engineer</b>       | SB   |
| <b>Variant</b>       | 802.11n HT-20; 6.5 MCS | <b>Temp (°C)</b>      | 26.6 |
| <b>Freq. Range</b>   | 1000 MHz - 18000 MHz   | <b>Rel. Hum.(%)</b>   | 31   |
| <b>Power Setting</b> | 21                     | <b>Press. (mBars)</b> | 1008 |
| <b>Antenna</b>       |                        | <b>Duty Cycle (%)</b> | 100  |
| <b>Test Notes 1</b>  |                        |                       |      |
| <b>Test Notes 2</b>  |                        |                       |      |

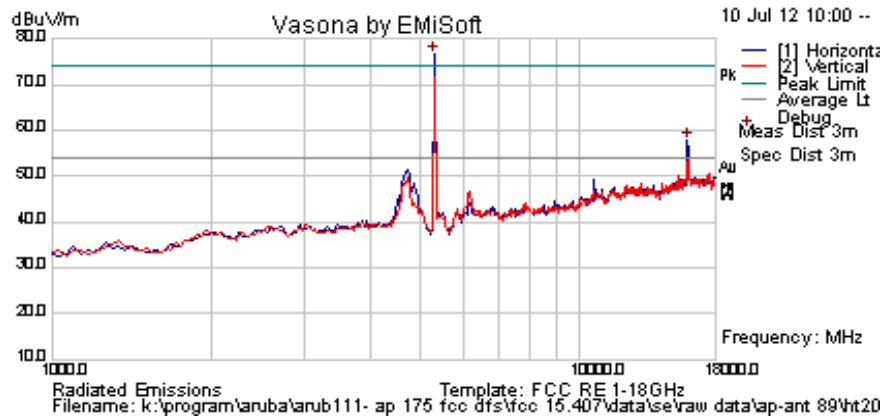

**Formally measured emission peaks**

| Frequency MHz   | Raw dBuV | Cable Loss | AF dB | Level dBuV/m | Measurement Type | Pol | Hgt cm | Azt Deg | Limit dBuV/m | Margin dB | Pass /Fail | Comments |
|---|----------|------------|-------|--------------|------------------|-----|--------|---------|--------------|-----------|------------|----------|
| 5292.585  | 81.6     | 4.6        | -9.6  | 76.7         | Peak [Scan]      | H   | 150    |         |              |           |            | FUND     |
| 15955.912   | 53.2     | 9.0        | 0.0   | 62.2         | Peak Max         | H   | 109    | 330     | 74.0         | -11.9     | Pass       |          |
| 15955.912   | 40.0     | 9.0        | 0.0   | 49.0         | Average Max      | H   | 109    | 330     | 54.0         | -5.1      | Pass       |          |
| Legend: TX = Transmitter Emissions; DIG = Digital Emissions; FUND = Fundamental; WB = Wideband Emission<br>NRB = Non-Restricted Band. Limit = 68.23 dBuV/m; RB = Restricted Band. Limits per 15.205 |          |            |       |              |                  |     |        |         |              |           |            |          |

This test report may be reproduced in full only. The document may only be updated by MiCOM Labs personnel. Any changes will be noted in the Document History section of the report.



**Title:** Aruba AP-175 802.11a/b/g/n Wireless AP  
**To:** FCC 47 CFR Part 15.407 & IC RSS-210  
**Serial #:** ARUB111-U1 Rev B  
**Issue Date:** 12th August 2013  
**Page:** 164 of 185

**5470 – 5725 MHz, 802.11n HT-20**

|                      |                        |                       |      |
|----------------------|------------------------|-----------------------|------|
| <b>Test Freq.</b>    | 5500 MHz               | <b>Engineer</b>       | SB   |
| <b>Variant</b>       | 802.11n HT-20; 6.5 MCS | <b>Temp (°C)</b>      | 26.6 |
| <b>Freq. Range</b>   | 1000 MHz - 18000 MHz   | <b>Rel. Hum.(%)</b>   | 31   |
| <b>Power Setting</b> | 21                     | <b>Press. (mBars)</b> | 1008 |
| <b>Antenna</b>       | AP-ANT89               | <b>Duty Cycle (%)</b> | 100  |
| <b>Test Notes 1</b>  |                        |                       |      |
| <b>Test Notes 2</b>  |                        |                       |      |

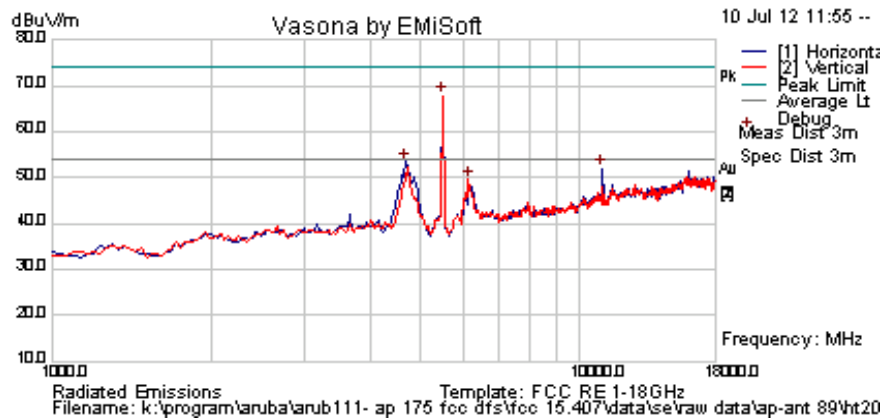

**Formally measured emission peaks**

| Frequency MHz | Raw dBuV | Cable Loss | AF dB | Level dBuV/m | Measurement Type | Pol | Hgt cm | Azt Deg | Limit dBuV/m | Margin dB | Pass /Fail | Comments |
|---------------|----------|------------|-------|--------------|------------------|-----|--------|---------|--------------|-----------|------------|----------|
| 4679.359      | 58.9     | 4.3        | -9.9  | 53.4         | Peak [Scan]      | H   | 150    | 0       | 54.0         | -0.6      | Pass       | BE       |
| 5496.993988   | 72.8     | 4.6        | -9.6  | 67.8         | Peak [Scan]      | V   | 100    |         |              |           |            | FUND     |
| 6144.289      | 52.6     | 5.0        | -8.1  | 49.5         | Peak [Scan]      | V   | 100    | 0       | 54           | -4.5      | Pass       | NRB      |
| 11016.032     | 51.9     | 7.0        | -3.1  | 55.8         | Peak Max         | H   | 101    | 346     | 74.0         | -18.3     | Pass       |          |
| 11016.032     | 38.0     | 7.0        | -3.1  | 41.9         | Average Max      | H   | 101    | 346     | 54.0         | -12.1     | Pass       |          |

Legend: TX = Transmitter Emissions; DIG = Digital Emissions; FUND = Fundamental; WB = Wideband Emission  
 NRB = Non-Restricted Band. Limit = 68.23 dBuV/m; RB = Restricted Band. Limits per 15.205

This test report may be reproduced in full only. The document may only be updated by MiCOM Labs personnel. Any changes will be noted in the Document History section of the report.



**Title:** Aruba AP-175 802.11a/b/g/n Wireless AP  
**To:** FCC 47 CFR Part 15.407 & IC RSS-210  
**Serial #:** ARUB111-U1 Rev B  
**Issue Date:** 12th August 2013  
**Page:** 165 of 185

|                      |                        |                       |      |
|----------------------|------------------------|-----------------------|------|
| <b>Test Freq.</b>    | 5580 MHz               | <b>Engineer</b>       | SB   |
| <b>Variant</b>       | 802.11n HT-20; 6.5 MCS | <b>Temp (°C)</b>      | 26.6 |
| <b>Freq. Range</b>   | 1000 MHz - 18000 MHz   | <b>Rel. Hum.(%)</b>   | 31   |
| <b>Power Setting</b> | 21                     | <b>Press. (mBars)</b> | 1008 |
| <b>Antenna</b>       | AP-ANT89               | <b>Duty Cycle (%)</b> | 100  |
| <b>Test Notes 1</b>  |                        |                       |      |
| <b>Test Notes 2</b>  |                        |                       |      |

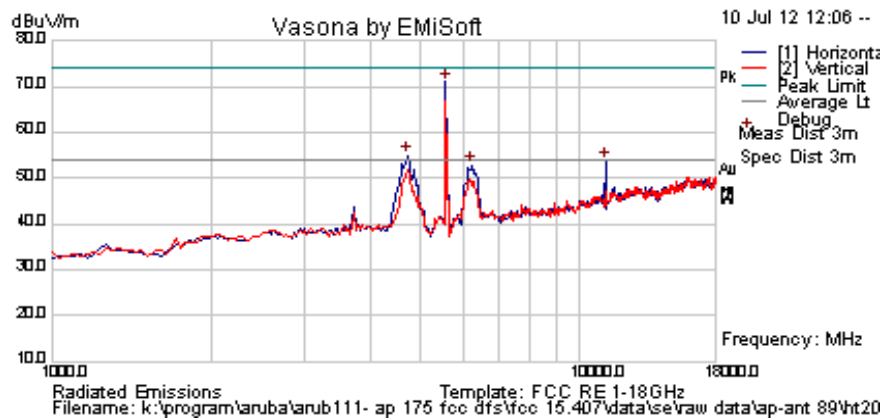

### Formally measured emission peaks

| Frequency MHz | Raw dBuV | Cable Loss | AF dB | Level dBuV/m | Measurement Type | Pol | Hgt cm | Azt Deg | Limit dBuV/m | Margin dB | Pass /Fail | Comments |
|---------------|----------|------------|-------|--------------|------------------|-----|--------|---------|--------------|-----------|------------|----------|
| 4713.427      | 64.0     | 4.4        | -9.8  | 58.6         | Peak Max         | H   | 102    | 350     | 74.0         | -15.4     | Pass       | BE       |
| 4713.427      | 50.3     | 4.4        | -9.8  | 44.8         | Average Max      | H   | 102    | 350     | 54.0         | -9.2      | Pass       | BE       |
| 11186.373     | 54.4     | 6.9        | -3.0  | 58.4         | Peak Max         | H   | 98     | 325     | 74           | -15.6     | Pass       |          |
| 11186.373     | 41.6     | 6.9        | -3.0  | 45.6         | Average Max      | H   | 98     | 325     | 54           | -8.5      | Pass       |          |
| 5565.130261   | 76.1     | 4.7        | -9.7  | 71.0         | Peak [Scan]      | H   | 100    |         |              |           |            | FUND     |
| 6246.493      | 55.4     | 5.0        | -7.6  | 52.8         | Peak [Scan]      | H   | 100    | 0       | 54           | -1.2      | Pass       | NRB      |

Legend: TX = Transmitter Emissions; DIG = Digital Emissions; FUND = Fundamental; WB = Wideband Emission  
 NRB = Non-Restricted Band. Limit = 68.23 dBuV/m; RB = Restricted Band. Limits per 15.205

This test report may be reproduced in full only. The document may only be updated by MiCOM Labs personnel. Any changes will be noted in the Document History section of the report.



**Title:** Aruba AP-175 802.11a/b/g/n Wireless AP  
**To:** FCC 47 CFR Part 15.407 & IC RSS-210  
**Serial #:** ARUB111-U1 Rev B  
**Issue Date:** 12th August 2013  
**Page:** 166 of 185

|                      |                        |                       |      |
|----------------------|------------------------|-----------------------|------|
| <b>Test Freq.</b>    | 5700 MHz               | <b>Engineer</b>       | SB   |
| <b>Variant</b>       | 802.11n HT-20; 6.5 MCS | <b>Temp (°C)</b>      | 26.6 |
| <b>Freq. Range</b>   | 1000 MHz - 18000 MHz   | <b>Rel. Hum.(%)</b>   | 31   |
| <b>Power Setting</b> | 21                     | <b>Press. (mBars)</b> | 1008 |
| <b>Antenna</b>       | AP-ANT89               | <b>Duty Cycle (%)</b> | 100  |
| <b>Test Notes 1</b>  |                        |                       |      |
| <b>Test Notes 2</b>  |                        |                       |      |

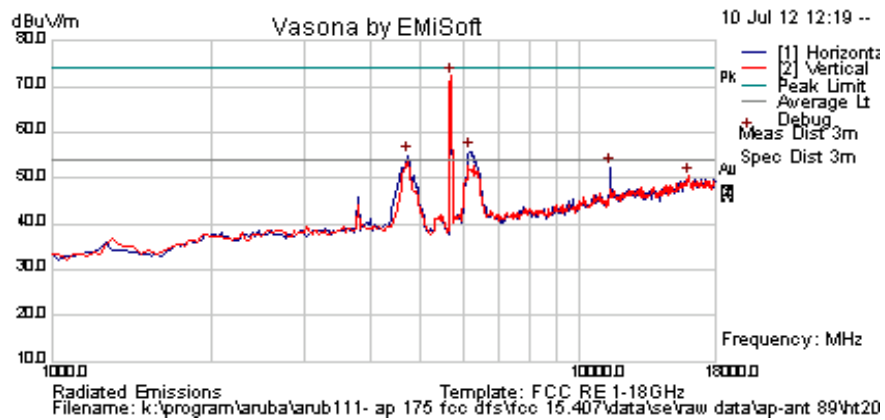

**Formally measured emission peaks**

| Frequency MHz | Raw dBuV | Cable Loss | AF dB | Level dBuV/m | Measurement Type | Pol | Hgt cm | Azt Deg | Limit dBuV/m | Margin dB | Pass /Fail | Comments |
|---------------|----------|------------|-------|--------------|------------------|-----|--------|---------|--------------|-----------|------------|----------|
| 4713.427      | 60.8     | 4.4        | -9.8  | 55.4         | Peak Max         | H   | 130    | 360     | 74.0         | -18.6     | Pass       | BE       |
| 11390.782     | 53.3     | 6.8        | -2.3  | 57.9         | Peak Max         | H   | 98     | 323     | 74.0         | -16.1     | Pass       |          |
| 4713.427      | 47.4     | 4.4        | -9.8  | 42.0         | Average Max      | H   | 130    | 360     | 54           | -12.0     | Pass       | BE       |
| 11390.782     | 39.5     | 6.8        | -2.3  | 44.0         | Average Max      | H   | 98     | 323     | 54           | -10.0     | Pass       |          |
| 5701.402806   | 77.1     | 4.7        | -9.6  | 72.2         | Peak [Scan]      | V   | 200    |         |              |           |            | FUND     |
| 6178.357      | 58.8     | 5.0        | -7.9  | 55.9         | Peak [Scan]      | H   | 100    |         |              |           |            | NRB      |

Legend: TX = Transmitter Emissions; DIG = Digital Emissions; FUND = Fundamental; WB = Wideband Emission  
 NRB = Non-Restricted Band. Limit = 68.23 dBuV/m; RB = Restricted Band. Limits per 15.205

This test report may be reproduced in full only. The document may only be updated by MiCOM Labs personnel. Any changes will be noted in the Document History section of the report.



**Title:** Aruba AP-175 802.11a/b/g/n Wireless AP  
**To:** FCC 47 CFR Part 15.407 & IC RSS-210  
**Serial #:** ARUB111-U1 Rev B  
**Issue Date:** 12th August 2013  
**Page:** 167 of 185

**5250 – 5350 MHz, 802.11n HT-40**

|                      |                         |                       |      |
|----------------------|-------------------------|-----------------------|------|
| <b>Test Freq.</b>    | 5270 MHz                | <b>Engineer</b>       | SB   |
| <b>Variant</b>       | 802.11n HT-40; 13.5 MCS | <b>Temp (°C)</b>      | 26.6 |
| <b>Freq. Range</b>   | 1000 MHz - 18000 MHz    | <b>Rel. Hum.(%)</b>   | 31   |
| <b>Power Setting</b> | 19                      | <b>Press. (mBars)</b> | 1008 |
| <b>Antenna</b>       | AP-ANT89                | <b>Duty Cycle (%)</b> | 100  |
| <b>Test Notes 1</b>  |                         |                       |      |
| <b>Test Notes 2</b>  |                         |                       |      |

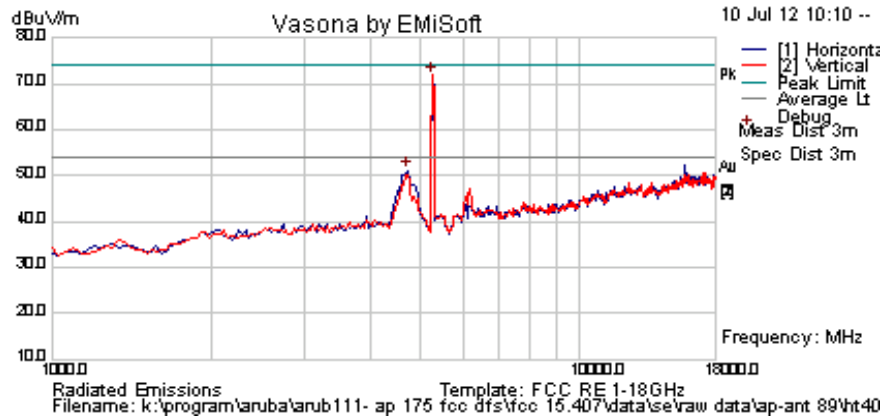

**Formally measured emission peaks**

| Frequency MHz   | Raw dBuV | Cable Loss | AF dB | Level dBuV/m | Measurement Type | Pol | Hgt cm | Azt Deg | Limit dBuV/m | Margin dB | Pass /Fail | Comments |
|---|----------|------------|-------|--------------|------------------|-----|--------|---------|--------------|-----------|------------|----------|
| 5258.517  | 77.0     | 4.6        | -9.7  | 71.8         | Peak [Scan]      | V   | 150    |         |              |           |            | FUND     |
| 4713.426854   | 56.6     | 4.4        | -9.8  | 51.2         | Peak [Scan]      | H   | 150    | 0       | 54.0         | -2.8      | Pass       | BE       |
| Legend: TX = Transmitter Emissions; DIG = Digital Emissions; FUND = Fundamental; WB = Wideband Emission<br>NRB = Non-Restricted Band. Limit = 68.23 dBuV/m; RB = Restricted Band. Limits per 15.205 |          |            |       |              |                  |     |        |         |              |           |            |          |

This test report may be reproduced in full only. The document may only be updated by MiCOM Labs personnel. Any changes will be noted in the Document History section of the report.



**Title:** Aruba AP-175 802.11a/b/g/n Wireless AP  
**To:** FCC 47 CFR Part 15.407 & IC RSS-210  
**Serial #:** ARUB111-U1 Rev B  
**Issue Date:** 12th August 2013  
**Page:** 168 of 185

|                      |                         |                       |      |
|----------------------|-------------------------|-----------------------|------|
| <b>Test Freq.</b>    | 5310 MHz                | <b>Engineer</b>       | SB   |
| <b>Variant</b>       | 802.11n HT-40; 13.5 MCS | <b>Temp (°C)</b>      | 26.6 |
| <b>Freq. Range</b>   | 1000 MHz - 18000 MHz    | <b>Rel. Hum.(%)</b>   | 31   |
| <b>Power Setting</b> | 19                      | <b>Press. (mBars)</b> | 1008 |
| <b>Antenna</b>       | AP-ANT89                | <b>Duty Cycle (%)</b> | 100  |
| <b>Test Notes 1</b>  |                         |                       |      |
| <b>Test Notes 2</b>  |                         |                       |      |

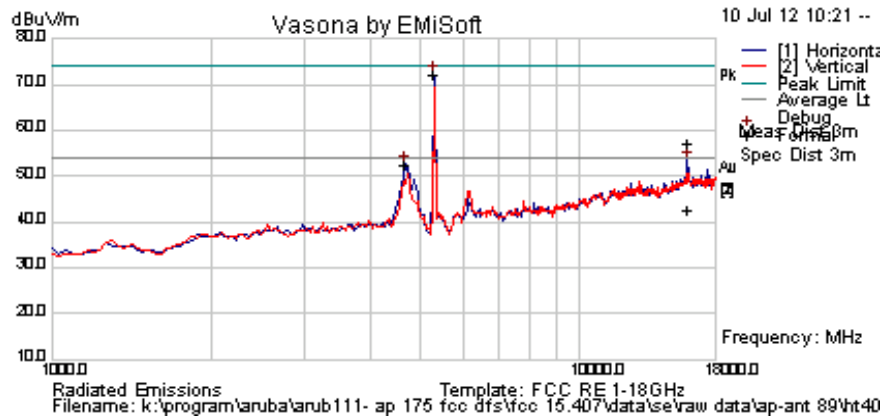

### Formally measured emission peaks

| Frequency MHz | Raw dBuV  | Cable Loss | AF dB | Level dBuV/m | Measurement Type | Pol | Hgt cm | Azt Deg | Limit dBuV/m | Margin dB | Pass /Fail | Comments |
|---------------|---|------------|-------|--------------|------------------|-----|--------|---------|--------------|-----------|------------|----------|
| 15955.271     | 48.1  | 9.0        | 0.0   | 57.1         | Peak Max         | H   | 118    | 334     | 74.0         | -16.9     | Pass       |          |
| 15955.271     | 33.5  | 9.0        | 0.0   | 42.4         | Average Max      | H   | 118    | 334     | 54.0         | -11.6     | Pass       |          |
| 5292.585      | 77.1  | 4.6        | -9.6  | 72.1         | Peak [Scan]      | H   | 150    |         |              |           |            | FUND     |
| 4679.359      | 58.2  | 4.3        | -9.9  | 52.7         | Peak [Scan]      | H   | 100    | 0       | 54           | -1.4      | Pass       |          |
| Legend:       | TX = Transmitter Emissions; DIG = Digital Emissions; FUND = Fundamental; WB = Wideband Emission<br>NRB = Non-Restricted Band. Limit = 68.23 dBuV/m; RB = Restricted Band. Limits per 15.205 |            |       |              |                  |     |        |         |              |           |            |          |

This test report may be reproduced in full only. The document may only be updated by MiCOM Labs personnel. Any changes will be noted in the Document History section of the report.





**Title:** Aruba AP-175 802.11a/b/g/n Wireless AP  
**To:** FCC 47 CFR Part 15.407 & IC RSS-210  
**Serial #:** ARUB111-U1 Rev B  
**Issue Date:** 12th August 2013  
**Page:** 169 of 185

**5470 – 5725 MHz, 802.11n HT-40**

|                      |                         |                       |      |
|----------------------|-------------------------|-----------------------|------|
| <b>Test Freq.</b>    | 5510 MHz                | <b>Engineer</b>       | SB   |
| <b>Variant</b>       | 802.11n HT-40; 13.5 MCS | <b>Temp (°C)</b>      | 26.6 |
| <b>Freq. Range</b>   | 1000 MHz - 18000 MHz    | <b>Rel. Hum.(%)</b>   | 31   |
| <b>Power Setting</b> | 19                      | <b>Press. (mBars)</b> | 1008 |
| <b>Antenna</b>       | AP-ANT89                | <b>Duty Cycle (%)</b> | 100  |
| <b>Test Notes 1</b>  |                         |                       |      |
| <b>Test Notes 2</b>  |                         |                       |      |

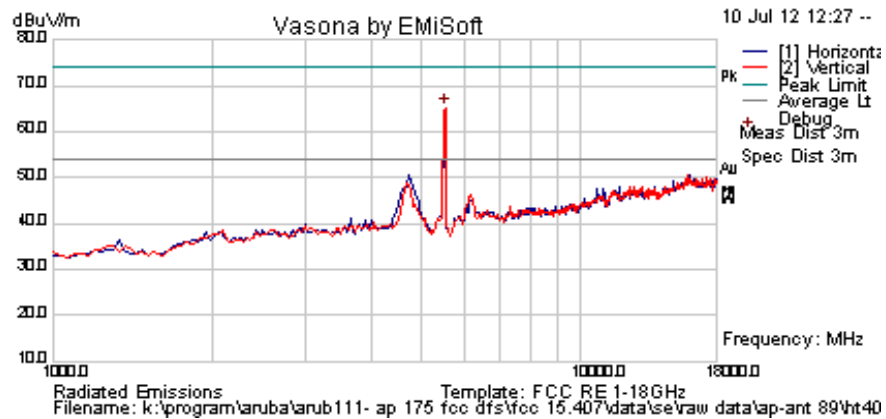

**Formally measured emission peaks**

| Frequency MHz | Raw dBuV | Cable Loss | AF dB | Level dBuV/m | Measurement Type | Pol | Hgt cm | Azt Deg | Limit dBuV/m | Margin dB | Pass /Fail | Comments |
|---------------|----------|------------|-------|--------------|------------------|-----|--------|---------|--------------|-----------|------------|----------|
| 5531.062      | 70.3     | 4.6        | -9.7  | 65.3         | Peak [Scan]      | V   | 100    |         |              |           |            | FUND     |

Legend: TX = Transmitter Emissions; DIG = Digital Emissions; FUND = Fundamental; WB = Wideband Emission  
 NRB = Non-Restricted Band. Limit = 68.23 dBuV/m; RB = Restricted Band. Limits per 15.205

This test report may be reproduced in full only. The document may only be updated by MiCOM Labs personnel. Any changes will be noted in the Document History section of the report.



**Title:** Aruba AP-175 802.11a/b/g/n Wireless AP  
**To:** FCC 47 CFR Part 15.407 & IC RSS-210  
**Serial #:** ARUB111-U1 Rev B  
**Issue Date:** 12th August 2013  
**Page:** 170 of 185

|                      |                         |                       |      |
|----------------------|-------------------------|-----------------------|------|
| <b>Test Freq.</b>    | 5550 MHz                | <b>Engineer</b>       | SB   |
| <b>Variant</b>       | 802.11n HT-40; 13.5 MCS | <b>Temp (°C)</b>      | 26.6 |
| <b>Freq. Range</b>   | 1000 MHz - 18000 MHz    | <b>Rel. Hum.(%)</b>   | 31   |
| <b>Power Setting</b> | 19                      | <b>Press. (mBars)</b> | 1008 |
| <b>Antenna</b>       | AP-ANT89                | <b>Duty Cycle (%)</b> | 100  |
| <b>Test Notes 1</b>  |                         |                       |      |
| <b>Test Notes 2</b>  |                         |                       |      |

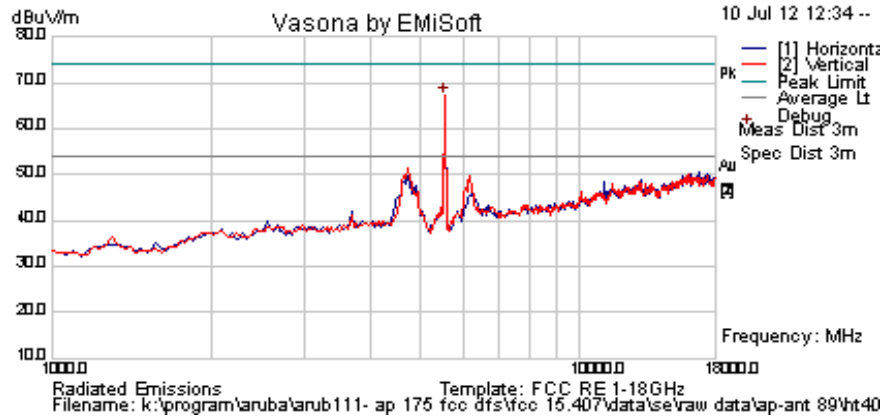

**Formally measured emission peaks**

| Frequency MHz | Raw dBuV | Cable Loss | AF dB | Level dBuV/m | Measurement Type | Pol | Hgt cm | Azt Deg | Limit dBuV/m | Margin dB | Pass /Fail | Comments |
|---------------|----------|------------|-------|--------------|------------------|-----|--------|---------|--------------|-----------|------------|----------|
| 5531.062      | 72.3     | 4.6        | -9.7  | 67.2         | Peak [Scan]      | V   | 100    |         |              |           |            | FUND     |

|         |   |
|---------|---|
| Legend: | TX = Transmitter Emissions; DIG = Digital Emissions; FUND = Fundamental; WB = Wideband Emission |
|         | NRB = Non-Restricted Band. Limit = 68.23 dBuV/m; RB = Restricted Band. Limits per 15.205        |

This test report may be reproduced in full only. The document may only be updated by MiCOM Labs personnel. Any changes will be noted in the Document History section of the report.



**Title:** Aruba AP-175 802.11a/b/g/n Wireless AP  
**To:** FCC 47 CFR Part 15.407 & IC RSS-210  
**Serial #:** ARUB111-U1 Rev B  
**Issue Date:** 12th August 2013  
**Page:** 171 of 185

|                      |                         |                       |      |
|----------------------|-------------------------|-----------------------|------|
| <b>Test Freq.</b>    | 5670 MHz                | <b>Engineer</b>       | SB   |
| <b>Variant</b>       | 802.11n HT-40; 13.5 MCS | <b>Temp (°C)</b>      | 26.6 |
| <b>Freq. Range</b>   | 1000 MHz - 18000 MHz    | <b>Rel. Hum.(%)</b>   | 31   |
| <b>Power Setting</b> | 19                      | <b>Press. (mBars)</b> | 1008 |
| <b>Antenna</b>       | AP-ANT89                | <b>Duty Cycle (%)</b> | 100  |
| <b>Test Notes 1</b>  |                         |                       |      |
| <b>Test Notes 2</b>  |                         |                       |      |

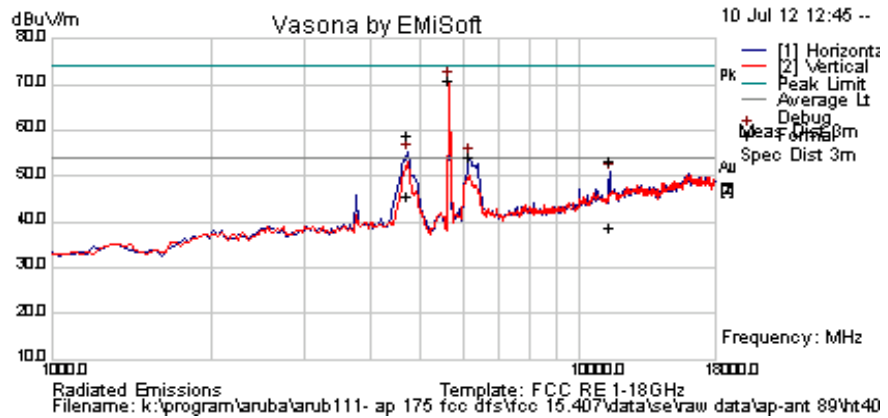

**Formally measured emission peaks**

| Frequency MHz | Raw dBuV | Cable Loss | AF dB | Level dBuV/m | Measurement Type | Pol | Hgt cm | Azt Deg | Limit dBuV/m | Margin dB | Pass /Fail | Comments |
|---------------|----------|------------|-------|--------------|------------------|-----|--------|---------|--------------|-----------|------------|----------|
| 4712.144      | 64.4     | 4.4        | -9.8  | 59.0         | Peak Max         | H   | 115    | 349     | 74.0         | -15.0     | Pass       | BE       |
| 11336.833     | 49.0     | 6.9        | -2.4  | 53.4         | Peak Max         | H   | 133    | 322     | 74.0         | -20.7     | Pass       |          |
| 4712.144      | 51.0     | 4.4        | -9.8  | 45.6         | Average Max      | H   | 115    | 349     | 54           | -8.4      | Pass       | BE       |
| 11336.833     | 34.5     | 6.9        | -2.4  | 39.0         | Average Max      | H   | 133    | 322     | 54           | -15.1     | Pass       |          |
| 5633.267      | 75.9     | 4.7        | -9.7  | 70.9         | Peak [Scan]      | V   | 100    |         |              |           |            | FUND     |
| 6178.357      | 57.1     | 5.0        | -7.9  | 54.2         | Peak [Scan]      | H   | 100    |         |              |           |            | NRB      |

Legend: TX = Transmitter Emissions; DIG = Digital Emissions; FUND = Fundamental; WB = Wideband Emission  
 NRB = Non-Restricted Band. Limit = 68.23 dBuV/m; RB = Restricted Band. Limits per 15.205

This test report may be reproduced in full only. The document may only be updated by MiCOM Labs personnel. Any changes will be noted in the Document History section of the report.



### 5.1.7.3. Radiated Band-Edge spurious emissions

#### 5320 MHz - 802.11a Legacy 5350 - 5460 MHz

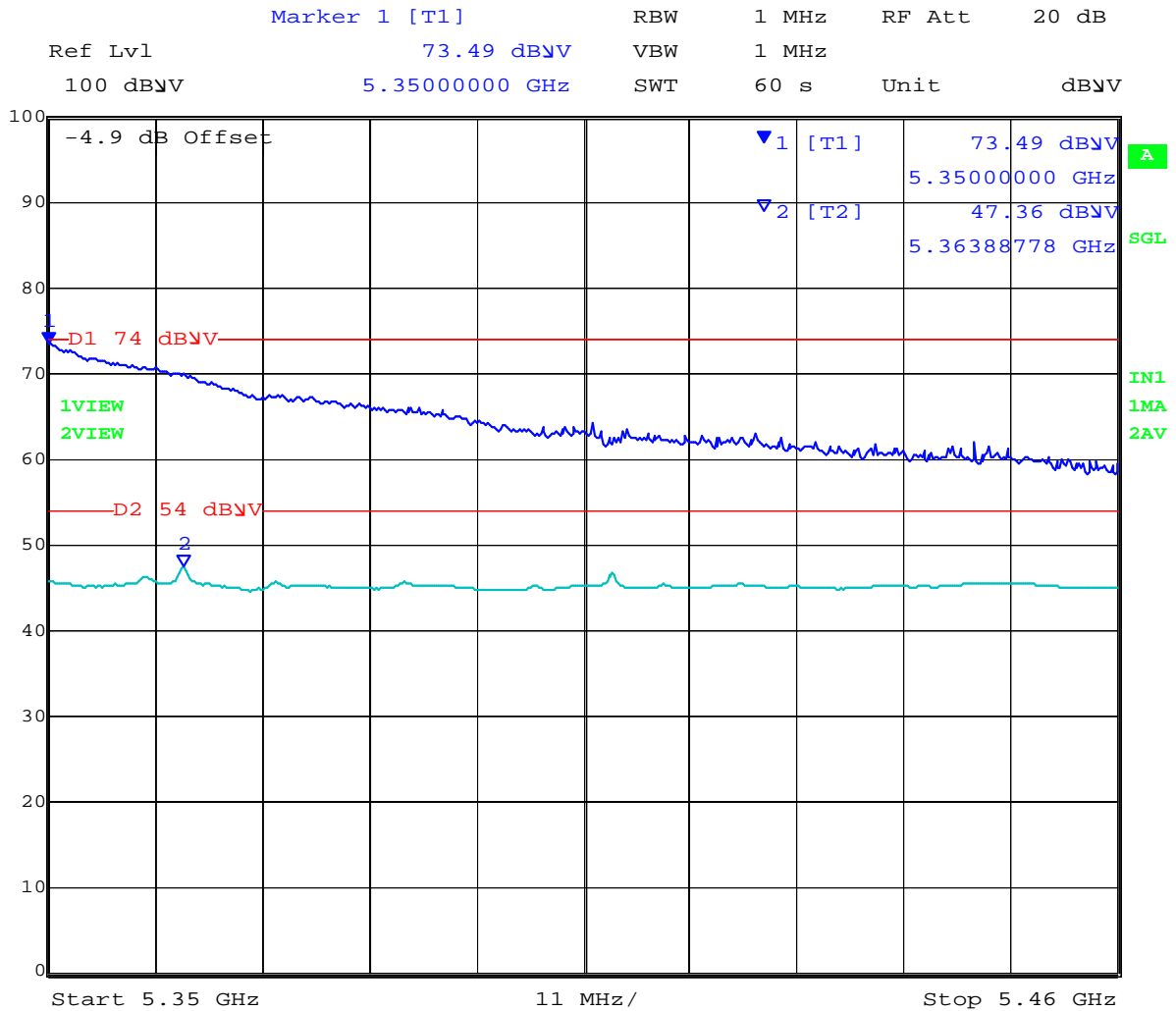

Date: 10.JUL.2012 17:58:38

NOTE: Power Reduction Required ART = 19

This test report may be reproduced in full only. The document may only be updated by MiCOM Labs personnel. Any changes will be noted in the Document History section of the report.



5320 MHz - 802.11n HT-20 5350 - 5460 MHz

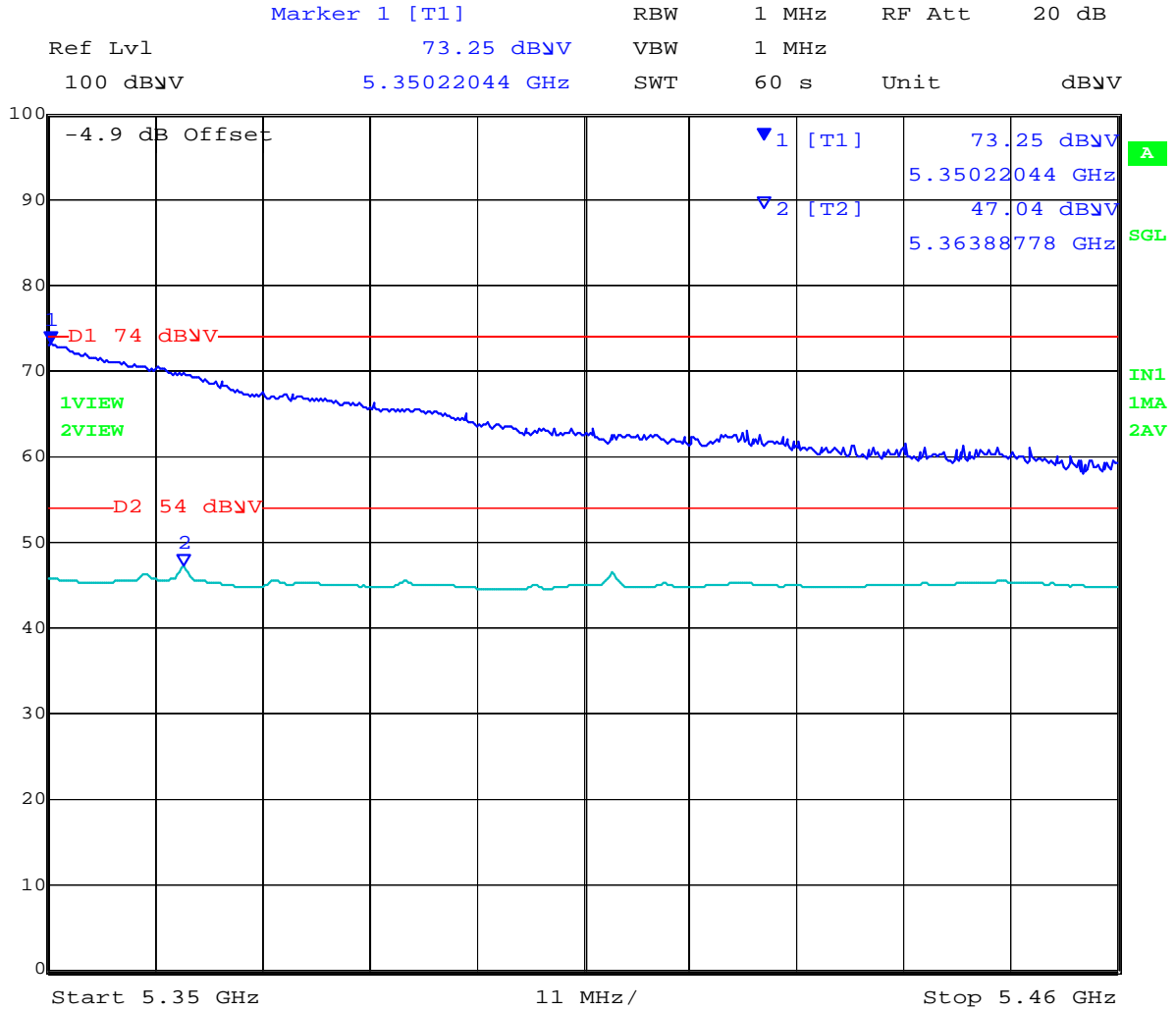

Date: 10.JUL.2012 18:04:33

NOTE: Power Reduction Required ART = 18.5

This test report may be reproduced in full only. The document may only be updated by MiCOM Labs personnel. Any changes will be noted in the Document History section of the report.



5310 MHz - 802.11n HT-40 5350 - 5460 MHz

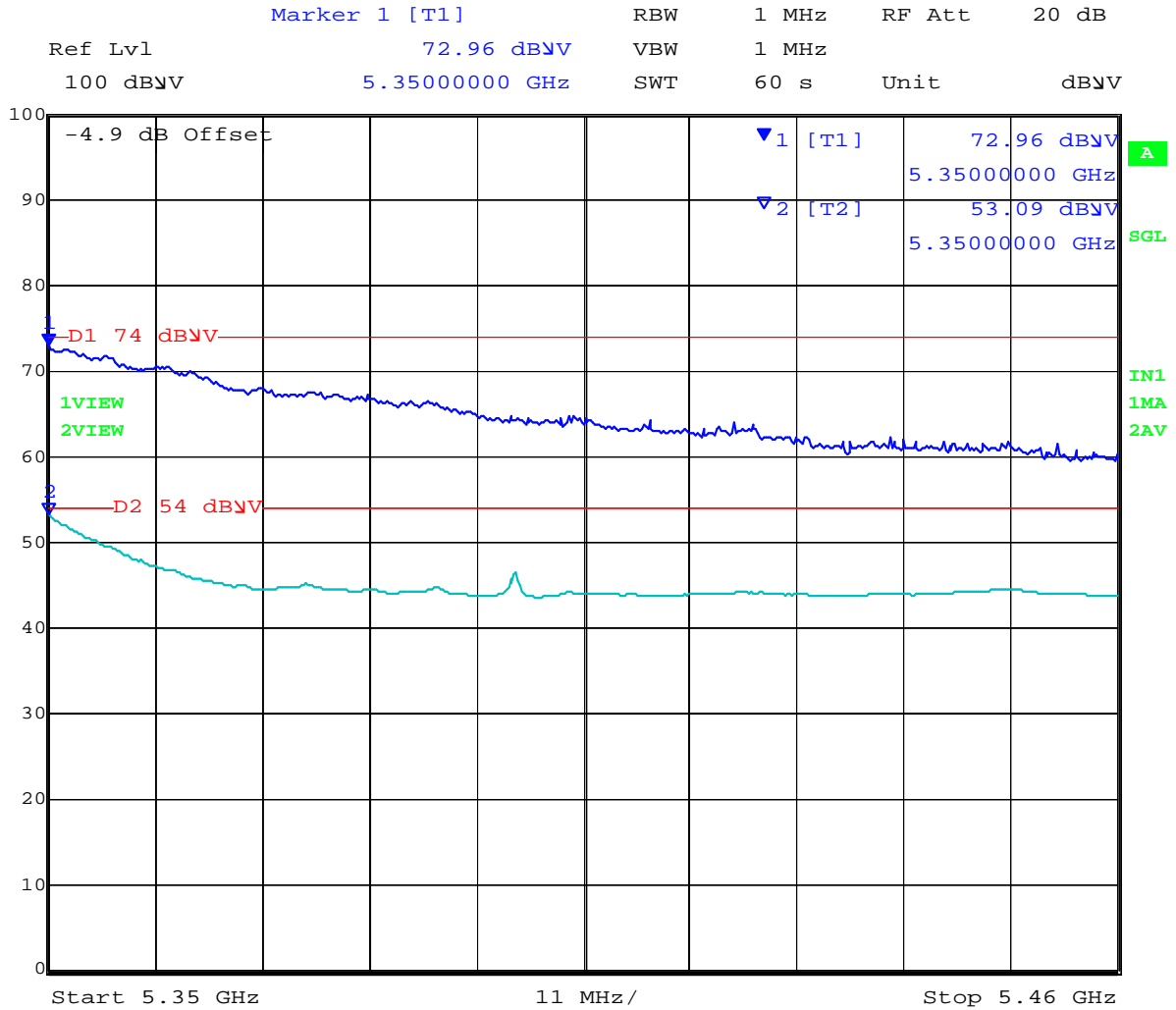

Date: 10.JUL.2012 18:11:15

NOTE: Power Reduction Required ART = 20.5

This test report may be reproduced in full only. The document may only be updated by MiCOM Labs personnel. Any changes will be noted in the Document History section of the report.



5500 MHz - 802.11a Legacy 5350 - 5460 MHz

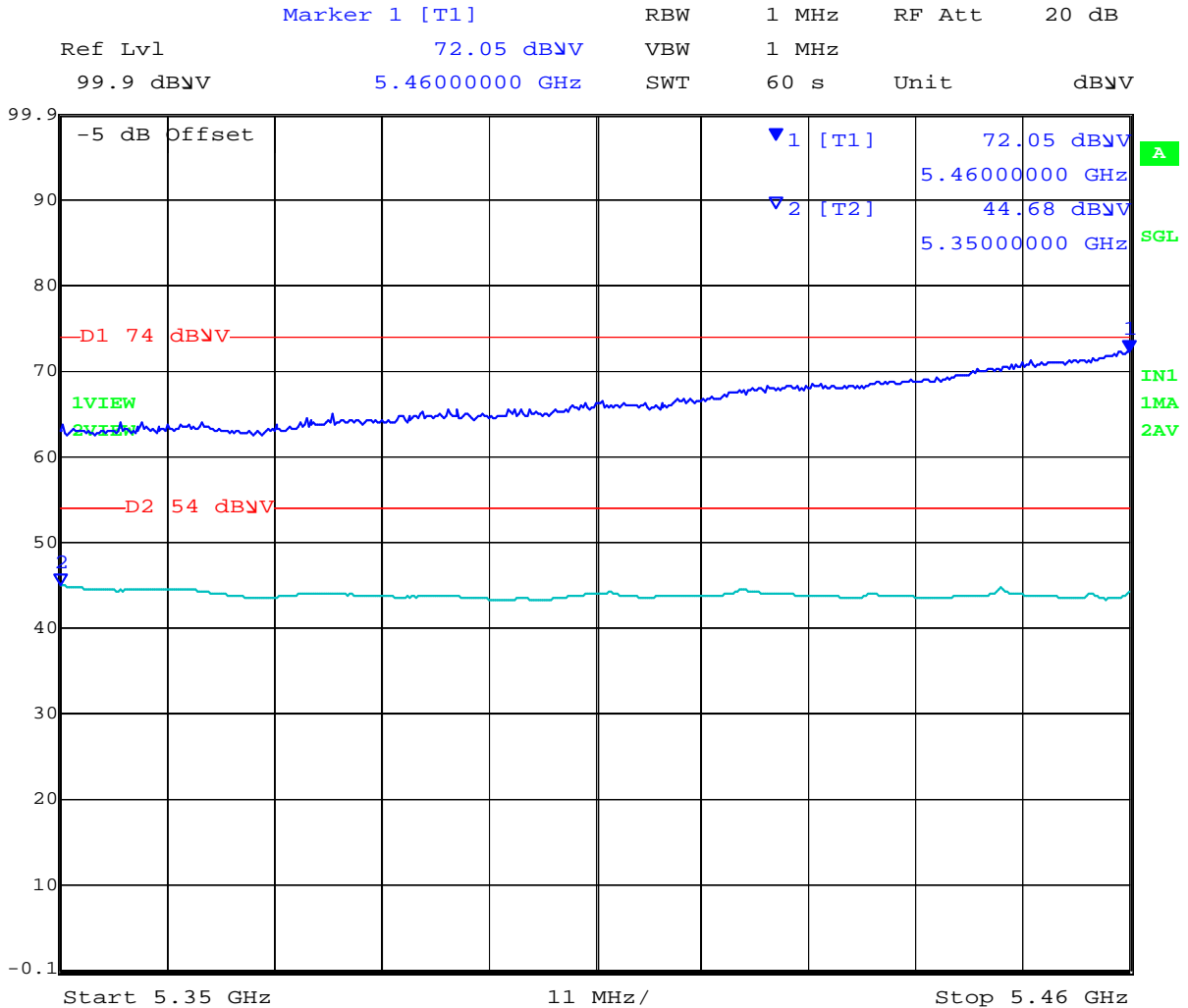

Date: 10.JUL.2012 18:25:04

NOTE: Power Reduction Required ART = 20



5500 MHz - 802.11n HT-20 5350 - 5460 MHz

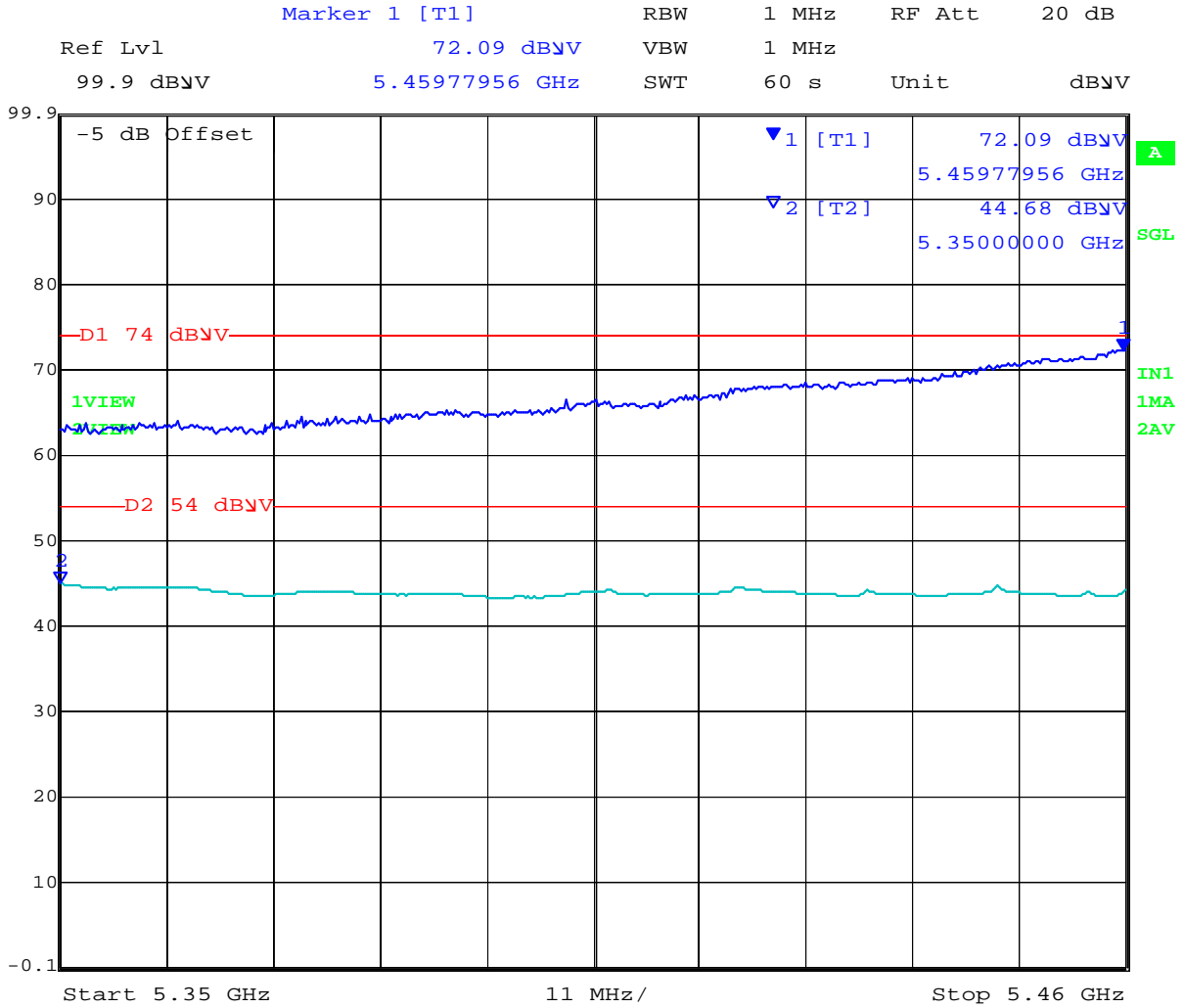

Date: 10.JUL.2012 18:22:20

NOTE: Power Reduction Required ART = 20





5510 MHz - 802.11n HT-40 5350 - 5460 MHz

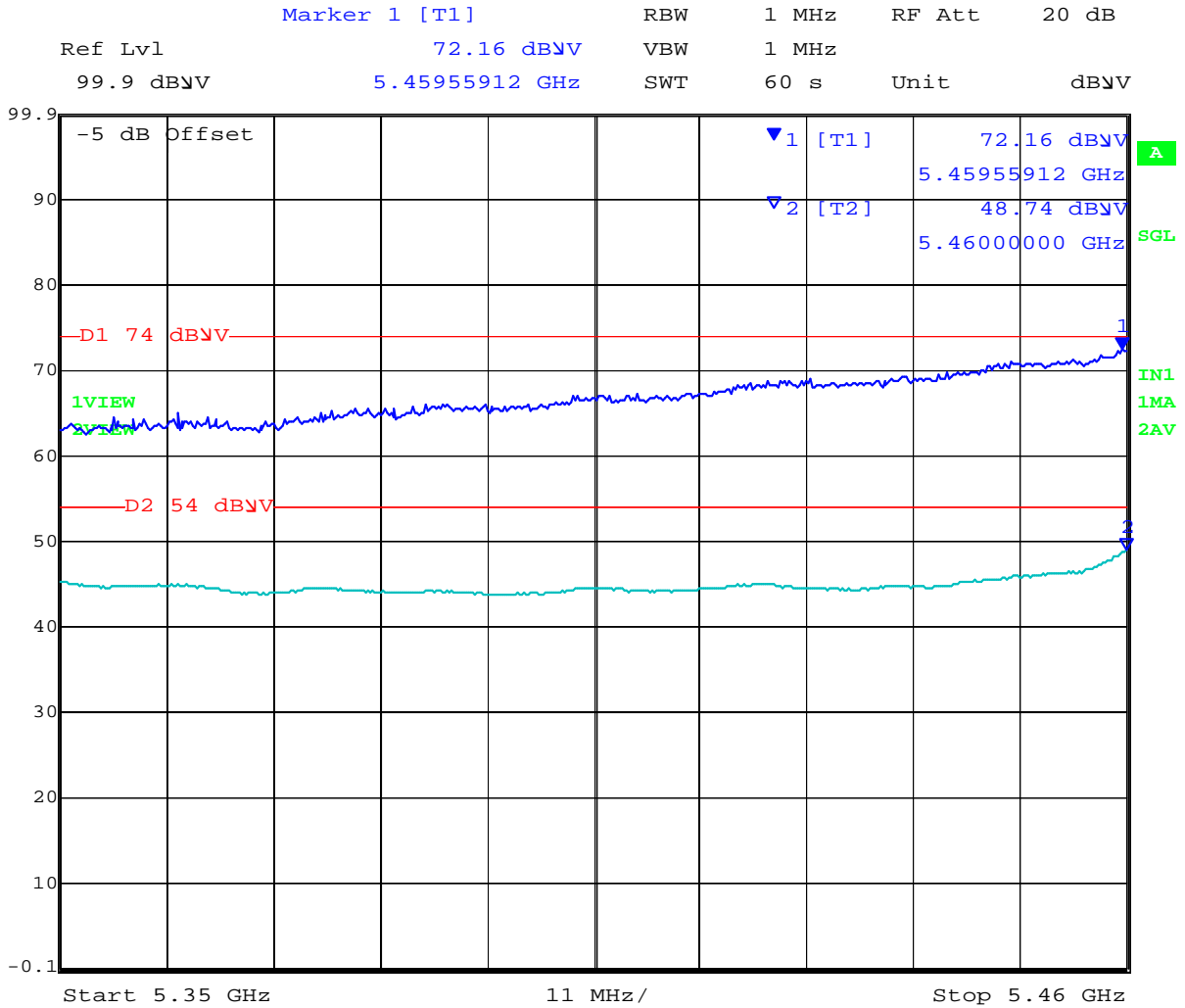

Date: 10.JUL.2012 18:26:41

NOTE: Power Reduction Required ART = 20

This test report may be reproduced in full only. The document may only be updated by MiCOM Labs personnel. Any changes will be noted in the Document History section of the report.



## Specification

### Limits

**§15.407(b)(6)** Unwanted emissions below 1 GHz must comply with the general field strength limits set forth in Section 15.209.

**§15.205 (a)** Except as shown in paragraph (d) of 15.205 (a), only spurious emissions are permitted in any of the frequency bands listed.

**§15.205 (a)** Except as shown in paragraphs (d) and (e) of this section, the field strength of emissions appearing within these frequency bands shall not exceed the limits shown in Section §15.209. At frequencies equal to or less than 1000 MHz, compliance with the limits in Section 15.209 shall be demonstrated using measurement instrumentation employing a CISPR quasi-peak detector. Above 1000 MHz, compliance with the emission limits in Section 15.209 shall be demonstrated based on the average value of the measured emissions. The provisions in Section 15.35 apply to these measurements.

**§15.209 (a)** Except as provided elsewhere in this subpart, the emissions from an intentional radiator shall not exceed the field strength levels specified in the following table.

**RSS-210 §2.2** refers to Section 2.7 Table 2 below;-

| Frequency(MHz) | Field Strength ( $\mu\text{V/m}$ ) | Field Strength ( $\text{dB}\mu\text{V/m}$ ) | Measurement Distance (meters) |
|----------------|------------------------------------|---|-------------------------------|
| 30-88          | 100                                | 40.0  | 3                             |
| 88-216         | 150                                | 43.5  | 3                             |
| 216-960        | 200                                | 46.0  | 3                             |
| Above 960      | 500                                | 54.0  | 3                             |

### Laboratory Measurement Uncertainty for Radiated Emissions

|                         |               |
|-------------------------|---------------|
| Measurement uncertainty | +5.6/ -4.5 dB |
|-------------------------|---------------|

### Traceability

| Method  | Test Equipment Used                            |
|---|--|
| Measurements were made per work instruction WI-03 'Measurement of Radiated Emissions' | 0088, 0158, 0134, 0304, 0311, 0315, 0310, 0312 |

This test report may be reproduced in full only. The document may only be updated by MiCOM Labs personnel. Any changes will be noted in the Document History section of the report.



#### 5.1.7.4. Radiated Spurious Emissions – 30MHz – 1000MHz

**FCC, Part 15 Subpart C §15.205/ §15.209**  
**Industry Canada RSS-210 §2.2**

##### Test Procedure

Testing 30M-1 GHz was performed in a 3-meter anechoic chamber using a CISPR compliant receiver. Preliminary radiated emissions were measured on every azimuth and with the receiving antenna in both horizontal and vertical polarizations. To further maximize emissions the receive antenna was varied between 1 and 4 meters. The emissions are recorded with receiver in peak hold mode. Emissions closest to the limits are measured in the quasi-peak mode with the tuned receiver using a bandwidth of 120 kHz. Only the highest emissions relative to the limit are listed. The anechoic chamber test set-up is identified in Section 6 Test Set-Up Photographs.

The EUT had two methods of powering on ac/dc converter and Power over Ethernet (POE). Both modes were tested for emissions below 1GHz.

##### Field Strength Calculation

The field strength is calculated by adding the Antenna Factor and Cable Loss, and subtracting Amplifier Gain from the measured reading. In this test facility, the Antenna Factor, Cable Loss, and Amplifier Gains are loaded into the Rohde & Schwarz Receiver and the corrected field strength can be read directly on the receiver.

$$FS = R + AF + CORR$$

where:

FS = Field Strength  
R = Measured Receiver Input Amplitude  
AF = Antenna Factor  
CORR = Correction Factor = CL – AG + NFL  
CL = Cable Loss  
AG = Amplifier Gain

For example:

Given a Receiver input reading of 51.5dB $\mu$ V; Antenna Factor of 8.5dB; Cable Loss of 1.3dB; Falloff Factor of 0dB, an Amplifier Gain of 26dB and Notch Filter Loss of 1dB. The Field Strength of the measured emission is:

$$FS = 51.5 + 8.5 + 1.3 - 26.0 + 1 = 36.3\text{dB}\mu\text{V/m}$$

Conversion between dB $\mu$ V/m (or dB $\mu$ V) and  $\mu$ V/m (or  $\mu$ V) are done as:

$$\text{Level (dB}\mu\text{V/m)} = 20 * \text{Log (level (\mu\text{V/m}))}$$

$$40 \text{ dB}\mu\text{V/m} = 100\mu\text{V/m}$$

$$48 \text{ dB}\mu\text{V/m} = 250\mu\text{V/m}$$

---

This test report may be reproduced in full only. The document may only be updated by MiCOM Labs personnel. Any changes will be noted in the Document History section of the report.

### Radiated Emission Measurement Setup – Below 1 GHz

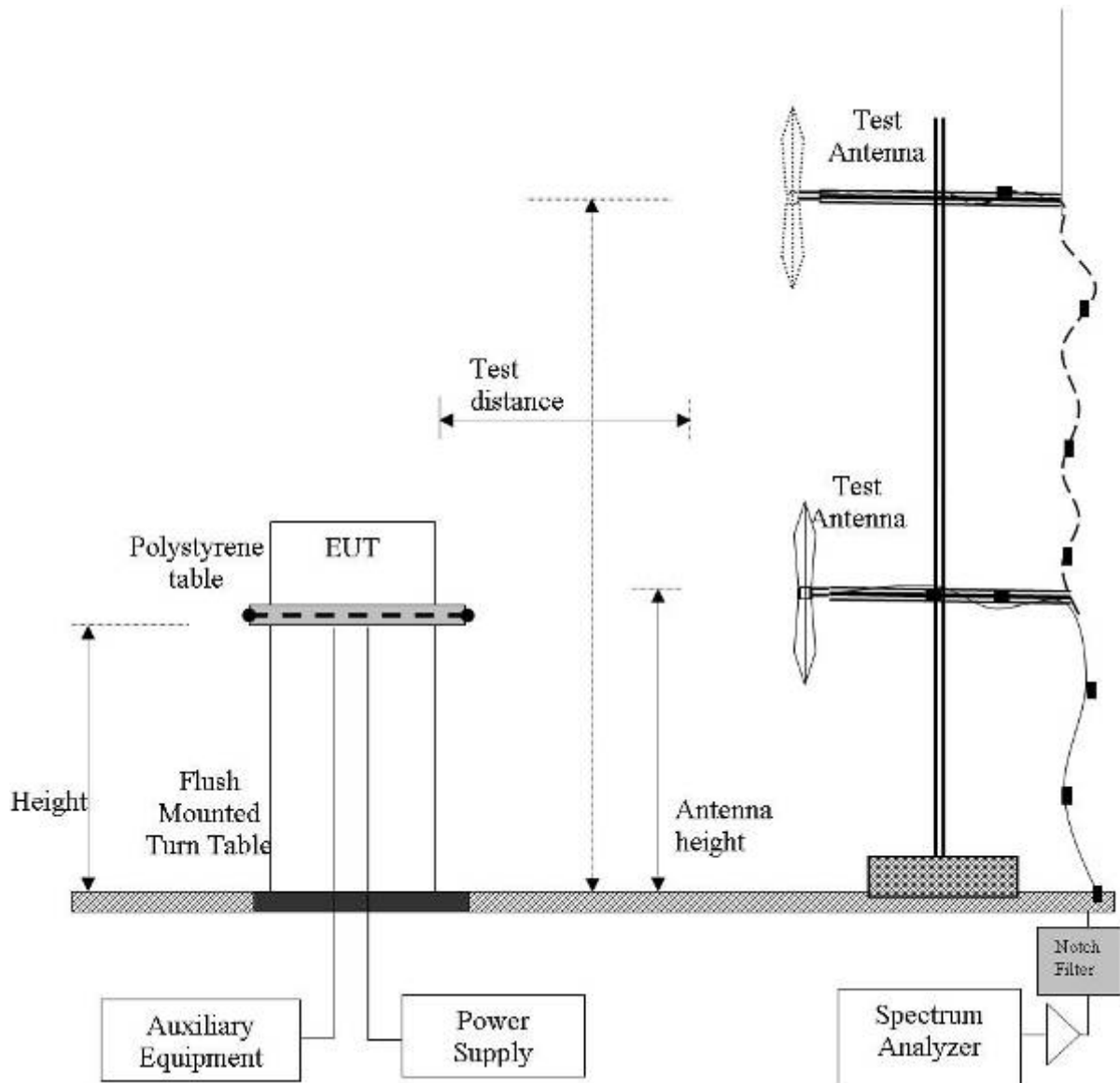

This test report may be reproduced in full only. The document may only be updated by MiCOM Labs personnel. Any changes will be noted in the Document History section of the report.



**Title:** Aruba AP-175 802.11a/b/g/n Wireless AP  
**To:** FCC 47 CFR Part 15.407 & IC RSS-210  
**Serial #:** ARUB111-U1 Rev B  
**Issue Date:** 12th August 2013  
**Page:** 181 of 185

|                      |  |                       |      |
|----------------------|--|-----------------------|------|
| <b>Test Freq.</b>    | N/A  | <b>Engineer</b>       | GMH  |
| <b>Variant</b>       | AP-175DC   | <b>Temp (°C)</b>      | 18   |
| <b>Freq. Range</b>   | 30 MHz - 1000 MHz  | <b>Rel. Hum.(%)</b>   | 43   |
| <b>Power Setting</b> | 48 Vdc   | <b>Press. (mBars)</b> | 1001 |
| <b>Antenna</b>       | 4 x 1' meter N-Type cable with 50 Ohm loads terminates antenna port            |                       |      |
| <b>Test Notes 1</b>  | EUT grounded to turntable. Shielded Ethernet cable connected and terminated.   |                       |      |
| <b>Test Notes 2</b>  | AP-175DC powered via 48Vdc (The Beast): Class B limit used to prove compliance |                       |      |

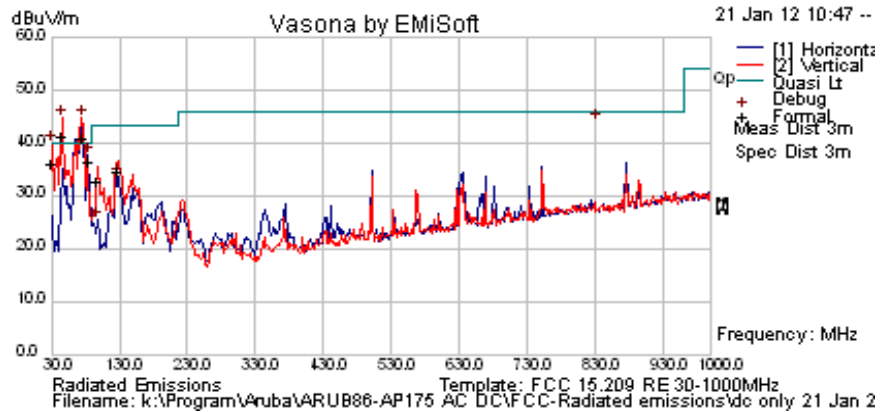

### Formally measured emission peaks

| Frequency MHz | Raw dBuV | Cable Loss | AF dB | Level dBuV/m | Measurement Type | Pol | Hgt cm | Azt Deg | Limit dBuV/m | Margin dB | Pass /Fail | Comments |
|---------------|----------|------------|-------|--------------|------------------|-----|--------|---------|--------------|-----------|------------|----------|
| 46.920        | 57.3     | 3.7        | -21.3 | 39.7         | Quasi Max        | V   | 101    | 235     | 40           | -0.3      | Pass       |          |
| 76.236        | 58.3     | 3.9        | -22.8 | 39.4         | Quasi Max        | V   | 184    | 305     | 40           | -0.6      | Pass       |          |
| 30.091        | 41.8     | 3.4        | -9.2  | 36.1         | Quasi Max        | V   | 100    | 188     | 40           | -3.9      | Pass       |          |
| 84.807        | 56.0     | 4.0        | -23.5 | 36.5         | Quasi Max        | H   | 362    | 123     | 40           | -3.5      | Pass       |          |
| 127.540       | 47.1     | 4.4        | -16.8 | 34.6         | Quasi Max        | V   | 100    | 252     | 43.5         | -8.9      | Pass       |          |
| 98.125        | 49.8     | 4.1        | -21.3 | 32.6         | Quasi Max        | V   | 98     | 82      | 43.5         | -10.9     | Pass       |          |

Legend: DIG = Digital Device Emission; TX = Transmitter Emission; FUND = Fundamental Frequency  
 NRB = Non-Restricted Band, Limit is 20 dB below Fundamental; RB = Restricted Band

This test report may be reproduced in full only. The document may only be updated by MiCOM Labs personnel. Any changes will be noted in the Document History section of the report.



## Specification

### Limits

**§15.205 (a)** Except as shown in paragraph (d) of 15.205 (a), only spurious emissions are permitted in any of the frequency bands listed.

**§15.205 (a)** Except as shown in paragraphs (d) and (e) of this section, the field strength of emissions appearing within these frequency bands shall not exceed the limits shown in Section §15.209. At frequencies equal to or less than 1000 MHz, compliance with the limits in Section 15.209 shall be demonstrated using measurement instrumentation employing a CISPR quasi-peak detector. Above 1000 MHz, compliance with the emission limits in Section 15.209 shall be demonstrated based on the average value of the measured emissions. The provisions in Section 15.35 apply to these measurements.

**§15.209 (a)** Except as provided elsewhere in this subpart, the emissions from an intentional radiator shall not exceed the field strength levels specified in the following table.

### §15.209 (a) and RSS-Gen §2.2 Limit Matrix

| Frequency(MHz) | Field Strength ( $\mu\text{V/m}$ ) | Field Strength ( $\text{dB}\mu\text{V/m}$ ) | Measurement Distance (meters) |
|----------------|------------------------------------|---|-------------------------------|
| 30-88          | 100                                | 40.0  | 3                             |
| 88-216         | 150                                | 43.5  | 3                             |
| 216-960        | 200                                | 46.0  | 3                             |
| Above 960      | 500                                | 54.0  | 3                             |

### Laboratory Measurement Uncertainty for Radiated Emissions

|                         |               |
|-------------------------|---------------|
| Measurement uncertainty | +5.6/ -4.5 dB |
|-------------------------|---------------|

### Traceability

| Method  | Test Equipment Used                            |
|---|--|
| Measurements were made per work instruction WI-03 'Measurement of Radiated Emissions' | 0088, 0158, 0134, 0304, 0311, 0315, 0310, 0312 |

This test report may be reproduced in full only. The document may only be updated by MiCOM Labs personnel. Any changes will be noted in the Document History section of the report.

## 6. PHOTOGRAPHS

### 6.1. Radiated Emissions > 1GHz

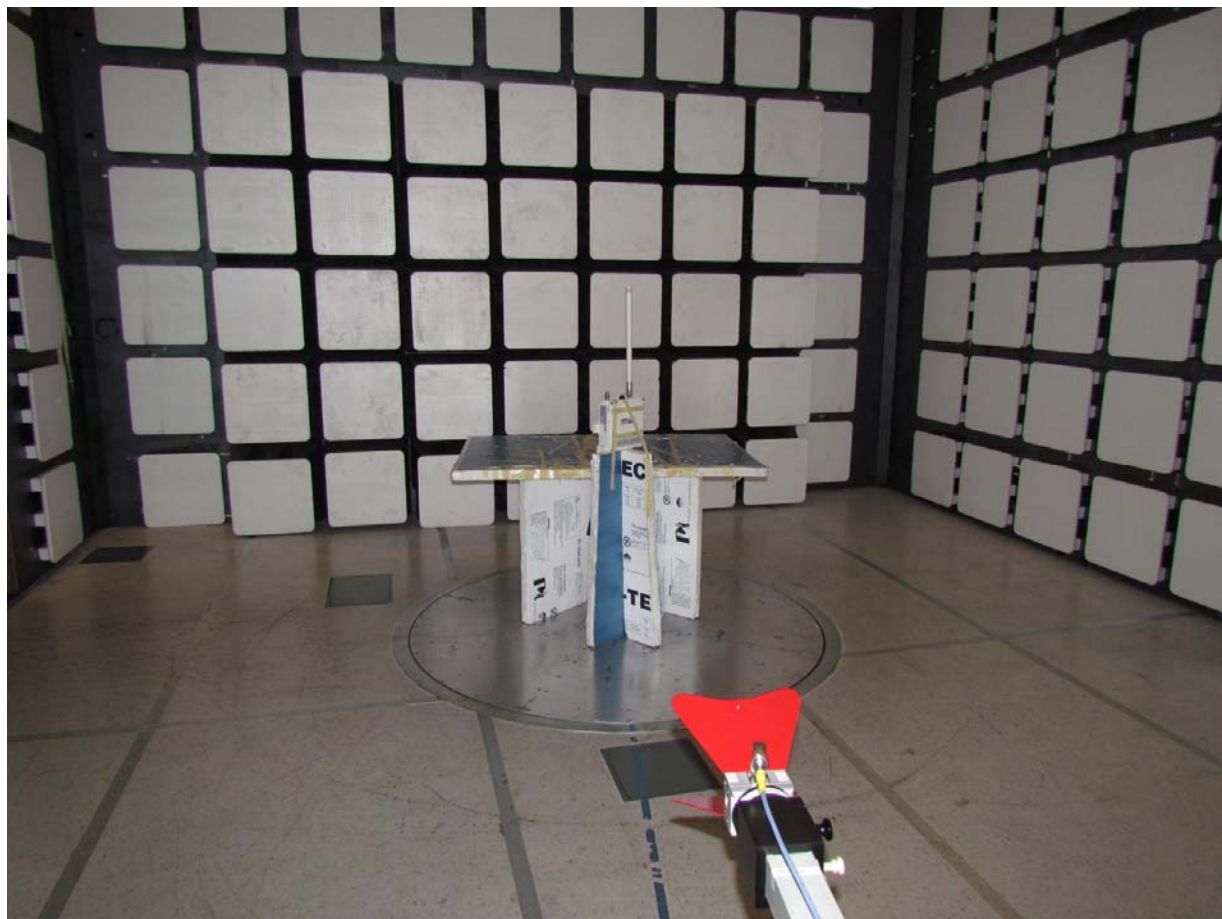

---

This test report may be reproduced in full only. The document may only be updated by MiCOM Labs personnel. Any changes will be noted in the Document History section of the report.



**Title:** Aruba AP-175 802.11a/b/g/n Wireless AP  
**To:** FCC 47 CFR Part 15.407 & IC RSS-210  
**Serial #:** ARUB111-U1 Rev B  
**Issue Date:** 12th August 2013  
**Page:** 184 of 185

## 7. TEST EQUIPMENT DETAILS

| Asset # | Instrument                 | Manufacturer         | Part #                | Serial #    | Calibration Due Date    |
|---------|----------------------------|----------------------|-----------------------|-------------|-------------------------|
| 0070    | Power Meter                | Hewlett Packard      | 437B                  | 3125U11552  | 28 <sup>th</sup> Nov 13 |
| 0117    | Power Sensor               | Hewlett Packard      | 8487D                 | 3318A00371  | 15 <sup>th</sup> Nov 13 |
| 0223    | Power Meter                | Hewlett Packard      | EPM-442A              | US37480256  | 15 <sup>th</sup> Nov 13 |
| 0374    | Power Sensor               | Hewlett Packard      | 8485A                 | 3318A19694  | 29 <sup>th</sup> Nov 13 |
| 0158    | Barometer /Thermometer     | Control Co.          | 4196                  | E2846       | 8 <sup>th</sup> Jan 13  |
| 0193    | EMI Receiver               | Rhode & Schwartz     | ESI 7                 | 838496/007  | 2 <sup>nd</sup> Dec 13  |
| 0287    | EMI Receiver               | Rhode & Schwartz     | ESIB40                | 100201      | 16 <sup>th</sup> Nov 13 |
| 0338    | 30 - 3000 MHz Antenna      | Sunol                | JB3                   | A052907     | 8 <sup>th</sup> Nov 13  |
| 0335    | 1-18 GHz Horn Antenna      | EMCO                 | 3117                  | 00066580    | 7 <sup>th</sup> Nov 13  |
| 0252    | SMA Cable                  | Megaphase            | Sucoflex 104          | None        | N/A                     |
| 0293    | BNC Cable                  | Megaphase            | 1689 1GVT4            | 15F50B001   | N/A                     |
| 0307    | BNC Cable                  | Megaphase            | 1689 1GVT4            | 15F50B002   | N/A                     |
| 0310    | 2m SMA Cable               | Micro-Coax           | UFA210A-0-0787-3G03G0 | 209089-001  | N/A                     |
| 0312    | 3m SMA Cable               | Micro-Coax           | UFA210A-1-1181-3G0300 | 209092-001  | N/A                     |
| 0314    | 30dB N-Type Attenuator     | ARRA                 | N9444-30              | 1623        | N/A                     |
|         | EMC Test Software          | EMISoft              | Vasona                | 5.0051      | N/A                     |
|         | RF Conducted Test Software | National Instruments | Labview               | Version 8.2 | N/A                     |
|         | RF Conducted Test Software | MiCOM Labs ATS       |                       | Version 1.5 | N/A                     |

This test report may be reproduced in full only. The document may only be updated by MiCOM Labs personnel. Any changes will be noted in the Document History section of the report.





440 Boulder Court, Suite 200  
Pleasanton, CA 94566, USA  
Tel: 1.925.462.0304  
Fax: 1.925.462.0306  
[www.micomlabs.com](http://www.micomlabs.com)