

Test of Aruba AP-175 802.11a/b/g/n Wireless AP

To: DFS Requirements of FCC 47 CFR
Part 15.407 & IC RSS-210

Test Report Serial No.: ARUB111-U2 Rev A



TEST REPORT

FROM



Test of Aruba AP-175 802.11a/b/g/n Wireless AP
to
To: DFS Requirements of FCC 47 CFR Part 15.407 & IC RSS-210

Test Report Serial No.: ARUB111-U2 Rev A

This report supersedes: NONE

Applicant: Aruba Networks, Inc
1344 Crossman Avenue
Sunnyvale
CA 94089, USA

Product Function: Wireless LAN Access Point

Copy No: pdf Issue Date: 17th December 2012

This Test Report is Issued Under the Authority of:

MiCOM Labs, Inc.

440 Boulder Court, Suite 200

Pleasanton, CA 94566 USA

Phone: +1 (925) 462-0304

Fax: +1 (925) 462-0306

www.micomlabs.com



TEST CERTIFICATE #2381.01

MiCOM Labs is an ISO 17025 Accredited Testing Laboratory



Title: Aruba AP-175 802.11a/b/g/n Wireless AP
To: DFS FCC 47 CFR Part 15.407 & IC RSS-210
Serial #: ARUB111-U2 Rev A
Date: 17th December 2012
Page: 3 of 63

This page has been left intentionally blank

This test report may be reproduced in full only. The document may only be updated by MiCOM Labs personnel. Any changes will be noted in the Document History section of the report.



TABLE OF CONTENTS

ACCREDITATION, LISTINGS & RECOGNITION	5
ACCREDITATION - TESTING	5
RECOGNITION.....	6
PRODUCT CERTIFICATION.....	7
1. TEST RESULT CERTIFICATE	9
2. REFERENCES AND MEASUREMENT UNCERTAINTY	10
2.1. Normative References	10
2.2. Test and Uncertainty Procedures	11
3. PRODUCT DETAILS AND TEST CONFIGURATIONS	12
3.1. Technical Details	12
3.2. Scope of Test Program.....	13
3.3. Equipment Model(s) and Serial Number(s)	14
3.4. Antenna Details	14
3.5. Cabling and I/O Ports	14
3.6. Deviations from the Test Standard	14
4. TEST SUMMARY	15
List of Measurements	15
5. Dynamic Frequency Selection (DFS).....	16
5.1. Test Procedure and Setup.....	16
5.1.1. <i>Interference Threshold values, Master or Client incorporating In-Service Monitoring</i>	16
5.1.2. <i>DFS Response requirement values</i>	16
5.1.3. <i>Radar Test Waveforms</i>	17
5.1.4. <i>Frequency Hopping Radar Test Waveform</i>	20
5.1.5. <i>Radar Waveform Calibration</i>	20
5.1.6. <i>Weather Radar Band Edge Plots</i>	21
5.1.7. <i>Test Set Up</i>	25
5.2. Dynamic Frequency Selection (DFS) Test Results	28
5.2.1. <i>UNII Detection Bandwidth</i> :	28
5.2.2. <i>Initial Channel Availability Check Time</i>	32
5.2.3. <i>Radar Burst at the Beginning of the Channel Availability Check Time</i> :	35
5.2.4. <i>Radar Burst at the End of the Channel Availability Check Time</i> :	38
5.2.5. <i>In-Service Monitoring for Channel Move Time, Channel Closing Transmission Time and Non-Occupancy Period</i>	41
5.2.6. <i>Statistical Performance Check</i>	56
6. PHOTOGRAPHS.....	60
6.1. Dynamic Frequency Selection Test Set-Up	60
7. TEST EQUIPMENT DETAILS.....	62

This test report may be reproduced in full only. The document may only be updated by MiCOM Labs personnel. Any changes will be noted in the Document History section of the report.



Title: Aruba AP-175 802.11a/b/g/n Wireless AP
To: DFS FCC 47 CFR Part 15.407 & IC RSS-210
Serial #: ARUB111-U2 Rev A
Date: 17th December 2012
Page: 5 of 63

ACCREDITATION, LISTINGS & RECOGNITION

ACCREDITATION - TESTING

MiCOM Labs, Inc. an accredited laboratory complies with the international standard EN ISO/IEC 17025. The company is accredited by the American Association for Laboratory Accreditation (A2LA) www.a2la.org test laboratory number 2381.01. MiCOM Labs test schedule is available at the following URL; <http://www.a2la.org/scopepdf/2381-01.pdf>



The American Association for Laboratory Accreditation

Accredited Laboratory

A2LA has accredited

MICOM LABS

Pleasanton, CA

for technical competence in the field of

Electrical Testing

This laboratory is accredited in accordance with the recognized International Standard ISO/IEC 17025:2005 *General Requirements for the Competence of Testing and Calibration Laboratories*. This accreditation demonstrates technical competence for a defined scope and the operation of a laboratory quality management system (refer to joint ISO-ILAC-IAF Communiqué dated 8 January 2009).

Presented this 27th day of March 2012.



President & CEO
For the Accreditation Council
Certificate Number 2381.01
Valid to November 30, 2013

For the tests or types of tests to which this accreditation applies, please refer to the laboratory's Electrical Scope of Accreditation.

This test report may be reproduced in full only. The document may only be updated by MiCOM Labs personnel. Any changes will be noted in the Document History section of the report.



Title: Aruba AP-175 802.11a/b/g/n Wireless AP
To: DFS FCC 47 CFR Part 15.407 & IC RSS-210
Serial #: ARUB111-U2 Rev A
Date: 17th December 2012
Page: 6 of 63

RECOGNITION

MiCOM Labs, Inc has widely recognized Electrical testing capabilities. Our international recognition includes Conformity Assessment Body designation by APEC MRA** countries. Our test reports are widely accepted for global type approvals.

Country	Recognition Body	Status	Phase	Identification No.
USA	Federal Communications Commission (FCC)	TCB	-	US0159 Listing #: 102167
Canada	Industry Canada (IC)	FCB	APEC MRA 2	US0159 Listing #: 4143A-2
Japan	MIC (Ministry of Internal Affairs and Communication)	CAB	APEC MRA 2	RCB 210
	VCCI	--	--	A-0012
Europe	European Commission	NB	EU MRA	NB 2280
Australia	Australian Communications and Media Authority (ACMA)	CAB	APEC MRA 1	US0159
Hong Kong	Office of the Telecommunication Authority (OFTA)	CAB	APEC MRA 1	
Korea	Ministry of Information and Communication Radio Research Laboratory (RRL)	CAB	APEC MRA 1	
Singapore	Infocomm Development Authority (IDA)	CAB	APEC MRA 1	
Taiwan	National Communications Commission (NCC) Bureau of Standards, Metrology and Inspection (BSMI)	CAB	APEC MRA 1	
Vietnam	Ministry of Communication (MIC)	CAB	APEC MRA 1	

**APEC MRA – Asia Pacific Economic Community Mutual Recognition Agreement.

Is a recognition agreement under which test lab is accredited to regulatory standards of the APEC member countries.

Phase I - recognition for product testing

Phase II – recognition for both product testing and certification

N/A – Not Applicable

**EU MRA – European Union Mutual Recognition Agreement.

Is a recognition agreement under which test lab is accredited to regulatory standards of the EU member countries.

**NB – Notified Body

This test report may be reproduced in full only. The document may only be updated by MiCOM Labs personnel. Any changes will be noted in the Document History section of the report.



Title: Aruba AP-175 802.11a/b/g/n Wireless AP
To: DFS FCC 47 CFR Part 15.407 & IC RSS-210
Serial #: ARUB111-U2 Rev A
Date: 17th December 2012
Page: 7 of 63

PRODUCT CERTIFICATION

MiCOM Labs, Inc. is an accredited Product Certification Body per the international standard EN ISO/IEC Guide 65. The company is accredited by the American Association for Laboratory Accreditation (A2LA) www.a2la.org test laboratory number 2381.02. MiCOM Labs test schedule is available at the following URL; <http://www.a2la.org/scopepdf/2381-02.pdf>



The American Association for Laboratory Accreditation

"World Class Accreditation"

Accredited Product Certification Body

A2LA has accredited

MICOM LABS

Pleasanton, CA

for technical competence as a

Product Certification Body

This product certification body is accredited in accordance with the recognized International Standard ISO/IEC Guide 65:1996 *General requirements for bodies operating product certification systems*. This accreditation demonstrates technical competence for a defined scope and the operation of a quality management system.

Presented this 27th day of March 2012.



President & CEO
For the Accreditation Council
Certificate Number 2381.02
Valid to November 30, 2013

For the product certification schemes to which this accreditation applies, please refer to the organization's Product Certification Scope of Accreditation

United States of America – Telecommunication Certification Body (TCB)

TCB Identifier – US0159

Industry Canada – Certification Body

CAB Identifier – US0159

Europe – Notified Body

Notified Body Identifier - 2280

Japan – Recognized Certification Body (RCB)

RCB Identifier - 210

This test report may be reproduced in full only. The document may only be updated by MiCOM Labs personnel. Any changes will be noted in the Document History section of the report.



Title: Aruba AP-175 802.11a/b/g/n Wireless AP
To: DFS FCC 47 CFR Part 15.407 & IC RSS-210
Serial #: ARUB111-U2 Rev A
Date: 17th December 2012
Page: 8 of 63

DOCUMENT HISTORY

Document History		
Revision	Date	Comments
Draft		
Rev A	17 th December 2012	Initial release.

This test report may be reproduced in full only. The document may only be updated by MiCOM Labs personnel. Any changes will be noted in the Document History section of the report.



Title: Aruba AP-175 802.11a/b/g/n Wireless AP
To: DFS FCC 47 CFR Part 15.407 & IC RSS-210
Serial #: ARUB111-U2 Rev A
Date: 17th December 2012
Page: 9 of 63

1. TEST RESULT CERTIFICATE

Applicant:	Aruba Networks, Inc 1344 Crossman Avenue Sunnyvale CA 94089, USA	Tested By:	MiCOM Labs, Inc. 440 Boulder Court Suite 200 Pleasanton California, 94566, USA
EUT:	802.11a/b/g/n Wireless Access Point	Tel:	+1 925 462 0304
Model:	AP-175	Fax:	+1 925 462 0306
S/N:	AY0009995		
Test Date(s):	18th - 25th June 2012	Website:	www.micomlabs.com

STANDARD(S)	TEST RESULTS
DFS Requirements of FCC 47 CFR Part 15.407 & IC RSS-210 The AP-175 does not operate in the weather radar band 5600 - 5650 Mz	EQUIPMENT COMPLIES

MiCOM Labs, Inc. tested the equipment mentioned in accordance with the requirements set forth in the above standards. Test results indicate that the equipment tested is capable of demonstrating compliance with the requirements as documented within this report.

Notes:

1. This document reports conditions under which testing was conducted and the results of testing performed.
2. Details of test methods used have been recorded and kept on file by the laboratory.
3. Test results apply only to the item(s) tested.

Approved & Released for MiCOM Labs, Inc. by:



TEST CERTIFICATE #2381.01



Graeme Grieve
Quality Manager MiCOM Labs,

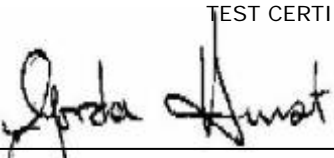

Gordon Hurst
President & CEO MiCOM Labs, Inc.

This test report may be reproduced in full only. The document may only be updated by MiCOM Labs personnel. Any changes will be noted in the Document History section of the report.

2. REFERENCES AND MEASUREMENT UNCERTAINTY

2.1. Normative References

Ref.	Publication	Year	Title
(i)	FCC 47 CFR Part 15.407	2012	Code of Federal Regulations
(ii)	FCC 06-96	June 2006	Memorandum Opinion and Order
(iii)	Industry Canada RSS-210	2010	Low Power License-Exempt Radiocommunication Devices (All Frequency Bands): Category 1 Equipment
(iv)	Industry Canada RSS-Gen	2010	General Requirements and Information for the Certification of Radiocommunication Equipment
(v)	ANSI C63.4	2009	American National Standards for Methods of Measurement of Radio-Noise Emissions from Low-Voltage Electrical and Electronic Equipment in the Range of 9 kHz to 40 GHz
(vi)	CISPR 22/ EN 55022	2008 2006+A1:20 07	Limits and Methods of Measurements of Radio Disturbance Characteristics of Information Technology Equipment
(vii)	M 3003	Edition 1 Dec. 1997	Expression of Uncertainty and Confidence in Measurements
(viii)	LAB34	Edition 1 Aug 2002	The expression of uncertainty in EMC Testing
(ix)	ETSI TR 100 028	2001	Parts 1 and 2 Electromagnetic compatibility and Radio Spectrum Matters (ERM); Uncertainties in the measurement of mobile radio equipment characteristics
(x)	A2LA	July 2012	Reference to A2LA Accreditation Status – A2LA Advertising Policy
(xi)	FCC Public Notice – DA 02-2138	2002	Guidelines for Assessing Unlicensed National Information Infrastructure (U-NII) Devices



Title: Aruba AP-175 802.11a/b/g/n Wireless AP
To: DFS FCC 47 CFR Part 15.407 & IC RSS-210
Serial #: ARUB111-U2 Rev A
Date: 17th December 2012
Page: 11 of 63

2.2. Test and Uncertainty Procedures

Conducted and radiated emission measurements were conducted in accordance with American National Standards Institute ANSI C63.4, listed in the Normative References section of this report.

Measurement uncertainty figures are calculated in accordance with ETSI TR 100 028 Parts 1 and 2.

Measurement uncertainties stated are based on a standard uncertainty multiplied by a coverage factor $k = 2$, providing a level of confidence of approximately 95 % in accordance with UKAS document M 3003 listed in the Normative References section of this report.

This test report may be reproduced in full only. The document may only be updated by MiCOM Labs personnel. Any changes will be noted in the Document History section of the report.



Title: Aruba AP-175 802.11a/b/g/n Wireless AP
To: DFS FCC 47 CFR Part 15.407 & IC RSS-210
Serial #: ARUB111-U2 Rev A
Date: 17th December 2012
Page: 12 of 63

3. PRODUCT DETAILS AND TEST CONFIGURATIONS

3.1. Technical Details

Details	Description														
Purpose:	Test of the Aruba AP-175 802.11a/b/g/n Wireless AP to the DFS requirements of FCC Part 15.407 and Industry Canada RSS-210 regulations.														
Applicant:	Aruba Networks, Inc 1344 Crossman Avenue Sunnyvale CA 94089, USA														
Manufacturer:	As applicant														
Laboratory performing the tests:	MiCOM Labs, Inc. 440 Boulder Court, Suite 200 Pleasanton, California 94566 USA														
Test report reference number:	ARUB111-U2 Rev A														
Date EUT received:	6 th June 2012														
Standard(s) applied:	FCC 47 CFR Part 15.407 & IC RSS-210														
Dates of test (from - to):	18th - 25th June 2012														
No of Units Tested:	One														
Type of Equipment:	802.11a/b/g/n Wireless Access Point, 2x2 Spatial Multiplexing MIMO configuration														
Applicants Trade Name:	Wireless Access Point														
Model(s):	AP-175														
Software Release	AOS Rev 6.2.0.0														
Location for use:	Indoor														
Declared Frequency Range(s):	5250 - 5350 MHz & 5470 – 5725 MHz														
Type of Modulation:	Per 802.11 –CCK, BPSK, QPSK, DSSS, OFDM														
Declared Nominal Output Power: (Average Power)	802.11a: Legacy +19 dBm 802.11n: HT-20 +19 dBm 802.11n: HT-40 +19 dBm														
EUT Modes of Operation:	Legacy 802.11a/b/g, 802.11n HT-20, HT-40														
Transmit/Receive Operation:	Time Division Duplex														
Rated Input Voltage and Current:	12Vdc 1.25A; POE														
Operating Temperature Range:	Declared range 0 to +40°C														
ITU Emission Designator:	<table border="0"> <tr> <td rowspan="3">5250 – 5350 MHz</td> <td>802.11a</td> <td>17M3D1D</td> </tr> <tr> <td>802.11n HT-20</td> <td>18M5D1D</td> </tr> <tr> <td>802.11n HT-40</td> <td>47M0D1D</td> </tr> <tr> <td rowspan="3">5470 – 5725 MHz</td> <td>802.11a</td> <td>18M0D1D</td> </tr> <tr> <td>802.11n HT-20</td> <td>19M1D1D</td> </tr> <tr> <td>802.11n HT-40</td> <td>54M0D1D</td> </tr> </table>	5250 – 5350 MHz	802.11a	17M3D1D	802.11n HT-20	18M5D1D	802.11n HT-40	47M0D1D	5470 – 5725 MHz	802.11a	18M0D1D	802.11n HT-20	19M1D1D	802.11n HT-40	54M0D1D
5250 – 5350 MHz	802.11a		17M3D1D												
	802.11n HT-20		18M5D1D												
	802.11n HT-40	47M0D1D													
5470 – 5725 MHz	802.11a	18M0D1D													
	802.11n HT-20	19M1D1D													
	802.11n HT-40	54M0D1D													
Frequency Stability:	±20 ppm max														
Equipment Dimensions:	10.2" x 10.2" x 4.0" (25.9cm x 25.9cm x 10.2cm)														
Weight:	7lbs (3.25 kgs)														
Primary function of equipment:	Wireless Access Point for transmitting data and voice.														

This test report may be reproduced in full only. The document may only be updated by MiCOM Labs personnel. Any changes will be noted in the Document History section of the report.



Title: Aruba AP-175 802.11a/b/g/n Wireless AP
To: DFS FCC 47 CFR Part 15.407 & IC RSS-210
Serial #: ARUB111-U2 Rev A
Date: 17th December 2012
Page: 13 of 63

3.2. Scope of Test Program

The scope of the test program was to verify compliance of the Aruba Networks AP-175 wireless access point in the frequency ranges 5,250 to 5,350 and 5,470 to 5,725 MHz as a Master device against the DFS requirements of FCC 47 CFR Part 15.407 and the FCC specification Memorandum Opinion and Order FCC 06-96.

The UUT was tested both in 11a mode at 5500 MHz and HT-40 mode at 5510 MHz from the operating channels of the UUT within the 5,470 – 5,725 MHz band for DFS testing per the requirements of FCC specification “Memorandum Opinion and Order FCC 06-96”, Section 7.8 “DFS Conformance Test Procedures”.

U-NII devices operating in the 5,250 – 5,350 MHz and 5,470 - 5,725 MHz bands shall employ a DFS radar detection mechanism to detect the presence of radar systems and to avoid co-channel operation with radar systems.

The Aruba Networks AP-175 product operates as a Master device with full radar detection and Dynamic Frequency Selection (DFS) capability.

The Master device provides, on aggregate, uniform loading of the spectrum across all devices by selecting an operating channel among the available channels using a random algorithm.

The EUT will not operate in the weather radar band 5600 – 5650 MHz.

This test report may be reproduced in full only. The document may only be updated by MiCOM Labs personnel. Any changes will be noted in the Document History section of the report.



Title: Aruba AP-175 802.11a/b/g/n Wireless AP
To: DFS FCC 47 CFR Part 15.407 & IC RSS-210
Serial #: ARUB111-U2 Rev A
Date: 17th December 2012
Page: 14 of 63

3.3. Equipment Model(s) and Serial Number(s)

Type (EUT/Support)	Equipment Description (Including Brand Name)	Mfr	Model No.	Serial No.
EUT	802.11a/b/g/n Wireless Access Point	Aruba Networks, Inc	AP-175	AY0009995
Support	Laptop PC	IBM	Thinkpad	None

3.4. Antenna Details

The following is a description of the EUT antennas.

Antenna Type:	Manufacturer	Model	Gain (dBi)	Frequency Range (MHz)
Dipole	Aruba	AP-ANT-10	6	5150 – 5875
Dipole	Aruba	AP-ANT-86D	9	5150 – 5875
Directional	Aruba	AP-ANT-89	14.0	5150 - 5350
			13.25	5470 – 5875

3.5. Cabling and I/O Ports

Number and type of I/O ports

1. 1000/100/10 Ethernet with POE x 1.
2. USB Local maintenance terminal (LMT) x 1.

3.6. Deviations from the Test Standard

The following deviations from the test standard were required in order to complete the test program:

1. NONE

This test report may be reproduced in full only. The document may only be updated by MiCOM Labs personnel. Any changes will be noted in the Document History section of the report.



Title: Aruba AP-175 802.11a/b/g/n Wireless AP
To: DFS FCC 47 CFR Part 15.407 & IC RSS-210
Serial #: ARUB111-U2 Rev A
Date: 17th December 2012
Page: 15 of 63

4. TEST SUMMARY

List of Measurements

Dynamic Frequency Selection (DFS)

The following table represents the list of measurements required under the **FCC CFR47 Part 15.407(h)(2)** and **FCC Memorandum Opinion and Order FCC 06-96 (Compliance Measurement procedures for Unlicensed National Information Infrastructure devices operating in the 5250-5350 MHz and 5470-5725 MHz bands incorporating dynamic frequency selection).**

Tests performed on Master Device

Section	Test Items	Description	Condition	Result	Test Report Section
7.8.1	Detection Bandwidth	UNII Detection Bandwidth	Conducted	Complies	5.2.1
7.8.2.1	Performance Requirements Check	Initial Channel Availability Check Time	Conducted	Complies	5.2.2
7.8.2.2		Radar Burst at the Beginning of the Channel Availability Check Time	Conducted	Complies	5.2.3
7.8.2.3		Radar Burst at the End of the Channel Availability Check Time	Conducted	Complies	5.2.4
7.8.3	In-Service Monitoring	In-Service Monitoring for Channel Move Time, Channel Closing Transmission Time and Non-Occupancy Period	Conducted	Complies	5.2.5
7.8.4	Radar Detection	Statistical Performance Check	Conducted	Complies	5.2.6

Note 1: Test results reported in this document relate only to the items tested.

Note 2: The required tests demonstrated compliance as per client declaration of test configuration, monitoring methodology and associated pass/fail criteria.

This test report may be reproduced in full only. The document may only be updated by MiCOM Labs personnel. Any changes will be noted in the Document History section of the report.



Title: Aruba AP-175 802.11a/b/g/n Wireless AP
To: DFS FCC 47 CFR Part 15.407 & IC RSS-210
Serial #: ARUB111-U2 Rev A
Date: 17th December 2012
Page: 16 of 63

5. Dynamic Frequency Selection (DFS)

5.1. Test Procedure and Setup

FCC, Part 15 Subpart C §15.407(h)
FCC 06-96 Memorandum Opinion and Order
Industry Canada RSS-210 A9.4

5.1.1. Interference Threshold values, Master or Client incorporating In-Service Monitoring

Maximum Transmit Power	Value (see note)
≥ 200 milliwatt	-64 dBm
< 200 milliwatt	-62 dBm

Note 1: This is the level at the input of the receiver assuming a 0 dBi receive antenna

5.1.2. DFS Response requirement values

Parameter	Value
<i>Non-occupancy period</i>	Minimum 30 minutes
<i>Channel Availability Check Time</i>	60 seconds
<i>Channel Move Time</i>	10 seconds See Note 1.
<i>Channel Closing Transmission Time</i>	200 milliseconds + an aggregate of 60 milliseconds over remaining 10 second period. See Notes 1 and 2.
<i>U-NII Detection Bandwidth</i>	Minimum 80% of the 99% power bandwidth See Note 3.

Note 1: The instant that the *Channel Move Time* and the *Channel Closing Transmission Time* begins is as follows:

- For the Short pulse radar Test Signals this instant is the end of the *Burst*.
- For the Frequency Hopping radar Test Signal, this instant is the end of the last radar *Burst* generated.
- For the Long Pulse radar Test Signal this instant is the end of the 12 second period defining the radar transmission.

Note 2: The *Channel Closing Transmission Time* is comprised of 200 milliseconds starting at the beginning of the *Channel Move Time* plus any additional intermittent control signals required to facilitate *Channel* changes (an aggregate of 60 milliseconds) during the remainder of the 10 second period. The aggregate duration of control signals will not count quiet periods in between transmissions.

Note 3: During the *U-NII Detection Bandwidth* detection test, radar type 1 is used and for each frequency step the minimum percentage of detection is 90%. Measurements are performed with no data traffic.

This test report may be reproduced in full only. The document may only be updated by MiCOM Labs personnel. Any changes will be noted in the Document History section of the report.



5.1.3. Radar Test Waveforms

This section provides the parameters for required test waveforms, minimum percentage of successful detections, and the minimum number of trials that must be used for determining DFS conformance. Step intervals of 0.1 microsecond for Pulse Width, 1 microsecond for PRI, 1 MHz for chirp width and 1 for the number of pulses will be utilized for the random determination of specific test waveforms.

Short Pulse Radar Test Waveforms

Radar Type	Pulse Width (µsec)	PRI (µsec)	Number of Pulses	Minimum Percentage of Successful Detection	Minimum Trials
1	1	1428	18	60%	30
2	1-5	150-230	23-29	60%	30
3	6-10	200-500	16-18	60%	30
4	11-20	200-500	12-16	60%	30
Aggregate (Radar Types 1-4)				80%	120

A minimum of 30 unique waveforms are required for each of the short pulse radar types 2 through 4. For short pulse radar type 1, the same waveform is used a minimum of 30 times. If more than 30 waveforms are used for short pulse radar types 2 through 4, then each additional waveform must also be unique and not repeated from the previous waveforms. The aggregate is the average of the percentage of successful detections of short pulse radar types 1-4.

Long Pulse Radar Test Waveform

Radar Type	Pulse Width (µsec)	Chirp Width (MHz)	PRI (µsec)	Number of Pulses per Burst	Number of Bursts	Minimum Percentage of Successful Detection	Minimum Trials
5	50-100	5-20	1000-2000	1-3	8-20	80%	30

The parameters for this waveform are randomly chosen. Thirty unique waveforms are required for the Long Pulse radar test signal. If more than 30 waveforms are used for the Long Pulse radar test signal, then each additional waveform must also be unique and not repeated from the previous waveforms.



Title: Aruba AP-175 802.11a/b/g/n Wireless AP
To: DFS FCC 47 CFR Part 15.407 & IC RSS-210
Serial #: ARUB111-U2 Rev A
Date: 17th December 2012
Page: 18 of 63

Each waveform is defined as follows:

- 1) The transmission period for the Long Pulse Radar test signal is 12 seconds.
- 2) There are a total of 8 to 20 *Bursts* in the 12 second period, with the number of *Bursts* being randomly chosen. This number is *Burst Count*.
- 3) Each *Burst* consists of 1 to 3 pulses, with the number of pulses being randomly chosen. Each *Burst* within the 12 second sequence may have a different number of pulses.
- 4) The pulse width is between 50 and 100 microseconds, with the pulse width being randomly chosen. Each pulse within a *Burst* will have the same pulse width. Pulses in different *Bursts* may have different pulse widths.
- 5) Each pulse has a linear FM chirp between 5 and 20 MHz, with the chirp width being randomly chosen. Each pulse within a *Burst* will have the same chirp width. Pulses in different *Bursts* may have different chirp widths. The chirp is centered on the pulse. For example, with a radar frequency of 5300 MHz and a 20 MHz chirped signal, the chirp starts at 5290 MHz and ends at 5310 MHz.
- 6) If more than one pulse is present in a *Burst*, the time between the pulses will be between 1000 and 2000 microseconds, with the time being randomly chosen. If three pulses are present in a *Burst*, the time between the first and second pulses is chosen independently of the time between the second and third pulses.
- 7) The 12 second transmission period is divided into even intervals. The number of intervals is equal to *Burst_Count*. Each interval is of length $(12,000,000 / \textit{Burst_Count})$ microseconds. Each interval contains one *Burst*. The start time for the *Burst*, relative to the beginning of the interval, is between 1 and $[(12,000,000 / \textit{Burst_Count}) - (\textit{Total Burst Length}) + (\textit{One Random PRI Interval})]$ microseconds, with the start time being randomly chosen. The step interval for the start time is 1 microsecond. The start time for each *Burst* is chosen independently.

This test report may be reproduced in full only. The document may only be updated by MiCOM Labs personnel. Any changes will be noted in the Document History section of the report.

A representative example of a Long Pulse radar test waveform:

- 1) The total test signal length is 12 seconds.
- 2) 8 *Bursts* are randomly generated for the *Burst_Count*.
- 3) *Burst 1* has 2 randomly generated pulses.
- 4) The pulse width (for both pulses) is randomly selected to be 75 microseconds.
- 5) The PRI is randomly selected to be at 1213 microseconds.
- 6) *Bursts 2* through 8 are generated using steps 3 – 5.
- 7) Each *Burst* is contained in even intervals of 1,500,000 microseconds. The starting location for Pulse 1, *Burst 1* is randomly generated (1 to 1,500,000 minus the total *Burst 1* length + 1 random PRI interval) at the 325,001 microsecond step. *Bursts 2* through 8 randomly fall in successive 1,500,000 microsecond intervals (i.e. *Burst 2* falls in the 1,500,001 – 3,000,000 microsecond range).

Graphical representation of the Long Pulse radar Test Waveform.

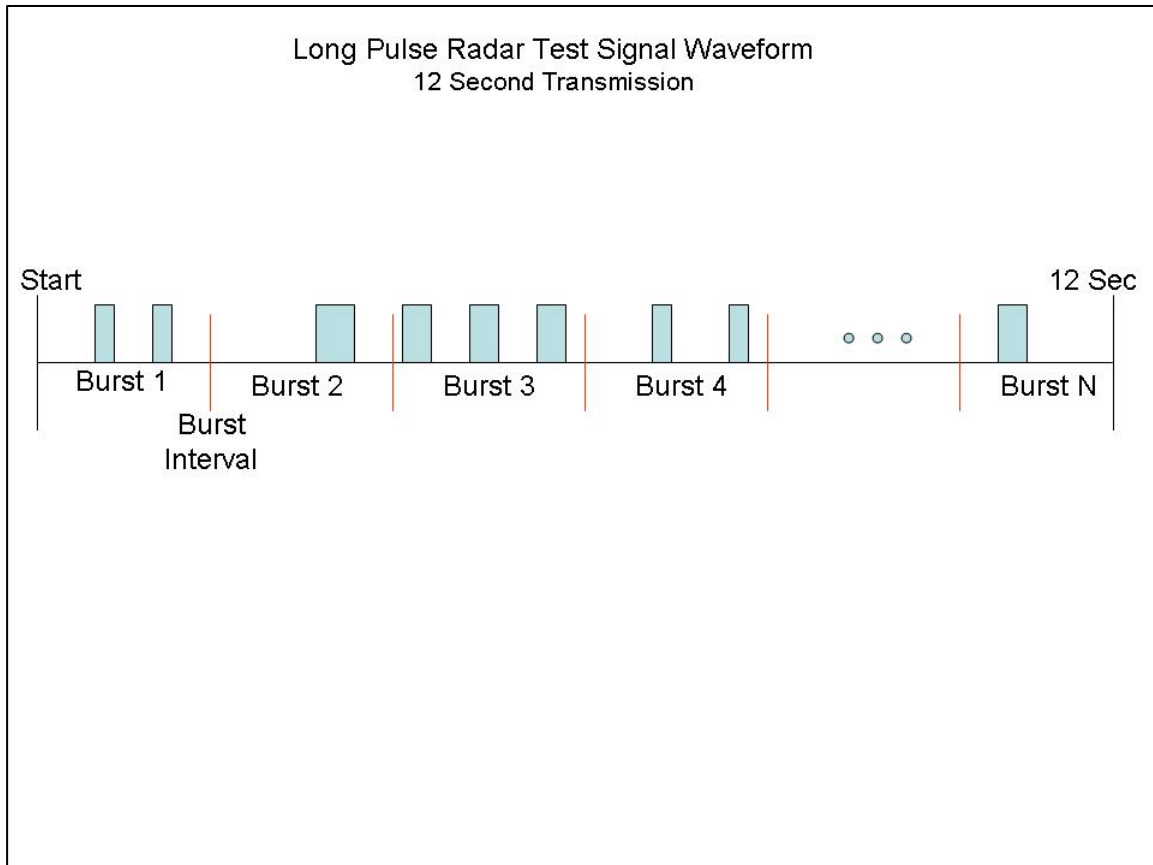

5.1.4. Frequency Hopping Radar Test Waveform

Frequency Hopping Radar Test Waveform

Radar Type	Pulse Width (µsec)	PRI (µsec)	Pulses per Hop	Hopping Rate (kHz)	Hopping Sequence Length (msec)	Minimum Percentage of Successful Detection	Minimum Trials
6	1	333	9	.333	300	70%	30

For the Frequency Hopping Radar Type, the same *Burst* parameters are used for each waveform. The hopping sequence is different for each waveform and a 100-length segment is selected from the hopping sequence defined by the following algorithm:

5.1.5. Radar Waveform Calibration

The following equipment setup was used to calibrate the conducted Radar Waveform. A spectrum analyzer was used to establish the test signal level for each radar type. During this process there were no transmissions by either the Master or Client Device. The spectrum analyzer was switched to the zero span (Time Domain) mode at the frequency of the Radar Waveform generator. Peak detection was utilized. The spectrum analyzer resolution bandwidth (RBW) and video bandwidth (VBW) were set to 3 MHz.

The signal generator amplitude was set so that the power level measured at the spectrum analyzer was -61dBm (Ref Section 5.1). The 30dB amplifier gain was entered as an amplitude offset on the spectrum analyzer.

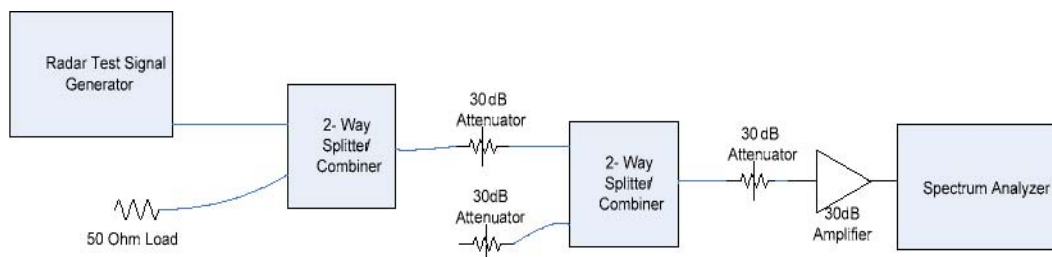

Conducted Calibration Setup



5.1.6. Weather Radar Band Edge Plots

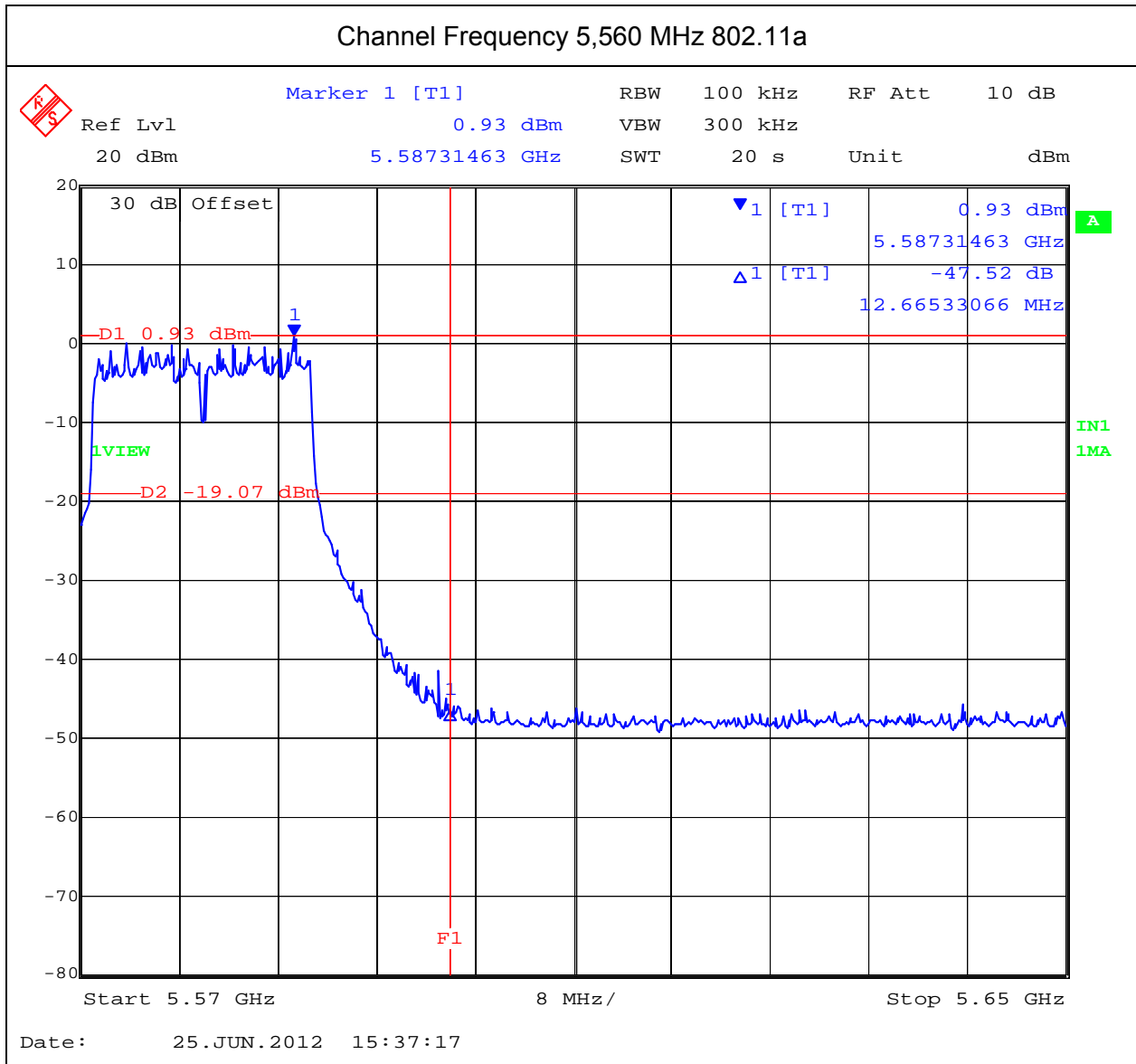

This test report may be reproduced in full only. The document may only be updated by MiCOM Labs personnel. Any changes will be noted in the Document History section of the report.



Title: Aruba AP-175 802.11a/b/g/n Wireless AP
To: DFS FCC 47 CFR Part 15.407 & IC RSS-210
Serial #: ARUB111-U2 Rev A
Date: 17th December 2012
Page: 22 of 63

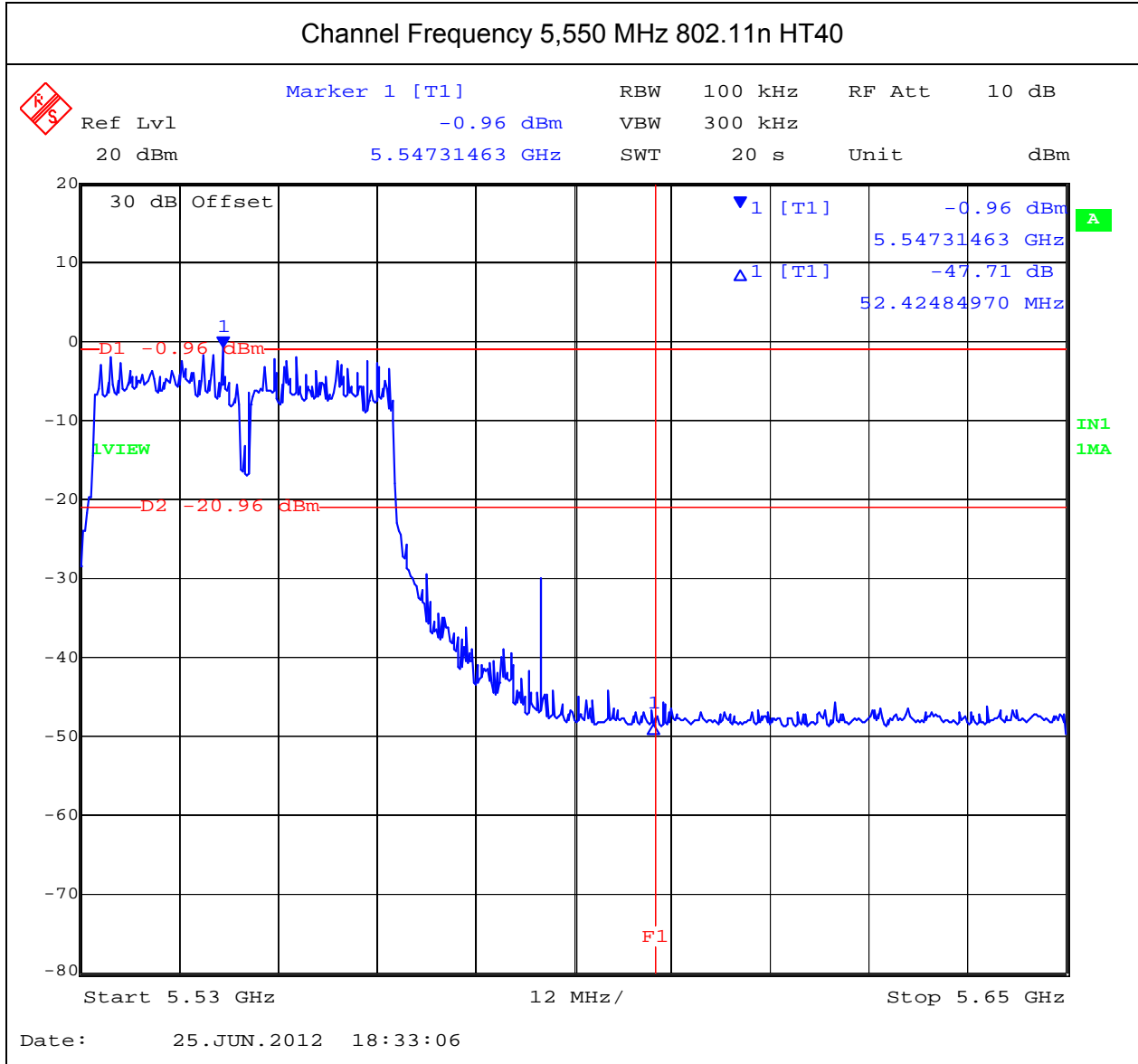

This test report may be reproduced in full only. The document may only be updated by MiCOM Labs personnel. Any changes will be noted in the Document History section of the report.

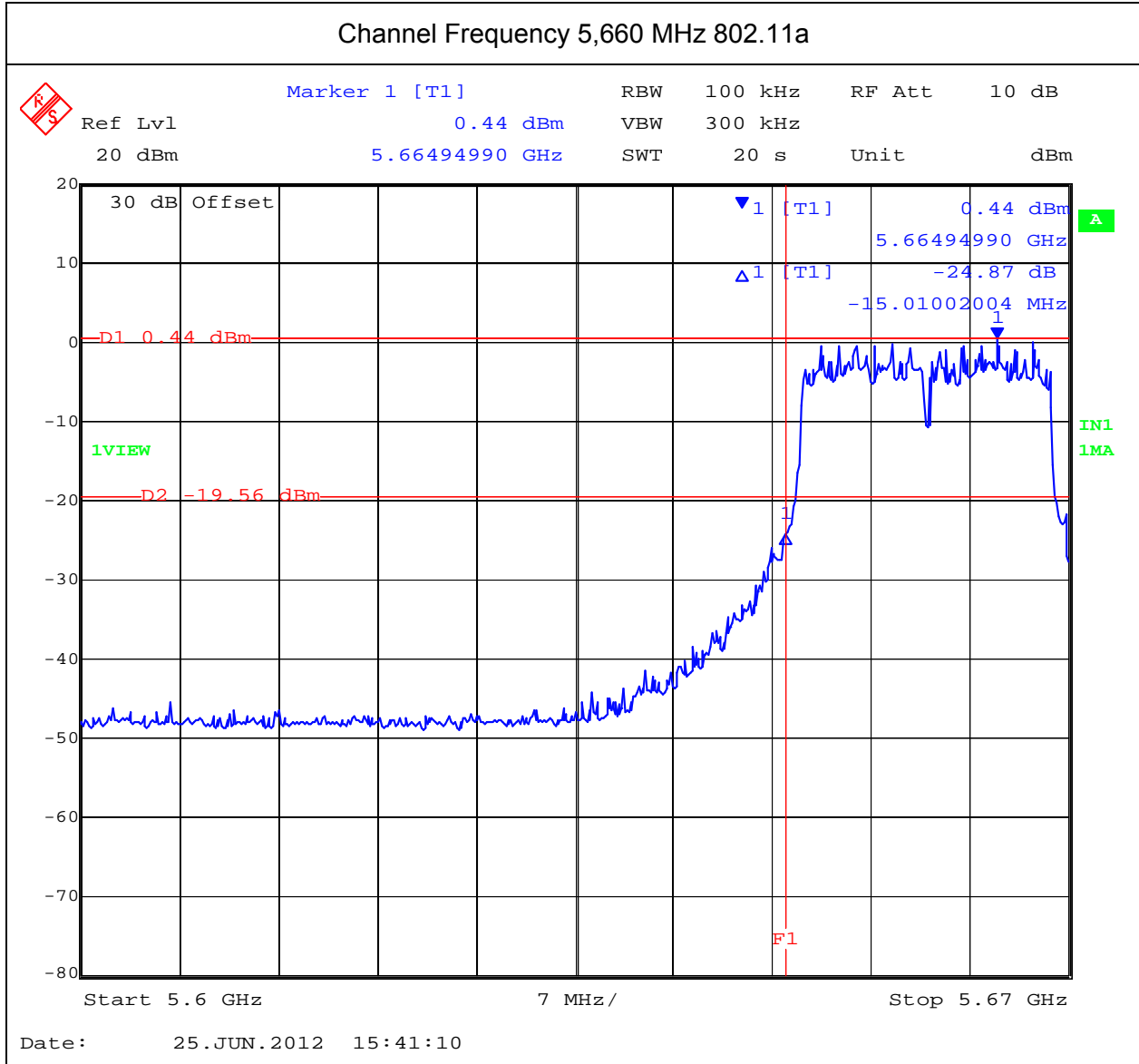

This test report may be reproduced in full only. The document may only be updated by MiCOM Labs personnel. Any changes will be noted in the Document History section of the report.



Title: Aruba AP-175 802.11a/b/g/n Wireless AP
To: DFS FCC 47 CFR Part 15.407 & IC RSS-210
Serial #: ARUB111-U2 Rev A
Date: 17th December 2012
Page: 24 of 63

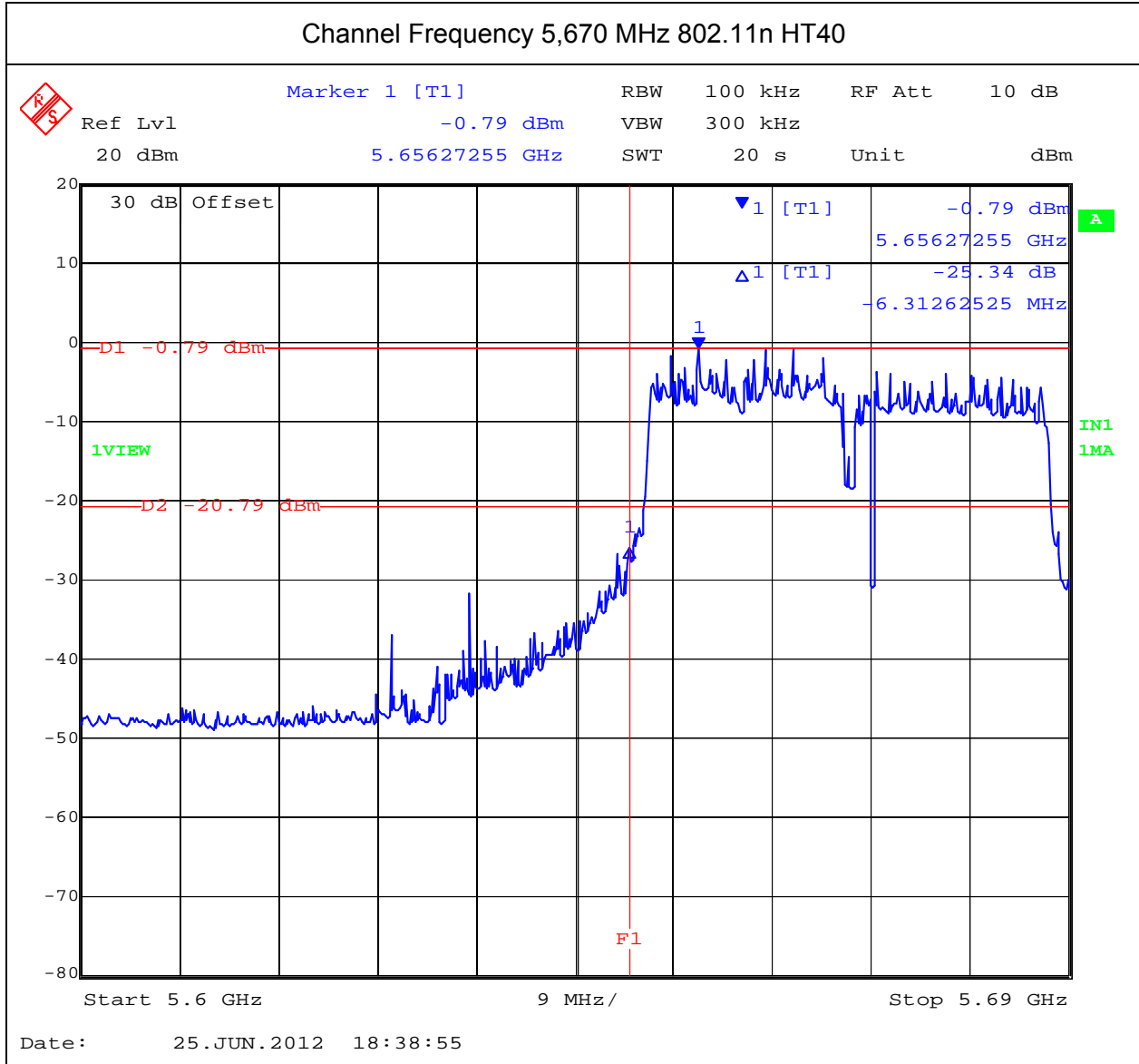

This test report may be reproduced in full only. The document may only be updated by MiCOM Labs personnel. Any changes will be noted in the Document History section of the report.

5.1.7. Test Set Up:

Block Diagram(s) of Test Setup

Setup for Conducted Measurements where the EUT is the Master with injection of Radar Test Waveforms at the Master.

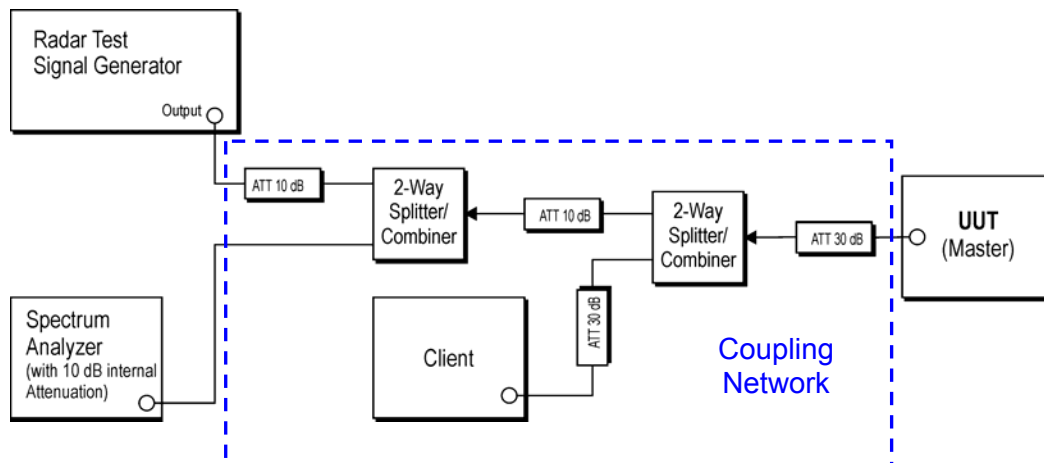

Support Equipment Configuration

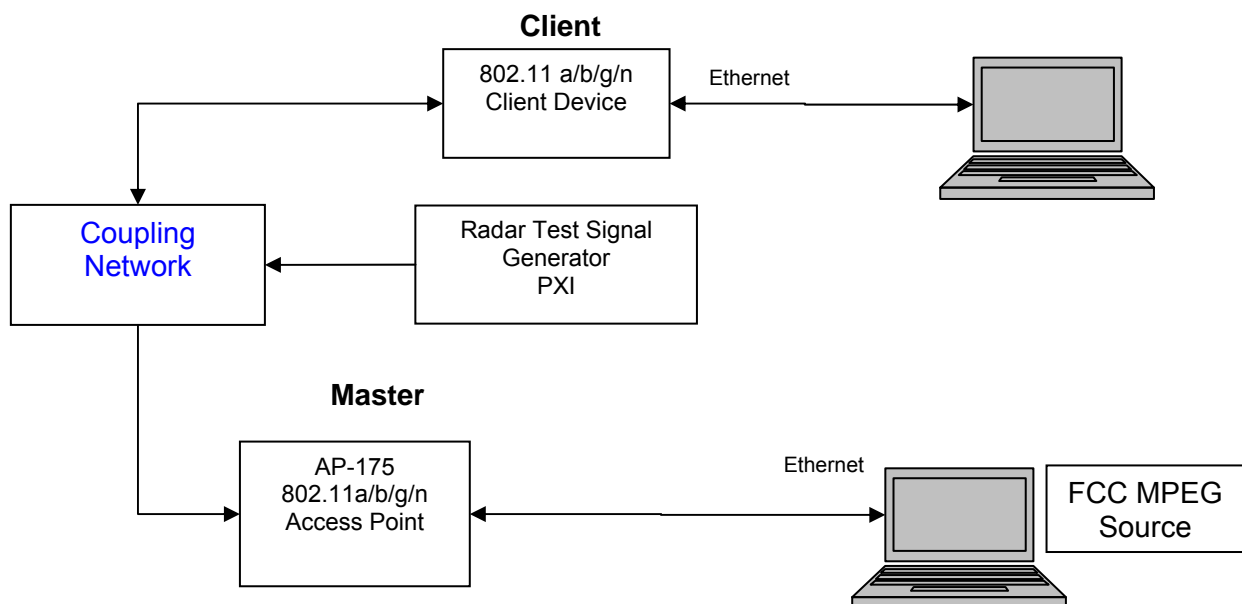

This test report may be reproduced in full only. The document may only be updated by MiCOM Labs personnel. Any changes will be noted in the Document History section of the report.



The EUT is a Master Device with radar detection.

Applicability of DFS Requirements Prior to Use of a Channel
(Ref Table 1 of FCC 06-96)

Requirement	Operational Mode		
	Master	Client Without Radar Detection	Client With Radar Detection
<i>Non-Occupancy Period</i>	Yes	Not required	Yes
<i>DFS Detection Threshold</i>	Yes	Not required	Yes
<i>Channel Availability Check Time</i>	Yes	Not required	Not required
<i>Uniform Spreading</i>	Yes	Not required	Not required
<i>U-NII Detection Bandwidth</i>	Yes	Not required	Yes

Applicability of DFS requirements during normal operation
(Ref Table 2 of FCC 06-96)

Requirement	Operational Mode		
	Master	Client Without Radar Detection	Client With Radar Detection
<i>DFS Detection Threshold</i>	Yes	Not required	Yes
<i>Channel Closing Transmission Time</i>	Yes	Yes	Yes
<i>Channel Move Time</i>	Yes	Yes	Yes
<i>U-NII Detection Bandwidth</i>	Yes	Not required	Yes

This test report may be reproduced in full only. The document may only be updated by MiCOM Labs personnel. Any changes will be noted in the Document History section of the report.



Title: Aruba AP-175 802.11a/b/g/n Wireless AP
To: DFS FCC 47 CFR Part 15.407 & IC RSS-210
Serial #: ARUB111-U2 Rev A
Date: 17th December 2012
Page: 27 of 63

For the frequency band 5,470 – 5,725 MHz, the Master device provides, on aggregate, uniform loading of the spectrum across all devices by selecting an operating channel among the available channels using a random algorithm. The EUT was tested in HT-40 mode.

Declared minimum antenna gain 0 dBi. ;

Radar receive signal level = -62 dBm + minimum antenna gain + 1 dB

$$= -62 + 0 + 1$$

Radar receive signal level = -61 dBm

Measurement Results - Dynamic Frequency Selection (DFS)

Ambient conditions.

Temperature: 17 to 23 °C Relative humidity: 31 to 57% Pressure: 999 to 1012 mbar

Radio parameters.

Test methodology: Conducted

Device Type: Master

Transmit Power: Maximum

Operational Details - Dynamic Frequency Selection (DFS)

Operational Modes: 802.11a & 802.11n HT40

Data Rates: 18 mpbs 802.11a / 13.5MCS 802.11n

**Note* No video pixilation was observed during the video stream at these rates. Video frames per second were noted to be at 30fps.*

Video Streaming Method - Dynamic Frequency Selection (DFS)

Using the VideoLan player a video stream was setup on the master laptop with the destination being the client laptop. The video profile chosen for the video stream is “MPEG-2 + MPGA (TS)”. On the client laptop the VideoLan player was setup to listen to an incoming video stream from the master device.

The requisite MPEG video file (“TestFile.mpg” available on the NTIA website at the following link <http://ntiacsd.ntia.doc.gov/dfs/>) is used during this video stream.

This test report may be reproduced in full only. The document may only be updated by MiCOM Labs personnel. Any changes will be noted in the Document History section of the report.



Title: Aruba AP-175 802.11a/b/g/n Wireless AP
To: DFS FCC 47 CFR Part 15.407 & IC RSS-210
Serial #: ARUB111-U2 Rev A
Date: 17th December 2012
Page: 28 of 63

5.2. Dynamic Frequency Selection (DFS) Test Results

5.2.1. UNII Detection Bandwidth:

All UNII channels for this device have identical channel bandwidths and DFS testing was completed on channel 5,500 MHz (802.11a) and 5510MHz (HT40).

The generating equipment is configured as shown in the Conducted Test Setup above. A single Burst of the short pulse radar Type 1 through 6 was produced at 5,500 MHz (802.11a) and 5,510 MHz (802.11n HT40) at a level of -61 dBm (Ref Section 5.1). The EUT is set up as a standalone device (no associated Client and no traffic).

A single radar Burst is generated for a minimum of 10 trials, and the response of the EUT is noted. The EUT must detect the Radar Waveform 90% or more of the time.

The radar frequency is increased in 1 MHz steps, repeating the above test sequence, until the detection rate falls below 90%. The highest frequency at which detection is greater than or equal to 90% is denoted as F_H .

The radar frequency is decreased in 1 MHz steps, repeating the above test sequence, until the detection rate falls below 90%. The lowest frequency at which detection is greater than or equal to 90% is denoted as F_L .

The U-NII Detection Bandwidth is calculated as follows:

$$\text{U-NII Detection Bandwidth} = F_H - F_L$$

The U-NII Detection Bandwidth must be at least 80% of the EUT transmitter 99% power Table of results are continued on the next page.



Title: Aruba AP-175 802.11a/b/g/n Wireless AP
To: DFS FCC 47 CFR Part 15.407 & IC RSS-210
Serial #: ARUB111-U2 Rev A
Date: 17th December 2012
Page: 29 of 63

EUT Frequency= 5,500 MHz 802.11a (Detection = √, No Detection = 0)											
Radar Frequency (MHz)	1	2	3	4	5	6	7	8	9	10	Detection Rate (%)
-17											%
-16											%
-15											%
-14											%
-13											%
-12											%
-11											%
-10	√	√	√	√	0	√	√	0			<90%
-9	√	√	√	√	√	√	√	√	√	√	100%
-8	√	√	√	√	√	√	√	√	√	√	100%
-7	√	√	√	√	√	√	√	√	√	√	100%
-6	√	√	√	√	√	√	√	√	√	√	100%
-5	√	√	√	√	√	√	√	√	√	√	100%
-4	√	√	√	√	√	√	√	√	√	√	100%
-3	√	√	√	√	√	√	√	√	√	√	100%
-2	√	√	√	√	√	√	√	√	√	√	100%
-1	√	√	√	√	√	√	√	√	√	√	100%
F ₀	√	√	√	√	√	√	√	√	√	√	100%
+1	√	√	√	√	√	√	√	√	√	√	100%
+2	√	√	√	√	√	√	√	√	√	√	100%
+3	√	√	√	√	√	√	√	√	√	√	100%
+4	√	√	√	√	√	√	√	√	√	√	100%
+5	√	√	√	√	√	√	√	√	√	√	100%
+6	√	√	√	√	√	√	√	√	√	√	100%
+7	√	√	√	√	√	√	√	√	√	√	100%
+8	√	√	√	√	√	√	√	√	√	√	100%
+9	√	√	√	√	√	√	√	√	0	√	90%
+10	√	0	√	0							<90%
+11											%
+12											%
+13											%
+14											%
+15											%
+16											%
+17											%

Detection Bandwidth = $F_H - F_L = 5491 - 5509 = 18$ MHz

EUT 99% Bandwidth = 17.535 MHz (ref. bandwidth channel 5500 MHz)

17.535 MHz *80% = 14.028 MHz

For each frequency step the minimum percentage detection is 90%

This test report may be reproduced in full only. The document may only be updated by MiCOM Labs personnel. Any changes will be noted in the Document History section of the report.



Title: Aruba AP-175 802.11a/b/g/n Wireless AP
To: DFS FCC 47 CFR Part 15.407 & IC RSS-210
Serial #: ARUB111-U2 Rev A
Date: 17th December 2012
Page: 30 of 63

EUT Frequency= 5,510 MHz 802.11n HT40 (Detection = √, No Detection = 0)											
Radar Frequency (MHz)	1	2	3	4	5	6	7	8	9	10	Detection Rate (%)
-21											<90%
-20	√	√	0	√	√	0					<90%
-19	√	√	√	√	√	0	√	√	√	√	90%
-18	√	√	√	√	√	√	√	√	√	√	100%
-17	√	√	√	√	√	√	√	√	√	√	100%
-16	√	√	√	√	√	√	√	√	√	√	100%
-15	√	√	√	√	√	√	√	√	√	√	100%
-14	√	√	√	√	√	√	√	√	√	√	100%
-13	√	√	√	√	√	√	√	√	√	√	100%
-12	√	√	√	√	√	√	√	√	√	√	100%
-11	√	√	√	√	√	√	√	√	√	√	100%
-10	√	√	√	√	√	√	√	√	√	√	100%
-9	√	√	√	√	√	√	√	√	√	√	100%
-8	√	√	√	√	√	√	√	√	√	√	100%
-7	√	√	√	√	√	√	√	√	√	√	100%
-6	√	√	√	√	√	√	√	√	√	√	100%
-5	√	√	√	√	√	√	√	√	√	√	100%
-4	√	√	√	√	√	√	√	√	√	√	100%
-3	√	√	√	√	√	√	√	√	√	√	100%
-2	√	√	√	√	√	√	√	√	√	√	100%
-1	√	√	√	√	√	√	√	√	√	√	100%
F ₀	√	√	√	√	√	√	√	√	√	√	100%

This test report may be reproduced in full only. The document may only be updated by MiCOM Labs personnel. Any changes will be noted in the Document History section of the report.



Title: Aruba AP-175 802.11a/b/g/n Wireless AP
To: DFS FCC 47 CFR Part 15.407 & IC RSS-210
Serial #: ARUB111-U2 Rev A
Date: 17th December 2012
Page: 31 of 63

EUT Frequency= 5,510 MHz 802.11n HT40 (Detection = √, No Detection = 0)											
Radar Frequency (MHz)	1	2	3	4	5	6	7	8	9	10	Detection Rate (%)
F ₀	√	√	√	√	√	√	√	√	√	√	100%
+1	√	√	√	√	√	√	√	√	√	√	100%
+2	√	√	√	√	√	√	√	√	√	√	100%
+3	√	√	√	√	√	√	√	√	√	√	100%
+4	√	√	√	√	√	√	√	√	√	√	100%
+5	√	√	√	√	√	√	√	√	√	√	100%
+6	√	√	√	√	√	√	√	√	√	√	100%
+7	√	√	√	√	√	√	√	√	√	√	100%
+8	√	√	√	√	√	√	√	√	√	√	100%
+9	√	√	√	√	√	√	√	√	√	√	100%
+10	√	√	√	√	√	√	√	√	√	√	100%
+11	√	√	√	√	√	√	√	√	√	√	100%
+12	√	√	√	√	√	√	√	√	√	√	100%
+13	√	√	√	√	√	√	√	√	√	√	100%
+14	√	√	√	√	√	√	√	√	√	√	100%
+15	√	√	√	√	√	√	√	√	√	√	100%
+16	√	√	√	√	√	√	√	√	√	√	100%
+17	√	√	√	√	√	√	√	√	√	√	100%
+18	√	√	√	√	√	√	√	√	√	√	100%
+19	√	√	√	√	√	√	√	√	√	√	100%
+20	√	0	√	√	0						<90%
+21											<90%
Detection Bandwidth = F _H -F _L = 5491-5529 = 38 MHz											
EUT 99% Bandwidth = 38.277 MHz (ref. bandwidth channel 5510 MHz)											
38.277 MHz *80% = 30.621 MHz											

For each frequency step the minimum percentage detection is 90%

This test report may be reproduced in full only. The document may only be updated by MiCOM Labs personnel. Any changes will be noted in the Document History section of the report.



Title: Aruba AP-175 802.11a/b/g/n Wireless AP
To: DFS FCC 47 CFR Part 15.407 & IC RSS-210
Serial #: ARUB111-U2 Rev A
Date: 17th December 2012
Page: 32 of 63

5.2.2. Initial Channel Availability Check Time

This test verifies that the EUT does not emit pulse, control, or data signals on the test Channel until the power-up sequence has been completed and the U-NII device checks for Radar Waveforms for one minute on the test Channel. This test does not use any Radar Waveforms.

The U-NII device is powered on and be instructed to operate at 5,500MHz 802.11a and 5,510MHz 802.11n HT40. At the same time the EUT is powered on, the spectrum analyzer is set for zero span with a 1 MHz resolution bandwidth at 5,500 & 5,510 MHz with a 260 second sweep time. The analyzer's sweep will be started the same time power is applied to the U-NII device.

The EUT should not transmit any pulse or data transmissions until at least 1 minute after the completion of the power-on cycle.

The first red marker line shown on the following plot denotes the instant when the EUT starts its power-up sequence i.e. T_0 (as defined within the FCC's MO&O 06-96 Normative Reference 2). The power-up reference T_0 is determined by the time it takes for the EUT to start "beaconing" i.e. initial beacon – 60 secs = end of power-up.

The Channel Availability Check Time commences at instant T_0 and will end no sooner than $T_0 + 60$ seconds.



Title: Aruba AP-175 802.11a/b/g/n Wireless AP
To: DFS FCC 47 CFR Part 15.407 & IC RSS-210
Serial #: ARUB111-U2 Rev A
Date: 17th December 2012
Page: 33 of 63

EUT power up and Initial Channel Availability Check Time
5,500MHz 802.11a Power On = 90.240 Seconds

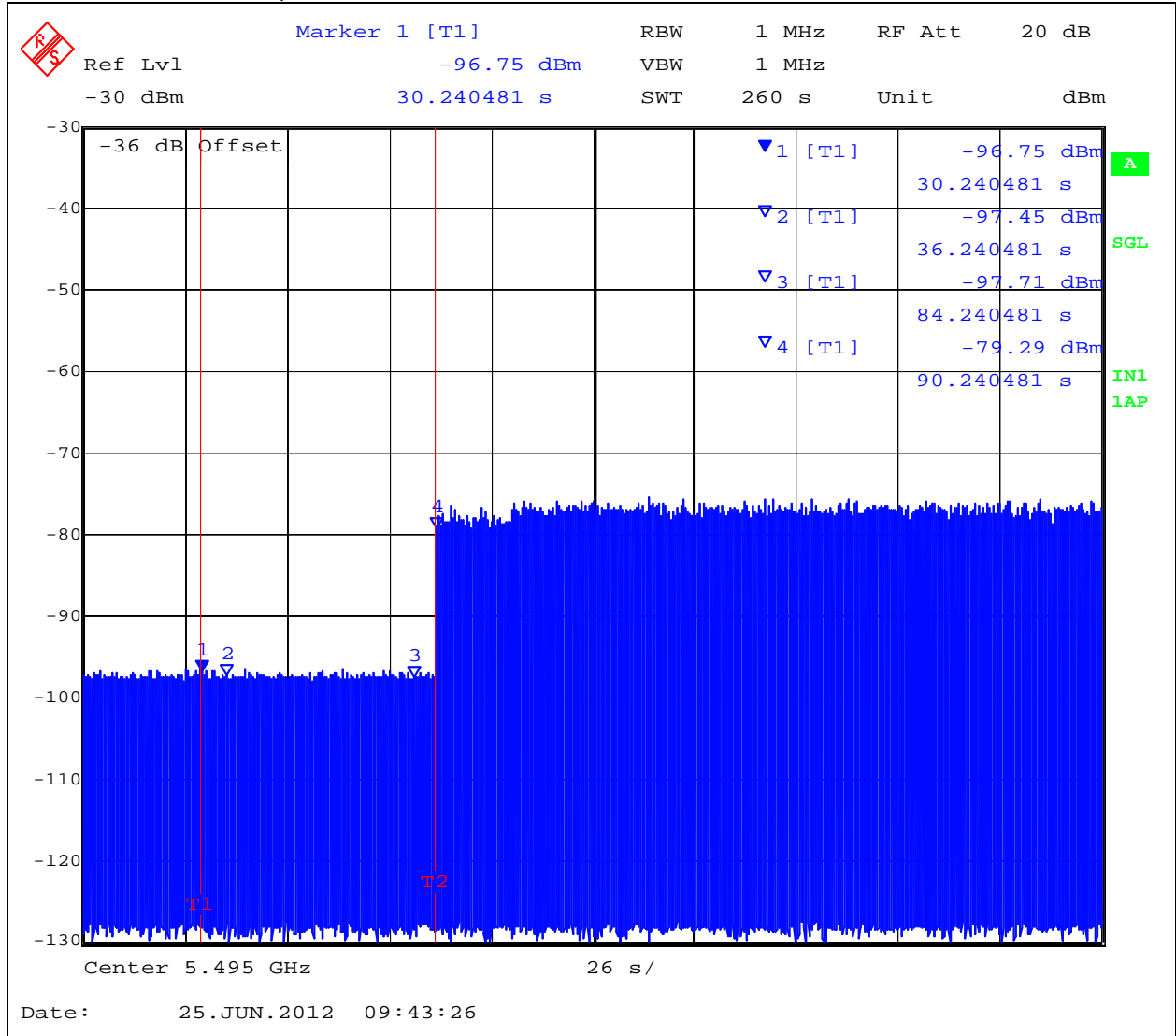

This test report may be reproduced in full only. The document may only be updated by MiCOM Labs personnel. Any changes will be noted in the Document History section of the report.



Title: Aruba AP-175 802.11a/b/g/n Wireless AP
To: DFS FCC 47 CFR Part 15.407 & IC RSS-210
Serial #: ARUB111-U2 Rev A
Date: 17th December 2012
Page: 34 of 63

EUT power up and Initial Channel Availability Check Time
5,510MHz 802.11n HT40 Power On = 91.803 Seconds

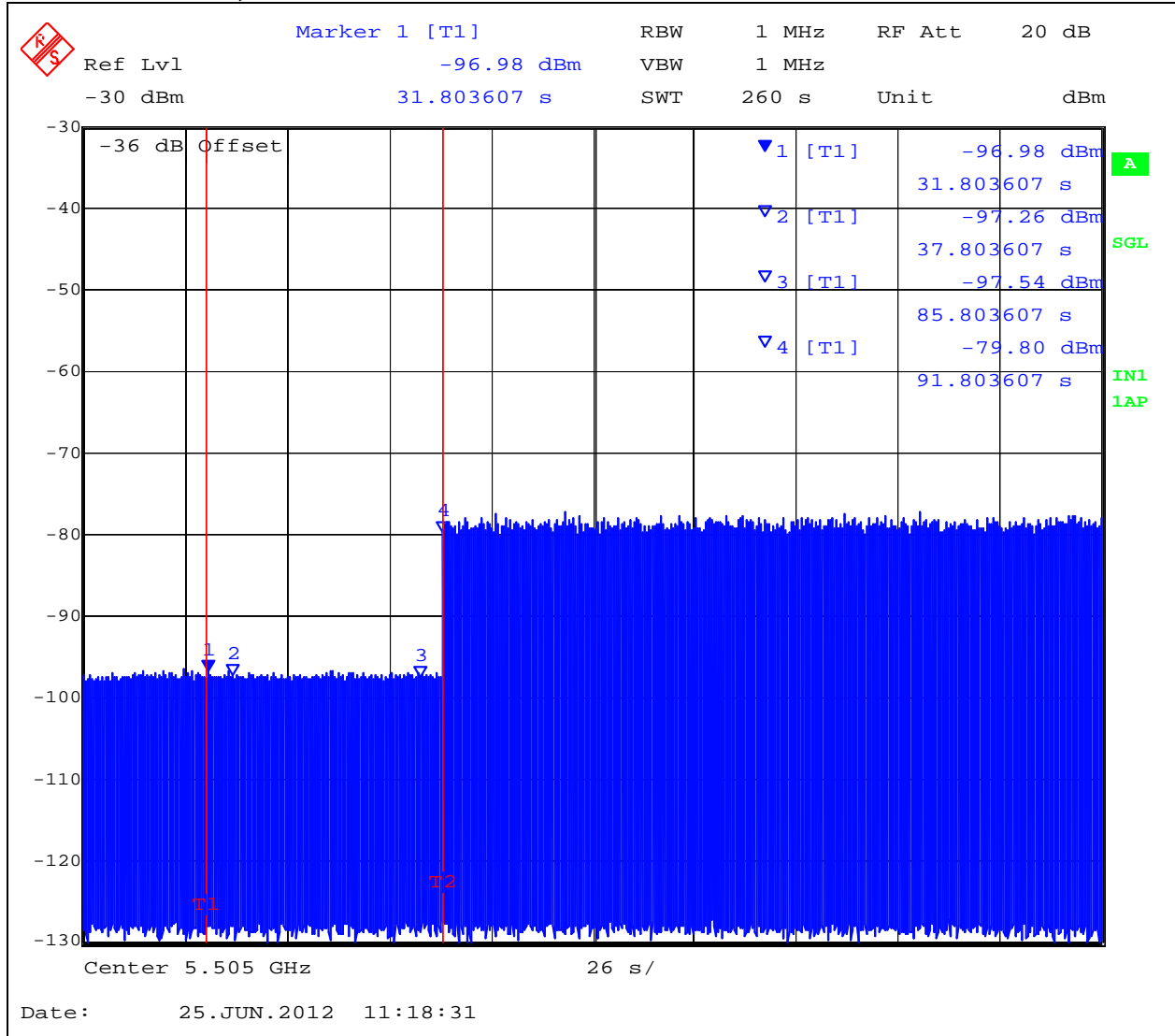

This test report may be reproduced in full only. The document may only be updated by MiCOM Labs personnel. Any changes will be noted in the Document History section of the report.



Title: Aruba AP-175 802.11a/b/g/n Wireless AP
To: DFS FCC 47 CFR Part 15.407 & IC RSS-210
Serial #: ARUB111-U2 Rev A
Date: 17th December 2012
Page: 35 of 63

5.2.3. Radar Burst at the Beginning of the Channel Availability Check Time:

The steps below define the procedure to verify successful radar detection on the selected Channel during a period equal to the Channel Availability Check Time and avoidance of operation on that Channel when a radar Burst with a level equal to the DFS Detection Threshold occurs at the beginning of the Channel Availability Check Time.

A single Burst of short pulse of radar Type 1 will commence within a 6 second window starting at T_0 (first red marker line on the following plot).

Visual indication on the EUT of successful detection of the radar Burst will be recorded and reported. Observation of emissions at 5,500MHz 802.11a & 5,510MHz 802.11n HT40 will continue for 2.5 minutes after the radar burst has been generated.

This test report may be reproduced in full only. The document may only be updated by MiCOM Labs personnel. Any changes will be noted in the Document History section of the report.



Title: Aruba AP-175 802.11a/b/g/n Wireless AP
To: DFS FCC 47 CFR Part 15.407 & IC RSS-210
Serial #: ARUB111-U2 Rev A
Date: 17th December 2012
Page: 36 of 63

**Channel Availability Check Time at the start T0 + 6 seconds Check Time
5,500MHz 802.11a**

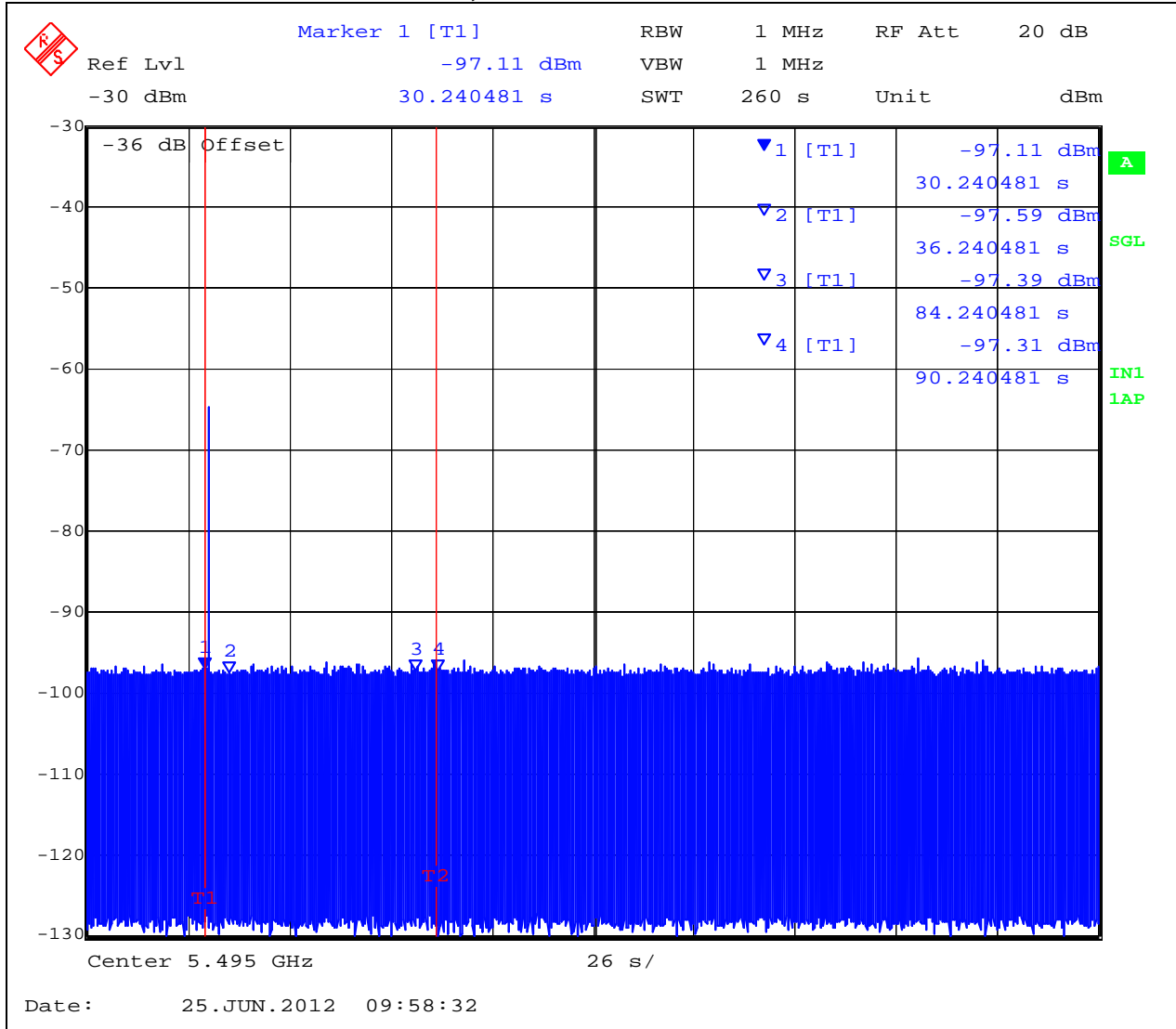

This test report may be reproduced in full only. The document may only be updated by MiCOM Labs personnel. Any changes will be noted in the Document History section of the report.



Title: Aruba AP-175 802.11a/b/g/n Wireless AP
To: DFS FCC 47 CFR Part 15.407 & IC RSS-210
Serial #: ARUB111-U2 Rev A
Date: 17th December 2012
Page: 37 of 63

**Channel Availability Check Time at the start T0 + 6 seconds Check Time
5,510MHz 802.11n HT40**

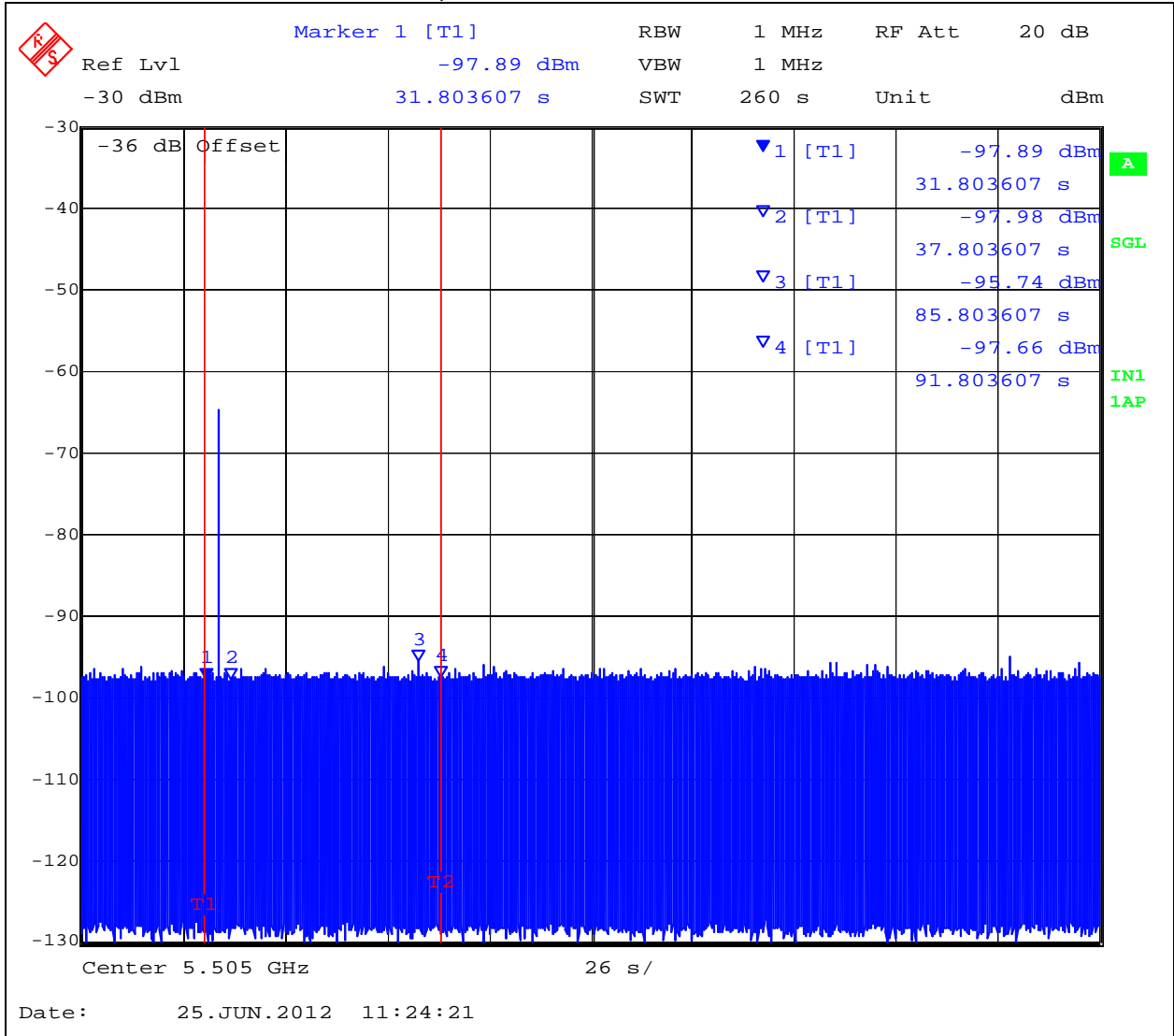

This test report may be reproduced in full only. The document may only be updated by MiCOM Labs personnel. Any changes will be noted in the Document History section of the report.



Title: Aruba AP-175 802.11a/b/g/n Wireless AP
To: DFS FCC 47 CFR Part 15.407 & IC RSS-210
Serial #: ARUB111-U2 Rev A
Date: 17th December 2012
Page: 38 of 63

5.2.4. Radar Burst at the End of the Channel Availability Check Time:

The steps below define the procedure to verify successful radar detection on the selected Channel during a period equal to the Channel Availability Check Time and avoidance of operation on that Channel when a radar Burst with a level equal to the DFS Detection Threshold occurs at the end of the Channel Availability Check Time.

A single Burst of short pulse of radar type 1 will commence within a 6 second window starting at $T_0 + 54$ seconds. The window will commence at marker 2 and end at the red frequency line T_2 .

Visual indication on the EUT of successful detection of the radar Burst will be recorded and reported. Observation of emissions at 5,500MHz 802.11a & 5,510MHz 802.11n HT40 will continue for 2.5 minutes after the radar burst has been generated.

This test report may be reproduced in full only. The document may only be updated by MiCOM Labs personnel. Any changes will be noted in the Document History section of the report.



Title: Aruba AP-175 802.11a/b/g/n Wireless AP
To: DFS FCC 47 CFR Part 15.407 & IC RSS-210
Serial #: ARUB111-U2 Rev A
Date: 17th December 2012
Page: 39 of 63

**Channel Availability Check Time at T0 + 54 seconds Check Time
5,500MHz 802.11a**

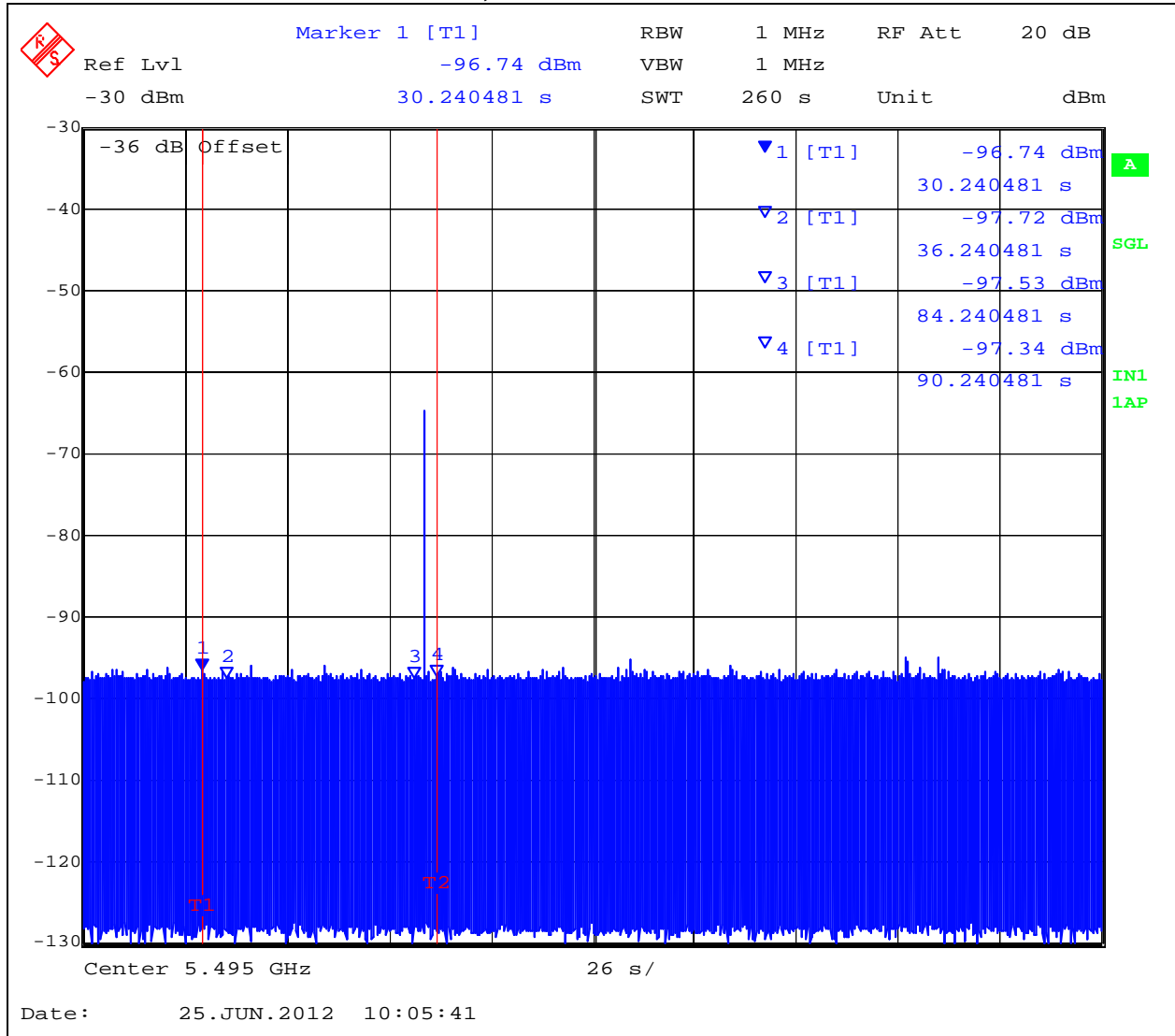

This test report may be reproduced in full only. The document may only be updated by MiCOM Labs personnel. Any changes will be noted in the Document History section of the report.



Title: Aruba AP-175 802.11a/b/g/n Wireless AP
To: DFS FCC 47 CFR Part 15.407 & IC RSS-210
Serial #: ARUB111-U2 Rev A
Date: 17th December 2012
Page: 40 of 63

**Channel Availability Check Time at T0 + 54 seconds Check Time
5,510MHz 802.11n HT40**

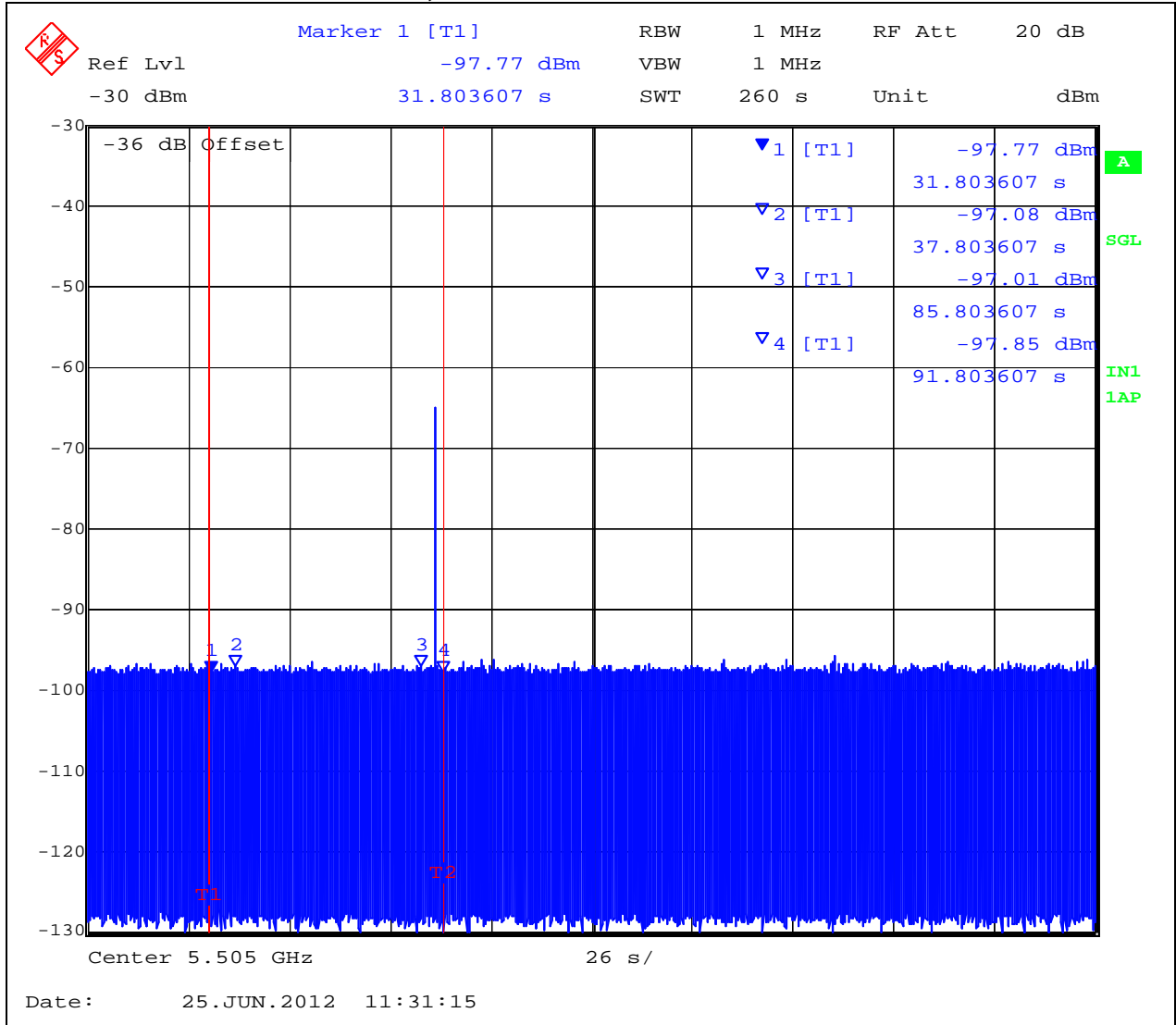

This test report may be reproduced in full only. The document may only be updated by MiCOM Labs personnel. Any changes will be noted in the Document History section of the report.



Title: Aruba AP-175 802.11a/b/g/n Wireless AP
To: DFS FCC 47 CFR Part 15.407 & IC RSS-210
Serial #: ARUB111-U2 Rev A
Date: 17th December 2012
Page: 41 of 63

5.2.5. In-Service Monitoring for Channel Move Time, Channel Closing Transmission Time and Non-Occupancy Period

FCC §15.407(h)(2)(iii)

The steps below define the procedure to determine the above mentioned parameters when a radar Burst with a level equal to the DFS Detection Threshold is generated on the Operating Channel of the U-NII device.

A U-NII device operating as a Client Device will associate with the EUT (Master). The requisite MPEG video file ("TestFile.mpg" available on the NTIA website at the following link <http://ntiacsd.ntia.doc.gov/dfs/>) is streamed from the master device (AP) to the client.

Channel Closing Transmission Time - Measurement

A Type 1 waveform was introduced to the EUT, from which a 12 second transmission record was digitally captured, collecting nearly 250M samples of data, which included in excess of 600 ms of pre-trigger data. This Type 1 waveform had an integral marker built into its construction, marking the start of the radar waveform play, which directly triggered the PXI digitizer's data capture via the PXI backplane trigger bus.

The test system was set-up to capture all transmission data for access point events above a threshold level of -50 dBm. The test equipment time stamps all captured events with respect to T_0 (zero time indicating the start of the measurements sequence) starting the 612.1 ms pre-trigger period followed by the radar type 1 burst period.

Radar (Type 1) Pre-trigger period 612.1 ms

Type 1 burst period 25.70 ms

(The period of the 18 pulse burst includes [18 pulses * 1.428mS PRI] = 25.704 ms. Then add 1 μ s pulse width for the final pulse.)

Channel Closing Transmission Time starts immediately after the last radar pulse is transmitted i.e. 637.8 ms after the start of the trace capture period.



Title: Aruba AP-175 802.11a/b/g/n Wireless AP
To: DFS FCC 47 CFR Part 15.407 & IC RSS-210
Serial #: ARUB111-U2 Rev A
Date: 17th December 2012
Page: 42 of 63

Therefore, pulses seen after this 637.8 ms boundary are identified and totaled to provide an aggregate total of transmissions in order to determine whether the EUT is compliant with the Channel Closing Transmission Time requirements as described in MO&O FCC 06-96. In this case, it was found that an aggregate total of 0.665 ms of transmission time accrued. This value is found at the right hand side at the foot of the following plot (10s Total).

Channel Closing Transmission Time 5,500 MHz (802.11a) = 0.665 mSecs (limit 260 mSecs)

Channel Move Time 5,500MHz (802.11a) = 0.7622 Secs (limit 10 Secs)

Channel Move Time, Channel Closing Transmission Time for Type 1 Radar Captured by the Test System - 0 to 2 seconds

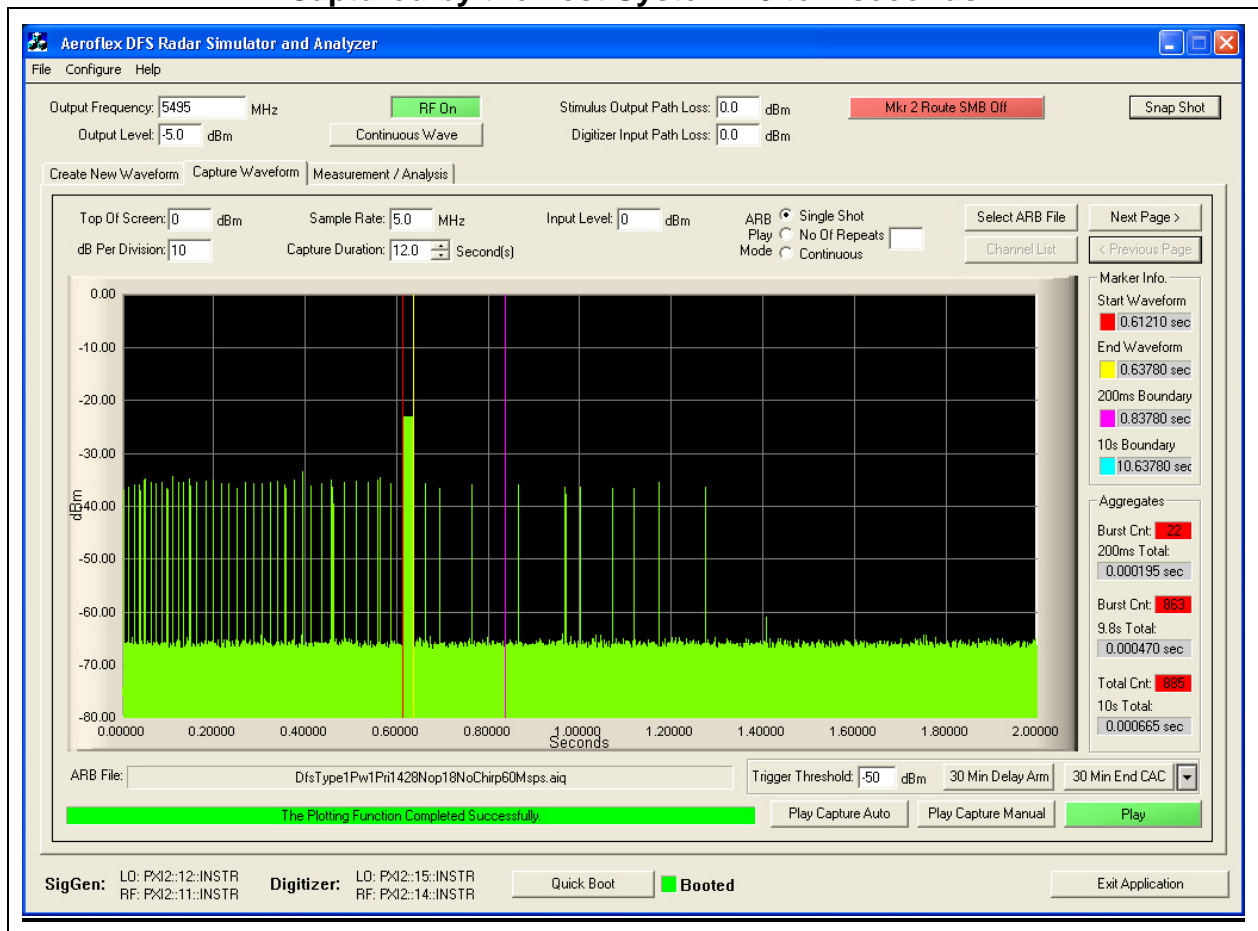

This test report may be reproduced in full only. The document may only be updated by MiCOM Labs personnel. Any changes will be noted in the Document History section of the report.



Title: Aruba AP-175 802.11a/b/g/n Wireless AP
To: DFS FCC 47 CFR Part 15.407 & IC RSS-210
Serial #: ARUB111-U2 Rev A
Date: 17th December 2012
Page: 43 of 63

Channel Move Time, Channel Closing Transmission Time for Type 1 Radar Captured by the Test System - 2 to 4 seconds

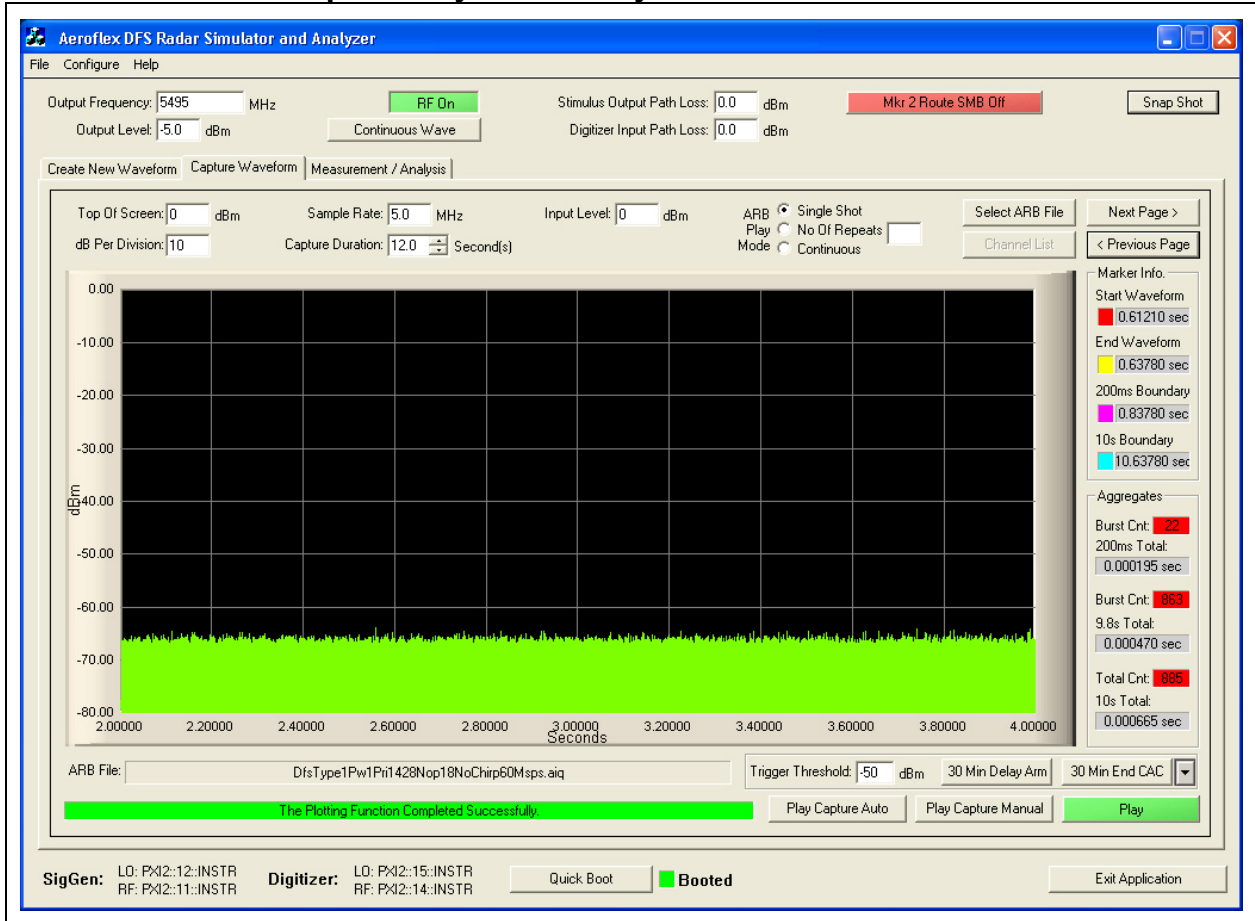

This test report may be reproduced in full only. The document may only be updated by MiCOM Labs personnel. Any changes will be noted in the Document History section of the report.



Title: Aruba AP-175 802.11a/b/g/n Wireless AP
To: DFS FCC 47 CFR Part 15.407 & IC RSS-210
Serial #: ARUB111-U2 Rev A
Date: 17th December 2012
Page: 44 of 63

Channel Move Time, Channel Closing Transmission Time for Type 1 Radar Captured by the Test System - 4 to 6 seconds

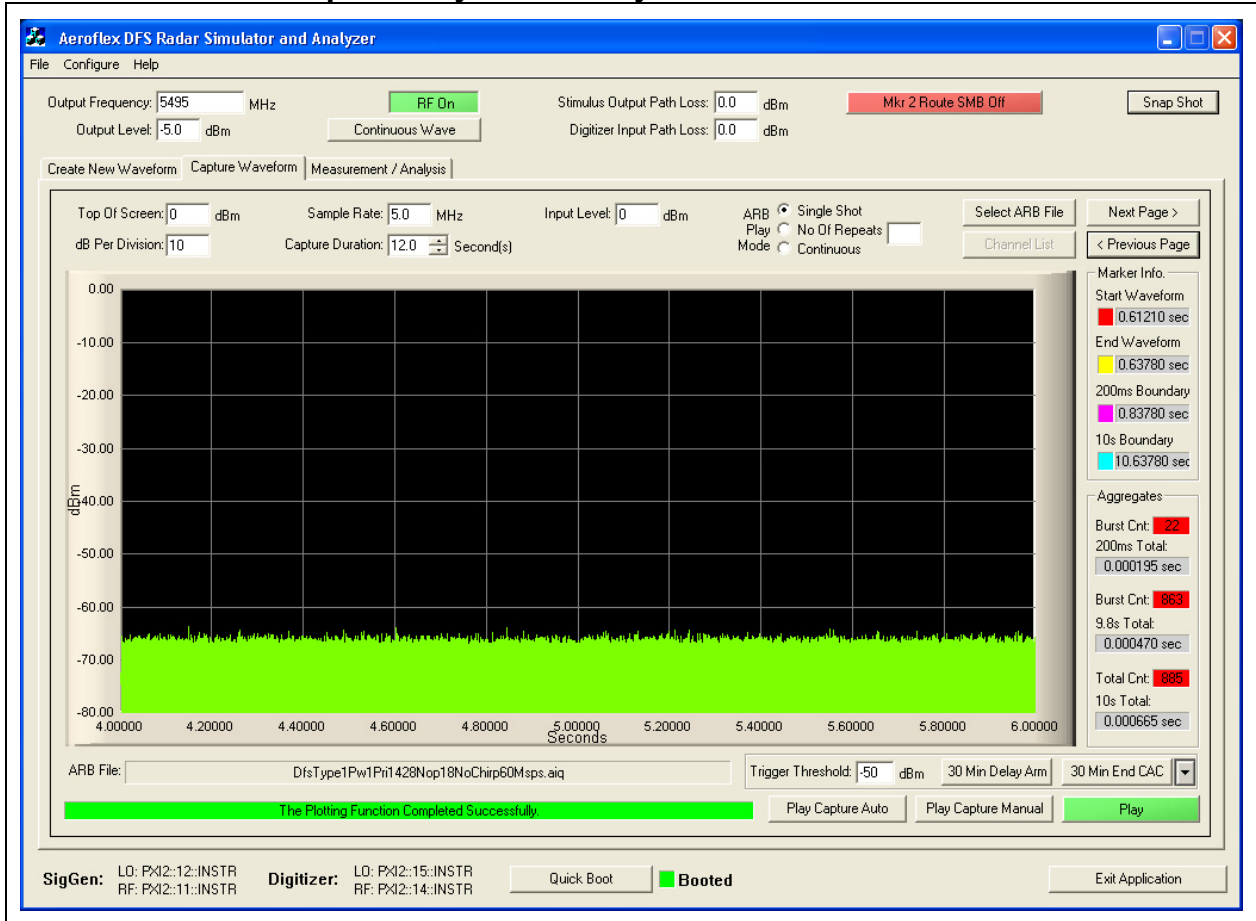

This test report may be reproduced in full only. The document may only be updated by MiCOM Labs personnel. Any changes will be noted in the Document History section of the report.



Title: Aruba AP-175 802.11a/b/g/n Wireless AP
To: DFS FCC 47 CFR Part 15.407 & IC RSS-210
Serial #: ARUB111-U2 Rev A
Date: 17th December 2012
Page: 45 of 63

Channel Move Time, Channel Closing Transmission Time for Type 1 Radar Captured by the Test System - 6 to 8 seconds

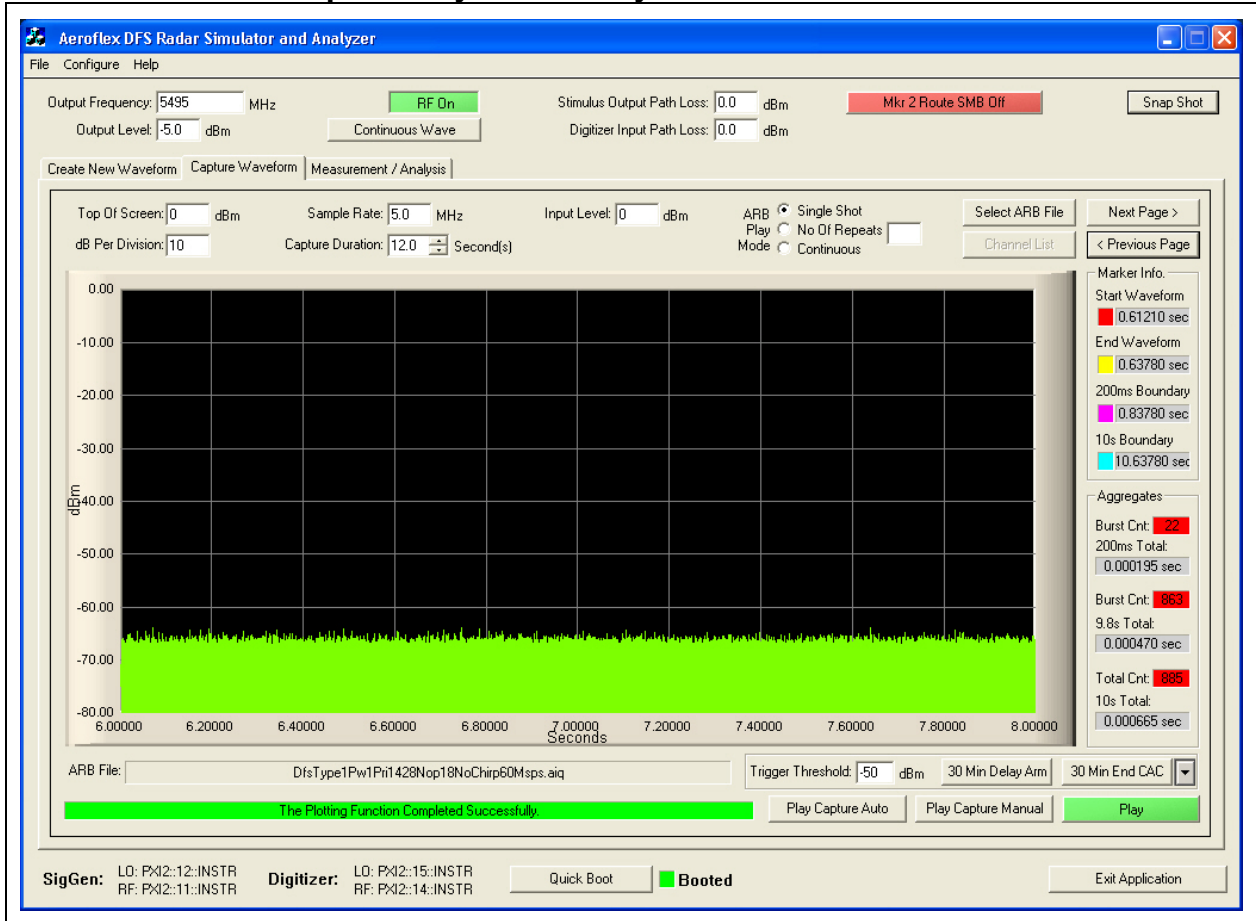

This test report may be reproduced in full only. The document may only be updated by MiCOM Labs personnel. Any changes will be noted in the Document History section of the report.



Title: Aruba AP-175 802.11a/b/g/n Wireless AP
To: DFS FCC 47 CFR Part 15.407 & IC RSS-210
Serial #: ARUB111-U2 Rev A
Date: 17th December 2012
Page: 46 of 63

Channel Move Time, Channel Closing Transmission Time for Type 1 Radar Captured by the Test System - 8 to 10 seconds

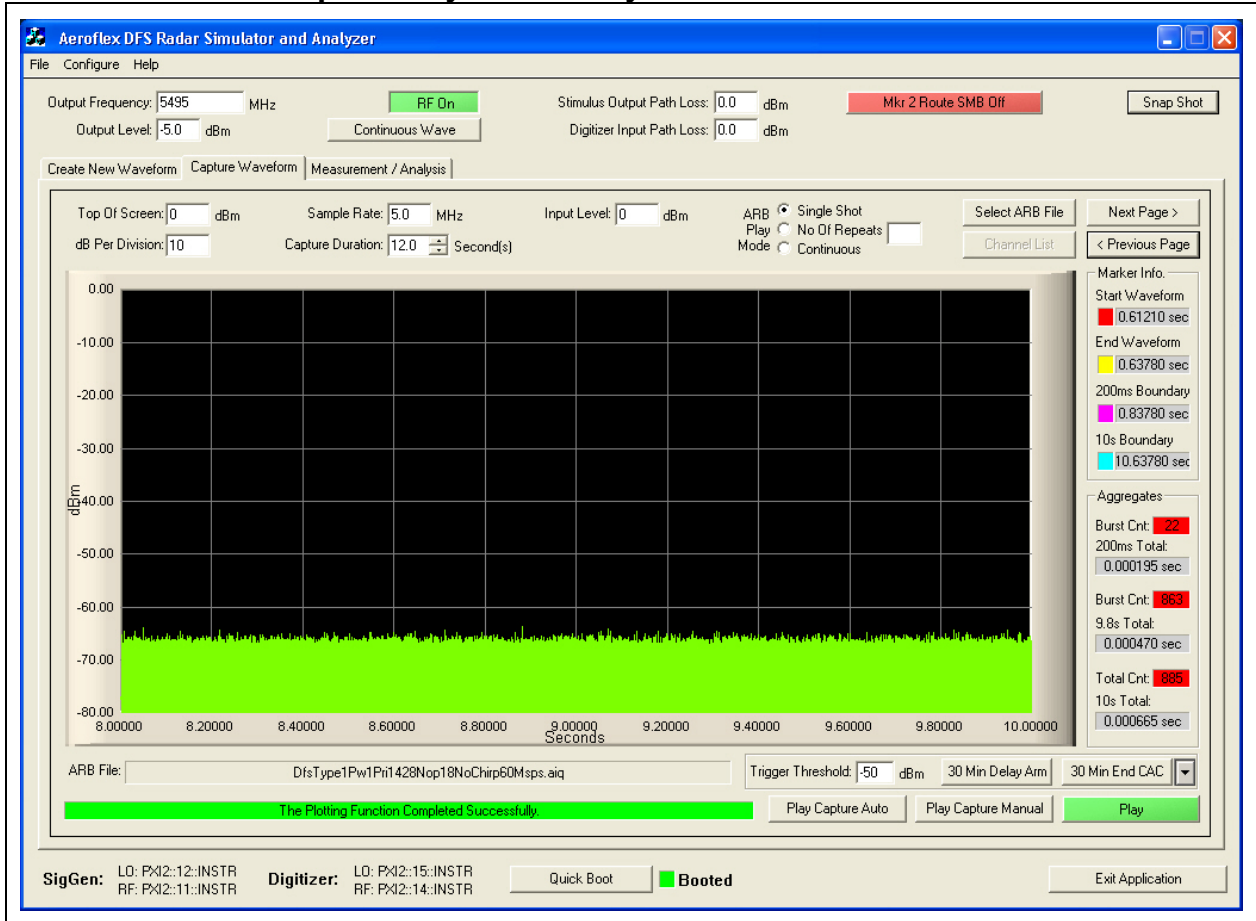

This test report may be reproduced in full only. The document may only be updated by MiCOM Labs personnel. Any changes will be noted in the Document History section of the report.



Title: Aruba AP-175 802.11a/b/g/n Wireless AP
To: DFS FCC 47 CFR Part 15.407 & IC RSS-210
Serial #: ARUB111-U2 Rev A
Date: 17th December 2012
Page: 47 of 63

Channel Move Time, Channel Closing Transmission Time for Type 1 Radar Captured by the Test System - 10 to 12 seconds

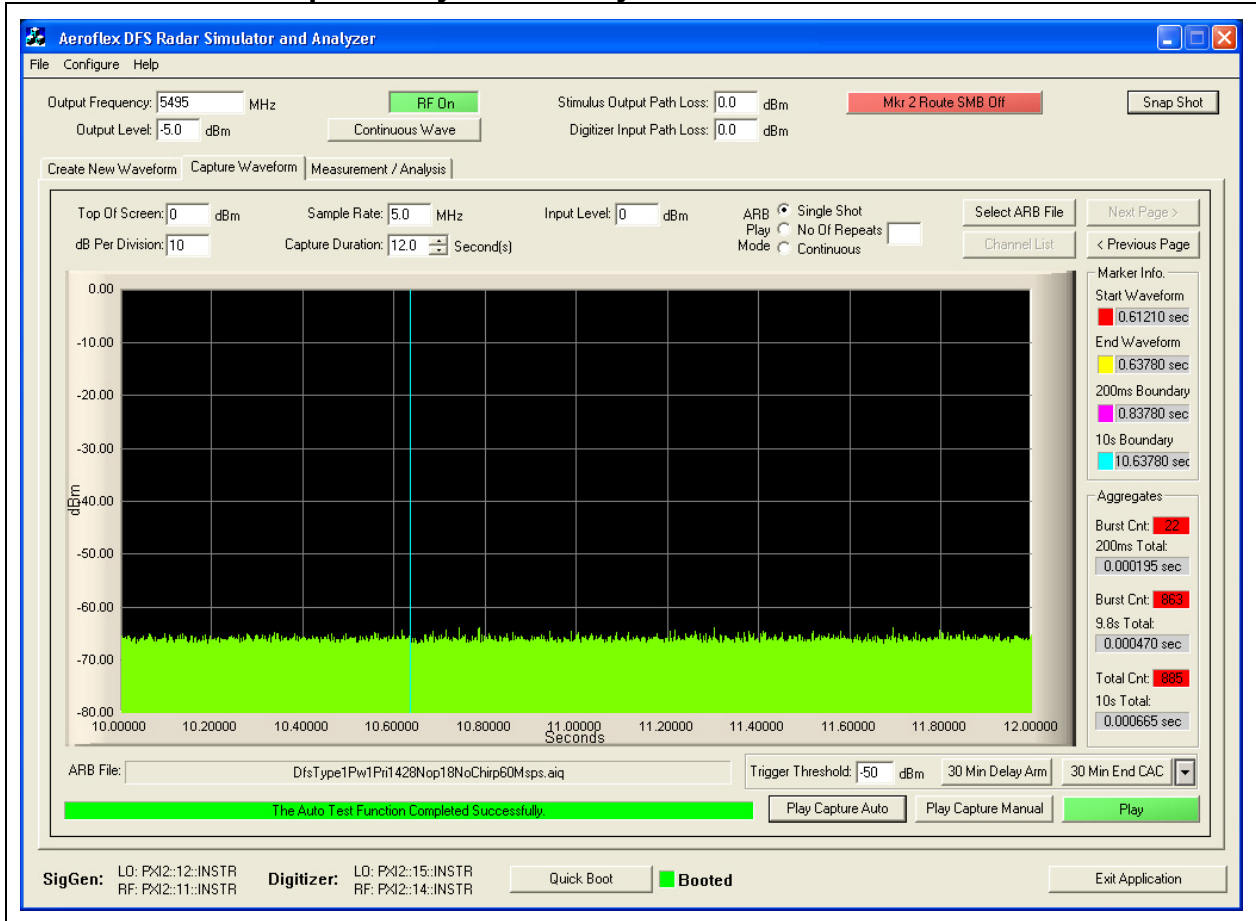

This test report may be reproduced in full only. The document may only be updated by MiCOM Labs personnel. Any changes will be noted in the Document History section of the report.



Title: Aruba AP-175 802.11a/b/g/n Wireless AP
To: DFS FCC 47 CFR Part 15.407 & IC RSS-210
Serial #: ARUB111-U2 Rev A
Date: 17th December 2012
Page: 48 of 63

Channel Closing Transmission Time 5,510 MHz (802.11n HT40) = 0.250 mSecs (limit 260 mSecs)

Channel Move Time 5,510 MHz (802.11n HT40) = 0.1622 Secs (limit 10 Secs)

Channel Move Time, Channel Closing Transmission Time for Type 1 Radar Captured by the Test System - 0 to 2 seconds

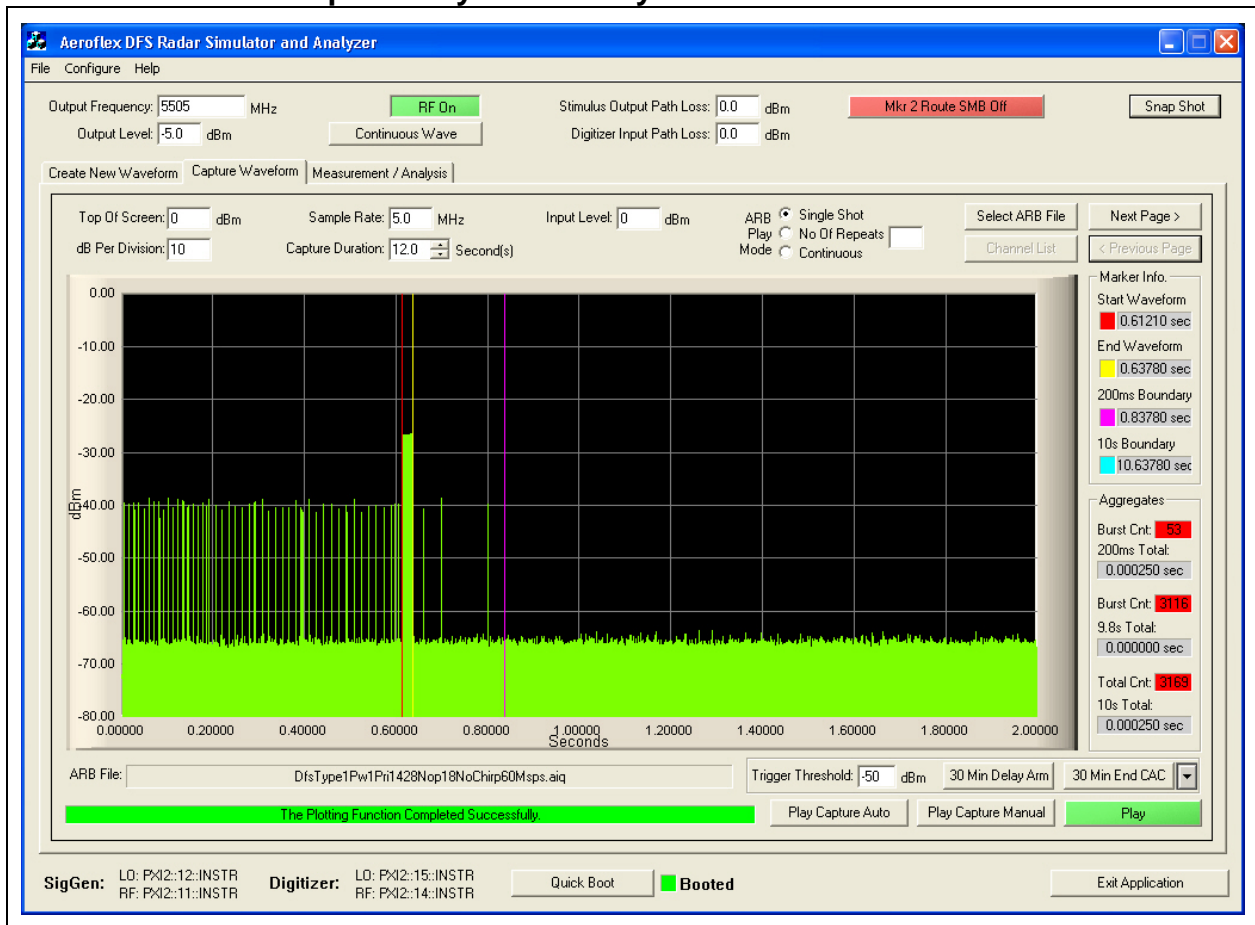

This test report may be reproduced in full only. The document may only be updated by MiCOM Labs personnel. Any changes will be noted in the Document History section of the report.



Title: Aruba AP-175 802.11a/b/g/n Wireless AP
To: DFS FCC 47 CFR Part 15.407 & IC RSS-210
Serial #: ARUB111-U2 Rev A
Date: 17th December 2012
Page: 49 of 63

Channel Move Time, Channel Closing Transmission Time for Type 1 Radar Captured by the Test System - 2 to 4 seconds

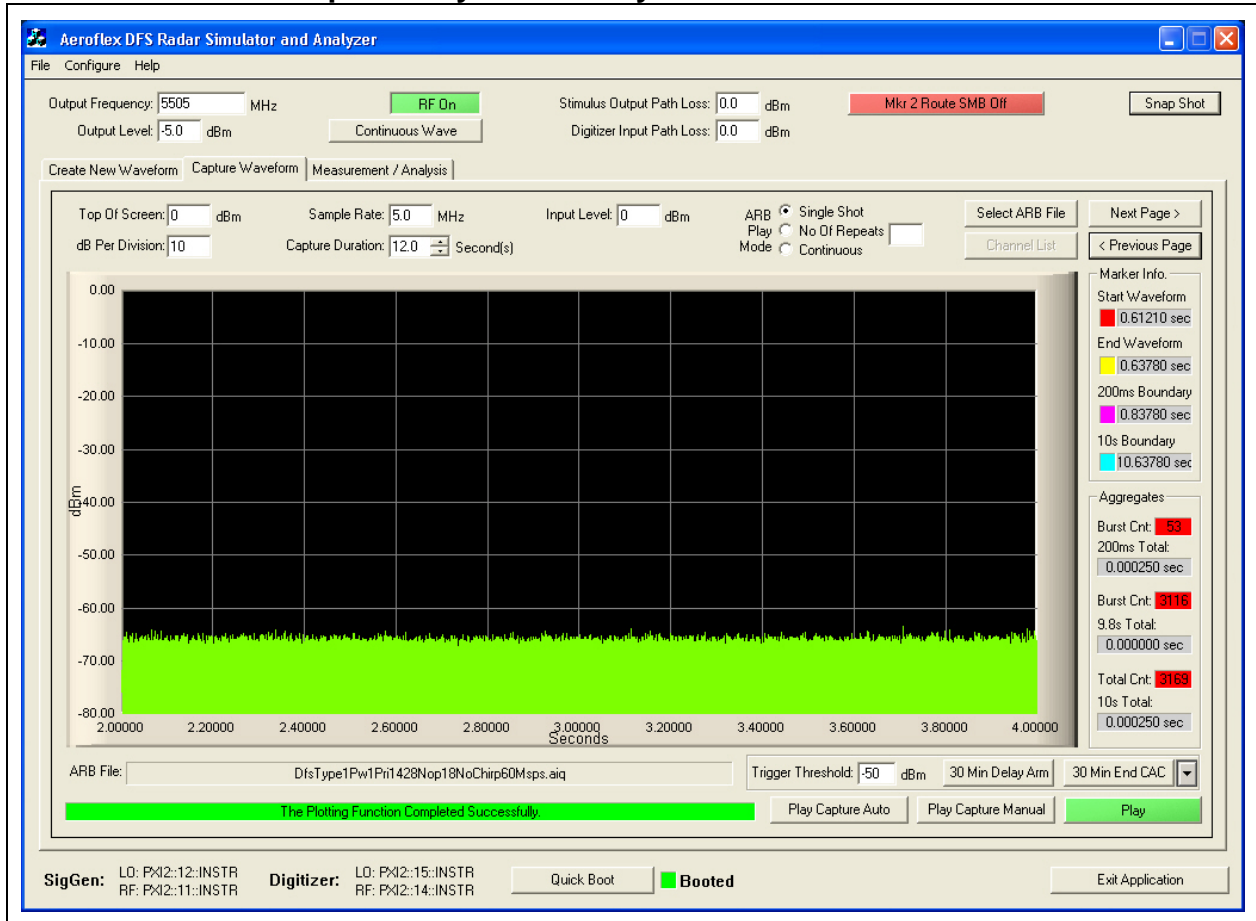

This test report may be reproduced in full only. The document may only be updated by MiCOM Labs personnel. Any changes will be noted in the Document History section of the report.



Title: Aruba AP-175 802.11a/b/g/n Wireless AP
To: DFS FCC 47 CFR Part 15.407 & IC RSS-210
Serial #: ARUB111-U2 Rev A
Date: 17th December 2012
Page: 50 of 63

Channel Move Time, Channel Closing Transmission Time for Type 1 Radar Captured by the Test System - 4 to 6 seconds

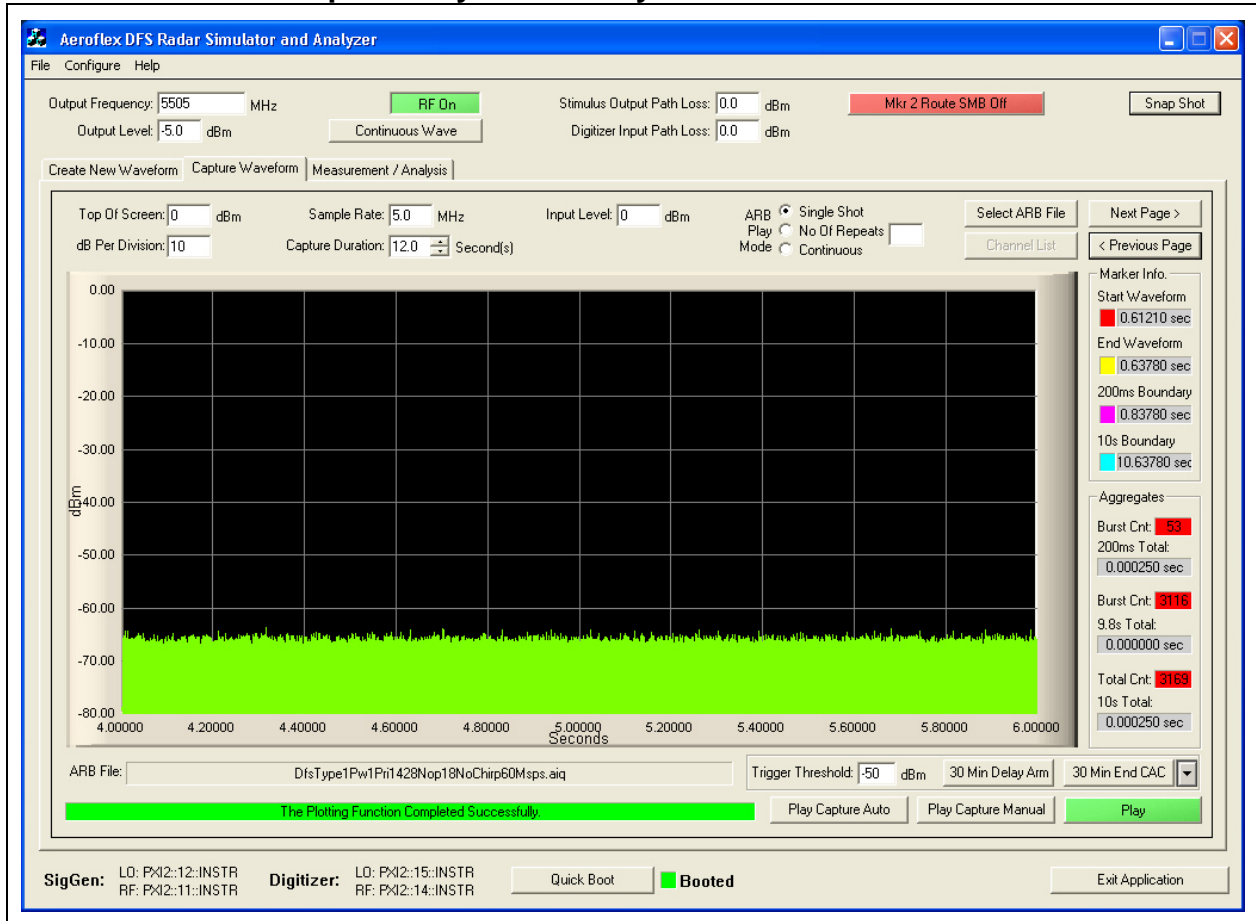

This test report may be reproduced in full only. The document may only be updated by MiCOM Labs personnel. Any changes will be noted in the Document History section of the report.



Title: Aruba AP-175 802.11a/b/g/n Wireless AP
To: DFS FCC 47 CFR Part 15.407 & IC RSS-210
Serial #: ARUB111-U2 Rev A
Date: 17th December 2012
Page: 51 of 63

Channel Move Time, Channel Closing Transmission Time for Type 1 Radar Captured by the Test System - 6 to 8 seconds

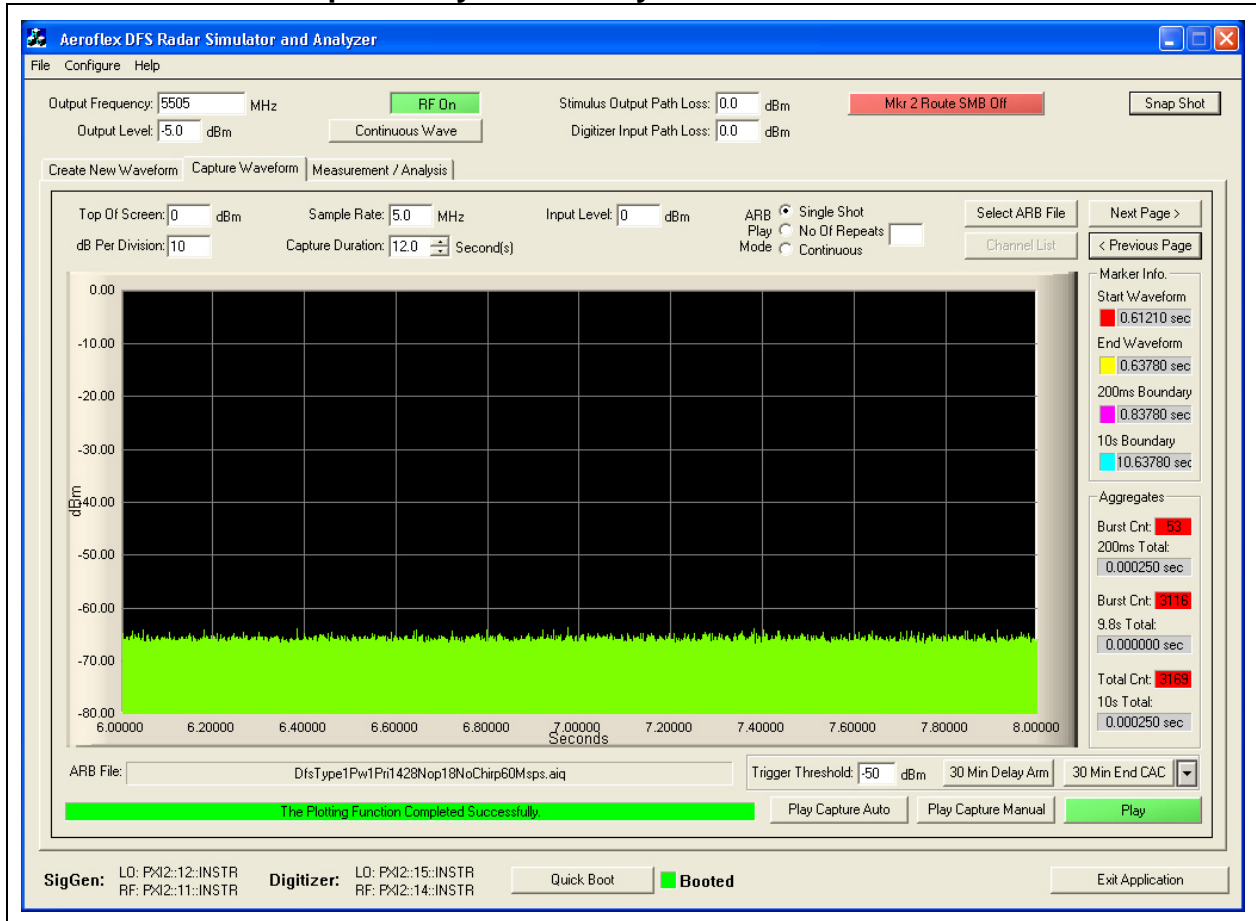

This test report may be reproduced in full only. The document may only be updated by MiCOM Labs personnel. Any changes will be noted in the Document History section of the report.



Title: Aruba AP-175 802.11a/b/g/n Wireless AP
To: DFS FCC 47 CFR Part 15.407 & IC RSS-210
Serial #: ARUB111-U2 Rev A
Date: 17th December 2012
Page: 52 of 63

Channel Move Time, Channel Closing Transmission Time for Type 1 Radar Captured by the Test System - 8 to 10 seconds

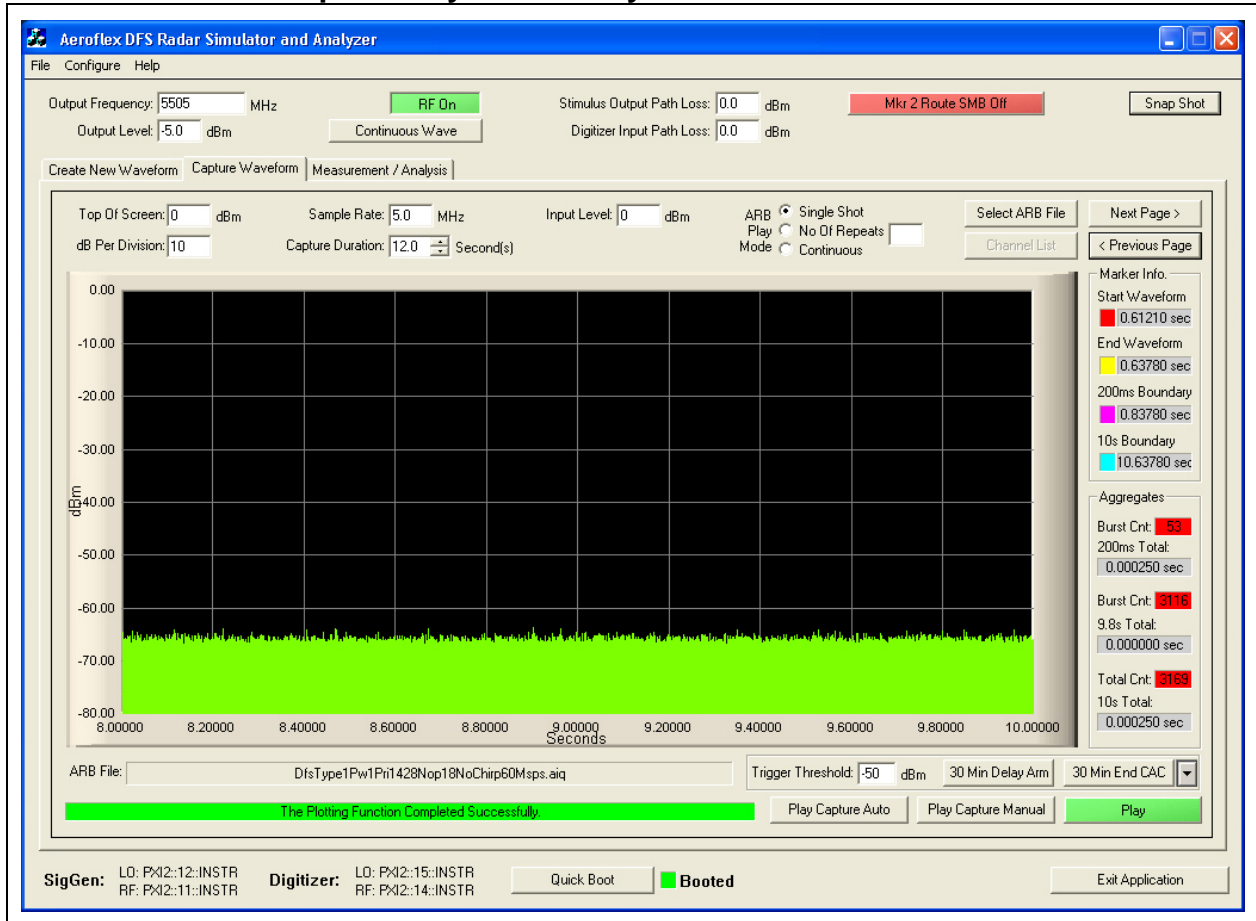

This test report may be reproduced in full only. The document may only be updated by MiCOM Labs personnel. Any changes will be noted in the Document History section of the report.



Title: Aruba AP-175 802.11a/b/g/n Wireless AP
To: DFS FCC 47 CFR Part 15.407 & IC RSS-210
Serial #: ARUB111-U2 Rev A
Date: 17th December 2012
Page: 53 of 63

Channel Move Time, Channel Closing Transmission Time for Type 1 Radar Captured by the Test System - 10 to 12 seconds

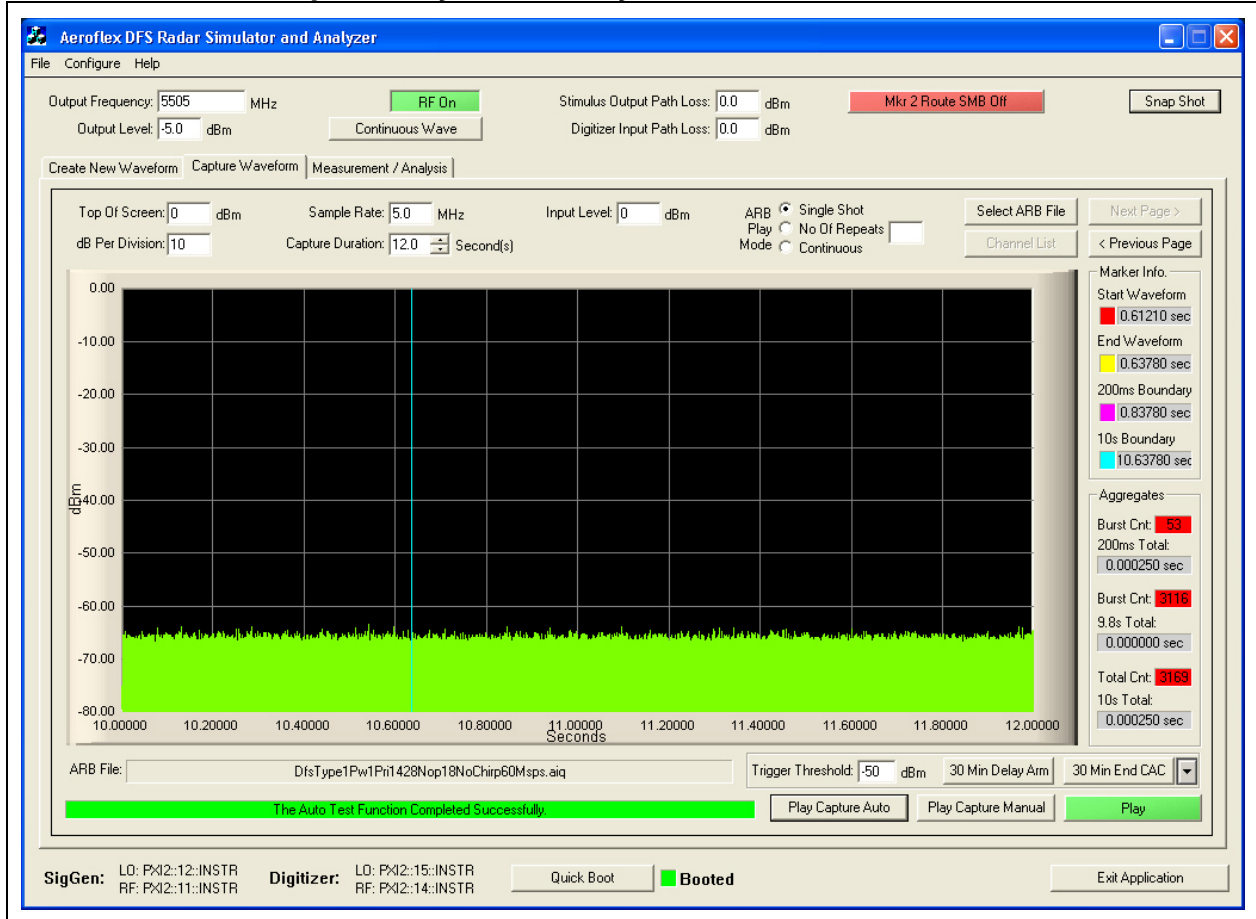

This test report may be reproduced in full only. The document may only be updated by MiCOM Labs personnel. Any changes will be noted in the Document History section of the report.



Title: Aruba AP-175 802.11a/b/g/n Wireless AP
To: DFS FCC 47 CFR Part 15.407 & IC RSS-210
Serial #: ARUB111-U2 Rev A
Date: 17th December 2012
Page: 54 of 63

30 Minute Non-Occupancy Period

The EUT is monitored for more than 30 minutes following the channel close/move time to verify no transmissions resume on this Channel.

30 Minute Non-Occupancy Period Type 1 Radar 5,500MHz 802.11a

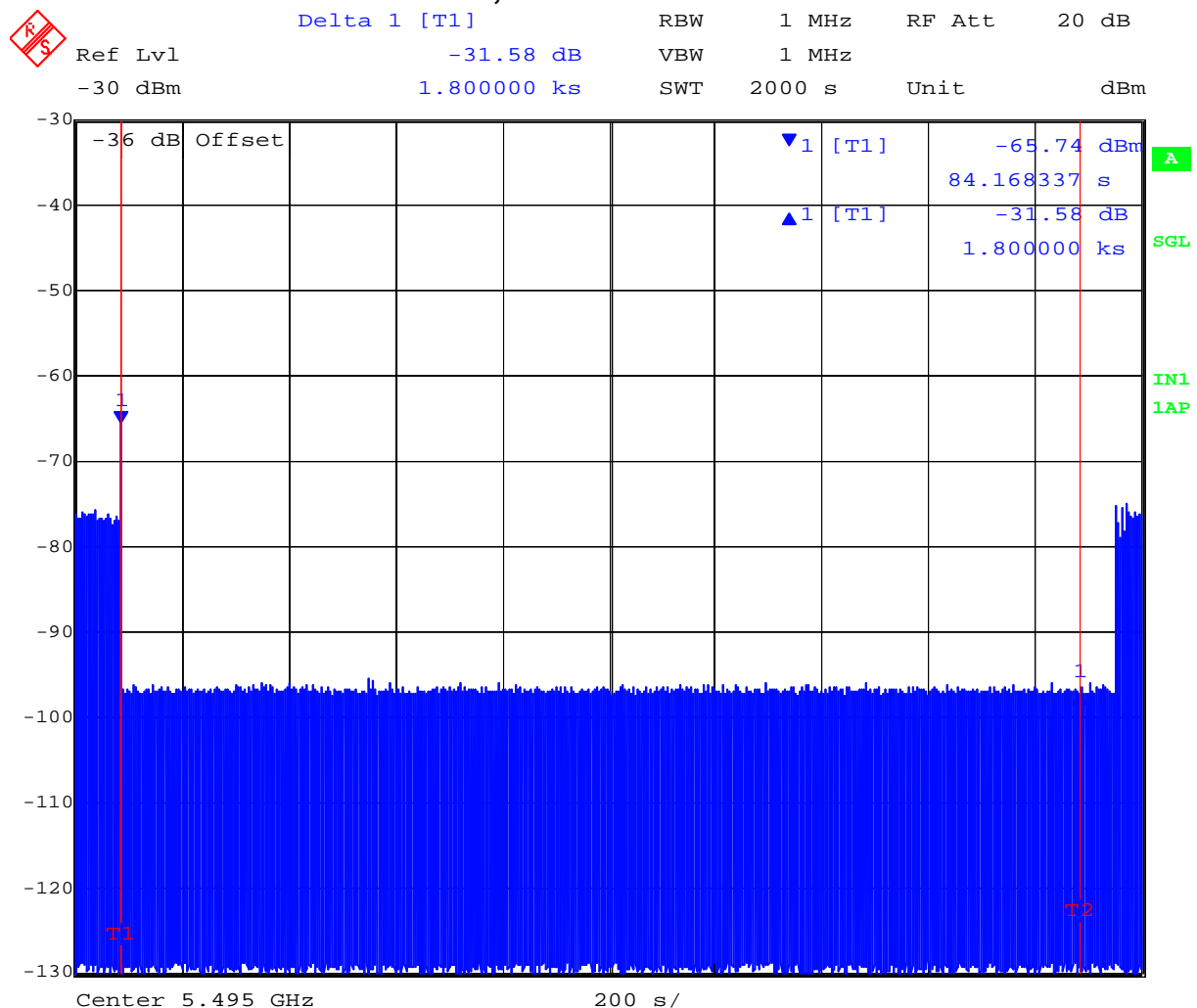

Date: 25.JUN.2012 12:50:43

This test report may be reproduced in full only. The document may only be updated by MiCOM Labs personnel. Any changes will be noted in the Document History section of the report.



Title: Aruba AP-175 802.11a/b/g/n Wireless AP
To: DFS FCC 47 CFR Part 15.407 & IC RSS-210
Serial #: ARUB111-U2 Rev A
Date: 17th December 2012
Page: 55 of 63

30 Minute Non-Occupancy Period Type 1 Radar 5,510 MHz 802.11n HT40

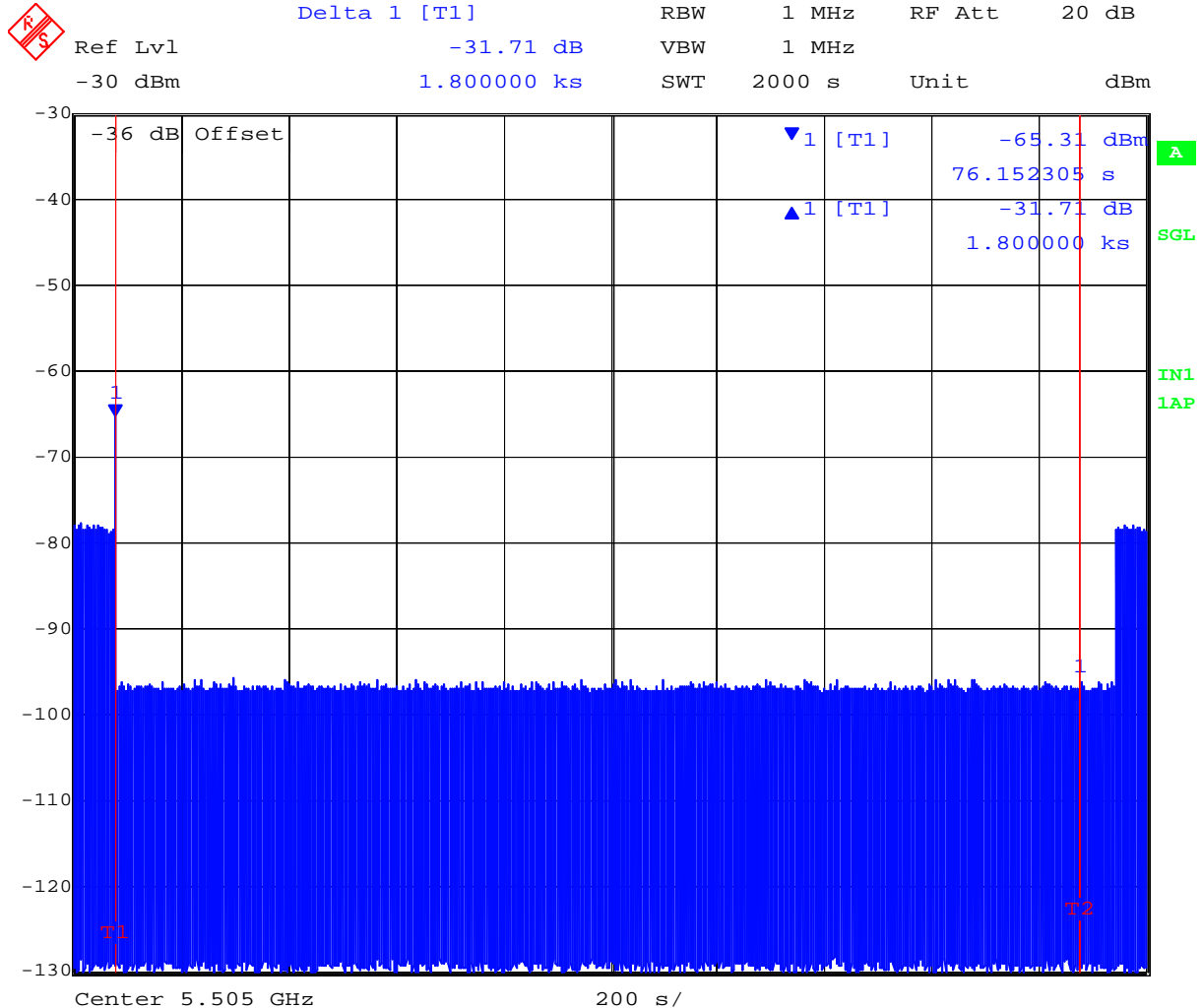

Date: 25.JUN.2012 12:12:30

This test report may be reproduced in full only. The document may only be updated by MiCOM Labs personnel. Any changes will be noted in the Document History section of the report.



Title: Aruba AP-175 802.11a/b/g/n Wireless AP
To: DFS FCC 47 CFR Part 15.407 & IC RSS-210
Serial #: ARUB111-U2 Rev A
Date: 17th December 2012
Page: 56 of 63

5.2.6. Statistical Performance Check

The steps below define the procedure to determine the minimum percentage of detection when a radar burst with a level equal to the DFS Detection Threshold is generated on the Operating Channel of the U-NII device.

A U-NII device operating as a Client Device will associate with the UUT (Master) at 5,500MHz 802.11a and 5,510MHz 802.11n HT40.

The Radar Waveform generator sends the individual waveform for each of the radar types 1-6. Statistical data will be gathered to determine the ability of the device to detect the radar test waveforms. The device can utilize a test mode to demonstrate when detection occurs to prevent the need to reset the device between trial runs. The percentage of successful detection is calculated by:

Total # of detections ÷ Total # of Trials × 100 = Probability of Detection

The Minimum number of trails, minimum percentage of successful detection and the average minimum percentage of successful detection are found in the Radar Test Waveforms section.

This test report may be reproduced in full only. The document may only be updated by MiCOM Labs personnel. Any changes will be noted in the Document History section of the report.



Title: Aruba AP-175 802.11a/b/g/n Wireless AP
To: DFS FCC 47 CFR Part 15.407 & IC RSS-210
Serial #: ARUB111-U2 Rev A
Date: 17th December 2012
Page: 57 of 63

Verification of Detection 5,500MHz 802.11a

Trial #	Detection = √, No Detection = 0					
	Type 1	Type 2	Type 3	Type 4	Type 5	Type 6
1	√	√	√	√	√	√
2	0	0	√	√	√	√
3	√	√	√	√	√	√
4	√	√	√	√	0	√
5	0	√	√	√	√	√
6	√	√	√	√	√	√
7	√	√	√	√	√	√
8	0	√	√	√	√	√
9	√	√	√	√	√	√
10	√	√	√	√	√	√
11	√	0	√	√	√	√
12	√	√	√	√	√	√
13	√	√	√	√	0	√
14	0	√	√	√	√	√
15	0	√	√	√	√	√
16	√	√	√	√	√	√
17	√	√	√	√	√	√
18	√	√	√	√	0	√
19	√	√	√	√	√	√
20	√	√	√	√	√	√
21	√	√	√	√	√	√
22	√	√	√	√	√	√
23	0	√	√	√	√	√
24	√	√	√	√	√	√
25	√	√	√	√	√	√
26	√	√	√	√	√	√
27	√	√	√	√	√	√
28	√	√	√	√	√	√
29	0	√	√	√	√	√
30	√	√	√	√	√	√
Detection Percentage	76.6% (>60%)	93.3% (>60%)	100.0% (>60%)	100.0% (>60%)	90% (>80%)	100% (>70%)

In addition an average minimum percentage of successful detection across all four Short pulse radar test waveforms is required and calculated as follows;

$$(P_{d1} + P_{d2} + P_{d3} + P_{d4}) / 4 = (76.6\% + 93.3\% + 100\% + 100\%) / 4 = 92.9\% (> 80\%)$$

This test report may be reproduced in full only. The document may only be updated by MiCOM Labs personnel. Any changes will be noted in the Document History section of the report.



Title: Aruba AP-175 802.11a/b/g/n Wireless AP
To: DFS FCC 47 CFR Part 15.407 & IC RSS-210
Serial #: ARUB111-U2 Rev A
Date: 17th December 2012
Page: 58 of 63

Verification of Detection 5,510MHz 802.11n HT40

Trial #	Detection = √, No Detection = 0					
	Type 1	Type 2	Type 3	Type 4	Type 5	Type 6
1	√	√	√	√	√	√
2	√	0	√	√	√	√
3	√	0	√	√	√	√
4	√	√	√	√	√	√
5	0	√	√	√	√	√
6	√	√	√	√	√	√
7	√	√	√	√	√	√
8	√	√	√	√	√	√
9	√	0	√	√	√	√
10	√	0	√	√	√	√
11	√	0	√	√	√	√
12	√	√	√	√	√	√
13	√	0	√	√	√	√
14	√	0	√	√	√	√
15	√	0	√	√	√	√
16	√	0	√	√	√	√
17	√	√	√	√	√	√
18	0	√	√	0	√	√
19	√	√	√	√	√	√
20	√	√	√	√	√	√
21	√	√	√	0	√	√
22	√	√	√	√	√	√
23	√	√	√	√	√	√
24	√	√	√	√	√	√
25	√	√	√	√	√	√
26	0	√	√	√	√	√
27	√	√	√	√	√	√
28	√	√	√	√	√	√
29	√	√	√	√	√	√
30	√	√	√	√	√	√
Detection Percentage	90% (>60%)	70% (>60%)	100% (>60%)	93.3% (>60%)	100% (>80%)	100% (>70%)

In addition an average minimum percentage of successful detection across all four Short pulse radar test waveforms is required and calculated as follows;

$$(P_{d1} + P_{d2} + P_{d3} + P_{d4}) / 4 = (90\% + 70\% + 100\% + 93.3\%) / 4 = 88.3\% (> 80\%)$$

This test report may be reproduced in full only. The document may only be updated by MiCOM Labs personnel. Any changes will be noted in the Document History section of the report.



Title: Aruba AP-175 802.11a/b/g/n Wireless AP
To: DFS FCC 47 CFR Part 15.407 & IC RSS-210
Serial #: ARUB111-U2 Rev A
Date: 17th December 2012
Page: 59 of 63

Measurement Uncertainty Time/Power

Measurement uncertainty		
- Time		4%
- Power		1.33dB

Traceability

Test Equipment Used
0072, 0083, 0098, 0116, 0132, 0158, 0313, 0314, 0193, 0223, 0252, 0253, 0251, 0256, 0328, 0329

This test report may be reproduced in full only. The document may only be updated by MiCOM Labs personnel. Any changes will be noted in the Document History section of the report.

6. PHOTOGRAPHS

6.1. Dynamic Frequency Selection Test Set-Up

General DFS Test Setup



DFS Test Equipment



This test report may be reproduced in full only. The document may only be updated by MiCOM Labs personnel. Any changes will be noted in the Document History section of the report.



Title: Aruba AP-175 802.11a/b/g/n Wireless AP
To: DFS FCC 47 CFR Part 15.407 & IC RSS-210
Serial #: ARUB111-U2 Rev A
Date: 17th December 2012
Page: 62 of 63

7. TEST EQUIPMENT DETAILS

Asset #	Instrument	Manufacturer	Part #	Serial #	Calibration Due Date
0117	Power Sensor	Hewlett Packard	8487D	3318A00371	15 th Nov 13
0223	Power Meter	Hewlett Packard	EPM-442A	US37480256	15 th Nov 13
0158	Barometer /Thermometer	Control Co.	4196	E2846	8 th Dec 13
0193	EMI Receiver	Rhode & Schwartz	ESI 7	838496/007	2 nd Dec 13
0335	1-18 GHz Horn Antenna	EMCO	3117	00066580	7 th Nov 13
0252	SMA Cable	Megaphase	Sucoflex 104	None	N/A
0293	BNC Cable	Megaphase	1689 1GVT4	15F50B001	N/A
0307	BNC Cable	Megaphase	1689 1GVT4	15F50B002	N/A
0310	2m SMA Cable	Micro-Coax	UFA210A-0-0787-3G03G0	209089-001	N/A
0312	3m SMA Cable	Micro-Coax	UFA210A-1-1181-3G0300	209092-001	N/A
0314	30dB N-Type Attenuator	ARRA	N9444-30	1623	N/A

This test report may be reproduced in full only. The document may only be updated by MiCOM Labs personnel. Any changes will be noted in the Document History section of the report.



440 Boulder Court, Suite 200
Pleasanton, CA 94566, USA
Tel: 1.925.462.0304
Fax: 1.925.462.0306
www.micomlabs.com