

Photographs of EUT

EUT 1 (External Antenna)

Model No.: AP-134







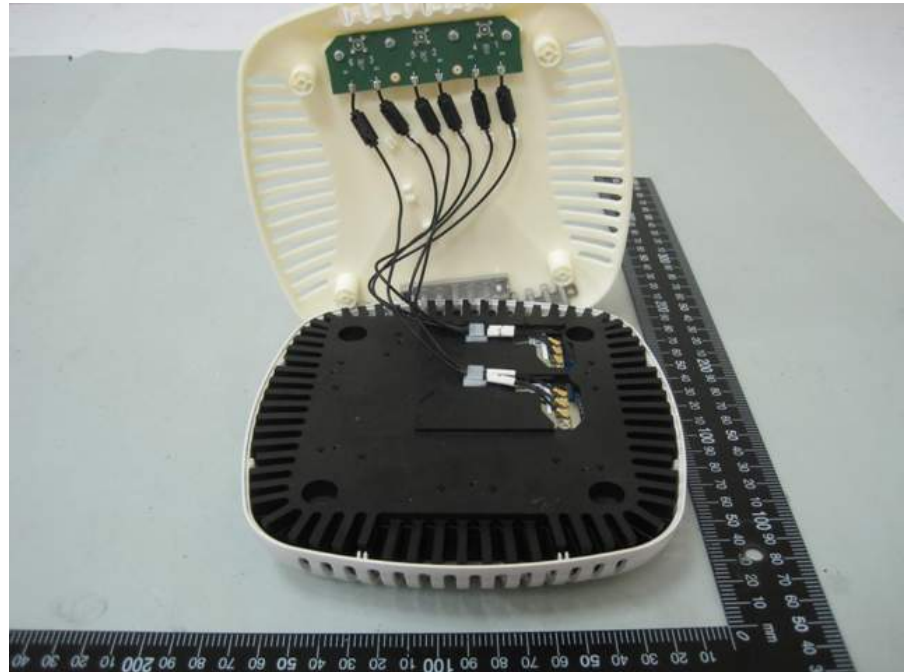

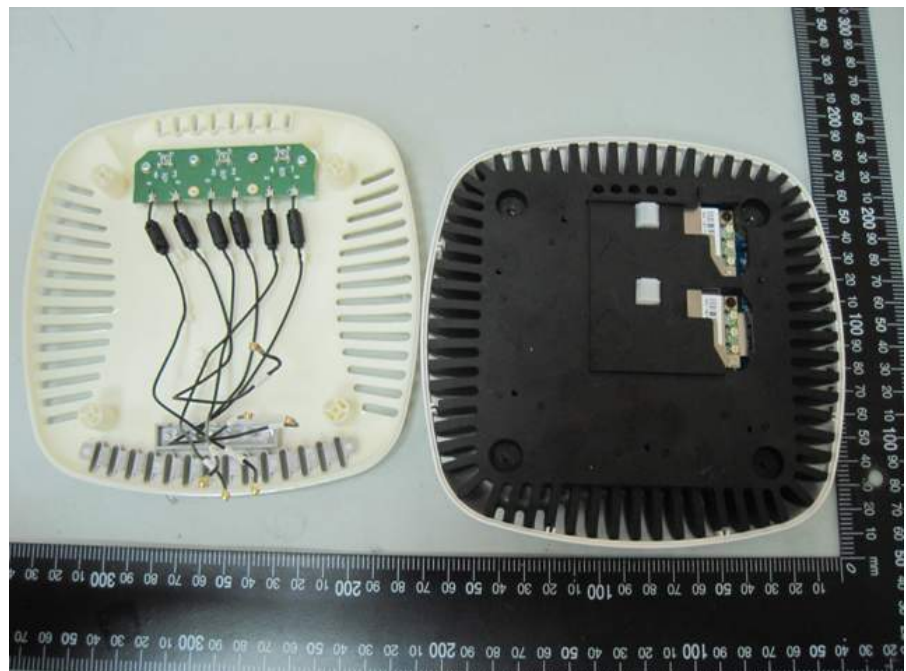
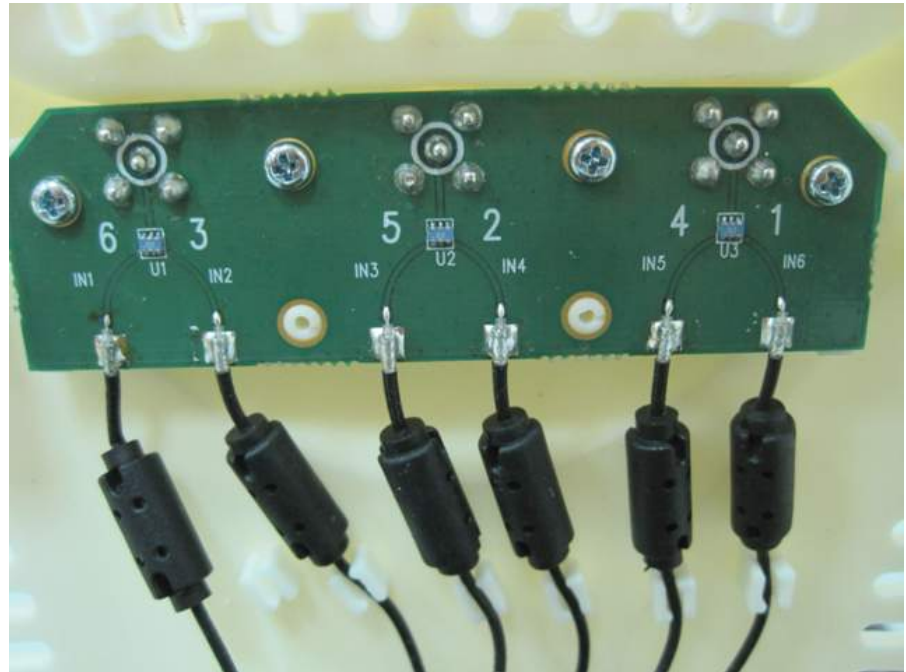

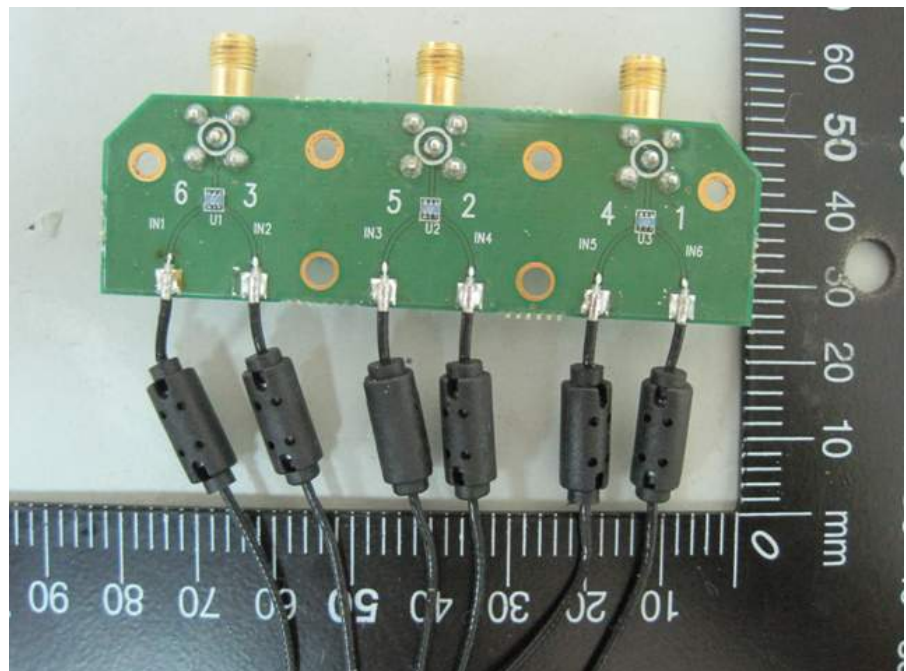
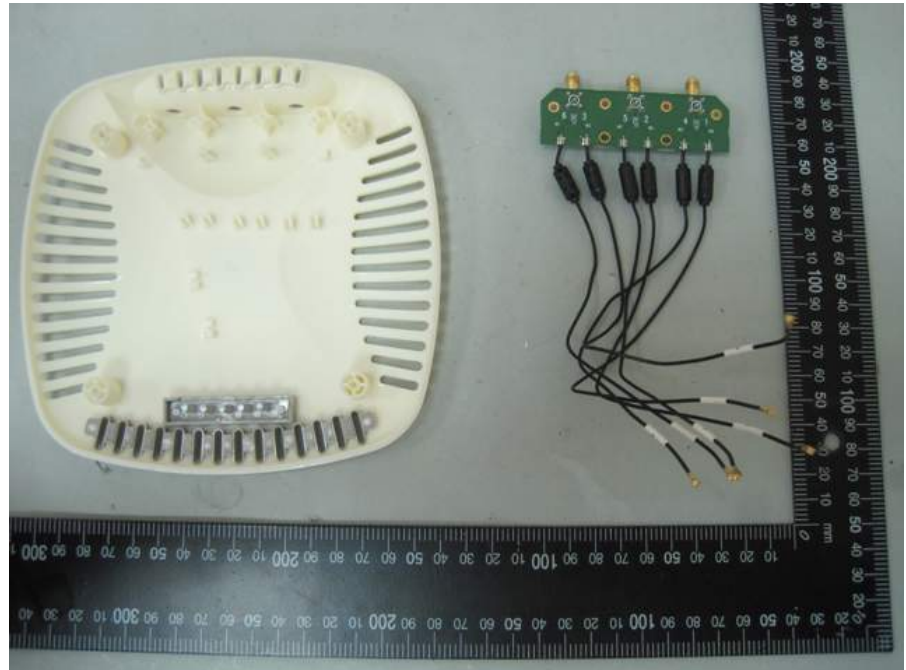

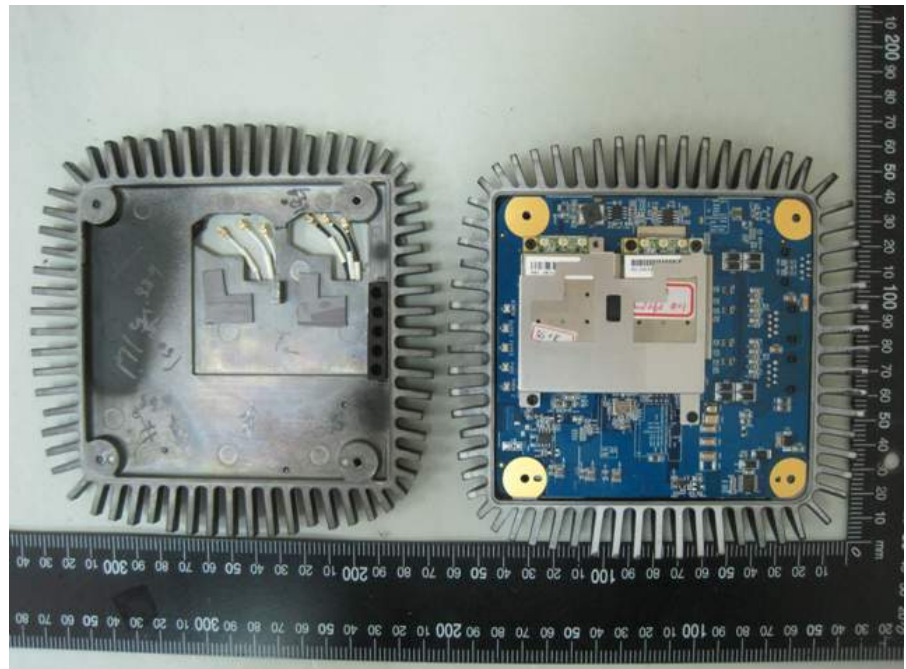
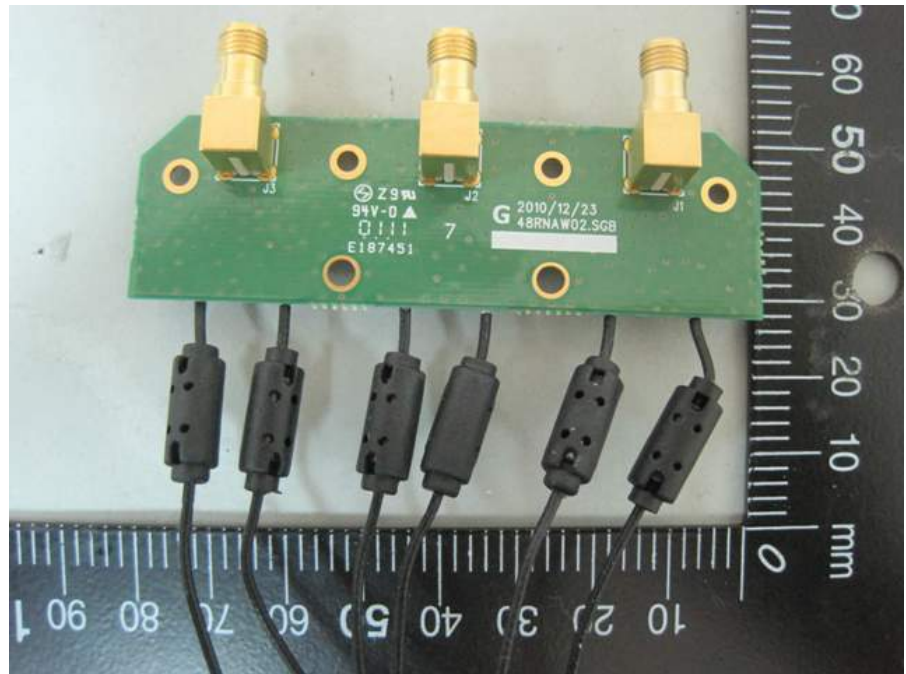

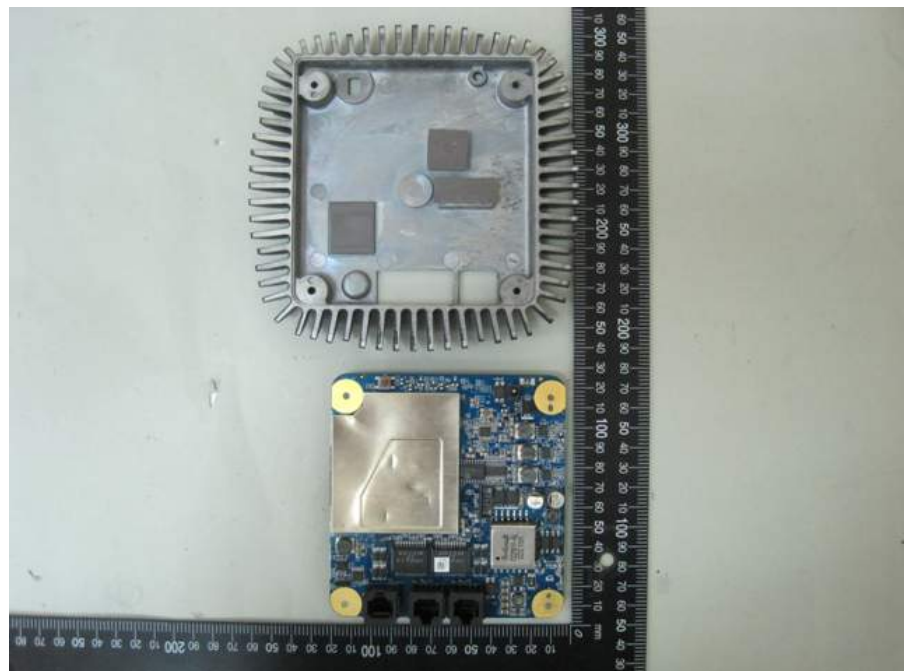
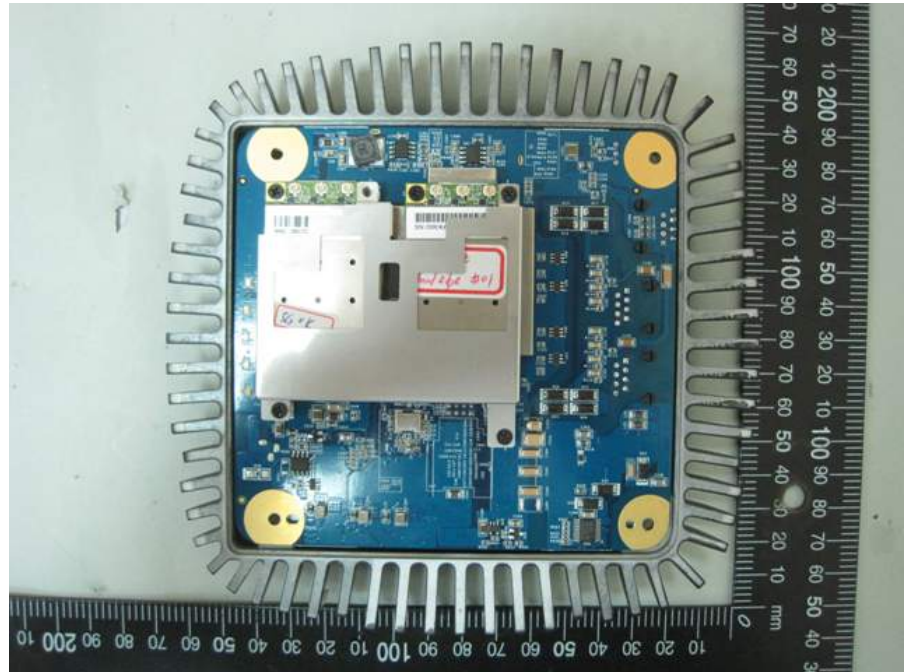

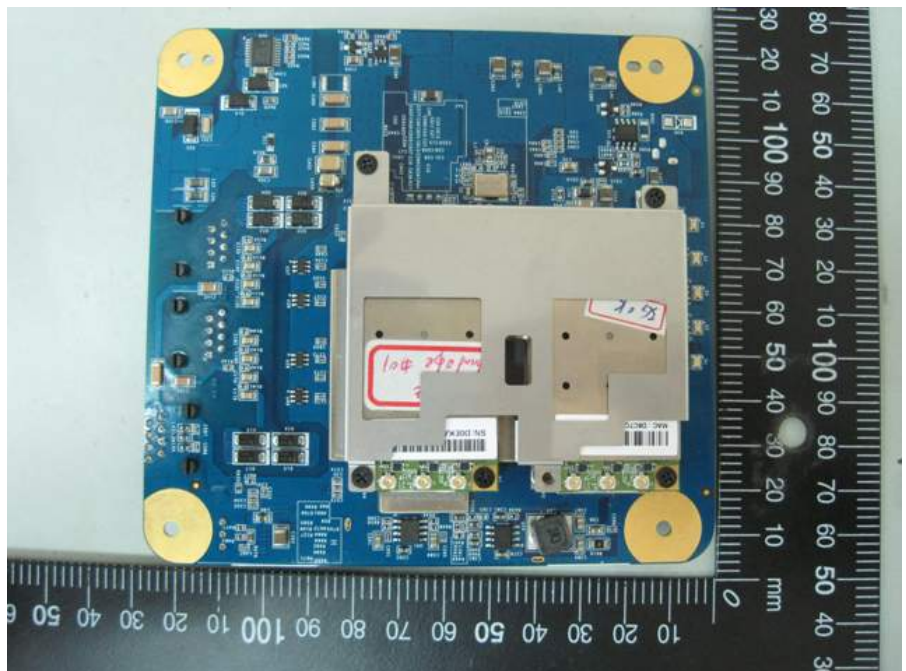

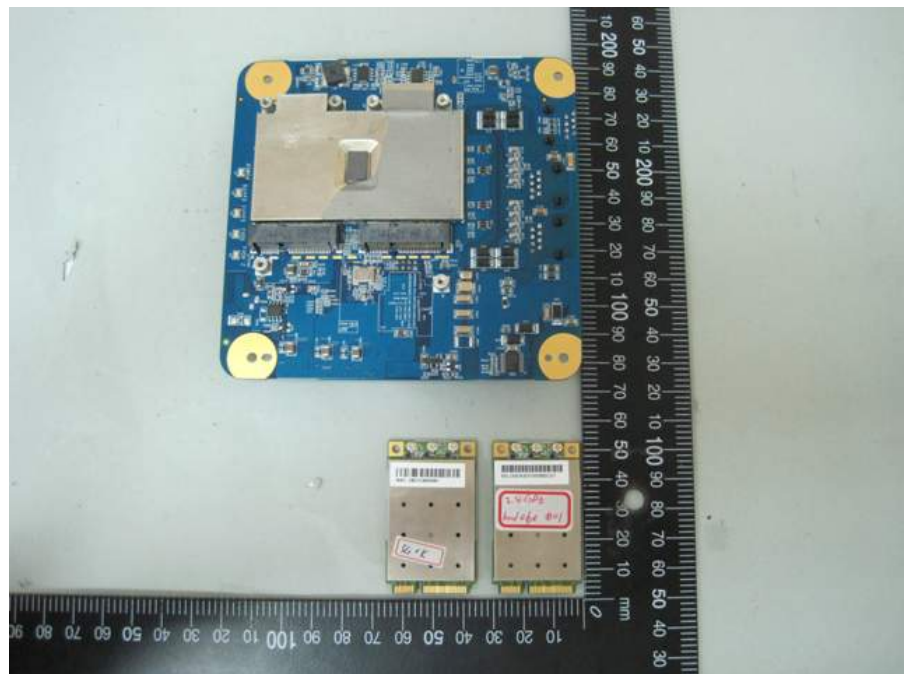
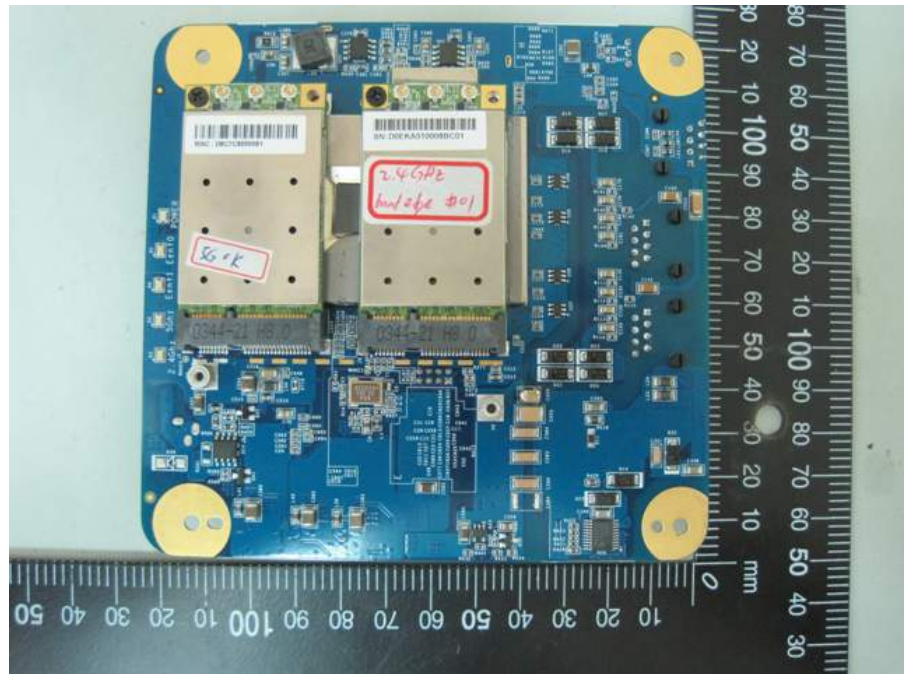



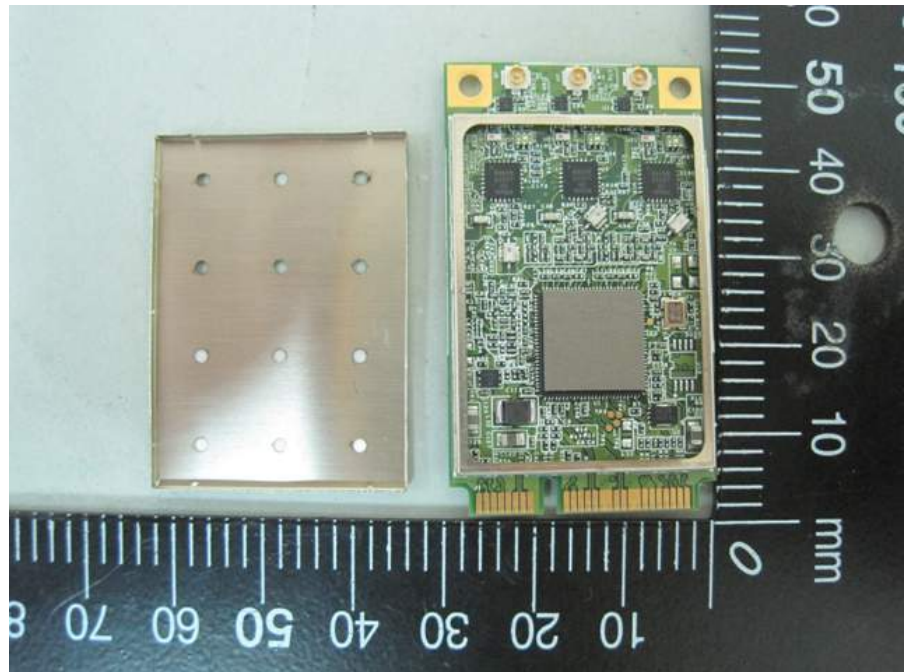

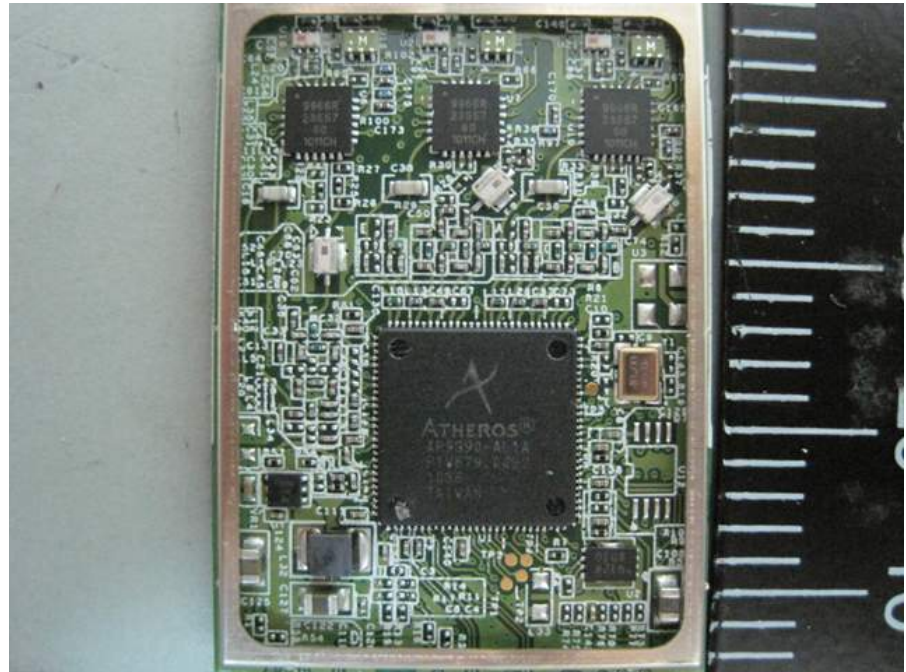

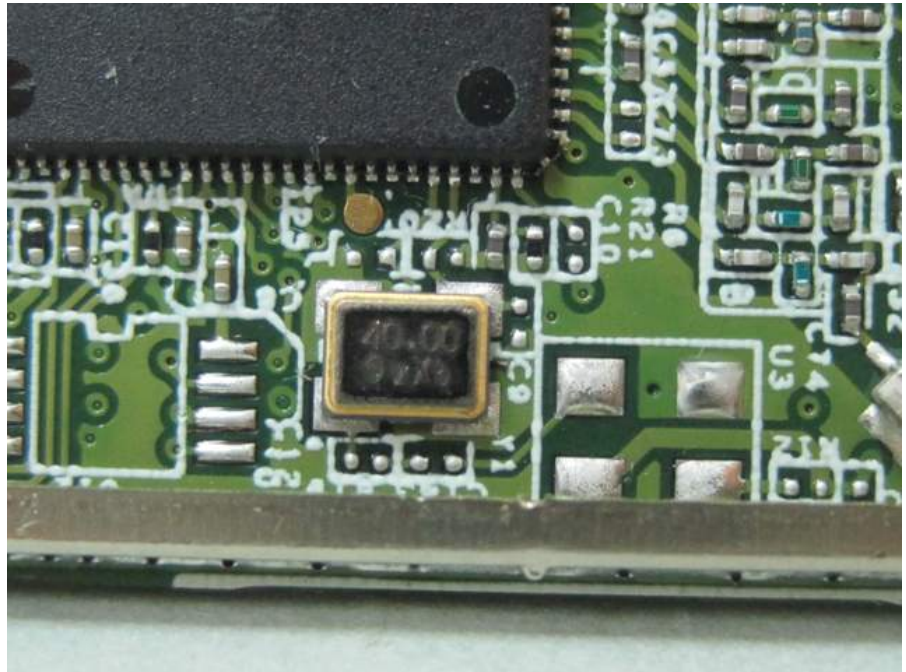

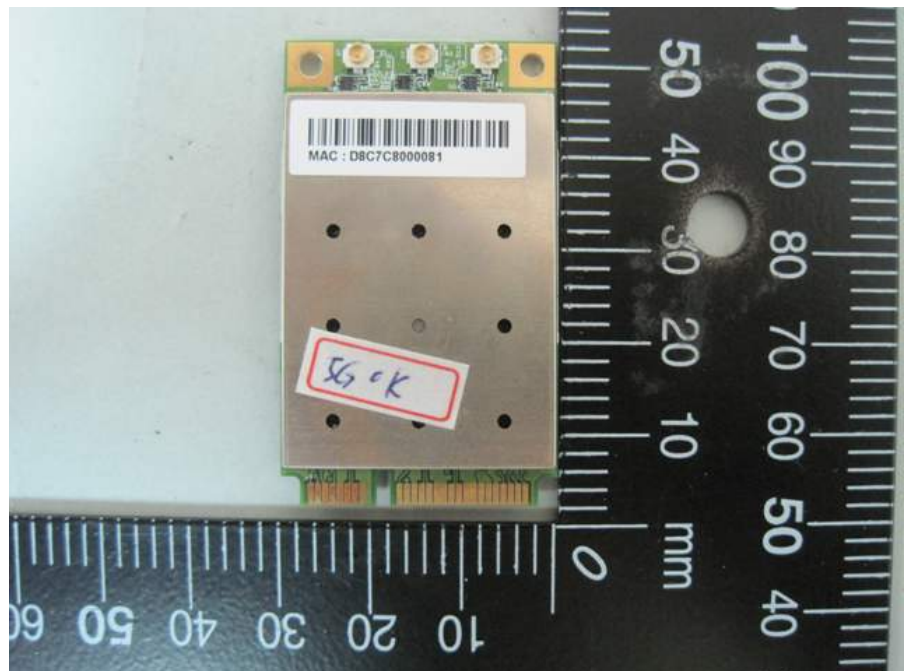
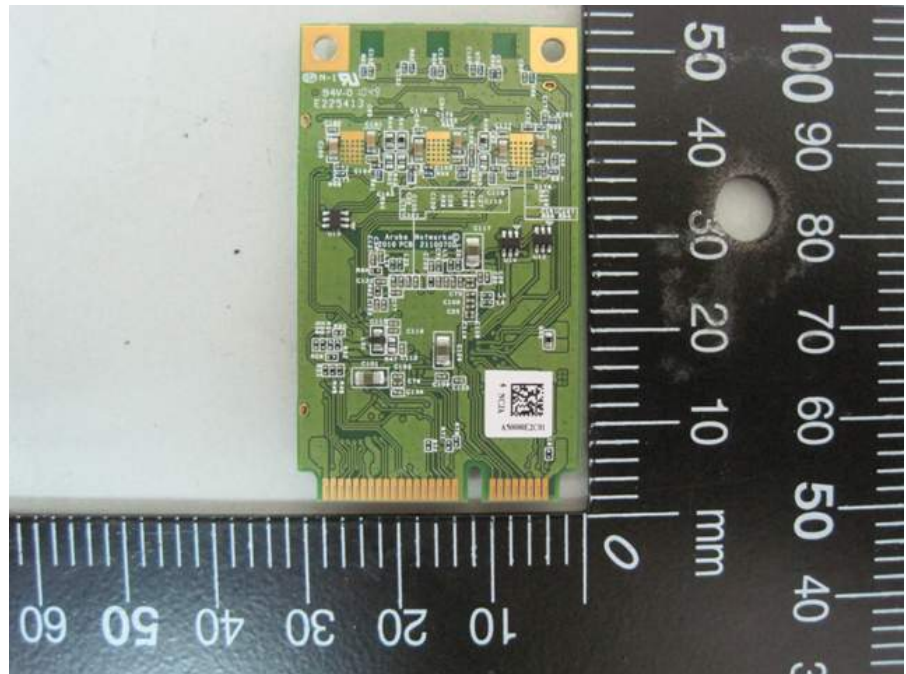

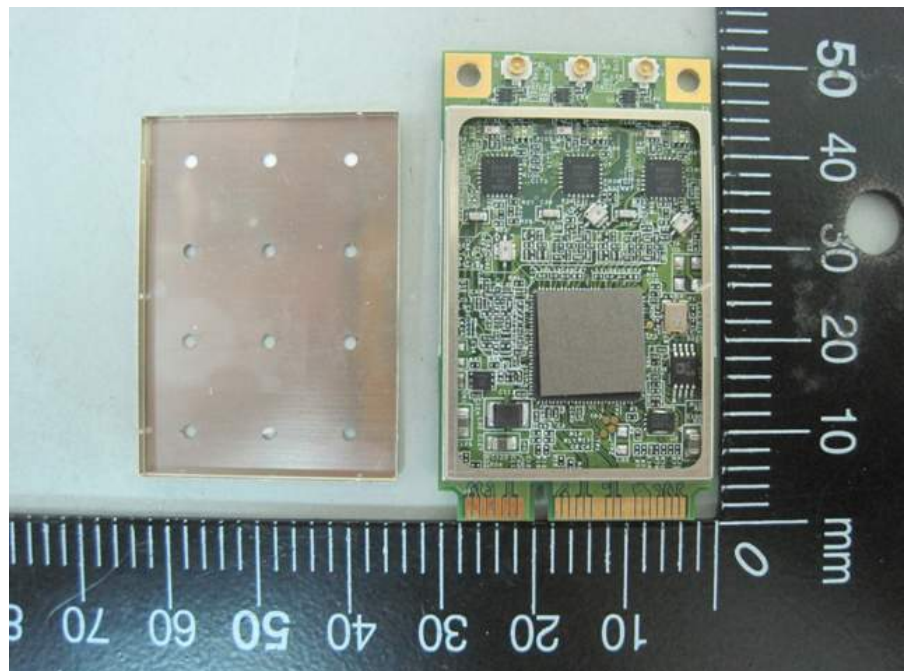

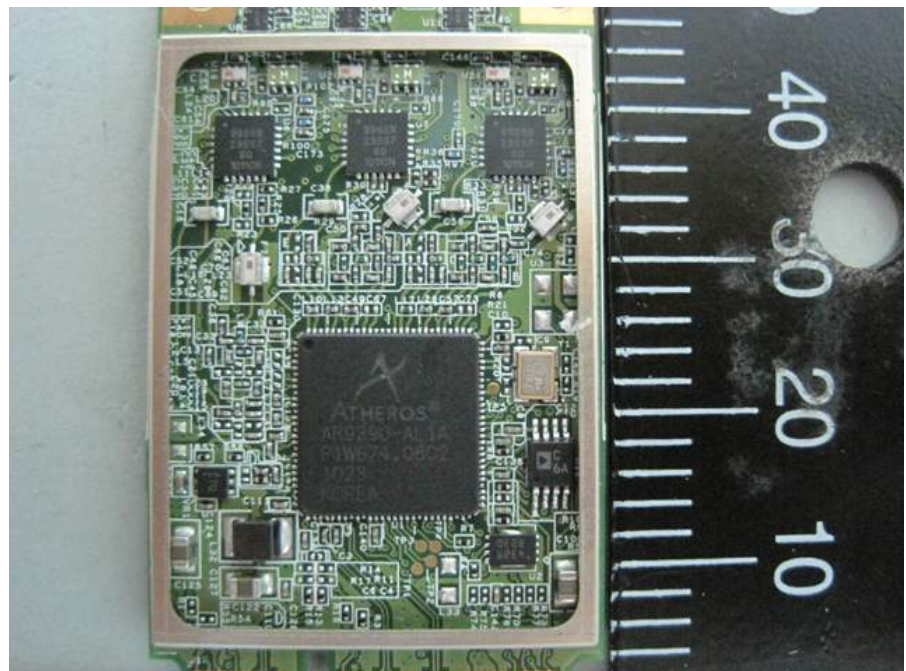

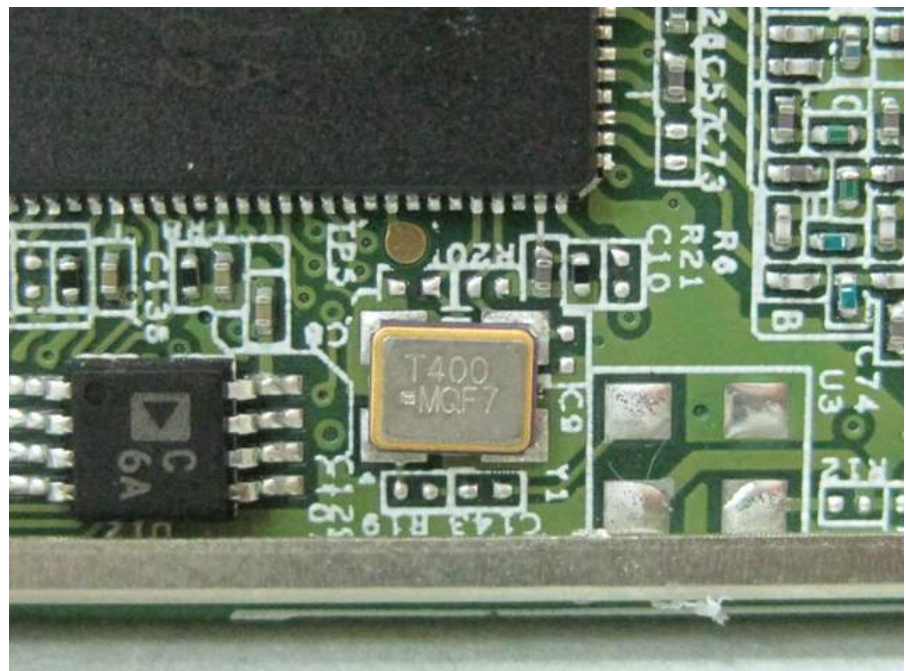

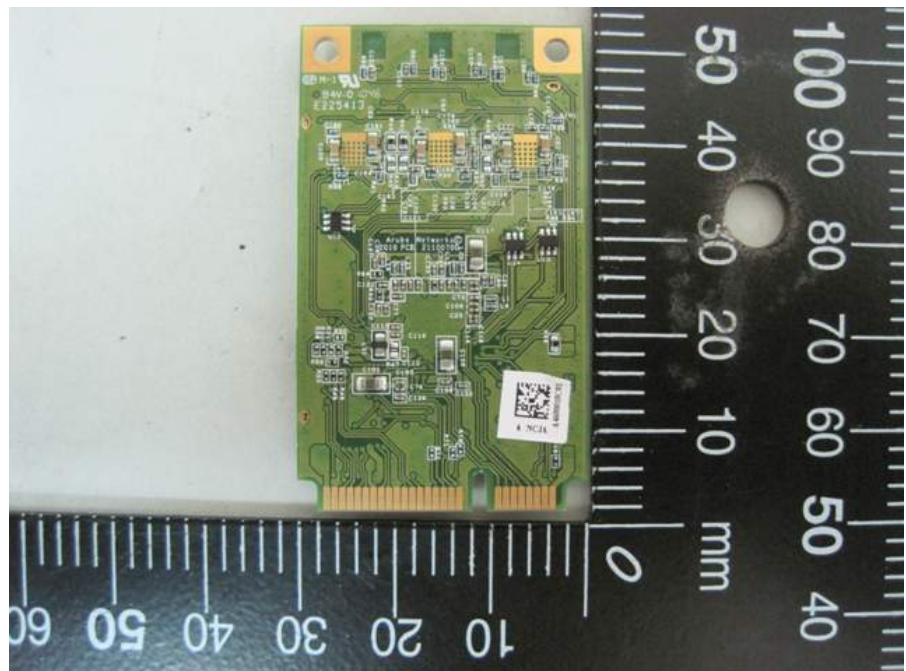
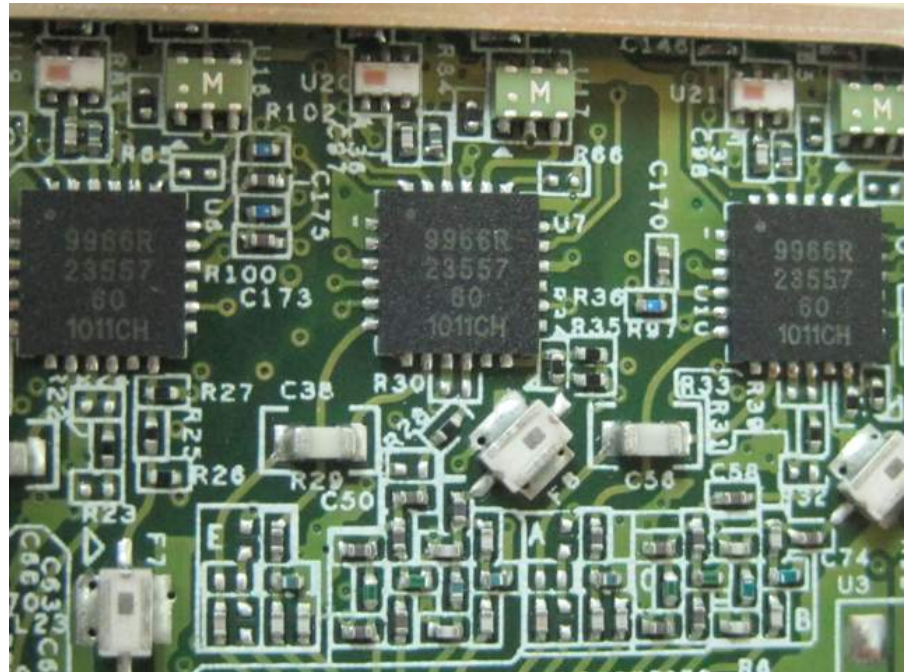

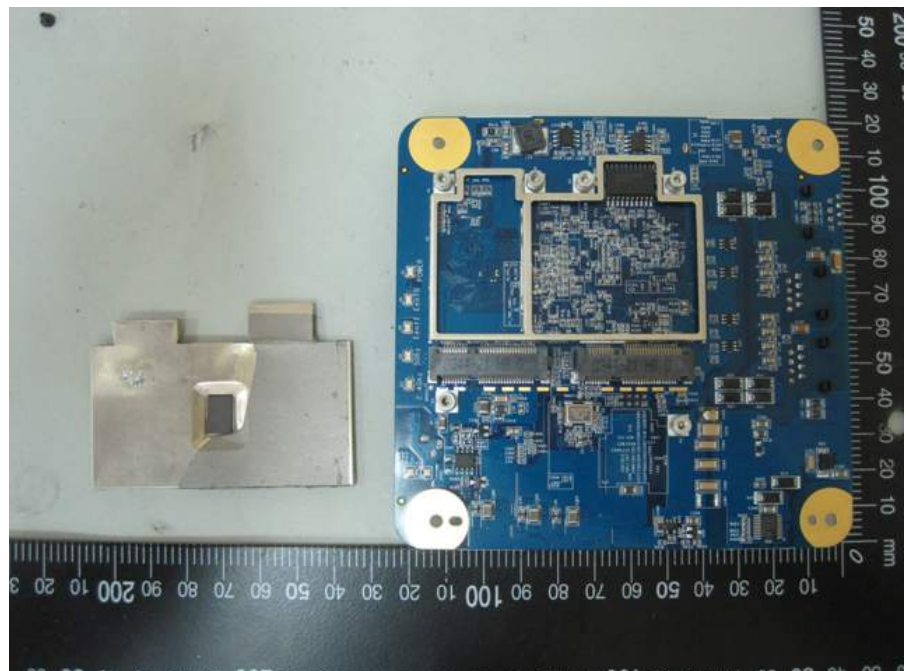

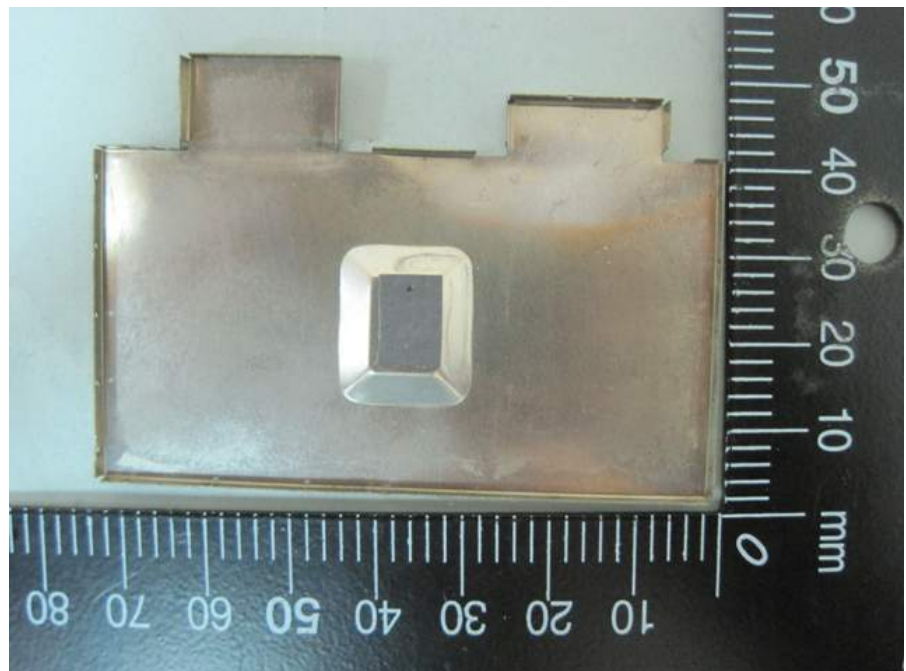
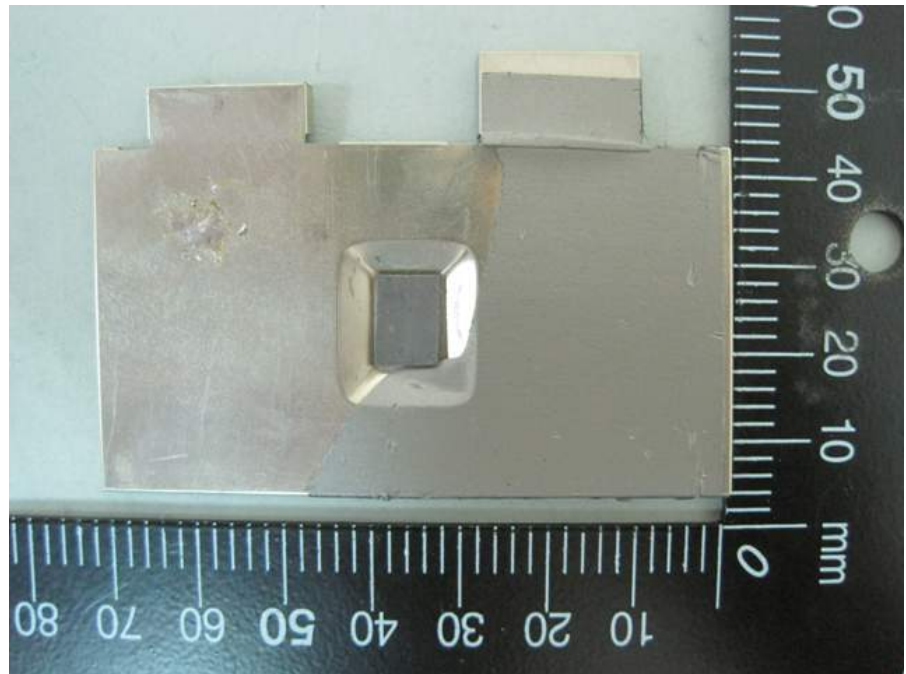

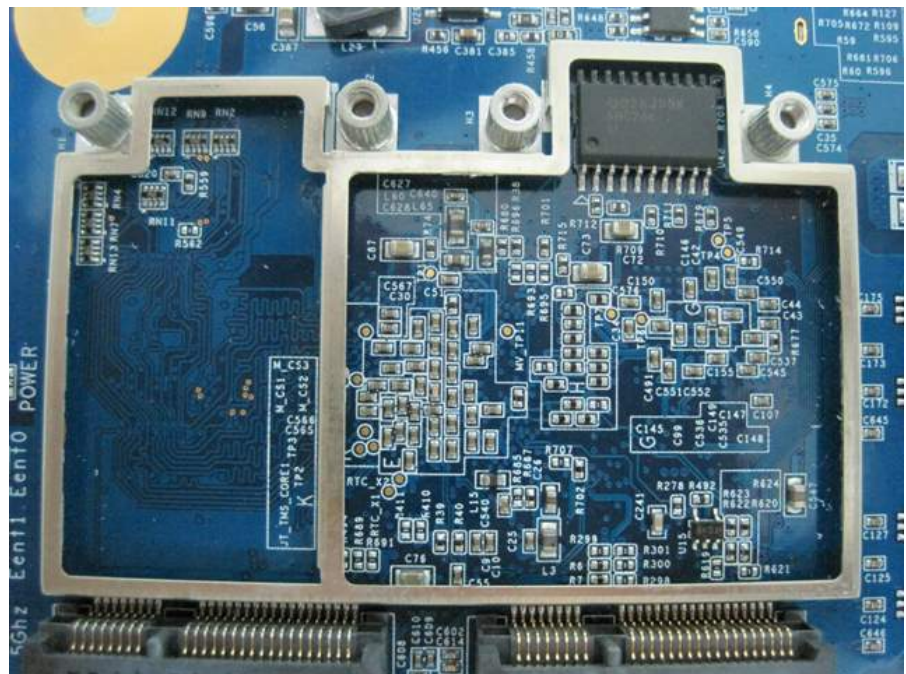

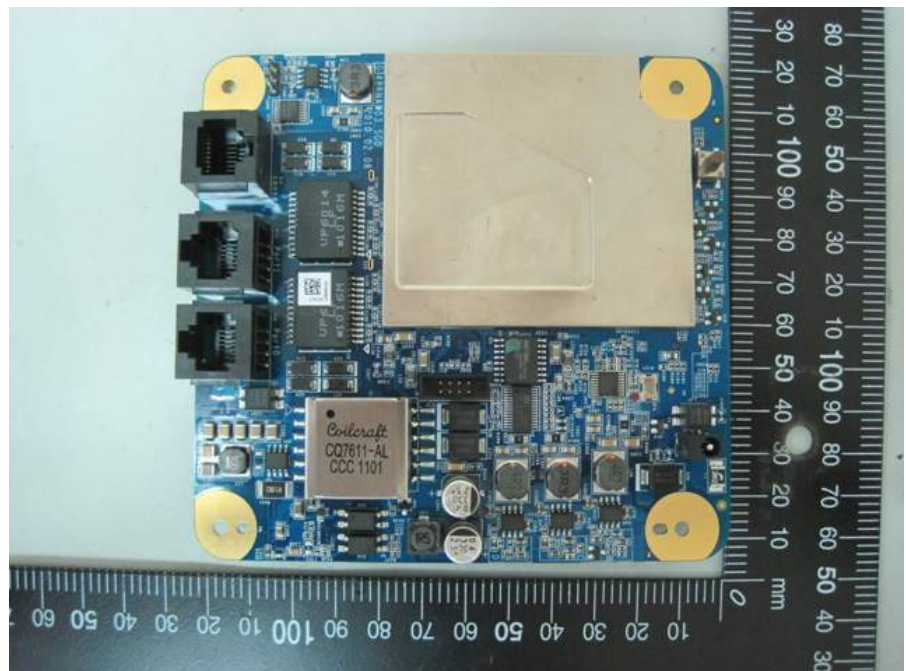
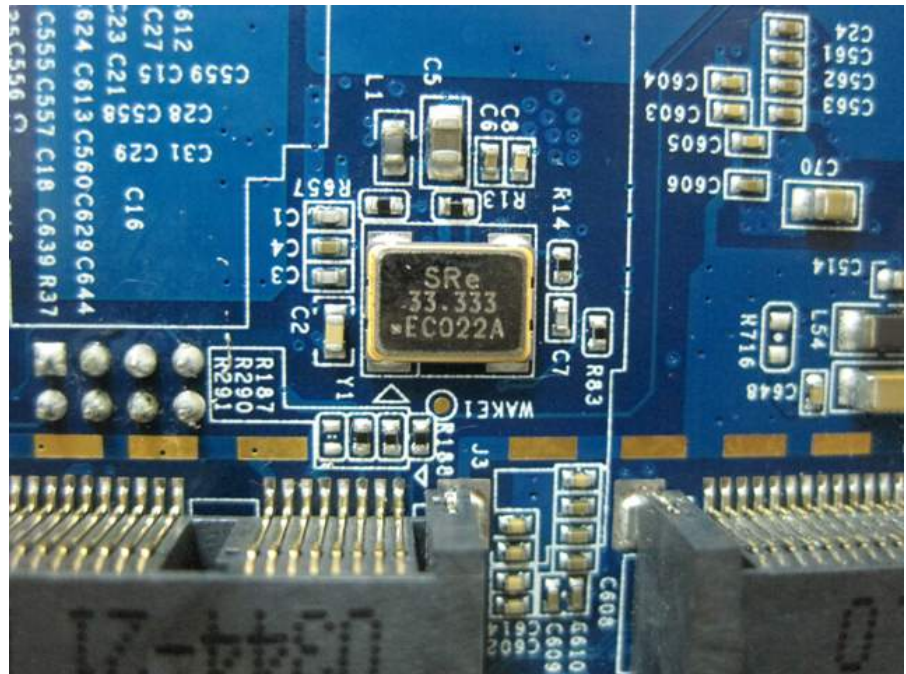

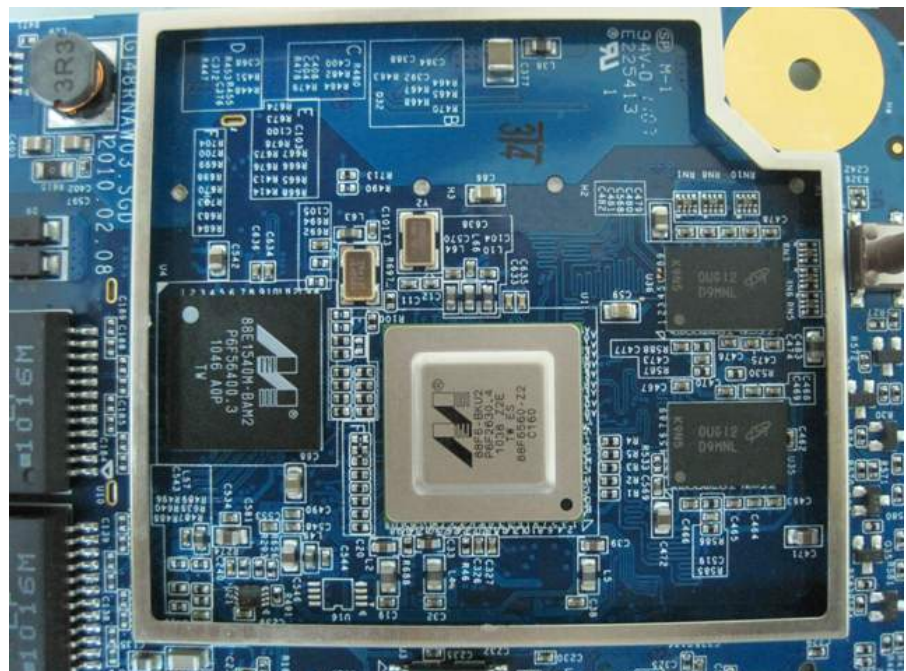
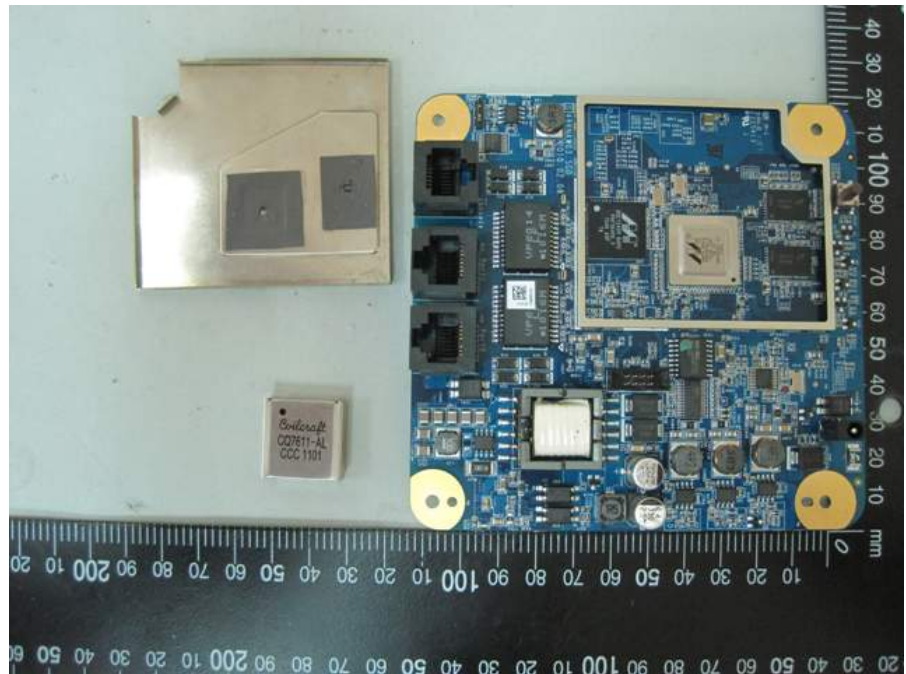

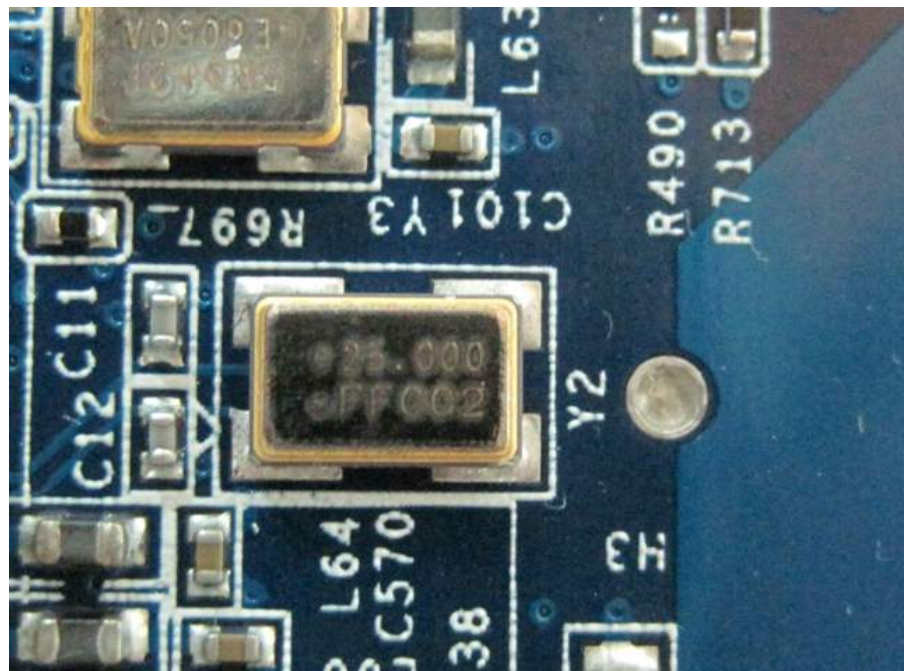
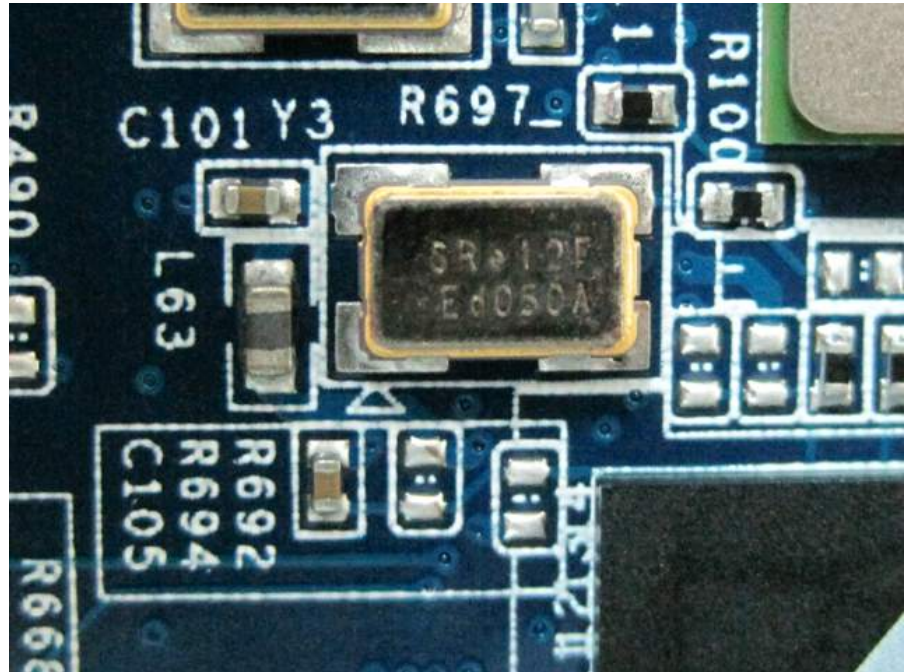

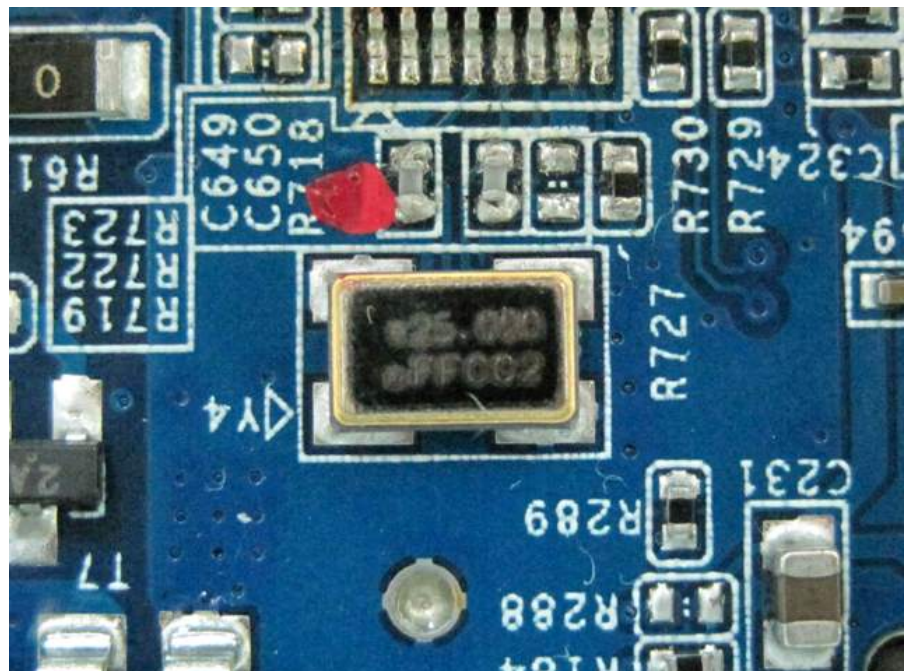
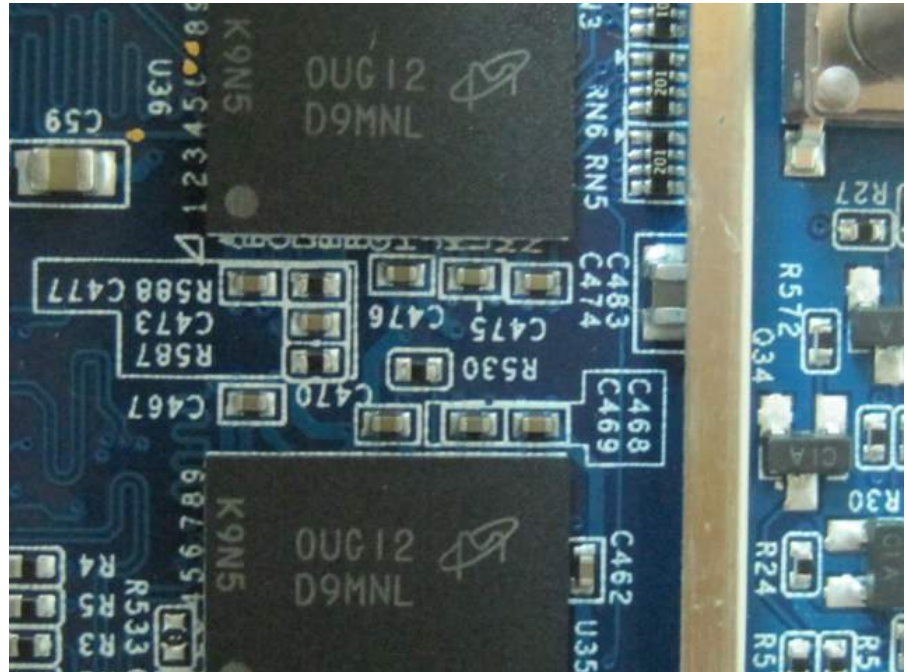

**External Antenna
Antenna 2**



**External Antenna
Antenna 5**

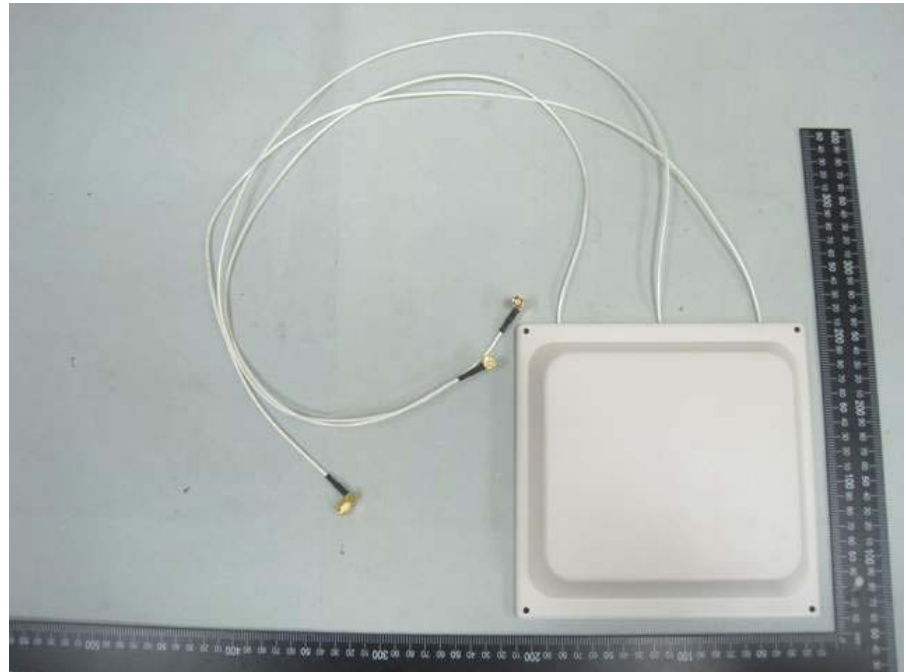



**External Antenna
Antenna 6**





**External Antenna
Antenna 7**







EUT 2 (Internal Antenna)
Model No.: AP-135







