

Test of Aruba AP-105 802.11a/b/g/n Wireless AP

To: FCC 47 CFR Part 15.407 & IC RSS-210

Test Report Serial No.: ARUB69-U3 Rev A



# TEST REPORT

FROM



Test of Aruba AP-105 802.11a/b/g/n Wireless AP  
to

To: FCC 47 CFR Part 15.407 & IC RSS-210

Test Report Serial No.: ARUB69-U3 Rev A

Note: this report contains data with regard to the 5,150 to 5,250 MHz, 5,250 to 5,350 MHz and 5,470 to 5,725 MHz bands for the Aruba Networks AP-105 Wireless Access Point. 2.4 and 5.8 GHz test data are reported in MiCOM Labs test report ARUB50-A2.

This report supersedes: MiCOM Labs Inc Report NONE

Applicant: Aruba Networks, Inc  
1344 Crossman Avenue  
Sunnyvale  
CA 94089, USA

Product Function: Wireless Access Point

Copy No: pdf Issue Date: 11th April 2011

**This Test Report is Issued Under the Authority of:**

**MiCOM Labs, Inc.**

440 Boulder Court, Suite 200

Pleasanton, CA 94566 USA

Phone: +1 (925) 462-0304

Fax: +1 (925) 462-0306

[www.micomlabs.com](http://www.micomlabs.com)



TESTING CERTIFICATE #2381.01

**MiCOM Labs is an ISO 17025 Accredited Testing Laboratory**



**Title:** Aruba AP-105 802.11a/b/g/n Wireless AP  
**To:** FCC 47 CFR Part 15.407 & IC RSS-210  
**Serial #:** ARUB69-U3 Rev A  
**Date:** 11th April 2011  
**Page:** 3 of 208

---

This page has been left intentionally blank

---

This test report may be reproduced in full only. The document may only be updated by MiCOM Labs personnel. Any changes will be noted in the Document History section of the report.



## TABLE OF CONTENTS

<b>ACCREDITATION, LISTINGS &amp; RECOGNITION .....</b>	<b>5</b>
TESTING ACCREDITATION .....	5
RECOGNITION.....	6
PRODUCT CERTIFICATION.....	7
<b>1. TEST RESULT CERTIFICATE .....</b>	<b>9</b>
<b>2. REFERENCES AND MEASUREMENT UNCERTAINTY .....</b>	<b>10</b>
2.1. Normative References .....	10
2.2. Test and Uncertainty Procedures .....	11
<b>3. PRODUCT DETAILS AND TEST CONFIGURATIONS .....</b>	<b>12</b>
3.1. Technical Details .....	12
3.2. Scope of Test Program.....	13
3.3. Equipment Model(s) and Serial Number(s) .....	14
3.4. Antenna Details .....	14
3.5. Cabling and I/O Ports .....	14
3.6. Test Configurations.....	15
3.7. Equipment Modifications.....	16
3.8. Deviations from the Test Standard .....	17
3.9. Subcontracted Testing or Third Party Data .....	17
<b>4. TEST SUMMARY .....</b>	<b>18</b>
<b>5. TEST RESULTS .....</b>	<b>21</b>
5.1. Device Characteristics .....	21
5.1.1. 26 dB and 99 % Bandwidth .....	21
5.1.2. Transmit Output Power.....	47
5.1.3. Peak Power Spectral Density .....	53
5.1.4. Peak Excursion Ratio .....	78
5.1.5. Frequency Stability.....	105
5.1.6. Maximum Permissible Exposure .....	106
5.1.7. Radiated Emissions.....	107
5.1.8. AC Wireline Conducted Emissions (150 kHz – 30 MHz).....	151
5.1.9. Dynamic Frequency Selection (DFS) .....	155
<b>6. PHOTOGRAPHS.....</b>	<b>201</b>
6.1. Radiated Emissions > 1GHz.....	201
6.2. Radiated Emissions < 1GHz.....	202
6.3. AC Wireline Conducted Emissions .....	203
6.4. Conducted RF Measurement Test Set-Up .....	204
6.5. Dynamic Frequency Selection Test Set-Up .....	205
<b>7. TEST EQUIPMENT DETAILS.....</b>	<b>207</b>

This test report may be reproduced in full only. The document may only be updated by MiCOM Labs personnel. Any changes will be noted in the Document History section of the report.



**Title:** Aruba AP-105 802.11a/b/g/n Wireless AP  
**To:** FCC 47 CFR Part 15.407 & IC RSS-210  
**Serial #:** ARUB69-U3 Rev A  
**Date:** 11th April 2011  
**Page:** 5 of 208

## ACCREDITATION, LISTINGS & RECOGNITION

### TESTING ACCREDITATION

MiCOM Labs, Inc. is an accredited Electrical testing laboratory per the international standard EN ISO/IEC 17025. The company is accredited by the American Association for Laboratory Accreditation (A2LA) [www.a2la.org](http://www.a2la.org) test laboratory number 2381.01. MiCOM Labs test schedule is available at the following URL; <http://www.a2la.org/scopepdf/2381-01.pdf>



The American Association for Laboratory Accreditation

World Class Accreditation

## *Accredited Laboratory*

A2LA has accredited

**MICOM LABS**

*Pleasanton, CA*

for technical competence in the field of

**Electrical Testing**

This laboratory is accredited in accordance with the recognized International Standard ISO/IEC 17025:2005 *General Requirements for the Competence of Testing and Calibration Laboratories*. This accreditation demonstrates technical competence for a defined scope and the operation of a laboratory quality management system (refer to joint ISO-ILAC-IAF Communiqué dated 8 January 2009).

Presented this 14<sup>th</sup> day of April 2010.



President & CEO  
For the Accreditation Council  
Certificate Number 2381.01  
Valid to November 30, 2011

*For the tests or types of tests to which this accreditation applies, please refer to the laboratory's Electrical Scope of Accreditation.*

This test report may be reproduced in full only. The document may only be updated by MiCOM Labs personnel. Any changes will be noted in the Document History section of the report.



**Title:** Aruba AP-105 802.11a/b/g/n Wireless AP  
**To:** FCC 47 CFR Part 15.407 & IC RSS-210  
**Serial #:** ARUB69-U3 Rev A  
**Date:** 11th April 2011  
**Page:** 6 of 208

## **RECOGNITION**

MiCOM Labs, Inc has widely recognized Electrical testing capabilities. Our international recognition includes Conformity Assessment Body designation by APEC MRA\*\* countries. Our test reports are widely accepted for global type approvals.

<b>Country</b>	<b>Recognition Body</b>	<b>Status</b>	<b>Phase</b>	<b>Identification No.</b>
USA	Federal Communications Commission (FCC)	TCB	-	Listing #: 102167
Canada	Industry Canada (IC)	FCB	APEC MRA 2	Listing #: 4143A
Japan	VCCI	-	-	No. 2959
Europe	European Commission	NB	EU MRA	NB 2280
Australia	Australian Communications and Media Authority (ACMA)	CAB	APEC MRA 1	US0159
Hong Kong	Office of the Telecommunication Authority (OFTA)	CAB	APEC MRA 1	
Korea	Ministry of Information and Communication Radio Research Laboratory (RRL)	CAB	APEC MRA 1	
Singapore	Infocomm Development Authority (IDA)	CAB	APEC MRA 1	
Taiwan	National Communications Commission (NCC) Bureau of Standards, Metrology and Inspection (BSMI)	CAB	APEC MRA 1	
Vietnam	Ministry of Communication (MIC)	CAB	APEC MRA 1	

\*\*APEC MRA – Asia Pacific Economic Community Mutual Recognition Agreement.

Is a recognition agreement under which test lab is accredited to regulatory standards of the APEC member countries.

Phase I - recognition for product testing

Phase II – recognition for both product testing and certification

N/A – Not Applicable

\*\*EU MRA – European Union Mutual Recognition Agreement.

Is a recognition agreement under which test lab is accredited to regulatory standards of the EU member countries.

\*\*NB – Notified Body

This test report may be reproduced in full only. The document may only be updated by MiCOM Labs personnel. Any changes will be noted in the Document History section of the report.



**Title:** Aruba AP-105 802.11a/b/g/n Wireless AP  
**To:** FCC 47 CFR Part 15.407 & IC RSS-210  
**Serial #:** ARUB69-U3 Rev A  
**Date:** 11th April 2011  
**Page:** 7 of 208

## **PRODUCT CERTIFICATION**

MiCOM Labs, Inc. is an accredited Product Certification Body per the international standard EN ISO/IEC Guide 65. The company is accredited by the American Association for Laboratory Accreditation (A2LA) [www.a2la.org](http://www.a2la.org) test laboratory number 2381.02. MiCOM Labs test schedule is available at the following URL; <http://www.a2la.org/scopepdf/2381-02.pdf>



The American Association for Laboratory Accreditation

World Class Accreditation

### *Accredited Product Certification Body*

A2LA has accredited

**MICOM LABS**

*Pleasanton, CA*

for technical competence as a

**Product Certification Body**

This product certification body is accredited in accordance with the recognized International Standard ISO/IEC Guide 65:1996 *General requirements for bodies operating product certification systems*. This accreditation demonstrates technical competence for a defined scope and the operation of a quality management system for a Telecommunications Certification Body (TCB) meeting FCC (U.S.), and IC (Canada) requirements.



Presented this 24<sup>th</sup> day of June 2010.

President & CEO  
For the Accreditation Council  
Certificate Number 2381.02  
Valid to November 30, 2011

*For the product certification schemes to which this accreditation applies, please refer to the organization's Product Certification Scope of Accreditation.*

### **United States of America – Telecommunication Certification Body (TCB)**

TCB Identifier – US0159

### **Industry Canada – Certification Body**

CAB Identifier – US0159

### **Europe – Notified Body**

Notified Body Identifier - 2280

This test report may be reproduced in full only. The document may only be updated by MiCOM Labs personnel. Any changes will be noted in the Document History section of the report.



**Title:** Aruba AP-105 802.11a/b/g/n Wireless AP  
**To:** FCC 47 CFR Part 15.407 & IC RSS-210  
**Serial #:** ARUB69-U3 Rev A  
**Date:** 11th April 2011  
**Page:** 8 of 208

---

## DOCUMENT HISTORY

Document History		
Revision	Date	Comments
Draft		
Rev A	11 <sup>th</sup> April 2011	Initial release.

---

This test report may be reproduced in full only. The document may only be updated by MiCOM Labs personnel. Any changes will be noted in the Document History section of the report.





**Title:** Aruba AP-105 802.11a/b/g/n Wireless AP  
**To:** FCC 47 CFR Part 15.407 & IC RSS-210  
**Serial #:** ARUB69-U3 Rev A  
**Date:** 11th April 2011  
**Page:** 9 of 208

**1. TEST RESULT CERTIFICATE**

<b>Applicant:</b>	Aruba Networks, Inc 1344 Crossman Avenue Sunnyvale CA 94089, USA	<b>Tested By:</b>	MiCOM Labs, Inc. 440 Boulder Court Suite 200 Pleasanton California, 94566, USA
<b>EUT:</b>	802.11a/b/g/n Wireless Access Point	<b>Tel:</b>	+1 925 462 0304
<b>Model:</b>	AP-105	<b>Fax:</b>	+1 925 462 0306
<b>S/N:</b>	AL0000439 (Conducted Testing), AL0000437 (Radiated Testing)		
<b>Test Date(s):</b>	2nd – 25 March 2011	<b>Website:</b>	www.micomlabs.com

STANDARD(S)	TEST RESULTS
FCC 47 CFR Part 15.407 & IC RSS-210	EQUIPMENT COMPLIES

MiCOM Labs, Inc. tested the equipment mentioned in accordance with the requirements set forth in the above standards. Test results indicate that the equipment tested is capable of demonstrating compliance with the requirements as documented within this report.

**Notes:**

1. This document reports conditions under which testing was conducted and the results of testing performed.
2. Details of test methods used have been recorded and kept on file by the laboratory.
3. Test results apply only to the item(s) tested.

**Approved & Released for MiCOM Labs, Inc. by:**



TESTING CERTIFICATE #2381.01

\_\_\_\_\_  
 Graeme Grieve  
 Quality Manager MiCOM Labs,

\_\_\_\_\_  
 Gordon Hurst  
 President & CEO MiCOM Labs, Inc.

This test report may be reproduced in full only. The document may only be updated by MiCOM Labs personnel. Any changes will be noted in the Document History section of the report.

## 2. REFERENCES AND MEASUREMENT UNCERTAINTY

### 2.1. Normative References

Ref.	Publication	Year	Title
i.	FCC 47 CFR Part 15 SubPart E 15.407	2010	Title 47: Telecommunication PART 15—RADIO FREQUENCY DEVICES Subpart E—Unlicensed National Information Infrastructure Devices
ii.	RSS-210 Annex 9	2010	Radio Standards Specification 210, Issue 8, Low-power Licence-exempt Radiocommunication Devices (All Frequency Bands): Category I Equipment,
iii.	RSS-GEN	2010	Radio Standards Specification-Gen, Issue 3, General Requirements and Information for the Certification of Radiocommunication Equipment,
iv.	47 CFR Part 15, SubPart B	2010	47 CFR Part 15, SubPart B; Unintentional Radiators
v.	ICES-003	2004	Spectrum Management and Telecommunications Policy Interference-Causing Equipment Standard Digital Apparatus; Issue 4
vi.	ANSI C63.4	2009	American National Standards for Methods of Measurement of Radio-Noise Emissions from Low-Voltage Electrical and Electronic Equipment in the Range of 9 kHz to 40 GHz
vii.	CISPR 22/ EN 55022	2008 2006+A1:2007	Limits and Methods of Measurements of Radio Disturbance Characteristics of Information Technology Equipment
viii.	M 3003	Edition 1 Dec. 1997	Expression of Uncertainty and Confidence in Measurements
ix.	LAB34	Edition 1 Aug 2002	The expression of uncertainty in EMC Testing
x.	ETSI TR 100 028	2001	Parts 1 and 2 Electromagnetic compatibility and Radio Spectrum Matters (ERM); Uncertainties in the measurement of mobile radio equipment characteristics
xi.	A2LA	9th June 2010	Reference to A2LA Accreditation Status – A2LA Advertising Policy

This test report may be reproduced in full only. The document may only be updated by MiCOM Labs personnel. Any changes will be noted in the Document History section of the report.



**Title:** Aruba AP-105 802.11a/b/g/n Wireless AP  
**To:** FCC 47 CFR Part 15.407 & IC RSS-210  
**Serial #:** ARUB69-U3 Rev A  
**Date:** 11th April 2011  
**Page:** 11 of 208

---

## **2.2. Test and Uncertainty Procedures**

Conducted and radiated emission measurements were conducted in accordance with American National Standards Institute ANSI C63.4, listed in the Normative References section of this report.

Measurement uncertainty figures are calculated in accordance with ETSI TR 100 028 Parts 1 and 2.

Measurement uncertainties stated are based on a standard uncertainty multiplied by a coverage factor  $k = 2$ , providing a level of confidence of approximately 95 % in accordance with UKAS document M 3003 listed in the Normative References section of this report.

---

This test report may be reproduced in full only. The document may only be updated by MiCOM Labs personnel. Any changes will be noted in the Document History section of the report.



**Title:** Aruba AP-105 802.11a/b/g/n Wireless AP  
**To:** FCC 47 CFR Part 15.407 & IC RSS-210  
**Serial #:** ARUB69-U3 Rev A  
**Date:** 11th April 2011  
**Page:** 12 of 208

### 3. PRODUCT DETAILS AND TEST CONFIGURATIONS

#### 3.1. Technical Details

Details	Description
Purpose:	Test of the Aruba AP-105 802.11a/b/g/n Wireless AP in the frequency ranges 5150 to 5250, 5250 to 5350 and 5470 to 5725 MHz to FCC Part 15.407 and Industry Canada RSS-210 regulations.
Applicant:	Aruba Networks, Inc 1344 Crossman Avenue Sunnyvale CA 94089, USA
Manufacturer:	As applicant
Laboratory performing the tests:	MiCOM Labs, Inc. 440 Boulder Court, Suite 200 Pleasanton, California 94566 USA
Test report reference number:	ARUB69-U3 Rev A
Date EUT received:	1 <sup>st</sup> February 2011
Standard(s) applied:	FCC 47 CFR Part 15.407 & IC RSS-210
Dates of test (from - to):	2 <sup>nd</sup> – 25 March 2011
No of Units Tested:	Two (separate units for conducted and radiated)
Type of Equipment:	802.11a/b/g/n Wireless Access Point, 2x2 Spatial Multiplexing MIMO configuration
Applicants Trade Name:	Wireless Access Point
Model(s):	AP-105
Software Release	3.3.3.0, ART version is v0_9_b7_ar928xALL
Location for use:	Indoor
Declared Frequency Range(s):	5150 to 5250, 5250 to 5350 and 5470 to 5725 MHz
Type of Modulation:	Per 802.11 –CCK, BPSK, QPSK, DSSS, OFDM
Declared Nominal Output Power: (Average Power)	802.11a: Legacy +19 dBm 802.11n: HT-20 +19 dBm 802.11n: HT-40 +19 dBm
EUT Modes of Operation:	Legacy 802.11a/b/g, 802.11n HT-20, HT-40
Transmit/Receive Operation:	Time Division Duplex
Rated Input Voltage and Current:	12Vdc 1.25A; POE 48 Vdc 350 mA
Operating Temperature Range:	Declared range 0 to +50°C
ITU Emission Designator:	802.11a 17M1D1D 802.11n HT-20 18M2D1D 802.11n HT-40 38M1D1D
Frequency Stability:	±20 ppm max
Equipment Dimensions:	5½" x 5½" x 1¾"
Weight:	1 lb (454 grams)
Primary function of equipment:	Wireless Access Point for transmitting data and voice.

This test report may be reproduced in full only. The document may only be updated by MiCOM Labs personnel. Any changes will be noted in the Document History section of the report.



**Title:** Aruba AP-105 802.11a/b/g/n Wireless AP  
**To:** FCC 47 CFR Part 15.407 & IC RSS-210  
**Serial #:** ARUB69-U3 Rev A  
**Date:** 11th April 2011  
**Page:** 13 of 208

---

### **3.2. Scope of Test Program**

The scope of the test program was to test the Aruba Networks AP-105 802.11a/b/g/n Wireless Access Point, 2x2 Spatial Multiplexing MIMO configurations in the DFS bands 5,250 – 5,350 and 5,470 – 5,725 MHz frequency bands for compliance against FCC 47 CFR Part 15.407 and Industry Canada RSS-210 specifications.

Test results for the DFS frequency bands were combined with the previously certified frequency band 5,150 – 5,250 MHz. Original test data for the 5,150 – 5,250 MHz band was reported in test report ARUB50-A4 Rev A 30<sup>th</sup> March 2010.

#### **Aruba AP-105 Access Point**

The AP-105 is a multi-band 802.11a/b/g/n dual-radio indoor wireless access point designed for dense enterprise deployments of 802.11n. The AP-105 delivers unprecedented value with the performance and reliability of 802.11n in a compact, streamlined 2x2 MIMO package. Capable of delivering wireless data rates of up to 300Mbps, the multifunction AP-105 provides wireless LAN access, air monitoring, and wireless intrusion detection and prevention over the 2.4GHz and 5GHz RF spectrum. The access point works in conjunction with Aruba's line of high-performance controllers to deliver high-speed, secure network services.

802.11n enables the use of wireless as a primary network connection with speed and reliability comparable to a wired LAN. 802.11n increases performance through techniques such as channel bonding, block acknowledgement, and Multiple In Multiple Out (MIMO). Advanced RF techniques such as Cyclic Delay Diversity also increase range and reliability.

The AP-105 features a 100/1000Base-T Ethernet interface and operates from standard 802.3af Power over Ethernet (PoE) sources. Equipped with four internal omni-directional antennas, the AP-105 provides full RF diversity and 2x2 MIMO operation on both the 2.4GHz and 5GHz bands.

---

This test report may be reproduced in full only. The document may only be updated by MiCOM Labs personnel. Any changes will be noted in the Document History section of the report.



**Title:** Aruba AP-105 802.11a/b/g/n Wireless AP  
**To:** FCC 47 CFR Part 15.407 & IC RSS-210  
**Serial #:** ARUB69-U3 Rev A  
**Date:** 11th April 2011  
**Page:** 14 of 208

---

### 3.3. Equipment Model(s) and Serial Number(s)

Type (EUT/Support)	Equipment Description (Including Brand Name)	Mfr	Model No.	Serial No.
EUT	802.11a/b/g/n Wireless Access Point	Aruba Networks	AP-105	AL0000439 (Conducted Testing), AL0000437 (Radiated Testing)
Support	Laptop PC	IBM	Thinkpad	None

### 3.4. Antenna Details

1. Integral Antenna;-
  - a. 4.9 – 5.875 GHz; Gain: 4.0 dBi

### 3.5. Cabling and I/O Ports

Number and type of I/O ports

1. 10/100/1000 Ethernet
2. Console - Serial maintenance terminal
3. 12 Vdc, 4mm supply connector

---

This test report may be reproduced in full only. The document may only be updated by MiCOM Labs personnel. Any changes will be noted in the Document History section of the report.



### 3.6. Test Configurations

Testing was performed to determine the highest power level versus bit rate. The variant with the highest power was used to exercise the product.

Matrix of test configurations

Operational Mode(s) (802.11)	Variant	Data Rates with Highest Power	Test Frequencies (MHz)		
			5,150 – 5,250	5,250 – 5,250	5,470 - 5,725
a,n	Legacy	6 MBit/s	5,180	5,260	5,500
			5,200	5,300	5,600
	HT-20	6.5 MCS	5,240	5,320	5,700
			5,190	5,270	5,510
	HT-40	13.5 MCS	5,230	5,310	5,590
					5,690

### Antenna Test Configurations for Radiated Emissions Spurious Emission and Band-Edge Test Strategy

#### 5150 – 5250 MHz

11a	11n HT-20	11n HT-40
SE 5180	SE 5180	SE 5190
SE 5200	SE 5200	
SE 5240	SE 5240	SE 5230
BE 5150	BE 5150	BE 5150

KEY;-

SE – Spurious Emissions  
BE – Band-Edge

#### 5250 – 5350 MHz

11a	11n HT-20	11n HT-40
SE 5260	SE 5260	SE 5270
SE 5300	SE 5300	
SE 5320	SE 5320	SE 5310
BE 5350	BE 5350	BE 5350

#### 5470 – 5725 MHz

11a	11n HT-20	11n HT-40
SE 5500	SE 5500	SE 5510
SE 5600	SE 5600	SE5590
SE 5700	SE 5700	SE 5690
BE 5460	BE 5460	BE 5460

This test report may be reproduced in full only. The document may only be updated by MiCOM Labs personnel. Any changes will be noted in the Document History section of the report.



### 3.7. Equipment Modifications

The following modifications were required to bring the equipment into compliance:

#### EUT Software Power Settings - Conducted Testing

- Reduction in output power to meet the Peak Power Spectral Density EIRP limits. The following matrix was generated identifying the reduction in power required bringing the EUT into compliance.

##### 5150 – 5250 MHz

	Channel Freq (MHz)	Nominal ART Power	Passing ART Power	Tx 1 Measured Pwr (dBm)	Tx 2 Measured Pwr (dBm)	Aggregate Measured Pwr (dBm)
11a	5180	20	17.5	+16.57	+16.65	+20.36
	5200	20	17.5	+16.57	+16.65	+20.36
	5240	20	17	+16.08	+16.15	+19.69
HT-20	5180	20	18	+16.90	+16.97	+21.11
	5200	20	18	+16.90	+16.97	+21.11
	5240	20	17.5	+16.49	+16.43	+20.55
HT-40	5190	20	17.5	+16.59	+16.56	+20.69
	5230	20	18	+17.19	+17.07	+21.11

#### EUT Software Power Settings - Radiated Testing

- Reduction in output power to meet band-edge and emission requirements was required in certain circumstances. The following matrix was generated identifying the reduction in power required bringing the EUT into compliance.

##### 5150 – 5250 MHz

	Channel Freq (MHz)	Nominal ART Power	Passing ART Power	Tx 1 Measured Pwr (dBm)	Tx 2 Measured Pwr (dBm)	Aggregate Measured Pwr (dBm)
11a	5180	20	15.5	+14.86	+14.19	+18.09
	5200	20	15.5	+14.86	+14.19	+18.09
	5240	20	15.5	+14.86	+14.19	+18.09
HT-20	5180	20	15.0	+14.38	+13.43	+17.72
	5200	20	15.0	+14.38	+13.43	+17.72
	5240	20	15.0	+14.38	+13.43	+17.72
HT-40	5190	20	13.5	+12.99	+12.31	+16.37
	5230	20	13.5	+12.99	+12.31	+16.37

This test report may be reproduced in full only. The document may only be updated by MiCOM Labs personnel. Any changes will be noted in the Document History section of the report.





**Title:** Aruba AP-105 802.11a/b/g/n Wireless AP  
**To:** FCC 47 CFR Part 15.407 & IC RSS-210  
**Serial #:** ARUB69-U3 Rev A  
**Date:** 11th April 2011  
**Page:** 17 of 208

---

### **3.8. Deviations from the Test Standard**

The following deviations from the test standard were required in order to complete the test program:

1. None

### **3.9. Subcontracted Testing or Third Party Data**

1. NONE

---

This test report may be reproduced in full only. The document may only be updated by MiCOM Labs personnel. Any changes will be noted in the Document History section of the report.



**Title:** Aruba AP-105 802.11a/b/g/n Wireless AP  
**To:** FCC 47 CFR Part 15.407 & IC RSS-210  
**Serial #:** ARUB69-U3 Rev A  
**Date:** 11th April 2011  
**Page:** 18 of 208

#### 4. TEST SUMMARY

##### List of Measurements

The following table represents the list of measurements required under the **FCC CFR47 Part 15.407** and **Industry Canada RSS-210** and **Industry Canada RSS-Gen**.

Section(s)	Test Items	Description	Condition	Result	Test Report Section
15.407(a) A9.2(2) 4.4	26dB and 99% Emission BW	Emission bandwidth measurement	Conducted	Complies	5.1.1
15.407(a) A9.2(2) 4.6	Transmit Output Power	Power Measurement	Conducted	Complies	5.1.2
15.407(a) A9.2(2)	Peak Power Spectral Density	PPSD	Conducted	Complies	5.1.3
15.407(a)(6)	Peak Excursion Ratio	<13dB in any 1MHz bandwidth	Conducted	Complies	5.1.4
15.407(g) 15.31 2.1 4.5	Frequency Stability	Limits: contained within band of operation at all times.	Applicant declaration	Complies	5.1.5
15.407(f) 5.5	Radio Frequency Radiation Exposure	Exposure to radio frequency energy levels, Maximum Permissible Exposure (MPE)	Conducted	Complies	5.1.6

This test report may be reproduced in full only. The document may only be updated by MiCOM Labs personnel. Any changes will be noted in the Document History section of the report.



**List of Measurements (continued)**

The following table represents the list of measurements required under the **FCC CFR47 Part 15.407** and **Industry Canada RSS-210** and **Industry Canada RSS-Gen**.

Section(s)	Test Items	Description	Condition	Result	Test Report Section
<b>15.407(b)(2)</b> <b>15.205(a)</b> <b>15.209(a)</b> <b>2.2</b> <b>2.6</b> <b>A9.3(2)</b> <b>4.7</b>	Radiated Emissions		Radiated		5.1.7
	Transmitter Radiated Spurious Emissions	Emissions above 1 GHz		Complies	5.1.7.1
	Radiated Band Edge	Band edge results		Complies	5.1.7.1
Industry Canada only <b>RSS-Gen §4.10, §6</b>	Receiver Radiated Spurious Emissions	Emissions above 1 GHz		Complies	5.1.7.2
<b>15.407(b)(6)</b> <b>15.205(a)</b> <b>15.209(a)</b> <b>2.2</b>	Radiated Emissions	Emissions <1 GHz (30M-1 GHz)		Complies	5.1.7.3
<b>15.407(b)(6)</b> <b>15.207</b> <b>7.2.2</b>	AC Wireline Conducted Emissions 150 kHz–30 MHz	Conducted Emissions	Conducted	Complies	5.1.8

This test report may be reproduced in full only. The document may only be updated by MiCOM Labs personnel. Any changes will be noted in the Document History section of the report.



**Title:** Aruba AP-105 802.11a/b/g/n Wireless AP  
**To:** FCC 47 CFR Part 15.407 & IC RSS-210  
**Serial #:** ARUB69-U3 Rev A  
**Date:** 11th April 2011  
**Page:** 20 of 208

### Dynamic Frequency Selection (DFS)

The following table represents the list of measurements required under the **FCC CFR47 Part 15.407(h)(2)** and **FCC Memorandum Opinion and Order FCC 06-96 (Compliance Measurement procedures for Unlicensed National Information Infrastructure devices operating in the 5250-5350 MHz and 5470-5725 MHz bands incorporating dynamic frequency selection).**

### Tests performed on Master Device

Section	Test Items	Description	Condition	Result	Test Report Section
7.8.1	Detection Bandwidth	UNII Detection Bandwidth	Conducted	Complies	5.1.9
7.8.2.1	Performance Requirements Check	Initial Channel Availability Check Time	Conducted	Complies	5.1.10
7.8.2.2		Radar Burst at the Beginning of the Channel Availability Check Time	Conducted	Complies	5.1.11
7.8.2.3		Radar Burst at the End of the Channel Availability Check Time	Conducted	Complies	5.1.12
7.8.3	In-Service Monitoring	In-Service Monitoring for Channel Move Time, Channel Closing Transmission Time and Non-Occupancy Period	Conducted	Complies	5.1.13
7.8.4	Radar Detection	Statistical Performance Check	Conducted	Complies	5.1.14

Note 1: Test results reported in this document relate only to the items tested

Note 2: The required tests demonstrated compliance as per client declaration of test configuration, monitoring methodology and associated pass/fail criteria

Note 3: Section 3.7 Equipment Modifications highlights the equipment modifications that were required to bring the product into compliance with the above test matrix

This test report may be reproduced in full only. The document may only be updated by MiCOM Labs personnel. Any changes will be noted in the Document History section of the report.

## 5. TEST RESULTS

### 5.1. Device Characteristics

#### 5.1.1. 26 dB and 99 % Bandwidth

**FCC, Part 15 Subpart C §15.407(a)**

**FCC, Part 15 Subpart C §15.407(a)**

**Industry Canada RSS-210 § A9.2(2)**

**Industry Canada RSS-Gen 4.4**

#### **Test Procedure**

The bandwidth at 26 dB and 99 % is measured with a spectrum analyzer connected to the antenna terminal, while EUT is operating in transmission mode at the appropriate center frequency.

#### **Test Measurement Set up**

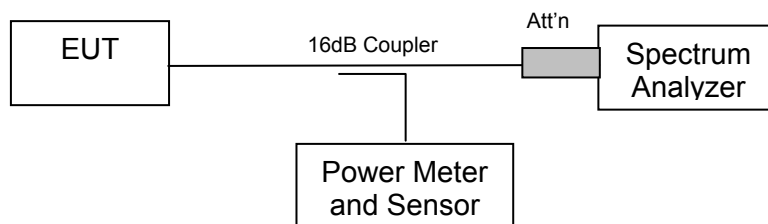

Measurement set up for 26 dB and 99 % bandwidth test

#### **Radio Parameters**

Duty Cycle: 100%

Output: Modulated Carrier

Power: Maximum Default Power



**Measurement Results for 26 dB and 99 % Operational Bandwidth(s)**

Ambient conditions.

Temperature: 17 to 23 °C    Relative humidity: 31 to 57 %    Pressure: 999 to 1012 mbar

**TABLE OF RESULTS – 802.11a Legacy**

Center Frequency (MHz)	26 dB Bandwidth (MHz)	99 % BW (MHz)
5,180	24.749	17.034
5,200	25.150	17.034
5,240	24.850	17.034

**5,180 MHz 802.11a Legacy 26 dB and 99 % Bandwidth**

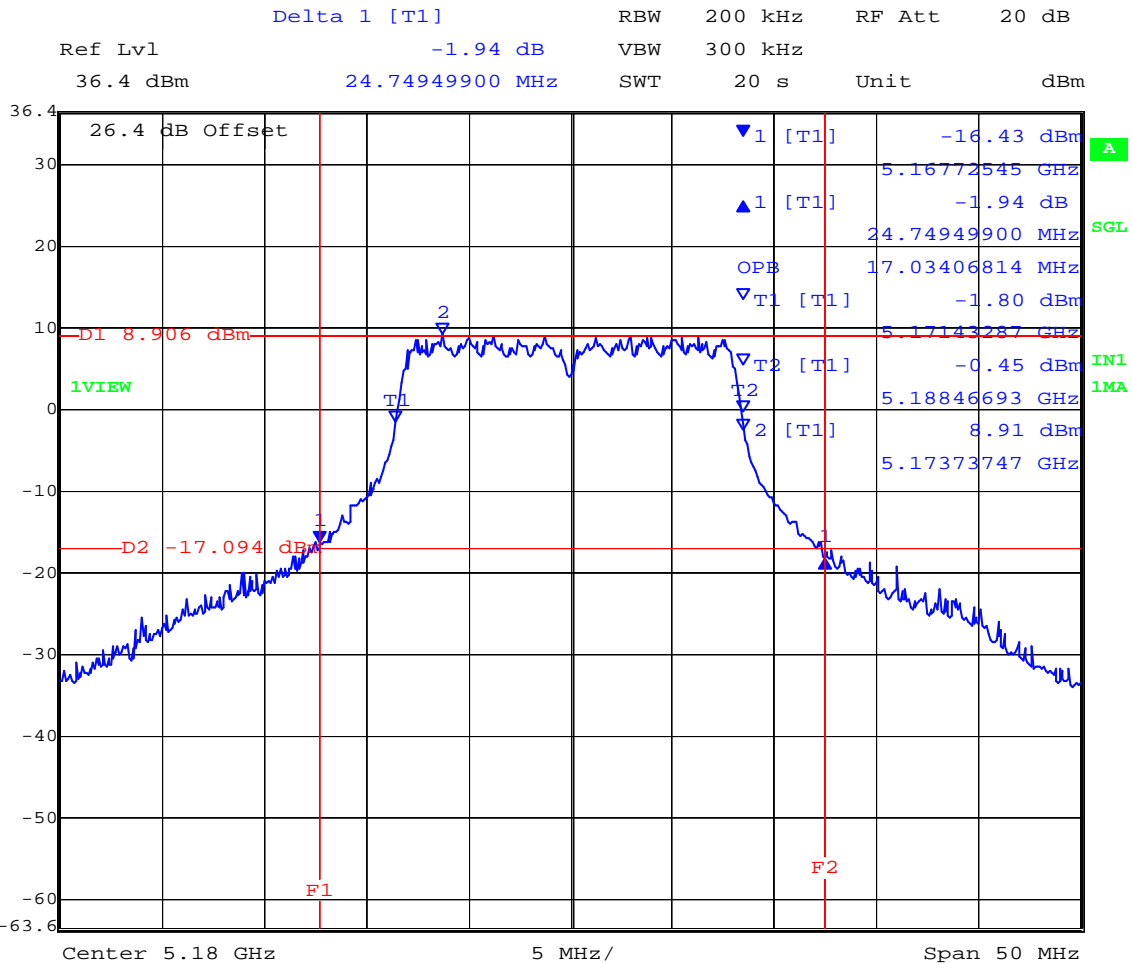

Date: 1.JUL.2009 11:11:45

This test report may be reproduced in full only. The document may only be updated by MiCOM Labs personnel. Any changes will be noted in the Document History section of the report.



**5,200 MHz 802.11a Legacy 26 dB and 99 % Bandwidth**

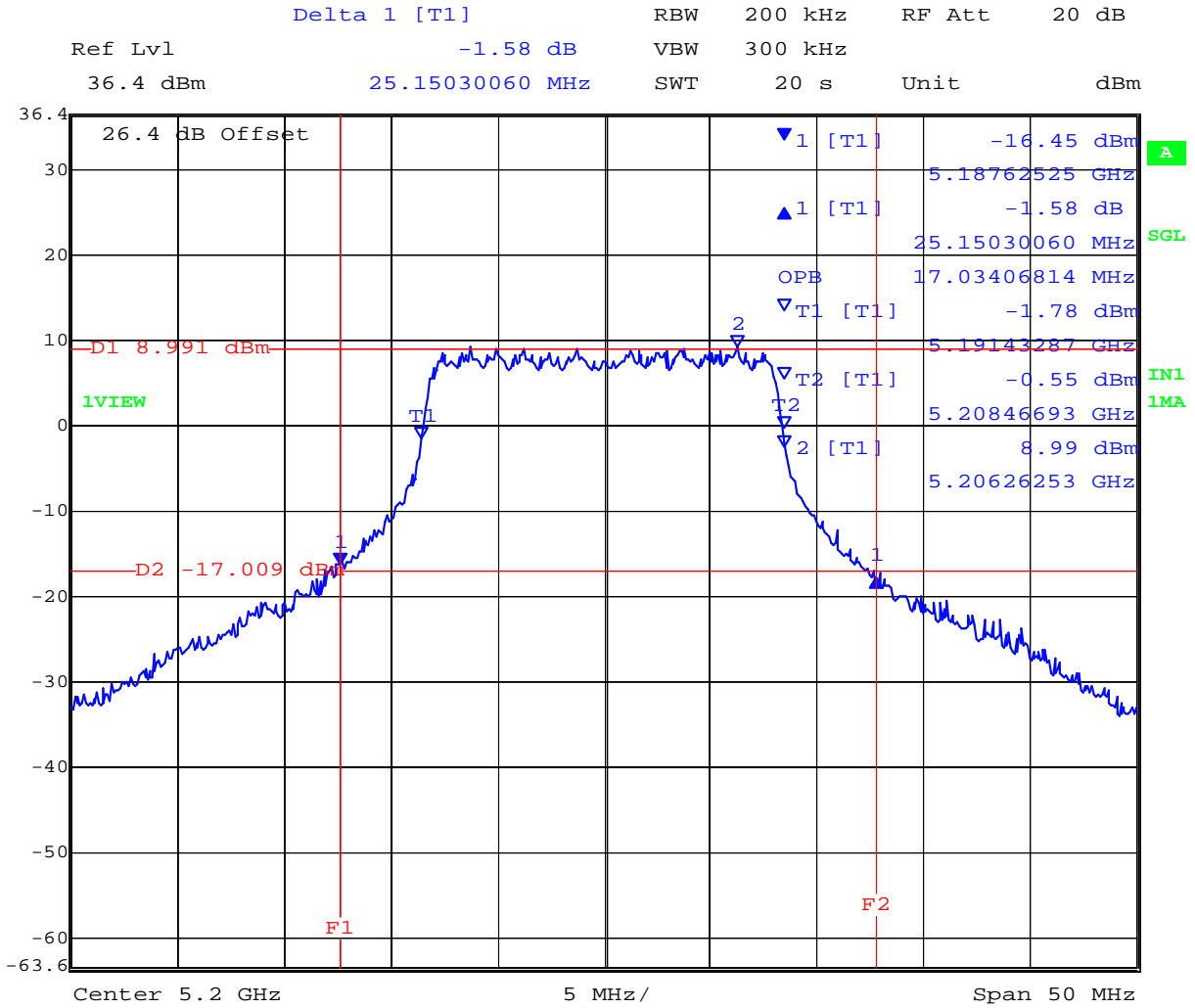

Date: 1.JUL.2009 11:14:11

This test report may be reproduced in full only. The document may only be updated by MiCOM Labs personnel. Any changes will be noted in the Document History section of the report.



**5,240 MHz 802.11a Legacy 26 dB and 99 % Bandwidth**

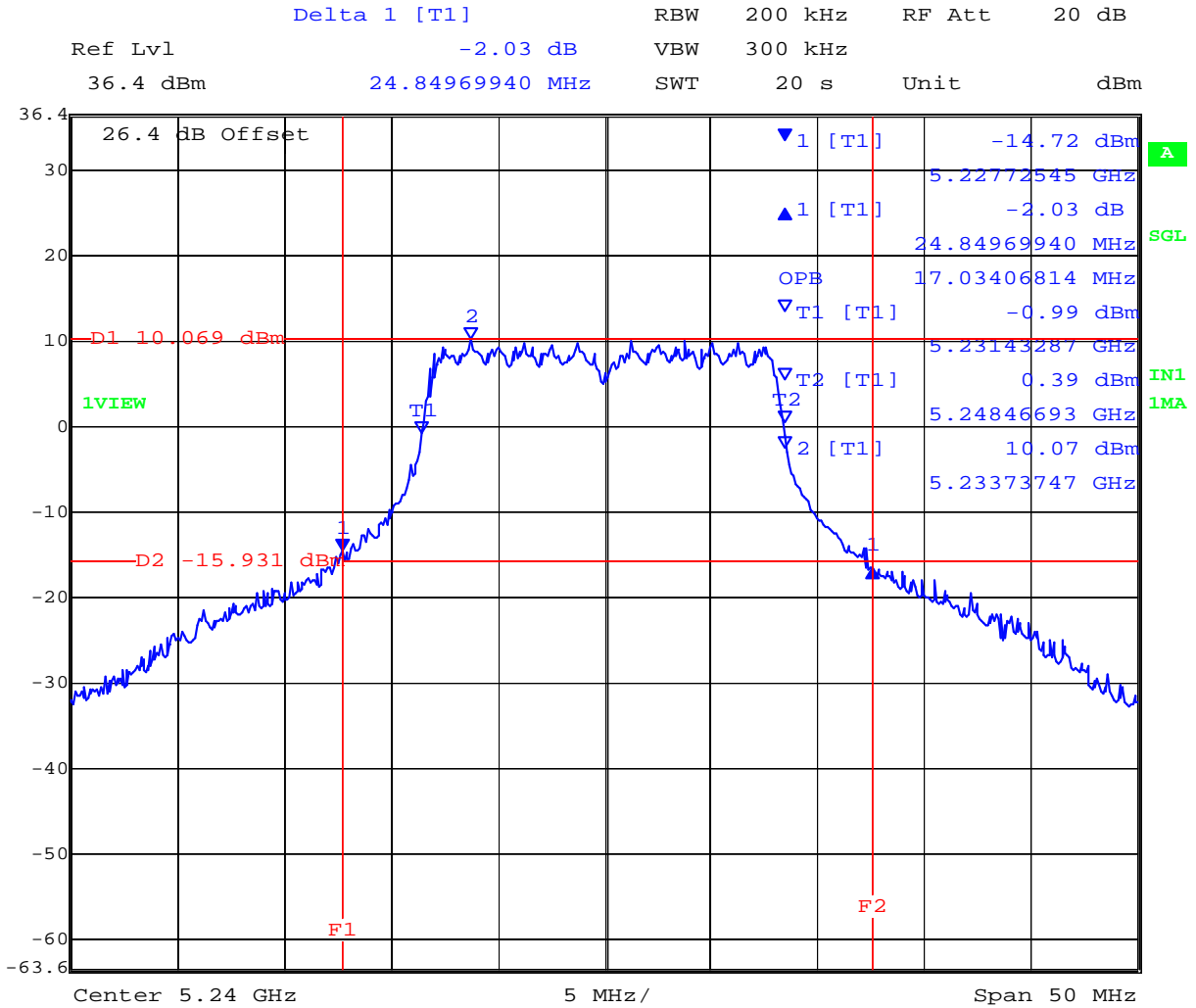

Date: 1.JUL.2009 11:16:38

This test report may be reproduced in full only. The document may only be updated by MiCOM Labs personnel. Any changes will be noted in the Document History section of the report.





**Measurement Results for 26 dB and 99 % Operational Bandwidth(s) -Continue**

**TABLE OF RESULTS – 802.11n HT20**

Center Frequency (MHz)	26 dB Bandwidth (MHz)	99 % BW (MHz)
5,180	25.451	18.136
5,200	25.050	18.136
5,240	25.551	18.136

**5,180 MHz 802.11n HT20 26 dB and 99 % Bandwidth**

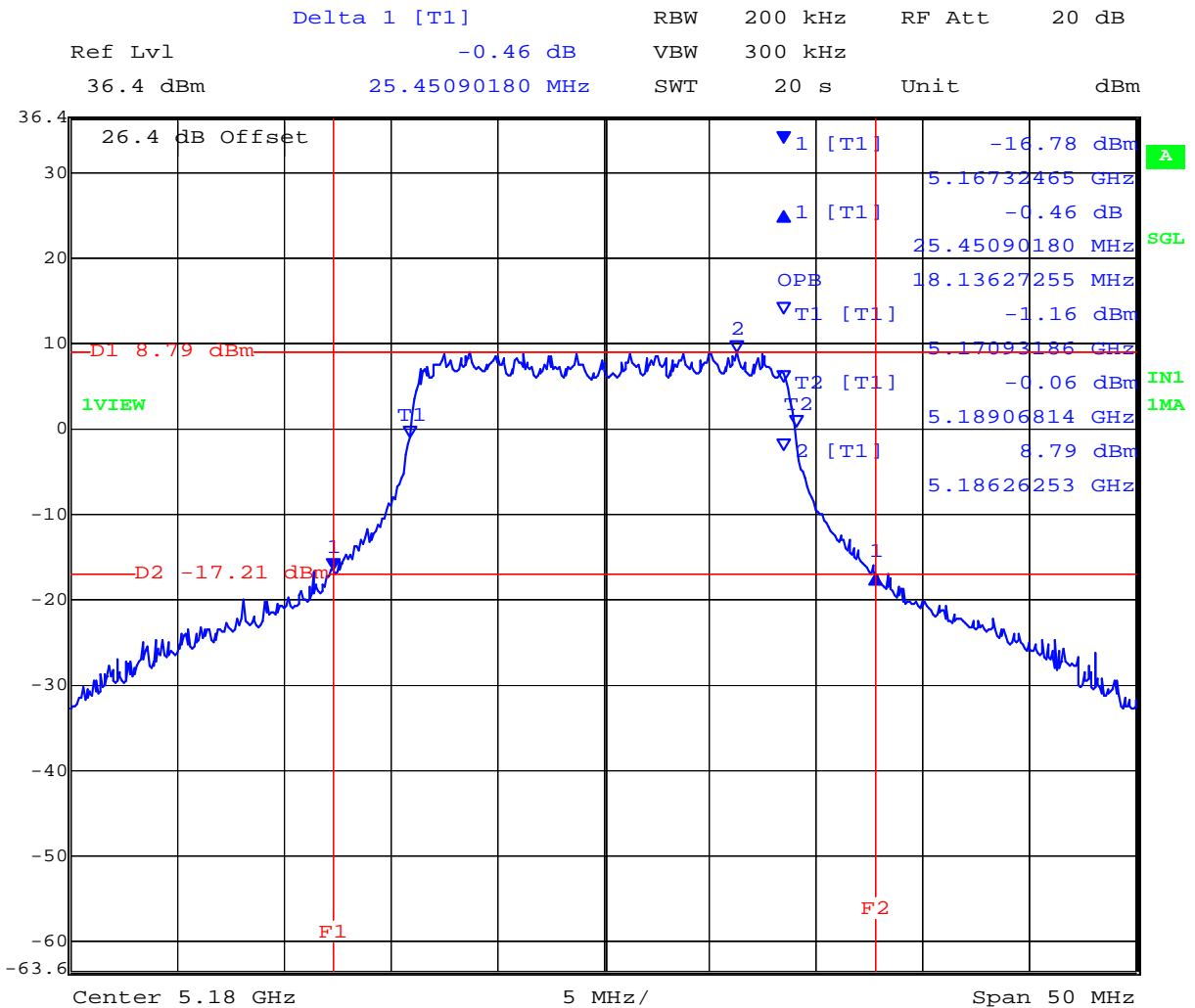

Date: 1.JUL.2009 12:30:36

This test report may be reproduced in full only. The document may only be updated by MiCOM Labs personnel. Any changes will be noted in the Document History section of the report.



**5,200 MHz 802.11n HT20 26 dB and 99 % Bandwidth**

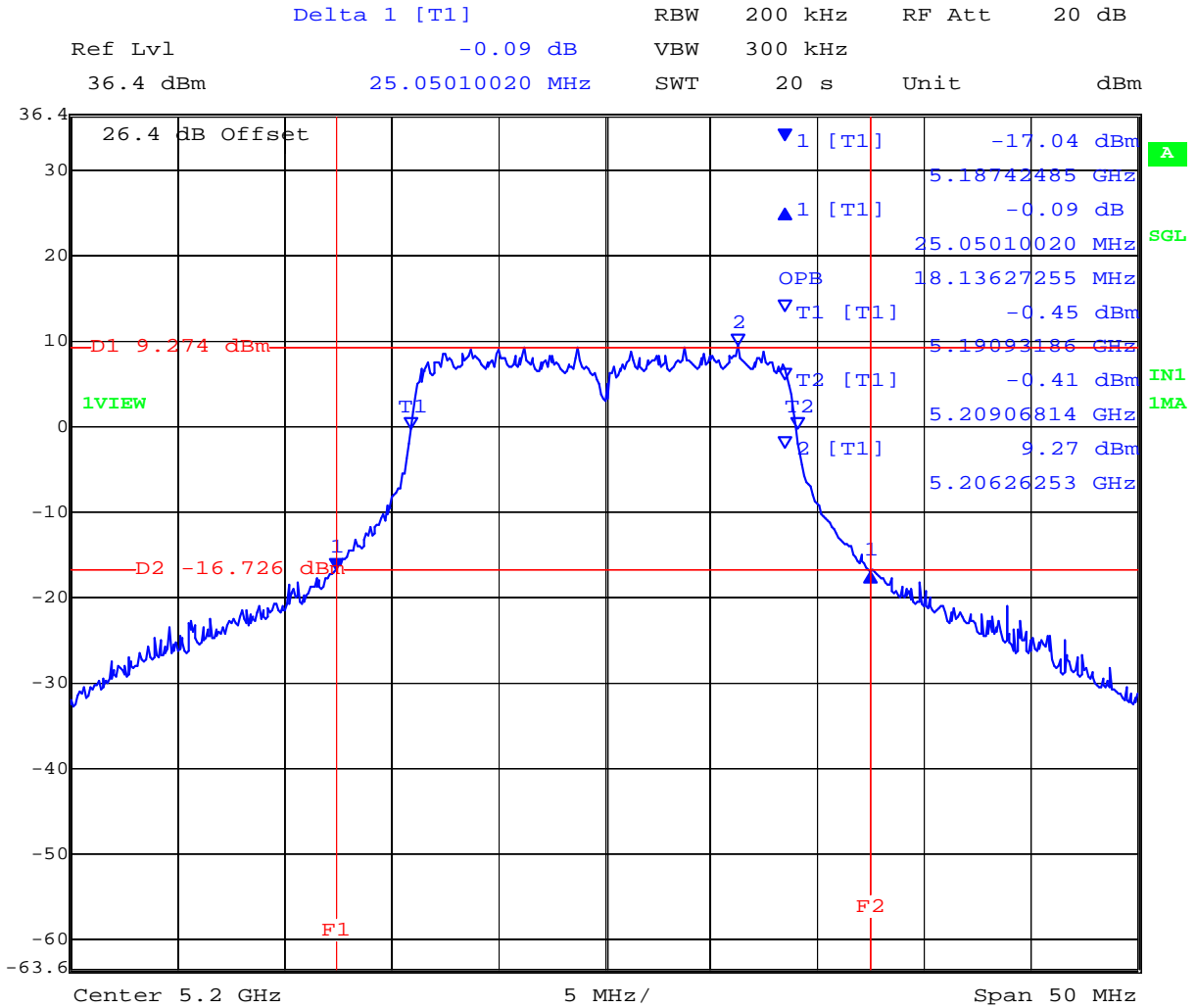

Date: 1.JUL.2009 12:24:52

This test report may be reproduced in full only. The document may only be updated by MiCOM Labs personnel. Any changes will be noted in the Document History section of the report.



**Title:** Aruba AP-105 802.11a/b/g/n Wireless AP  
**To:** FCC 47 CFR Part 15.407 & IC RSS-210  
**Serial #:** ARUB69-U3 Rev A  
**Date:** 11th April 2011  
**Page:** 27 of 208

**5,240 MHz 802.11n HT20 26 dB and 99 % Bandwidth**

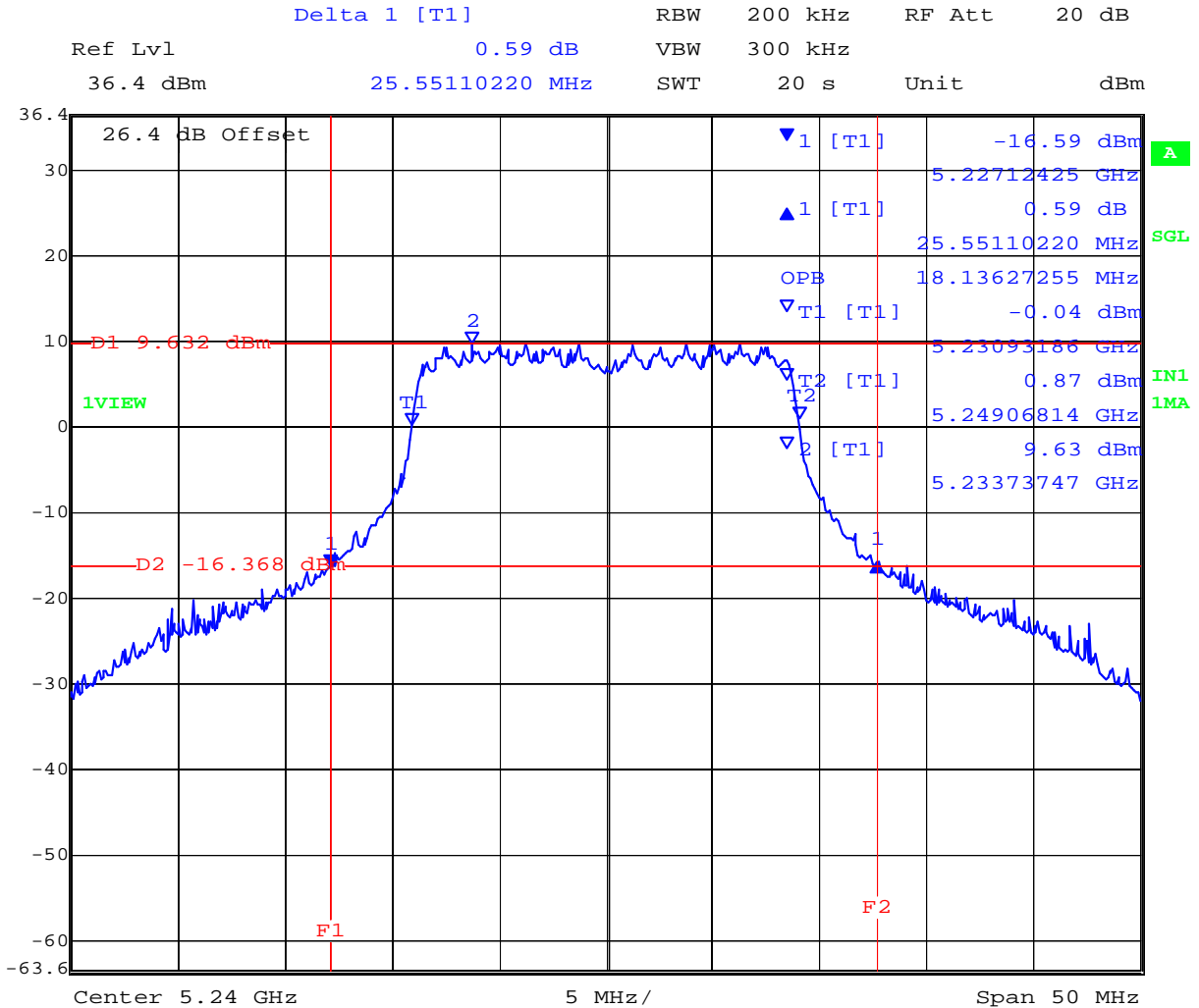

Date: 1.JUL.2009 12:14:08

This test report may be reproduced in full only. The document may only be updated by MiCOM Labs personnel. Any changes will be noted in the Document History section of the report.



**Measurement Results for 26 dB and 99 % Operational Bandwidth(s) -Continued**

TABLE OF RESULTS – 802.11n HT40

Center Frequency (MHz)	26 dB Bandwidth (MHz)	99 % BW (MHz)
5,190	69.339	37.876
5,230	69.138	38.076

**5,190 MHz 802.11n HT40 26 dB and 99 % Bandwidth**

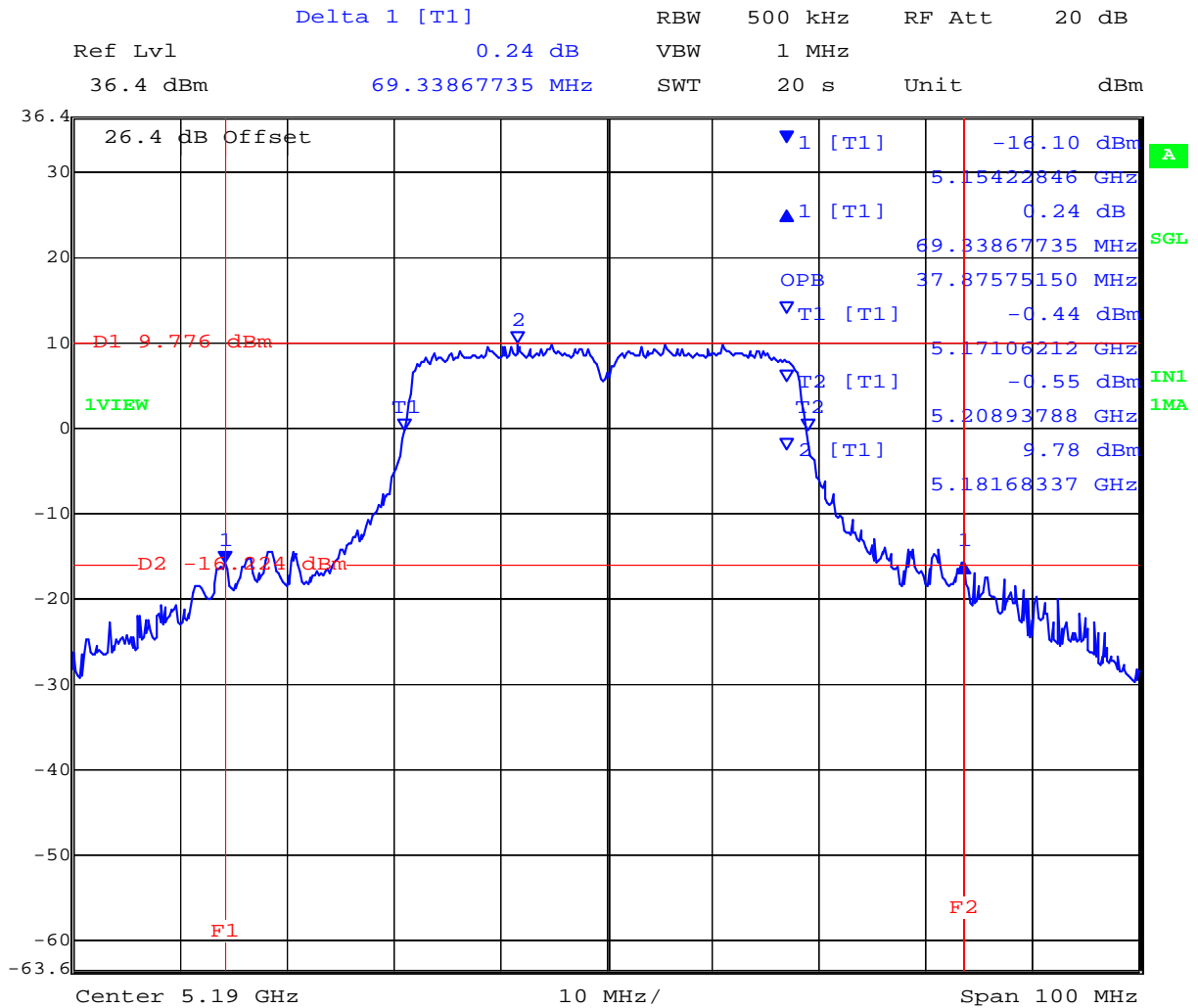

Date: 1.JUL.2009 16:31:16

This test report may be reproduced in full only. The document may only be updated by MiCOM Labs personnel. Any changes will be noted in the Document History section of the report.



**5,230 MHz 802.11n HT40 26 dB and 99 % Bandwidth**

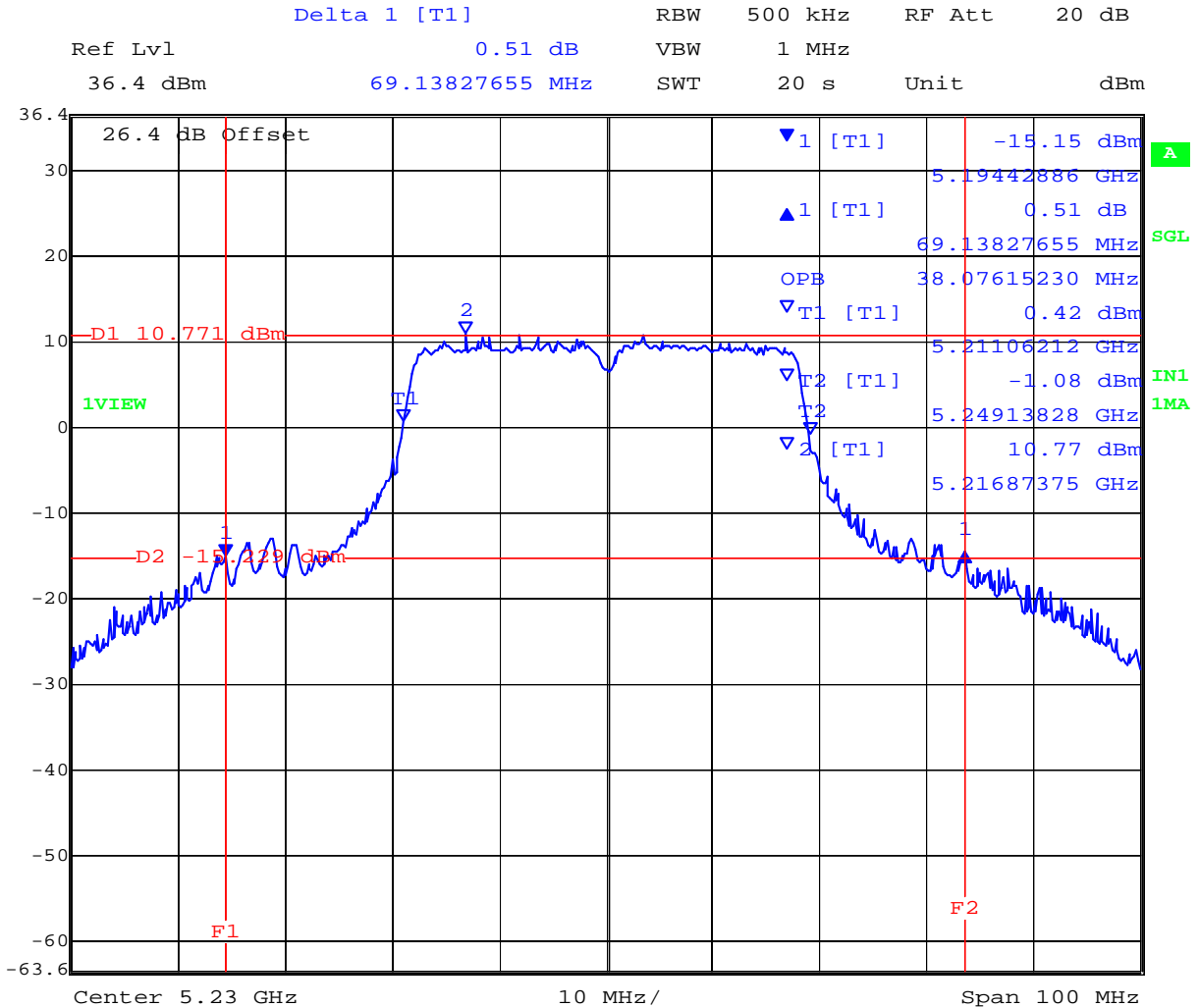

Date: 1.JUL.2009 14:13:30

This test report may be reproduced in full only. The document may only be updated by MiCOM Labs personnel. Any changes will be noted in the Document History section of the report.



**Measurement Results for 26 dB and 99 % Operational Bandwidth(s)**

Ambient conditions.

Temperature: 17 to 23 °C    Relative humidity: 31 to 57 %    Pressure: 999 to 1012 mbar

**TABLE OF RESULTS – 802.11a Legacy**

Center Frequency (MHz)	26 dB Bandwidth (MHz)	99 % BW (MHz)
5260	29.058	17.335
5,300	33.066	18.337
5,320	36.373	19.439

**5,260 MHz 802.11a Legacy 26 dB and 99 % Bandwidth**

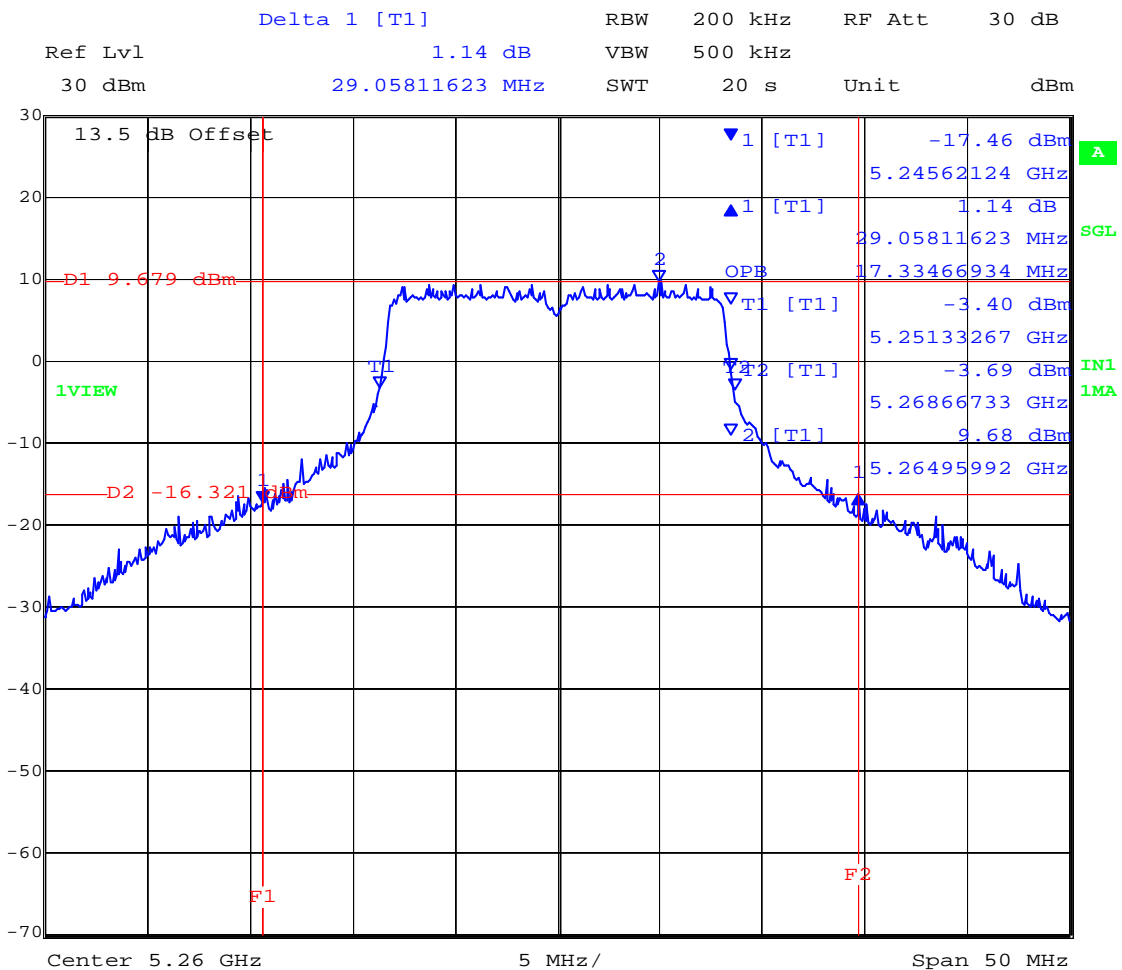

Date: 3.MAR.2010 09:52:52

This test report may be reproduced in full only. The document may only be updated by MiCOM Labs personnel. Any changes will be noted in the Document History section of the report.



**5,300 MHz 802.11a Legacy 26 dB and 99 % Bandwidth**

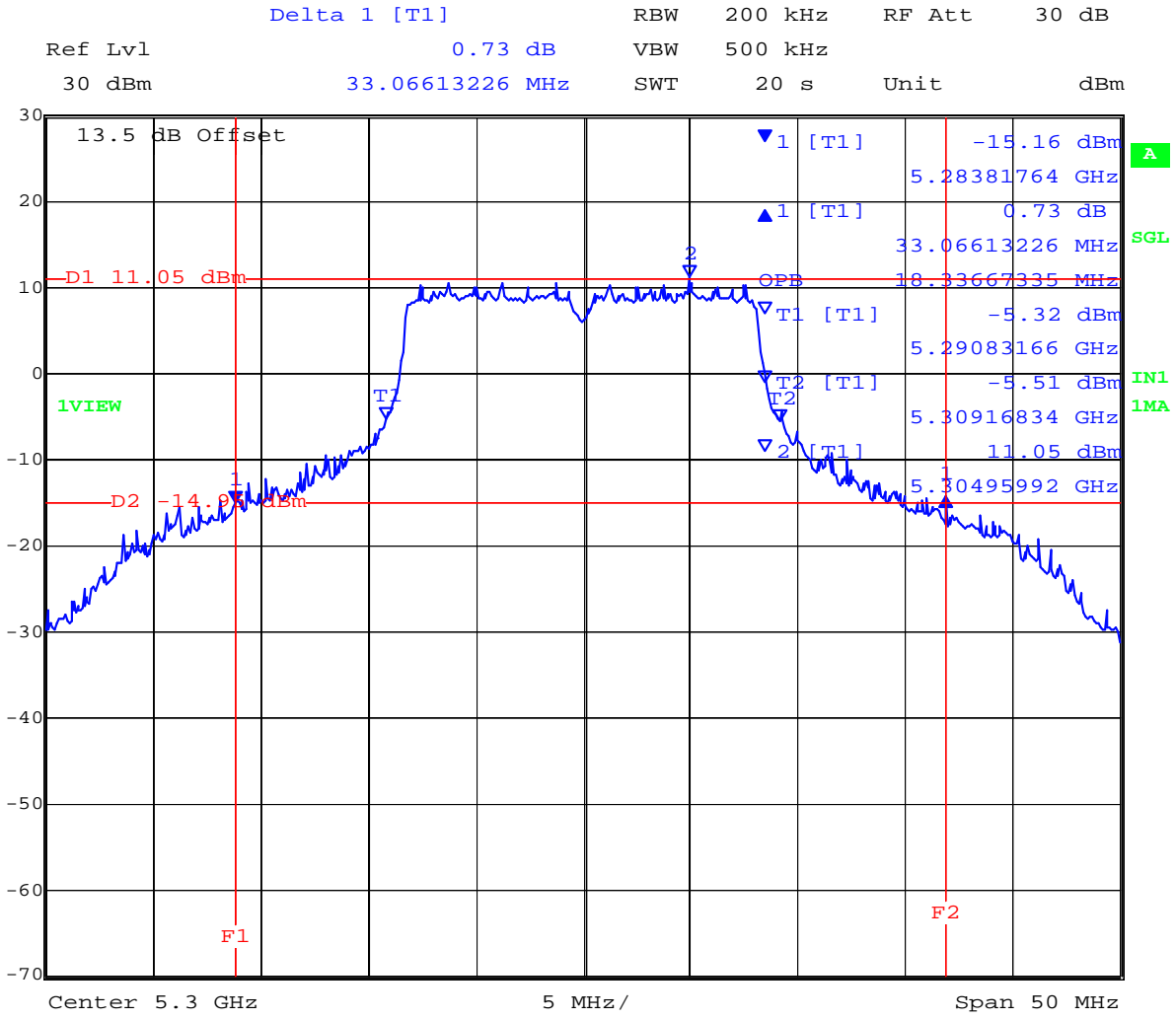

Date: 3.MAR.2010 10:04:58

This test report may be reproduced in full only. The document may only be updated by MiCOM Labs personnel. Any changes will be noted in the Document History section of the report.







**Measurement Results for 26 dB and 99 % Operational Bandwidth(s) -Continue**

TABLE OF RESULTS – 802.11n HT20

Center Frequency (MHz)	26 dB Bandwidth (MHz)	99 % BW (MHz)
5260	36.573	19.526
5,300	36.573	19.238
5,320	37.475	20.040

**5,300 MHz 802.11n HT20 26 dB and 99 % Bandwidth**

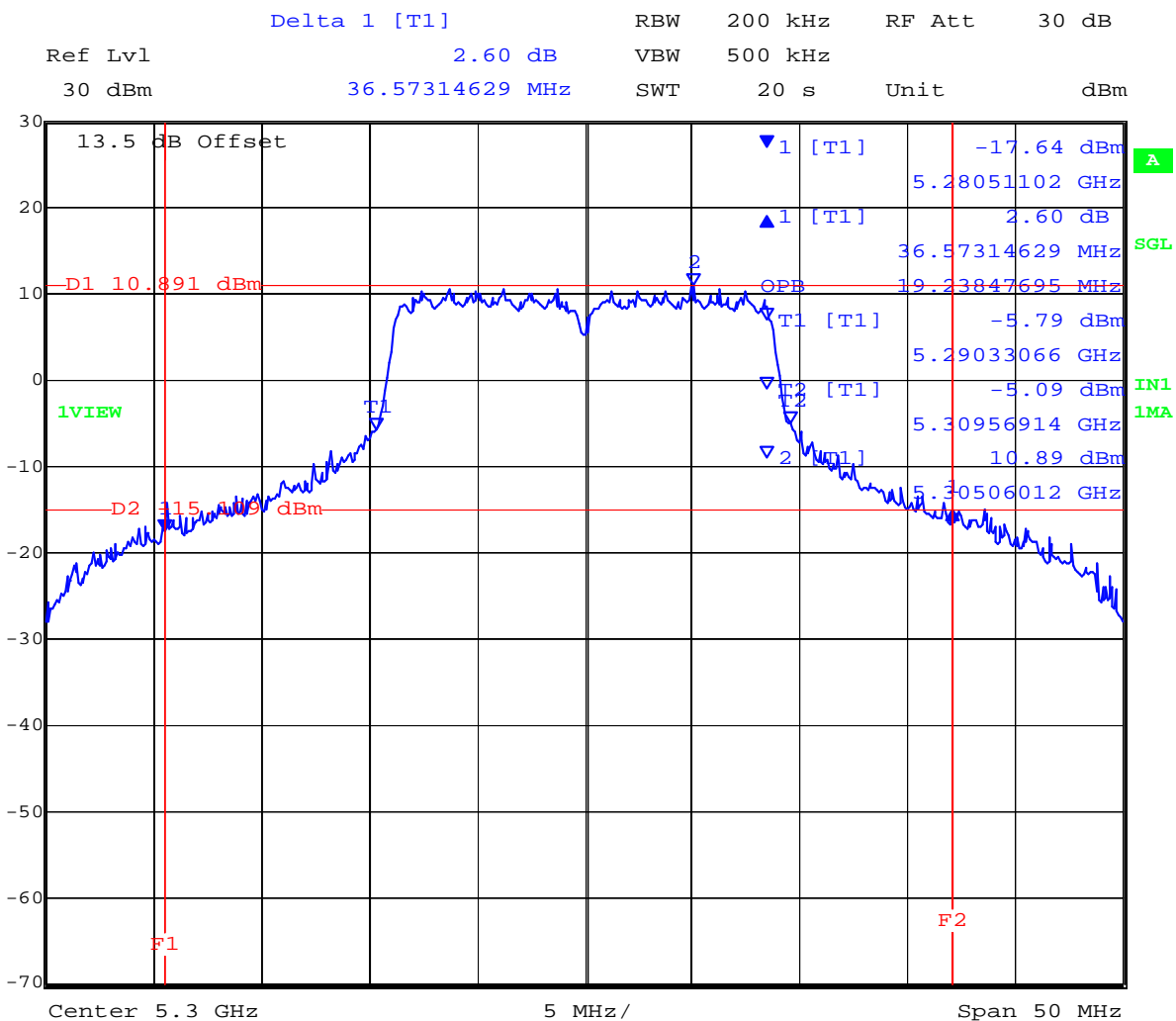

Date: 3.MAR.2010 10:52:39

This test report may be reproduced in full only. The document may only be updated by MiCOM Labs personnel. Any changes will be noted in the Document History section of the report.



**Title:** Aruba AP-105 802.11a/b/g/n Wireless AP  
**To:** FCC 47 CFR Part 15.407 & IC RSS-210  
**Serial #:** ARUB69-U3 Rev A  
**Date:** 11th April 2011  
**Page:** 34 of 208

**5,320 MHz 802.11n HT20 26 dB and 99 % Bandwidth**

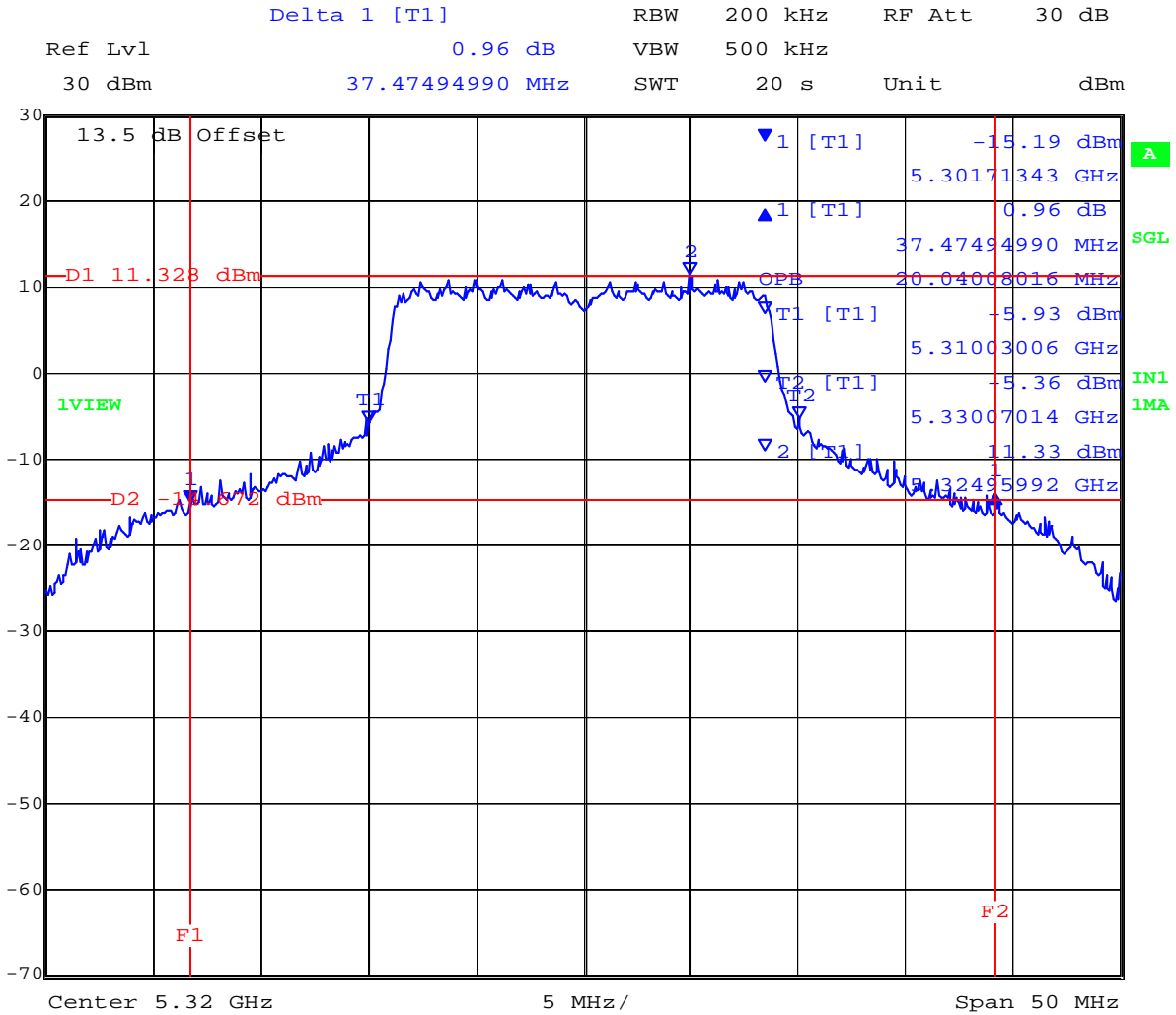

Date: 3.MAR.2010 11:01:49

This test report may be reproduced in full only. The document may only be updated by MiCOM Labs personnel. Any changes will be noted in the Document History section of the report.



**Measurement Results for 26 dB and 99 % Operational Bandwidth(s) -Continued**

TABLE OF RESULTS – 802.11n HT40

Center Frequency (MHz)	26 dB Bandwidth (MHz)	99 % BW (MHz)
5,270	67.936	36.673
5,310	75.551	37.475

**5,270 MHz 802.11n HT40 26 dB and 99 % Bandwidth**

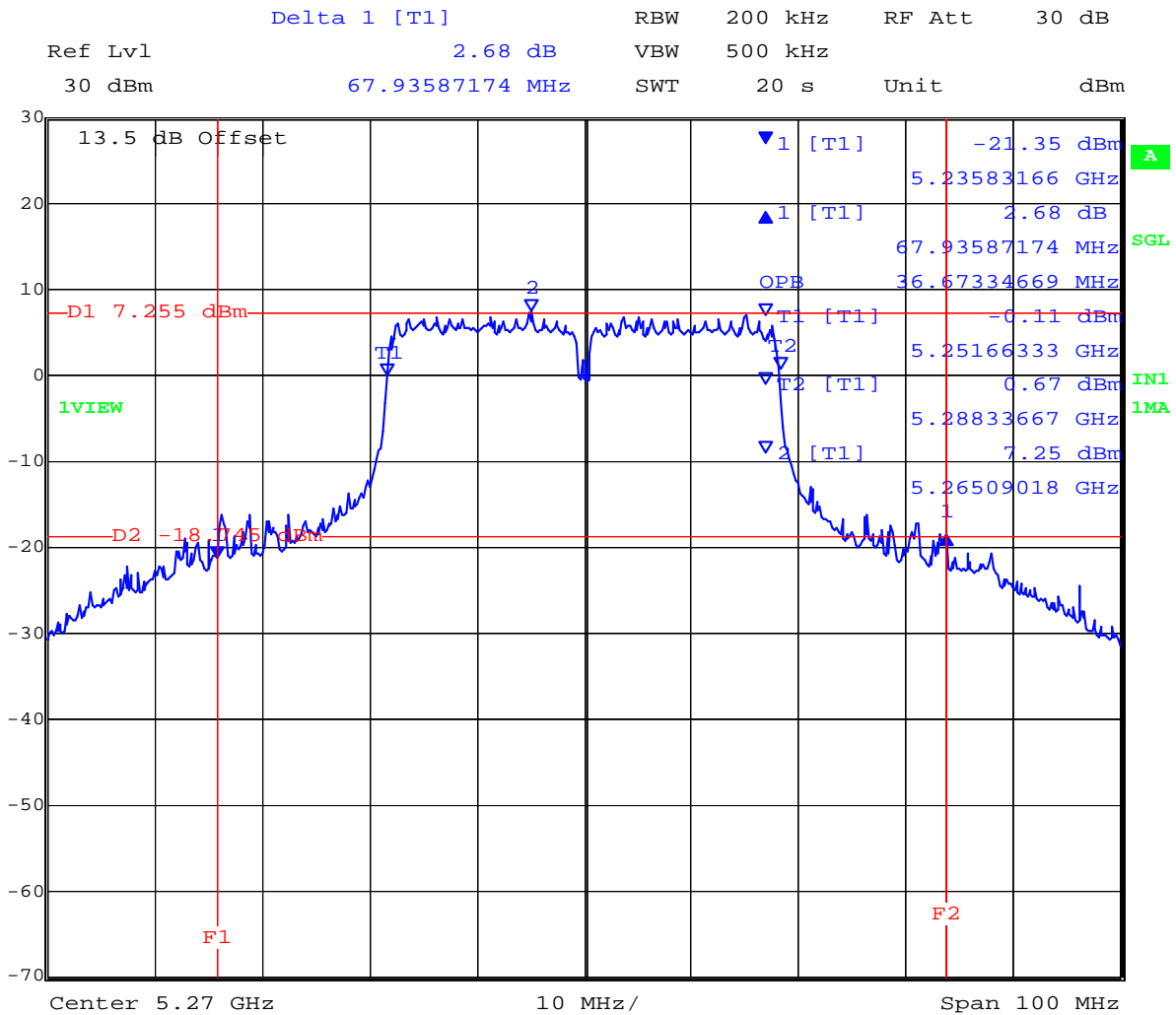

Date: 3.MAR.2010 11:17:03

This test report may be reproduced in full only. The document may only be updated by MiCOM Labs personnel. Any changes will be noted in the Document History section of the report.



**5, 130 MHz 802.11n HT40 26 dB and 99 % Bandwidth**

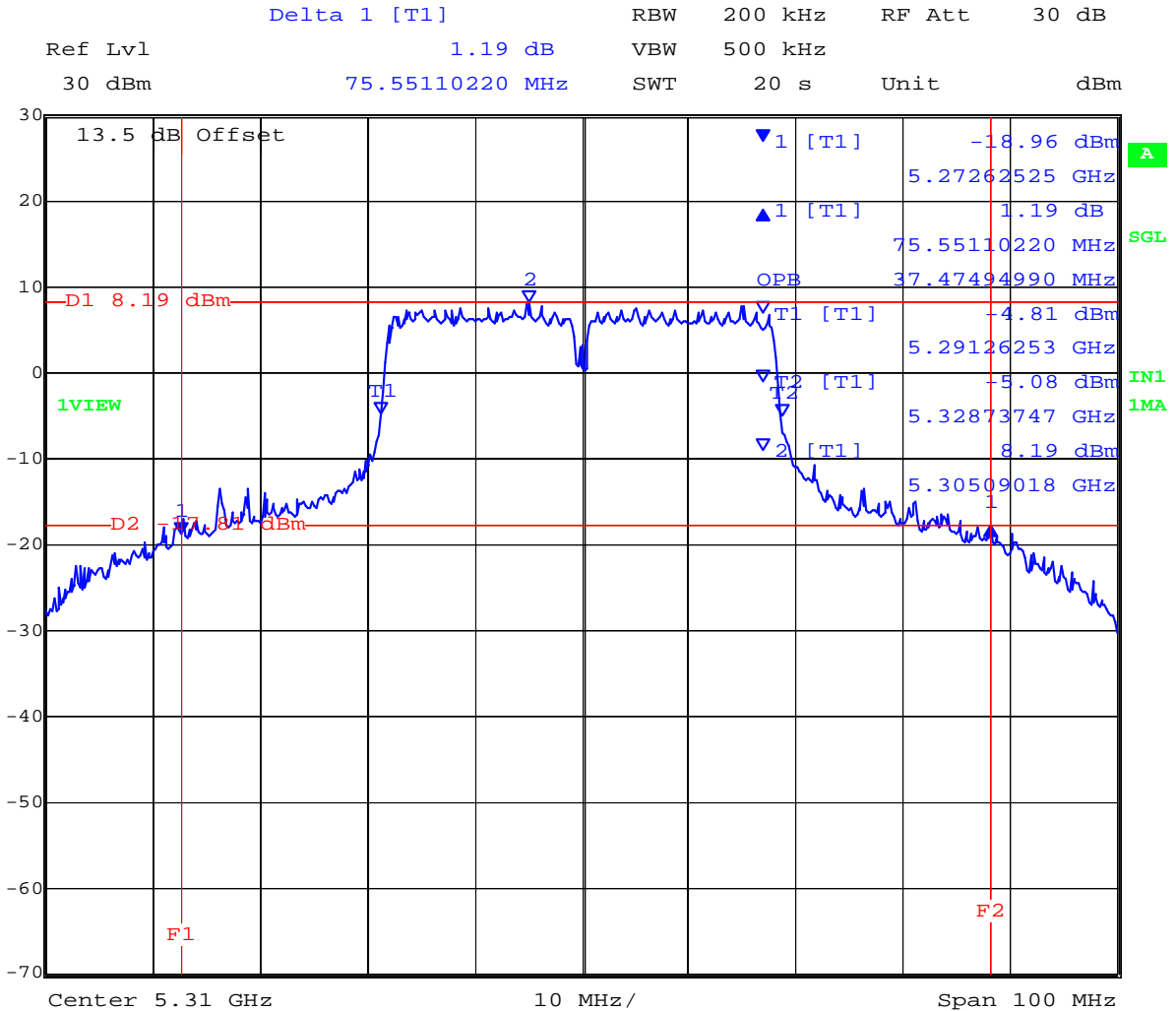

Date: 3.MAR.2010 11:38:12

This test report may be reproduced in full only. The document may only be updated by MiCOM Labs personnel. Any changes will be noted in the Document History section of the report.



**Measurement Results for 26 dB and 99 % Operational Bandwidth(s)**

Ambient conditions.

Temperature: 17 to 23 °C    Relative humidity: 31 to 57 %    Pressure: 999 to 1012 mbar

**TABLE OF RESULTS – 802.11a Legacy**

Center Frequency (MHz)	26 dB Bandwidth (MHz)	99 % BW (MHz)
5,500	27.455	17.034
5,600	29.259	17.335
5,700	26.754	17.034

**5,500 MHz 802.11a Legacy 26 dB and 99 % Bandwidth**

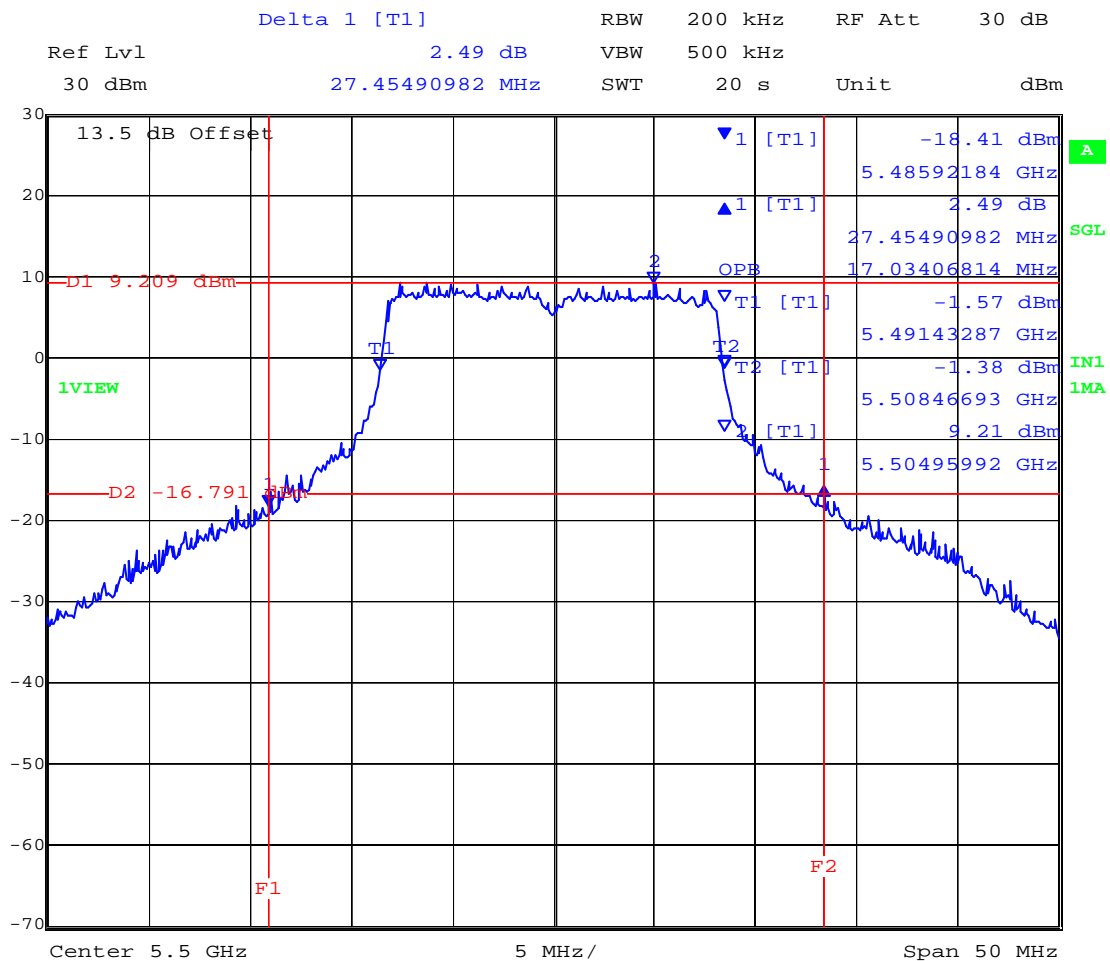

Date: 3.MAR.2010 12:07:40

This test report may be reproduced in full only. The document may only be updated by MiCOM Labs personnel. Any changes will be noted in the Document History section of the report.



**5,600 MHz 802.11a Legacy 26 dB and 99 % Bandwidth**

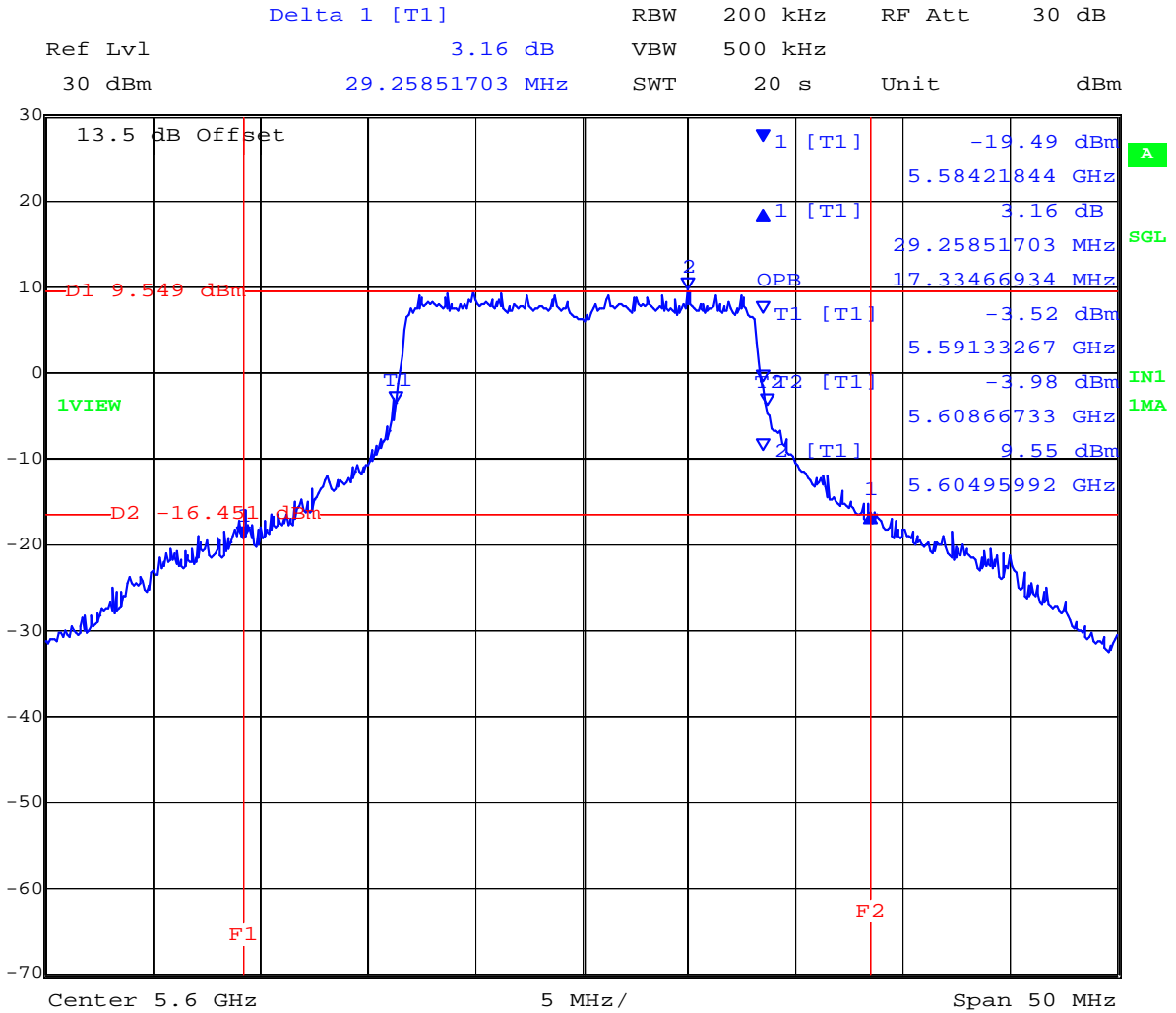

Date: 3.MAR.2010 12:24:20

This test report may be reproduced in full only. The document may only be updated by MiCOM Labs personnel. Any changes will be noted in the Document History section of the report.



**5,700 MHz 802.11a Legacy 26 dB and 99 % Bandwidth**

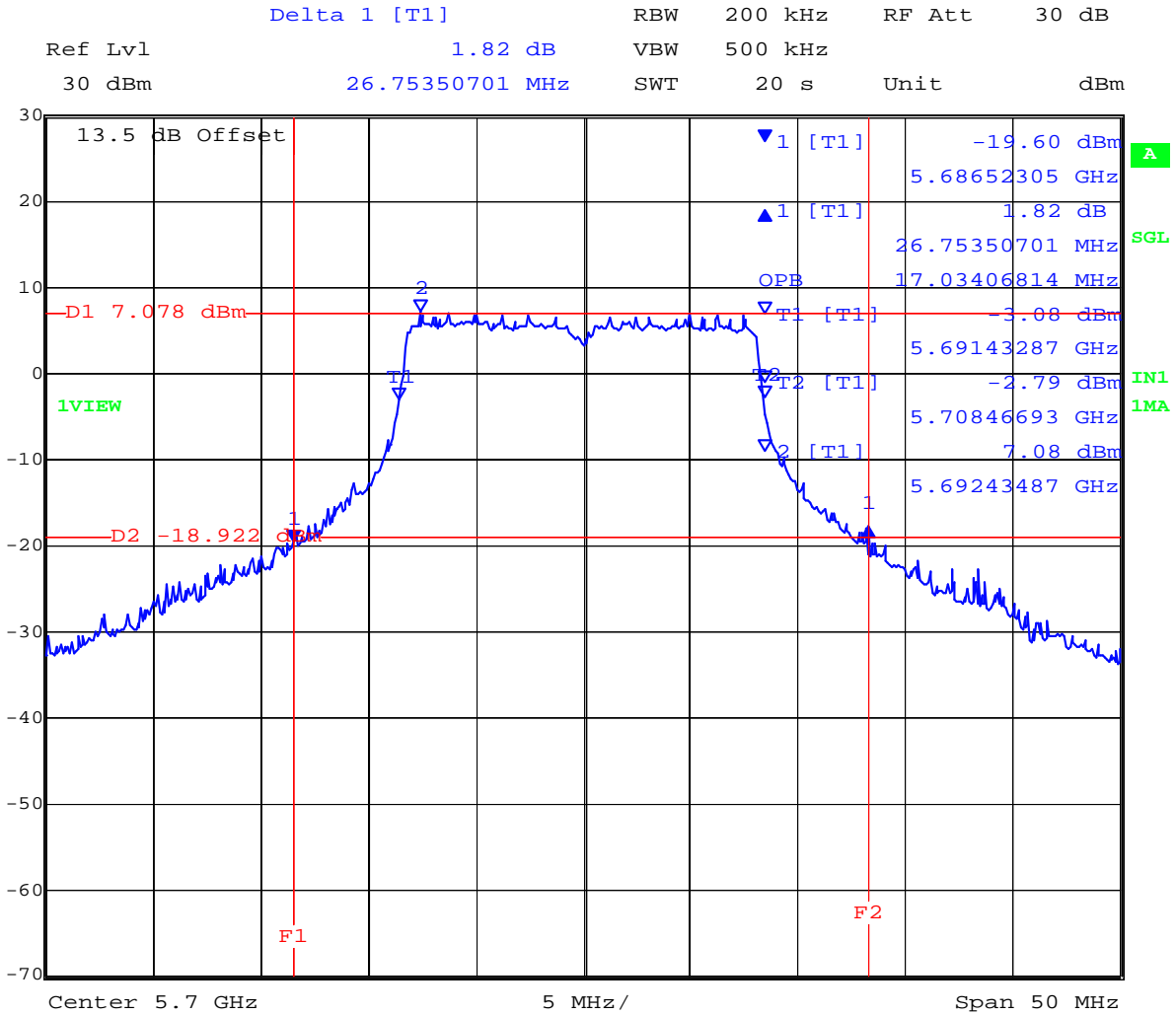

Date: 3.MAR.2010 12:34:13

This test report may be reproduced in full only. The document may only be updated by MiCOM Labs personnel. Any changes will be noted in the Document History section of the report.



**Measurement Results for 26 dB and 99 % Operational Bandwidth(s) -Continue**

**TABLE OF RESULTS – 802.11n HT20**

Center Frequency (MHz)	26 dB Bandwidth (MHz)	99 % BW (MHz)
5,500	26.754	18.136
5,600	27.856	18.337
5,700	26.954	18.236

**5,500 MHz 802.11n HT20 26 dB and 99 % Bandwidth**

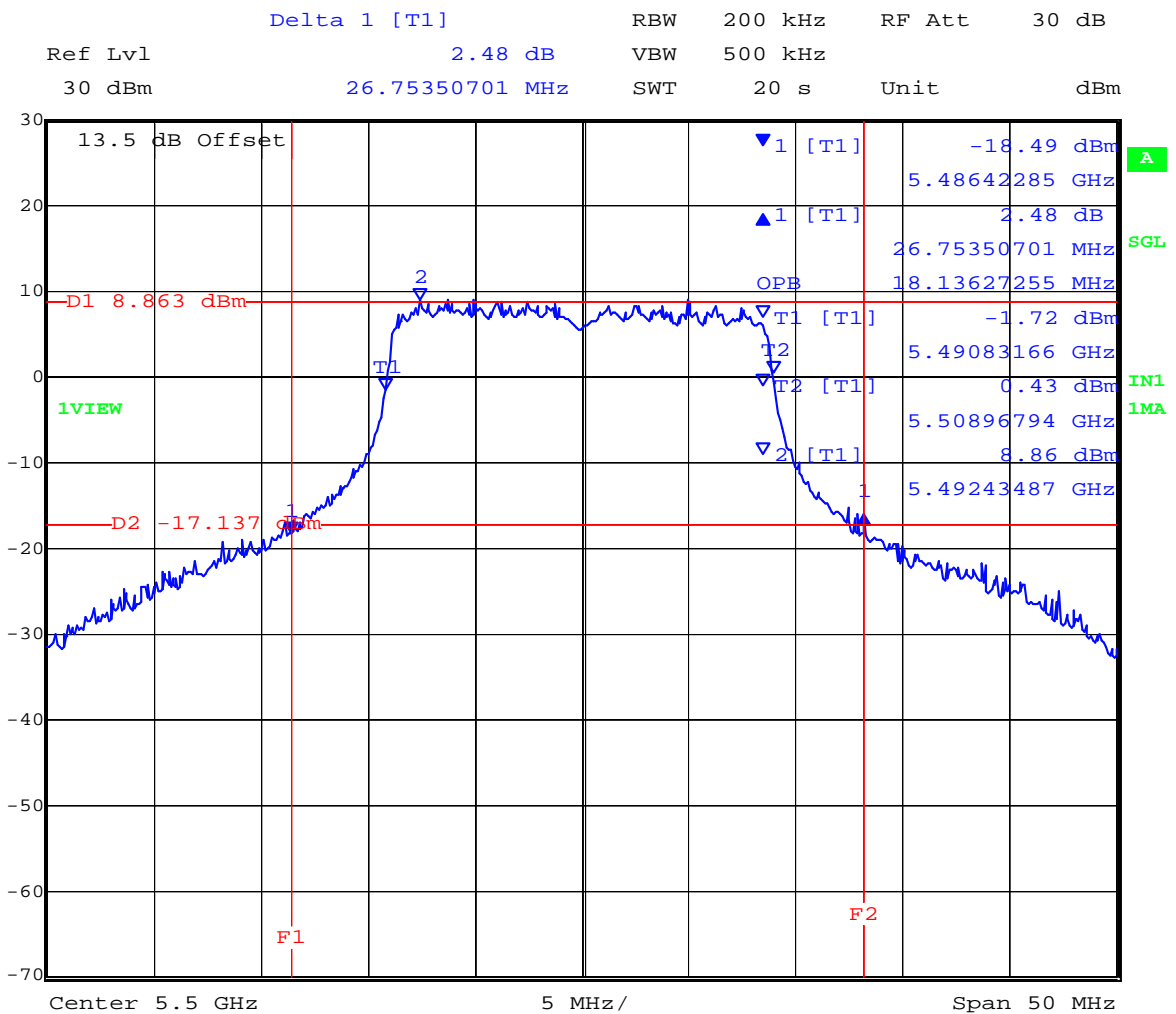

Date: 3.MAR.2010 13:51:12

This test report may be reproduced in full only. The document may only be updated by MiCOM Labs personnel. Any changes will be noted in the Document History section of the report.





**Title:** Aruba AP-105 802.11a/b/g/n Wireless AP  
**To:** FCC 47 CFR Part 15.407 & IC RSS-210  
**Serial #:** ARUB69-U3 Rev A  
**Date:** 11th April 2011  
**Page:** 41 of 208

**5,600 MHz 802.11n HT20 26 dB and 99 % Bandwidth**

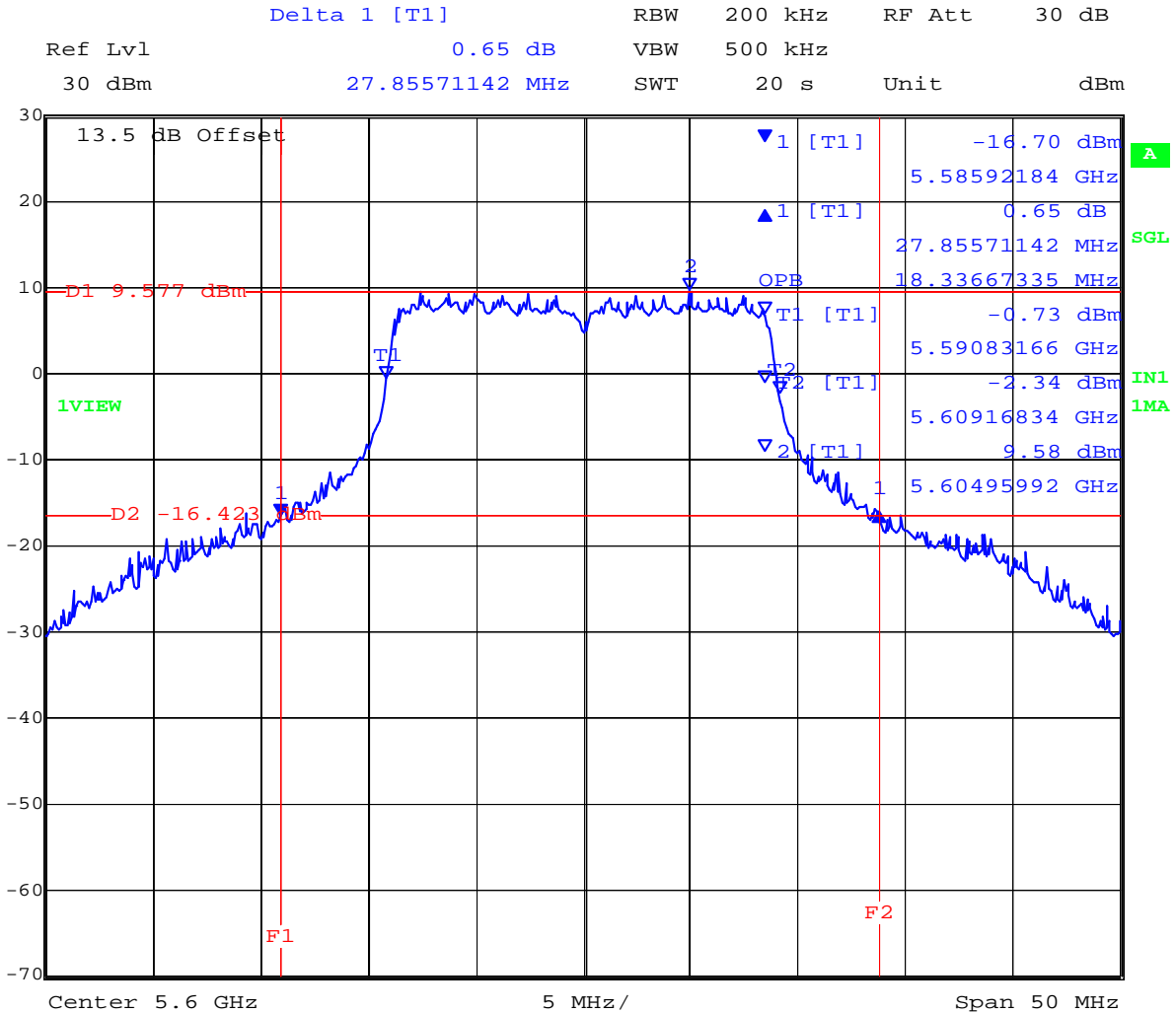

Date: 3.MAR.2010 14:16:35

This test report may be reproduced in full only. The document may only be updated by MiCOM Labs personnel. Any changes will be noted in the Document History section of the report.



**5,700 MHz 802.11n HT20 26 dB and 99 % Bandwidth**

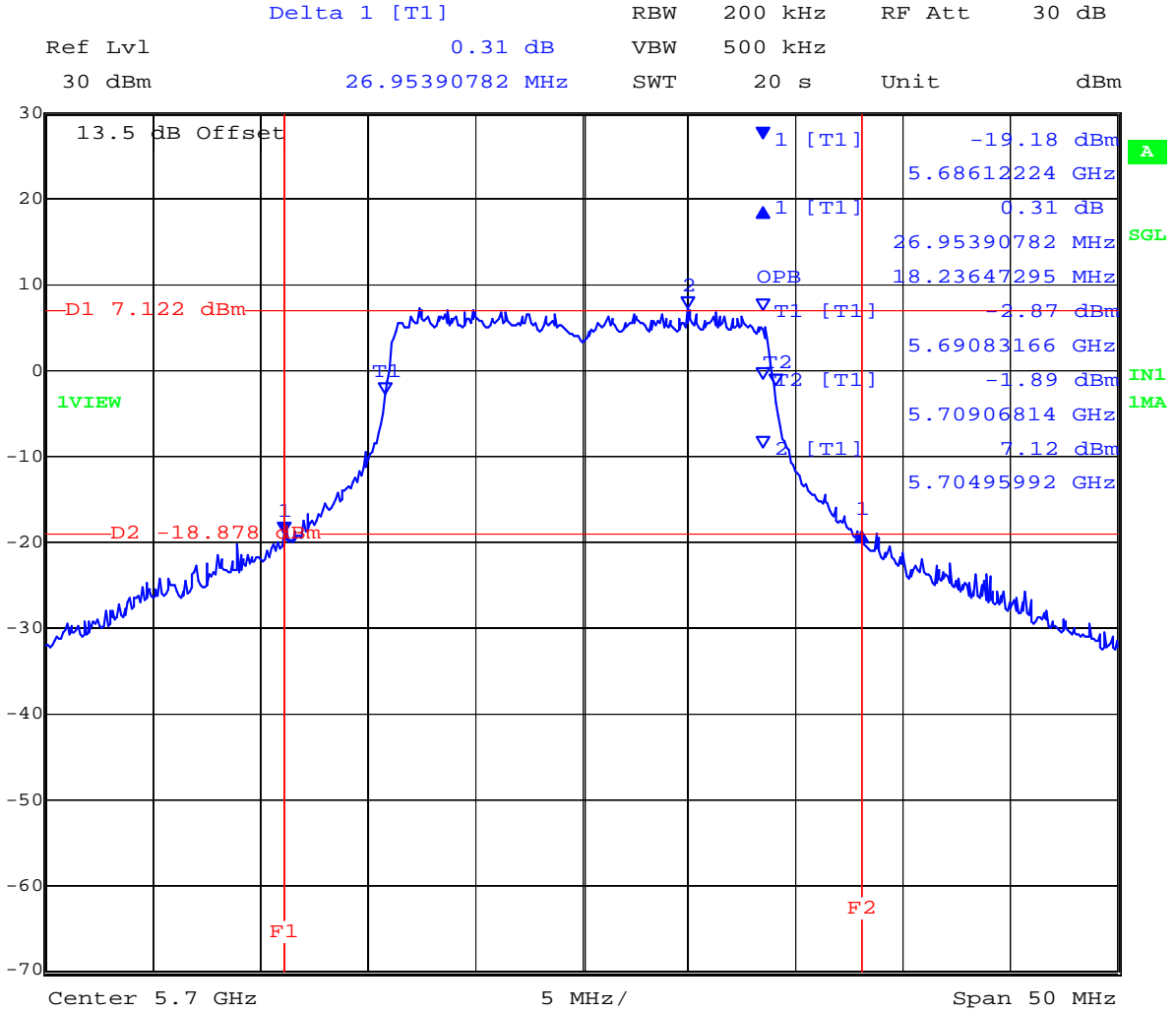

Date: 3.MAR.2010 14:26:43

This test report may be reproduced in full only. The document may only be updated by MiCOM Labs personnel. Any changes will be noted in the Document History section of the report.



**Measurement Results for 26 dB and 99 % Operational Bandwidth(s) -Continued**

TABLE OF RESULTS – 802.11n HT40

Center Frequency (MHz)	26 dB Bandwidth (MHz)	99 % BW (MHz)
5,510	49.699	36.673
5,590	65.531	36.673
5,690	65.130	36.473

**5,510 MHz 802.11n HT40 26 dB and 99 % Bandwidth**

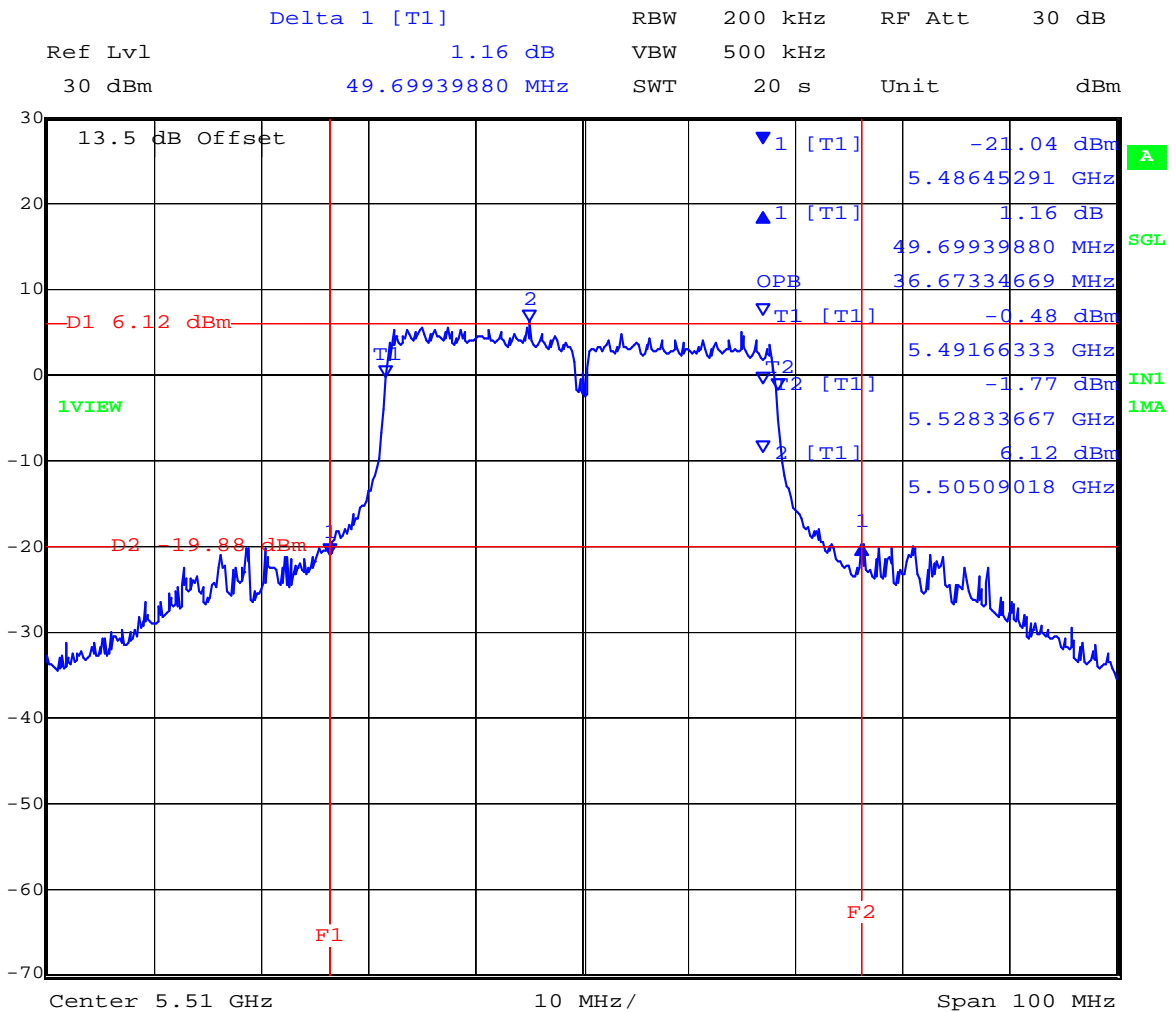

Date: 3.MAR.2010 14:42:52

This test report may be reproduced in full only. The document may only be updated by MiCOM Labs personnel. Any changes will be noted in the Document History section of the report.





**5,690 MHz 802.11n HT40 26 dB and 99 % Bandwidth**

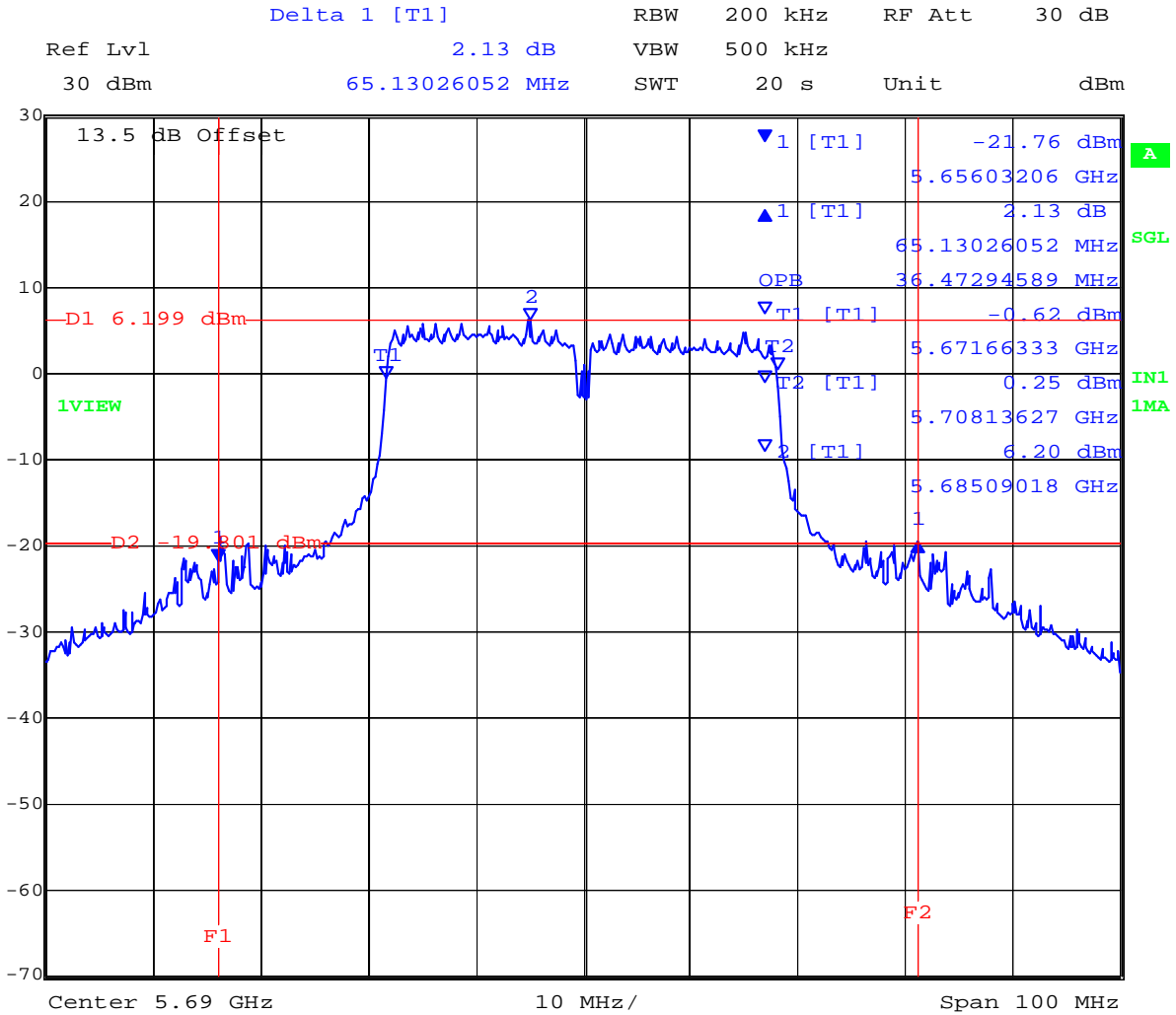

Date: 3.MAR.2010 15:18:53

This test report may be reproduced in full only. The document may only be updated by MiCOM Labs personnel. Any changes will be noted in the Document History section of the report.



## Specification

### Limits

#### FCC, Part 15 §15.407 (a)(1), (a)(2) and Industry Canada RSS-210 § A9.2(2)

**(a)(1)** For the band 5.15-5.25 GHz the maximum conducted output power over the frequency band of operation shall not exceed the lesser of 50 mW or +4 dBm + 10 log B, where B is the 26 dB emission bandwidth in megahertz. In addition, the peak power spectral density shall not exceed +4 dBm in any 1 megahertz band.

**(a)(2)** For the 5.25-5.35 GHz band the maximum conducted output power over the frequency band of operation shall not exceed the lesser of 250 mW or +11 dBm + 10 log B, where B is the 26 dB emission bandwidth in megahertz. In addition, the peak power spectral density shall not exceed +11 dBm in any 1 megahertz band.

#### Industry Canada RSS-Gen 4.4

When an occupied bandwidth value is not specified in the applicable RSS, the transmitted signal bandwidth to be reported is to be its 99% emission bandwidth, as calculated or measured.

## Laboratory Measurement Uncertainty for Spectrum Measurement

Measurement uncertainty	±2.81 dB
-------------------------	----------

## Traceability

Method	Test Equipment Used
Measurements were made per work instruction WI-03 'Measurement of RF Spectrum Mask'	0158, 0287, 0252, 0313, 0314, 0070, 0116, 0117

This test report may be reproduced in full only. The document may only be updated by MiCOM Labs personnel. Any changes will be noted in the Document History section of the report.

### 5.1.2. Transmit Output Power

**FCC, Part 15 Subpart C §15.407(a)**  
**Industry Canada RSS-210 §9.9(2)**  
**Industry Canada RSS-Gen 4.6**

#### Test Procedure

The transmitter terminal of EUT was connected to the input of an average power meter. Measurements were made while EUT was operating in a continuous transmission mode i.e. 100 % duty cycle at the appropriate center frequency. All cable losses and offsets were taken into consideration in the measured result.

#### Test Measurement Set up

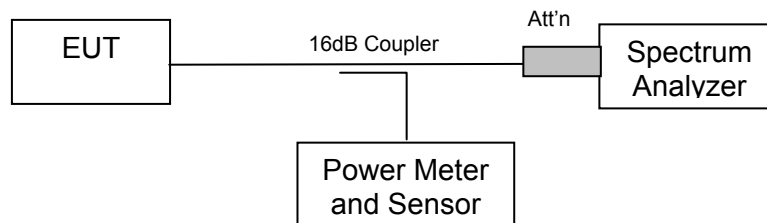

Measurement set up for Transmitter Output Power



**Title:** Aruba AP-105 802.11a/b/g/n Wireless AP  
**To:** FCC 47 CFR Part 15.407 & IC RSS-210  
**Serial #:** ARUB69-U3 Rev A  
**Date:** 11th April 2011  
**Page:** 48 of 208

**Maximum Transmit Power, FCC Limits**

Limit 5150 – 5250 MHz: Lesser of 50 mW (+17dBm) or  $4 + 10 \log(B)$  dBm

Frequency Range (MHz)	Maximum 26 dB Bandwidth (MHz)	$4 + 10 \log(B)$ (dBm)	Limit (dBm)
5150 – 5250	69.339	+22.41	+17.00

**Industry Canada Limits**

Limit 5150 – 5250 MHz: Lesser of 200 mW (+23 dBm) or  $10 + 10 \log(B)$  dBm

Frequency Range (MHz)	Maximum 99% Bandwidth (MHz)	$10 + 10 \log(B)$ (dBm)	Limit (dBm)
5150 – 5250	38.076	+25.81	+23.00

**Maximum Transmit (Conducted) Power, FCC Limits and Industry Canada Limits**

**Bands 5250 – 5350 and 5470 – 5725 MHz**

Limit lesser of: 250 mW or  $11 \text{ dBm} + 10 \log(B)$  dBm

Mode	Frequency Range (MHz)	Maximum 26 dB Bandwidth (MHz)	$11 + 10 \log(B)$ (dBm)	Limit (dBm)
a	5250 – 5350 5470 – 5725	36.373	+26.61	+24.00
HT-20		37.475	+26.74	+24.00
HT-40		75.551	+29.78	+24.00

This test report may be reproduced in full only. The document may only be updated by MiCOM Labs personnel. Any changes will be noted in the Document History section of the report.





**Measurement Results for Transmit Output Power**

Ambient conditions.

Temperature: 17 to 23 °C    Relative humidity: 31 to 57 %    Pressure: 999 to 1012 mbar

EUT parameters.

Power Level: Maximum

Duty Cycle: 100%

**5150 – 5250 MHz**

TABLE OF RESULTS – **802.11a Legacy**

Center Frequency (MHz)	Maximum Conducted Power (dBm)
5,180	+16.09
5,200	+16.11
5,240	+16.21

TABLE OF RESULTS – **802.11n HT20**

Center Frequency (MHz)	Maximum Conducted Power (dBm)
5,180	+16.52
5,200	+16.71
5,240	+16.67

TABLE OF RESULTS – **802.11n HT40**

Center Frequency (MHz)	Maximum Conducted Power (dBm)
5,190	+16.60
5,230	+16.76

This test report may be reproduced in full only. The document may only be updated by MiCOM Labs personnel. Any changes will be noted in the Document History section of the report.



**Title:** Aruba AP-105 802.11a/b/g/n Wireless AP  
**To:** FCC 47 CFR Part 15.407 & IC RSS-210  
**Serial #:** ARUB69-U3 Rev A  
**Date:** 11th April 2011  
**Page:** 50 of 208

---

**5250 – 5350 MHz**

**TABLE OF RESULTS – 802.11a Legacy**

<b>Center Frequency (MHz)</b>	<b>Maximum Conducted Power (dBm)</b>
5,260	+18.73
5,300	+19.56
5,320	+20.08

**TABLE OF RESULTS – 802.11n HT20**

<b>Center Frequency (MHz)</b>	<b>Maximum Conducted Power (dBm)</b>
5,260	+18.69
5,300	+19.48
5,320	+20.12

**TABLE OF RESULTS – 802.11n HT40**

<b>Center Frequency (MHz)</b>	<b>Maximum Conducted Power (dBm)</b>
5,270	+19.05
5,310	+19.84

---

This test report may be reproduced in full only. The document may only be updated by MiCOM Labs personnel. Any changes will be noted in the Document History section of the report.



**Title:** Aruba AP-105 802.11a/b/g/n Wireless AP  
**To:** FCC 47 CFR Part 15.407 & IC RSS-210  
**Serial #:** ARUB69-U3 Rev A  
**Date:** 11th April 2011  
**Page:** 51 of 208

---

**5500 – 5700 MHz**

**TABLE OF RESULTS – 802.11a Legacy**

<b>Center Frequency (MHz)</b>	<b>Maximum Conducted Power (dBm)</b>
5,500	+18.21
5,600	+18.24
5,700	+16.65

**TABLE OF RESULTS – 802.11n HT20**

<b>Center Frequency (MHz)</b>	<b>Maximum Conducted Power (dBm)</b>
5,500	+18.15
5,600	+18.34
5,700	+16.66

**TABLE OF RESULTS – 802.11n HT40**

<b>Center Frequency (MHz)</b>	<b>Maximum Conducted Power (dBm)</b>
5,510	+17.40
5,590	+18.32
5,690	+17.54

---

This test report may be reproduced in full only. The document may only be updated by MiCOM Labs personnel. Any changes will be noted in the Document History section of the report.



**Specification**

**Limits**

**FCC, Part 15 §15.407 (a)(1), (a)(2) and Industry Canada RSS-210 § A9.2(2)**

**(a)(1)** For the band 5.15-5.25 GHz the maximum conducted output power over the frequency band of operation shall not exceed the lesser of 50 mW or +4 dBm + 10 log B, where B is the 26 dB emission bandwidth in megahertz. In addition, the peak power spectral density shall not exceed +4 dBm in any 1 megahertz band.

**(a)(2)** For the 5.25-5.35 GHz band the maximum conducted output power over the frequency band of operation shall not exceed the lesser of 250 mW or +11 dBm + 10 log B, where B is the 26 dB emission bandwidth in megahertz. In addition, the peak power spectral density shall not exceed +11 dBm in any 1 megahertz band.

**Industry Canada RSS-210 §A9.2(2)**

For the band 5150-5250 MHz, the maximum equivalent isotropically radiated power (e.i.r.p.) shall not exceed 200 mW or 10 + 10 log<sub>10</sub> B, dBm, whichever power is less. B is the 99% emission bandwidth in MHz. The e.i.r.p. spectral density shall not exceed 10 dBm in any 1.0 MHz band.

For the band 5250-5350 MHz and 5470-5725 MHz, the maximum conducted output power shall not exceed 250 mW or 11 + 10 log<sub>10</sub> B, dBm, whichever power is less. The power spectral density shall not exceed 11 dBm in any 1.0 MHz band. The maximum e.i.r.p. shall not exceed 1.0 W or 17 + 10 log<sub>10</sub> B, dBm, whichever power is less. B is the 99% emission bandwidth in MHz.

**Industry Canada RSS-Gen 4.4**

When an occupied bandwidth value is not specified in the applicable RSS, the transmitted signal bandwidth to be reported is to be its 99% emission bandwidth, as calculated or measured.

**Laboratory Measurement Uncertainty for Power Measurements**

Measurement uncertainty	±1.33 dB
-------------------------	----------

**Traceability**

Method	Test Equipment Used
Measurements were made per work instruction WI-01 'Measuring RF Output Power'	0158, 0287, 0252, 0313, 0314, 0070, 0116, 0117

This test report may be reproduced in full only. The document may only be updated by MiCOM Labs personnel. Any changes will be noted in the Document History section of the report.

### 5.1.3. Peak Power Spectral Density

**FCC, Part 15 Subpart C §15.407(a)**  
**Industry Canada RSS-210 § A9.2(2)**

#### **Test Procedure**

The transmitter output was connected to a spectrum analyzer and the peak power spectral density measured. Method 2 Sample Detection and power averaging, specified in FCC document DA 02-2138 (Normative Reference (ix) Section 2.1 “Guidelines for Assessing Unlicensed National Information Infrastructure (U-NII) Devices”) was used to determine the peak power spectral density of the emission. The Peak Power Spectral Density is the highest level found across the emission in a 1 MHz resolution bandwidth.

#### **Test Measurement Set up**

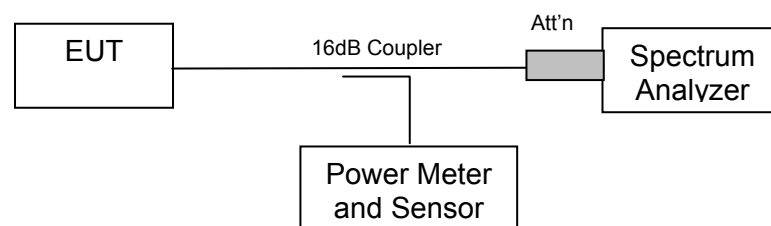

Measurement set up for Peak Power Spectral Density

#### **Measurement Results for Peak Power Spectral Density**

Ambient conditions.

Temperature: 17 to 23 °C      Relative humidity: 31 to 57 %      Pressure: 999 to 1012 mbar

Radio Parameters

Duty Cycle: 100%

Output: Modulated Carrier

Power: Maximum Default Power



**TABLE OF RESULTS – 802.11a Legacy**

Center Frequency (MHz)	Peak Frequency (MHz)	PPSD (dBm)
5,180	5176.14228	+3.39
5,200	5204.45892	+3.05
5,240	5233.03607	+3.53

**5,180 MHz 802.11a Legacy Peak Power Spectral Density**

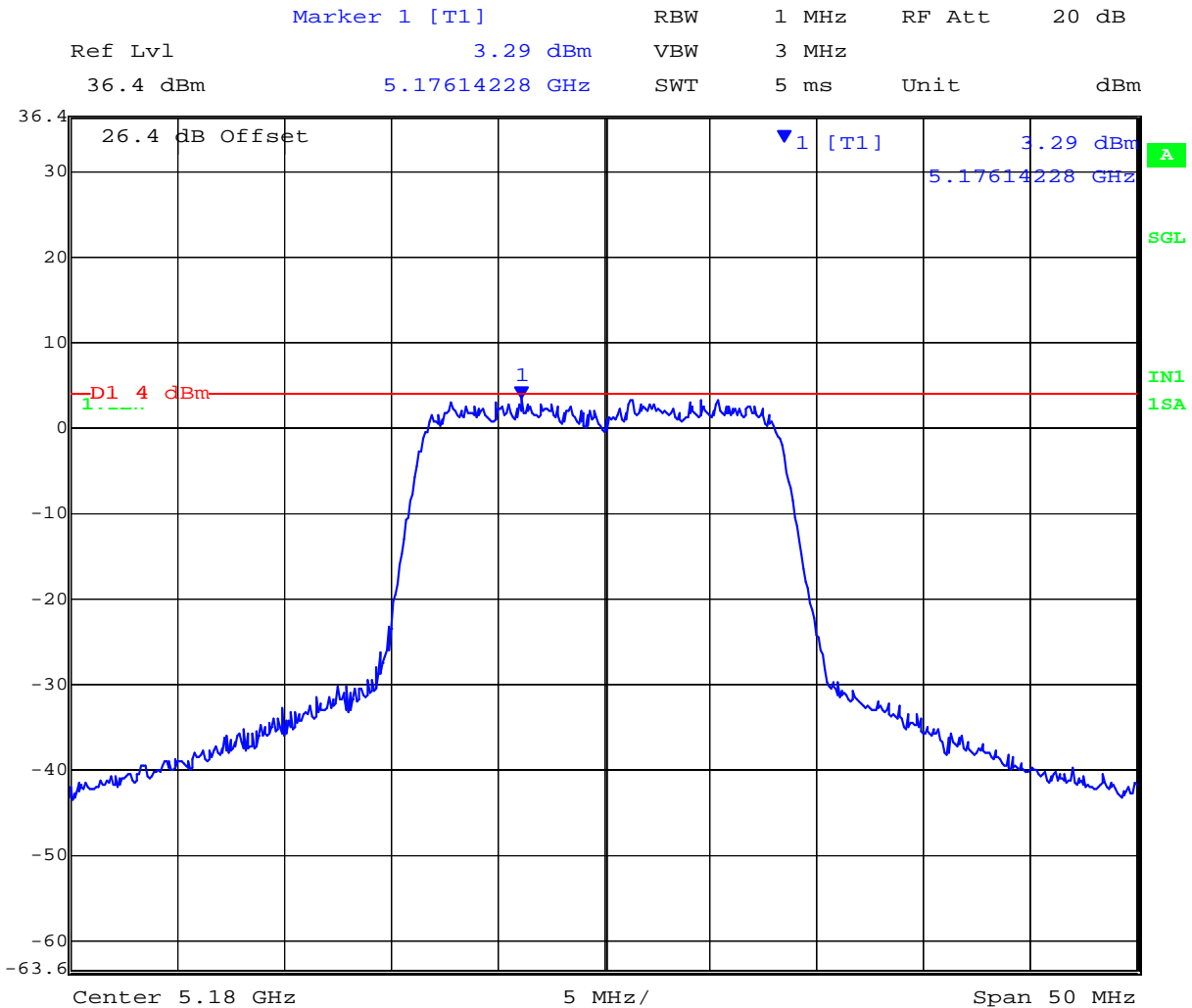

Date: 2.JUL.2009 10:37:27

This test report may be reproduced in full only. The document may only be updated by MiCOM Labs personnel. Any changes will be noted in the Document History section of the report.



Title: Aruba AP-105 802.11a/b/g/n Wireless AP  
To: FCC 47 CFR Part 15.407 & IC RSS-210  
Serial #: ARUB69-U3 Rev A  
Date: 11th April 2011  
Page: 55 of 208

### 5,200 MHz 802.11a Legacy Peak Power Spectral Density

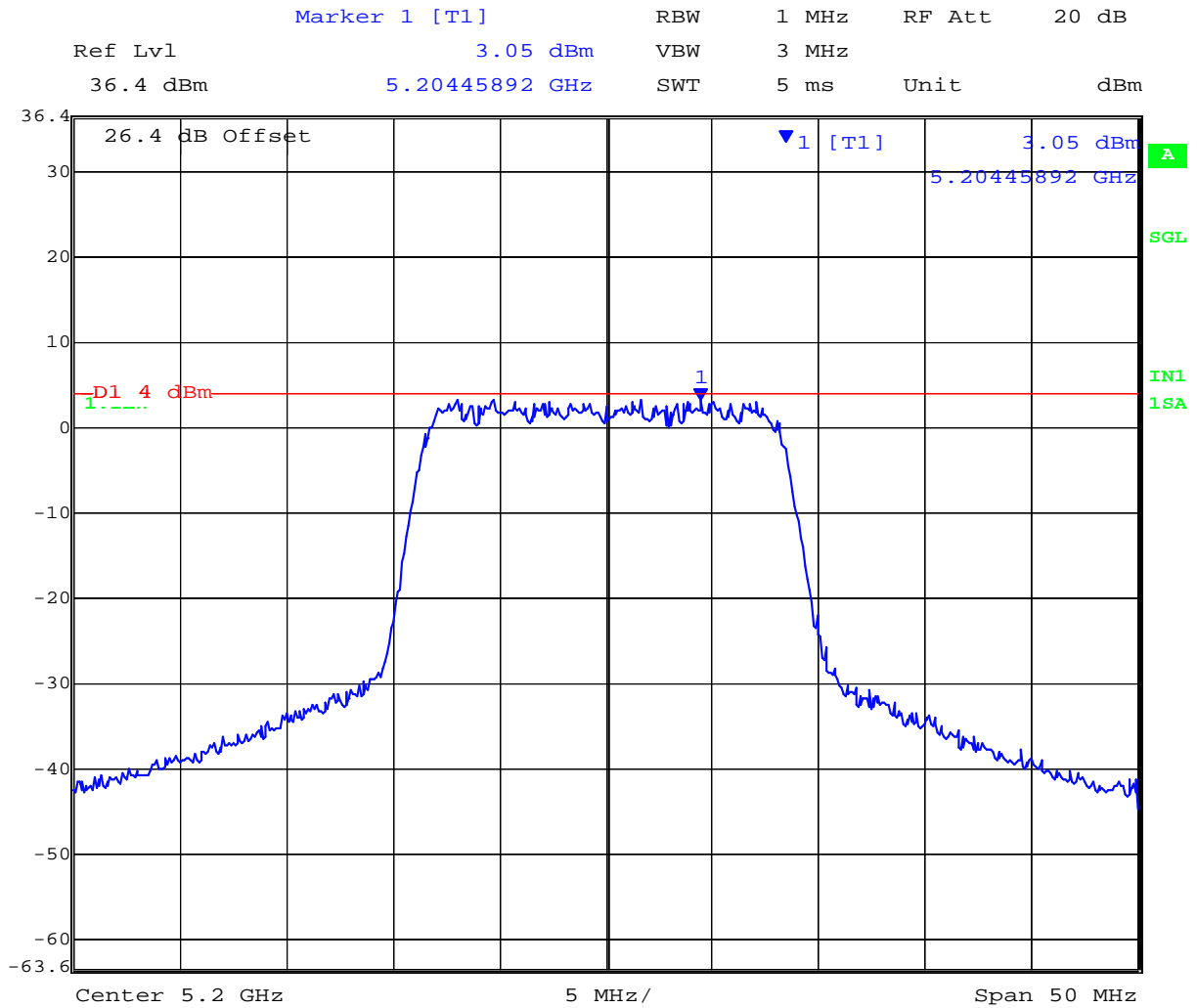

Date: 2.JUL.2009 10:55:30

This test report may be reproduced in full only. The document may only be updated by MiCOM Labs personnel. Any changes will be noted in the Document History section of the report.



Title: Aruba AP-105 802.11a/b/g/n Wireless AP  
To: FCC 47 CFR Part 15.407 & IC RSS-210  
Serial #: ARUB69-U3 Rev A  
Date: 11th April 2011  
Page: 56 of 208

### 5,240 MHz 802.11a Legacy Peak Power Spectral Density

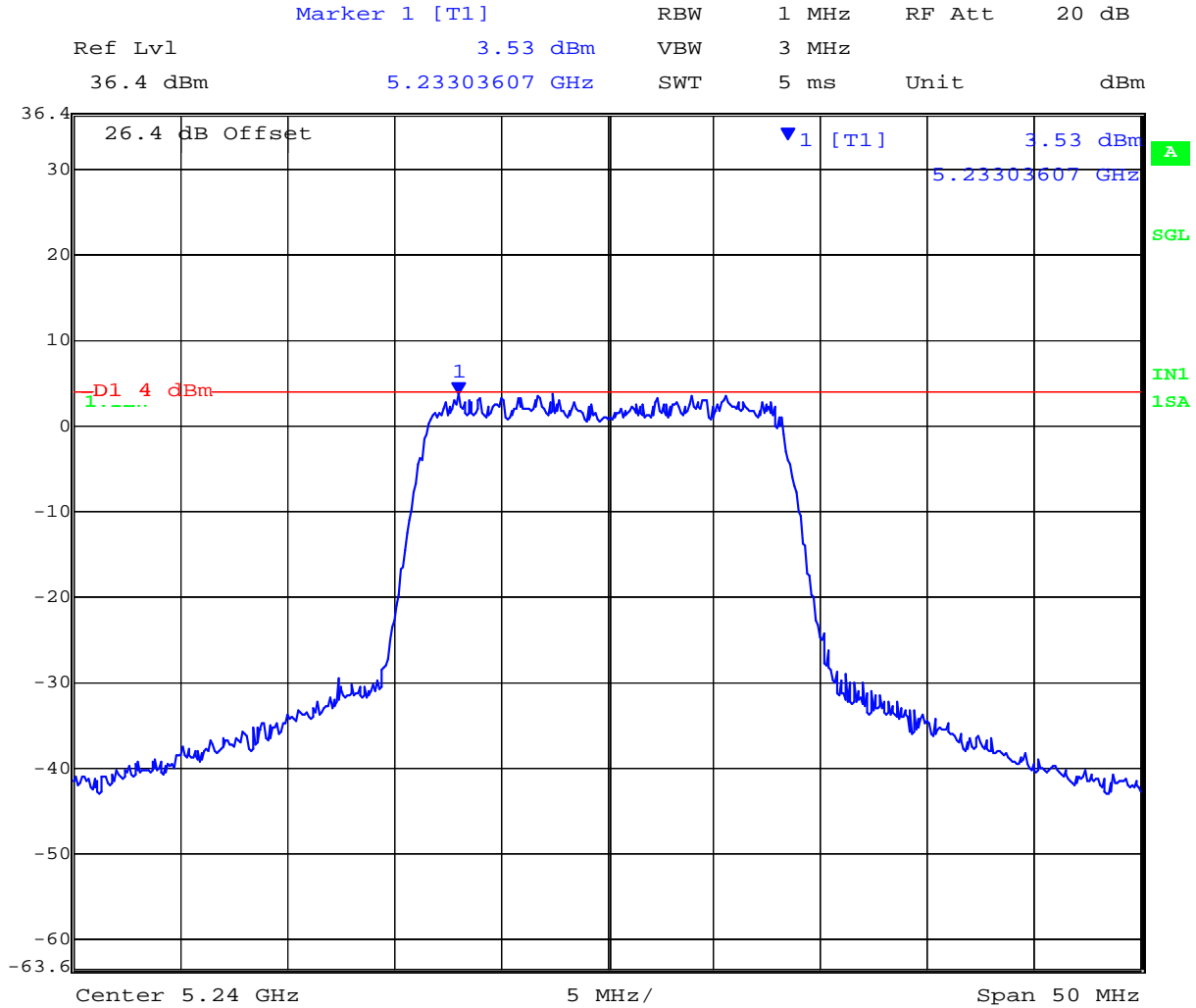

Date: 2.JUL.2009 10:56:53

This test report may be reproduced in full only. The document may only be updated by MiCOM Labs personnel. Any changes will be noted in the Document History section of the report.

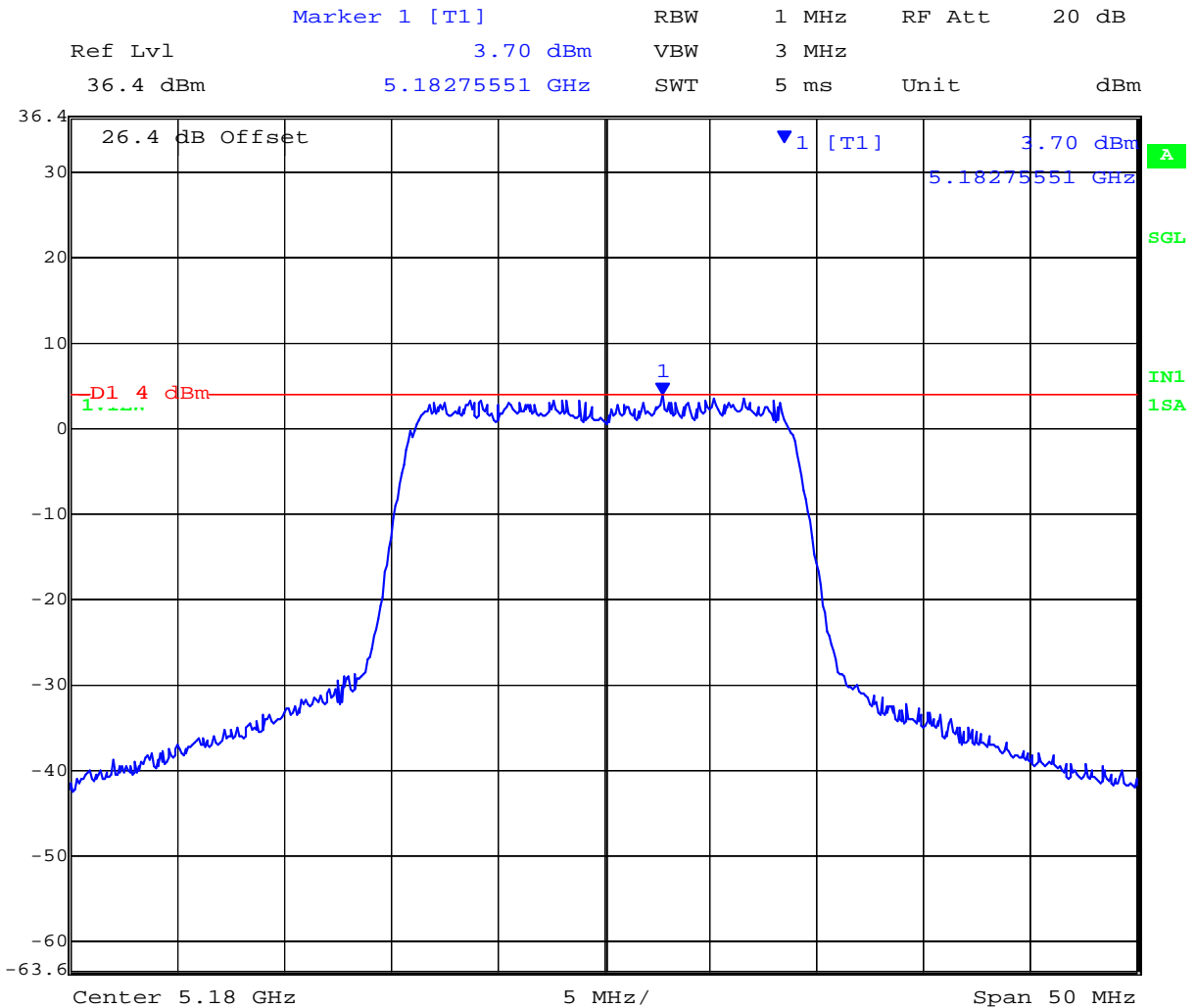



**TABLE OF RESULTS – 802.11n HT20**

Center Frequency (MHz)	Peak Frequency (MHz)	PPSD (dBm)
5,180	5182.75551	+3.70
5,200	5193.23647	+3.49
5,240	5244.15832	+3.95

**5,180 MHz 802.11n HT20 Peak Power Spectral Density**



Date: 2.JUL.2009 10:36:21

This test report may be reproduced in full only. The document may only be updated by MiCOM Labs personnel. Any changes will be noted in the Document History section of the report.



Title: Aruba AP-105 802.11a/b/g/n Wireless AP  
To: FCC 47 CFR Part 15.407 & IC RSS-210  
Serial #: ARUB69-U3 Rev A  
Date: 11th April 2011  
Page: 58 of 208

### 5,200 MHz 802.11n HT20 Peak Power Spectral Density

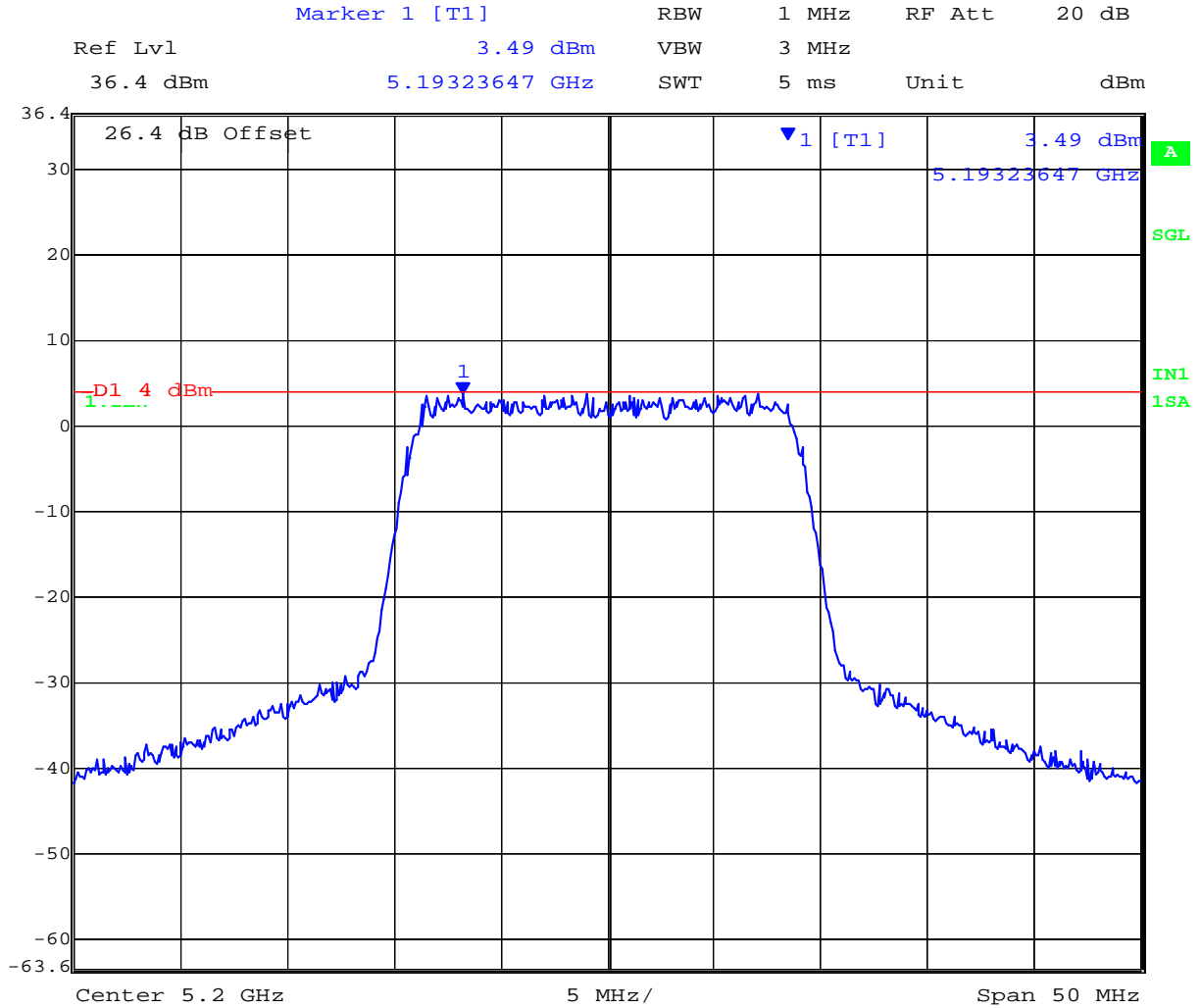

Date: 2.JUL.2009 10:14:01

This test report may be reproduced in full only. The document may only be updated by MiCOM Labs personnel. Any changes will be noted in the Document History section of the report.



Title: Aruba AP-105 802.11a/b/g/n Wireless AP  
To: FCC 47 CFR Part 15.407 & IC RSS-210  
Serial #: ARUB69-U3 Rev A  
Date: 11th April 2011  
Page: 59 of 208

### 5,240 MHz 802.11n HT20 Peak Power Spectral Density

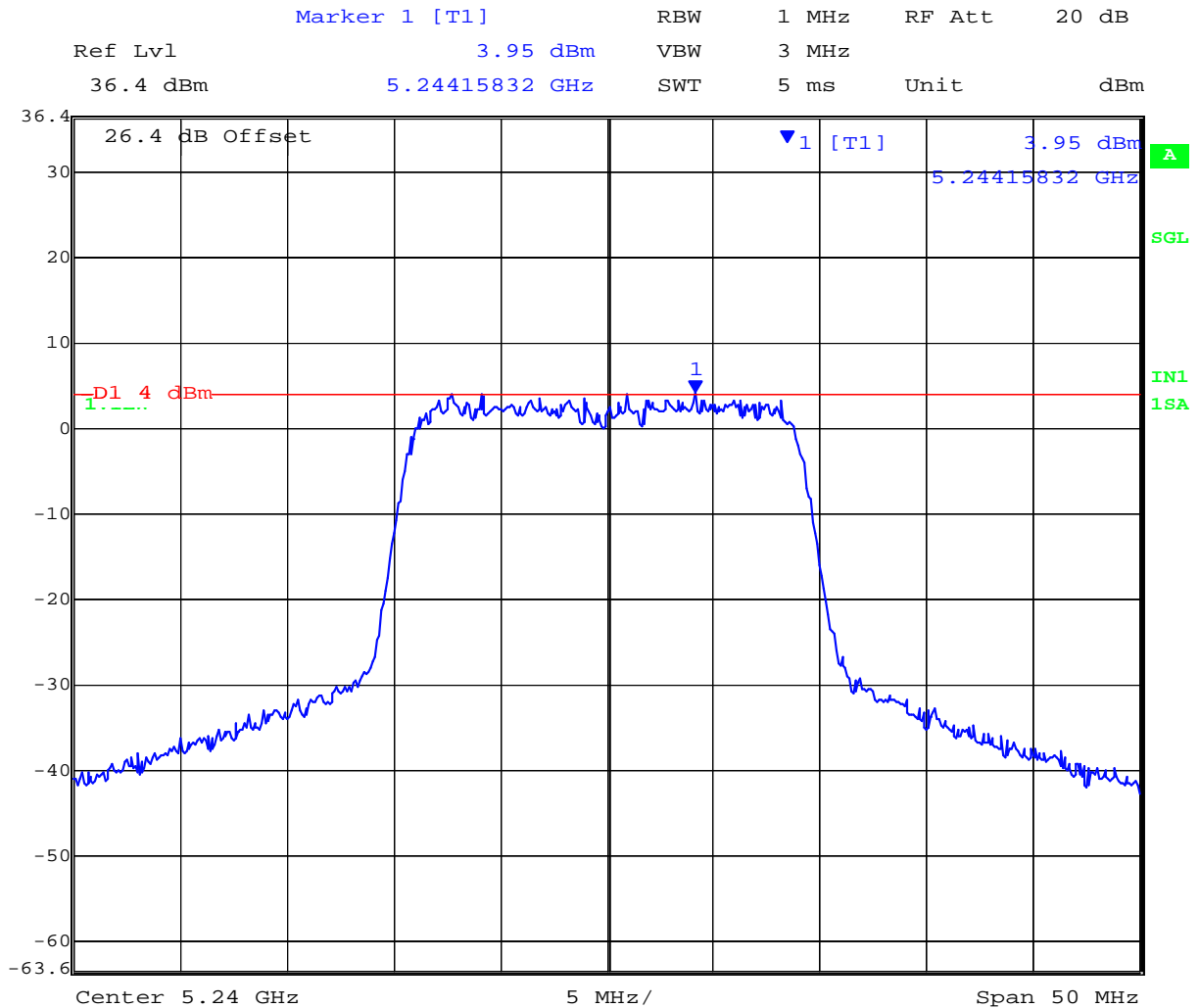

Date: 2.JUL.2009 10:08:13

This test report may be reproduced in full only. The document may only be updated by MiCOM Labs personnel. Any changes will be noted in the Document History section of the report.



TABLE OF RESULTS – 802.11n HT40

Center Frequency (MHz)	Peak Frequency (MHz)	PPSD (dBm)
5,190	5180.75651	+0.55
5,230	5220.60621	+0.49

5,190 MHz 802.11n HT40 Peak Power Spectral Density

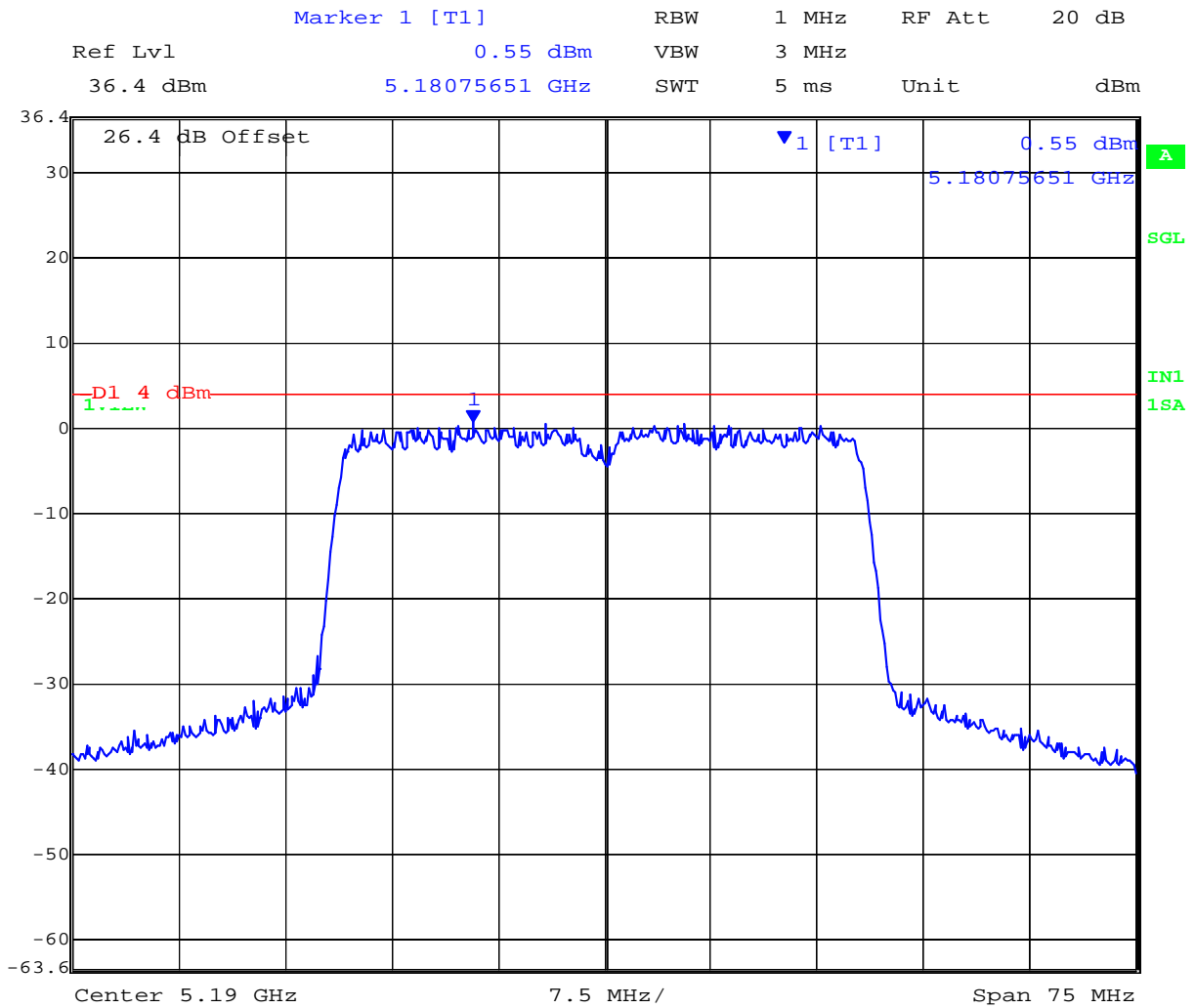

Date: 2.JUL.2009 11:24:49

This test report may be reproduced in full only. The document may only be updated by MiCOM Labs personnel. Any changes will be noted in the Document History section of the report.



### 5,230 MHz 802.11n HT40 Peak Power Spectral Density

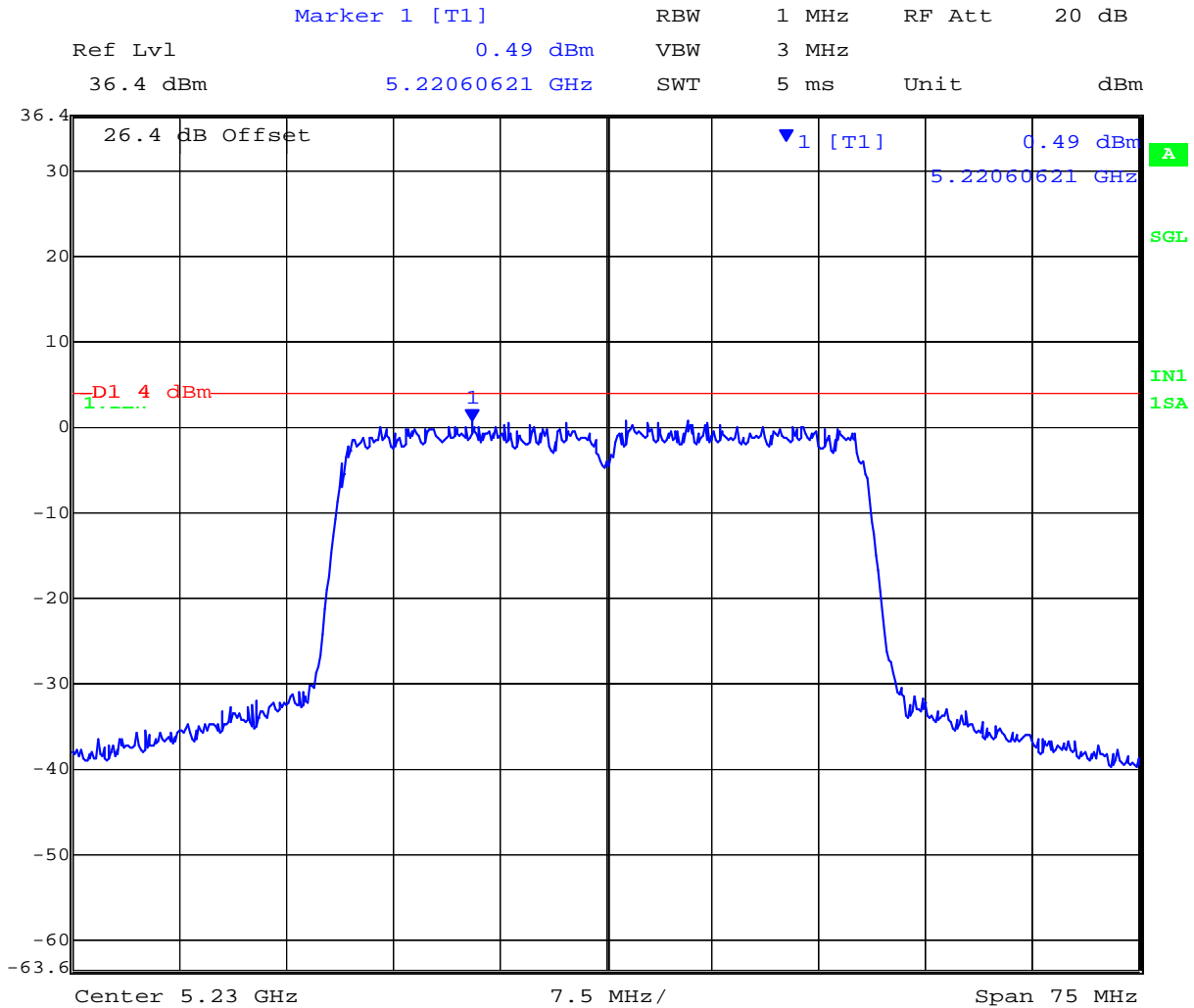

Date: 2.JUL.2009 11:26:08

This test report may be reproduced in full only. The document may only be updated by MiCOM Labs personnel. Any changes will be noted in the Document History section of the report.



**TABLE OF RESULTS – 802.11a Legacy**

Center Frequency (MHz)	Peak Frequency (MHz)	PPSD (dBm)
5,260	5256.24248	+5.89
5,300	5306.46293	+6.69
5,320	5325.96192	+7.45

**5,260 MHz 802.11a Legacy Peak Power Spectral Density**

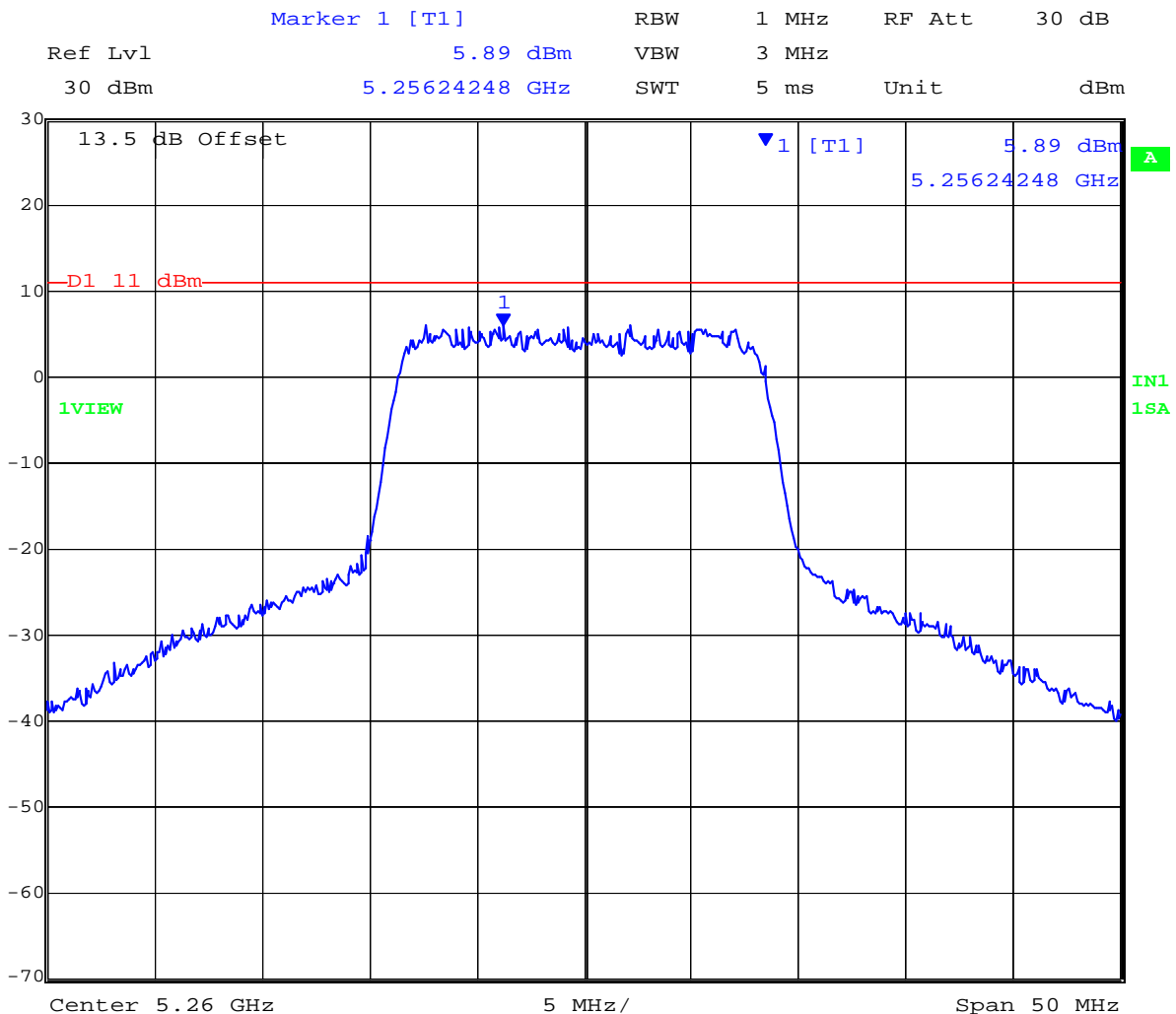

Date: 3.MAR.2010 09:54:19

This test report may be reproduced in full only. The document may only be updated by MiCOM Labs personnel. Any changes will be noted in the Document History section of the report.



Title: Aruba AP-105 802.11a/b/g/n Wireless AP  
To: FCC 47 CFR Part 15.407 & IC RSS-210  
Serial #: ARUB69-U3 Rev A  
Date: 11th April 2011  
Page: 63 of 208

### 5,300 MHz 802.11a Legacy Peak Power Spectral Density

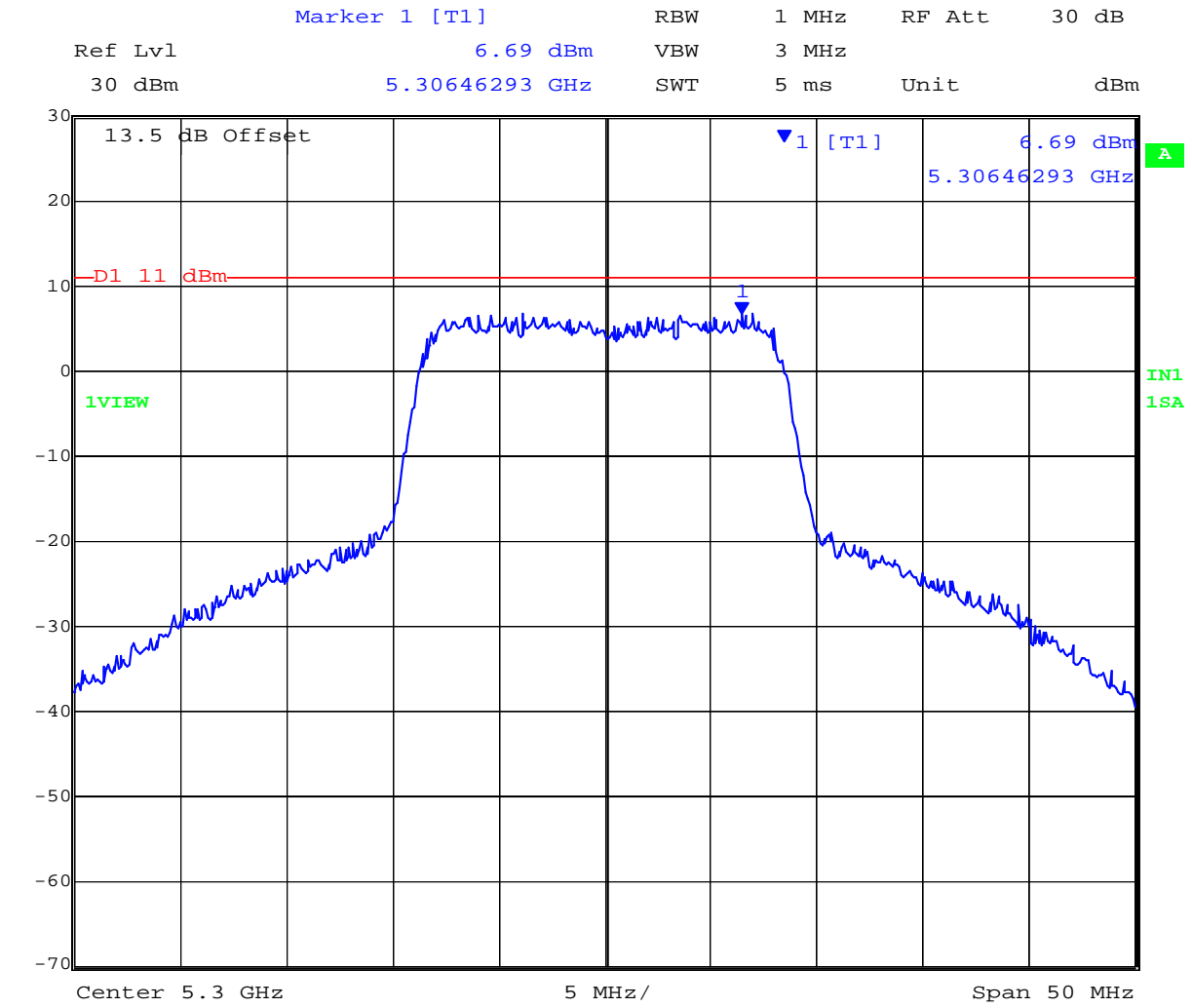

Date: 3.MAR.2010 10:06:25

This test report may be reproduced in full only. The document may only be updated by MiCOM Labs personnel. Any changes will be noted in the Document History section of the report.



Title: Aruba AP-105 802.11a/b/g/n Wireless AP  
To: FCC 47 CFR Part 15.407 & IC RSS-210  
Serial #: ARUB69-U3 Rev A  
Date: 11th April 2011  
Page: 64 of 208

### 5,320 MHz 802.11a Legacy Peak Power Spectral Density

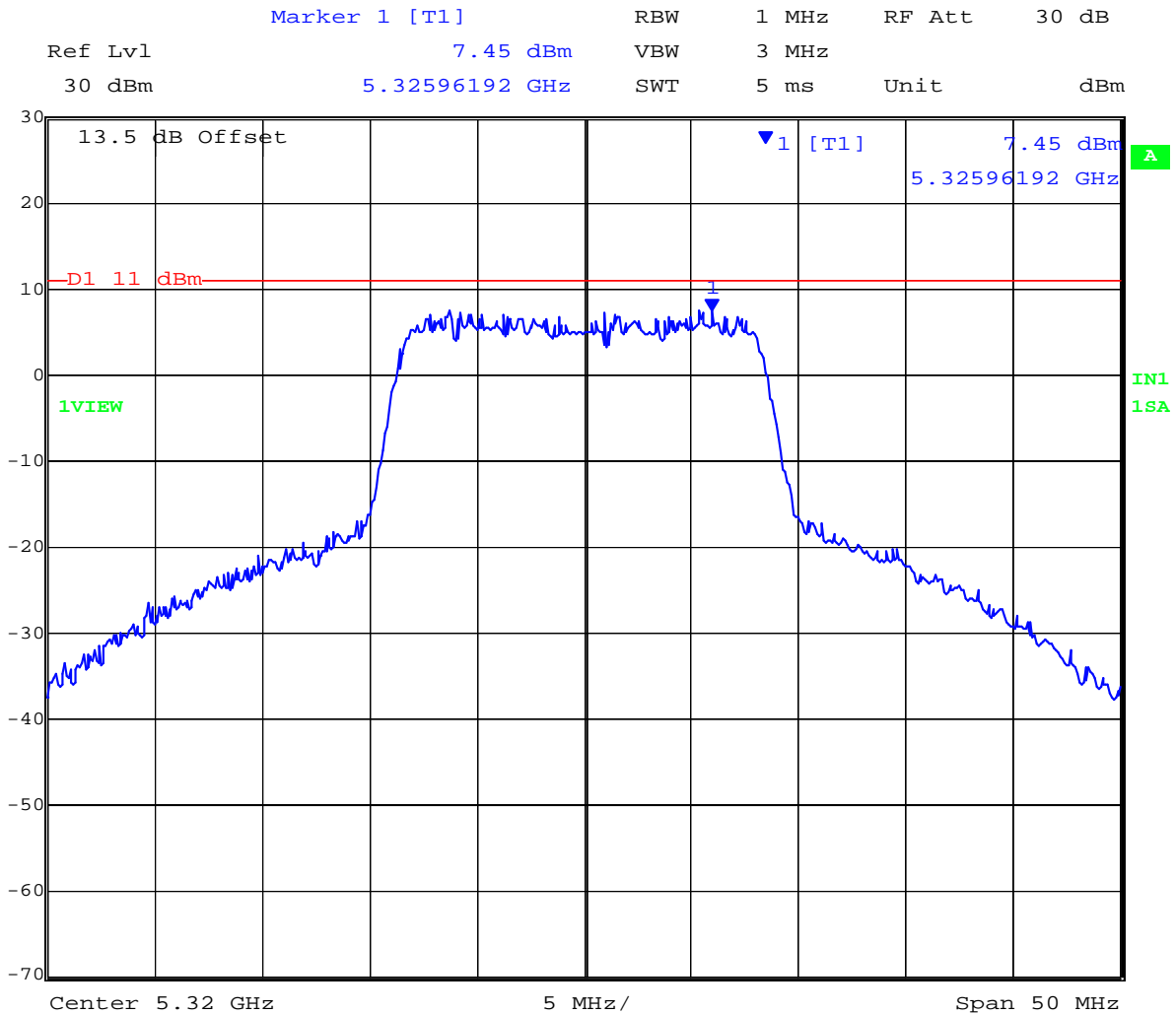

Date: 3.MAR.2010 10:16:55

This test report may be reproduced in full only. The document may only be updated by MiCOM Labs personnel. Any changes will be noted in the Document History section of the report.

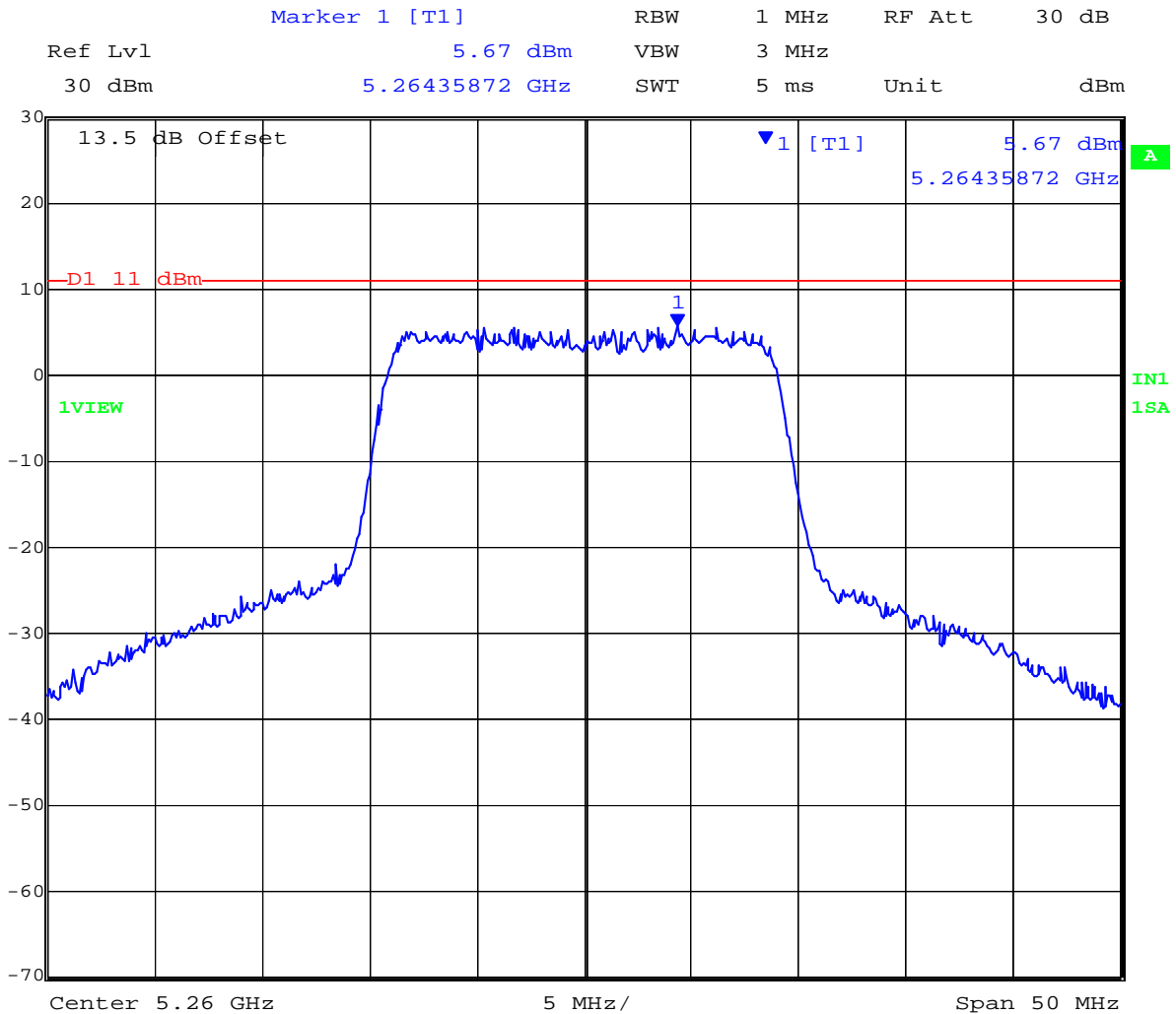



TABLE OF RESULTS – 802.11n HT20

Center Frequency (MHz)	Peak Frequency (MHz)	PPSD (dBm)
5,260	5264.35872	+5.67
5,300	5292.23447	+6.57
5,320	5312.73547	+7.29

5,260 MHz 802.11n HT20 Peak Power Spectral Density



Date: 3.MAR.2010 10:36:38

This test report may be reproduced in full only. The document may only be updated by MiCOM Labs personnel. Any changes will be noted in the Document History section of the report.



Title: Aruba AP-105 802.11a/b/g/n Wireless AP  
To: FCC 47 CFR Part 15.407 & IC RSS-210  
Serial #: ARUB69-U3 Rev A  
Date: 11th April 2011  
Page: 66 of 208

### 5,300 MHz 802.11n HT20 Peak Power Spectral Density

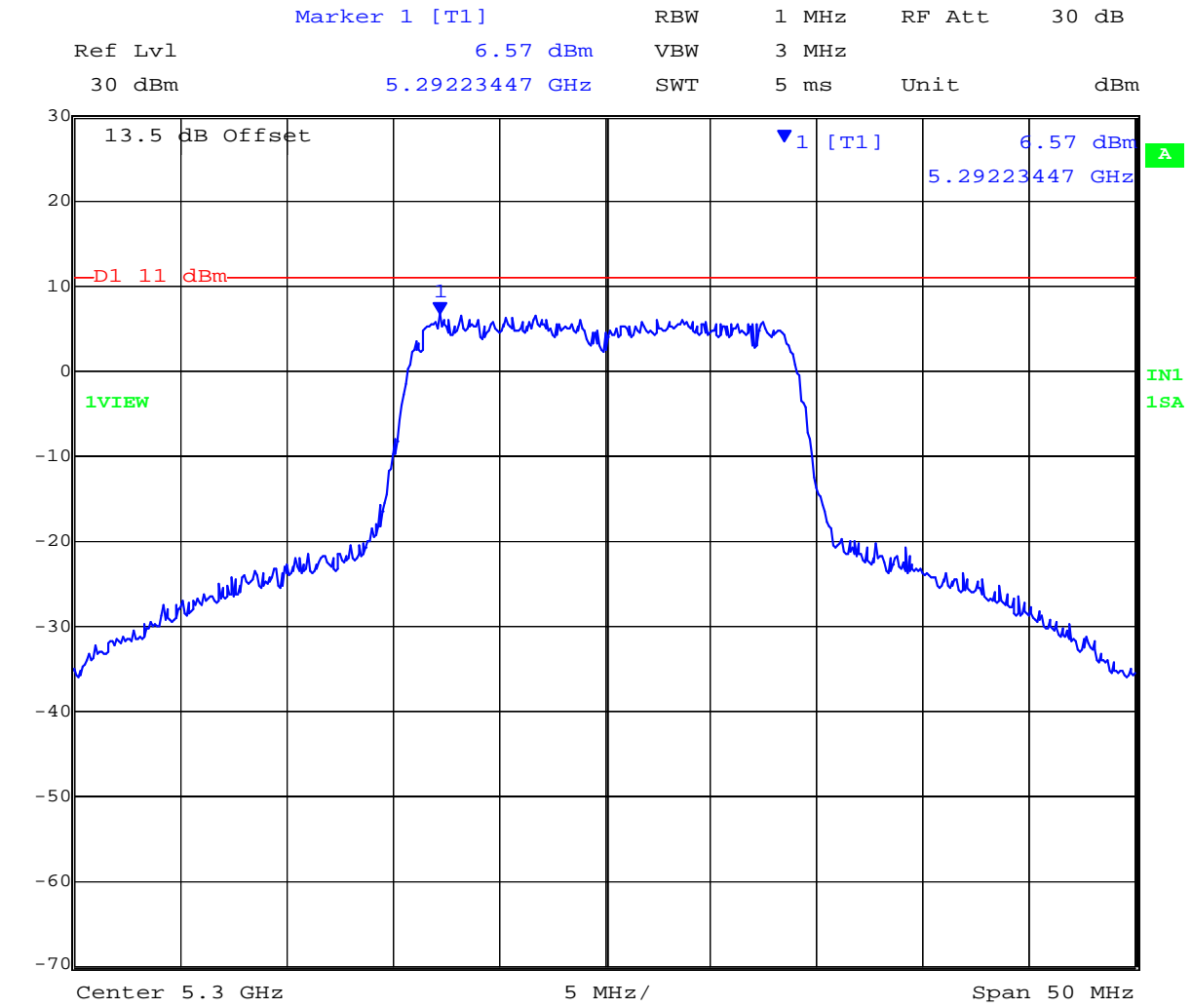

Date: 3.MAR.2010 10:54:07

This test report may be reproduced in full only. The document may only be updated by MiCOM Labs personnel. Any changes will be noted in the Document History section of the report.



### 5,320 MHz 802.11n HT20 Peak Power Spectral Density

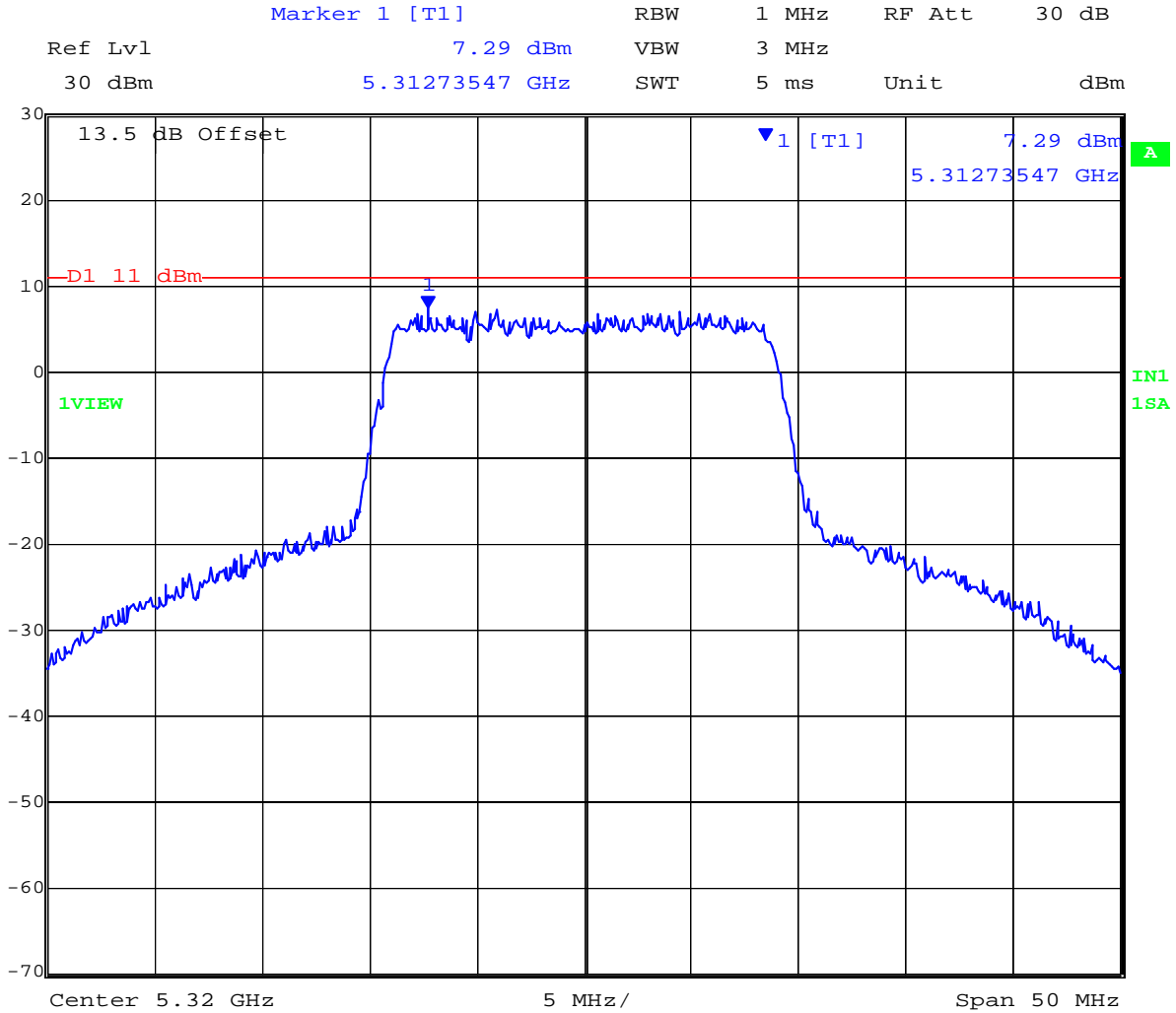

Date: 3.MAR.2010 11:03:17

This test report may be reproduced in full only. The document may only be updated by MiCOM Labs personnel. Any changes will be noted in the Document History section of the report.



TABLE OF RESULTS – 802.11n HT40

Center Frequency (MHz)	Peak Frequency (MHz)	PPSD (dBm)
5,270	5256.87375	+3.05
5,310	5300.68136	+3.29

5,510 MHz 802.11n HT40 Peak Power Spectral Density

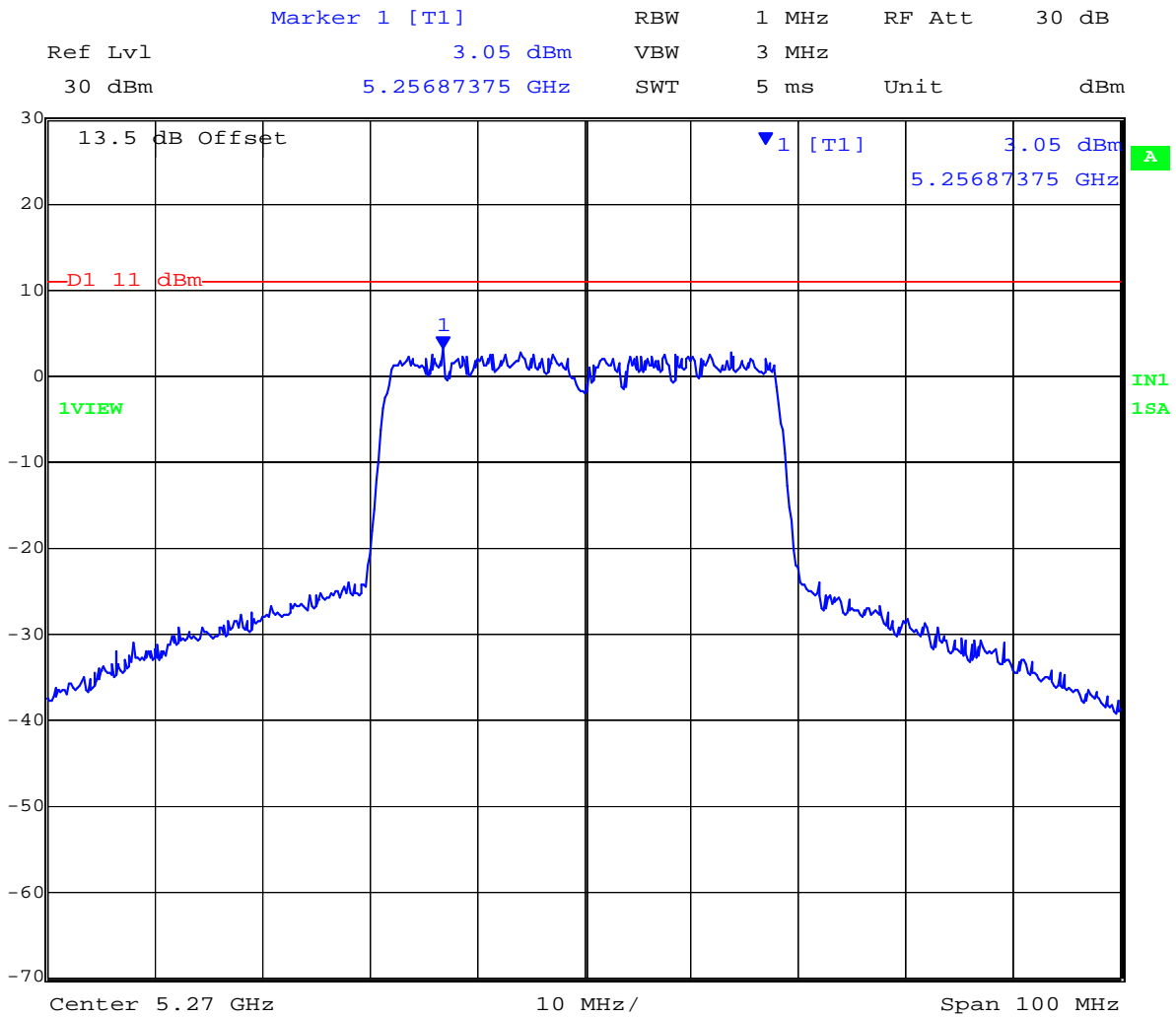

Date: 3.MAR.2010 11:18:30

This test report may be reproduced in full only. The document may only be updated by MiCOM Labs personnel. Any changes will be noted in the Document History section of the report.



Title: Aruba AP-105 802.11a/b/g/n Wireless AP  
To: FCC 47 CFR Part 15.407 & IC RSS-210  
Serial #: ARUB69-U3 Rev A  
Date: 11th April 2011  
Page: 69 of 208

### 5,310 MHz 802.11n HT40 Peak Power Spectral Density

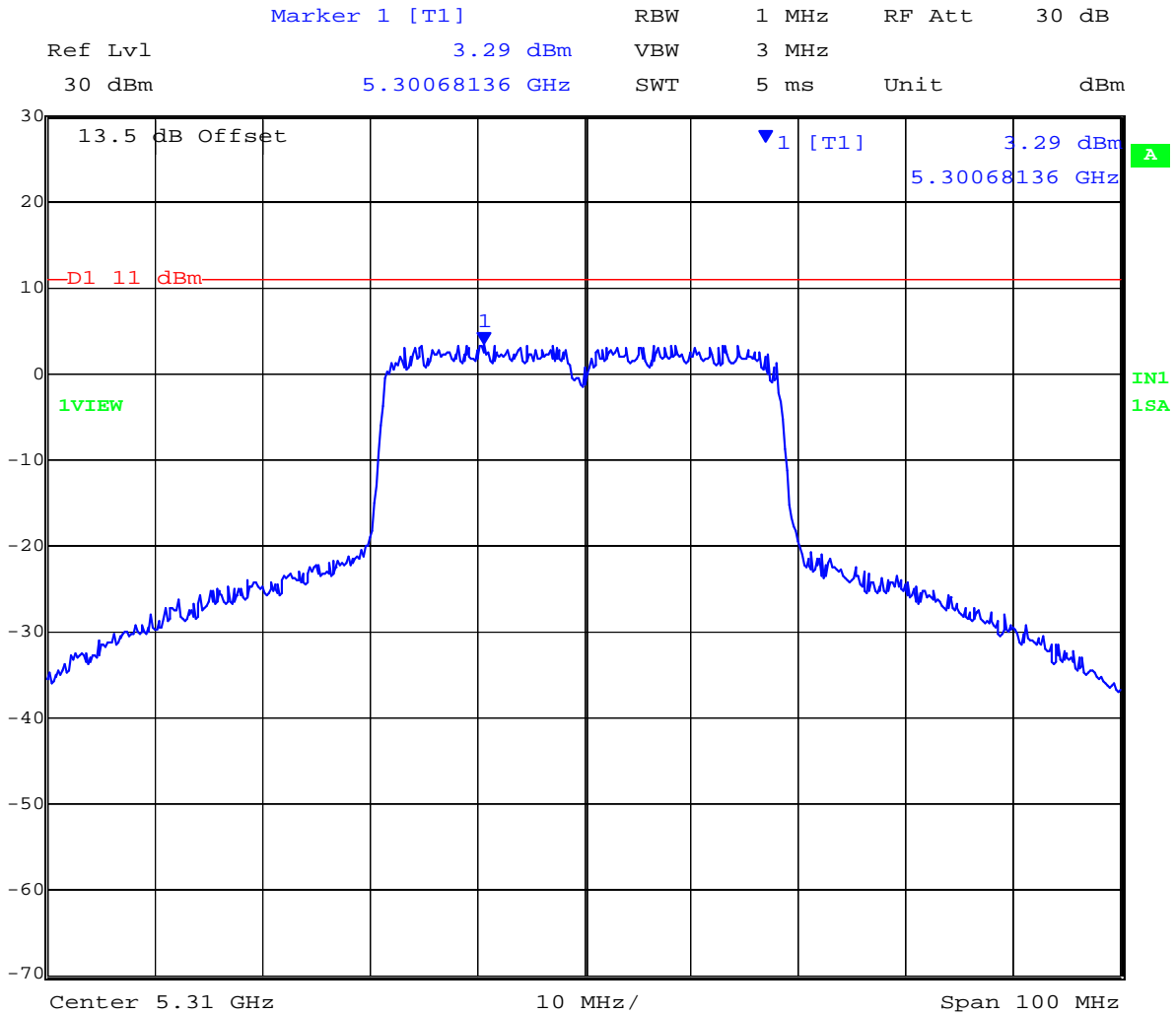

Date: 3.MAR.2010 11:39:40

This test report may be reproduced in full only. The document may only be updated by MiCOM Labs personnel. Any changes will be noted in the Document History section of the report.



**TABLE OF RESULTS – 802.11a Legacy**

Center Frequency (MHz)	Peak Frequency (MHz)	PPSD (dBm)
5,500	5495.24048	+5.83
5,600	5597.94589	+5.70
5,700		

**5,500 MHz 802.11a Legacy Peak Power Spectral Density**

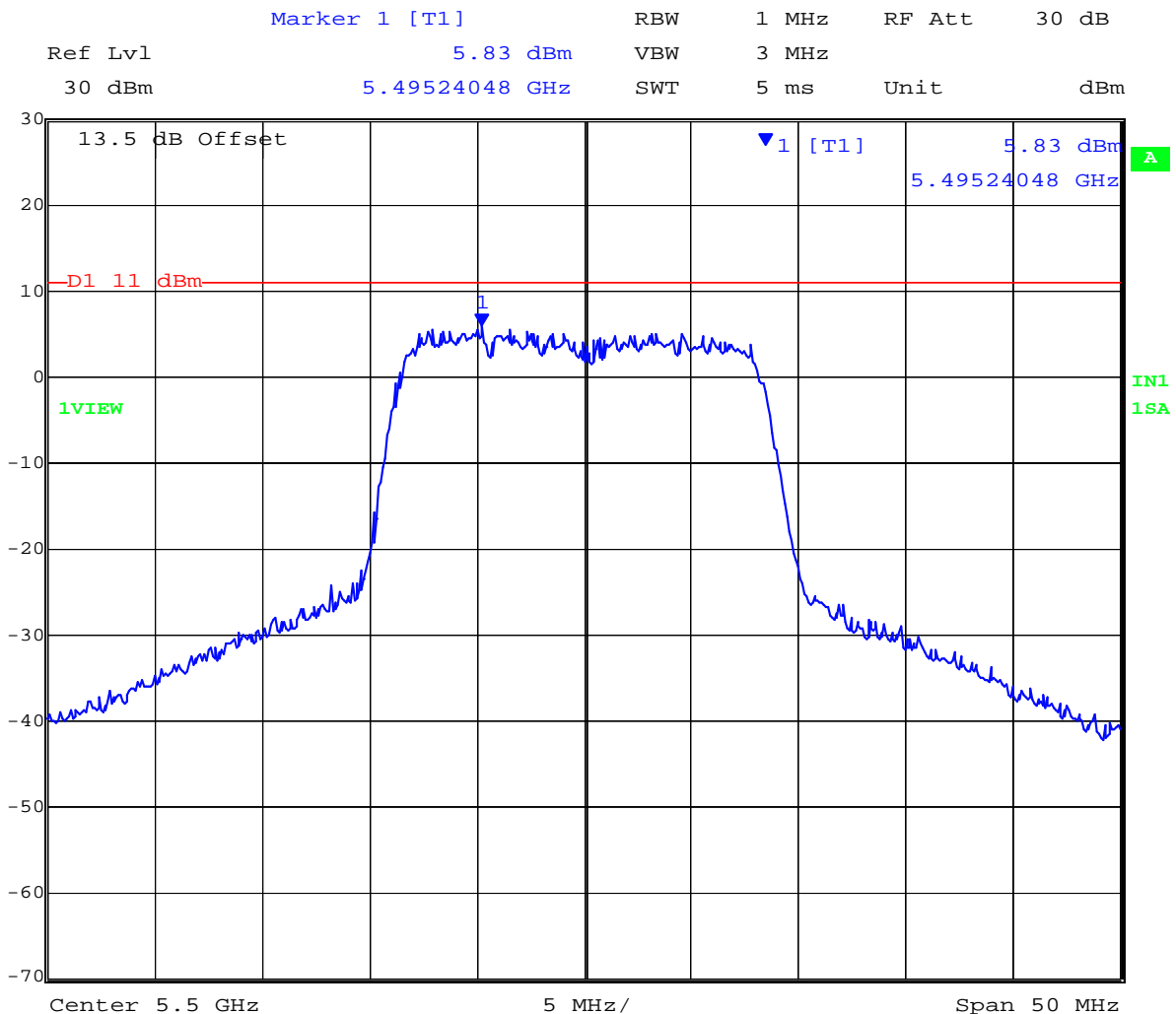

Date: 3.MAR.2010 12:09:08

This test report may be reproduced in full only. The document may only be updated by MiCOM Labs personnel. Any changes will be noted in the Document History section of the report.



### 5,600 MHz 802.11a Legacy Peak Power Spectral Density

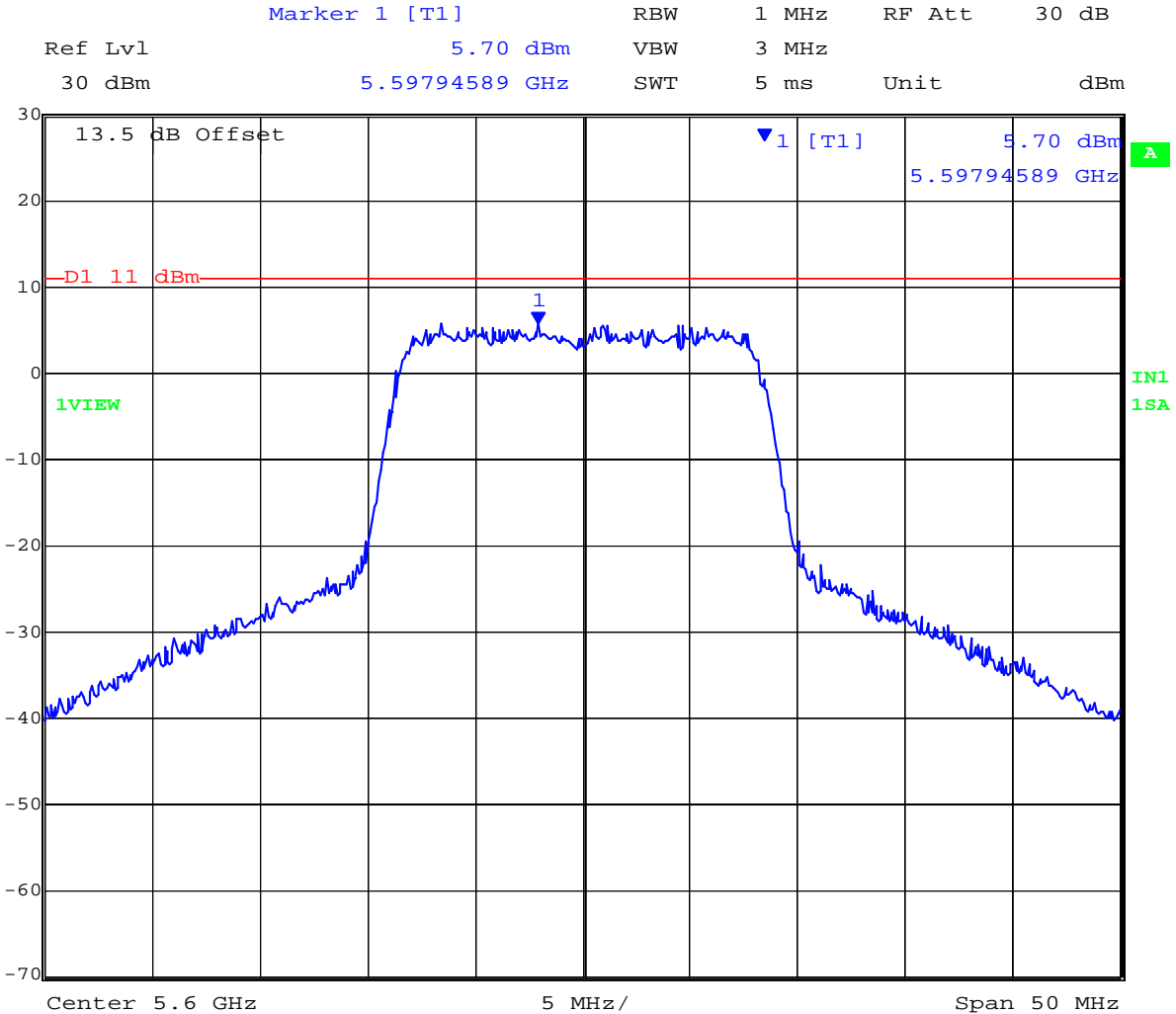

Date: 3.MAR.2010 12:25:47

This test report may be reproduced in full only. The document may only be updated by MiCOM Labs personnel. Any changes will be noted in the Document History section of the report.



**TABLE OF RESULTS – 802.11n HT20**

Center Frequency (MHz)	Peak Frequency (MHz)	PPSD (dBm)
5,500	5502.35687	+5.11
5,600	5597.84569	+5.32
5,700	5702.35471	+3.45

**5,600 MHz 802.11n HT20 Peak Power Spectral Density**

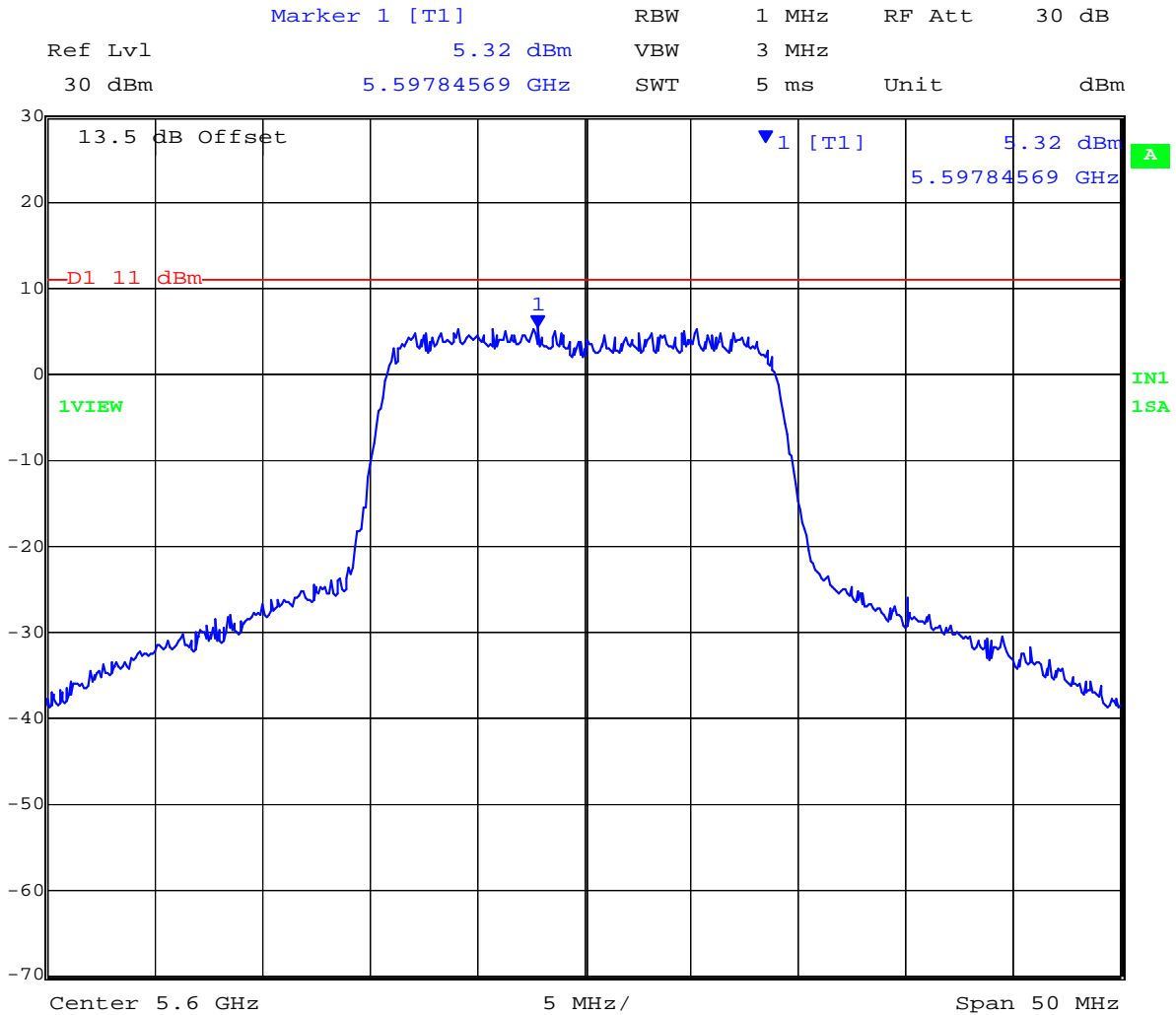

Date: 3.MAR.2010 14:18:02

This test report may be reproduced in full only. The document may only be updated by MiCOM Labs personnel. Any changes will be noted in the Document History section of the report.





Title: Aruba AP-105 802.11a/b/g/n Wireless AP  
To: FCC 47 CFR Part 15.407 & IC RSS-210  
Serial #: ARUB69-U3 Rev A  
Date: 11th April 2011  
Page: 73 of 208

### 5,700 MHz 802.11n HT20 Peak Power Spectral Density

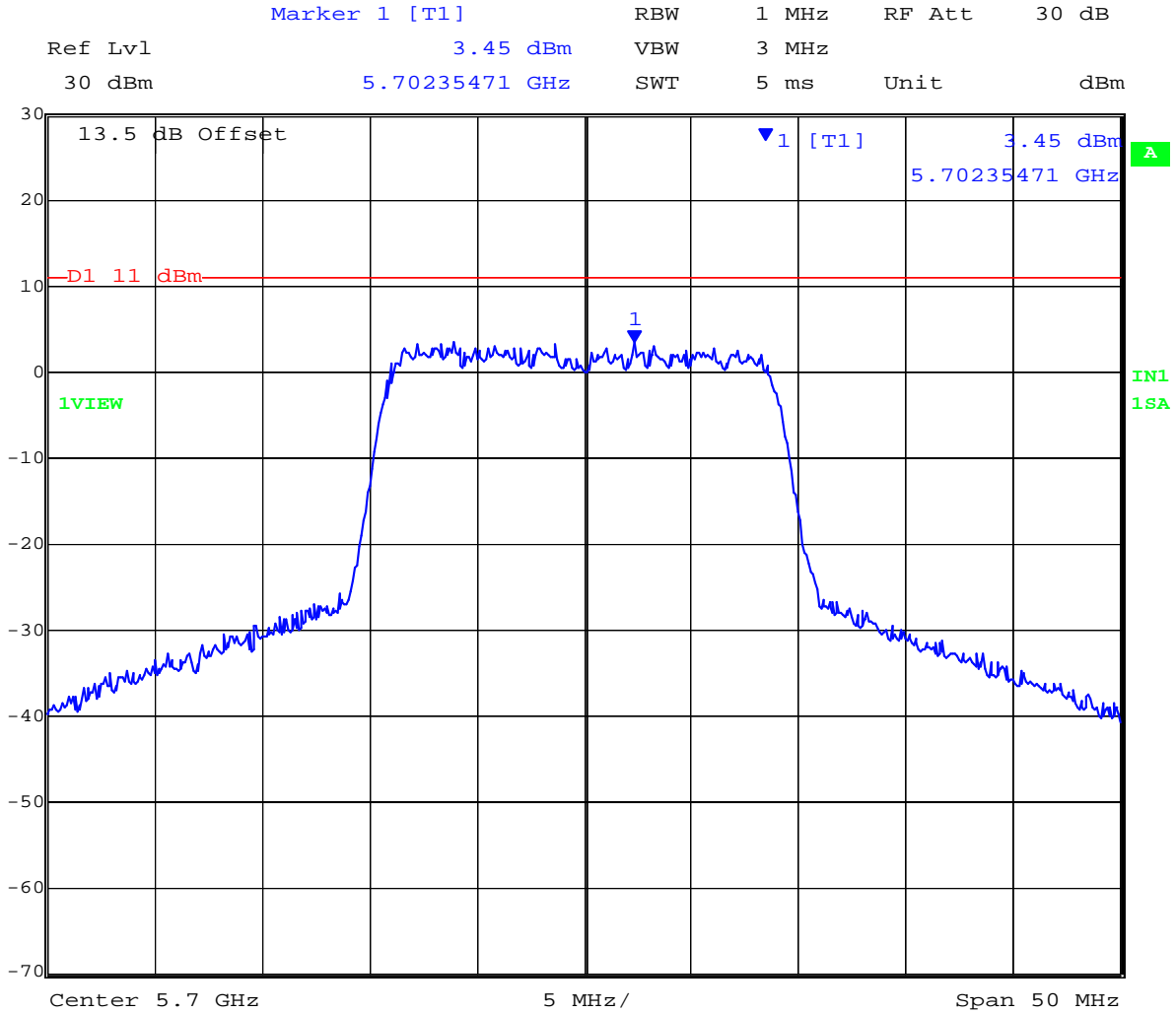

Date: 3.MAR.2010 14:28:10

This test report may be reproduced in full only. The document may only be updated by MiCOM Labs personnel. Any changes will be noted in the Document History section of the report.



TABLE OF RESULTS – 802.11n HT40

Center Frequency (MHz)	Peak Frequency (MHz)	PPSD (dBm)
5,510	5494.66934	+1.36
5,590	5576.27255	+1.67
5,690	5677.67535	+1.77

5,510 MHz 802.11n HT40 Peak Power Spectral Density

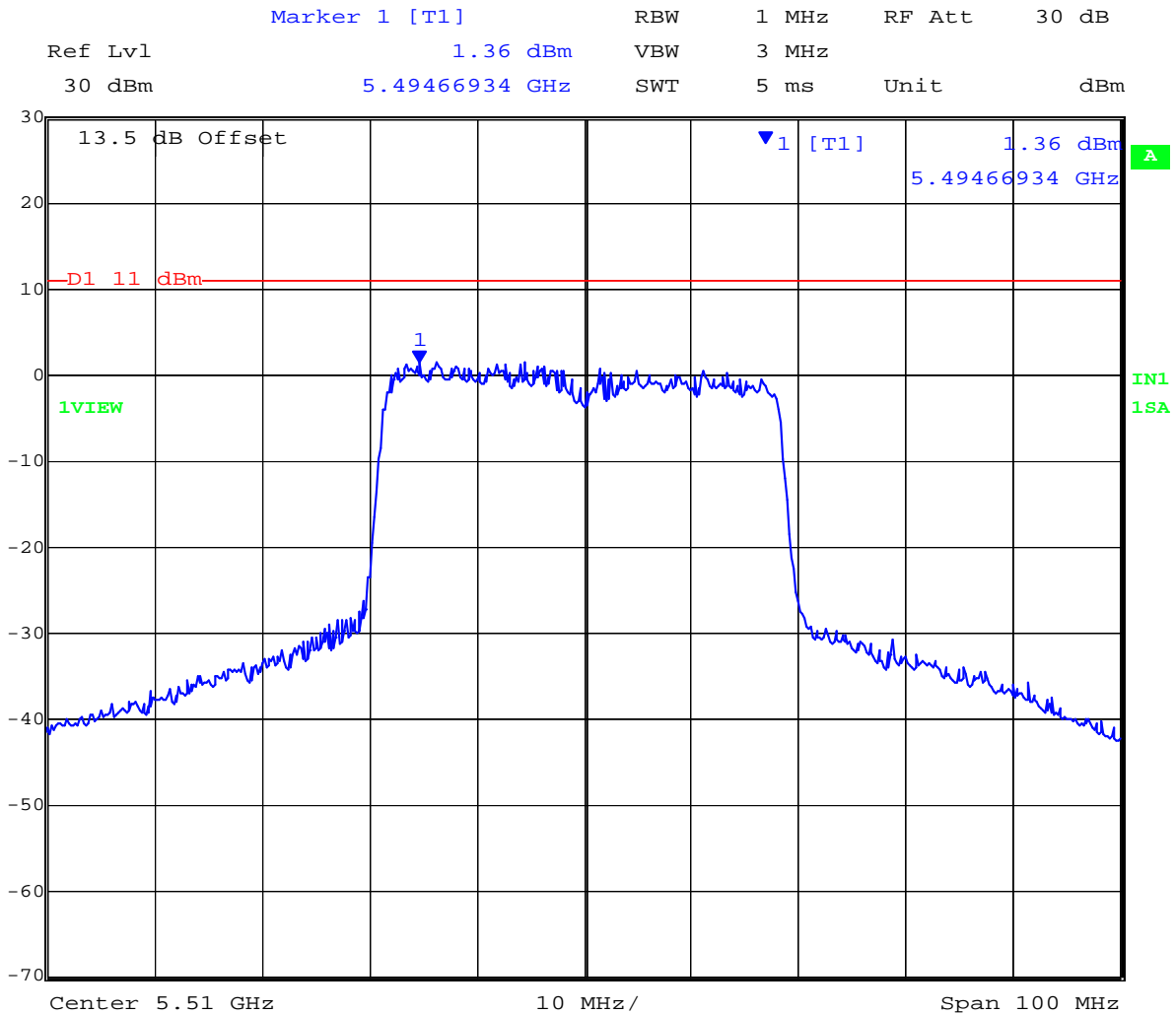

Date: 3.MAR.2010 14:44:19

This test report may be reproduced in full only. The document may only be updated by MiCOM Labs personnel. Any changes will be noted in the Document History section of the report.



### 5,590 MHz 802.11n HT40 Peak Power Spectral Density

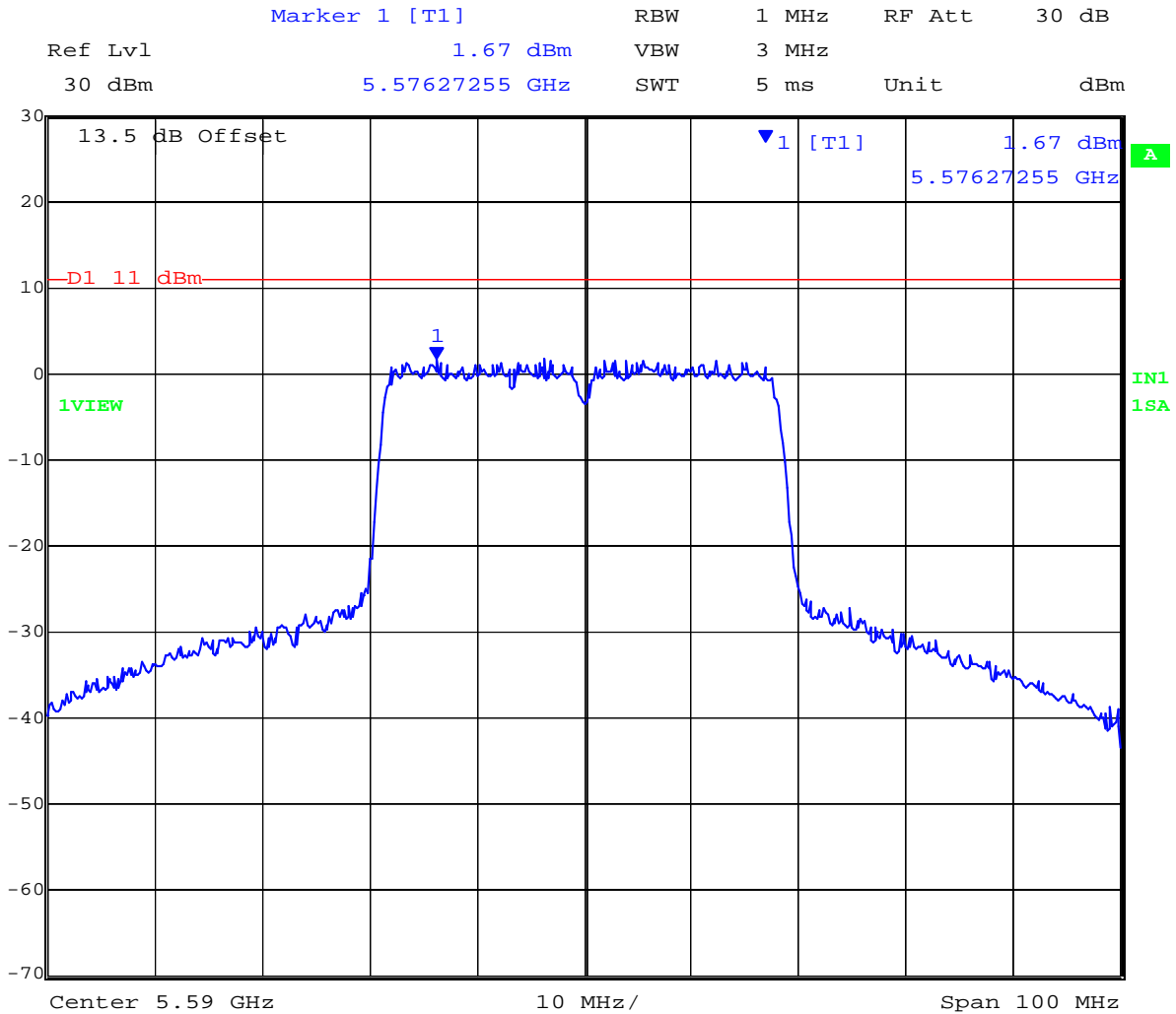

Date: 3.MAR.2010 14:56:47

This test report may be reproduced in full only. The document may only be updated by MiCOM Labs personnel. Any changes will be noted in the Document History section of the report.



Title: Aruba AP-105 802.11a/b/g/n Wireless AP  
To: FCC 47 CFR Part 15.407 & IC RSS-210  
Serial #: ARUB69-U3 Rev A  
Date: 11th April 2011  
Page: 76 of 208

### 5,690 MHz 802.11n HT40 Peak Power Spectral Density

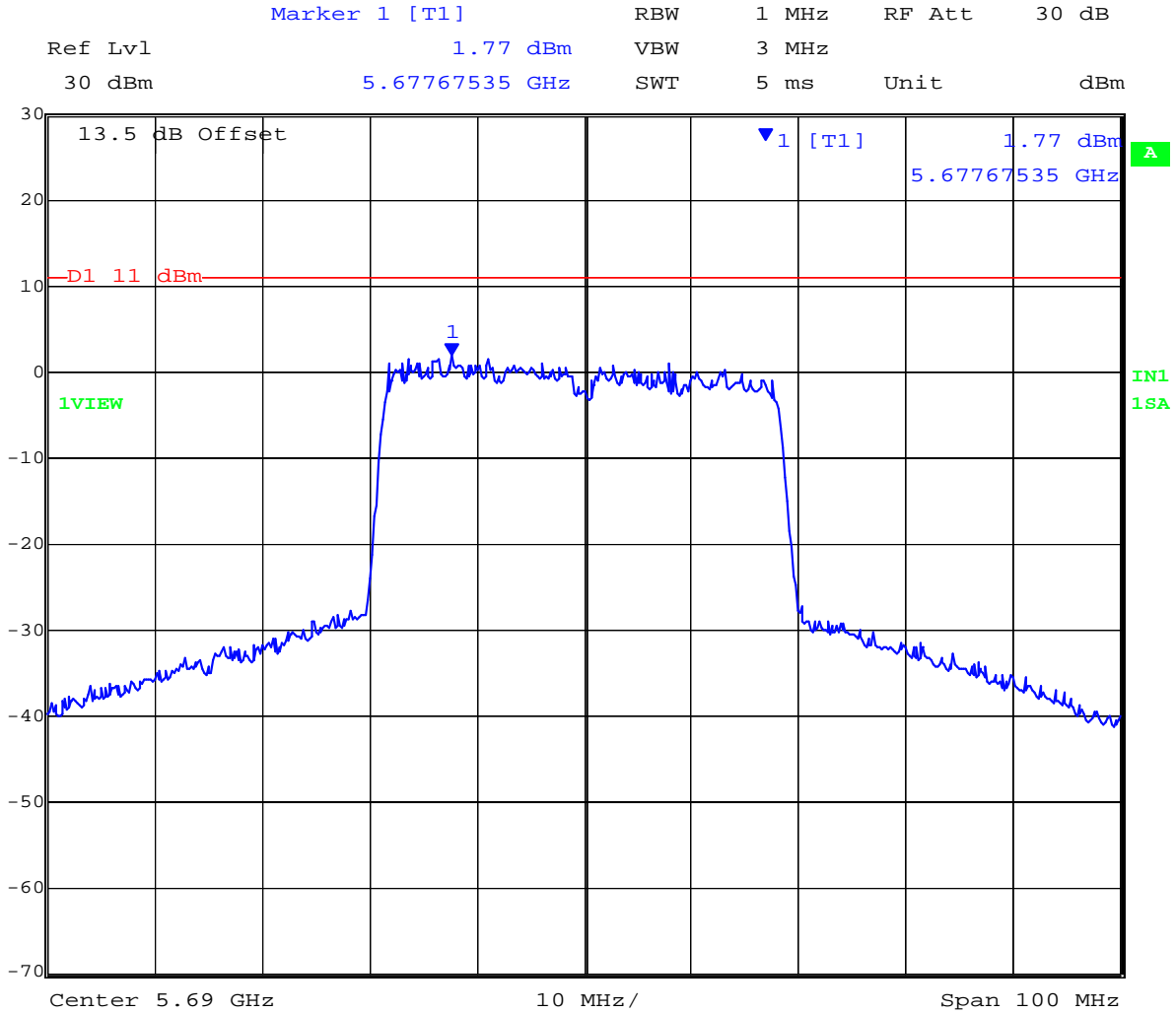

Date: 3.MAR.2010 15:20:20

This test report may be reproduced in full only. The document may only be updated by MiCOM Labs personnel. Any changes will be noted in the Document History section of the report.



**Title:** Aruba AP-105 802.11a/b/g/n Wireless AP  
**To:** FCC 47 CFR Part 15.407 & IC RSS-210  
**Serial #:** ARUB69-U3 Rev A  
**Date:** 11th April 2011  
**Page:** 77 of 208

### Specification

**FCC, Part 15 §15.407 (a)(1), (a)(2)**

**5150 – 5250 MHz**

**(a)(1)** The peak power spectral density shall not exceed +4 dBm in any 1 megahertz band.

**5250 – 5350 MHz & 5470 – 5725 MHz**

**(a)(2)** The peak power spectral density shall not exceed +11 dBm in any 1 megahertz band.

**Industry Canada RSS-210 § A9.2(1), A9.2(2)**

**5150 – 5250 MHz**

§ **A9.2(1)** The eirp spectral density shall not exceed +10 dBm in any 1 MHz band

**5250 – 5350 MHz & 5470 – 5725 MHz**

§ **A9.2(2)** The power spectral density shall not exceed +11 dBm in any 1 MHz band

### Laboratory Measurement Uncertainty for Spectral Density

Measurement uncertainty	±1.33 dB
-------------------------	----------

### Traceability

Method	Test Equipment Used
Measurements were made per work instruction WI-01 'Measuring RF Output Power'	0158, 0287, 0252, 0313, 0314, 0070, 0116, 0117

This test report may be reproduced in full only. The document may only be updated by MiCOM Labs personnel. Any changes will be noted in the Document History section of the report.

#### 5.1.4. Peak Excursion Ratio

#### FCC, Part 15 Subpart C §15.407(a)(6)

##### Test Procedure

Normative Reference (xi) Section 2.1 Measurement Procedure DA 02-2138 "Measurement Procedure Updated for Peak Transmit Power in the UNII Bands" was implemented to determine the Peak Excursion Ratio. This is a conducted measurement using a spectrum analyzer. The Peak Excursion Ratio is the difference in amplitude (dB) between the two traces.

##### Test Measurement Set up

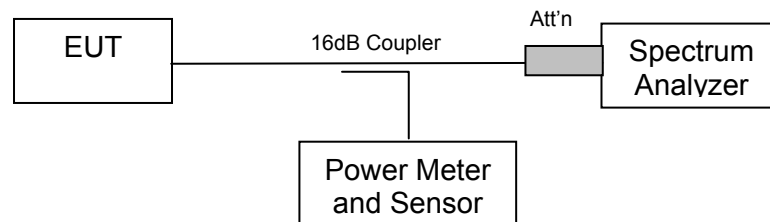

Measurement set up for Peak Excursion Ratio

##### Measurement Results for Peak Excursion Ratio

Ambient conditions.

Temperature: 17 to 23 °C Relative humidity: 31 to 57% Pressure: 999 to 1012 mbar

Radio Parameters

Duty Cycle: 100%

Output: Modulated Carrier

Power: Maximum Default Power



**TABLE OF RESULTS – 802.11a Legacy**

Centre Frequency (MHz)	Peak Excursion Ratio (dB)
5,180	10.36
5,200	10.18
5,240	9.80

**5,180 MHz 802.11a Legacy - Peak Excursion Ratio**

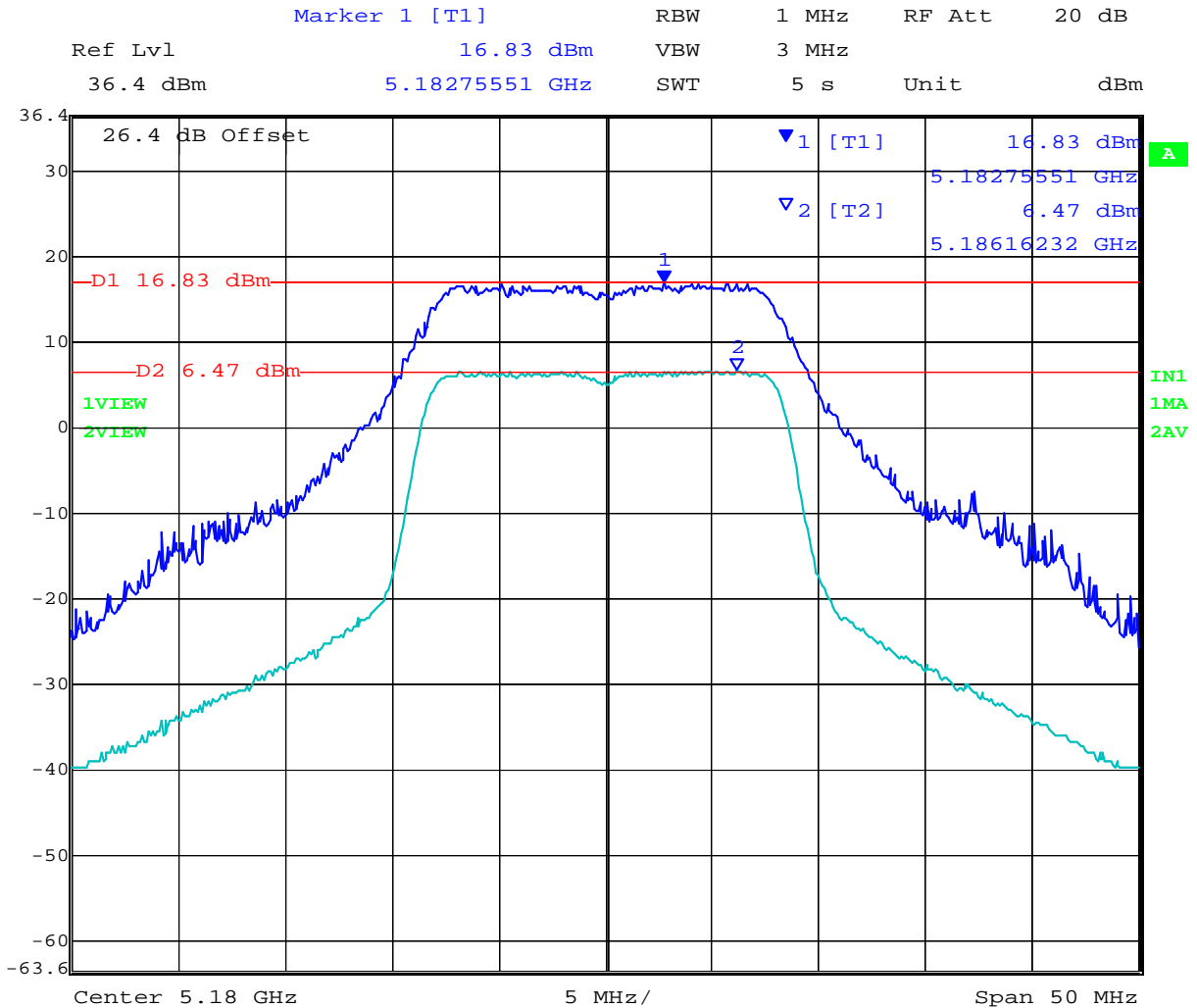

Date: 3.JUL.2008 11:18:14

This test report may be reproduced in full only. The document may only be updated by MiCOM Labs personnel. Any changes will be noted in the Document History section of the report.



Title: Aruba AP-105 802.11a/b/g/n Wireless AP  
To: FCC 47 CFR Part 15.407 & IC RSS-210  
Serial #: ARUB69-U3 Rev A  
Date: 11th April 2011  
Page: 80 of 208

### 5,200 MHz 802.11a Legacy - Peak Excursion Ratio

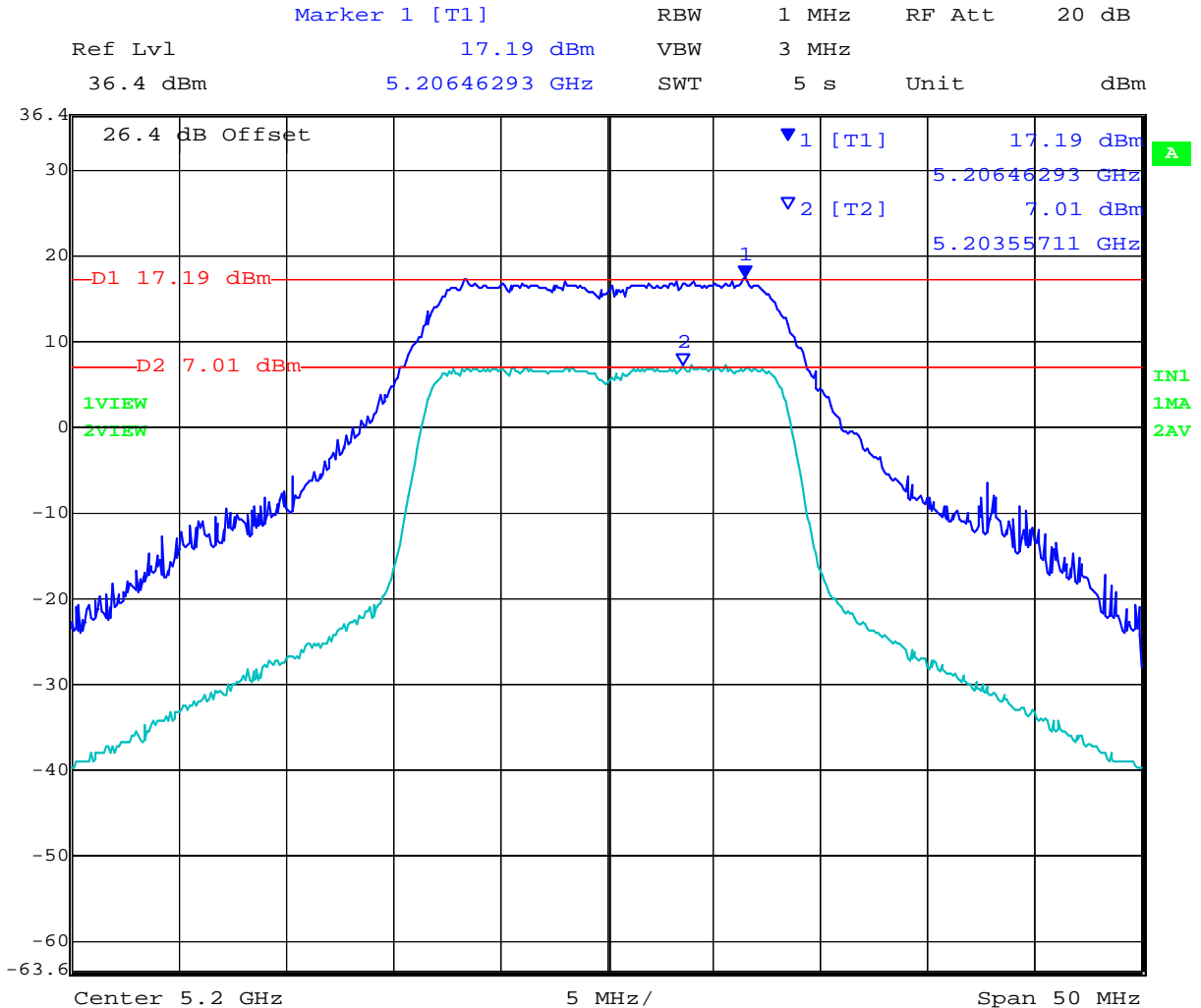

Date: 3.JUL.2008 11:16:46

This test report may be reproduced in full only. The document may only be updated by MiCOM Labs personnel. Any changes will be noted in the Document History section of the report.





**Title:** Aruba AP-105 802.11a/b/g/n Wireless AP  
**To:** FCC 47 CFR Part 15.407 & IC RSS-210  
**Serial #:** ARUB69-U3 Rev A  
**Date:** 11th April 2011  
**Page:** 81 of 208

### 5,240 MHz 802.11a Legacy - Peak Excursion Ratio

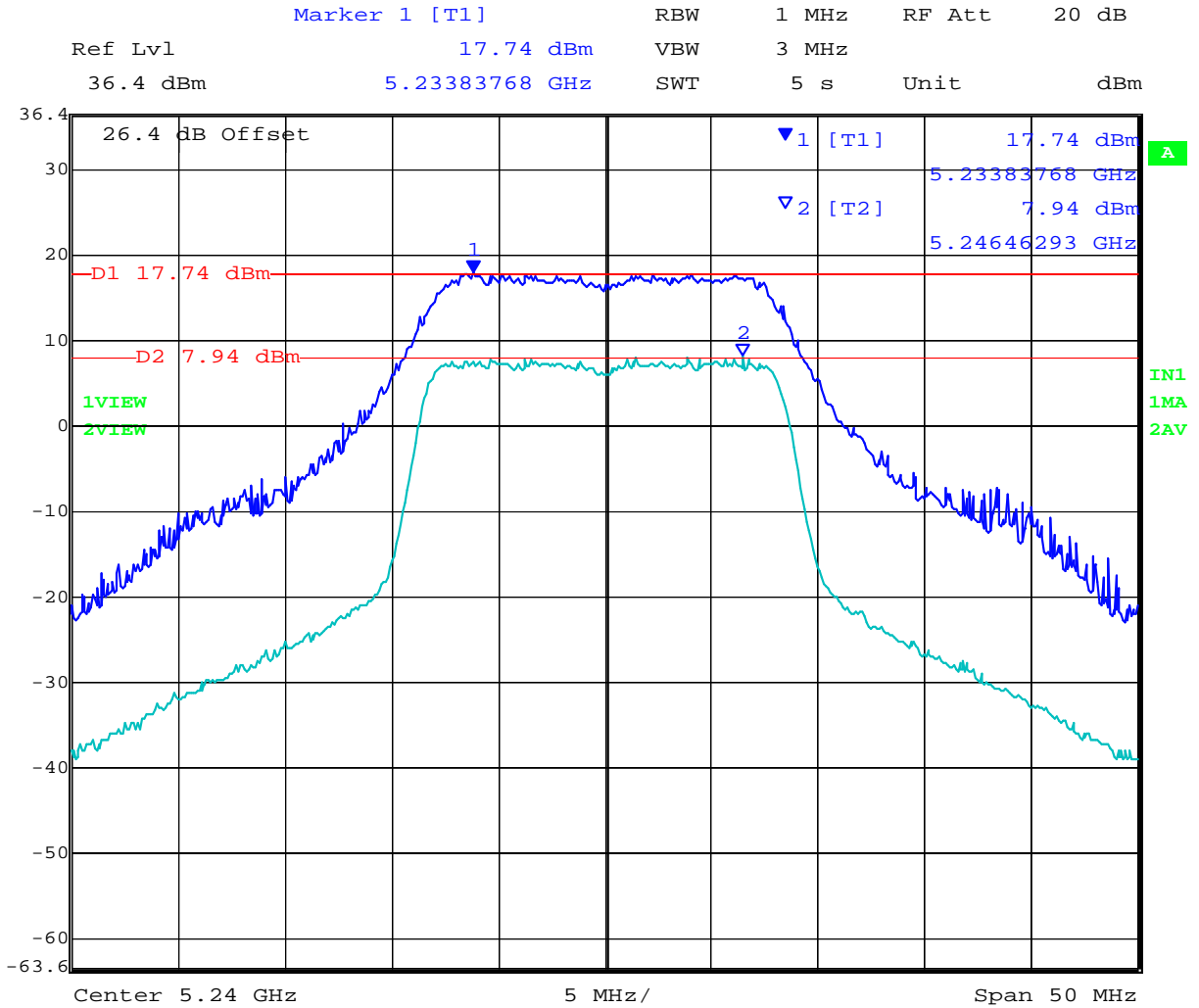

Date: 3.JUL.2008 11:27:25

This test report may be reproduced in full only. The document may only be updated by MiCOM Labs personnel. Any changes will be noted in the Document History section of the report.



**TABLE OF RESULTS – 802.11n HT20**

Centre Frequency (MHz)	Peak Excursion Ratio (dB)
5,180	10.49
5,200	10.11
5,240	9.82

**5,180 MHz 802.11n HT20 - Peak Excursion Ratio**

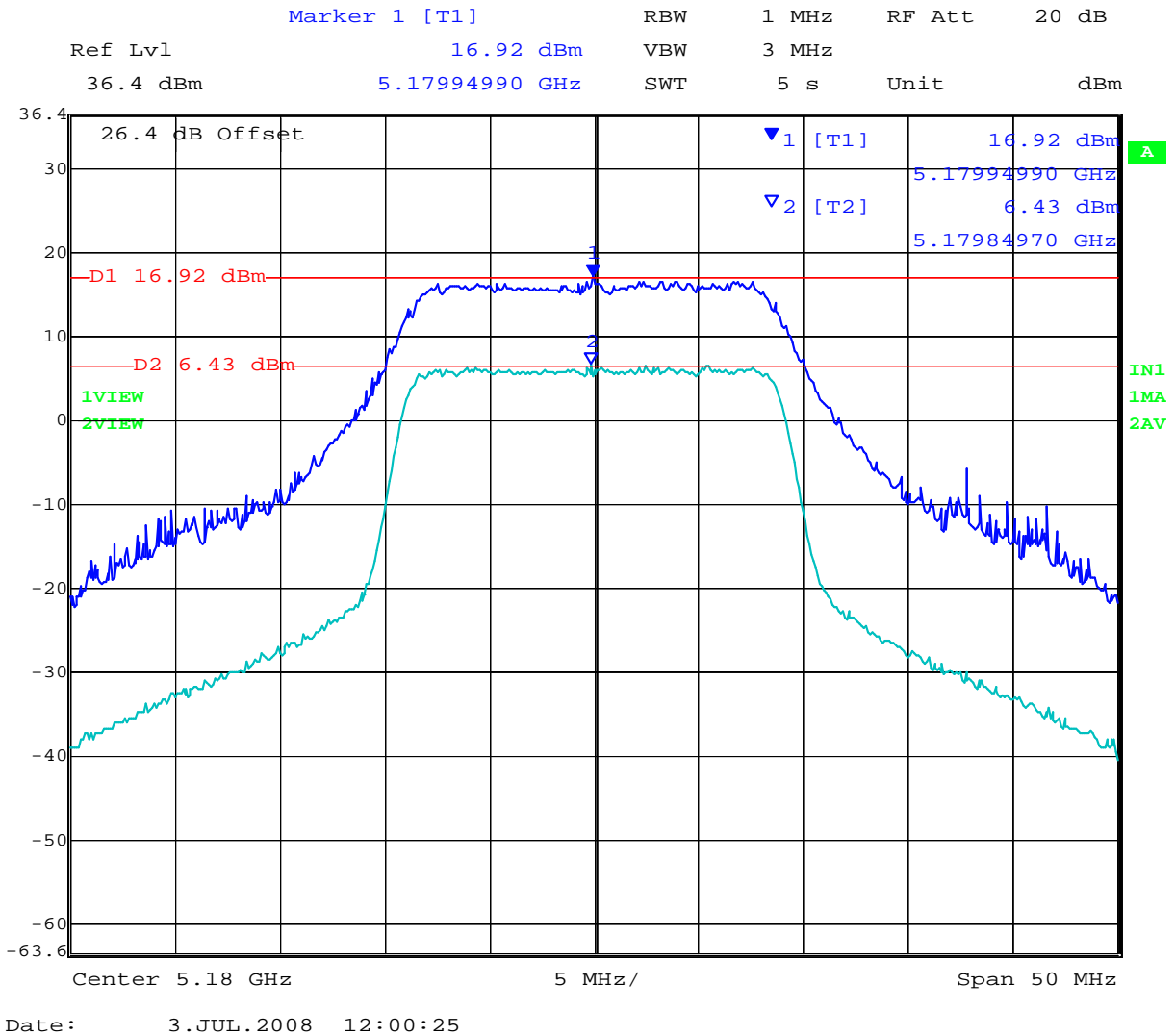

This test report may be reproduced in full only. The document may only be updated by MiCOM Labs personnel. Any changes will be noted in the Document History section of the report.



Title: Aruba AP-105 802.11a/b/g/n Wireless AP  
To: FCC 47 CFR Part 15.407 & IC RSS-210  
Serial #: ARUB69-U3 Rev A  
Date: 11th April 2011  
Page: 83 of 208

### 5,200 MHz 802.11n HT20 - Peak Excursion Ratio

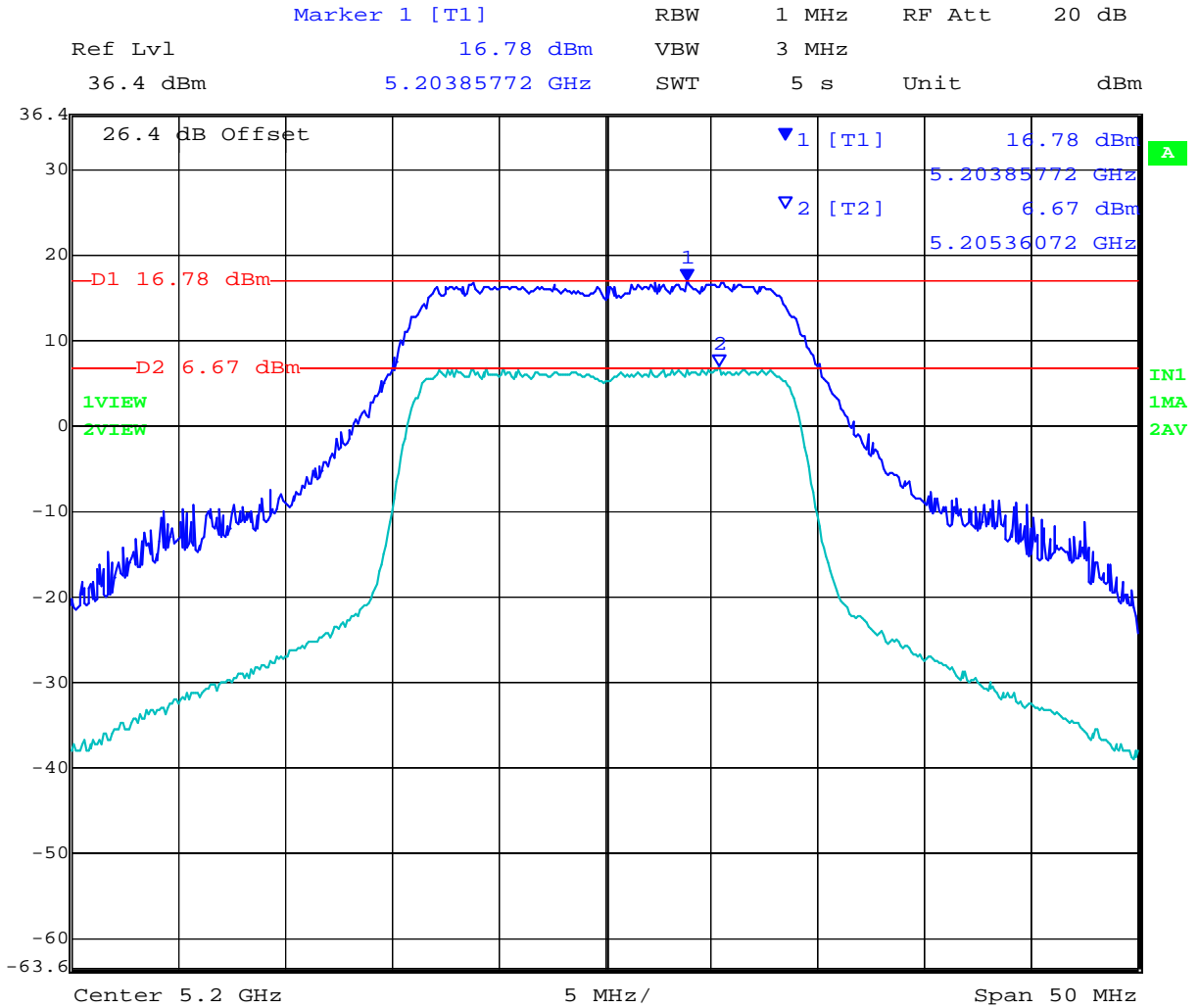

Date: 3.JUL.2008 12:01:41

This test report may be reproduced in full only. The document may only be updated by MiCOM Labs personnel. Any changes will be noted in the Document History section of the report.



### 5,240 MHz 802.11n HT20 - Peak Excursion Ratio

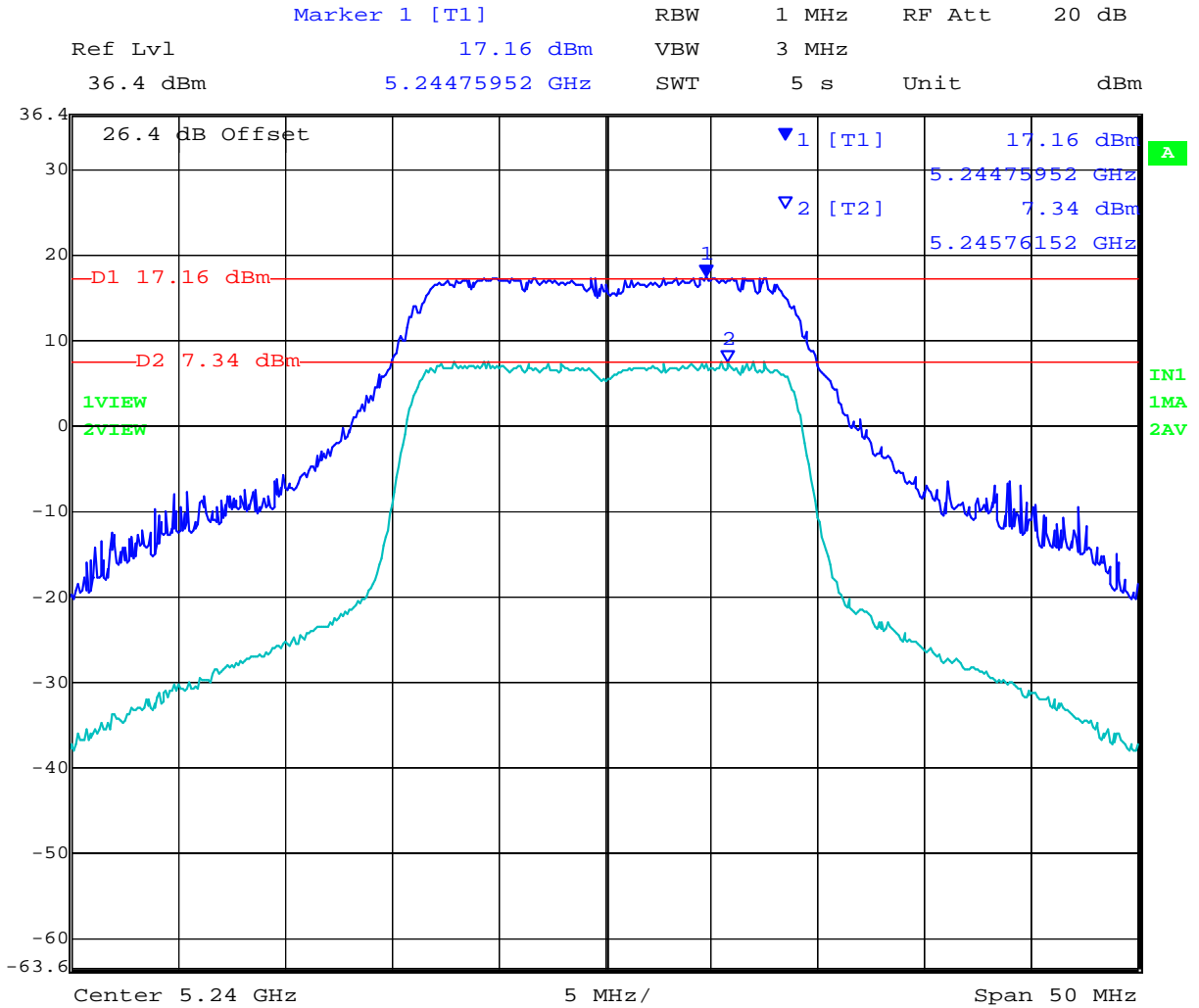

Date: 3.JUL.2008 12:03:22

This test report may be reproduced in full only. The document may only be updated by MiCOM Labs personnel. Any changes will be noted in the Document History section of the report.



**TABLE OF RESULTS – 802.11n HT40**

Centre Frequency (MHz)	Peak Excursion Ratio (dB)
5,190	10.84
5,230	10.76

**5,190 MHz 802.11n HT40 - Peak Excursion Ratio**

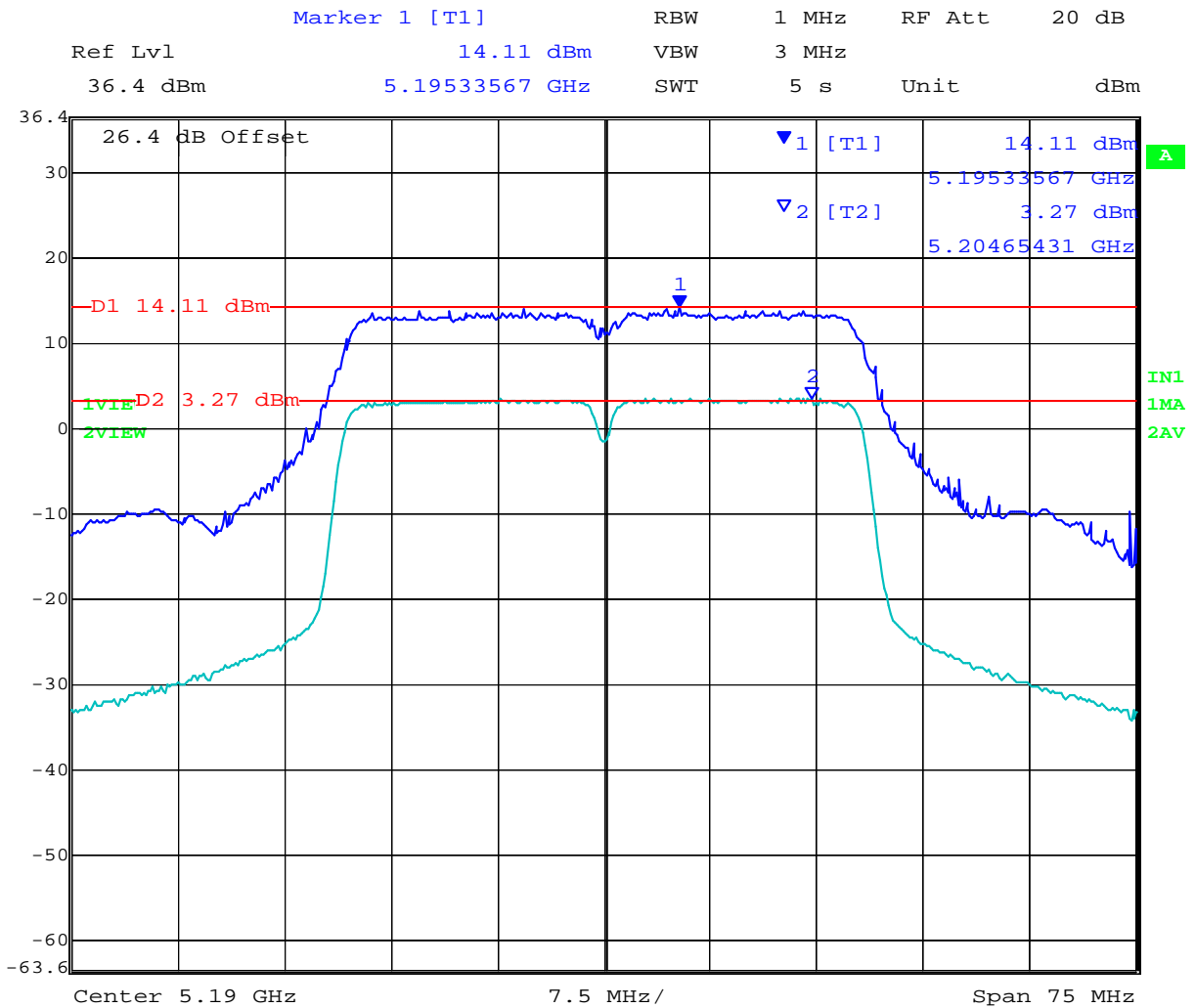

Date: 3.JUL.2008 12:49:57

This test report may be reproduced in full only. The document may only be updated by MiCOM Labs personnel. Any changes will be noted in the Document History section of the report.



Title: Aruba AP-105 802.11a/b/g/n Wireless AP  
To: FCC 47 CFR Part 15.407 & IC RSS-210  
Serial #: ARUB69-U3 Rev A  
Date: 11th April 2011  
Page: 86 of 208

### 5,230 MHz 802.11n HT40 - Peak Excursion Ratio

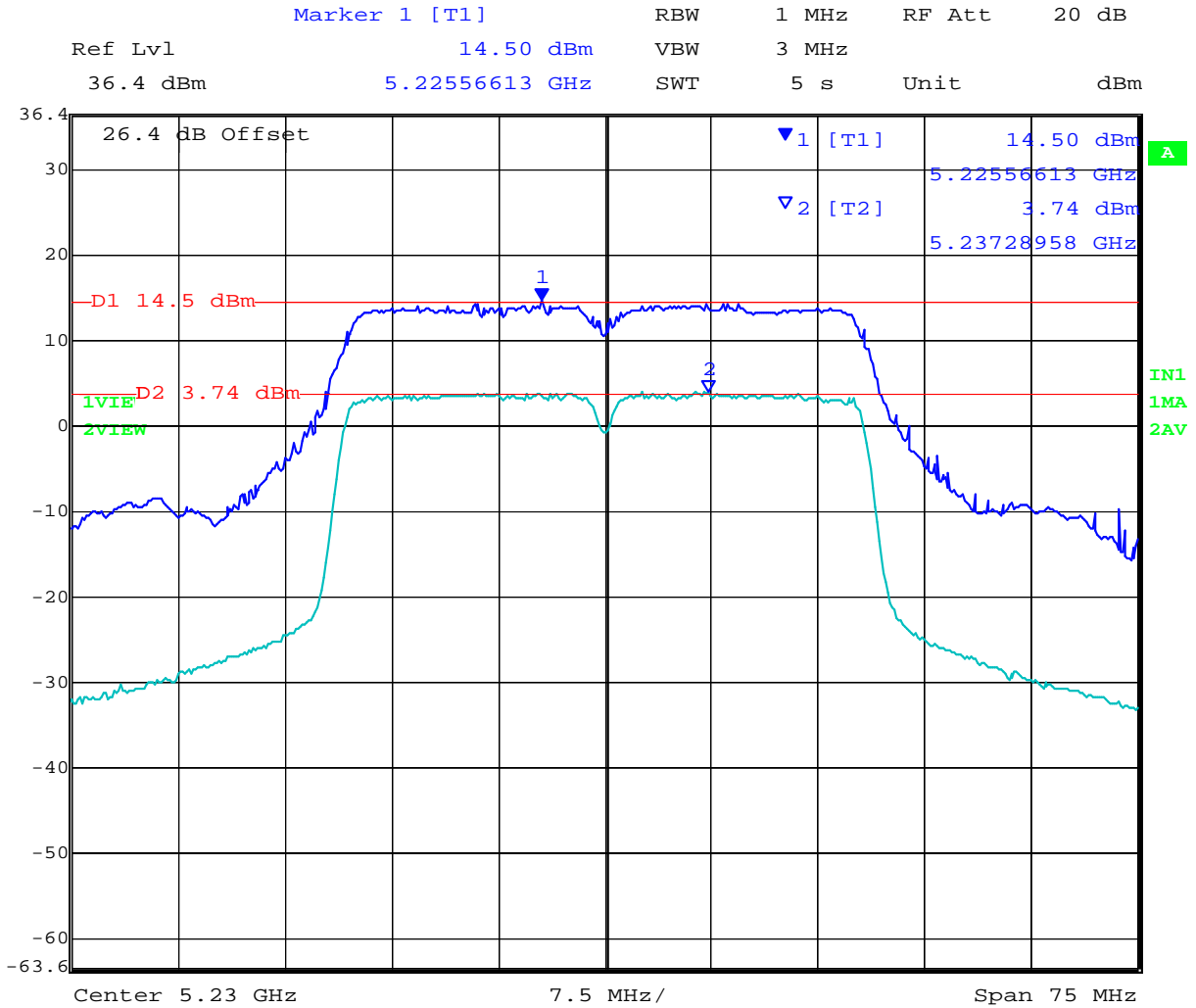

Date: 3.JUL.2008 12:47:53

This test report may be reproduced in full only. The document may only be updated by MiCOM Labs personnel. Any changes will be noted in the Document History section of the report.



**TABLE OF RESULTS – 802.11a Legacy**

Centre Frequency (MHz)	Peak Excursion Ratio (dB)
5,260	+11.82
5,300	+11.92
5,320	+11.82

**5,260 MHz 802.11a Legacy - Peak Excursion Ratio**

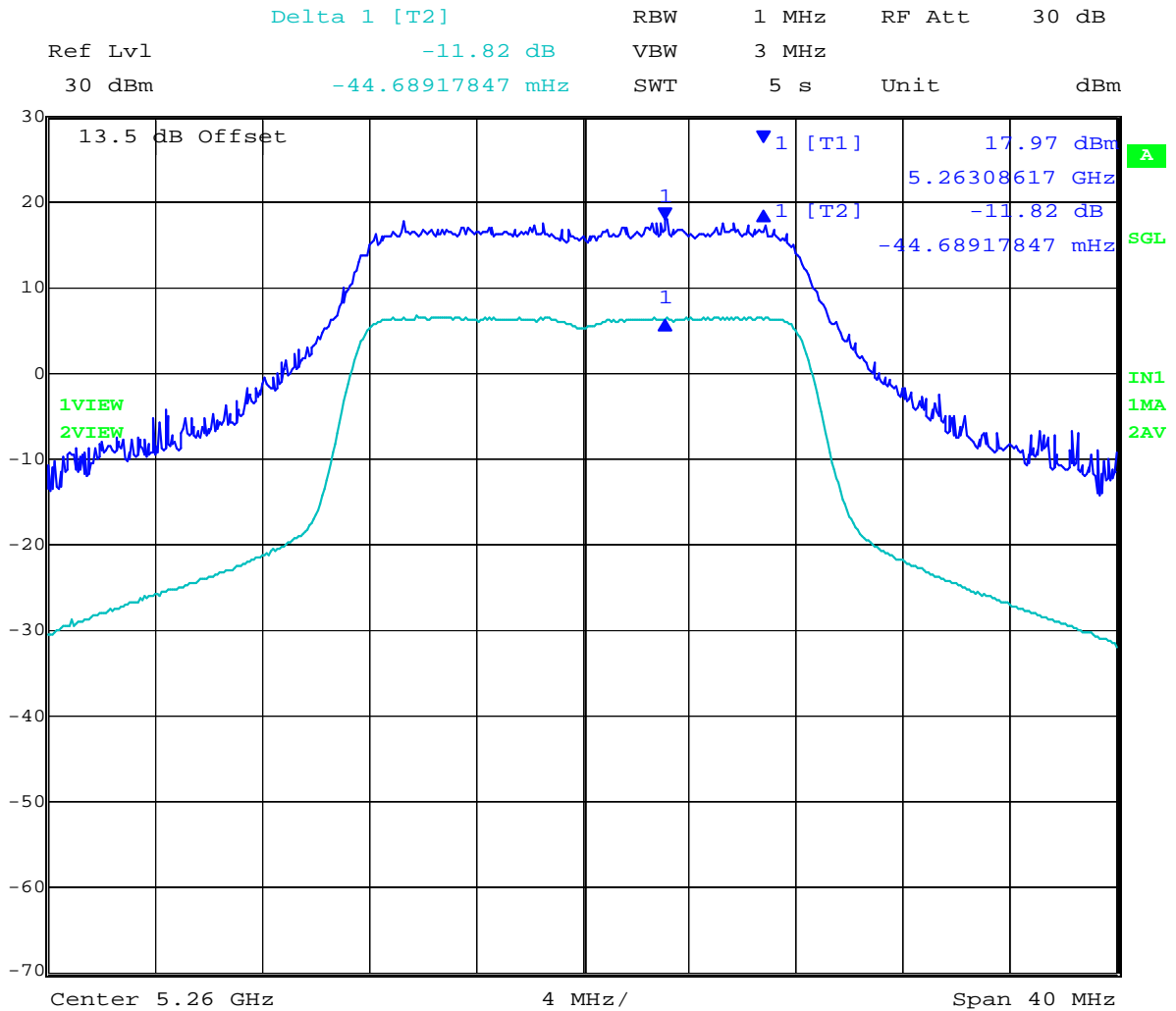

Date: 3.MAR.2010 09:55:28

This test report may be reproduced in full only. The document may only be updated by MiCOM Labs personnel. Any changes will be noted in the Document History section of the report.



### 5,300 MHz 802.11a Legacy - Peak Excursion Ratio

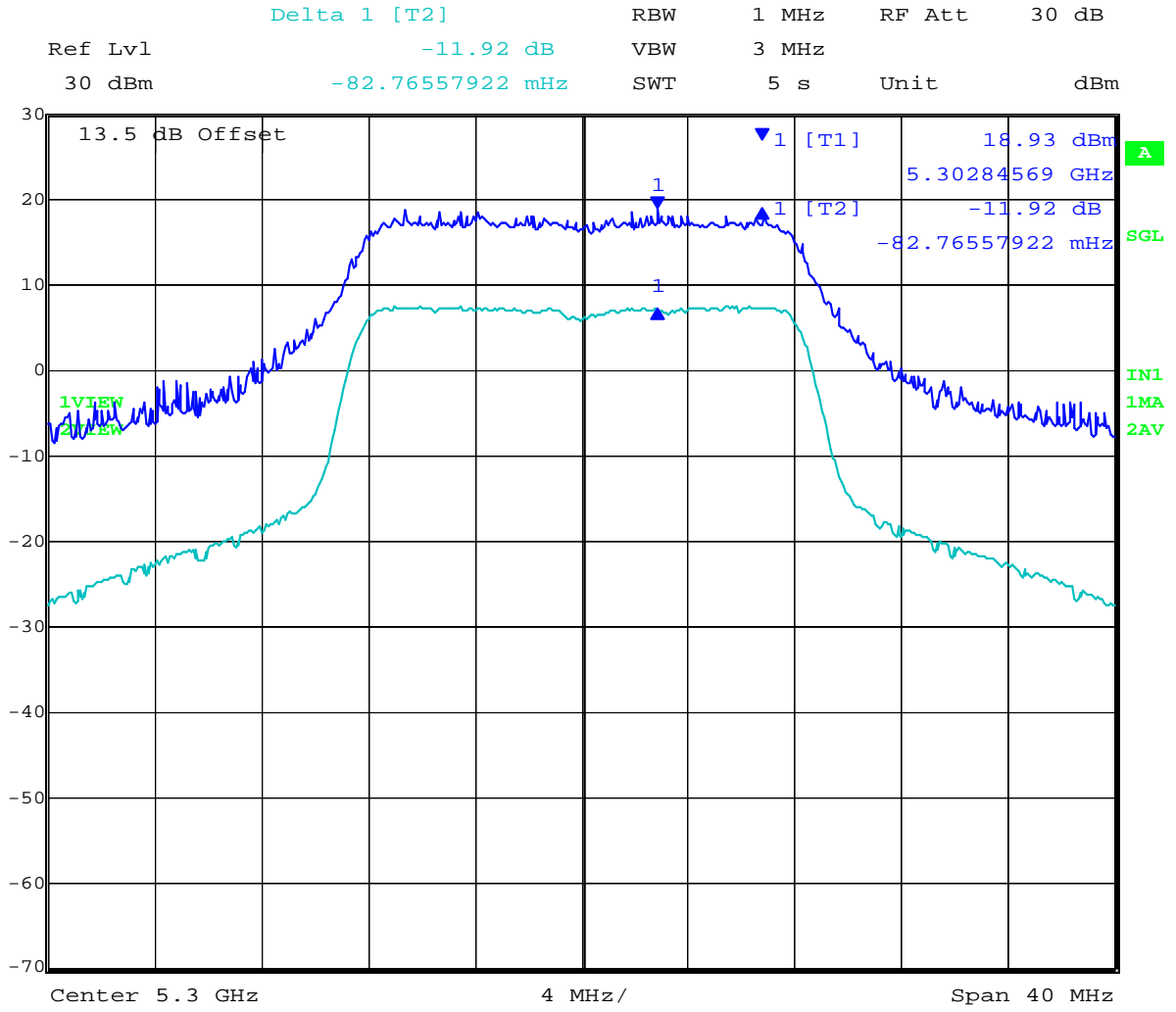

Date: 3.MAR.2010 10:07:35

This test report may be reproduced in full only. The document may only be updated by MiCOM Labs personnel. Any changes will be noted in the Document History section of the report.





### 5,320 MHz 802.11a Legacy - Peak Excursion Ratio

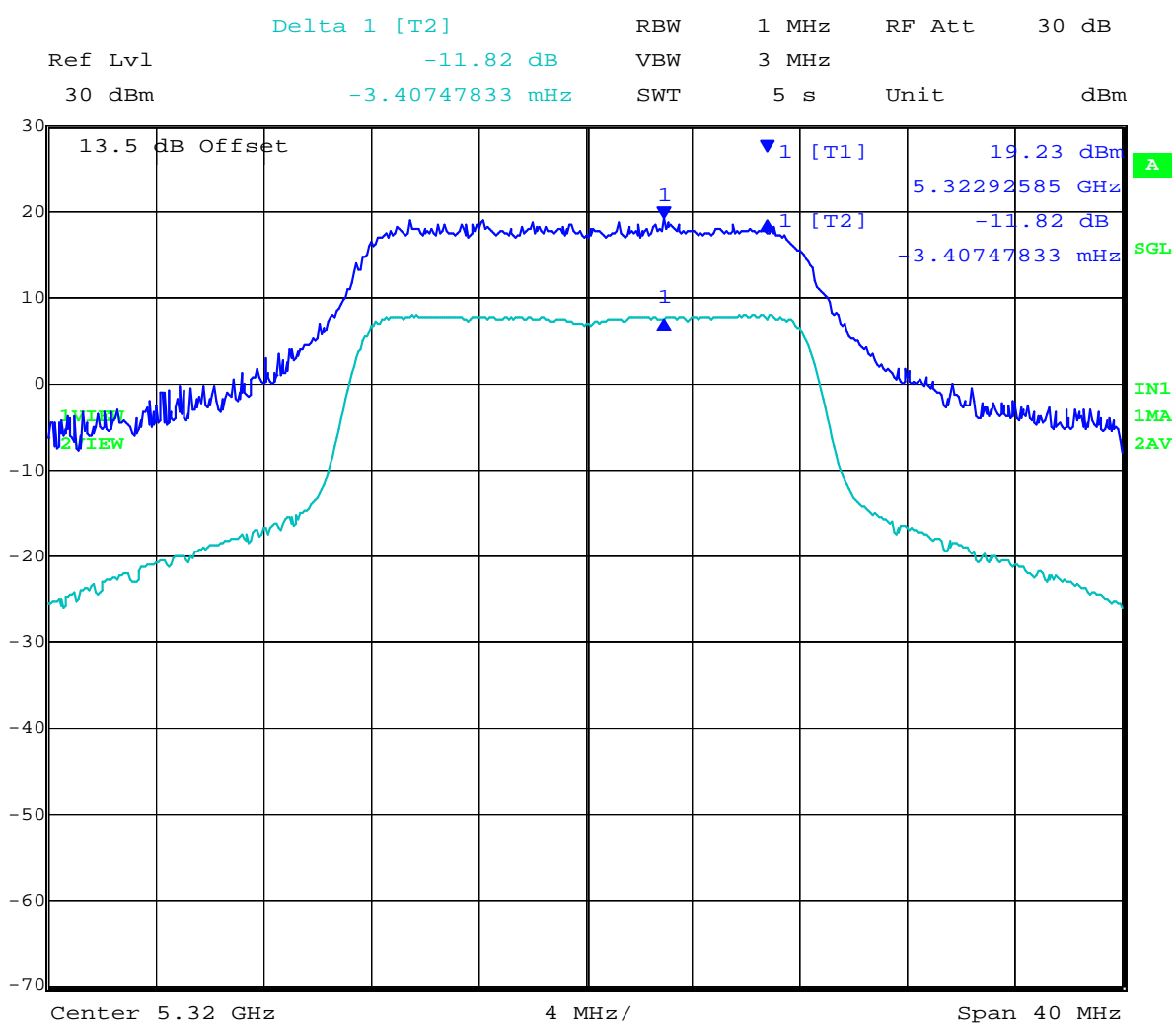

Date: 3.MAR.2010 10:18:04

This test report may be reproduced in full only. The document may only be updated by MiCOM Labs personnel. Any changes will be noted in the Document History section of the report.



**TABLE OF RESULTS – 802.11n HT20**

Centre Frequency (MHz)	Peak Excursion Ratio (dB)
5,260	+10.45
5,300	+10.54
5,320	+11.39

**5,260 MHz 802.11n HT20 - Peak Excursion Ratio**

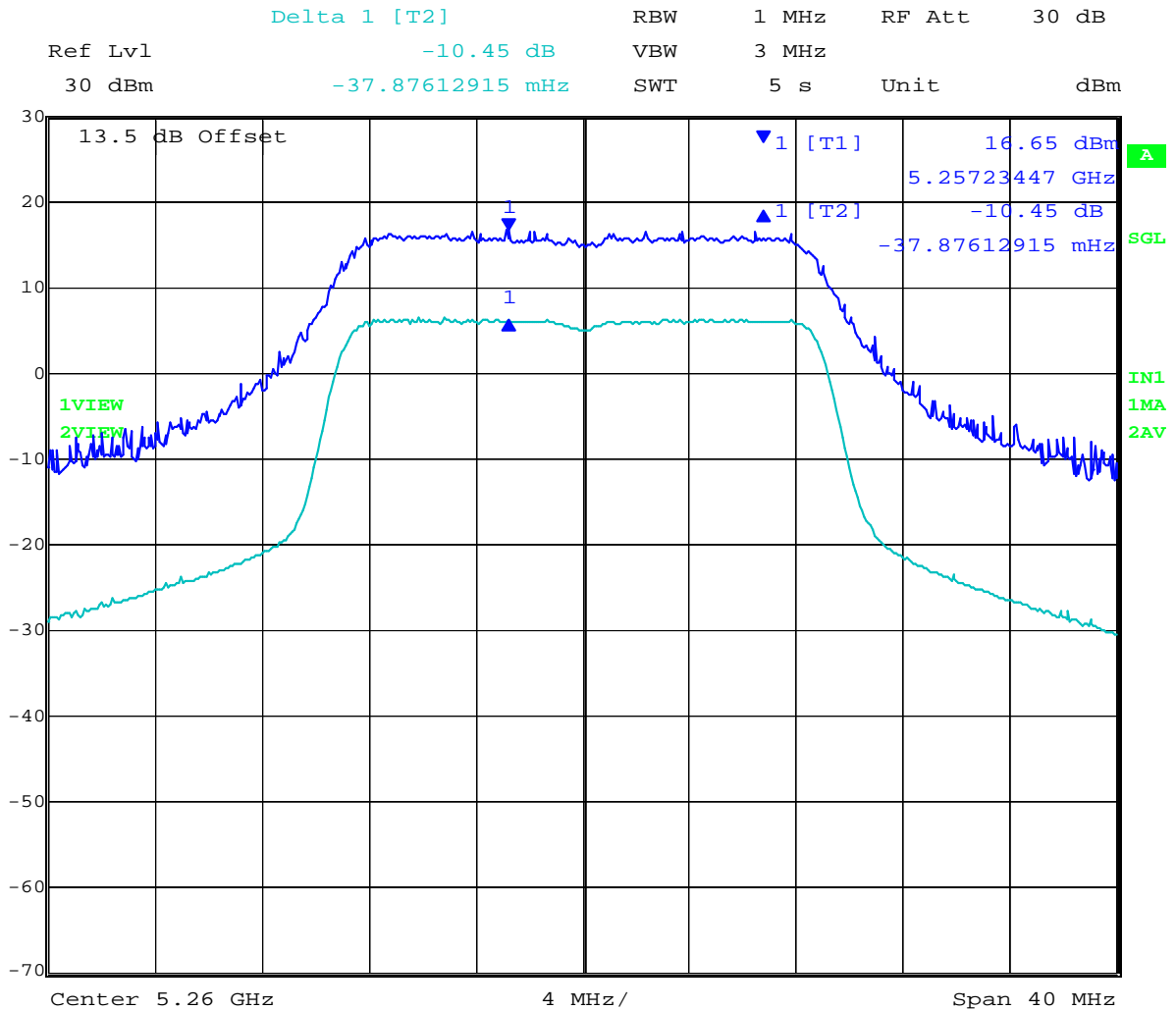

Date: 3.MAR.2010 10:37:48

This test report may be reproduced in full only. The document may only be updated by MiCOM Labs personnel. Any changes will be noted in the Document History section of the report.





Title: Aruba AP-105 802.11a/b/g/n Wireless AP  
To: FCC 47 CFR Part 15.407 & IC RSS-210  
Serial #: ARUB69-U3 Rev A  
Date: 11th April 2011  
Page: 92 of 208

### 5,320 MHz 802.11n HT20 - Peak Excursion Ratio

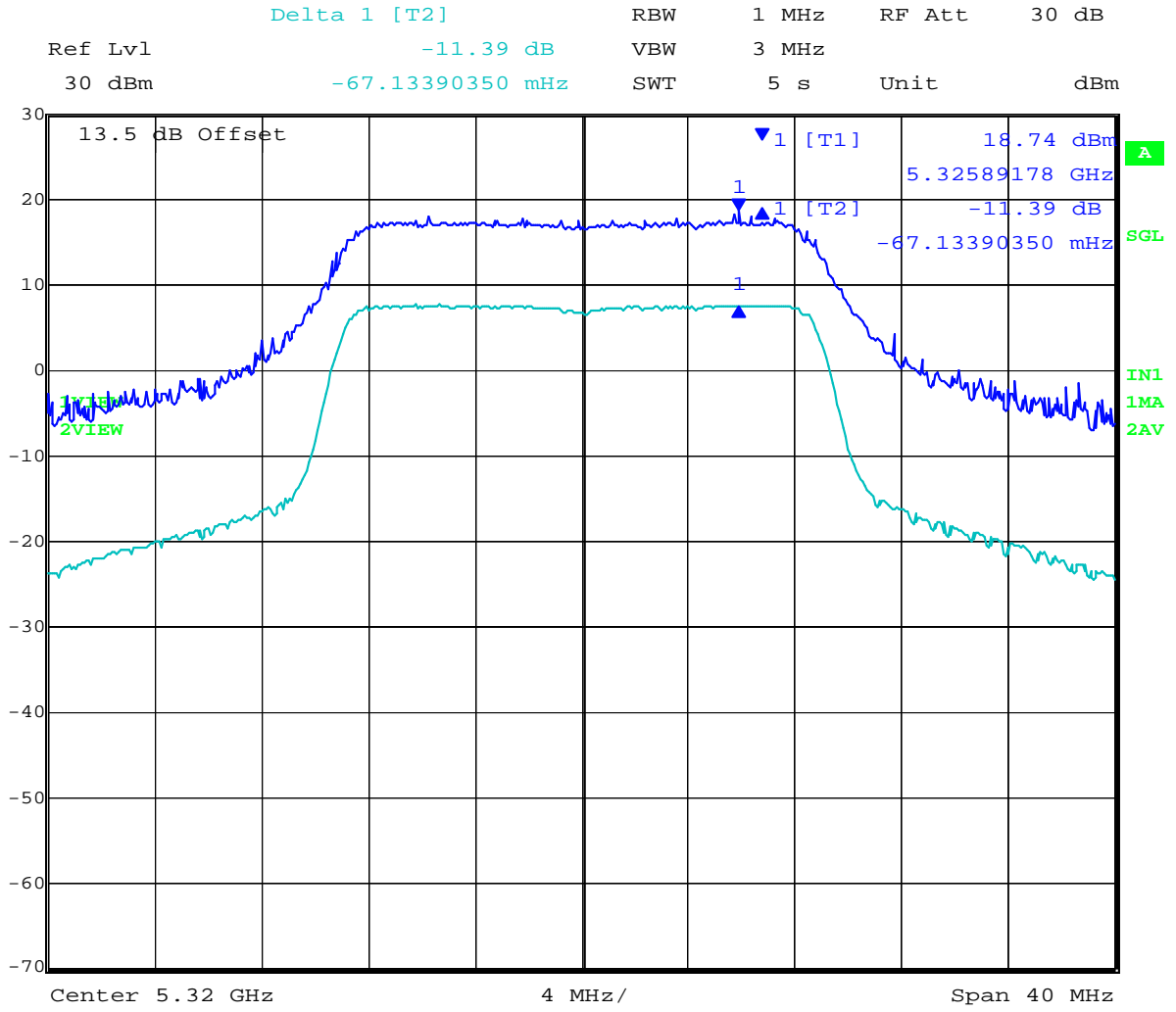

Date: 3.MAR.2010 11:04:25

This test report may be reproduced in full only. The document may only be updated by MiCOM Labs personnel. Any changes will be noted in the Document History section of the report.



**TABLE OF RESULTS – 802.11n HT40**

Centre Frequency (MHz)	Peak Excursion Ratio (dB)
5,270	+11.27
5,310	+10.88

**5,270 MHz 802.11n HT40 - Peak Excursion Ratio**

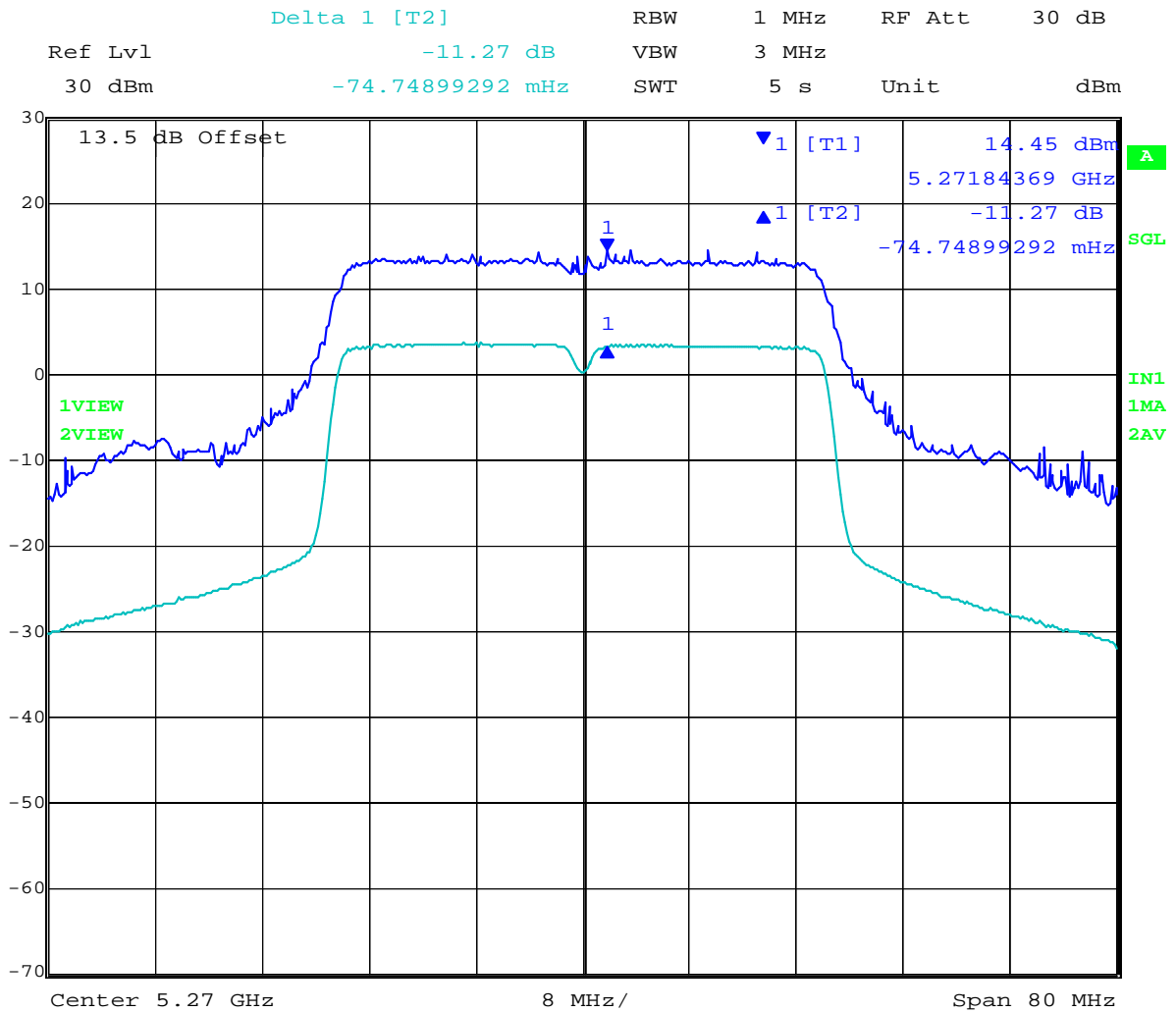

Date: 3.MAR.2010 11:19:40

This test report may be reproduced in full only. The document may only be updated by MiCOM Labs personnel. Any changes will be noted in the Document History section of the report.



### 5,310 MHz 802.11n HT40 - Peak Excursion Ratio

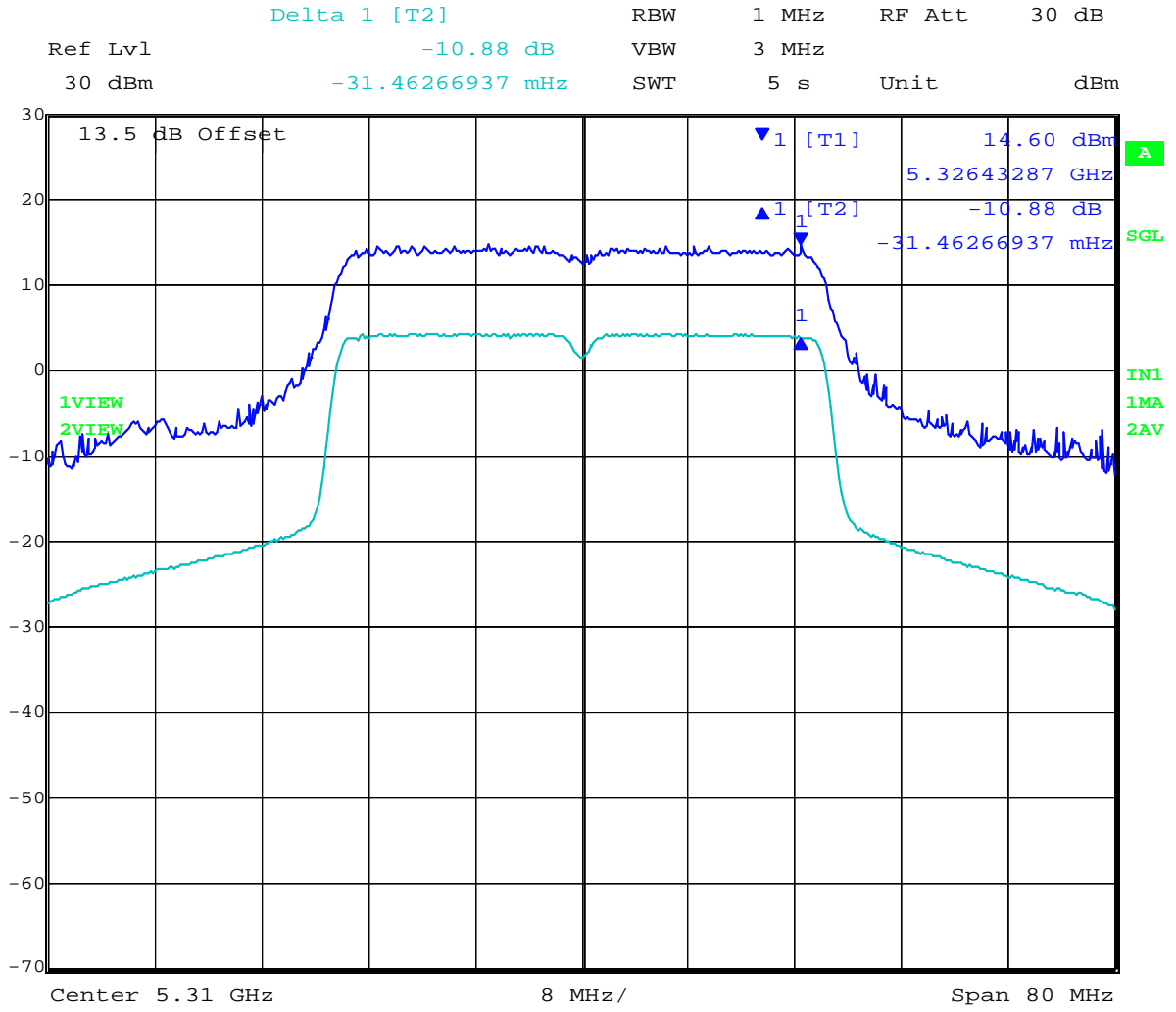

Date: 3.MAR.2010 11:40:49

This test report may be reproduced in full only. The document may only be updated by MiCOM Labs personnel. Any changes will be noted in the Document History section of the report.



**TABLE OF RESULTS – 802.11a Legacy**

Centre Frequency (MHz)	Peak Excursion Ratio (dB)
5,500	+11.49
5,600	+11.50
5,700	+12.04

**5,500 MHz 802.11a Legacy - Peak Excursion Ratio**

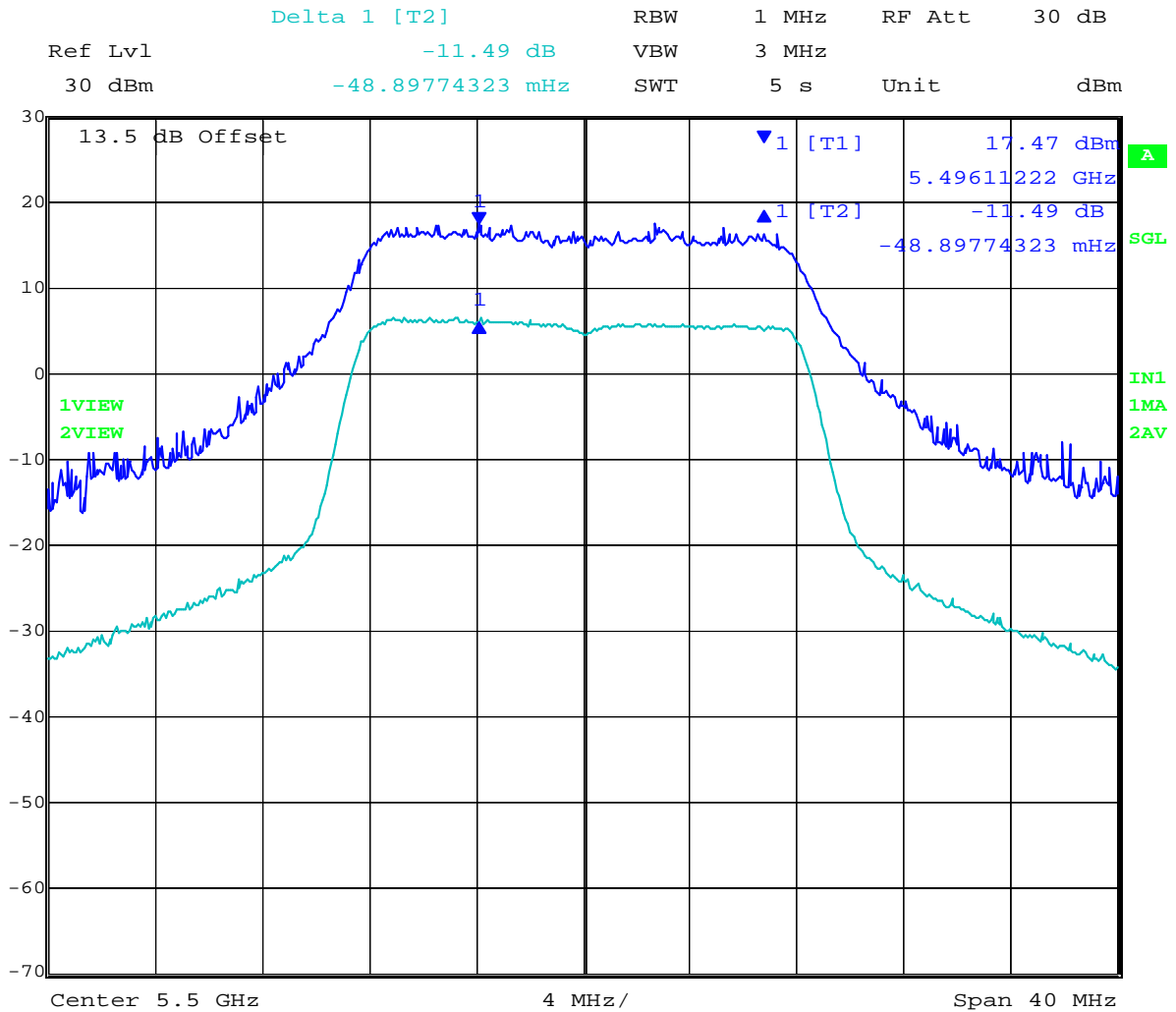

Date: 3.MAR.2010 12:10:16

This test report may be reproduced in full only. The document may only be updated by MiCOM Labs personnel. Any changes will be noted in the Document History section of the report.



### 5,600 MHz 802.11a Legacy - Peak Excursion Ratio

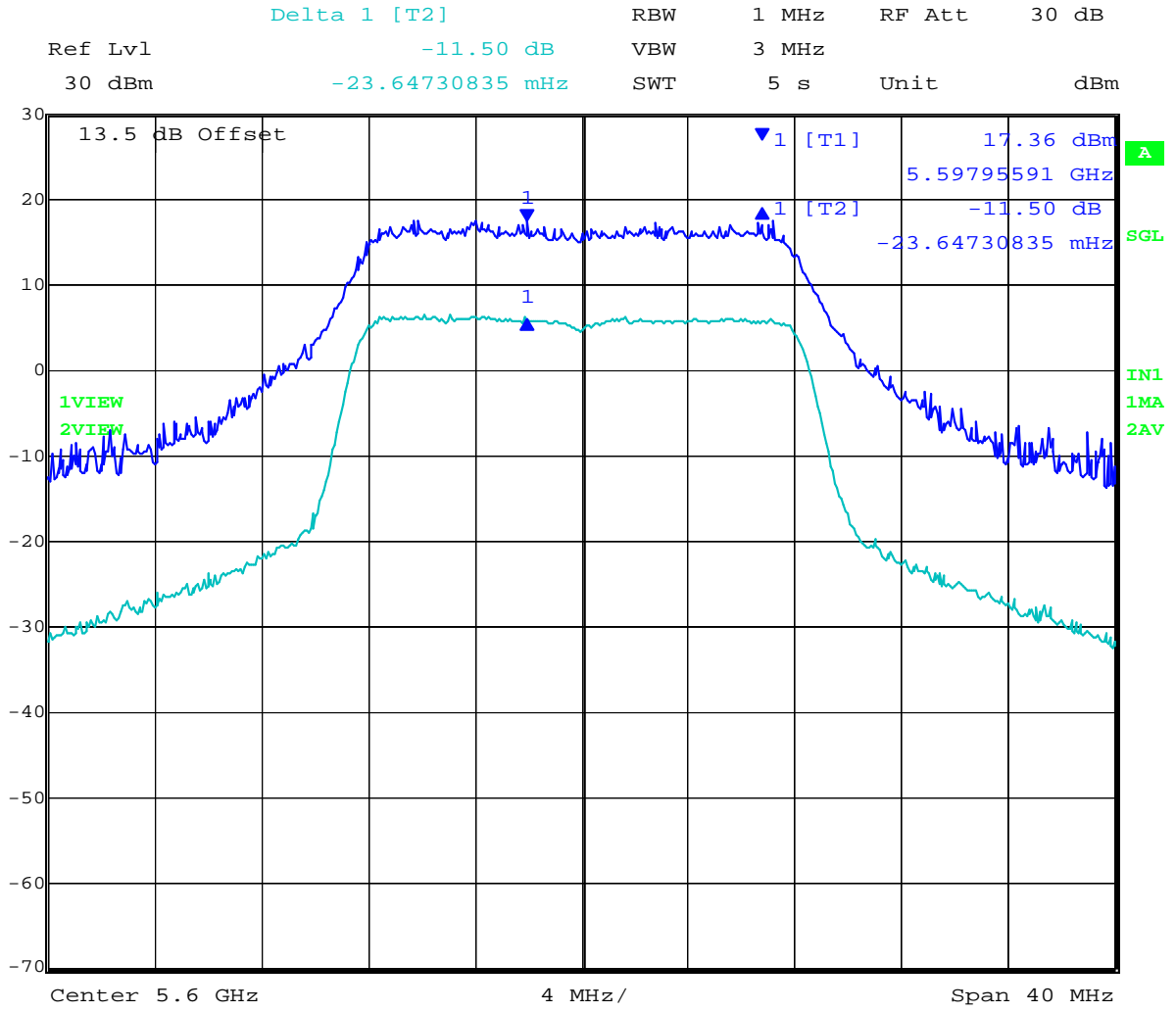

Date: 3.MAR.2010 12:26:56

This test report may be reproduced in full only. The document may only be updated by MiCOM Labs personnel. Any changes will be noted in the Document History section of the report.





Title: Aruba AP-105 802.11a/b/g/n Wireless AP  
To: FCC 47 CFR Part 15.407 & IC RSS-210  
Serial #: ARUB69-U3 Rev A  
Date: 11th April 2011  
Page: 97 of 208

### 5,700 MHz 802.11a Legacy - Peak Excursion Ratio

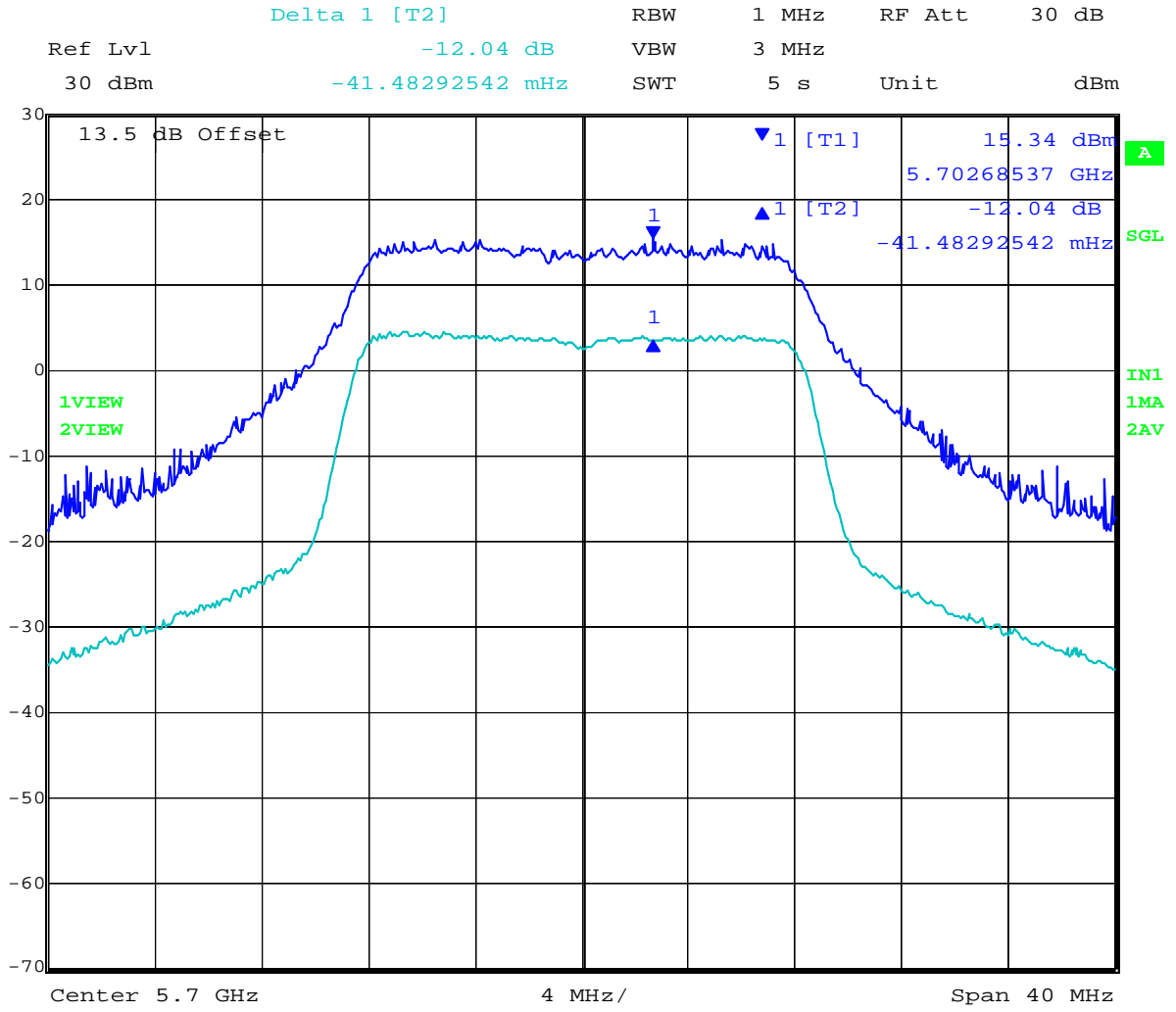

Date: 3.MAR.2010 12:36:49

This test report may be reproduced in full only. The document may only be updated by MiCOM Labs personnel. Any changes will be noted in the Document History section of the report.



**TABLE OF RESULTS – 802.11n HT20**

Centre Frequency (MHz)	Peak Excursion Ratio (dB)
5,500	+10.55
5,600	+11.01
5,700	+10.79

**5,500 MHz 802.11n HT20 - Peak Excursion Ratio**

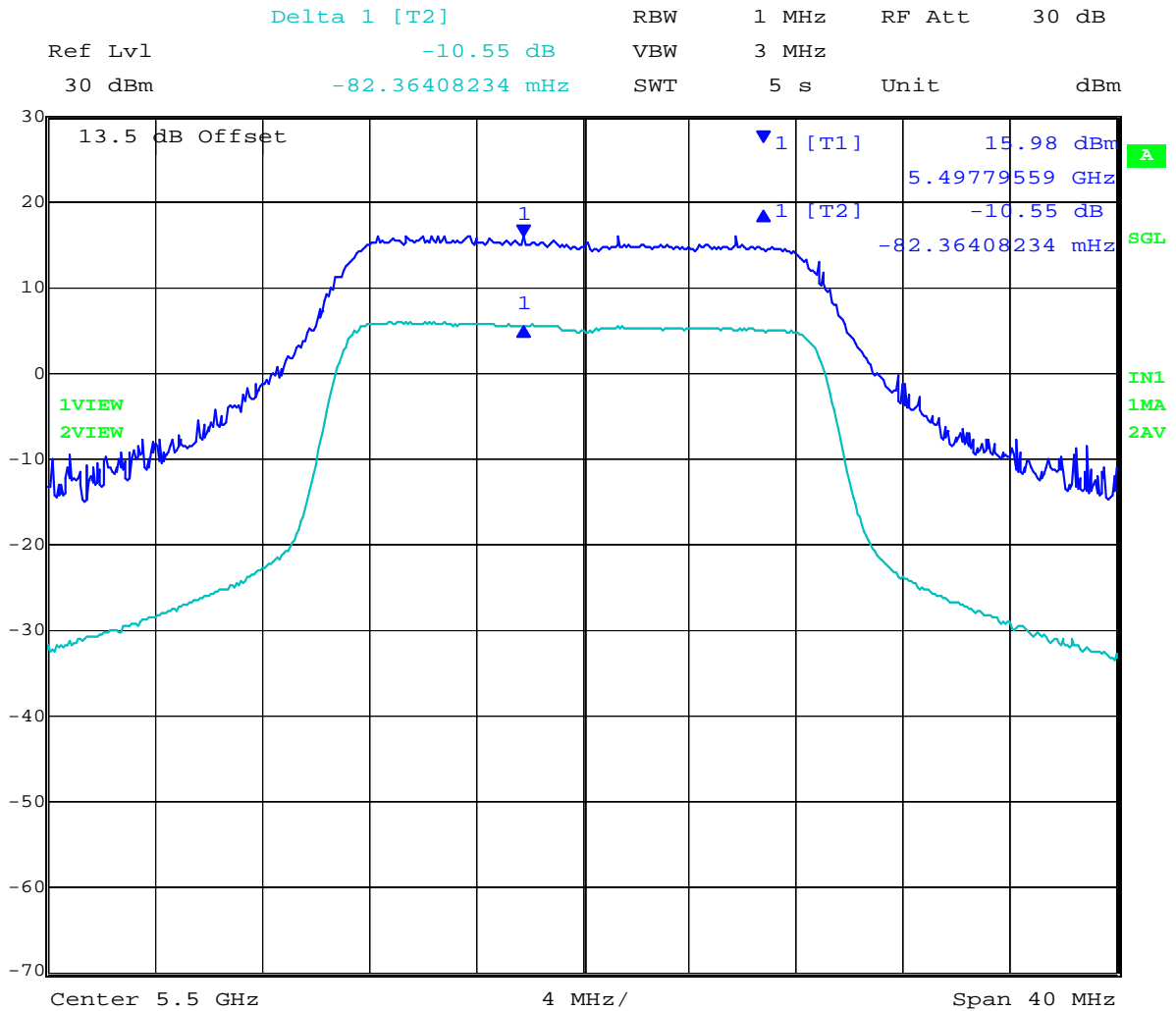

Date: 3.MAR.2010 13:53:49

This test report may be reproduced in full only. The document may only be updated by MiCOM Labs personnel. Any changes will be noted in the Document History section of the report.



### 5,600 MHz 802.11n HT20 - Peak Excursion Ratio

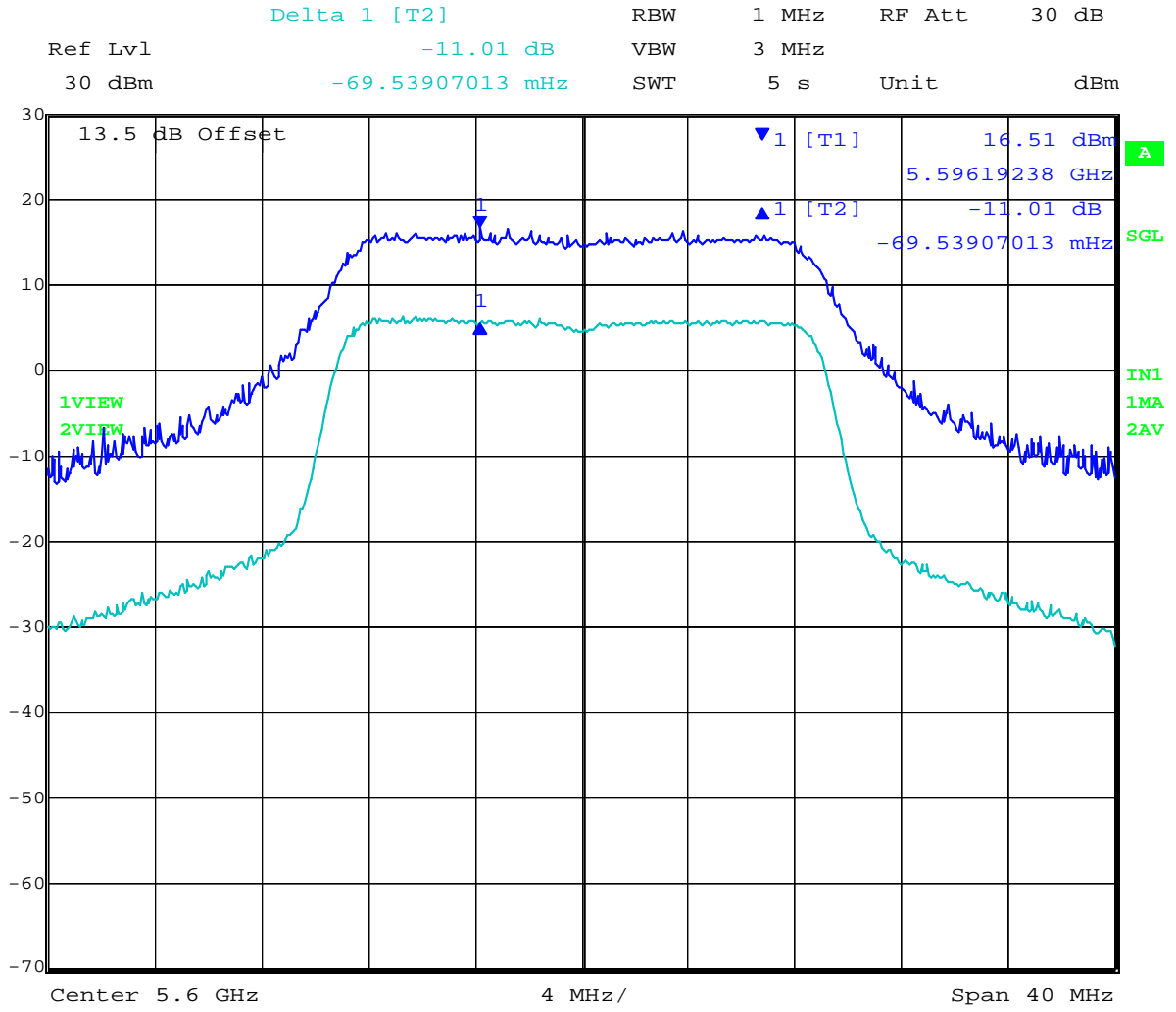

Date: 3.MAR.2010 14:19:12

This test report may be reproduced in full only. The document may only be updated by MiCOM Labs personnel. Any changes will be noted in the Document History section of the report.



### 5,700 MHz 802.11n HT20 - Peak Excursion Ratio

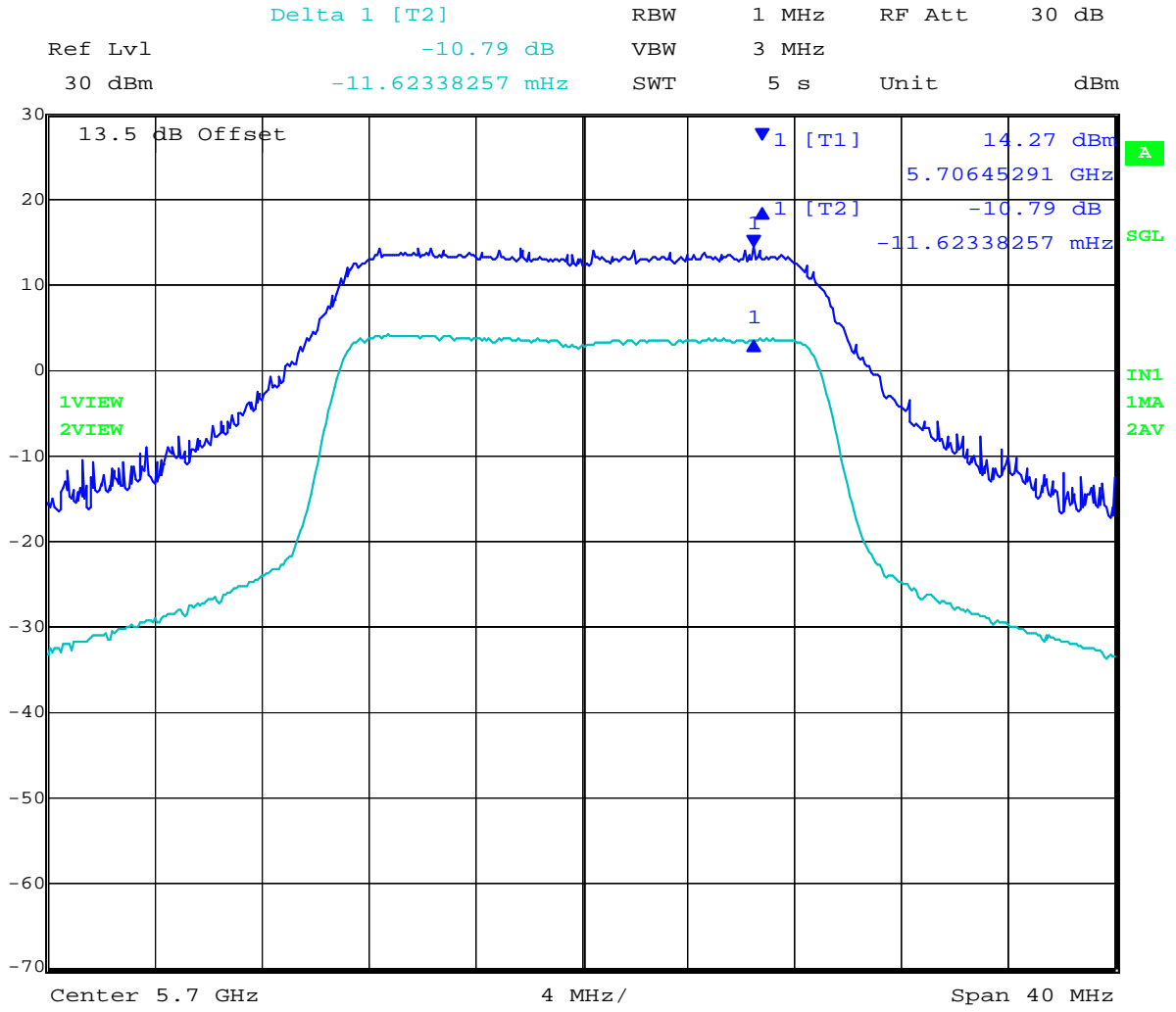

Date: 3.MAR.2010 14:29:18

This test report may be reproduced in full only. The document may only be updated by MiCOM Labs personnel. Any changes will be noted in the Document History section of the report.



TABLE OF RESULTS – 802.11n HT40

Centre Frequency (MHz)	Peak Excursion Ratio (dB)
5,510	+10.71
5,590	+11.00
5,690	+10.74

5,510 MHz 802.11n HT40 - Peak Excursion Ratio

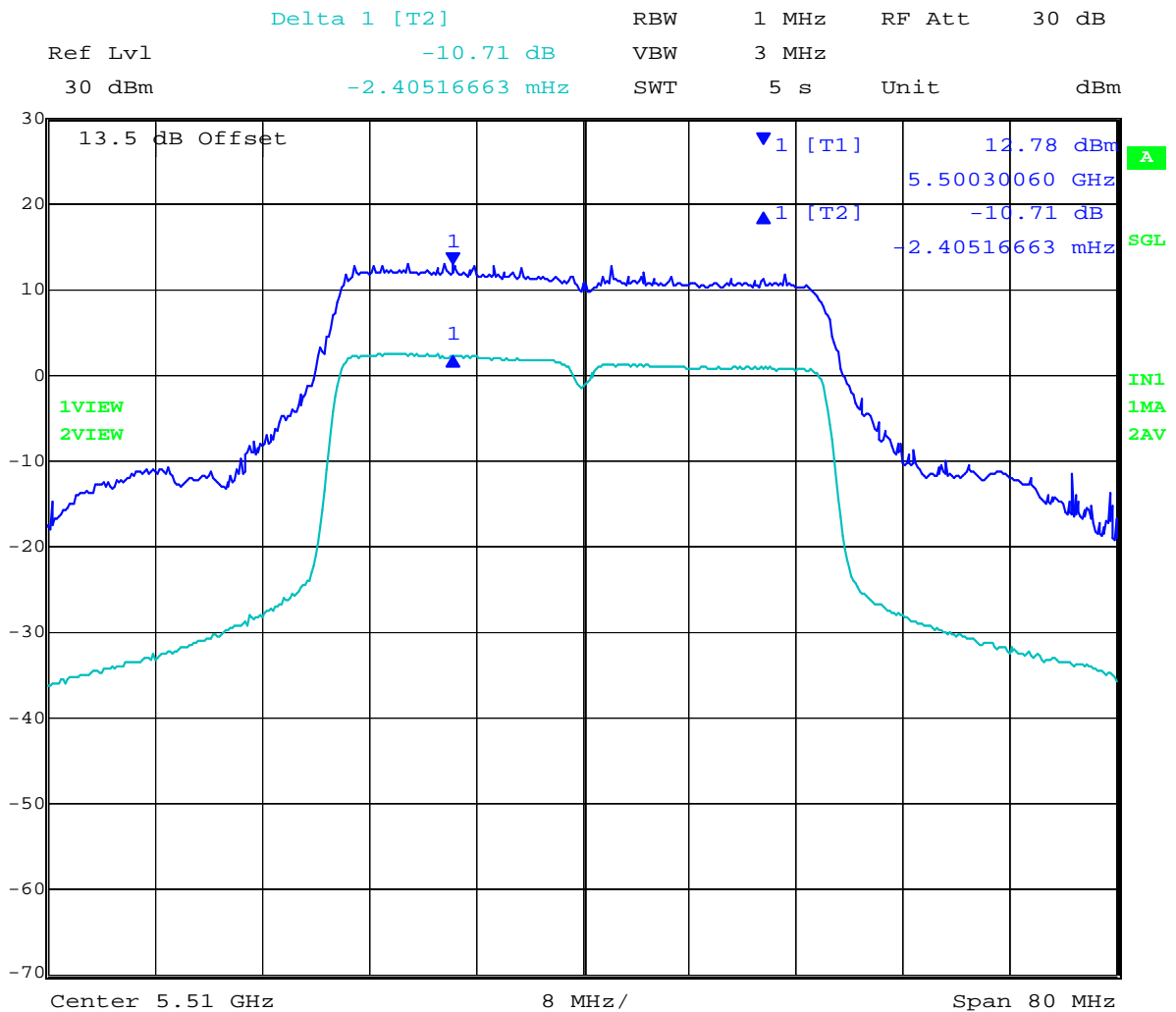

Date: 3.MAR.2010 14:45:28

This test report may be reproduced in full only. The document may only be updated by MiCOM Labs personnel. Any changes will be noted in the Document History section of the report.



### 5,590 MHz 802.11n HT40 - Peak Excursion Ratio

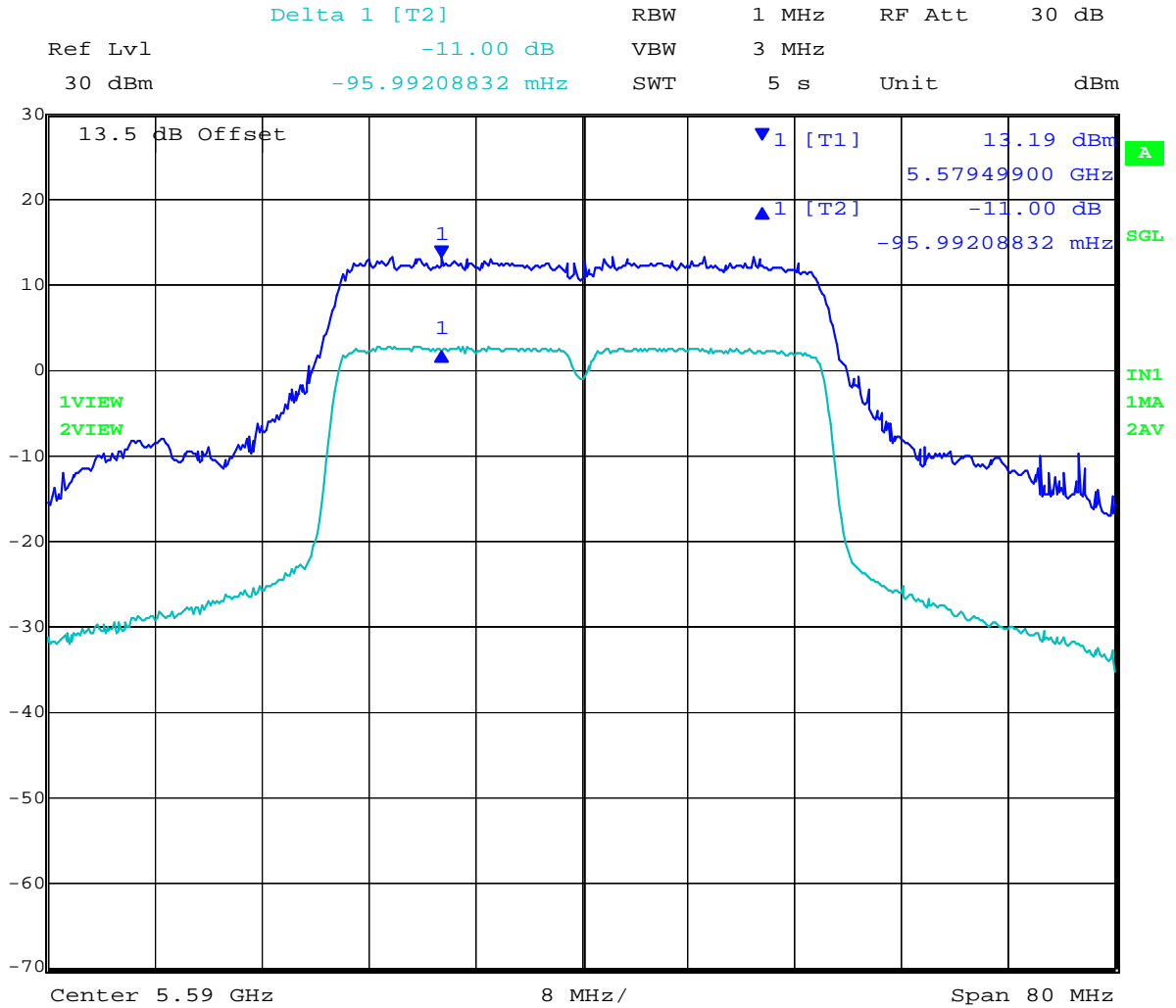

Date: 3.MAR.2010 14:57:56

This test report may be reproduced in full only. The document may only be updated by MiCOM Labs personnel. Any changes will be noted in the Document History section of the report.



### 5,690 MHz 802.11n HT40 - Peak Excursion Ratio

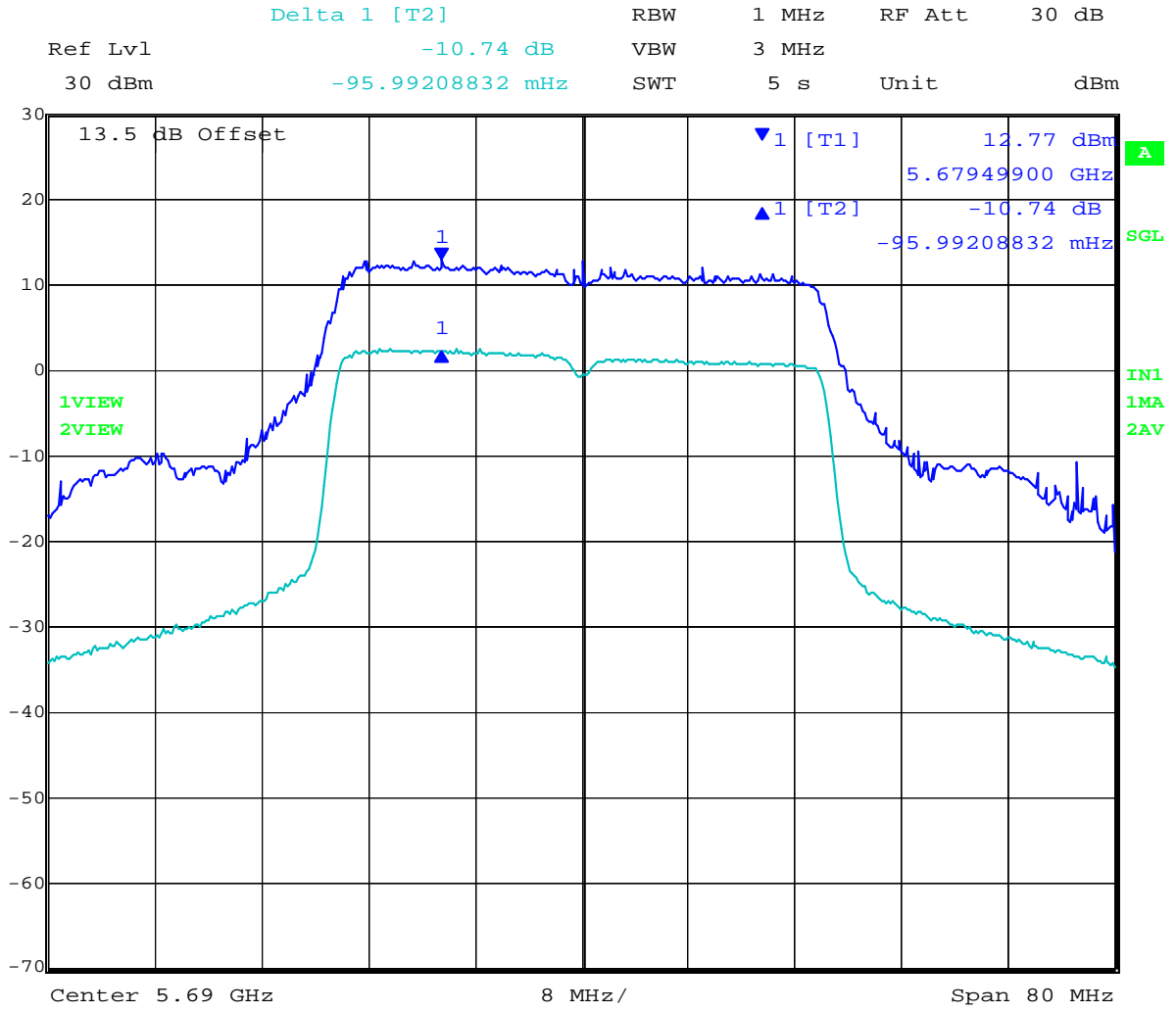

Date: 3.MAR.2010 15:21:29

This test report may be reproduced in full only. The document may only be updated by MiCOM Labs personnel. Any changes will be noted in the Document History section of the report.



**Title:** Aruba AP-105 802.11a/b/g/n Wireless AP  
**To:** FCC 47 CFR Part 15.407 & IC RSS-210  
**Serial #:** ARUB69-U3 Rev A  
**Date:** 11th April 2011  
**Page:** 104 of 208

---

## Specification

### Limits

**§15.407 (a)(6)** The ratio of the peak excursion of the modulation envelope (measured using a peak hold function) to the peak transmit power (measured as specified in this paragraph) shall not exceed 13dB across any 1MHz bandwidth or the emission bandwidth whichever is less

## Laboratory Measurement Uncertainty for Spectrum Measurement

Measurement uncertainty	± 2.81dB
-------------------------	----------

## Traceability

Method	Test Equipment Used
Measurements were made per work instruction WI-03 'Measurement of RF Spectrum Mask'	0158, 0287, 0252, 0313, 0314, 0070, 0116, 0117

---

This test report may be reproduced in full only. The document may only be updated by MiCOM Labs personnel. Any changes will be noted in the Document History section of the report.





**Title:** Aruba AP-105 802.11a/b/g/n Wireless AP  
**To:** FCC 47 CFR Part 15.407 & IC RSS-210  
**Serial #:** ARUB69-U3 Rev A  
**Date:** 11th April 2011  
**Page:** 105 of 208

---

### 5.1.5. Frequency Stability

**FCC, Part 15 Subpart C §15.407(g)**  
**Industry Canada RSS-210 §2.1**

#### **Test Procedure**

The manufacturer of the equipment is responsible for ensuring that the frequency stability is such that emissions are always maintained within the band of operation under all conditions.

#### **Manufacturer Declaration**

The frequency stability of the reference oscillator sets the frequency stability of the RF transceiver signals. Therefore all of the RF signals should have  $\pm 20$ ppm stability.

This stability accounts for room temp tolerance of the crystal oscillator circuit, frequency variation across temperature, and crystal ageing.

$\pm 20$ ppm at 5.250 GHz translates to a maximum frequency shift of  $\pm 105$  KHz. As the edge of the channels is at least one MHz from either of the band edges,  $\pm 105$  KHz is more than sufficient to guarantee that the intentional emission will remain in the band over the entire operating range of the EUT.

#### **Specification**

#### **Limits**

**§15.407 (g)** Manufacturers of U-NII devices are responsible for ensuring frequency stability such that an emission is maintained within the band of operation under all conditions of normal operation as specified in the user's manual.

---

This test report may be reproduced in full only. The document may only be updated by MiCOM Labs personnel. Any changes will be noted in the Document History section of the report.



**5.1.6. Maximum Permissible Exposure**

**FCC, Part 15 Subpart C §15.407(f)**  
**Industry Canada RSS-Gen §5.5**

**Calculations for Maximum Permissible Exposure Levels**

Power Density = Pd (mW/cm<sup>2</sup>) = EIRP/(4πd<sup>2</sup>)

EIRP = P \* G \* 2

P = Peak output power (mW)

G = Antenna numeric gain (numeric)

d = Separation distance (cm)

Numeric Gain = 10 ^ (G (dBi)/10)

The Aruba AP-105 has two transmitters. The peak power in the table below is calculated by assuming a worst case scenario where the two transmitters are operating simultaneously in the same band. The Peak Power in mW is calculated by taking the maximum conducted power measured in each band and multiplying by 2.

Because the EUT belongs to the General Population/Uncontrolled Exposure the limit of power density is 1.0 mW/cm<sup>2</sup>

Freq. Band (MHz)	Antenna Gain (dBi)	Numeric Gain (numeric)	Peak Output Power (dBm)	Peak Output Power (mW)	Calculated Safe Distance @ 1mW/cm <sup>2</sup> Limit(cm)	Minimum Separation Distance (cm)
5150 - 5250	4.0	2.51	+16.76	95.0	4.3	20
5250 - 5350			+20.12	205.6	6.4	
5500 - 5700			+18.34	136.5	5.2	

**Note:** for mobile or fixed location transmitters the minimum separation distance is 20cm, even if calculations indicate the MPE distance to be less.

**Specification**  
**Maximum Permissible Exposure Limits**

**FCC §1.1310** Limit = 1mW / cm<sup>2</sup> from 1.310 Table 1

**RSS-Gen §5.5** Before equipment certification is granted, the application requirements of RSS-102 shall be met.

**Laboratory Measurement Uncertainty for Power Measurements**

Measurement uncertainty

±1.33 dB

This test report may be reproduced in full only. The document may only be updated by MiCOM Labs personnel. Any changes will be noted in the Document History section of the report.



**Title:** Aruba AP-105 802.11a/b/g/n Wireless AP  
**To:** FCC 47 CFR Part 15.407 & IC RSS-210  
**Serial #:** ARUB69-U3 Rev A  
**Date:** 11th April 2011  
**Page:** 107 of 208

---

#### **5.1.7. Radiated Emissions**

**FCC, Part 15 Subpart C §15.407(b)(2), §15.205(a)/15.209(a)**  
**Industry Canada RSS-210 §A9.3(2); §2.2; §2.6; RSS-Gen §4.7**

#### **Test Procedure**

Testing was performed in a 3-meter anechoic chamber. Preliminary radiated emissions were measured on every azimuth and with the receiving antenna in both horizontal and vertical polarizations. Preliminary emissions were recorded with in Spectrum Analyzer mode, using a maximum peak detector while in peak hold mode. Depending on the frequency band spanned a notch filter and/or waveguide filter was used to remove the fundamental frequency.

Emissions nearest the limits were chosen for maximization and formal measurement using a CISPR compliant receiver. Emissions above 1000 MHz are measured utilizing a CISPR compliant average detector with a tuned receiver, using a bandwidth of 1 MHz. Emissions from 30 MHz – 1000 MHz are measured utilizing a CISPR compliant quasi-peak detector with a tuned receiver, using a bandwidth of 120 kHz. Only the highest emissions relative to the limit are listed.

---

This test report may be reproduced in full only. The document may only be updated by MiCOM Labs personnel. Any changes will be noted in the Document History section of the report.

### Test Measurement Set Up

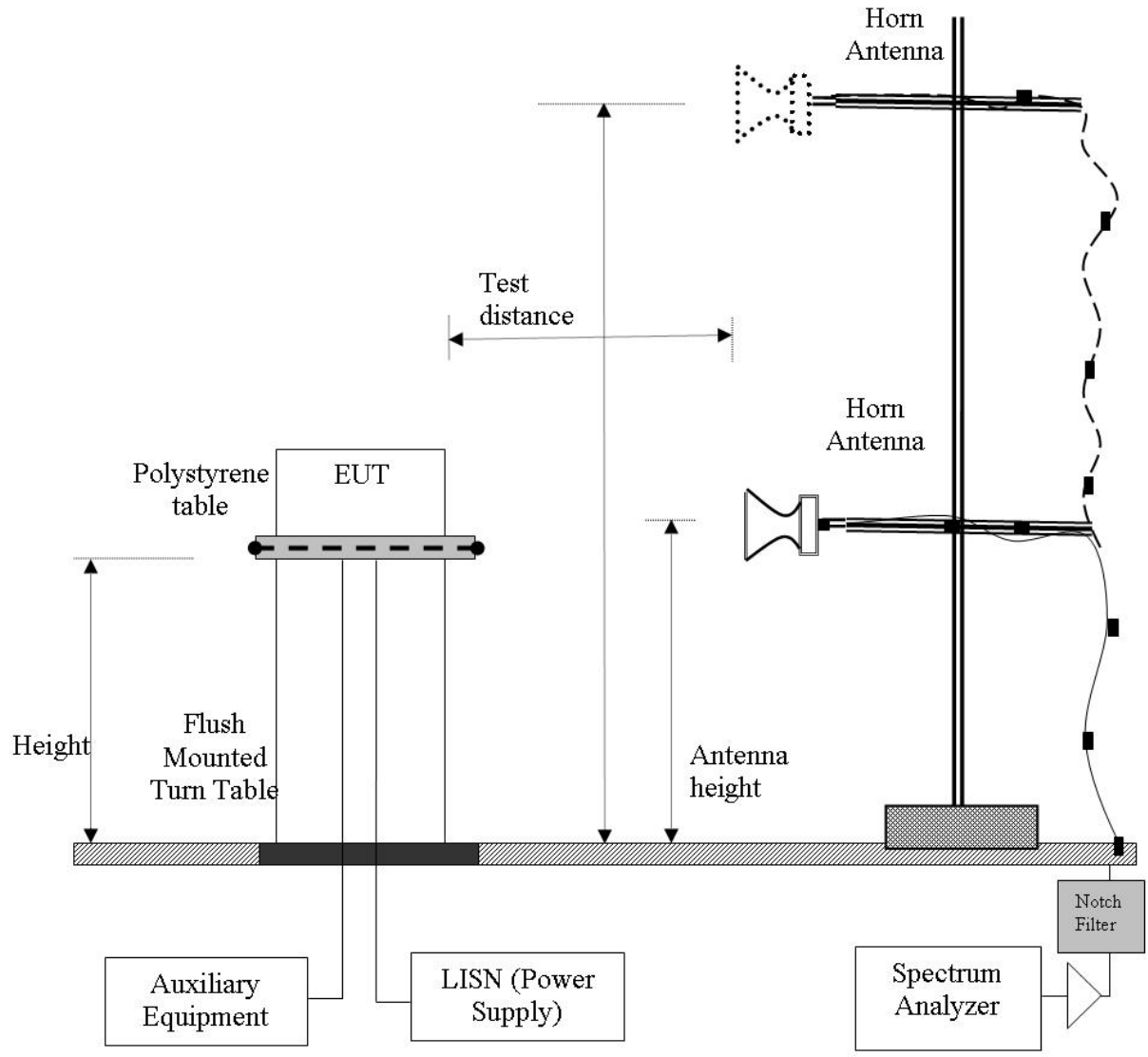

Radiated Emission Measurement Setup – Above 1 GHz

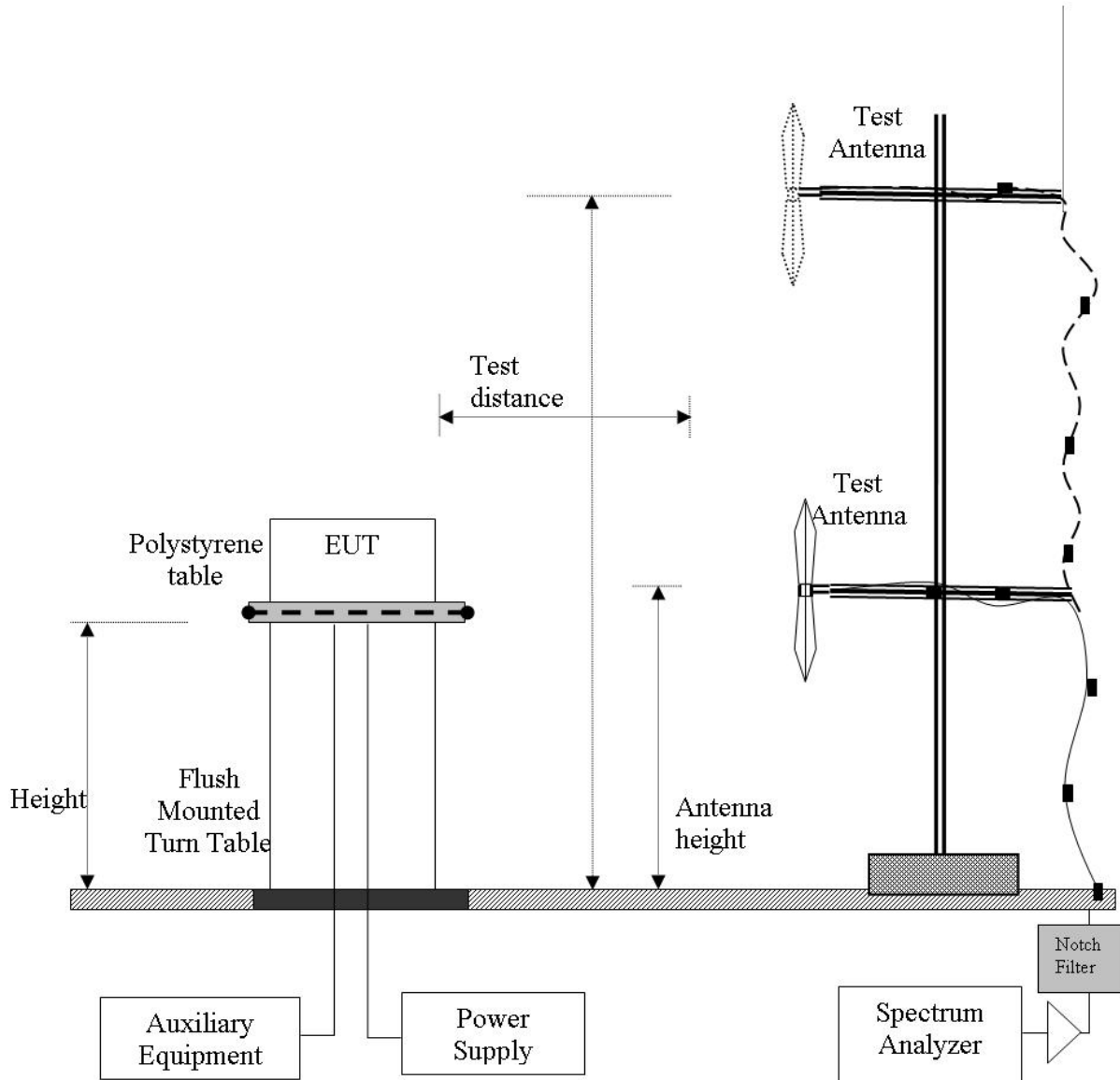

Radiated Emission Measurement Setup – Below 1 GHz

### Field Strength Calculation

The field strength is calculated by adding the Antenna Factor and Cable Loss, and subtracting Amplifier Gain from the measured reading. All factors are included in the reported data.

$$FS = R + AF + CORR - FO$$

FS = Field Strength

R = Measured Spectrum analyzer Input Amplitude

AF = Antenna Factor

This test report may be reproduced in full only. The document may only be updated by MiCOM Labs personnel. Any changes will be noted in the Document History section of the report.



**Title:** Aruba AP-105 802.11a/b/g/n Wireless AP  
**To:** FCC 47 CFR Part 15.407 & IC RSS-210  
**Serial #:** ARUB69-U3 Rev A  
**Date:** 11th April 2011  
**Page:** 110 of 208

**CORR = Correction Factor = CL – AG + NFL**

CL = Cable Loss

AG = Amplifier Gain

FO = Distance Falloff Factor

NFL = Notch Filter Loss or Waveguide Loss

Field Strength Calculation Example:

Given receiver input reading of 51.5 dB $\mu$ V; Antenna Factor of 8.5 dB; Cable Loss of 1.3 dB; Falloff Factor of 0 dB, an Amplifier Gain of 26 dB and Notch Filter Loss of 1 dB. The Field Strength of the measured emission is:

$$FS = 51.5 + 8.5 + 1.3 - 26.0 + 1 = 36.3 \text{ dB}\mu\text{V/m}$$

Conversion between dB $\mu$ V/m (or dB $\mu$ V) and  $\mu$ V/m (or  $\mu$ V) are done as:

$$\text{Level (dB}\mu\text{V/m)} = 20 * \text{Log (level (\mu\text{V/m}))}$$

$$40 \text{ dB}\mu\text{V/m} = 100 \mu\text{V/m}$$

$$48 \text{ dB}\mu\text{V/m} = 250 \mu\text{V/m}$$

The following formula is used to convert the equipment isotropic radiated power (eirp) to field strength (dB $\mu$ V/m);

$$E = 1000000 \times \sqrt{30P} / 3 \mu\text{V/m}$$

where P is the EIRP in Watts

$$\text{Therefore: } -27 \text{ dBm/MHz} = 68.23 \text{ dB}\mu\text{V/m}$$

**Note:** The data in this Section identifies that the EUT is in compliance with the -27dBm/MHz EIRP limit (68.23 dB $\mu$ V/m) for out of band emissions. All out of band emissions are less than 68.23 dB  $\mu$ V/m.

This test report may be reproduced in full only. The document may only be updated by MiCOM Labs personnel. Any changes will be noted in the Document History section of the report.



**Title:** Aruba AP-105 802.11a/b/g/n Wireless AP  
**To:** FCC 47 CFR Part 15.407 & IC RSS-210  
**Serial #:** ARUB69-U3 Rev A  
**Date:** 11th April 2011  
**Page:** 111 of 208

<b>Date</b>	5th August, 2009
<b>Engineer</b>	CSB
<b>Test Case</b>	ARUB40
<b>Frequency</b>	5180 MHz
<b>Antenna Model</b>	Integral
<b>Power setting</b>	15.5 in ART test utility
<b>Test</b>	802.11a; 6 Mbps
<b>Conditions</b>	120V AC Mains - Ethernet cable attached for ART control

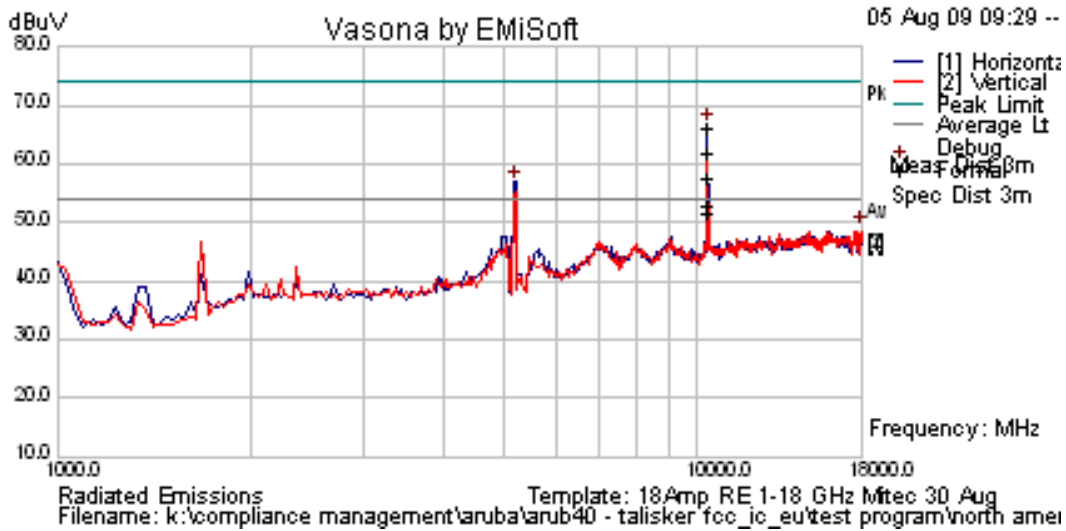

Frequency MHz	Raw dBuV	Cable Loss	AF dB	Level dBuV	Measurement Type	Pol	Hgt cm	Azt Deg	Limit dBuV	Margin dB	Pass /Fail	Comments
5150.00	ART Power = 15.5			68.20	Peak				74	-5.8	Pass	BE
5150.00	ART Power = 15.5			52.32	Average				54	-1.68	Pass	BE
5181.06	58.88	14.62	34.65	108.1	Peak	H						FUND
10360.10	68.78	6.69	-0.24	75.24	Peak	V	122	313	68.23	-7.01	Pass	NRB
15533.95	48.43	8.27	-0.75	55.94	Peak	H	98	311	74	-18.06	Pass	RB
15533.95	34.19	8.27	-0.75	41.71	Average	H	98	311	54	-12.29	Pass	RB

This test report may be reproduced in full only. The document may only be updated by MiCOM Labs personnel. Any changes will be noted in the Document History section of the report.



**Peak Emission Scan**

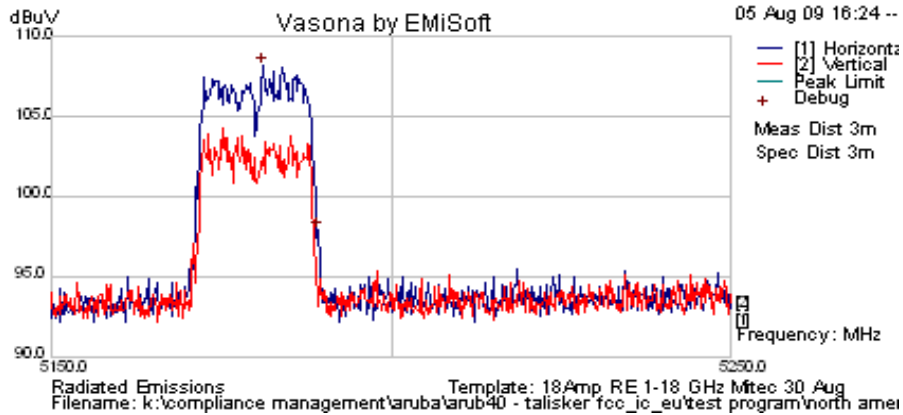

**Band-Edge Emission Scan - 802.11a 4500 to 5150 MHz**

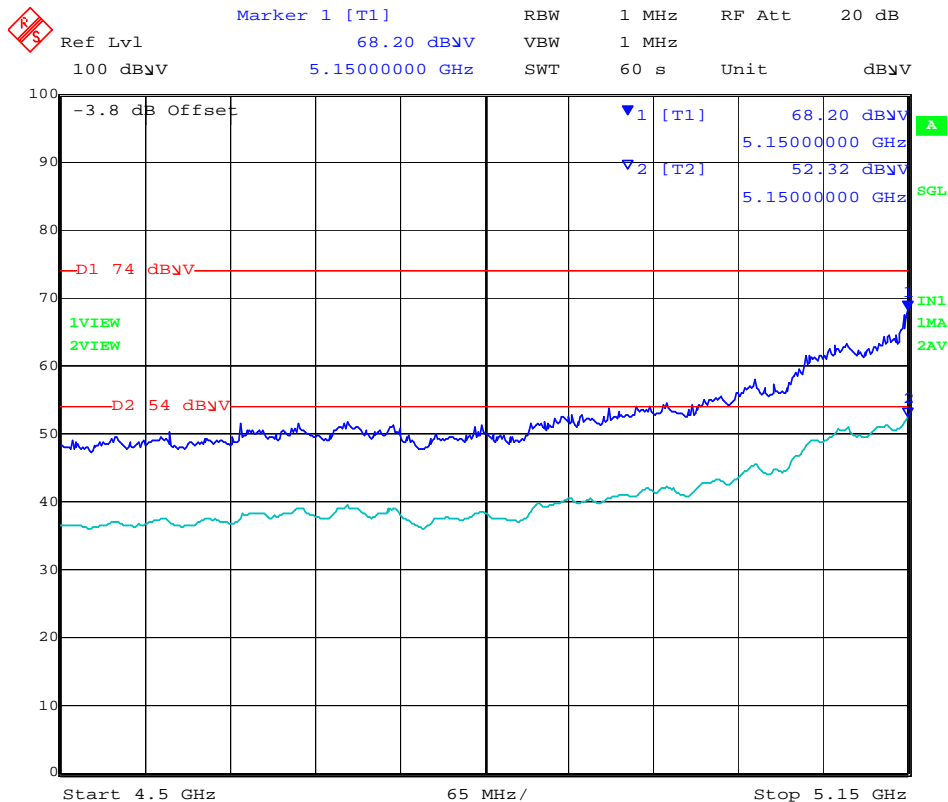

Date: 5.AUG.2009 12:57:39

This test report may be reproduced in full only. The document may only be updated by MiCOM Labs personnel. Any changes will be noted in the Document History section of the report.







**Title:** Aruba AP-105 802.11a/b/g/n Wireless AP  
**To:** FCC 47 CFR Part 15.407 & IC RSS-210  
**Serial #:** ARUB69-U3 Rev A  
**Date:** 11th April 2011  
**Page:** 114 of 208

Peak Emission Scan

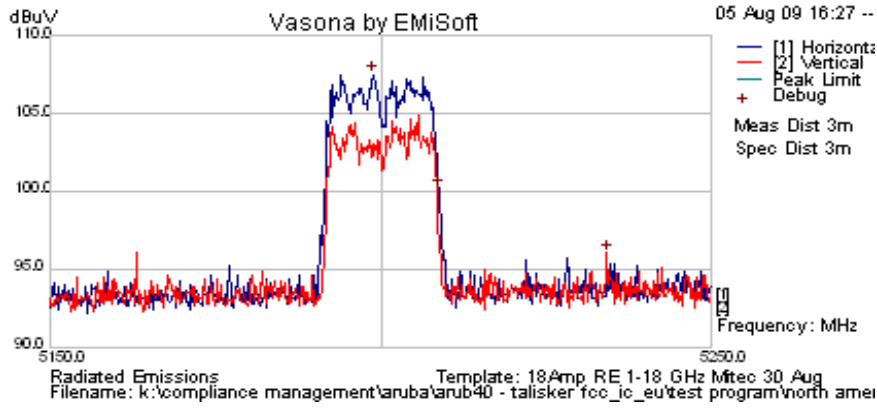

This test report may be reproduced in full only. The document may only be updated by MiCOM Labs personnel. Any changes will be noted in the Document History section of the report.



**Title:** Aruba AP-105 802.11a/b/g/n Wireless AP  
**To:** FCC 47 CFR Part 15.407 & IC RSS-210  
**Serial #:** ARUB69-U3 Rev A  
**Date:** 11th April 2011  
**Page:** 115 of 208

<b>Date</b>	5th August, 2009
<b>Engineer</b>	CSB
<b>Test Case</b>	ARUB40
<b>Frequency</b>	5240 MHz
<b>Antenna Model</b>	Integral
<b>Power setting</b>	15.5 in ART test utility
<b>Test</b>	802.11a; 6 Mbps
<b>Conditions</b>	120V AC Mains - Ethernet cable attached for ART control

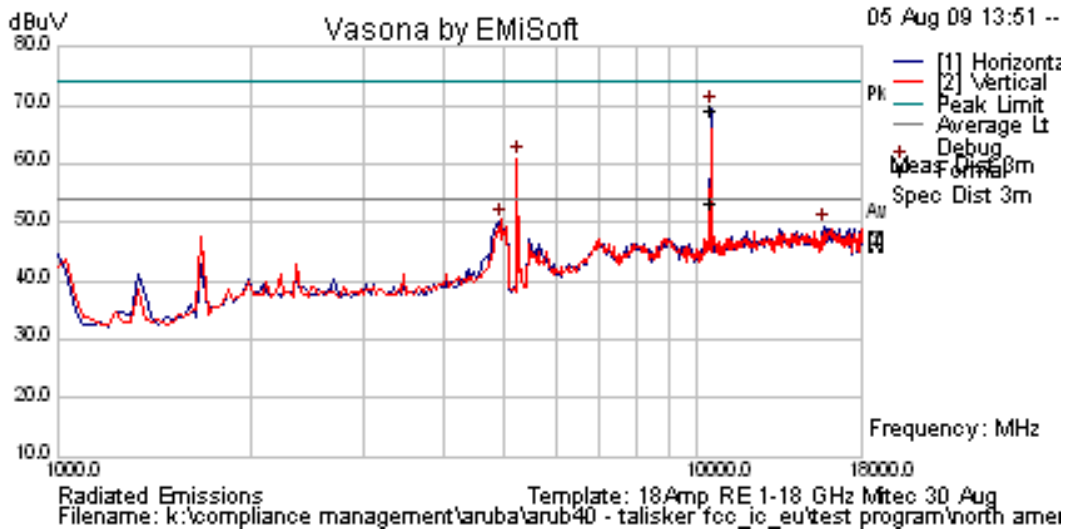

Frequency MHz	Raw dBuV	Cable Loss	AF dB	Level dBuV	Measurement Type	Pol	Hgt cm	Azt Deg	Limit dBuV	Margin dB	Pass /Fail	Comments
5246.393	59.1	14.62	34.7	108.4	Peak	H						FUND
10480.1	66.71	6.77	-0.52	72.96	Peak	V	98	315	68.23	-4.73	Pass	NRB

This test report may be reproduced in full only. The document may only be updated by MiCOM Labs personnel. Any changes will be noted in the Document History section of the report.



**Title:** Aruba AP-105 802.11a/b/g/n Wireless AP  
**To:** FCC 47 CFR Part 15.407 & IC RSS-210  
**Serial #:** ARUB69-U3 Rev A  
**Date:** 11th April 2011  
**Page:** 116 of 208

Peak Emission Scan

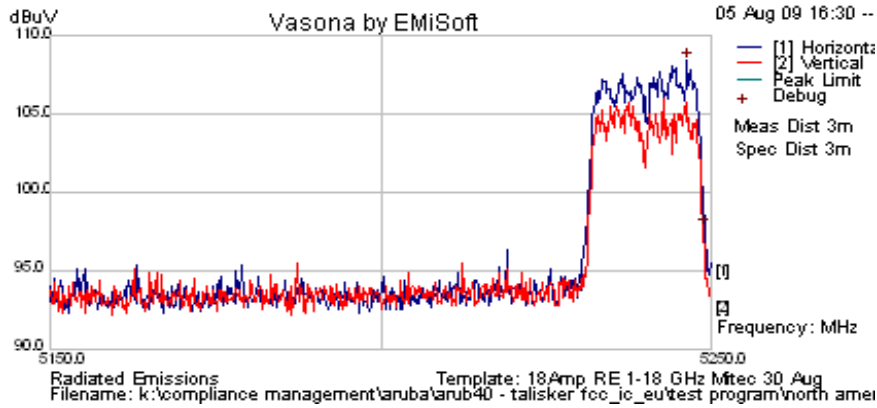

This test report may be reproduced in full only. The document may only be updated by MiCOM Labs personnel. Any changes will be noted in the Document History section of the report.



**Title:** Aruba AP-105 802.11a/b/g/n Wireless AP  
**To:** FCC 47 CFR Part 15.407 & IC RSS-210  
**Serial #:** ARUB69-U3 Rev A  
**Date:** 11th April 2011  
**Page:** 117 of 208

<b>Date</b>	5th August, 2009
<b>Engineer</b>	CSB
<b>Test Case</b>	ARUB40
<b>Frequency</b>	5180 MHz
<b>Antenna Model</b>	Integral
<b>Power setting</b>	15 in ART test utility
<b>Test</b>	802.11n HT-20; 6.5 MCS
<b>Conditions</b>	120V AC Mains - Ethernet cable attached for ART control

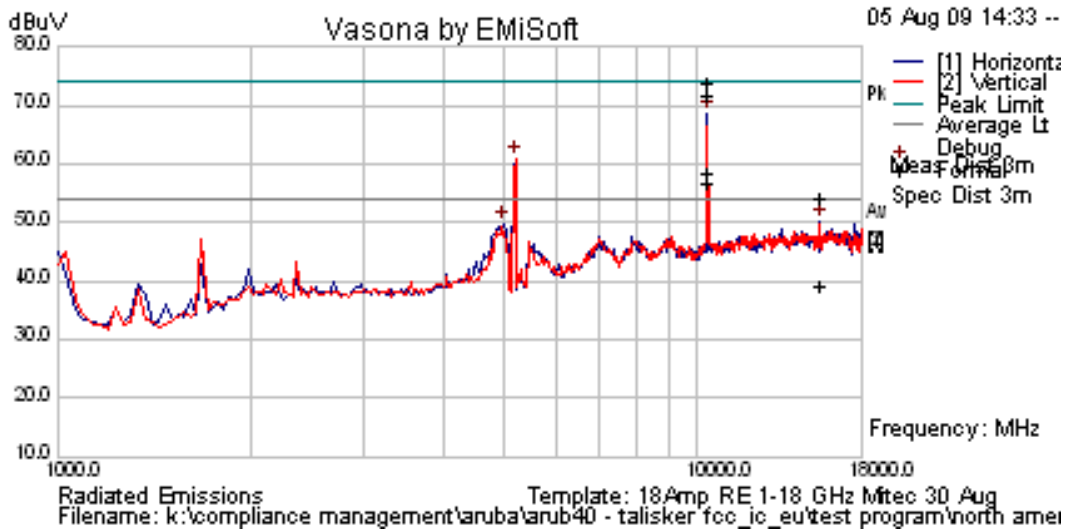

Frequency MHz	Raw dBuV	Cable Loss	AF dB	Level dBuV	Measurement Type	Pol	Hgt cm	Azt Deg	Limit dBuV	Margin dB	Pass /Fail	Comments
5150	ART Power = 15.0			72.04	Peak				74	-1.96	Pass	BE
5150				51.93	Average				54	-2.07	Pass	BE
5187.275	61.97	14.62	34.65	111.3	Peak	H						FUND
10360.86	63.43	6.7	-0.23	69.89	Peak	V	100	315	68.23	-1.66	Pass	NRB
15534.94	48.05	8.27	-0.75	55.56	Peak	H	101	25	74	-18.44	Pass	RB
15534.94	32.76	8.27	-0.75	40.27	Average	H	101	25	54	-13.73	Pass	RB

This test report may be reproduced in full only. The document may only be updated by MiCOM Labs personnel. Any changes will be noted in the Document History section of the report.



Peak Emission Scan

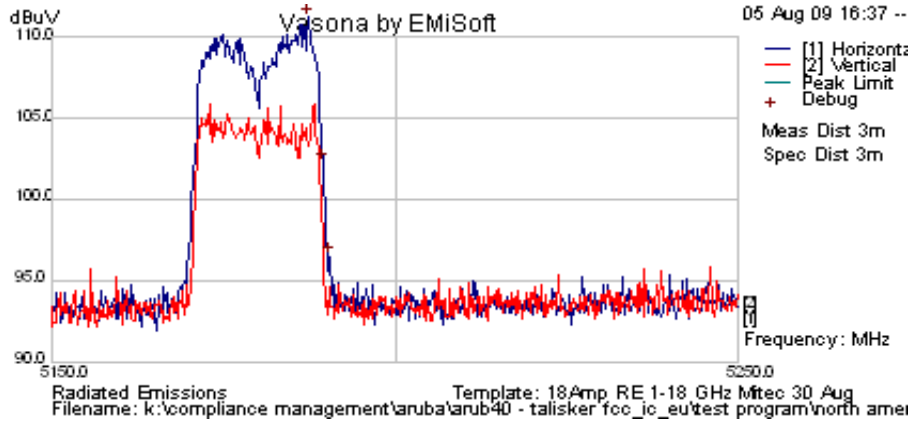

Band-Edge Emission Scan - 802.11 HT-20 4500 to 5150 MHz

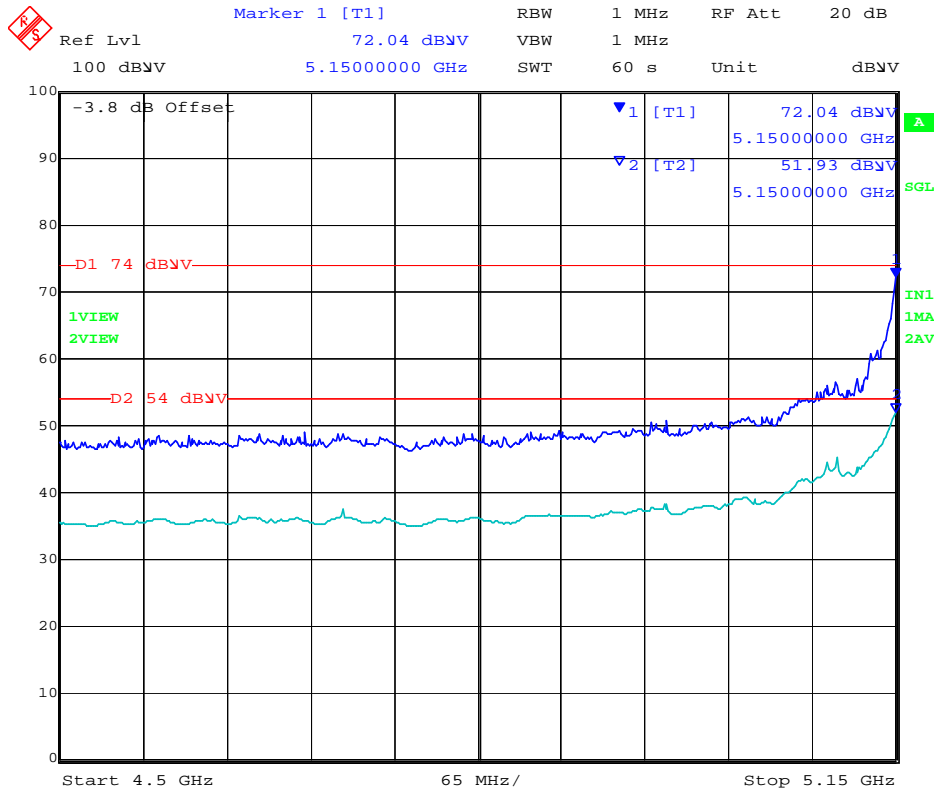

Date: 5.AUG.2009 13:09:54

This test report may be reproduced in full only. The document may only be updated by MiCOM Labs personnel. Any changes will be noted in the Document History section of the report.



**Title:** Aruba AP-105 802.11a/b/g/n Wireless AP  
**To:** FCC 47 CFR Part 15.407 & IC RSS-210  
**Serial #:** ARUB69-U3 Rev A  
**Date:** 11th April 2011  
**Page:** 119 of 208

<b>Date</b>	5th August, 2009
<b>Engineer</b>	CSB
<b>Test Case</b>	ARUB40
<b>Frequency</b>	5200 MHz
<b>Antenna Model</b>	Integral
<b>Power setting</b>	15 in ART test utility
<b>Test</b>	802.11n HT-20; 6.5 MCS
<b>Conditions</b>	120V AC Mains - Ethernet cable attached for ART control

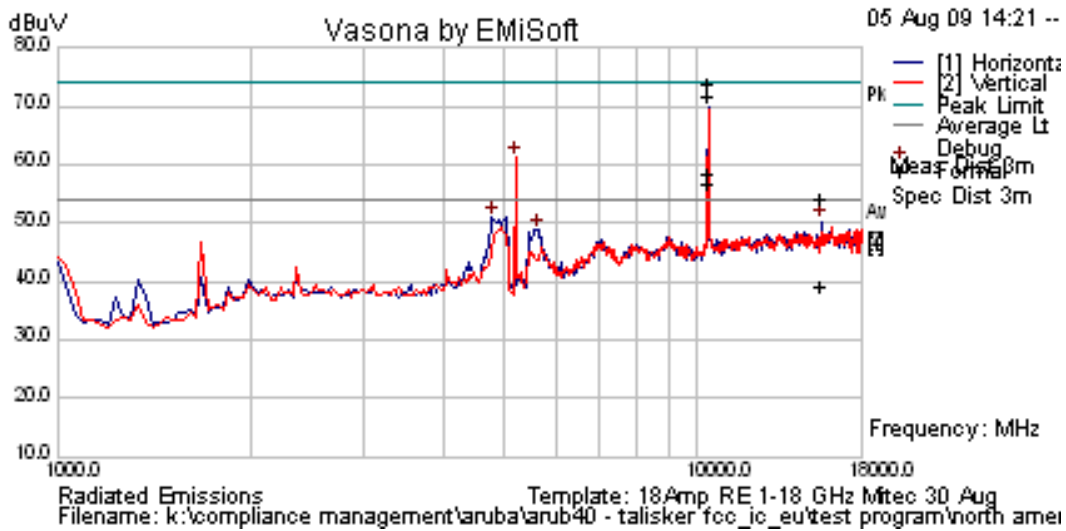

Frequency MHz	Raw dBuV	Cable Loss	AF dB	Level dBuV	Measurement Type	Pol	Hgt cm	Azt Deg	Limit dBuV	Margin dB	Pass /Fail	Comments
5205.311	59.82	14.62	34.67	109.1	Peak	H						FUND
10400.48	67.28	6.72	-0.28	73.72	Peak	V	98	315	68.23	-5.49	Pass	NRB
15605.04	46.64	8.38	-0.75	54.27	Peak	H	110	0	74	-19.73	Pass	RB
15605.04	31.43	8.38	-0.75	39.06	Average	H	110	0	54	-14.94	Pass	RB

This test report may be reproduced in full only. The document may only be updated by MiCOM Labs personnel. Any changes will be noted in the Document History section of the report.



**Title:** Aruba AP-105 802.11a/b/g/n Wireless AP  
**To:** FCC 47 CFR Part 15.407 & IC RSS-210  
**Serial #:** ARUB69-U3 Rev A  
**Date:** 11th April 2011  
**Page:** 120 of 208

Peak Emission Scan

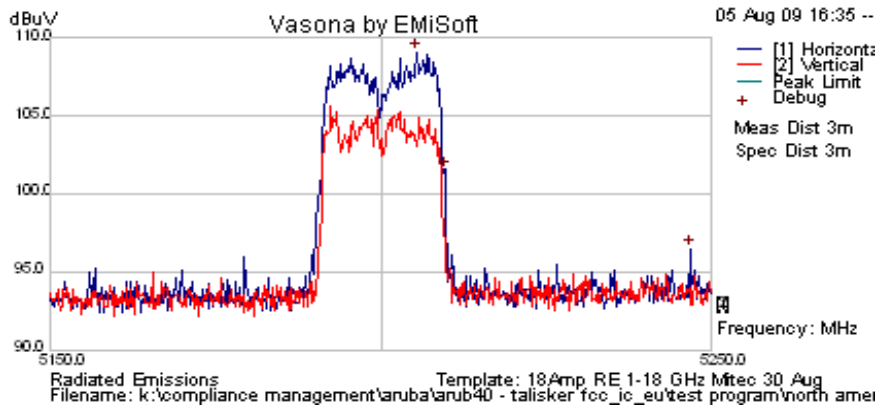

This test report may be reproduced in full only. The document may only be updated by MiCOM Labs personnel. Any changes will be noted in the Document History section of the report.





**Title:** Aruba AP-105 802.11a/b/g/n Wireless AP  
**To:** FCC 47 CFR Part 15.407 & IC RSS-210  
**Serial #:** ARUB69-U3 Rev A  
**Date:** 11th April 2011  
**Page:** 121 of 208

<b>Date</b>	5th August, 2009
<b>Engineer</b>	CSB
<b>Test Case</b>	ARUB40
<b>Frequency</b>	5240 MHz
<b>Antenna Model</b>	Integral
<b>Power setting</b>	15 in ART test utility
<b>Test</b>	802.11n HT-20; 6.5 MCS
<b>Conditions</b>	120V AC Mains - Ethernet cable attached for ART control

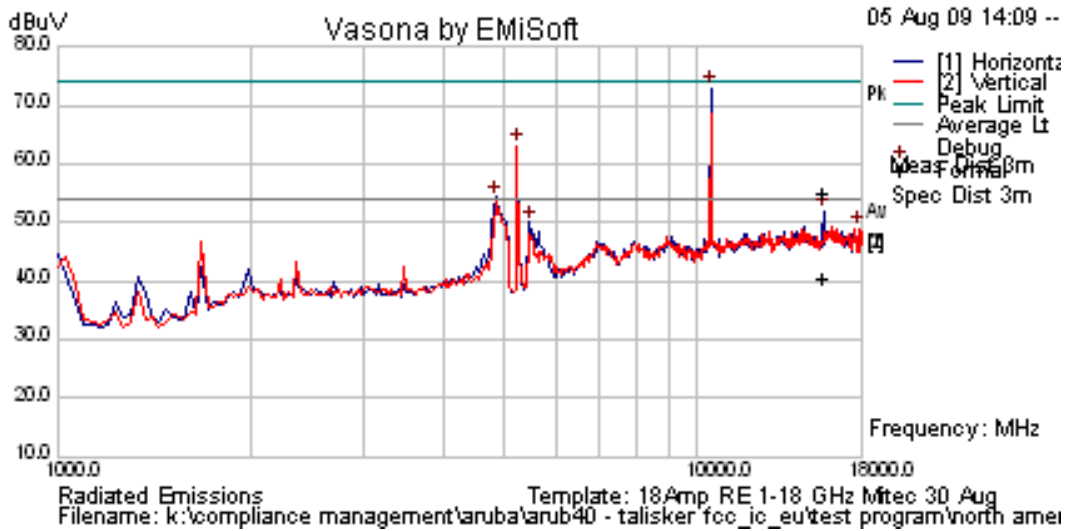

Frequency MHz	Raw dBuV	Cable Loss	AF dB	Level dBuV	Measurement Type	Pol	Hgt cm	Azt Deg	Limit dBuV	Margin dB	Pass /Fail	Comments
5237.575	61.17	14.62	34.69	110.5	Peak	H						FUND
10478.81	65.24	6.77	-0.52	71.49	Peak	V	98	315	68.23	-3.26	Pass	NRB
15728.58	47.28	8.58	-0.62	55.24	Peak	H	98	355	74	-18.76	Pass	RB
15728.58	32.37	8.58	-0.62	40.34	Average	H	98	355	54	-13.66	Pass	RB

This test report may be reproduced in full only. The document may only be updated by MiCOM Labs personnel. Any changes will be noted in the Document History section of the report.



**Title:** Aruba AP-105 802.11a/b/g/n Wireless AP  
**To:** FCC 47 CFR Part 15.407 & IC RSS-210  
**Serial #:** ARUB69-U3 Rev A  
**Date:** 11th April 2011  
**Page:** 122 of 208

Peak Emission Scan

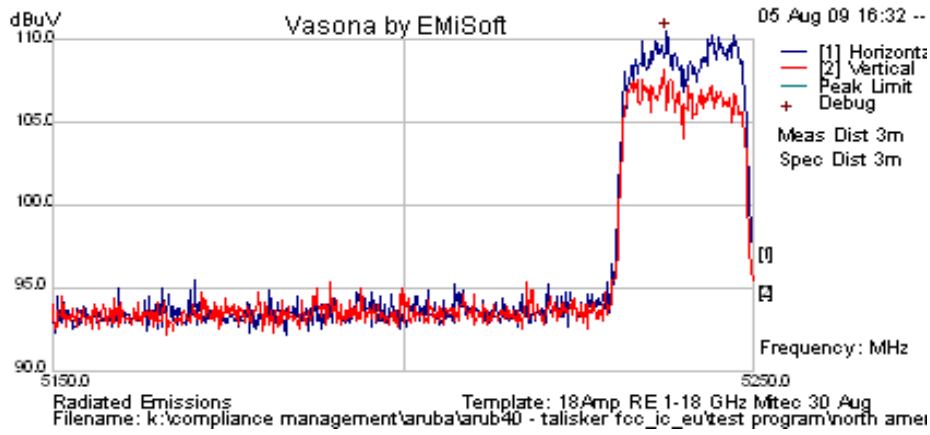

This test report may be reproduced in full only. The document may only be updated by MiCOM Labs personnel. Any changes will be noted in the Document History section of the report.





**Peak Emission Scan**

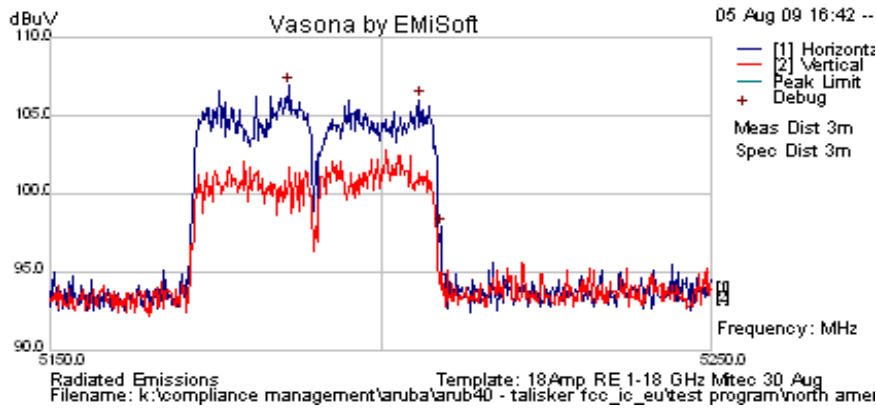

**Band-Edge Emission Scan - 802.11 HT-40 4500 to 5150 MHz**

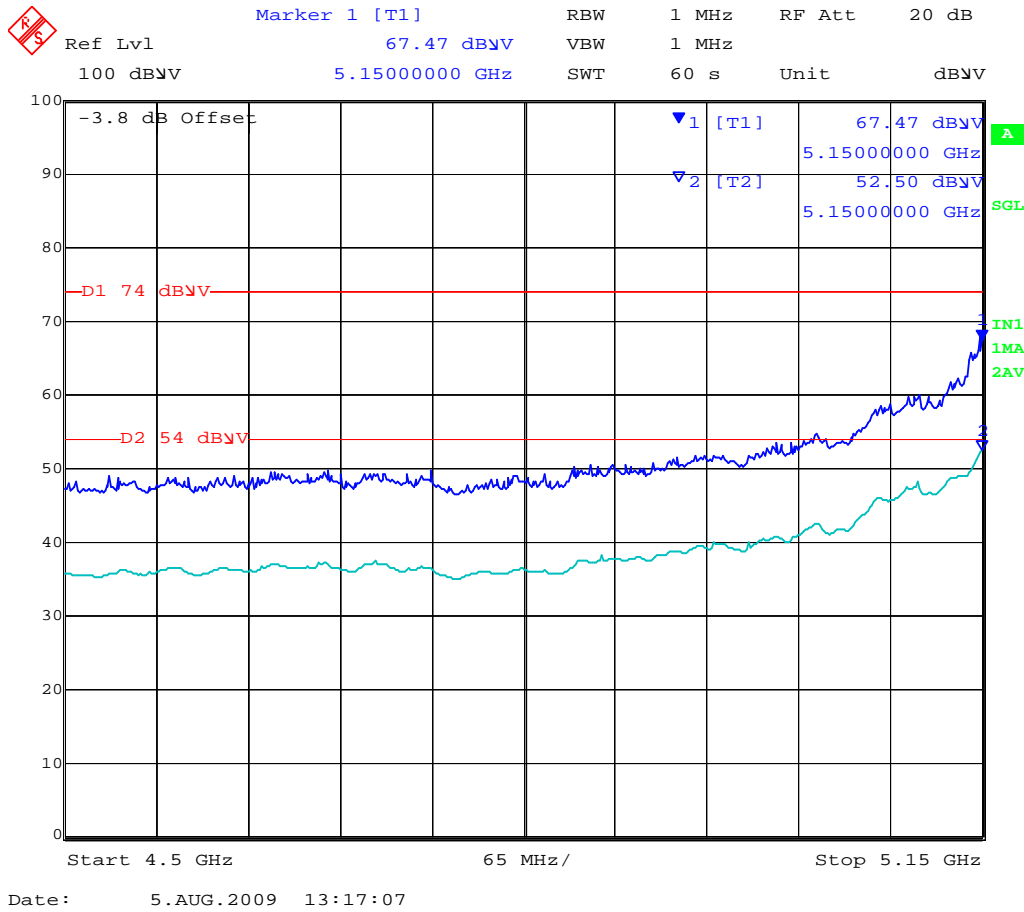

This test report may be reproduced in full only. The document may only be updated by MiCOM Labs personnel. Any changes will be noted in the Document History section of the report.



**Title:** Aruba AP-105 802.11a/b/g/n Wireless AP  
**To:** FCC 47 CFR Part 15.407 & IC RSS-210  
**Serial #:** ARUB69-U3 Rev A  
**Date:** 11th April 2011  
**Page:** 125 of 208

<b>Date</b>	5th August, 2009
<b>Engineer</b>	CSB
<b>Test Case</b>	ARUB40
<b>Frequency</b>	5230 MHz
<b>Antenna Model</b>	Integral
<b>Power setting</b>	13.5 in ART test utility
<b>Test</b>	802.11n HT-40; 13.5 MCS
<b>Conditions</b>	120V AC Mains - Ethernet cable attached for ART control

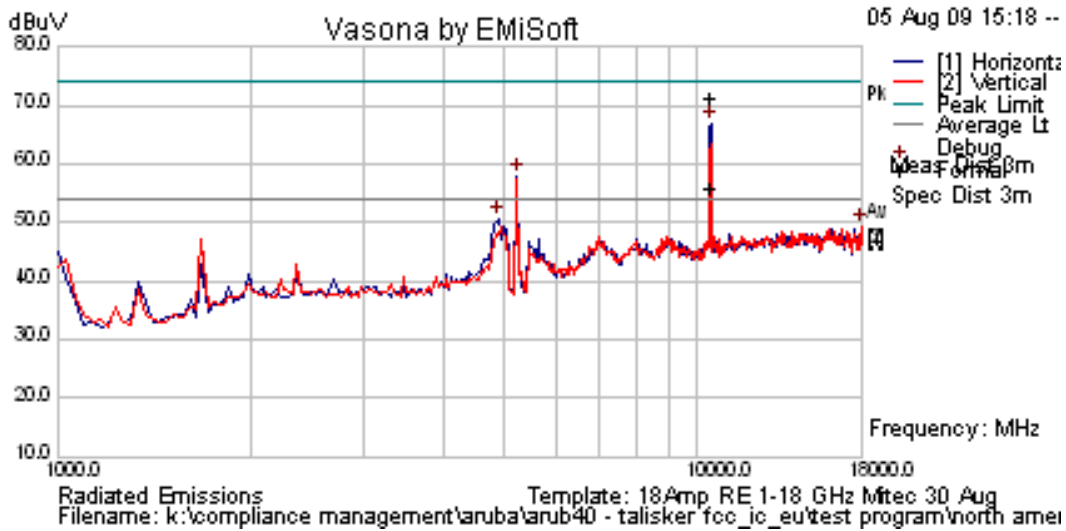

Frequency MHz	Raw dBuV	Cable Loss	AF dB	Level dBuV	Measurement Type	Pol	Hgt cm	Azt Deg	Limit dBuV	Margin dB	Pass /Fail	Comments
5236.373	57.14	14.62	34.69	106.5	Peak	H						FUND
10460.02	65.11	6.76	-0.46	71.4	Peak	V	109	315	68.23	-3.17	Pass	NRB

This test report may be reproduced in full only. The document may only be updated by MiCOM Labs personnel. Any changes will be noted in the Document History section of the report.



**Title:** Aruba AP-105 802.11a/b/g/n Wireless AP  
**To:** FCC 47 CFR Part 15.407 & IC RSS-210  
**Serial #:** ARUB69-U3 Rev A  
**Date:** 11th April 2011  
**Page:** 126 of 208

Peak Emission Scan

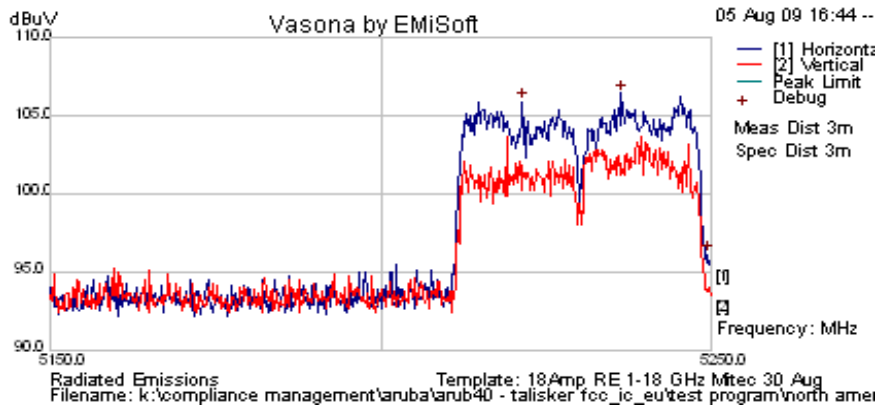

This test report may be reproduced in full only. The document may only be updated by MiCOM Labs personnel. Any changes will be noted in the Document History section of the report.



**Title:** Aruba AP-105 802.11a/b/g/n Wireless AP  
**To:** FCC 47 CFR Part 15.407 & IC RSS-210  
**Serial #:** ARUB69-U3 Rev A  
**Date:** 11th April 2011  
**Page:** 127 of 208

<b>Test Freq.</b>	5500 MHz	<b>Engineer</b>	GMH
<b>Variant</b>	802.11a; 6 Mbs	<b>Temp (°C)</b>	22
<b>Freq. Range</b>	1000 MHz - 18000 MHz	<b>Rel. Hum.(%)</b>	41
<b>Power Setting</b>	20	<b>Press. (mBars)</b>	1011
<b>Antenna</b>	Integral	<b>Duty Cycle (%)</b>	100
<b>Test Notes 1</b>	5500 - 5700 MHz Notch Filter Included		
<b>Test Notes 2</b>			

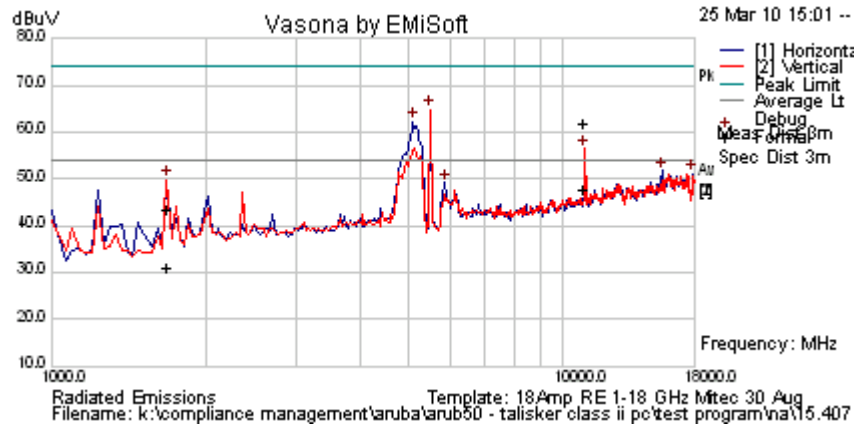

### Formally measured emission peaks

Frequency MHz	Raw dBuV	Cable Loss	AF dB	Level dBuV	Measurement Type	Pol	Hgt cm	Azt Deg	Limit dBuV	Margin dB	Pass /Fail	Comments
10997.764	57.7	7.0	-2.9	61.8	Peak Max	V	98	40	74.0	-12.2	Pass	RB
1680.84872	54.5	2.5	-13.7	43.3	Peak Max	H	171	0	74.0	-30.7	Pass	RB
10997.764	43.5	7.0	-2.9	47.6	Average Max	V	98	40	54.0	-6.4	Pass	RB
1680.849	42.2	2.5	-13.7	31.1	Average Max	H	171	0	54.0	-22.9	Pass	RB

Legend: TX = Transmitter Emissions; DIG = Digital Emissions; FUND = Fundamental; WB = Wideband Emission

This test report may be reproduced in full only. The document may only be updated by MiCOM Labs personnel. Any changes will be noted in the Document History section of the report.



**Band-edge 5460 MHz Transmitting Channel 5,500 MHz 802.11a Closest to Band-edge**

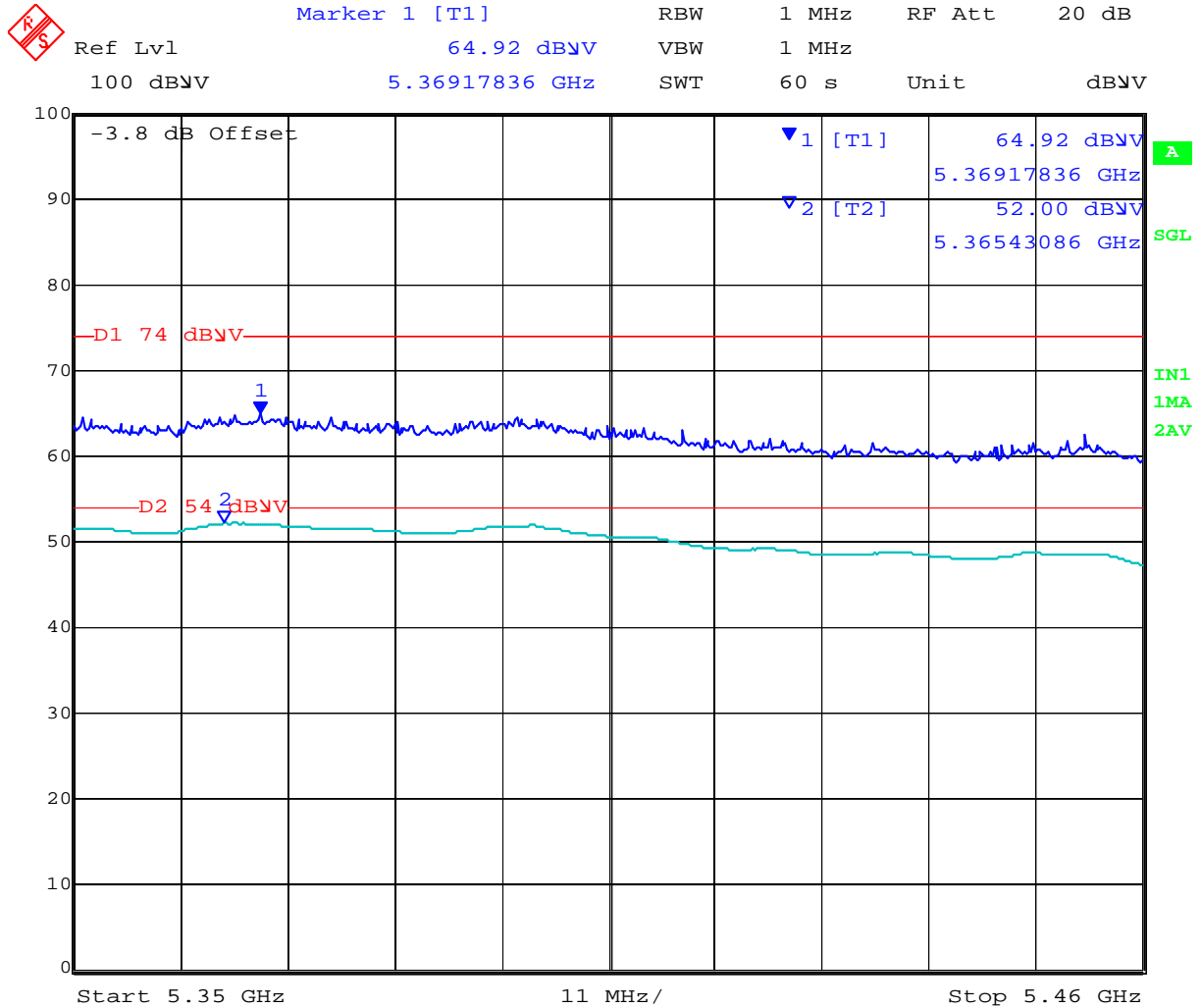

Date: 3.MAR.2010 11:17:44

This test report may be reproduced in full only. The document may only be updated by MiCOM Labs personnel. Any changes will be noted in the Document History section of the report.





**Title:** Aruba AP-105 802.11a/b/g/n Wireless AP  
**To:** FCC 47 CFR Part 15.407 & IC RSS-210  
**Serial #:** ARUB69-U3 Rev A  
**Date:** 11th April 2011  
**Page:** 129 of 208

<b>Test Freq.</b>	5600 MHz	<b>Engineer</b>	GMH
<b>Variant</b>	802.11a; 6 Mbs	<b>Temp (°C)</b>	22
<b>Freq. Range</b>	1000 MHz - 18000 MHz	<b>Rel. Hum.(%)</b>	41
<b>Power Setting</b>	20	<b>Press. (mBars)</b>	1011
<b>Antenna</b>	Integral	<b>Duty Cycle (%)</b>	100
<b>Test Notes 1</b>	5500 - 5700 MHz Notch Filter Included		
<b>Test Notes 2</b>			

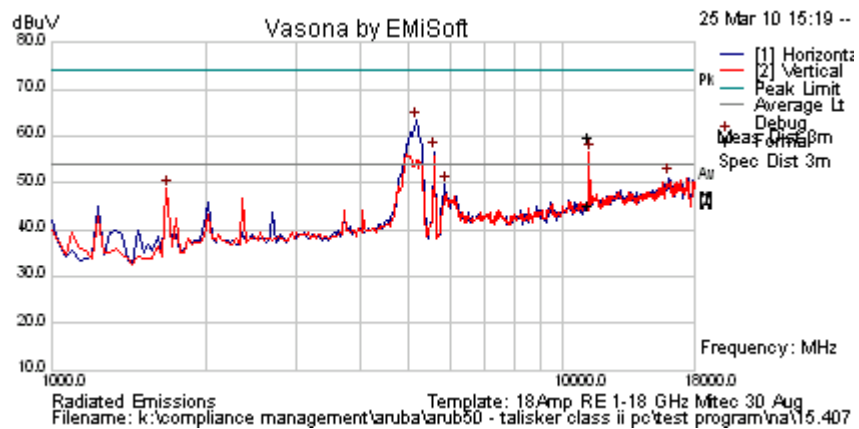

**Formally measured emission peaks**

Frequency MHz	Raw dBuV	Cable Loss	AF dB	Level dBuV	Measurement Type	Pol	Hgt cm	Azt Deg	Limit dBuV	Margin dB	Pass /Fail	Comments
11202.625	55.8	6.9	-3.0	59.7	Peak Max	V	98	7	74.0	-14.3	Pass	RB
1680.84872	54.5	2.5	-13.7	43.3	Peak Max	H	171	0	74.0	-30.7	Pass	RB
11202.625	41.5	6.9	-3.0	45.4	Average Max	V	98	7	54.0	-8.7	Pass	RB
1680.849	42.2	2.5	-13.7	31.1	Average Max	H	171	0	54	-22.9	Pass	RB

Legend: TX = Transmitter Emissions; DIG = Digital Emissions; FUND = Fundamental; WB = Wideband Emission

This test report may be reproduced in full only. The document may only be updated by MiCOM Labs personnel. Any changes will be noted in the Document History section of the report.



**Title:** Aruba AP-105 802.11a/b/g/n Wireless AP  
**To:** FCC 47 CFR Part 15.407 & IC RSS-210  
**Serial #:** ARUB69-U3 Rev A  
**Date:** 11th April 2011  
**Page:** 130 of 208

<b>Test Freq.</b>	5700 MHz	<b>Engineer</b>	GMH
<b>Variant</b>	802.11a; 6 Mbs	<b>Temp (°C)</b>	22
<b>Freq. Range</b>	1000 MHz - 18000 MHz	<b>Rel. Hum.(%)</b>	41
<b>Power Setting</b>	20	<b>Press. (mBars)</b>	1011
<b>Antenna</b>	Integral	<b>Duty Cycle (%)</b>	100
<b>Test Notes 1</b>	5500 - 5700 MHz Notch Filter Included		
<b>Test Notes 2</b>			

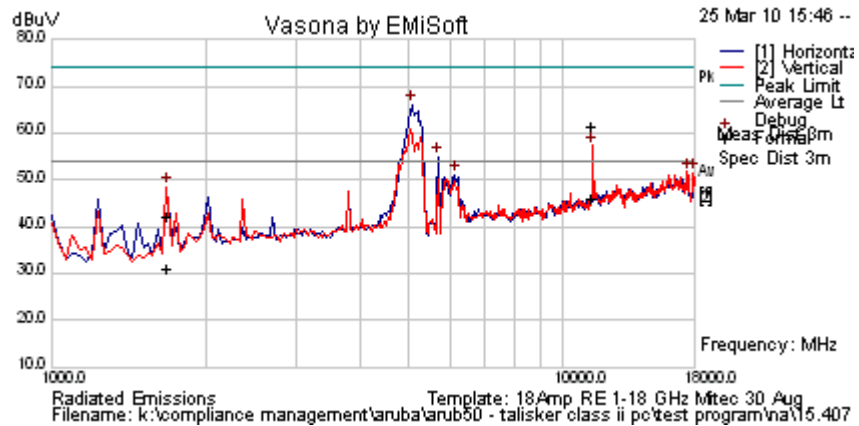

**Formally measured emission peaks**

Frequency MHz	Raw dBuV	Cable Loss	AF dB	Level dBuV	Measurement Type	Pol	Hgt cm	Azt Deg	Limit dBuV	Margin dB	Pass /Fail	Comments
11398.457	56.3	6.8	-1.6	61.5	Peak Max	V	100	14	74.0	-12.5	Pass	RB
1680.001	53.1	2.5	-13.7	42.0	Peak Max	H	178	4	74.0	-32.0	Pass	RB
11398.457	40.9	6.8	-1.6	46.1	Average Max	V	100	14	54	-7.9	Pass	RB
1680.001	42.3	2.5	-13.7	31.2	Average Max	H	178	4	54	-22.8	Pass	RB

Legend: TX = Transmitter Emissions; DIG = Digital Emissions; FUND = Fundamental; WB = Wideband Emission

This test report may be reproduced in full only. The document may only be updated by MiCOM Labs personnel. Any changes will be noted in the Document History section of the report.



**Title:** Aruba AP-105 802.11a/b/g/n Wireless AP  
**To:** FCC 47 CFR Part 15.407 & IC RSS-210  
**Serial #:** ARUB69-U3 Rev A  
**Date:** 11th April 2011  
**Page:** 131 of 208

<b>Test Freq.</b>	5500 MHz	<b>Engineer</b>	GMH
<b>Variant</b>	802.11n; HT-20; 6.5 MCS	<b>Temp (°C)</b>	22.5
<b>Freq. Range</b>	1000 MHz - 18000 MHz	<b>Rel. Hum.(%)</b>	41
<b>Power Setting</b>	20	<b>Press. (mBars)</b>	1011
<b>Antenna</b>	Integral	<b>Duty Cycle (%)</b>	100
<b>Test Notes 1</b>	5500 - 5700 MHz Notch Filter Included		
<b>Test Notes 2</b>			

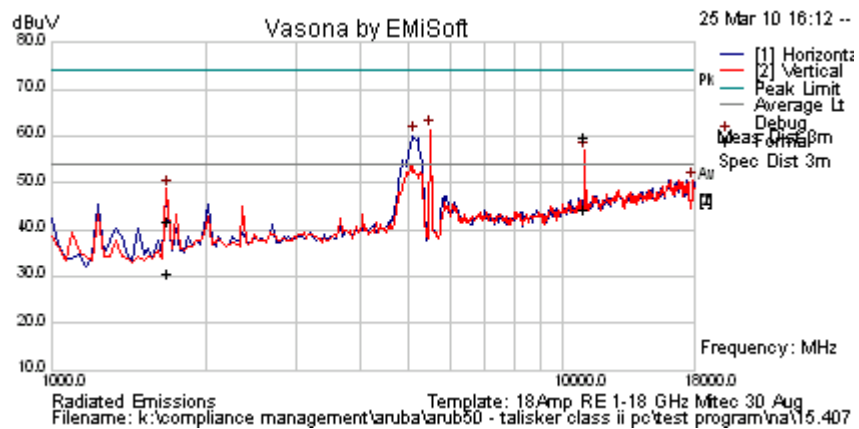

**Formally measured emission peaks**

Frequency MHz	Raw dBuV	Cable Loss	AF dB	Level dBuV	Measurement Type	Pol	Hgt cm	Azt Deg	Limit dBuV	Margin dB	Pass /Fail	Comments
10992.485	55.6	7.0	-2.8	59.8	Peak Max	V	118	41	74.0	-14.2	Pass	
1679.998	53.0	2.5	-13.7	41.9	Peak Max	H	133	352	74.0	-32.2	Pass	
10992.485	40.2	7.0	-2.8	44.3	Average Max	V	118	41	54	-9.7	Pass	
1679.998	41.6	2.5	-13.7	30.5	Average Max	H	133	352	54	-23.5	Pass	

Legend: TX = Transmitter Emissions; DIG = Digital Emissions; FUND = Fundamental; WB = Wideband Emission

This test report may be reproduced in full only. The document may only be updated by MiCOM Labs personnel. Any changes will be noted in the Document History section of the report.



**Band-edge 5460 MHz Transmitting Channel 5,500 MHz 802.11n HT-20 Closest to Band-edge**

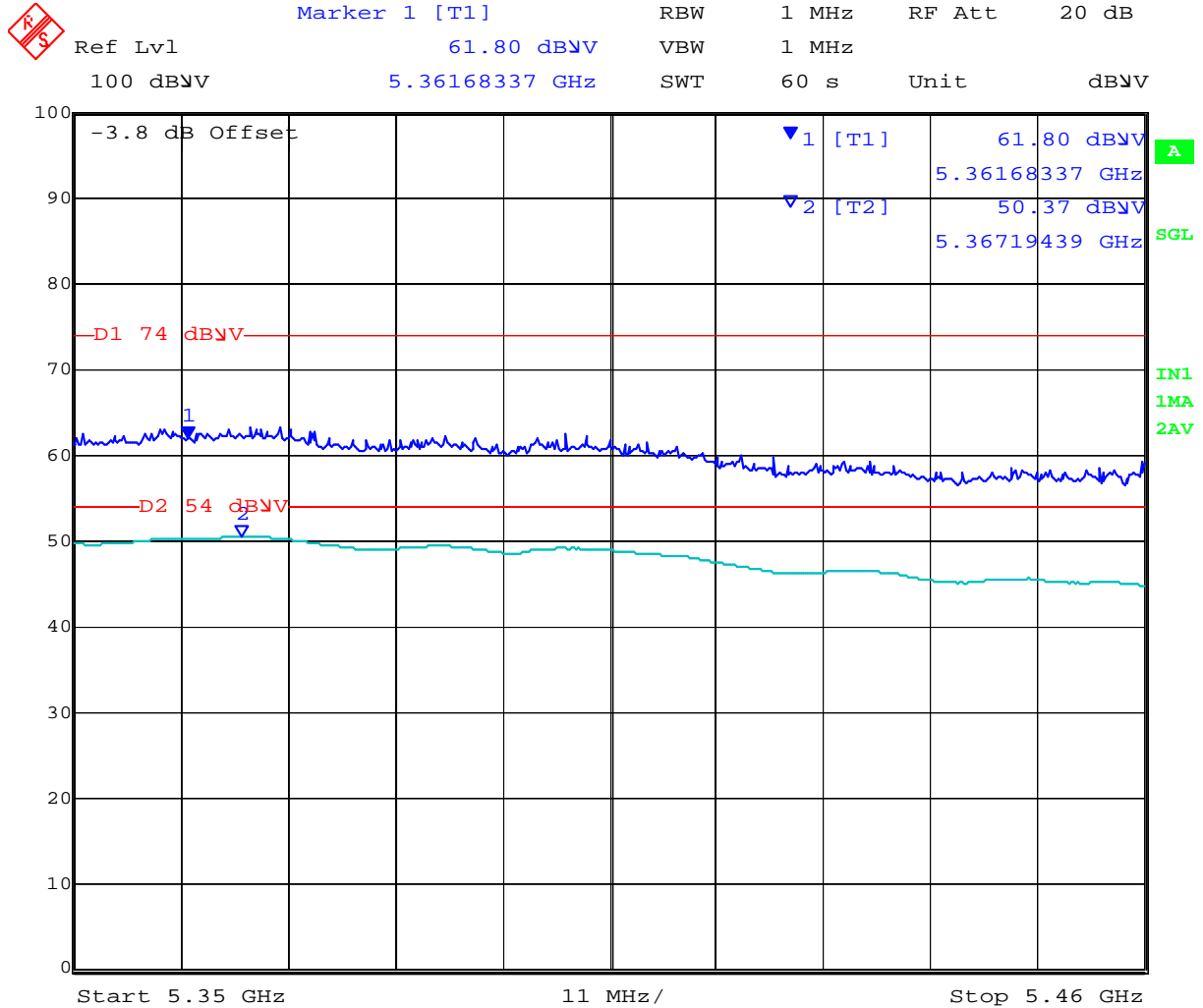

Date: 26.MAR.2010 11:31:18

This test report may be reproduced in full only. The document may only be updated by MiCOM Labs personnel. Any changes will be noted in the Document History section of the report.



**Title:** Aruba AP-105 802.11a/b/g/n Wireless AP  
**To:** FCC 47 CFR Part 15.407 & IC RSS-210  
**Serial #:** ARUB69-U3 Rev A  
**Date:** 11th April 2011  
**Page:** 133 of 208

<b>Test Freq.</b>	5600 MHz	<b>Engineer</b>	GMH
<b>Variant</b>	802.11n; HT-20; 6.5 MCS	<b>Temp (°C)</b>	22.5
<b>Freq. Range</b>	1000 MHz - 18000 MHz	<b>Rel. Hum.(%)</b>	41
<b>Power Setting</b>	20	<b>Press. (mBars)</b>	1011
<b>Antenna</b>	Integral	<b>Duty Cycle (%)</b>	100
<b>Test Notes 1</b>	5500 - 5700 MHz Notch Filter Included		
<b>Test Notes 2</b>			

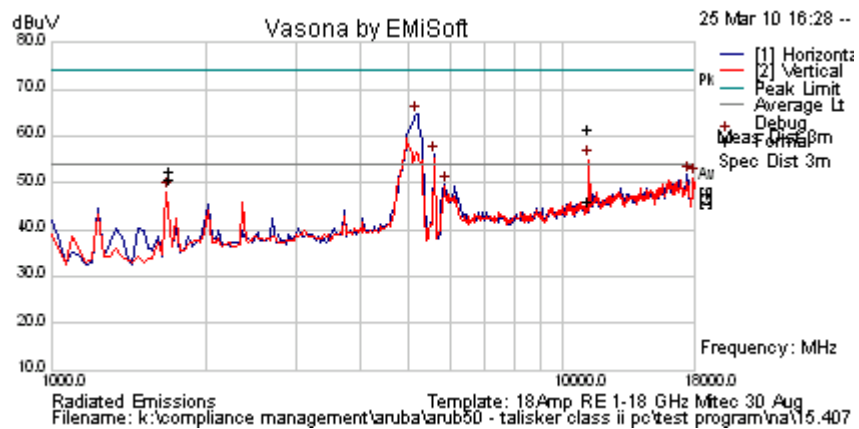

### Formally measured emission peaks

Frequency MHz	Raw dBuV	Cable Loss	AF dB	Level dBuV	Measurement Type	Pol	Hgt cm	Azt Deg	Limit dBuV	Margin dB	Pass /Fail	Comments
11192.726	57.5	6.9	-2.9	61.5	Peak Max	V	101	9	74.0	-12.5	Pass	
1700.048	63.6	2.5	-13.6	52.6	Peak Max	H	180	12	74.0	-21.5	Pass	
11192.726	41.8	6.9	-2.9	45.9	Average Max	V	101	9	54	-8.1	Pass	
1700.048	61.9	2.5	-13.6	50.9	Average Max	H	180	12	54	-3.2	Pass	

Legend: TX = Transmitter Emissions; DIG = Digital Emissions; FUND = Fundamental; WB = Wideband Emission

This test report may be reproduced in full only. The document may only be updated by MiCOM Labs personnel. Any changes will be noted in the Document History section of the report.



**Title:** Aruba AP-105 802.11a/b/g/n Wireless AP  
**To:** FCC 47 CFR Part 15.407 & IC RSS-210  
**Serial #:** ARUB69-U3 Rev A  
**Date:** 11th April 2011  
**Page:** 134 of 208

<b>Test Freq.</b>	5700 MHz	<b>Engineer</b>	GMH
<b>Variant</b>	802.11n; HT-20; 6.5 MCS	<b>Temp (°C)</b>	22.5
<b>Freq. Range</b>	1000 MHz - 18000 MHz	<b>Rel. Hum.(%)</b>	41
<b>Power Setting</b>	20	<b>Press. (mBars)</b>	1011
<b>Antenna</b>	Integral	<b>Duty Cycle (%)</b>	100
<b>Test Notes 1</b>	5500 - 5700 MHz Notch Filter Included		
<b>Test Notes 2</b>			

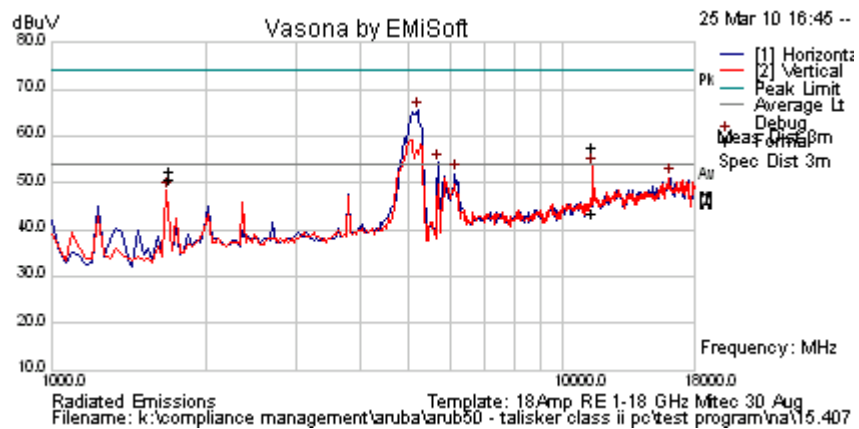

### Formally measured emission peaks

Frequency MHz	Raw dBuV	Cable Loss	AF dB	Level dBuV	Measurement Type	Pol	Hgt cm	Azt Deg	Limit dBuV	Margin dB	Pass /Fail	Comments
11395.000	52.6	6.8	-1.6	57.8	Peak Max	V	180	6	74.0	-16.2	Pass	
1699.994	63.3	2.5	-13.6	52.3	Peak Max	H	131	360	74.0	-21.7	Pass	
11395.000	38.1	6.8	-1.6	43.3	Average Max	V	180	6	54	-10.7	Pass	
1699.994	61.6	2.5	-13.6	50.6	Average Max	H	131	360	54	-3.4	Pass	

Legend: TX = Transmitter Emissions; DIG = Digital Emissions; FUND = Fundamental; WB = Wideband Emission

This test report may be reproduced in full only. The document may only be updated by MiCOM Labs personnel. Any changes will be noted in the Document History section of the report.



**Title:** Aruba AP-105 802.11a/b/g/n Wireless AP  
**To:** FCC 47 CFR Part 15.407 & IC RSS-210  
**Serial #:** ARUB69-U3 Rev A  
**Date:** 11th April 2011  
**Page:** 135 of 208

<b>Test Freq.</b>	5510 MHz	<b>Engineer</b>	GMH
<b>Variant</b>	802.11n; HT-40; 13.5 MCS	<b>Temp (°C)</b>	22
<b>Freq. Range</b>	1000 MHz - 18000 MHz	<b>Rel. Hum.(%)</b>	41
<b>Power Setting</b>	20	<b>Press. (mBars)</b>	1011
<b>Antenna</b>	Integral	<b>Duty Cycle (%)</b>	100
<b>Test Notes 1</b>	5500 - 5700 MHz Notch Filter Implemented		
<b>Test Notes 2</b>			

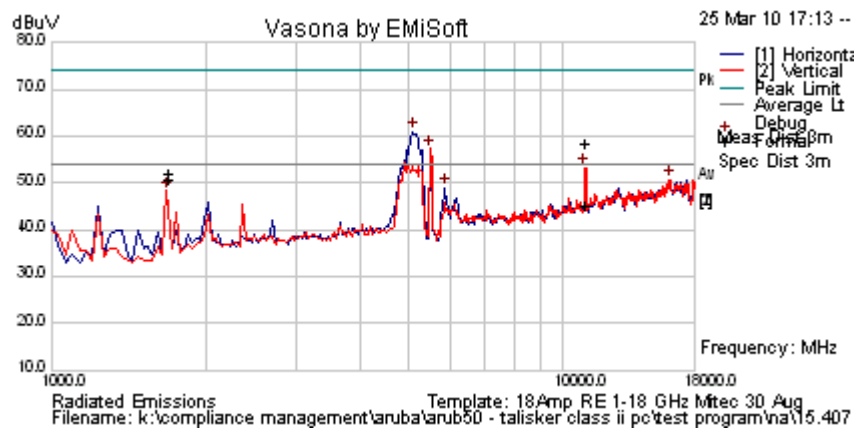

### Formally measured emission peaks

Frequency MHz	Raw dBuV	Cable Loss	AF dB	Level dBuV	Measurement Type	Pol	Hgt cm	Azt Deg	Limit dBuV	Margin dB	Pass /Fail	Comments
11032.365	54.3	7.0	-3.0	58.3	Peak Max	V	116	41	74.0	-15.7	Pass	
1699.942	63.2	2.5	-13.6	52.1	Peak Max	H	131	360	74.0	-21.9	Pass	
11032.365	41.1	7.0	-3.0	45.1	Average Max	V	116	41	54	-8.9	Pass	
1699.942	61.6	2.5	-13.6	50.6	Average Max	H	131	360	54	-3.4	Pass	

Legend: TX = Transmitter Emissions; DIG = Digital Emissions; FUND = Fundamental; WB = Wideband Emission

This test report may be reproduced in full only. The document may only be updated by MiCOM Labs personnel. Any changes will be noted in the Document History section of the report.



Title: Aruba AP-105 802.11a/b/g/n Wireless AP  
To: FCC 47 CFR Part 15.407 & IC RSS-210  
Serial #: ARUB69-U3 Rev A  
Date: 11th April 2011  
Page: 136 of 208

**Band-edge 5460 MHz Transmitting Channel 5,510 MHz 802.11n HT-40 Closest to Band-edge**

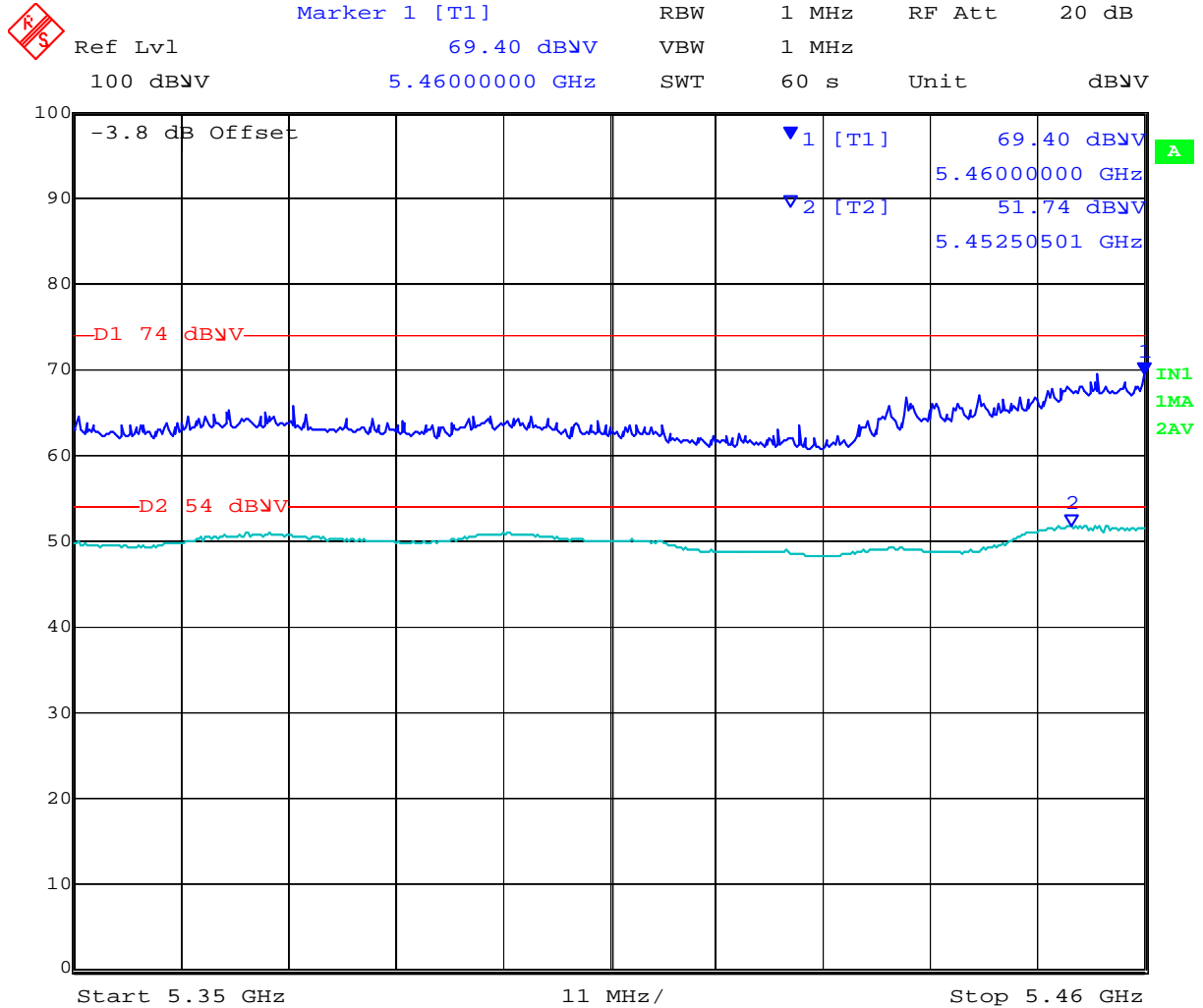

Date: 26.MAR.2010 11:36:11

This test report may be reproduced in full only. The document may only be updated by MiCOM Labs personnel. Any changes will be noted in the Document History section of the report.





**Title:** Aruba AP-105 802.11a/b/g/n Wireless AP  
**To:** FCC 47 CFR Part 15.407 & IC RSS-210  
**Serial #:** ARUB69-U3 Rev A  
**Date:** 11th April 2011  
**Page:** 137 of 208

<b>Test Freq.</b>	5590 MHz	<b>Engineer</b>	GMH
<b>Variant</b>	802.11n; HT-40; 13.5 MCS	<b>Temp (°C)</b>	22
<b>Freq. Range</b>	1000 MHz - 18000 MHz	<b>Rel. Hum.(%)</b>	41
<b>Power Setting</b>	20	<b>Press. (mBars)</b>	1011
<b>Antenna</b>	Integral	<b>Duty Cycle (%)</b>	100
<b>Test Notes 1</b>	5500 - 5700 MHz Notch Filter Implemented		
<b>Test Notes 2</b>			

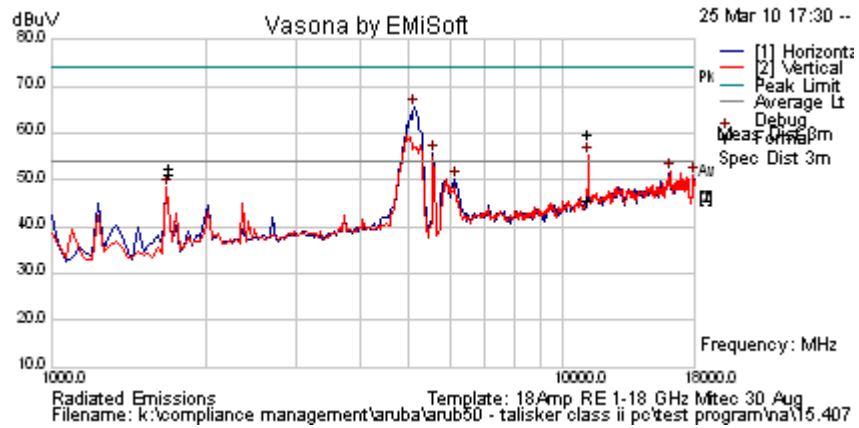

**Formally measured emission peaks**

Frequency MHz	Raw dBuV	Cable Loss	AF dB	Level dBuV	Measurement Type	Pol	Hgt cm	Azt Deg	Limit dBuV	Margin dB	Pass /Fail	Comments
11174.073	56.3	6.9	-3.4	59.8	Peak Max	V	102	11	74.0	-14.2	Pass	
1700.016	63.6	2.5	-13.6	52.6	Peak Max	H	180	6	74.0	-21.5	Pass	
11174.073	42.1	6.9	-3.4	45.6	Average Max	V	102	11	54	-8.4	Pass	
1700.016	62.0	2.5	-13.6	51.0	Average Max	H	180	6	54	-3.0	Pass	

Legend: TX = Transmitter Emissions; DIG = Digital Emissions; FUND = Fundamental; WB = Wideband Emission

This test report may be reproduced in full only. The document may only be updated by MiCOM Labs personnel. Any changes will be noted in the Document History section of the report.



**Title:** Aruba AP-105 802.11a/b/g/n Wireless AP  
**To:** FCC 47 CFR Part 15.407 & IC RSS-210  
**Serial #:** ARUB69-U3 Rev A  
**Date:** 11th April 2011  
**Page:** 138 of 208

<b>Test Freq.</b>	5690 MHz	<b>Engineer</b>	GMH
<b>Variant</b>	802.11n; HT-40; 13.5 MCS	<b>Temp (°C)</b>	22
<b>Freq. Range</b>	1000 MHz - 18000 MHz	<b>Rel. Hum.(%)</b>	41
<b>Power Setting</b>	20	<b>Press. (mBars)</b>	1011
<b>Antenna</b>	Integral	<b>Duty Cycle (%)</b>	100
<b>Test Notes 1</b>	5500 - 5700 MHz Notch Filter Implemented		
<b>Test Notes 2</b>			

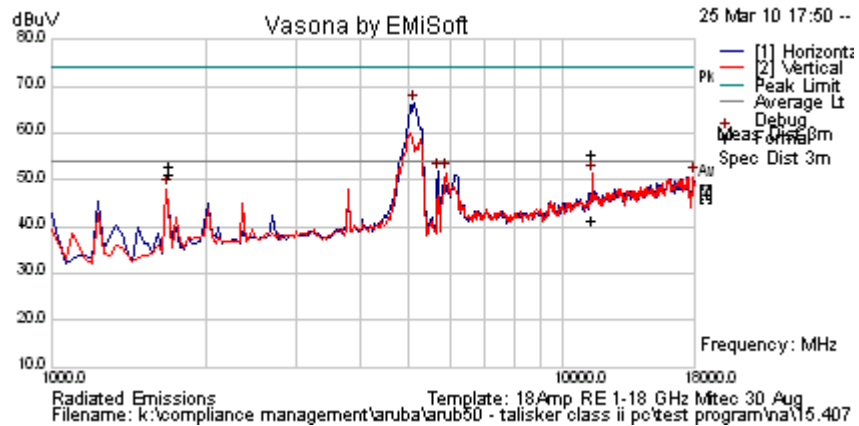

### Formally measured emission peaks

Frequency MHz	Raw dBuV	Cable Loss	AF dB	Level dBuV	Measurement Type	Pol	Hgt cm	Azt Deg	Limit dBuV	Margin dB	Pass /Fail	Comments
11376.614	50.3	6.8	-1.8	55.4	Peak Max	V	101	15	74.0	-18.6	Pass	
1700.016	63.8	2.5	-13.6	52.8	Peak Max	H	179	6	74.0	-21.2	Pass	
11376.614	36.1	6.8	-1.8	41.1	Average Max	V	101	15	54	-12.9	Pass	
1700.016	62.3	2.5	-13.6	51.3	Average Max	H	179	6	54	-2.7	Pass	

Legend: TX = Transmitter Emissions; DIG = Digital Emissions; FUND = Fundamental; WB = Wideband Emission

This test report may be reproduced in full only. The document may only be updated by MiCOM Labs personnel. Any changes will be noted in the Document History section of the report.



**Specification**

**Limits**

**15.407 (b)(2).** All emissions outside of the 5,150-5,350MHz band shall not exceed an EIRP of -27dBm/MHz.

**§15.205 (a)** Except as shown in paragraph (d) of 15.205 (a), only spurious emissions are permitted in any of the frequency bands listed.

**§15.205 (a)** Except as shown in paragraphs (d) and (e) of this section, the field strength of emissions appearing within these frequency bands shall not exceed the limits shown in Section §15.209. At frequencies equal to or less than 1000 MHz, compliance with the limits in Section 15.209 shall be demonstrated using measurement instrumentation employing a CISPR quasi-peak detector. Above 1000 MHz, compliance with the emission limits in Section 15.209 shall be demonstrated based on the average value of the measured emissions. The provisions in Section 15.35 apply to these measurements.

**§15.209 (a)** Except as provided elsewhere in this subpart, the emissions from an intentional radiator shall not exceed the field strength levels specified in the following table.

**RSS-210 §A9.3(2)** For transmitters operating in the 5250-5350 MHz band, all emissions outside the 5150-5350 MHz band shall not exceed -27 dBm/MHz e.i.r.p. Devices operating in the 5250-5350 MHz band that generate emissions in the 5150-5250 MHz band shall not exceed out of band emission limit of 27 dBm/MHz e.i.r.p. in the 5150-5250 MHz band in order to operate indoor/outdoor, or alternatively shall comply with the spectral power density for operation within the 5150-5250 MHz band and shall be labeled “for indoor use only”.

**RSS-Gen §4.7** The search for unwanted emissions shall be from the lowest frequency internally generated or used in the device (local oscillator, intermediate of carrier frequency), or from 30 MHz , whichever is the lowest frequency, to the 5<sup>th</sup> harmonic of the highest frequency generated without exceeding 40 GHz.

**RSS-Gen §6** Receiver Spurious Emission Standard

If a radiated measurement is made, all spurious emissions shall comply with the limits of the following Table. The resolution bandwidth of the spectrum analyzer shall be 100 kHz for spurious emission measurements below 1.0 GHz and 1.0 MHz for measurements above 1.0 GHz

**§15.209 (a)** Limit Matrix

Frequency(MHz)	Field Strength (µV/m)	Field Strength (dBµV/m)	Measurement Distance (meters)
30-88	100	40.0	3
88-216	150	43.5	3
216-960	200	46.0	3
Above 960	500	54.0	3

This test report may be reproduced in full only. The document may only be updated by MiCOM Labs personnel. Any changes will be noted in the Document History section of the report.



**Title:** Aruba AP-105 802.11a/b/g/n Wireless AP  
**To:** FCC 47 CFR Part 15.407 & IC RSS-210  
**Serial #:** ARUB69-U3 Rev A  
**Date:** 11th April 2011  
**Page:** 140 of 208

---

### Laboratory Measurement Uncertainty for Radiated Emissions

Measurement uncertainty	+5.6/ -4.5 dB
-------------------------	---------------

### Traceability

Method	Test Equipment Used
Measurements were made per work instruction WI-03 'Measurement of Radiated Emissions'	0088, 0158, 0134, 0304, 0311, 0315, 0310, 0312

---

This test report may be reproduced in full only. The document may only be updated by MiCOM Labs personnel. Any changes will be noted in the Document History section of the report.



**Title:** Aruba AP-105 802.11a/b/g/n Wireless AP  
**To:** FCC 47 CFR Part 15.407 & IC RSS-210  
**Serial #:** ARUB69-U3 Rev A  
**Date:** 11th April 2011  
**Page:** 141 of 208

---

#### **5.1.7.1. Receiver Radiated Spurious Emissions (above 1 GHz)**

##### **Industry Canada RSS-Gen §4.10, §6**

##### **Test Procedure**

Radiated emissions above 1 GHz are measured in the anechoic chamber at a 3-meter distance on every azimuth in both horizontal and vertical polarities. The emissions are recorded and maximized as a function of azimuth by rotation through 360° with a spectrum analyzer in peak hold mode. Depending on the frequency band spanned a notch filter and waveguide filter was used to remove the fundamental frequency. The highest emissions relative to the limit are listed for each frequency spanned.

All measurements on any frequency or frequencies over 1 MHz are based on the use of measurement instrumentation employing an average detector function. All measurements above 1 GHz were performed using a minimum resolution bandwidth of 1 MHz.

All Sectors of the EUT were tested simultaneously.

---

This test report may be reproduced in full only. The document may only be updated by MiCOM Labs personnel. Any changes will be noted in the Document History section of the report.

### Test Measurement Set Up

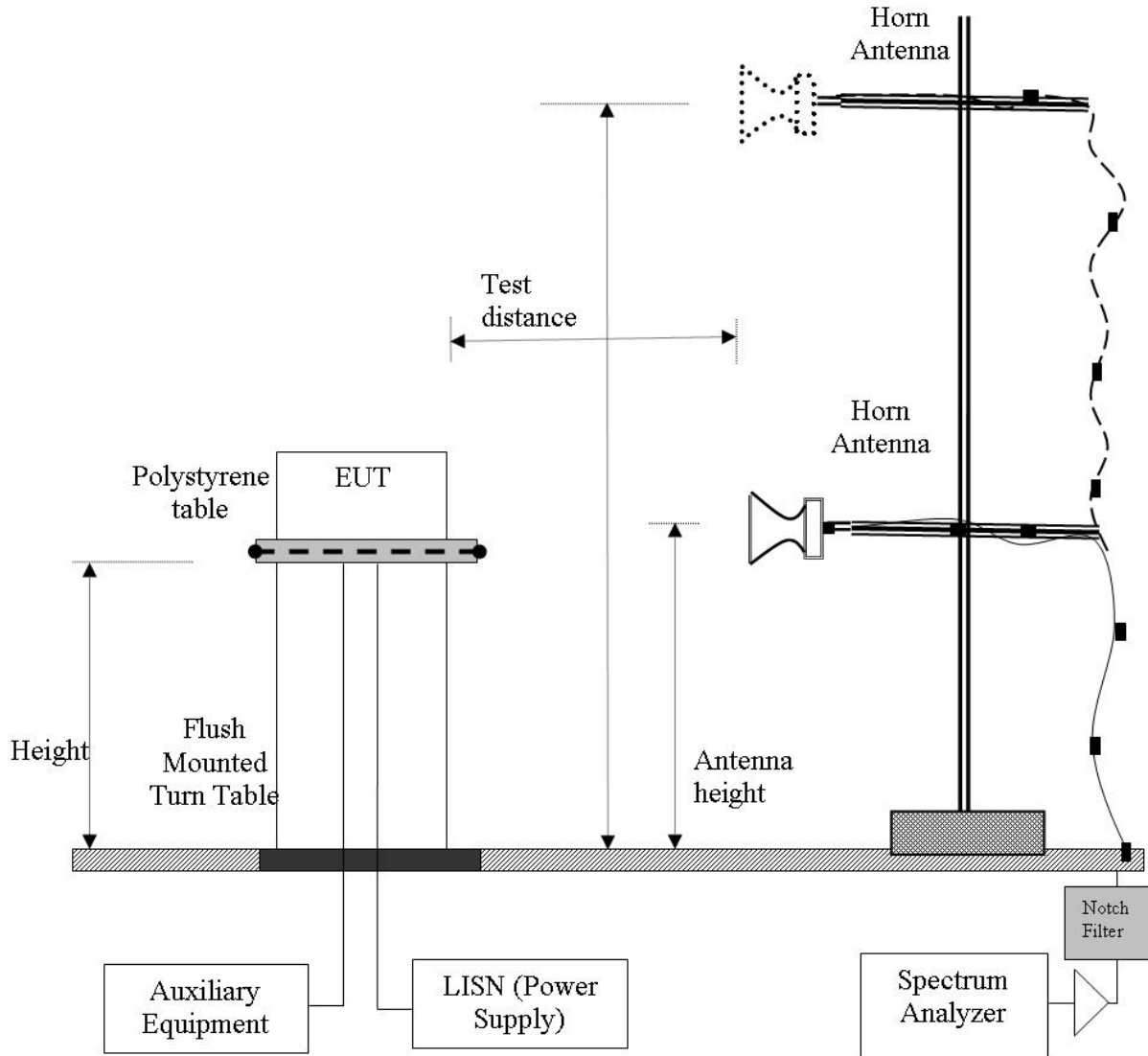

Radiated Emission Measurement Setup – Above 1 GHz



**Title:** Aruba AP-105 802.11a/b/g/n Wireless AP  
**To:** FCC 47 CFR Part 15.407 & IC RSS-210  
**Serial #:** ARUB69-U3 Rev A  
**Date:** 11th April 2011  
**Page:** 143 of 208

---

### Field Strength Calculation

The field strength is calculated by adding the Antenna Factor and Cable Loss, and subtracting Amplifier Gain from the measured reading. All factors are included in the reported data.

$$FS = R + AF + CORR - FO$$

where: FS = Field Strength

R = Measured Spectrum analyzer Input Amplitude

AF = Antenna Factor

CORR = Correction Factor = CL – AG + NFL

CL = Cable Loss

AG = Amplifier Gain

FO = Distance Falloff Factor

NFL = Notch Filter Loss or Waveguide Loss

For example:

Given receiver input reading of 51.5 dB $\mu$ V; Antenna Factor of 8.5 dB; Cable Loss of 1.3 dB; Falloff Factor of 0 dB, an Amplifier Gain of 26 dB and Notch Filter Loss of 1 dB. The Field Strength of the measured emission is:

$$FS = 51.5 + 8.5 + 1.3 - 26.0 + 1 = 36.3 \text{ dB}\mu\text{V/m}$$

Conversion between dB $\mu$ V/m (or dB $\mu$ V) and  $\mu$ V/m (or  $\mu$ V) are done as:

$$\text{Level (dB}\mu\text{V/m)} = 20 * \text{Log (level (\mu\text{V/m}))}$$

$$40 \text{ dB}\mu\text{V/m} = 100 \mu\text{V/m}$$

$$48 \text{ dB}\mu\text{V/m} = 250 \mu\text{V/m}$$

---

This test report may be reproduced in full only. The document may only be updated by MiCOM Labs personnel. Any changes will be noted in the Document History section of the report.



**Title:** Aruba AP-105 802.11a/b/g/n Wireless AP  
**To:** FCC 47 CFR Part 15.407 & IC RSS-210  
**Serial #:** ARUB69-U3 Rev A  
**Date:** 11th April 2011  
**Page:** 144 of 208

**Receiver Radiated Spurious Emissions above 1 GHz**

<b>Date</b>	5th August, 2009
<b>Engineer</b>	CSB
<b>Test Case</b>	ARUB40
<b>Antenna Model</b>	Integral
<b>Power setting</b>	Receive in ART test Utility
<b>Test</b>	802.11a/n
<b>Conditions</b>	120V AC Mains - Ethernet cable attached for ART control

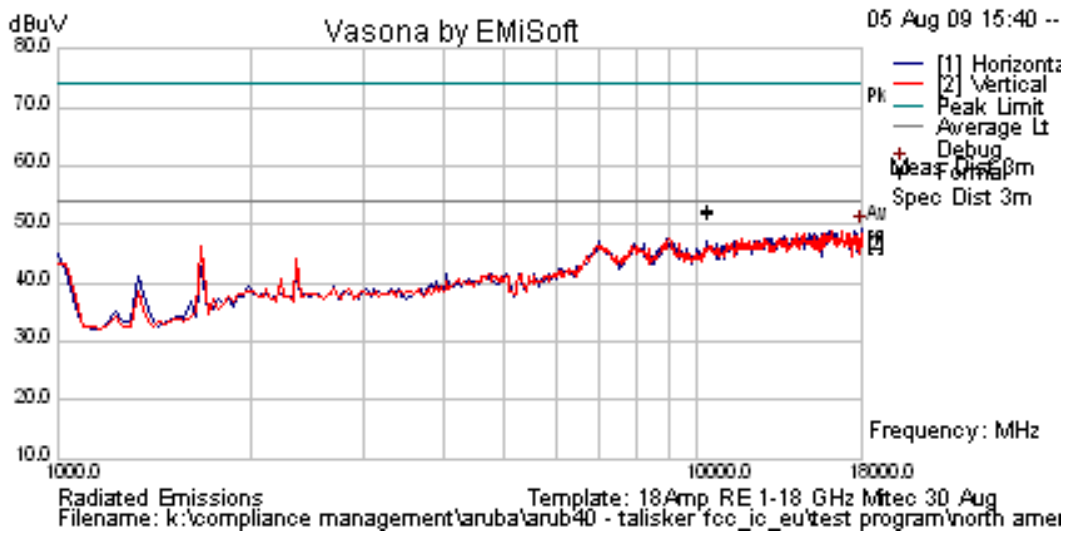

Frequency MHz	Raw dBuV	Cable Loss	AF dB	Level dBuV	Measurement Type	Pol	Hgt cm	Azt Deg	Limit dBuV	Margin dB	Pass /Fail	Comments

No receiver emissions were observed.

This test report may be reproduced in full only. The document may only be updated by MiCOM Labs personnel. Any changes will be noted in the Document History section of the report.





## Specification

### Receiver Radiated Spurious Emissions

#### Industry Canada RSS-Gen §4.10,

The search for spurious emissions shall be from the lowest frequency internally generated or used in the receiver (e.g. local oscillator, intermediate or carrier frequency), or 30 MHz, whichever is the higher, to at least 3 times the highest tunable or local oscillator frequency, whichever is the higher, without exceeding 40 GHz.

#### RSS-Gen §6

The following receiver spurious emission limits shall be complied with;

(a) If a radiated measurement is made, all spurious emissions shall comply with the limits of Table 1.

Frequency (MHz)	Field Strength ( $\mu\text{V/m}$ )	Field Strength ( $\text{dB}\mu\text{V/m}$ )	Measurement Distance (meters)
30-88	100	40.0	3
88-216	150	43.5	3
216-960	200	46.0	3
Above 960	500	54.0	3

### Laboratory Measurement Uncertainty for Radiated Emissions

Measurement uncertainty	+5.6/ -4.5 dB
-------------------------	---------------

### Traceability

Method	Test Equipment Used
Measurements were made per work instruction WI-03 'Measurement of Radiated Emissions'	0088, 0158, 0134, 0304, 0311, 0315, 0310, 0312

This test report may be reproduced in full only. The document may only be updated by MiCOM Labs personnel. Any changes will be noted in the Document History section of the report.

### 5.1.7.2. Radiated Spurious Emissions (30M-1 GHz)

**FCC, Part 15 Subpart C §15.407(b)(6); §15.205(a); §15.209(a)**  
**Industry Canada RSS-210 §2.2**

#### Test Procedure

Preliminary radiated emissions are measured in the anechoic chamber at a 10-meter distance on every azimuth in both horizontal and vertical polarity. The emissions are recorded with a spectrum analyzer in peak hold mode. Emissions closest to the limits are measured in the quasi-peak mode with the tuned receiver using a bandwidth of 120 kHz. Only the highest emissions relative to the limit are listed. The anechoic chamber test set-up is identified in Section 6 Test Set-Up Photographs.

The EUT had two methods of powering on ac/dc converter and Power over Ethernet, Both modes were tested.

#### Test Measurement Set up

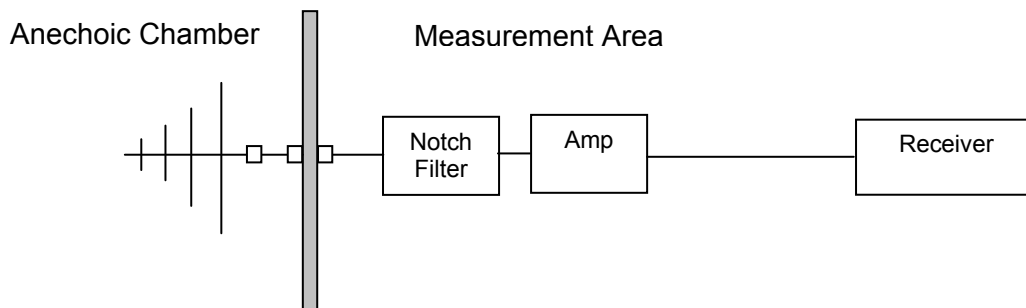

#### Field Strength Calculation

The field strength is calculated by adding the Antenna Factor and Cable Loss, and subtracting Amplifier Gain from the measured reading. In this test facility, the Antenna Factor, Cable Loss, and Amplifier Gains are loaded into the Rohde & Schwarz Receiver and the corrected field strength can be read directly on the receiver.

$$FS = R + AF + CORR$$

where:

FS = Field Strength  
R = Measured Receiver Input Amplitude  
AF = Antenna Factor  
CORR = Correction Factor = CL – AG + NFL  
CL = Cable Loss  
AG = Amplifier Gain



**Title:** Aruba AP-105 802.11a/b/g/n Wireless AP  
**To:** FCC 47 CFR Part 15.407 & IC RSS-210  
**Serial #:** ARUB69-U3 Rev A  
**Date:** 11th April 2011  
**Page:** 147 of 208

---

For example:

Given a Receiver input reading of 51.5dB $\mu$ V; Antenna Factor of 8.5dB; Cable Loss of 1.3dB; Falloff Factor of 0dB, an Amplifier Gain of 26dB and Notch Filter Loss of 1dB. The Field Strength of the measured emission is:

$$FS = 51.5 + 8.5 + 1.3 - 26.0 + 1 = 36.3\text{dB}\mu\text{V/m}$$

Conversion between dB $\mu$ V/m (or dB $\mu$ V) and  $\mu$ V/m (or  $\mu$ V) are done as:

$$\text{Level (dB}\mu\text{V/m)} = 20 * \text{Log (level (\mu\text{V/m}))}$$

$$40 \text{ dB}\mu\text{V/m} = 100\mu\text{V/m}$$

$$48 \text{ dB}\mu\text{V/m} = 250\mu\text{V/m}$$

### Measurement Results for Spurious Emissions (30 MHz – 1 GHz)

Ambient conditions.

Temperature: 17 to 23 °C    Relative humidity: 31 to 57 %    Pressure: 999 to 1012 mbar

For emissions below 1 GHz the AP-105 Wireless Access Point ports were fully loaded and exercised;

---

This test report may be reproduced in full only. The document may only be updated by MiCOM Labs personnel. Any changes will be noted in the Document History section of the report.



**Title:** Aruba AP-105 802.11a/b/g/n Wireless AP  
**To:** FCC 47 CFR Part 15.407 & IC RSS-210  
**Serial #:** ARUB69-U3 Rev A  
**Date:** 11th April 2011  
**Page:** 148 of 208

**TABLE OF RESULTS – AC Power Supply**

<b>Test Freq.</b>	2437 MHz	<b>Engineer</b>	CSB
<b>Variant</b>	Radiated Digital Emissions	<b>Temp (°C)</b>	20.5
<b>Freq. Range</b>	30 MHz - 1000 MHz	<b>Rel. Hum.(%)</b>	38
<b>Power Setting</b>	Default (ART = 20)	<b>Press. (mBars)</b>	1008
<b>Antenna</b>	Integral Antenna's connected		
<b>Test Notes 1</b>			
<b>Test Notes 2</b>			

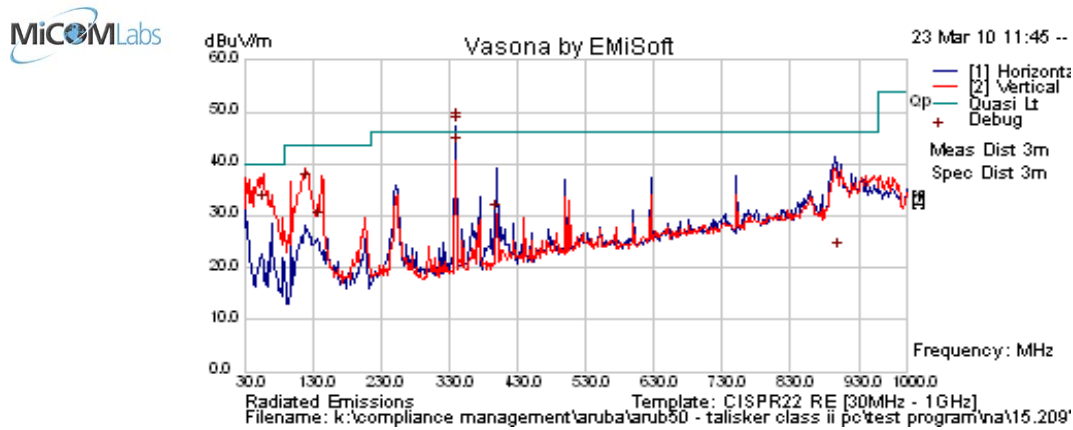

**Formally measured emission peaks**

Frequency MHz	Raw dBuV	Cable Loss	AF dB	Level dBuV/m	Measurement Type	PoI	Hgt cm	Azt Deg	Limit dBuV/m	Margin dB	Pass /Fail	Comments
57.199	52.6	3.8	-23.9	32.5	Quasi Peak	V	98	360	40	-7.5	Pass	DIG
119.508	49.3	4.3	-17.2	36.4	Quasi Peak	V	100	44	43.5	-7.1	Pass	DIG
139.299	42.6	4.4	-18.0	29.0	Quasi Peak	V	98	262	43.5	-14.5	Pass	DIG
339.995	54.1	5.4	-16.1	43.4	Quasi Peak	H	101	250	46	-2.6	Pass	DIG
399.991	39.2	5.7	-14.4	30.4	Quasi Peak	H	107	252	46	-15.6	Pass	DIG
901.082	23.4	7.3	-7.4	23.3	Quasi Peak	H	102	91	46	-22.8	Pass	DIG

Legend: DIG = Digital Device Emission; TX = Transmitter Emission; FUND = Fundamental Frequency  
 NRB = Non-Restricted Band, Limit is 20 dB below Fundamental; RB = Restricted Band

This test report may be reproduced in full only. The document may only be updated by MiCOM Labs personnel. Any changes will be noted in the Document History section of the report.



**Title:** Aruba AP-105 802.11a/b/g/n Wireless AP  
**To:** FCC 47 CFR Part 15.407 & IC RSS-210  
**Serial #:** ARUB69-U3 Rev A  
**Date:** 11th April 2011  
**Page:** 149 of 208

**TABLE OF RESULTS – POE Power Supply**

<b>Test Freq.</b>	2437 MHz	<b>Engineer</b>	CSB
<b>Variant</b>	Radiated Digital Emissions	<b>Temp (°C)</b>	20.5
<b>Freq. Range</b>	30 MHz - 1000 MHz	<b>Rel. Hum.(%)</b>	38
<b>Power Setting</b>	Default (ART = 20)	<b>Press. (mBars)</b>	1008
<b>Antenna</b>	Integral Antenna's connected		
<b>Test Notes 1</b>	EUT Powered by PoE Adaptor		
<b>Test Notes 2</b>			

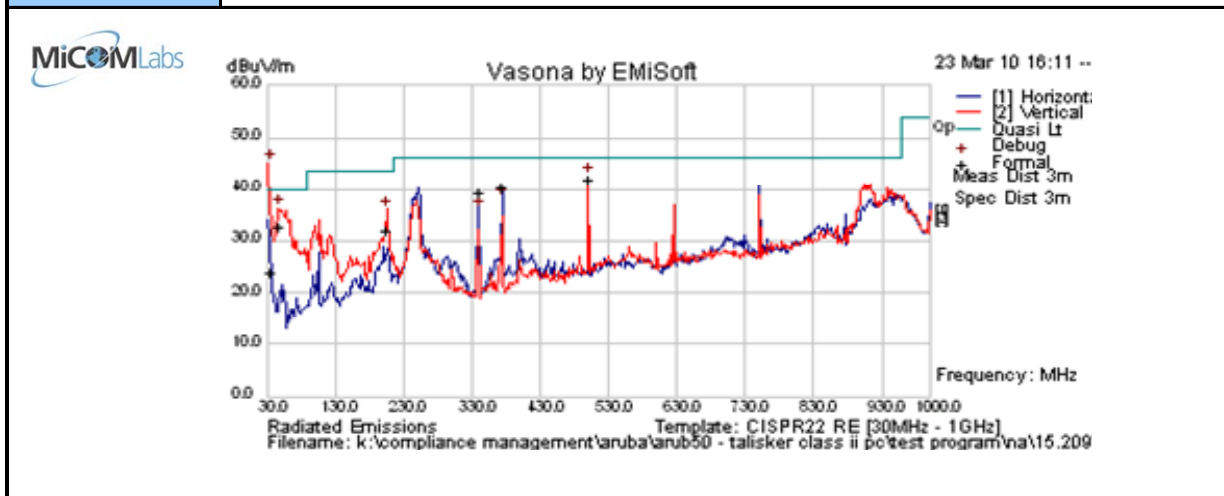

**Formally measured emission peaks**

Frequency MHz	Raw dBuV	Cable Loss	AF dB	Level dBuV/m	Measurement Type	Pol	Hgt cm	Azt Deg	Limit dBuV/m	Margin dB	Pass /Fail	Comments
34.790	33.7	3.5	-13.3	23.9	Quasi Max	V	123	295	40	-16.1	Pass	DIG
48.481	51.0	3.7	-22.0	32.7	Quasi Max	V	111	228	40	-7.3	Pass	DIG
206.718	46.8	4.8	-19.5	32.1	Quasi Max	V	98	179	43.5	-11.4	Pass	DIG
499.979	48.6	6.0	-12.6	42.0	Quasi Max	V	98	95	46	-4.0	Pass	DIG
374.989	50.1	5.6	-15.1	40.6	Quasi Max	H	102	49	46	-5.5	Pass	DIG
339.988	50.1	5.4	-16.1	39.4	Quasi Max	H	106	325	46	-6.6	Pass	DIG

Legend: DIG = Digital Device Emission; TX = Transmitter Emission; FUND = Fundamental Frequency  
 NRB = Non-Restricted Band, Limit is 20 dB below Fundamental; RB = Restricted Band

This test report may be reproduced in full only. The document may only be updated by MiCOM Labs personnel. Any changes will be noted in the Document History section of the report.



## Specification

### Limits

**§15.407(b)(6)** Unwanted emissions below 1 GHz must comply with the general field strength limits set forth in Section 15.209.

**§15.205 (a)** Except as shown in paragraph (d) of 15.205 (a), only spurious emissions are permitted in any of the frequency bands listed.

**§15.205 (a)** Except as shown in paragraphs (d) and (e) of this section, the field strength of emissions appearing within these frequency bands shall not exceed the limits shown in Section §15.209. At frequencies equal to or less than 1000 MHz, compliance with the limits in Section 15.209 shall be demonstrated using measurement instrumentation employing a CISPR quasi-peak detector. Above 1000 MHz, compliance with the emission limits in Section 15.209 shall be demonstrated based on the average value of the measured emissions. The provisions in Section 15.35 apply to these measurements.

**§15.209 (a)** Except as provided elsewhere in this subpart, the emissions from an intentional radiator shall not exceed the field strength levels specified in the following table.

**RSS-210 §2.2** refers to Section 2.7 Table 2 below;-

Frequency(MHz)	Field Strength ( $\mu\text{V}/\text{m}$ )	Field Strength ( $\text{dB}\mu\text{V}/\text{m}$ )	Measurement Distance (meters)
30-88	100	40.0	3
88-216	150	43.5	3
216-960	200	46.0	3
Above 960	500	54.0	3

### Laboratory Measurement Uncertainty for Radiated Emissions

Measurement uncertainty	+5.6/ -4.5 dB
-------------------------	---------------

### Traceability

Method	Test Equipment Used
Measurements were made per work instruction WI-03 'Measurement of Radiated Emissions'	0088, 0158, 0134, 0304, 0311, 0315, 0310, 0312

This test report may be reproduced in full only. The document may only be updated by MiCOM Labs personnel. Any changes will be noted in the Document History section of the report.

### 5.1.8. AC Wireline Conducted Emissions (150 kHz – 30 MHz)

**FCC, Part 15 Subpart C §15.407(b)(6)/15.207**

**Industry Canada RSS-Gen §7.2.2**

#### **Test Procedure**

The EUT is configured in accordance with ANSI C63.4. The conducted emissions are measured in a shielded room with a spectrum analyzer in peak hold in the first instance. Emissions closest to the limit are measured in the quasi-peak mode (QP) with the tuned receiver using a bandwidth of 9 kHz. The emissions are maximized further by cable manipulation. The highest emissions relative to the limit are listed.

#### **Test Measurement Set up**

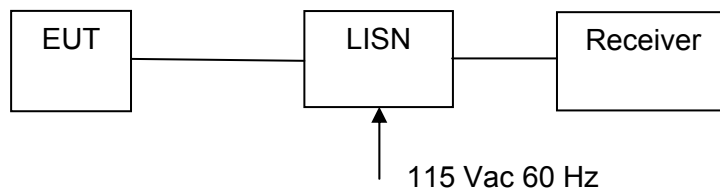

Measurement set up for AC Wireline Conducted Emissions Test



**Title:** Aruba AP-105 802.11a/b/g/n Wireless AP  
**To:** FCC 47 CFR Part 15.407 & IC RSS-210  
**Serial #:** ARUB69-U3 Rev A  
**Date:** 11th April 2011  
**Page:** 152 of 208

**Measurement Results for AC Wireline Conducted Emissions (150 kHz – 30 MHz)**

<b>Test Freq.</b>	2437	<b>Engineer</b>	CSB
<b>Variant</b>	Conducted Emissions - AC Line	<b>Temp (°C)</b>	21.5
<b>Freq. Range</b>	0.150 MHz - 30 MHz	<b>Rel. Hum.(%)</b>	37
<b>Power Setting</b>	Default (ART = 20)	<b>Press. (mBars)</b>	1007
<b>Antenna</b>	Integral Antenna's attached		
<b>Test Notes 1</b>	Plot below includes peak emissions; 2nd plot includes average detector emissions (next page)		
<b>Test Notes 2</b>	EUT Powered by AC/DC Adaptor		

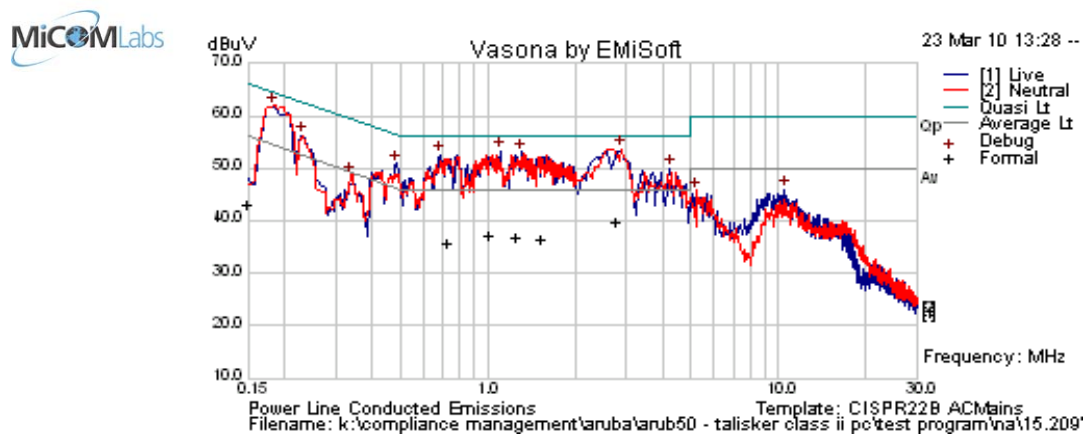

**Formally measured emission peaks**

Frequency MHz	Raw dBuV	Cable Loss	Factors dB	Level dBuV	Measurement Type	Line	Limit dBuV	Margin dB	Pass /Fail	Comments
0.150	33.2	9.9	0.1	43.2	Quasi Peak	Live	66	-22.8	Pass	DIG
0.150	16.9	9.9	0.1	26.9	Average	Live	56	-29.1	Pass	DIG
0.729	29.5	10.0	0.1	39.5	Average	Neutral	46	-6.5	Pass	DIG
0.729	39.3	10.0	0.1	49.4	Quasi Peak	Neutral	56	-6.6	Pass	DIG
1.023	29.6	9.9	0.1	39.6	Average	Neutral	46	-6.4	Pass	DIG
1.023	39.0	9.9	0.1	49.0	Quasi Peak	Neutral	56	-7.0	Pass	DIG
1.271	38.7	10.0	0.1	48.7	Quasi Peak	Neutral	56	-7.3	Pass	DIG
1.271	29.2	10.0	0.1	39.3	Average	Neutral	46	-6.7	Pass	DIG
1.544	38.1	10.0	0.1	48.2	Quasi Peak	Neutral	56	-7.8	Pass	DIG
1.544	28.6	10.0	0.1	38.7	Average	Neutral	46	-7.3	Pass	DIG
2.791	39.0	10.1	0.1	49.3	Quasi Peak	Neutral	56	-6.7	Pass	DIG
2.791	29.9	10.1	0.1	40.1	Average	Neutral	46	-5.9	Pass	DIG

Legend: DIG = Digital Device Emission; TX = Transmitter Emission; FUND = Fundamental Frequency  
 NRB = Non-Restricted Band, Limit is 20 dB below Fundamental; RB = Restricted Band

This test report may be reproduced in full only. The document may only be updated by MiCOM Labs personnel. Any changes will be noted in the Document History section of the report.





**Title:** Aruba AP-105 802.11a/b/g/n Wireless AP  
**To:** FCC 47 CFR Part 15.407 & IC RSS-210  
**Serial #:** ARUB69-U3 Rev A  
**Date:** 11th April 2011  
**Page:** 153 of 208

**Average Detector plot – AC Wireline Emissions**

<b>Test Freq.</b>	2437		CSB
<b>Variant</b>	Conducted Emissions - AC Line		21.5
<b>Freq. Range</b>	0.150 MHz - 30 MHz		37
<b>Power Setting</b>	Default (ART = 20)		1007
<b>Antenna</b>	Integral Antenna's attached		
<b>Test Notes 1</b>	Plot below indicated average detector emissions		
<b>Test Notes 2</b>	EUT Powered by AC/DC Adaptor		

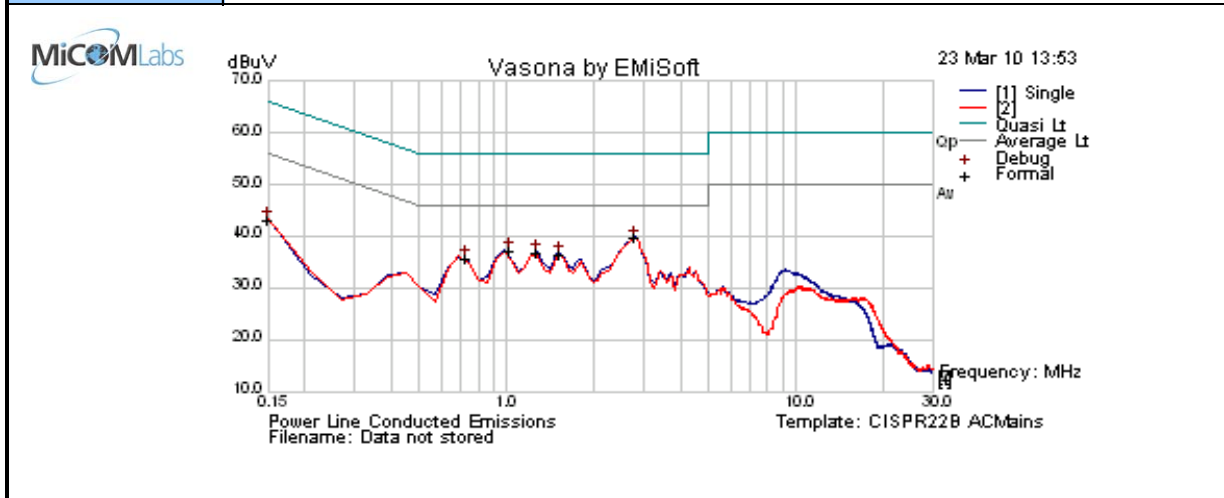

This test report may be reproduced in full only. The document may only be updated by MiCOM Labs personnel. Any changes will be noted in the Document History section of the report.



## Specification

### Limit

**§15.407 (b)(6);** Any U-NII devices using an AC power line are required to comply also with the limits set forth in Section 15.207.

**§15.207 (a)** Except as shown in paragraphs (b) and (c) of this section, for an intentional radiator that is designed to be connected to the public utility (AC) power line, the radio frequency voltage that is conducted back onto the AC power line on any frequency or frequencies within the band 150 kHz to 30 MHz shall not exceed the limits in the following table, as measured using a 50  $\mu\Omega$  line impedance stabilization network (LISN), see §15.207 (a) matrix below. Compliance with the provisions of this paragraph shall be based on the measurement of the radio frequency voltage between each power line and ground at the power terminal.

#### **RSS-Gen §7.2.2**

The radio frequency voltage that is conducted back into the AC power lines in the frequency range of 0.15 MHz to 30 MHz shall not exceed the limits shown in the table below. The tighter limit applies at the frequency range boundaries.

### **§15.207 (a)** and **RSS-Gen §7.2.2** Limit Matrix

The lower limit applies at the boundary between frequency ranges

Frequency of Emission (MHz)	Conducted Limit (dB $\mu$ V)	
	Quasi-peak	Average
0.15-0.5	66 to 56*	56 to 46*
0.5-5	56	46
5-30	60	50

\* Decreases with the logarithm of the frequency

### Laboratory Measurement Uncertainty for Conducted Emissions

Measurement uncertainty	$\pm 2.64$ dB
-------------------------	---------------

### Traceability

Method	Test Equipment Used
Measurements were made per work instruction WI-EMC-01 'Measurement of Conducted Emissions'	0158, 0184, 0287, 0190, 0293, 0307

This test report may be reproduced in full only. The document may only be updated by MiCOM Labs personnel. Any changes will be noted in the Document History section of the report.



**Title:** Aruba AP-105 802.11a/b/g/n Wireless AP  
**To:** FCC 47 CFR Part 15.407 & IC RSS-210  
**Serial #:** ARUB69-U3 Rev A  
**Date:** 11th April 2011  
**Page:** 155 of 208

### 5.1.9. Dynamic Frequency Selection (DFS)

#### 5.1.9.1. Test Procedure and Setup

FCC, Part 15 Subpart C §15.407(h)  
FCC 06-96 Memorandum Opinion and Order  
Industry Canada RSS-210 A9.4

#### 5.1.9.2. Interference Threshold values, Master or Client incorporating In-Service Monitoring

Maximum Transmit Power	Value (see note)
≥ 200 milliwatt	-64 dBm
< 200 milliwatt	-62 dBm
Note 1: This is the level at the input of the receiver assuming a 0 dBi receive antenna	

#### 5.1.9.3. DFS Response requirement values

Parameter	Value
<i>Non-occupancy period</i>	Minimum 30 minutes
<i>Channel Availability Check Time</i>	60 seconds
<i>Channel Move Time</i>	10 seconds See Note 1.
<i>Channel Closing Transmission Time</i>	200 milliseconds + an aggregate of 60 milliseconds over remaining 10 second period. See Notes 1 and 2.
<i>U-NII Detection Bandwidth</i>	Minimum 80% of the 99% power bandwidth See Note 3.

Note 1: The instant that the *Channel Move Time* and the *Channel Closing Transmission Time* begins is as follows:

- For the Short pulse radar Test Signals this instant is the end of the *Burst*.
- For the Frequency Hopping radar Test Signal, this instant is the end of the last radar *Burst* generated.
- For the Long Pulse radar Test Signal this instant is the end of the 12 second period defining the radar transmission.

Note 2: The *Channel Closing Transmission Time* is comprised of 200 milliseconds starting at the beginning of the *Channel Move Time* plus any additional intermittent control signals required to facilitate *Channel* changes (an aggregate of 60 milliseconds) during the remainder of the 10 second period. The aggregate duration of control signals will not count quiet periods in between transmissions.

Note 3: During the *U-NII Detection Bandwidth* detection test, radar type 1 is used and for each frequency step the minimum percentage of detection is 90%. Measurements are performed with no data traffic.

This test report may be reproduced in full only. The document may only be updated by MiCOM Labs personnel. Any changes will be noted in the Document History section of the report.



#### 5.1.9.4. Radar Test Waveforms

This section provides the parameters for required test waveforms, minimum percentage of successful detections, and the minimum number of trials that must be used for determining DFS conformance. Step intervals of 0.1 microsecond for Pulse Width, 1 microsecond for PRI, 1 MHz for chirp width and 1 for the number of pulses will be utilized for the random determination of specific test waveforms.

##### Short Pulse Radar Test Waveforms

Radar Type	Pulse Width (μsec)	PRI (μsec)	Number of Pulses	Minimum Percentage of Successful Detection	Minimum Trials
1	1	1428	18	60%	30
2	1-5	150-230	23-29	60%	30
3	6-10	200-500	16-18	60%	30
4	11-20	200-500	12-16	60%	30
Aggregate (Radar Types 1-4)				80%	120

A minimum of 30 unique waveforms are required for each of the short pulse radar types 2 through 4. For short pulse radar type 1, the same waveform is used a minimum of 30 times. If more than 30 waveforms are used for short pulse radar types 2 through 4, then each additional waveform must also be unique and not repeated from the previous waveforms. The aggregate is the average of the percentage of successful detections of short pulse radar types 1-4.

##### Long Pulse Radar Test Waveform

Radar Type	Pulse Width (μsec)	Chirp Width (MHz)	PRI (μsec)	Number of Pulses per Burst	Number of Bursts	Minimum Percentage of Successful Detection	Minimum Trials
5	50-100	5-20	1000-2000	1-3	8-20	80%	30

The parameters for this waveform are randomly chosen. Thirty unique waveforms are required for the Long Pulse radar test signal. If more than 30 waveforms are used for the Long Pulse radar test signal, then each additional waveform must also be unique and not repeated from the previous waveforms.



**Title:** Aruba AP-105 802.11a/b/g/n Wireless AP  
**To:** FCC 47 CFR Part 15.407 & IC RSS-210  
**Serial #:** ARUB69-U3 Rev A  
**Date:** 11th April 2011  
**Page:** 157 of 208

---

Each waveform is defined as follows:

- 1) The transmission period for the Long Pulse Radar test signal is 12 seconds.
- 2) There are a total of 8 to 20 *Bursts* in the 12 second period, with the number of *Bursts* being randomly chosen. This number is *Burst Count*.
- 3) Each *Burst* consists of 1 to 3 pulses, with the number of pulses being randomly chosen. Each *Burst* within the 12 second sequence may have a different number of pulses.
- 4) The pulse width is between 50 and 100 microseconds, with the pulse width being randomly chosen. Each pulse within a *Burst* will have the same pulse width. Pulses in different *Bursts* may have different pulse widths.
- 5) Each pulse has a linear FM chirp between 5 and 20 MHz, with the chirp width being randomly chosen. Each pulse within a *Burst* will have the same chirp width. Pulses in different *Bursts* may have different chirp widths. The chirp is centered on the pulse. For example, with a radar frequency of 5300 MHz and a 20 MHz chirped signal, the chirp starts at 5290 MHz and ends at 5310 MHz.
- 6) If more than one pulse is present in a *Burst*, the time between the pulses will be between 1000 and 2000 microseconds, with the time being randomly chosen. If three pulses are present in a *Burst*, the time between the first and second pulses is chosen independently of the time between the second and third pulses.
- 7) The 12 second transmission period is divided into even intervals. The number of intervals is equal to *Burst\_Count*. Each interval is of length  $(12,000,000 / \textit{Burst\_Count})$  microseconds. Each interval contains one *Burst*. The start time for the *Burst*, relative to the beginning of the interval, is between 1 and  $[(12,000,000 / \textit{Burst\_Count}) - (\textit{Total Burst Length}) + (\textit{One Random PRI Interval})]$  microseconds, with the start time being randomly chosen. The step interval for the start time is 1 microsecond. The start time for each *Burst* is chosen independently.

---

This test report may be reproduced in full only. The document may only be updated by MiCOM Labs personnel. Any changes will be noted in the Document History section of the report.

**A representative example of a Long Pulse radar test waveform:**

- 1) The total test signal length is 12 seconds.
- 2) 8 *Bursts* are randomly generated for the *Burst\_Count*.
- 3) *Burst 1* has 2 randomly generated pulses.
- 4) The pulse width (for both pulses) is randomly selected to be 75 microseconds.
- 5) The PRI is randomly selected to be at 1213 microseconds.
- 6) *Bursts 2* through 8 are generated using steps 3 – 5.
- 7) Each *Burst* is contained in even intervals of 1,500,000 microseconds. The starting location for Pulse 1, *Burst 1* is randomly generated (1 to 1,500,000 minus the total *Burst 1* length + 1 random PRI interval) at the 325,001 microsecond step. *Bursts 2* through 8 randomly fall in successive 1,500,000 microsecond intervals (i.e. *Burst 2* falls in the 1,500,001 – 3,000,000 microsecond range).

**Graphical representation of the Long Pulse radar Test Waveform.**

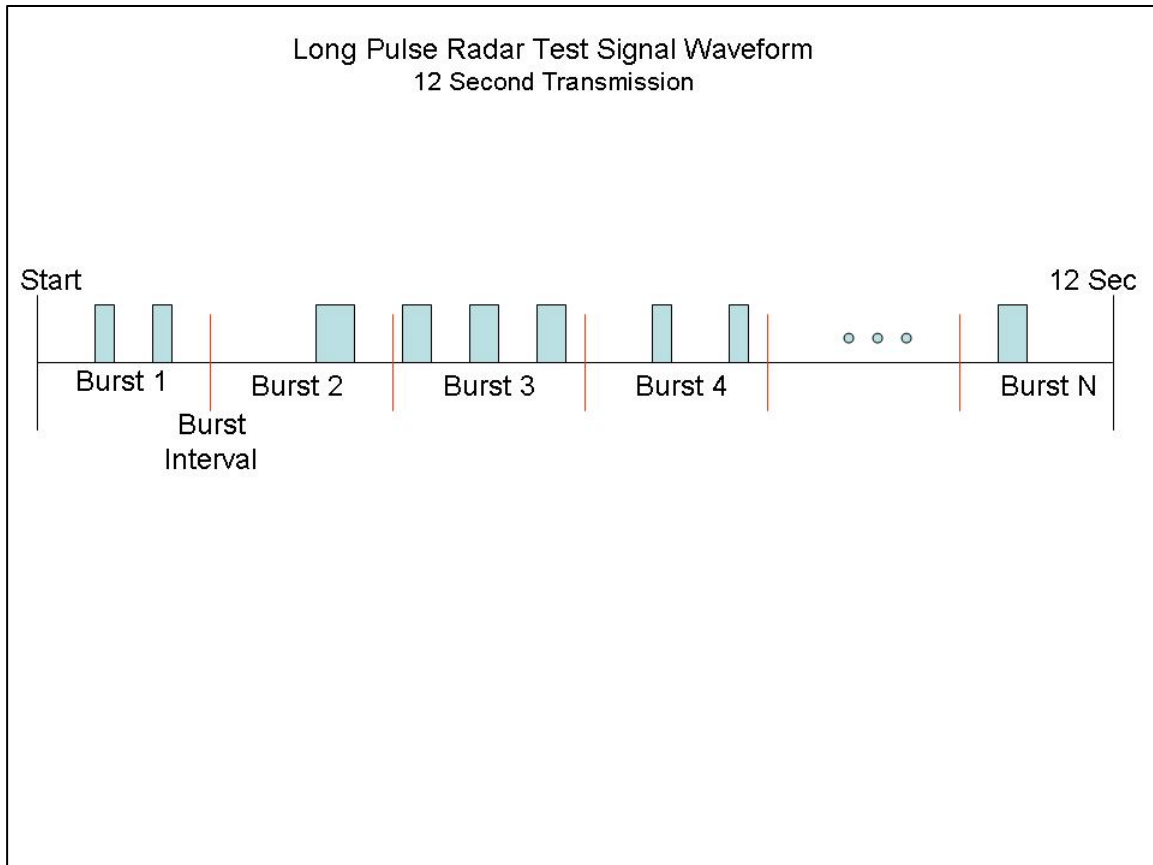

### 5.1.9.5. Frequency Hopping Radar Test Waveform

**Frequency Hopping Radar Test Waveform**

Radar Type	Pulse Width (µsec)	PRI (µsec)	Pulses per Hop	Hopping Rate (kHz)	Hopping Sequence Length (msec)	Minimum Percentage of Successful Detection	Minimum Trials
6	1	333	9	.333	300	70%	30

For the Frequency Hopping Radar Type, the same *Burst* parameters are used for each waveform. The hopping sequence is different for each waveform and a 100-length segment is selected from the hopping sequence defined by the following algorithm:

### 5.1.9.6. Radar Waveform Calibration

The following equipment setup was used to calibrate the conducted Radar Waveform. A spectrum analyzer was used to establish the test signal level for each radar type. During this process there were no transmissions by either the Master or Client Device. The spectrum analyzer was switched to the zero span (Time Domain) mode at the frequency of the Radar Waveform generator. Peak detection was utilized. The spectrum analyzer resolution bandwidth (RBW) and video bandwidth (VBW) were set to 3 MHz.

The signal generator amplitude was set so that the power level measured at the spectrum analyzer was -61dBm (Ref Section 5.1). The 30dB amplifier gain was entered as an amplitude offset on the spectrum analyzer.

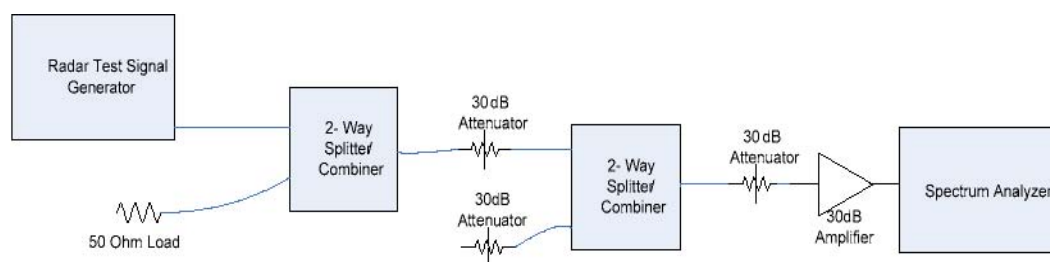

**Conducted Calibration Setup**



### 5.1.9.7. Weather Radar Band Edge Plots

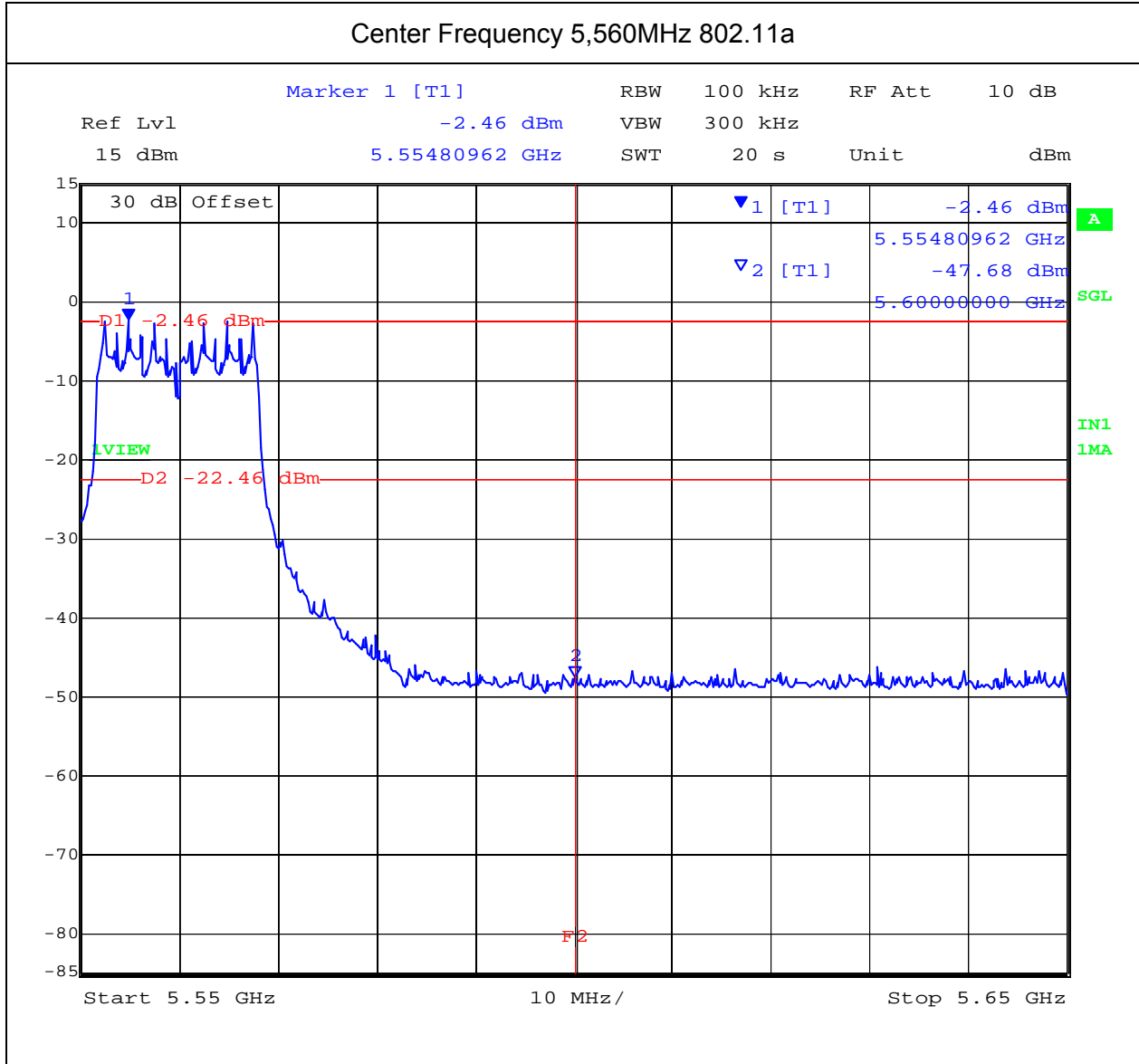

This test report may be reproduced in full only. The document may only be updated by MiCOM Labs personnel. Any changes will be noted in the Document History section of the report.



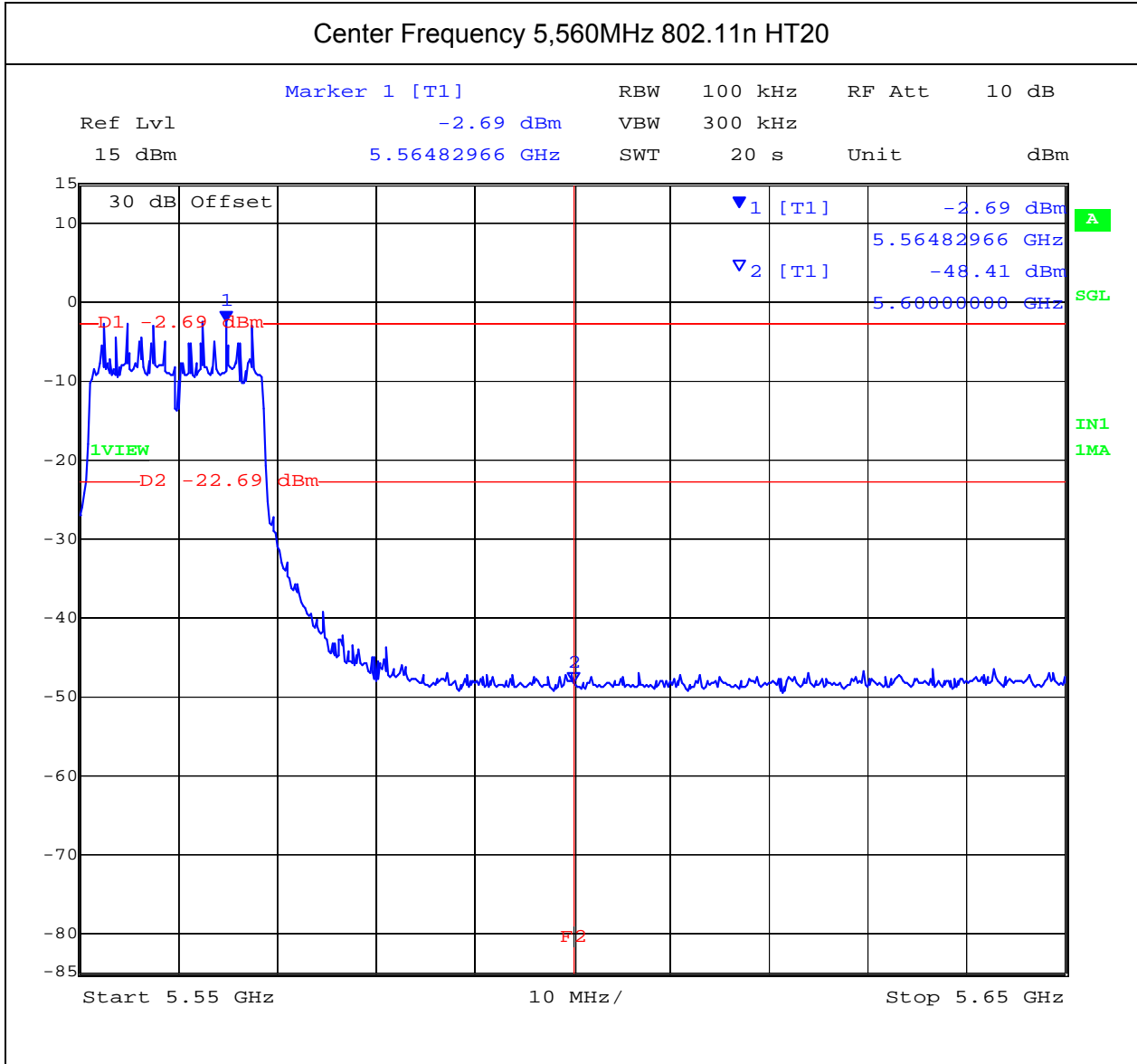

This test report may be reproduced in full only. The document may only be updated by MiCOM Labs personnel. Any changes will be noted in the Document History section of the report.

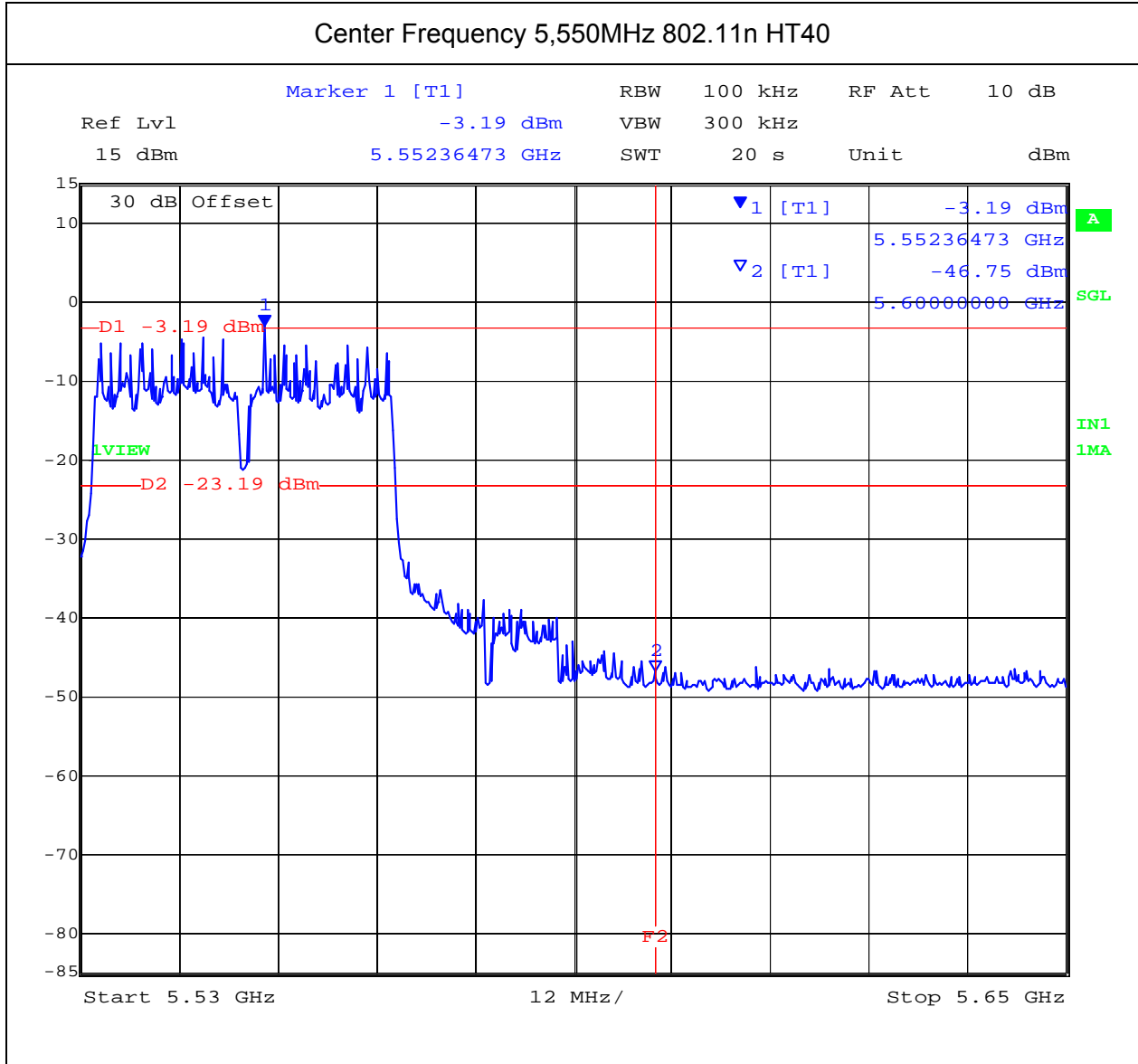

This test report may be reproduced in full only. The document may only be updated by MiCOM Labs personnel. Any changes will be noted in the Document History section of the report.

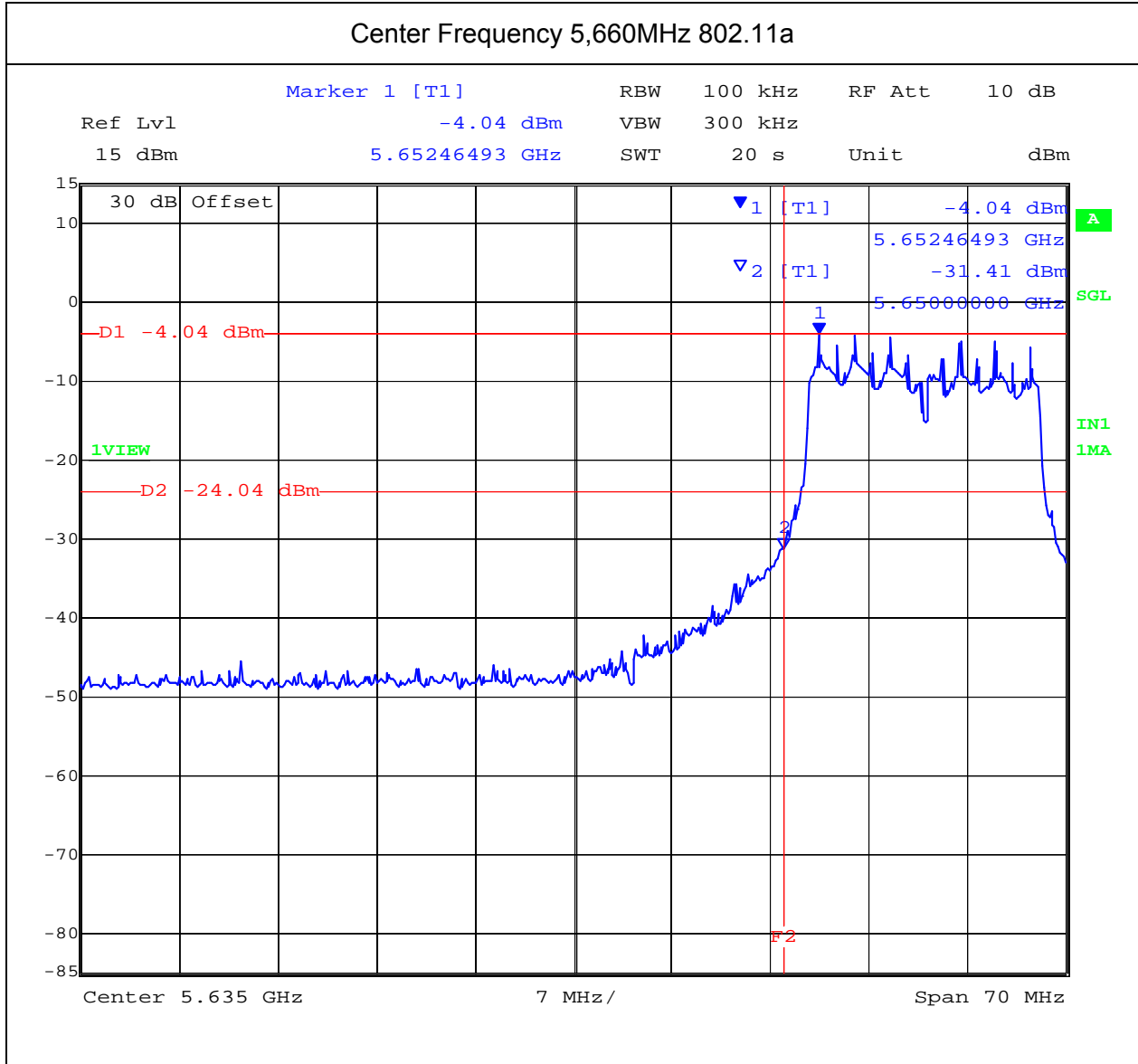

This test report may be reproduced in full only. The document may only be updated by MiCOM Labs personnel. Any changes will be noted in the Document History section of the report.

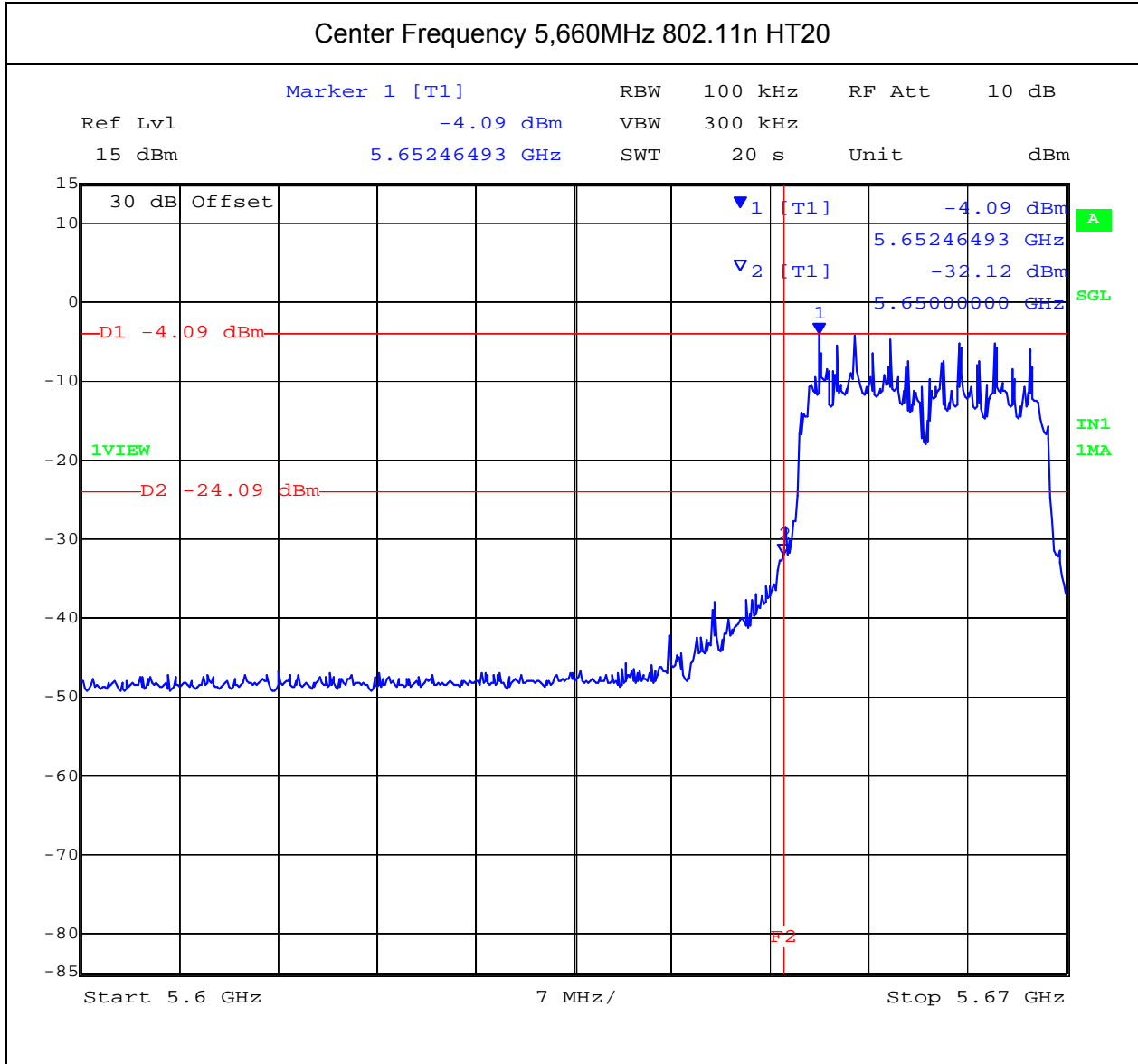

This test report may be reproduced in full only. The document may only be updated by MiCOM Labs personnel. Any changes will be noted in the Document History section of the report.

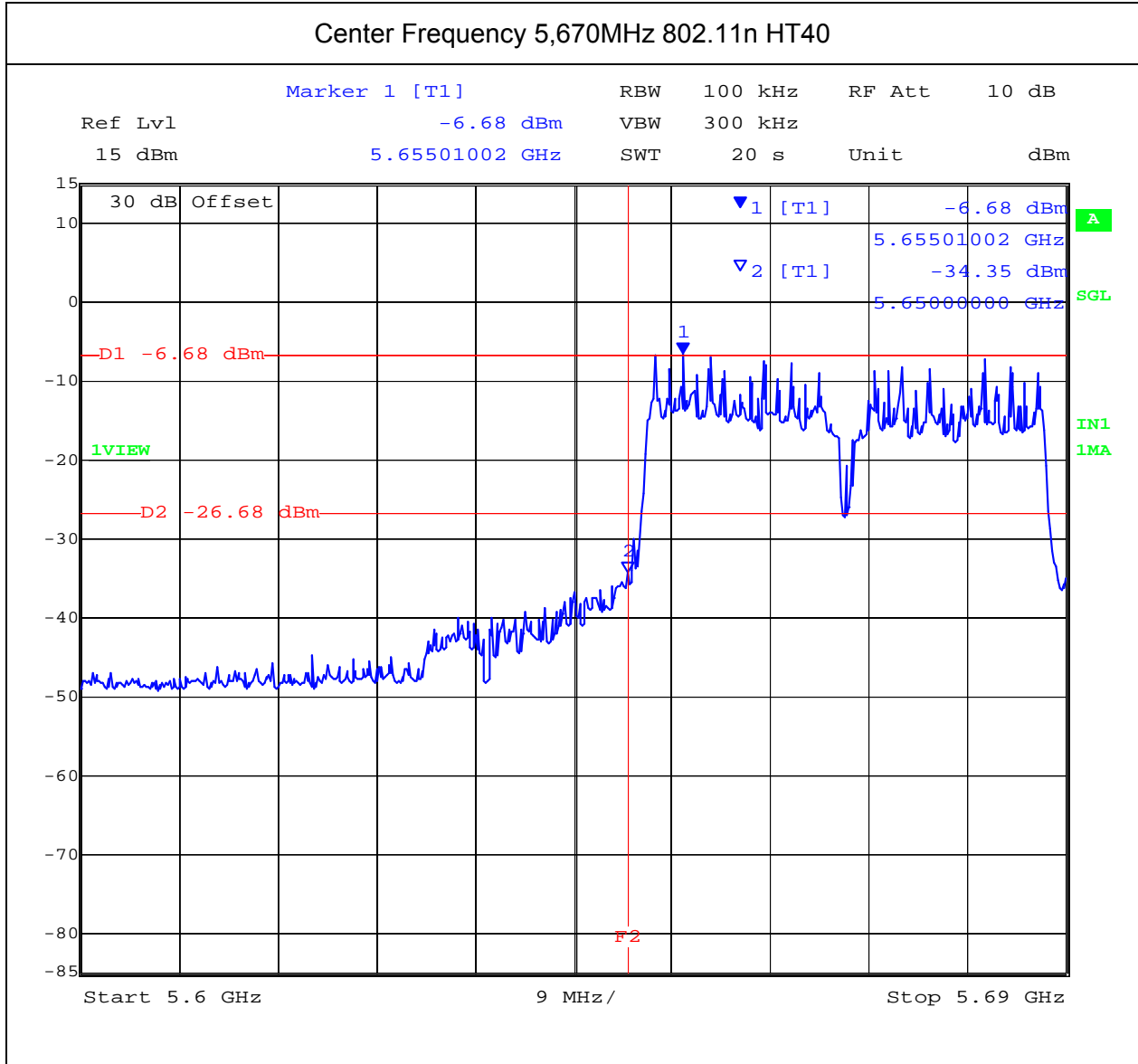

This test report may be reproduced in full only. The document may only be updated by MiCOM Labs personnel. Any changes will be noted in the Document History section of the report.

### 5.1.9.8. Test Set Up:

#### Block Diagram(s) of Test Setup

Setup for Conducted Measurements where the EUT is the Master with injection of Radar Test Waveforms at the Master.

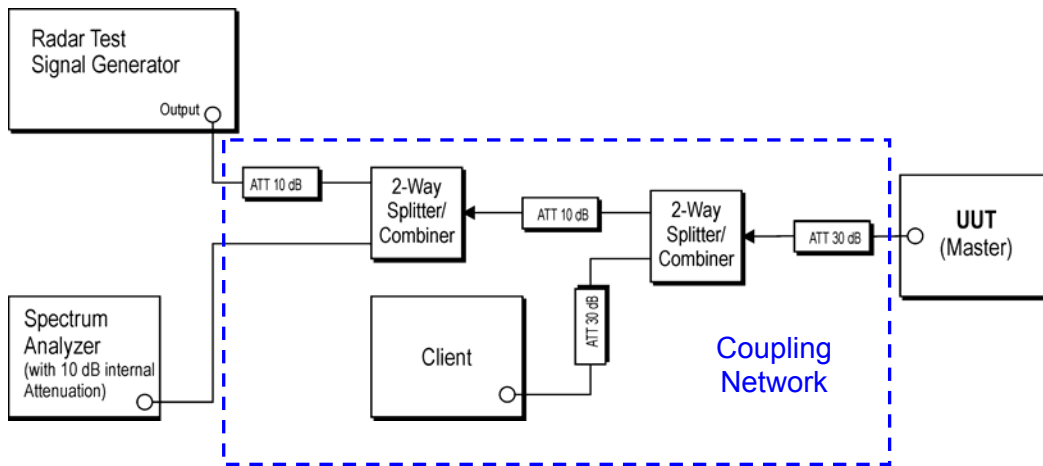

#### Support Equipment Configuration

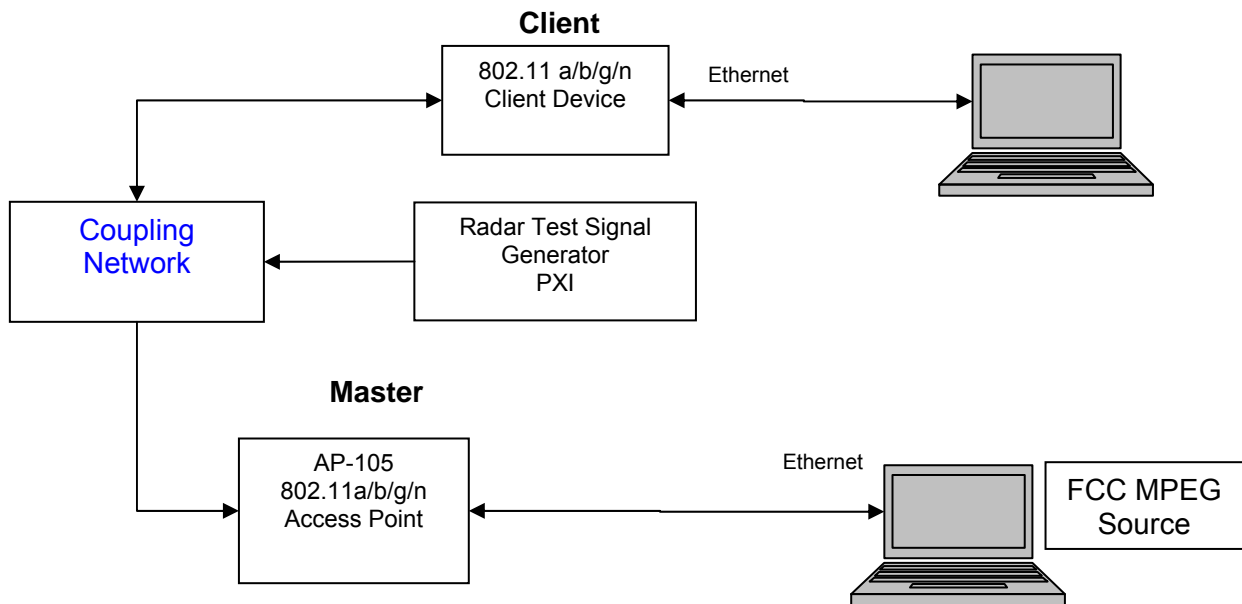

This test report may be reproduced in full only. The document may only be updated by MiCOM Labs personnel. Any changes will be noted in the Document History section of the report.



The EUT is a Master Device with radar detection.

**Applicability of DFS Requirements Prior to Use of a Channel**  
**(Ref Table 1 of FCC 06-96)**

Requirement	Operational Mode		
	Master	Client Without Radar Detection	Client With Radar Detection
<i>Non-Occupancy Period</i>	Yes	Not required	Yes
<i>DFS Detection Threshold</i>	Yes	Not required	Yes
<i>Channel Availability Check Time</i>	Yes	Not required	Not required
<i>Uniform Spreading</i>	Yes	Not required	Not required
<i>U-NII Detection Bandwidth</i>	Yes	Not required	Yes

**Applicability of DFS requirements during normal operation**  
**(Ref Table 2 of FCC 06-96)**

Requirement	Operational Mode		
	Master	Client Without Radar Detection	Client With Radar Detection
<i>DFS Detection Threshold</i>	Yes	Not required	Yes
<i>Channel Closing Transmission Time</i>	Yes	Yes	Yes
<i>Channel Move Time</i>	Yes	Yes	Yes
<i>U-NII Detection Bandwidth</i>	Yes	Not required	Yes

This test report may be reproduced in full only. The document may only be updated by MiCOM Labs personnel. Any changes will be noted in the Document History section of the report.



**Title:** Aruba AP-105 802.11a/b/g/n Wireless AP  
**To:** FCC 47 CFR Part 15.407 & IC RSS-210  
**Serial #:** ARUB69-U3 Rev A  
**Date:** 11th April 2011  
**Page:** 168 of 208

---

For the frequency band 5,470 – 5,725 MHz, the Master device provides, on aggregate, uniform loading of the spectrum across all devices by selecting an operating channel among the available channels using a random algorithm. The EUT was tested in HT-40 mode.

Declared minimum antenna gain 0 dBi. ;

Radar receive signal level = -62 dBm + minimum antenna gain + 1 dB

$$= -62 + 0 + 1$$

Radar receive signal level = -61 dBm

### **Measurement Results - Dynamic Frequency Selection (DFS)**

Ambient conditions.

Temperature: 17 to 23 °C    Relative humidity: 31 to 57%    Pressure: 999 to 1012 mbar

Radio parameters.

Test methodology: Conducted

Device Type: Master

Transmit Power: Maximum

### **Operational Details - Dynamic Frequency Selection (DFS)**

Operational Modes: 802.11a & 802.11n HT40

Data Rates: 18 mpbs 802.11a / 13.5MCS 802.11n

*\*Note\* No video pixilation was observed during the video stream at these rates. Video frames per second were noted to be at 30fps.*

### **Video Streaming Method - Dynamic Frequency Selection (DFS)**

Using the VideoLan player a video stream was setup on the master laptop with the destination being the client laptop. The video profile chosen for the video stream is "MPEG-2 + MPGA (TS)". On the client laptop the VideoLan player was setup to listen to an incoming video stream from the master device.

The requisite MPEG video file ("TestFile.mpg" available on the NTIA website at the following link <http://ntiacsd.ntia.doc.gov/dfs/>) is used during this video stream.

---

This test report may be reproduced in full only. The document may only be updated by MiCOM Labs personnel. Any changes will be noted in the Document History section of the report.





**Title:** Aruba AP-105 802.11a/b/g/n Wireless AP  
**To:** FCC 47 CFR Part 15.407 & IC RSS-210  
**Serial #:** ARUB69-U3 Rev A  
**Date:** 11th April 2011  
**Page:** 169 of 208

---

#### **5.1.9.9. Dynamic Frequency Selection (DFS) Test Results**

##### **5.1.9.10. UNII Detection Bandwidth:**

All UNII channels for this device have identical channel bandwidths and DFS testing was completed on channel 5,500 MHz (802.11a) and 5510MHz (HT40).

The generating equipment is configured as shown in the Conducted Test Setup above. A single Burst of the short pulse radar Type 1 through 6 was produced at 5,500 MHz (802.11a) and 5,510 MHz (802.11n HT40) at a level of -61 dBm (Ref Section 5.1). The EUT is set up as a standalone device (no associated Client and no traffic).

A single radar Burst is generated for a minimum of 10 trials, and the response of the EUT is noted. The EUT must detect the Radar Waveform 90% or more of the time.

The radar frequency is increased in 1 MHz steps, repeating the above test sequence, until the detection rate falls below 90%. The highest frequency at which detection is greater than or equal to 90% is denoted as  $F_H$ .

The radar frequency is decreased in 1 MHz steps, repeating the above test sequence, until the detection rate falls below 90%. The lowest frequency at which detection is greater than or equal to 90% is denoted as  $F_L$ .

The U-NII Detection Bandwidth is calculated as follows:

$$\text{U-NII Detection Bandwidth} = F_H - F_L$$

The U-NII Detection Bandwidth must be at least 80% of the EUT transmitter 99% power  
Table of results are continued on the next page.



**Title:** Aruba AP-105 802.11a/b/g/n Wireless AP  
**To:** FCC 47 CFR Part 15.407 & IC RSS-210  
**Serial #:** ARUB69-U3 Rev A  
**Date:** 11th April 2011  
**Page:** 170 of 208

EUT Frequency= 5,500 MHz 802.11a (Detection = √, No Detection = 0)											
Radar Frequency (MHz)	1	2	3	4	5	6	7	8	9	10	Detection Rate (%)
-20											%
-19											%
-18											%
-17											%
-16											%
-15											%
-14											%
-13											%
-12											%
-11	0	0									<90%
-10	0	0									<90%
-9	√	√	√	√	√	0	√	√	√	0	<90%
-8	√	√	√	√	√	√	0	√	√	√	90%
-7	√	√	√	√	√	√	√	√	√	√	100%
-6	√	√	√	√	√	√	√	√	√	√	100%
-5	√	√	√	√	√	√	√	√	√	√	100%
-4	√	√	√	√	√	√	√	√	√	√	100%
-3	√	√	√	√	√	√	√	√	√	√	100%
-2	√	√	√	√	√	√	√	√	√	√	100%
-1	√	√	√	√	√	√	√	√	√	√	100%
F <sub>0</sub>	√	√	√	√	√	√	√	√	√	√	100%
+1	√	√	√	√	√	√	√	√	√	√	100%
+2	√	√	√	√	√	√	√	√	√	√	100%
+3	√	√	√	√	√	√	√	√	√	√	100%
+4	√	√	√	√	√	√	√	√	√	√	100%
+5	√	√	√	√	√	√	√	√	√	√	100%
+6	√	√	√	√	√	√	√	√	√	√	100%
+7	√	√	√	√	√	√	√	√	√	√	100%
+8	√	√	√	√	√	√	√	√	√	√	100%
+9	0	√	√	√	√	√	√	√	√	√	90%
+10	0	0									<90%
+11	0	0									<90%
+12											%
+13											%
+14											%
+15											%
+16											%
+17											%
Detection Bandwidth = F <sub>H</sub> -F <sub>L</sub> = 5509-5492 = 18 MHz											
EUT 99% Bandwidth = 17.034 MHz (ref. bandwidth channel 5500 MHz)											
17.034 MHz *80% = 13.627 MHz											

This test report may be reproduced in full only. The document may only be updated by MiCOM Labs personnel. Any changes will be noted in the Document History section of the report.



**Title:** Aruba AP-105 802.11a/b/g/n Wireless AP  
**To:** FCC 47 CFR Part 15.407 & IC RSS-210  
**Serial #:** ARUB69-U3 Rev A  
**Date:** 11th April 2011  
**Page:** 171 of 208

For each frequency step the minimum percentage detection is 90%

EUT Frequency= 5,510 MHz 802.11n HT40 (Detection = √, No Detection = 0)											
Radar Frequency (MHz)	1	2	3	4	5	6	7	8	9	10	Detection Rate (%)
-21	0	0									<90%
-20	0	√	√	0							<90%
-19	√	√	√	√	0	0					<90%
-18	√	√	√	0	0						<90%
-17	√	√	√	√	0	√	√	√	0		<90%
-16	√	√	0	√	√	√	√	√	√	√	90%
-15	√	√	0	√	√	√	√	√	√	√	90%
-14	√	√	√	√	√	0	√	√	√	√	90%
-13	√	√	√	√	√	√	√	0	√	√	90%
-12	√	√	√	√	√	√	√	√	√	√	100%
-11	√	√	√	√	√	0	√	√	√	√	90%
-10	√	√	√	√	√	√	√	√	√	√	100%
-9	√	√	√	√	√	√	√	√	√	√	100%
-8	√	√	√	√	0	√	√	√	√	√	90%
-7	√	√	√	√	√	√	√	√	√	√	100%
-6	√	√	√	√	√	√	√	√	0	√	90%
-5	√	√	√	√	√	√	√	√	√	√	100%
-4	√	√	√	√	√	√	√	√	√	√	100%
-3	√	√	√	√	√	√	√	√	√	√	100%
-2	√	√	√	√	√	√	√	√	√	√	100%
-1	√	√	√	√	√	√	√	√	√	√	100%
F <sub>0</sub>	√	√	√	√	√	√	√	√	√	√	100%

This test report may be reproduced in full only. The document may only be updated by MiCOM Labs personnel. Any changes will be noted in the Document History section of the report.



**Title:** Aruba AP-105 802.11a/b/g/n Wireless AP  
**To:** FCC 47 CFR Part 15.407 & IC RSS-210  
**Serial #:** ARUB69-U3 Rev A  
**Date:** 11th April 2011  
**Page:** 172 of 208

EUT Frequency= 5,510 MHz 802.11n HT40 (Detection = √, No Detection = 0)											
Radar Frequency (MHz)	1	2	3	4	5	6	7	8	9	10	Detection Rate (%)
F <sub>0</sub>	√	√	√	√	√	√	√	√	√	√	100%
+1	√	√	√	√	√	√	√	√	√	√	100%
+2	√	√	√	√	√	√	√	√	√	√	100%
+3	√	√	√	√	√	√	√	√	√	√	100%
+4	√	√	√	√	√	√	√	√	√	√	100%
+5	√	√	√	√	√	√	√	√	√	√	100%
+6	√	√	√	√	√	√	√	√	√	√	100%
+7	√	√	√	√	√	√	√	√	√	√	100%
+8	√	√	√	√	√	√	√	√	√	√	100%
+9	√	√	√	√	√	√	√	√	√	√	100%
+10	√	√	√	√	√	√	√	√	√	√	100%
+11	√	√	√	√	√	√	√	√	√	√	100%
+12	√	√	√	√	√	√	√	√	√	√	100%
+13	√	√	√	√	√	√	√	√	√	√	100%
+14	√	√	√	√	√	√	√	√	√	√	100%
+15	√	√	√	√	√	√	√	√	√	√	100%
+16	√	0	0								<90%
+17	√	√	0	√	0						<90%
+18	0	0									<90%
+19	0	0									<90%
+20	0	0									<90%
+21	0	0									<90%
Detection Bandwidth = $F_H - F_L = 5524 - 5494 = 31$ MHz											
EUT 99% Bandwidth = 36.673 MHz (ref. bandwidth channel 5510 MHz)											
36.673 MHz *80% = 29.34 MHz											

For each frequency step the minimum percentage detection is 90%

This test report may be reproduced in full only. The document may only be updated by MiCOM Labs personnel. Any changes will be noted in the Document History section of the report.



**Title:** Aruba AP-105 802.11a/b/g/n Wireless AP  
**To:** FCC 47 CFR Part 15.407 & IC RSS-210  
**Serial #:** ARUB69-U3 Rev A  
**Date:** 11th April 2011  
**Page:** 173 of 208

---

#### 5.1.9.11. Initial Channel Availability Check Time

This test verifies that the EUT does not emit pulse, control, or data signals on the test Channel until the power-up sequence has been completed and the U-NII device checks for Radar Waveforms for one minute on the test Channel. This test does not use any Radar Waveforms.

The U-NII device is powered on and be instructed to operate at 5,500MHz 802.11a and 5,510MHz 802.11n HT40. At the same time the EUT is powered on, the spectrum analyzer is set for zero span with a 1 MHz resolution bandwidth at 5,500 & 5,510 MHz with a 260 second sweep time. The analyzer's sweep will be started the same time power is applied to the U-NII device.

The EUT should not transmit any pulse or data transmissions until at least 1 minute after the completion of the power-on cycle.

The first red marker line shown on the following plot denotes the instant when the EUT starts its power-up sequence i.e.  $T_0$  (as defined within the FCC's MO&O 06-96 Normative Reference 2 ). The power-up reference  $T_0$  is determined by the time it takes for the EUT to start "beaconing" i.e. initial beacon – 60 secs = end of power-up.

The Channel Availability Check Time commences at instant  $T_0$  and will end no sooner than  $T_0 + 60$  seconds.



**Title:** Aruba AP-105 802.11a/b/g/n Wireless AP  
**To:** FCC 47 CFR Part 15.407 & IC RSS-210  
**Serial #:** ARUB69-U3 Rev A  
**Date:** 11th April 2011  
**Page:** 174 of 208

**EUT power up and Initial Channel Availability Check Time**  
**5,500MHz 802.11a Power On = 105.77 Seconds**

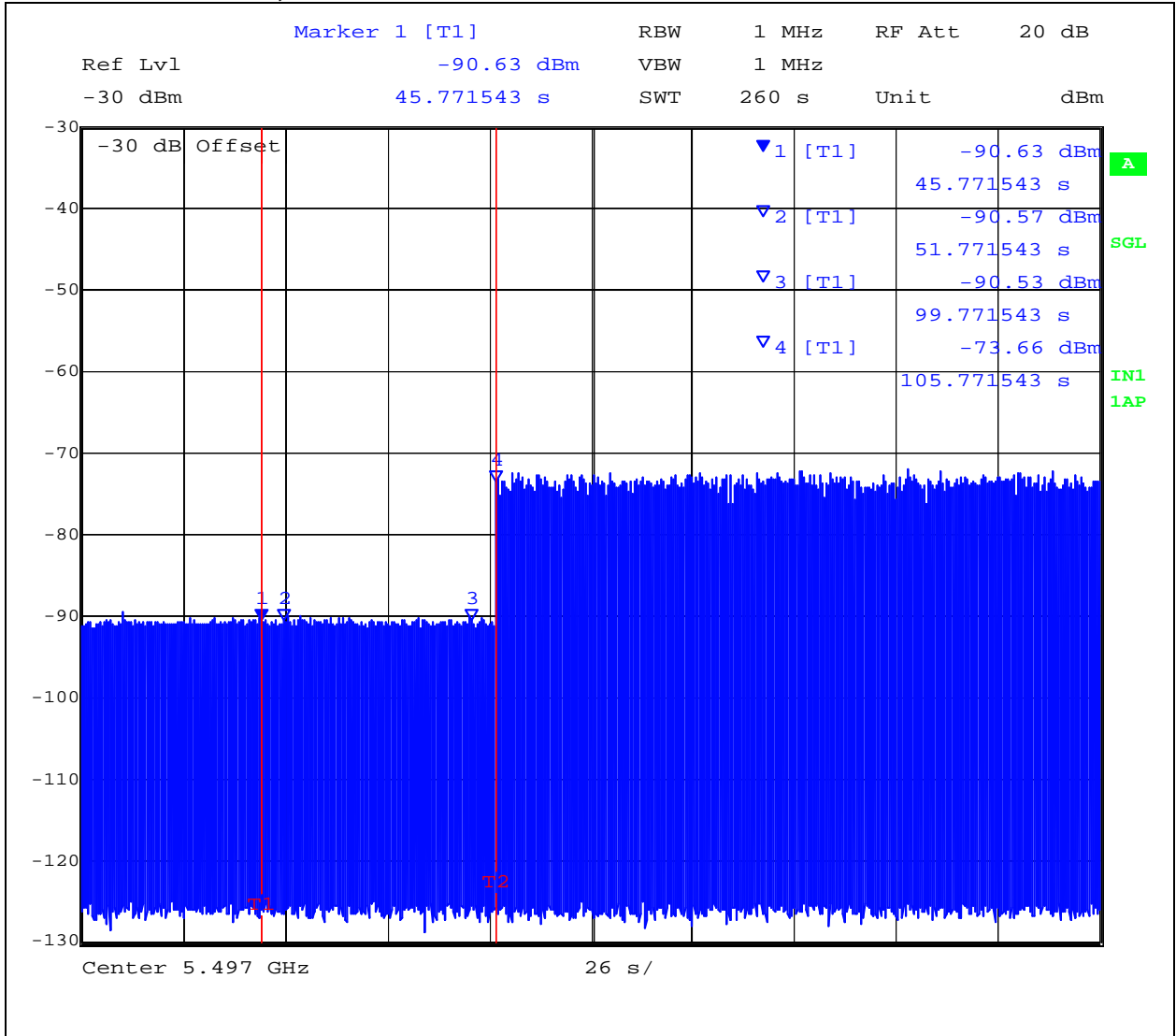

This test report may be reproduced in full only. The document may only be updated by MiCOM Labs personnel. Any changes will be noted in the Document History section of the report.



**Title:** Aruba AP-105 802.11a/b/g/n Wireless AP  
**To:** FCC 47 CFR Part 15.407 & IC RSS-210  
**Serial #:** ARUB69-U3 Rev A  
**Date:** 11th April 2011  
**Page:** 175 of 208

**EUT power up and Initial Channel Availability Check Time**  
**5,510MHz 802.11n HT40 Power On = 105.77 Seconds**

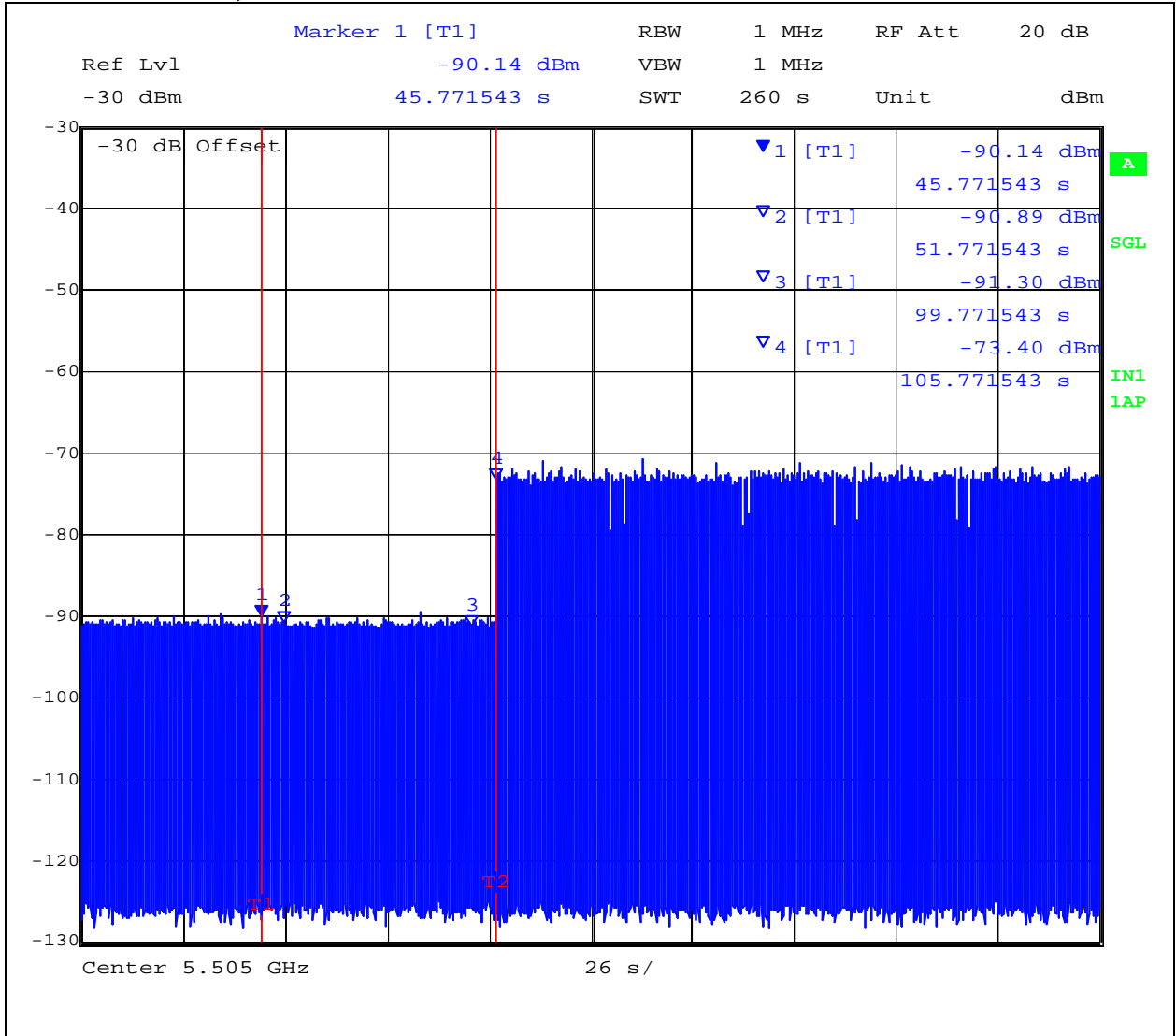

This test report may be reproduced in full only. The document may only be updated by MiCOM Labs personnel. Any changes will be noted in the Document History section of the report.



**Title:** Aruba AP-105 802.11a/b/g/n Wireless AP  
**To:** FCC 47 CFR Part 15.407 & IC RSS-210  
**Serial #:** ARUB69-U3 Rev A  
**Date:** 11th April 2011  
**Page:** 176 of 208

---

#### **5.1.9.12. Radar Burst at the Beginning of the Channel Availability Check Time:**

The steps below define the procedure to verify successful radar detection on the selected Channel during a period equal to the Channel Availability Check Time and avoidance of operation on that Channel when a radar Burst with a level equal to the DFS Detection Threshold +6 dB (-62 dBm Ref Section 6.1.7) occurs at the beginning of the Channel Availability Check Time.

A single Burst of short pulse of radar Type 1 will commence within a 6 second window starting at  $T_0$  (first red marker line on the following plot).

Visual indication on the EUT of successful detection of the radar Burst will be recorded and reported. Observation of emissions at 5,500MHz 802.11a & 5,510MHz 802.11n HT40 will continue for 2.5 minutes after the radar burst has been generated.

---

This test report may be reproduced in full only. The document may only be updated by MiCOM Labs personnel. Any changes will be noted in the Document History section of the report.





**Channel Availability Check Time at the start T0 + 6 seconds Check Time  
 5,500MHz 802.11a**

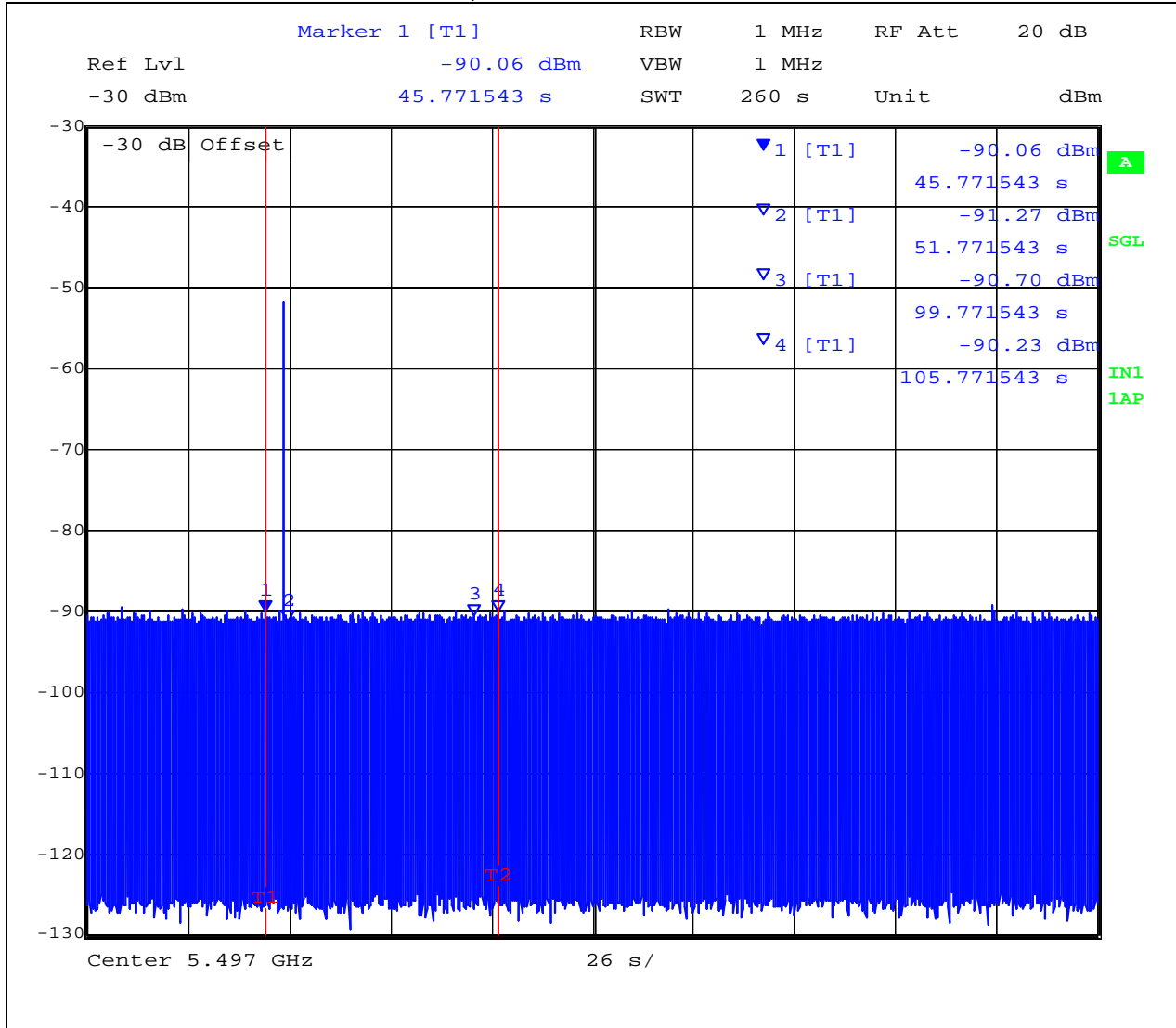

This test report may be reproduced in full only. The document may only be updated by MiCOM Labs personnel. Any changes will be noted in the Document History section of the report.



Channel Availability Check Time at the start T0 + 6 seconds Check Time  
5,510MHz 802.11n HT40

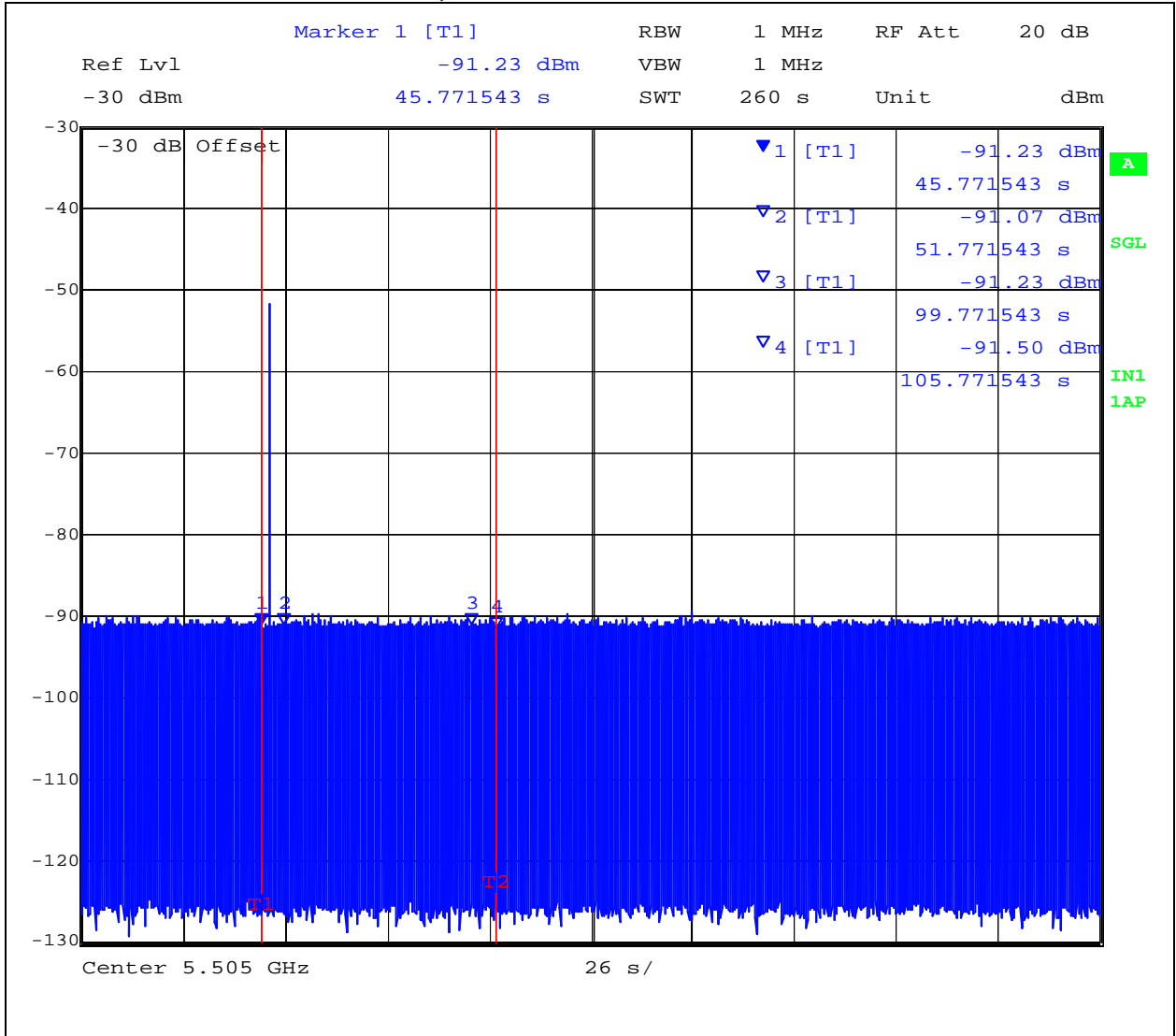

This test report may be reproduced in full only. The document may only be updated by MiCOM Labs personnel. Any changes will be noted in the Document History section of the report.



**Title:** Aruba AP-105 802.11a/b/g/n Wireless AP  
**To:** FCC 47 CFR Part 15.407 & IC RSS-210  
**Serial #:** ARUB69-U3 Rev A  
**Date:** 11th April 2011  
**Page:** 179 of 208

---

#### **5.1.9.13. Radar Burst at the End of the Channel Availability Check Time:**

The steps below define the procedure to verify successful radar detection on the selected Channel during a period equal to the Channel Availability Check Time and avoidance of operation on that Channel when a radar Burst with a level equal to the DFS Detection Threshold occurs at the end of the Channel Availability Check Time.

A single Burst of short pulse of radar type 1 will commence within a 6 second window starting at  $T_0 + 54$  seconds. The window will commence at marker 2 and end at the red frequency line  $T_2$ .

Visual indication on the EUT of successful detection of the radar Burst will be recorded and reported. Observation of emissions at 5,500MHz 802.11a & 5,510MHz 802.11n HT40 will continue for 2.5 minutes after the radar burst has been generated.

---

This test report may be reproduced in full only. The document may only be updated by MiCOM Labs personnel. Any changes will be noted in the Document History section of the report.



**Channel Availability Check Time at T0 + 54 seconds Check Time  
 5,500MHz 802.11a**

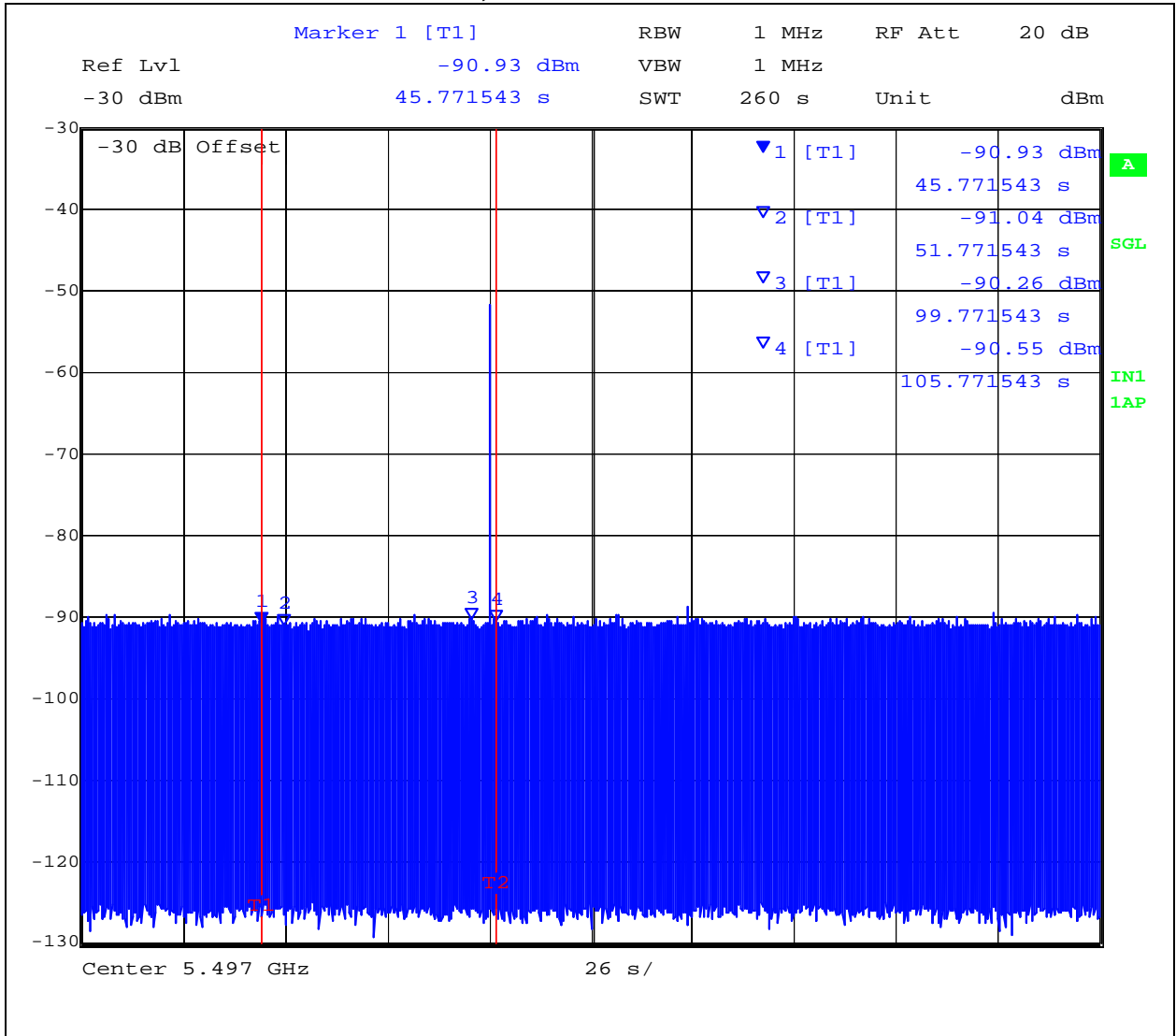

This test report may be reproduced in full only. The document may only be updated by MiCOM Labs personnel. Any changes will be noted in the Document History section of the report.



**Channel Availability Check Time at T0 + 54 seconds Check Time**  
**5,510MHz 802.11n HT40**

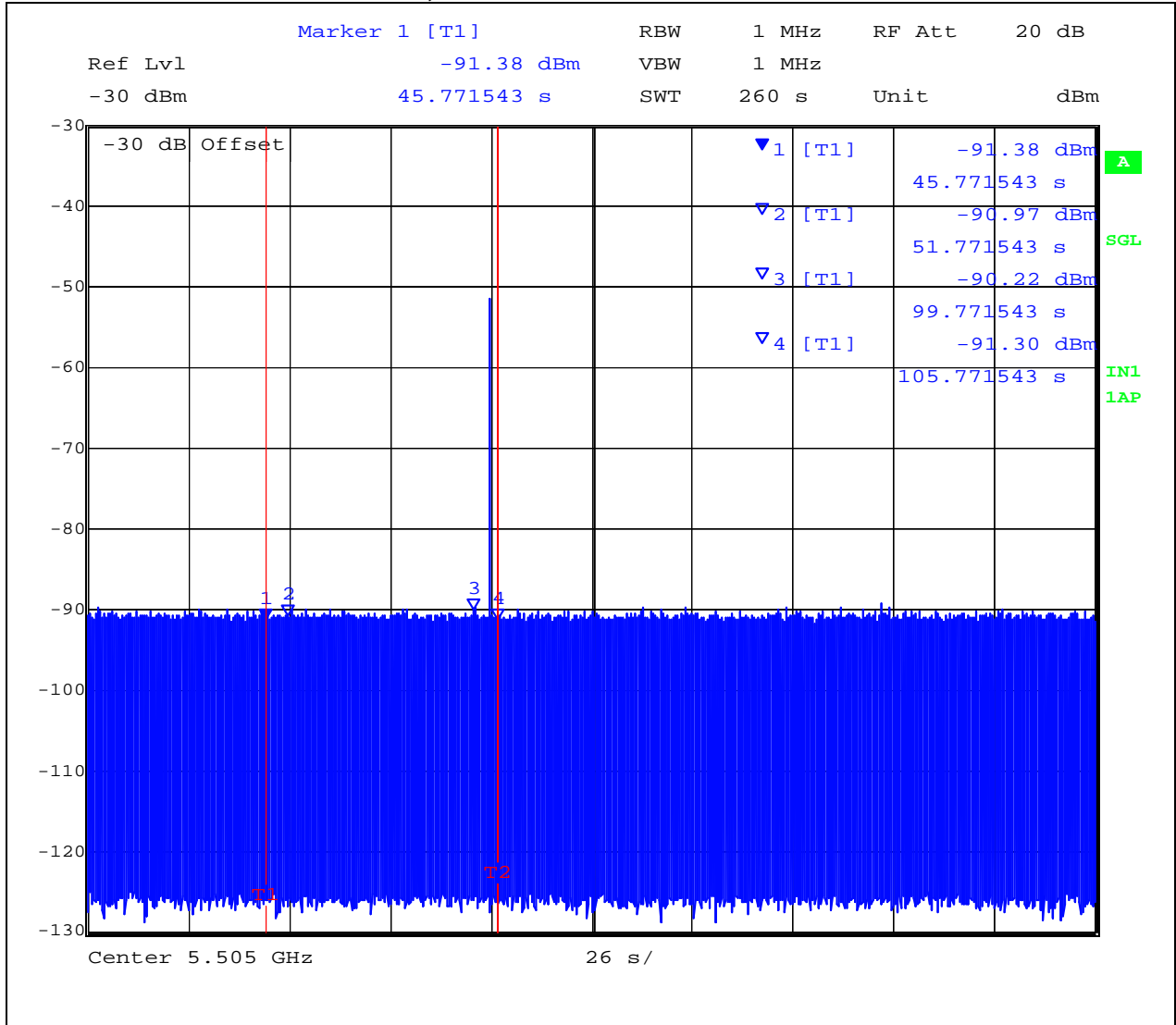

This test report may be reproduced in full only. The document may only be updated by MiCOM Labs personnel. Any changes will be noted in the Document History section of the report.