

Antenna size 56.6x24.96mm
 Freq range 2.4GHz-2.48GHz
 VSWR 2 Max
 Gain 0dBi max
 Impedance 50ohm
 Antenna type Internal Pifa with coaxial cable attachment
 Polarization Linear
 Max Power 200mW
 Operating temp -20 to +55 deg celcius
 Interconnection and cable assembly MMCX to Hirose UFL connector with 1.13 RF cable

Manufacturer: Cardo
 PN: UCS antenna

Testing LAB Hermon labs - <https://hermonlabs.com/>

- Antenna position in the product

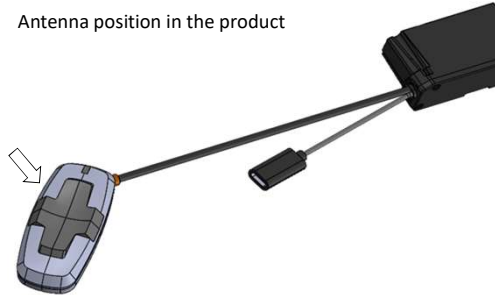

- Antenan size in mm

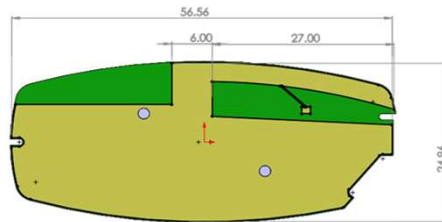

- RF cable connection MMCX to UFL (all size in mm)

| ITEM NO. | PART NUMBER | DESCRIPTION | QTY. |
|----------|-----------------------|----------------------|------|
| 1 | OM PVC 30P | OM PVC 30P | 1 |
| 2 | USB C F Charger | Type C F to 5p 0.8mm | 1 |
| 3 | MMCX+12p to side unit | MMCX+12p 0.8mm | 1 |

| REV. | DESCRIPTION | REVISIONS | DATE | DESIGNER | APPROVER |
|------|---|-----------|------------|----------|----------|
| 7 | CHANGE OVER MOLD | | 24/05/2022 | ARNON.A | |
| 8 | CHANGE ANTENNA CABLE LENGTH FRM 25.5 TO 24.5 CHANGE 12P CONECTRIOR LENGTH FROM 13.5 TO 16 ADD TEST REQUIREMENT, UPDATE CABLE DEFINITION | | 23/06/2022 | ARNON.A | |
| 9 | ADD DETAILES E AND F CHANGE USB INNER MOLD TO PVC25P | | 24/07/2022 | ARNON.A | |
| 10 | UPDATE CABLE DEFINITION AND USB CONNECTION TABLE | | 18/08/2022 | ARNON.A | |
| 11 | ADDING ACETATE TAPE REDUCED 12P CABLE LENGTH | | 01/09/2022 | ARNON.A | |
| 12 | CHANGE USB OM MATERIAL TO PVC45P | | 31/10/2022 | ARNON.A | |

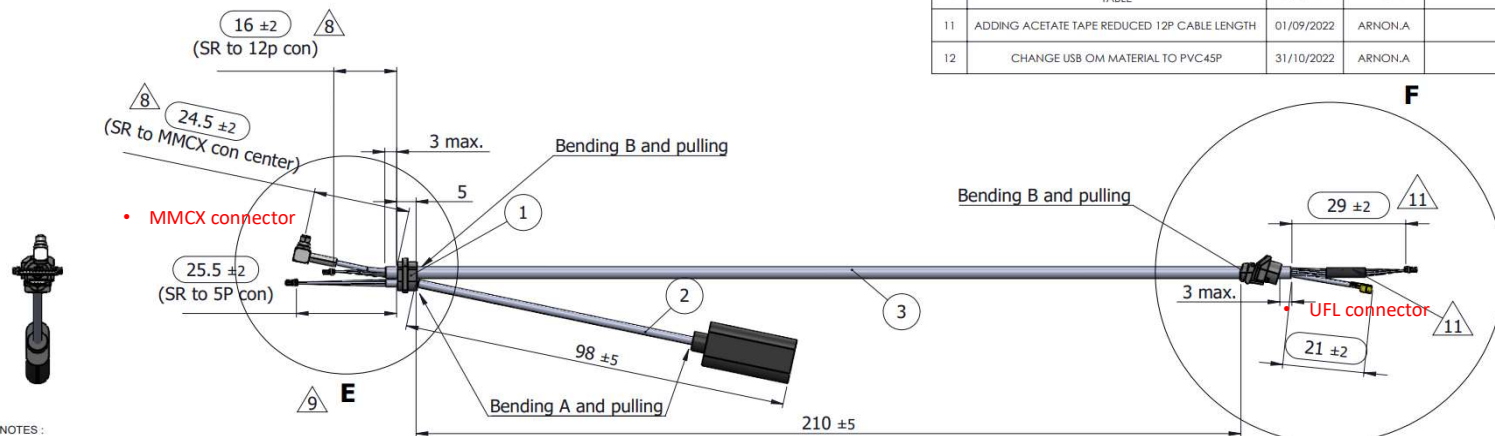

CABLE NOTES :

- RF chain

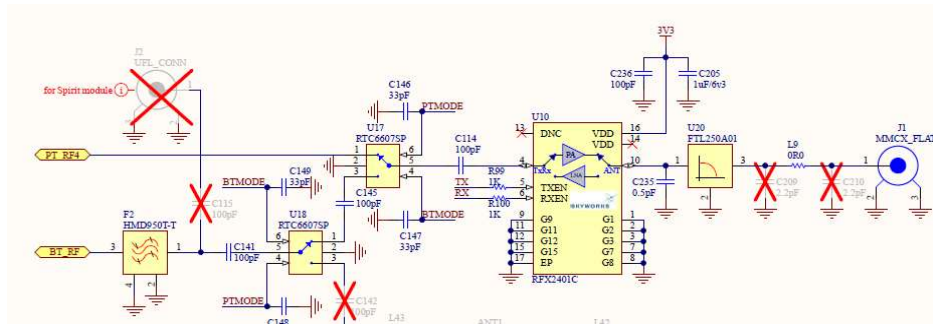

| Vertical position of EUT | | | |
|--------------------------|------------------------------------|-----------|----------------------|
| Frequency: | 2480 | MHz | |
| Angle (deg) | Spectrum Analyzer reading (dBuV/m) | EIRP, dBm | Antenna Pattern, dBi |
| 0 | 100.26 | 3.52 | 0.00 |
| 20 | 96.42 | -0.32 | -3.84 |
| 40 | 99.15 | 2.41 | -1.11 |
| 60 | 98.29 | 1.55 | -1.97 |
| 80 | 81.65 | -15.09 | -18.61 |
| 100 | 99.65 | 2.91 | -0.61 |
| 120 | 99.35 | 2.61 | -0.91 |
| 140 | 99.87 | 3.13 | -0.39 |
| 160 | 97.38 | 0.64 | -2.88 |
| 180 | 94.78 | -1.96 | -5.48 |
| 200 | 99.14 | 2.4 | -1.12 |
| 220 | 100.15 | 3.41 | -0.11 |
| 240 | 96.81 | 0.07 | -3.45 |
| 260 | 94.15 | -2.59 | -6.11 |
| 280 | 92.81 | -3.93 | -7.45 |
| 300 | 99.22 | 2.48 | -1.04 |
| 320 | 98.22 | 1.48 | -2.04 |
| 340 | 100.25 | 3.51 | -0.01 |
| 360 | 100.24 | 3.5 | -0.02 |
| | | | -3.01 |
| | | | |
| | | | |
| | | | |
| | | | |
| | | | |
| | | | |

| Spectrum Analyzer Data | | | sweep time 20 ms Substitution |
|-------------------------------|--------|--------|--------------------------------------|
| Span | 10 | MHz | |
| RBW | 1000 | kHz | |
| VBW | 3000 | kHz | |
| Ref Level | 120 | dBuV/m | |
| SG | 0 | dBm | |
| F, MHz | 2480 | MHz | |
| SA reading | 103.87 | dBuV/m | |
| AG, dBi | 10.3 | dBi | |
| Cable Loss | 3.17 | dB | |
| Antenna polarization Vertical | | | |
| Antenna Horn HL 4474 | | | |

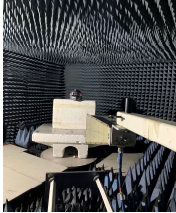

-96.74

Gain measurement calculation:
 =(Reference SA reading)+(SA reading of Antenna Power)+(Reference Signal Generator RF Power)+(Ref Antenna gain)-(Reference Antenna cable loss)

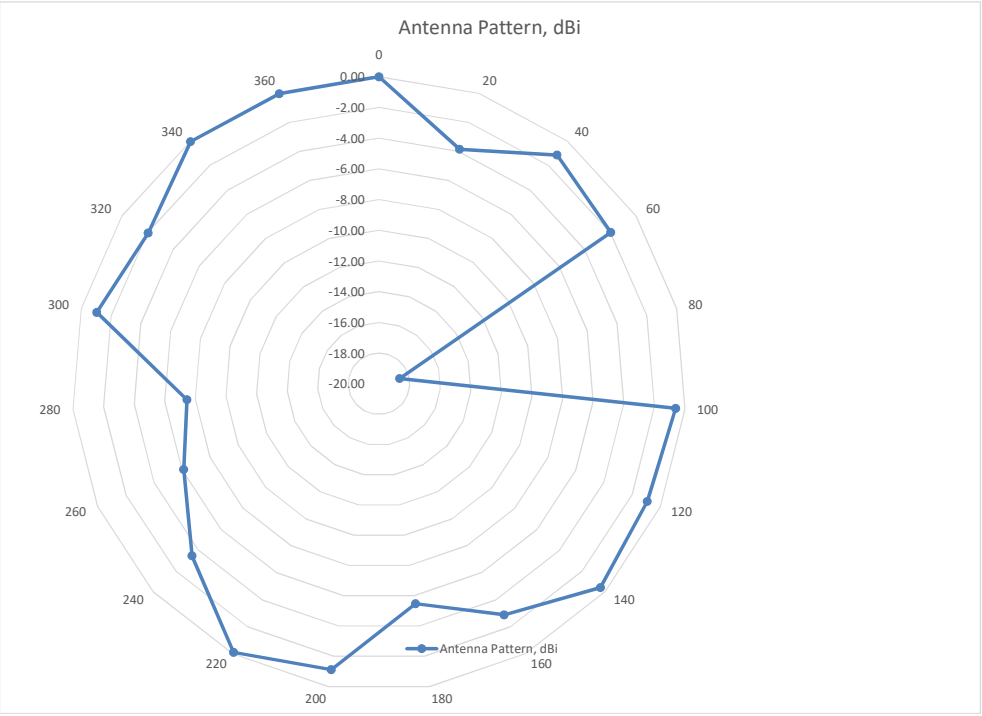

| Vertical position of EUT | | | |
|--------------------------|------------------------------------|-----------|----------------------|
| Frequency: | 2480 | | |
| Angle (deg) | Spectrum Analyzer reading (dBuV/m) | EIRP, dBm | Antenna Pattern, dBi |
| 0 | 89.62 | -7.12 | 0.00 |
| 20 | 88.15 | -8.59 | -1.47 |
| 40 | 85.86 | -10.88 | -3.76 |
| 60 | 84.26 | -12.48 | -5.36 |
| 80 | 85.09 | -11.65 | -4.53 |
| 100 | 85.59 | -11.15 | -4.03 |
| 120 | 89.45 | -7.29 | -0.17 |
| 140 | 76.1 | -20.64 | -13.52 |
| 160 | 89.34 | -7.4 | -0.28 |
| 180 | 89.12 | -7.62 | -0.50 |
| 200 | 78.83 | -17.91 | -10.79 |
| 220 | 89.55 | -7.19 | -0.07 |
| 240 | 88.09 | -8.65 | -1.53 |
| 260 | 89.1 | -7.64 | -0.52 |
| 280 | 89.12 | -7.62 | -0.50 |
| 300 | 89.2 | -7.54 | -0.42 |
| 320 | 87.62 | -9.12 | -2.00 |
| 340 | 89.55 | -7.19 | -0.07 |
| 360 | 89.6 | -7.14 | -0.02 |
| | | | -2.61 |
| | | | |
| | | | |
| | | | |
| | | | |
| | | | |
| | | | |
| | | | |

| Spectrum Analyzer Data | | |
|------------------------|--------|--------|
| Span | 10 | MHz |
| RBW | 1000 | kHz |
| VBW | 3000 | kHz |
| Ref Level | 120 | dBuV/m |
| SG | 0 | dBm |
| F, MHz | 2480 | MHz |
| SA reading | 103.87 | dBuV/m |
| AG, dBi | 10.3 | dBi |
| Cable Loss | 3.17 | dB |

Antenna polarization Vertical

Antenna Horn HL 4474

sweep time 20 ms

Substitution

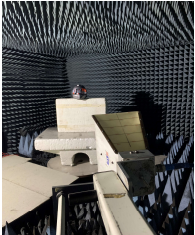

Gain measurement calculation:
 $=(\text{Reference SA reading})+(\text{SA reading of Antenna Power})+(\text{Reference Signal Generator RF Power})+(\text{Ref Antenna gain})-(\text{Reference Antenna cable loss})$

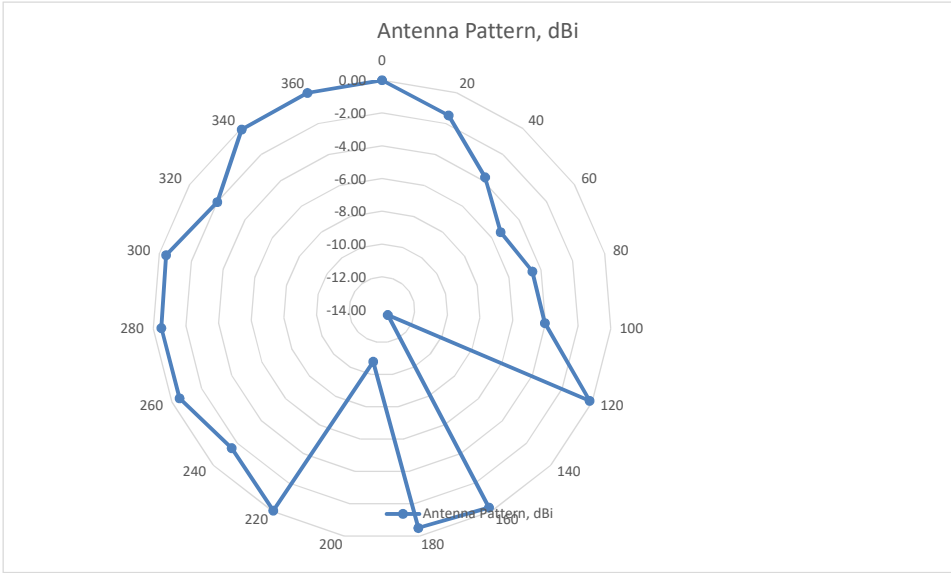

Vertical position of EUT

| Frequency: 2440 MHz | | | |
|---------------------|------------------------------------|-----------|----------------------|
| Angle (deg) | Spectrum Analyzer reading (dBuV/m) | EIRP, dBm | Antenna Pattern, dBi |
| 0 | 93.06 | -3.36 | 0.00 |
| 20 | 91.76 | -4.66 | -1.30 |
| 40 | 89.58 | -6.84 | -3.48 |
| 60 | 86.75 | -9.67 | -6.31 |
| 80 | 91.16 | -5.26 | -1.90 |
| 100 | 83.21 | -13.21 | -9.85 |
| 120 | 93.01 | -3.41 | -0.05 |
| 140 | 84.13 | -12.29 | -8.93 |
| 160 | 92.98 | -3.44 | -0.08 |
| 180 | 92.98 | -3.44 | -0.08 |
| 200 | 88.02 | -8.4 | -5.04 |
| 220 | 93.01 | -3.41 | -0.05 |
| 240 | 93.04 | -3.38 | -0.02 |
| 260 | 92.99 | -3.43 | -0.07 |
| 280 | 92.98 | -3.44 | -0.08 |
| 300 | 89.53 | -6.89 | -3.53 |
| 320 | 93.02 | -3.4 | -0.04 |
| 340 | 92.91 | -3.51 | -0.15 |
| 360 | 92.46 | -3.96 | -0.60 |
| | | | -2.19 |
| | | | |
| | | | |
| | | | |
| | | | |
| | | | |
| | | | |

| Spectrum Analyzer Data | | |
|------------------------|-------|--------|
| Span | 10 | MHz |
| RBW | 1000 | kHz |
| VBW | 3000 | kHz |
| Ref Level | 120 | dBuV/m |
| SG | 0 | dBm |
| F, MHz | 2440 | MHz |
| SA reading | 103.5 | dBuV/m |
| AG, dBi | 10.2 | dBi |
| Cable Loss | 3.12 | dB |

sweep time 20 ms

Substitution

Antenna polarization Vertical

Antenna Horn HL 4474

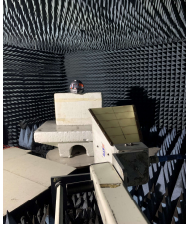

Gain measurement calculation:

$$= -(Reference\ SA\ reading) + (SA\ reading\ of\ Antenna\ Power) + (Reference\ Signal\ Generator\ RF\ Power) + (Ref\ Antenna\ gain) - (Reference\ Antenna\ cable\ loss)$$

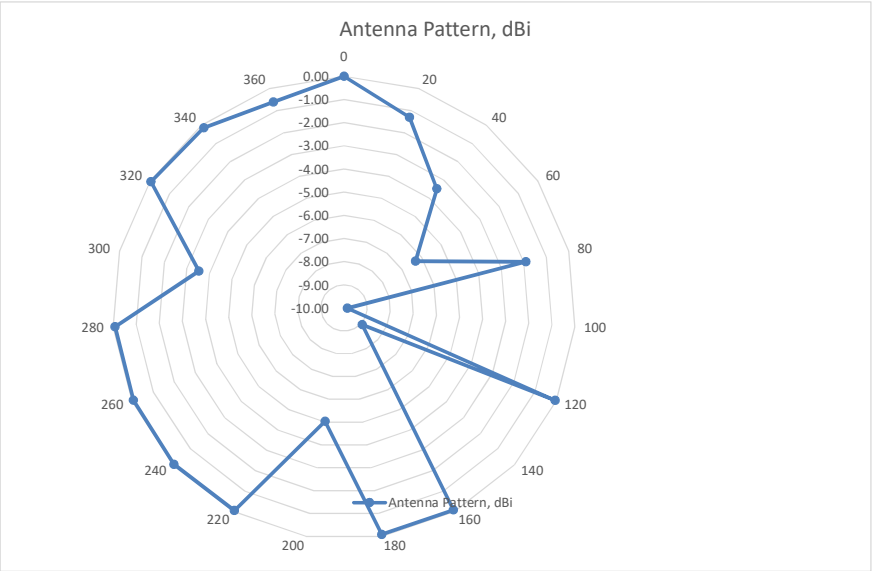

Vertical position of EUT

| Frequency: | 2440 | | |
|-------------|------------------------------------|-----------|----------------------|
| Angle (deg) | Spectrum Analyzer reading (dBuV/m) | EIRP, dBm | Antenna Pattern, dBi |
| 0 | 100.33 | 3.91 | 0.00 |
| 20 | 97.18 | 0.76 | -3.15 |
| 40 | 94.66 | -1.76 | -5.67 |
| 60 | 99.31 | 2.89 | -1.02 |
| 80 | 93.38 | -3.04 | -6.95 |
| 100 | 100.04 | 3.62 | -0.29 |
| 120 | 100.18 | 3.76 | -0.15 |
| 140 | 100.23 | 3.81 | -0.10 |
| 160 | 97.54 | 1.12 | -2.79 |
| 180 | 92.99 | -3.43 | -7.34 |
| 200 | 99.62 | 3.2 | -0.71 |
| 220 | 100.15 | 3.73 | -0.18 |
| 240 | 94.75 | -1.67 | -5.58 |
| 260 | 83.09 | -13.33 | -17.24 |
| 280 | 98.67 | 2.25 | -1.66 |
| 300 | 100.11 | 3.69 | -0.22 |
| 320 | 97.71 | 1.29 | -2.62 |
| 340 | 100.23 | 3.81 | -0.10 |
| 360 | 100.02 | 3.6 | -0.31 |
| | | | -2.95 |
| | | | |
| | | | |
| | | | |
| | | | |
| | | | |
| | | | |

| Spectrum Analyzer Data | | | |
|-------------------------------|-------|--------|------------------|
| Span | 10 | MHz | sweep time 20 ms |
| RBW | 1000 | kHz | |
| VBW | 3000 | kHz | Substitution |
| Ref Level | 120 | dBuV/m | |
| SG | 0 | dBm | |
| F, MHz | 2440 | MHz | |
| SA reading | 103.5 | dBuV/m | |
| AG, dBi | 10.2 | dBi | |
| Cable Loss | 3.12 | dB | |
| Antenna polarization Vertical | | | |
| Antenna Horn HL 4474 | | | |

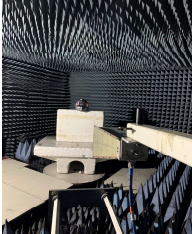

Gain measurement calculation:
 $Gain = -(Reference\ SA\ reading) + (SA\ reading\ of\ Antenna\ Power) + (Reference\ Signal\ Generator\ RF\ Power) + (Ref\ Antenna\ gain) - (Reference\ Antenna\ cable\ loss)$

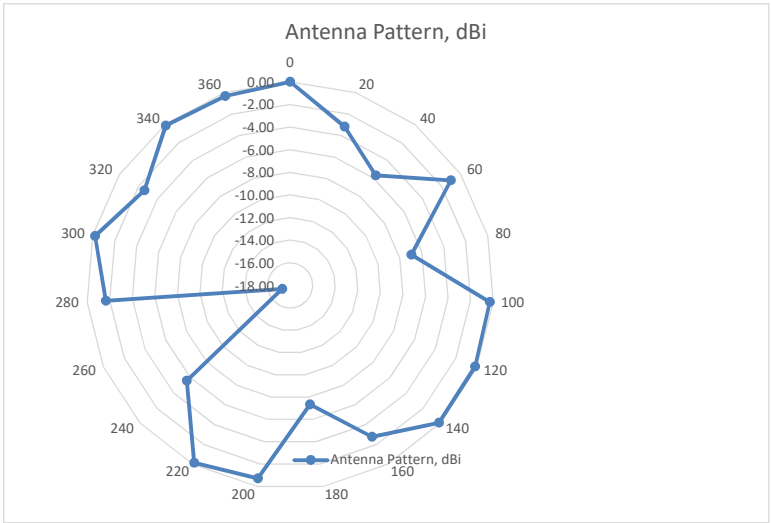

| Vertical position of EUT | | | |
|--------------------------|------------------------------------|-----------|----------------------|
| Frequency: | 2402 | MHz | |
| Angle (deg) | Spectrum Analyzer reading (dBuV/m) | EIRP, dBm | Antenna Pattern, dBi |
| 0 | 92.35 | -4.04 | 0.00 |
| 20 | 91.23 | -5.16 | -1.12 |
| 40 | 92 | -4.39 | -0.35 |
| 60 | 92.14 | -4.25 | -0.21 |
| 80 | 92.23 | -4.16 | -0.12 |
| 100 | 92.08 | -4.31 | -0.27 |
| 120 | 92.29 | -4.1 | -0.06 |
| 140 | 88.33 | -8.06 | -4.02 |
| 160 | 92.32 | -4.07 | -0.03 |
| 180 | 92.24 | -4.15 | -0.11 |
| 200 | 91.72 | -4.67 | -0.63 |
| 220 | 91.46 | -4.93 | -0.89 |
| 240 | 92.12 | -4.27 | -0.23 |
| 260 | 92.29 | -4.1 | -0.06 |
| 280 | 92.32 | -4.07 | -0.03 |
| 300 | 85.92 | -10.47 | -6.43 |
| 320 | 92.12 | -4.27 | -0.23 |
| 340 | 86.39 | -10 | -5.96 |
| 360 | 92.19 | -4.2 | -0.16 |
| | | | -1.10 |
| | | | |
| | | | |
| | | | |
| | | | |
| | | | |
| | | | |
| | | | |

| Spectrum Analyzer Data | | | sweep time 20 ms |
|-------------------------------|-------|--------|------------------|
| Span | 10 | MHz | |
| RBW | 1000 | kHz | |
| VBW | 3000 | kHz | |
| Ref Level | 120 | dBuV/m | |
| SG | 0 | dBm | |
| F, MHz | 2405 | MHz | |
| SA reading | 103.2 | dBuV/m | |
| AG, dBi | 9.9 | dBi | |
| Cable Loss | 3.09 | dB | |
| Substitution | | | |
| Antenna polarization Vertical | | | |
| Antenna Horn HL 4474 | | | |

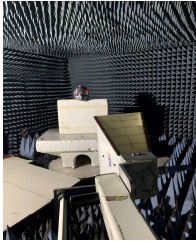

Gain measurement calculation:
 =-(Reference SA reading)+(SA reading of Antenna Power)+(Reference Signal Generator RF Power)+(Ref Antenna gain)-(Reference Antenna cable loss)

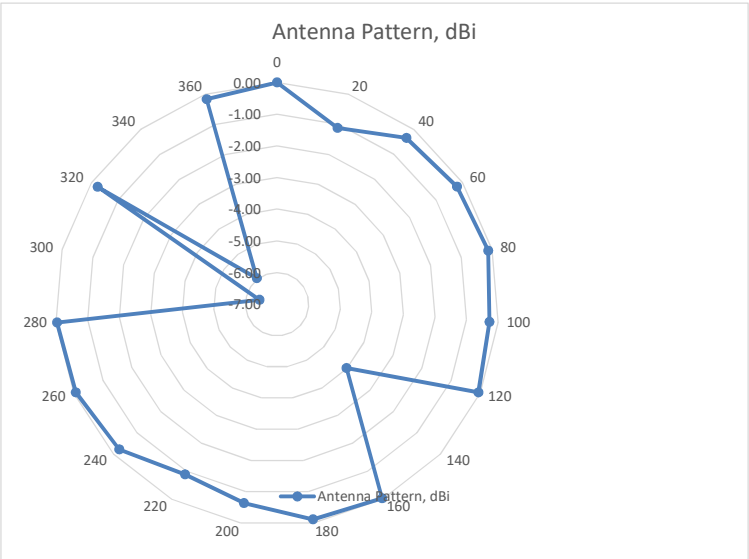

| Vertical position of EUT | | | |
|--------------------------|------------------------------------|-----------|----------------------|
| Frequency: | 2402 | MHz | |
| Angle (deg) | Spectrum Analyzer reading (dBuV/m) | EIRP, dBm | Antenna Pattern, dBi |
| 0 | 101.63 | 5.24 | 0.00 |
| 20 | 97.62 | 1.23 | -4.01 |
| 40 | 98.01 | 1.62 | -3.62 |
| 60 | 97.98 | 1.59 | -3.65 |
| 80 | 86.51 | -9.88 | -15.12 |
| 100 | 98.26 | 1.87 | -3.37 |
| 120 | 101.1 | 4.71 | -0.53 |
| 140 | 101.45 | 5.06 | -0.18 |
| 160 | 101.58 | 5.19 | -0.05 |
| 180 | 98.16 | 1.77 | -3.47 |
| 200 | 100.5 | 4.11 | -1.13 |
| 220 | 101.23 | 4.84 | -0.40 |
| 240 | 89.29 | -7.1 | -12.34 |
| 260 | 87.09 | -9.3 | -14.54 |
| 280 | 100.32 | 3.93 | -1.31 |
| 300 | 101.24 | 4.85 | -0.39 |
| 320 | 101.18 | 4.79 | -0.45 |
| 340 | 100.47 | 4.08 | -1.16 |
| 360 | 101.63 | 5.24 | 0.00 |
| | | | -3.46 |

| Spectrum Analyzer Data | | | sweep time 20 ms |
|-------------------------------|-------|--------|------------------|
| Span | 10 | MHz | |
| RBW | 1000 | kHz | |
| VBW | 3000 | kHz | |
| Ref Level | 120 | dBuV/m | |
| SG | 0 | dBm | |
| F, MHz | 2405 | MHz | |
| SA reading | 103.2 | dBuV/m | |
| AG, dBi | 9.9 | dBi | |
| Cable Loss | 3.09 | dB | |
| Substitution | | | |
| Antenna polarization Vertical | | | |
| Antenna Horn HL 4474 | | | |

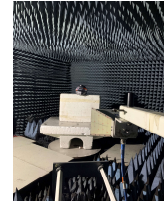

Gain measurement calculation:
 $= -(\text{Reference SA reading}) + (\text{SA reading of Antenna Power}) + (\text{Reference Signal Generator RF Power}) + (\text{Ref Antenna gain}) - (\text{Reference Antenna cable loss})$

