

4 MOUNT THE CRADLE

4.b

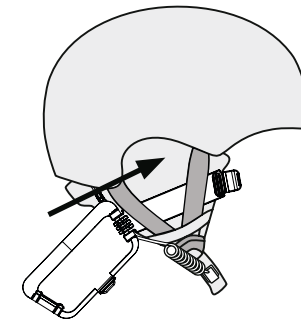

4.c

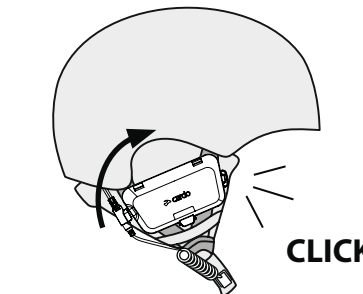

-9-

Option 2

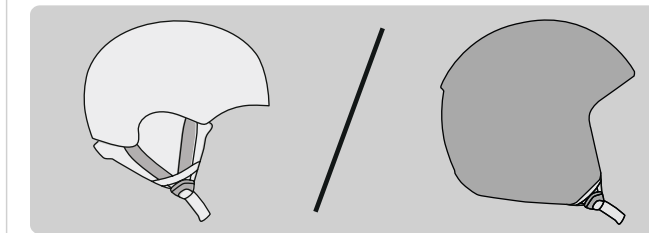

E + B



x2 +

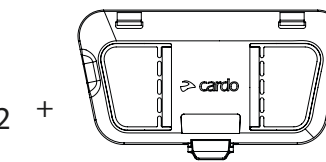

4.a*

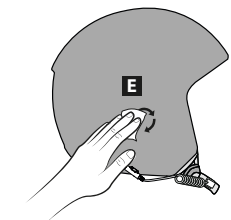

-10-

4.b*

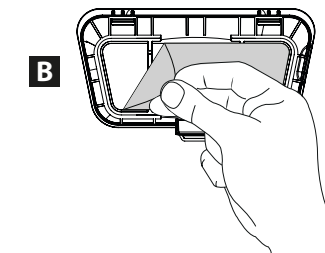

4.c*

Place under goggle strap
Posiziona sotto il cinturino degli occhiali
Colocar debajo de la correa de las gafas
Placer sous la lanière des lunettes
Unter dem Brillenband platzieren

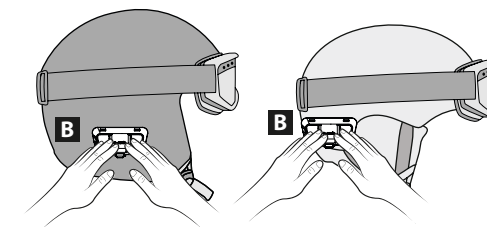

-11-

5 INSERT UNIT

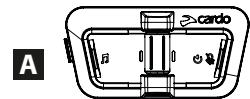

5.a

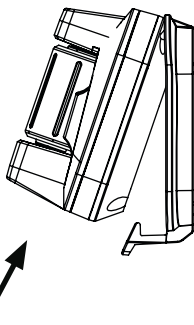

5.b

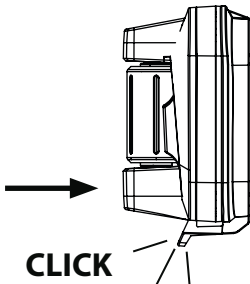

-12-

6 CONNECT AUDIO KIT

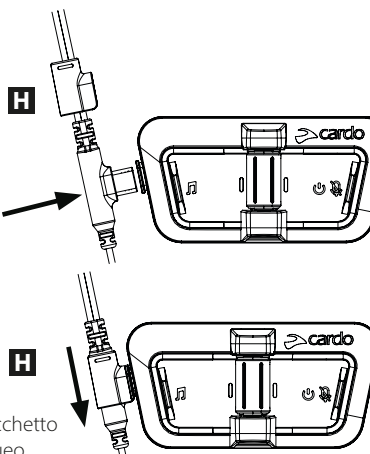

Slide the Lock
Fai scorrere il lucchetto
Deslizar el bloqueo
Faire glisser la fermeture
Sicherung aufschieben

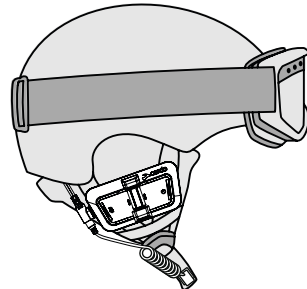

-13-

7 REMOVE THE UNIT

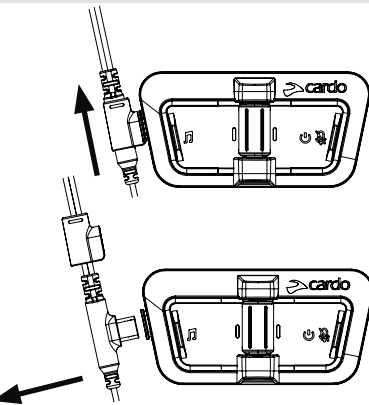

Press
Premi
Presionar
Appuyer
Drücken

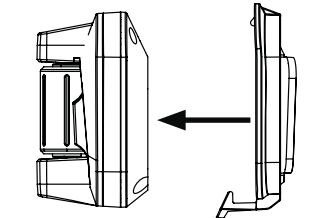

-14-

OPTIONAL: CONNECT YOUR OWN HEADPHONES

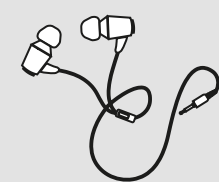

Not Included
Non incluso
No incluido
Non inclus
Nicht enthalten

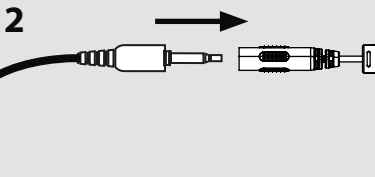
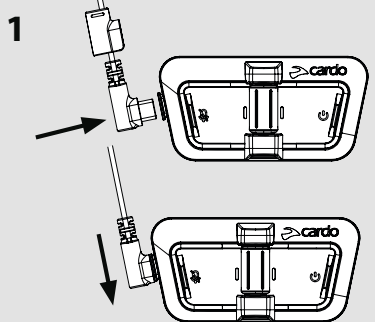
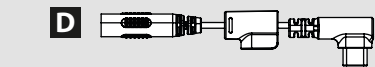

-15-

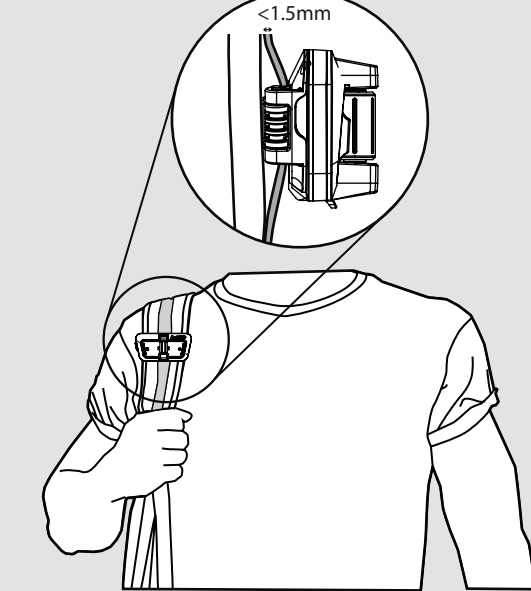
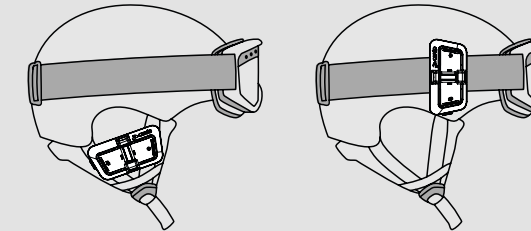

-16-

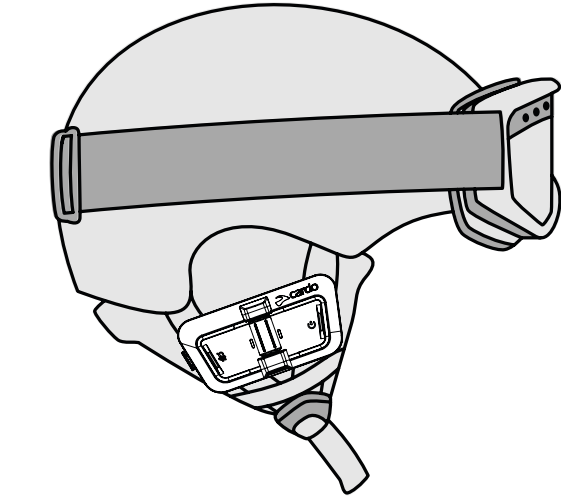

PACKTALK OUTDOOR

INSTALLATION GUIDE

EN/IT/SP/FR/DE

INSTRUCTOR CONTENTS

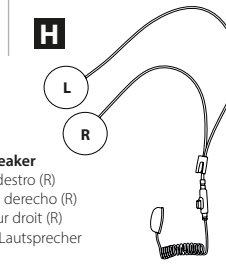
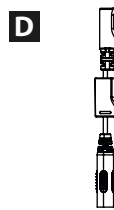
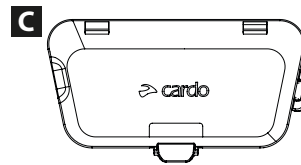
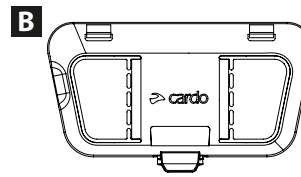
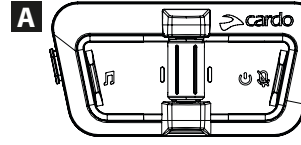

Short Cord on Right (R) Speaker
 Cavo corto sull'altoparlante destro (R)
 Cordón corto en el altavoces derecho (R)
 Cordon court sur haut-parleur droit (R)
 Kurzes Kabel am rechten (R) Lautsprecher

Installation Video
 Video d'installazione
 Video de instalación
 Vidéo d'installation
 Installationsvideo

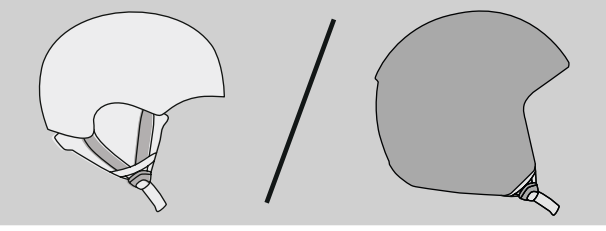

1 INSTALL THE SPEAKERS

Option 1: In Ear Pockets

Place speakers into ear pockets
 Posiziona gli altoparlanti nelle tasche per le orecchie
 Colocar los altavoces en los bolsillos
 Placer les écouteurs dans les étuis auriculaires
 Lautsprecher in die Polsterung einsetzen

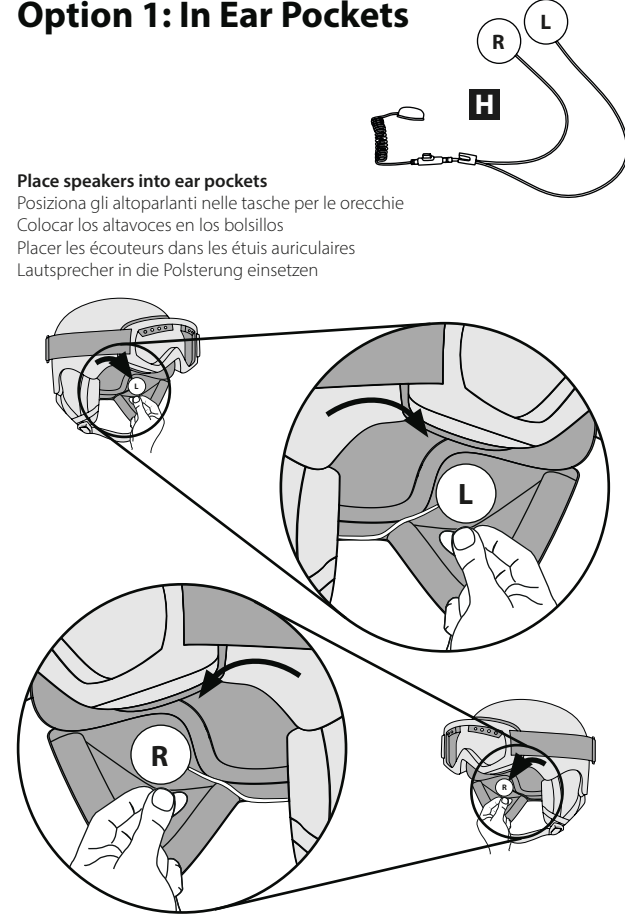

Option 2: Velcro on Inner Padding

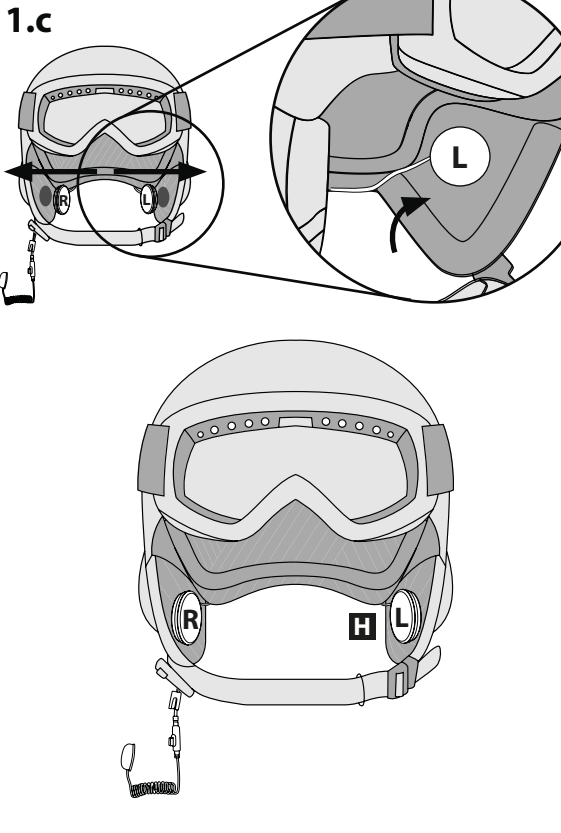
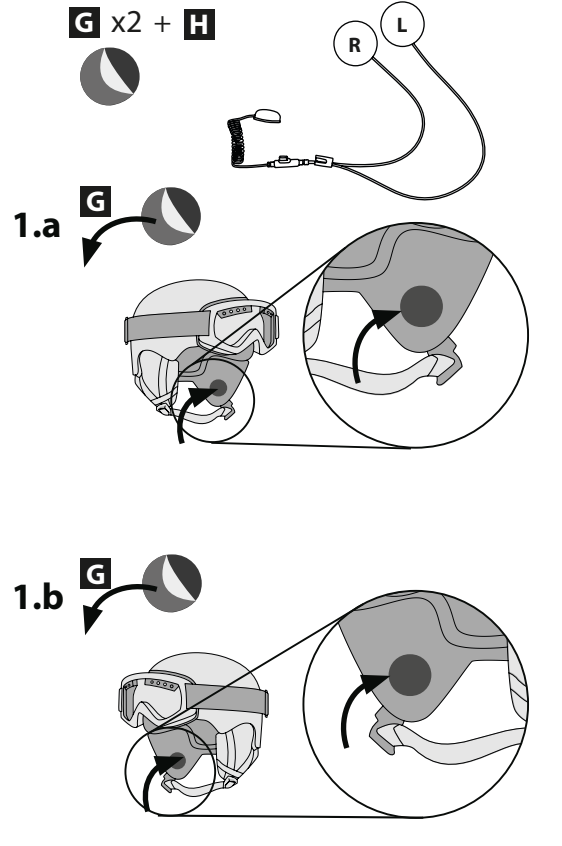

2 SET WIRE ON HELMET

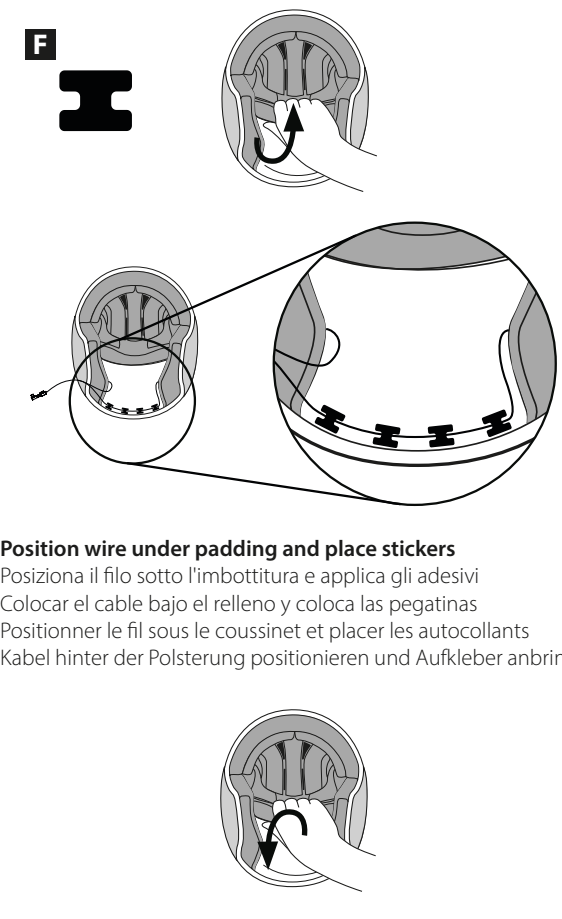

Position wire under padding and place stickers
 Posiziona il filo sotto l'imbottitura e applica gli adesivi
 Colocar el cable bajo el relleno y coloca las pegatinas
 Positionner le fil sous le coussinet et placer les autocollants
 Kabel hinter der Polsterung positionieren und Aufkleber anbringen

3 ATTACH THE MICROPHONE

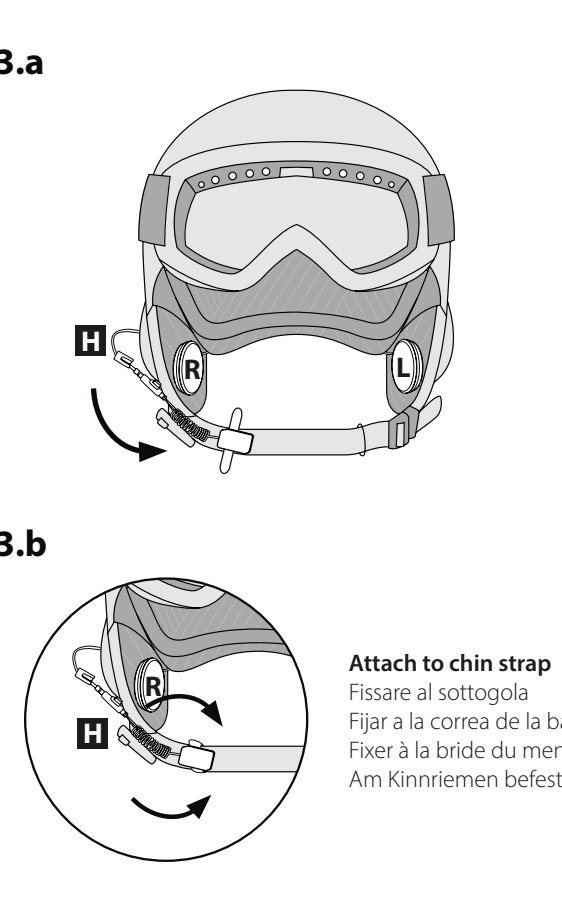

Attach to chin strap
 Fissare al sottogola
 Fijar a la correa de la barbilla
 Fixer à la bride du menton
 Am Kinnriemen befestigen

4 MOUNT THE CRADLE

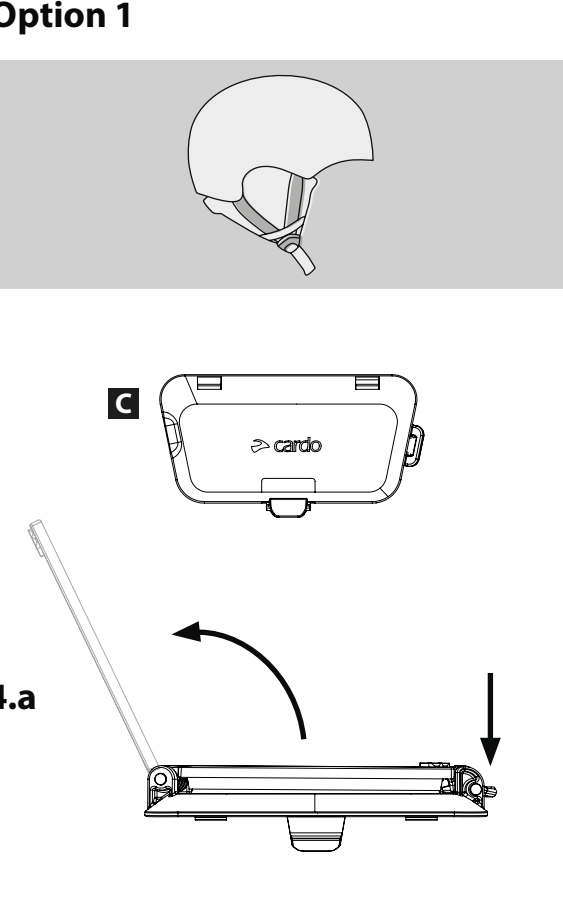

cardosystems.com/outdoor

cardosystems.com/support

YouTube
 Follow Cardo Outdoor

Download:
 Cardo Connect App
 Download on the App Store
 GET IT ON Google Play

MAN00632MANOUTDOORCONSUMERINSTALLATIONGUIDE_A05

Measurements

front
90 mm

145 mm

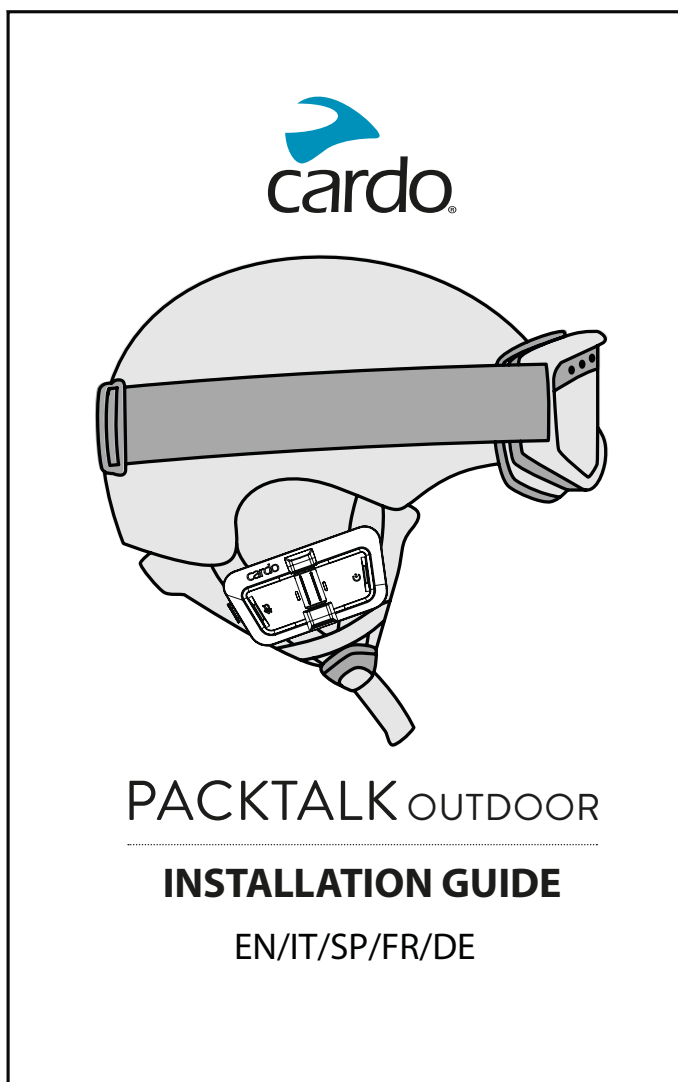

back
90 mm

145 mm

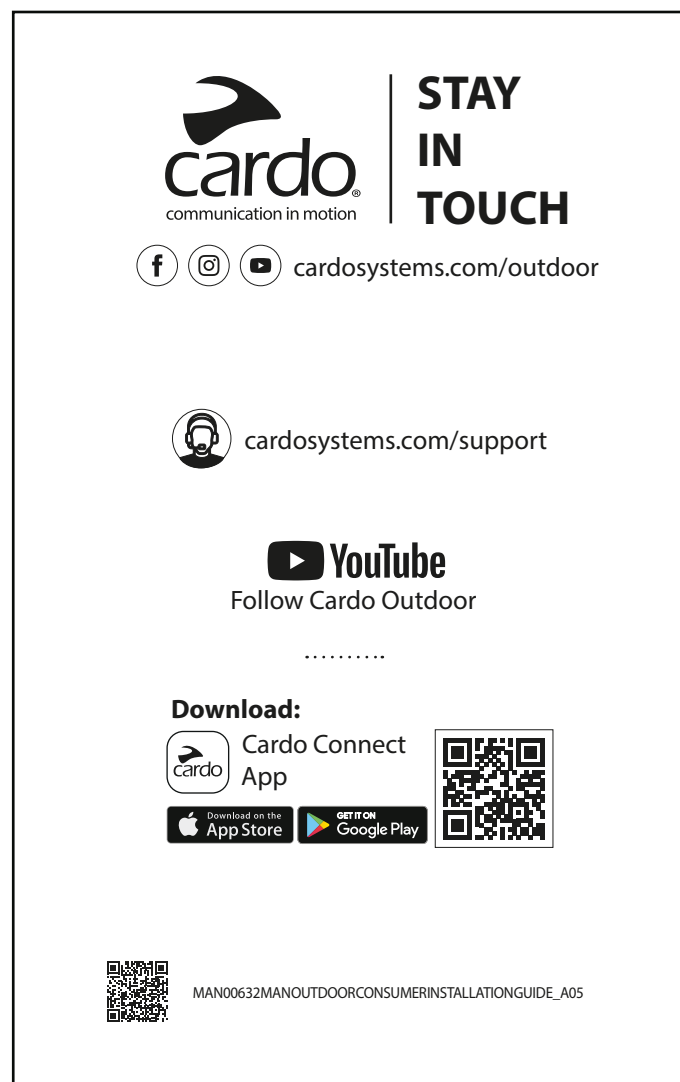

TYPE APPROVAL

P/N	MAN00632		
DESCRIPTION	INSTALLATION GUIDE		
FILE NAME	MAN00632 MAN OUTDOOR CONSUMER INSTALLATION GUIDE_A05		
LANGUAGE	EN/DE/FR/IT/ES		
PRODUCT TYPE	MANUAL		
MATERIAL	P2 C4+4 80 gr offset folded		
PRINTING PROCESS	COLOR: CMYK		
SECONDARY PROCESS			
ATTACHED FILES	1. GRAPHIC FILE - PDF		
MEASUREMENT	SPREAD: 145MM-810MM , FOLDED: 145MM-90MM		
CLIENTS/ DISTRIBUTOR	 		
SPECIAL REQUIREMENT	 		
REVISION	DESCRIPTION	DATE	NAME
A01	First Version	11.1.2022	DANNA
A02	Many Graphics and Text Changes	27.4.22	Richard
A03	DVT- FIXED QR CODE AND FILE NAME DESCRIPTION-CUSTOMER TO CONSUMER	16.2.2022	Kerry
A04	Many Graphics and Text Changes	29.5.22	Richard
A05	Removed arrows and fixed unit drawings	13.7.22	Richard