

FCC Test Report

Product Name : OUTDOOR CONSUMER, OUTDOOR INSTRUCTOR,
OUTDOOR STUDENT

Brand Name : Cardo Systems, LTD

Model No. : OUTDOOR CONSUMER, OUTDOOR INSTRUCTOR,
OUTDOOR STUDENT

FCC ID : Q95ER29

Applicant : Cardo Systems, LTD

Address : 101 E. Park Blvd, Suite 600, Plano TX, 75074 USA

Date of Receipt : Jul. 06, 2022

Issued Date : Sep. 26, 2022

Report No. : 2270132R-RFUSOTHV05-A

Report Version : V1.0



The test results relate only to the samples tested.

The test results shown in the test report are traceable to the national/international standard through the calibration of the equipment and evaluated measurement uncertainty herein.

This report must not be used to claim product endorsement by TAF or any agency of the government.

Measurement uncertainties evaluated for each testing system and associated connections are given here to provide the system information for reference. Compliance determinations do not take into account measurement uncertainties for each testing system, but are based on the results of the compliance measurement.

The test report shall not be reproduced except in full without the written approval of DEKRA Testing and Certification Co., Ltd.



Product Name : OUTDOOR CONSUMER, OUTDOOR INSTRUCTOR,
OUTDOOR STUDENT

Applicant : Cardo Systems, LTD

Address : 101 E. Park Blvd, Suite 600, Plano TX, 75074 USA

Manufacturer : Cardo Systems Inc.

Address : 101 E. Park Blvd., Suite 600, Plano TX, 75074, USA

Brand Name : Cardo Systems, LTD

Model No. : OUTDOOR CONSUMER, OUTDOOR INSTRUCTOR,
OUTDOOR STUDENT

FCC ID : Q95ER29

EUT Voltage : DC 5V (host equipment)
DC 3.7 for battery

Applicable Standard : FCC CFR Title 47 Part 15 Subpart C Section 15.247
ANSI C63.10: 2013

Laboratory Name : DEKRA Testing and Certification Co., Ltd.
Hsin Chu Laboratory

Address : No.372-2, Sec. 4, Zhongxing Rd., Zhudong Township, Hsinchu
County 310, Taiwan, R.O.C.

Test Result : Complied

Documented By : Amelia Wu
(Amelia Wu / Project Specialist)

Approved By : Rueyyan Lin
(Rueyyan Lin / Supervisor)

The test results relate only to the samples tested.
The test report shall not be reproduced except in full without the written approval of DEKRA Testing and Certification Co., Ltd.

Revision History

Version	Description	Issued Date
V1.0	Initial issue of report	Sep. 26, 2022

TABLE OF CONTENTS

Description	Page
1. General Information	6
1.1 EUT Description	6
1.2 Test Mode	8
1.3 Comments and Remarks	8
1.4 Tested System Details	9
1.5 Configuration of tested System	9
1.6 EUT Operation of during Test	9
1.7 Test Facility	10
1.8 List of Test Equipment	11
1.9 Measurement Uncertainty	12
1.10 Duty Cycle	13
2. AC Power Line Conducted Emission	14
2.1 Test Setup	14
2.2 Test Limit	14
2.3 Test Procedure	14
2.4 Test Specification	14
2.5 Test Result of AC Power Line Conducted Emission	15
3. Maximum Conducted Output Power	17
3.1 Test Setup	17
3.2 Test Limit	17
3.3 Test procedures	17
3.4 Test Specification	17
3.5 Test Result of Maximum Conducted Output Power	18
4. Radiated Emission	19
4.1 Test Setup	19
4.2 Test Limit	20
4.3 Test Procedure	21
4.4 Test Specification	21
4.5 Test Result of Radiated Emissions (30 MHz ~ 1 GHz)	22
4.6 Test Result of Radiated Emissions (1 GHz ~ 10 th Harmonic)	23
5. Antenna Port Conducted Emission	25
5.1 Test Setup	25
5.2 Test Limit	25
5.3 Test Procedure	25
5.4 Test Specification	25
5.5 Test Result of Antenna Port Conducted Emission	26
6. Radiated Emission Band Edge	28
6.1 Test Setup	28
6.2 Test Limit	28
6.3 Test Procedure	29
6.4 Test Specification	29
6.5 Test Result of Radiated Emission Band Edge	30

7.	Occupied Bandwidth & DTS Bandwidth.....	32
7.1	Test Setup.....	32
7.2	Test Limit	32
7.3	Test Procedures.....	32
7.4	Test Specification.....	32
7.5	Test Result of Occupied Bandwidth.....	33
7.6	Test Result of DTS Bandwidth.....	34
8.	Maximum Power Spectral Density	35
8.1	Test Setup.....	35
8.2	Test Limit	35
8.3	Test Procedures.....	35
8.4	Test Specification.....	35
8.5	Test Result of Maximum Power Spectral Density	36
Appendix A	37
<input type="checkbox"/>	Test Setup Photograph	37

1. General Information

1.1 EUT Description

Product Name	OUTDOOR CONSUMER, OUTDOOR INSTRUCTOR, OUTDOOR STUDENT
Brand Name	Cardo Systems, LTD
Model No.	OUTDOOR CONSUMER, OUTDOOR INSTRUCTOR, OUTDOOR STUDENT
Frequency Range	2405 ~ 2475 MHz
Channel Number	8 Channels
Type of Modulation / Data Rate	O-QPSK / 1 Mbps

Accessories Information				
No.	Equipment Name	Brand Name	Model No.	Marketing for Product Name
1	Audio Kit 1	Transound	PT OUTDOOR INSTRUCTOR	OUTDOOR INSTRUCTOR
2	Audio Kit 2	Transound	PT OUTDOOR CONSUMER	OUTDOOR CONSUMER
3	Audio Kit 3	Cardo	PT OUTDOOR STUDENT	OUTDOOR STUDENT
No.	Equipment Name	Description		
4	USB Cable	Shielded, 0.6m		

The difference for each product name/model number is shown as below:

Product Name and Model No.	Audio Kit		
	Equipment Name	Brand Name	Model No.
OUTDOOR INSTRUCTOR	Audio Kit 1	Transound	PT OUTDOOR INSTRUCTOR
OUTDOOR CONSUMER	Audio Kit 2	Transound	PT OUTDOOR CONSUMER
OUTDOOR STUDENT	Audio Kit 3	Cardo	PT OUTDOOR STUDENT

The product ships with different audio kits.

Antenna Information				
Ant.	Brand Name	Model No.	Type	Gain (dBi)
0	N/A	N/A	PCB	0

EUT Operational Condition	
Testing Voltage	AC 120V/60Hz

Working Frequency of Each Channel							
Channel	Frequency	Channel	Frequency	Channel	Frequency	Channel	Frequency
00	2405 MHz	01	2415 MHz	02	2425 MHz	03	2435 MHz
04	2445 MHz	05	2455 MHz	06	2465 MHz	07	2475 MHz

Note:

1. Regards to the frequency band operation; the lowest , middle and highest frequency of channel were selected to perform the test, and then shown on this report.
2. The above EUT information is declared by the manufacturer.

1.2 Test Mode

DEKRA has verified the construction and function in typical operation. All the test modes were carried out with the EUT in transmitting operation, which was shown in this test report and defined as follows:

Test Mode	Mode 1: Transmit
-----------	------------------

Test Items	Test Mode	Modulation	Channel	Result
AC Power Line Conducted Emission	Mode 1	O-QPSK	07	Pass
Maximum Conducted Output Power	Mode 1	O-QPSK	00/04/07	Pass
Radiated Emission Below 1 GHz	Mode 1	O-QPSK	07	Pass
Radiated Emission Above 1 GHz	Mode 1	O-QPSK	00/04/07	Pass
Antenna Port Conducted Emission	Mode 1	O-QPSK	00/04/07	Pass
Radiated Emission Band Edge	Mode 1	O-QPSK	00/04/07	Pass
Occupied Bandwidth & DTS Bandwidth	Mode 1	O-QPSK	00/04/07	Pass
Maximum Power Spectral Density	Mode 1	O-QPSK	00/04/07	Pass

Note:

1. Determining compliance shall be based on the results of the compliance measurement, not taking into account measurement instrumentation uncertainty.
2. For radiated emission below 1 GHz and AC power line conducted emission have performed all modes of operation were investigated and the worst-case emissions are reported.
3. The EUT was performed at X axis, Y axis and Z axis position for radiated emission and band edge tests. The worst case was found at Z axis, so the measurement will follow this same test configuration.

1.3 Comments and Remarks

The product specification and testing instructions for the EUT declared in the report are provided by the manufacturer who will take all responsibilities for the accuracy.

1.4 Tested System Details

The types for all equipment, plus descriptions of all cables used in the tested system.

	Product	Manufacturer	Model No.	Serial No.
1	Notebook	HP	HSTNN-I33C-4	N/A

1.5 Configuration of tested System

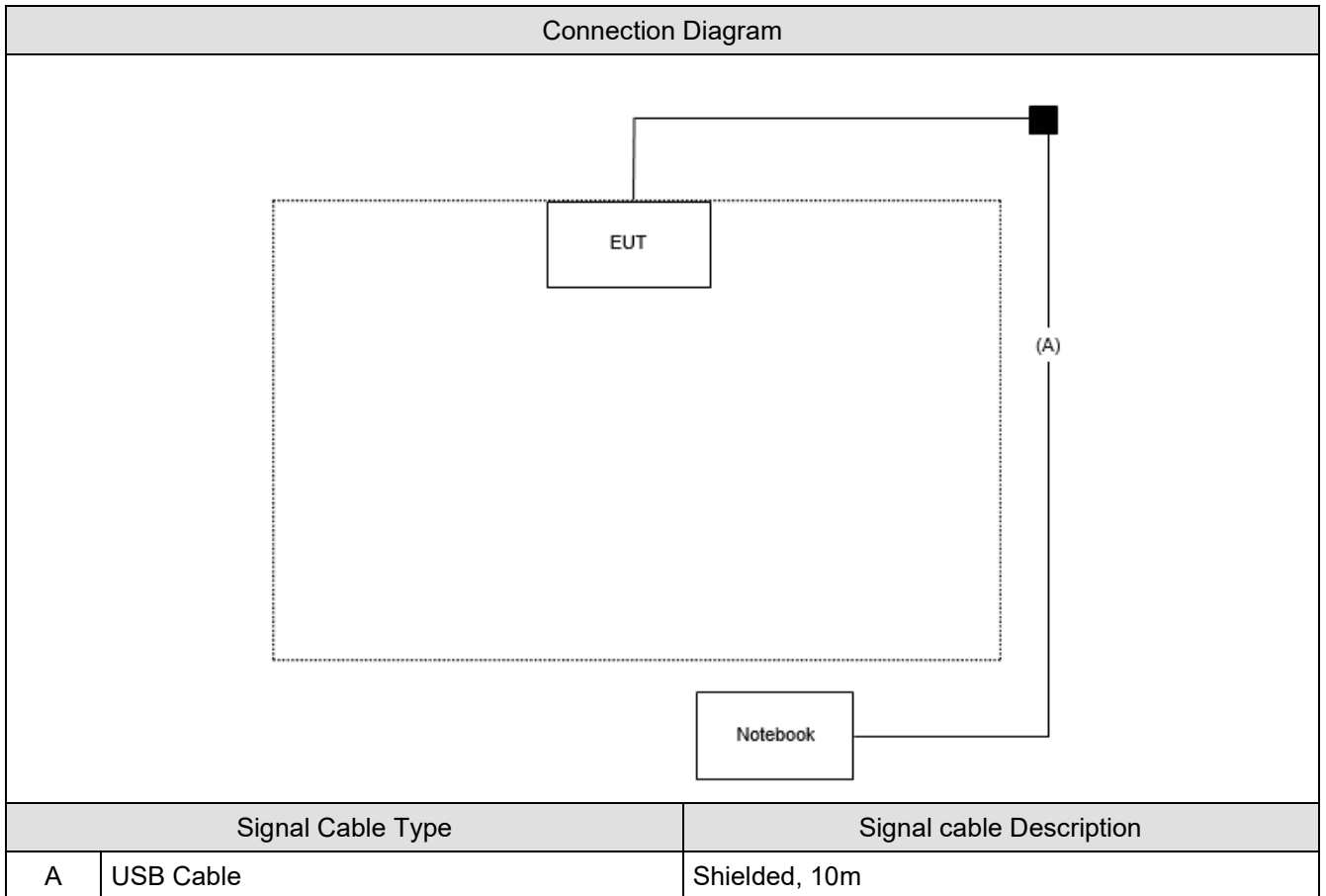

1.6 EUT Operation of during Test

1	Execute control command by software "CMD.exe".
2	Configure the test mode, the test channel, and the data rate.
3	Press "Start TX" to start the continuous transmitting.
4	Verify that the EUT works properly.

1.7 Test Facility

Ambient conditions in the laboratory:

Items	Test Item	Actually	Tested by	Test Date	Test Site
Temperature (°C)	AC power Line Conducted Emission	24.5	Getaz Yang	2022/08/17	HC-SR02
Humidity (%RH)		65			
Temperature (°C)	Maximum Peak Conducted Output Power	23.6	Scott Chang	2022/08/11	HC-SR12
Humidity (%RH)		53			
Temperature (°C)	Radiated Emission	24.2 ~ 25	Ling Chen	2022/08/08 ~	HC-CB02
Humidity (%RH)		53 ~ 56	Gary Liao	2022/08/15	
Temperature (°C)	Antenna Port Conducted Emission	22 ~ 23.6	Scott Chang	2022/08/10 ~	HC-SR12
Humidity (%RH)		53 ~ 65		2022/08/16	
Temperature (°C)	Radiated Emission Band Edge	25	Ling Chen	2022/08/15	HC-CB02
Humidity (%RH)		53	Gary Liao		
Temperature (°C)	Occupied Bandwidth & DTS Bandwidth	22 ~ 23	Scott Chang	2022/08/10 ~	HC-SR12
Humidity (%RH)		64 ~ 65		2022/08/16	
Temperature (°C)	Maximum Power Spectral Density	22 ~ 23.6	Scott Chang	2022/08/11 ~	HC-SR12
Humidity (%RH)		53 ~ 64		2022/08/16	

Note: Test site information refers to Laboratory Information.

Laboratory Information

USA : FCC Registration Number: TW3024
Canada : CAB identifier : TW3024

The address and introduction of DEKRA Testing and Certification Co., Ltd. laboratories can be founded in our Web site: <http://www.dekra.com.tw>

If you have any comments, please don't hesitate to contact us. Our test sites as below:

Test Laboratory	DEKRA Testing and Certification Co., Ltd.
Address	1. No.372-2, Sec. 4, Zhongxing Rd., Zhudong Township, Hsinchu County 31061, Taiwan, R.O.C. 2. No.372, Sec. 4, Zhongxing Rd., Zhudong Township, Hsinchu County 31061, Taiwan, R.O.C.
Phone number	1. +886-3-582-8001 2. +886-3-582-8001
Fax number	1. +886-3-582-8958 2. +886-3-582-8958
Email address	info.tw@dekra.com
Website	http://www.dekra.com.tw
Note: Test site number for address 1 includes HC-SR02. Test site number for address 2 includes HC-CB02, HC-CB03, HC-CB04, HC-SR10 and HC-SR12.	

1.8 List of Test Equipment

HC-SR02

Instrument	Manufacturer	Model No.	Serial No.	Cal. Date	Next Cal. Date
Artificial Mains Network	R&S	ENV4200	848411/010	2021/12/27	2022/12/26
EMI Test Receiver	R&S	ESR3	102608	2022/05/30	2023/05/29
LISN	R&S	ENV216	100092	2022/04/29	2023/04/28
Coaxial Cable(9 m)	Harbour	RG-400	HC-SR02	2022/08/15	2023/08/14
DEKRA Testing System	DEKRA	Version 2.0	HC-SR02	N/A	N/A

HC-SR12

Instrument	Manufacturer	Model No.	Serial No.	Cal. Date	Next Cal. Date
High Speed Peak Power Meter Dual Input	Anritsu	ML2496A	1602004	2021/11/12	2022/11/11
Pulse Power Sensor	Anritsu	MA2411B	1531043	2021/11/12	2022/11/11
EXA Signal Analyzer	Keysight	N9010A	MY51440132	2022/01/07	2023/01/06
Pulse Power Sensor	Anritsu	MA2411B	1531044	2021/11/12	2022/11/11
Power Meter	Keysight	8990B	MY51000248	2022/05/06	2023/05/05
Power Sensor	Keysight	N1923A	MY57240005	2022/05/06	2023/05/05
Signal and Spectrum Analyzer	R&S	FSVA40	101435	2022/05/30	2023/05/29

HC-CB02

Instrument	Manufacturer	Model No.	Serial No.	Cal. Date	Next Cal. Date
Signal Analyzer	R&S	FSVA40	101455	2021/10/22	2022/10/21
EXA Signal Analyzer	Keysight	N9010A	MY51440132	2022/01/07	2023/01/06
Trilog Broadband Antenna	Schwarzbeck	VULB 9168	1272	2022/05/19	2023/05/18
Horn Antenna	Schwarzbeck	BBHA 9120D	639	2022/05/06	2023/05/05
Horn Antenna	Schwarzbeck	BBHA 9170	203	2022/02/23	2023/02/22
Pre-Amplifier	EMCI	EMC01820I	980365	2022/04/15	2023/04/14
Pre-Amplifier	EMEC	EM01G18GA	060741	2022/05/06	2023/05/05
Pre-Amplifier	DEKRA	AP-400C	201801231	2021/12/24	2022/12/23
Coaxial Cable(13m)	Suhner	SF104	HC-CB02	2021/08/17	2022/08/16
Coaxial Cable(13m)	Suhner	SF104	HC-CB02	2022/08/15	2023/08/14
Coaxial Cable(3m)	Suhner,Rosnol	SF102_UP0264	HC-CB02_1	2021/08/17	2022/08/16
Coaxial Cable(3m)	Suhner,Rosnol	SF102_UP0264	HC-CB02_1	2022/08/14	2023/08/13
EMI Test Receiver	R&S	ESR7	102260	2021/12/22	2022/12/21
Magnetic Loop Antenna	Teseq	HLA 6121	44287	2021/09/06	2022/09/05
Radiated Software	AUDIX	e3 V9	HC-CB02_1	N/A	N/A

Note: All equipment upon which need to calibrated are with calibration period of 1 year.

1.9 Measurement Uncertainty

Uncertainties have been calculated according to the DEKRA internal document with the emissions test results be included in the report. The measurement uncertainties given below are based on a 95% confidence level (based on a coverage factor ($k=2$)).

Test item	Uncertainty
AC Power Line Conducted Emission	± 2.10 dB
Maximum Conducted Output Power	± 1.16 dB
Radiated Emission	± 3.25 dB below 1 GHz ± 3.32 dB above 1 GHz
Antenna Port Conducted Emission	± 1.60 dB
Radiated Emission Band Edge	± 3.32 dB
Occupied Bandwidth & DTS Bandwidth	± 282.55 Hz
Maximum Power Spectral Density	± 1.60 dB

1.10 Duty Cycle

Modulation	On Times (ms)	On+Off Times (ms)	Duty Cycle (%)	Duty Cycle Correction Factor (dB)
O-QPSK	4.440	100	4.44	-27.05

Note: If the duty cycle correction factor lower than -20dB, the Max. duty cycle correction factor is -20dB.

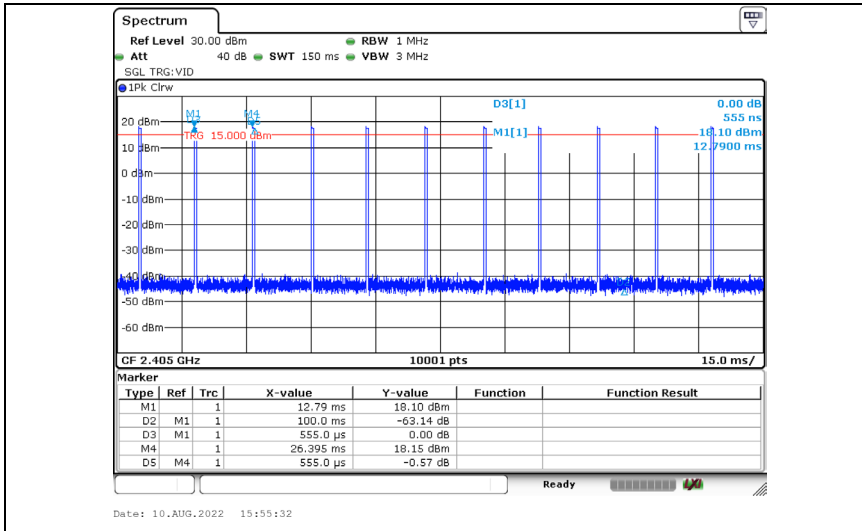

2. AC Power Line Conducted Emission

2.1 Test Setup

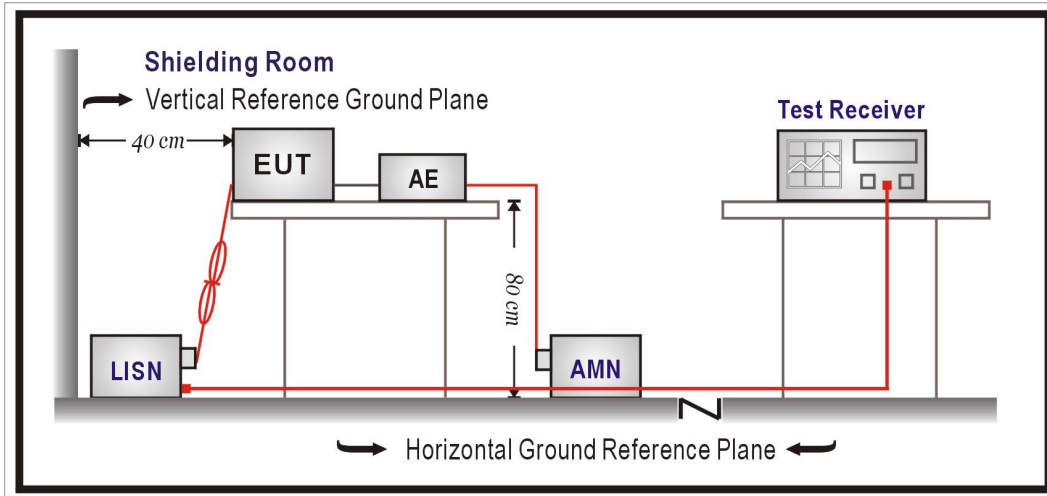

2.2 Test Limit

Frequency (MHz)	QP (dBuV)	AV (dBuV)
0.15 - 0.50	66 - 56	56 - 46
0.50 - 5.0	56	46
5.0 - 30	60	50

Remarks: In the above table, the tighter limit applies at the band edges.

2.3 Test Procedure

The EUT and simulators are connected to the main power through a line impedance stabilization network (L.I.S.N.). This provides a 50 ohm /50 uH coupling impedance for the measuring equipment. The peripheral devices are also connected to the main power through a LISN that provides a 50 ohm/50 uH coupling impedance with 50 ohm termination. (Please refer to the block diagram of the test setup and photographs.)

Both sides of A.C. line are checked for maximum conducted interference. In order to find the maximum emission, the relative positions of equipment and all of the interface cables must be changed according to ANSI C63.10: 2013 on conducted measurement.

AC Power Line Conducted Emissions were investigated over the frequency range from 0.15 MHz to 30 MHz using a receiver bandwidth of 9 kHz.

2.4 Test Specification

According to FCC Part 15 Subpart C Paragraph 15.207.

2.5 Test Result of AC Power Line Conducted Emission

Test Mode	Mode 1: Transmit	Phase	Line
Test Condition	O-QPSK / 2475 MHz		

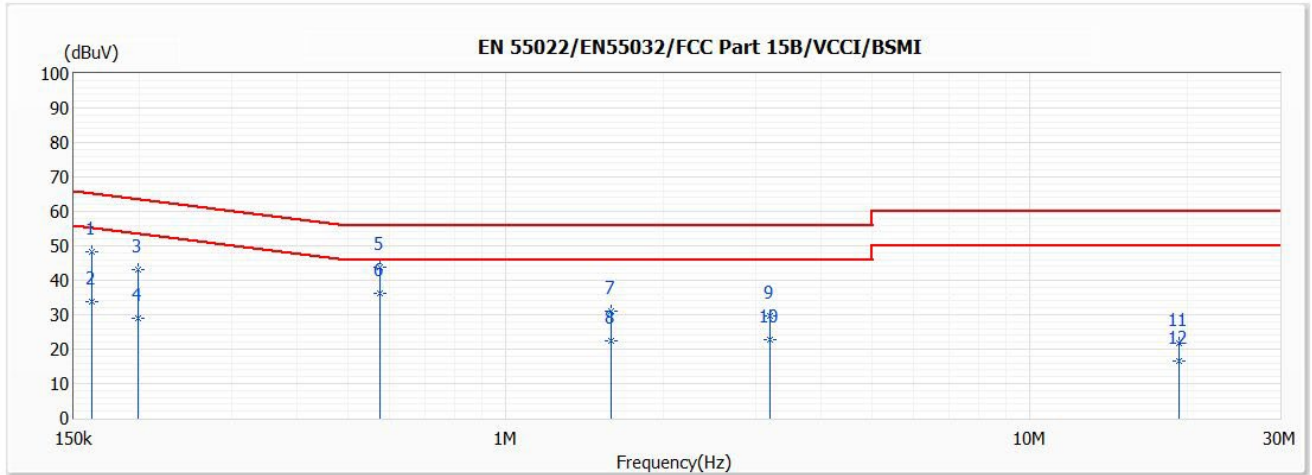

No	Frequency (MHz)	Emission Level (dBuV)	Limit (dBuV)	Margin (dB)	Reading Level (dBuV)	Correct Factor (dB)	Detector Type
1	0.162	48.43	65.34	-16.91	38.81	9.62	QP
2	0.162	33.69	55.34	-21.65	24.07	9.62	AV
3	0.199	43.22	63.67	-20.45	33.61	9.61	QP
4	0.199	28.81	53.67	-24.86	19.20	9.61	AV
5	0.576	43.84	56.00	-12.16	34.18	9.66	QP
*6	0.576	36.11	46.00	-9.89	26.45	9.66	AV
7	1.589	31.16	56.00	-24.84	21.43	9.73	QP
8	1.589	22.26	46.00	-23.74	12.53	9.73	AV
9	3.187	29.67	56.00	-26.33	19.87	9.80	QP
10	3.187	22.65	46.00	-23.35	12.85	9.80	AV
11	19.276	21.89	60.00	-38.11	11.55	10.34	QP
12	19.276	16.39	50.00	-33.61	6.05	10.34	AV

Remark:

1. "*" means this data is the worst emission level.
2. Emission Level = Reading Level + Correct Factor (Correct Factor = LISN Insertion Loss + Cable Loss).
3. Margin = Emission Level - Limit.

Test Mode	Mode 1: Transmit	Phase	Neutral
Test Condition	O-QPSK / 2475 MHz		

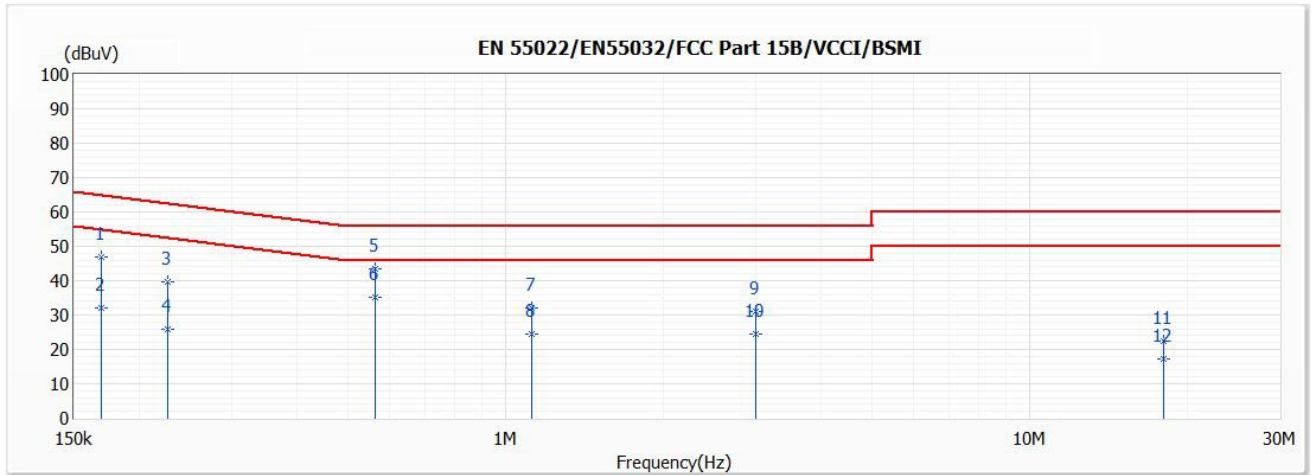

No	Frequency (MHz)	Emission Level (dBuV)	Limit (dBuV)	Margin (dB)	Reading Level (dBuV)	Correct Factor (dB)	Detector Type
1	0.169	46.87	65.01	-18.14	37.25	9.62	QP
2	0.169	31.94	55.01	-23.07	22.32	9.62	AV
3	0.227	39.81	62.57	-22.76	30.19	9.62	QP
4	0.227	25.99	52.57	-26.58	16.37	9.62	AV
5	0.565	43.46	56.00	-12.54	33.80	9.66	QP
*6	0.565	35.25	46.00	-10.75	25.59	9.66	AV
7	1.121	32.07	56.00	-23.93	22.36	9.71	QP
8	1.121	24.63	46.00	-21.37	14.92	9.71	AV
9	3.000	31.00	56.00	-25.00	21.20	9.80	QP
10	3.000	24.35	46.00	-21.65	14.55	9.80	AV
11	18.049	22.42	60.00	-37.58	11.96	10.46	QP
12	18.049	17.08	50.00	-32.92	6.62	10.46	AV

Remark:

1. "*" means this data is the worst emission level.
2. Emission Level = Reading Level + Correct Factor (Correct Factor = LISN Insertion Loss + Cable Loss).
3. Margin = Emission Level - Limit.

3. Maximum Conducted Output Power

3.1 Test Setup

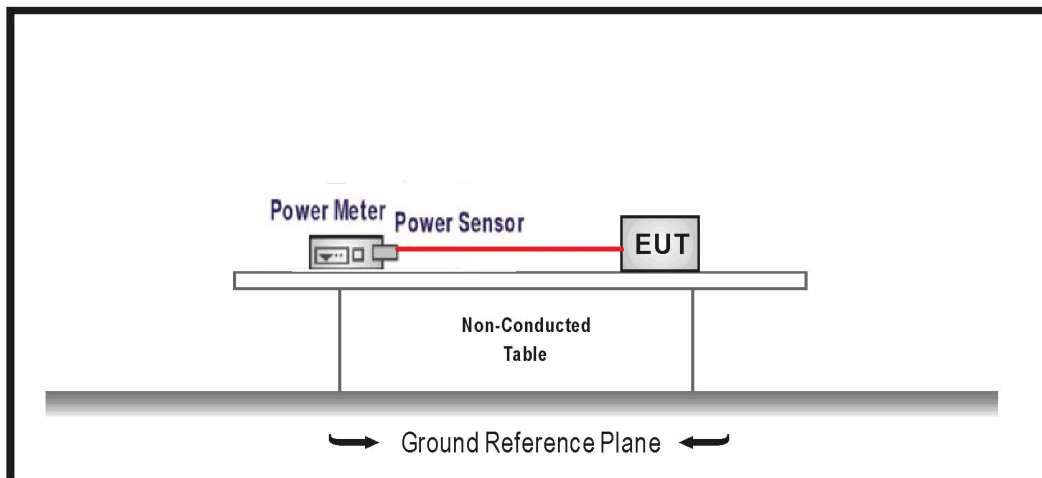

3.2 Test Limit

The Maximum Conducted Output Power shall be less 1 Watt.

3.3 Test procedures

The EUT was setup according to ANSI C63.10: 2013; tested according to DTS test procedure of KDB 558074 D01 v05r02 for compliance to FCC 47CFR 15.247 requirements.

3.4 Test Specification

According to FCC Part 15 Subpart C Paragraph 15.247.

3.5 Test Result of Maximum Conducted Output Power

Modulation	Channel	Frequency (MHz)	Measure Level (dBm)	Limit (dBm)	Result
O-QPSK	00	2405	20.170	≤ 30.00	Pass
	04	2445	20.560	≤ 30.00	Pass
	07	2475	20.510	≤ 30.00	Pass

4. Radiated Emission

4.1 Test Setup

9 kHz ~ 30 MHz

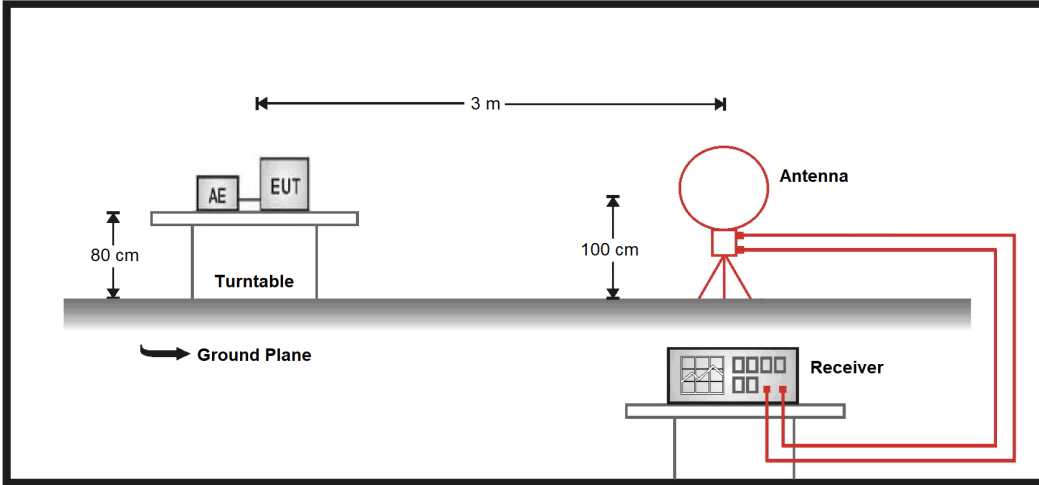

30 MHz ~ 1 GHz

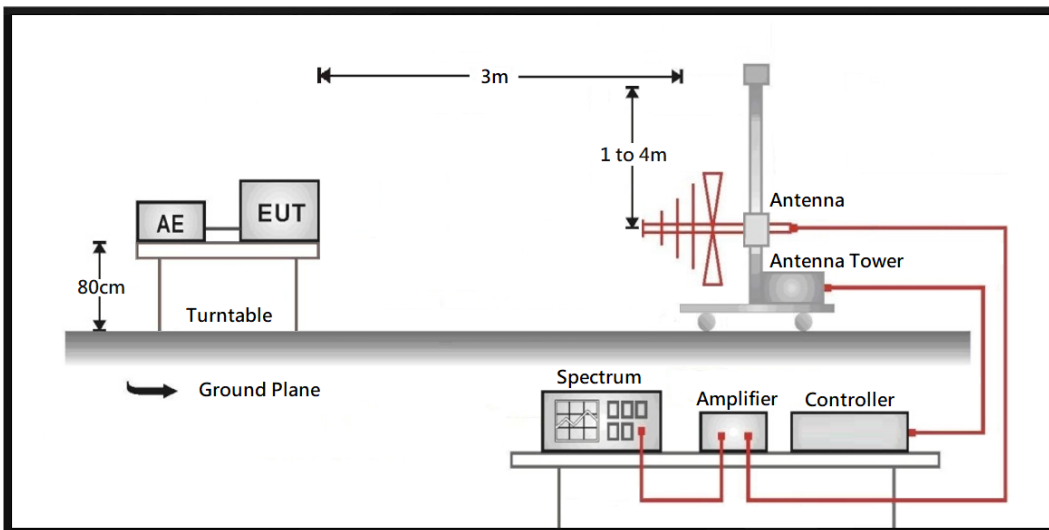

Above 1 GHz

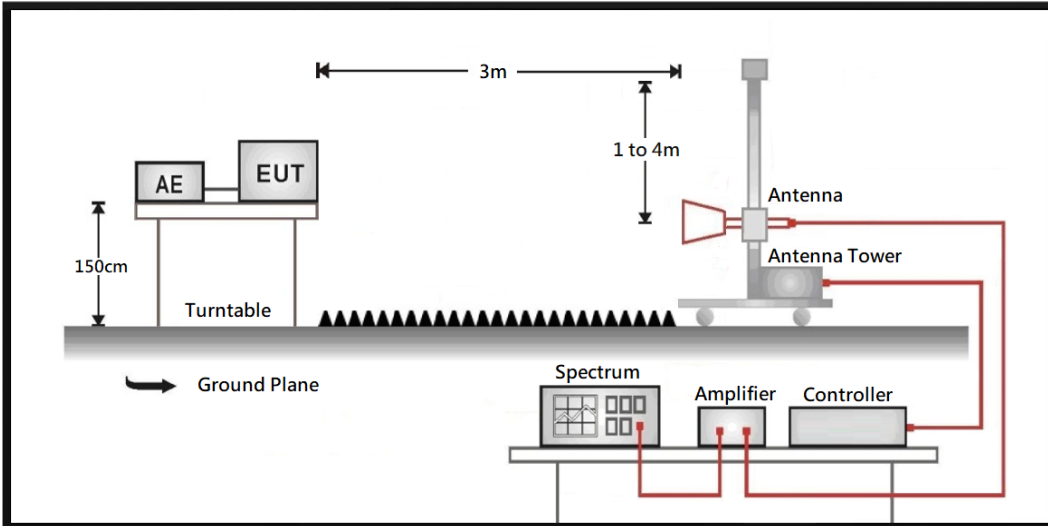

4.2 Test Limit

Emissions radiated outside of the specified frequency bands, except for harmonics, shall be attenuated by at least 20 dB below the level of the fundamental or to the general radiated emission limit in paragraph 15.209, whichever is the lesser attenuation.

Frequency (MHz)	Field strength (uV/m)	Field strength (dBuV/m)	Measurement distance (m)
0.009 – 0.490	2400/F(kHz)	20 log (2400/F(kHz))	300
0.490 – 1.705	24000/F(kHz)	20 log (24000/F(kHz))	30
1.705 - 30	30	29.5	30
30 - 88	100	40	3
88 - 216	150	43.5	3
216 - 960	200	46	3
Above 960	500	54	3

Remarks:

1. Field strength (dBuV/m) = 20 log Field strength (uV/m)
2. In the Above Table, the tighter limit applies at the band edges.
3. Distance refers to the distance in meters between the measuring instrument antenna and the closed point of any part of the device or system

4.3 Test Procedure

The EUT was setup according to ANSI C63.10: 2013 and tested according to DTS test procedure of KDB 558074 D01V05r02 for compliance to FCC 47CFR 15.247 requirements.

The EUT and its simulators are placed on a turn table which is 0.8 or 1.5 meter above ground. The turn table can rotate 360 degrees to determine the position of the maximum emission level.

The antenna can move up and down between 1 meter and 4 meters to find out the maximum emission level. Both horizontal and vertical polarization of the antenna are set on measurement. In order to find the maximum emission, all of the interface cables must be manipulated according to ANSI C63.10: 2013 on radiated measurement.

On any frequency or frequencies from 9 kHz (include The the lowest oscillator frequency generated within the device up to the 10th harmonic) to 1000 MHz, the limit shown are based on measuring equipment employing a quasi-peak detector function and on any frequency or frequencies above 1000 MHz the radiated limit shown are based upon the use of measurement instrumentation employing an average detector function. When average radiated emission measurement are included emission measurement below 1000 MHz, there also is a limit on the radio frequency emissions, as measured using instrumentation with a peak detector function, corresponding to 20 dB above the maximum permitted average limit.

The bandwidth below 1 GHz setting on the field strength meter is 120 kHz and above 1 GHz is 1MHz.

4.4 Test Specification

According to FCC Part 15 Subpart C Paragraph 15.247.

4.5 Test Result of Radiated Emissions (30 MHz ~ 1 GHz)

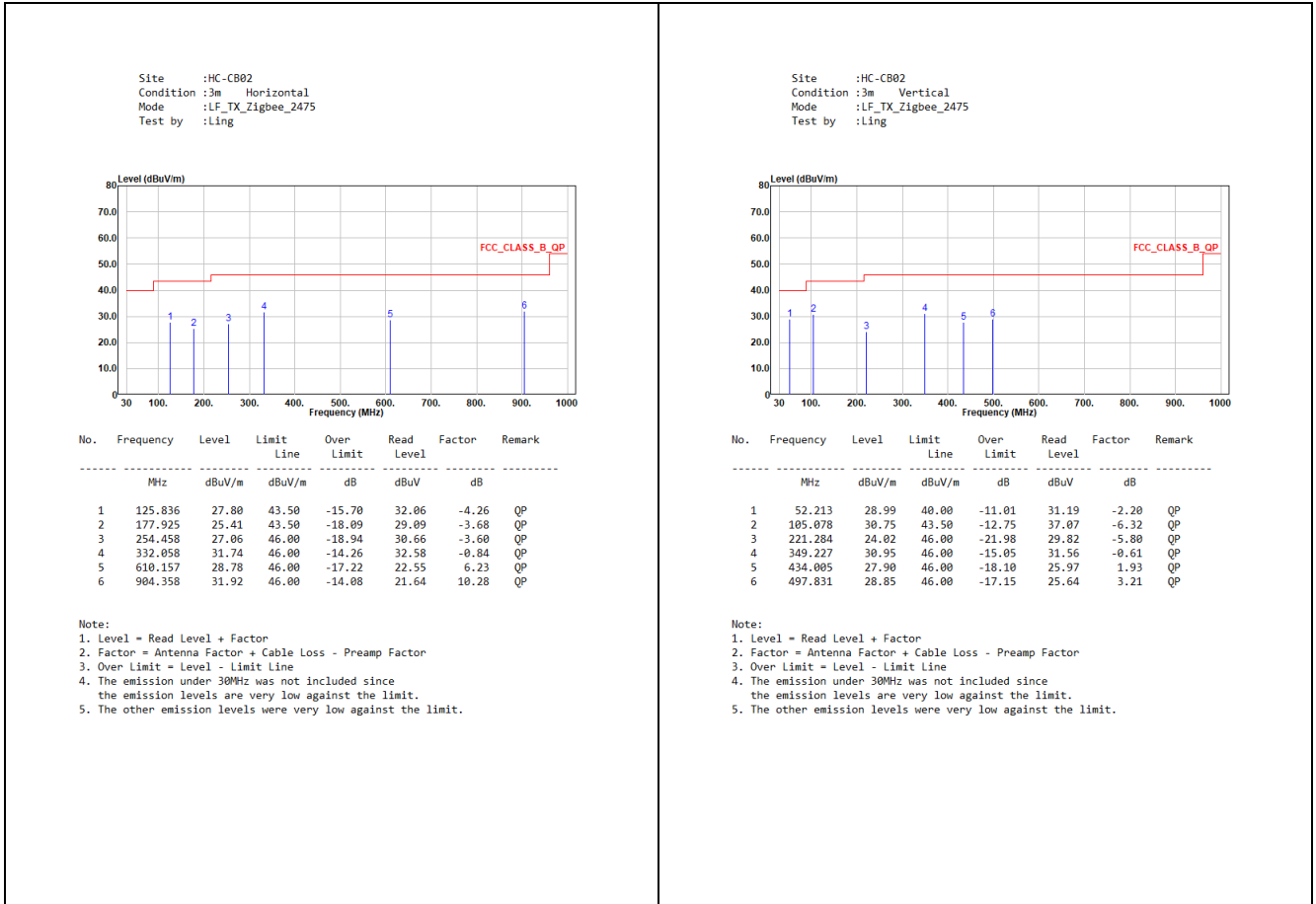

4.6 Test Result of Radiated Emissions (1 GHz ~ 10th Harmonic)

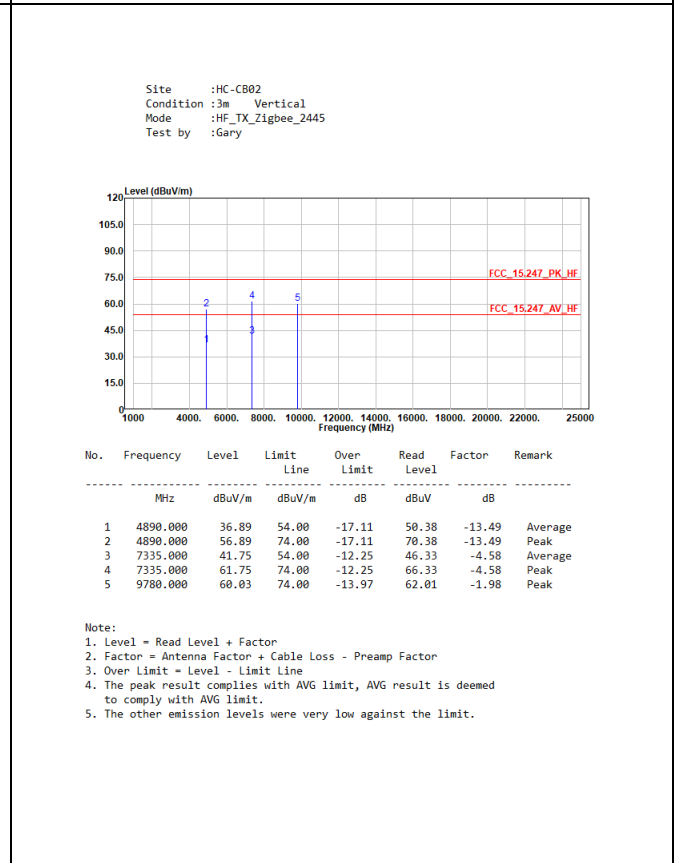
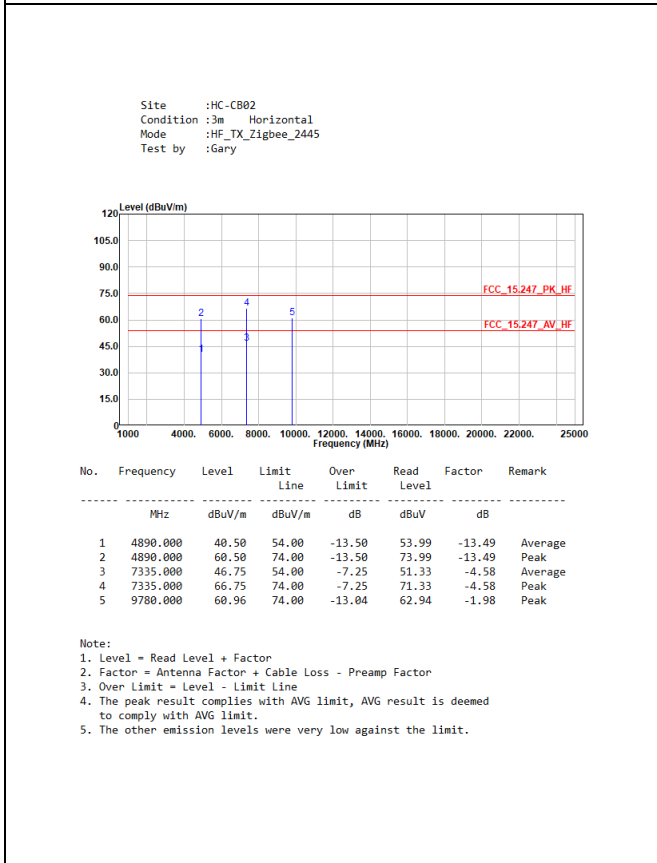
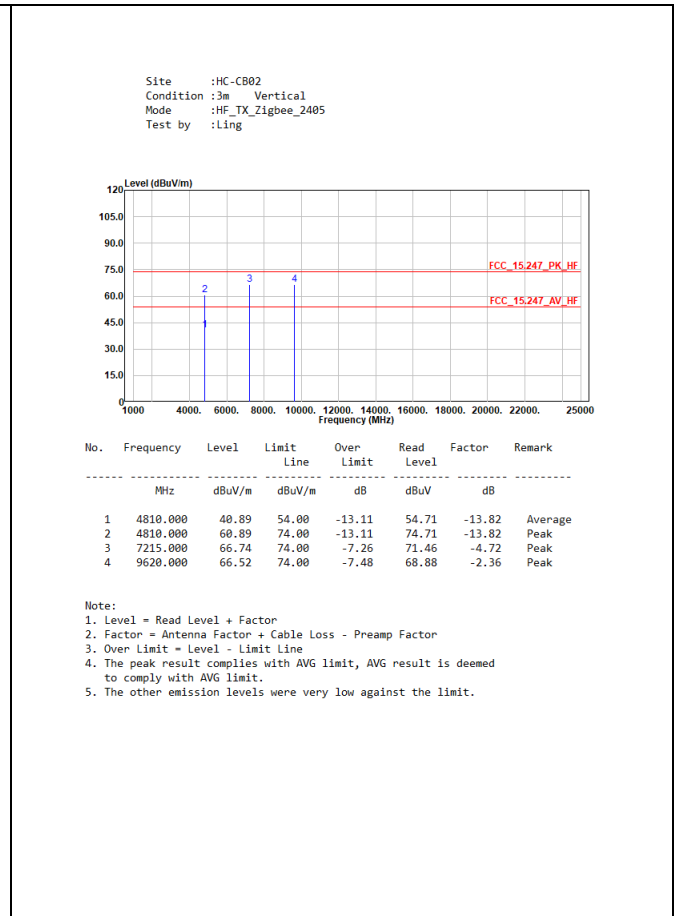
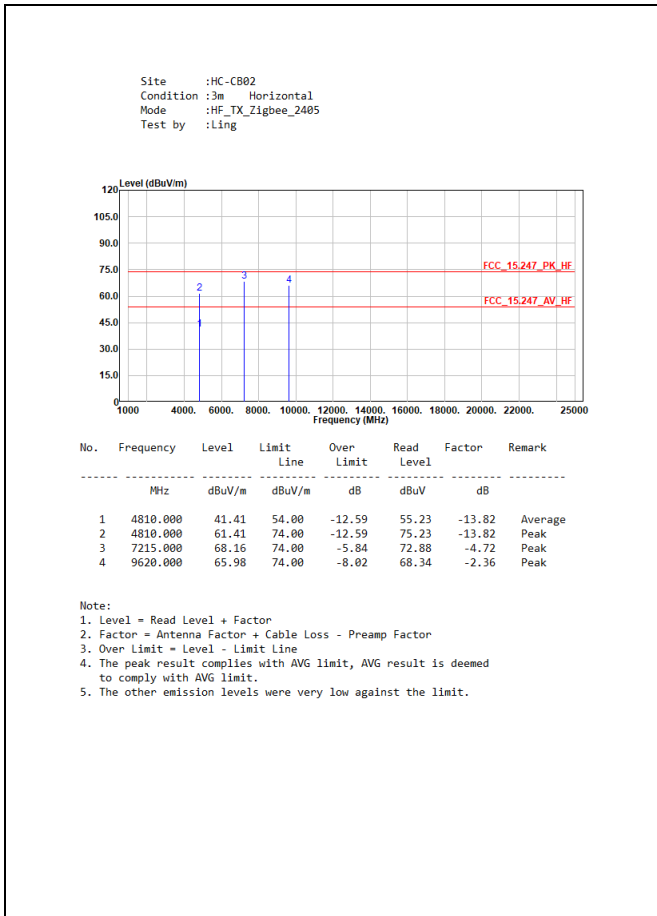

Site :HC-CB02
 Condition :3m Horizontal
 Mode :HF_TX_Zigbee_2475
 Test by :Gary

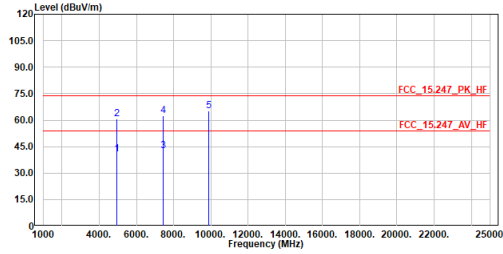

No.	Frequency MHz	Level dBuV/m	Limit dBuV/m	Over Limit dB	Read Level dBuV	Factor dB	Remark
1	4950.000	40.86	54.00	-13.14	54.11	-13.25	Average
2	4950.000	60.86	74.00	-13.14	74.11	-13.25	Peak
3	7425.000	42.71	54.00	-11.29	47.17	-4.46	Average
4	7425.000	62.71	74.00	-11.29	67.17	-4.46	Peak
5	9900.000	65.42	74.00	-8.58	67.11	-1.69	Peak

Note:
 1. Level = Read Level + Factor
 2. Factor = Antenna Factor + Cable Loss - Preamp Factor
 3. Over Limit = Level - Limit Line
 4. The peak result complies with AVG limit, AVG result is deemed to comply with AVG limit.
 5. The other emission levels were very low against the limit.

Site :HC-CB02
 Condition :3m Vertical
 Mode :HF_TX_Zigbee_2475
 Test by :Gary

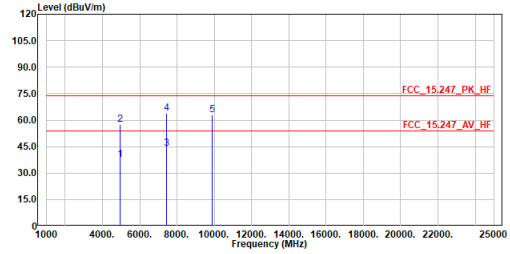

No.	Frequency MHz	Level dBuV/m	Limit dBuV/m	Over Limit dB	Read Level dBuV	Factor dB	Remark
1	4950.000	37.66	54.00	-16.34	50.91	-13.25	Average
2	4950.000	57.66	74.00	-16.34	70.91	-13.25	Peak
3	7425.000	43.72	54.00	-10.28	48.18	-4.46	Average
4	7425.000	63.72	74.00	-10.28	68.18	-4.46	Peak
5	9900.000	63.06	74.00	-10.94	64.75	-1.69	Peak

Note:
 1. Level = Read Level + Factor
 2. Factor = Antenna Factor + Cable Loss - Preamp Factor
 3. Over Limit = Level - Limit Line
 4. The peak result complies with AVG limit, AVG result is deemed to comply with AVG limit.
 5. The other emission levels were very low against the limit.

5. Antenna Port Conducted Emission

5.1 Test Setup

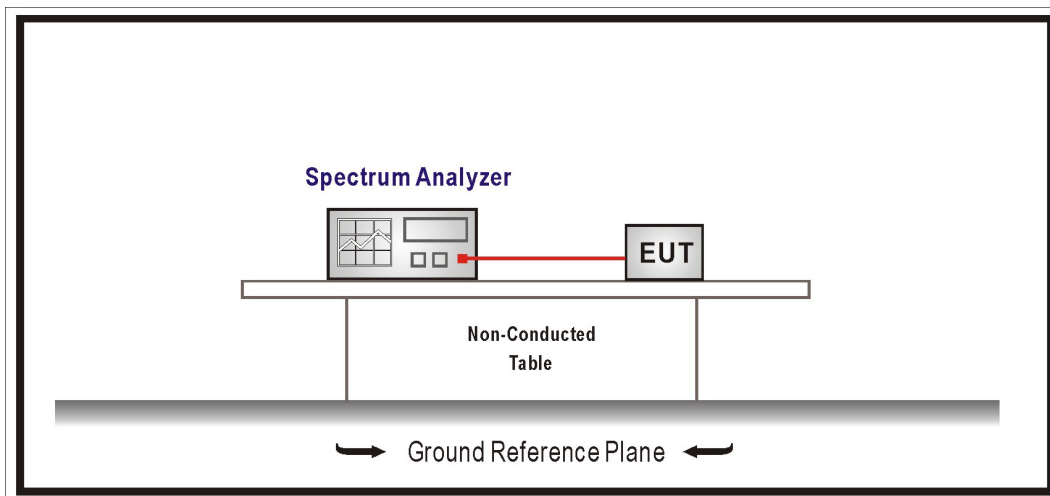

5.2 Test Limit

In any 100 kHz bandwidth outside the frequency band in which the spread spectrum or digitally modulated intentional radiator is operating, the radio frequency power that is produced by the intentional radiator shall be at least 20 dB below that in the 100 kHz bandwidth within the band that contains the highest level of the desired power, based on either an RF conducted or a radiated measurement, provided the transmitter demonstrates compliance with the peak conducted power limit. If the transmitter complies with the conducted power limit based on the use of RMS averaging over a time interval, the attenuation required under this paragraph shall be 30 dB instead of 20 dB. Attenuation below the general limit specified in §15.209(a) is not required. In addition, radiated emissions which fall in the restricted bands, as defined in §15.205(a), must also comply with the radiated emission limit specified in §15.209(a) (see §15.205(c)).

5.3 Test Procedure

The EUT was setup according to ANSI C63.10: 2013 and tested according to DTS test procedure of KDB 558074 D01 V05r02 for compliance to FCC 47CFR 15.247 requirements.

Set RBW = 100 kHz, Set VBW > RBW, scan up through 10th harmonic.

5.4 Test Specification

According to FCC Part 15 Subpart C Paragraph 15.247.

5.5 Test Result of Antenna Port Conducted Emission

O-QPSK / 2405 MHz

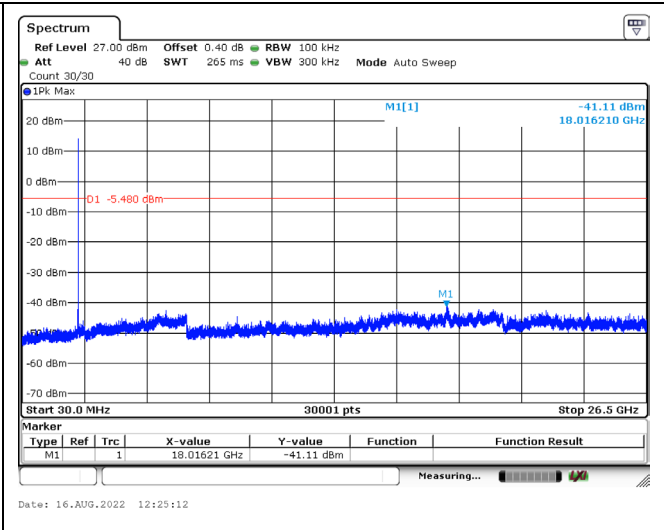
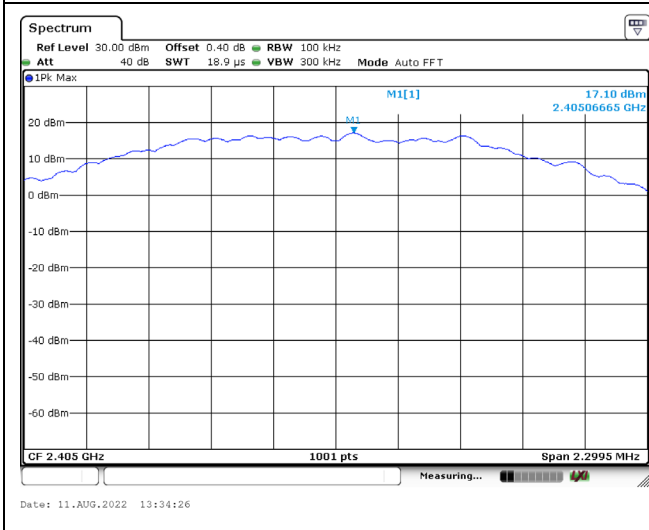

O-QPSK / 2445 MHz

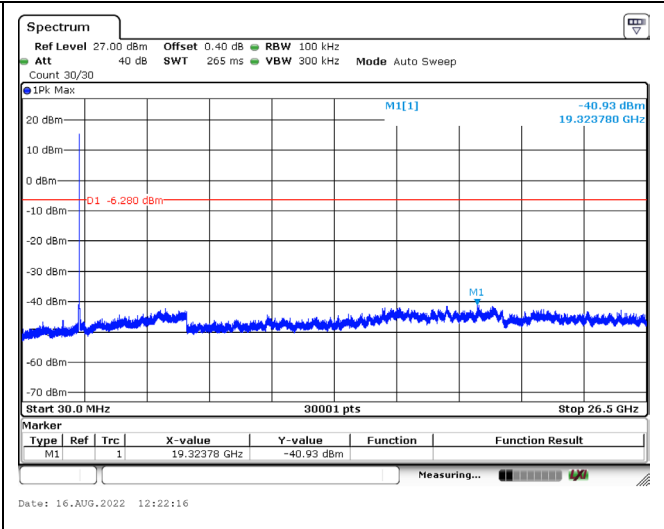
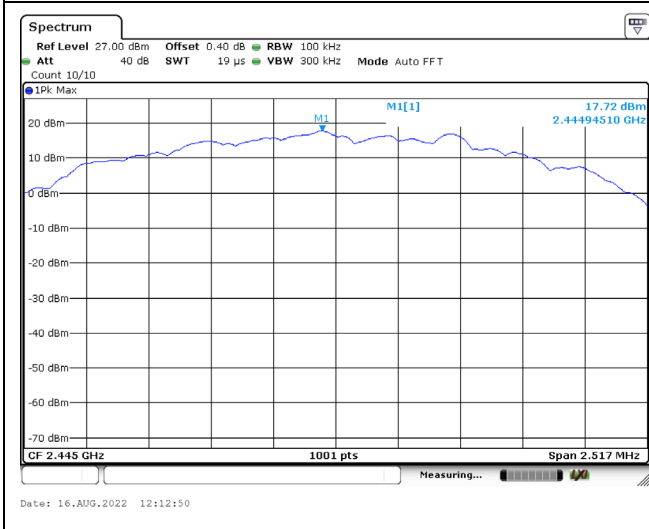

O-QPSK / 2475 MHz

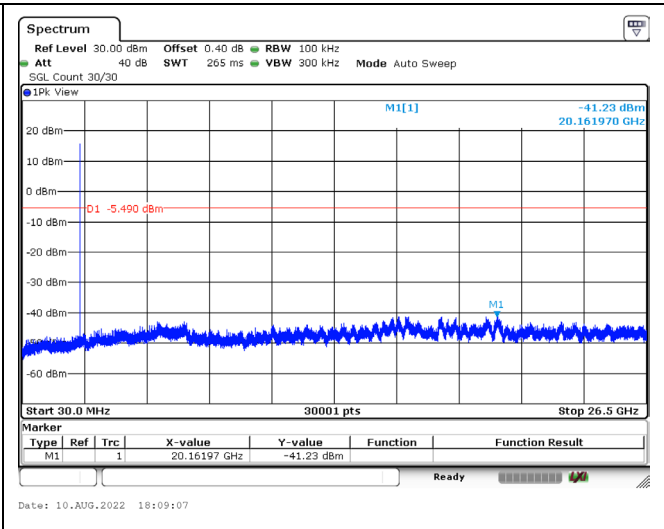
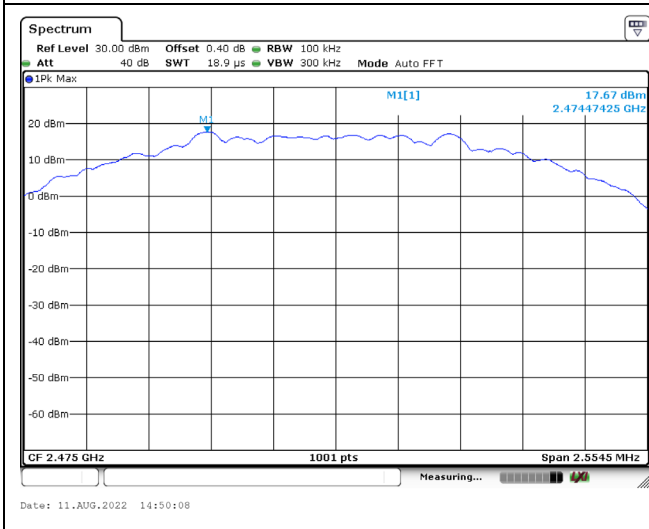

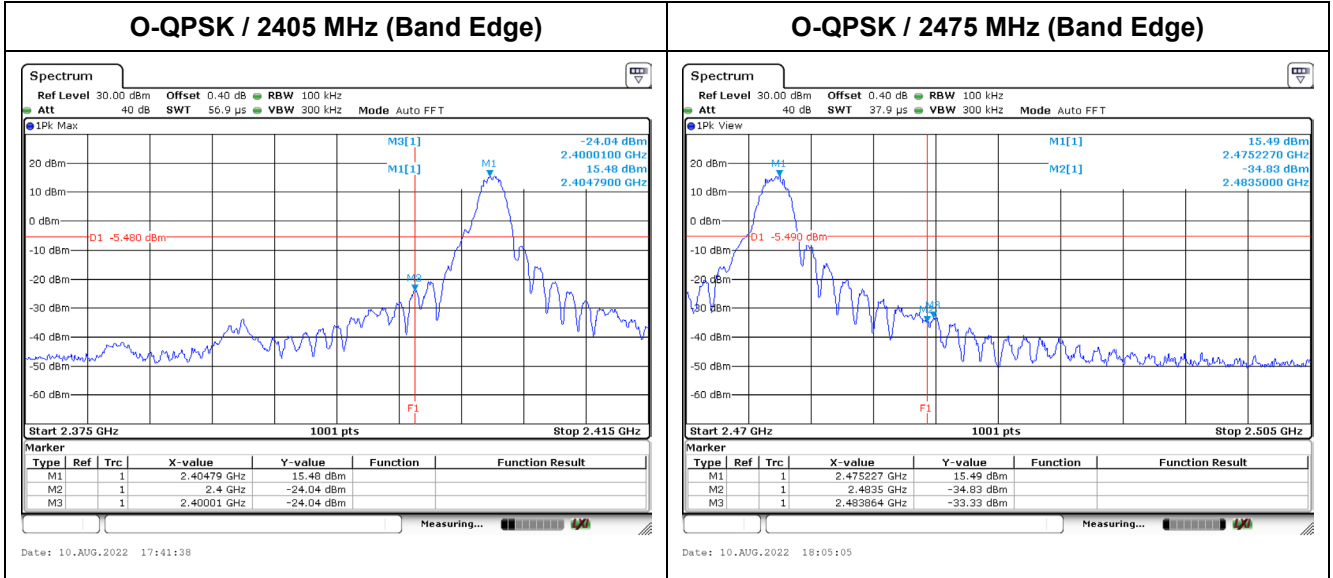

6. Radiated Emission Band Edge

6.1 Test Setup

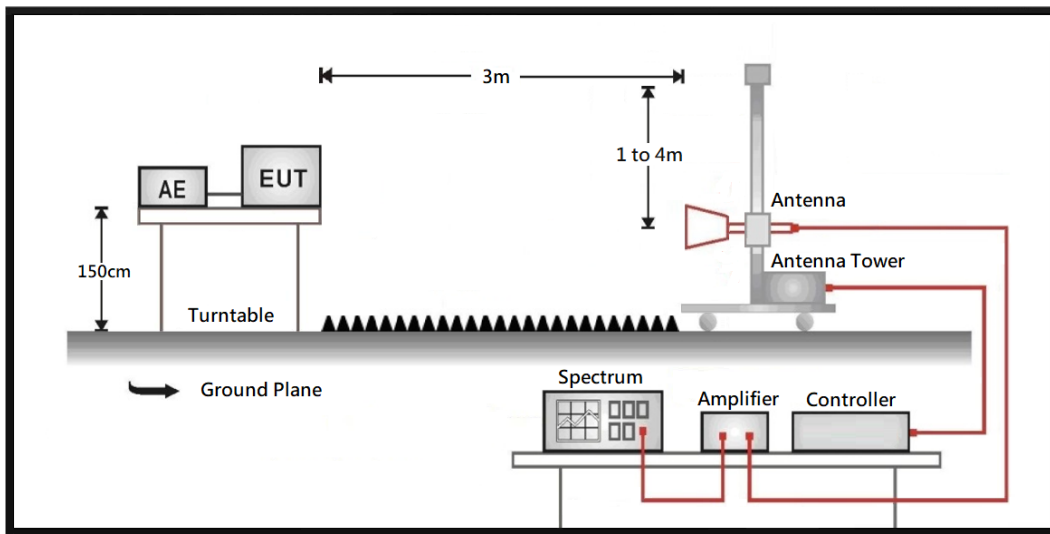

6.2 Test Limit

Emissions radiated outside of the specified frequency bands, except for harmonics, shall be attenuated by at least 20 dB below the level of the fundamental or to the general radiated emission limit in paragraph 15.209, whichever is the lesser attenuation.

Frequency (MHz)	Field strength (uV/m)	Field strength (dBuV/m)	Measurement distance (m)
30 - 88	100	40	3
88 - 216	150	43.5	3
216 - 960	200	46	3
Above 960	500	54	3

Remarks:

1. Field strength (dBuV/m) = 20 log Field strength (uV/m)
2. In the Above Table, the tighter limit applies at the band edges.
3. Distance refers to the distance in meters between the measuring instrument antenna and the closed point of any part of the device or system

6.3 Test Procedure

The EUT was setup according to ANSI C63.10: 2013 and tested according to the FCC KDB 558074 D01 v05r02 for compliance to FCC 47CFR 15.247 requirements.

The EUT and its simulators are placed on a turn table which is 1.5 meter above ground. The turn table can rotate 360 degrees to determine the position of the maximum emission level. The antenna can move up and down between 1 meter and 4 meters to find out the maximum emission level.

Both horizontal and vertical polarization of the antenna are set on measurement. In order to find the maximum emission, all of the interface cables must be manipulated according to ANSI C63.10: 2013 on radiated measurement.

6.4 Test Specification

According to FCC Part 15 Subpart C Paragraph 15.247.

6.5 Test Result of Radiated Emission Band Edge

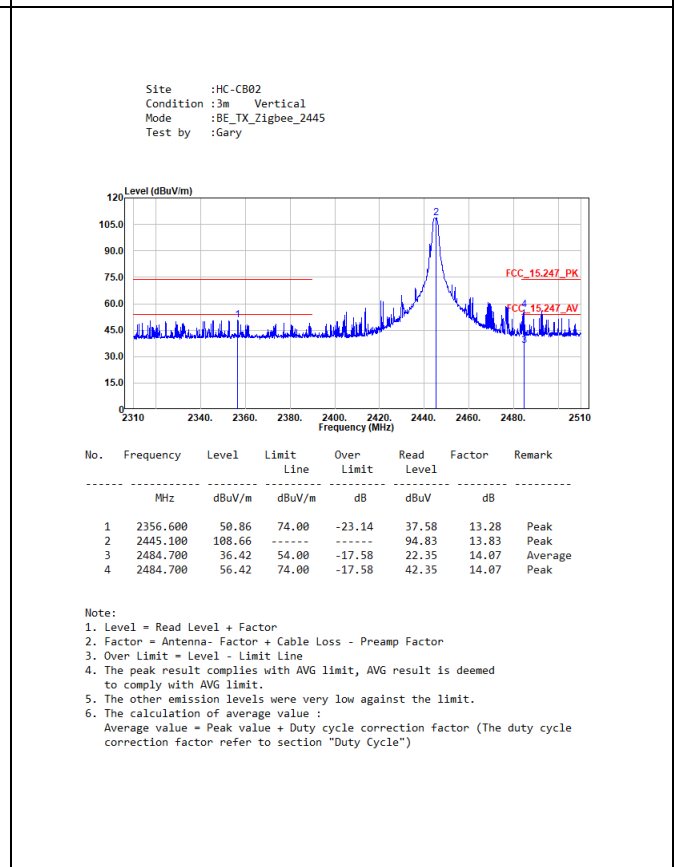
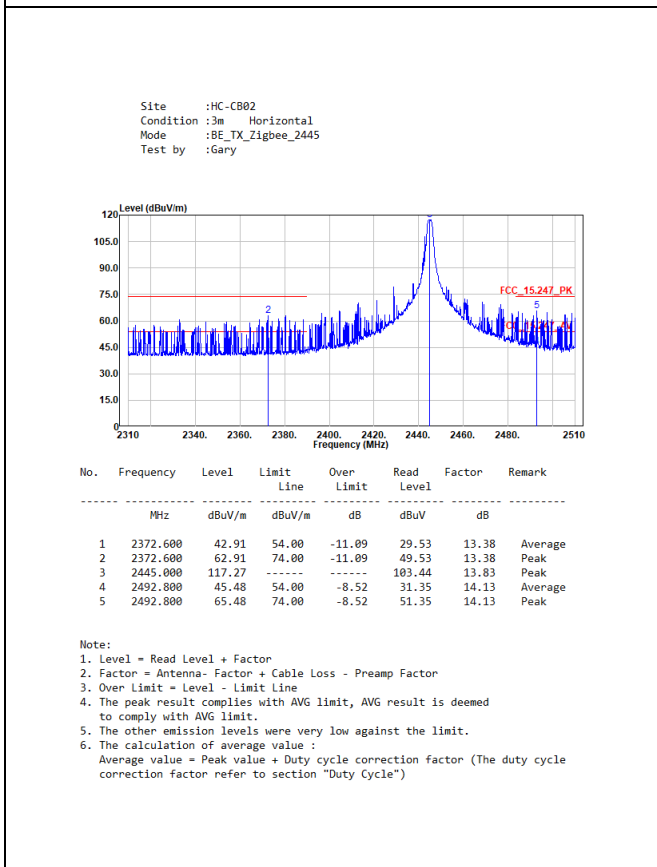
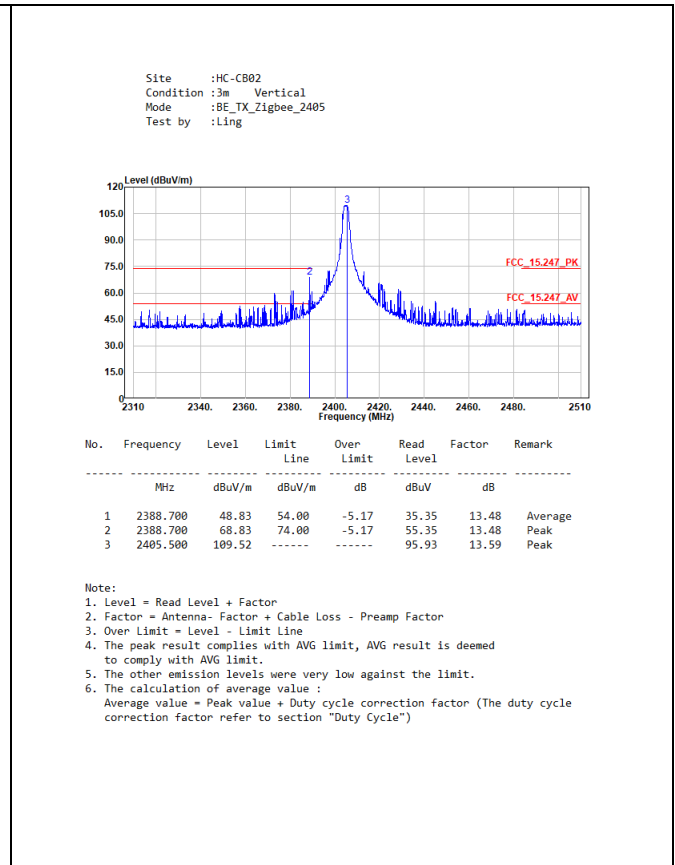
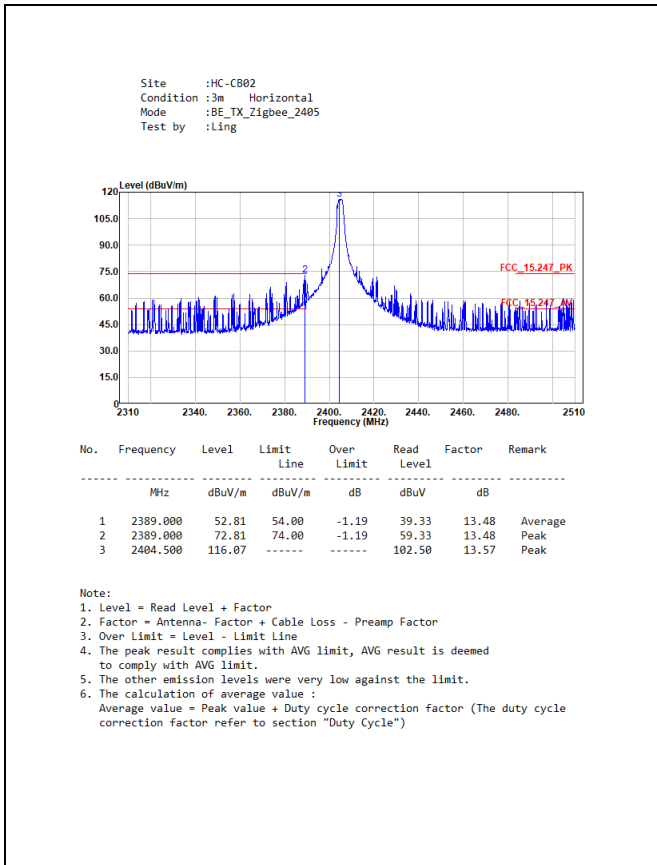

Site :HC-CB02
 Condition :3m Horizontal
 Mode :BE_TX_Zigbee_2475
 Test by :Ling

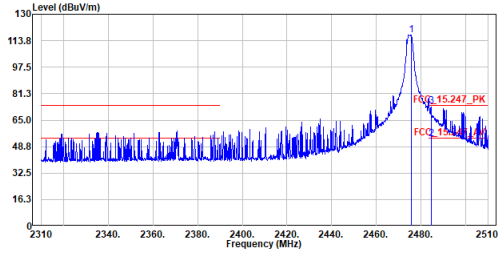

No.	Frequency MHz	Level dBuV/m	Limit dBuV/m	Over Limit dB	Read Level dBuV	Factor dB	Remark
1	2475.600	117.17	-----	-----	103.14	14.03	Peak
2	2484.500	53.67	54.00	-0.33	39.60	14.07	Average
3	2484.500	73.67	74.00	-0.33	59.60	14.07	Peak

Note:
 1. Level = Read Level + Factor
 2. Factor = Antenna Factor + Cable Loss - Preamp Factor
 3. Over Limit = Level - Limit Line
 4. The peak result complies with AVG limit, AVG result is deemed to comply with AVG limit.
 5. The other emission levels were very low against the limit.
 6. The calculation of average value :
 Average value = Peak value + Duty cycle correction factor (The duty cycle correction factor refer to section "Duty Cycle")

Site :HC-CB02
 Condition :3m Vertical
 Mode :BE_TX_Zigbee_2475
 Test by :Ling

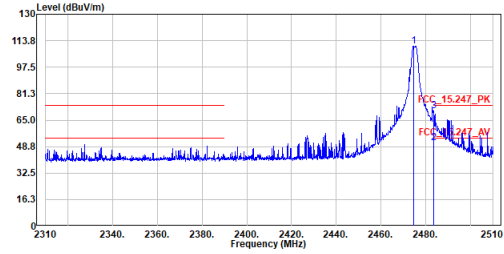

No.	Frequency MHz	Level dBuV/m	Limit dBuV/m	Over Limit dB	Read Level dBuV	Factor dB	Remark
1	2474.500	110.34	-----	-----	96.34	14.00	Peak
2	2483.700	50.79	54.00	-3.21	36.72	14.07	Average
3	2483.700	70.79	74.00	-3.21	56.72	14.07	Peak

Note:
 1. Level = Read Level + Factor
 2. Factor = Antenna Factor + Cable Loss - Preamp Factor
 3. Over Limit = Level - Limit Line
 4. The peak result complies with AVG limit, AVG result is deemed to comply with AVG limit.
 5. The other emission levels were very low against the limit.
 6. The calculation of average value :
 Average value = Peak value + Duty cycle correction factor (The duty cycle correction factor refer to section "Duty Cycle")

7. Occupied Bandwidth & DTS Bandwidth

7.1 Test Setup

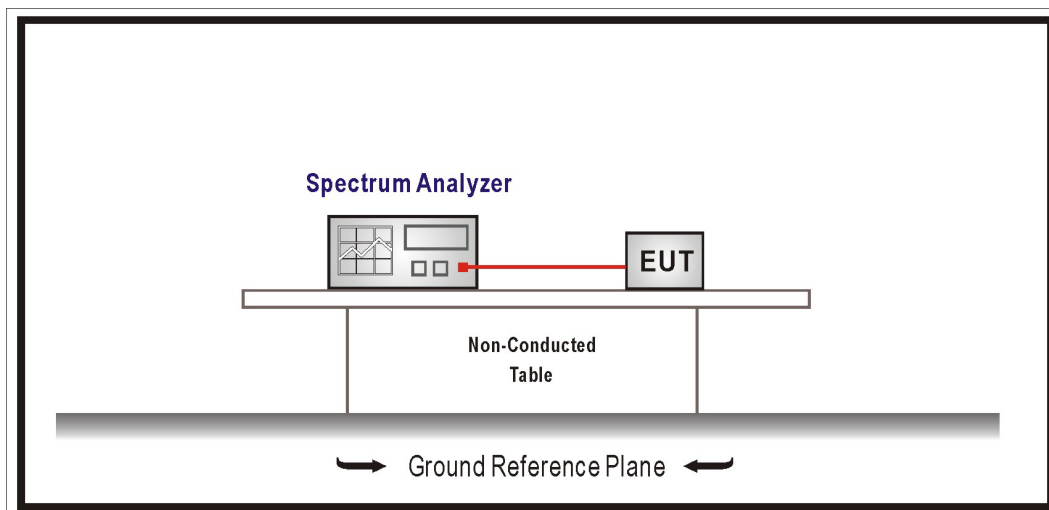

7.2 Test Limit

The 6 dB bandwidth: ≥ 500 kHz.

Occupied Bandwidth: NA

7.3 Test Procedures

The EUT was setup according to ANSI C63.10: 2013; tested according to DTS test procedure of KDB 558074 D01 V05r02 for compliance to FCC 47CFR 15.247 requirements.

7.4 Test Specification

According to FCC Part 15 Subpart C Paragraph 15.247.

7.5 Test Result of Occupied Bandwidth

Modulation	Channel	Frequency (MHz)	Measure Level (MHz)	Limit (MHz)
O-QPSK	00	2405	2.362	-
	04	2445	2.412	-
	07	2475	2.407	-

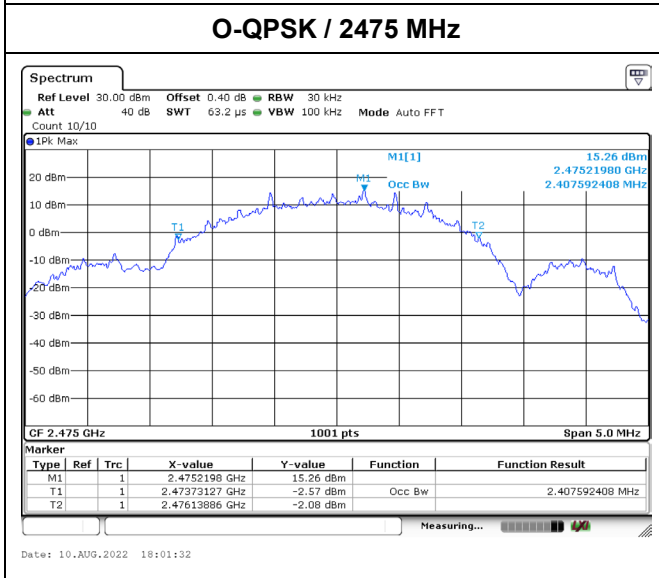
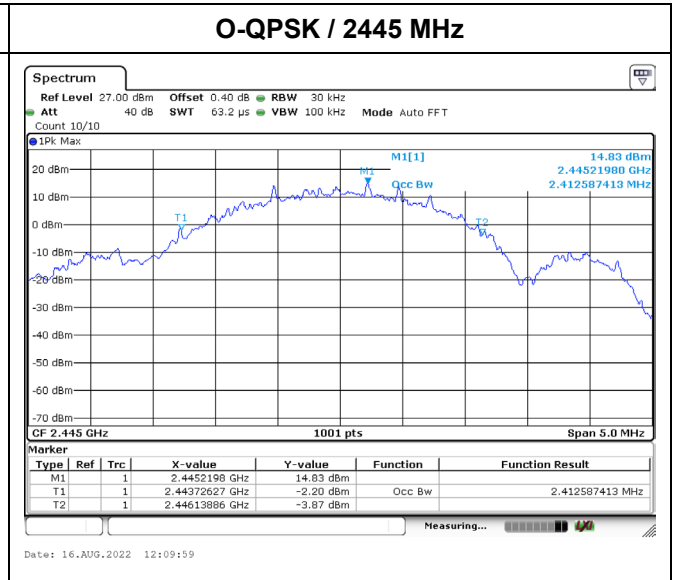
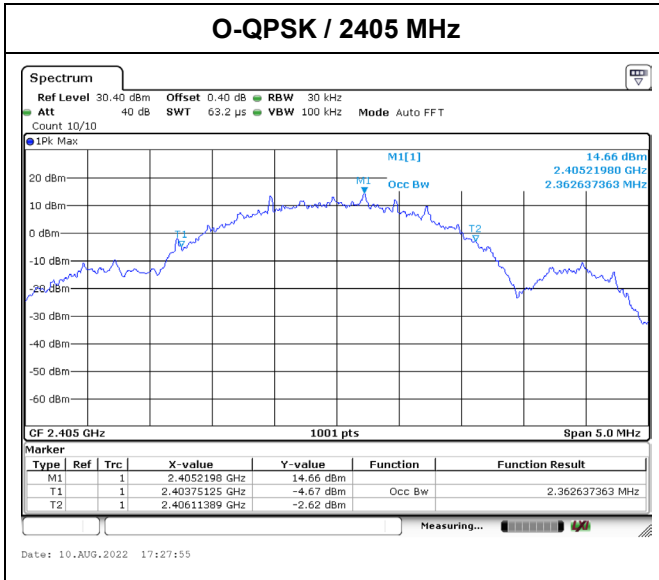

7.6 Test Result of DTS Bandwidth

Modulation	Channel	Frequency (MHz)	Measure Level (MHz)	Limit (MHz)	Result
O-QPSK	00	2405	1.533	≥ 0.500	Pass
	04	2445	1.628	≥ 0.500	Pass
	07	2475	1.703	≥ 0.500	Pass

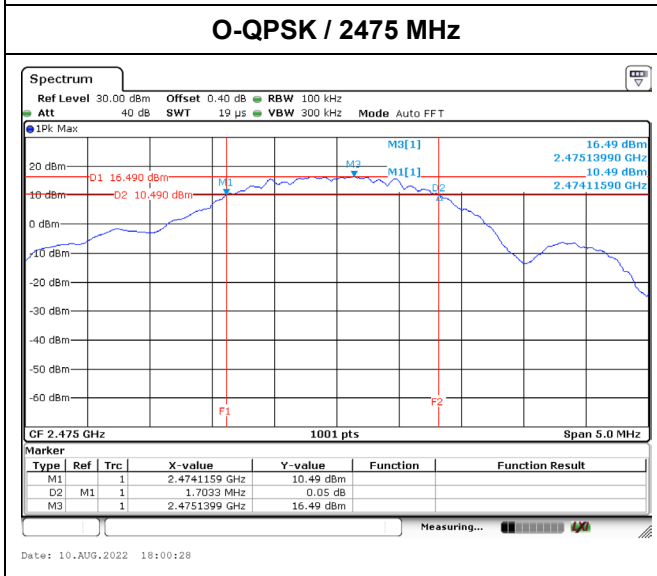
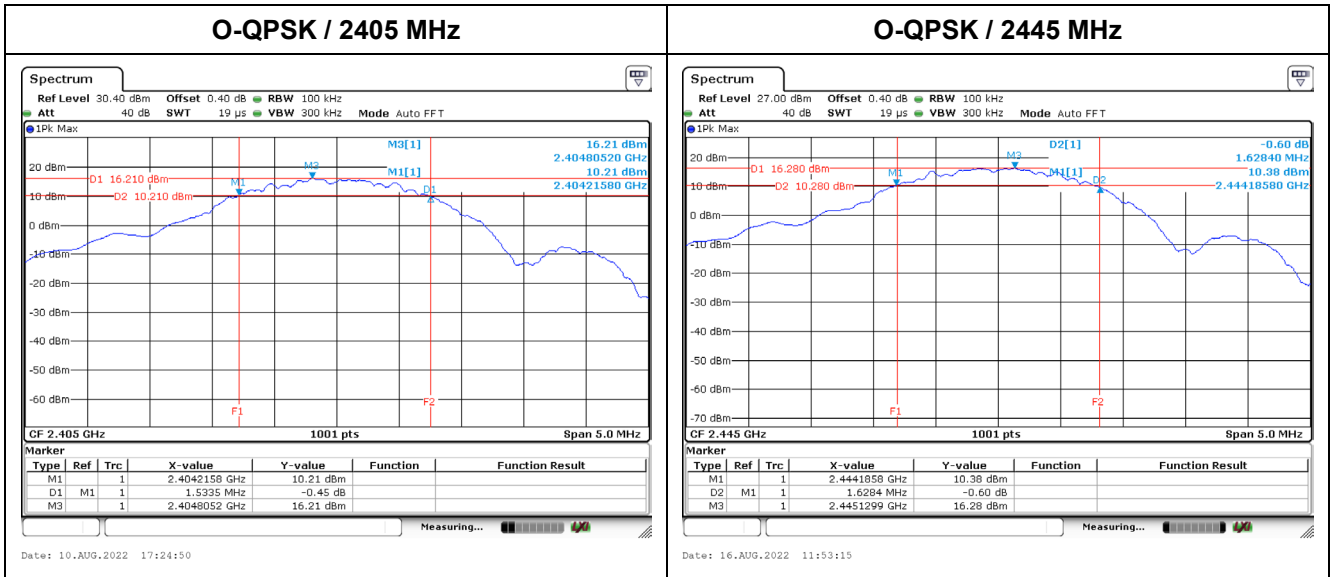

8. Maximum Power Spectral Density

8.1 Test Setup

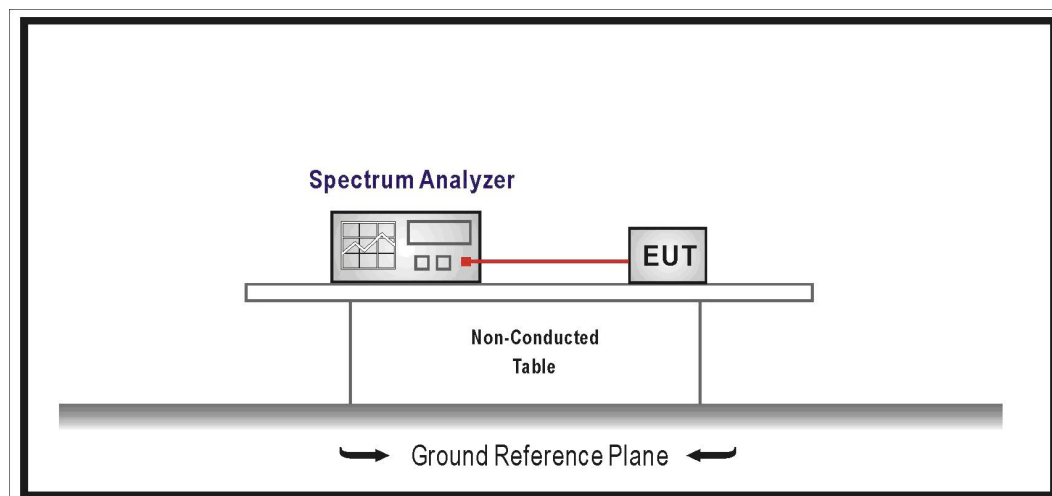

8.2 Test Limit

The peak power spectral density conducted from the intentional radiated to the antenna shall not be greater than +8 dBm in any 3 kHz band during any time interval of continuous transmission.

8.3 Test Procedures

The EUT was setup according to ANSI C63.10: 2013; tested according to DTS test procedure of KDB 558074 D01 V05r02 for compliance to FCC 47CFR 15.247 requirements.

8.4 Test Specification

According to FCC Part 15 Subpart C Paragraph 15.247

8.5 Test Result of Maximum Power Spectral Density

Modulation	Channel	Frequency (MHz)	Measure Value (dBm/3kHz)	Limit (dBm/3kHz)	Result
O-QPSK	00	2405	4.560	≤ 8.000	Pass
	04	2445	4.670	≤ 8.000	Pass
	07	2475	4.550	≤ 8.000	Pass

