

FCC Test Report

Product Name : PACKTALK EDGE
PACKTALK CUSTOM
Brand Name : Cardo Systems, LTD
Model No. : PACKTALK EDGE/CUSTOM
FCC ID : Q95ER28

Applicant : Cardo Systems, LTD
Address : 101 E. Park Blvd, Suite 600, Plano TX, 75074 USA

Date of Receipt : Oct. 22, 2021
Issued Date : Dec. 10, 2021
Report No. : 21A0733R-RFUSBT2V01-A
Report Version : V1.0



The test results relate only to the samples tested.

The test results shown in the test report are traceable to the national/international standard through the calibration of the equipment and evaluated measurement uncertainty herein.

This report must not be used to claim product endorsement by TAF or any agency of the government.

Measurement uncertainties evaluated for each testing system and associated connections are given here to provide the system information for reference. Compliance determinations do not take into account measurement uncertainties for each testing system, but are based on the results of the compliance measurement.

The test report shall not be reproduced except in full without the written approval of DEKRA Testing and Certification Co., Ltd.

Test Report Certification



Product Name : PACKTALK EDGE
 PACKTALK CUSTOM

Applicant : Cardo Systems, LTD

Address : 101 E. Park Blvd, Suite 600, Plano TX, 75074 USA

Manufacturer : Cardo Systems, LTD

Address : 101 E. Park Blvd, Suite 600, Plano TX, 75074 USA

Brand Name : Cardo Systems, LTD

Model No. : PACKTALK EDGE/CUSTOM

FCC ID : Q95ER28

EUT Voltage : DC 5V (adapter or host equipment)
 DC 3.7 for battery

Testing Voltage : AC 120V/60Hz

Applicable Standard : FCC CFR Title 47 Part 15 Subpart C Section 15.247
 ANSI C63.10: 2013

Laboratory Name : Hsin Chu Laboratory

Address : No.372-2, Sec. 4, Zhongxing Rd., Zhudong Township, Hsinchu
 County 310, Taiwan, R.O.C.
 TEL: +886-3-582-8001 / FAX: +886-3-582-8958

Test Result : Complied

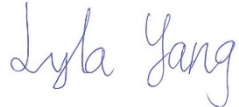
Documented By : 

 (Lyla Yang / Engineering Adm. Specialist)

Approved By : 

 (Louis Hsu / Deputy Manager)

The test results relate only to the samples tested.
 The test report shall not be reproduced except in full without the written approval of DEKRA
 Testing and Certification Co., Ltd.

Revision History

Version	Description	Issued Date
V1.0	Initial issue of report	Dec. 10, 2021

TABLE OF CONTENTS

Description	Page
1. General Information.....	6
1.1. EUT Description.....	6
1.2. Test Mode	8
1.3. Comments and Remarks	8
1.4. Tested System Details	9
1.5. Configuration of tested System	9
1.6. EUT Operation of during Test	9
1.7. Test Facility	10
1.8. List of Test Equipment	12
1.9. Measurement Uncertainty	13
1.10. Duty Cycle	14
2. AC Power Line Conducted Emission	15
2.1. Test Setup.....	15
2.2. Test Limit.....	15
2.3. Test Procedure	15
2.4. Test Specification	15
2.5. Test Result of AC Power Line Conducted Emission.....	16
3. Maximum Conducted Output Power	20
3.1. Test Setup.....	20
3.2. Test Limit.....	20
3.3. Test Procedures.....	20
3.4. Test Specification	20
3.5. Test Result of Maximum Conducted Output Power.....	21
4. Radiated Emission	22
4.1. Test Setup.....	22
4.2. Test Limit.....	23
4.3. Test Procedure	23
4.4. Test Specification	23
4.5. Test Result of Radiated Emissions (30 MHz ~ 1 GHz).....	24
4.6. Test Result of Radiated Emissions (1 GHz ~ 10 th Harmonic).....	26
5. Antenna Port Conducted Emission	32
5.1. Test Setup.....	32
5.2. Test Limit.....	32
5.3. Test Procedure	32
5.4. Test Specification	32
5.5. Test Result of Antenna Port Conducted Emission.....	33

6.	Radiated Emission Band Edge.....	37
6.1.	Test Setup.....	37
6.2.	Test Limit.....	37
6.3.	Test Procedure	38
6.4.	Test Specification	38
6.5.	Test Result of Radiated Emission Band Edge.....	39
7.	Number of Hopping Frequency	47
7.1.	Test Setup.....	47
7.2.	Test Limit.....	47
7.3.	Test Procedures.....	47
7.4.	Test Specification	47
7.5.	Test Result of Number of Hopping Frequency	48
8.	Carrier Frequency Separation	49
8.1.	Test Setup.....	49
8.2.	Test Limit.....	49
8.3.	Test Procedures.....	49
8.4.	Test Specification	49
8.5.	Test Result of Carrier Frequency Separation	50
9.	20dB Bandwidth	53
9.1.	Test Setup.....	53
9.2.	Test Limit.....	53
9.3.	Test Procedures.....	53
9.4.	Test Specification	53
9.5.	Test Result of 20dB Bandwidth.....	54
10.	Dwell Time.....	57
10.1.	Test Setup.....	57
10.2.	Test Limit.....	57
10.3.	Test Procedures.....	58
10.4.	Test Specification	58
10.5.	Test Result of Dwell Time	59
Appendix A	62
	Test Setup Photograph	62

1. General Information

1.1. EUT Description

Product Name	PACKTALK EDGE PACKTALK CUSTOM
Brand Name	Cardo Systems, LTD
Model No.	PACKTALK EDGE/CUSTOM
Frequency Range	2402 ~ 2480 MHz
Channel Number	79 Channels
Type of Modulation	Frequency Hopping Spread Spectrum
Data Rate	BR uses a GFSK (1 Mbps) EDR uses a combination of $\pi/4$ -DQPSK (2 Mbps) and 8DPSK (3 Mbps)

Accessories Information				
No.	Equipment Name	Brand Name	Model No.	Description
1	Headphone	JBL	40mm 32ohm speakers	3 wire audio lines
2	USB Cable	Hailink	USB 2.0 A/M to Type C cable 28# L=60cm	Shielded cable w/o ferrite core, 0.6m
3	Microphone	Transound	Boom Microphone	2 wire audio lines
4	Audio Kit	Leflexo	Pack Talk Edge Audio kit	5 wire audio lines

The difference for each product name is shown as below:

Product Name	Description
PACKTALK EDGE	The difference are related to pay per feature on the mobile application that manufacturer enable the user to use but the product is exactly the same. For instance, noise cancellation feature can be operate by mobile app and for PACKTALK CUSTOM user pay per this feature.
PACKTALK CUSTOM	

From the above product, product name: PACKTALK CUSTOM was selected as representative model for the test and its data was recorded in this report.

Antenna Information				
Ant.	Brand Name	Model No.	Type	Gain (dBi)
0	N/A	N/A	PCB	0
1	AMOTECH	AMAN301512ST01	Chip	2.21

Working Frequency of Each Channel							
Channel	Frequency	Channel	Frequency	Channel	Frequency	Channel	Frequency
00	2402 MHz	20	2422 MHz	40	2442 MHz	60	2462 MHz
01	2403 MHz	21	2423 MHz	41	2443 MHz	61	2463 MHz
02	2404 MHz	22	2424 MHz	42	2444 MHz	62	2464 MHz
03	2405 MHz	23	2425 MHz	43	2445 MHz	63	2465 MHz
04	2406 MHz	24	2426 MHz	44	2446 MHz	64	2466 MHz
05	2407 MHz	25	2427 MHz	45	2447 MHz	65	2467 MHz
06	2408 MHz	26	2428 MHz	46	2448 MHz	66	2468 MHz
07	2409 MHz	27	2429 MHz	47	2449 MHz	67	2469 MHz
08	2410 MHz	28	2430 MHz	48	2450 MHz	68	2470 MHz
09	2411 MHz	29	2431 MHz	49	2451 MHz	69	2471 MHz
10	2412 MHz	30	2432 MHz	50	2452 MHz	70	2472 MHz
11	2413 MHz	31	2433 MHz	51	2453 MHz	71	2473 MHz
12	2414 MHz	32	2434 MHz	52	2454 MHz	72	2474 MHz
13	2415 MHz	33	2435 MHz	53	2455 MHz	73	2475 MHz
14	2416 MHz	34	2436 MHz	54	2456 MHz	74	2476 MHz
15	2417 MHz	35	2437 MHz	55	2457 MHz	75	2477 MHz
16	2418 MHz	36	2438 MHz	56	2458 MHz	76	2478 MHz
17	2419 MHz	37	2439 MHz	57	2459 MHz	77	2479 MHz
18	2420 MHz	38	2440 MHz	58	2460 MHz	78	2480 MHz
19	2421 MHz	39	2441 MHz	59	2461 MHz	-	-

Note:

1. Regards to the frequency band operation; the lowest , middle and highest frequency of channel were selected to perform the test, and then shown on this report.
2. The above EUT information is declared by the manufacturer.

1.2. Test Mode

DEKRA has verified the construction and function in typical operation. All the test modes were carried out with the EUT in transmitting operation, which was shown in this test report and defined as follows:

Test Mode	Mode 1: Transmit
-----------	------------------

Test Items	Test Mode	Modulation	Channel	Result
AC Power Line Conducted Emission	Mode 1	8-DPSK	78	Pass
Maximum Conducted Output Power	Mode 1	GFSK	00/39/78	Pass
		8-DPSK	00/39/78	Pass
Radiated Emission Below 1 GHz	Mode 1	8-DPSK	78	Pass
Radiated Emission Above 1 GHz	Mode 1	GFSK	00/39/78	Pass
		8-DPSK	00/39/78	Pass
Antenna Port Conducted Emission	Mode 1	GFSK	00/39/78	Pass
		8-DPSK	00/39/78	Pass
Radiated Emission Band Edge	Mode 1	GFSK	00/39/78	Pass
		8-DPSK	00/39/78	Pass
Number of Hopping Frequency	Mode 1	GFSK	Hopping mode	Pass
		8-DPSK	Hopping mode	Pass
Carrier Frequency Separation	Mode 1	GFSK	00/39/78	Pass
		8-DPSK	00/39/78	Pass
20dB Bandwidth	Mode 1	GFSK	00/39/78	Pass
		8-DPSK	00/39/78	Pass
Dwell Time	Mode 1	GFSK	00/39/78	Pass
		8-DPSK	00/39/78	Pass

Note:

1. Determining compliance shall be based on the results of the compliance measurement, not taking into account measurement instrumentation uncertainty.
2. Pre-Scan has been conducted to determine the worst-case mode from all possible combinations between available modulations, data rates and antenna ports (if EUT with antenna diversity architecture).
3. For below 1GHz radiated emission and AC Power Line Conducted Emission have performed all modes of operation were investigated and the worst-case emissions are reported.
4. The EUT was performed at X axis, Y axis and Z axis position for radiated emission and band edge tests. The worst case was found at Z axis, so the measurement will follow this same test configuration.
- 5.

1.3. Comments and Remarks

The product specification and testing instructions for the EUT declared in the report are provided by the manufacturer who will take all responsibilities for the accuracy.

1.4. Tested System Details

The types for all equipment, plus descriptions of all cables used in the tested system (including inserted cards) are:

Product	Manufacturer	Model No.	Serial No.	Power Cord
1 Notebook	HP	HSTNN-I33C-4	N/A	Non-Shielded, 1.8m, One ferrite core bonded

1.5. Configuration of tested System

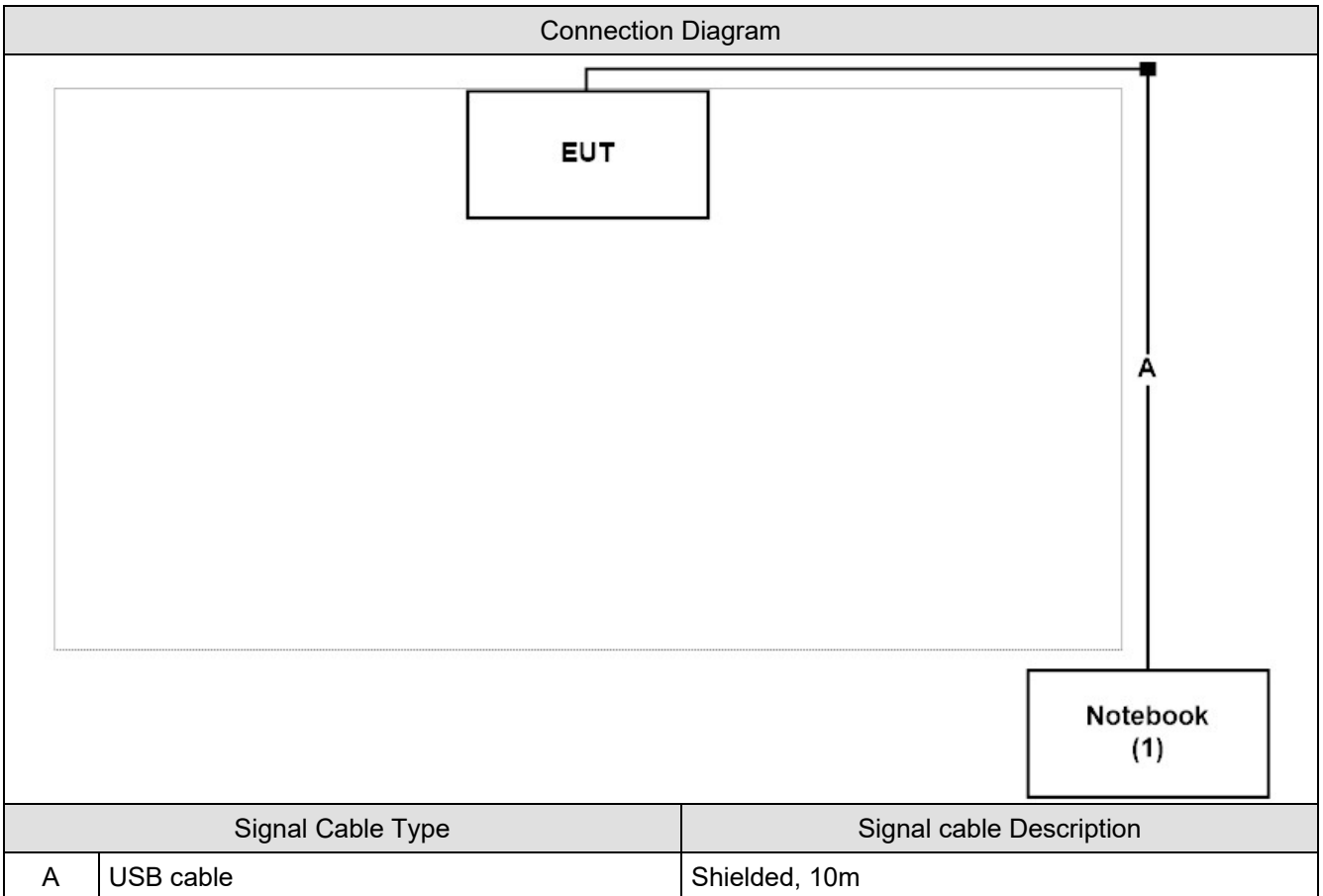

1.6. EUT Operation of during Test

1	Set the EUT as shown.
2	Execute the control software Bluetest3
3	Configure test mode, test channel and packet.
4	Let the EUT start transmitting signal continuously.
5	Verify that device is working properly

1.7. Test Facility

Ambient conditions in the laboratory:

Items	Test Item	Actually	Tested by	Test Date	Test Site
Temperature (°C)	AC Power Line Conducted	23.2	Max Chang	2021/11/23	SR2-H
Humidity (%RH)	Emission	51.0			
Temperature (°C)	Maximum Conducted Output	24.0	Elwin Lin	2021/11/04	SR12-H
Humidity (%RH)	Power	69.0			
Temperature (°C)	Radiated Emission	23.2 ~ 25.4	Ling Chen	2021/10/29 ~ 2021/11/02	CB2-H
Humidity (%RH)		55.0 ~ 58.0			
Temperature (°C)	Antenna Port Conducted	24.0	Elwin Lin	2021/11/04	SR12-H
Humidity (%RH)	Emission	69.0			
Temperature (°C)	Radiated Emission Band Edge	23.2 ~ 24.1	Ling Chen	2021/10/29 ~ 2021/11/01	CB2-H
Humidity (%RH)		55.0 ~ 60.0	Getaz Yang		
Temperature (°C)	Number of Hopping Frequency	24.0	Elwin Lin	2021/11/04	SR12-H
Humidity (%RH)		69.0			
Temperature (°C)	Carrier Frequency Separation	24.0	Elwin Lin	2021/11/04	SR12-H
Humidity (%RH)		69.0			
Temperature (°C)	20dB Bandwidth	24.0	Elwin Lin	2021/11/04	SR12-H
Humidity (%RH)		69.0			
Temperature (°C)	Dwell Time	24.0	Elwin Lin	2021/11/04	SR12-H
Humidity (%RH)		69.0			

Note: Test site information refers to Laboratory Information.

Laboratory Information

USA : **FCC Registration Number: TW3024**
Canada : **CAB identifier : TW3024**

The address and introduction of DEKRA Testing and Certification Co., Ltd. laboratories can be founded in our Web site: <http://www.dekra.com.tw>

If you have any comments, please don't hesitate to contact us. Our test sites as below:

Test Laboratory	DEKRA Testing and Certification Co., Ltd.
Address	1. No.372-2, Sec. 4, Zhongxing Rd., Zhudong Township, Hsinchu County 31061, Taiwan, R.O.C. 2. No.372, Sec. 4, Zhongxing Rd., Zhudong Township, Hsinchu County 31061, Taiwan, R.O.C.
Phone number	1. +886-3-582-8001 2. +886-3-582-8001
Fax number	1. +886-3-582-8958 2. +886-3-582-8958
Email address	info.tw@dekra.com
Website	http://www.dekra.com.tw
Note: Test site number for address 1 includes SR2-H. Test site number for address 2 includes CB2-H, CB3-H, CB4-H, SR10-H and SR12-H.	

1.8. List of Test Equipment

SR2-H

Instrument	Manufacturer	Model No.	Serial No.	Cal. Date	Next Cal. Date
Artificial Mains Network	R&S	ENV4200	848411/010	2020/12/24	2021/12/23
Test Receiver	R&S	ESCS 30	836858/022	2021/02/22	2022/02/21
LISN	R&S	ENV216	100092	2021/06/08	2022/06/07
Coaxial Cable(9 m)	Harbour	RG-400	SR2-H	2021/08/15	2022/08/14
DEKRA Testing System	DEKRA	Version 2.0	SR2-H	NA	NA

SR12-H

Instrument	Manufacturer	Model No.	Serial No.	Cal. Date	Next Cal. Date
EXA Signal Analyzer	Keysight	N9010A	MY51440132	2021/01/25	2022/01/24
Power Meter	Keysight	8990B	MY51000248	2021/05/21	2022/05/20
Power Sensor	Keysight	N1923A	MY57240005	2021/05/21	2022/05/20
Spectrum Analyzer	Keysight	N9010B	MY57110159	2021/03/29	2022/03/28
Spectrum Analyzer	Agilent	N9010A	US47140172	2021/05/28	2022/05/27
Signal & Spectrum Analyzer	R&S	FSV40	101049	2021/03/31	2022/03/30

CB2-H

Instrument	Manufacturer	Model No.	Serial No.	Cal. Date	Next Cal. Date
Signal & Spectrum Analyzer	R&S	FSV40	101049	2021/03/31	2022/03/30
Signal Analyzer	R&S	FSVA40	101435	2021/06/04	2022/06/03
EXA Signal Analyzer	Keysight	N9010A	MY51440132	2021/01/25	2022/01/24
Trilog Broadband Antenna	Schwarzbeck	VULB 9168	1272	2021/08/20	2022/08/19
Bilog Antenna	Teseq	CBL6112D	23191	2021/02/26	2022/02/25
Horn Antenna	Schwarzbeck	BBHA 9120D	639	2021/05/17	2022/05/16
Horn Antenna	Schwarzbeck	BBHA 9170	202	2020/12/16	2021/12/15
Pre-Amplifier	EMCI	EMC01820I	980365	2021/05/28	2022/05/27
Pre-Amplifier	EMEC	EM01G18GA	060741	2021/07/02	2022/07/01
Pre-Amplifier	DEKRA	AP-400C	201801231	2021/11/12	2022/11/11
EMI Test Receiver	R&S	ESR7	102,260	2020/12/28	2021/12/27
Magnetic Loop Antenna	Teseq	HLA 6121	44287	2021/09/06	2022/09/05
Coaxial Cable(13m)	Huber+Suhner	SF104	CB2-H	2021/08/17	2022/08/16
Radiated Software	AUDIX	e3 V9	CB2-H_1	NA	NA
Coaxial Cable(3m)	Suhnerr,Rosnol	SF102_Rosnol	CB2-H_1	2021/08/17	2022/08/18

Note: All equipment upon which need to calibrated are with calibration period of 1 year.

1.9. Measurement Uncertainty

Uncertainties have been calculated according to the DEKRA internal document with the emissions test results be included in the report. The measurement uncertainties given below are based on a 95% confidence level (based on a coverage factor ($k=2$)).

Test item	Uncertainty
AC Power Line Conducted Emission	± 2.10 dB
Maximum Conducted Output Power	± 1.16 dB
Radiated Emission	± 3.25 dB below 1 GHz ± 3.32 dB above 1 GHz
Antenna Port Conducted Emission	± 1.60 dB
Band Edge	± 3.32 dB above 1GHz
Number of Hopping Frequency	N/A
Carrier Frequency Separation	± 282.55 Hz
20dB Bandwidth	± 282.55 Hz
Dwell Time	± 19.555 msec

1.10. Duty Cycle

Modulation	On Times (ms)	On+Off Times (ms)	Duty Cycle (%)	Duty Cycle Correction Factor (dB)
GFSK (ANT0)	2.880	100	2.88%	-30.81
8-DPSK (ANT0)	2.888	100	2.89%	-30.79
GFSK (ANT1)	2.876	100	2.88%	-30.82
8-DPSK (ANT1)	2.864	100	2.86%	-30.86

Note: If the duty cycle correction factor lower than -20dB, the Max. duty cycle correction factor is -20dB.

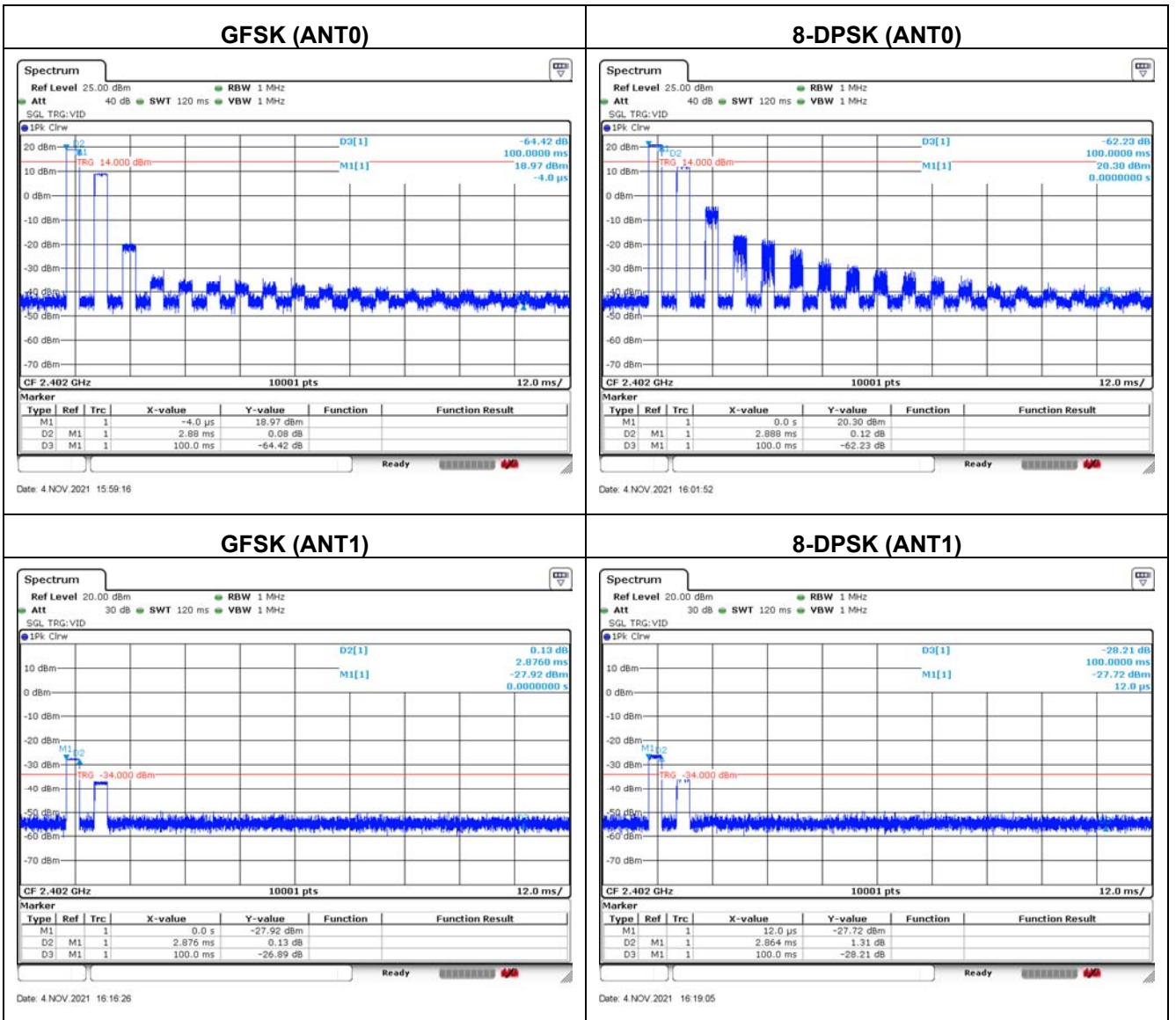

2.5. Test Result of AC Power Line Conducted Emission

Test Mode	Mode 1: Transmit	Phase	Line
Test Condition	8-DPSK (ANT0) / 2480MHz		

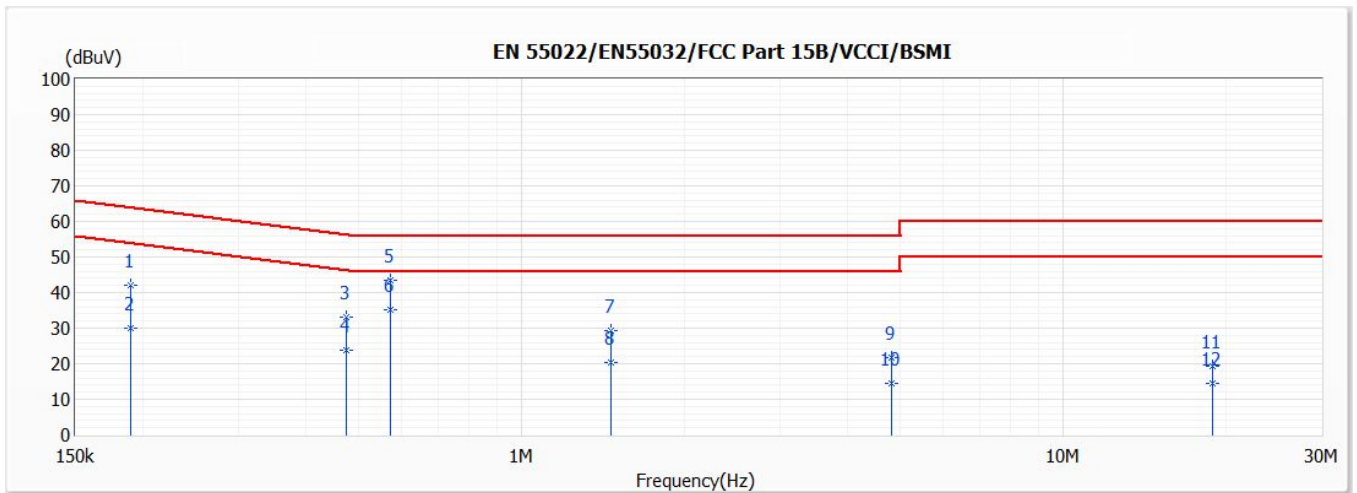

No	Frequency (MHz)	Emission Level (dBuV)	Limit (dBuV)	Margin (dB)	Reading Level (dBuV)	Correct Factor (dB)	Detector Type
1	0.189	42.02	64.07	-22.05	32.39	9.63	QP
2	0.189	29.96	54.07	-24.11	20.33	9.63	AV
3	0.475	33.01	56.43	-23.42	23.34	9.67	QP
4	0.475	23.85	46.43	-22.58	14.18	9.67	AV
5	0.571	43.32	56.00	-12.68	33.64	9.68	QP
*6	0.571	35.19	46.00	-10.81	25.51	9.68	AV
7	1.464	29.40	56.00	-26.60	19.66	9.74	QP
8	1.464	20.40	46.00	-25.60	10.66	9.74	AV
9	4.828	21.78	56.00	-34.22	11.86	9.92	QP
10	4.828	14.43	46.00	-31.57	4.51	9.92	AV
11	18.913	19.34	60.00	-40.66	8.98	10.36	QP
12	18.913	14.56	50.00	-35.44	4.20	10.36	AV

Remark:

1. "*" means this data is the worst emission level.
2. Emission Level = Reading Level + Correct Factor (Correct Factor = LISN Insertion Loss + Cable Loss).
3. Margin = Emission Level - Limit.

Test Mode	Mode 1: Transmit	Phase	Neutral
Test Condition	8-DPSK (ANT0) / 2480MHz		

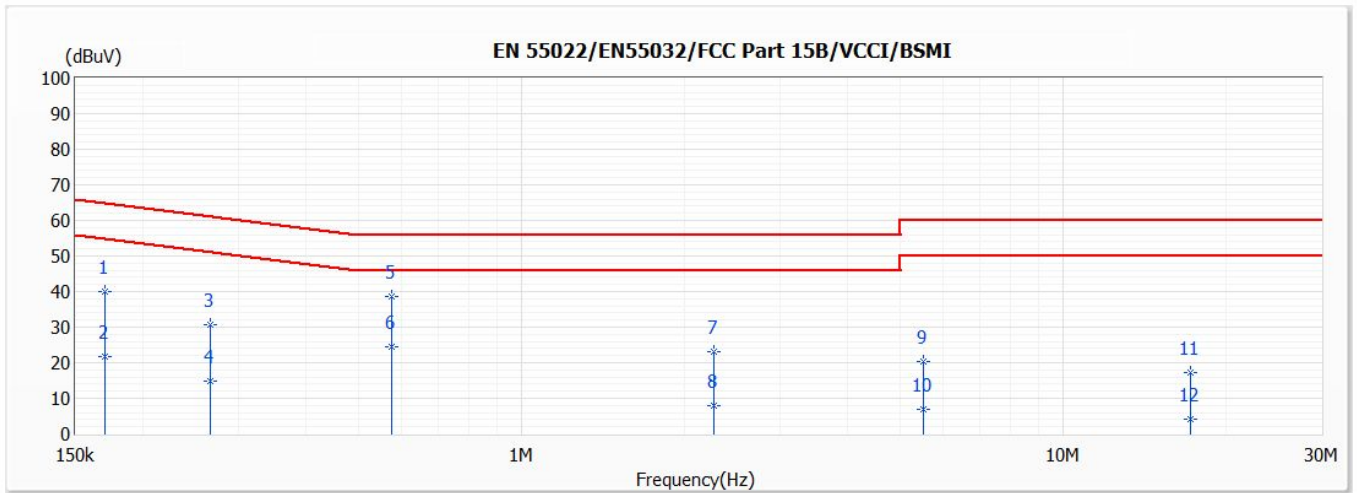

No	Frequency (MHz)	Emission Level (dBuV)	Limit (dBuV)	Margin (dB)	Reading Level (dBuV)	Correct Factor (dB)	Detector Type
1	0.170	39.91	64.98	-25.07	30.27	9.64	QP
2	0.170	21.87	54.98	-33.11	12.23	9.64	AV
3	0.266	30.84	61.23	-30.39	21.20	9.64	QP
4	0.266	14.86	51.23	-36.37	5.22	9.64	AV
*5	0.575	38.58	56.00	-17.42	28.89	9.69	QP
6	0.575	24.54	46.00	-21.46	14.85	9.69	AV
7	2.264	23.11	56.00	-32.89	13.31	9.80	QP
8	2.264	8.00	46.00	-38.00	-1.80	9.80	AV
9	5.532	20.49	60.00	-39.51	10.52	9.97	QP
10	5.532	6.99	50.00	-43.01	-2.98	9.97	AV
11	17.157	17.08	60.00	-42.92	6.64	10.44	QP
12	17.157	4.27	50.00	-45.73	-6.17	10.44	AV

Remark:

1. "*" means this data is the worst emission level.
2. Emission Level = Reading Level + Correct Factor (Correct Factor = LISN Insertion Loss + Cable Loss).
3. Margin = Emission Level - Limit.

Test Mode	Mode 1: Transmit	Phase	Line
Test Condition	8-DPSK (ANT1) / 2480MHz		

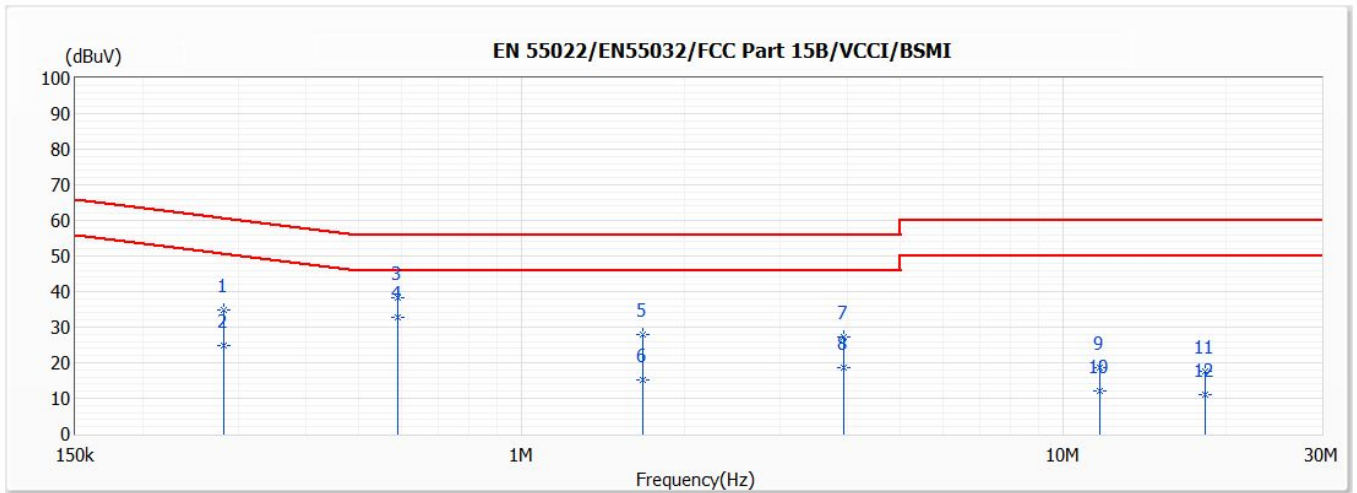

No	Frequency (MHz)	Emission Level (dBuV)	Limit (dBuV)	Margin (dB)	Reading Level (dBuV)	Correct Factor (dB)	Detector Type
1	0.281	34.72	60.78	-26.06	25.08	9.64	QP
2	0.281	24.80	50.78	-25.98	15.16	9.64	AV
3	0.592	38.15	56.00	-17.85	28.47	9.68	QP
*4	0.592	32.69	46.00	-13.31	23.01	9.68	AV
5	1.675	28.09	56.00	-27.91	18.33	9.76	QP
6	1.675	15.14	46.00	-30.86	5.38	9.76	AV
7	3.932	27.30	56.00	-28.70	17.42	9.88	QP
8	3.932	18.52	46.00	-27.48	8.64	9.88	AV
9	11.660	18.59	60.00	-41.41	8.43	10.16	QP
10	11.660	12.10	50.00	-37.90	1.94	10.16	AV
11	18.307	17.55	60.00	-42.45	7.21	10.34	QP
12	18.307	10.90	50.00	-39.10	0.56	10.34	AV

Remark:

1. "*" means this data is the worst emission level.
2. Emission Level = Reading Level + Correct Factor (Correct Factor = LISN Insertion Loss + Cable Loss).
3. Margin = Emission Level - Limit.

Test Mode	Mode 1: Transmit	Phase	Neutral
Test Condition	8-DPSK (ANT1) / 2480MHz		

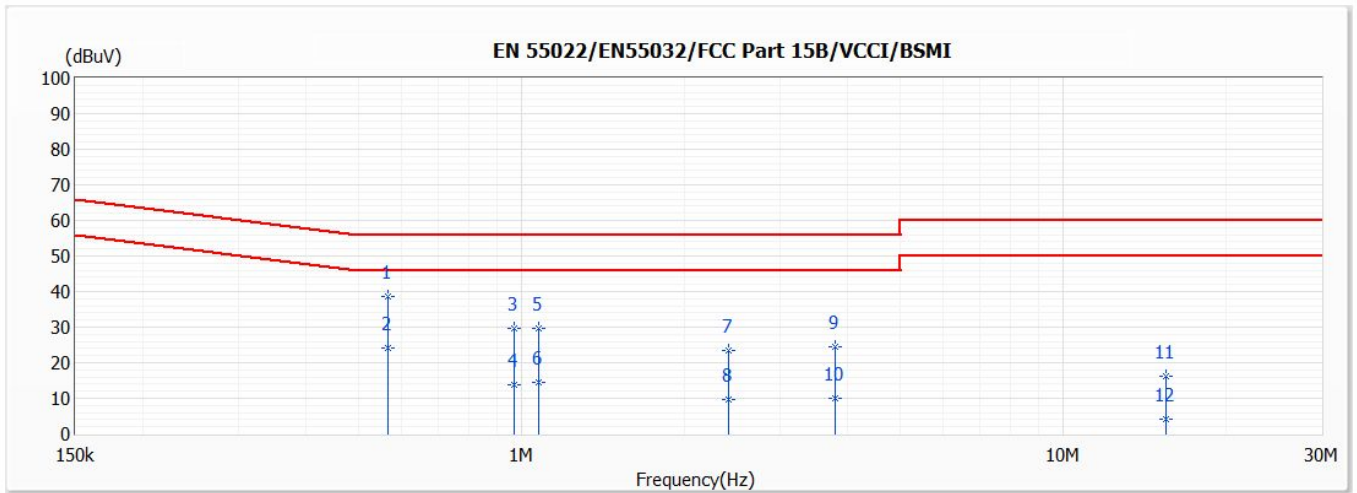

No	Frequency (MHz)	Emission Level (dBuV)	Limit (dBuV)	Margin (dB)	Reading Level (dBuV)	Correct Factor (dB)	Detector Type
*1	0.567	38.75	56.00	-17.25	29.06	9.69	QP
2	0.567	24.16	46.00	-21.84	14.47	9.69	AV
3	0.968	29.61	56.00	-26.39	19.88	9.73	QP
4	0.968	13.74	46.00	-32.26	4.01	9.73	AV
5	1.077	29.55	56.00	-26.45	19.82	9.73	QP
6	1.077	14.45	46.00	-31.55	4.72	9.73	AV
7	2.404	23.29	56.00	-32.71	13.48	9.81	QP
8	2.404	9.54	46.00	-36.46	-0.27	9.81	AV
9	3.795	24.60	56.00	-31.40	14.72	9.88	QP
10	3.795	9.97	46.00	-36.03	0.09	9.88	AV
11	15.503	16.06	60.00	-43.94	5.67	10.39	QP
12	15.503	4.16	50.00	-45.84	-6.23	10.39	AV

Remark:

1. "*" means this data is the worst emission level.
2. Emission Level = Reading Level + Correct Factor (Correct Factor = LISN Insertion Loss + Cable Loss).
3. Margin = Emission Level - Limit.

3. Maximum Conducted Output Power

3.1. Test Setup

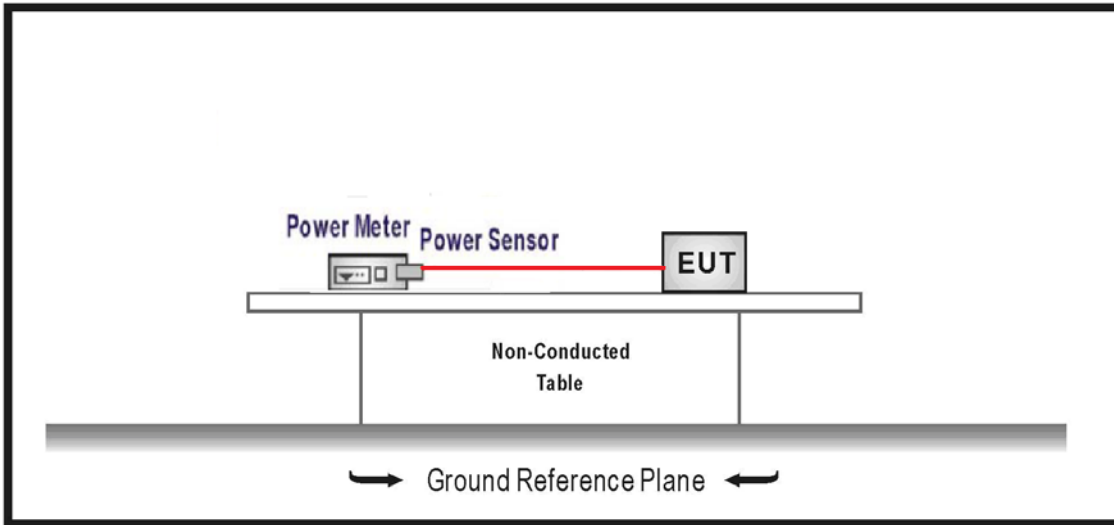

3.2. Test Limit

For frequency hopping systems operating in the 902 ~ 928 MHz band: 1 Watt for systems employing at least 50 hopping channels; and, 0.25 Watts for systems employing less than 50 hopping channels.
For frequency hopping systems operating in the 2400 ~ 2483.5 MHz band employing at least 75 non-overlapping hopping channels, and all frequency hopping systems in the 5725 ~ 5850 MHz band: 1 watt. For all other frequency hopping systems in the 2400 ~ 2483.5 MHz band: 0.125 watts.

3.3. Test Procedures

The EUT was setup according to ANSI C63.10: 2013 and tested according to FHSS test procedure of FCC KDB 558074 D01 v05r02 for compliance to FCC 47CFR 15.247 requirements.

3.4. Test Specification

According to FCC Part 15 Subpart C Paragraph 15.247.

3.5. Test Result of Maximum Conducted Output Power

Modulation	Channel	Frequency (MHz)	Measure Level (dBm)	Limit (dBm)	Result
GFSK (ANT0)	00	2402	21.840	≤ 30.00	Pass
	39	2441	21.960	≤ 30.00	Pass
	78	2480	16.620	≤ 30.00	Pass
8-DPSK (ANT0)	00	2402	22.470	≤ 30.00	Pass
	39	2441	22.500	≤ 30.00	Pass
	78	2480	18.950	≤ 30.00	Pass
GFSK (ANT1)	00	2402	-2.530	≤ 30.00	Pass
	39	2441	-2.580	≤ 30.00	Pass
	78	2480	-2.590	≤ 30.00	Pass
8-DPSK (ANT1)	00	2402	-0.360	≤ 30.00	Pass
	39	2441	-0.200	≤ 30.00	Pass
	78	2480	-0.110	≤ 30.00	Pass

4. Radiated Emission

4.1. Test Setup

9 kHz ~ 30 MHz

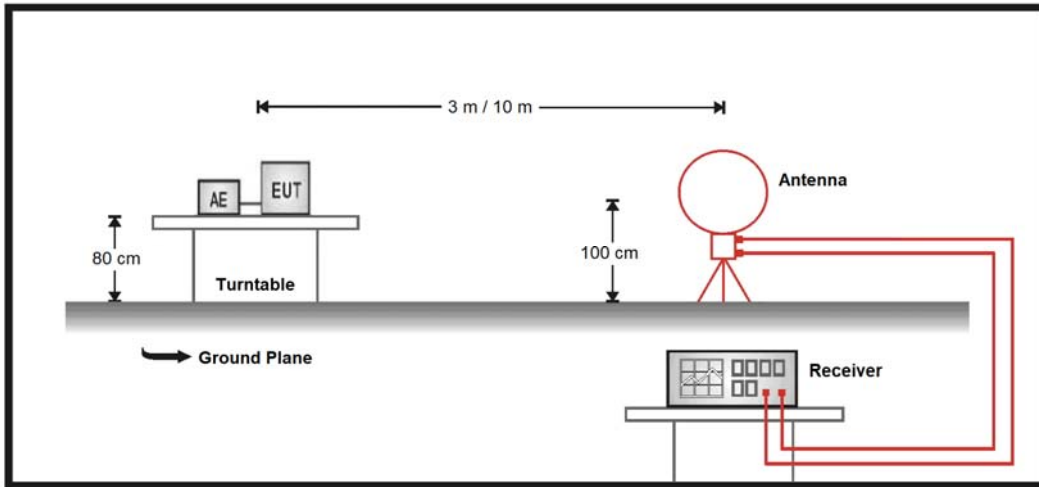

30 MHz ~ 1 GHz

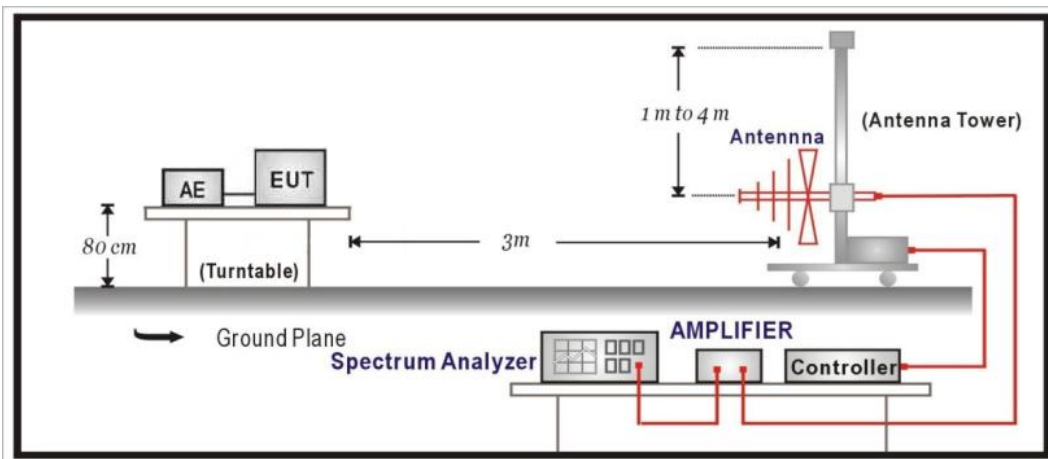

Above 1 GHz

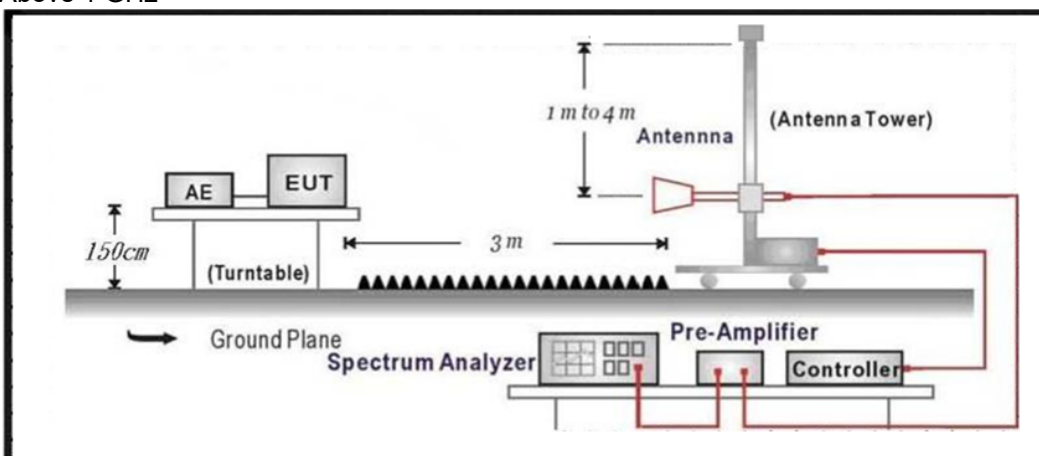

4.2. Test Limit

Emissions radiated outside of the specified frequency bands, except for harmonics, shall be attenuated by at least 20 dB below the level of the fundamental or to the general radiated emission limit in paragraph 15.209, whichever is the lesser attenuation.

Frequency (MHz)	Field strength (uV/m)	Field strength (dBuV/m)	Measurement distance (m)
0.009 – 0.490	2400/F(kHz)	20 log (2400/F(kHz))	300
0.490 – 1.705	24000/F(kHz)	20 log (24000/F(kHz))	30
1.705 - 30	30	29.5	30
30 - 88	100	40	3
88 - 216	150	43.5	3
216 - 960	200	46	3
Above 960	500	54	3

Remarks:

1. Field strength (dBuV/m) = 20 log Field strength (uV/m)
2. In the Above Table, the tighter limit applies at the band edges.
3. Distance refers to the distance in meters between the measuring instrument antenna and the closed point of any part of the device or system

4.3. Test Procedure

The EUT was setup according to ANSI C63.10: 2013 and tested according to FHSS test procedure of FCC KDB 558074 D01 v05r02 for compliance to FCC 47CFR 15.247 requirements.

The EUT and its simulators are placed on a turn table which is 0.8 or 1.5 meter above ground. The turn table can rotate 360 degrees to determine the position of the maximum emission level. The antenna can move up and down between 1 meter and 4 meters to find out the maximum emission level.

Both horizontal and vertical polarization of the antenna are set on measurement. In order to find the maximum emission, all of the interface cables must be manipulated according to ANSI C63.10: 2013 on radiated measurement.

On any frequency or frequencies from 9kHz(include The the lowest oscillator frequency generated within the device up to the 10th harmonic) to 1000 MHz, the limit shown are based on measuring equipment employing a quasi-peak detector function and on any frequency or frequencies above 1000 MHz the radiated limit shown are based upon the use of measurement instrumentation employing an average detector function. When average radiated emission measurement are included emission measurement below 1000 MHz, there also is a limit on the radio frequency emissions, as measured using instrumentation with a peak detector function, corresponding to 20 dB above the maximum permitted average limit.

The bandwidth below 1 GHz setting on the field strength meter is 120 kHz and above 1 GHz is 1MHz.

4.4. Test Specification

According to FCC Part 15 Subpart C Paragraph 15.247.

4.5. Test Result of Radiated Emissions (30 MHz ~ 1 GHz)

<For ANT0>

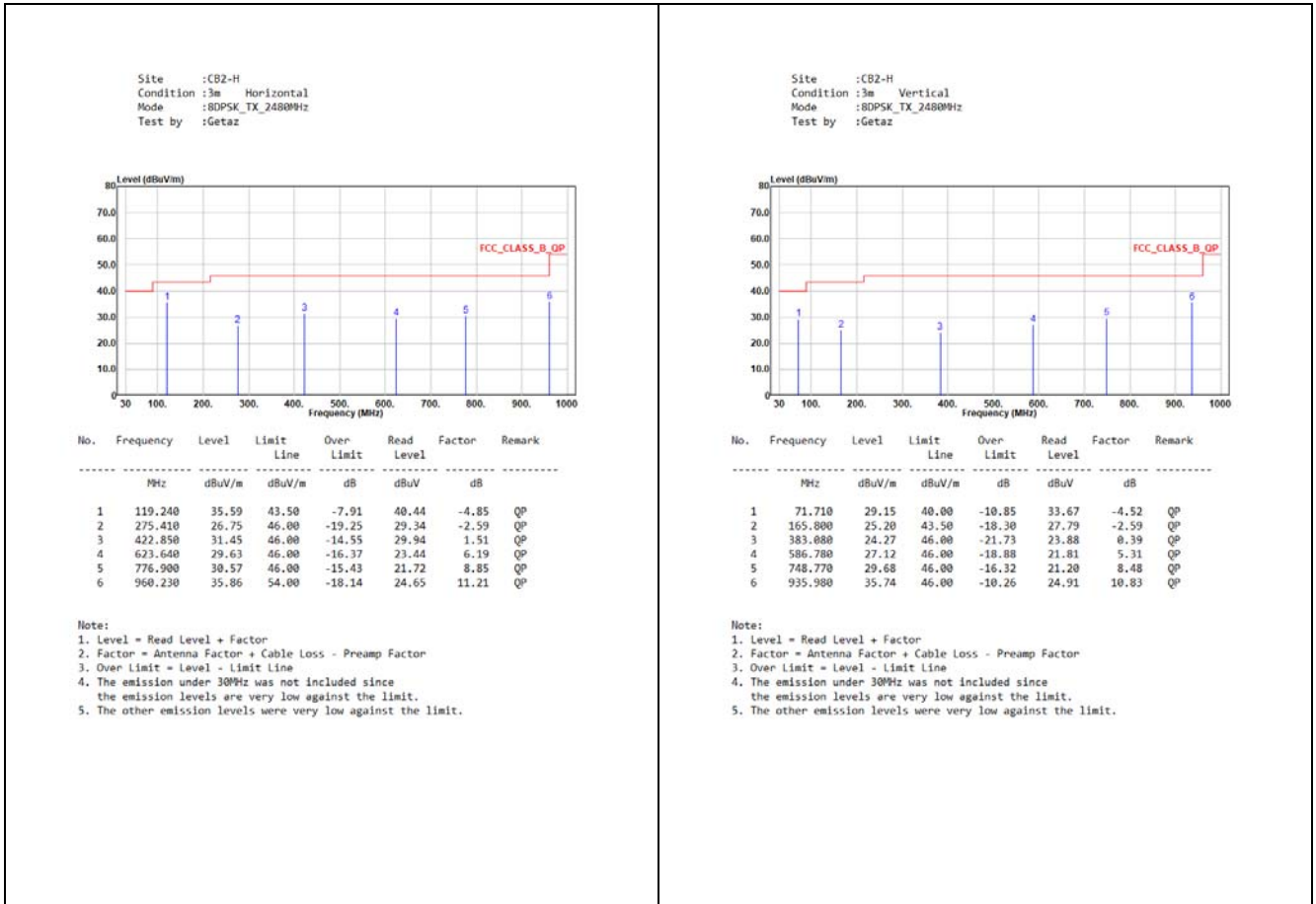

<For ANT1>

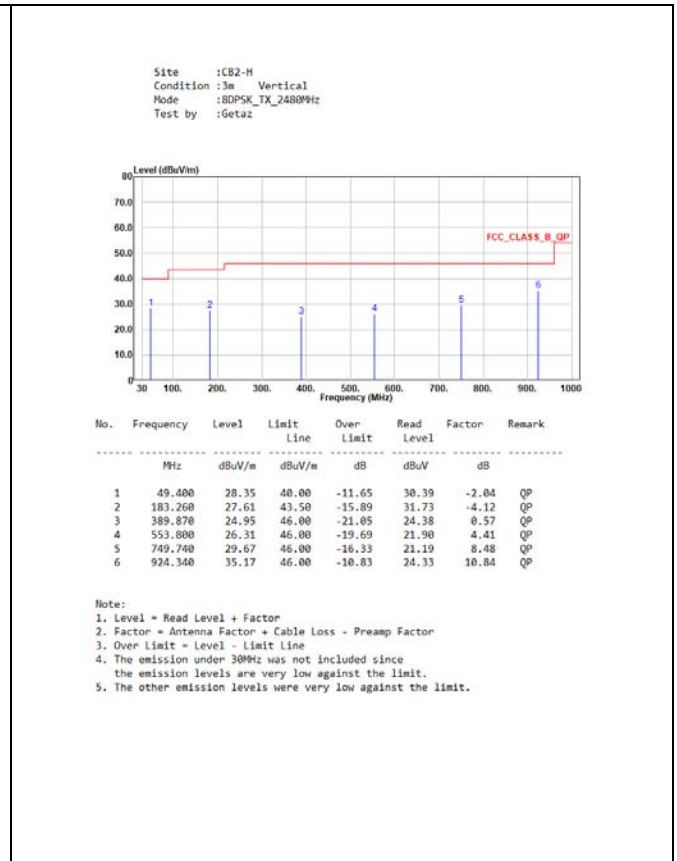
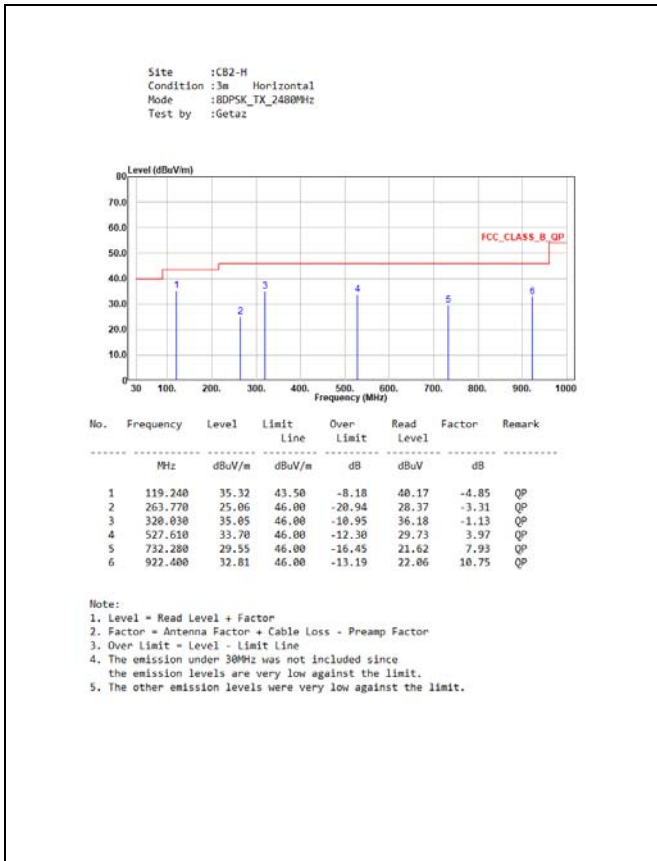

4.6. Test Result of Radiated Emissions (1 GHz ~ 10th Harmonic)

<For ANT0>

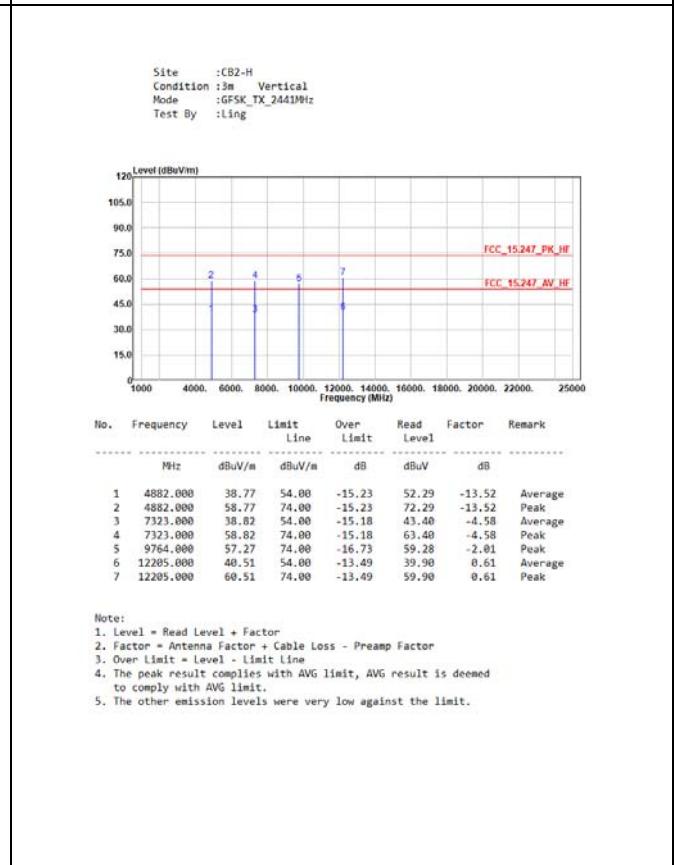
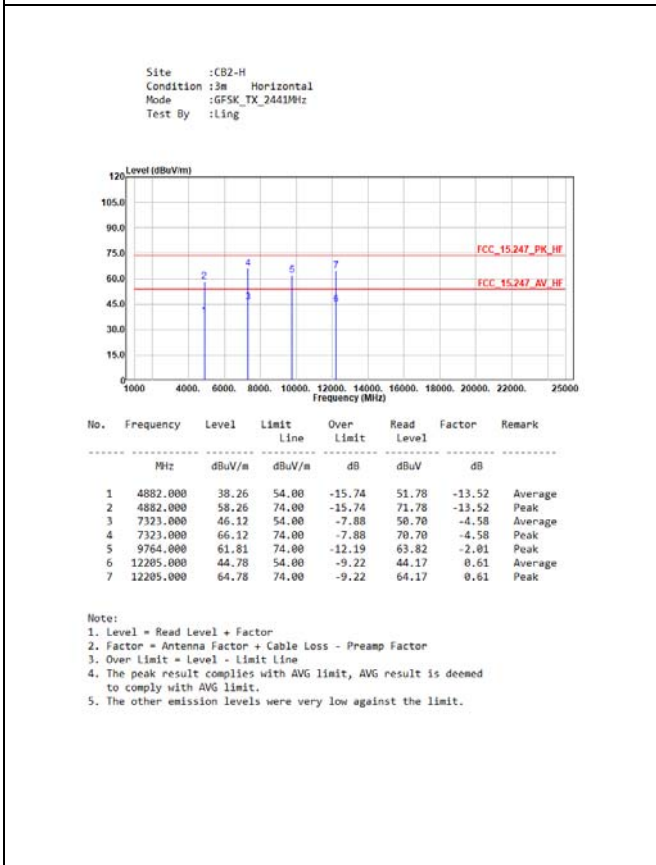
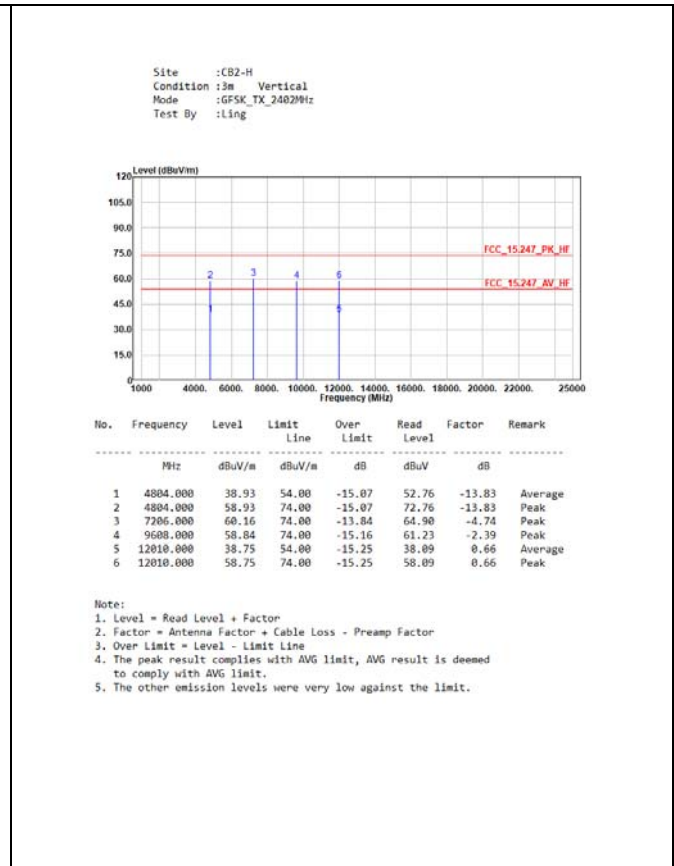
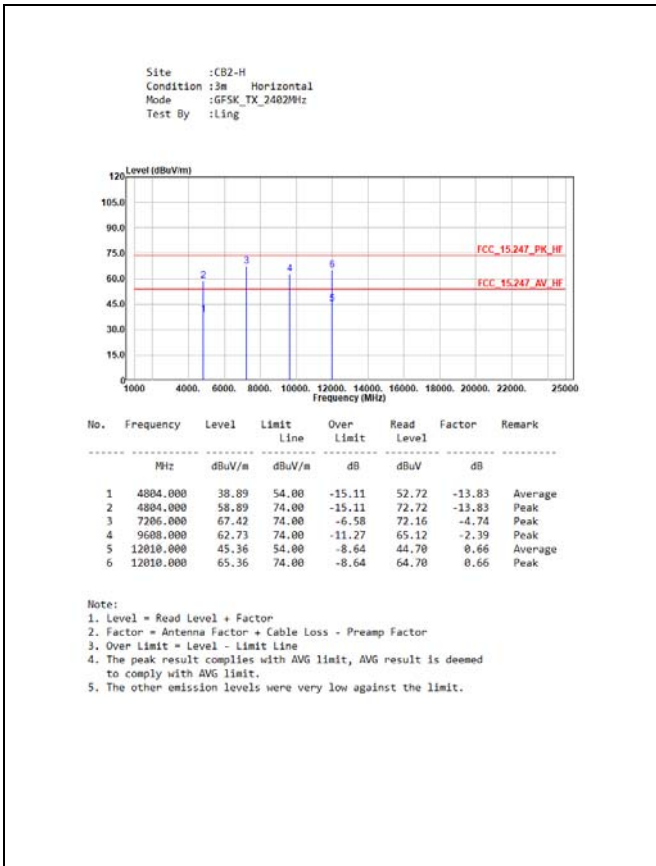

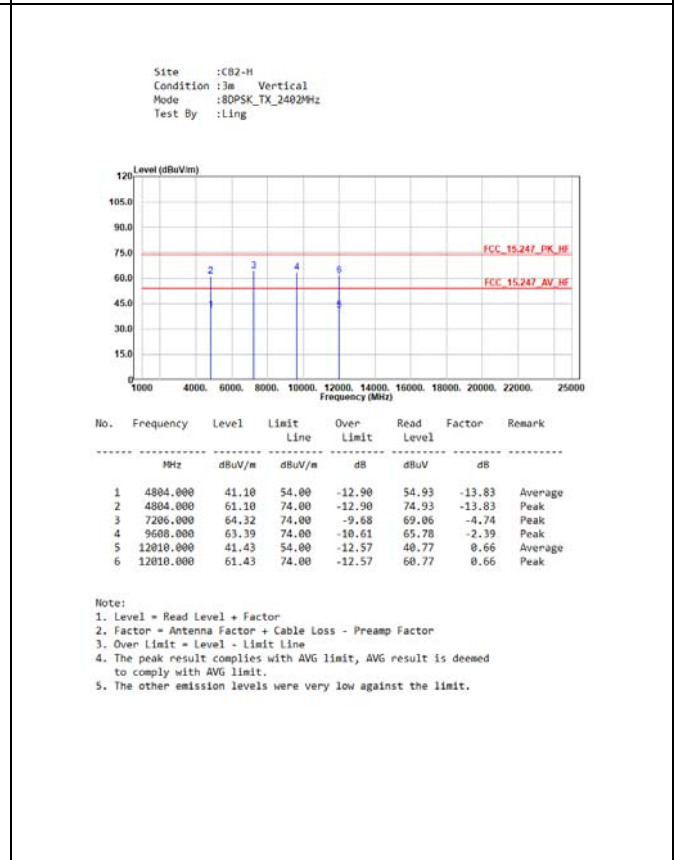
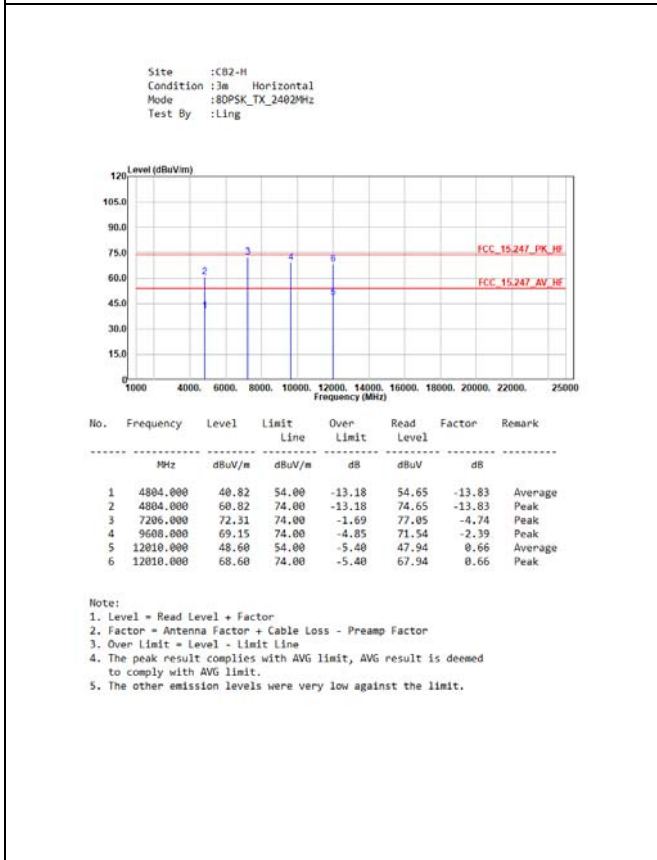
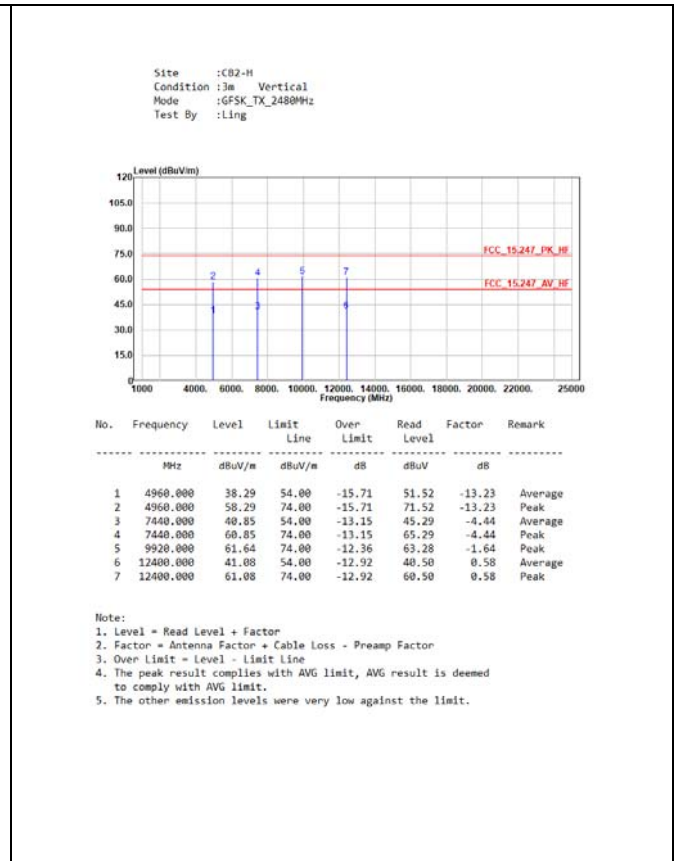
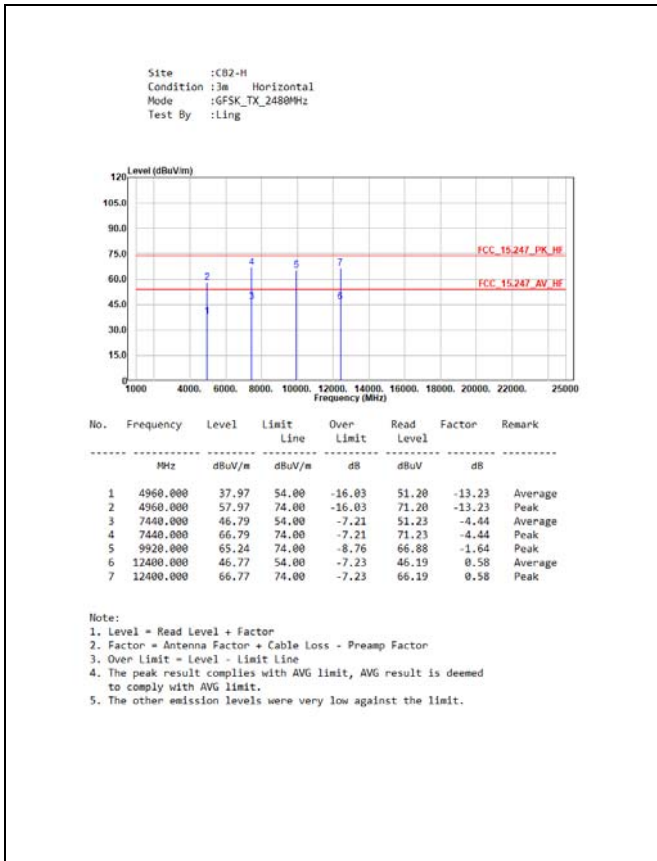

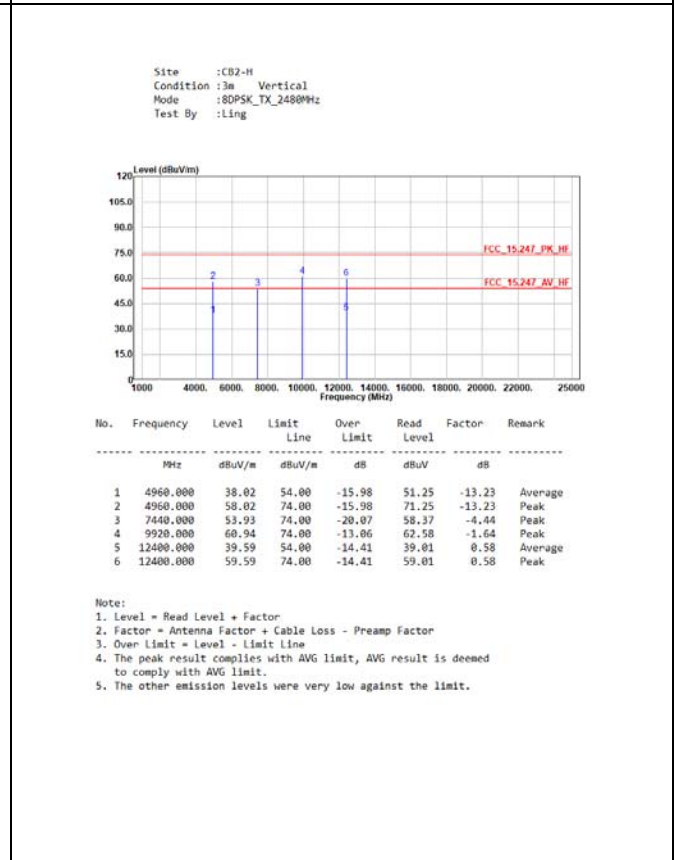
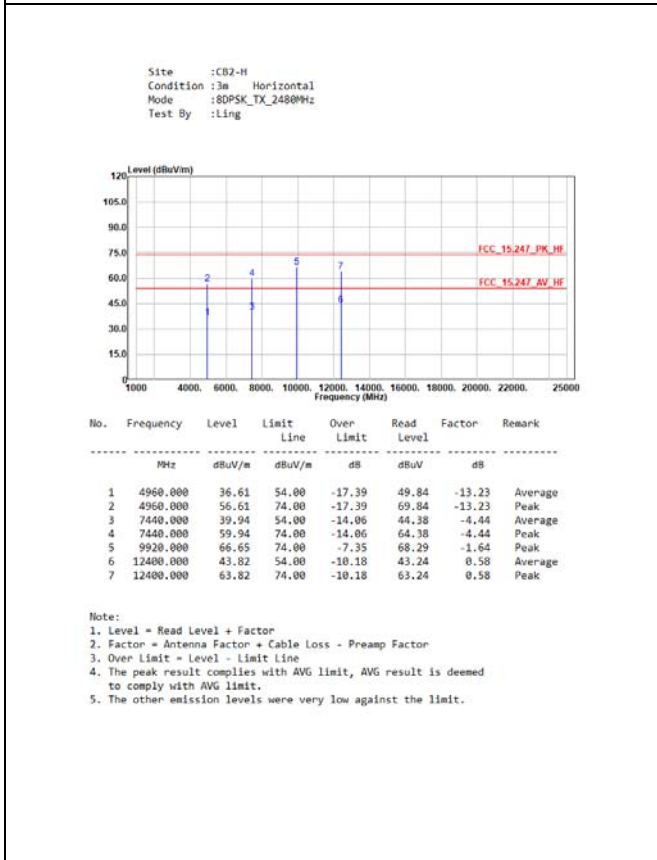
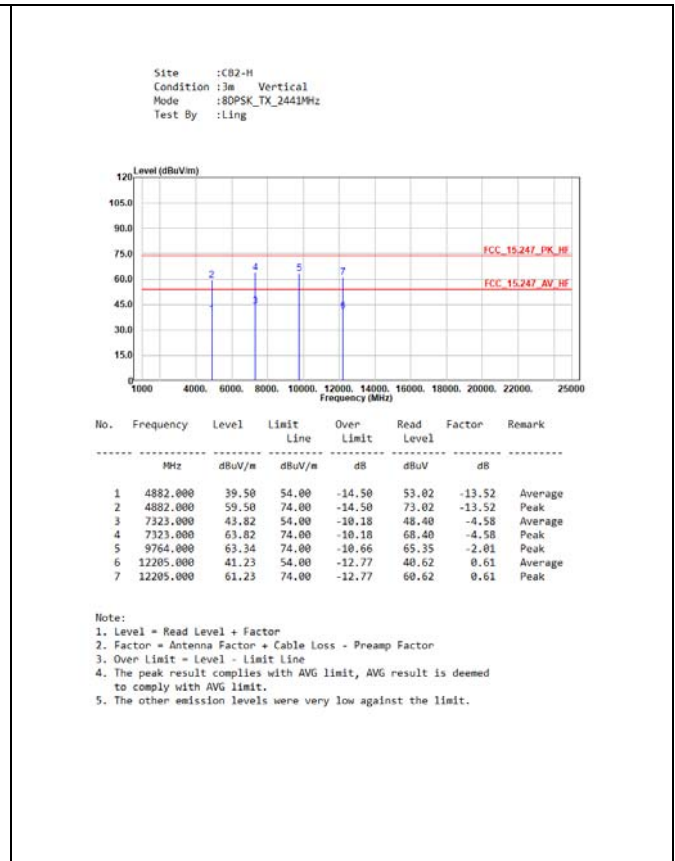
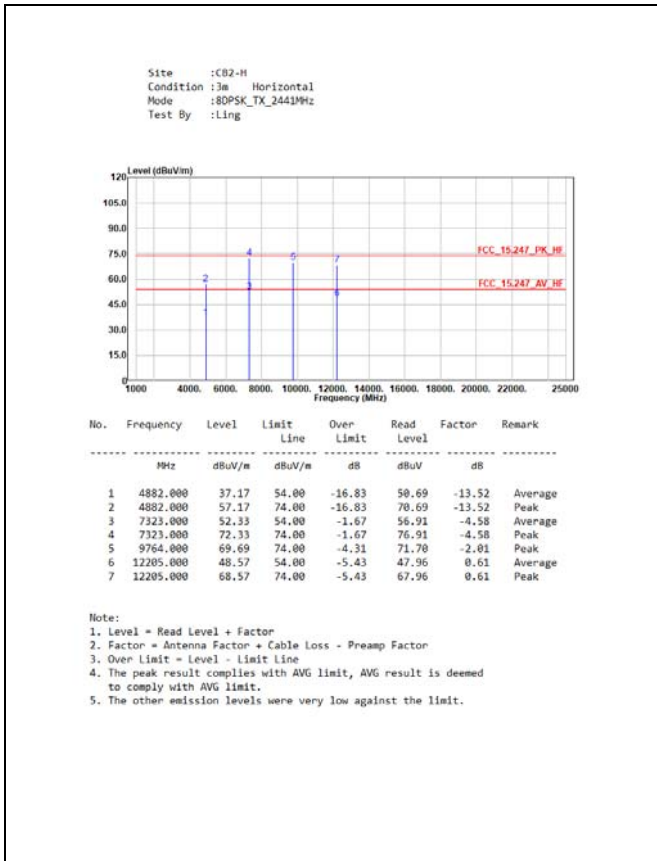

<For ANT1>

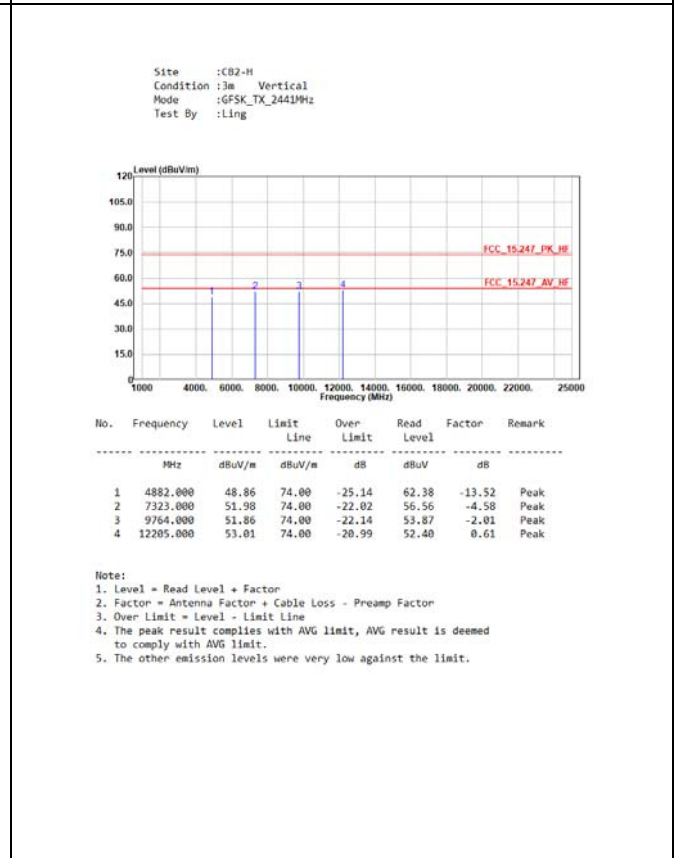
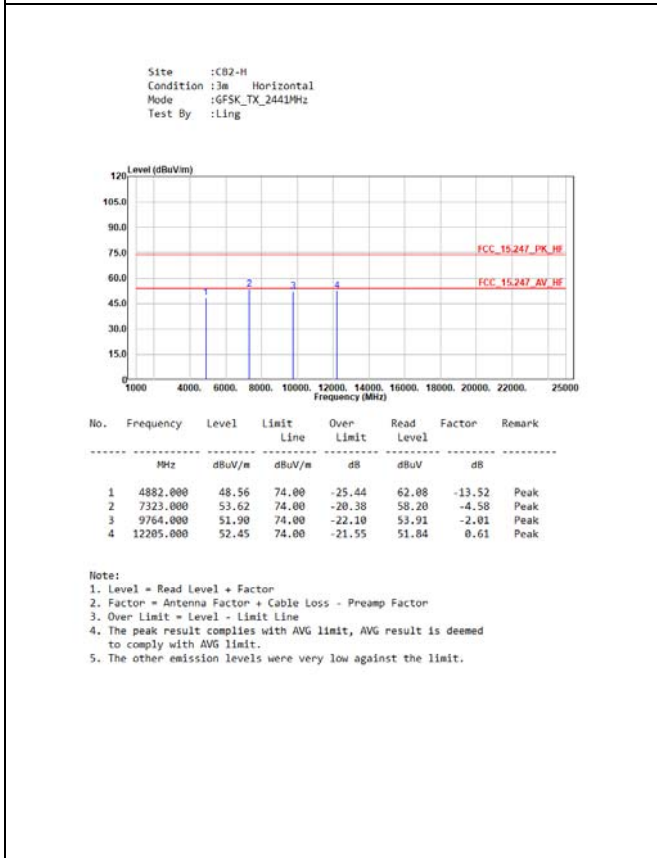
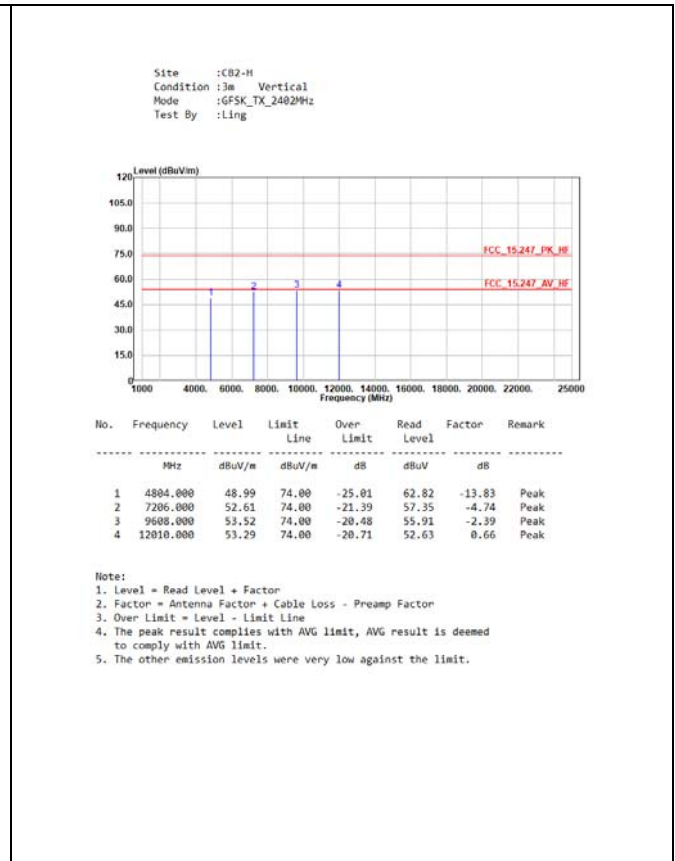
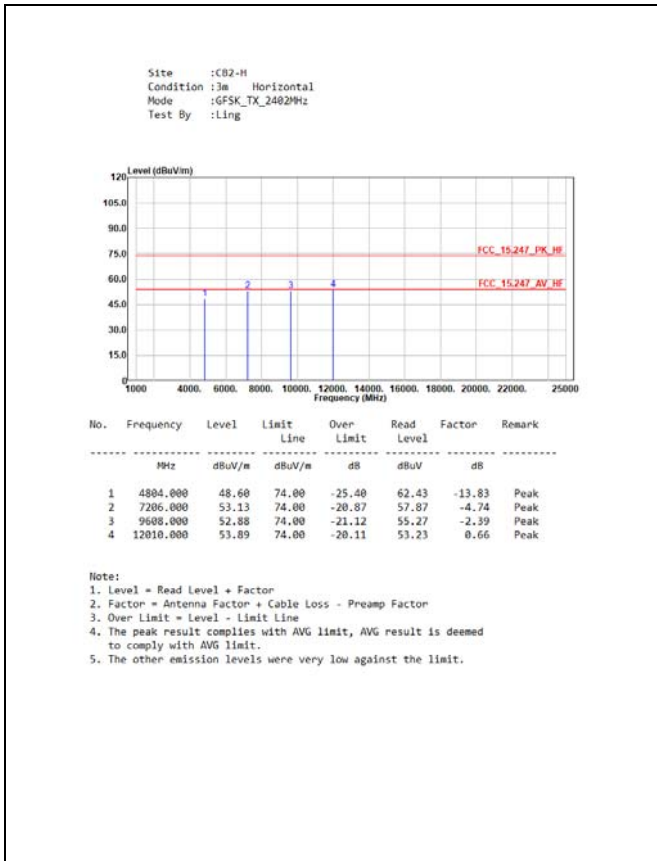

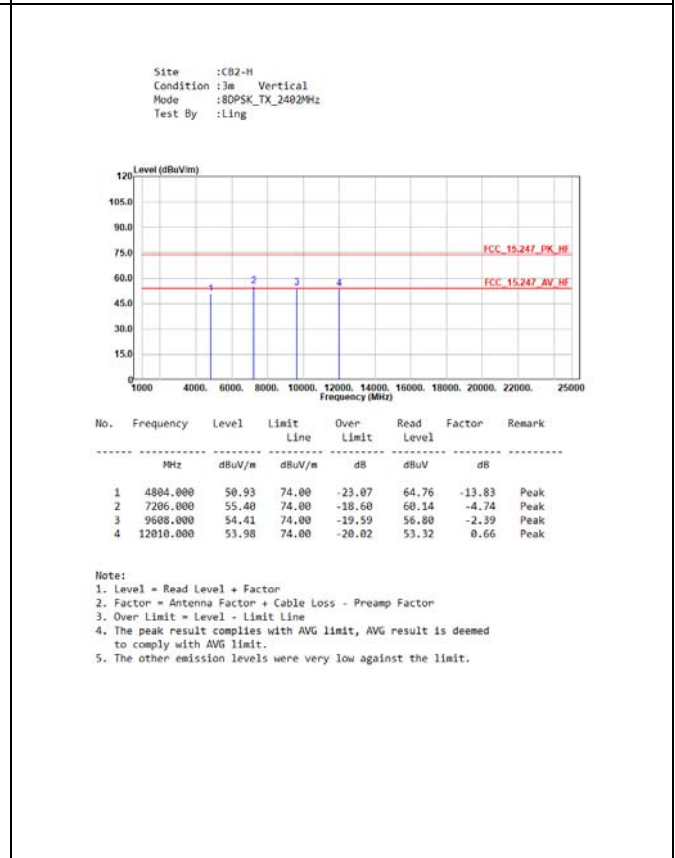
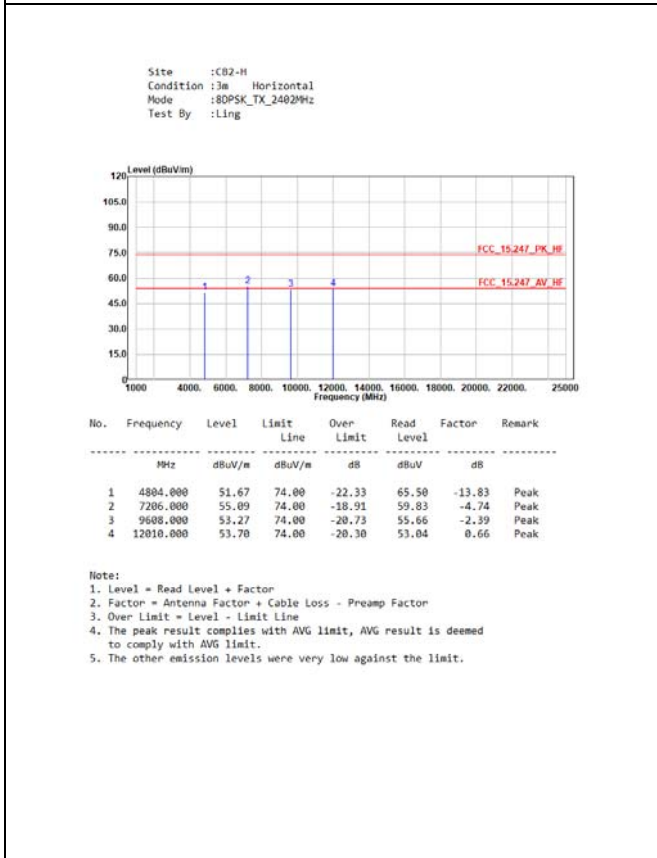
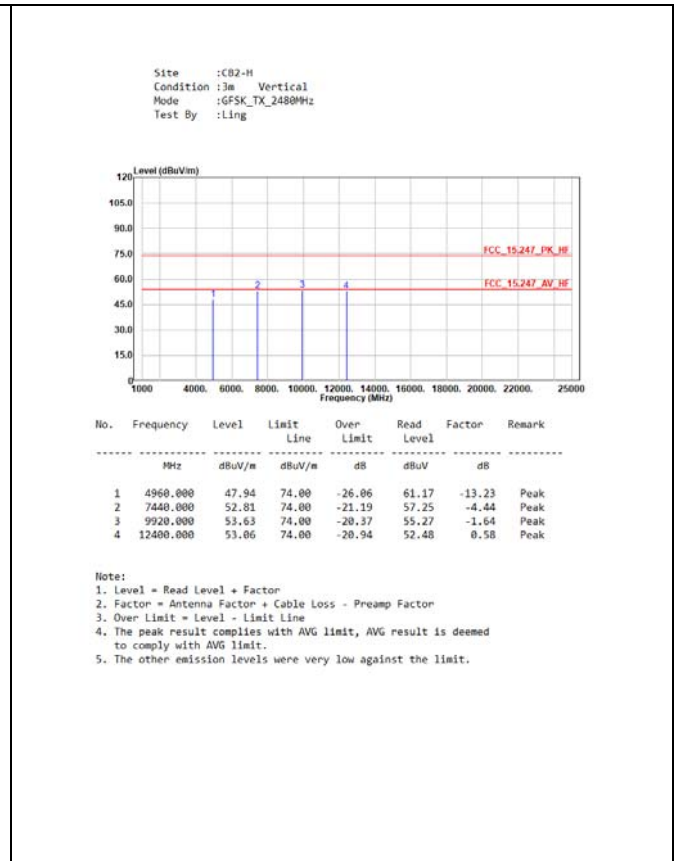
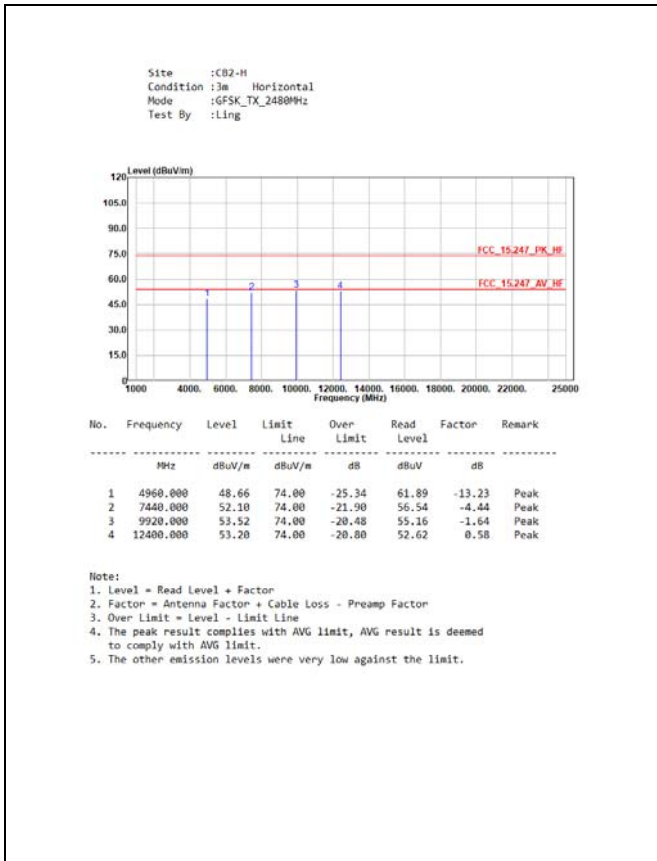

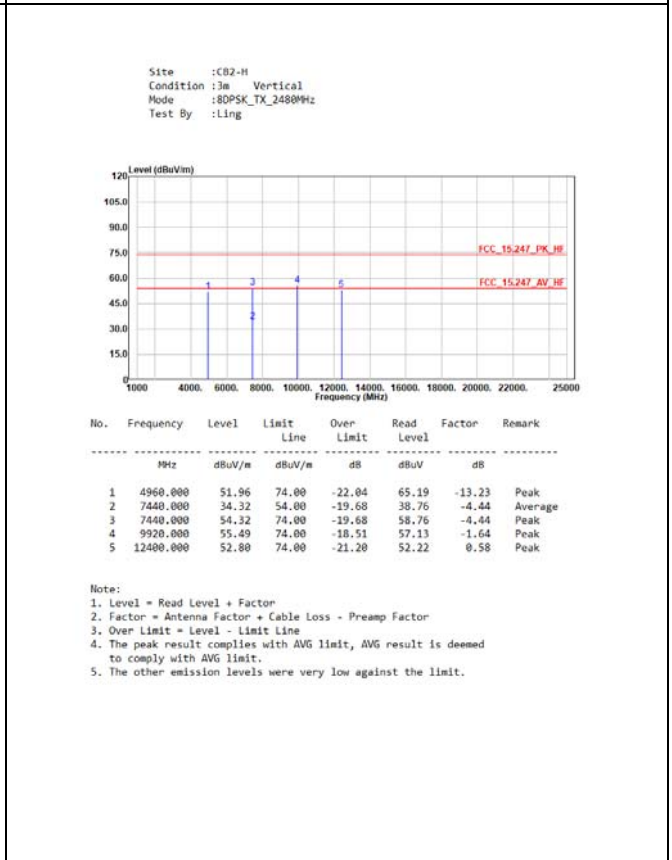
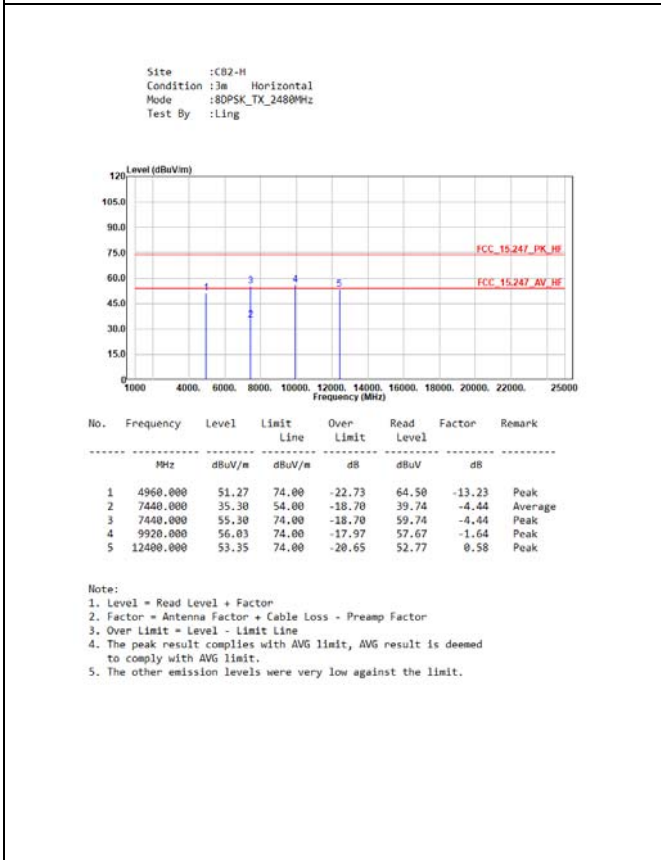
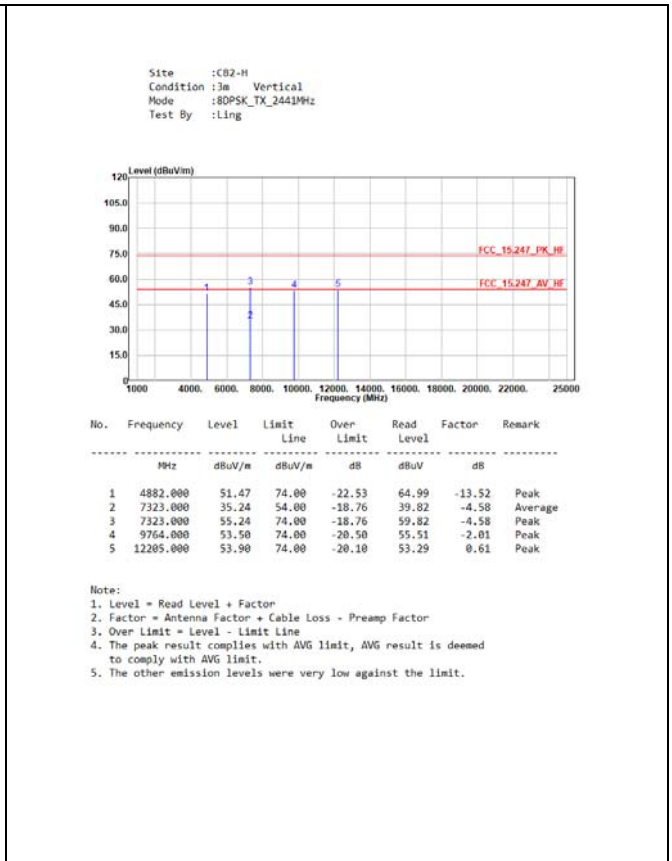
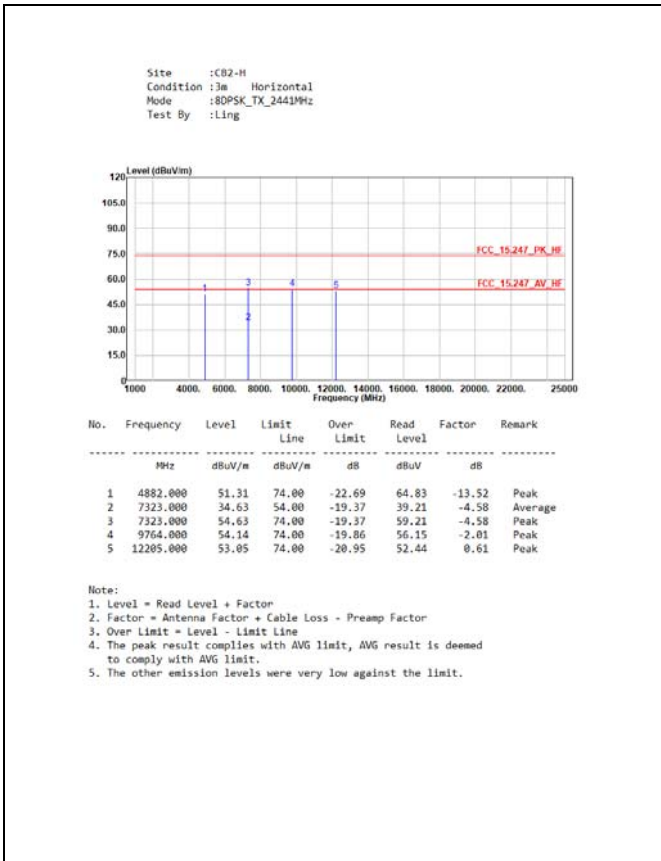

5. Antenna Port Conducted Emission

5.1. Test Setup

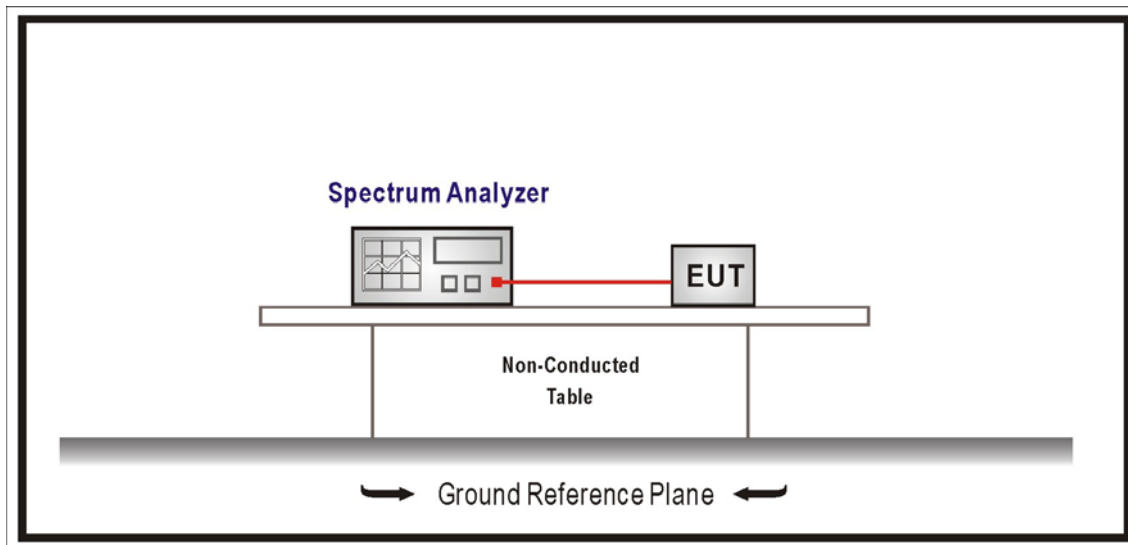

5.2. Test Limit

In any 100 kHz bandwidth outside the frequency band in which the spread spectrum intentional radiator is operating, the radio frequency power that is produced by the intentional radiator shall be at least 20 dB below that in the 100 kHz bandwidth within the band that contains the highest level of the desired power, based on an RF conducted or radiated measurement. Attenuation below the general limit specified in Section 15.209(a) is not required. In addition, radiated emissions which fall in the restricted bands, as defined in Section 15.205(a), must also comply with the radiated emission limit specified in Section 15.209(a) (see Section 15.205(c)).

5.3. Test Procedure

The EUT was setup according to ANSI C63.10: 2013 and tested according to FHSS test procedure of FCC KDB 558074 D01 v05r02 for compliance to FCC 47CFR 15.247

5.4. Test Specification

According to FCC Part 15 Subpart C Paragraph 15.247.

5.5. Test Result of Antenna Port Conducted Emission

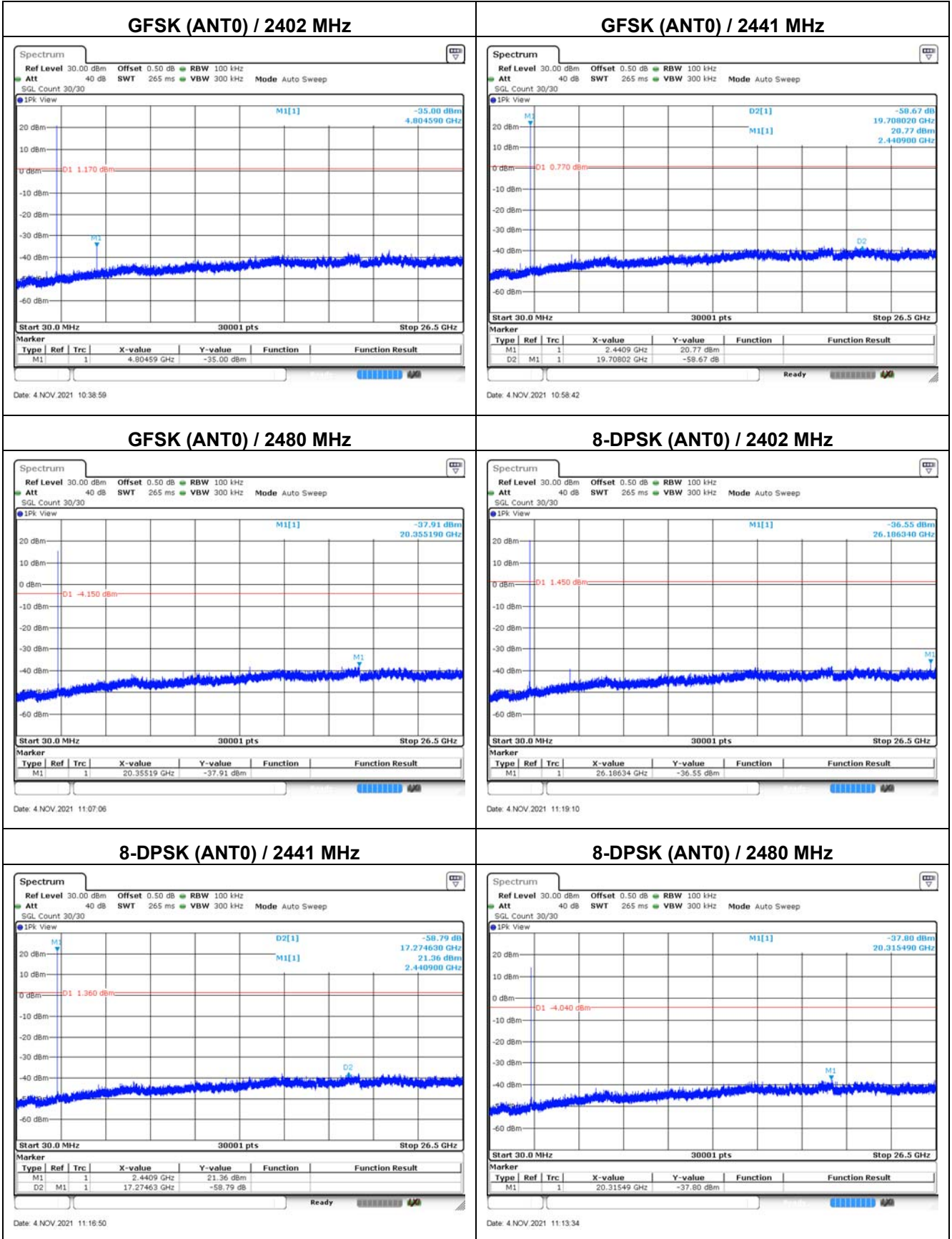

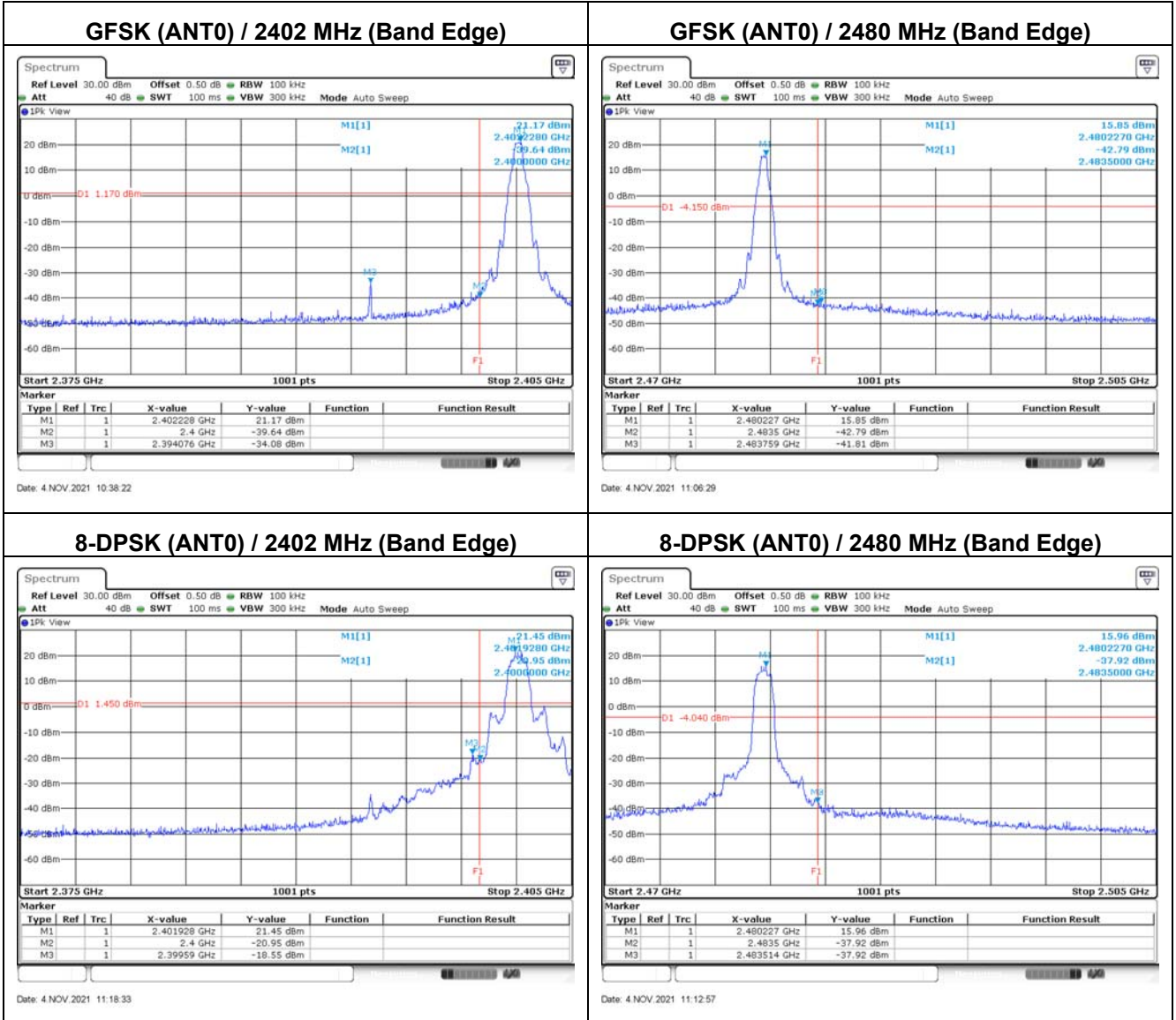

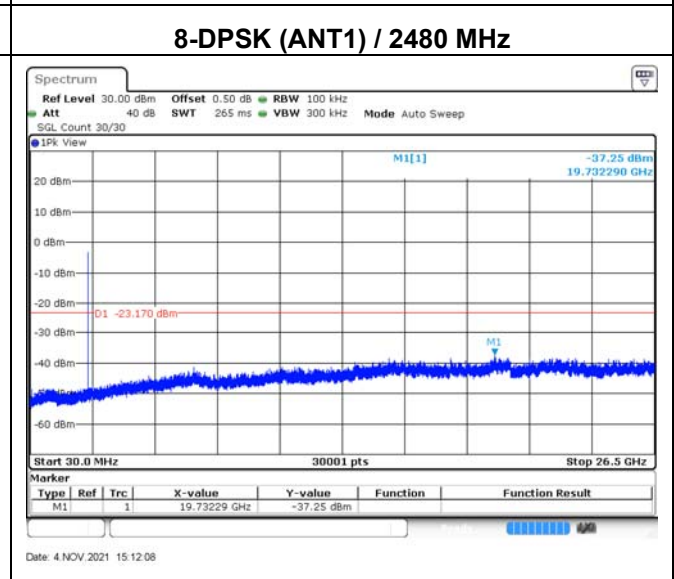
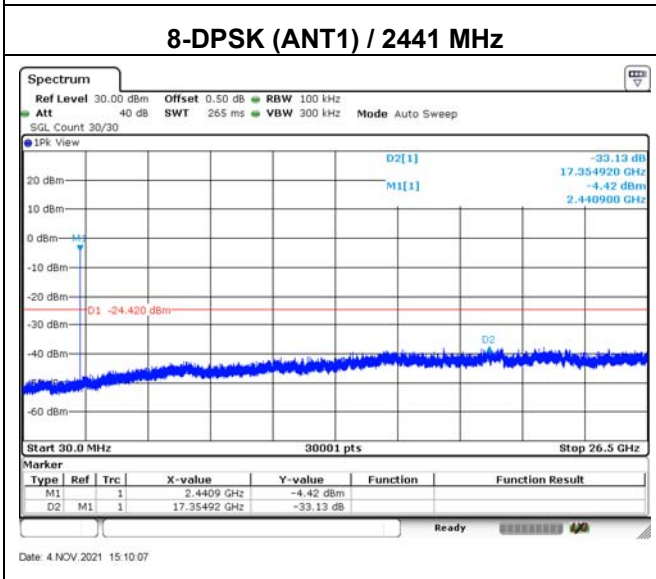
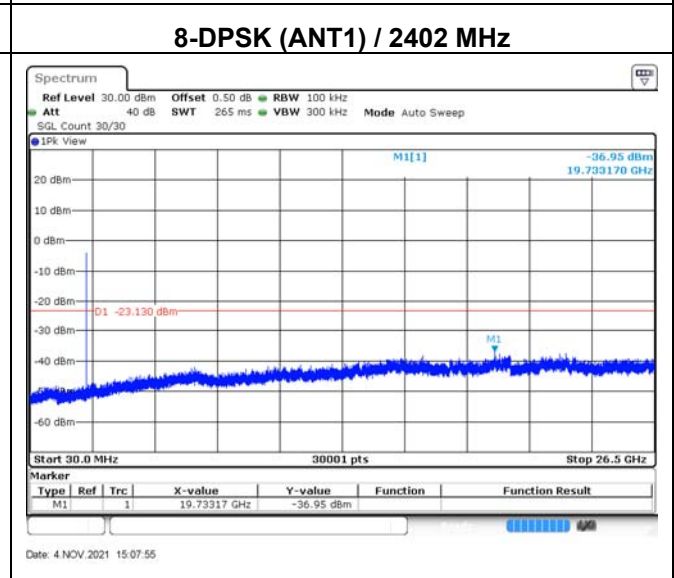
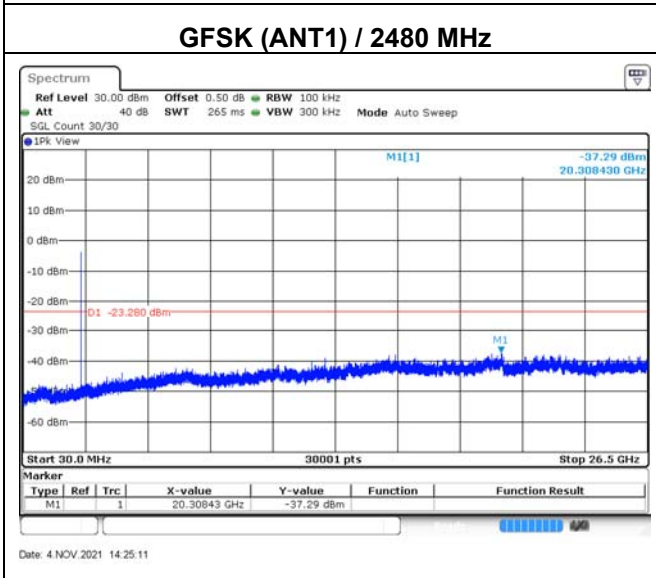
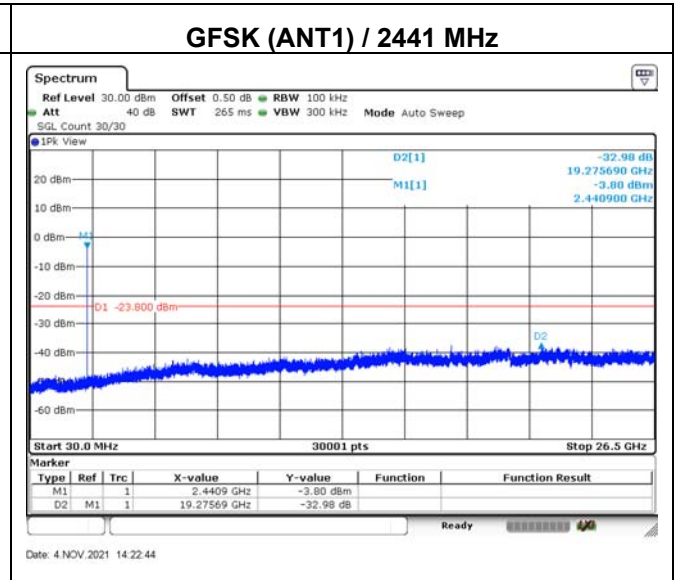
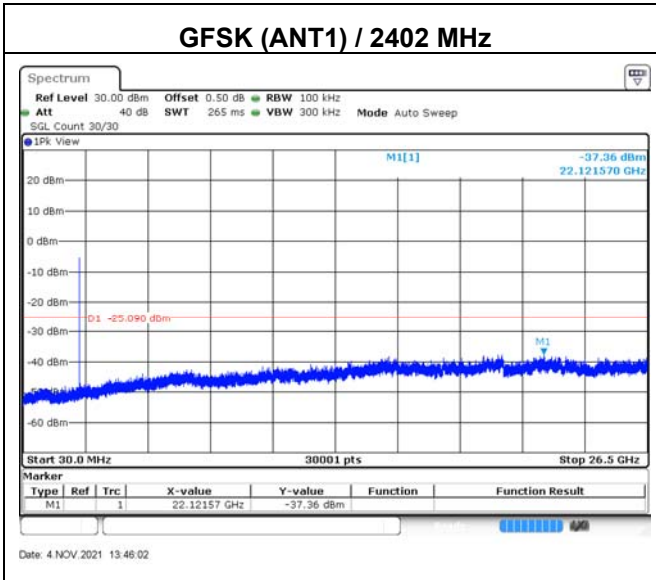

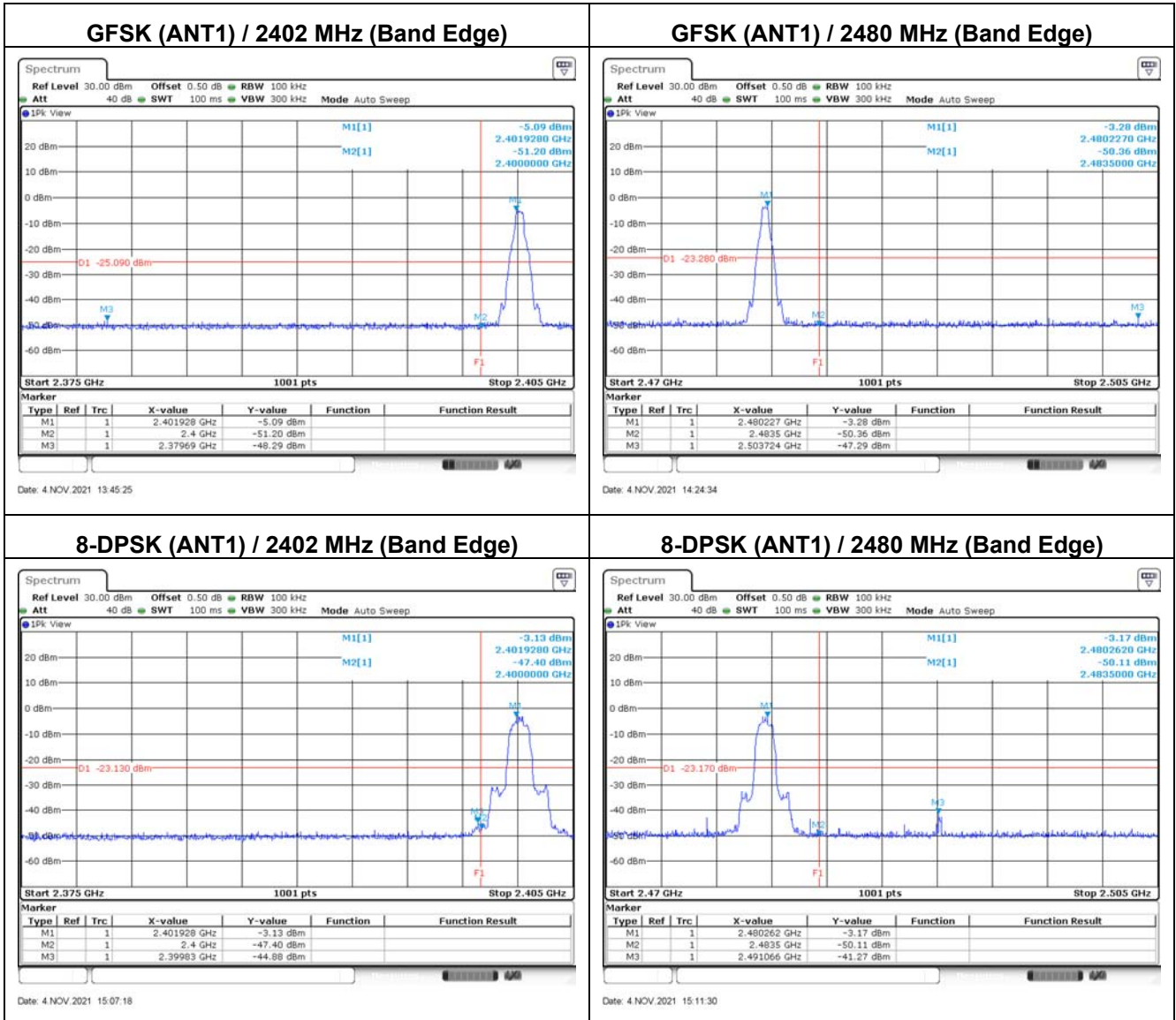

6. Radiated Emission Band Edge

6.1. Test Setup

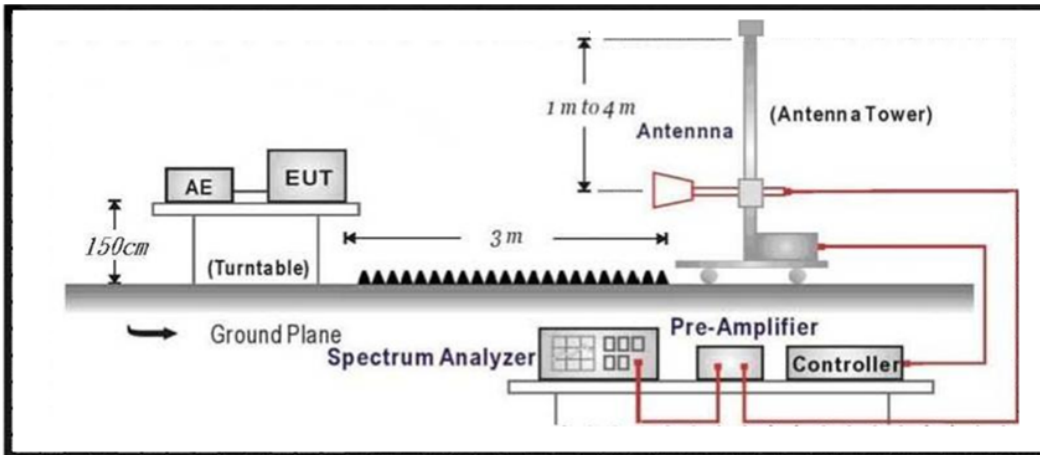

6.2. Test Limit

Emissions radiated outside of the specified frequency bands, except for harmonics, shall be attenuated by at least 20 dB below the level of the fundamental or to the general radiated emission limit in paragraph 15.209, whichever is the lesser attenuation.

Frequency (MHz)	Field strength (uV/m)	Field strength (dBuV/m)	Measurement distance (m)
30 - 88	100	40	3
88 - 216	150	43.5	3
216 - 960	200	46	3
Above 960	500	54	3

Remarks:

1. Field strength (dBuV/m) = 20 log Field strength (uV/m)
2. In the Above Table, the tighter limit applies at the band edges.
3. Distance refers to the distance in meters between the measuring instrument antenna and the closed point of any part of the device or system

6.3. Test Procedure

The EUT was setup according to ANSI C63.10: 2013 and tested according to FHSS test procedure of FCC KDB 558074 D01 v05r02 for compliance to FCC 47CFR 15.247 requirements.

The EUT and its simulators are placed on a turn table which is 1.5 meter above ground. The turn table can rotate 360 degrees to determine the position of the maximum emission level. The antenna can move up and down between 1 meter and 4 meters to find out the maximum emission level.

Both horizontal and vertical polarization of the antenna are set on measurement. In order to find the maximum emission, all of the interface cables must be manipulated according to ANSI C63.10: 2013 on radiated measurement.

6.4. Test Specification

According to FCC Part 15 Subpart C Paragraph 15.247.

6.5. Test Result of Radiated Emission Band Edge

<For ANT0>

Band Edge

<p>Site :CB2-H Condition :3m Horizontal Mode :GFSK_TX_2402MHz Test By :Ling</p> <table border="1"> <thead> <tr> <th>No.</th> <th>Frequency</th> <th>Level</th> <th>Limit</th> <th>Over</th> <th>Read</th> <th>Factor</th> <th>Remark</th> </tr> <tr> <th></th> <th>MHz</th> <th>dBuV/m</th> <th>dBuV/m</th> <th>dB</th> <th>dBuV</th> <th>dB</th> <th></th> </tr> </thead> <tbody> <tr> <td>1</td> <td>2389.400</td> <td>38.59</td> <td>54.00</td> <td>-15.41</td> <td>25.11</td> <td>13.48</td> <td>Average</td> </tr> <tr> <td>2</td> <td>2389.400</td> <td>58.59</td> <td>74.00</td> <td>-15.41</td> <td>45.11</td> <td>13.48</td> <td>Peak</td> </tr> <tr> <td>3</td> <td>2402.000</td> <td>118.95</td> <td>-----</td> <td>-----</td> <td>105.39</td> <td>13.56</td> <td>Peak</td> </tr> </tbody> </table> <p>Note: 1. Level = Read Level + Factor 2. Factor = Antenna Factor + Cable Loss - Preamp Factor 3. Over Limit = Level - Limit Line 4. The peak result complies with AVG limit, AVG result is deemed to comply with AVG limit. 5. The other emission levels were very low against the limit.</p>	No.	Frequency	Level	Limit	Over	Read	Factor	Remark		MHz	dBuV/m	dBuV/m	dB	dBuV	dB		1	2389.400	38.59	54.00	-15.41	25.11	13.48	Average	2	2389.400	58.59	74.00	-15.41	45.11	13.48	Peak	3	2402.000	118.95	-----	-----	105.39	13.56	Peak	<p>Site :CB2-H Condition :3m Vertical Mode :GFSK_TX_2402MHz Test By :Ling</p> <table border="1"> <thead> <tr> <th>No.</th> <th>Frequency</th> <th>Level</th> <th>Limit</th> <th>Over</th> <th>Read</th> <th>Factor</th> <th>Remark</th> </tr> <tr> <th></th> <th>MHz</th> <th>dBuV/m</th> <th>dBuV/m</th> <th>dB</th> <th>dBuV</th> <th>dB</th> <th></th> </tr> </thead> <tbody> <tr> <td>1</td> <td>2389.400</td> <td>52.95</td> <td>74.00</td> <td>-21.05</td> <td>39.47</td> <td>13.48</td> <td>Peak</td> </tr> <tr> <td>2</td> <td>2402.000</td> <td>113.52</td> <td>-----</td> <td>-----</td> <td>99.96</td> <td>13.56</td> <td>Peak</td> </tr> </tbody> </table> <p>Note: 1. Level = Read Level + Factor 2. Factor = Antenna Factor + Cable Loss - Preamp Factor 3. Over Limit = Level - Limit Line 4. The peak result complies with AVG limit, AVG result is deemed to comply with AVG limit. 5. The other emission levels were very low against the limit.</p>	No.	Frequency	Level	Limit	Over	Read	Factor	Remark		MHz	dBuV/m	dBuV/m	dB	dBuV	dB		1	2389.400	52.95	74.00	-21.05	39.47	13.48	Peak	2	2402.000	113.52	-----	-----	99.96	13.56	Peak								
No.	Frequency	Level	Limit	Over	Read	Factor	Remark																																																																										
	MHz	dBuV/m	dBuV/m	dB	dBuV	dB																																																																											
1	2389.400	38.59	54.00	-15.41	25.11	13.48	Average																																																																										
2	2389.400	58.59	74.00	-15.41	45.11	13.48	Peak																																																																										
3	2402.000	118.95	-----	-----	105.39	13.56	Peak																																																																										
No.	Frequency	Level	Limit	Over	Read	Factor	Remark																																																																										
	MHz	dBuV/m	dBuV/m	dB	dBuV	dB																																																																											
1	2389.400	52.95	74.00	-21.05	39.47	13.48	Peak																																																																										
2	2402.000	113.52	-----	-----	99.96	13.56	Peak																																																																										
<p>Site :CB2-H Condition :3m Horizontal Mode :GFSK_TX_2441MHz Test By :Ling</p> <table border="1"> <thead> <tr> <th>No.</th> <th>Frequency</th> <th>Level</th> <th>Limit</th> <th>Over</th> <th>Read</th> <th>Factor</th> <th>Remark</th> </tr> <tr> <th></th> <th>MHz</th> <th>dBuV/m</th> <th>dBuV/m</th> <th>dB</th> <th>dBuV</th> <th>dB</th> <th></th> </tr> </thead> <tbody> <tr> <td>1</td> <td>2383.200</td> <td>49.13</td> <td>74.00</td> <td>-24.87</td> <td>35.69</td> <td>13.44</td> <td>Peak</td> </tr> <tr> <td>2</td> <td>2441.000</td> <td>119.66</td> <td>-----</td> <td>-----</td> <td>105.86</td> <td>13.80</td> <td>Peak</td> </tr> <tr> <td>3</td> <td>2488.400</td> <td>51.12</td> <td>74.00</td> <td>-22.88</td> <td>37.02</td> <td>14.10</td> <td>Peak</td> </tr> </tbody> </table> <p>Note: 1. Level = Read Level + Factor 2. Factor = Antenna Factor + Cable Loss - Preamp Factor 3. Over Limit = Level - Limit Line 4. The peak result complies with AVG limit, AVG result is deemed to comply with AVG limit. 5. The other emission levels were very low against the limit.</p>	No.	Frequency	Level	Limit	Over	Read	Factor	Remark		MHz	dBuV/m	dBuV/m	dB	dBuV	dB		1	2383.200	49.13	74.00	-24.87	35.69	13.44	Peak	2	2441.000	119.66	-----	-----	105.86	13.80	Peak	3	2488.400	51.12	74.00	-22.88	37.02	14.10	Peak	<p>Site :CB2-H Condition :3m Vertical Mode :GFSK_TX_2441MHz Test By :Ling</p> <table border="1"> <thead> <tr> <th>No.</th> <th>Frequency</th> <th>Level</th> <th>Limit</th> <th>Over</th> <th>Read</th> <th>Factor</th> <th>Remark</th> </tr> <tr> <th></th> <th>MHz</th> <th>dBuV/m</th> <th>dBuV/m</th> <th>dB</th> <th>dBuV</th> <th>dB</th> <th></th> </tr> </thead> <tbody> <tr> <td>1</td> <td>2377.600</td> <td>46.20</td> <td>74.00</td> <td>-27.80</td> <td>32.79</td> <td>13.41</td> <td>Peak</td> </tr> <tr> <td>2</td> <td>2441.000</td> <td>114.33</td> <td>-----</td> <td>-----</td> <td>100.53</td> <td>13.80</td> <td>Peak</td> </tr> <tr> <td>3</td> <td>2486.400</td> <td>47.44</td> <td>74.00</td> <td>-26.56</td> <td>33.35</td> <td>14.09</td> <td>Peak</td> </tr> </tbody> </table> <p>Note: 1. Level = Read Level + Factor 2. Factor = Antenna Factor + Cable Loss - Preamp Factor 3. Over Limit = Level - Limit Line 4. The peak result complies with AVG limit, AVG result is deemed to comply with AVG limit. 5. The other emission levels were very low against the limit.</p>	No.	Frequency	Level	Limit	Over	Read	Factor	Remark		MHz	dBuV/m	dBuV/m	dB	dBuV	dB		1	2377.600	46.20	74.00	-27.80	32.79	13.41	Peak	2	2441.000	114.33	-----	-----	100.53	13.80	Peak	3	2486.400	47.44	74.00	-26.56	33.35	14.09	Peak
No.	Frequency	Level	Limit	Over	Read	Factor	Remark																																																																										
	MHz	dBuV/m	dBuV/m	dB	dBuV	dB																																																																											
1	2383.200	49.13	74.00	-24.87	35.69	13.44	Peak																																																																										
2	2441.000	119.66	-----	-----	105.86	13.80	Peak																																																																										
3	2488.400	51.12	74.00	-22.88	37.02	14.10	Peak																																																																										
No.	Frequency	Level	Limit	Over	Read	Factor	Remark																																																																										
	MHz	dBuV/m	dBuV/m	dB	dBuV	dB																																																																											
1	2377.600	46.20	74.00	-27.80	32.79	13.41	Peak																																																																										
2	2441.000	114.33	-----	-----	100.53	13.80	Peak																																																																										
3	2486.400	47.44	74.00	-26.56	33.35	14.09	Peak																																																																										

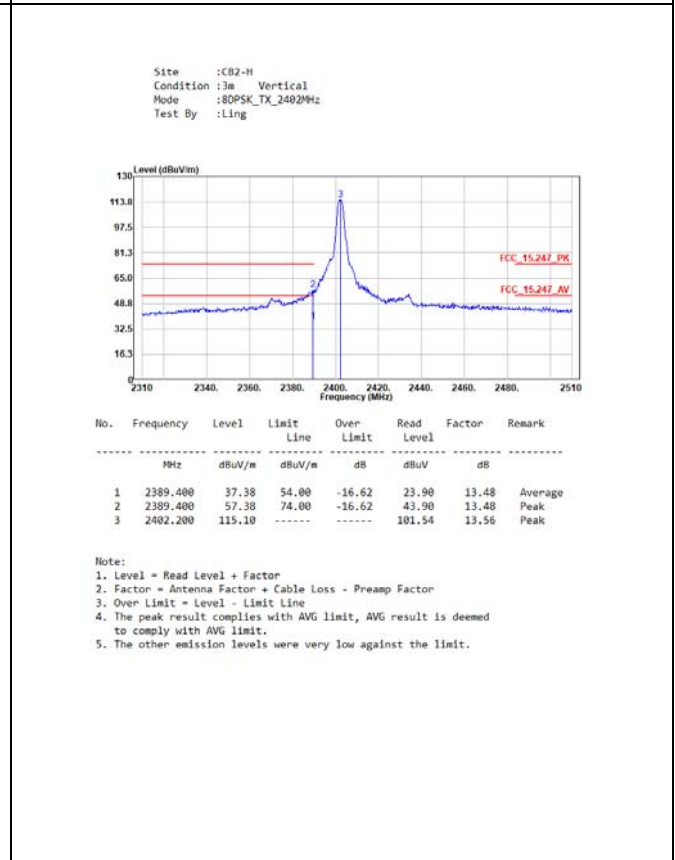
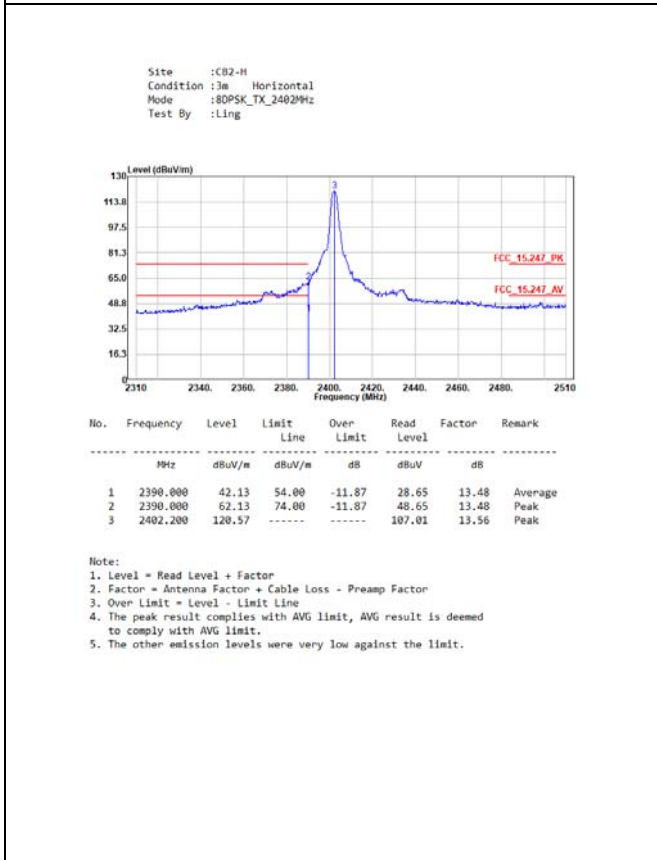
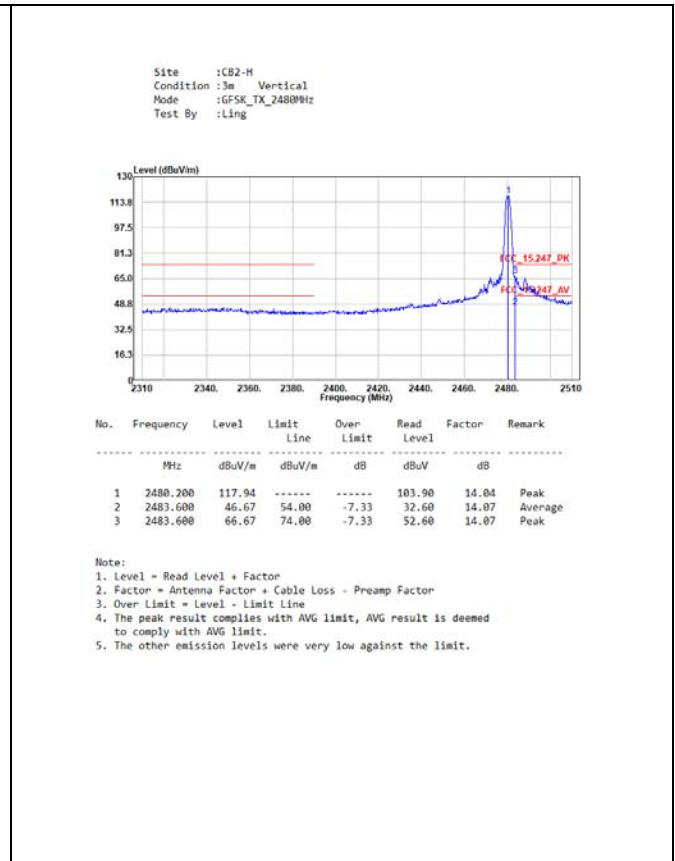
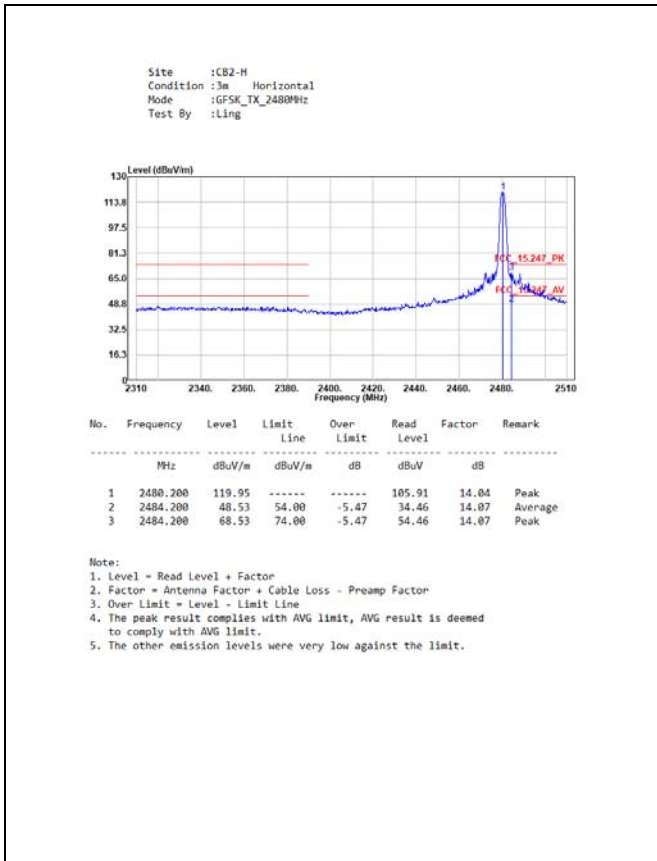

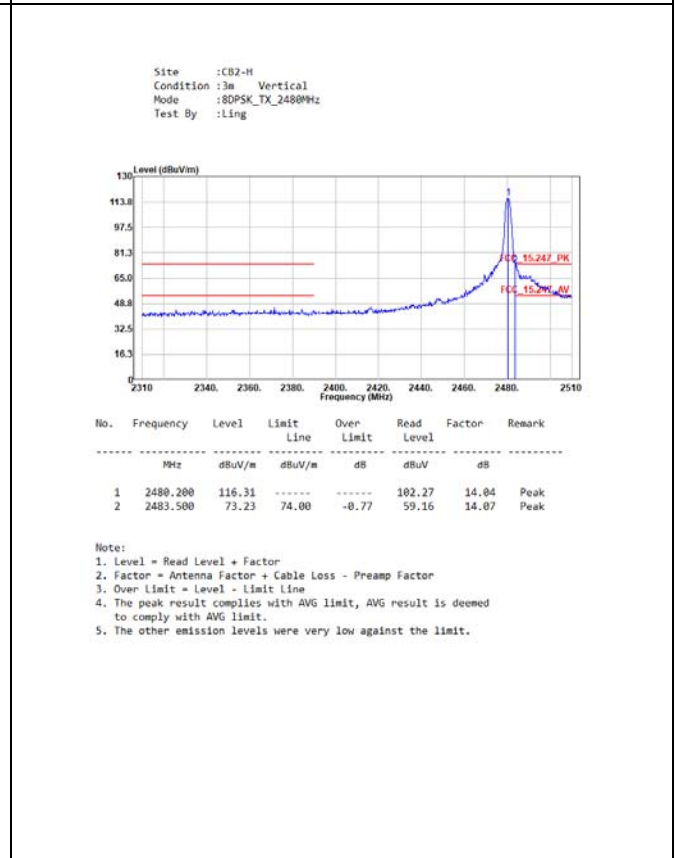
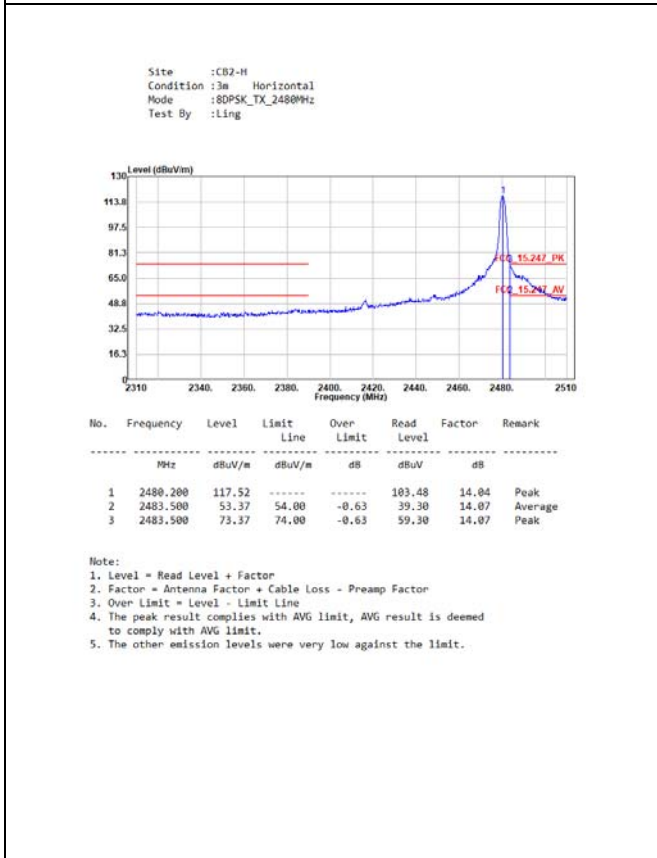
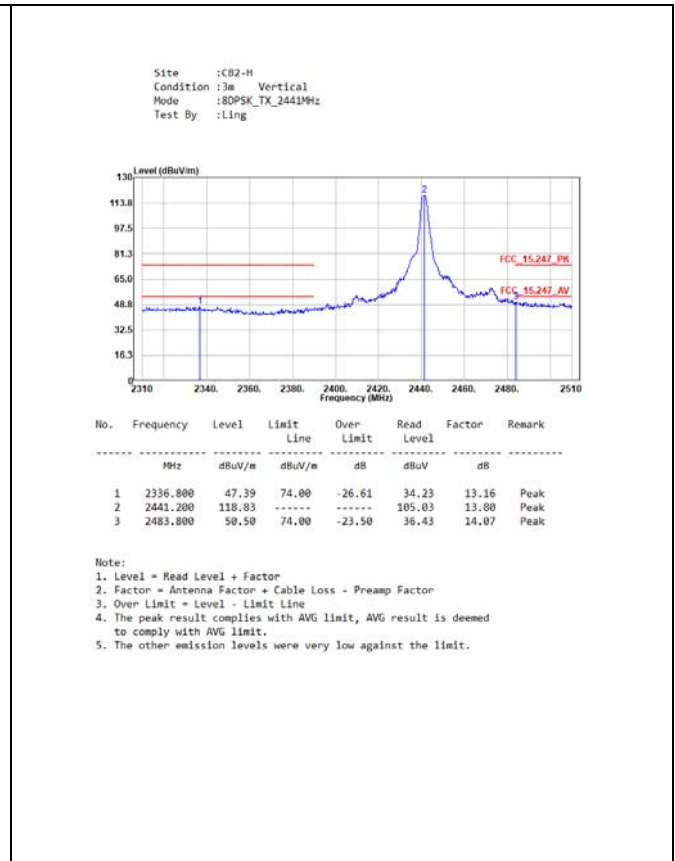
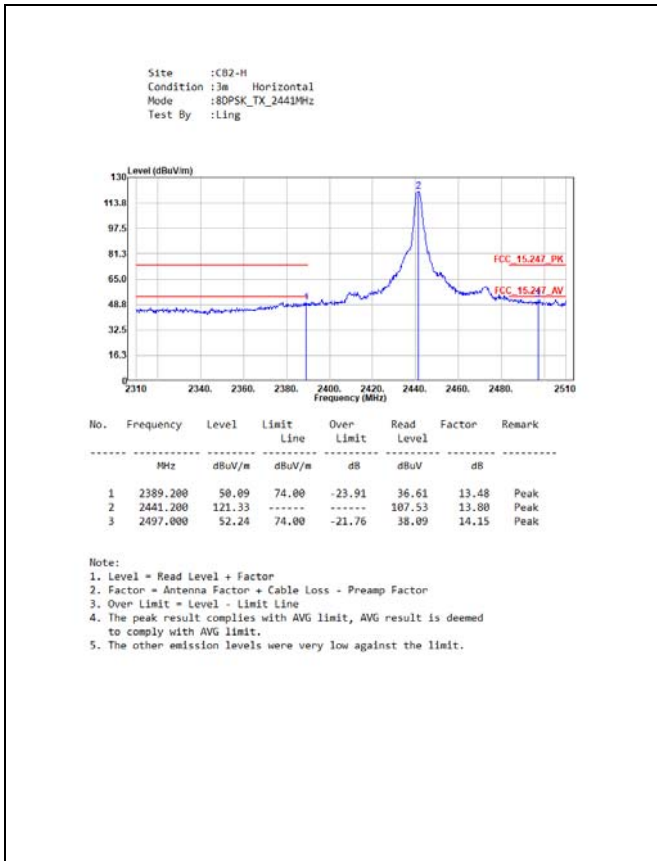

Band Edge – Hopping

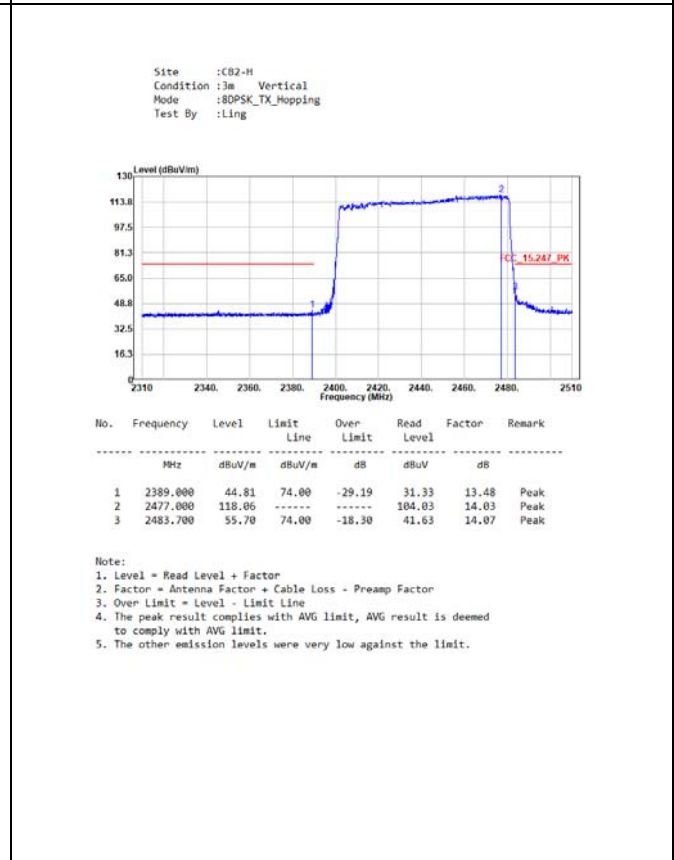
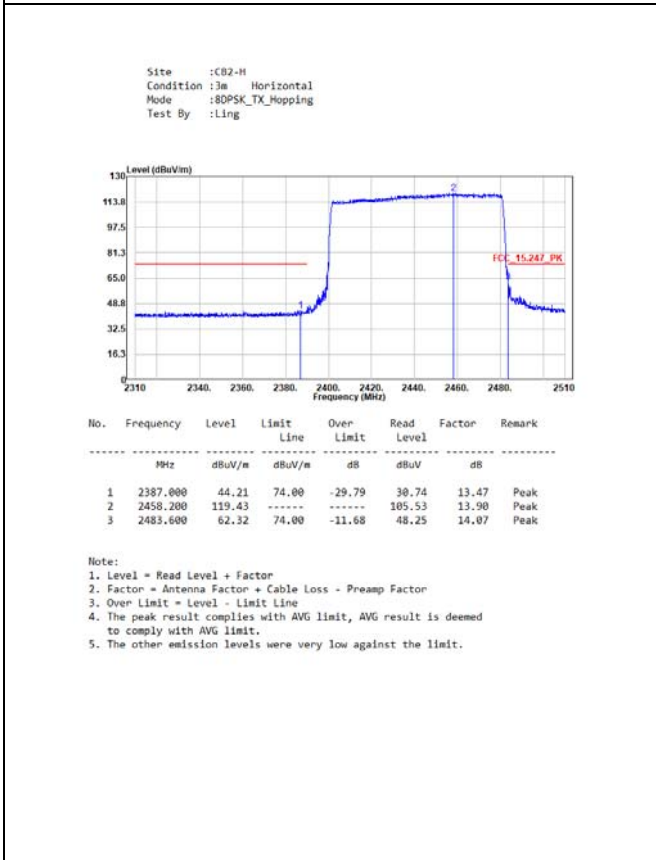
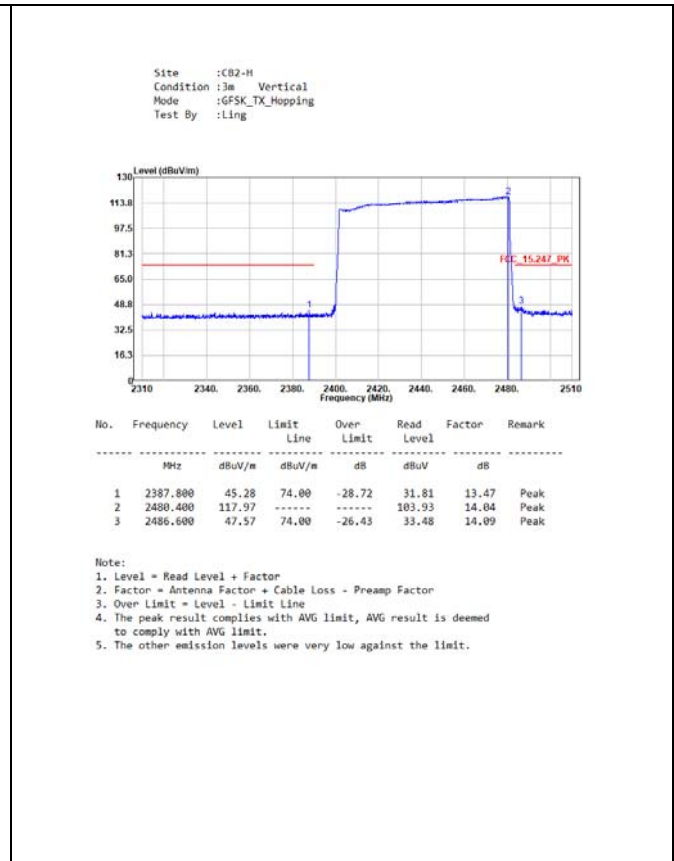
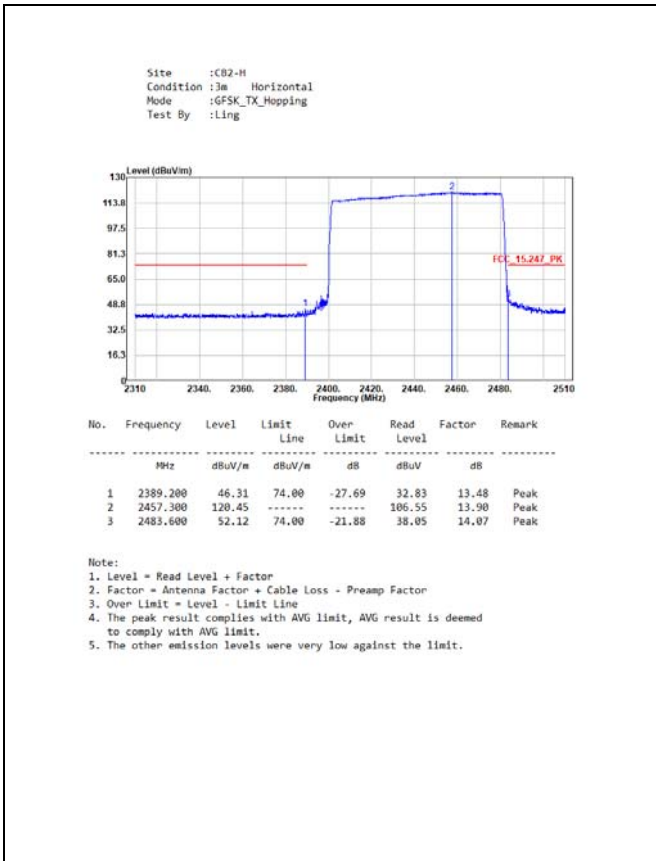

<For ANT1>

Band Edge

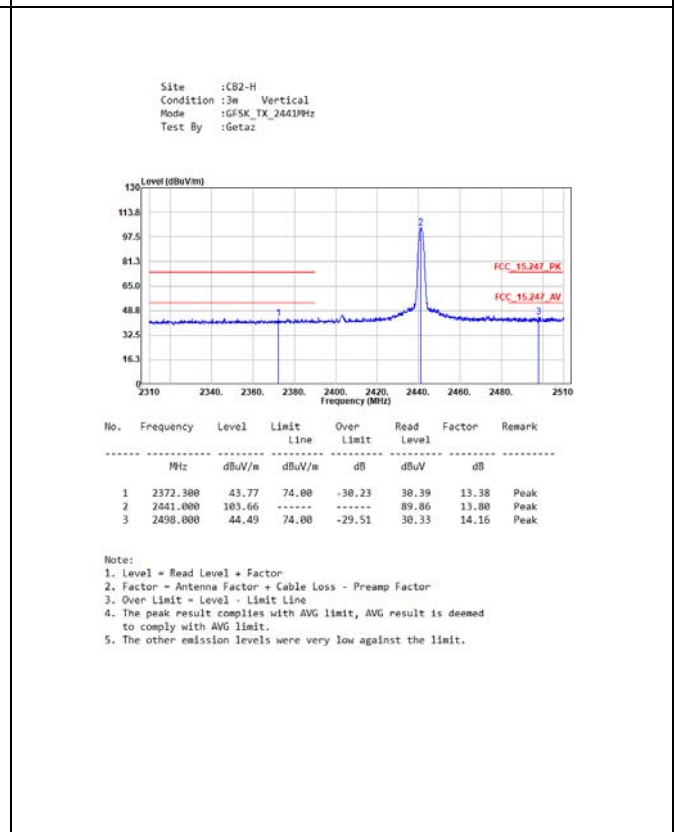
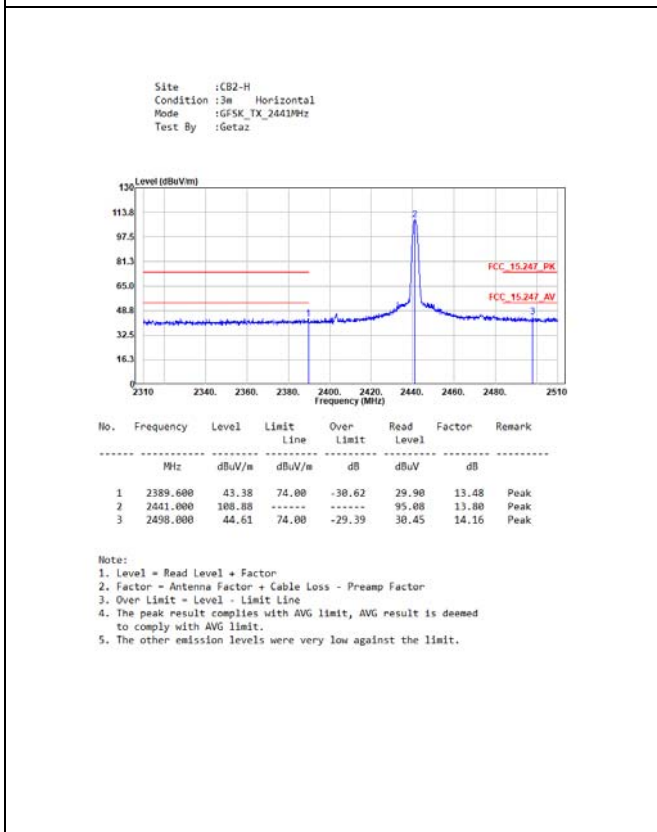
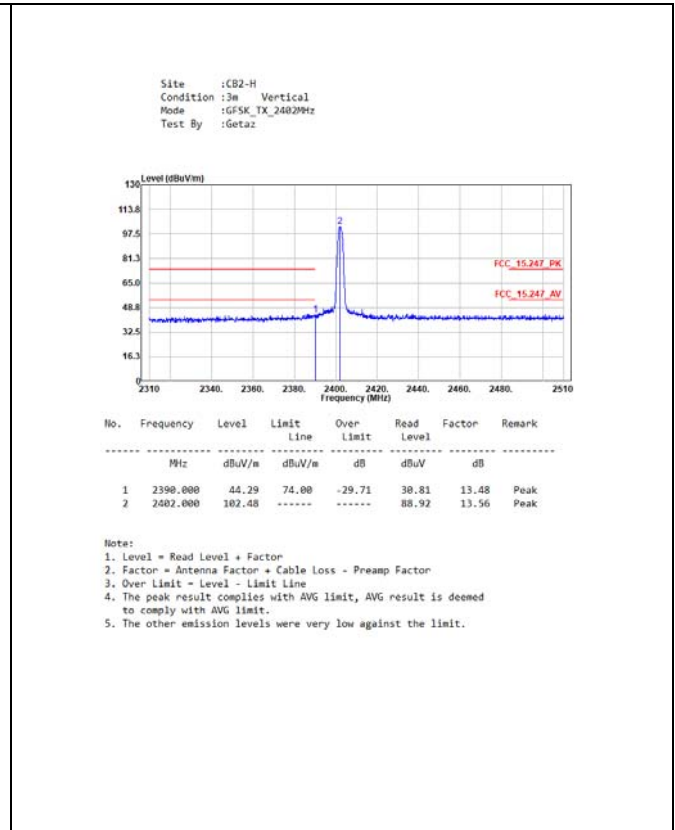
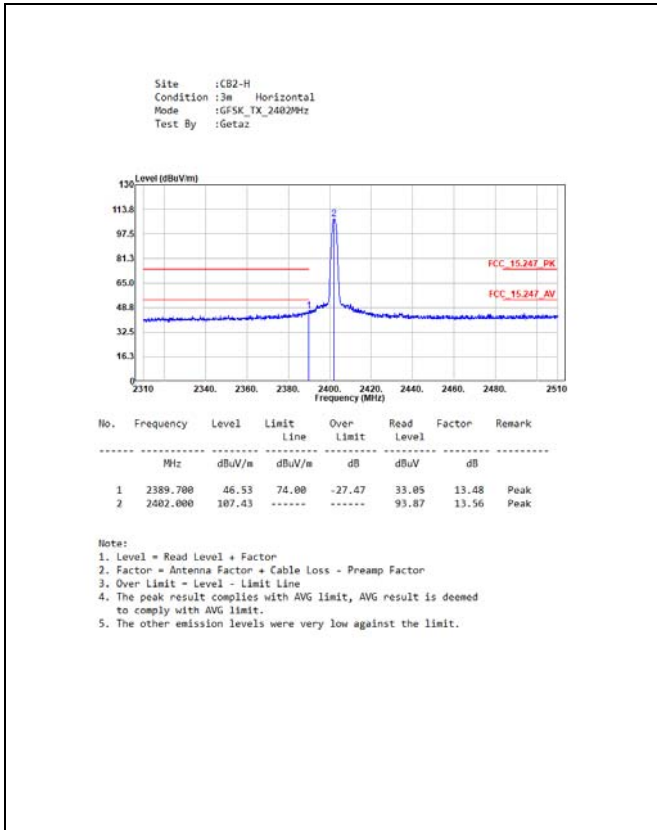

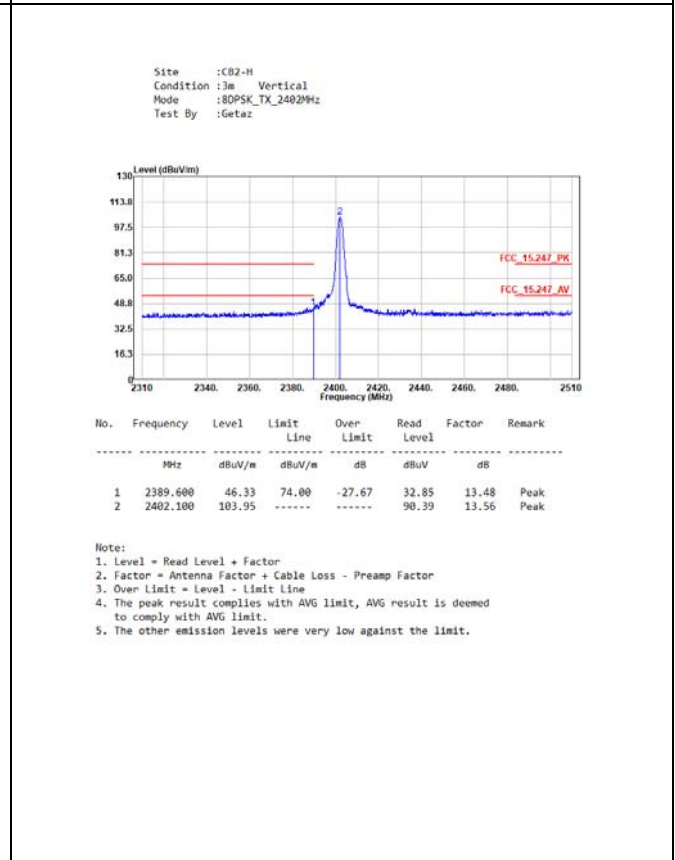
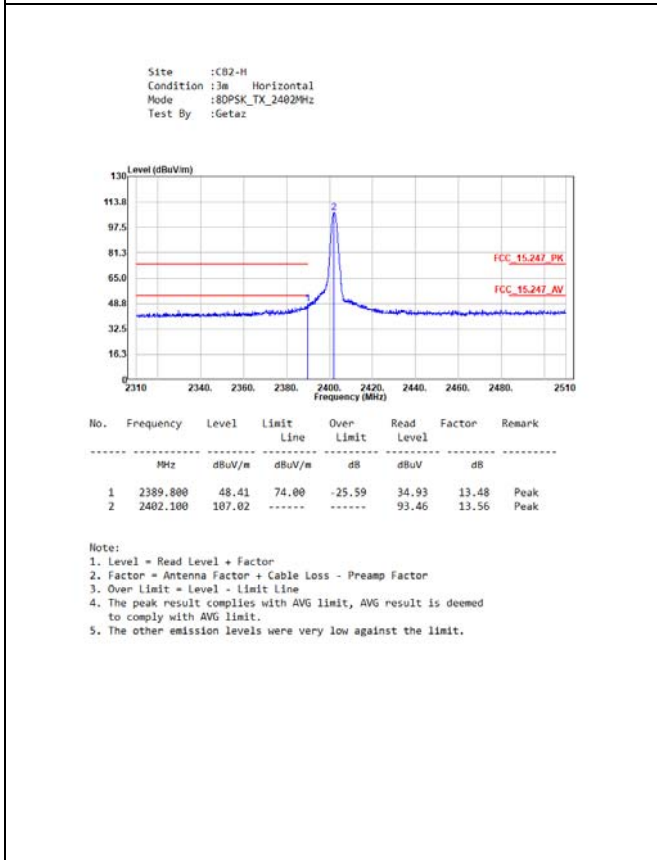
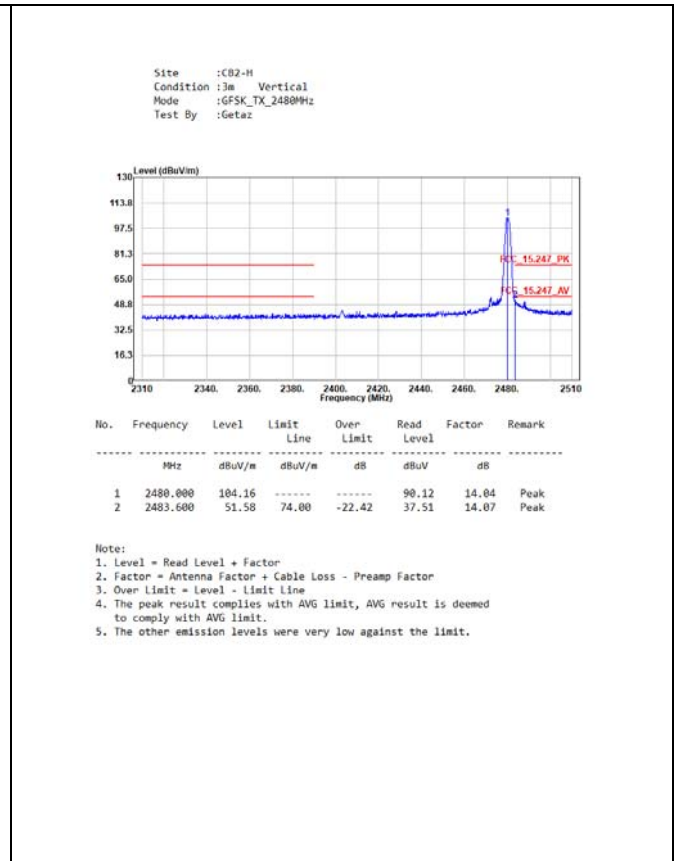
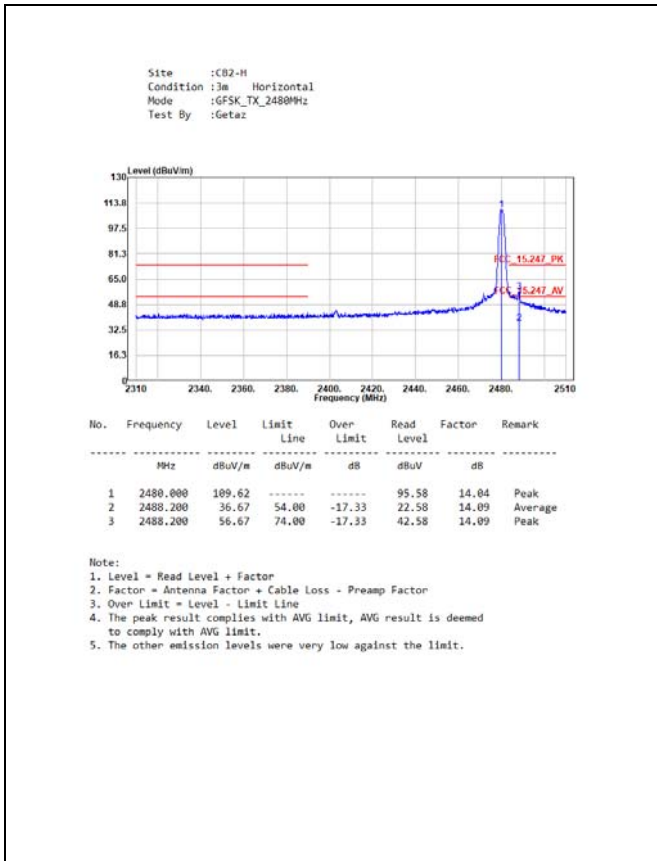

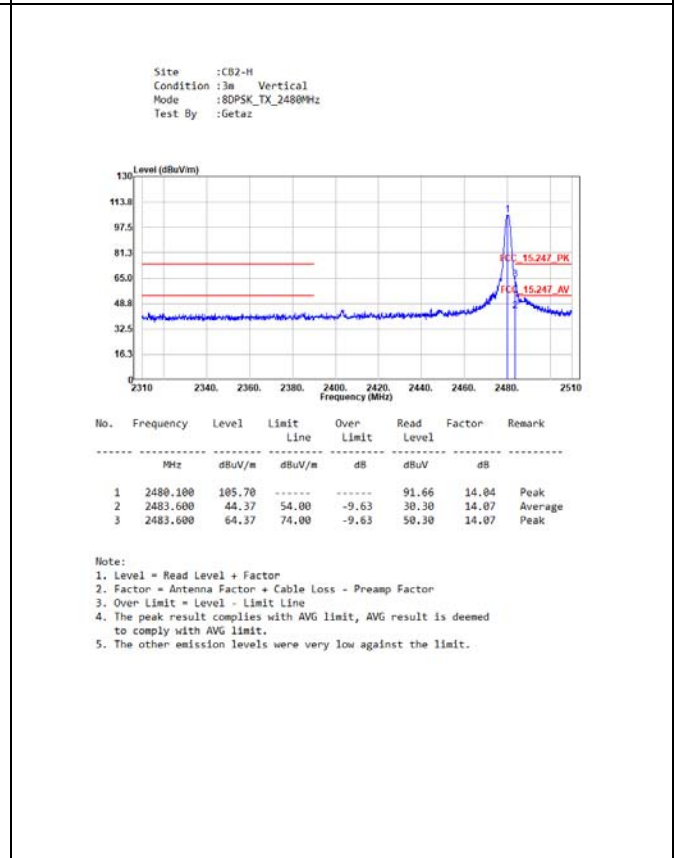
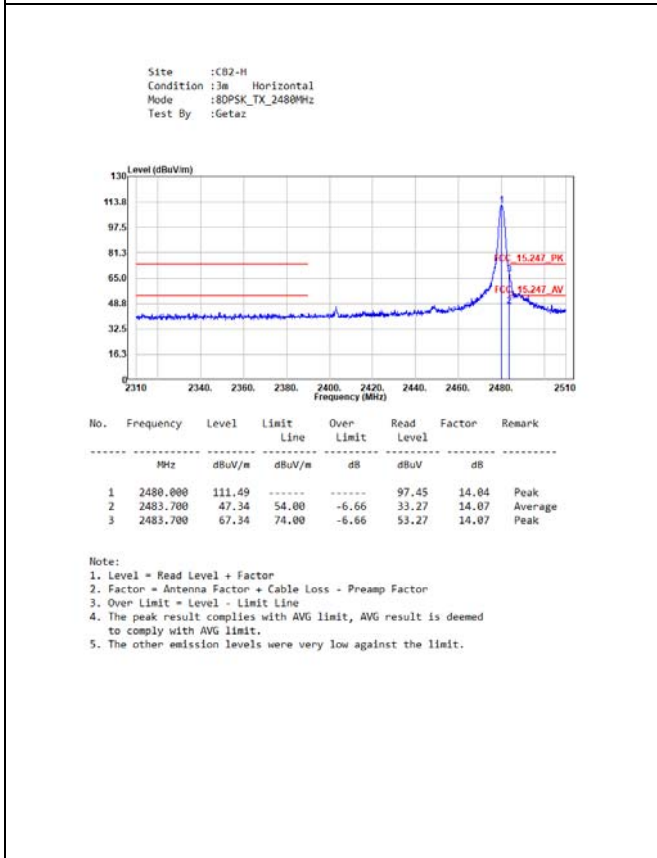
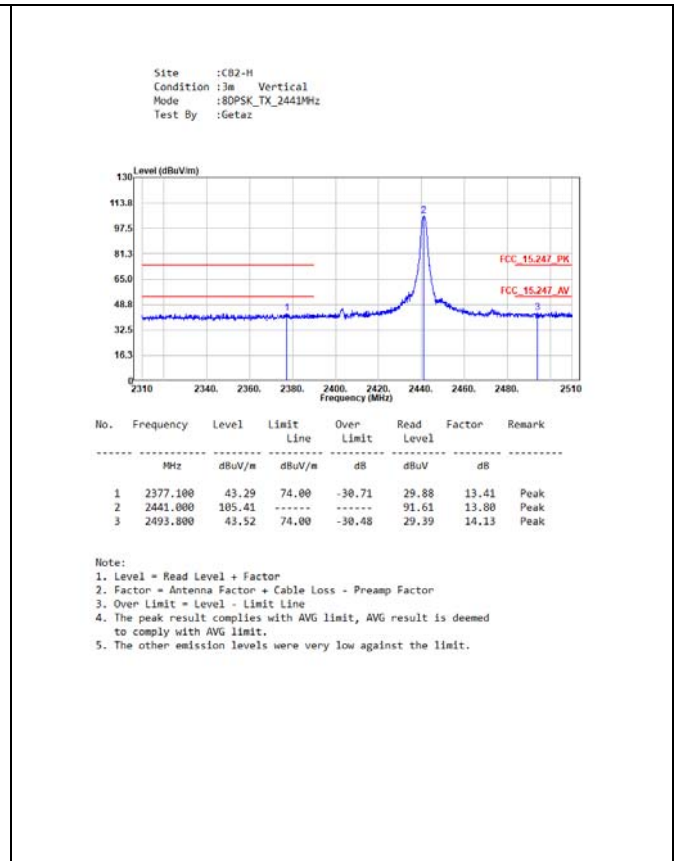
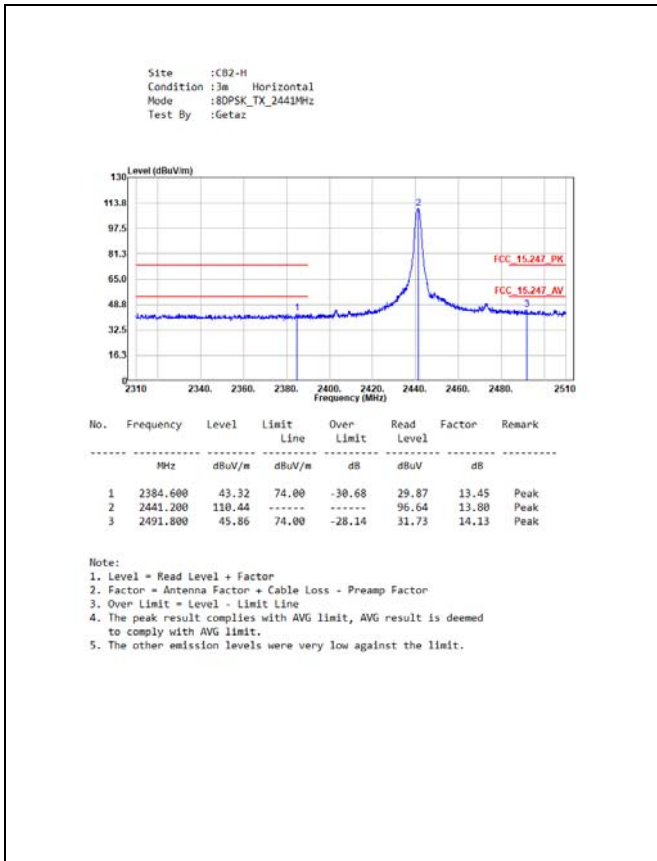

Band Edge – Hopping

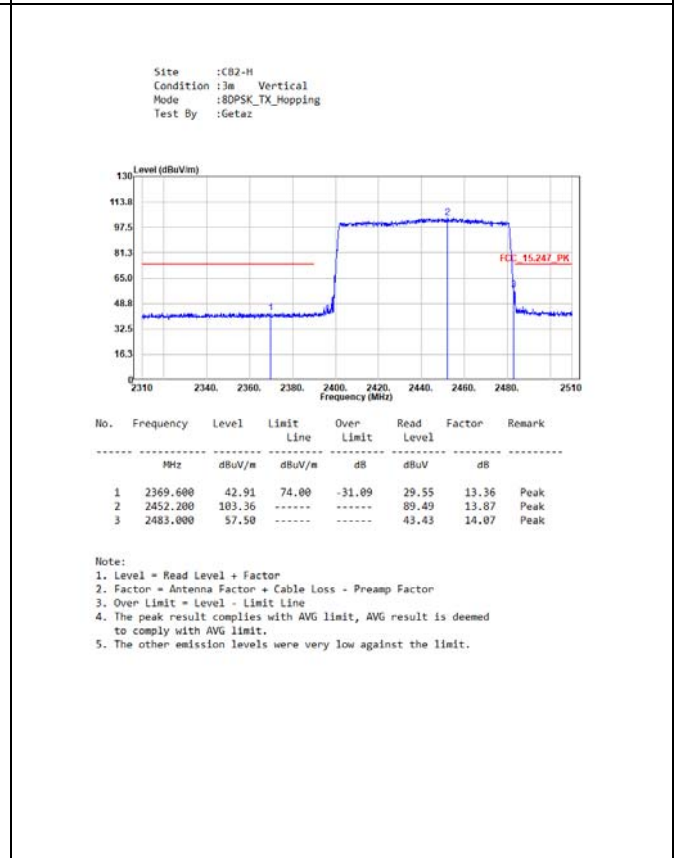
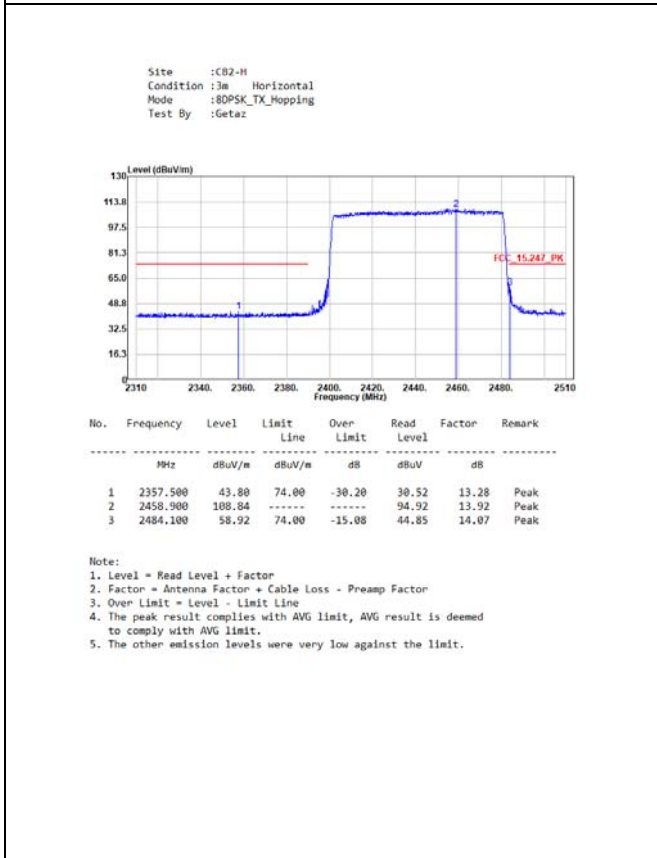
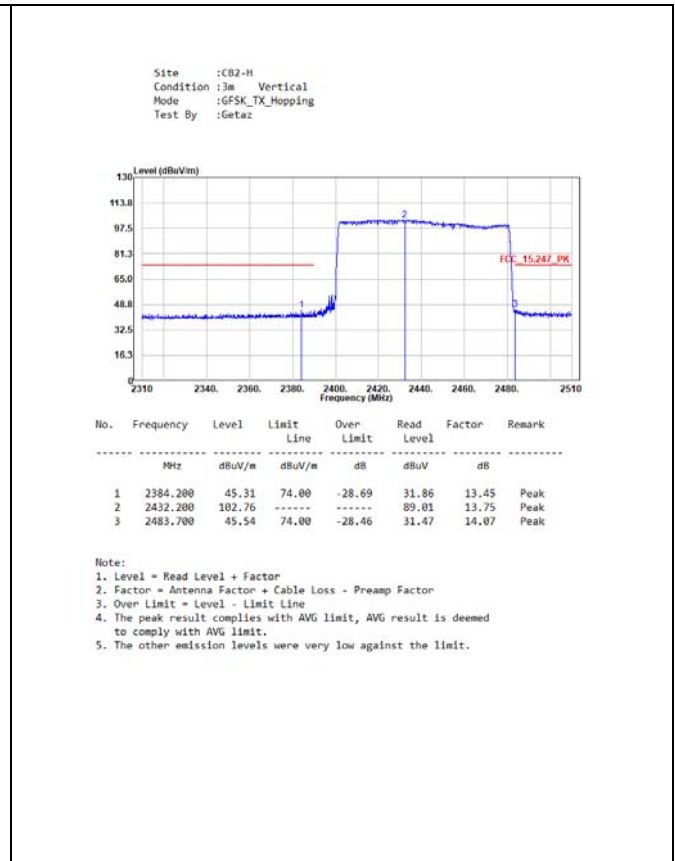
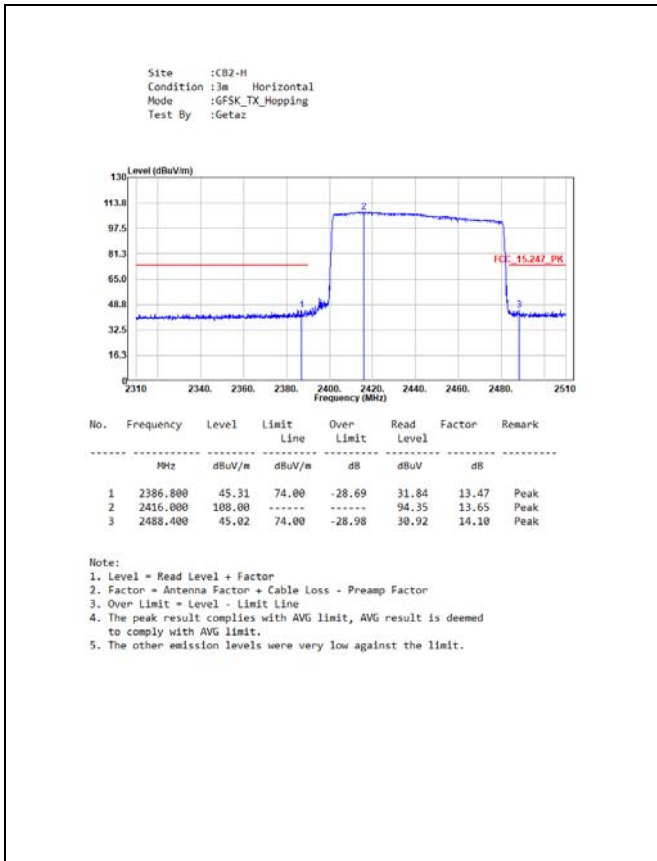

7. Number of Hopping Frequency

7.1. Test Setup

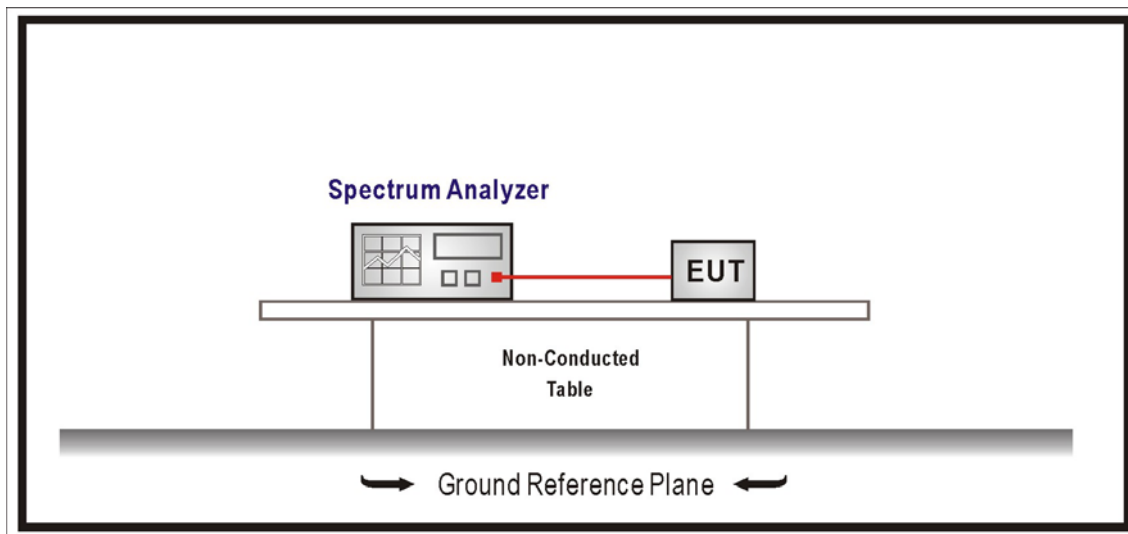

7.2. Test Limit

For frequency hopping systems operating in the 902 ~ 928 MHz band: if the 20 dB bandwidth of the hopping channel is less than 250 kHz, the system shall use at least 50 hopping frequencies and the average time of occupancy on any frequency shall not be greater than 0.4 seconds within a 20 second period; if the 20 dB bandwidth of the hopping channel is 250 kHz or greater, the system shall use at least 25 hopping frequencies and the average time of occupancy on any frequency shall not be greater than 0.4 seconds within a 10 second period. The maximum allowed 20 dB bandwidth of the hopping channel is 500 kHz.

Frequency hopping systems in the 2400 ~ 2483.5 MHz band shall use at least 15 channels. The average time of occupancy on any channel shall not be greater than 0.4 seconds within a period of 0.4 seconds multiplied by the number of hopping channels employed. Frequency hopping systems may avoid or suppress transmissions on a particular hopping frequency provided that a minimum of 15 channels are used.

Frequency hopping systems operating in the 5725 ~ 5850 MHz band shall use at least 75 hopping frequencies. The maximum 20 dB bandwidth of the hopping channel is 1 MHz. The average time of occupancy on any frequency shall not be greater than 0.4 seconds within a 30 second period.

7.3. Test Procedures

The EUT was setup according to ANSI C63.10: 2013 and tested according to FHSS test procedure of FCC KDB 558074 D01 v05r02 for compliance to FCC 47CFR 15.247 requirements.

7.4. Test Specification

According to FCC Part 15 Subpart C Paragraph 15.247.

7.5. Test Result of Number of Hopping Frequency

Frequency Range (MHz)	Measure Level (Channels)	Limit (Channels)
2402 ~ 2480	79	≥ 75

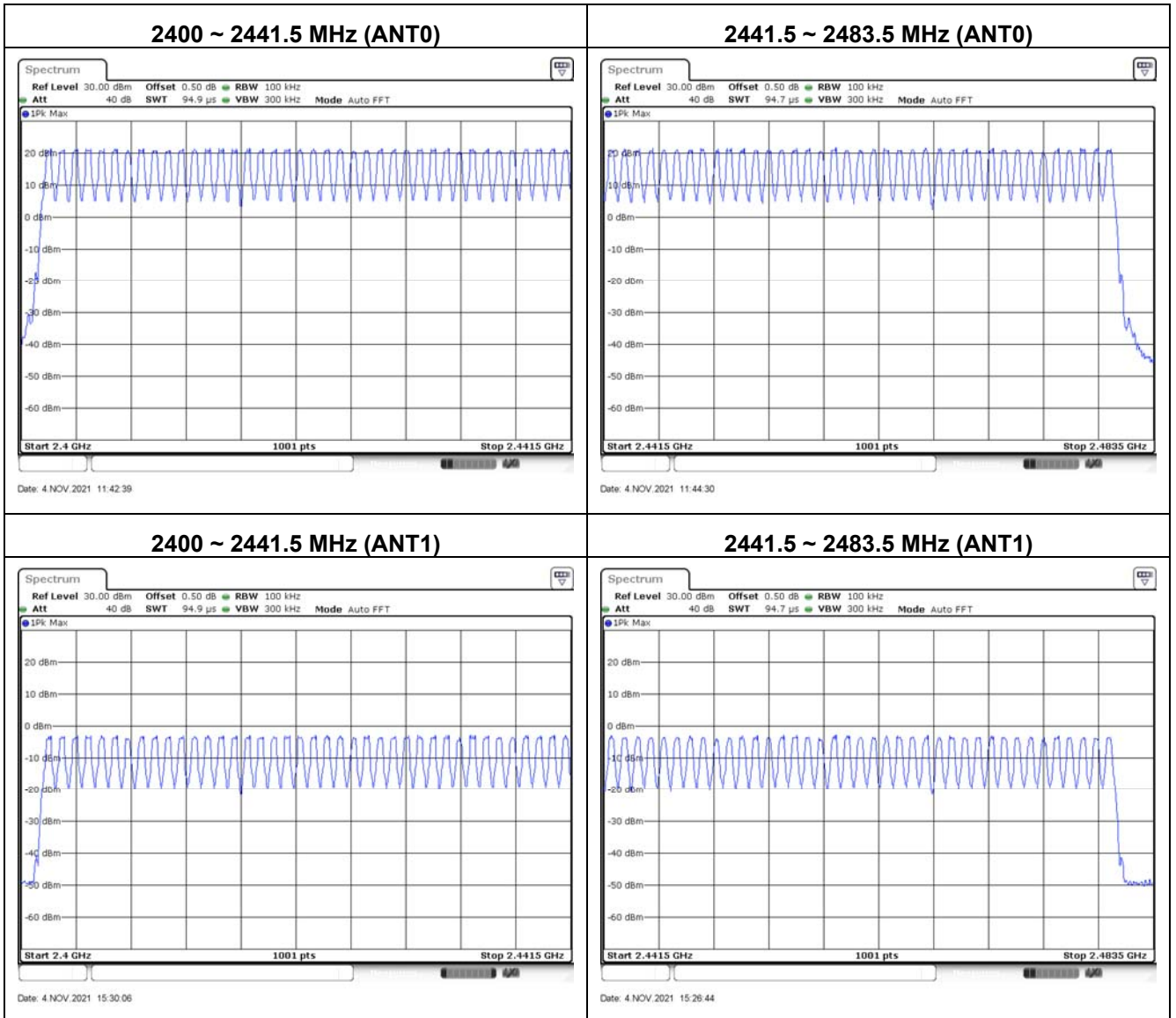

8. Carrier Frequency Separation

8.1. Test Setup

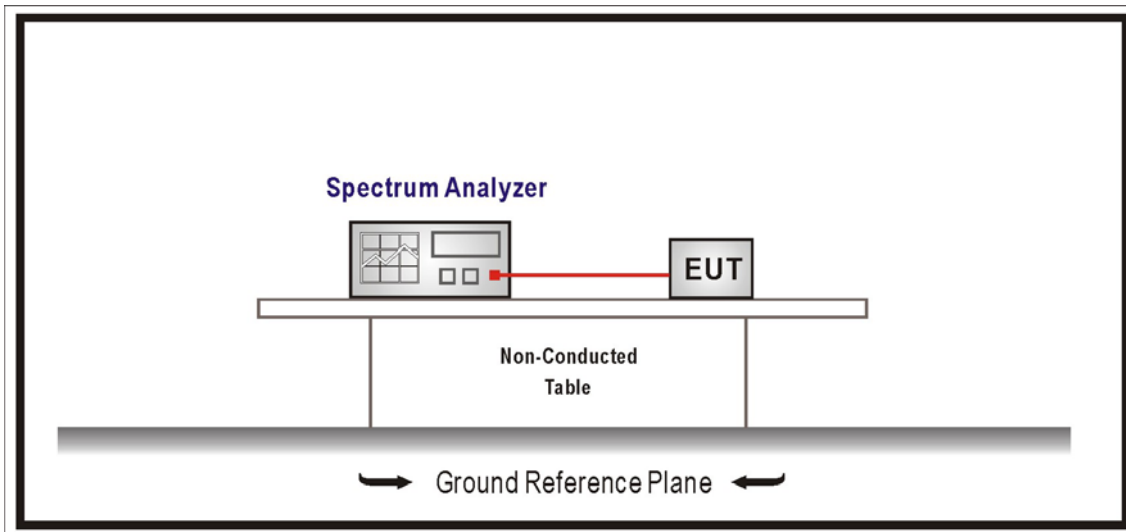

8.2. Test Limit

Frequency hopping systems shall have hopping channel carrier frequencies separated by a minimum of 25 kHz or the 20 dB bandwidth of the hopping channel, whichever is greater. Alternatively, frequency hopping systems operating in the 2400 ~ 2483.5 MHz band may have hopping channel carrier frequencies that are separated by 25 kHz or two-thirds of the 20 dB bandwidth of the hopping channel, whichever is greater, provided the systems operate with an Maximum Conducted Output Power no greater than 125 mW. The system shall hop to channel frequencies that are selected at the system hopping rate from a pseudo randomly ordered list of hopping frequencies. Each frequency must be used equally on the average by each transmitter. The system receivers shall have input bandwidths that match the hopping channel bandwidths of their corresponding transmitters and shall shift frequencies in synchronization with the transmitted signals.

8.3. Test Procedures

The EUT was setup according to ANSI C63.10: 2013 and tested according to FHSS test procedure of FCC KDB 558074 D01 v05r02 for compliance to FCC 47CFR 15.247 requirements.

8.4. Test Specification

According to FCC Part 15 Subpart C Paragraph 15.247.

8.5. Test Result of Carrier Frequency Separation

Modulation	Channel	Frequency (MHz)	Measure Level (MHz)	Limit (MHz)	Result
GFSK (ANT0)	00	2402	0.998	≥ 0.64	Pass
	39	2441	0.998	≥ 0.63	Pass
	78	2480	1.001	≥ 0.63	Pass
8-DPSK (ANT0)	00	2402	1.001	≥ 0.89	Pass
	39	2441	1.001	≥ 0.89	Pass
	78	2480	0.995	≥ 0.87	Pass
GFSK (ANT1)	00	2402	0.998	≥ 0.64	Pass
	39	2441	1.001	≥ 0.64	Pass
	78	2480	0.998	≥ 0.63	Pass
8-DPSK (ANT1)	00	2402	1.004	≥ 0.88	Pass
	39	2441	0.998	≥ 0.88	Pass
	78	2480	0.998	≥ 0.87	Pass

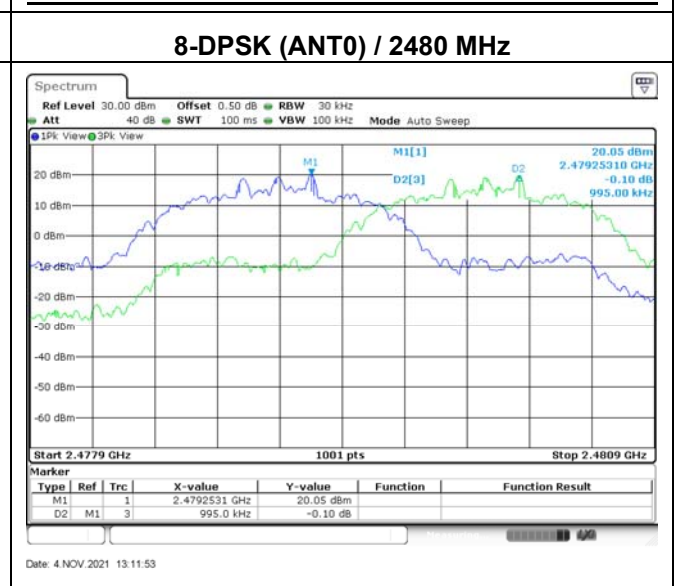
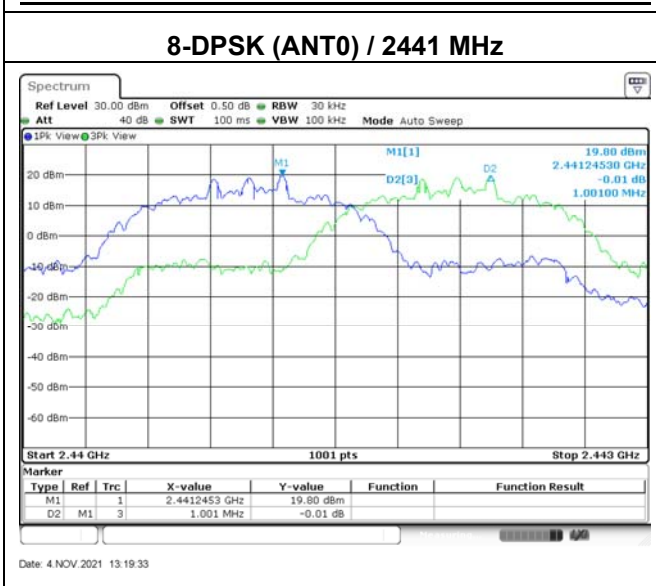
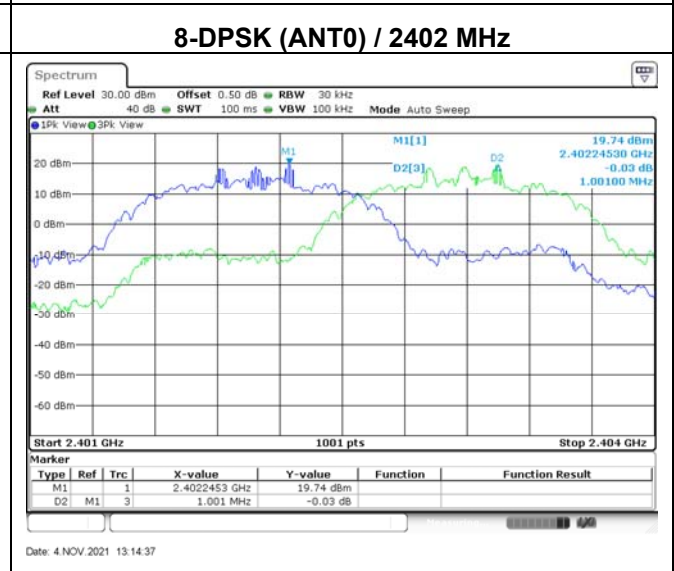
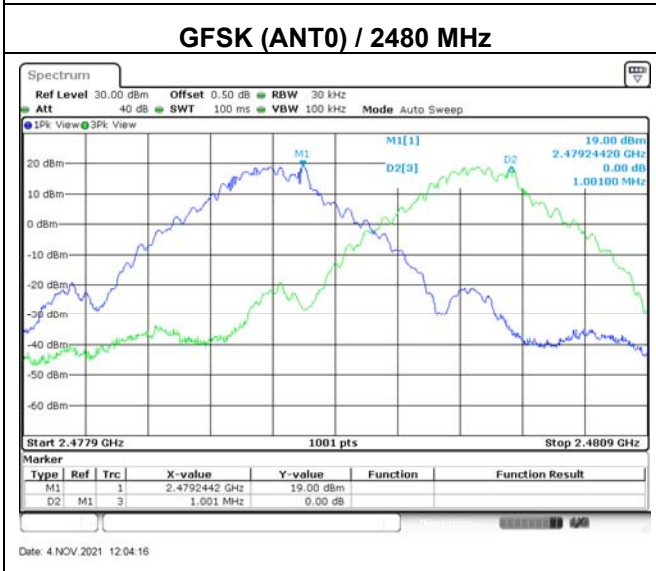
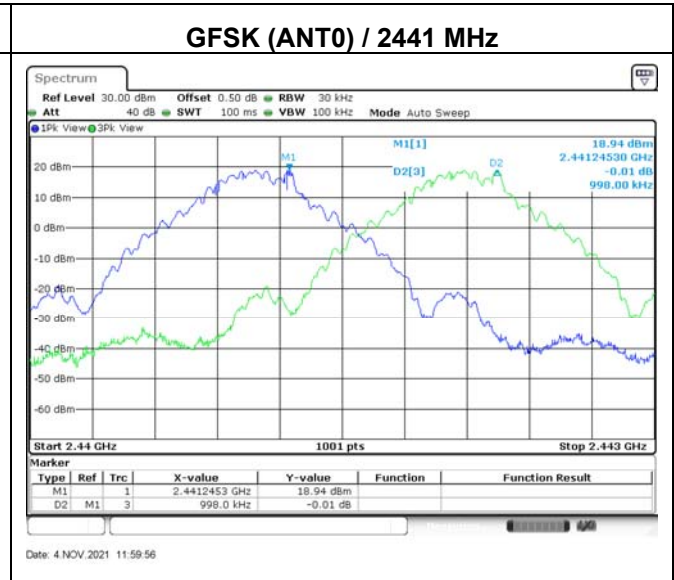
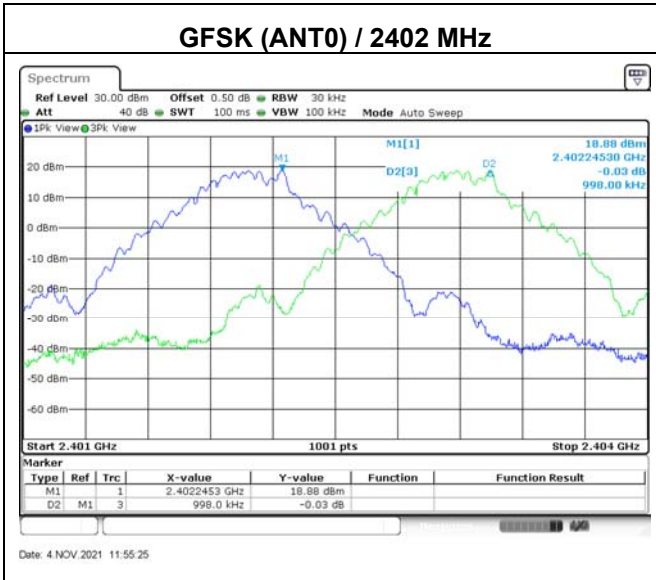

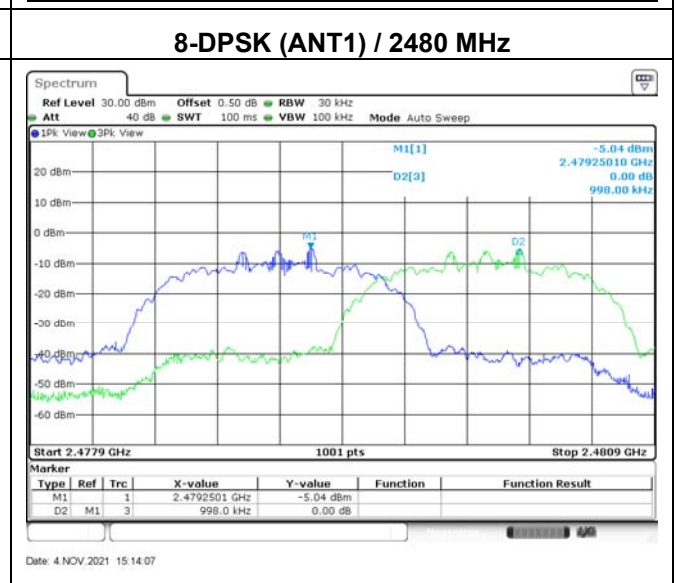
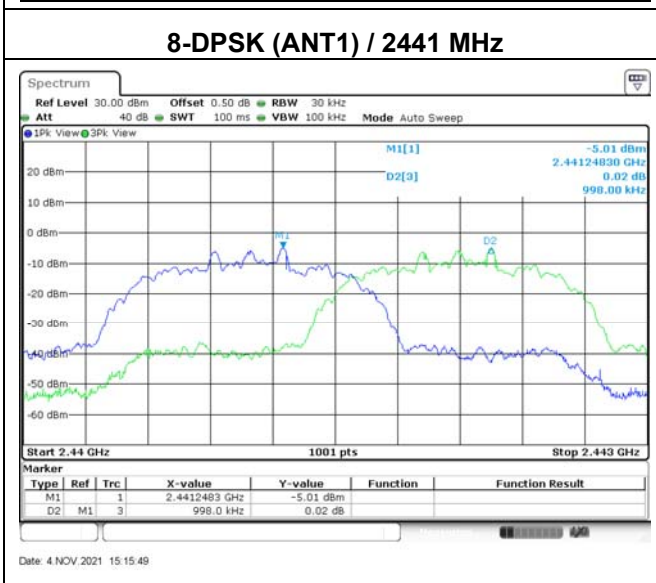
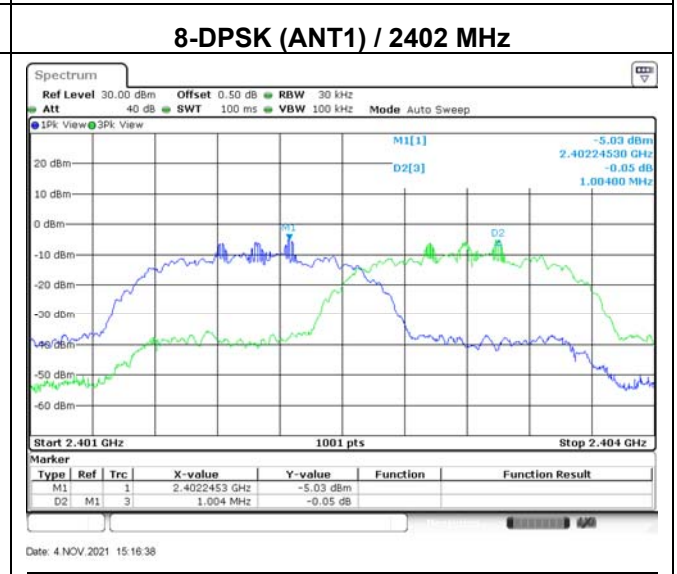
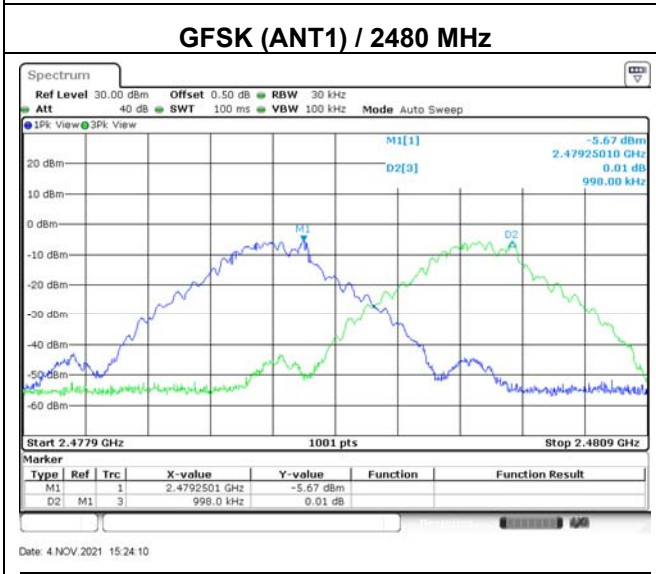
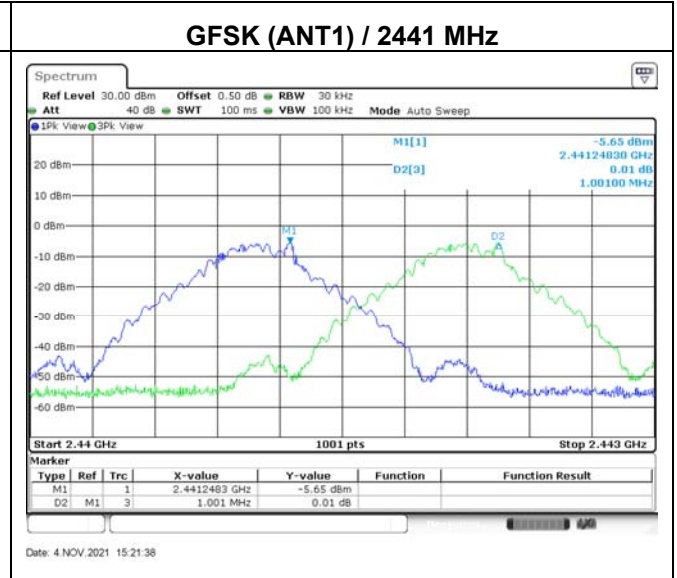
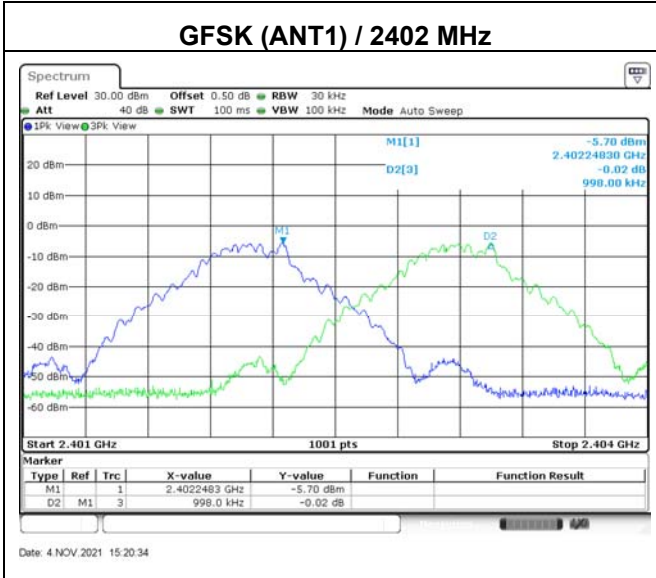

9. 20dB Bandwidth

9.1. Test Setup

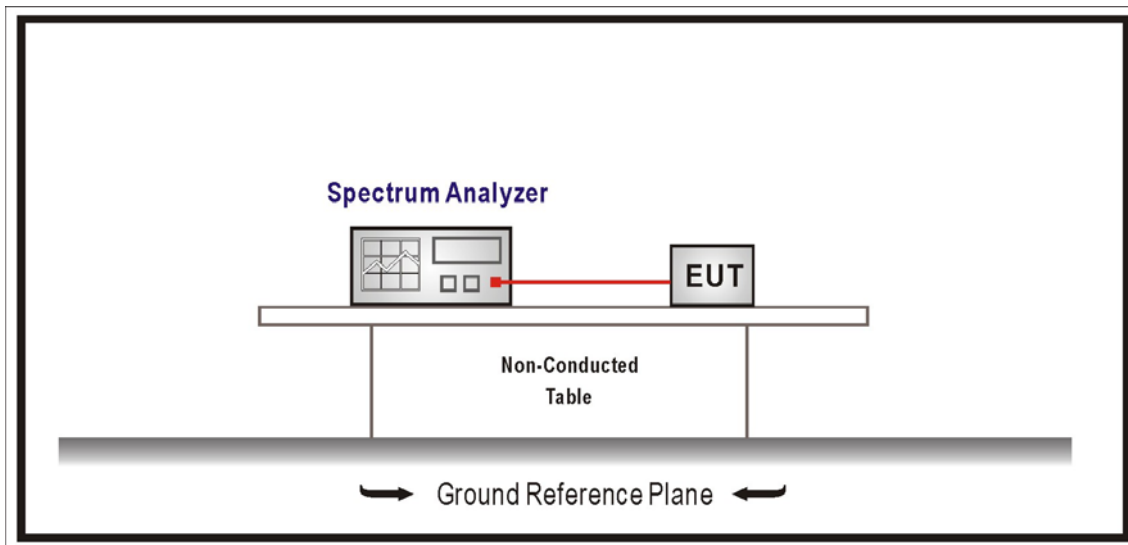

9.2. Test Limit

N/A

9.3. Test Procedures

The EUT was setup according to ANSI C63.10: 2013 and tested according to FHSS test procedure of FCC KDB 558074 D01 v05r02 for compliance to FCC 47CFR 15.247 requirements

Use the following spectrum analyzer settings:

Span = approximately 2 to 3 times the 20 dB bandwidth, centered on a hopping channel

RBW \geq 1% of the 20 dB bandwidth, VBW \geq RBW, Sweep = auto, Detector function = peak, Trace = max hold,

The EUT should be transmitting at its maximum data rate.

9.4. Test Specification

According to FCC Part 15 Subpart C Paragraph 15.247.

9.5. Test Result of 20dB Bandwidth

Modulation	Channel	Frequency (MHz)	Measure Level (MHz)	Limit (MHz)
GFSK (ANT0)	00	2402	0.953	-
	39	2441	0.950	-
	78	2480	0.950	-
8-DPSK (ANT0)	00	2402	1.340	-
	39	2441	1.340	-
	78	2480	1.298	-
GFSK (ANT1)	00	2402	0.953	-
	39	2441	0.953	-
	78	2480	0.950	-
8-DPSK (ANT1)	00	2402	1.325	-
	39	2441	1.322	-
	78	2480	1.300	-

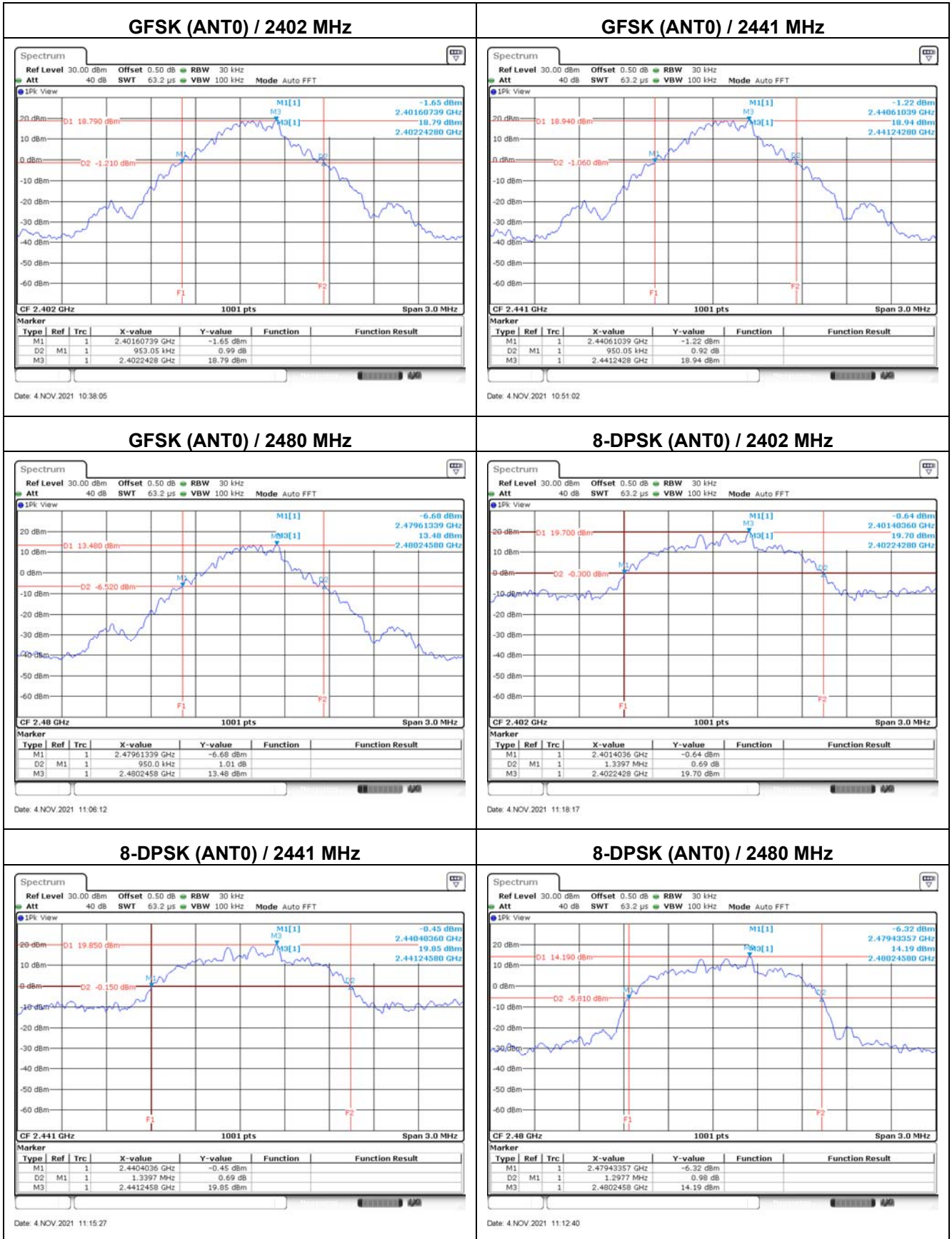

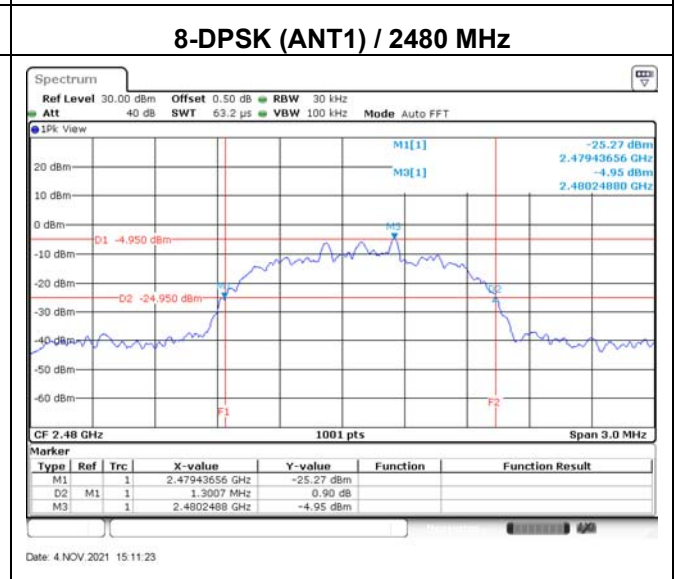
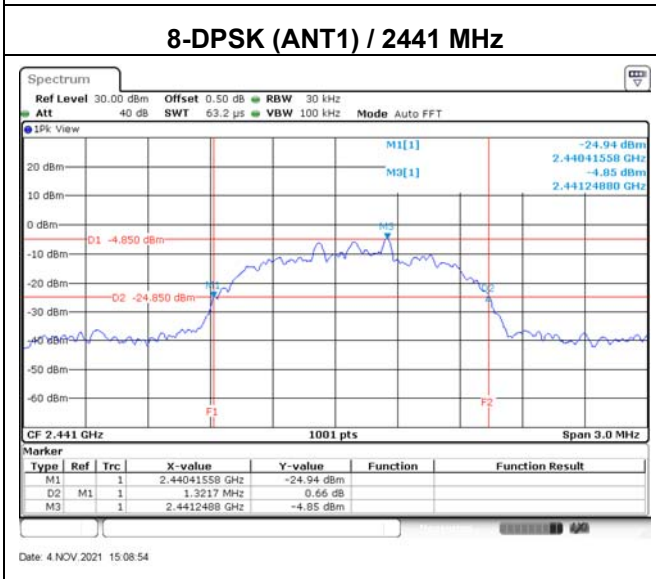
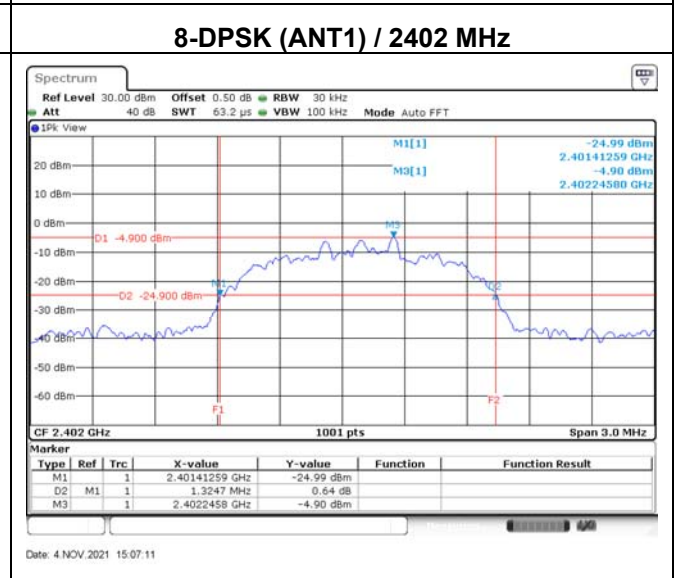
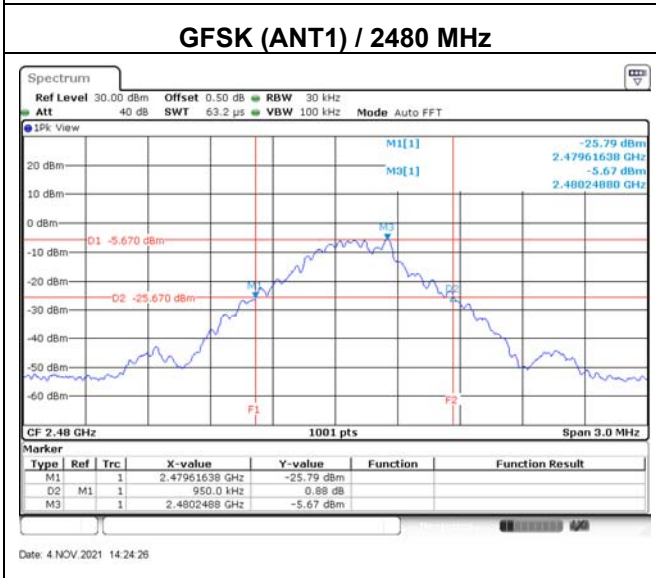
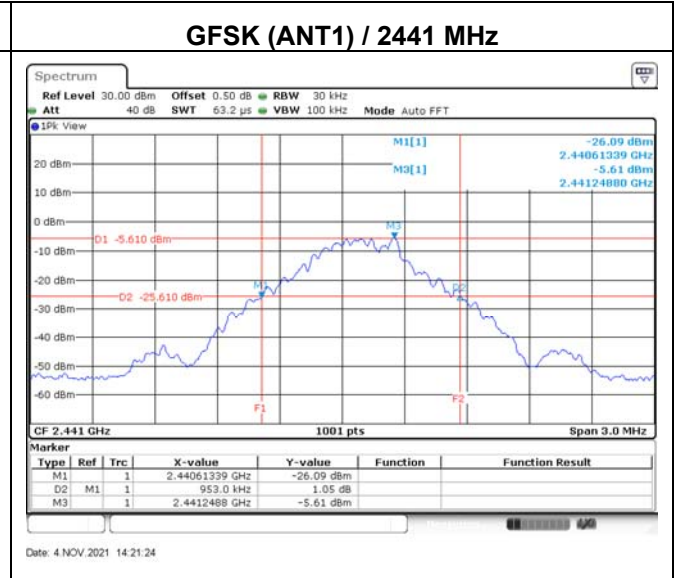
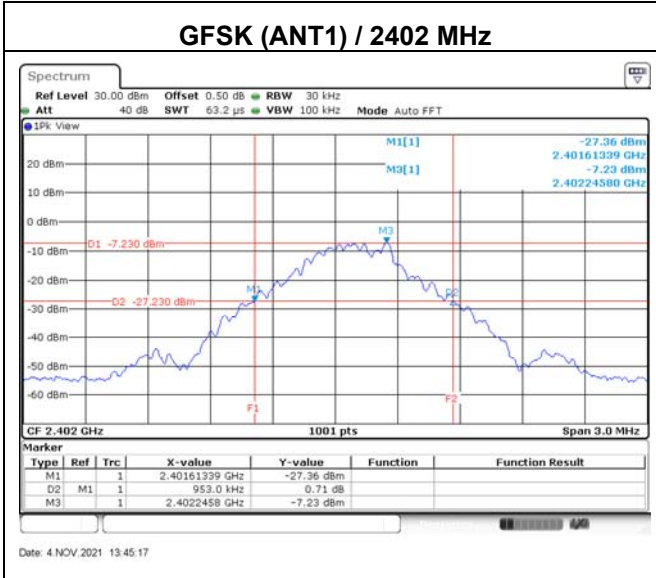

10. Dwell Time

10.1. Test Setup

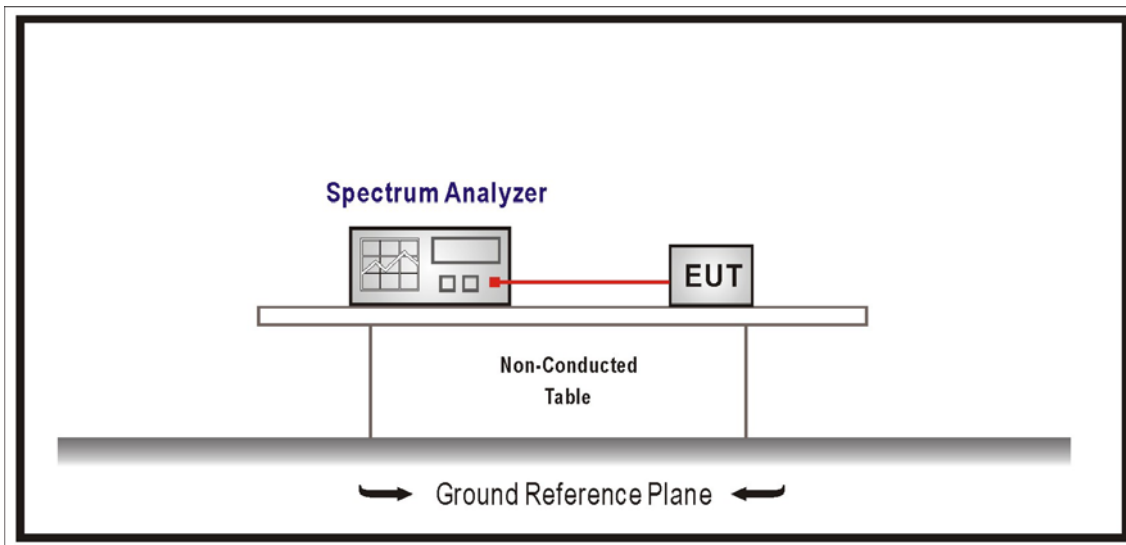

10.2. Test Limit

For frequency hopping systems operating in the 902-928 MHz band: if the 20 dB bandwidth of the hopping channel is less than 250 kHz, the system shall use at least 50 hopping frequencies and the average time of occupancy on any frequency shall not be greater than 0.4 seconds within a 20 second period; if the 20 dB bandwidth of the hopping channel is 250 kHz or greater, the system shall use at least 25 hopping frequencies and the average time of occupancy on any frequency shall not be greater than 0.4 seconds within a 10 second period.

For frequency hopping systems operating in the 2400-2483.5 MHz bands. The average time of occupancy on any channel shall not be greater than 0.4 seconds within a period of 0.4 seconds multiplied by the number of hopping channels employed.

For frequency hopping systems operating in the 5725-5850 MHz bands. The average time of occupancy on any frequency shall not be greater than 0.4 seconds within a 30 second period.

10.3. Test Procedures

The EUT was setup according to ANSI C63.10: 2013 and tested according to FHSS test procedure of FCC KDB 558074 D01 v05r02 for compliance to FCC 47CFR 15.247 requirements

Span = zero span, centered on a hopping channel, RBW = 1 MHz, VBW \geq RBW,

Sweep = as necessary to capture the entire dwell time per hopping channel,

Detector function = peak, Trace = max hold.

10.4. Test Specification

According to FCC Part 15 Subpart C Paragraph 15.247

10.5. Test Result of Dwell Time

Modulation	Occupancy Time of Frequency Hopping System
GFSK (ANT0)	A) 2402 MHz Test Time Period: $0.4 \times 79 = 31.60$ sec, Time slot length : 2.880 ms = 0.002880 sec Dwell Time : $0.002880 \times (266.67/79) \times 31.60 = 0.3072$ sec
	B) 2441 MHz Test Time Period: $0.4 \times 79 = 31.60$ sec, Time slot length : 2.860 ms = 0.002860 sec Dwell Time : $0.002860 \times (266.67/79) \times 31.60 = 0.3051$ sec
	C) 2480 MHz Test Time Period: $0.4 \times 79 = 31.60$ sec, Time slot length : 2.860 ms = 0.002860 sec Dwell Time : $0.002860 \times (266.67/79) \times 31.60 = 0.3051$ sec
	A) 2402 MHz Test Time Period: $0.4 \times 79 = 31.60$ sec, Time slot length : 2.880 ms = 0.002880 sec Dwell Time : $0.002880 \times (266.67/79) \times 31.60 = 0.3072$ sec
	B) 2441 MHz Test Time Period: $0.4 \times 79 = 31.60$ sec, Time slot length : 2.880 ms = 0.002880 sec Dwell Time : $0.002880 \times (266.67/79) \times 31.60 = 0.3072$ sec
	C) 2480 MHz Test Time Period: $0.4 \times 79 = 31.60$ sec, Time slot length : 2.880 ms = 0.002880 sec Dwell Time : $0.002880 \times (266.67/79) \times 31.60 = 0.3072$ sec
GFSK (ANT1)	A) 2402 MHz Test Time Period: $0.4 \times 79 = 31.60$ sec, Time slot length : 2.860 ms = 0.002860 sec Dwell Time : $0.002860 \times (266.67/79) \times 31.60 = 0.3051$ sec
	B) 2441 MHz Test Time Period: $0.4 \times 79 = 31.60$ sec, Time slot length : 2.860 ms = 0.002860 sec Dwell Time : $0.002860 \times (266.67/79) \times 31.60 = 0.3051$ sec
	C) 2480 MHz Test Time Period: $0.4 \times 79 = 31.60$ sec, Time slot length : 2.880 ms = 0.002880 sec Dwell Time : $0.002880 \times (266.67/79) \times 31.60 = 0.3072$ sec
	A) 2402 MHz Test Time Period: $0.4 \times 79 = 31.60$ sec, Time slot length : 2.860 ms = 0.002860 sec Dwell Time : $0.002860 \times (266.67/79) \times 31.60 = 0.3051$ sec
	B) 2441 MHz Test Time Period: $0.4 \times 79 = 31.60$ sec, Time slot length : 2.860 ms = 0.002860 sec Dwell Time : $0.002860 \times (266.67/79) \times 31.60 = 0.3051$ sec
	C) 2480 MHz Test Time Period: $0.4 \times 79 = 31.60$ sec, Time slot length : 2.880 ms = 0.002880 sec Dwell Time : $0.002880 \times (266.67/79) \times 31.60 = 0.3072$ sec
Test Result: The Average Occupancy Time of Each Highest, Middle and Lowest Channel Is Less Than 0.4 sec, And Corresponds to The Standard.	

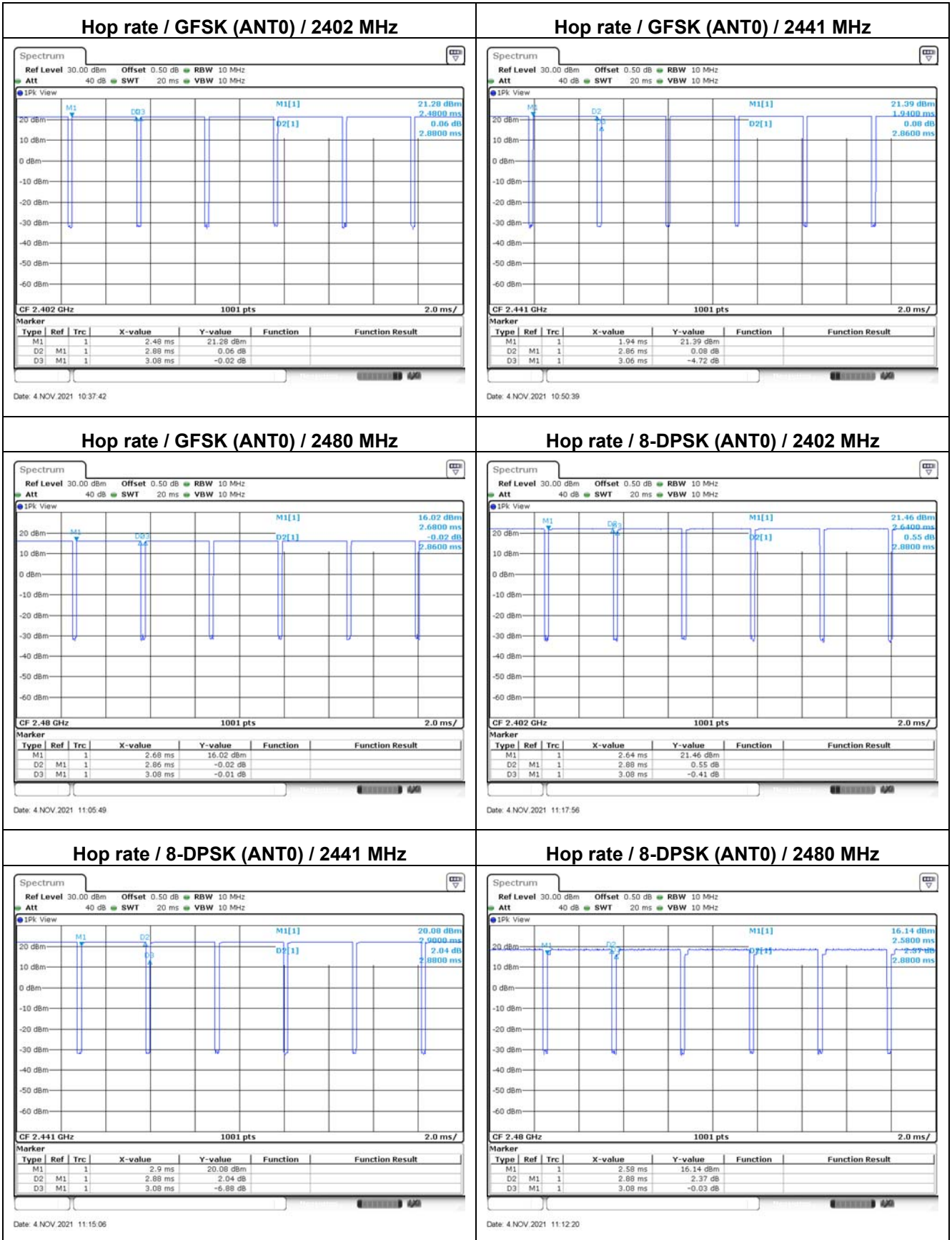

Note: Dwell time = time slot length * hop rate / number of hopping channels * period

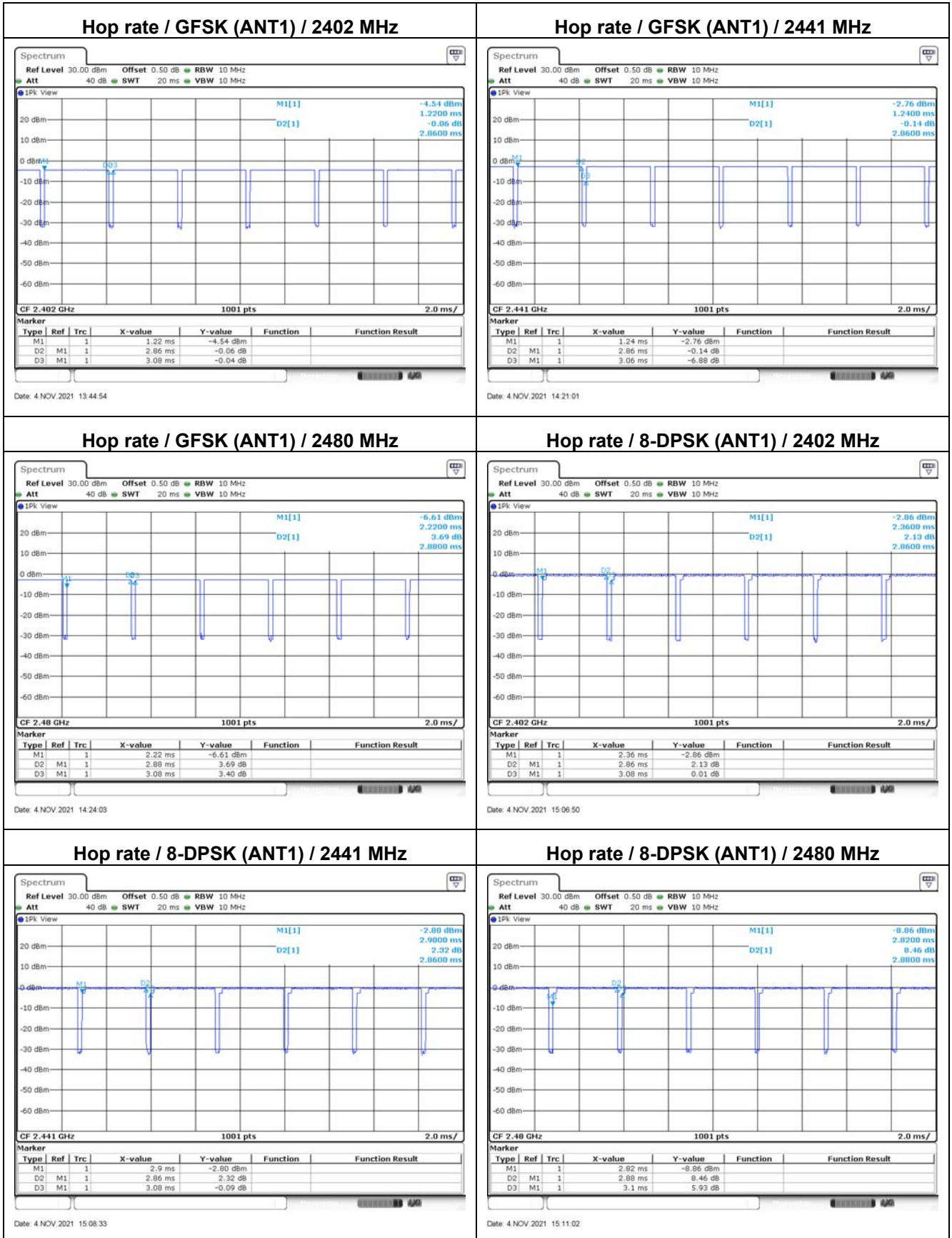

Note: Dwell time = time slot length * hop rate / number of hopping channels * period