

# FCC Test Report

Product Name : Insyde  
Trade Name : Cardo  
Model No. : Insyde  
FCC ID : Q95ER27

Applicant : Cardo Systems, LTD  
Address : 101 E. Park Blvd., Suite 600, Plano TX, 75074, USA

Date of Receipt : Aug. 25, 2020  
Issued Date : Feb. 04, 2021  
Report No. : 2080779R-E3032110108  
Report Version : V1.0



The test results relate only to the samples tested.

The test report shall not be reproduced except in full without the written approval of DEKRA Testing and Certification Co., Ltd.

# Test Report Certification

Issued Date : Feb. 04, 2021

Report No. : 2080779R-E3032110108



Product Name : Insyde  
 Applicant : Cardo Systems, LTD  
 Address : 101 E. Park Blvd., Suite 600, Plano TX, 75074, USA  
 Manufacturer : Cardo Systems, LTD  
 Address : 101 E. Park Blvd., Suite 600, Plano TX, 75074, USA  
 Trade name : Cardo  
 Model No. : Insyde  
 FCC ID : Q95ER27  
 EUT Voltage : DC 5V (Power by USB)  
                   DC 3.7V (Power by Battery)  
 Testing Voltage : AC 120V/60Hz  
 Applicable Standard : FCC CFR Title 47 Part 15 Subpart C Section 15.247: 2019  
                           ANSI C63.10: 2013  
 Laboratory Name : Hsin Chu Laboratory  
 Address : No.372-2, Sec. 4, Zhongxing Rd., Zhudong Township, Hsinchu  
                   County 310, Taiwan, R.O.C.  
                   TEL: +886-3-582-8001 / FAX: +886-3-582-8958  
 Test Result : Complied

Documented By :

( Demi Chang / Senior Engineering Adm. Specialist )

Tested By :

( Lion Wang / Senior Engineer )

Approved By :

( Louis Hsu / Deputy Manager )

**Revision History**

<b>Version</b>	<b>Description</b>	<b>Issued Date</b>
V1.0	Initial issue of report	Feb. 04, 2021

## TABLE OF CONTENTS

Description	Page
1. General Information .....	6
1.1. EUT Description .....	6
1.2. Test Mode .....	8
1.3. Tested System Details .....	9
1.4. Configuration of tested System .....	9
1.5. EUT Exercise Software .....	9
1.6. Comments and Remarks .....	9
1.7. Test Facility .....	10
1.8. List of Test Equipment .....	12
1.9. Duty Cycle .....	15
1.10. Uncertainty .....	17
2. Conducted Emission .....	18
2.1. Test Setup .....	18
2.2. Limits .....	18
2.3. Test Procedure .....	18
2.4. Test Specification .....	18
2.5. Test Result .....	19
3. Maximum peak conducted output power .....	23
3.1. Test Setup .....	23
3.2. Test procedures .....	23
3.3. Limits .....	23
3.4. Test Specification .....	23
3.5. Test Result .....	24
4. Radiated Emission .....	26
4.1. Test Setup .....	26
4.2. Limits .....	27
4.3. Test Procedure .....	28
4.4. Test Specification .....	28
4.5. Test Result .....	29
5. RF antenna conducted test .....	57
5.1. Test Setup .....	57
5.2. Limits .....	57
5.3. Test Procedure .....	57
5.4. Test Specification .....	57
5.5. Test Result .....	58
6. Bandedge .....	74

6.1.	Test Setup .....	74
6.2.	Limits .....	74
6.3.	Test Procedure .....	74
6.4.	Test Specification .....	74
6.5.	Test Result .....	75
7.	Number of hopping frequency .....	83
7.1.	Test Setup .....	83
7.2.	Limits .....	83
7.3.	Test Procedures .....	84
7.4.	Test Specification .....	84
7.5.	Test Result .....	85
8.	Carrier Frequency Separation .....	91
8.1.	Test Setup .....	91
8.2.	Limits .....	91
8.3.	Test Procedures .....	91
8.4.	Test Specification .....	91
8.5.	Test Result .....	92
9.	-20dB Bandwidth .....	100
9.1.	Test Setup .....	100
9.2.	Limits .....	100
9.3.	Test Procedures .....	100
9.4.	Test Specification .....	100
9.5.	Test Result .....	101
10.	Dwell Time .....	109
10.1.	Test Setup .....	109
10.2.	Limits .....	109
10.3.	Test Procedures .....	110
10.4.	Test Specification .....	110
10.5.	Test Result .....	111
Attachment 1	.....	119
	Test Setup Photograph.....	119
Attachment 2	.....	122
	EUT External Photograph .....	122
Attachment 3	.....	127
	EUT Internal Photograph .....	127

## 1. General Information

### 1.1. EUT Description

Product Name	Insyde
Trade Name	Cardo
Model No.	Insyde
Frequency Range/Channel Number	2402~2480MHz / 79 Channels
Type of Modulation	GFSK, $\pi/4$ -DQPSK, 8-DPSK

Antenna Information				
No.	Brand	Model No.	Antenna Type	Antenna Gain
0	N/A	N/A	PCB Antenna	0.1 dBi
1	RALTRON	RCA-5220-A0-TR	PIFA Antenna	2.66 dBi

Accessories Information	
Microphone	1pcs, Non-Shielded, 0.2m
Headphone	1pcs, Non-Shielded, 0.55m
USB Cable	Shielded, 0.5 m

Working Frequency of Each Channel							
Channel	Frequency	Channel	Frequency	Channel	Frequency	Channel	Frequency
Channel 00	2402 MHz	Channel 20	2422 MHz	Channel 40	2442 MHz	Channel 60	2462 MHz
Channel 01	2403 MHz	Channel 21	2423 MHz	Channel 41	2443 MHz	Channel 61	2463 MHz
Channel 02	2404 MHz	Channel 22	2424 MHz	Channel 42	2444 MHz	Channel 62	2464 MHz
Channel 03	2405 MHz	Channel 23	2425 MHz	Channel 43	2445 MHz	Channel 63	2465 MHz
Channel 04	2406 MHz	Channel 24	2426 MHz	Channel 44	2446 MHz	Channel 64	2466 MHz
Channel 05	2407 MHz	Channel 25	2427 MHz	Channel 45	2447 MHz	Channel 65	2467 MHz
Channel 06	2408 MHz	Channel 26	2428 MHz	Channel 46	2448 MHz	Channel 66	2468 MHz
Channel 07	2409 MHz	Channel 27	2429 MHz	Channel 47	2449 MHz	Channel 67	2469 MHz
Channel 08	2410 MHz	Channel 28	2430 MHz	Channel 48	2450 MHz	Channel 68	2470 MHz
Channel 09	2411 MHz	Channel 29	2431 MHz	Channel 49	2451 MHz	Channel 69	2471 MHz
Channel 10	2412 MHz	Channel 30	2432 MHz	Channel 50	2452 MHz	Channel 70	2472 MHz
Channel 11	2413 MHz	Channel 31	2433 MHz	Channel 51	2453 MHz	Channel 71	2473 MHz
Channel 12	2414 MHz	Channel 32	2434 MHz	Channel 52	2454 MHz	Channel 72	2474 MHz
Channel 13	2415 MHz	Channel 33	2435 MHz	Channel 53	2455 MHz	Channel 73	2475 MHz
Channel 14	2416 MHz	Channel 34	2436 MHz	Channel 54	2456 MHz	Channel 74	2476 MHz
Channel 15	2417 MHz	Channel 35	2437 MHz	Channel 55	2457 MHz	Channel 75	2477 MHz
Channel 16	2418 MHz	Channel 36	2438 MHz	Channel 56	2458 MHz	Channel 76	2478 MHz
Channel 17	2419 MHz	Channel 37	2439 MHz	Channel 57	2459 MHz	Channel 77	2479 MHz
Channel 18	2420 MHz	Channel 38	2440 MHz	Channel 58	2460 MHz	Channel 78	2480 MHz
Channel 19	2421 MHz	Channel 39	2441 MHz	Channel 59	2461 MHz	-	-

## Note:

1. This device is a Insyde including Zigbee, BT2.0 and BT 5.0 transmitting functions.
2. Regards to the frequency band operation; the lowest , middle and highest frequency of channel were selected to perform the test, and then shown on this report.
3. The spurious emission was measured in three position (X, Y & Z axis), and the worst case (X axis) was recorded in the report.
4. The EUT description is from the customer declaration.

## 1.2. Test Mode

DEKRA has verified the construction and function in typical operation. All the test modes were carried out with the EUT in transmitting operation, which was shown in this test report and defined as follows:

Test Mode	Mode 1: Transmit mode
-----------	-----------------------

Test Items	Modulation	Channel	Result
Conducted Emission	GFSK/8-DPSK	39	Complies
Maximum peak conducted output power	GFSK/8-DPSK	00/39/78	Complies
Radiated Emission	GFSK/8-DPSK	00/39/78	Complies
RF antenna conducted test	GFSK/8-DPSK	00/39/78	Complies
Bandedge	GFSK/8-DPSK	00/39/78	Complies
Number of hopping Frequency	GFSK/8-DPSK	00/39/78	Complies
Carrier Frequency Separation	GFSK/8-DPSK	00/39/78	Complies
-20dB Bandwidth	GFSK/8-DPSK	00/39/78	Complies
Dwell Time	GFSK/8-DPSK	00/39/78	Complies

Note:

1. Determining compliance shall be based on the results of the compliance measurement, not taking into account measurement instrumentation uncertainty.
2. Pre-Scan has been conducted to determine the worst-case mode from all possible combinations between available modulations, data rates and antenna ports (if EUT with antenna diversity architecture).



### 1.3. Tested System Details

The types for all equipment, plus descriptions of all cables used in the tested system (including inserted cards) are:

Product	Manufacturer	Model No.	Serial No.	FCC ID	Power Cord
1   Notebook PC	Lenovo	Thinkpad	N/A	DoC	Non-Shielded, 1.8m, one ferrite core bonded.

### 1.4. Configuration of tested System

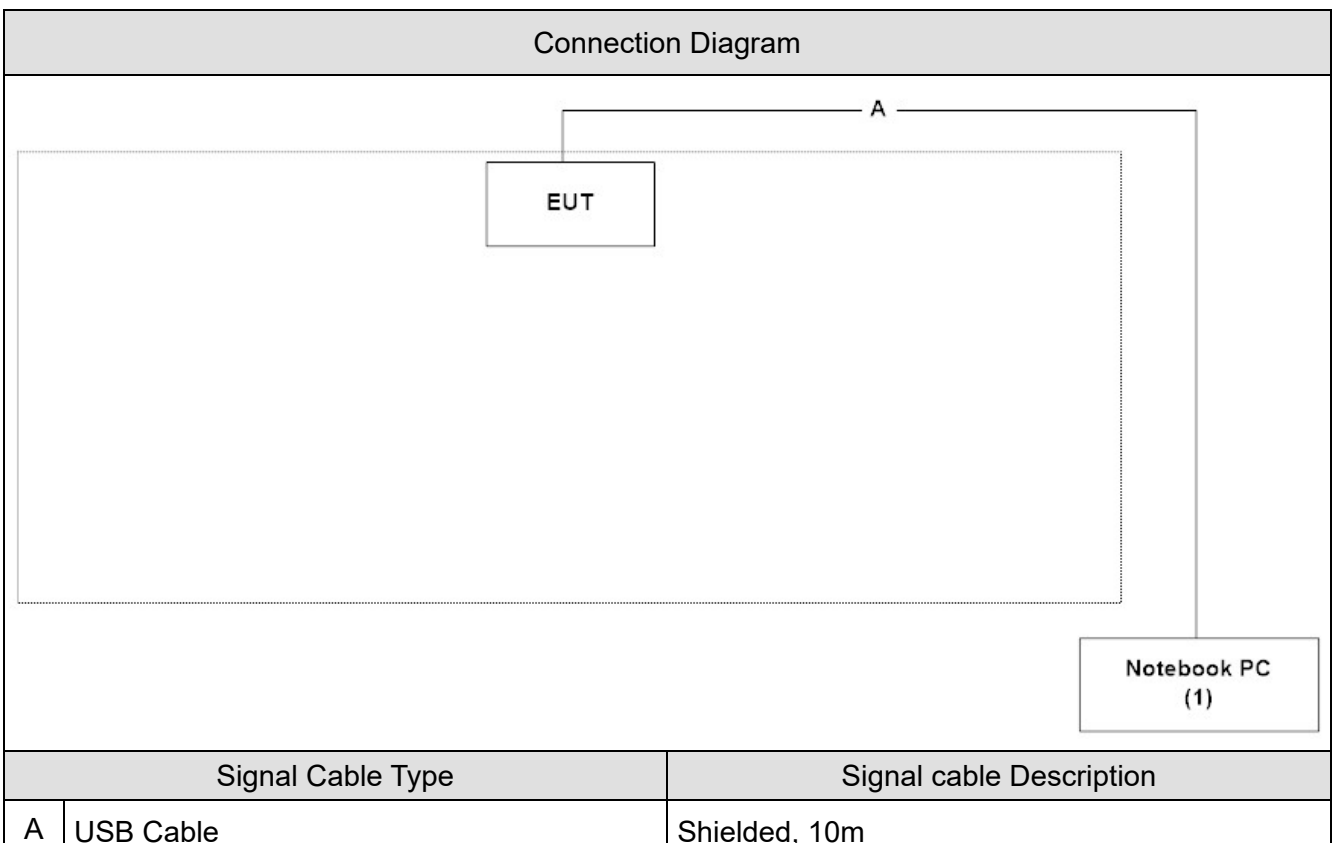

### 1.5. EUT Exercise Software

1	Set the EUT as shown.
2	Open the control software Bluetest3
3	Configure test mode, test channel and packet.
4	Let the EUT start transmitting signal continuously.
5	Verify that device is working properly

### 1.6. Comments and Remarks

The product specification and testing instructions for the EUT declared in the report are provided by the manufacturer who will take all responsibilities for the accuracy.

### 1.7. Test Facility

Ambient conditions in the laboratory:

Items	Test Item	Required	Test Site
Temperature (°C)	FCC PART 15 C 15.207	15 - 35	2
Humidity (%RH)	Conducted Emission	25 - 75	
Temperature (°C)	FCC PART 15 C 15.247	15 - 35	1
Humidity (%RH)	Maximum peak conducted output power	25 - 75	
Temperature (°C)	FCC PART 15 C 15.247	15 - 35	1
Humidity (%RH)	Radiated Emission	25 - 75	
Temperature (°C)	FCC PART 15 C 15.247	15 - 35	1
Humidity (%RH)	RF antenna conducted test	25 - 75	
Temperature (°C)	FCC PART 15 C 15.247	15 - 35	1
Humidity (%RH)	Bandedge	25 - 75	
Temperature (°C)	FCC PART 15 C 15.247	15 - 35	1
Humidity (%RH)	Number of hopping Frequency	25 - 75	
Temperature (°C)	FCC PART 15 C 15.247	15 - 35	1
Humidity (%RH)	Carrier Frequency Separation	25 - 75	
Temperature (°C)	FCC PART 15 C 15.247	15 - 35	1
Humidity (%RH)	-20dB Bandwidth	25 - 75	
Temperature (°C)	FCC PART 15 C 15.247	15 - 35	1
Humidity (%RH)	Dwell Time	25 - 75	

Note: Test site information refers to Laboratory Information.

## Laboratory Information

<b>USA</b>	<b>: FCC Registration Number: TW3024</b>
<b>Canada</b>	<b>: IC Registration Number: 22397-1 / 22397-2 / 22397-3</b>

The address and introduction of DEKRA Testing and Certification Co., Ltd. laboratories can be founded in our Web site: <http://www.dekra.com.tw>

If you have any comments, please don't hesitate to contact us. Our test sites as below:

Test Laboratory	DEKRA Testing and Certification Co., Ltd.
Address	1. No.372, Sec. 4, Zhongxing Rd., Zhudong Township, Hsinchu County 31061, Taiwan, R.O.C. 2. No.372-2, Sec. 4, Zhongxing Rd., Zhudong Township, Hsinchu County 31061, Taiwan, R.O.C.
Phone number	1. +886-3-582-8001 2. +886-3-582-8001
Fax number	1. +886-3-582-8958 2. +886-3-582-8958
Email address	<a href="mailto:info.tw@dekra.com">info.tw@dekra.com</a>
Website	<a href="http://www.dekra.com.tw">http://www.dekra.com.tw</a>

## 1.8. List of Test Equipment

### Conducted Emission / SR2-H

Instrument	Manufacturer	Model No.	Serial No.	Cal. Date	Next Cal. Date
Artificial Mains Network	R&S	ENV4200	848411/010	2020/01/08	2021/01/07
Test Receiver	R&S	ESCS 30	836858/022	2020/02/25	2021/02/24
LISN	R&S	ENV216	100092	2020/06/22	2021/06/21

### Maximum peak conducted output power / SR12-H

Instrument	Manufacturer	Model No.	Serial No.	Cal. Date	Next Cal. Date
High Speed Peak Power Meter Dual Input	Anritsu	ML2496A	1602004	2020/11/30	2021/11/29
Pulse Power Sensor	Anritsu	MA2411B	1531043	2020/11/30	2021/11/29
Pulse Power Sensor	Anritsu	MA2411B	1531044	2020/11/30	2021/11/29
Power Meter	Keysight	8990B	MY51000248	2020/05/20	2021/05/19
Power Sensor	Keysight	N1923A	MY57240005	2020/05/20	2021/05/19

### Radiated Emission / CB2-H

Instrument	Manufacturer	Model No.	Serial No.	Cal. Date	Next Cal. Date
Signal Analyzer	R&S	FSVA40	101455	2020/10/12	2021/10/11
Signal & Spectrum Analyzer	R&S	FSV40	101049	2020/03/30	2021/03/29
EXA Signal Analyzer	Keysight	N9010A	MY51440132	2020/02/21	2021/02/20
Bilog Antenna	Teseq	CBL6112D	23191	2020/06/12	2021/06/11
Horn Antenna	Schwarzbeck	BBHA 9120D	639	2020/06/04	2021/06/03
Horn Antenna	Schwarzbeck	BBHA 9170	202	2020/12/16	2021/12/15
Pre-Amplifier	DEKRA	AP-025C	12183122	2020/09/03	2021/09/02
Pre-Amplifier	EMCI	EMC11830I	980366	2020/11/30	2021/11/29
Pre-Amplifier	DEKRA	AP-400C	201801231	2020/11/16	2021/11/15
Horn Antenna	Schwarzbeck	BBHA 9120D	01656	2020/10/14	2021/10/13
Band Reject Filter	Micro-Tronics	BRM50702	G192	2020/03/09	2021/03/08
Signal Analyzer	R&S	FSV40	101435	2020/06/24	2021/06/23
Coaxial Cable(13m)	Huber+Suhner	SF104	CB2-H	2020/07/25	2021/07/24
DEKRA Testing System	DEKRA	Version 1.2	CB2-H	NA	NA

## RF antenna conducted test / SR12-H

Instrument	Manufacturer	Model No.	Serial No.	Cal. Date	Next Cal. Date
Spectrum Analyzer	Keysight	N9030B	MY57140404	2020/06/03	2021/06/02
Spectrum Analyzer	Keysight	N9010B	MY57110159	2020/04/15	2021/04/14
Spectrum Analyzer	Agilent	N9010A	US47140172	2020/06/18	2021/06/17
Signal & Spectrum Analyzer	R&S	FSV40	101049	2020/03/30	2021/03/29

## Bandedge / SR12-H

Instrument	Manufacturer	Model No.	Serial No.	Cal. Date	Next Cal. Date
Spectrum Analyzer	Keysight	N9030B	MY57140404	2020/06/03	2021/06/02
Spectrum Analyzer	Keysight	N9010B	MY57110159	2020/04/15	2021/04/14
Spectrum Analyzer	Agilent	N9010A	US47140172	2020/06/18	2021/06/17
Signal & Spectrum Analyzer	R&S	FSV40	101049	2020/03/30	2021/03/29

## Number of hopping frequency / SR12-H

Instrument	Manufacturer	Model No.	Serial No.	Cal. Date	Next Cal. Date
Spectrum Analyzer	Keysight	N9030B	MY57140404	2020/06/03	2021/06/02
Spectrum Analyzer	Keysight	N9010B	MY57110159	2020/04/15	2021/04/14
Spectrum Analyzer	Agilent	N9010A	US47140172	2020/06/18	2021/06/17
Signal & Spectrum Analyzer	R&S	FSV40	101049	2020/03/30	2021/03/29

## Carrier Frequency Separation / SR12-H

Instrument	Manufacturer	Model No.	Serial No.	Cal. Date	Next Cal. Date
Spectrum Analyzer	Keysight	N9030B	MY57140404	2020/06/03	2021/06/02
Spectrum Analyzer	Keysight	N9010B	MY57110159	2020/04/15	2021/04/14
Spectrum Analyzer	Agilent	N9010A	US47140172	2020/06/18	2021/06/17
Signal & Spectrum Analyzer	R&S	FSV40	101049	2020/03/30	2021/03/29

## -20dB Bandwidth / SR12-H

Instrument	Manufacturer	Model No.	Serial No.	Cal. Date	Next Cal. Date
Spectrum Analyzer	Keysight	N9030B	MY57140404	2020/06/03	2021/06/02
Spectrum Analyzer	Keysight	N9010B	MY57110159	2020/04/15	2021/04/14
Spectrum Analyzer	Agilent	N9010A	US47140172	2020/06/18	2021/06/17
Signal & Spectrum Analyzer	R&S	FSV40	101049	2020/03/30	2021/03/29

## Dwell Time / SR12-H

Instrument	Manufacturer	Model No.	Serial No.	Cal. Date	Next Cal. Date
Spectrum Analyzer	Keysight	N9030B	MY57140404	2020/06/03	2021/06/02
Spectrum Analyzer	Keysight	N9010B	MY57110159	2020/04/15	2021/04/14
Spectrum Analyzer	Agilent	N9010A	US47140172	2020/06/18	2021/06/17
Signal & Spectrum Analyzer	R&S	FSV40	101049	2020/03/30	2021/03/29

Note: All equipment upon which need to calibrated are with calibration period of 1 year.

### 1.9. Duty Cycle

Mode	On Time(ms)	On+Off Time(ms)	Duty Cycle(%)	Duty Factor(dB) linear voltage	Duty Factor(dB) Power	1/T Minimum VBW (kHz)
DH5	2.890	3.112	92.87%	0.642835	0.32	0.346
2DH5	2.900	3.118	93.01%	0.629562	0.31	0.345
3DH5	2.902	3.118	93.07%	0.623574	0.31	0.345

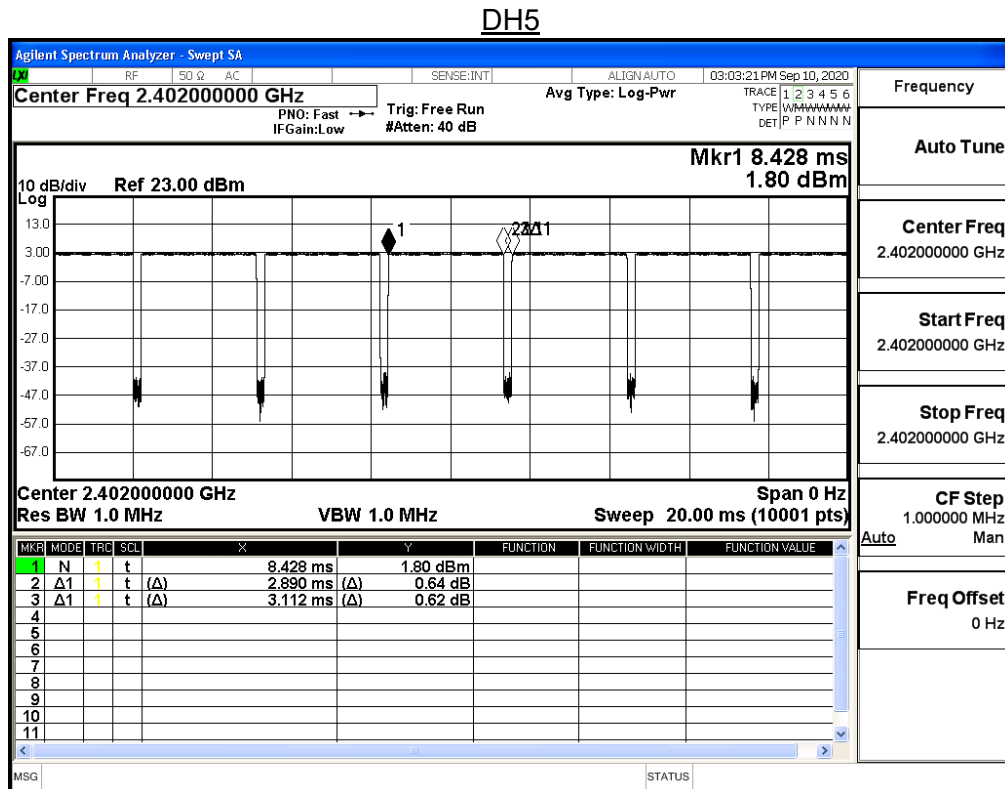

2DH5

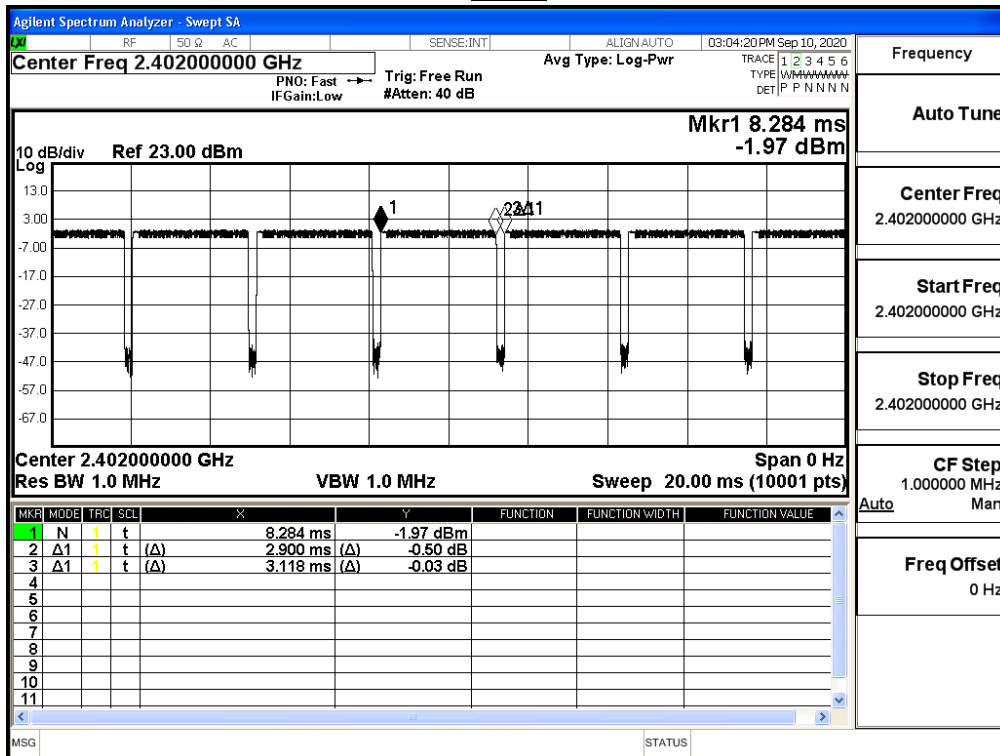

3DH5

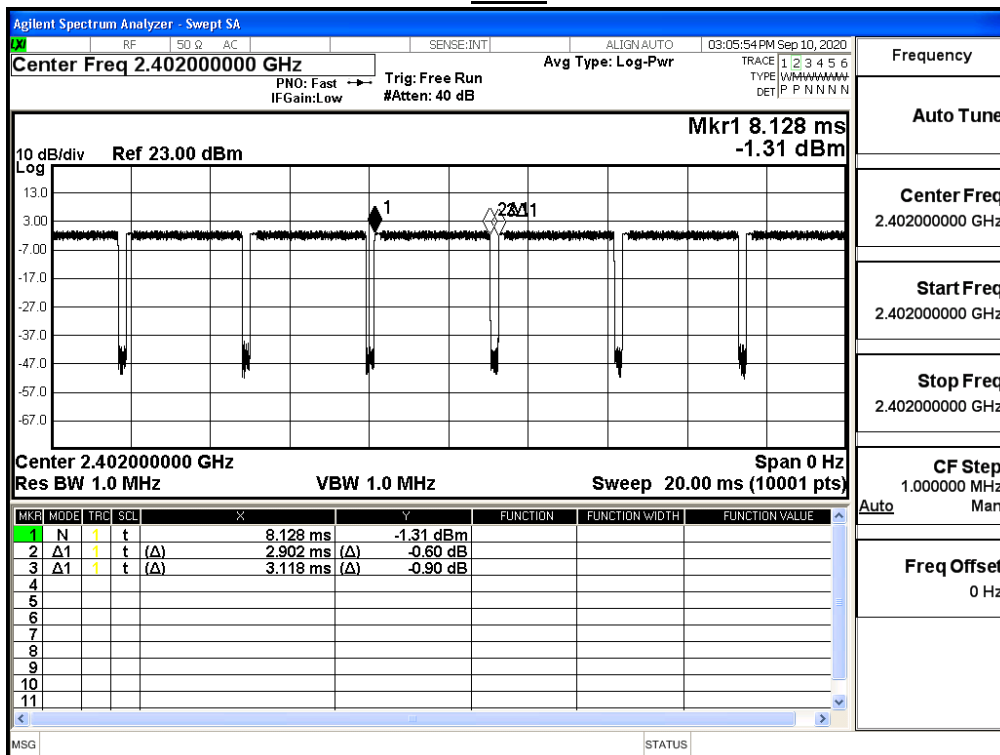



**1.10. Uncertainty**

Test item	Uncertainty
Conducted Emission	$\pm 2.26$ dB
Maximum peak conducted output power	$\pm 1.27$ dB
Radiated Emission	30MHz~1GHz as $\pm 3.43$ dB 1GHz~26.5Ghz as $\pm 3.65$ dB
RF antenna conducted test	$\pm 1.27$ dB
Bandedge	$\pm 1.27$ dB
Number of hopping frequency	$\pm 1.27$ dB
Carrier Frequency Separation	$\pm 50$ Hz
-20dB Bandwidth	$\pm 50$ Hz
Dwell Time	$\pm 25$ msec

## 2. Conducted Emission

### 2.1. Test Setup

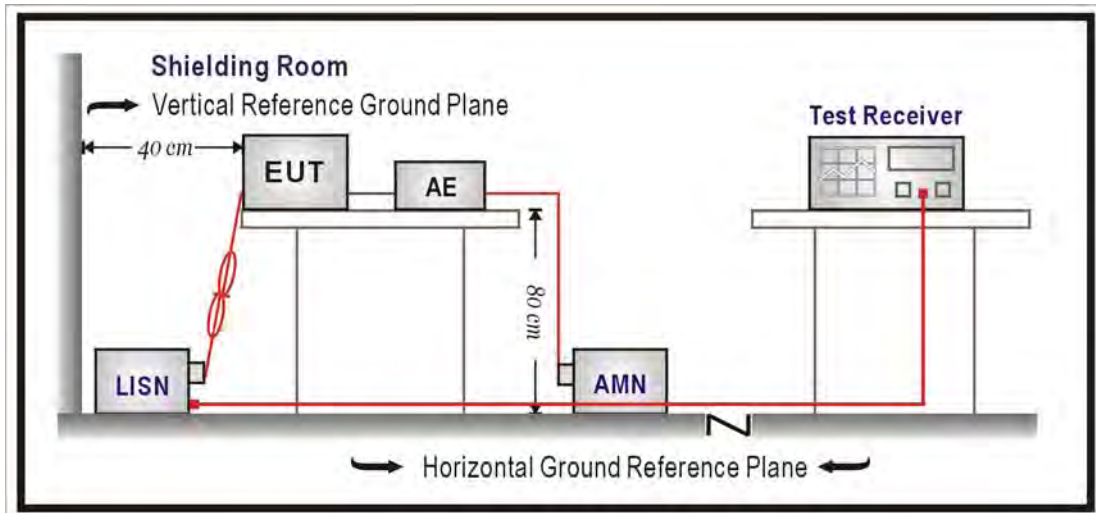

### 2.2. Limits

FCC Part 15 Subpart C Paragraph 15.207 Limits (dBuV)		
Frequency	QP	AV
0.15 - 0.50	66 - 56	56 - 46
0.50 - 5.0	56	46
5.0 - 30	60	50

Remarks: In the above table, the tighter limit applies at the band edges.

### 2.3. Test Procedure

The EUT and simulators are connected to the main power through a line impedance stabilization network (L.I.S.N.). This provides a 50 ohm /50uH coupling impedance for the measuring equipment. The peripheral devices are also connected to the main power through a LISN that provides a 50ohm /50uH coupling impedance with 50ohm termination. (Please refer to the block diagram of the test setup and photographs.)

Both sides of A.C. line are checked for maximum conducted interference. In order to find the maximum emission, the relative positions of equipment and all of the interface cables must be changed according to ANSI C63.10: 2013 on conducted measurement.

Conducted emissions were investigated over the frequency range from 0.15MHz to 30MHz using a receiver bandwidth of 9 kHz.

### 2.4. Test Specification

According to FCC Part 15 Subpart C Paragraph 15.207: 2019

## 2.5. Test Result

Model No	Insyde	Site	SR2-H
Test Voltage	AC 120V/60Hz	Test Date	2020/12/22
Test Mode	Mode 1: Transmit mode_ PCB Ant	Engineer	Lion Wang
Phase	L	Temperature (°C)	20.4
Test Condition	CE_DH5, Ch 78,2.48G	Humidity (%RH)	52.3

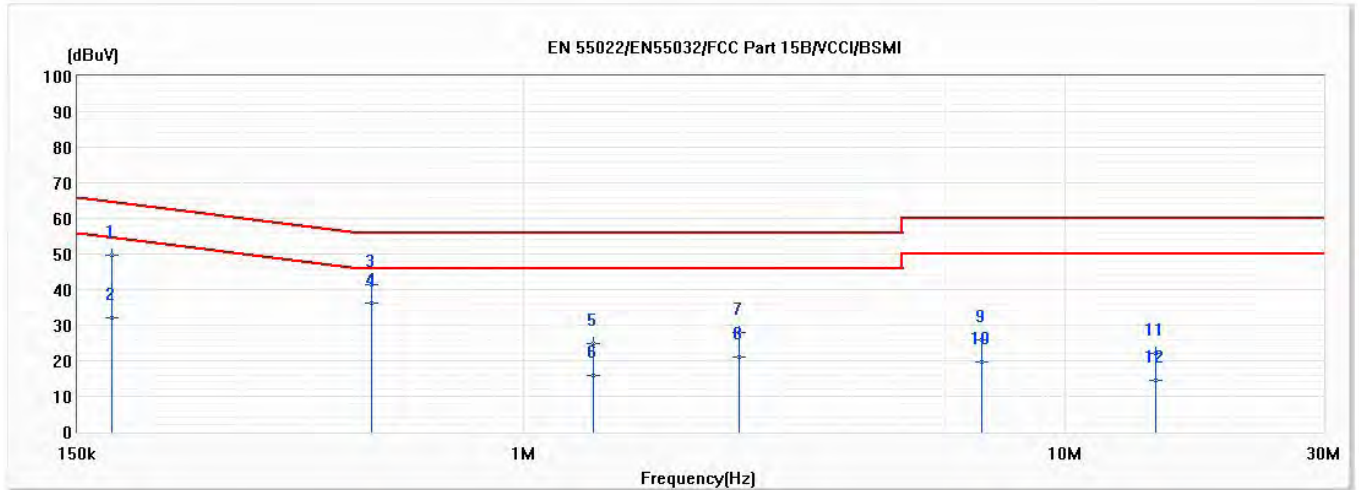

No	Frequency (MHz)	Emission Level (dBuV)	Limit (dBuV)	Margin (dB)	Reading Level (dBuV)	Correct Factor (dB)	Detector Type
1	0.173	49.65	64.80	-15.15	40.00	9.65	QP
2	0.173	32.08	54.80	-22.72	22.43	9.65	AV
3	0.523	41.28	56.00	-14.72	31.58	9.69	QP
*4	0.523	36.33	46.00	-9.67	26.64	9.69	AV
5	1.343	24.89	56.00	-31.11	15.13	9.76	QP
6	1.343	15.80	46.00	-30.20	6.04	9.76	AV
7	2.496	28.09	56.00	-27.91	18.28	9.81	QP
8	2.496	20.97	46.00	-25.03	11.16	9.81	AV
9	7.025	25.95	60.00	-34.05	15.94	10.02	QP
10	7.025	19.77	50.00	-30.23	9.75	10.02	AV
11	14.726	22.05	60.00	-37.95	11.80	10.25	QP
12	14.726	14.56	50.00	-35.44	4.30	10.25	AV

Remark:

1. "\*" means this data is the worst emission level.
2. Emission Level = Reading Level + Correct Factor (Correct Factor = LISN Insertion Loss + Cable Loss).
3. Margin = Emission Level - Limit.

Model No	Insyde	Site	SR2-H
Test Voltage	AC 120V/60Hz	Test Date	2020/12/22
Test Mode	Mode 1: Transmit mode_ PCB Ant	Engineer	Lion Wang
Phase	N	Temperature (°C)	20.4
Test Condition	CE_DH5, Ch 78,2.48G,	Humidity (%RH)	52.3

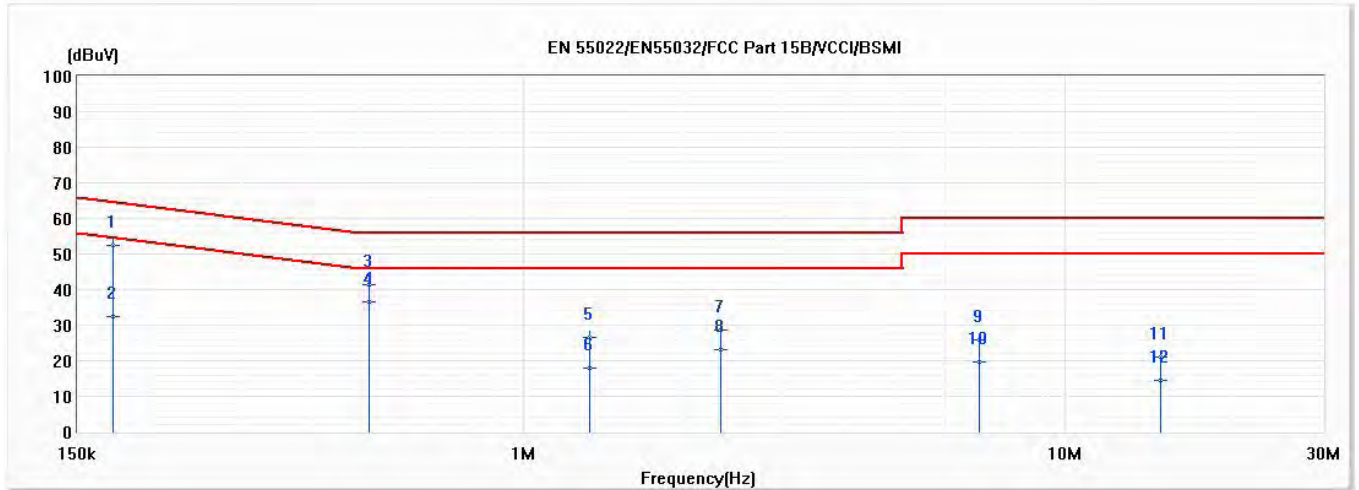

No	Frequency (MHz)	Emission Level (dBuV)	Limit (dBuV)	Margin (dB)	Reading Level (dBuV)	Correct Factor (dB)	Detector Type
1	0.175	52.25	64.74	-12.49	42.61	9.64	QP
2	0.175	32.45	54.74	-22.29	22.81	9.64	AV
3	0.518	41.46	56.00	-14.54	31.78	9.68	QP
*4	0.518	36.50	46.00	-9.50	26.82	9.68	AV
5	1.321	26.66	56.00	-29.34	16.92	9.74	QP
6	1.321	17.86	46.00	-28.14	8.12	9.74	AV
7	2.312	28.59	56.00	-27.41	18.79	9.79	QP
8	2.312	23.04	46.00	-22.96	13.25	9.79	AV
9	6.939	25.78	60.00	-34.22	15.77	10.02	QP
10	6.939	19.76	50.00	-30.24	9.74	10.02	AV
11	14.968	21.04	60.00	-38.96	10.70	10.34	QP
12	14.968	14.55	50.00	-35.45	4.20	10.34	AV

Remark:

1. "\*" means this data is the worst emission level.
2. Emission Level = Reading Level + Correct Factor (Correct Factor = LISN Insertion Loss + Cable Loss).
3. Margin = Emission Level - Limit.

Model No	Insyde	Site	SR2-H
Test Voltage	AC 120V/60Hz	AC 120V/60Hz	2020/12/22
Test Mode	Mode 1: Transmit mode_ PIFA Ant	Engineer	Lion Wang
Phase	L	Temperature (°C)	20.4
Test Condition	CE_BT2.0,DH5,Ch39,2.441G	Humidity (%RH)	52.3

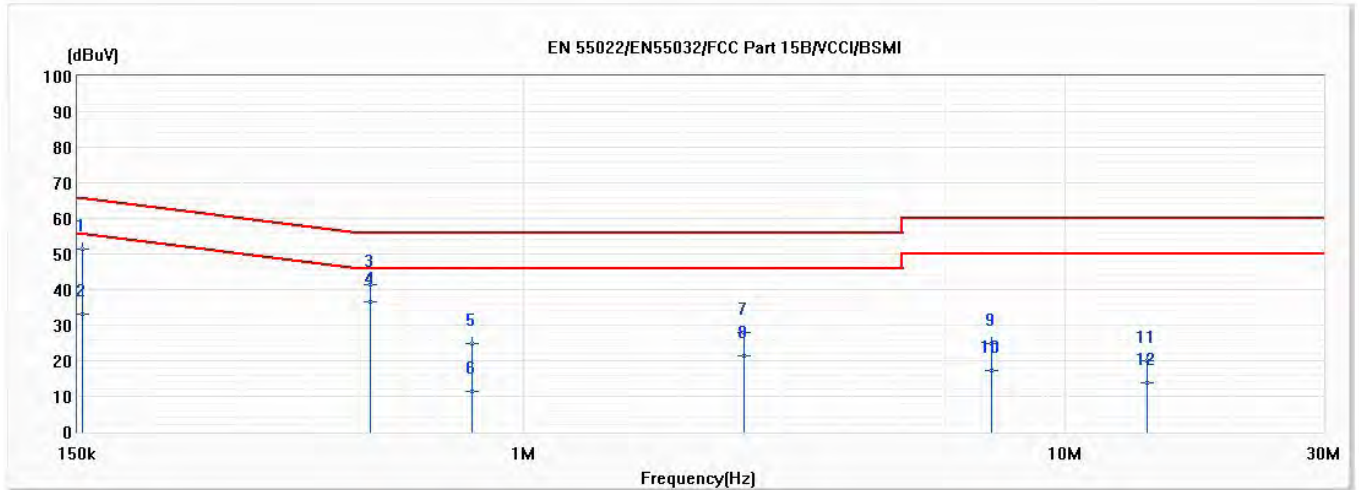

No	Frequency (MHz)	Emission Level (dBuV)	Limit (dBuV)	Margin (dB)	Reading Level (dBuV)	Correct Factor (dB)	Detector Type
1	0.153	51.52	65.82	-14.30	41.87	9.65	QP
2	0.153	33.10	55.82	-22.71	23.45	9.65	AV
3	0.520	41.47	56.00	-14.53	31.77	9.69	QP
*4	0.520	36.72	46.00	-9.28	27.02	9.69	AV
5	0.803	24.85	56.00	-31.15	15.13	9.72	QP
6	0.803	11.48	46.00	-34.52	1.76	9.72	AV
7	2.554	28.06	56.00	-27.94	18.25	9.82	QP
8	2.554	21.28	46.00	-24.72	11.47	9.82	AV
9	7.304	24.77	60.00	-35.23	14.74	10.03	QP
10	7.304	17.07	50.00	-32.93	7.05	10.03	AV
11	14.195	20.06	60.00	-39.94	9.82	10.23	QP
12	14.195	13.90	50.00	-36.10	3.67	10.23	AV

Remark:

1. "\*" means this data is the worst emission level.
2. Emission Level = Reading Level + Correct Factor (Correct Factor = LISN Insertion Loss + Cable Loss).
3. Margin = Emission Level - Limit.

Model No	Insyde	Site	SR2-H
Test Voltage	AC 120V/60Hz	Test Date	2020/12/22
Test Mode	Mode 1: Transmit mode_ PIFA Ant	Engineer	Lion Wang
Phase	N	Temperature (°C)	20.4
Test Condition	CE_BT2.0,DH5,Ch39,2.441G	Humidity (%RH)	52.3

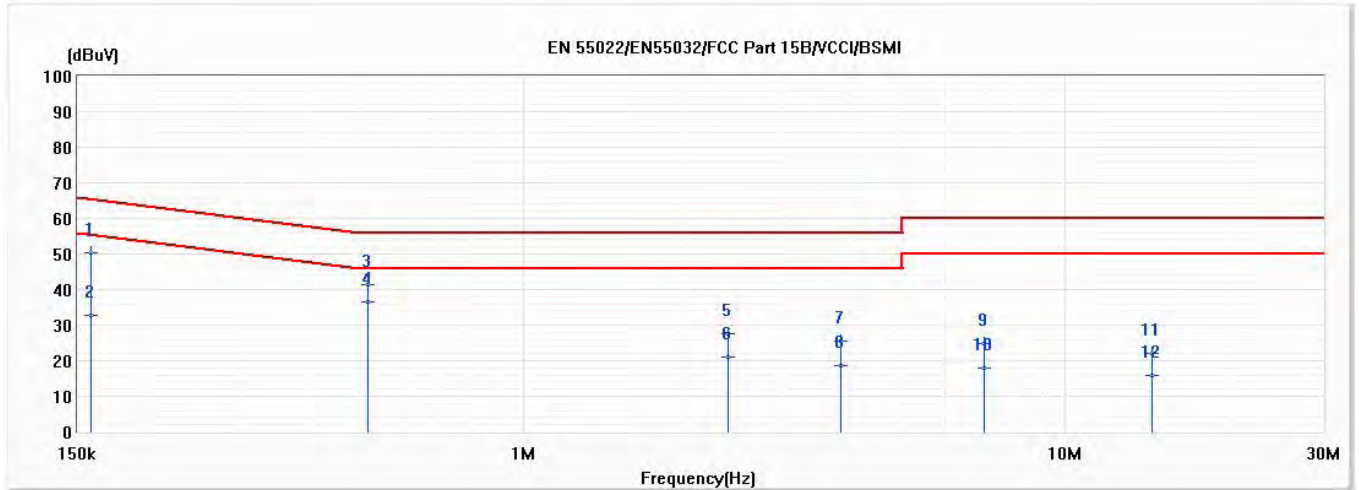

No	Frequency (MHz)	Emission Level (dBuV)	Limit (dBuV)	Margin (dB)	Reading Level (dBuV)	Correct Factor (dB)	Detector Type
1	0.159	50.26	65.53	-15.27	40.62	9.64	QP
2	0.159	32.63	55.53	-22.90	22.99	9.64	AV
3	0.514	41.28	56.00	-14.72	31.60	9.68	QP
*4	0.514	36.64	46.00	-9.36	26.96	9.68	AV
5	2.385	27.68	56.00	-28.32	17.88	9.80	QP
6	2.385	21.18	46.00	-24.82	11.38	9.80	AV
7	3.850	25.42	56.00	-30.58	15.55	9.87	QP
8	3.850	18.71	46.00	-27.29	8.84	9.87	AV
9	7.072	24.81	60.00	-35.19	14.79	10.02	QP
10	7.072	17.88	50.00	-32.12	7.86	10.02	AV
11	14.433	22.01	60.00	-37.99	11.69	10.32	QP
12	14.433	15.99	50.00	-34.01	5.67	10.32	AV

Remark:

1. "\*" means this data is the worst emission level.
2. Emission Level = Reading Level + Correct Factor (Correct Factor = LISN Insertion Loss + Cable Loss).
3. Margin = Emission Level - Limit.

### 3. Maximum peak conducted output power

#### 3.1. Test Setup

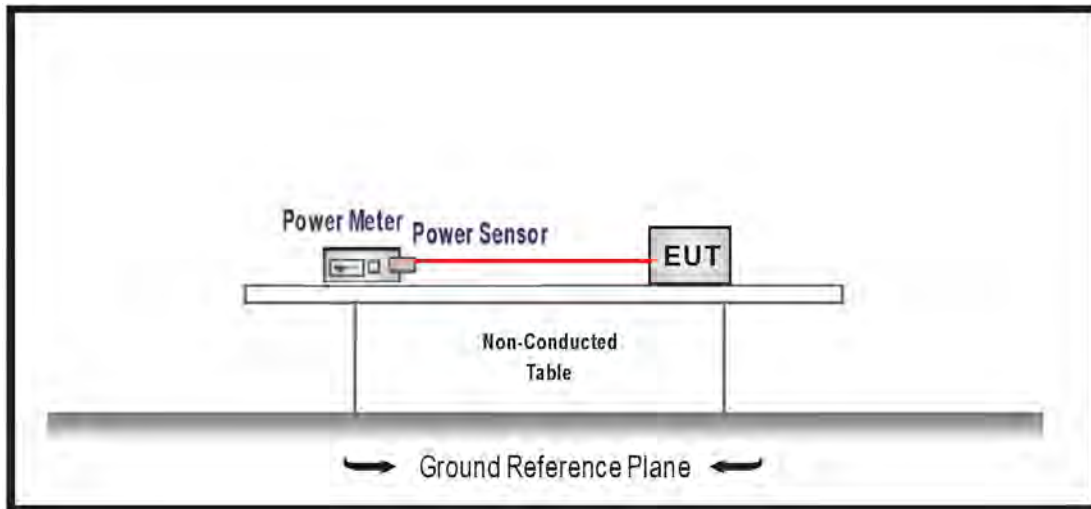

#### 3.2. Test procedures

The EUT was setup according to ANSI C63.10: 2013 and tested according to FHSS test procedure of FCC KDB 558074 D01 v05r02 for compliance to FCC 47CFR 15.247 requirements

#### 3.3. Limits

For frequency hopping systems operating in the 902-928 MHz band: 1 Watt for systems employing at least 50 hopping channels; and, 0.25 Watts for systems employing less than 50 hopping channels.

For frequency hopping systems operating in the 2400-2483.5 MHz band employing at least 75 non-overlapping hopping channels, and all frequency hopping systems in the 5725-5850 MHz band: 1 watt. For all other frequency hopping systems in the 2400-2483.5 MHz band: 0.125 watts.

#### 3.4. Test Specification

According to FCC Part 15 Subpart C Paragraph 15.247: 2019.

### 3.5. Test Result

Product	Insyde		
Test Item	Maximum peak conducted output power		
Test Mode	Mode 1: Transmit mode_ PCB Ant		
Date of Test	2020/10/27	Test Site	SR12-H
Temperature(°C)	24	Humidity (%RH)	62

#### GFSK

Channel No.	Frequency (MHz)	Measure Level (dBm)	Limit (dBm)
00	2402	16.610	≤30
39	2441	17.640	≤30
78	2480	17.420	≤30

#### 8-DPSK

Channel No.	Frequency (MHz)	Measure Level (dBm)	Limit (dBm)
00	2402	14.160	≤30
39	2441	15.280	≤30
78	2480	15.030	≤30



Product	Insyde		
Test Item	Maximum peak conducted output power		
Test Mode	Mode 1: Transmit mode_ PIFA Ant		
Date of Test	2021/01/18	Test Site	SR12-H
Temperature(°C)	18	Humidity (%RH)	63

## GFSK

Channel No.	Frequency (MHz)	Measure Level (dBm)	Limit (dBm)
00	2402	-0.610	$\leq 30$
39	2441	3.150	$\leq 30$
78	2480	4.510	$\leq 30$

## 8-DPSK

Channel No.	Frequency (MHz)	Measure Level (dBm)	Limit (dBm)
00	2402	-2.880	$\leq 30$
39	2441	0.880	$\leq 30$
78	2480	2.540	$\leq 30$

## 4. Radiated Emission

### 4.1. Test Setup

Under 30MHz Test Setup:

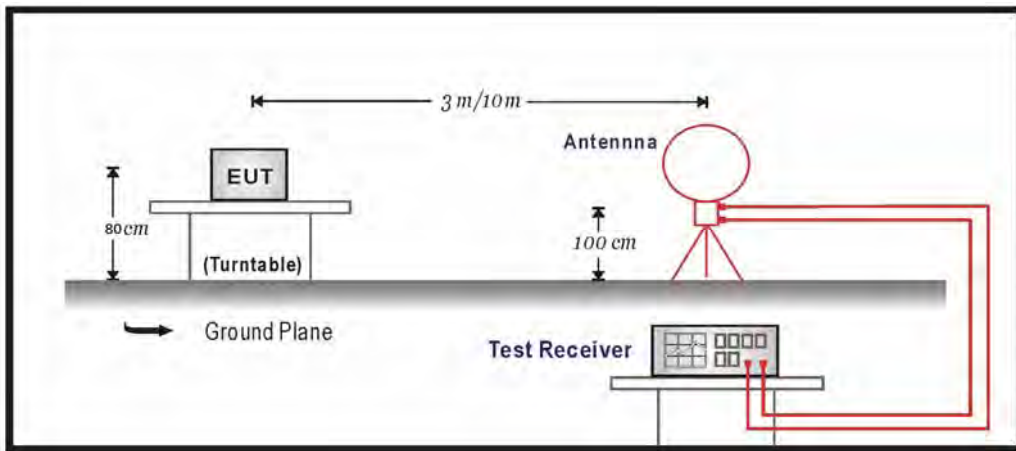

Under 1GHz Test Setup:

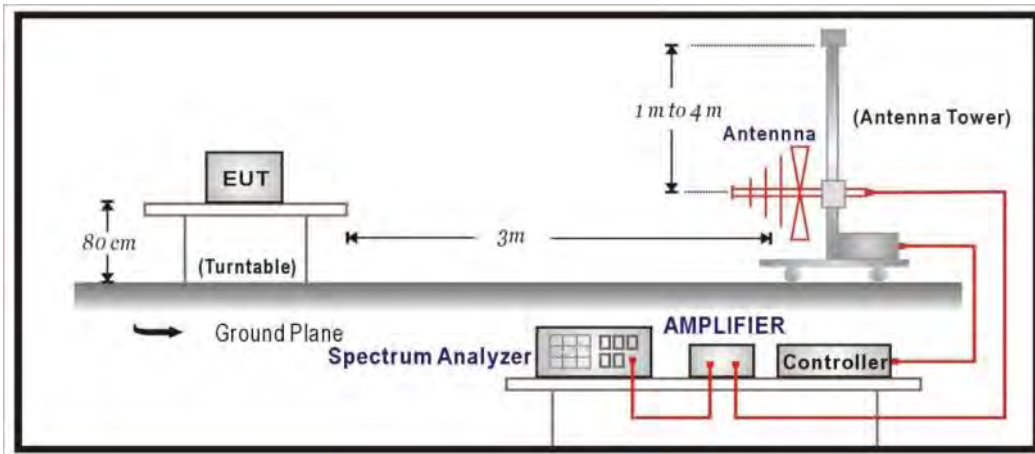

Above 1GHz Test Setup:

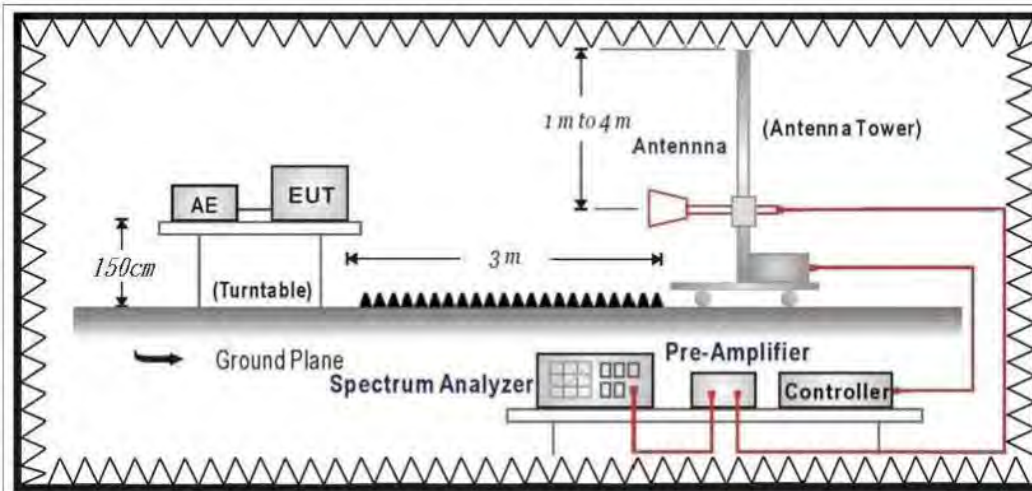

## 4.2. Limits

Emissions radiated outside of the specified frequency bands, except for harmonics, shall be attenuated by at least 20dB below the level of the fundamental or to the general radiated emission limits in paragraph 15.209, whichever is the lesser attenuation.

<b>FCC Part 15 Subpart C Paragraph 15.209 Limits</b>		
Frequency (MHz)	uV/m	dBuV/m
30-88	100	40
88-216	150	43.5
216-960	200	46
Above 960	500	54

Remarks: 1. RF Voltage (dBuV) = 20 log RF Voltage (uV)  
2. In the Above Table, the tighter limit applies at the band edges.  
3. Distance refers to the distance in meters between the measuring instrument antenna and the closed point of any part of the device or system.

### **4.3. Test Procedure**

The EUT was setup according to ANSI C63.10: 2013 and tested according to FHSS test procedure of FCC KDB 558074 D01 v05r02 for compliance to FCC 47CFR 15.247 requirements.

The EUT and its simulators are placed on a turn table which is 0.8 or 1.5 meter above ground. The turn table can rotate 360 degrees to determine the position of the maximum emission level.

The antenna can move up and down between 1 meter and 4 meters to find out the maximum emission level.

Both horizontal and vertical polarization of the antenna are set on measurement. In order to find the maximum emission, all of the interface cables must be manipulated according to ANSI C63.10: 2013 on radiated measurement.

On any frequency or frequencies from 9KHz(include The the lowest oscillator frequency generated within the device up to the 10th harmonic) to 1000 MHz, the limits shown are based on measuring equipment employing a quasi-peak detector function and on any frequency or frequencies above 1000 MHz the radiated limits shown are based upon the use of measurement instrumentation employing an average detector function. When average radiated emission measurement are included emission measurement below 1000 MHz, there also is a limit on the radio frequency emissions, as measured using instrumentation with a peak detector function, corresponding to 20 dB above the maximum permitted average limit. The bandwidth below 1GHz setting on the field strength meter is 120 kHz and above 1GHz is 1MHz.

### **4.4. Test Specification**

According to FCC Part 15 Subpart C Paragraph 15.247: 2019

### 4.5. Test Result

#### 30MHz-1GHz Spurious

Model No	Insyde	Site	CB2-H
Test Voltage	AC 120V/60Hz	Test Date	2020/12/16
Test Mode	Mode 1: Transmit mode_ PCB Ant	Engineer	Ling Chen
Polarity	Horizontal	Temperature (°C)	23.5
Test Condition	RE_DH5, Ch 78,2.48G	Humidity (%RH)	58.0

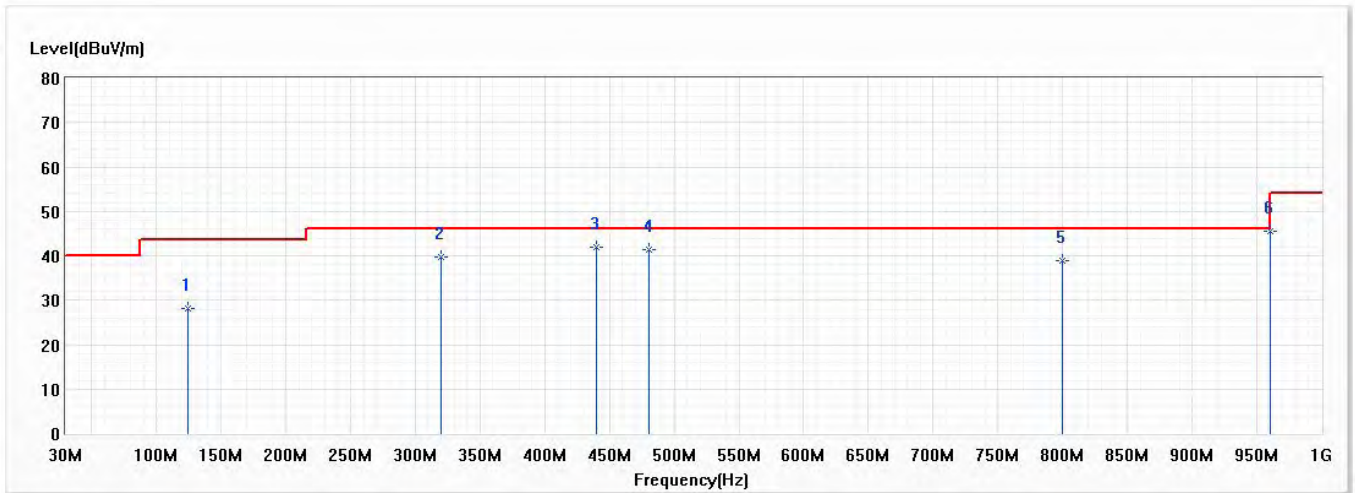

No	Frequency (MHz)	Emission Level (dBuV/m)	Limit (dBuV/m)	Margin (dB)	Reading Level (dBuV)	Correct Factor (dB)	Detector Type
1	124.575	28.12	43.50	-15.38	30.62	-2.50	QP
2	320.030	39.84	46.00	-6.16	40.41	-0.57	QP
* 3	439.825	41.93	46.00	-4.07	39.17	2.76	QP
4	480.080	41.46	46.00	-4.54	38.02	3.44	QP
5	800.180	38.86	46.00	-7.14	31.51	7.35	QP
6	960.230	45.46	54.00	-8.54	35.89	9.57	QP

Note:

1. All reading levels is Quasi-Peak value.
2. “ \* ”, means this data is the worst value.
3. Emission Level = Reading Level + Correct Factor
4. The emission under 30MHz were not included is because their levels are lower than 20dB from limit.

Model No	Insyde	Site	CB2-H
Test Voltage	AC 120V/60Hz	Test Date	2020/12/16
Test Mode	Mode 1: Transmit mode_ PCB Ant	Engineer	Ling Chen
Polarity	Vertical	Temperature (°C)	23.5
Test Condition	RE_DH5, Ch 78,2.48G	Humidity (%RH)	58.0

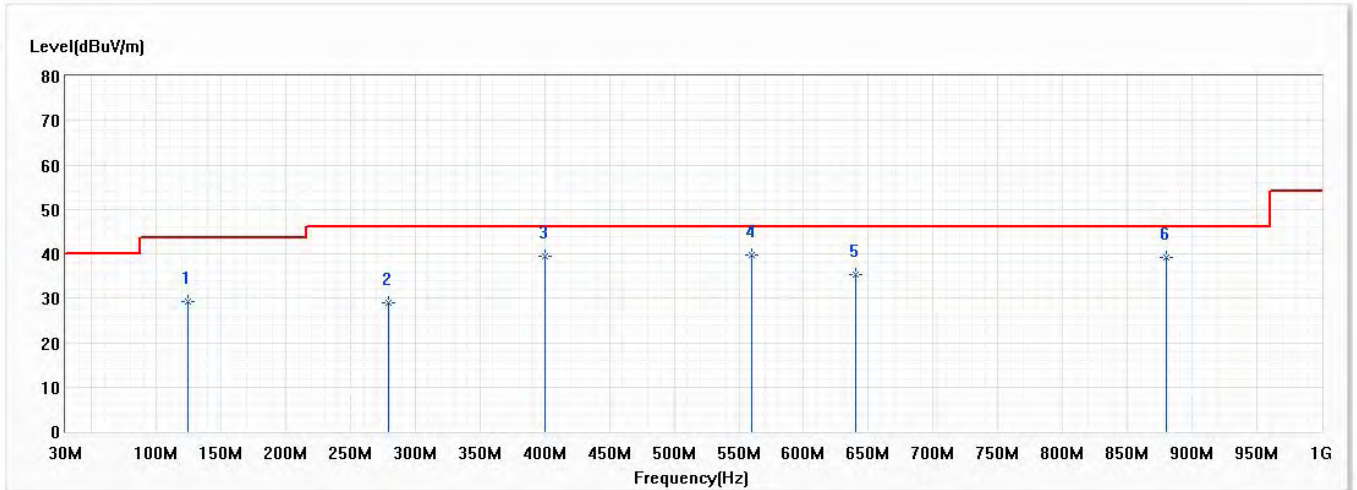

No	Frequency (MHz)	Emission Level (dBuV/m)	Limit (dBuV/m)	Margin (dB)	Reading Level (dBuV)	Correct Factor (dB)	Detector Type
1	124.575	29.11	43.50	-14.39	31.61	-2.50	QP
2	279.775	29.08	46.00	-16.92	30.63	-1.55	QP
3	400.055	39.35	46.00	-6.65	37.33	2.02	QP
* 4	560.105	39.67	46.00	-6.33	35.12	4.55	QP
5	640.130	35.34	46.00	-10.66	29.85	5.49	QP
6	880.205	39.16	46.00	-6.84	30.82	8.34	QP

Note:

1. All reading levels is Quasi-Peak value.
2. “ \* ”, means this data is the worst value.
3. Emission Level = Reading Level + Correct Factor
4. The emission under 30MHz were not included is because their levels are lower than 20dB from limit.

Model No	Insyde	Site	CB2-H
Test Voltage	AC 120V/60Hz	Test Date	2020/10/26
Test Mode	Mode 1: Transmit mode_ PIFA Ant	Engineer	Scott Lin
Polarity	Horizontal	Temperature (°C)	24.0
Test Condition	RE_BT2.0,DH5,Ch39,2.441G	Humidity (%RH)	58.0

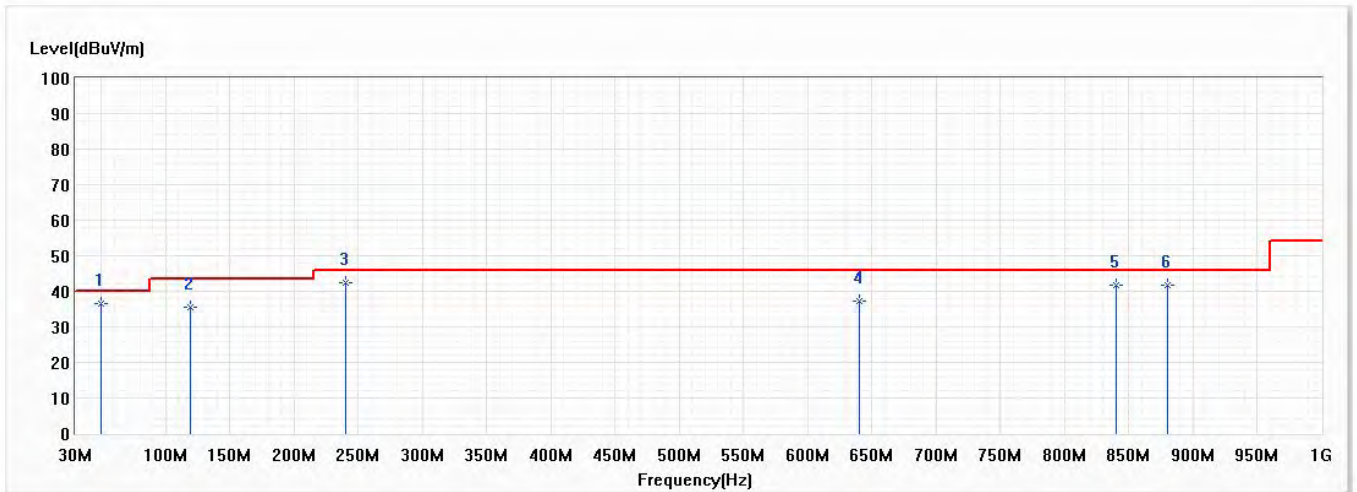

No	Frequency (MHz)	Emission Level (dBuV/m)	Limit (dBuV/m)	Margin (dB)	Reading Level (dBuV)	Correct Factor (dB)	Detector Type
* 1	49.885	36.45	40.00	-3.55	42.12	-5.67	QP
2	119.119	35.66	43.50	-7.84	38.42	-2.76	QP
3	240.005	42.28	46.00	-3.72	45.08	-2.80	QP
4	640.009	37.24	46.00	-8.76	32.09	5.15	QP
5	840.071	41.83	46.00	-4.17	34.12	7.71	QP
6	880.084	41.56	46.00	-4.44	33.40	8.16	QP

Note:

1. All reading levels is Quasi-Peak value.
2. “ \* ”, means this data is the worst value.
3. Emission Level = Reading Level + Correct Factor
4. The emission under 30MHz were not included is because their levels are lower than 20dB from limit.

Model No	Insyde	Site	CB2-H
Test Voltage	AC 120V/60Hz	Test Date	2020/10/26
Test Mode	Mode 1: Transmit mode_ PIFA Ant	Engineer	Scott Lin
Polarity	Vertical	Temperature (°C)	24.0
Test Condition	RE_BT2.0,DH5,Ch39,2.441G	Humidity (%RH)	58.0

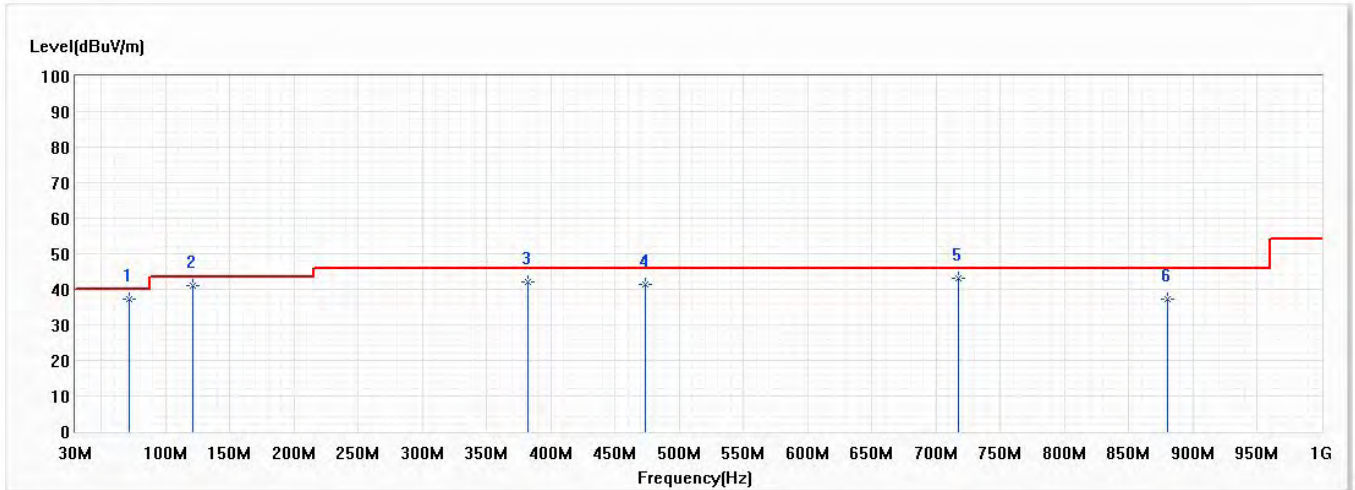

No	Frequency (MHz)	Emission Level (dBuV/m)	Limit (dBuV/m)	Margin (dB)	Reading Level (dBuV)	Correct Factor (dB)	Detector Type
1	72.074	37.35	40.00	-2.65	46.01	-8.66	QP
* 2	121.665	40.92	43.50	-2.58	43.56	-2.64	QP
3	382.231	42.06	46.00	-3.94	40.81	1.25	QP
4	473.290	41.48	46.00	-4.52	38.42	3.06	QP
5	717.124	42.98	46.00	-3.02	37.03	5.95	QP
6	880.084	37.16	46.00	-8.84	29.00	8.16	QP

Note:

1. All reading levels is Quasi-Peak value.
2. “ \* ”, means this data is the worst value.
3. Emission Level = Reading Level + Correct Factor
4. The emission under 30MHz were not included is because their levels are lower than 20dB from limit.



**Harmonic & Spurious:**

Model No	Insyde	Site	CB2-H
Test Voltage	AC 120V/60Hz	Test Date	2020/12/15
Test Mode	Mode 1: Transmit mode_ PCB Ant	Engineer	Ling Chen
Polarity	Horizontal	Temperature (°C)	23.5
Test Condition	RF_BT 2.0,DH5, Ch 0,2.402G	Humidity (%RH)	58.0

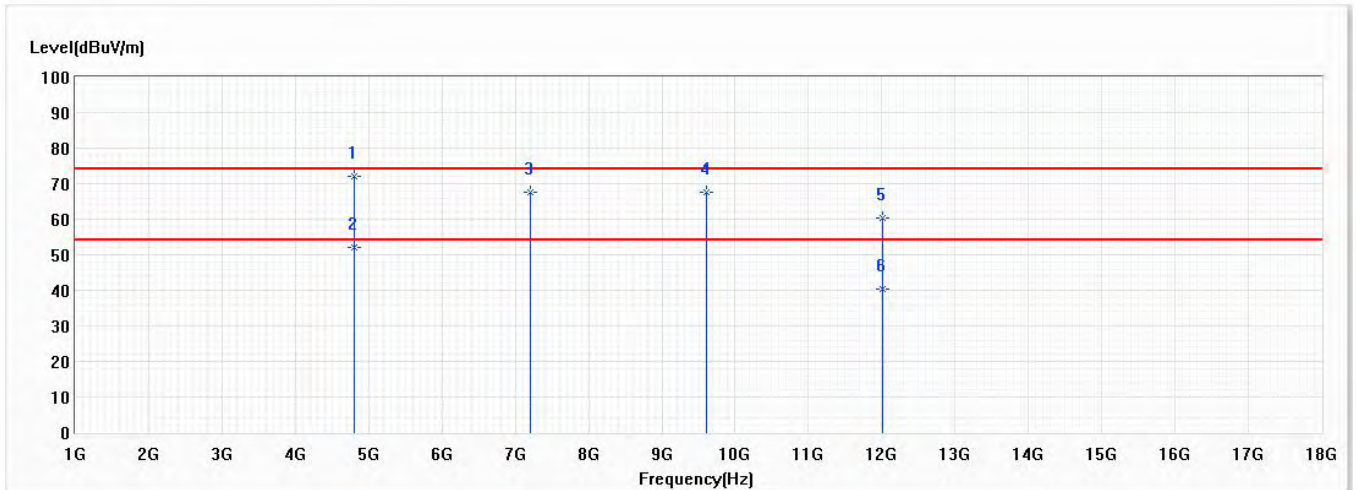

No	Frequency (MHz)	Emission Level (dBuV/m)	Limit (dBuV/m)	Margin (dB)	Reading Level (dBuV)	Correct Factor (dB)	Detector Type
* 1	4804.000	72.04	74.00	-1.96	84.07	-12.03	PK
2	4804.000	52.04	54.00	-1.96	64.07	-12.03	AV
3	7206.000	67.70	74.00	-6.30	72.38	-4.68	PK
4	9608.000	67.46	74.00	-6.54	68.79	-1.33	PK
5	12010.000	60.39	74.00	-13.61	57.58	2.81	PK
6	12010.000	40.39	54.00	-13.61	37.58	2.81	AV

**Note:**

- 1.All reading above 1GHz is performed with peak and/or average measurements as necessary.
2. “ \* ”, means this data is the worst value.
- 3.Emission Level = Reading Level + Correct Factor.
- 4.The average measurement was not performed when the peak measured data under the limit of average detection.
- 5.The emission above 13GHz were not included is because their levels are lower than 20dB form limit.

Model No	Insyde	Site	CB2-H
Test Voltage	AC 120V/60Hz	Test Date	2020/12/15
Test Mode	Mode 1: Transmit mode_ PCB Ant	Engineer	Ling Chen
Polarity	Vertical	Temperature (°C)	23.5
Test Condition	RF_BT 2.0,DH5, Ch 0,2.402G	Humidity (%RH)	58.0

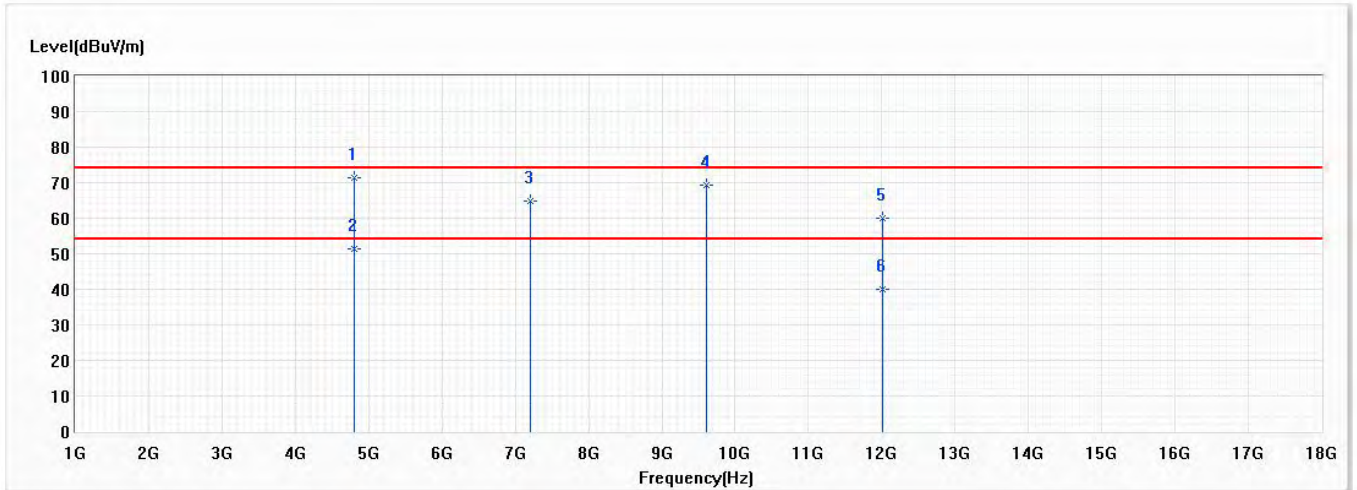

No	Frequency (MHz)	Emission Level (dBuV/m)	Limit (dBuV/m)	Margin (dB)	Reading Level (dBuV)	Correct Factor (dB)	Detector Type
* 1	4804.000	71.44	74.00	-2.56	83.47	-12.03	PK
2	4804.000	51.44	54.00	-2.56	63.47	-12.03	AV
3	7206.000	64.91	74.00	-9.09	69.59	-4.68	PK
4	9608.000	69.23	74.00	-4.77	70.56	-1.33	PK
5	12010.000	60.15	74.00	-13.85	57.34	2.81	PK
6	12010.000	40.15	54.00	-13.85	37.34	2.81	AV

Note:

- 1.All reading above 1GHz is performed with peak and/or average measurements as necessary.
2. “ \* ”, means this data is the worst value.
- 3.Emission Level = Reading Level + Correct Factor.
- 4.The average measurement was not performed when the peak measured data under the limit of average detection.
- 5.The emission above 13GHz were not included is because their levels are lower than 20dB form limit.

Model No	Insyde	Site	CB2-H
Test Voltage	AC 120V/60Hz	Test Date	2020/12/15
Test Mode	Mode 1: Transmit mode_ PCB Ant	Engineer	Ling Chen
Polarity	Horizontal	Temperature (°C)	23.5
Test Condition	RF_BT 2.0,DH5, Ch 39,2.441G	Humidity (%RH)	58.0

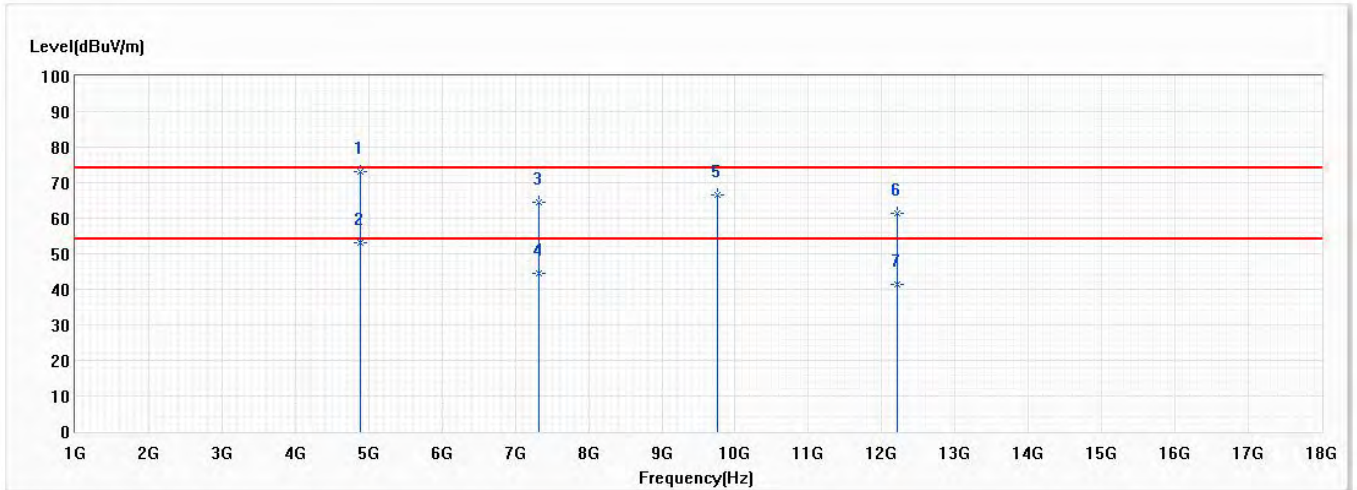

No	Frequency (MHz)	Emission Level (dBuV/m)	Limit (dBuV/m)	Margin (dB)	Reading Level (dBuV)	Correct Factor (dB)	Detector Type
* 1	4882.000	72.97	74.00	-1.03	84.79	-11.82	PK
2	4882.000	52.97	54.00	-1.03	64.79	-11.82	AV
3	7323.000	64.46	74.00	-9.54	68.80	-4.34	PK
4	7323.000	44.46	54.00	-9.54	48.80	-4.34	AV
5	9764.000	66.72	74.00	-7.28	67.99	-1.27	PK
6	12205.000	61.26	74.00	-12.74	58.69	2.57	PK
7	12205.000	41.26	54.00	-12.74	38.69	2.57	AV

Note:

- 1.All reading above 1GHz is performed with peak and/or average measurements as necessary.
2. “ \* ”, means this data is the worst value.
- 3.Emission Level = Reading Level + Correct Factor.
- 4.The average measurement was not performed when the peak measured data under the limit of average detection.
- 5.The emission above 13GHz were not included is because their levels are lower than 20dB form limit.

Model No	Insyde	Site	CB2-H
Test Voltage	AC 120V/60Hz	Test Date	2020/12/15
Test Mode	Mode 1: Transmit mode_ PCB Ant	Engineer	Ling Chen
Polarity	Vertical	Temperature (°C)	23.5
Test Condition	RF_BT 2.0,DH5, Ch 39,2.441G	Humidity (%RH)	58.0

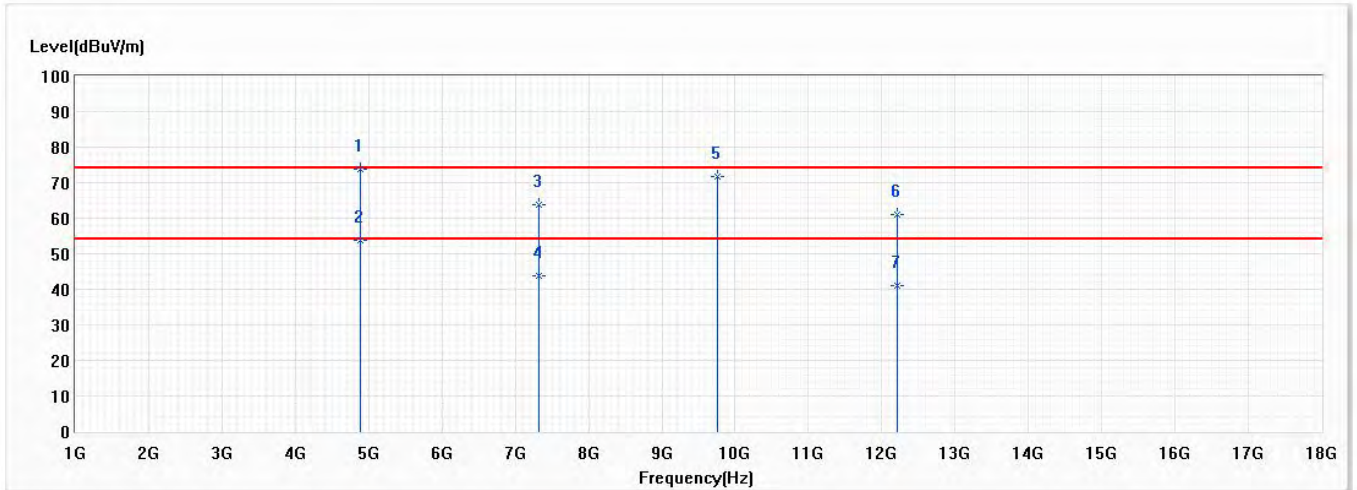

No	Frequency (MHz)	Emission Level (dBuV/m)	Limit (dBuV/m)	Margin (dB)	Reading Level (dBuV)	Correct Factor (dB)	Detector Type
* 1	4882.000	73.85	74.00	-0.15	85.67	-11.82	PK
2	4882.000	53.85	54.00	-0.15	65.67	-11.82	AV
3	7323.000	63.78	74.00	-10.22	68.12	-4.34	PK
4	7323.000	43.78	54.00	-10.22	48.12	-4.34	AV
5	9764.000	71.86	74.00	-2.14	73.13	-1.27	PK
6	12205.000	61.16	74.00	-12.84	58.59	2.57	PK
7	12205.000	41.16	54.00	-12.84	38.59	2.57	AV

Note:

- 1.All reading above 1GHz is performed with peak and/or average measurements as necessary.
2. “ \* ”, means this data is the worst value.
- 3.Emission Level = Reading Level + Correct Factor.
- 4.The average measurement was not performed when the peak measured data under the limit of average detection.
- 5.The emission above 13GHz were not included is because their levels are lower than 20dB form limit.

Model No	Insyde	Site	CB2-H
Test Voltage	AC 120V/60Hz	Test Date	2020/12/15
Test Mode	Mode 1: Transmit mode_ PCB Ant	Engineer	Ling Chen
Polarity	Horizontal	Temperature (°C)	23.5
Test Condition	RF_BT 2.0,DH5, Ch 78,2.48G	Humidity (%RH)	58.0

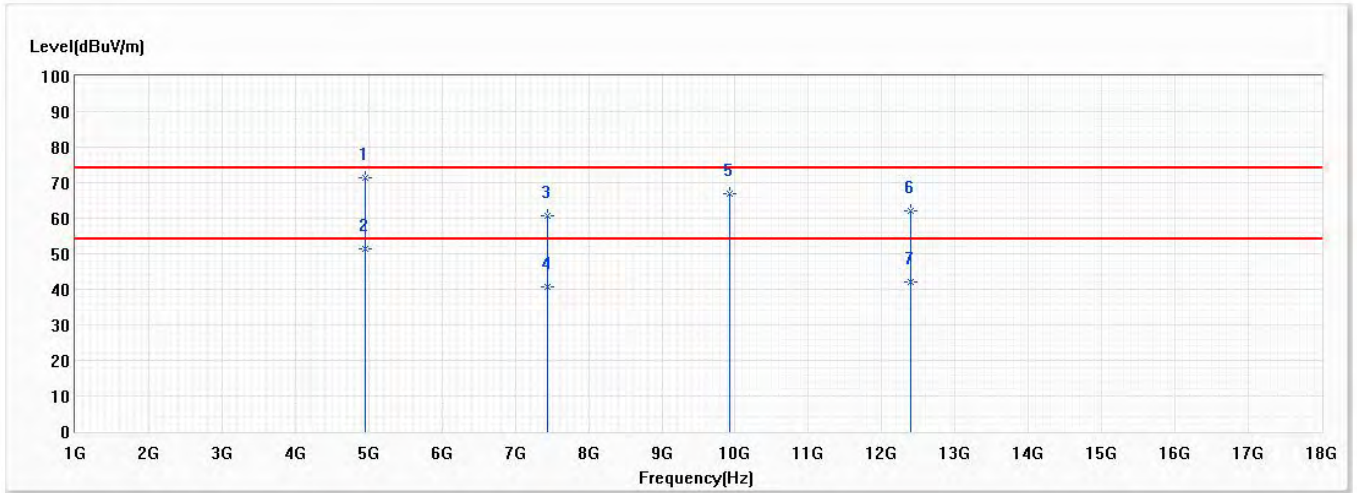

No	Frequency (MHz)	Emission Level (dBuV/m)	Limit (dBuV/m)	Margin (dB)	Reading Level (dBuV)	Correct Factor (dB)	Detector Type
* 1	4960.000	71.32	74.00	-2.68	82.92	-11.60	PK
2	4960.000	51.32	54.00	-2.68	62.92	-11.60	AV
3	7440.000	60.62	74.00	-13.38	64.63	-4.01	PK
4	7440.000	40.62	54.00	-13.38	44.63	-4.01	AV
5	9920.000	67.02	74.00	-6.98	68.21	-1.19	PK
6	12400.000	62.02	74.00	-11.98	59.68	2.34	PK
7	12400.000	42.02	54.00	-11.98	39.68	2.34	AV

Note:

- 1.All reading above 1GHz is performed with peak and/or average measurements as necessary.
2. “ \* ”, means this data is the worst value.
- 3.Emission Level = Reading Level + Correct Factor.
- 4.The average measurement was not performed when the peak measured data under the limit of average detection.
- 5.The emission above 13GHz were not included is because their levels are lower than 20dB form limit.

Model No	Insyde	Site	CB2-H
Test Voltage	AC 120V/60Hz	Test Date	2020/12/15
Test Mode	Mode 1: Transmit mode_ PCB Ant	Engineer	Ling Chen
Polarity	Vertical	Temperature (°C)	23.5
Test Condition	RF_BT 2.0,DH5, Ch 78,2.48G	Humidity (%RH)	58.0

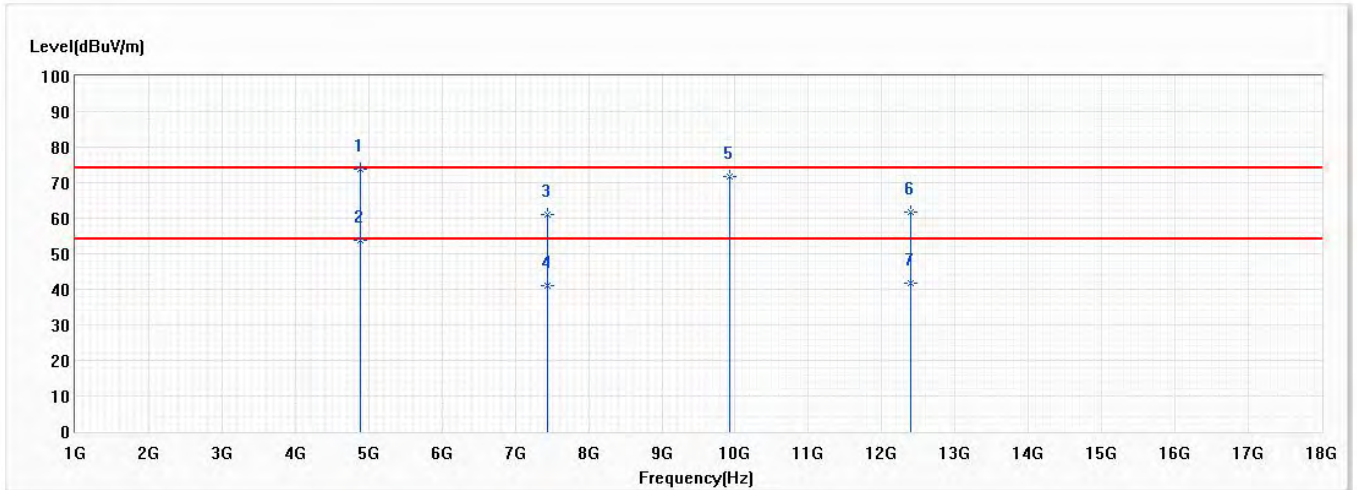

No	Frequency (MHz)	Emission Level (dBuV/m)	Limit (dBuV/m)	Margin (dB)	Reading Level (dBuV)	Correct Factor (dB)	Detector Type
* 1	4882.000	73.88	74.00	-0.12	85.70	-11.82	PK
2	4882.000	53.88	54.00	-0.12	65.70	-11.82	AV
3	7440.000	61.08	74.00	-12.92	65.09	-4.01	PK
4	7440.000	41.08	54.00	-12.92	45.09	-4.01	AV
5	9920.000	71.89	74.00	-2.11	73.08	-1.19	PK
6	12400.000	61.57	74.00	-12.43	59.23	2.34	PK
7	12400.000	41.57	54.00	-12.43	39.23	2.34	AV

Note:

- 1.All reading above 1GHz is performed with peak and/or average measurements as necessary.
2. “ \* ”, means this data is the worst value.
- 3.Emission Level = Reading Level + Correct Factor.
- 4.The average measurement was not performed when the peak measured data under the limit of average detection.
- 5.The emission above 13GHz were not included is because their levels are lower than 20dB form limit.

Model No	Insyde	Site	CB2-H
Test Voltage	AC 120V/60Hz	Test Date	2020/12/15
Test Mode	Mode 1: Transmit mode_ PCB Ant	Engineer	Ling Chen
Polarity	Horizontal	Temperature (°C)	23.5
Test Condition	RF_BT 2.0,3DH5, Ch 0,2.402G	Humidity (%RH)	58.0

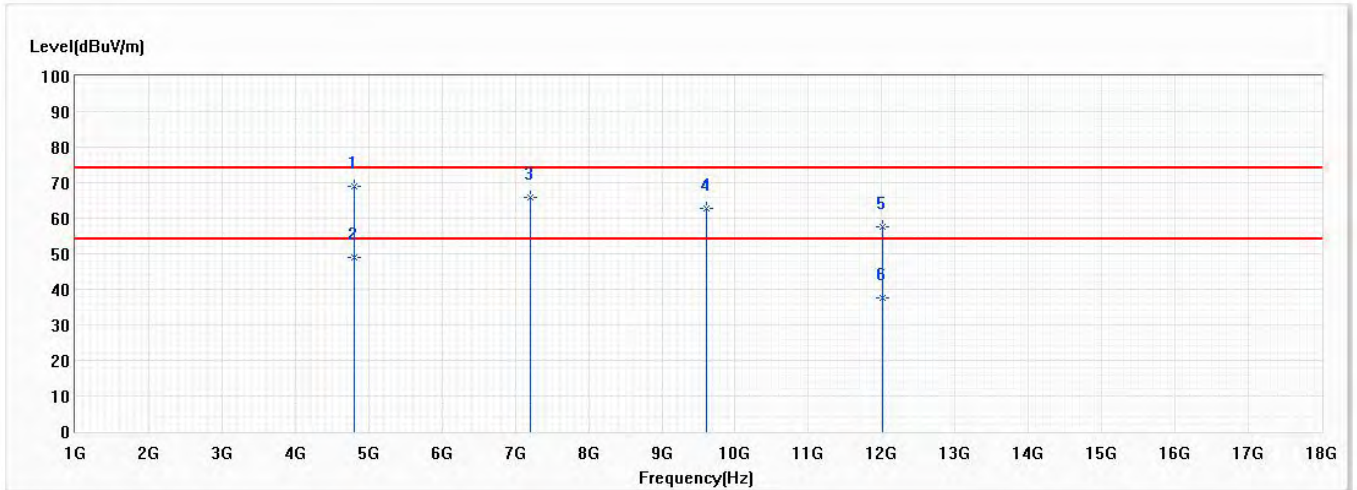

No	Frequency (MHz)	Emission Level (dBuV/m)	Limit (dBuV/m)	Margin (dB)	Reading Level (dBuV)	Correct Factor (dB)	Detector Type
* 1	4804.000	68.97	74.00	-5.03	81.00	-12.03	PK
2	4804.000	48.97	54.00	-5.03	61.00	-12.03	AV
3	7206.000	65.72	74.00	-8.28	70.40	-4.68	PK
4	9608.000	62.87	74.00	-11.13	64.20	-1.33	PK
5	12010.000	57.53	74.00	-16.47	54.72	2.81	PK
6	12010.000	37.53	54.00	-16.47	34.72	2.81	AV

Note:

- 1.All reading above 1GHz is performed with peak and/or average measurements as necessary.
2. “ \* ”, means this data is the worst value.
- 3.Emission Level = Reading Level + Correct Factor.
- 4.The average measurement was not performed when the peak measured data under the limit of average detection.
- 5.The emission above 13GHz were not included is because their levels are lower than 20dB form limit.

Model No	Insyde	Site	CB2-H
Test Voltage	AC 120V/60Hz	Test Date	2020/12/15
Test Mode	Mode 1: Transmit mode_ PCB Ant	Engineer	Ling Chen
Polarity	Vertical	Temperature (°C)	23.5
Test Condition	RF_BT 2.0,3DH5, Ch 0,2.402G	Humidity (%RH)	58.0

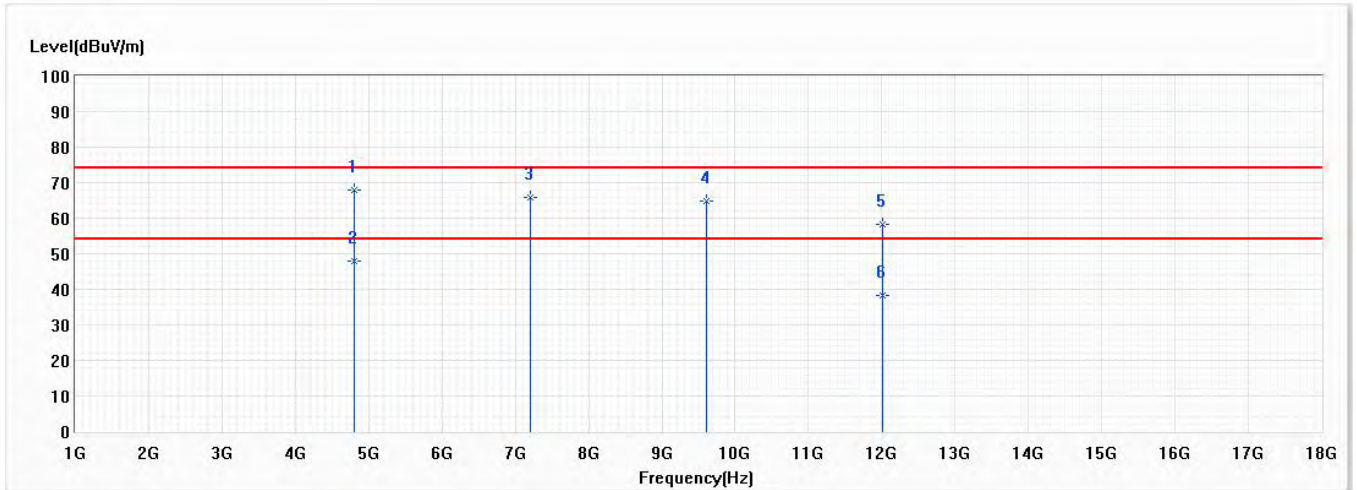

No	Frequency (MHz)	Emission Level (dBuV/m)	Limit (dBuV/m)	Margin (dB)	Reading Level (dBuV)	Correct Factor (dB)	Detector Type
* 1	4804.000	68.06	74.00	-5.94	80.09	-12.03	PK
2	4804.000	48.06	54.00	-5.94	60.09	-12.03	AV
3	7206.000	65.73	74.00	-8.27	70.41	-4.68	PK
4	9608.000	64.73	74.00	-9.27	66.06	-1.33	PK
5	12010.000	58.34	74.00	-15.66	55.53	2.81	PK
6	12010.000	38.34	54.00	-15.66	35.53	2.81	AV

Note:

- 1.All reading above 1GHz is performed with peak and/or average measurements as necessary.
2. “ \* ”, means this data is the worst value.
- 3.Emission Level = Reading Level + Correct Factor.
- 4.The average measurement was not performed when the peak measured data under the limit of average detection.
- 5.The emission above 13GHz were not included is because their levels are lower than 20dB form limit.



Model No	Insyde	Site	CB2-H
Test Voltage	AC 120V/60Hz	Test Date	2020/12/15
Test Mode	Mode 1: Transmit mode_ PCB Ant	Engineer	Ling Chen
Polarity	Horizontal	Temperature (°C)	23.5
Test Condition	RF_BT 2.0,3DH5, Ch 39,2.441G	Humidity (%RH)	58.0

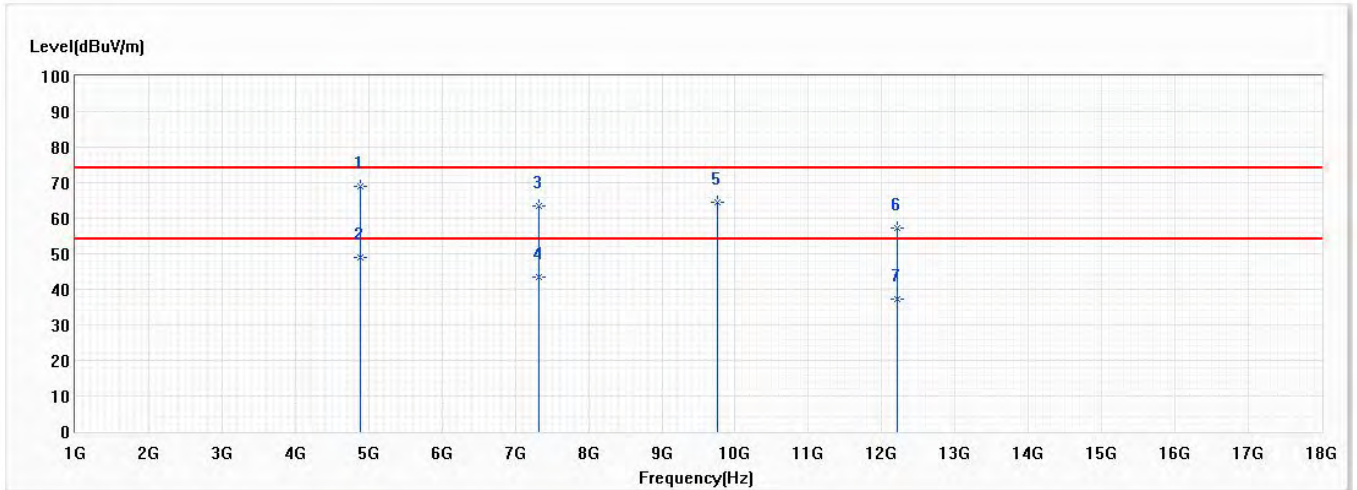

No	Frequency (MHz)	Emission Level (dBuV/m)	Limit (dBuV/m)	Margin (dB)	Reading Level (dBuV)	Correct Factor (dB)	Detector Type
* 1	4882.000	69.02	74.00	-4.98	80.84	-11.82	PK
2	4882.000	49.02	54.00	-4.98	60.84	-11.82	AV
3	7323.000	63.57	74.00	-10.43	67.91	-4.34	PK
4	7323.000	43.57	54.00	-10.43	47.91	-4.34	AV
5	9764.000	64.55	74.00	-9.45	65.82	-1.27	PK
6	12205.000	57.36	74.00	-16.64	54.79	2.57	PK
7	12205.000	37.36	54.00	-16.64	34.79	2.57	AV

Note:

- 1.All reading above 1GHz is performed with peak and/or average measurements as necessary.
2. “ \* ”, means this data is the worst value.
- 3.Emission Level = Reading Level + Correct Factor.
- 4.The average measurement was not performed when the peak measured data under the limit of average detection.
- 5.The emission above 13GHz were not included is because their levels are lower than 20dB form limit.

Model No	Insyde	Site	CB2-H
Test Voltage	AC 120V/60Hz	Test Date	2020/12/15
Test Mode	Mode 1: Transmit mode_ PCB Ant	Engineer	Ling Chen
Polarity	Vertical	Temperature (°C)	23.5
Test Condition	RF_BT 2.0,3DH5, Ch 39,2.441G	Humidity (%RH)	58.0

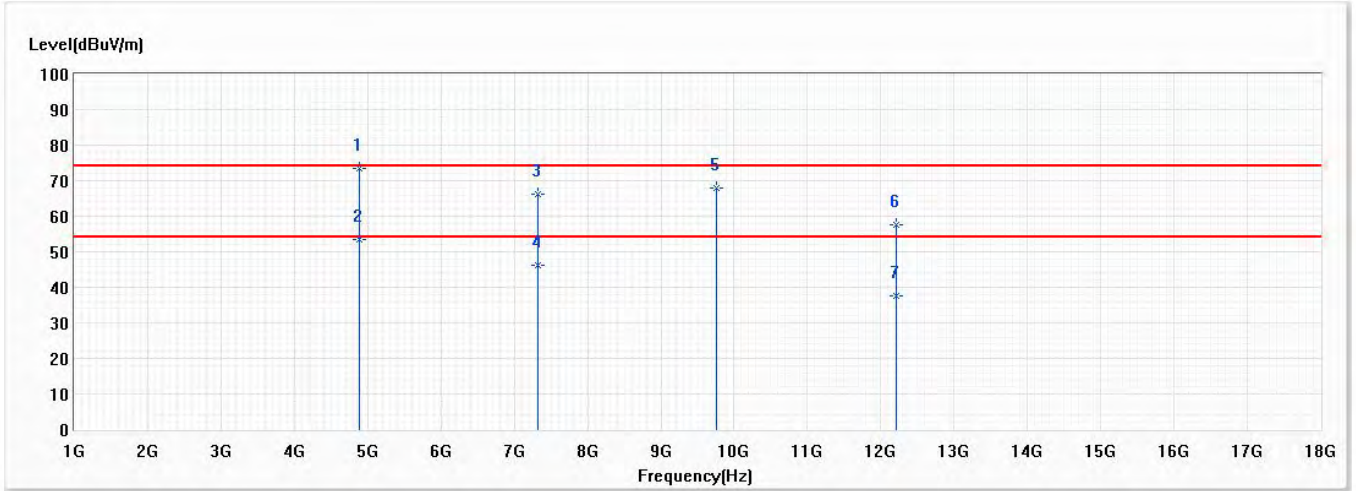

No	Frequency (MHz)	Emission Level (dBuV/m)	Limit (dBuV/m)	Margin (dB)	Reading Level (dBuV)	Correct Factor (dB)	Detector Type
* 1	4882.000	73.30	74.00	-0.70	85.12	-11.82	PK
2	4882.000	53.30	54.00	-0.70	65.12	-11.82	AV
3	7323.000	66.18	74.00	-7.82	70.52	-4.34	PK
4	7323.000	46.18	54.00	-7.82	50.52	-4.34	AV
5	9764.000	67.77	74.00	-6.23	69.04	-1.27	PK
6	12205.000	57.73	74.00	-16.27	55.16	2.57	PK
7	12205.000	37.73	54.00	-16.27	35.16	2.57	AV

Note:

- 1.All reading above 1GHz is performed with peak and/or average measurements as necessary.
2. “ \* ”, means this data is the worst value.
- 3.Emission Level = Reading Level + Correct Factor.
- 4.The average measurement was not performed when the peak measured data under the limit of average detection.
- 5.The emission above 13GHz were not included is because their levels are lower than 20dB form limit.

Model No	Insyde	Site	CB2-H
Test Voltage	AC 120V/60Hz	Test Date	2020/12/15
Test Mode	Mode 1: Transmit mode_ PCB Ant	Engineer	Ling Chen
Polarity	Horizontal	Temperature (°C)	23.5
Test Condition	RF_BT 2.0,3DH5, Ch 78,2.48G	Humidity (%RH)	58.0

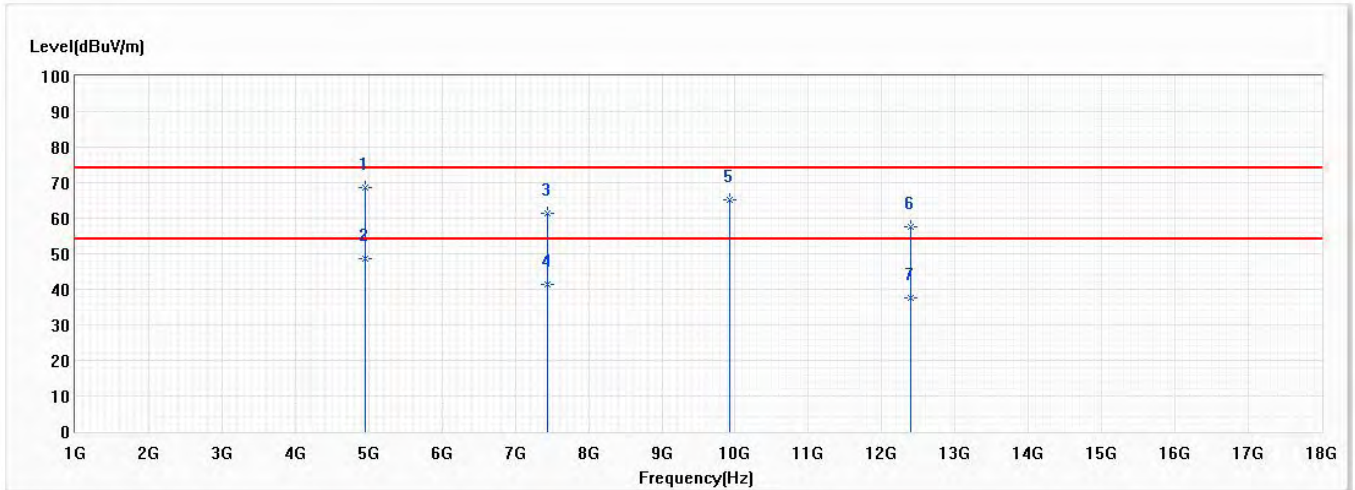

No	Frequency (MHz)	Emission Level (dBuV/m)	Limit (dBuV/m)	Margin (dB)	Reading Level (dBuV)	Correct Factor (dB)	Detector Type
* 1	4960.000	68.69	74.00	-5.31	80.29	-11.60	PK
2	4960.000	48.69	54.00	-5.31	60.29	-11.60	AV
3	7440.000	61.53	74.00	-12.47	65.54	-4.01	PK
4	7440.000	41.53	54.00	-12.47	45.54	-4.01	AV
5	9920.000	65.28	74.00	-8.72	66.47	-1.19	PK
6	12400.000	57.63	74.00	-16.37	55.29	2.34	PK
7	12400.000	37.63	54.00	-16.37	35.29	2.34	AV

Note:

- 1.All reading above 1GHz is performed with peak and/or average measurements as necessary.
2. “ \* ”, means this data is the worst value.
- 3.Emission Level = Reading Level + Correct Factor.
- 4.The average measurement was not performed when the peak measured data under the limit of average detection.
- 5.The emission above 13GHz were not included is because their levels are lower than 20dB form limit.

Model No	Insyde	Site	CB2-H
Test Voltage	AC 120V/60Hz	Test Date	2020/12/15
Test Mode	Mode 1: Transmit mode_ PCB Ant	Engineer	Ling Chen
Polarity	Vertical	Temperature (°C)	23.5
Test Condition	RF_BT 2.0,3DH5, Ch 78,2.48G	Humidity (%RH)	58.0

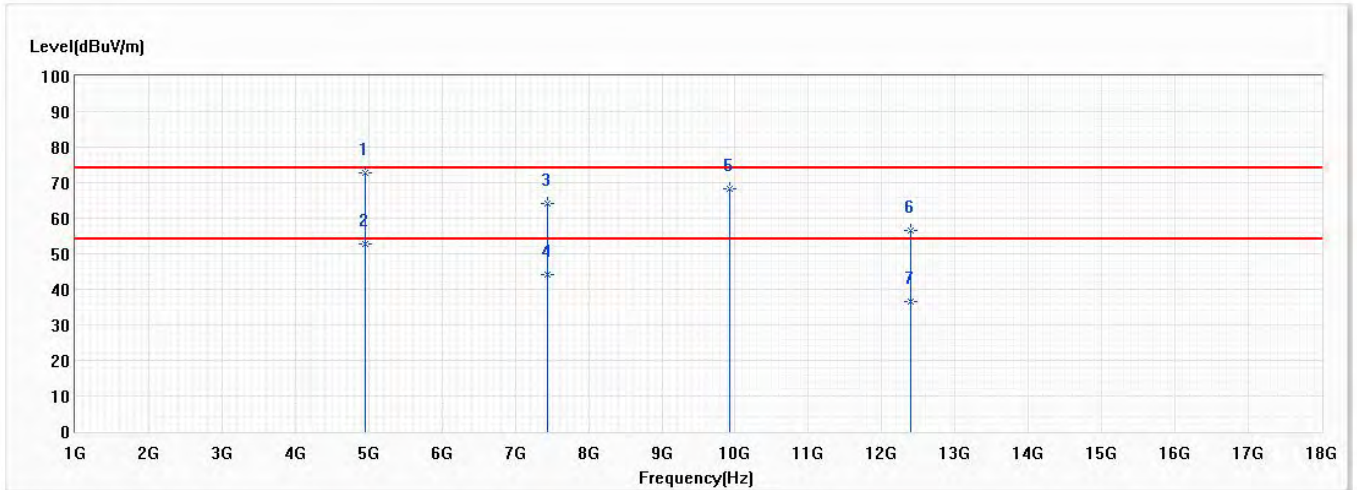

No	Frequency (MHz)	Emission Level (dBuV/m)	Limit (dBuV/m)	Margin (dB)	Reading Level (dBuV)	Correct Factor (dB)	Detector Type
* 1	4960.000	72.61	74.00	-1.39	84.21	-11.60	PK
2	4960.000	52.61	54.00	-1.39	64.21	-11.60	AV
3	7440.000	64.07	74.00	-9.93	68.08	-4.01	PK
4	7440.000	44.07	54.00	-9.93	48.08	-4.01	AV
5	9920.000	68.39	74.00	-5.61	69.58	-1.19	PK
6	12400.000	56.67	74.00	-17.33	54.33	2.34	PK
7	12400.000	36.67	54.00	-17.33	34.33	2.34	AV

Note:

- 1.All reading above 1GHz is performed with peak and/or average measurements as necessary.
2. “ \* ”, means this data is the worst value.
- 3.Emission Level = Reading Level + Correct Factor.
- 4.The average measurement was not performed when the peak measured data under the limit of average detection.
- 5.The emission above 13GHz were not included is because their levels are lower than 20dB form limit.

Model No	Insyde	Site	CB2-H
Test Voltage	AC 120V/60Hz	Test Date	2020/10/26
Test Mode	Mode 1: Transmit mode_ PIFA Ant	Engineer	Scott Lin
Polarity	Horizontal	Temperature (°C)	24.0
Test Condition	RF_BT2.0,DH5,Ch0,2.402G	Humidity (%RH)	58.0

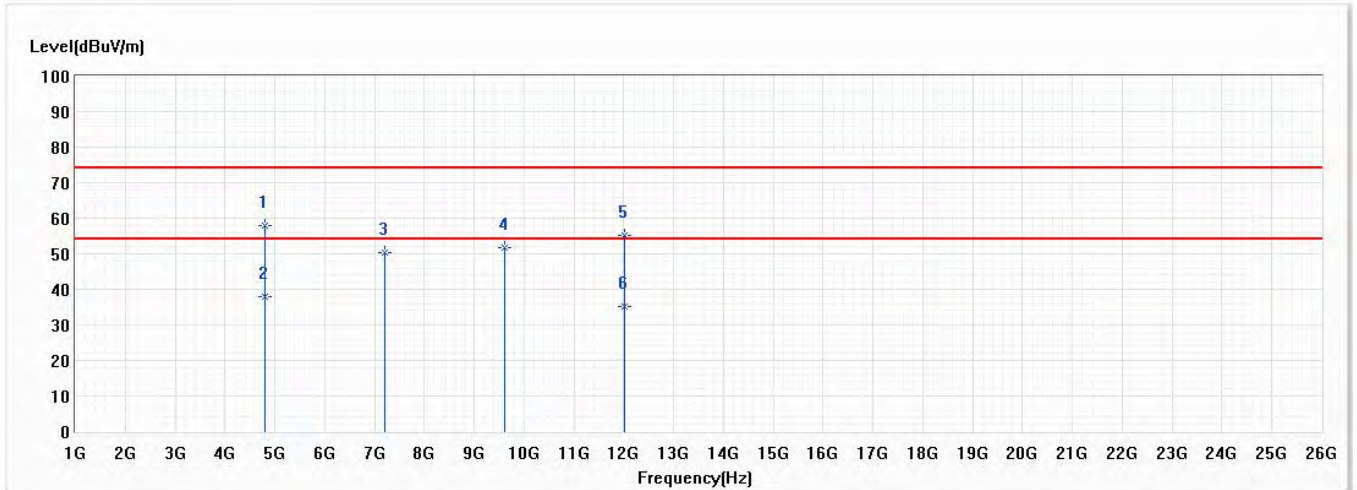

No	Frequency (MHz)	Emission Level (dBuV/m)	Limit (dBuV/m)	Margin (dB)	Reading Level (dBuV)	Correct Factor (dB)	Detector Type
* 1	4804.000	57.95	74.00	-16.05	69.98	-12.03	PK
2	4804.000	37.95	54.00	-16.05	49.98	-12.03	AV
3	7206.000	50.30	74.00	-23.70	54.98	-4.68	PK
4	9608.000	51.59	74.00	-22.41	52.92	-1.33	PK
5	12010.000	55.05	74.00	-18.95	52.24	2.81	PK
6	12010.000	35.05	54.00	-18.95	32.24	2.81	AV

Note:

- 1.All reading above 1GHz is performed with peak and/or average measurements as necessary.
2. “ \* ”, means this data is the worst value.
- 3.Emission Level = Reading Level + Correct Factor.
- 4.The average measurement was not performed when the peak measured data under the limit of average detection.
- 5.The emission above 13GHz were not included is because their levels are lower than 20dB form limit.

Model No	Insyde	Site	CB2-H
Test Voltage	AC 120V/60Hz	Test Date	2020/10/26
Test Mode	Mode 1: Transmit mode_ PIFA Ant	Engineer	Scott Lin
Polarity	Vertical	Temperature (°C)	24.0
Test Condition	RF_BT2.0,DH5,Ch0,2.402G	Humidity (%RH)	58.0

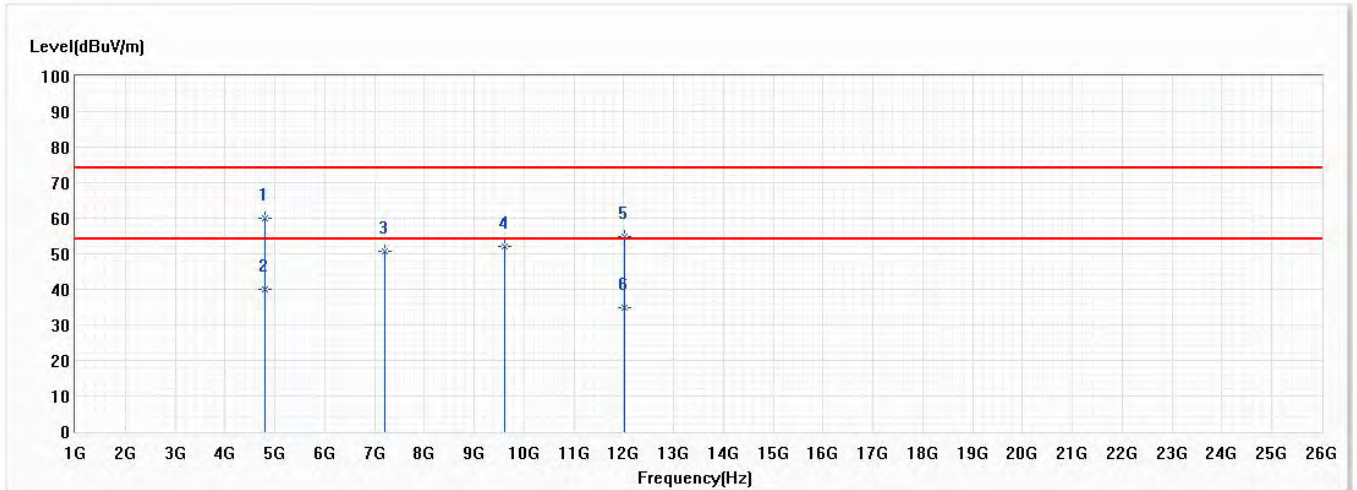

No	Frequency (MHz)	Emission Level (dBuV/m)	Limit (dBuV/m)	Margin (dB)	Reading Level (dBuV)	Correct Factor (dB)	Detector Type
* 1	4804.000	59.95	74.00	-14.05	71.98	-12.03	PK
2	4804.000	39.95	54.00	-14.05	51.98	-12.03	AV
3	7206.000	50.54	74.00	-23.46	55.22	-4.68	PK
4	9608.000	52.06	74.00	-21.94	53.39	-1.33	PK
5	12010.000	54.83	74.00	-19.17	52.02	2.81	PK
6	12010.000	34.83	54.00	-19.17	32.02	2.81	AV

Note:

- 1.All reading above 1GHz is performed with peak and/or average measurements as necessary.
2. “ \* ”, means this data is the worst value.
- 3.Emission Level = Reading Level + Correct Factor.
- 4.The average measurement was not performed when the peak measured data under the limit of average detection.
- 5.The emission above 13GHz were not included is because their levels are lower than 20dB form limit.

Model No	Insyde	Site	CB2-H
Test Voltage	AC 120V/60Hz	Test Date	2020/10/26
Test Mode	Mode 1: Transmit mode_ PIFA Ant	Engineer	Scott Lin
Polarity	Horizontal	Temperature (°C)	24.0
Test Condition	RF_BT2.0,DH5,Ch39,2.441G	Humidity (%RH)	58.0

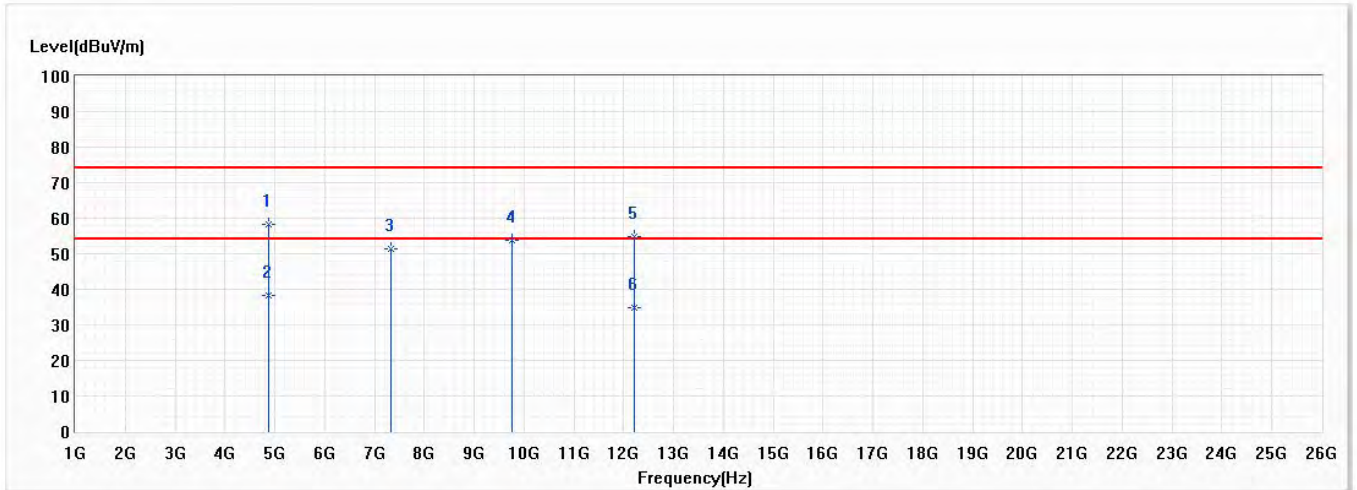

No	Frequency (MHz)	Emission Level (dBuV/m)	Limit (dBuV/m)	Margin (dB)	Reading Level (dBuV)	Correct Factor (dB)	Detector Type
* 1	4882.000	58.42	74.00	-15.58	70.24	-11.82	PK
2	4882.000	38.42	54.00	-15.58	50.24	-11.82	AV
3	7323.000	51.37	74.00	-22.63	55.71	-4.34	PK
4	9764.000	53.71	74.00	-20.29	54.98	-1.27	PK
5	12205.000	54.77	74.00	-19.23	52.20	2.57	PK
6	12205.000	34.77	54.00	-19.23	32.20	2.57	AV

Note:

- 1.All reading above 1GHz is performed with peak and/or average measurements as necessary.
2. “ \* ”, means this data is the worst value.
- 3.Emission Level = Reading Level + Correct Factor.
- 4.The average measurement was not performed when the peak measured data under the limit of average detection.
- 5.The emission above 13GHz were not included is because their levels are lower than 20dB form limit.

Model No	Insyde	Site	CB2-H
Test Voltage	AC 120V/60Hz	Test Date	2020/10/26
Test Mode	Mode 1: Transmit mode_ PIFA Ant	Engineer	Scott Lin
Polarity	Vertical	Temperature (°C)	24.0
Test Condition	RF_BT2.0,DH5,Ch39,2.441G	Humidity (%RH)	58.0

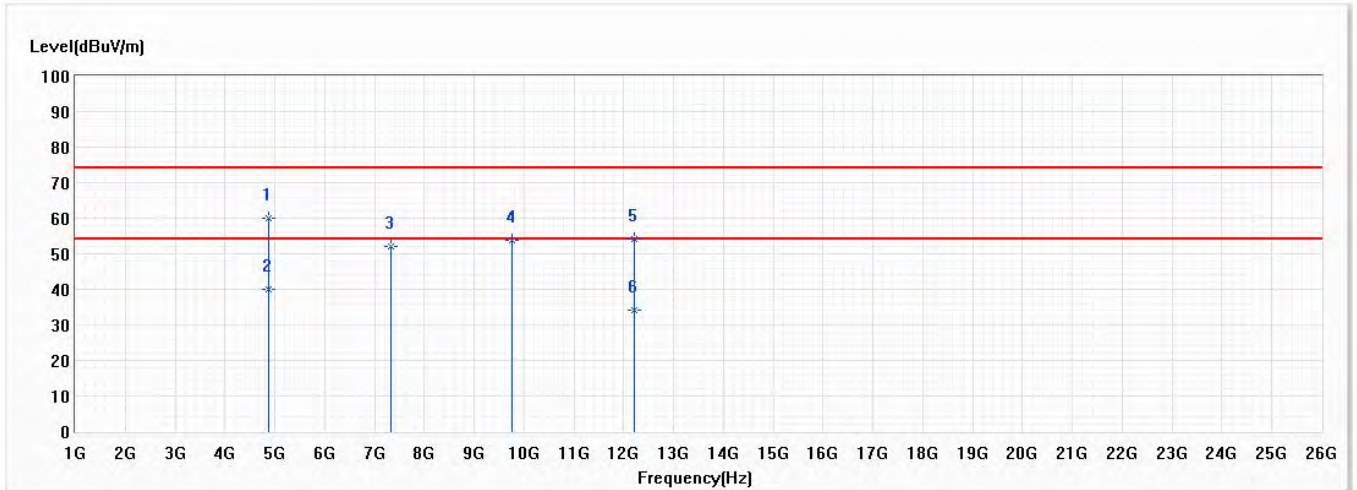

No	Frequency (MHz)	Emission Level (dBuV/m)	Limit (dBuV/m)	Margin (dB)	Reading Level (dBuV)	Correct Factor (dB)	Detector Type
* 1	4882.000	60.16	74.00	-13.84	71.98	-11.82	PK
2	4882.000	40.16	54.00	-13.84	51.98	-11.82	AV
3	7323.000	51.93	74.00	-22.07	56.27	-4.34	PK
4	9764.000	53.87	74.00	-20.13	55.14	-1.27	PK
5	12205.000	54.29	74.00	-19.71	51.72	2.57	PK
6	12205.000	34.29	54.00	-19.71	31.72	2.57	AV

Note:

- 1.All reading above 1GHz is performed with peak and/or average measurements as necessary.
2. “ \* ”, means this data is the worst value.
- 3.Emission Level = Reading Level + Correct Factor.
- 4.The average measurement was not performed when the peak measured data under the limit of average detection.
- 5.The emission above 13GHz were not included is because their levels are lower than 20dB form limit.



Model No	Insyde	Site	CB2-H
Test Voltage	AC 120V/60Hz	Test Date	2020/10/26
Test Mode	Mode 1: Transmit mode_ PIFA Ant	Engineer	Scott Lin
Polarity	Horizontal	Temperature (°C)	24.0
Test Condition	RF_BT2.0,DH5,Ch78,2.48G	Humidity (%RH)	58.0

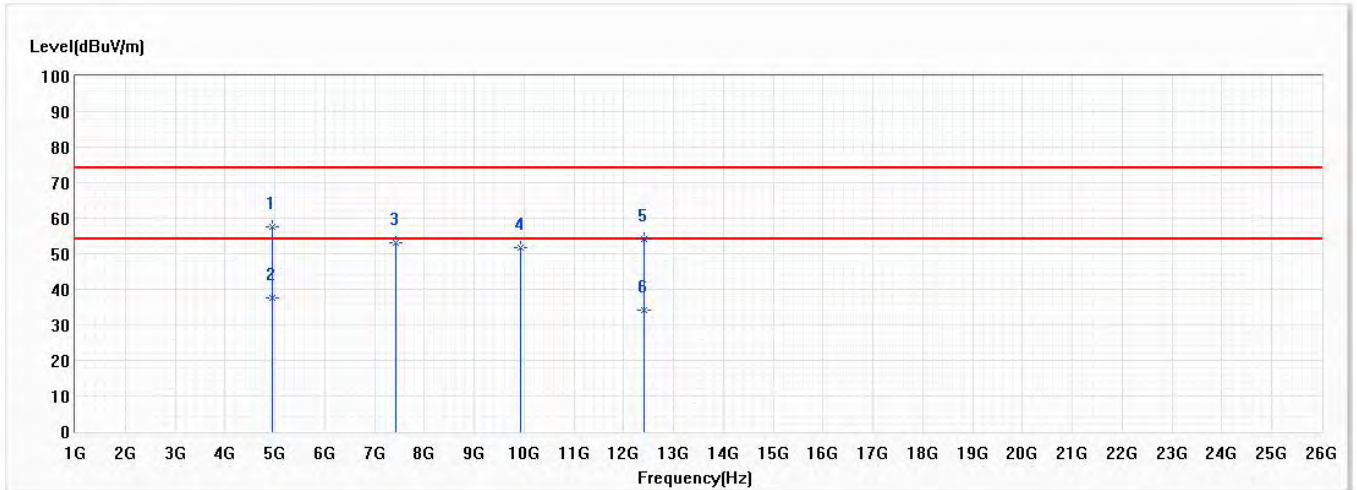

No	Frequency (MHz)	Emission Level (dBuV/m)	Limit (dBuV/m)	Margin (dB)	Reading Level (dBuV)	Correct Factor (dB)	Detector Type
* 1	4960.000	57.64	74.00	-16.36	69.24	-11.60	PK
2	4960.000	37.64	54.00	-16.36	49.24	-11.60	AV
3	7440.000	52.98	74.00	-21.02	56.99	-4.01	PK
4	9920.000	51.65	74.00	-22.35	52.84	-1.19	PK
5	12400.000	54.12	74.00	-19.88	51.78	2.34	PK
6	12400.000	34.12	54.00	-19.88	31.78	2.34	AV

Note:

- 1.All reading above 1GHz is performed with peak and/or average measurements as necessary.
2. “ \* ”, means this data is the worst value.
- 3.Emission Level = Reading Level + Correct Factor.
- 4.The average measurement was not performed when the peak measured data under the limit of average detection.
- 5.The emission above 13GHz were not included is because their levels are lower than 20dB form limit.

Model No	Insyde	Site	CB2-H
Test Voltage	AC 120V/60Hz	Test Date	2020/10/26
Test Mode	Mode 1: Transmit mode_ PIFA Ant	Engineer	Scott Lin
Polarity	Vertical	Temperature (°C)	24.0
Test Condition	RF_BT2.0,DH5,Ch78,2.48G	Humidity (%RH)	58.0

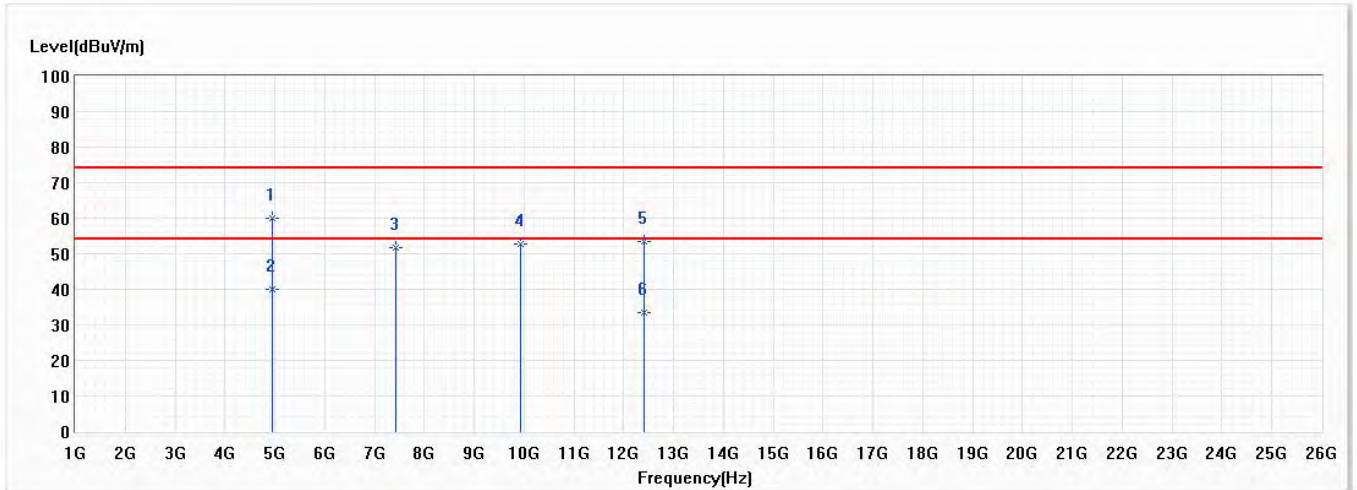

No	Frequency (MHz)	Emission Level (dBuV/m)	Limit (dBuV/m)	Margin (dB)	Reading Level (dBuV)	Correct Factor (dB)	Detector Type
* 1	4960.000	59.90	74.00	-14.10	71.50	-11.60	PK
2	4960.000	39.90	54.00	-14.10	51.50	-11.60	AV
3	7440.000	51.88	74.00	-22.12	55.89	-4.01	PK
4	9920.000	52.83	74.00	-21.17	54.02	-1.19	PK
5	12400.000	53.56	74.00	-20.44	51.22	2.34	PK
6	12400.000	33.56	54.00	-20.44	31.22	2.34	AV

Note:

- 1.All reading above 1GHz is performed with peak and/or average measurements as necessary.
2. “ \* ”, means this data is the worst value.
- 3.Emission Level = Reading Level + Correct Factor.
- 4.The average measurement was not performed when the peak measured data under the limit of average detection.
- 5.The emission above 13GHz were not included is because their levels are lower than 20dB form limit.

Model No	Insyde	Site	CB2-H
Test Voltage	AC 120V/60Hz	Test Date	2020/10/26
Test Mode	Mode 1: Transmit mode_ PIFA Ant	Engineer	Scott Lin
Polarity	Horizontal	Temperature (°C)	24.0
Test Condition	RF_BT2.0,3DH5,Ch0,2.402G	Humidity (%RH)	58.0

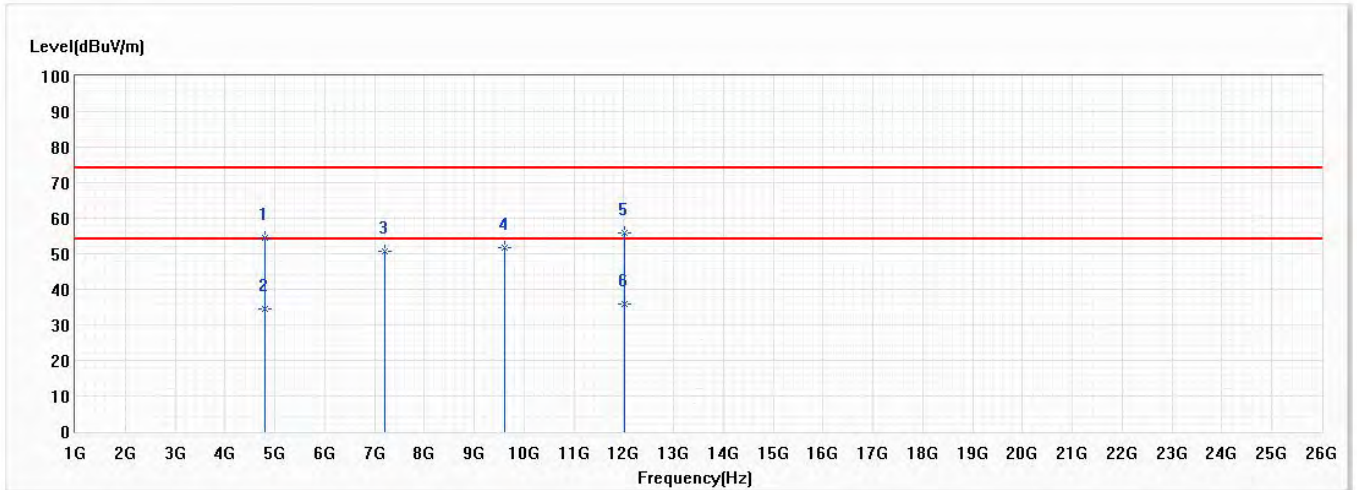

No	Frequency (MHz)	Emission Level (dBuV/m)	Limit (dBuV/m)	Margin (dB)	Reading Level (dBuV)	Correct Factor (dB)	Detector Type
1	4804.000	54.61	74.00	-19.39	66.64	-12.03	PK
2	4804.000	34.61	54.00	-19.39	46.64	-12.03	AV
3	7206.000	50.66	74.00	-23.34	55.34	-4.68	PK
4	9608.000	51.76	74.00	-22.24	53.09	-1.33	PK
* 5	12010.000	55.82	74.00	-18.18	53.01	2.81	PK
6	12010.000	35.82	54.00	-18.18	33.01	2.81	AV

Note:

- 1.All reading above 1GHz is performed with peak and/or average measurements as necessary.
2. “ \* ”, means this data is the worst value.
- 3.Emission Level = Reading Level + Correct Factor.
- 4.The average measurement was not performed when the peak measured data under the limit of average detection.
- 5.The emission above 13GHz were not included is because their levels are lower than 20dB form limit.

Model No	Insyde	Site	CB2-H
Test Voltage	AC 120V/60Hz	Test Date	2020/10/26
Test Mode	Mode 1: Transmit mode_ PIFA Ant	Engineer	Scott Lin
Polarity	Vertical	Temperature (°C)	24.0
Test Condition	RF_BT2.0,3DH5,Ch0,2.402G	Humidity (%RH)	58.0

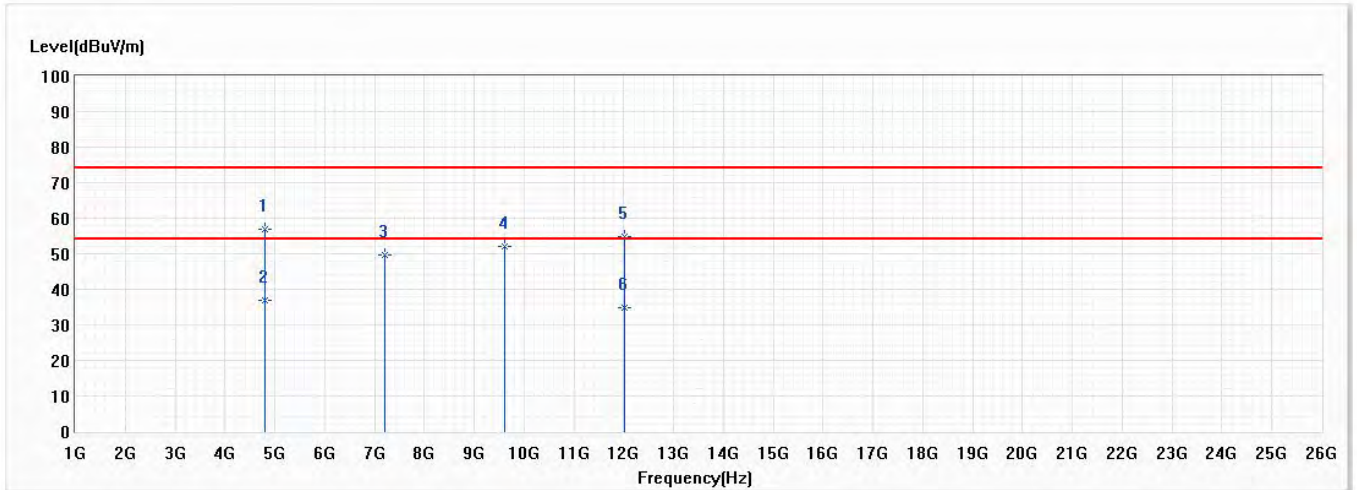

No	Frequency (MHz)	Emission Level (dBuV/m)	Limit (dBuV/m)	Margin (dB)	Reading Level (dBuV)	Correct Factor (dB)	Detector Type
* 1	4804.000	56.83	74.00	-17.17	68.86	-12.03	PK
2	4804.000	36.83	54.00	-17.17	48.86	-12.03	AV
3	7206.000	49.50	74.00	-24.50	54.18	-4.68	PK
4	9608.000	52.22	74.00	-21.78	53.55	-1.33	PK
5	12010.000	54.84	74.00	-19.16	52.03	2.81	PK
6	12010.000	34.84	54.00	-19.16	32.03	2.81	AV

Note:

- 1.All reading above 1GHz is performed with peak and/or average measurements as necessary.
2. “ \* ”, means this data is the worst value.
- 3.Emission Level = Reading Level + Correct Factor.
- 4.The average measurement was not performed when the peak measured data under the limit of average detection.
- 5.The emission above 13GHz were not included is because their levels are lower than 20dB form limit.

Model No	Insyde	Site	CB2-H
Test Voltage	AC 120V/60Hz	Test Date	2020/10/26
Test Mode	Mode 1: Transmit mode_ PIFA Ant	Engineer	Scott Lin
Polarity	Horizontal	Temperature (°C)	24.0
Test Condition	RF_BT2.0,3DH5,Ch39,2.441G	Humidity (%RH)	58.0

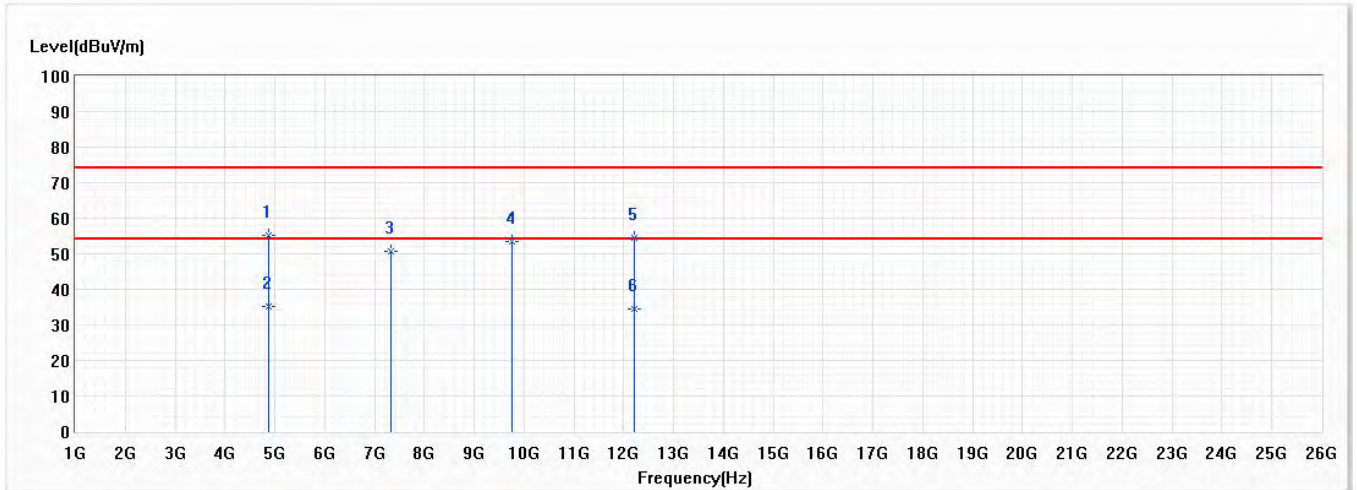

No	Frequency (MHz)	Emission Level (dBuV/m)	Limit (dBuV/m)	Margin (dB)	Reading Level (dBuV)	Correct Factor (dB)	Detector Type
* 1	4882.000	55.28	74.00	-18.72	67.10	-11.82	PK
2	4882.000	35.28	54.00	-18.72	47.10	-11.82	AV
3	7323.000	50.70	74.00	-23.30	55.04	-4.34	PK
4	9764.000	53.60	74.00	-20.40	54.87	-1.27	PK
5	12205.000	54.38	74.00	-19.62	51.81	2.57	PK
6	12205.000	34.38	54.00	-19.62	31.81	2.57	AV

Note:

- 1.All reading above 1GHz is performed with peak and/or average measurements as necessary.
2. “ \* ”, means this data is the worst value.
- 3.Emission Level = Reading Level + Correct Factor.
- 4.The average measurement was not performed when the peak measured data under the limit of average detection.
- 5.The emission above 13GHz were not included is because their levels are lower than 20dB form limit.

Model No	Insyde	Site	CB2-H
Test Voltage	AC 120V/60Hz	Test Date	2020/10/26
Test Mode	Mode 1: Transmit mode_ PIFA Ant	Engineer	Scott Lin
Polarity	Vertical	Temperature (°C)	24.0
Test Condition	RF_BT2.0,3DH5,Ch39,2.441G	Humidity (%RH)	58.0

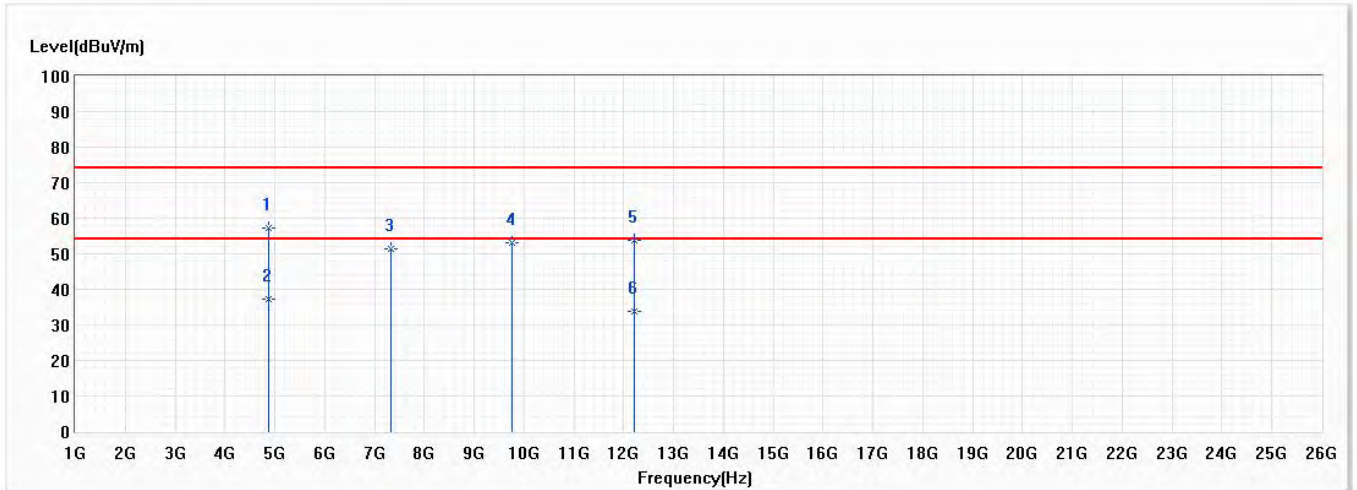

No	Frequency (MHz)	Emission Level (dBuV/m)	Limit (dBuV/m)	Margin (dB)	Reading Level (dBuV)	Correct Factor (dB)	Detector Type
* 1	4882.000	57.10	74.00	-16.90	68.92	-11.82	PK
2	4882.000	37.10	54.00	-16.90	48.92	-11.82	AV
3	7323.000	51.50	74.00	-22.50	55.84	-4.34	PK
4	9764.000	52.95	74.00	-21.05	54.22	-1.27	PK
5	12205.000	53.74	74.00	-20.26	51.17	2.57	PK
6	12205.000	33.74	54.00	-20.26	31.17	2.57	AV

Note:

- 1.All reading above 1GHz is performed with peak and/or average measurements as necessary.
2. “ \* ”, means this data is the worst value.
- 3.Emission Level = Reading Level + Correct Factor.
- 4.The average measurement was not performed when the peak measured data under the limit of average detection.
- 5.The emission above 13GHz were not included is because their levels are lower than 20dB form limit.

Model No	Insyde	Site	CB2-H
Test Voltage	AC 120V/60Hz	Test Date	2020/10/26
Test Mode	Mode 1: Transmit mode_ PIFA Ant	Engineer	Scott Lin
Polarity	Horizontal	Temperature (°C)	24.0
Test Condition	RF_BT2.0,3DH5,Ch78,2.48G	Humidity (%RH)	58.0

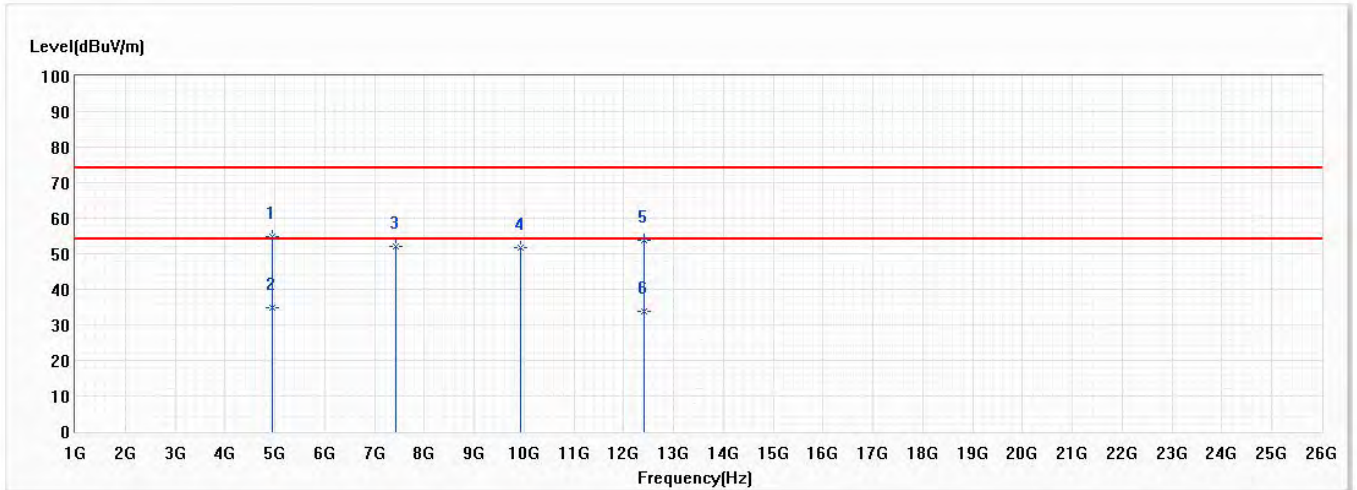

No	Frequency (MHz)	Emission Level (dBuV/m)	Limit (dBuV/m)	Margin (dB)	Reading Level (dBuV)	Correct Factor (dB)	Detector Type
* 1	4960.000	54.86	74.00	-19.14	66.46	-11.60	PK
2	4960.000	34.86	54.00	-19.14	46.46	-11.60	AV
3	7440.000	52.04	74.00	-21.96	56.05	-4.01	PK
4	9920.000	51.87	74.00	-22.13	53.06	-1.19	PK
5	12400.000	53.65	74.00	-20.35	51.31	2.34	PK
6	12400.000	33.65	54.00	-20.35	31.31	2.34	AV

Note:

- 1.All reading above 1GHz is performed with peak and/or average measurements as necessary.
2. “ \* ”, means this data is the worst value.
- 3.Emission Level = Reading Level + Correct Factor.
- 4.The average measurement was not performed when the peak measured data under the limit of average detection.
- 5.The emission above 13GHz were not included is because their levels are lower than 20dB form limit.

Model No	Insyde	Site	CB2-H
Test Voltage	AC 120V/60Hz	Test Date	2020/10/26
Test Mode	Mode 1: Transmit mode_ PIFA Ant	Engineer	Scott Lin
Polarity	Vertical	Temperature (°C)	24.0
Test Condition	RF_BT2.0,3DH5,Ch78,2.48G	Humidity (%RH)	58.0

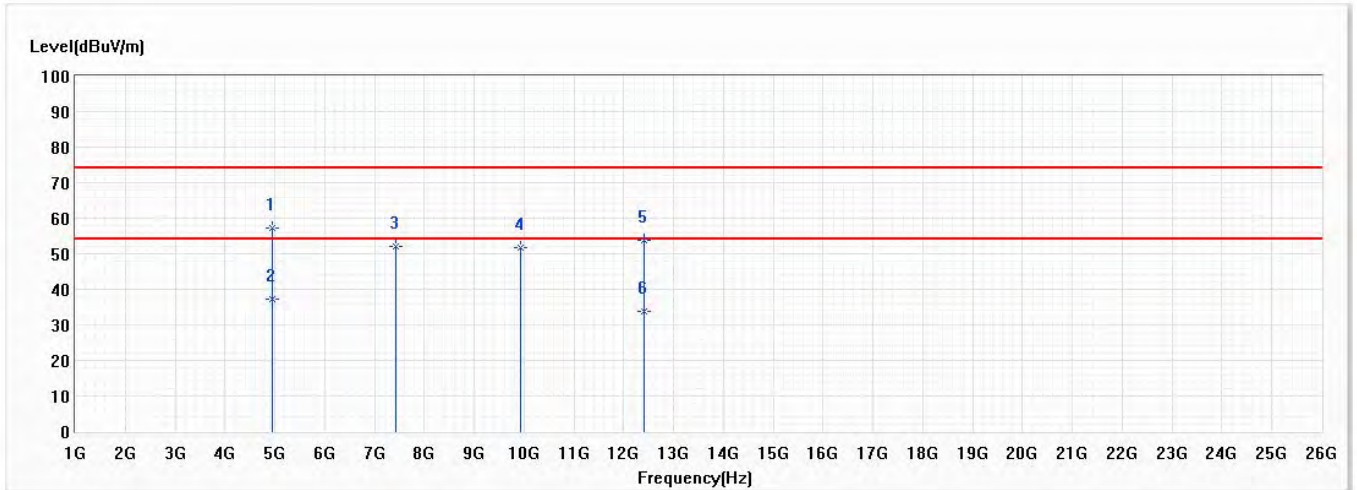

No	Frequency (MHz)	Emission Level (dBuV/m)	Limit (dBuV/m)	Margin (dB)	Reading Level (dBuV)	Correct Factor (dB)	Detector Type
* 1	4960.000	57.41	74.00	-16.59	69.01	-11.60	PK
2	4960.000	37.41	54.00	-16.59	49.01	-11.60	AV
3	7440.000	52.17	74.00	-21.83	56.18	-4.01	PK
4	9920.000	51.87	74.00	-22.13	53.06	-1.19	PK
5	12400.000	53.68	74.00	-20.32	51.34	2.34	PK
6	12400.000	33.68	54.00	-20.32	31.34	2.34	AV

Note:

- 1.All reading above 1GHz is performed with peak and/or average measurements as necessary.
2. “ \* ”, means this data is the worst value.
- 3.Emission Level = Reading Level + Correct Factor.
- 4.The average measurement was not performed when the peak measured data under the limit of average detection.
- 5.The emission above 13GHz were not included is because their levels are lower than 20dB form limit.



## 5. RF antenna conducted test

### 5.1. Test Setup

RF Conducted Measurement:

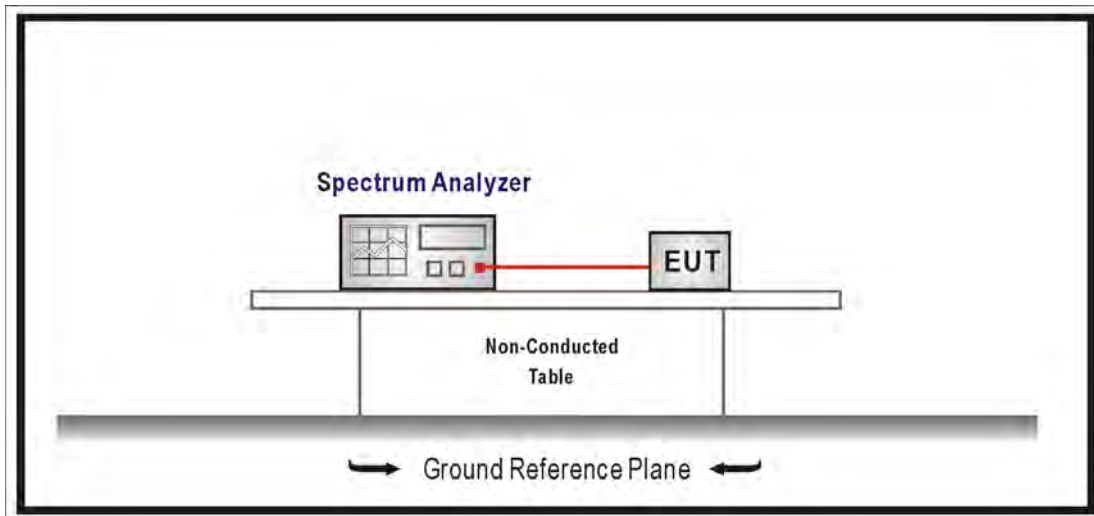

### 5.2. Limits

In any 100 kHz bandwidth outside the frequency band in which the spread spectrum intentional radiator is operating, the radio frequency power that is produced by the intentional radiator shall be at least 20 dB below that in the 100 kHz bandwidth within the band that contains the highest level of the desired power, based on an RF conducted or radiated measurement. Attenuation below the general limits specified in Section 15.209(a) is not required. In addition, radiated emissions which fall in the restricted bands, as defined in Section 15.205(a), must also comply with the radiated emission limits specified in Section 15.209(a) (see Section 15.205(c)).

### 5.3. Test Procedure

The EUT was setup according to ANSI C63.10: 2013 and tested according to FHSS test procedure of FCC KDB 558074 D01 v05r02 for compliance to FCC 47CFR 15.247

### 5.4. Test Specification

According to FCC Part 15 Subpart C Paragraph 15.247: 2019

### 5.5. Test Result

Product	Insyde		
Test Item	RF antenna conducted test		
Test Mode	Mode 1: Transmit mode_ PCB Ant		
Date of Test	2020/10/27	Test Site	SR12-H
Temperature(°C)	24	Humidity (%RH)	62

#### GFSK

Channel	Frequency (MHz)	Measure Level (dBc)	Limit (dBc)
00	2402	46.814	≥20
39	2441	51.459	≥20
78	2480	50.202	≥20

Channel 00

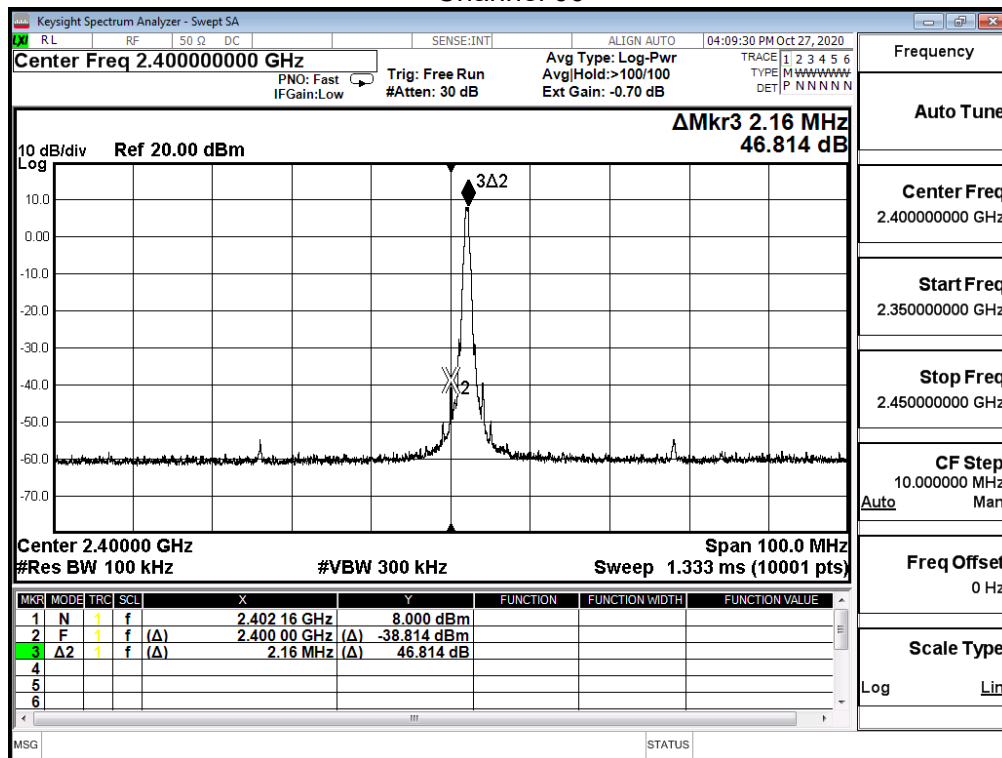

### Channel 39

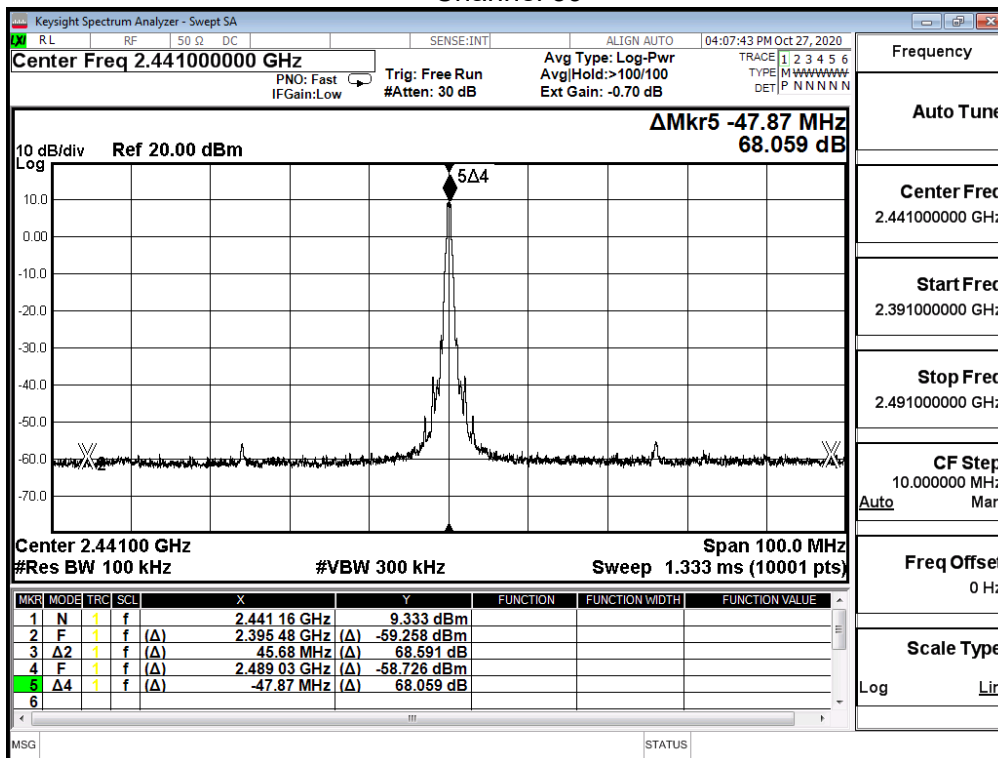

### Channel 78

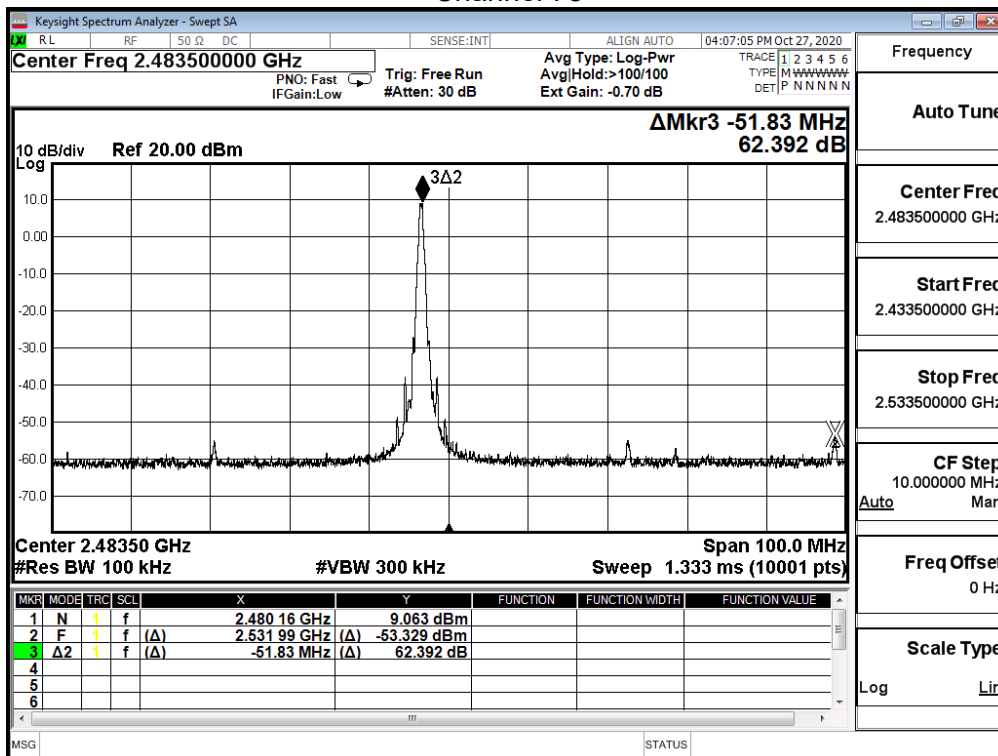

Channel 00 (30MHz-25GHz)-GFSK

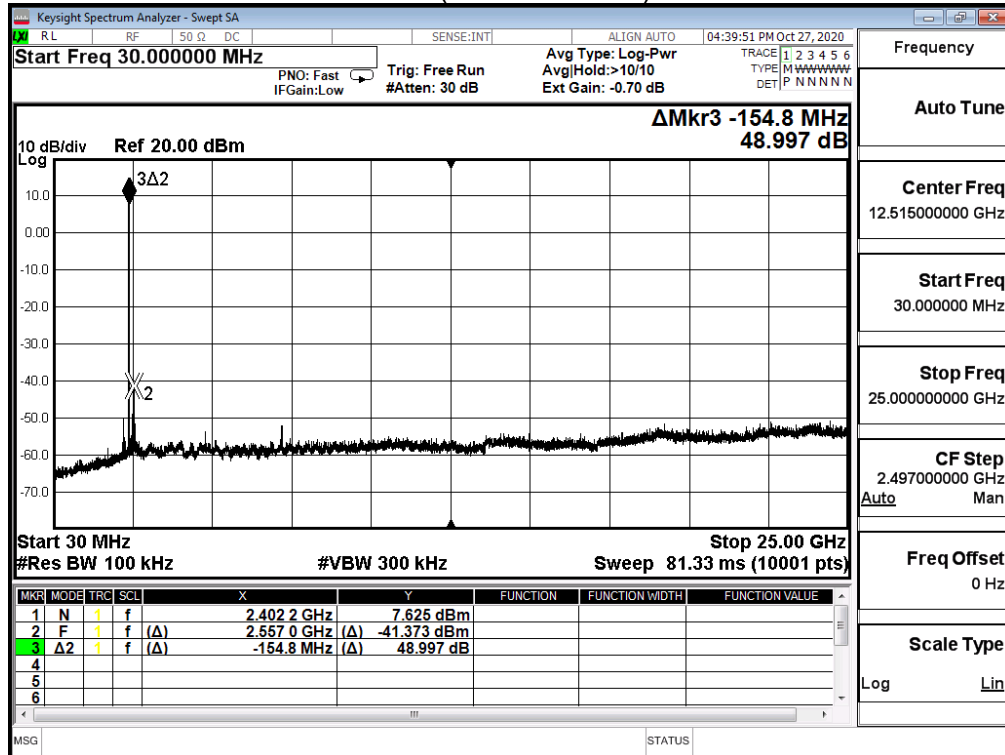

Channel 39 (30MHz-25GHz)-GFSK

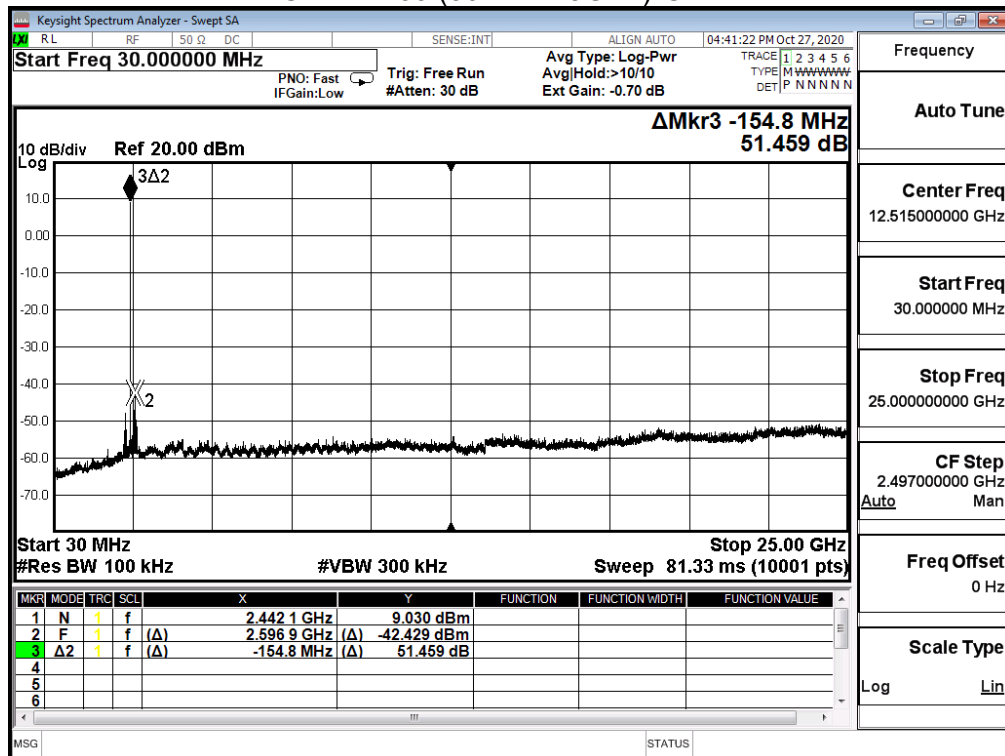

Channel 78 (30MHz-25GHz)-GFSK

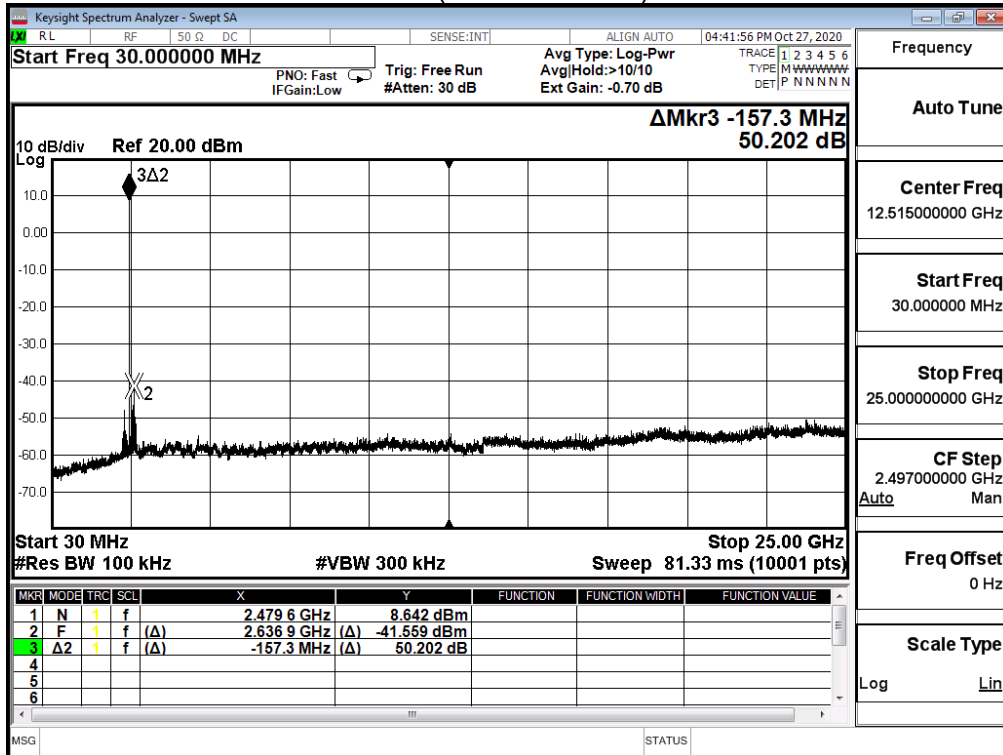

Product	Insyde		
Test Item	RF antenna conducted test		
Test Mode	Mode 1: Transmit mode_ PCB Ant		
Date of Test	2020/10/27	Test Site	SR12-H
Temperature(°C)	24	Humidity (%RH)	62

8-DPSK

Channel	Frequency (MHz)	Measure Level (dBc)	Limit (dBc)
00	2402	47.881	≥20
39	2441	49.765	≥20
78	2480	45.919	≥20

Channel 00

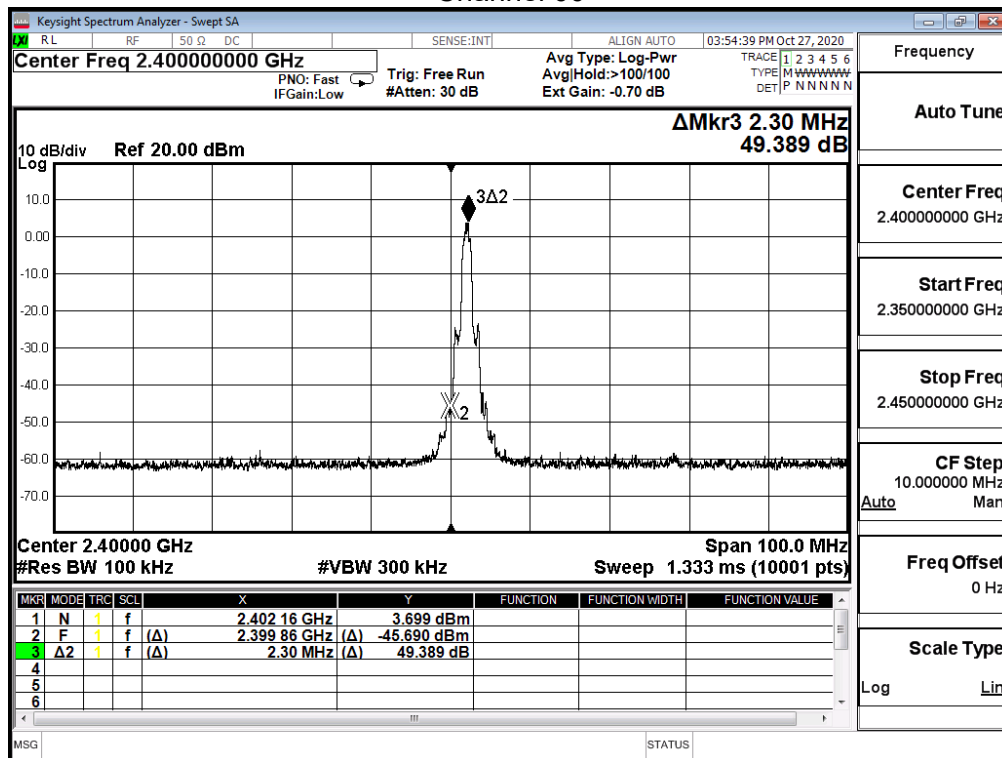

Channel 39

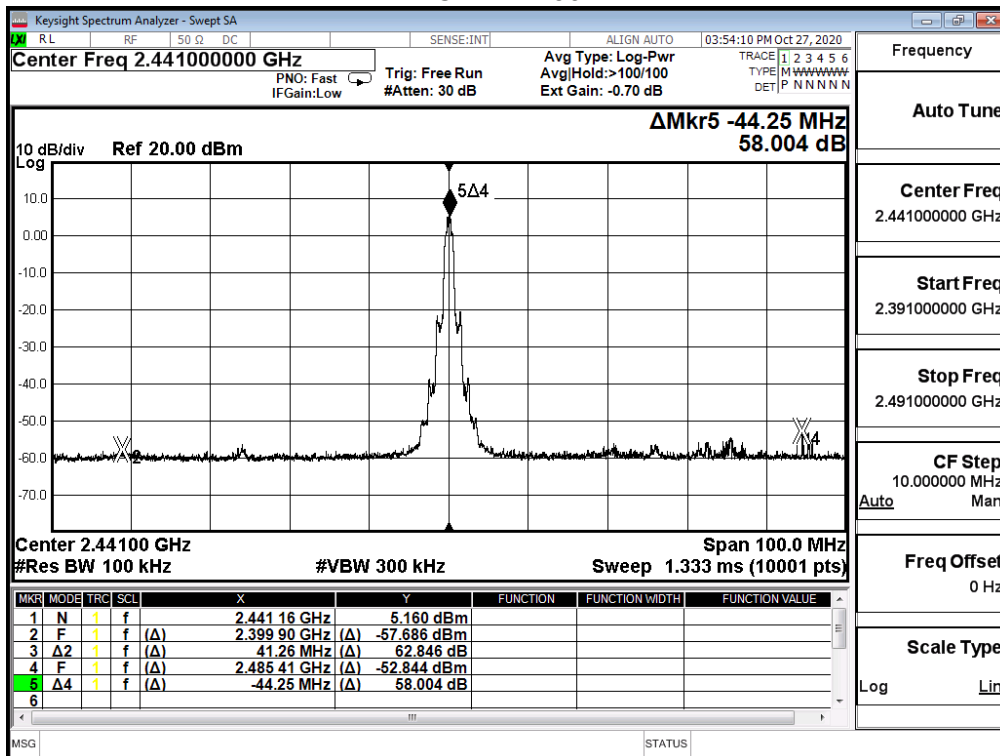

Channel 78

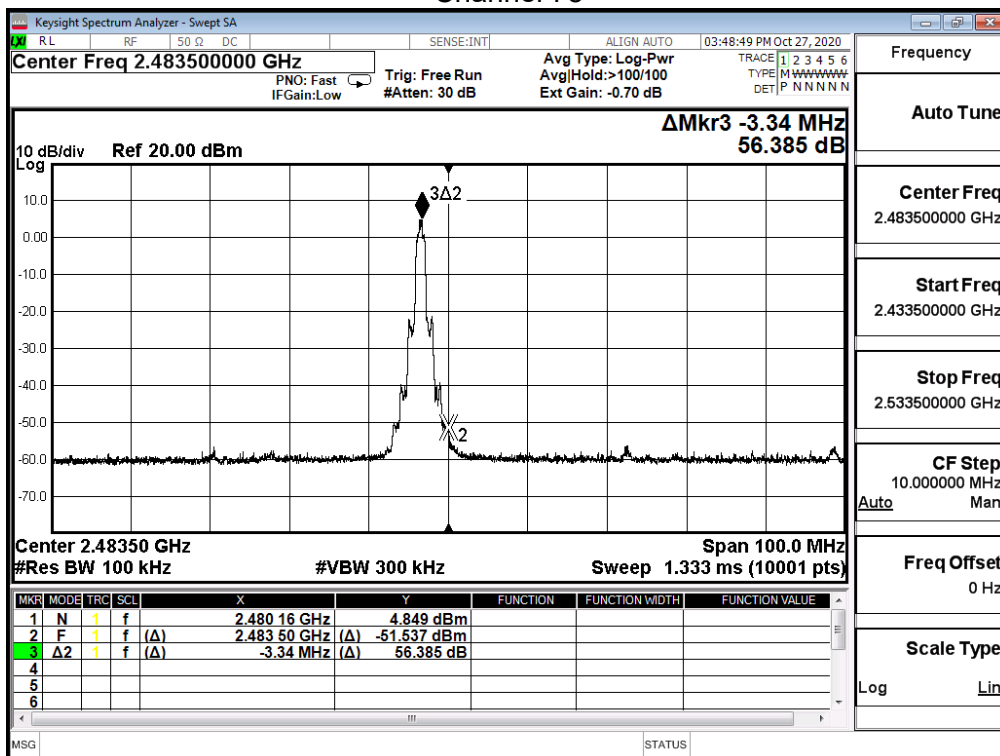

Channel 00 (30MHz-25GHz)-8-DPSK

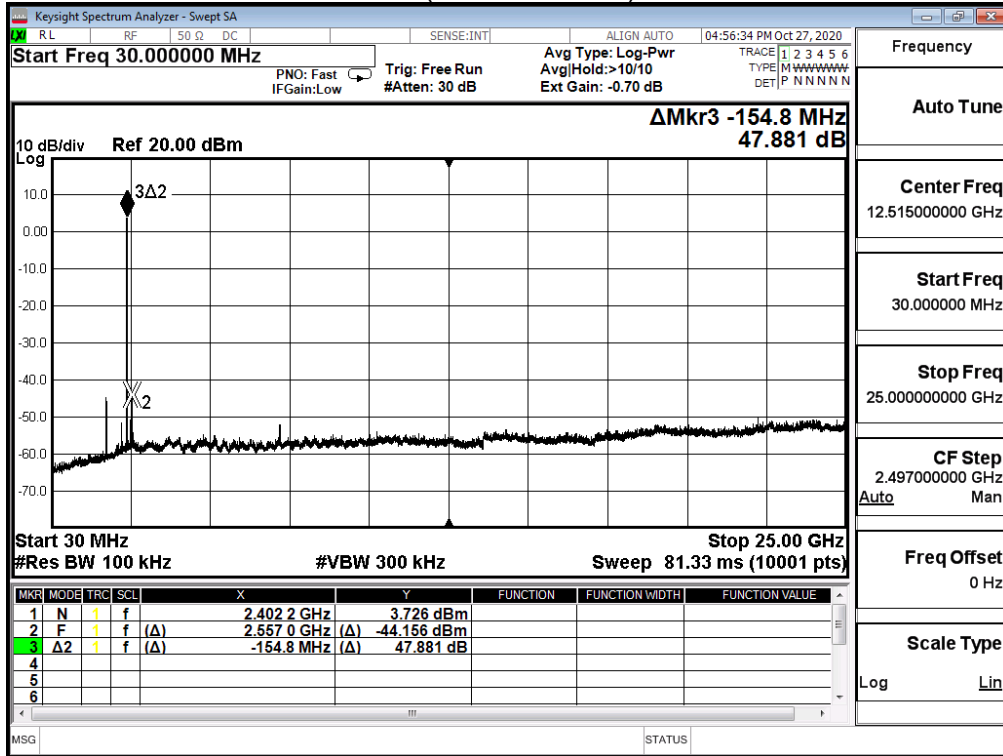

Channel 39 (30MHz-25GHz)-8-DPSK

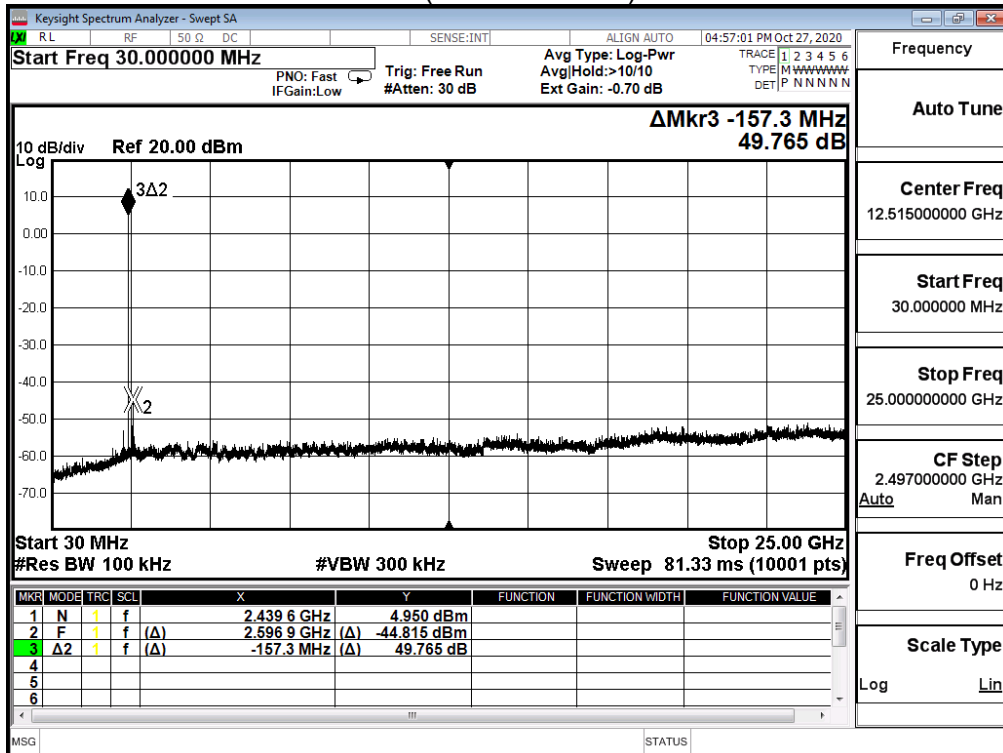



Channel 78 (30MHz-25GHz)-8-DPSK

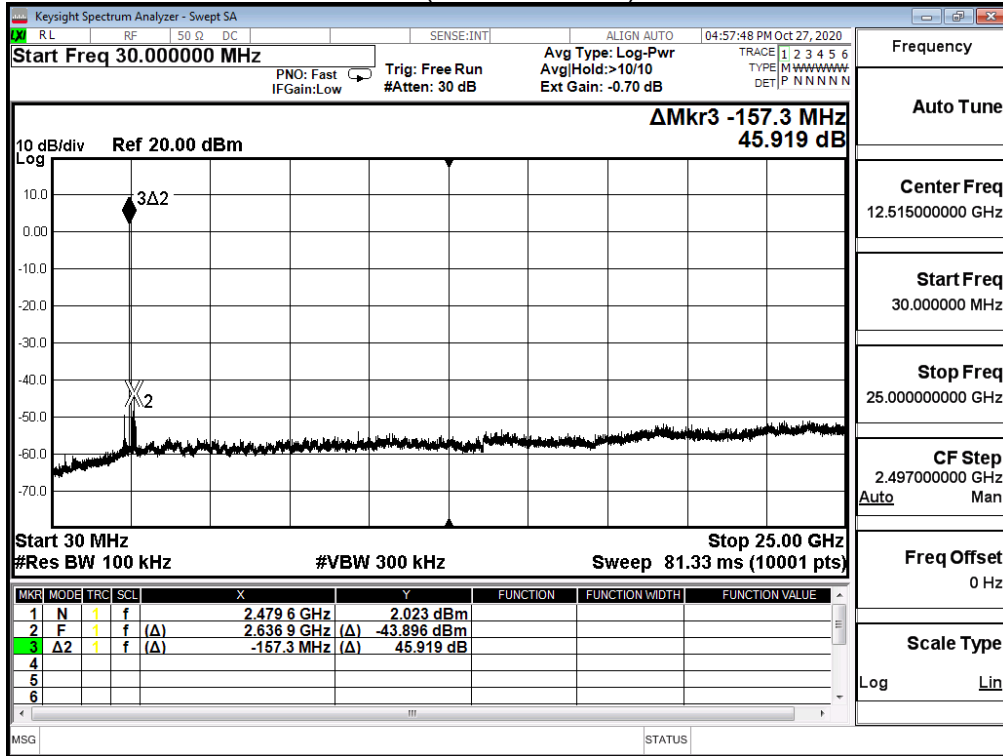

Product	Insyde		
Test Item	RF antenna conducted test		
Test Mode	Mode 1: Transmit mode_ PIFA Ant		
Date of Test	2020/09/17	Test Site	SR12-H
Temperature(°C)	22	Humidity (%RH)	55

GFSK

Channel	Frequency (MHz)	Measure Level (dBc)	Limit (dBc)
00	2402	47.503	≥20
39	2441	58.461	≥20
78	2480	60.053	≥20

Channel 00

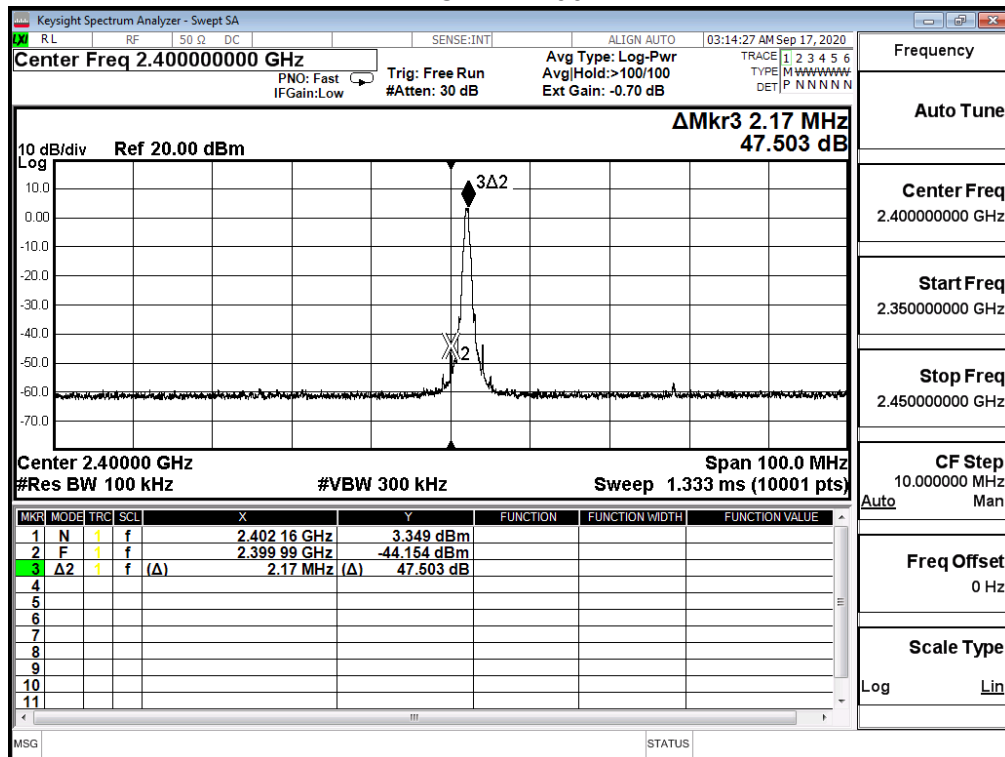

### Channel 39

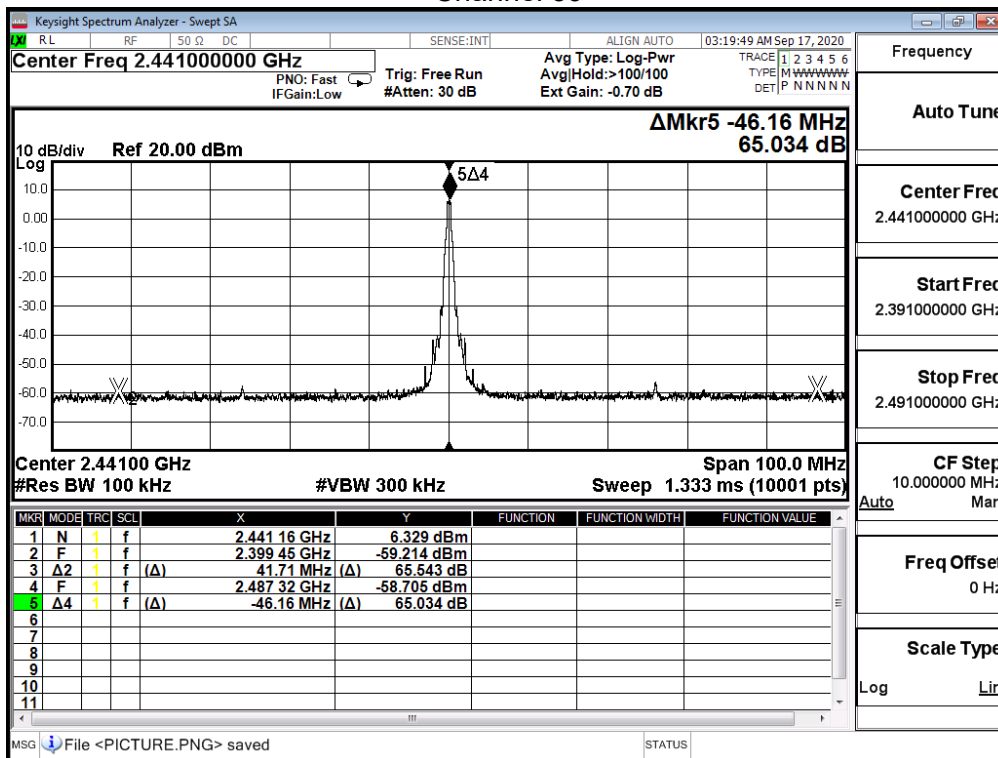

### Channel 78

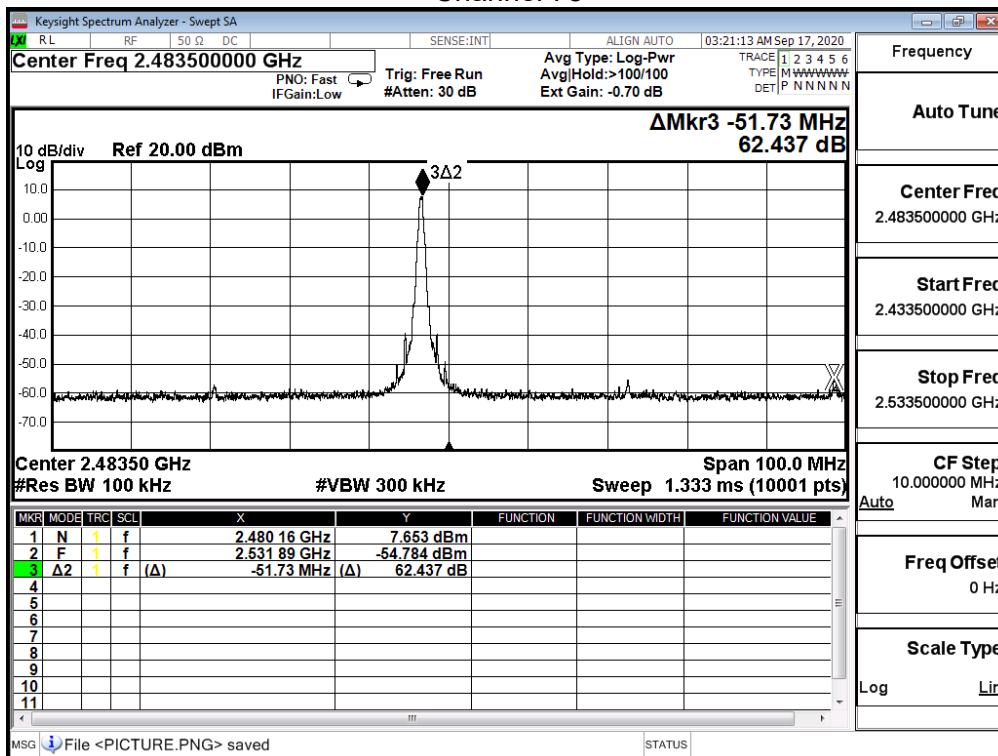

Channel 00 (30MHz-25GHz)-GFSK

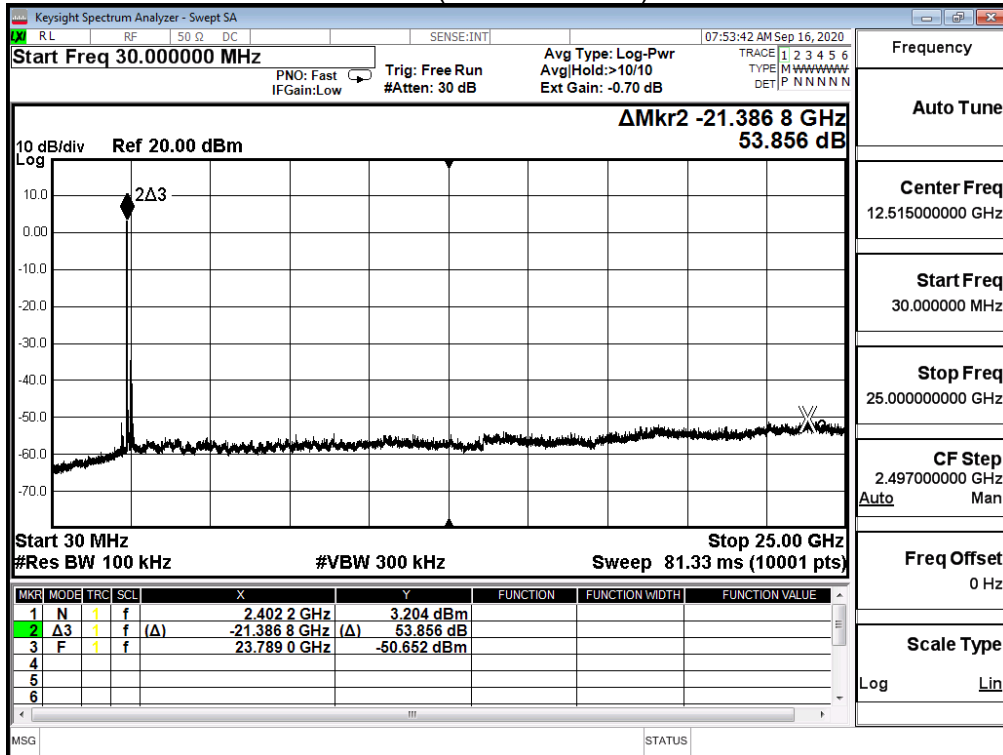

Channel 39 (30MHz-25GHz)-GFSK

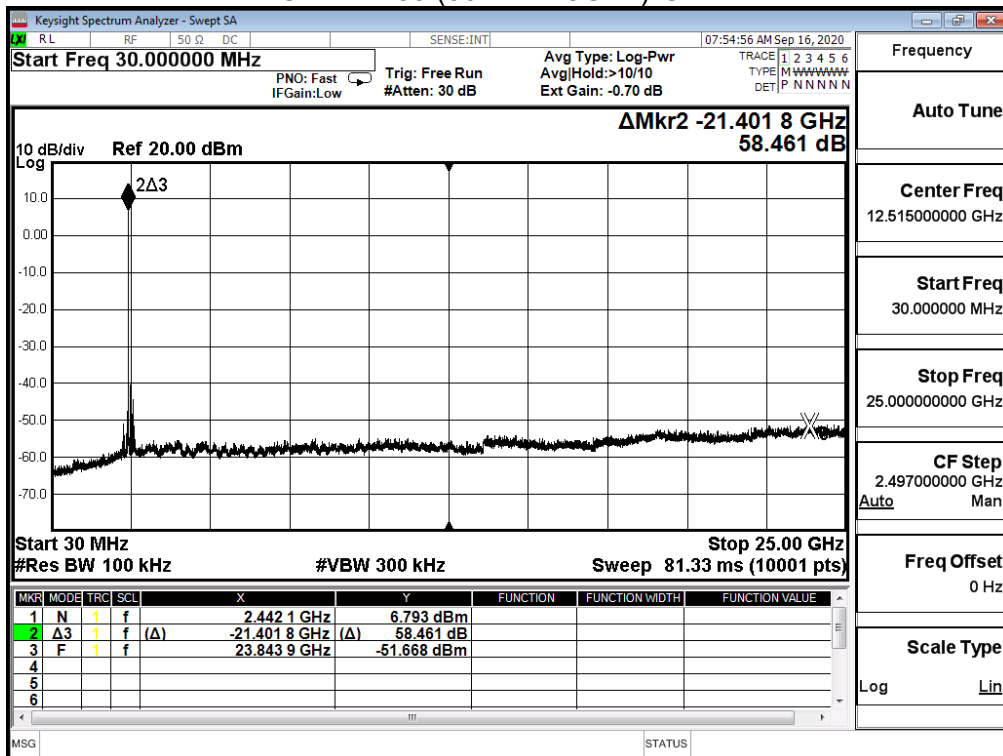

Channel 78 (30MHz-25GHz)-GFSK

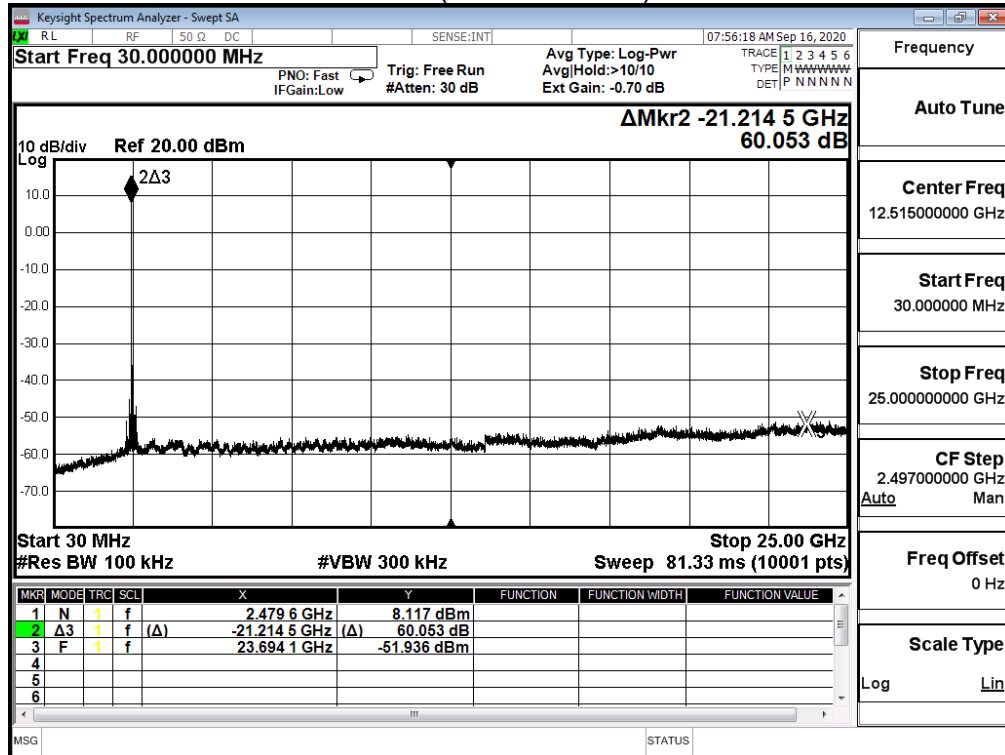

Product	Insyde		
Test Item	RF antenna conducted test		
Test Mode	Mode 1: Transmit mode_ PIFA Ant		
Date of Test	2020/09/17	Test Site	SR12-H
Temperature(°C)	22	Humidity (%RH)	55

8-DPSK

Channel	Frequency (MHz)	Measure Level (dBc)	Limit (dBc)
00	2402	47.505	≥20
39	2441	54.395	≥20
78	2480	56.083	≥20

Channel 00

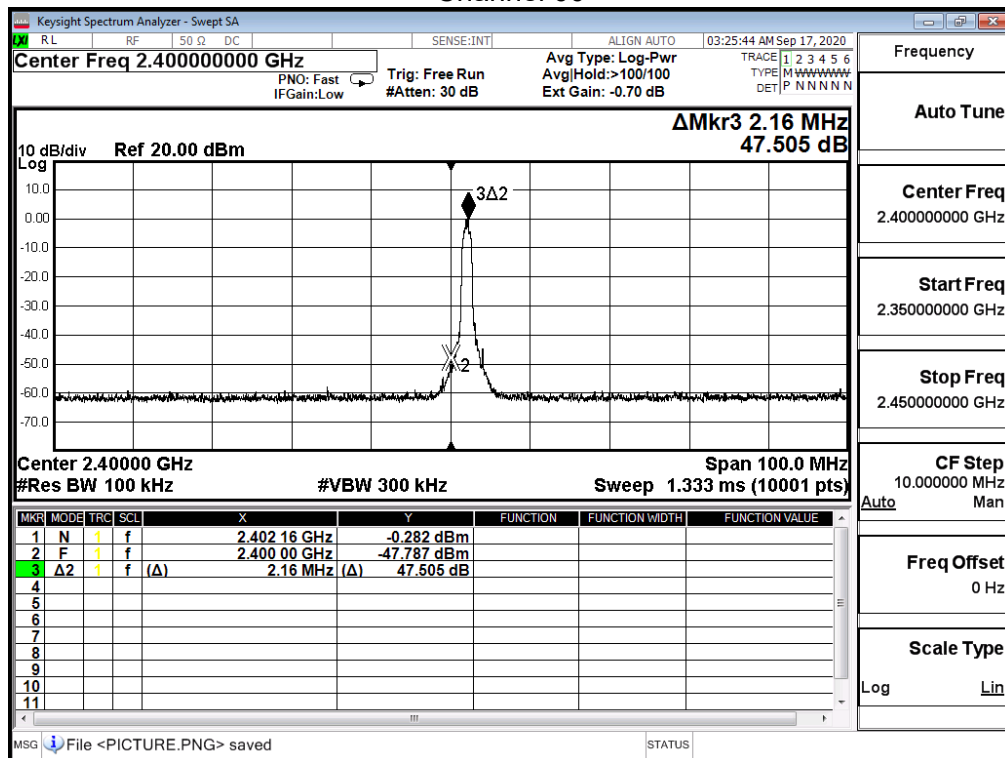

### Channel 39

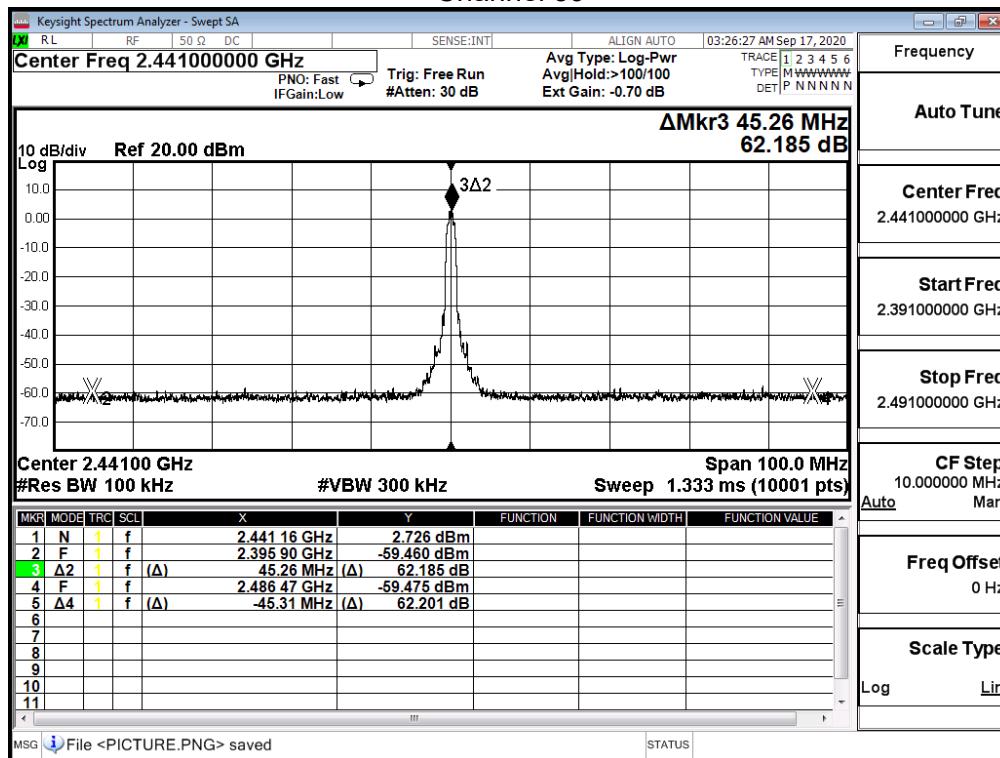

### Channel 78

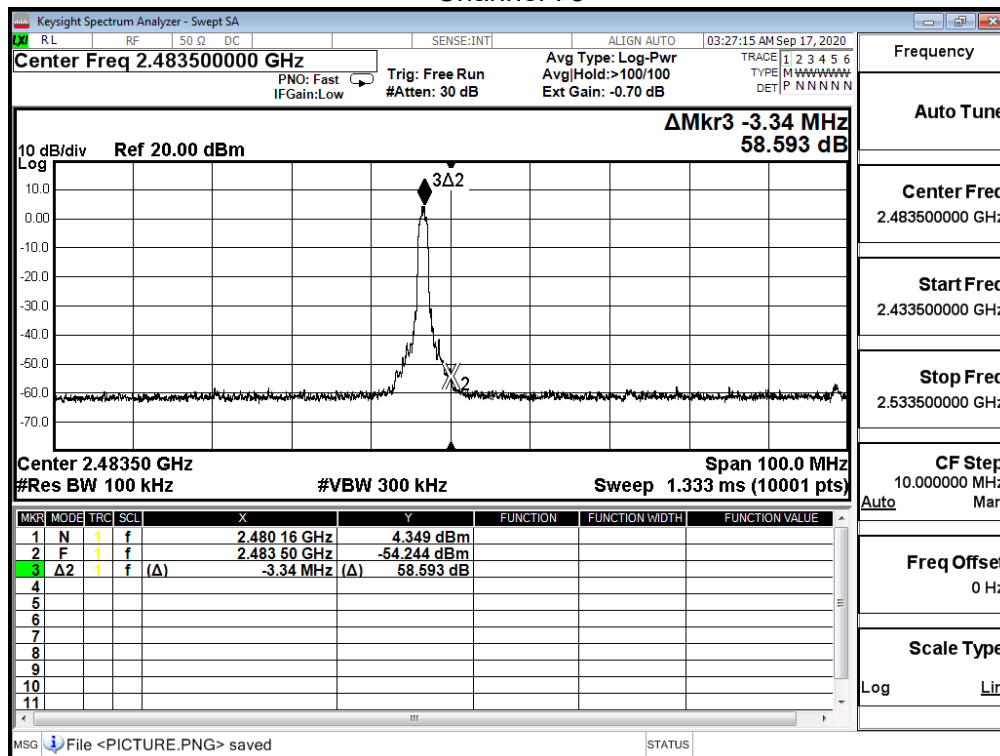

Channel 00 (30MHz-25GHz)-8-DPSK

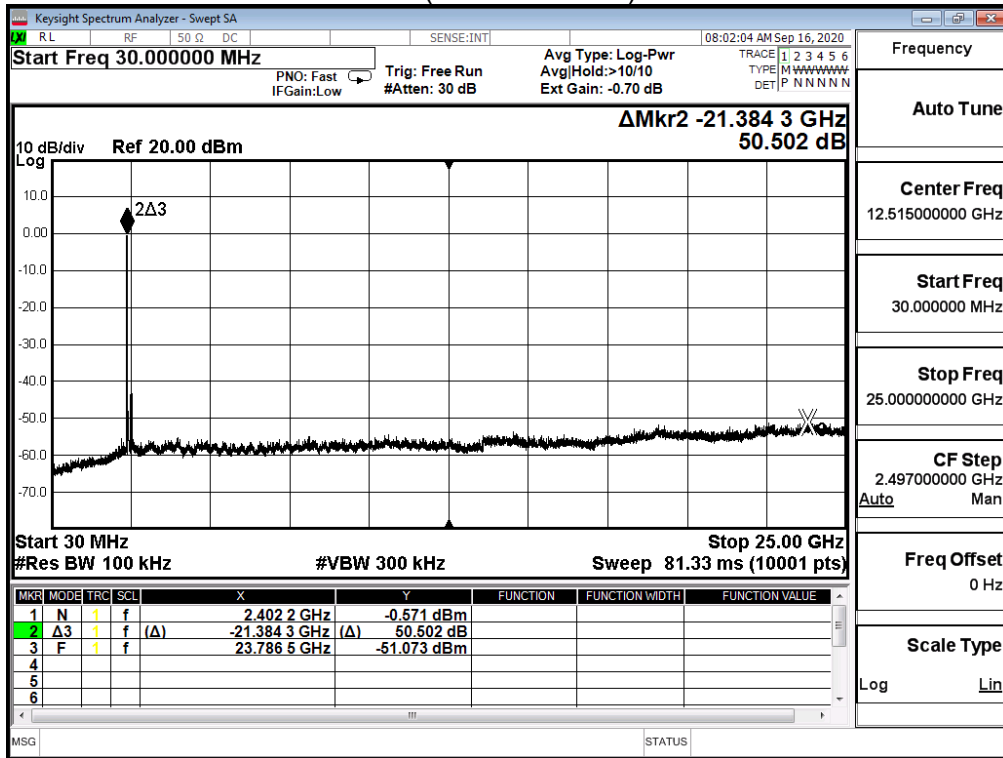

Channel 39 (30MHz-25GHz)-8-DPSK

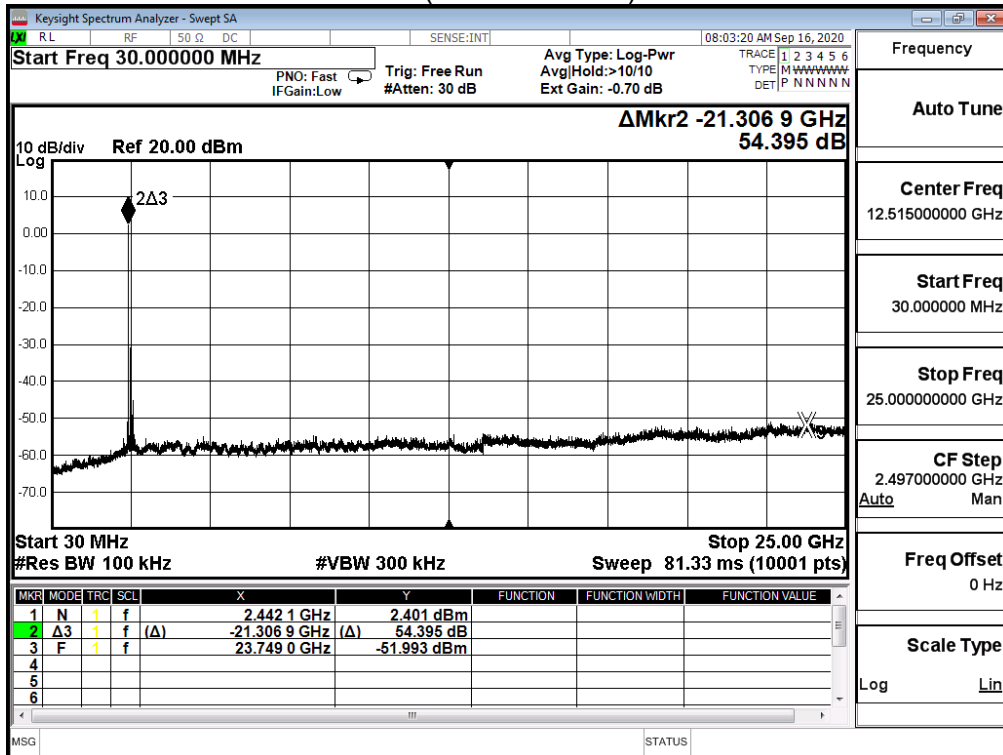



Channel 78 (30MHz-25GHz)-8-DPSK

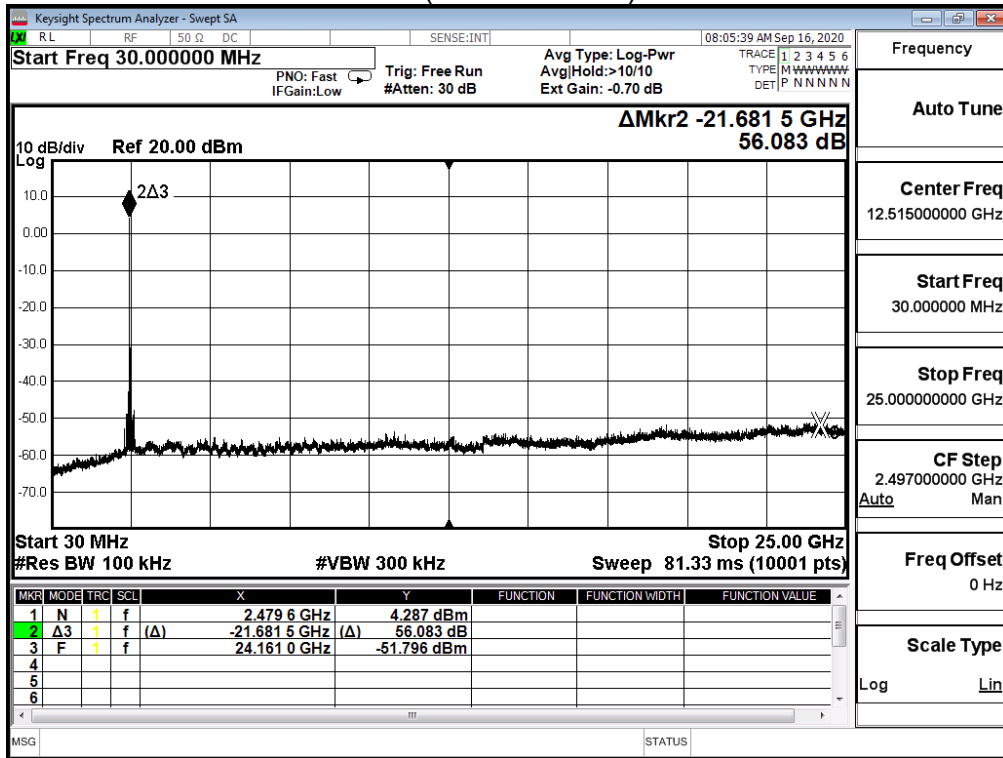

## 6. Bandedge

### 6.1. Test Setup

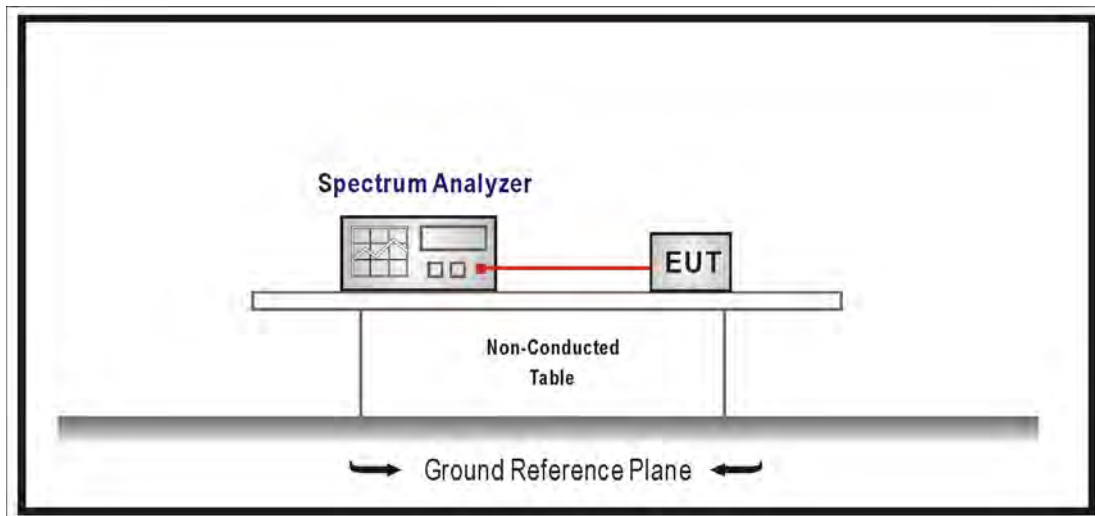

### 6.2. Limits

Emissions radiated outside of the specified frequency bands, except for harmonics, shall be attenuated by at least 20dB below the level of the fundamental or to the general radiated emission limits in paragraph 15.209, whichever is the lesser attenuation.

### 6.3. Test Procedure

The EUT was setup according to ANSI C63.10: 2013 and tested according to FHSS test procedure of FCC KDB 558074 D01 v05r02 for compliance to FCC 47CFR 15.247 requirements

### 6.4. Test Specification

According to FCC Part 15 Subpart C Paragraph 15.247: 2019

### 6.5. Test Result

Product	Insyde		
Test Item	Bandedge		
Test Mode	Mode 1: Transmit mode_ PCB Ant		
Date of Test	2020/10/27	Test Site	SR12-H
Temperature(°C)	24	Humidity (%RH)	62

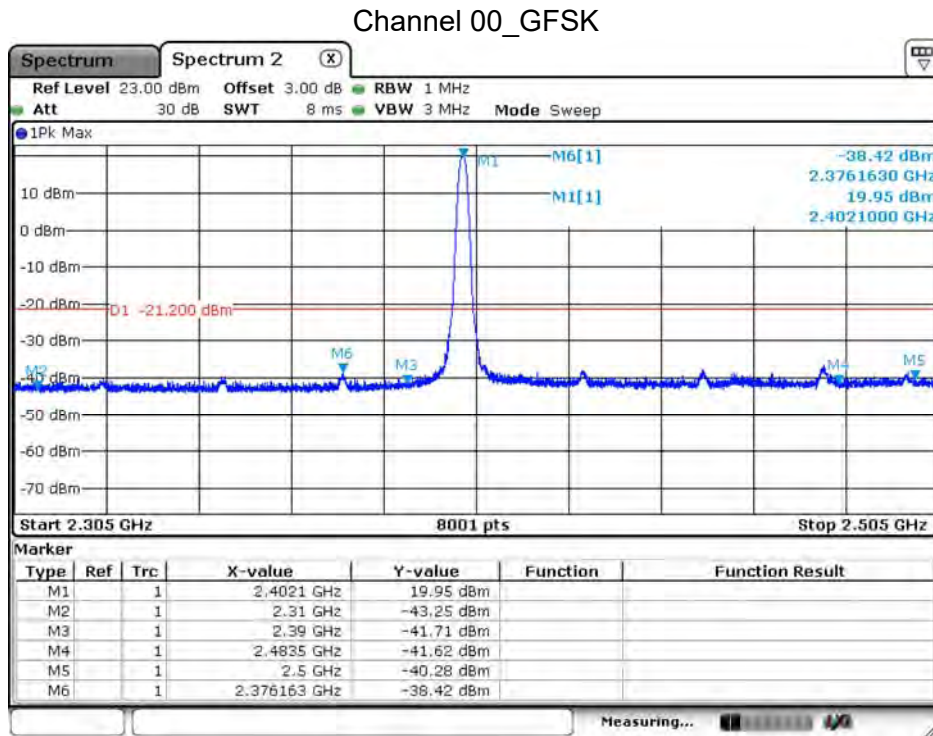

Date: 27.OCT.2020 20:27:52

### Channel 39\_GFSK

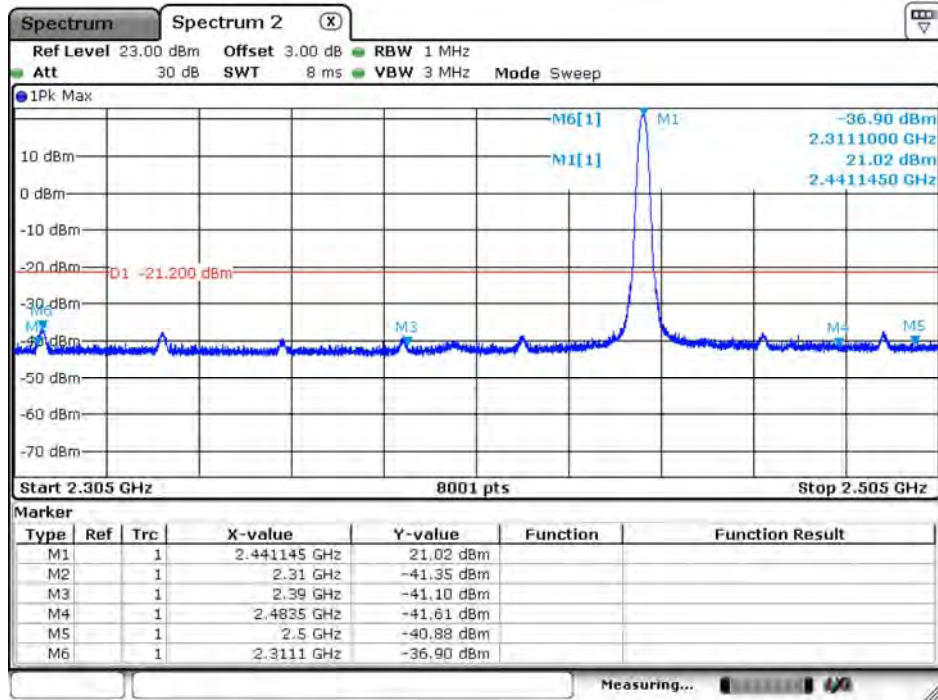

Date: 27.OCT.2020 20:50:58

### Channel 78\_GFSK

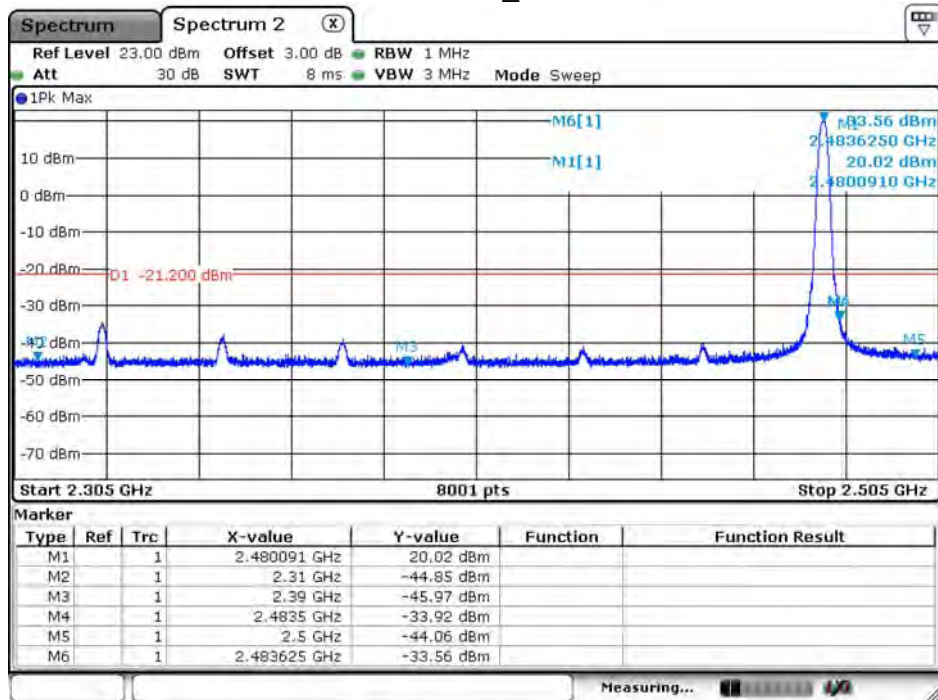

Date: 24.OCT.2020 13:00:49

Channel 00\_8-DPSK

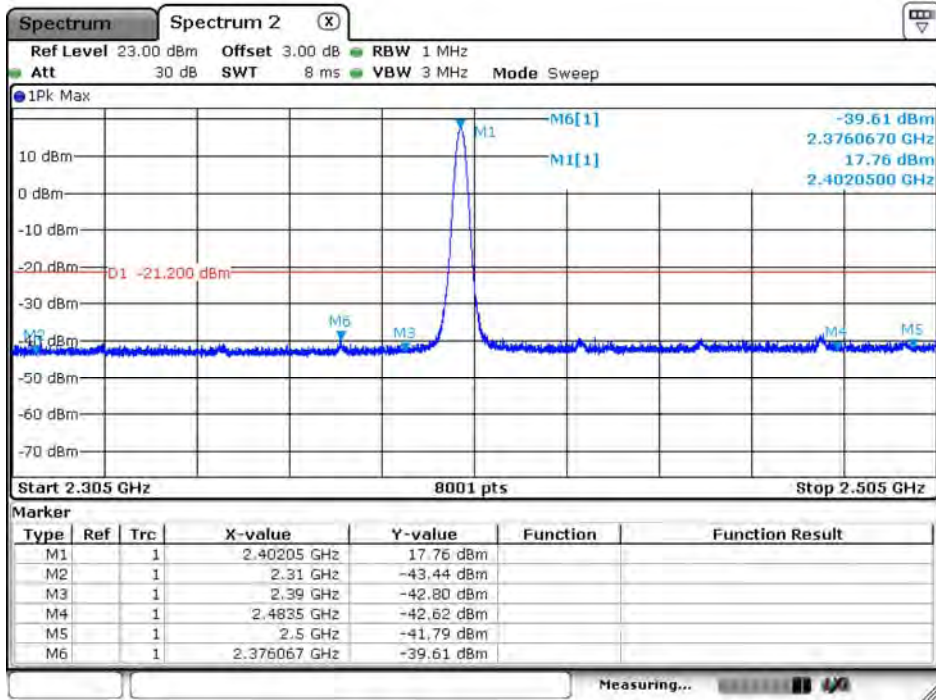

Date: 27.OCT.2020 21:01:07

Channel 39\_8-DPSK

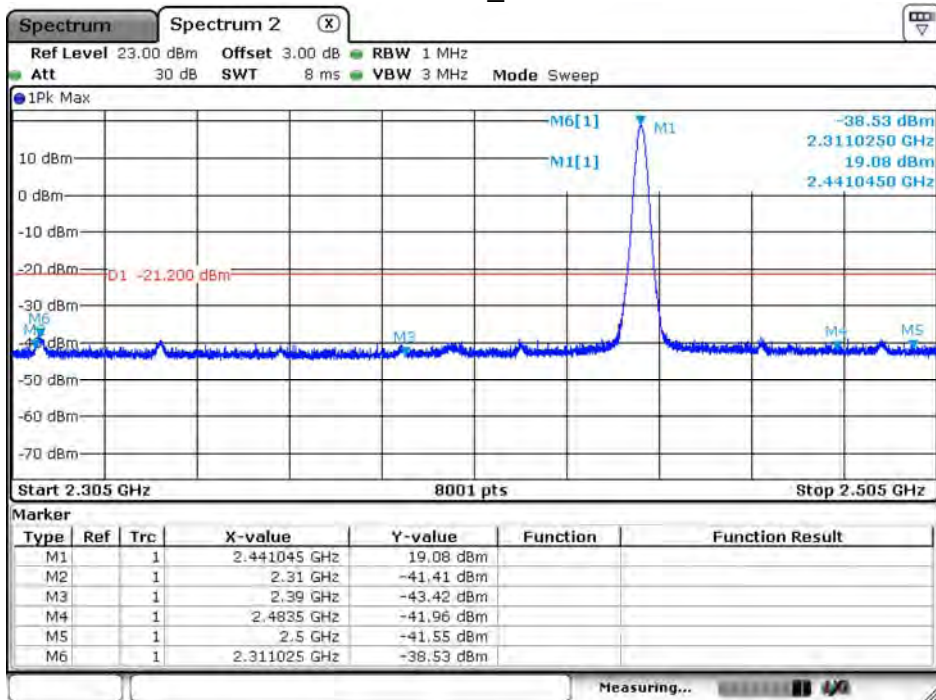

Date: 27.OCT.2020 21:05:21

Channel 78\_8-DPSK

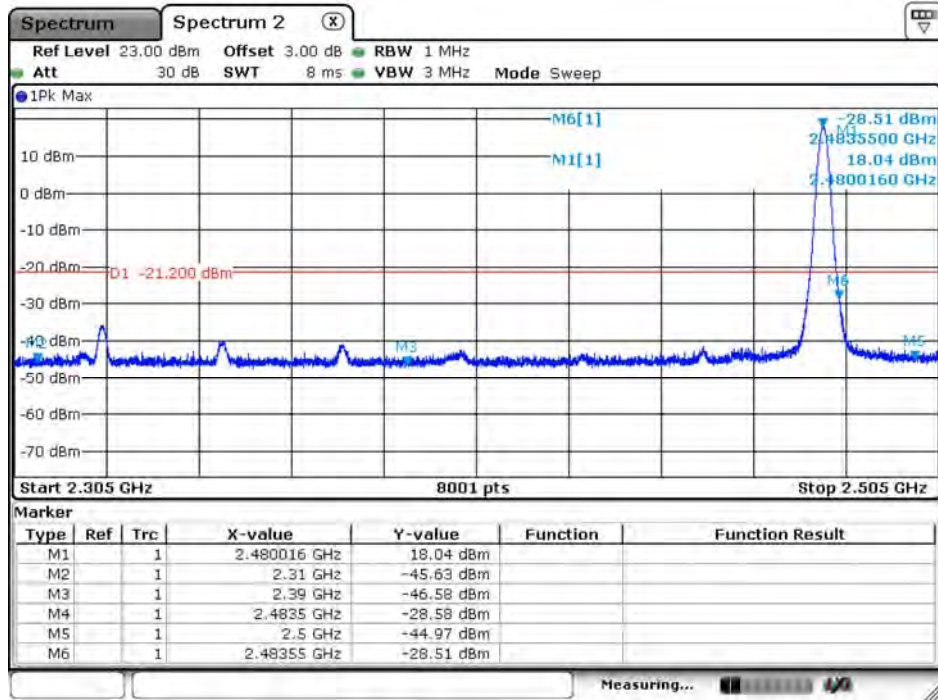

Date: 24.OCT.2020 13:09:18

Product	Insyde		
Test Item	Bandedge		
Test Mode	Mode 1: Transmit mode_ PIFA Ant		
Date of Test	2020/10/21	Test Site	SR12-H
Temperature(°C)	25.1	Humidity (%RH)	55

Channel 00\_GFSK

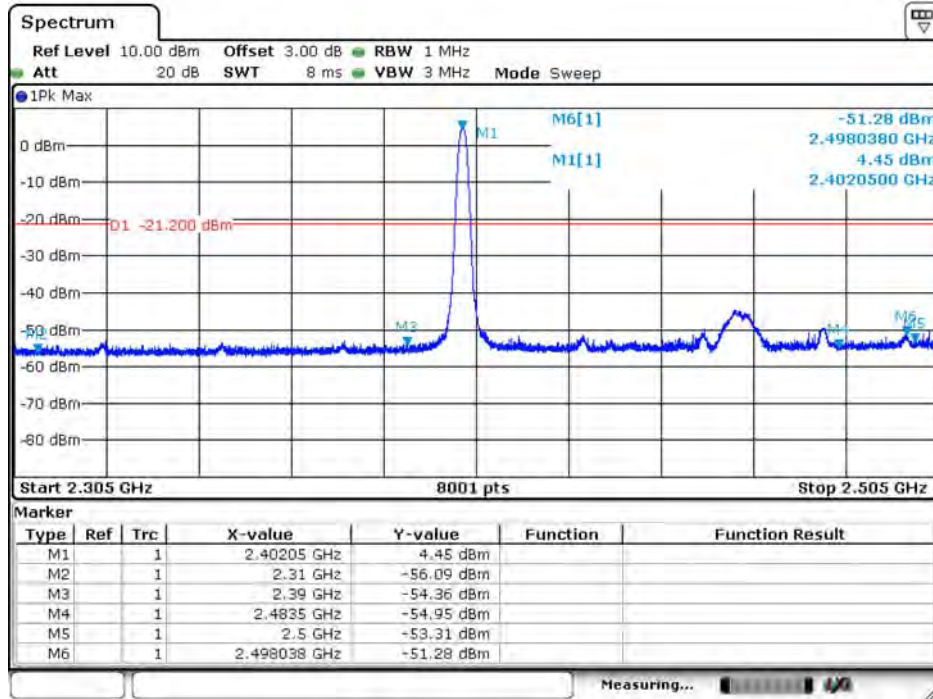

Date: 21.OCT.2020 10:27:27

Channel 39\_GFSK

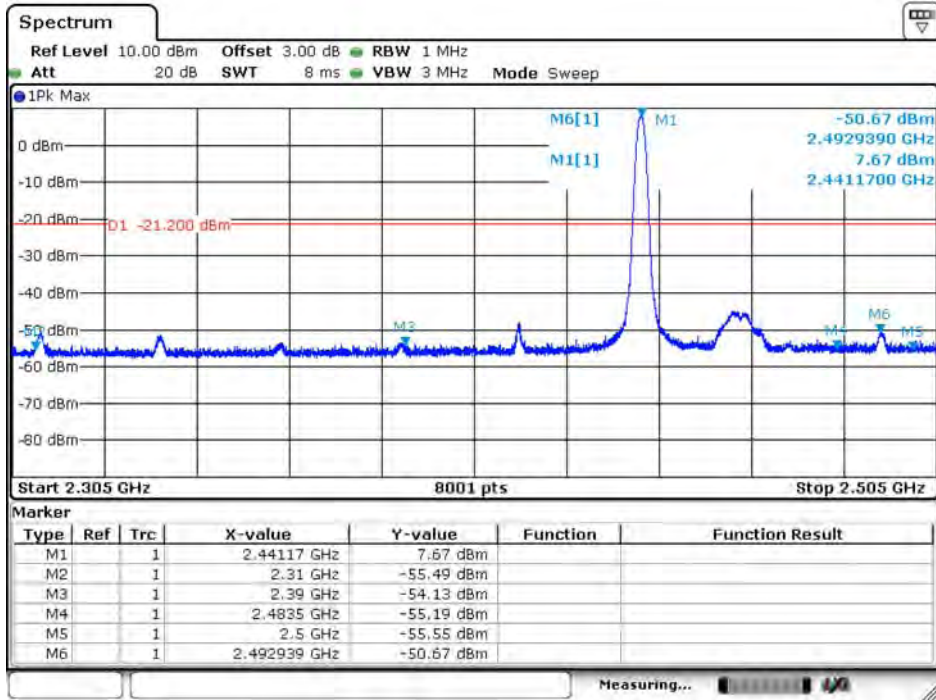

Date: 21.OCT.2020 10:24:42

Channel 78\_GFSK

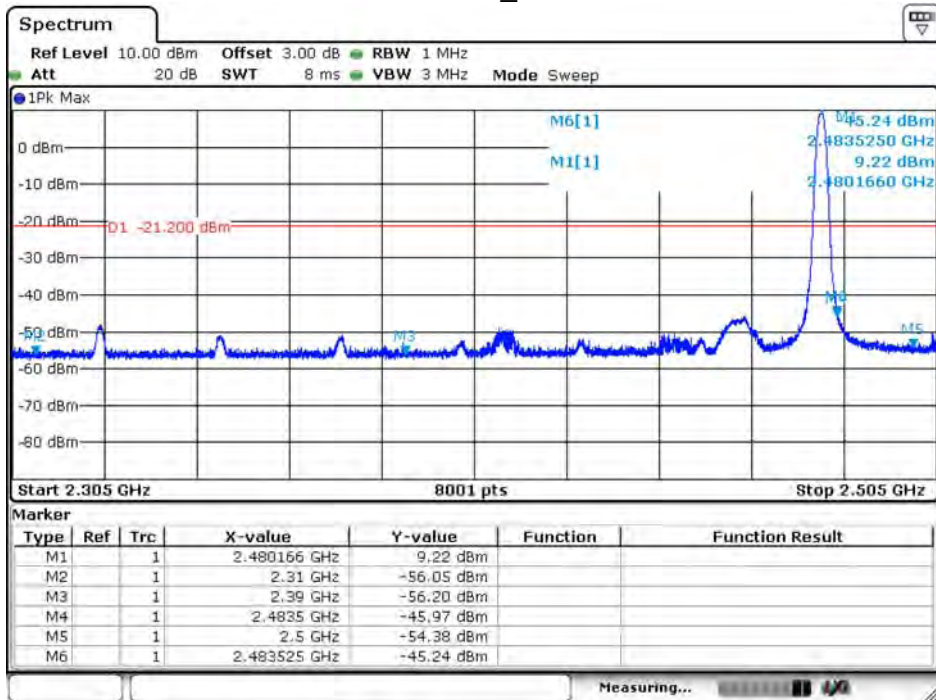

Date: 21.OCT.2020 10:28:41



### Channel 00\_8-DPSK

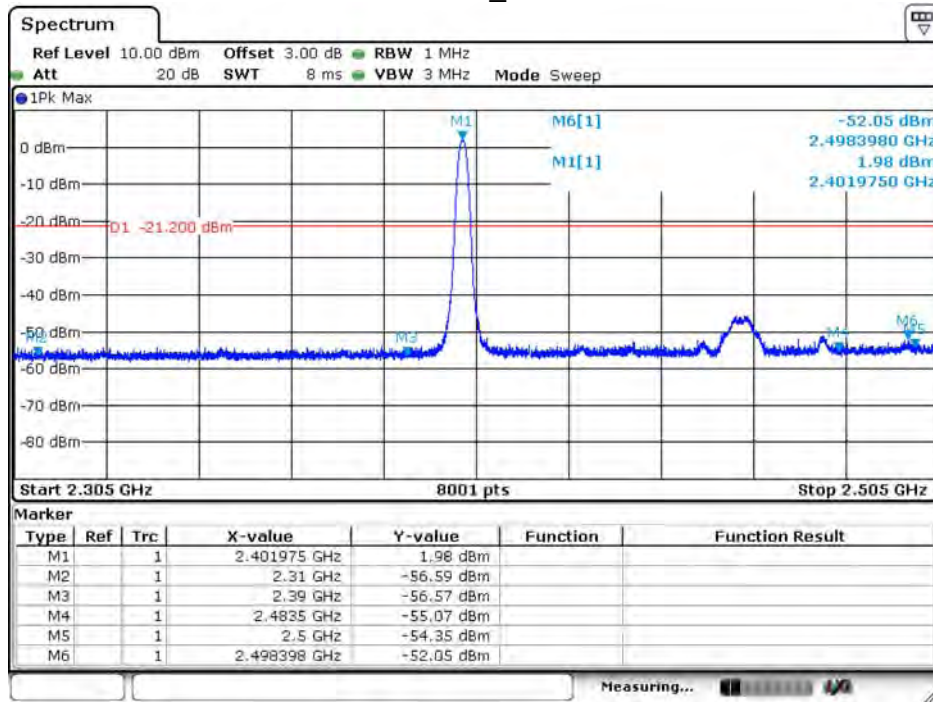

Date: 21.OCT.2020 10:49:25

### Channel 39\_8-DPSK

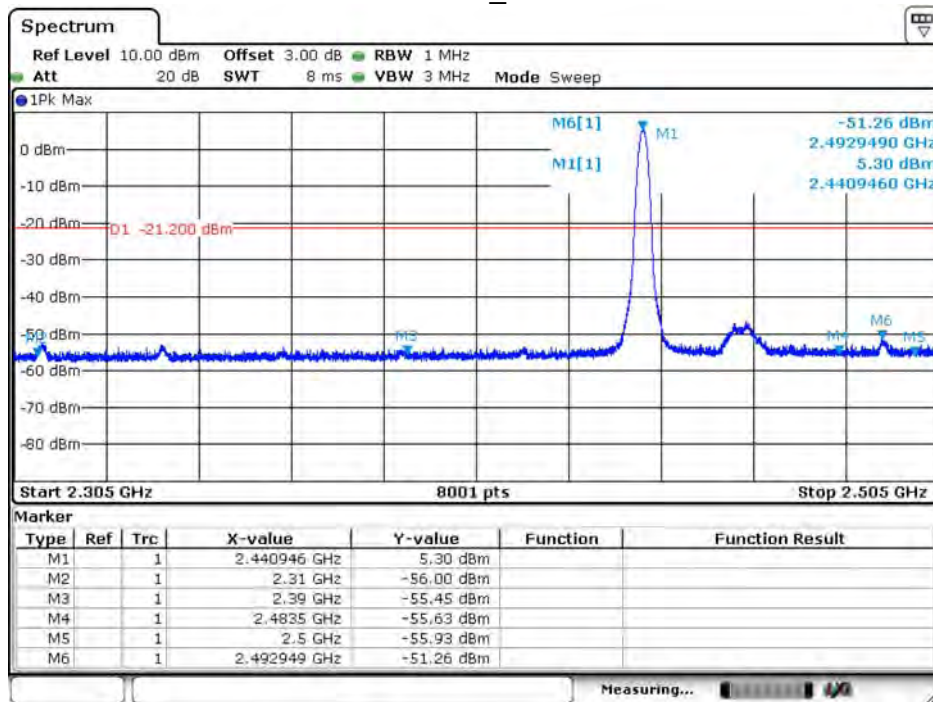

Date: 21.OCT.2020 10:46:55

Channel 78\_8-DPSK

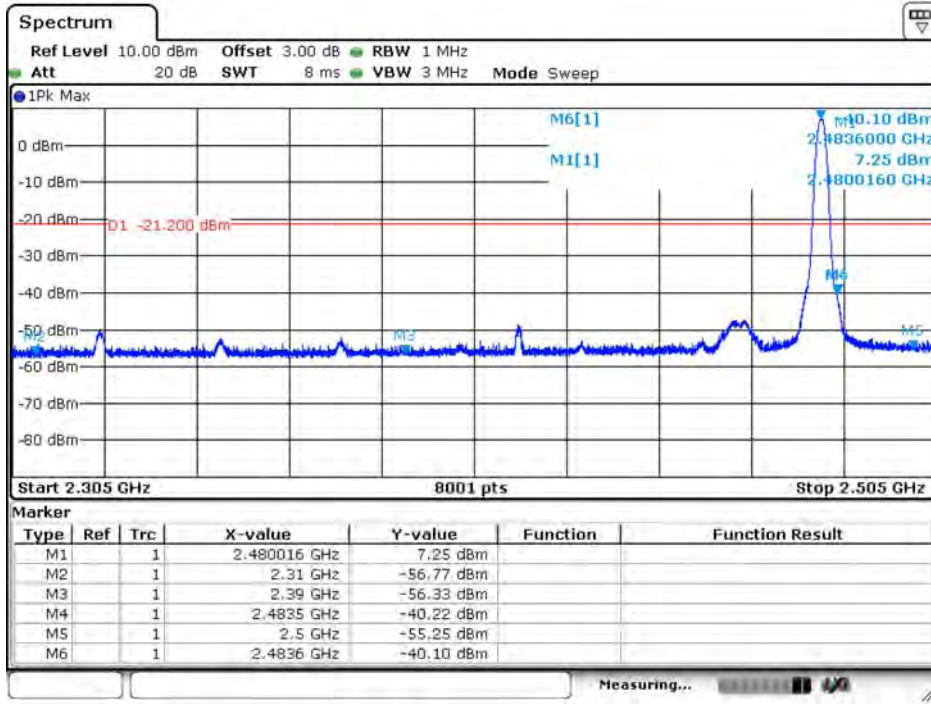

Date: 2010 OCT 20 2020 10:47:30

## 7. Number of hopping frequency

### 7.1. Test Setup

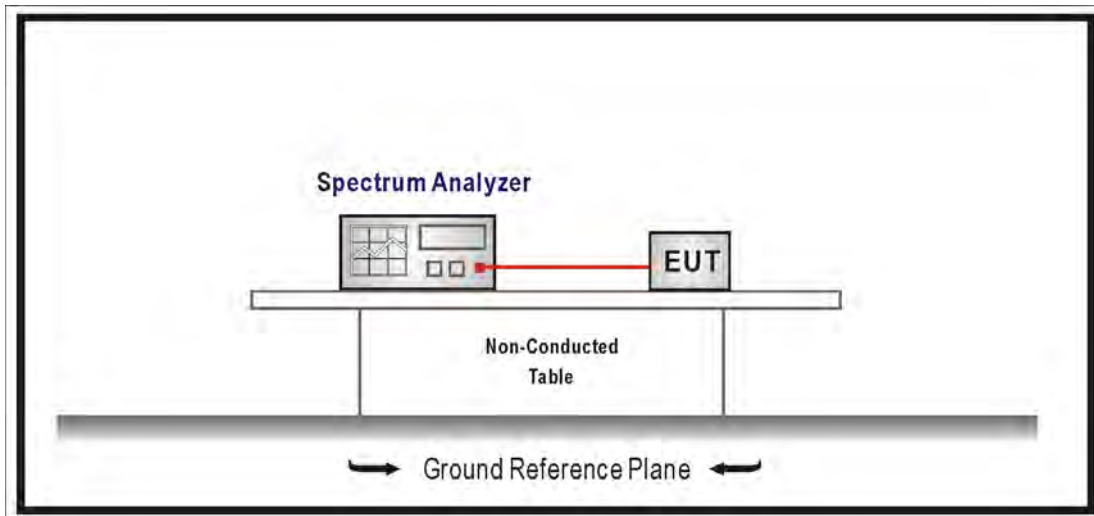

### 7.2. Limits

For frequency hopping systems operating in the 902-928 MHz band: if the 20 dB bandwidth of the hopping channel is less than 250 kHz, the system shall use at least 50 hopping frequencies and the average time of occupancy on any frequency shall not be greater than 0.4 seconds within a 20 second period; if the 20 dB bandwidth of the hopping channel is 250 kHz or greater, the system shall use at least 25 hopping frequencies and the average time of occupancy on any frequency shall not be greater than 0.4 seconds within a 10 second period. The maximum allowed 20 dB bandwidth of the hopping channel is 500 kHz.

Frequency hopping systems in the 2400-2483.5 MHz band shall use at least 15 channels. The average time of occupancy on any channel shall not be greater than 0.4 seconds within a period of 0.4 seconds multiplied by the number of hopping channels employed. Frequency hopping systems may avoid or suppress transmissions on a particular hopping frequency provided that a minimum of 15 channels are used.

Frequency hopping systems operating in the 5725-5850 MHz band shall use at least 75 hopping frequencies. The maximum 20 dB bandwidth of the hopping channel is 1 MHz. The average time of occupancy on any frequency shall not be greater than 0.4 seconds within a 30 second period.

### **7.3. Test Procedures**

The EUT was setup according to ANSI C63.10: 2013 and tested according to FHSS test procedure of FCC KDB 558074 D01 v05r02 for compliance to FCC 47CFR 15.247 requirements.

### **7.4. Test Specification**

According to FCC Part 15 Subpart C Paragraph 15.247: 2019

### 7.5. Test Result

Product	Insyde		
Test Item	Number of hopping frequency		
Test Mode	Mode 1: Transmit mode_ PCB Ant		
Date of Test	2020/10/27	Test Site	SR12-H
Temperature(°C)	24	Humidity (%RH)	62

Frequency Range (MHz)	Measure Level (Channels)	Limit (Channels)
2402 - 2480	79	≥ 75

2401.5-2420.5MHz

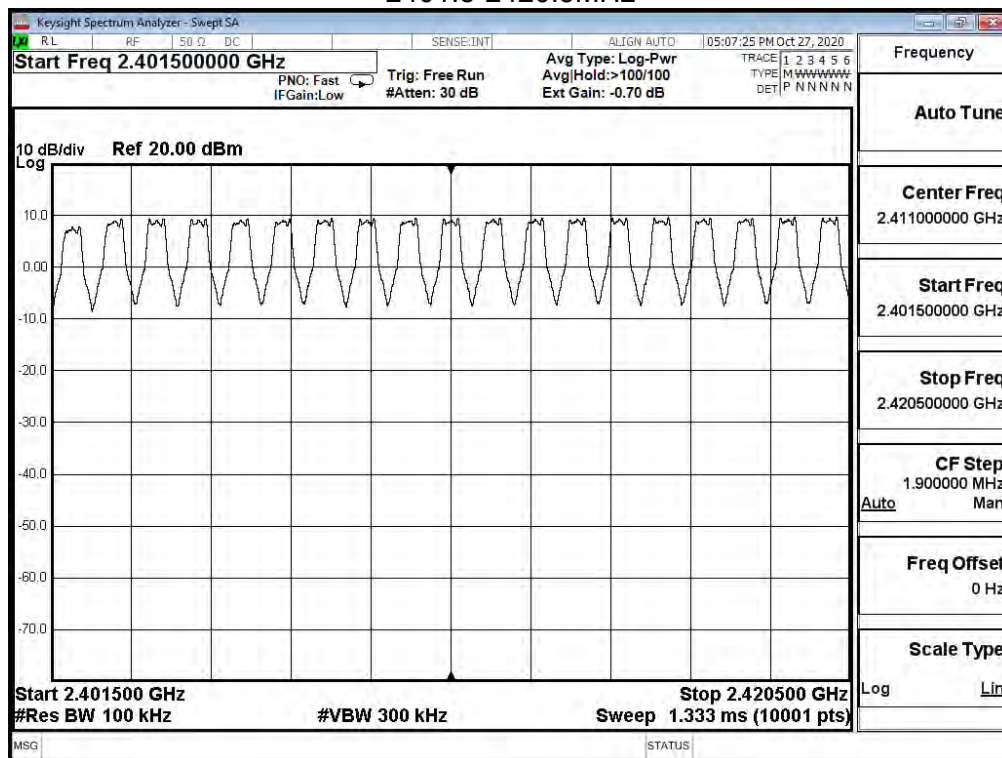

2420.5-2440.5MHz

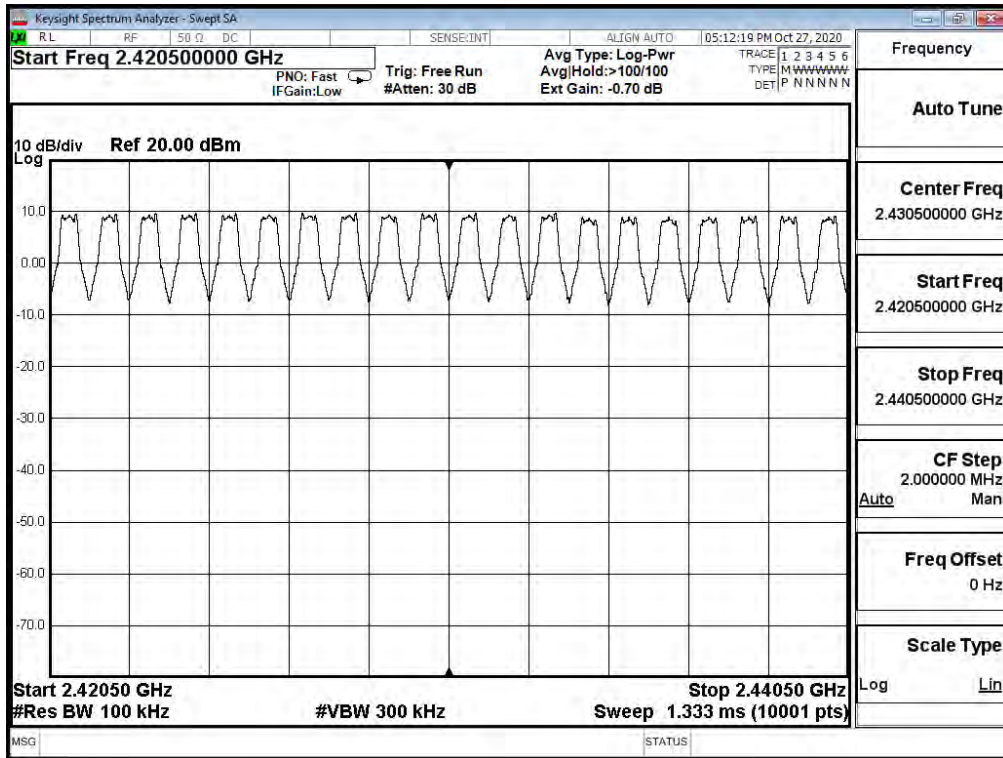

2440.5-2460.5MHz

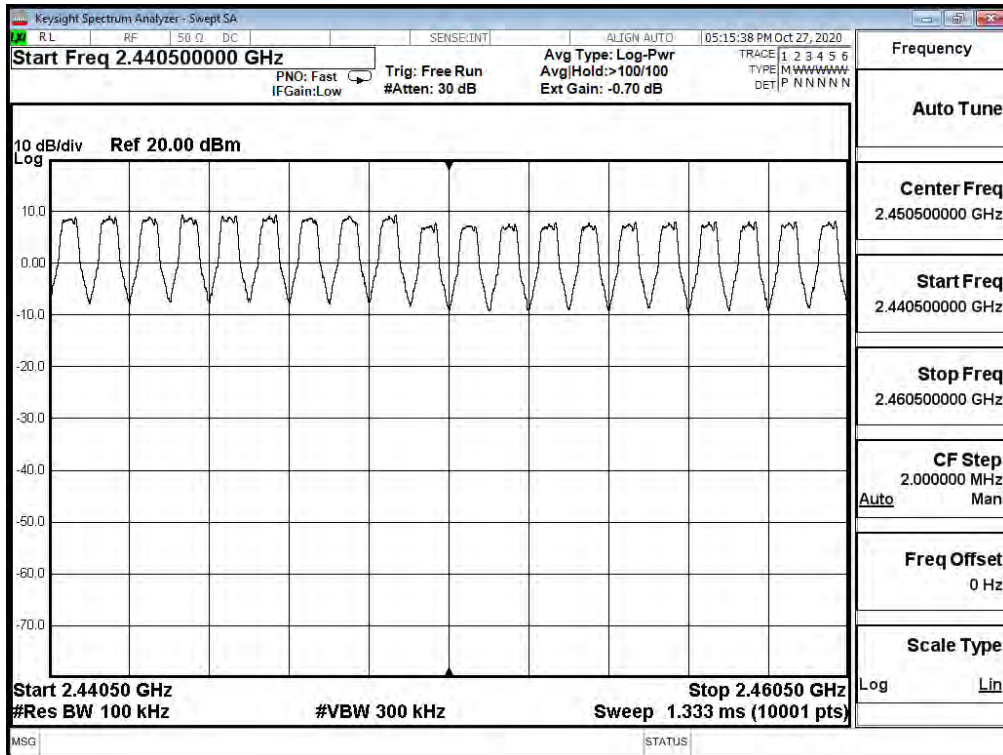

2460.5-2480.5MHz

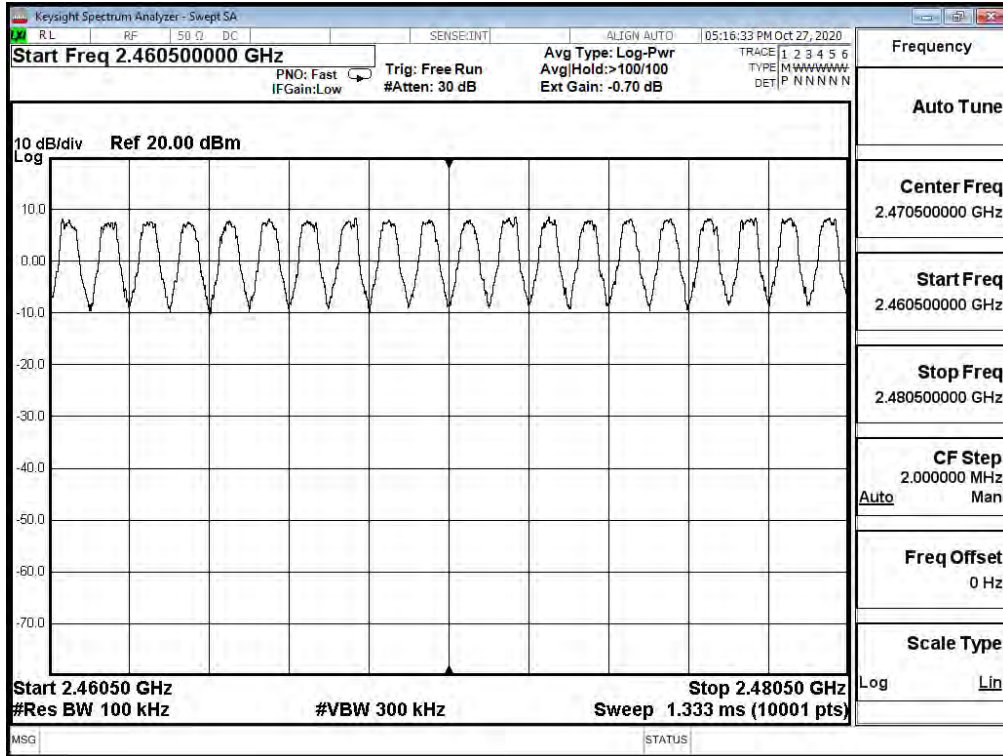

Product	Insyde		
Test Item	Number of hopping frequency		
Test Mode	Mode 1: Transmit mode_ PIFA Ant		
Date of Test	2020/09/17	Test Site	SR12-H
Temperature(°C)	22	Humidity (%RH)	55

Frequency Range (MHz)	Measure Level (Channels)	Limit (Channels)
2402 - 2480	79	≥ 75

2401.5-2420.5MHz

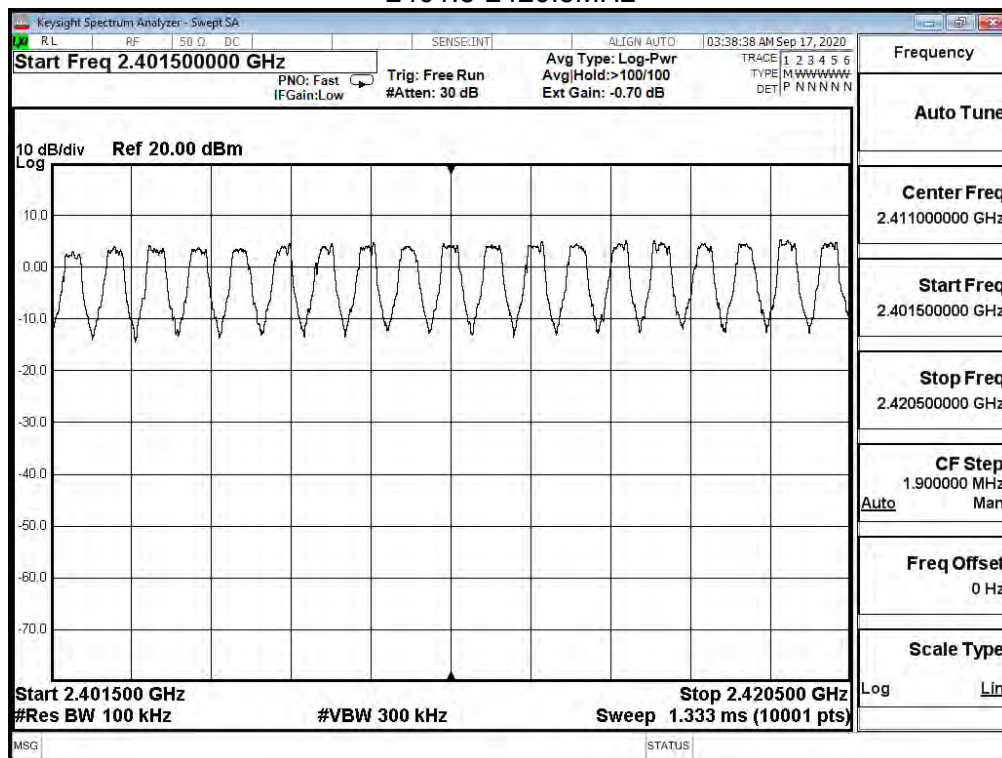



2420.5-2440.5MHz

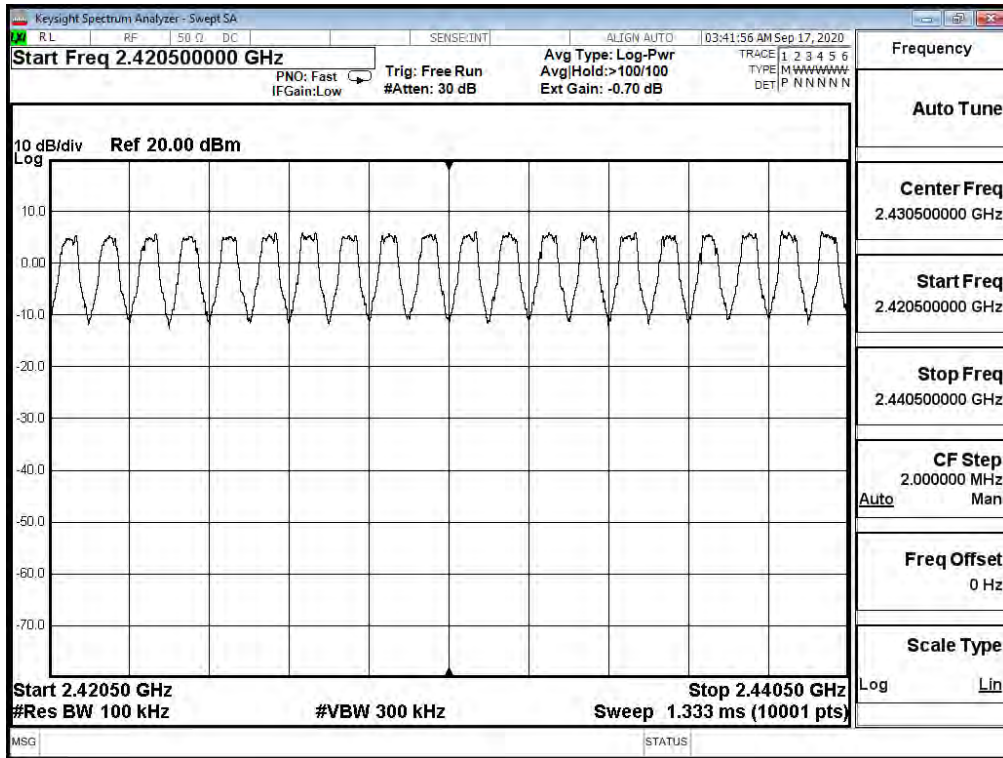

2440.5-2460.5MHz

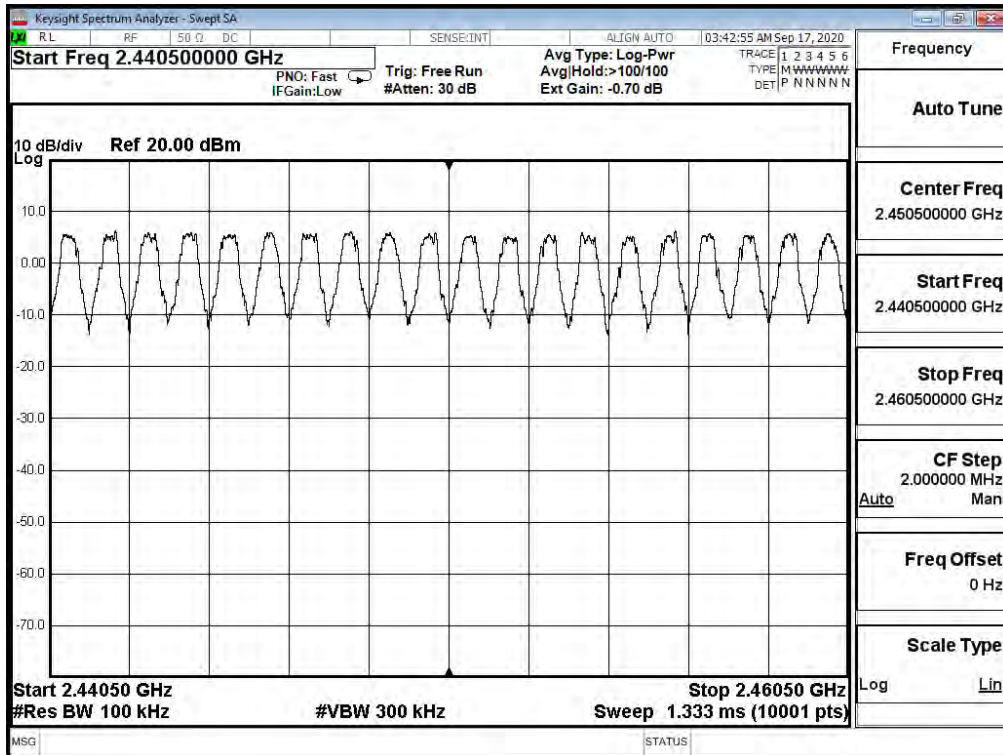

### 2460.5-2480.5MHz

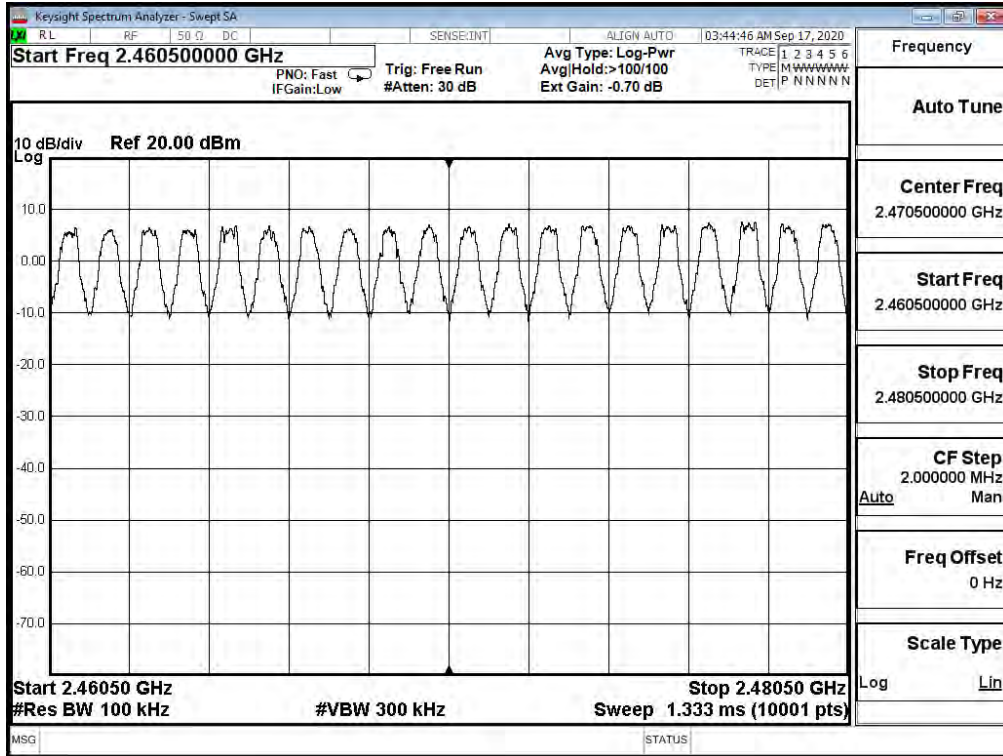

## 8. Carrier Frequency Separation

### 8.1. Test Setup

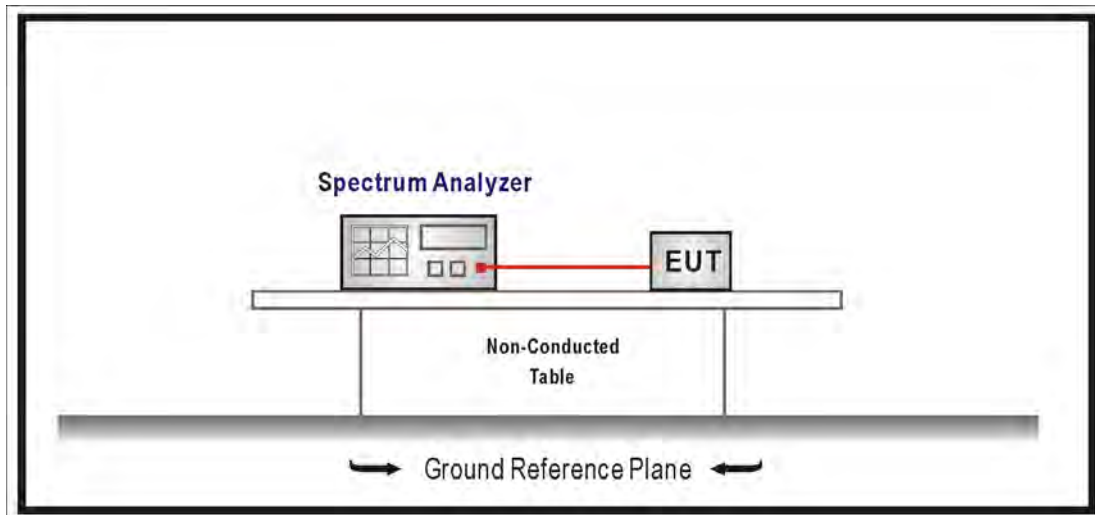

### 8.2. Limits

Frequency hopping systems shall have hopping channel carrier frequencies separated by a minimum of 25 kHz or the 20 dB bandwidth of the hopping channel, whichever is greater. Alternatively, frequency hopping systems operating in the 2400-2483.5 MHz band may have hopping channel carrier frequencies that are separated by 25 kHz or two-thirds of the 20 dB bandwidth of the hopping channel, whichever is greater, provided the systems operate with an Maximum peak conducted output power no greater than 125 mW. The system shall hop to channel frequencies that are selected at the system hopping rate from a pseudo randomly ordered list of hopping frequencies. Each frequency must be used equally on the average by each transmitter. The system receivers shall have input bandwidths that match the hopping channel bandwidths of their corresponding transmitters and shall shift frequencies in synchronization with the transmitted signals.

### 8.3. Test Procedures

The EUT was setup according to ANSI C63.10: 2013 and tested according to FHSS test procedure of FCC KDB 558074 D01 v05r02 for compliance to FCC 47CFR 15.247 requirements

### 8.4. Test Specification

According to FCC Part 15 Subpart C Paragraph 15.247: 2019

### 8.5. Test Result

Product	Insyde		
Test Item	Carrier Frequency Separation		
Test Mode	Mode 1: Transmit mode_ PCB Ant		
Date of Test	2020/10/27	Test Site	SR12-H
Temperature(°C)	24	Humidity (%RH)	62

#### GFSK

Channel No.	Frequency (MHz)	Measure Level (MHz)	Limit (MHz)
00	2402	1.000	≥ 0.741
39	2441	1.001	≥ 0.743
78	2480	1.000	≥ 0.741

Channel 00

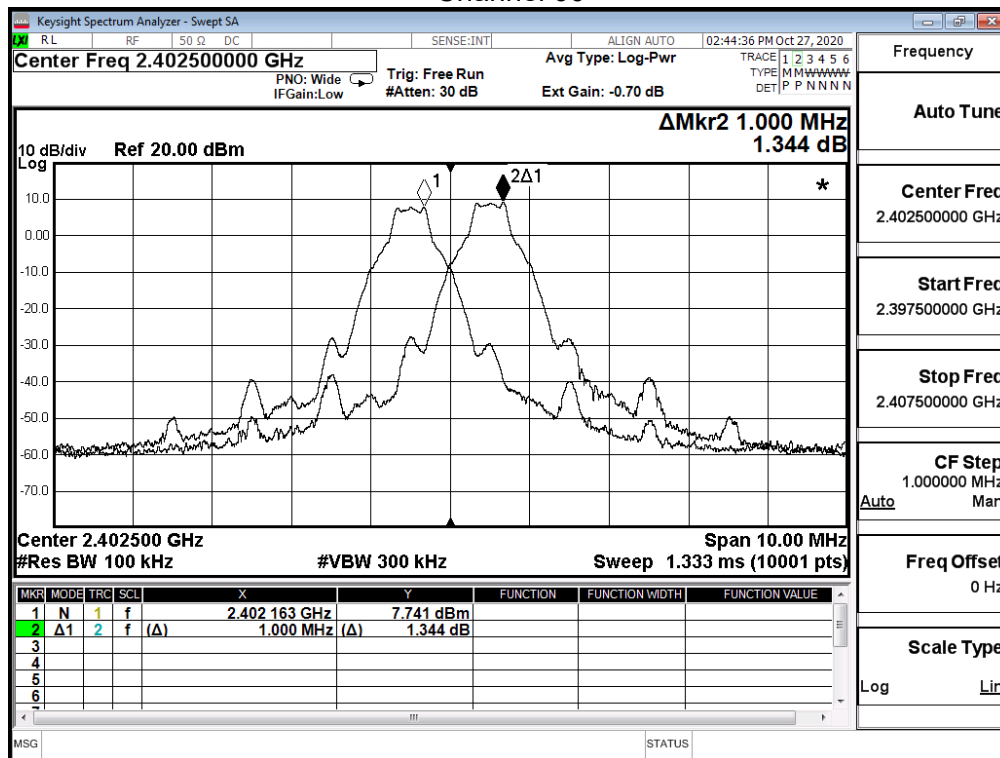

### Channel 39

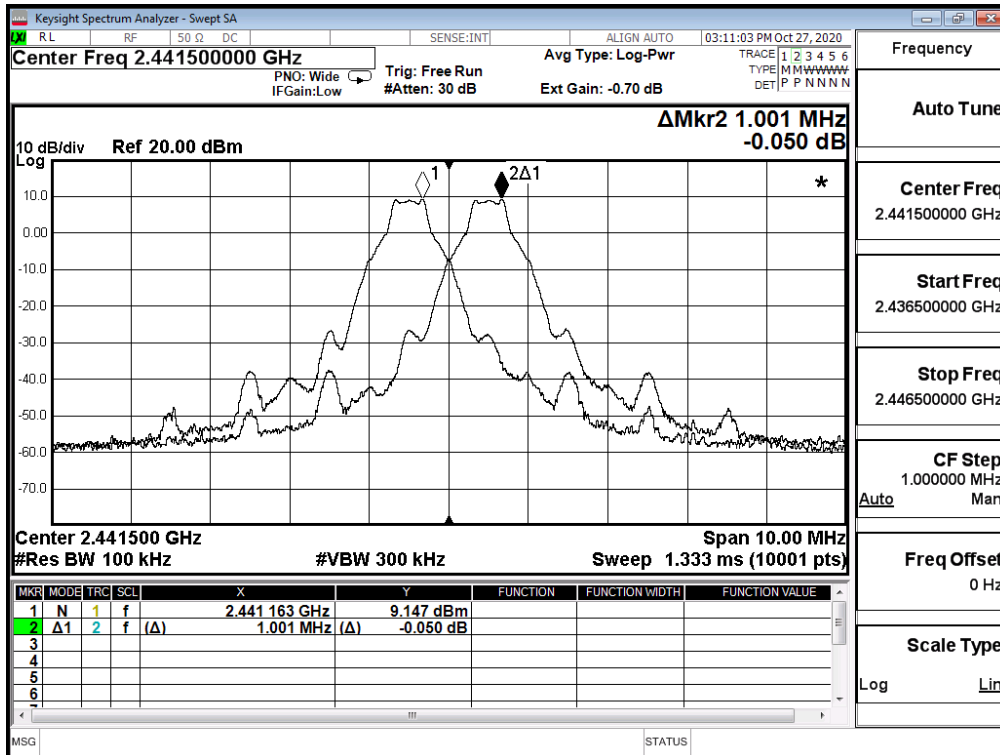

### Channel 78

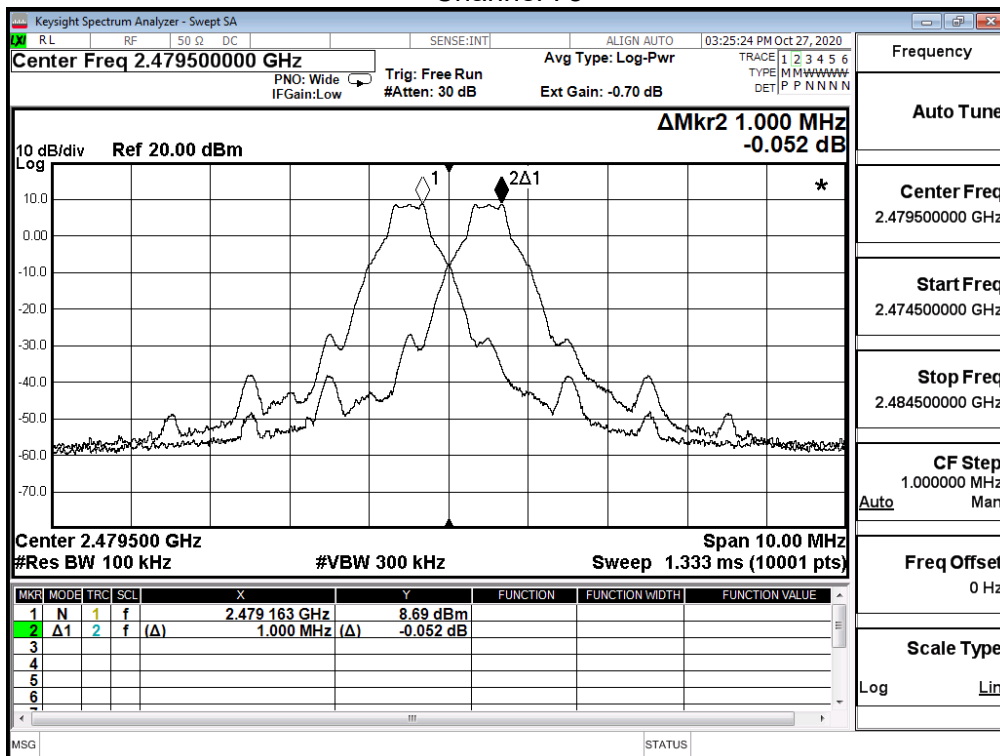

Product	Insyde		
Test Item	Carrier Frequency Separation		
Test Mode	Mode 1: Transmit mode_ PCB Ant		
Date of Test	2020/10/27	Test Site	SR12-H
Temperature(°C)	24	Humidity (%RH)	62

8-DPSK

Channel No.	Frequency (MHz)	Measure Level (MHz)	Limit (MHz)
00	2402	1.001	≥ 0.918
39	2441	1.000	≥ 0.917
78	2480	1.000	≥ 0.917

Channel 00

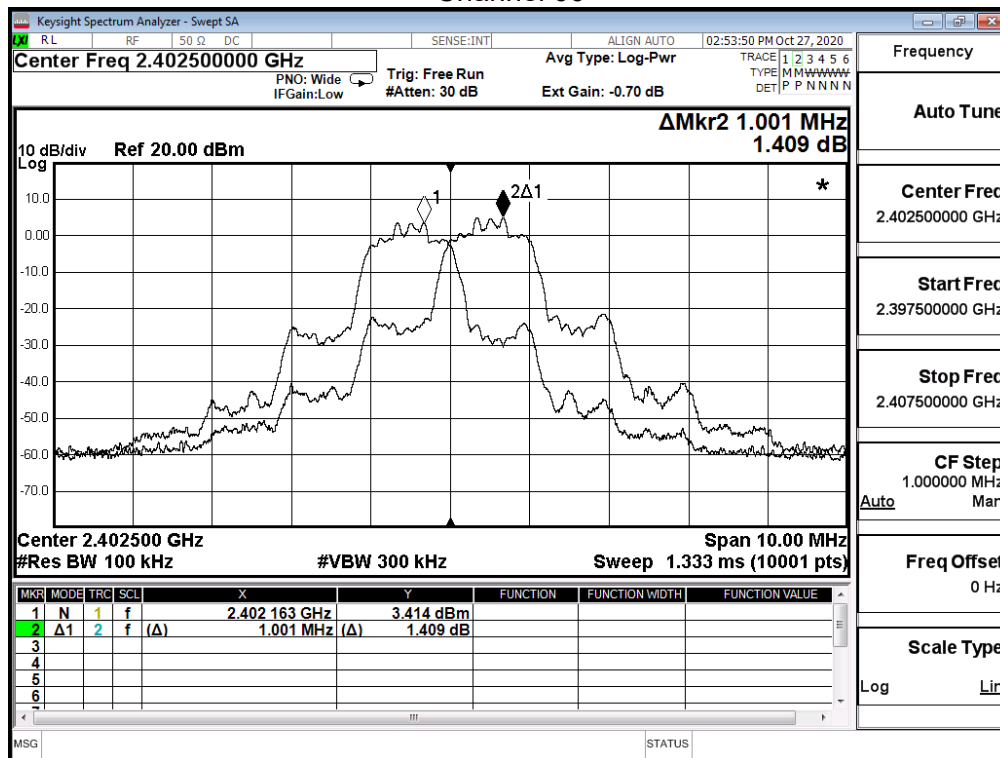

Channel 39

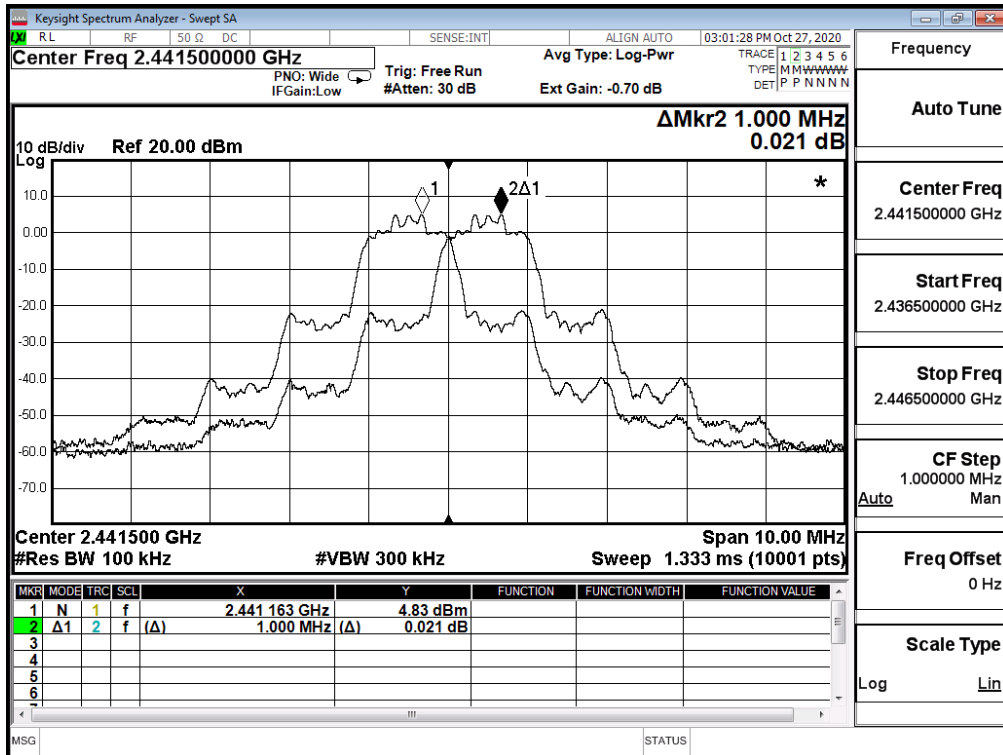

Channel 78

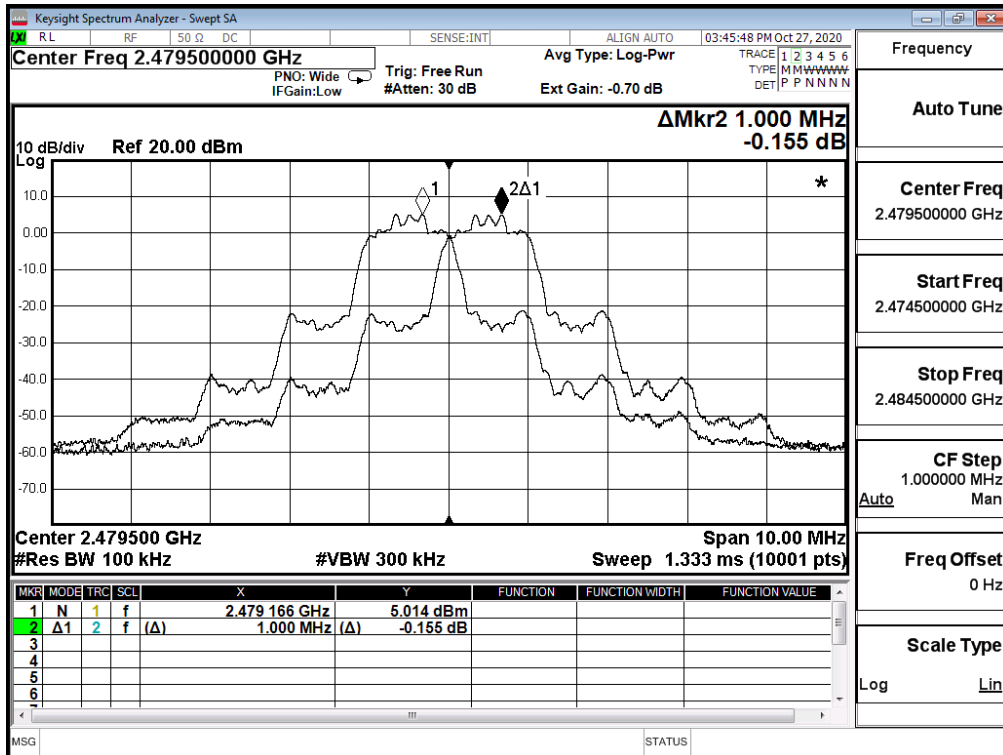

Product	Insyde		
Test Item	Carrier Frequency Separation		
Test Mode	Mode 1: Transmit mode_ PIFA Ant		
Date of Test	2020/09/17	Test Site	SR12-H
Temperature(°C)	22	Humidity (%RH)	55

GFSK

Channel No.	Frequency (MHz)	Measure Level (MHz)	Limit (MHz)
00	2402	1.000	≥ 0.638
39	2441	1.000	≥ 0.639
78	2480	1.000	≥ 0.640

Channel 00

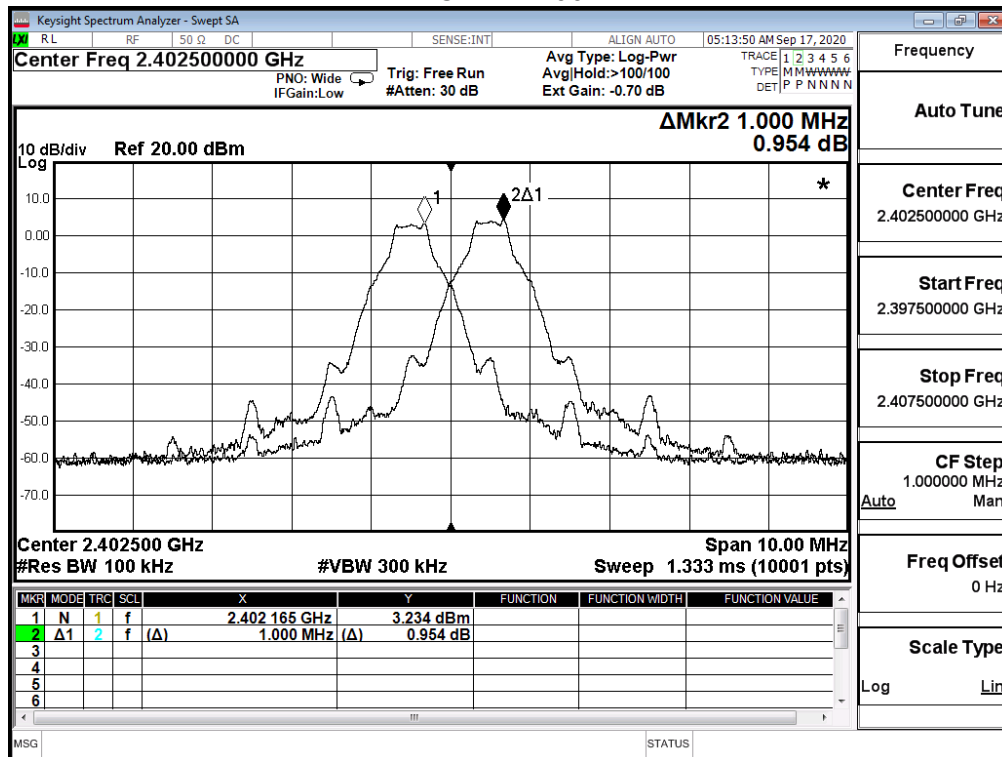



### Channel 39

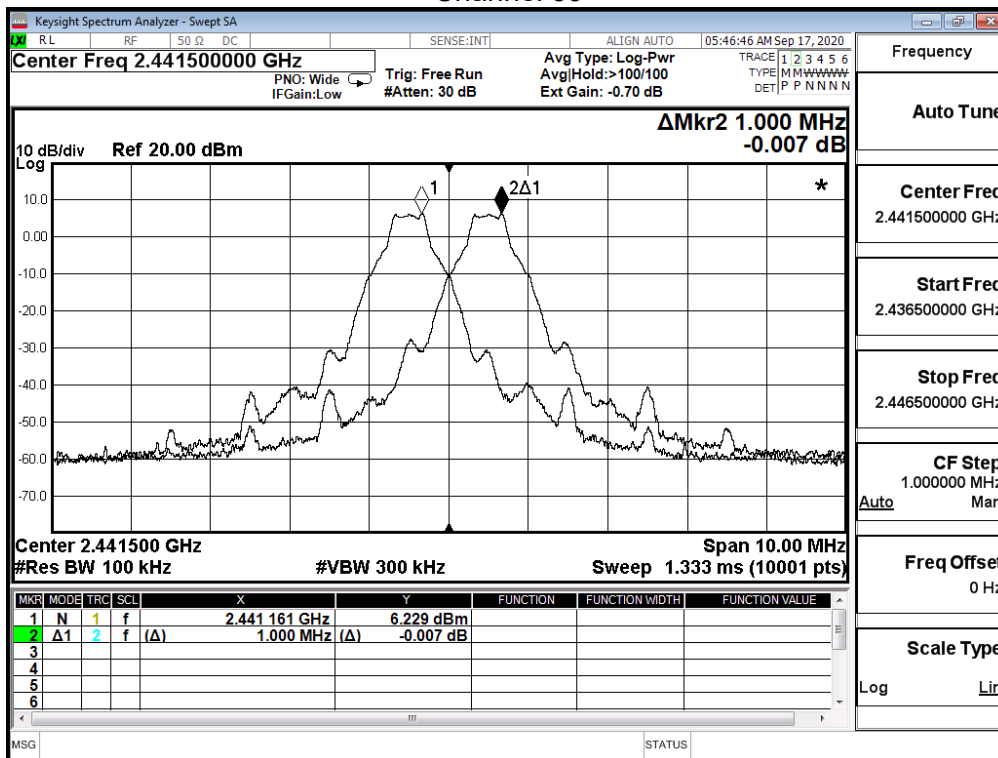

### Channel 78

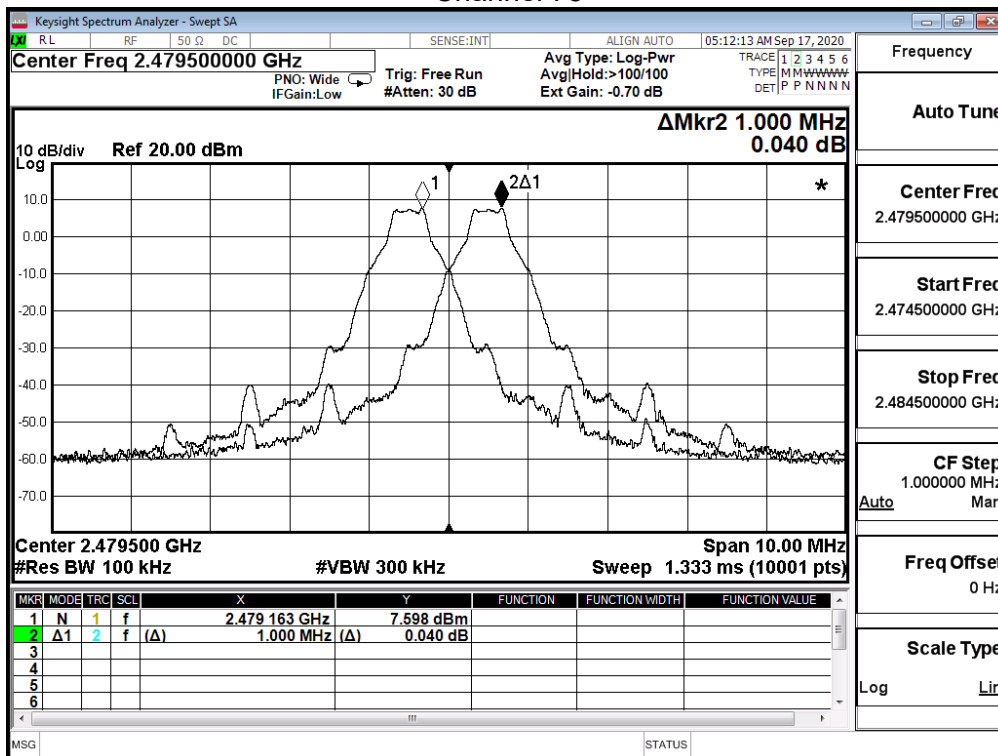

Product	Insyde		
Test Item	Carrier Frequency Separation		
Test Mode	Mode 1: Transmit mode_ PIFA Ant		
Date of Test	2020/09/17	Test Site	SR12-H
Temperature(°C)	22	Humidity (%RH)	55

8-DPSK

Channel No.	Frequency (MHz)	Measure Level (MHz)	Limit (MHz)
00	2402	1.000	≥ 0.807
39	2441	1.000	≥ 0.805
78	2480	1.000	≥ 0.807

Channel 00

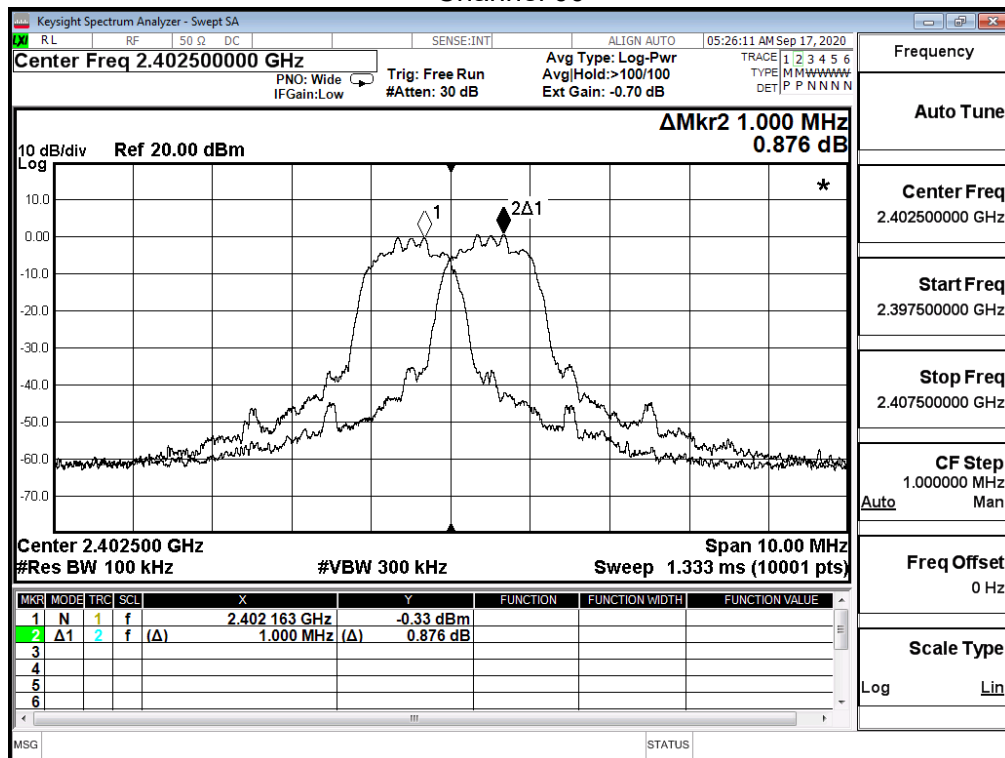

### Channel 39

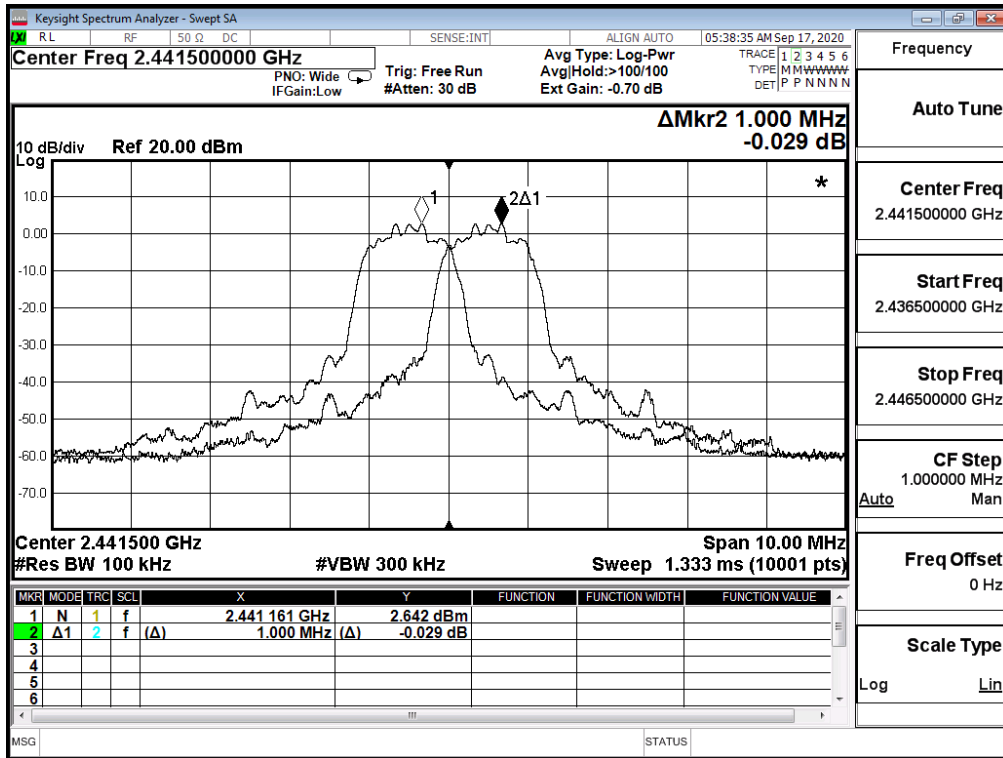

### Channel 78

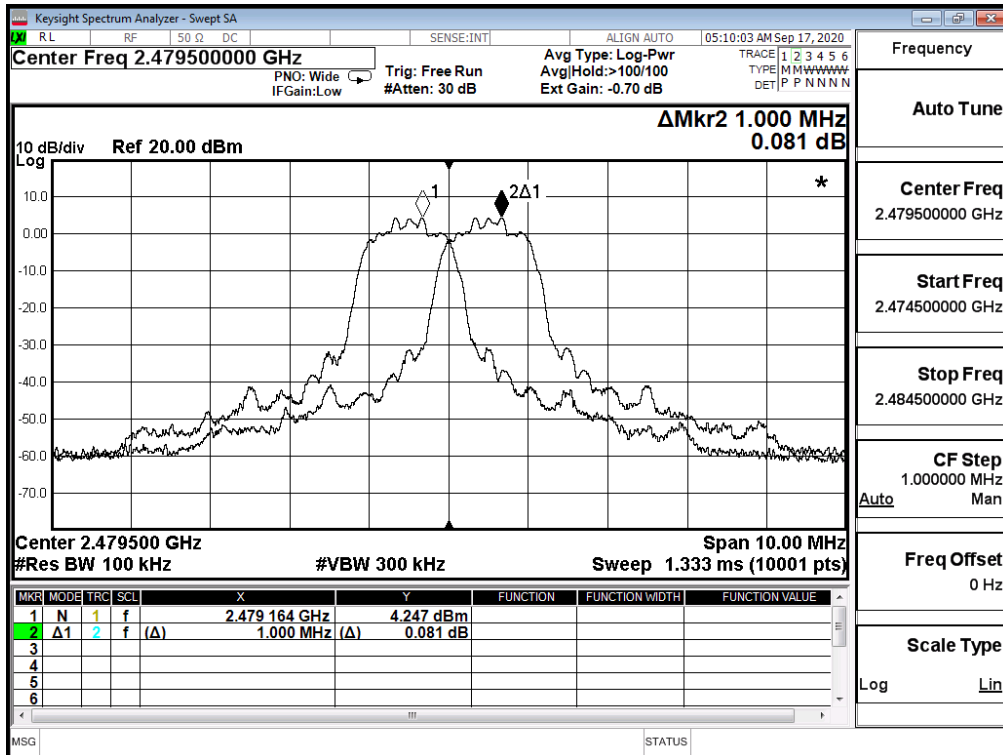

## 9. -20dB Bandwidth

### 9.1. Test Setup

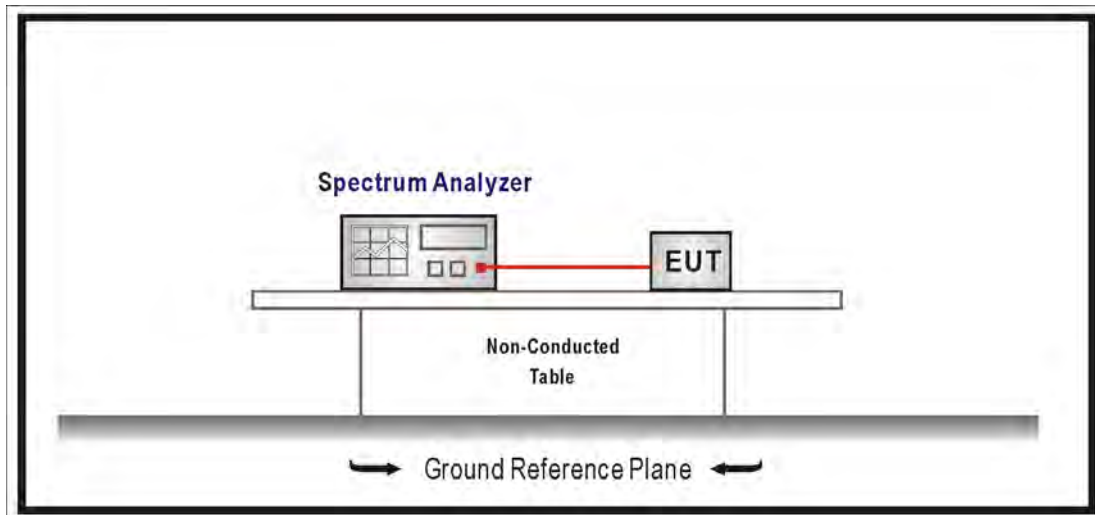

### 9.2. Limits

N/A

### 9.3. Test Procedures

The EUT was setup according to ANSI C63.10: 2013 and tested according to FHSS test procedure of FCC KDB 558074 D01 v05r02 for compliance to FCC 47CFR 15.247 requirements

Use the following spectrum analyzer settings:

Span = approximately 2 to 3 times the 20 dB bandwidth, centered on a hopping channel  
RBW  $\geq$  1% of the 20 dB bandwidth, VBW  $\geq$  RBW, Sweep = auto, Detector function = peak, Trace = max hold, The EUT should be transmitting at its maximum data rate.

### 9.4. Test Specification

According to FCC Part 15 Subpart C Paragraph 15.247: 2019.

### 9.5. Test Result

Product	Insyde		
Test Item	-20dB Bandwidth		
Test Mode	Mode 1: Transmit mode_ PCB Ant		
Date of Test	2021/02/02	Test Site	SR12-H
Temperature(°C)	22	Humidity (%RH)	69

#### GFSK

Channel No.	Frequency (MHz)	Measure Level (MHz)	Limit (MHz)
00	2402	0.940	---
39	2441	0.944	---
78	2480	0.945	---

Channel 00

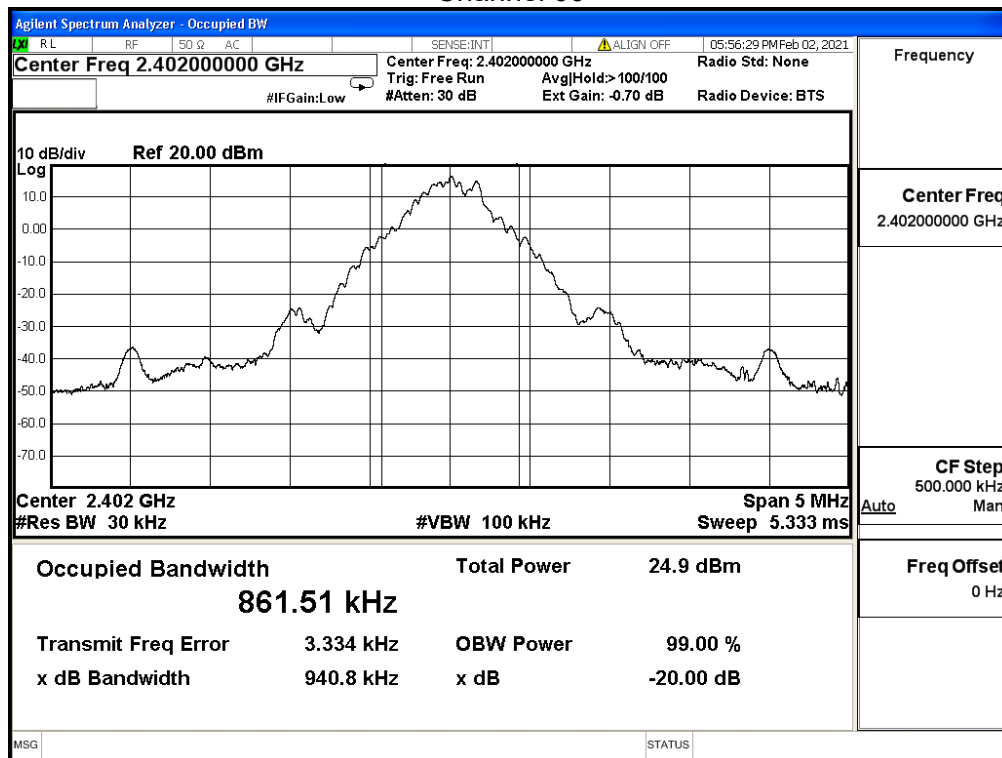

### Channel 39

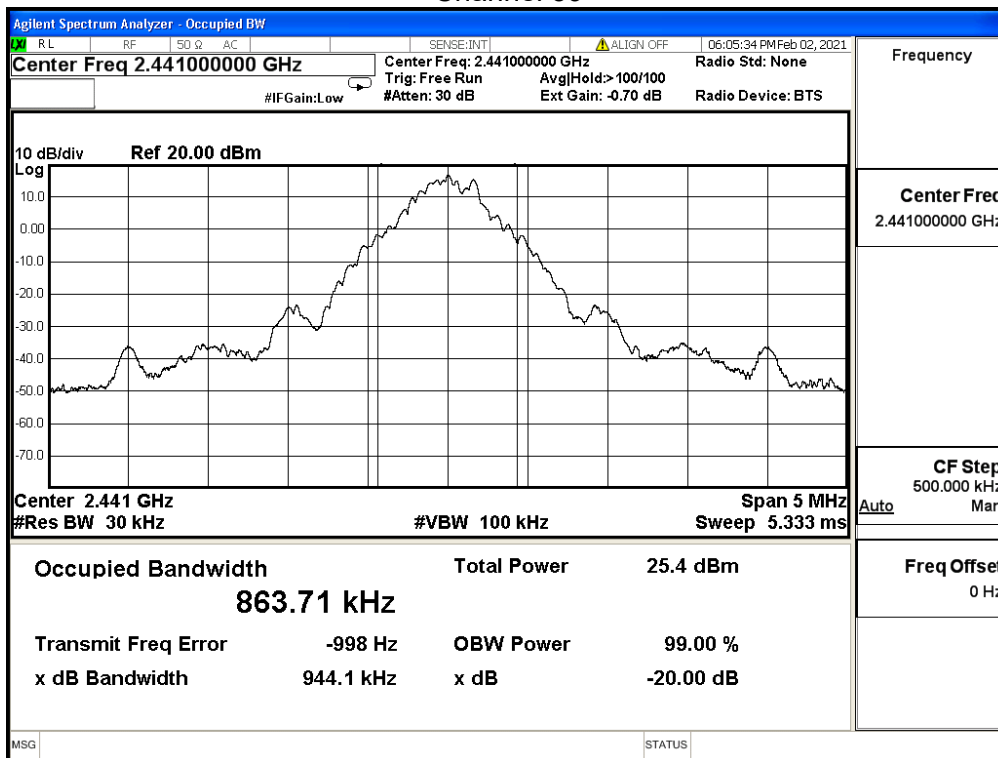

### Channel 78

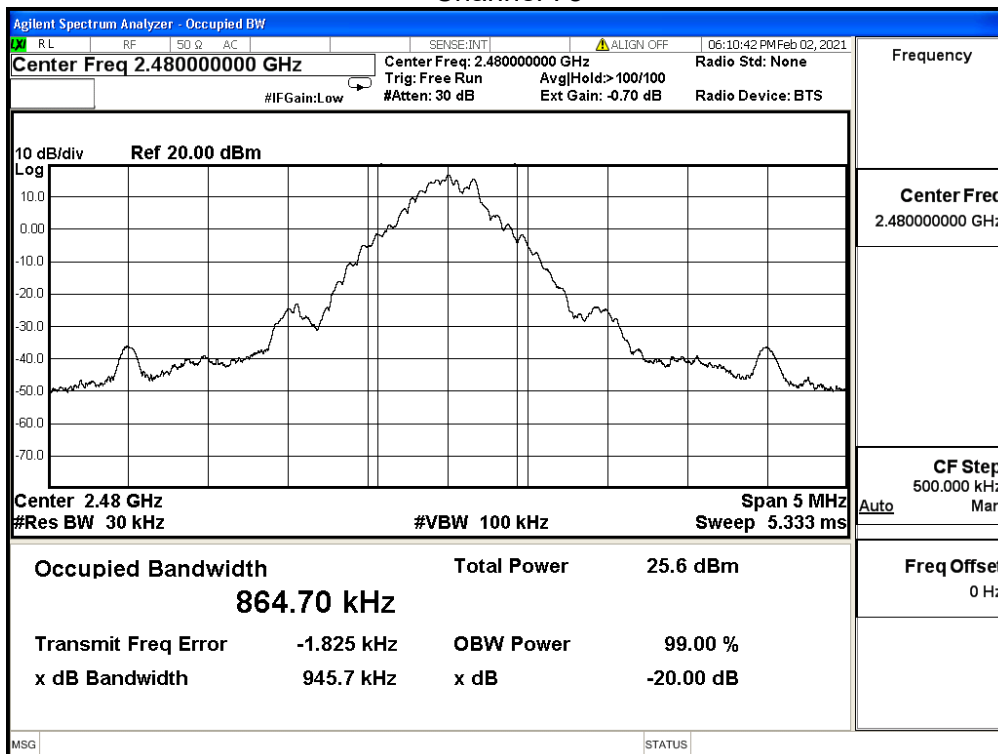

Product	Insyde		
Test Item	-20dB Bandwidth		
Test Mode	Mode 1: Transmit mode_ PCB Ant		
Date of Test	2021/02/02	Test Site	SR12-H
Temperature(°C)	22	Humidity (%RH)	69

8-DPSK

Channel No.	Frequency (MHz)	Measure Level (MHz)	Limit (MHz)
00	2402	1.259	---
39	2441	1.255	---
78	2480	1.256	---

Channel 00

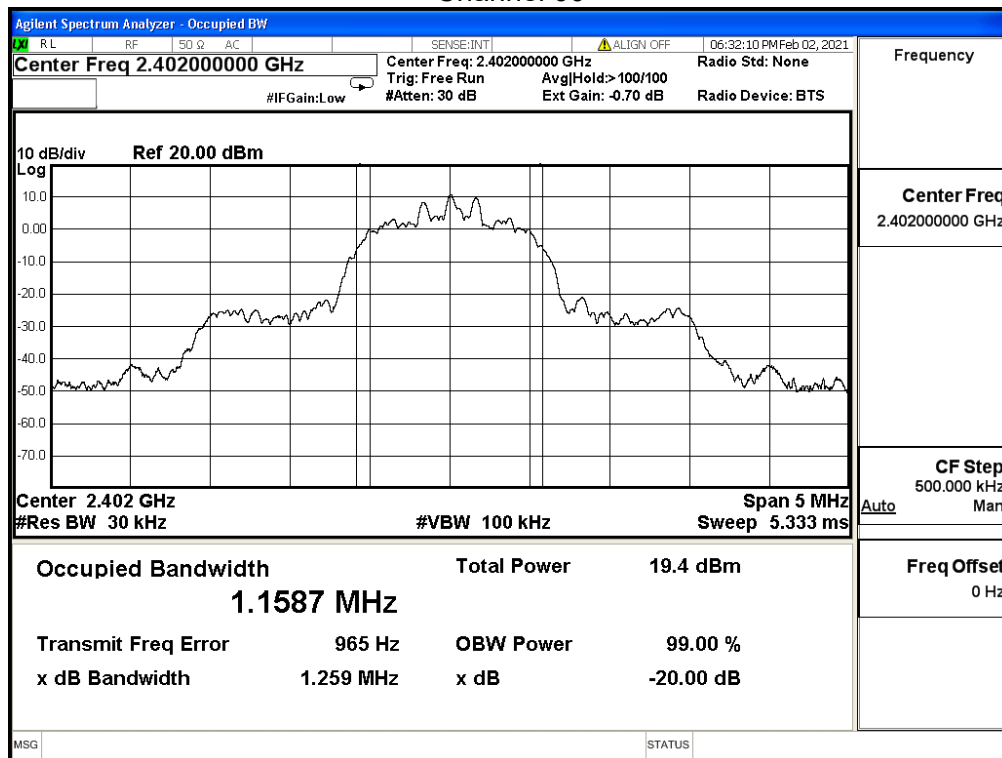

Channel 39

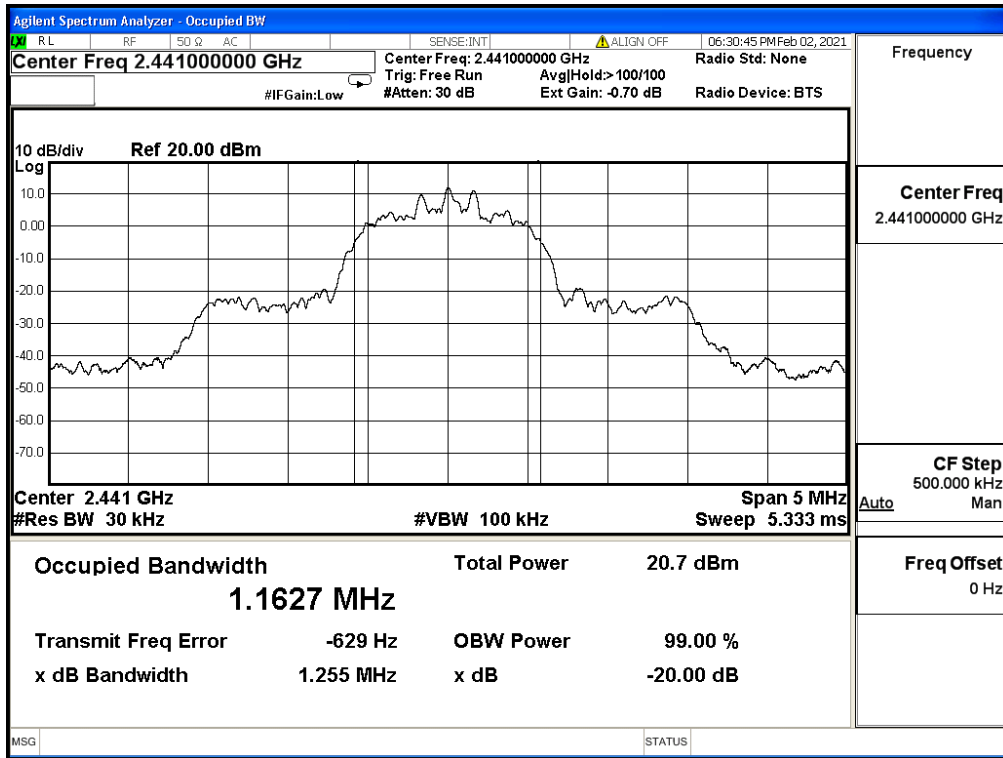

Channel 78

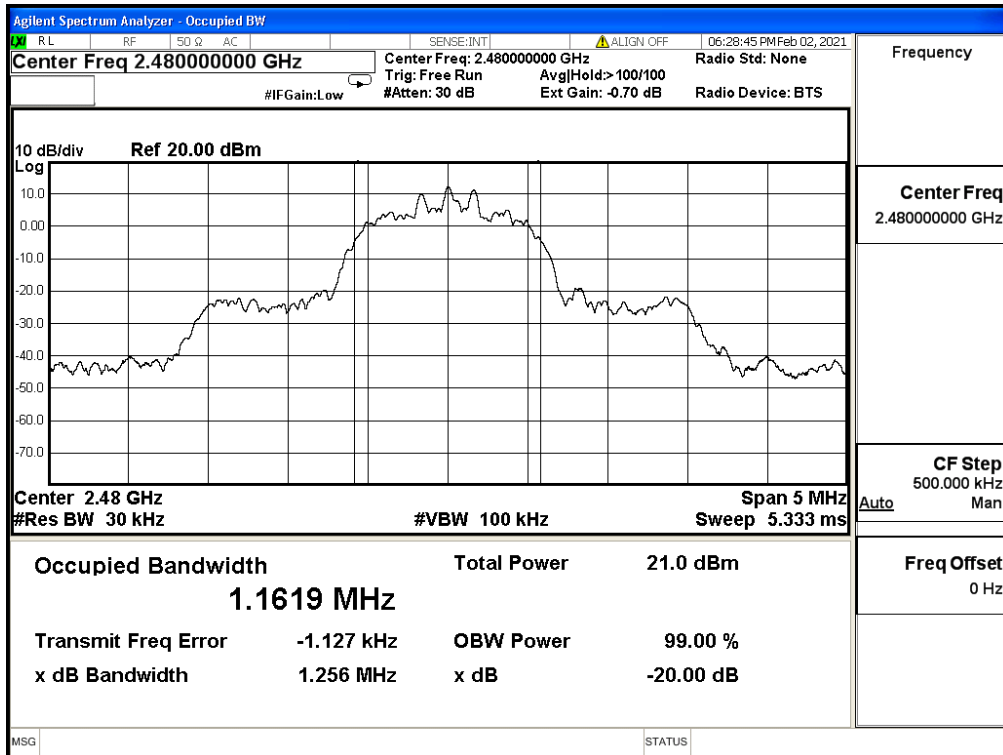



Product	Insyde		
Test Item	-20dB Bandwidth		
Test Mode	Mode 1: Transmit mode_ PIFA Ant		
Date of Test	2021/02/02	Test Site	SR12-H
Temperature(°C)	22	Humidity (%RH)	69

GFSK

Channel No.	Frequency (MHz)	Measure Level (MHz)	Limit (MHz)
00	2402	0.942	---
39	2441	0.949	---
78	2480	0.947	---

Channel 00

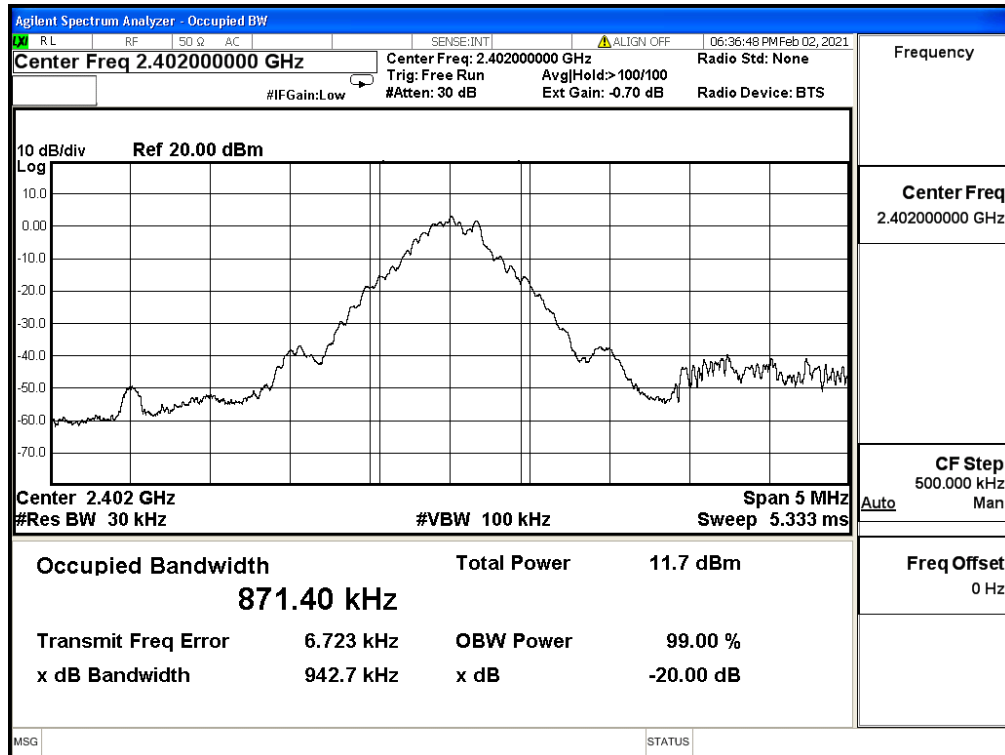

### Channel 39

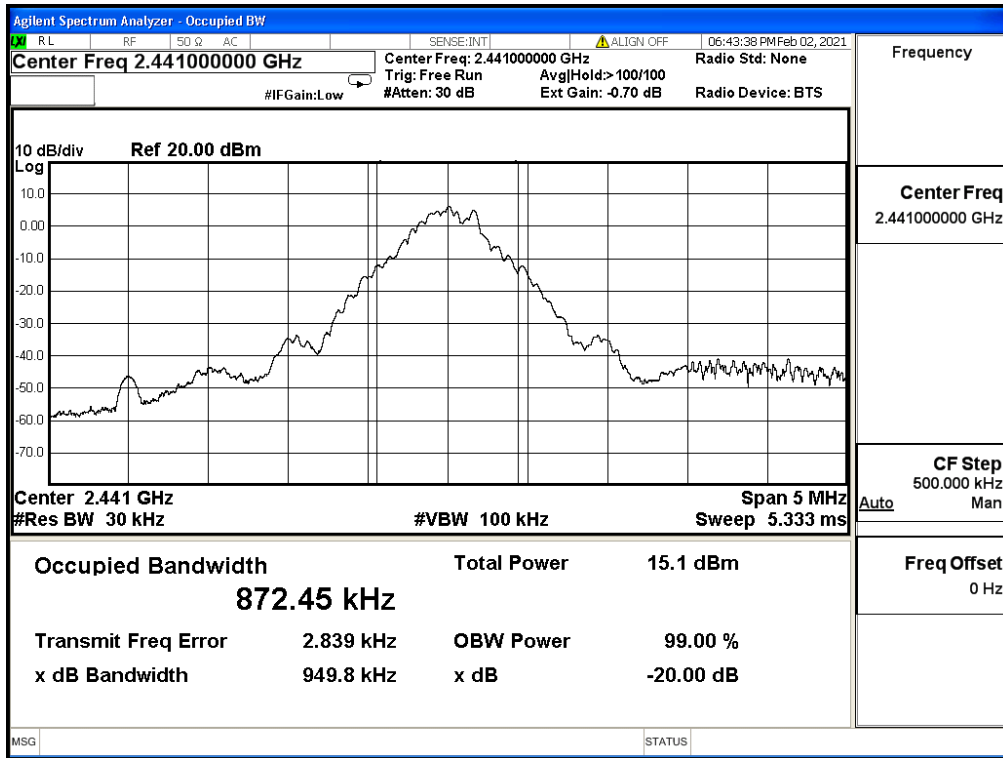

### Channel 78

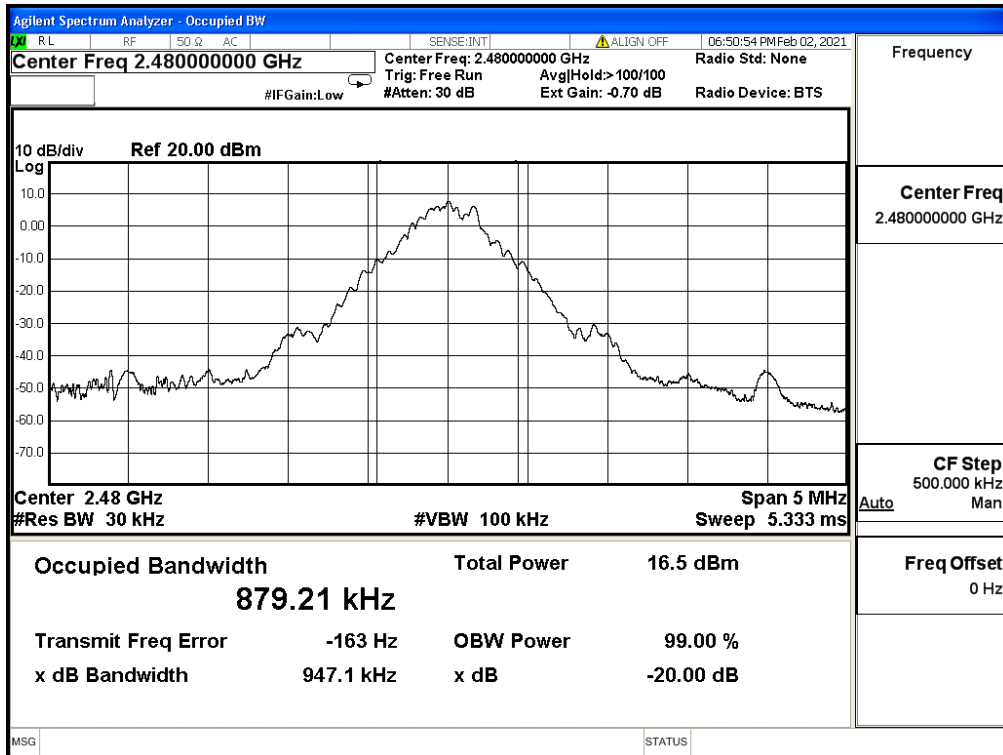

Product	Insyde		
Test Item	-20dB Bandwidth		
Test Mode	Mode 1: Transmit mode_ PIFA Ant		
Date of Test	2021/02/02	Test Site	SR12-H
Temperature(°C)	22	Humidity (%RH)	69

8-DPSK

Channel No.	Frequency (MHz)	Measure Level (MHz)	Limit (MHz)
00	2402	1.272	---
39	2441	1.270	---
78	2480	1.273	---

Channel 00

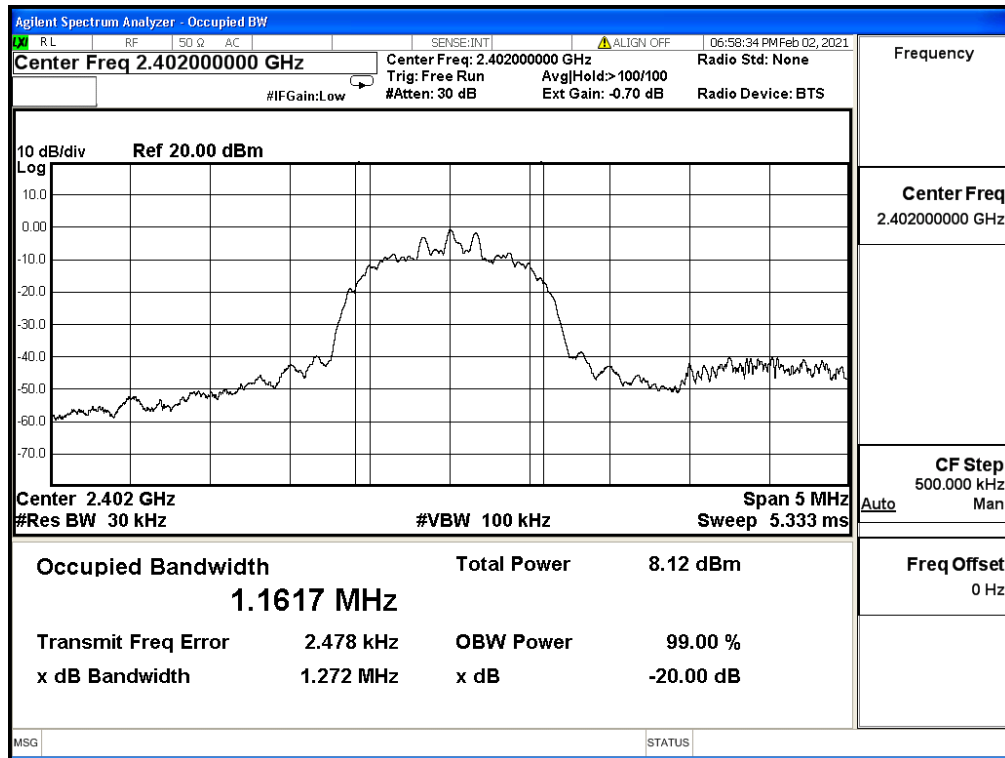

Channel 39

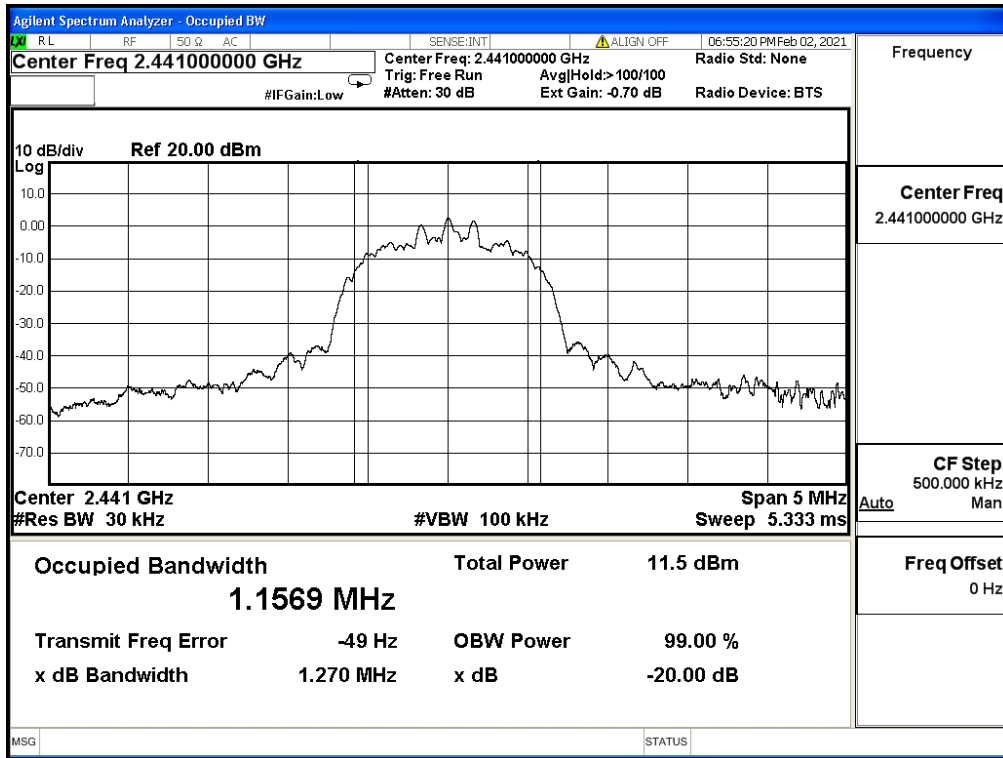

Channel 78

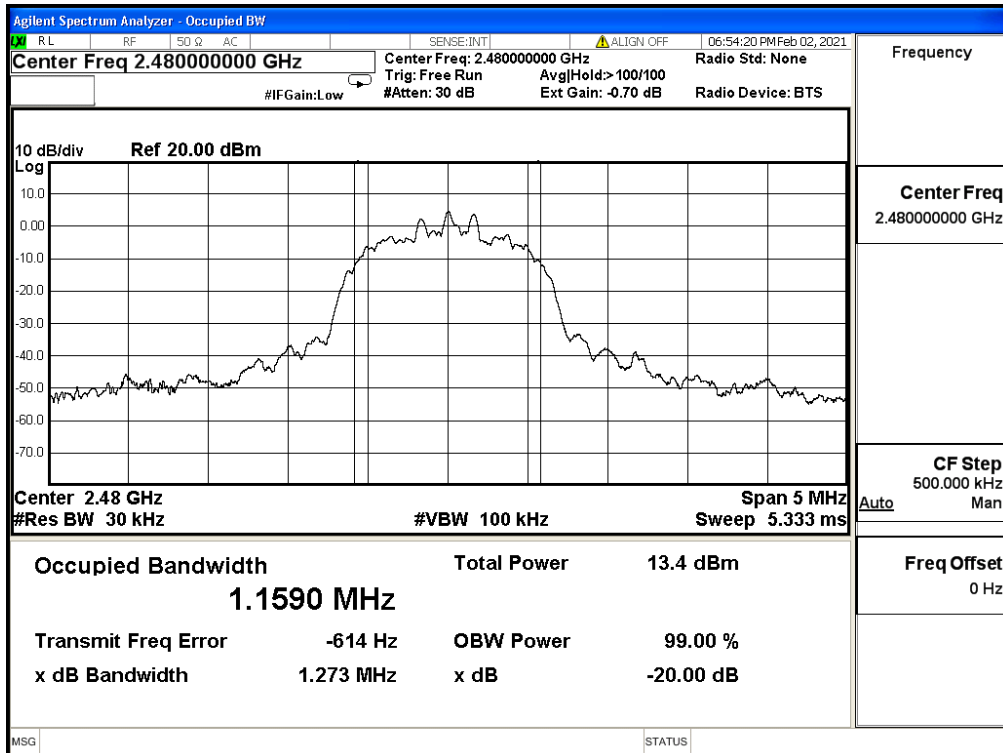

## 10. Dwell Time

### 10.1. Test Setup

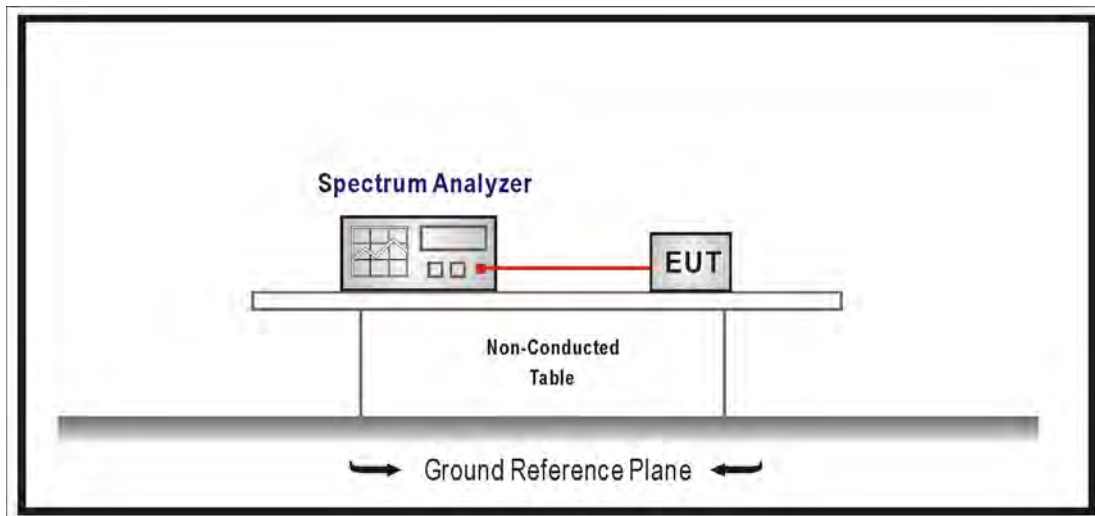

### 10.2. Limits

For frequency hopping systems operating in the 902-928 MHz band: if the 20 dB bandwidth of the hopping channel is less than 250 kHz, the system shall use at least 50 hopping frequencies and the average time of occupancy on any frequency shall not be greater than 0.4 seconds within a 20 second period; if the 20 dB bandwidth of the hopping channel is 250 kHz or greater, the system shall use at least 25 hopping frequencies and the average time of occupancy on any frequency shall not be greater than 0.4 seconds within a 10 second period.

For frequency hopping systems operating in the 2400-2483.5 MHz bands. The average time of occupancy on any channel shall not be greater than 0.4 seconds within a period of 0.4 seconds multiplied by the number of hopping channels employed.

For frequency hopping systems operating in the 5725-5850 MHz bands. The average time of occupancy on any frequency shall not be greater than 0.4 seconds within a 30 second period.

---

### **10.3. Test Procedures**

The EUT was setup according to ANSI C63.10: 2013 and tested according to FHSS test procedure of FCC KDB 558074 D01 v05r02 for compliance to FCC 47CFR 15.247 requirements

Span = zero span, centered on a hopping channel, RBW = 1 MHz, VBW  $\geq$  RBW,

Sweep = as necessary to capture the entire dwell time per hopping channel,

Detector function = peak, Trace = max hold.

### **10.4. Test Specification**

According to FCC Part 15 Subpart C Paragraph 15.247: 2019

### 10.5. Test Result

Product	Insyde		
Test Item	Dwell Time		
Test Mode	Mode 1: Transmit mode_ PCB Ant		
Date of Test	2020/10/27	Test Site	SR12-H
Temperature(°C)	24	Humidity (%RH)	62

GFSK

Occupancy Time of Frequency Hopping System

A) 2402MHz Test Time Period:  $0.4 \times 79 = 31.60 \text{ sec}$  , Time slot length : 2.889 ms = 0.002889 sec

Dwell Time :  $0.002889 \times (266.67/79) \times 31.60 = 0.3082$  sec ◦

B) 2441MHz Test Time Period:  $0.4 \times 79 = 31.60 \text{ sec}$  , Time slot length : 2.889 ms = 0.002889 sec

Dwell Time :  $0.002889 \times (266.67/79) \times 31.60 = 0.3082$  sec ◦

C) 2480MHz Test Time Period:  $0.4 \times 79 = 31.60 \text{ sec}$  , Time slot length : 2.889 ms = 0.002889 sec

Dwell Time :  $0.002889 \times (266.67/79) \times 31.60 = 0.3082$  sec ◦

Test Result: The Average Occupancy Time of Each Highest , Middle and Lowest Channel Is Less Than 0.4sec , And Corresponds to The Standard ◦

Hop rate-2402MHz

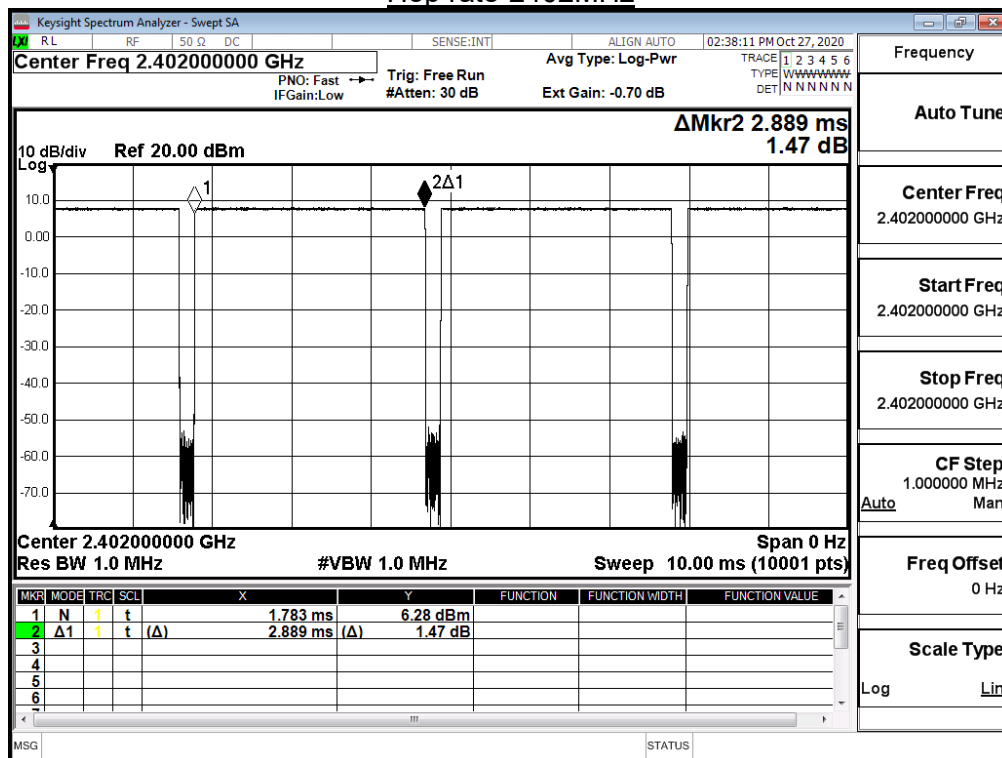

### Hop rate-2441MHz

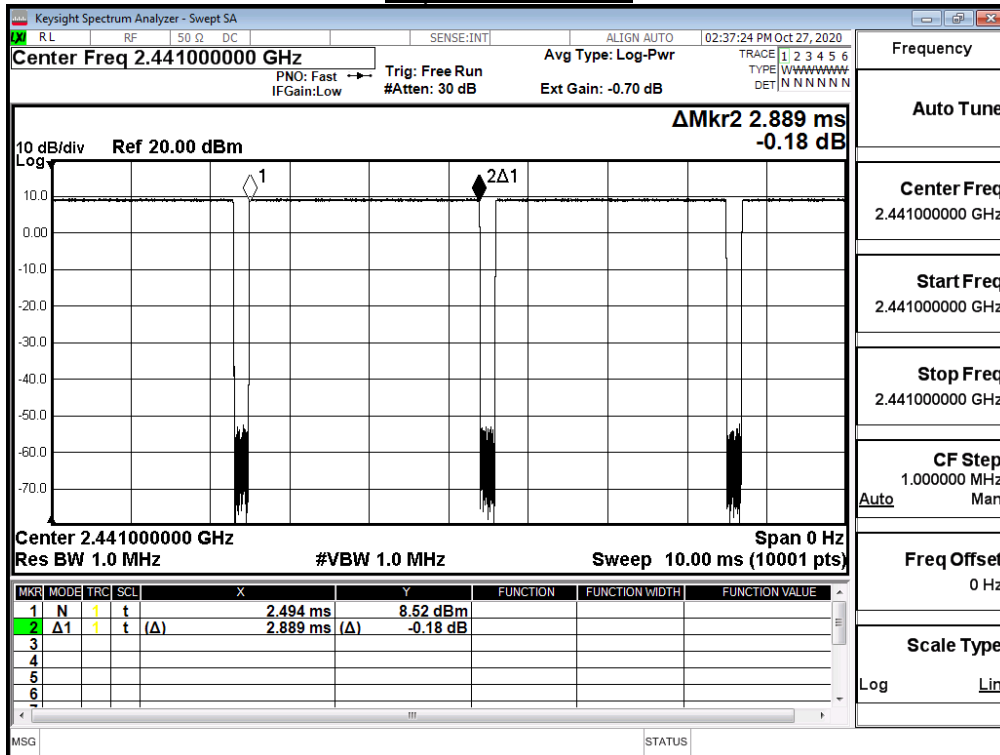

### Hop rate-2480MHz

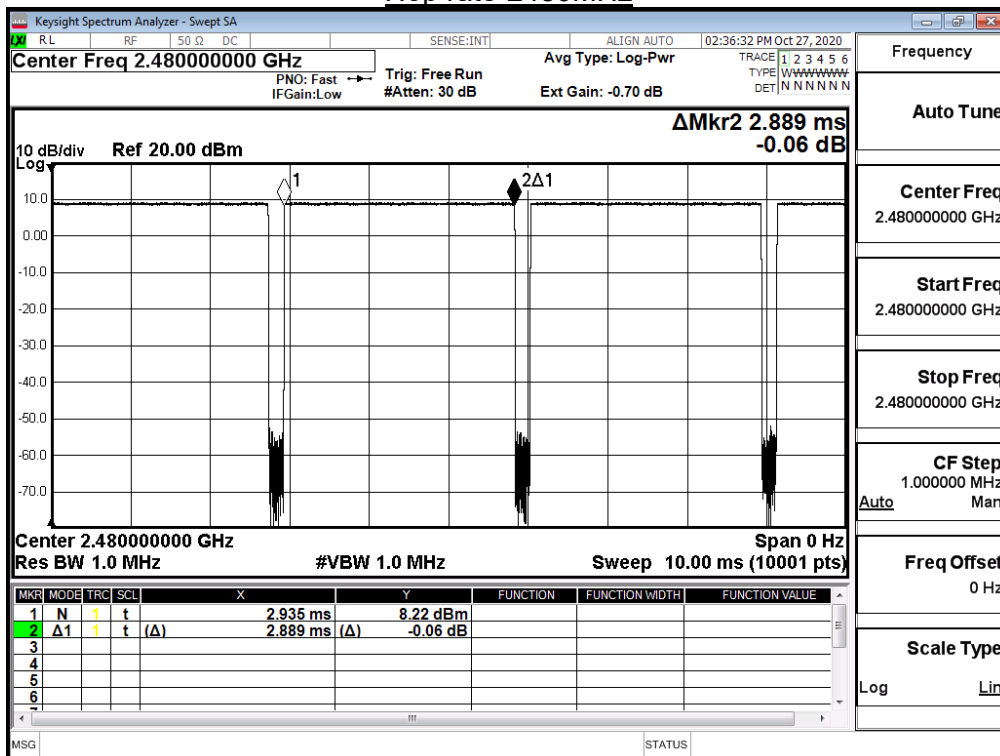

Note: Dwell time = time slot length \* hop rate / number of hopping channels \* period



Product	Insyde		
Test Item	Dwell Time		
Test Mode	Mode 1: Transmit mode_ PCB Ant		
Date of Test	2020/10/27	Test Site	SR12-H
Temperature(°C)	24	Humidity (%RH)	62

8-DPSK

Occupancy Time of Frequency Hopping System

A) 2402MHz Test Time Period:  $0.4 \times 79 = 31.60 \text{ sec}$  , Time slot length : 2.900 ms = 0.002900 sec

Dwell Time :  $0.002900 \times (266.67/79) \times 31.60 = 0.3093$  sec ◦

B) 2441MHz Test Time Period:  $0.4 \times 79 = 31.60 \text{ sec}$  , Time slot length : 2.900 ms = 0.002900 sec

Dwell Time :  $0.002900 \times (266.67/79) \times 31.60 = 0.3093$  sec ◦

C) 2480MHz Test Time Period:  $0.4 \times 79 = 31.60 \text{ sec}$  , Time slot length : 2.900 ms = 0.002900 sec

Dwell Time :  $0.002900 \times (266.67/79) \times 31.60 = 0.3093$  sec ◦

Test Result: The Average Occupancy Time of Each Highest , Middle and Lowest Channel Is Less Than 0.4sec , And Corresponds to The Standard ◦

Hop rate-2402MHz

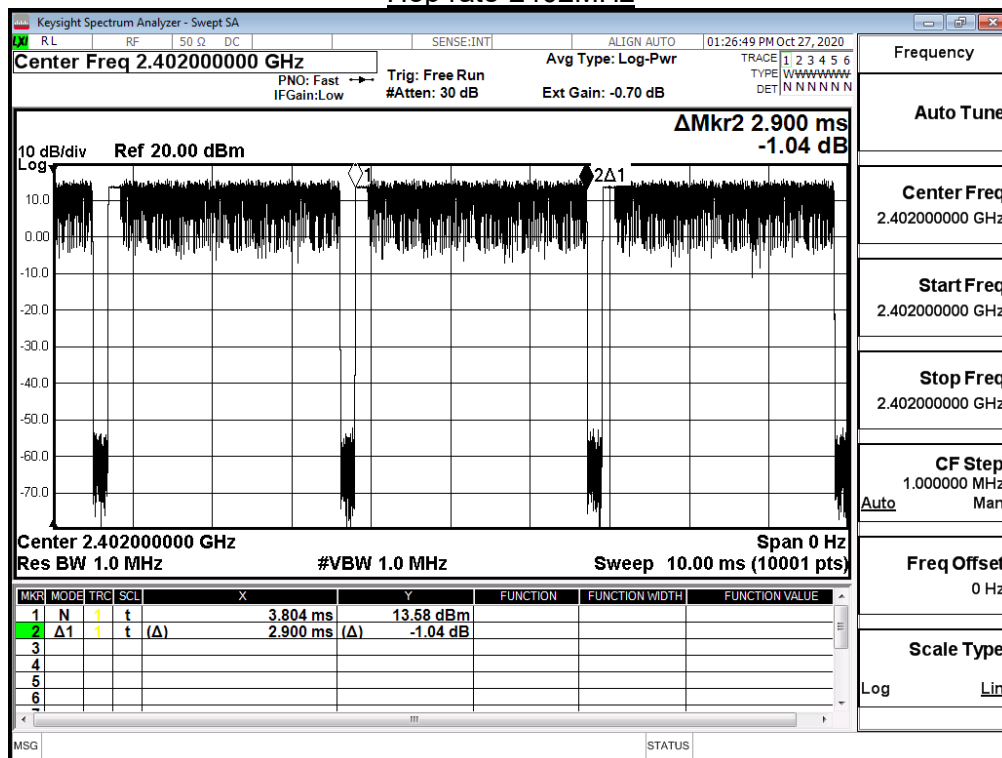

### Hop rate-2441MHz

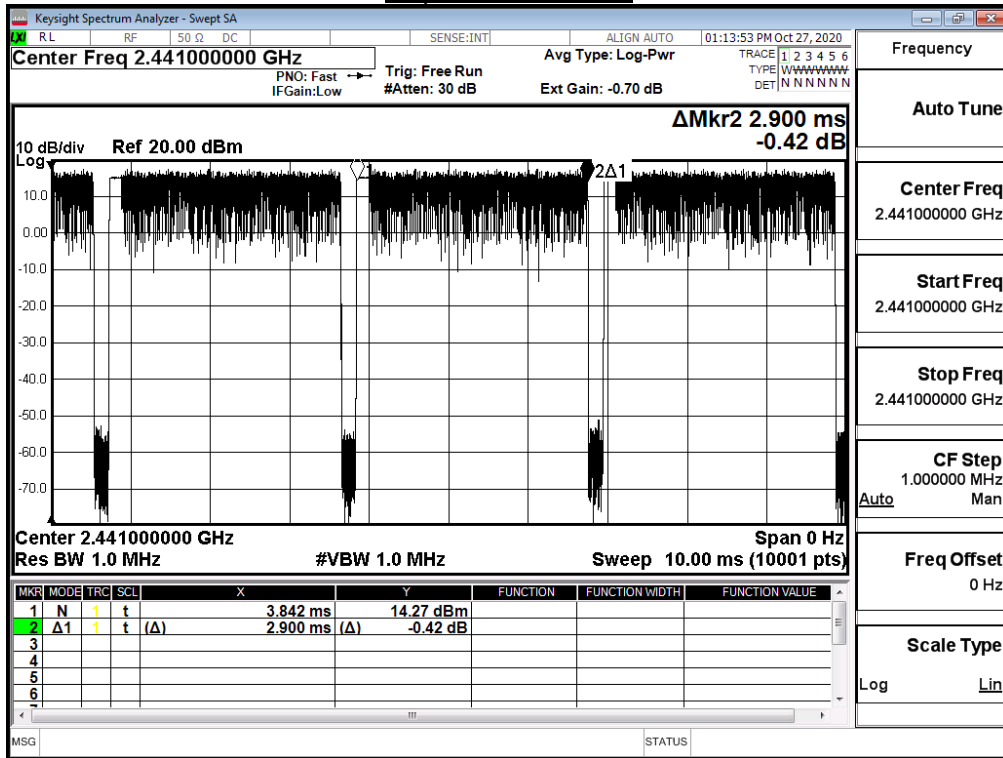

### Hop rate-2480MHz

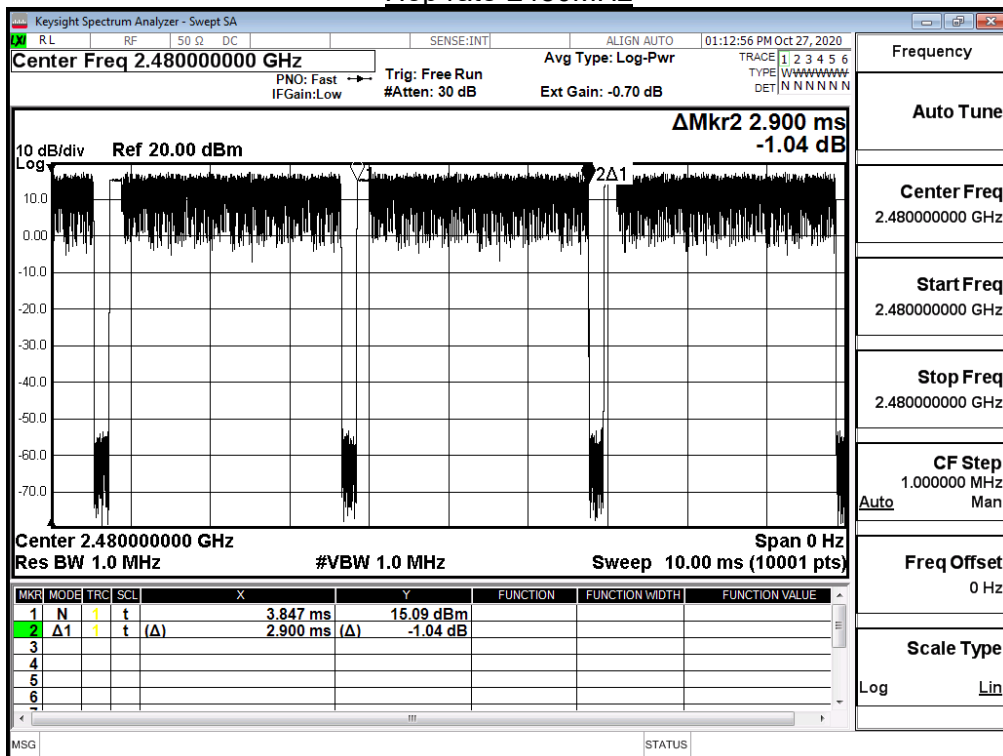

Note: Dwell time = time slot length \* hop rate / number of hopping channels \* period

Product	Insyde		
Test Item	Dwell Time		
Test Mode	Mode 1: Transmit mode_ PIFA Ant		
Date of Test	2020/09/17	Test Site	SR12-H
Temperature(°C)	22	Humidity (%RH)	55

GFSK

Occupancy Time of Frequency Hopping System

A) 2402MHz Test Time Period:  $0.4 \times 79 = 31.60 \text{ sec}$  , Time slot length : 2.889 ms = 0.002889 sec

Dwell Time :  $0.002889 \times (266.67/79) \times 31.60 = 0.3082$  sec ◦

B) 2441MHz Test Time Period:  $0.4 \times 79 = 31.60 \text{ sec}$  , Time slot length : 2.890 ms = 0.002890 sec

Dwell Time :  $0.002890 \times (266.67/79) \times 31.60 = 0.3083$  sec ◦

C) 2480MHz Test Time Period:  $0.4 \times 79 = 31.60 \text{ sec}$  , Time slot length : 2.890 ms = 0.002890 sec

Dwell Time :  $0.002890 \times (266.67/79) \times 31.60 = 0.3083$  sec ◦

Test Result: The Average Occupancy Time of Each Highest , Middle and Lowest Channel Is Less Than 0.4sec , And Corresponds to The Standard ◦

Hop rate-2402MHz

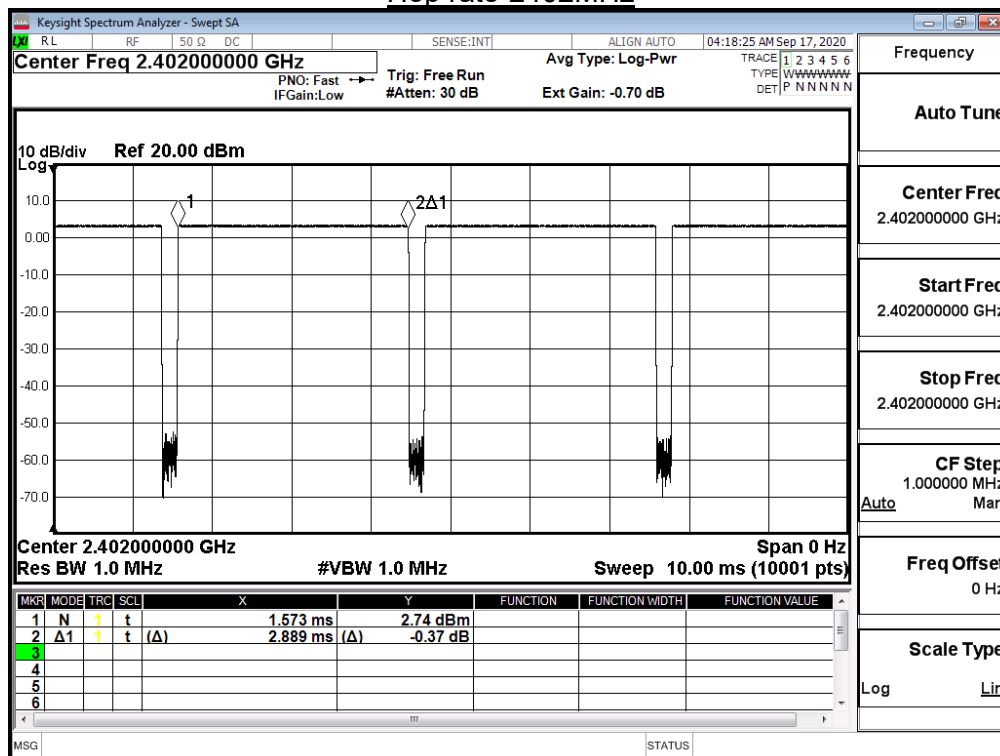

### Hop rate-2441MHz

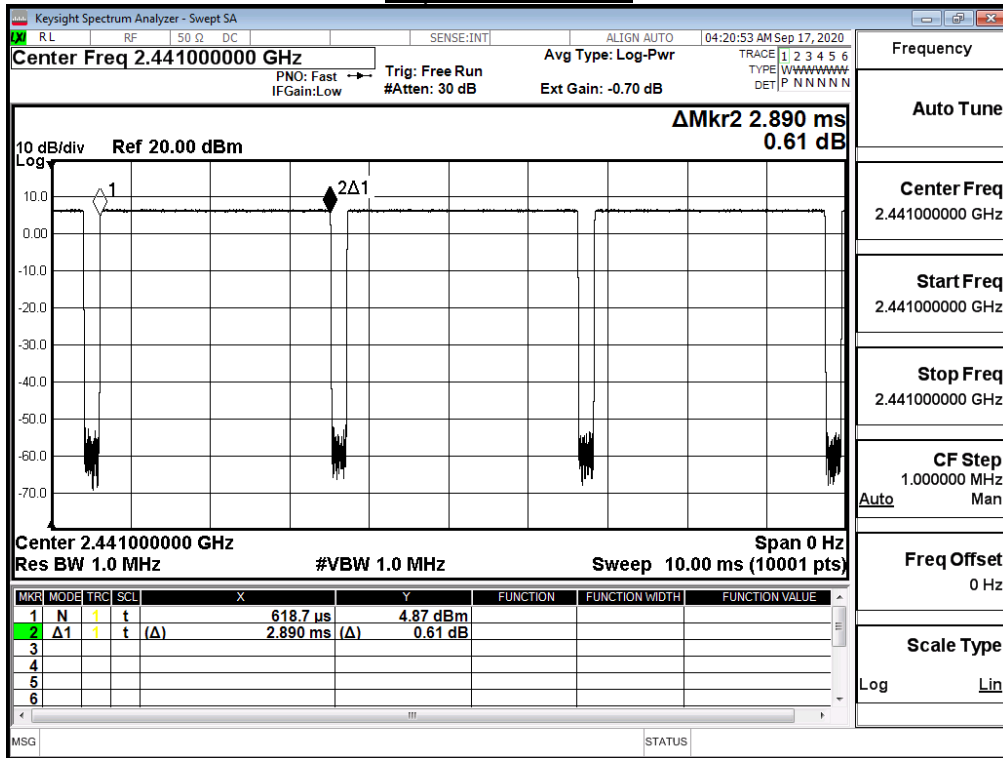

### Hop rate-2480MHz

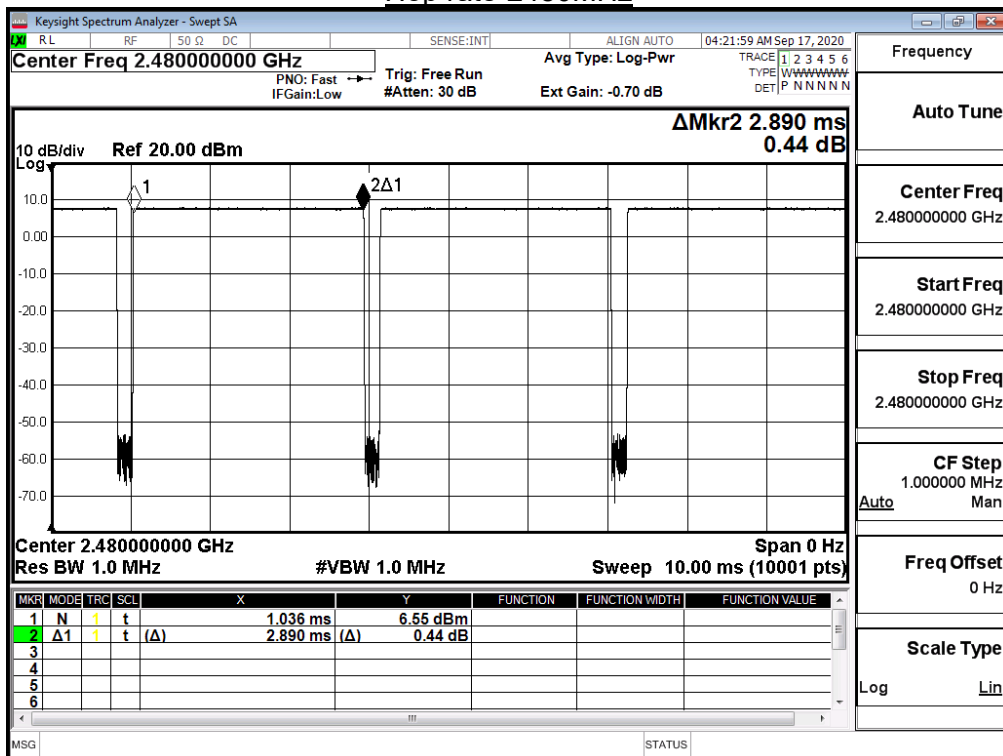

Note: Dwell time = time slot length \* hop rate / number of hopping channels \* period

Product	Insyde		
Test Item	Dwell Time		
Test Mode	Mode 1: Transmit mode_ PIFA Ant		
Date of Test	2020/09/17	Test Site	SR12-H
Temperature(°C)	22	Humidity (%RH)	55

8-DPSK

Occupancy Time of Frequency Hopping System

A) 2402MHz Test Time Period:  $0.4 \times 79 = 31.60 \text{sec}$  , Time slot length : 2.891 ms = 0.002891 sec

Dwell Time :  $0.002891 \times (266.67/79) \times 31.60 = 0.3084$  sec ◦

B) 2441MHz Test Time Period:  $0.4 \times 79 = 31.60 \text{sec}$  , Time slot length : 2.891 ms = 0.002891 sec

Dwell Time :  $0.002891 \times (266.67/79) \times 31.60 = 0.3084$  sec ◦

C) 2480MHz Test Time Period:  $0.4 \times 79 = 31.60 \text{sec}$  , Time slot length : 2.891 ms = 0.002891 sec

Dwell Time :  $0.002891 \times (266.67/79) \times 31.60 = 0.3084$  sec ◦

Test Result: The Average Occupancy Time of Each Highest , Middle and Lowest Channel Is Less Than 0.4sec , And Corresponds to The Standard ◦

Hop rate-2402MHz

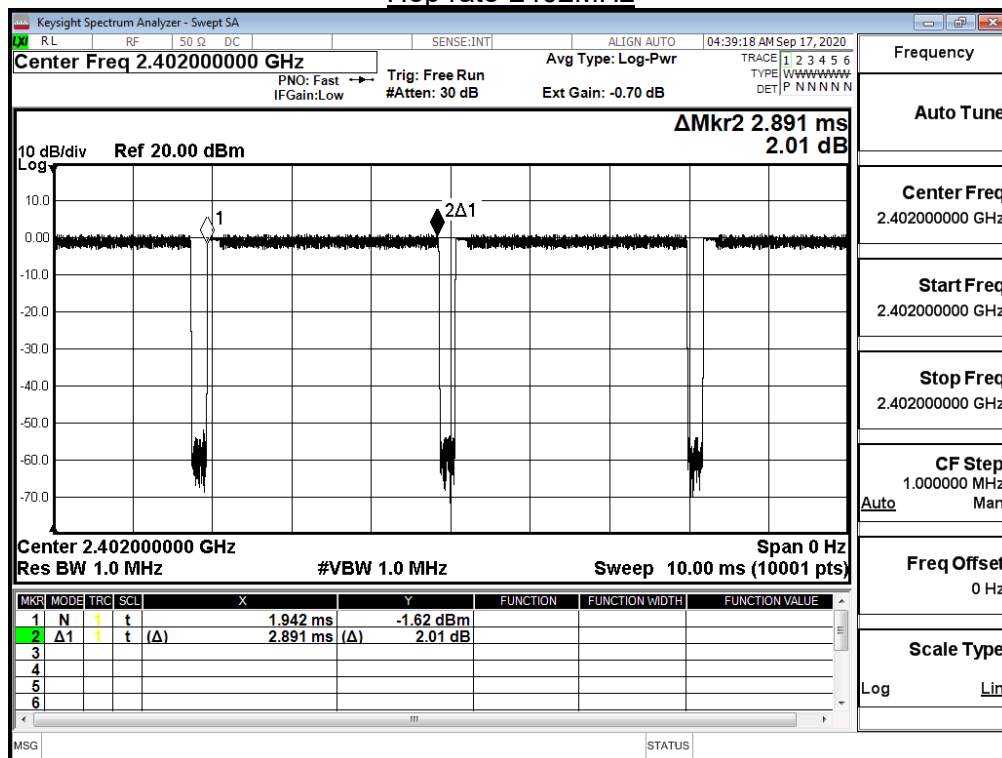

### Hop rate-2441MHz

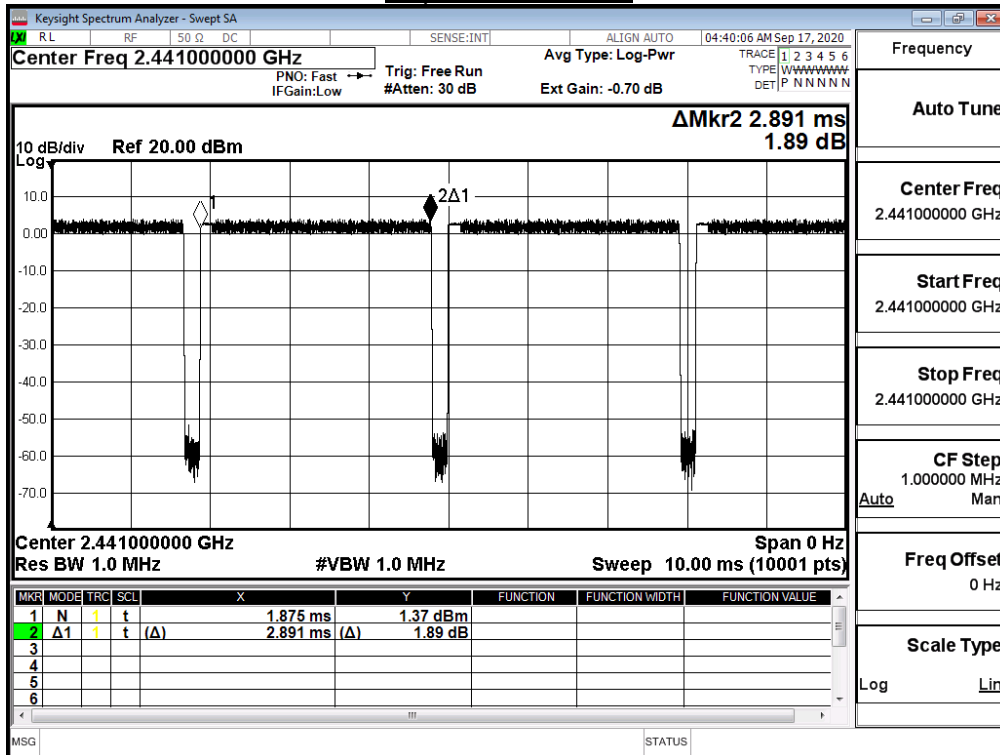

### Hop rate-2480MHz

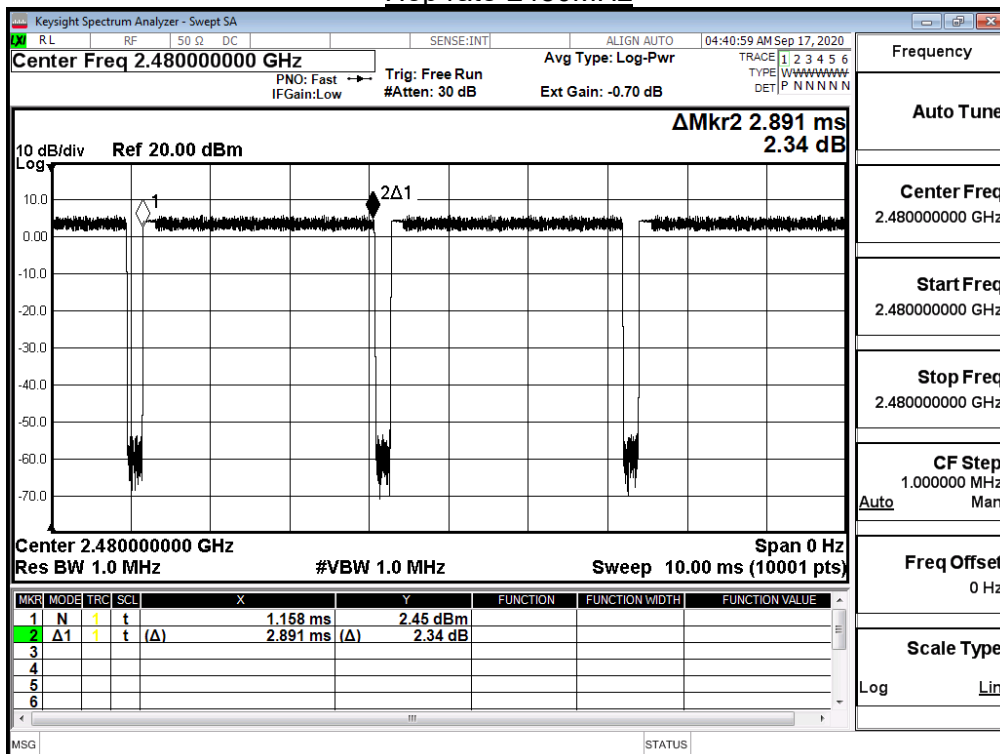

Note: Dwell time = time slot length \* hop rate / number of hopping channels \* period