

FCC Test Report

Product Name : Insyde
Trade Name : Cardo
Model No. : Insyde
FCC ID : Q95ER27

Applicant : Cardo Systems, LTD
Address : 101 E. Park Blvd., Suite 600, Plano TX, 75074, USA

Date of Receipt : Aug. 25, 2020
Issued Date : Feb. 04, 2021
Report No. : 2080779R-E3032110108-A
Report Version : V1.0



The test results relate only to the samples tested.

The test report shall not be reproduced except in full without the written approval of DEKRA Testing and Certification Co., Ltd.

Test Report Certification

Issued Date: Feb. 04, 2021

Report No. : 2080779R-E3032110108-A



Product Name : Insyde
Applicant : Cardo Systems, LTD
Address : 101 E. Park Blvd., Suite 600, Plano TX, 75074, USA
Manufacturer : Cardo Systems, LTD
Address : 101 E. Park Blvd., Suite 600, Plano TX, 75074, USA
Trade Name : Cardo
Model No. : Insyde
FCC ID : Q95ER27
EUT Voltage : DC 5V (Power by USB)
DC 3.7V (Power by Battery)
Testing Voltage : AC 120V/60Hz
Applicable Standard : FCC CFR Title 47 Part 15 Subpart C Section 15.247: 2019
ANSI C63.10: 2013
Laboratory Name : Hsin Chu Laboratory
Address : No.372-2, Sec. 4, Zhongxing Rd., Zhudong Township, Hsinchu
County 310, Taiwan, R.O.C.
TEL: +886-3-582-8001 / FAX: +886-3-582-8958
Test Result : Complied

Documented By : 

(Demi Chang / Senior Engineering Adm. Specialist)

Tested By : 

(Lion Wang / Senior Engineer)

Approved By : 

(Louis Hsu / Deputy Manager)

Revision History

Version	Description	Issued Date
V1.0	Initial issue of report	Feb. 04, 2021

TABLE OF CONTENTS

Description	Page
1. General Information.....	6
1.1. EUT Description	6
1.2. Test Mode	7
1.3. Tested System Details	8
1.4. Configuration of tested System	8
1.5. EUT Exercise Software	8
1.6. Comments and Remarks.....	8
1.7. Test Facility.....	9
1.8. List of Test Equipment	11
1.9. Duty cycle	13
1.10. Uncertainty	14
2. Conducted Emission	15
2.1. Test Setup.....	15
2.2. Limits	15
2.3. Test Procedure	16
2.4. Test Specification.....	16
2.5. Test Result.....	17
3. Maximum peak conducted output power.....	19
3.1. Test Setup.....	19
3.2. Limits	19
3.3. Test procedures.....	19
3.4. Test Specification.....	19
3.5. Test Result.....	20
4. Radiated Emission	21
4.1. Test Setup.....	21
4.2. Limits	22
4.3. Test Procedure	23
4.4. Test Specification.....	23
4.5. Test Result.....	24
5. RF antenna conducted test	32
5.1. Test Setup.....	32
5.2. Limits	32
5.3. Test Procedure	32
5.4. Test Specification.....	32
5.5. Test Result.....	33
6. Bandedge	37
6.1. Test Setup.....	37
6.2. Limits	37
6.3. Test Procedure	37
6.4. Test Specification.....	37
6.5. Test Result.....	38
7. Occupied Bandwidth & DTS Bandwidth	40

7.1.	Test Setup.....	40
7.2.	Test Procedures.....	40
7.3.	Limits	40
7.4.	Test Specification.....	40
7.5.	Test Result.....	41
8.	Power Density	45
8.1.	Test Setup.....	45
8.2.	Limits	45
8.3.	Test Procedures.....	45
8.4.	Test Specification.....	45
8.5.	Test Result.....	46
	Attachment 1	48
	Test Setup Photograph	48
	Attachment 2	51
	EUT External Photograph.....	51
	Attachment 3	56
	EUT Internal Photograph.....	56

1. General Information

1.1. EUT Description

Product Name	Insyde
Trade Name	Cardo
Model No.	Insyde
Frequency Range	2402~2480MHz
Channel Number	40 Channels
Type of Modulation	GFSK

Antenna Information				
No.	Brand	Model No.	Antenna Type	Antenna Gain
0	RALTRON	RCA-5220-A0-TR	PIFA Antenna	2.66 dBi

Accessories Information	
Microphone	1pcs, Non-Shielded, 0.2m
Headphone	1pcs, Non-Shielded, 0.55m
USB Cable	Shielded, 0.5 m

Working Frequency of Each Channel							
Channel	Frequency	Channel	Frequency	Channel	Frequency	Channel	Frequency
Channel 00	2402 MHz	Channel 10	2422 MHz	Channel 20	2442 MHz	Channel 30	2462 MHz
Channel 01	2404 MHz	Channel 11	2424 MHz	Channel 21	2444 MHz	Channel 31	2464 MHz
Channel 02	2406 MHz	Channel 12	2426 MHz	Channel 22	2446 MHz	Channel 32	2466 MHz
Channel 03	2408 MHz	Channel 13	2428 MHz	Channel 23	2448 MHz	Channel 33	2468 MHz
Channel 04	2410 MHz	Channel 14	2430 MHz	Channel 24	2450 MHz	Channel 34	2470 MHz
Channel 05	2412 MHz	Channel 15	2432 MHz	Channel 25	2452 MHz	Channel 35	2472 MHz
Channel 06	2414 MHz	Channel 16	2434 MHz	Channel 26	2454 MHz	Channel 36	2474 MHz
Channel 07	2416MHz	Channel 17	2436 MHz	Channel 27	2456 MHz	Channel 37	2476 MHz
Channel 08	2418 MHz	Channel 18	2438 MHz	Channel 28	2458 MHz	Channel 38	2478 MHz
Channel 09	2420 MHz	Channel 19	2440 MHz	Channel 29	2460 MHz	Channel 39	2480 MHz

Note:

1. This device is a Insyde including Zigbee, BT2.0 and BT BLE transmitting functions.
2. Regards to the frequency band operation; the lowest 、 middle and highest frequency of channel were selected to perform the test, and then shown on this report.
3. The spurious emission was measured in three position (X, Y & Z axis), and the worst case (X axis) was recorded in the report.
4. The EUT description is from the customer declaration.

1.2. Test Mode

DEKRA has verified the construction and function in typical operation. All the test modes were carried out with the EUT in transmitting operation, which was shown in this test report and defined as follows:

Test Mode	Mode 1: Transmit Mode
-----------	-----------------------

Test Items	Modulation	Channel	Result
Conducted Emission	GFSK	00	Complies
Maximum peak conducted	GFSK	00/19/39	Complies
Radiated Emission	GFSK	00/19/39	Complies
RF antenna conducted test	GFSK	00/19/39	Complies
Bandedge	GFSK	00/19/39	Complies
Occupied Bandwidth & DTS Bandwidth	GFSK	00/19/39	Complies
Power Density	GFSK	00/19/39	Complies

Note: Determining compliance shall be based on the results of the compliance measurement, not taking into account measurement instrumentation uncertainty.

1.3. Tested System Details

The types for all equipment, plus descriptions of all cables used in the tested system (including inserted cards) are:

Product	Manufacturer	Model No.	Serial No.	FCC ID	Power Cord
1 Notebook PC	Lenovo	Thinkpad	N/A	DoC	Non-Shielded, 1.8m, one ferrite core bonded.

1.4. Configuration of tested System

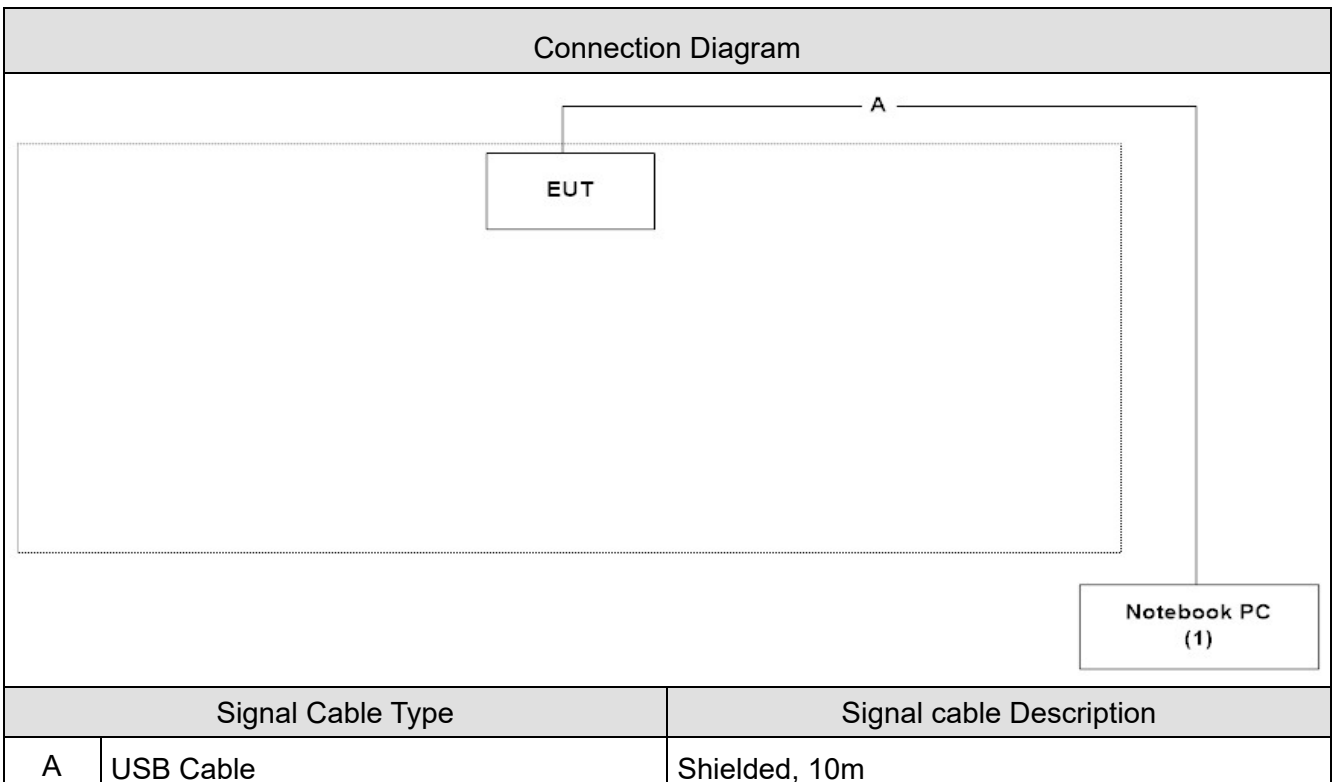

1.5. EUT Exercise Software

1	Set the EUT as shown.
2	Open the control software Bluetest3
3	Configure test mode, test channel and packet.
4	Let the EUT start transmitting signal continuously.
5	Verify that device is working properly

1.6. Comments and Remarks

The product specification and testing instructions for the EUT declared in the report are provided by the manufacturer who will take all responsibilities for the accuracy.

1.7. Test Facility

Ambient conditions in the laboratory:

Items	Test Item	Required	Test Site
Temperature (°C)	FCC PART 15 C 15.207 Conducted Emission	15 - 35	2
Humidity (%RH)		25 - 75	
Temperature (°C)	FCC PART 15 C 15.247 Maximum peak conducted output power	15 - 35	1
Humidity (%RH)		25 - 75	
Temperature (°C)	FCC PART 15 C 15.247 Radiated Emission	15 - 35	1
Humidity (%RH)		25 - 75	
Temperature (°C)	FCC PART 15 C 15.247 RF antenna conducted test	15 - 35	1
Humidity (%RH)		25 - 75	
Temperature (°C)	FCC PART 15 C 15.247 Bandedge	15 - 35	1
Humidity (%RH)		25 - 75	
Temperature (°C)	FCC PART 15 C 15.247 Occupied Bandwidth & DTS Bandwidth	15 - 35	1
Humidity (%RH)		25 - 75	
Temperature (°C)	FCC PART 15 C 15.247 Power Density	15 - 35	1
Humidity (%RH)		25 - 75	

Note: Test site information refers to Laboratory Information.

Laboratory Information

USA	:	FCC Registration Number: TW3024
Canada	:	IC Registration Number: 22397-1 / 22397-2 / 22397-3

The address and introduction of DEKRA Testing and Certification Co., Ltd. laboratories can be founded in our Web site: <http://www.dekra.com.tw>

If you have any comments, please don't hesitate to contact us. Our test sites as below:

Test Laboratory	DEKRA Testing and Certification Co., Ltd.
Address	1. No.372, Sec. 4, Zhongxing Rd., Zhudong Township, Hsinchu County 31061, Taiwan, R.O.C. 2. No.372-2, Sec. 4, Zhongxing Rd., Zhudong Township, Hsinchu County 31061, Taiwan, R.O.C.
Phone number	1. +886-3-582-8001 2. +886-3-582-8001
Fax number	1. +886-3-582-8958 2. +886-3-582-8958
Email address	info.tw@dekra.com
Website	http://www.dekra.com.tw

1.8. List of Test Equipment

Conducted Emission / SR2-H

Instrument	Manufacturer	Model No.	Serial No.	Cal. Date	Next Cal. Date
Artificial Mains Network	R&S	ENV4200	848411/010	2020/01/08	2021/01/07
Test Receiver	R&S	ESCS 30	836858/022	2020/02/25	2021/02/24
LISN	R&S	ENV216	100092	2020/06/22	2021/06/21

Maximum peak conducted output power / SR12-H

Instrument	Manufacturer	Model No.	Serial No.	Cal. Date	Next Cal. Date
High Speed Peak Power Meter Dual Input	Anritsu	ML2496A	1602004	2020/11/30	2021/11/29
Pulse Power Sensor	Anritsu	MA2411B	1531043	2020/11/30	2021/11/29
Pulse Power Sensor	Anritsu	MA2411B	1531044	2020/11/30	2021/11/29
Power Meter	Keysight	8990B	MY51000248	2020/05/20	2021/05/19
Power Sensor	Keysight	N1923A	MY57240005	2020/05/20	2021/05/19

Radiated Emission / CB2-H

Instrument	Manufacturer	Model No.	Serial No.	Cal. Date	Next Cal. Date
Signal Analyzer	R&S	FSVA40	101455	2020/10/12	2021/10/11
Signal & Spectrum Analyzer	R&S	FSV40	101049	2020/03/30	2021/03/29
EXA Signal Analyzer	Keysight	N9010A	MY51440132	2020/02/21	2021/02/20
Bilog Antenna	Teseq	CBL6112D	23191	2020/06/12	2021/06/11
Horn Antenna	Schwarzbeck	BBHA 9120D	639	2020/06/04	2021/06/03
Horn Antenna	Schwarzbeck	BBHA 9170	202	2020/12/16	2021/12/15
Pre-Amplifier	DEKRA	AP-025C	12183122	2020/09/03	2021/09/02
Pre-Amplifier	EMCI	EMC11830I	980366	2020/11/30	2021/11/29
Pre-Amplifier	DEKRA	AP-400C	201801231	2020/11/16	2021/11/15
Horn Antenna	Schwarzbeck	BBHA 9120D	01656	2020/10/14	2021/10/13
Band Reject Filter	Micro-Tronics	BRM50702	G192	2020/03/09	2021/03/08
Signal Analyzer	R&S	FSV40	101435	2020/06/24	2021/06/23
Coaxial Cable(13m)	Huber+Suhner	SF104	CB2-H	2020/07/25	2021/07/24
DEKRA Testing System	DEKRA	Version 1.2	CB2-H	NA	NA

RF antenna conducted test / SR12-H

Instrument	Manufacturer	Model No.	Serial No.	Cal. Date	Next Cal. Date
Spectrum Analyzer	Keysight	N9030B	MY57140404	2020/06/03	2021/06/02
Spectrum Analyzer	Keysight	N9010B	MY57110159	2020/04/15	2021/04/14
Spectrum Analyzer	Agilent	N9010A	US47140172	2020/06/18	2021/06/17
Signal & Spectrum Analyzer	R&S	FSV40	101049	2020/03/30	2021/03/29

Bandedge / SR12-H

Instrument	Manufacturer	Model No.	Serial No.	Cal. Date	Next Cal. Date
Spectrum Analyzer	Keysight	N9030B	MY57140404	2020/06/03	2021/06/02
Spectrum Analyzer	Keysight	N9010B	MY57110159	2020/04/15	2021/04/14
Spectrum Analyzer	Agilent	N9010A	US47140172	2020/06/18	2021/06/17
Signal & Spectrum Analyzer	R&S	FSV40	101049	2020/03/30	2021/03/29

Occupied Bandwidth & DTS Bandwidth / SR12-H

Instrument	Manufacturer	Model No.	Serial No.	Cal. Date	Next Cal. Date
Spectrum Analyzer	Keysight	N9030B	MY57140404	2020/06/03	2021/06/02
Spectrum Analyzer	Keysight	N9010B	MY57110159	2020/04/15	2021/04/14
Spectrum Analyzer	Agilent	N9010A	US47140172	2020/06/18	2021/06/17
Signal & Spectrum Analyzer	R&S	FSV40	101049	2020/03/30	2021/03/29

Power Density / SR12-H

Instrument	Manufacturer	Model No.	Serial No.	Cal. Date	Next Cal. Date
Spectrum Analyzer	Keysight	N9030B	MY57140404	2020/06/03	2021/06/02
Spectrum Analyzer	Keysight	N9010B	MY57110159	2020/04/15	2021/04/14
Spectrum Analyzer	Agilent	N9010A	US47140172	2020/06/18	2021/06/17
Signal & Spectrum Analyzer	R&S	FSV40	101049	2020/03/30	2021/03/29

Note: All equipment upon which need to calibrated are with calibration period of 1 year.

1.9. Duty cycle

Mode	On Time (ms)	On+Off Time (ms)	Duty Cycle (%)	Duty Factor(dB) linear voltage	Duty Factor(dB) Power	1/T Minimum VBW (kHz)
BLE	0.394	0.648	60.80%	4.321576	2.16	2.538

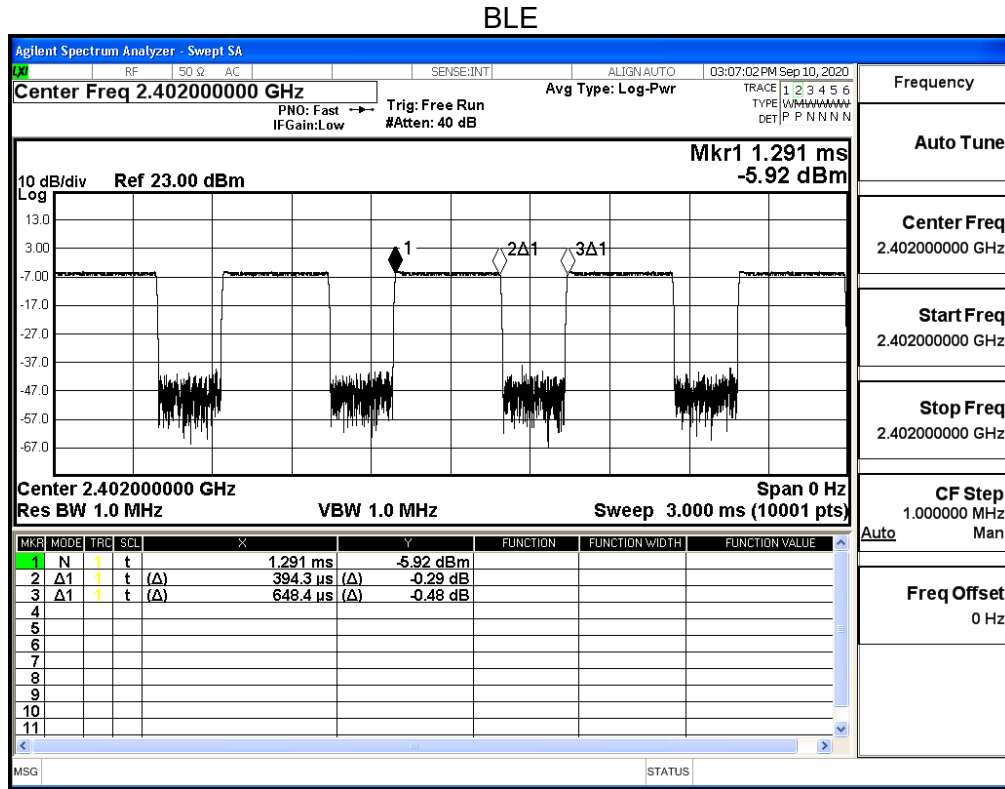

1.10. Uncertainty

Test item	Uncertainty
Conducted Emission	± 2.26 dB
Maximum peak conducted output power	± 1.27 dB
Radiated Emission	30MHz~1GHz as ± 3.43 dB 1GHz~26.5GHz as ± 3.65 dB
RF antenna conducted test	± 1.27 dB
Bandedge	± 1.27 dB
Occupied Bandwidth & DTS Bandwidth	± 50 Hz
Power Density	± 1.27 dB

2. Conducted Emission

2.1. Test Setup

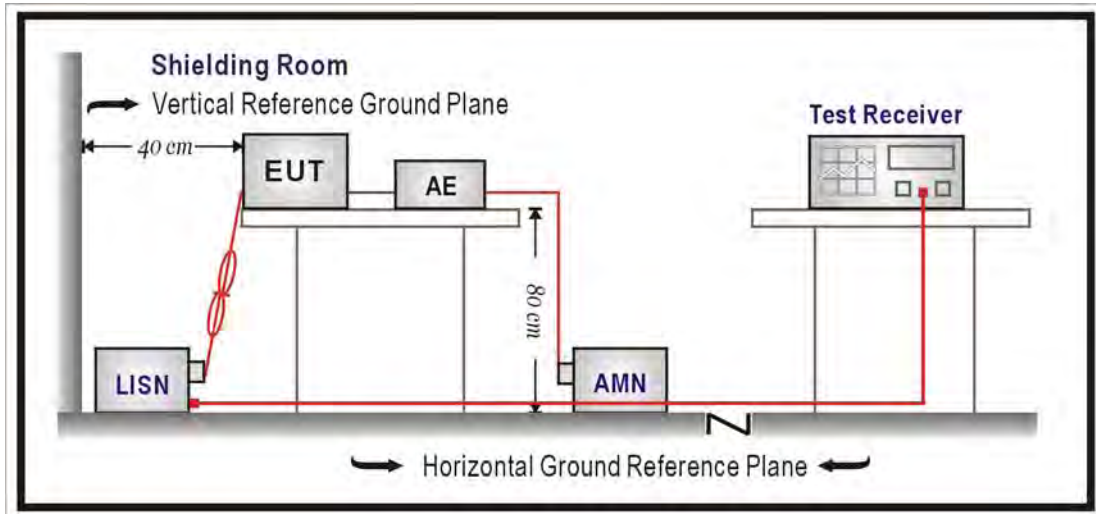

2.2. Limits

FCC Part 15 Subpart C Paragraph 15.207 Limits (dBuV)		
Frequency MHz	QP	AV
0.15 - 0.50	66 - 56	56 - 46
0.50 - 5.0	56	46
5.0 - 30	60	50

Remarks: In the above table, the tighter limit applies at the band edges.

2.3. Test Procedure

The EUT and simulators are connected to the main power through a line impedance stabilization network (L.I.S.N.). This provides a 50 ohm /50uH coupling impedance for the measuring equipment. The peripheral devices are also connected to the main power through a LISN that provides a 50ohm/50uH coupling impedance with 50ohm termination. (Please refer to the block diagram of the test setup and photographs.)

Both sides of A.C. line are checked for maximum conducted interference. In order to find the maximum emission, the relative positions of equipment and all of the interface cables must be changed according to ANSI C63.4: 2014 on conducted measurement.

Conducted emissions were investigated over the frequency range from 0.15MHz to 30MHz using a receiver bandwidth of 9KHz.

2.4. Test Specification

According to FCC Part 15 Subpart C Paragraph 15.207: 2019

2.5. Test Result

Model No	Insyde	Site	SR2-H
Test Voltage	AC 120V/60Hz	Test Date	2020/12/22
Test Mode	Mode 1: Transmit mode	Engineer	Lion Wang
Phase	L	Temperature (°C)	20.4
Test Condition	CE BT5.0, BLE, Ch0, 2.402G	Humidity (%RH)	52.3

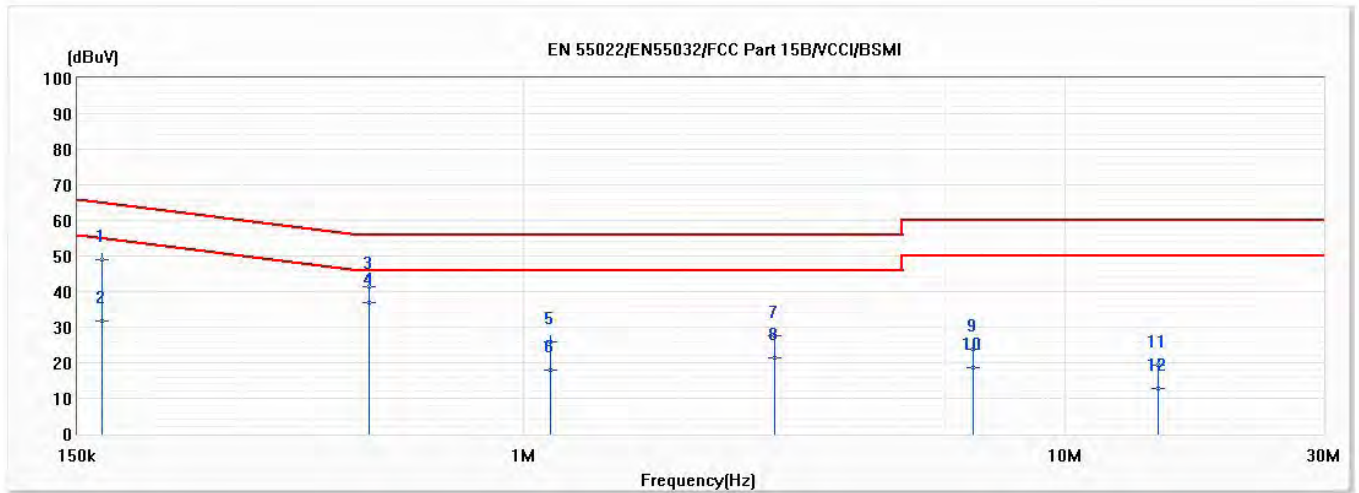

No	Frequency (MHz)	Emission Level (dBuV)	Limit (dBuV)	Margin (dB)	Reading Level (dBuV)	Correct Factor (dB)	Detector Type
1	0.166	48.91	65.14	-16.24	39.26	9.65	QP
2	0.166	31.62	55.14	-23.52	21.98	9.65	AV
3	0.518	41.40	56.00	-14.60	31.71	9.69	QP
*4	0.518	36.84	46.00	-9.16	27.15	9.69	AV
5	1.119	25.90	56.00	-30.10	16.16	9.75	QP
6	1.119	17.82	46.00	-28.18	8.08	9.75	AV
7	2.905	27.57	56.00	-28.43	17.73	9.84	QP
8	2.905	21.33	46.00	-24.67	11.50	9.84	AV
9	6.760	23.95	60.00	-36.05	13.95	10.00	QP
10	6.760	18.48	50.00	-31.52	8.48	10.00	AV
11	14.883	19.14	60.00	-40.86	8.88	10.26	QP
12	14.883	12.60	50.00	-37.40	2.35	10.26	AV

Remark:

1. "*" means this data is the worst emission level.
2. Emission Level = Reading Level + Correct Factor (Correct Factor = LISN Insertion Loss + Cable Loss).
3. Margin = Emission Level - Limit.

Model No	Insyde	Site	SR2-H
Test Voltage	AC 120V/60Hz	Test Date	2020/12/22
Test Mode	Mode 1: Transmit mode	Engineer	Lion Wang
Phase	N	Temperature (°C)	20.4
Test Condition	CE BT5.0,BLE,Ch0,2.402G	Humidity (%RH)	52.3

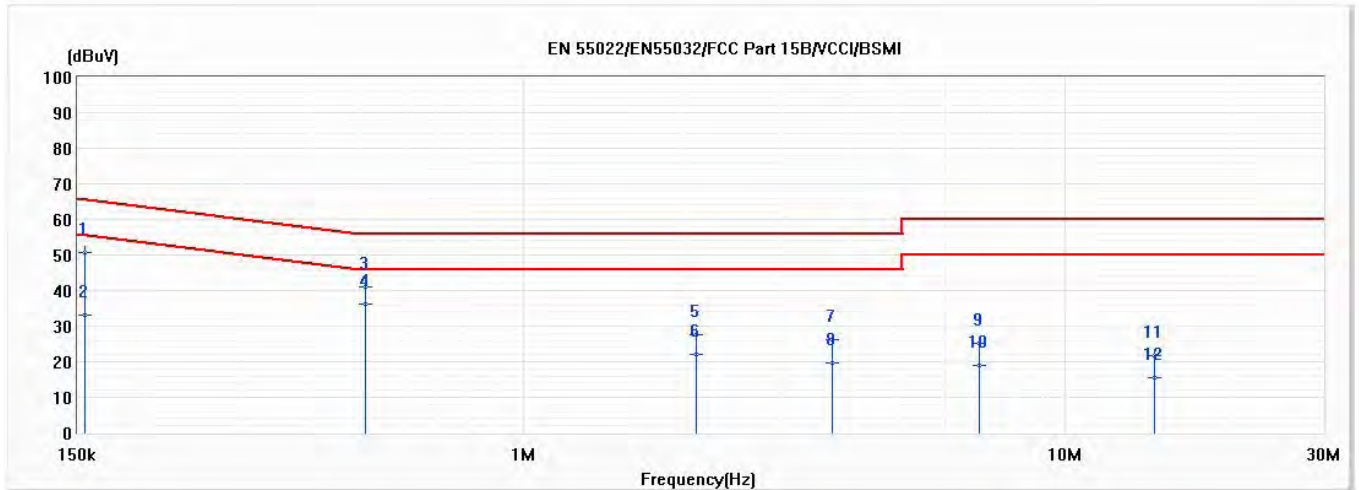

No	Frequency (MHz)	Emission Level (dBuV)	Limit (dBuV)	Margin (dB)	Reading Level (dBuV)	Correct Factor (dB)	Detector Type
1	0.155	50.82	65.74	-14.92	41.18	9.64	QP
2	0.155	33.02	55.74	-22.72	23.38	9.64	AV
3	0.510	40.93	56.00	-15.07	31.25	9.68	QP
*4	0.510	36.20	46.00	-9.80	26.52	9.68	AV
5	2.088	27.43	56.00	-28.57	17.65	9.78	QP
6	2.088	22.05	46.00	-23.95	12.27	9.78	AV
7	3.722	26.21	56.00	-29.79	16.35	9.87	QP
8	3.722	19.73	46.00	-26.27	9.86	9.87	AV
9	6.956	25.12	60.00	-34.88	15.11	10.02	QP
10	6.956	18.91	50.00	-31.09	8.90	10.02	AV
11	14.607	21.72	60.00	-38.28	11.39	10.33	QP
12	14.607	15.51	50.00	-34.49	5.18	10.33	AV

Remark:

1. "*" means this data is the worst emission level.
2. Emission Level = Reading Level + Correct Factor (Correct Factor = LISN Insertion Loss + Cable Loss).
3. Margin = Emission Level - Limit.

3. Maximum peak conducted output power

3.1. Test Setup

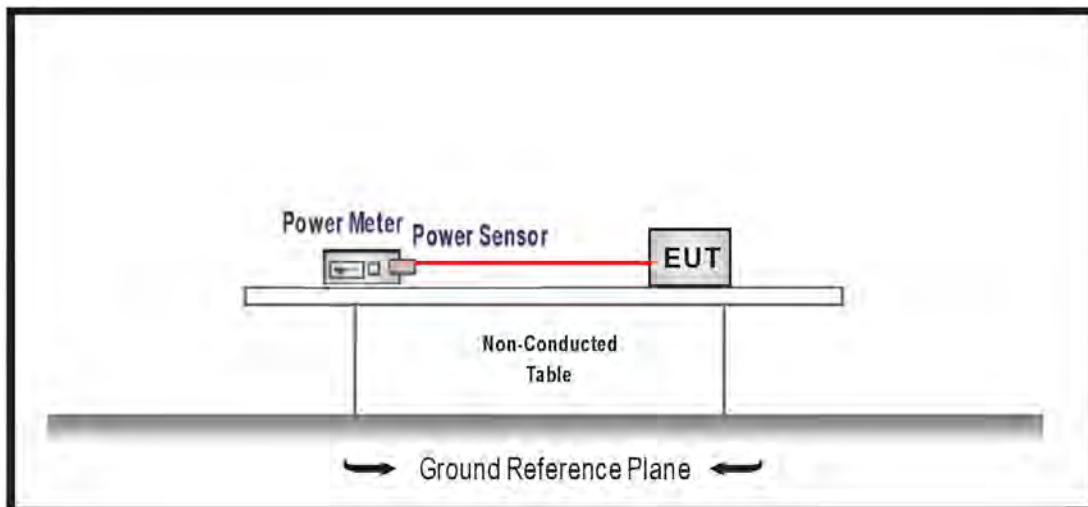

3.2. Limits

The maximum peak conducted output power shall be less 1 Watt.

3.3. Test procedures

The EUT was setup according to ANSI C63.10: 2013; tested according to DTS test procedure of KDB 558074 D01V05r02 for compliance to FCC 47CFR 15.247 requirements.

3.4. Test Specification

According to FCC Part 15 Subpart C Paragraph 15.247: 2019

3.5. Test Result

Product	Insyde		
Test Item	Maximum peak conducted output power		
Test Mode	Mode 1: Transmit Mode		
Date of Test	2020/09/16	Test Site	SR12-H
Temperature(°C)	22	Humidity (%RH)	56

GFSK

Channel No.	Frequency (MHz)	Measure Level (dBm)	Limit (dBm)
00	2402	-3.090	≤ 30
19	2440	0.300	≤ 30
39	2480	2.290	≤ 30

4. Radiated Emission

4.1. Test Setup

Under 30MHz Test Setup:

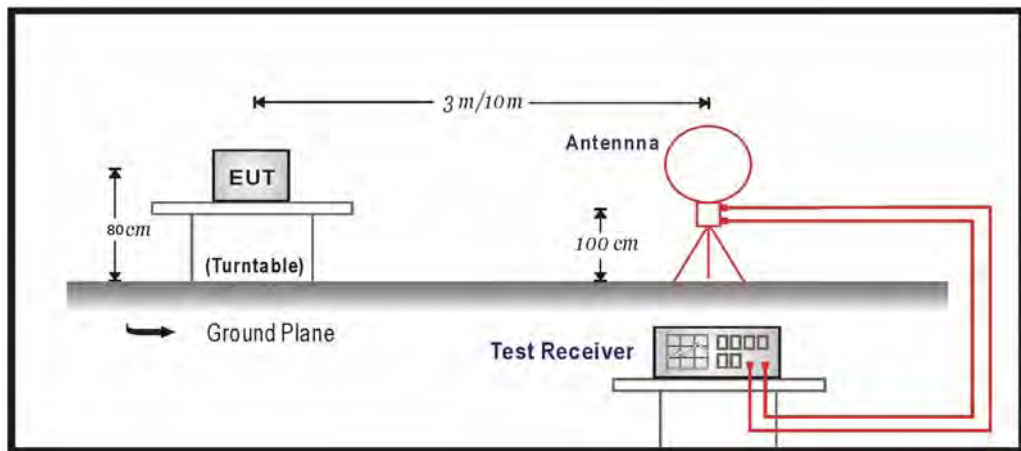

Under 1GHz Test Setup:

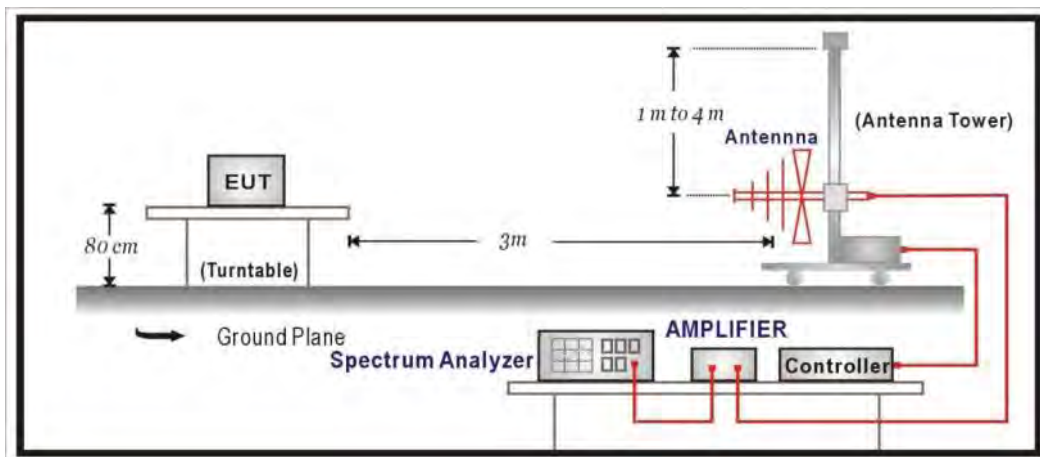

Above 1GHz Test Setup:

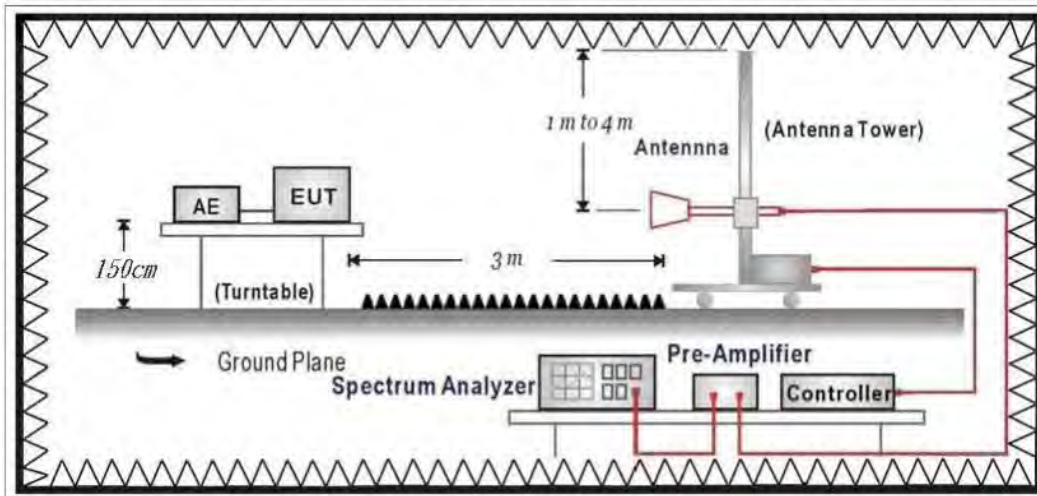

4.2. Limits

Emissions radiated outside of the specified frequency bands, except for harmonics, shall be attenuated by at least 20dB below the level of the fundamental or to the general radiated emission limits in paragraph 15.209, whichever is the lesser attenuation.

FCC Part 15 Subpart C Paragraph 15.209 Limits		
Frequency (MHz)	uV/m	dBuV/m
30-88	100	40
88-216	150	43.5
216-960	200	46
Above 960	500	54

Remarks: 1. RF Voltage (dBuV) = 20 log RF Voltage (uV)

2. In the Above Table, the tighter limit applies at the Bandedges.

3. Distance refers to the distance in meters between the measuring instrument antenna and the closed point of any part of the device or system.

4.3. Test Procedure

The EUT was setup according to ANSI C63.10: 2013 and tested according to DTS test procedure of KDB 558074 D01V05r02 for compliance to FCC 47CFR 15.247 requirements. The EUT and its simulators are placed on a turn table which is 0.8 or 1.5 meter above ground. The turn table can rotate 360 degrees to determine the position of the maximum emission level.

The antenna can move up and down between 1 meter and 4 meters to find out the maximum emission level.

Both horizontal and vertical polarization of the antenna are set on measurement. In order to find the maximum emission, all of the interface cables must be manipulated according to ANSI C63.10: 2013 on radiated measurement.

On any frequency or frequencies from 9KHz (include The the lowest oscillator frequency generated within the device up to the 10th harmonic) to 1000 MHz, the limits shown are based on measuring equipment employing a quasi-peak detector function and on any frequency or frequencies above 1000 MHz the radiated limits shown are based upon the use of measurement instrumentation employing an average detector function. When average radiated emission measurement are included emission measurement below 1000 MHz, there also is a limit on the radio frequency emissions, as measured using instrumentation with a peak detector function, corresponding to 20 dB above the maximum permitted average limit. The bandwidth below 1GHz setting on the field strength meter is 120 kHz and above 1GHz is 1MHz.

4.4. Test Specification

According to FCC Part 15 Subpart C Paragraph 15.247: 2019

4.5. Test Result

30MHz-1GHz Spurious

Model No	Insyde	Site	CB2-H
Test Voltage	AC 120V/60Hz	Test Date	2020/10/26
Test Mode	Mode 1: Transmit mode	Engineer	Scott Lin
Polarity	Horizontal	Temperature (°C)	24.0
Test Condition	RE_BT5.0,BLE,Ch0,2.402G	Humidity (%RH)	58.0

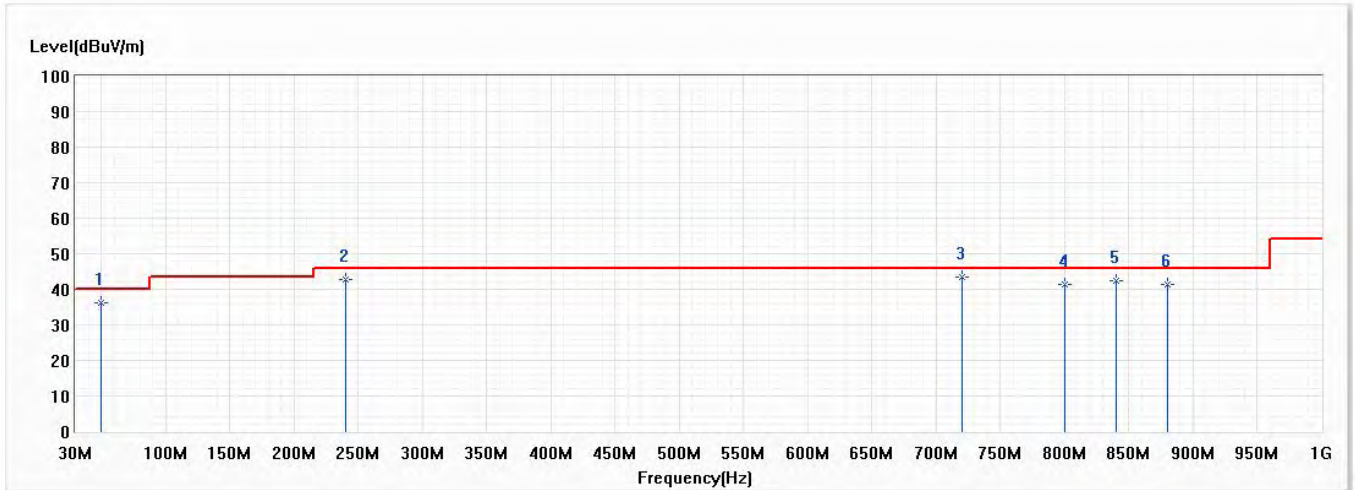

No	Frequency (MHz)	Emission Level (dBuV/m)	Limit (dBuV/m)	Margin (dB)	Reading Level (dBuV)	Correct Factor (dB)	Detector Type
1	49.764	36.10	40.00	-3.90	41.73	-5.63	QP
2	240.005	42.87	46.00	-3.13	45.67	-2.80	QP
* 3	720.034	43.44	46.00	-2.56	37.44	6.00	QP
4	800.059	41.30	46.00	-4.70	34.05	7.25	QP
5	840.071	42.48	46.00	-3.52	34.77	7.71	QP
6	880.084	41.51	46.00	-4.49	33.35	8.16	QP

Note:

1. All reading levels is Quasi-Peak value.
2. “ * ”, means this data is the worst value.
3. Emission Level = Reading Level + Correct Factor
4. The emission under 30MHz were not included is because their levels are lower than 20dB from limit.

Model No	Insyde	Site	CB2-H
Test Voltage	AC 120V/60Hz	Test Date	2020/10/26
Test Mode	Mode 1: Transmit mode	Engineer	Scott Lin
Polarity	Vertical	Temperature (°C)	24.0
Test Condition	RE_BT5.0,BLE,Ch0,2.402G	Humidity (%RH)	58.0

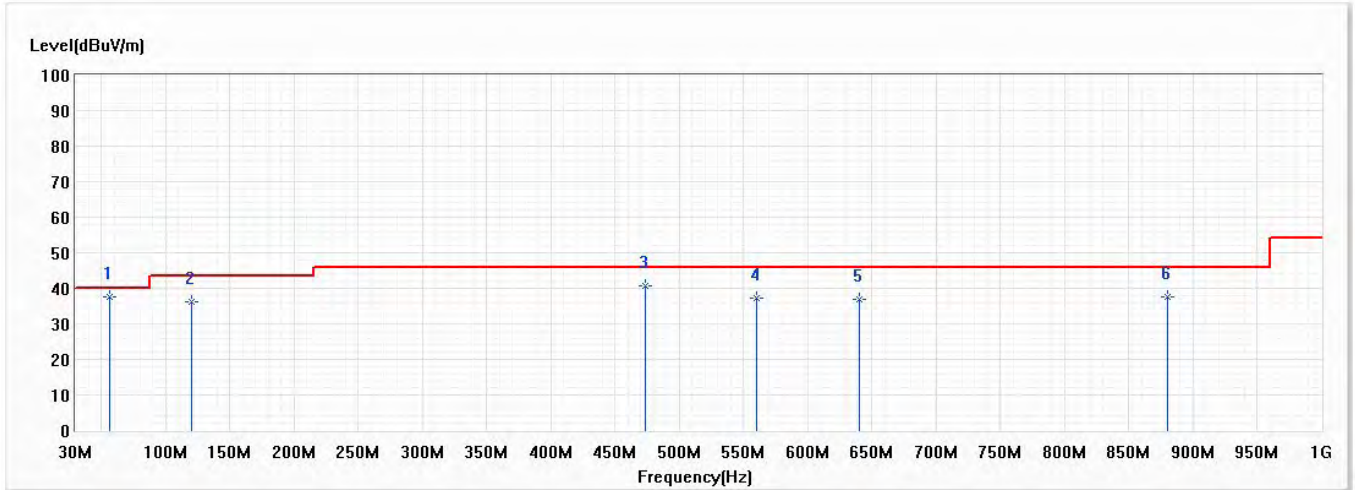

No	Frequency (MHz)	Emission Level (dBuV/m)	Limit (dBuV/m)	Margin (dB)	Reading Level (dBuV)	Correct Factor (dB)	Detector Type
* 1	56.796	37.65	40.00	-2.35	45.51	-7.86	QP
2	119.968	36.27	43.50	-7.23	38.99	-2.72	QP
3	473.290	40.60	46.00	-5.40	37.54	3.06	QP
4	559.984	37.33	46.00	-8.67	33.08	4.25	QP
5	640.009	36.92	46.00	-9.08	31.77	5.15	QP
6	880.084	37.53	46.00	-8.47	29.37	8.16	QP

Note:

1. All reading levels is Quasi-Peak value.
2. " * ", means this data is the worst value.
3. Emission Level = Reading Level + Correct Factor
4. The emission under 30MHz were not included is because their levels are lower than 20dB from limit.

Harmonic & Spurious:

Model No	Insyde	Site	CB2-H
Test Voltage	AC 120V/60Hz	Test Date	2020/10/26
Test Mode	Mode 1: Transmit mode	Engineer	Scott Lin
Polarity	Horizontal	Temperature (°C)	24.0
Test Condition	RF_BT5.0,BLE,Ch0,2.402G	Humidity (%RH)	58.0

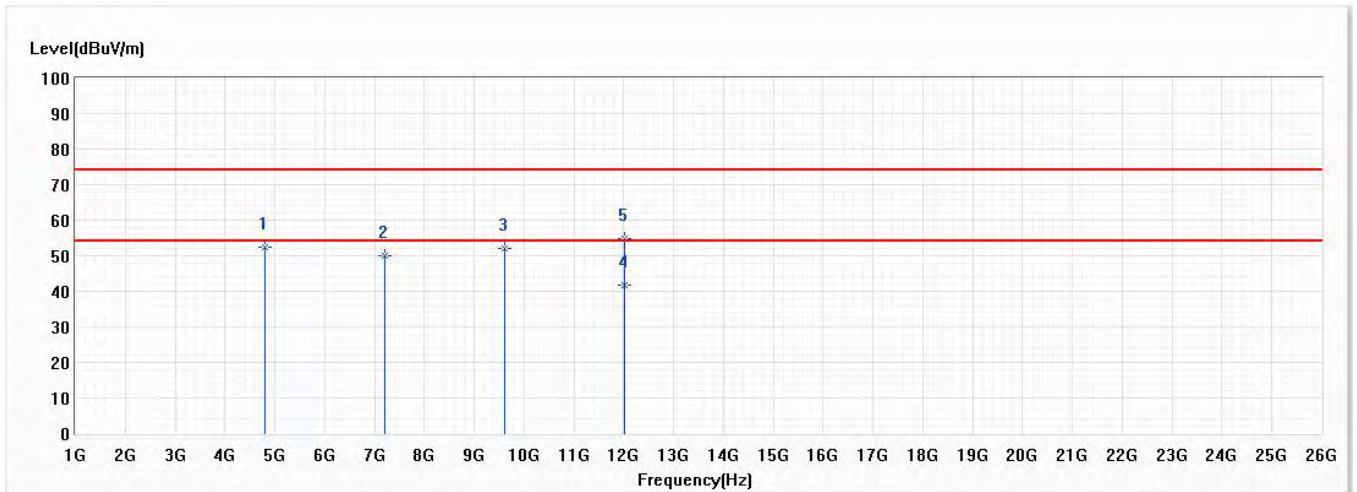

No	Frequency (MHz)	Emission Level (dBuV/m)	Limit (dBuV/m)	Margin (dB)	Reading Level (dBuV)	Correct Factor (dB)	Detector Type
1	4804.000	52.33	74.00	-21.67	64.36	-12.03	PK
2	7206.000	50.07	74.00	-23.93	54.75	-4.68	PK
3	9608.000	51.98	74.00	-22.02	53.31	-1.33	PK
* 4	12010.000	41.61	54.00	-12.39	38.80	2.81	AV
5	12010.000	54.86	74.00	-19.14	52.05	2.81	PK

Note:

- 1.All reading above 1GHz is performed with peak and/or average measurements as necessary.
2. “ * ”, means this data is the worst value.
- 3.Emission Level = Reading Level + Correct Factor.
- 4.The average measurement was not performed when the peak measured data under the limit of average detection.
- 5.The emission above 13GHz were not included is because their levels are lower than 20dB form limit.

Model No	Insyde	Site	CB2-H
Test Voltage	AC 120V/60Hz	Test Date	2020/10/26
Test Mode	Mode 1: Transmit mode	Engineer	Scott Lin
Polarity	Vertical	Temperature (°C)	24.0
Test Condition	RF_BT5.0,BLE,Ch0,2.402G	Humidity (%RH)	58.0

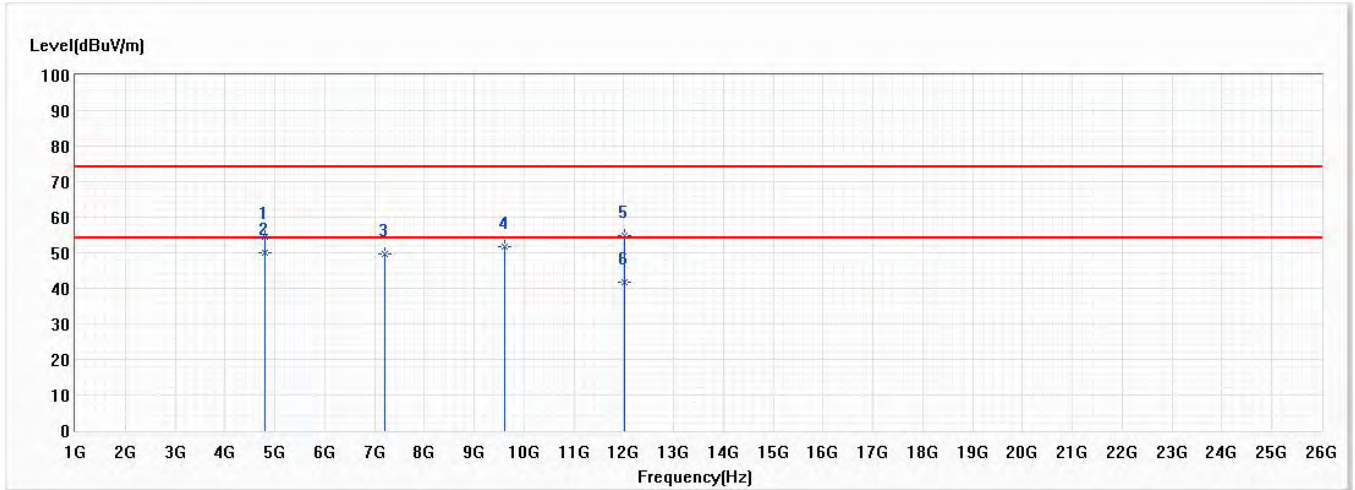

No	Frequency (MHz)	Emission Level (dBuV/m)	Limit (dBuV/m)	Margin (dB)	Reading Level (dBuV)	Correct Factor (dB)	Detector Type
1	4804.000	54.54	74.00	-19.46	66.57	-12.03	PK
* 2	4804.000	50.04	54.00	-3.96	62.07	-12.03	AV
3	7206.000	49.77	74.00	-24.23	54.45	-4.68	PK
4	9608.000	51.57	74.00	-22.43	52.90	-1.33	PK
5	12010.000	54.80	74.00	-19.20	51.99	2.81	PK
6	12010.000	41.61	54.00	-12.39	38.80	2.81	AV

Note:

- 1.All reading above 1GHz is performed with peak and/or average measurements as necessary.
2. “ * ”, means this data is the worst value.
- 3.Emission Level = Reading Level + Correct Factor.
- 4.The average measurement was not performed when the peak measured data under the limit of average detection.
- 5.The emission above 13GHz were not included is because their levels are lower than 20dB form limit.

Model No	Insyde	Site	CB2-H
Test Voltage	AC 120V/60Hz	Test Date	2020/10/26
Test Mode	Mode 1: Transmit mode	Engineer	Scott Lin
Polarity	Horizontal	Temperature (°C)	24.0
Test Condition	RF_BT5.0,BLE,Ch19,2.44G	Humidity (%RH)	58.0

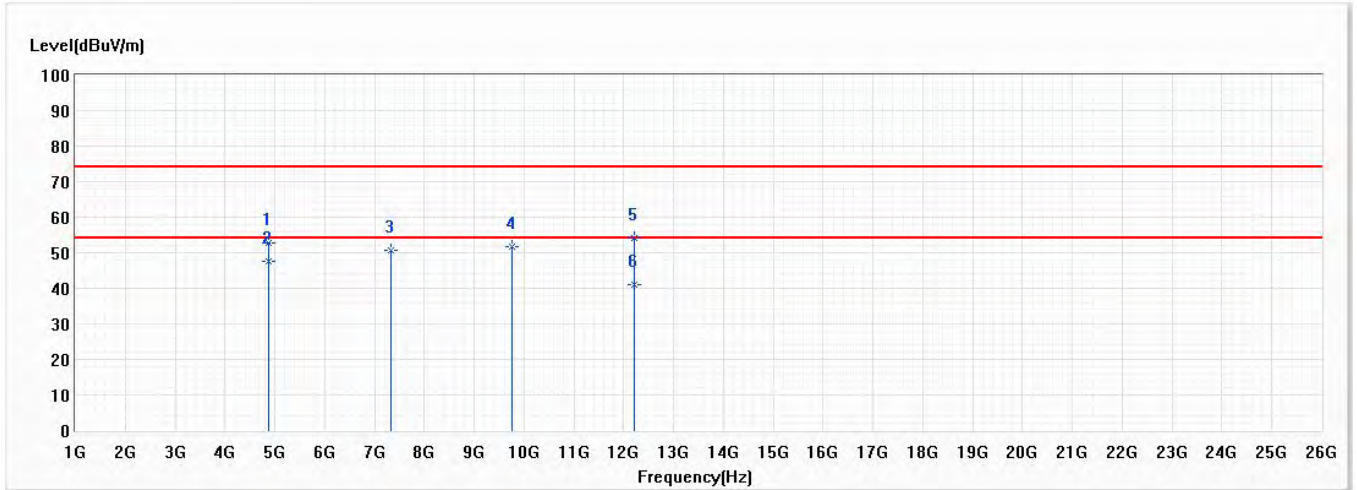

No	Frequency (MHz)	Emission Level (dBuV/m)	Limit (dBuV/m)	Margin (dB)	Reading Level (dBuV)	Correct Factor (dB)	Detector Type
1	4880.000	52.93	74.00	-21.07	64.76	-11.83	PK
* 2	4880.000	47.71	54.00	-6.29	59.54	-11.83	AV
3	7320.000	50.65	74.00	-23.35	55.00	-4.35	PK
4	9760.000	51.69	74.00	-22.31	52.96	-1.27	PK
5	12200.000	53.98	74.00	-20.02	51.40	2.58	PK
6	12200.000	41.11	54.00	-12.89	38.53	2.58	AV

Note:

- 1.All reading above 1GHz is performed with peak and/or average measurements as necessary.
2. “ * ”, means this data is the worst value.
- 3.Emission Level = Reading Level + Correct Factor.
- 4.The average measurement was not performed when the peak measured data under the limit of average detection.
- 5.The emission above 13GHz were not included is because their levels are lower than 20dB form limit.

Model No	Insyde	Site	CB2-H
Test Voltage	AC 120V/60Hz	Test Date	2020/10/26
Test Mode	Mode 1: Transmit mode	Engineer	Scott Lin
Polarity	Vertical	Temperature (°C)	24.0
Test Condition	RF_BT5.0,BLE,Ch19,2.44G	Humidity (%RH)	58.0

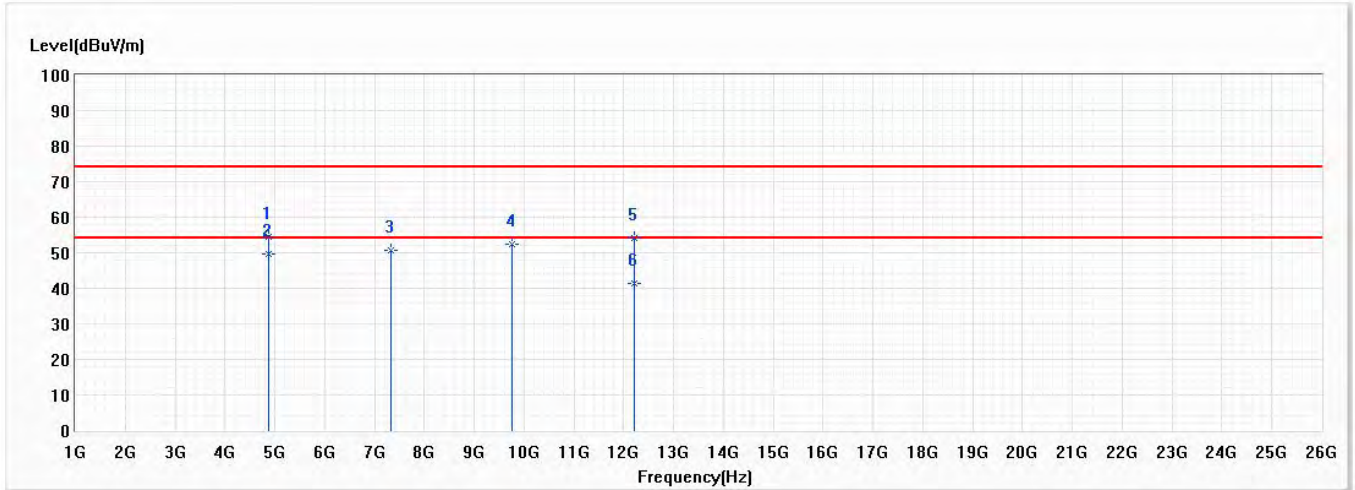

No	Frequency (MHz)	Emission Level (dBuV/m)	Limit (dBuV/m)	Margin (dB)	Reading Level (dBuV)	Correct Factor (dB)	Detector Type
1	4880.000	54.51	74.00	-19.49	66.34	-11.83	PK
* 2	4880.000	49.78	54.00	-4.22	61.61	-11.83	AV
3	7320.000	50.54	74.00	-23.46	54.89	-4.35	PK
4	9760.000	52.35	74.00	-21.65	53.62	-1.27	PK
5	12200.000	54.19	74.00	-19.81	51.61	2.58	PK
6	12200.000	41.42	54.00	-12.58	38.84	2.58	AV

Note:

- 1.All reading above 1GHz is performed with peak and/or average measurements as necessary.
2. “ * ”, means this data is the worst value.
- 3.Emission Level = Reading Level + Correct Factor.
- 4.The average measurement was not performed when the peak measured data under the limit of average detection.
- 5.The emission above 13GHz were not included is because their levels are lower than 20dB form limit.

Model No	Insyde	Site	CB2-H
Test Voltage	AC 120V/60Hz	Test Date	2020/10/26
Test Mode	Mode 1: Transmit mode	Engineer	Scott Lin
Polarity	Horizontal	Temperature (°C)	24.0
Test Condition	RF_BT5.0,BLE,Ch39,2.48G	Humidity (%RH)	58.0

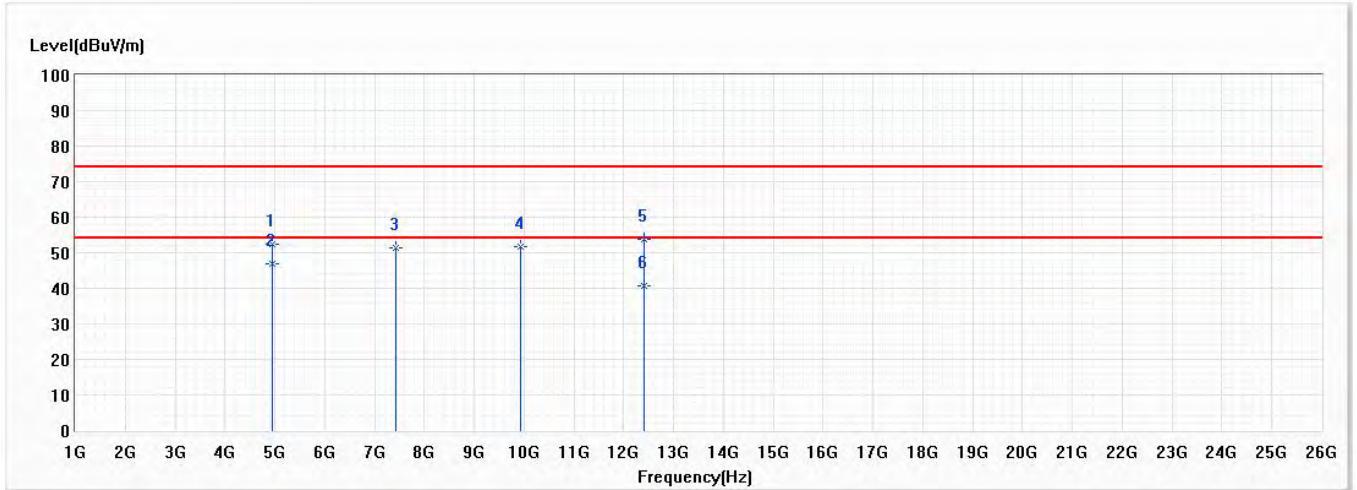

No	Frequency (MHz)	Emission Level (dBuV/m)	Limit (dBuV/m)	Margin (dB)	Reading Level (dBuV)	Correct Factor (dB)	Detector Type
1	4960.000	52.43	74.00	-21.57	64.55	-12.12	PK
* 2	4960.000	47.04	54.00	-6.96	59.16	-12.12	AV
3	7440.000	51.35	74.00	-22.65	56.54	-5.19	PK
4	9920.000	51.72	74.00	-22.28	52.33	-0.61	PK
5	12400.000	53.92	74.00	-20.08	52.08	1.84	PK
6	12400.000	40.63	54.00	-13.37	38.79	1.84	AV

Note:

- 1.All reading above 1GHz is performed with peak and/or average measurements as necessary.
2. “ * ”, means this data is the worst value.
- 3.Emission Level = Reading Level + Correct Factor.
- 4.The average measurement was not performed when the peak measured data under the limit of average detection.
- 5.The emission above 13GHz were not included is because their levels are lower than 20dB form limit.

Model No	Insyde	Site	CB2-H
Test Voltage	AC 120V/60Hz	Test Date	2020/10/26
Test Mode	Mode 1: Transmit mode	Engineer	Scott Lin
Polarity	Vertical	Temperature (°C)	24.0
Test Condition	RF_BT5.0,BLE,Ch39,2.48G	Humidity (%RH)	58.0

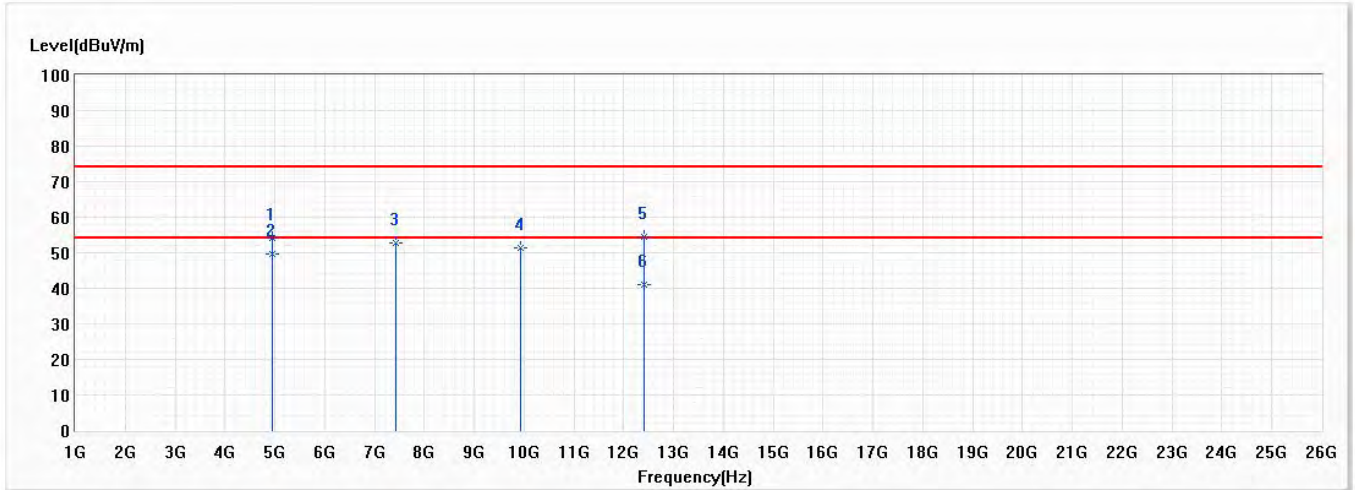

No	Frequency (MHz)	Emission Level (dBuV/m)	Limit (dBuV/m)	Margin (dB)	Reading Level (dBuV)	Correct Factor (dB)	Detector Type
1	4960.000	54.26	74.00	-19.74	65.86	-11.60	PK
* 2	4960.000	49.64	54.00	-4.36	61.24	-11.60	AV
3	7440.000	52.75	74.00	-21.25	56.76	-4.01	PK
4	9920.000	51.27	74.00	-22.73	52.46	-1.19	PK
5	12400.000	54.38	74.00	-19.62	52.04	2.34	PK
6	12400.000	41.19	54.00	-12.81	38.85	2.34	AV

Note:

- 1.All reading above 1GHz is performed with peak and/or average measurements as necessary.
2. “ * ”, means this data is the worst value.
- 3.Emission Level = Reading Level + Correct Factor.
- 4.The average measurement was not performed when the peak measured data under the limit of average detection.
- 5.The emission above 13GHz were not included is because their levels are lower than 20dB form limit.

5. RF antenna conducted test

5.1. Test Setup

RF Conducted Measurement:

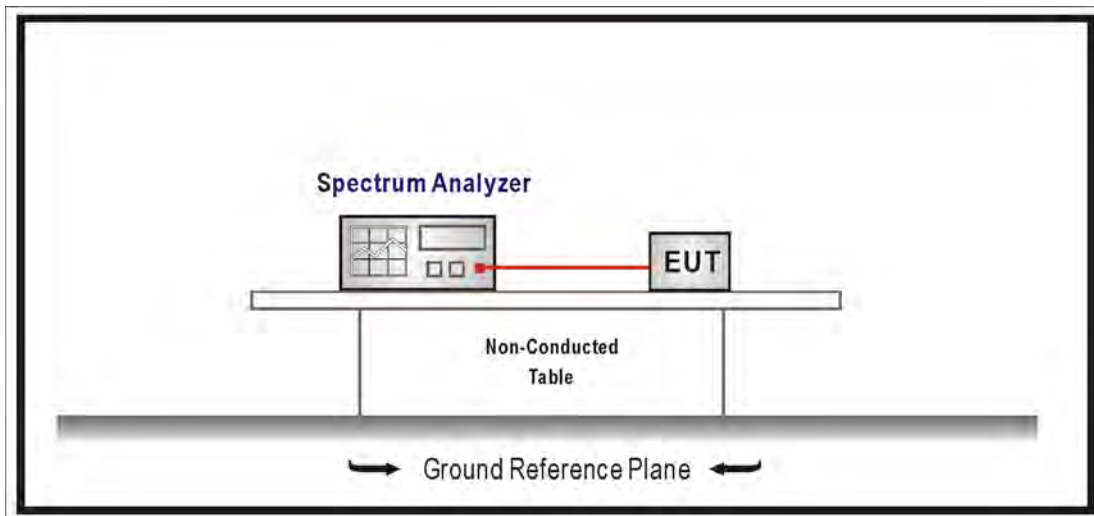

5.2. Limits

In any 100 kHz bandwidth outside the frequency band in which the spread spectrum or digitally modulated intentional radiator is operating, the radio frequency power that is produced by the intentional radiator shall be at least 20 dB below that in the 100 kHz bandwidth within the band that contains the highest level of the desired power, based on either an RF conducted or a radiated measurement, provided the transmitter demonstrates compliance with the peak conducted power limits. If the transmitter complies with the conducted power limits based on the use of RMS averaging over a time interval, the attenuation required under this paragraph shall be 30 dB instead of 20 dB. Attenuation below the general limits specified in §15.209(a) is not required. In addition, radiated emissions which fall in the restricted bands, as defined in §15.205(a), must also comply with the radiated emission limits specified in §15.209(a) (see §15.205(c)).

5.3. Test Procedure

The EUT was setup according to ANSI C63.10: 2013 and tested according to DTS test procedure of KDB 558074 D01V05r02 for compliance to FCC 47CFR 15.247 requirements. Set RBW = 100 kHz, Set VBW > RBW, scan up through 10th harmonic.

5.4. Test Specification

According to FCC Part 15 Subpart C Paragraph 15.247: 2019

5.5. Test Result

Product	Insyde		
Test Item	RF antenna conducted test		
Test Mode	Mode 1: Transmit Mode		
Date of Test	2020/09/17	Test Site	SR12-H
Temperature(°C)	22	Humidity (%RH)	56

GFSK

Channel	Frequency (MHz)	Measure Level (dBc)	Limit (dBc)
00	2402	47.102	≥ 20
19	2440	51.693	≥ 20
39	2480	53.301	≥ 20

Channel 00

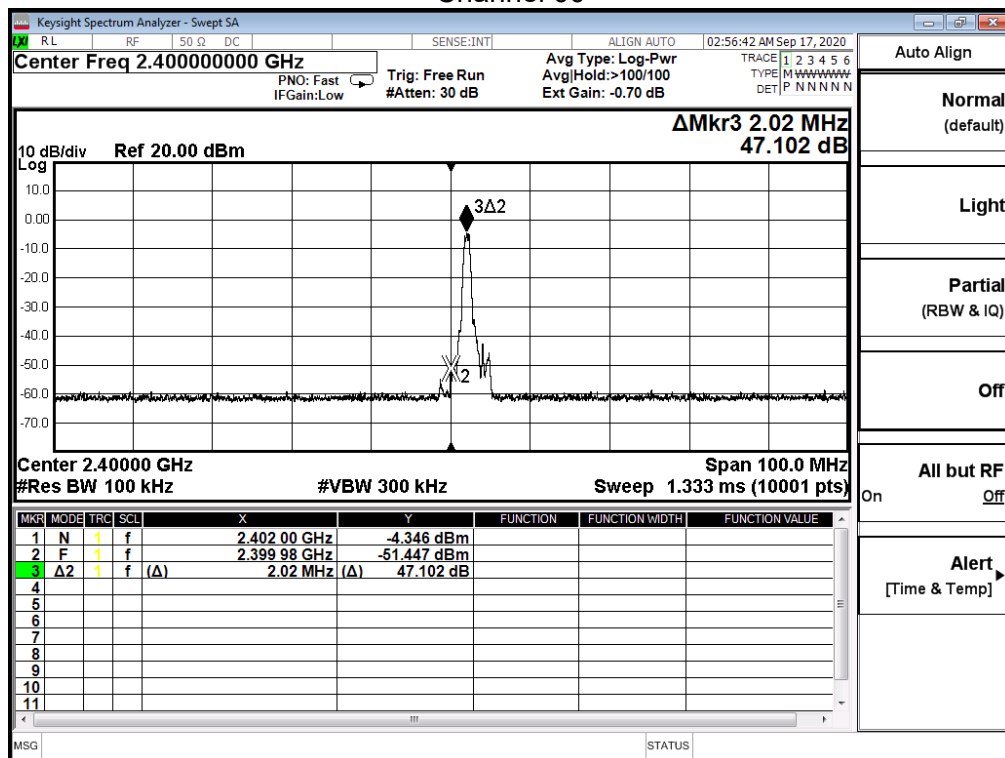

Channel 19

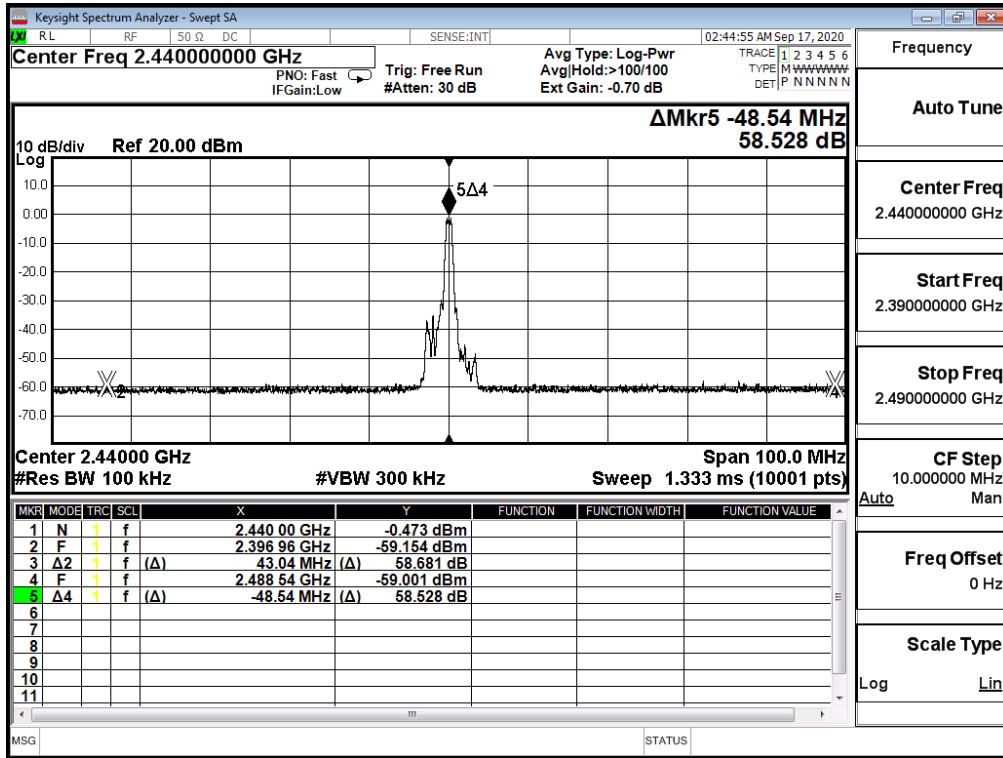

Channel 39

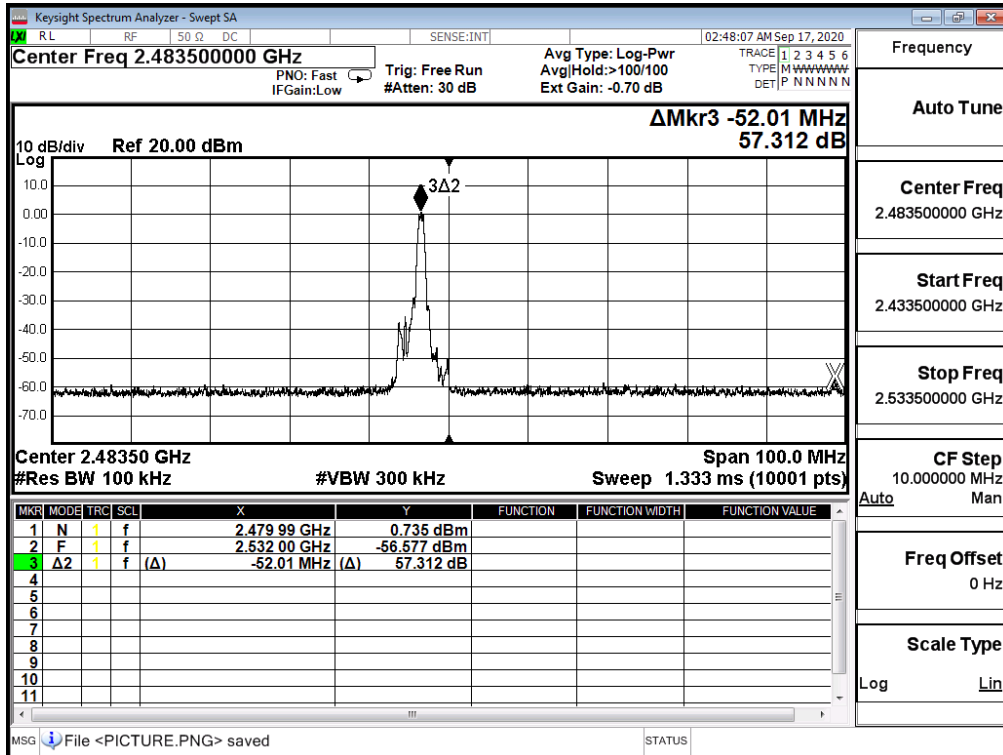

Channel 00 (30MHz-25GHz)- GFSK

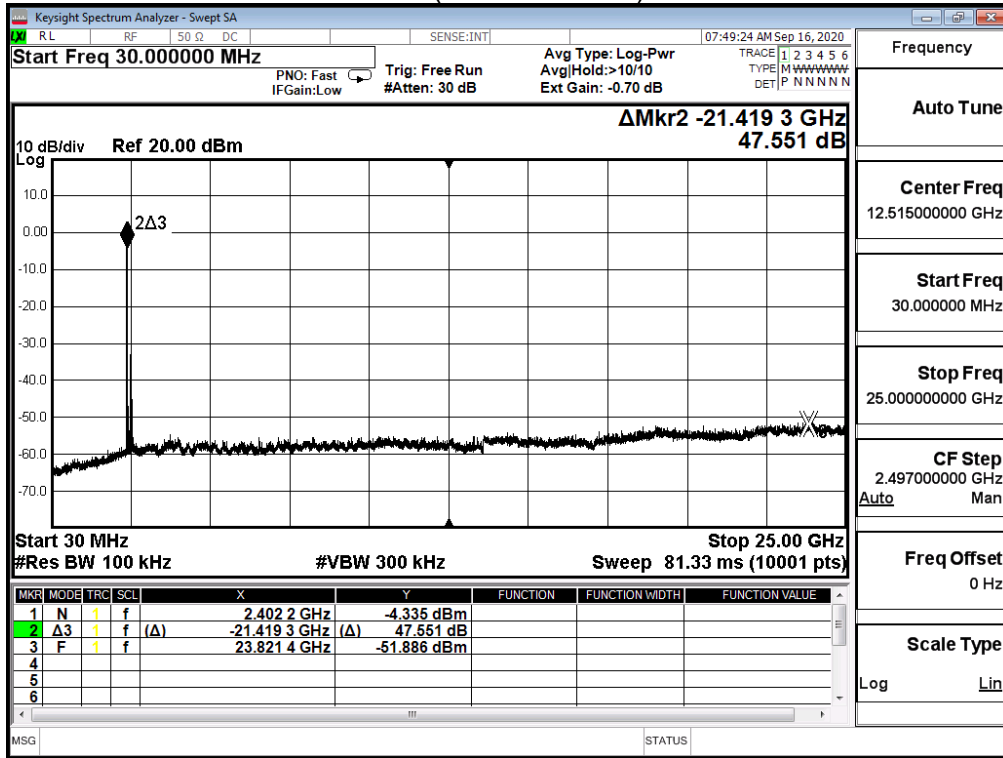

Channel 19 (30MHz-25GHz)- GFSK

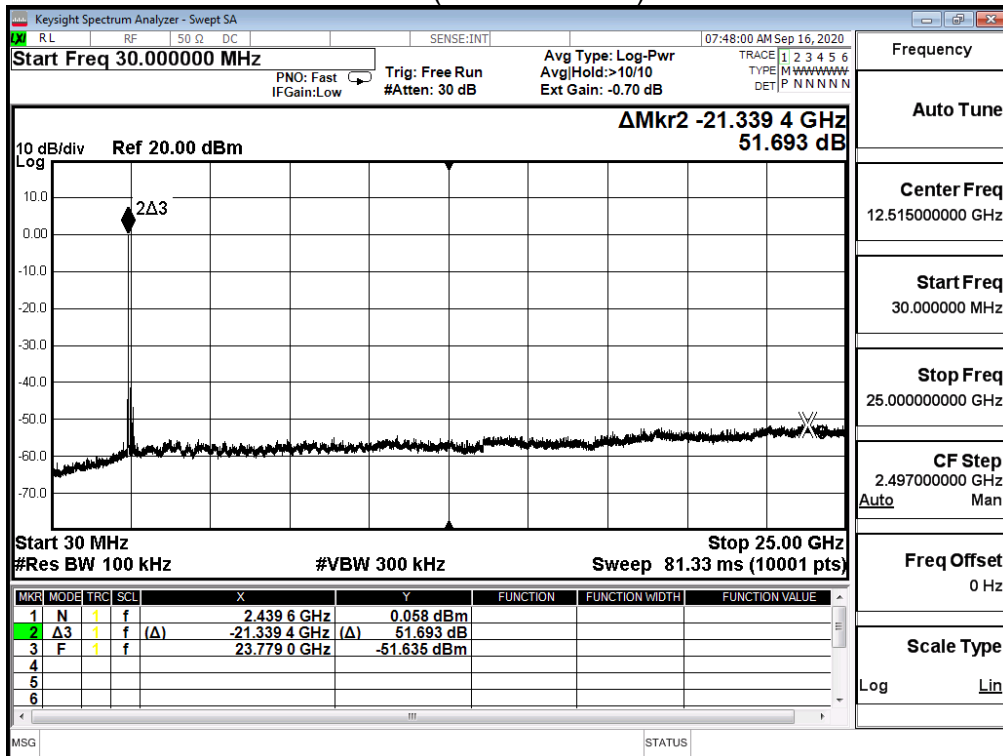

Channel 39 (30MHz-25GHz)- GFSK

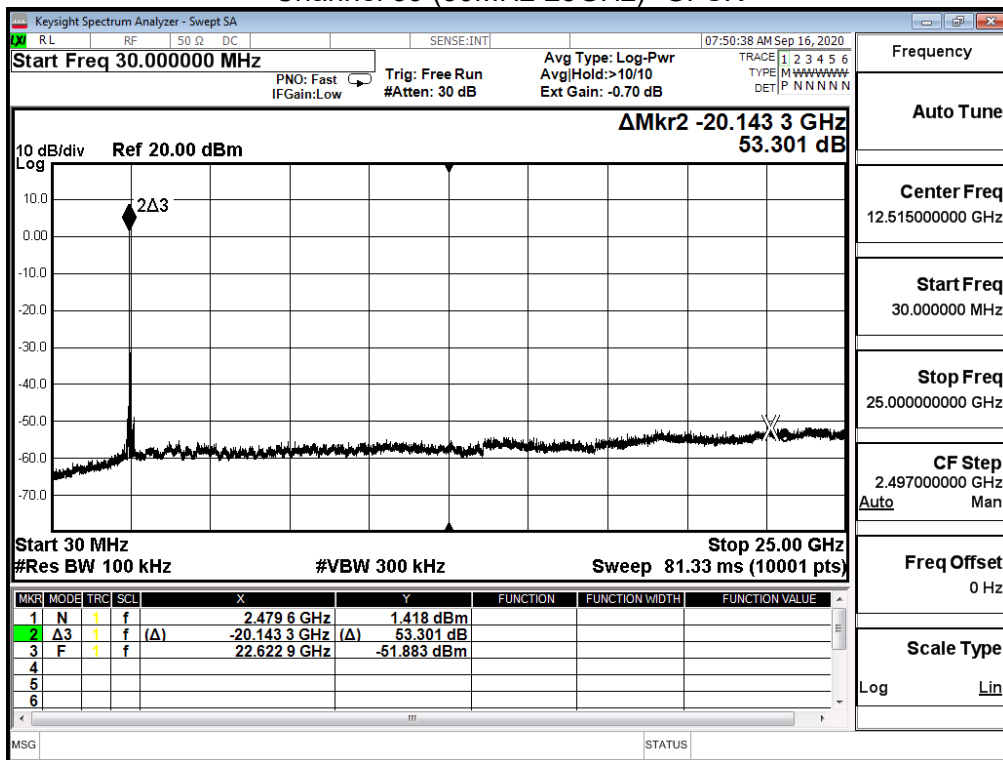

6. Bandedge

6.1. Test Setup

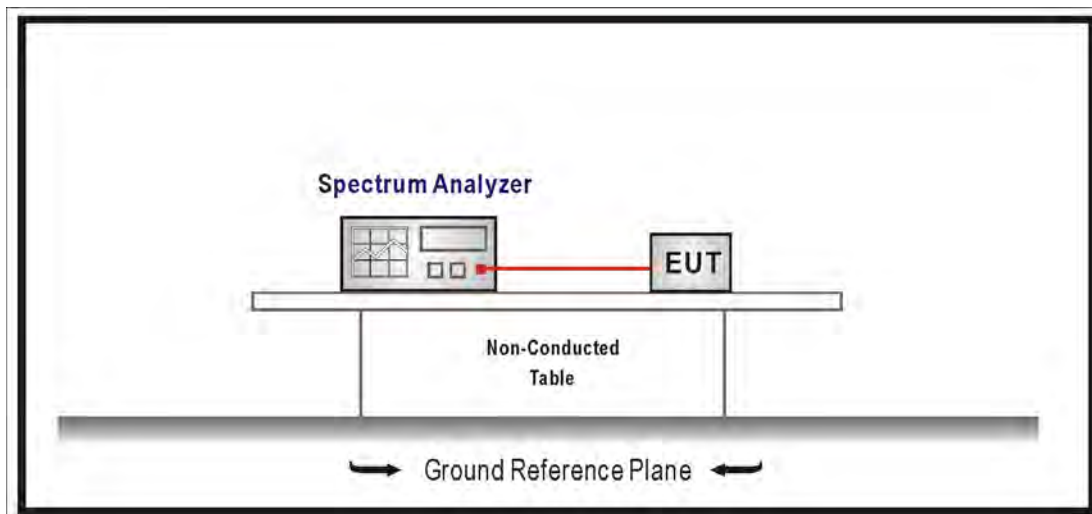

6.2. Limits

Emissions radiated outside of the specified frequency bands, except for harmonics, shall be attenuated by at least 20dB below the level of the fundamental or to the general radiated emission limits in paragraph 15.209, whichever is the lesser attenuation.

6.3. Test Procedure

The EUT was setup according to ANSI C63.10: 2013 and tested according to DTS test procedure of KDB 558074 D01V05r02 for compliance to FCC 47CFR 15.247 requirements.

6.4. Test Specification

According to FCC Part 15 Subpart C Paragraph 15.247: 2019

6.5. Test Result

Product	Insyde		
Test Item	Bandedge test		
Test Mode	Mode 1: Transmit Mode		
Date of Test	2020/10/21	Test Site	SR12-H
Temperature(°C)	25.1	Humidity (%RH)	55

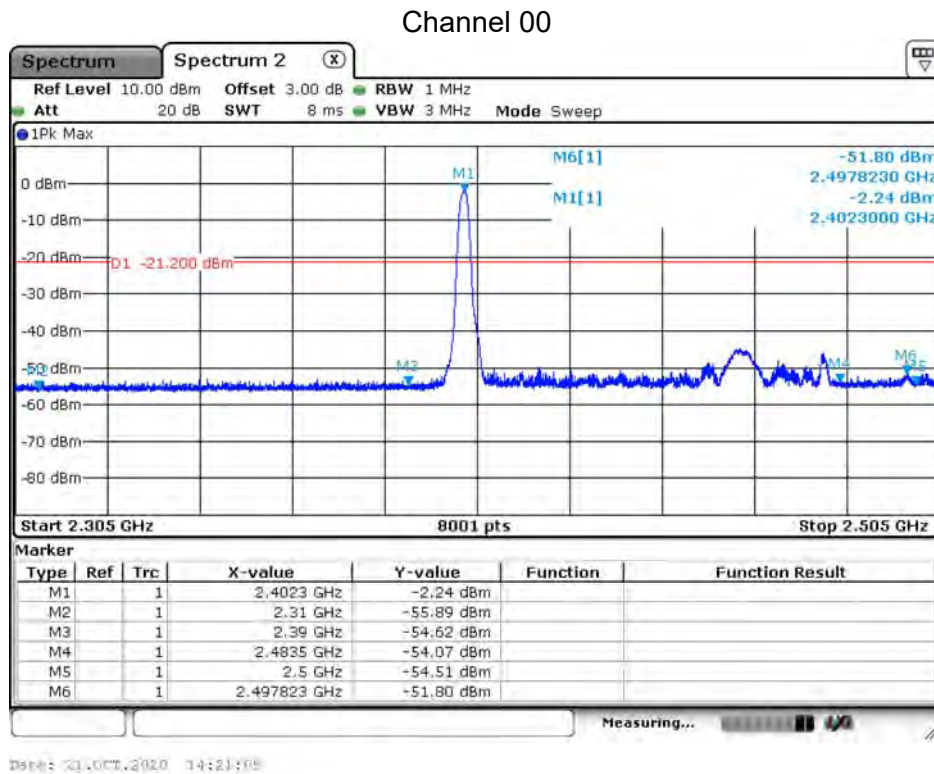

Channel 19

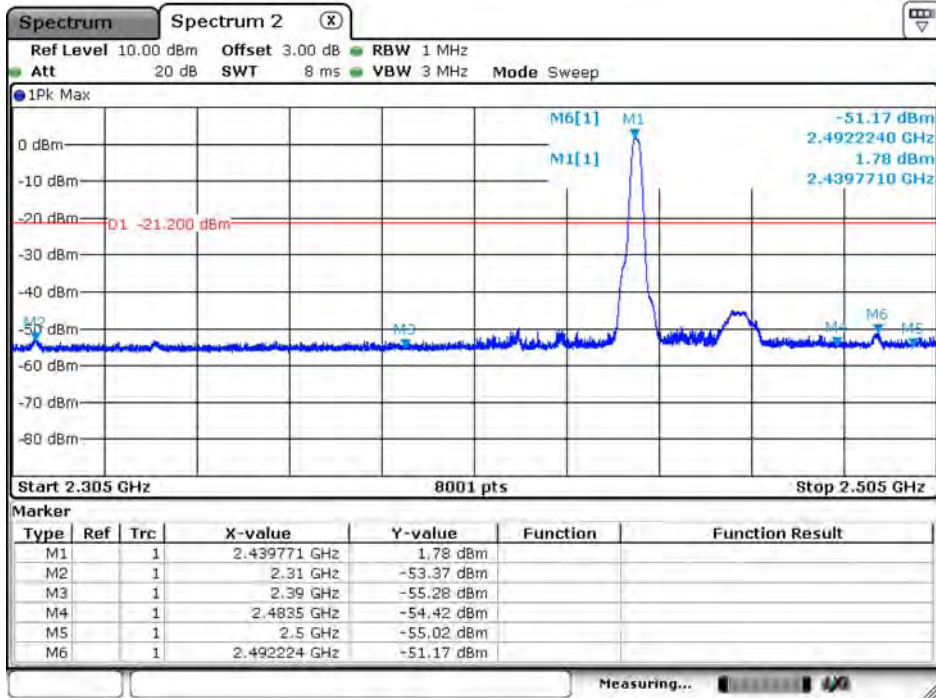

Date: 21.OCT.2020 14:07:47

Channel 39

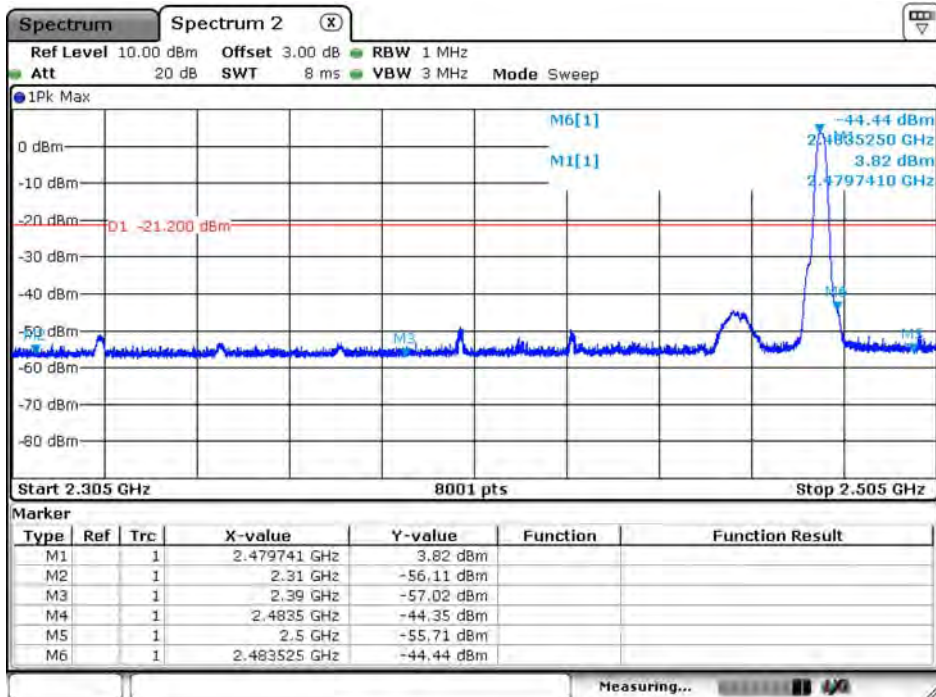

Date: 21.OCT.2020 13:33:00

7. Occupied Bandwidth & DTS Bandwidth

7.1. Test Setup

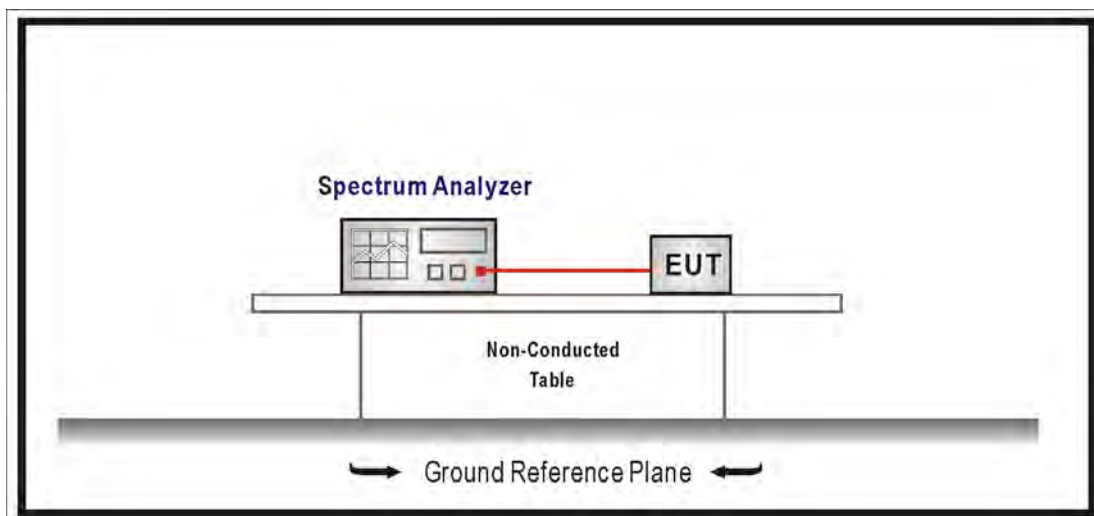

7.2. Test Procedures

The EUT was setup according to ANSI C63.10: 2013; tested according to DTS test procedure of KDB 558074 D01V05r02 for compliance to FCC 47CFR 15.247 requirements.

7.3. Limits

The 6 dB bandwidth: ≥ 500 kHz.

Occupied Bandwidth: NA

7.4. Test Specification

According to FCC Part 15 Subpart C Paragraph 15.247: 2019

7.5. Test Result

Product	Insyde		
Test Item	Occupied Bandwidth & DTS Bandwidth		
Test Mode	Mode 1: Transmit Mode		
Date of Test	2020/09/16 ~ 2021/02/02	Test Site	SR12-H
Temperature(°C)	22	Humidity (%RH)	69

Channel No.	Frequency (MHz)	Measure Level (MHz)		Limit (MHz)	
		Occupied Bandwidth	DTS Bandwidth	Occupied Bandwidth	DTS Bandwidth
00	2402	1.036	0.699	--	≥ 500
19	2440	1.029	0.703	--	≥ 500
39	2480	1.030	0.694	--	≥ 500

Channel 00

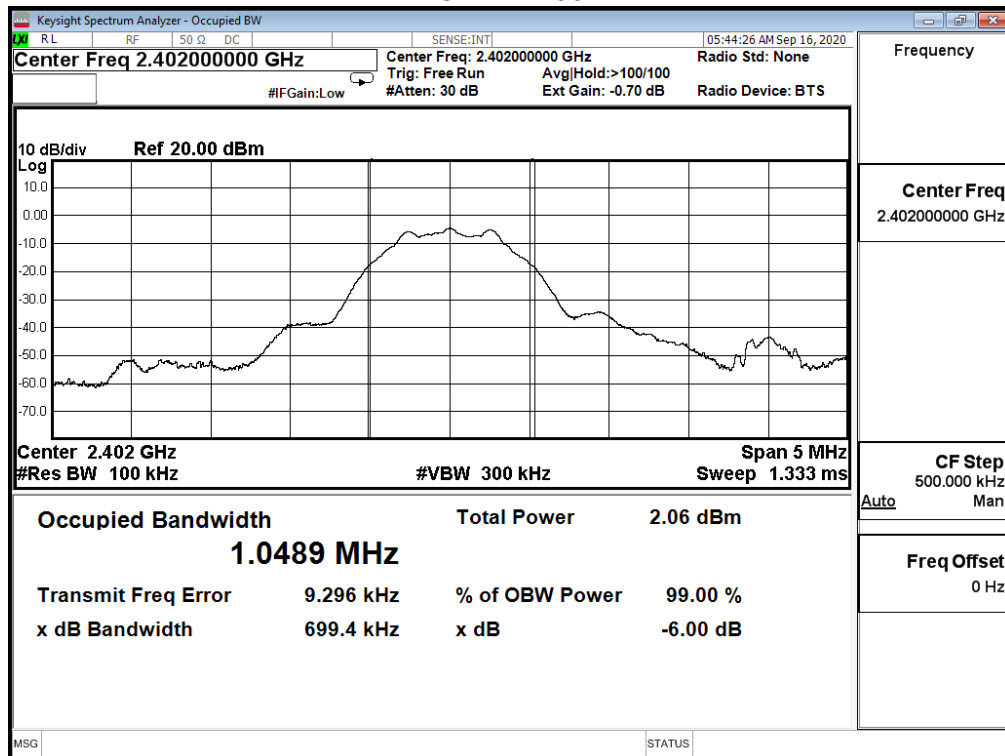

Channel 19

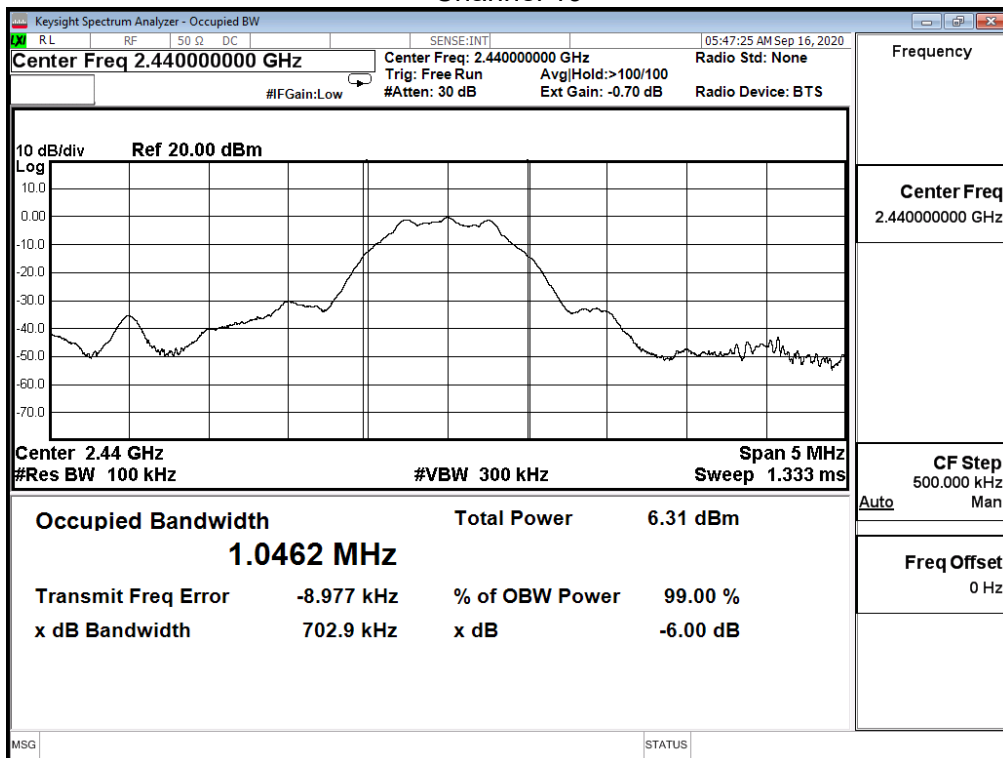

Channel 39

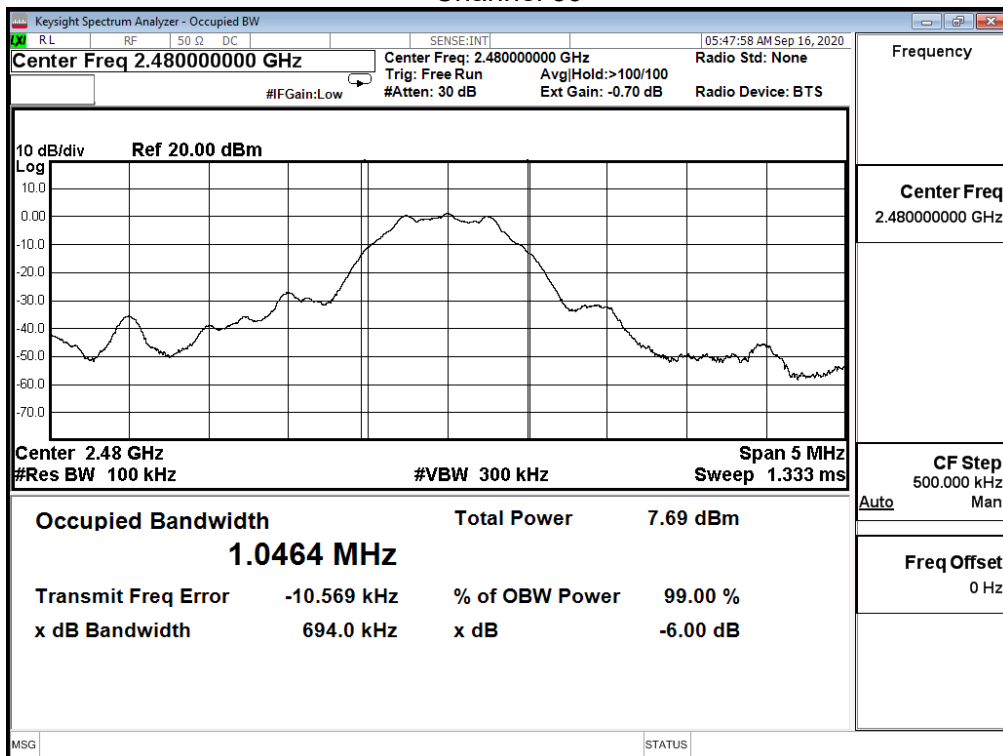

Channel 00

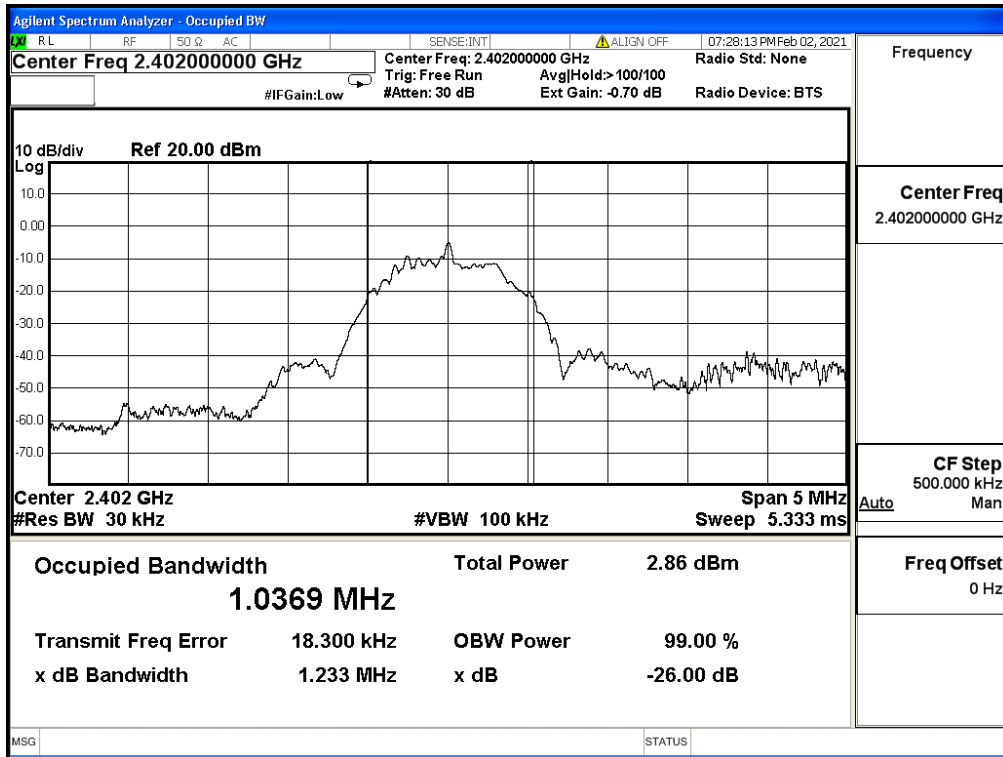

Channel 19

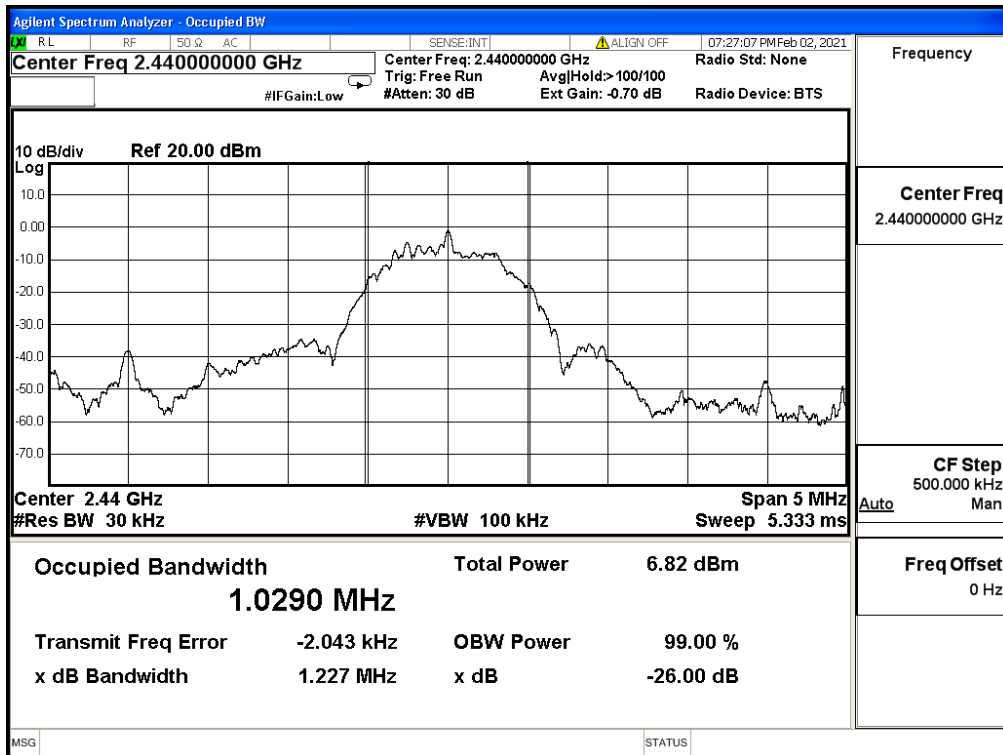

Channel 39

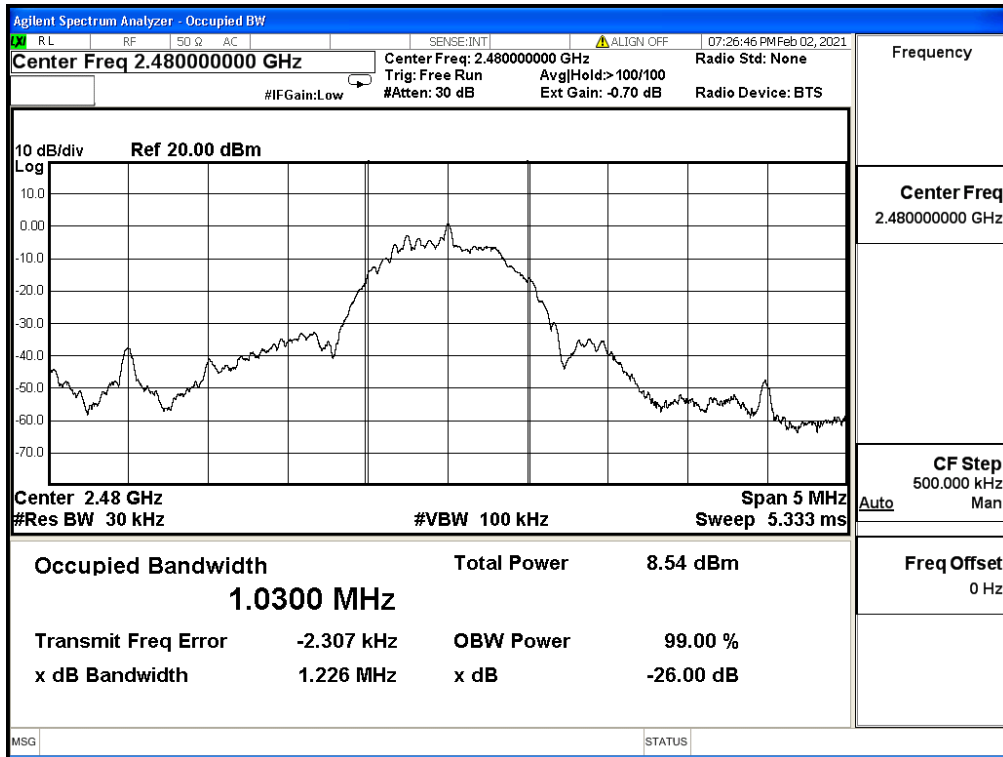

8. Power Density

8.1. Test Setup

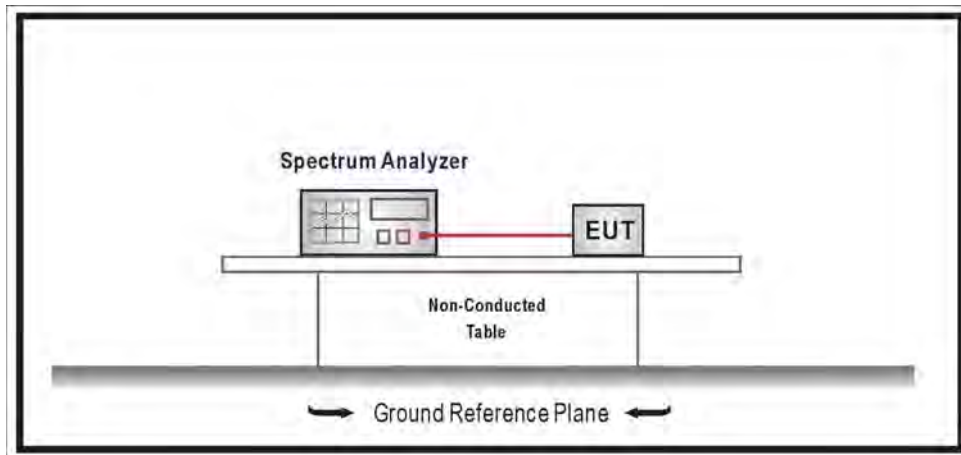

8.2. Limits

The peak power spectral density conducted from the intentional radiated to the antenna shall not be greater than +8dBm in any 3kHz band during any time interval of continuous transmission.

8.3. Test Procedures

The EUT was setup according to ANSI C63.10: 2013; tested according to DTS test procedure of KDB 558074 D01V05r02 for compliance to FCC 47CFR 15.247 requirements.

8.4. Test Specification

According to FCC Part 15 Subpart C Paragraph 15.247

8.5. Test Result

Product	Insyde		
Test Item	Power Density		
Test Mode	Mode 1: Transmit Mode		
Date of Test	2020/09/16	Test Site	SR12-H
Temperature(°C)	22	Humidity (%RH)	56

Channel No.	Frequency (MHz)	Measure Value (dBm/RBW)	Limit (dBm/3kHz)
00	2402	-12.306	≤ 8.000
19	2440	-8.153	≤ 8.000
39	2480	-6.687	≤ 8.000

Channel 00

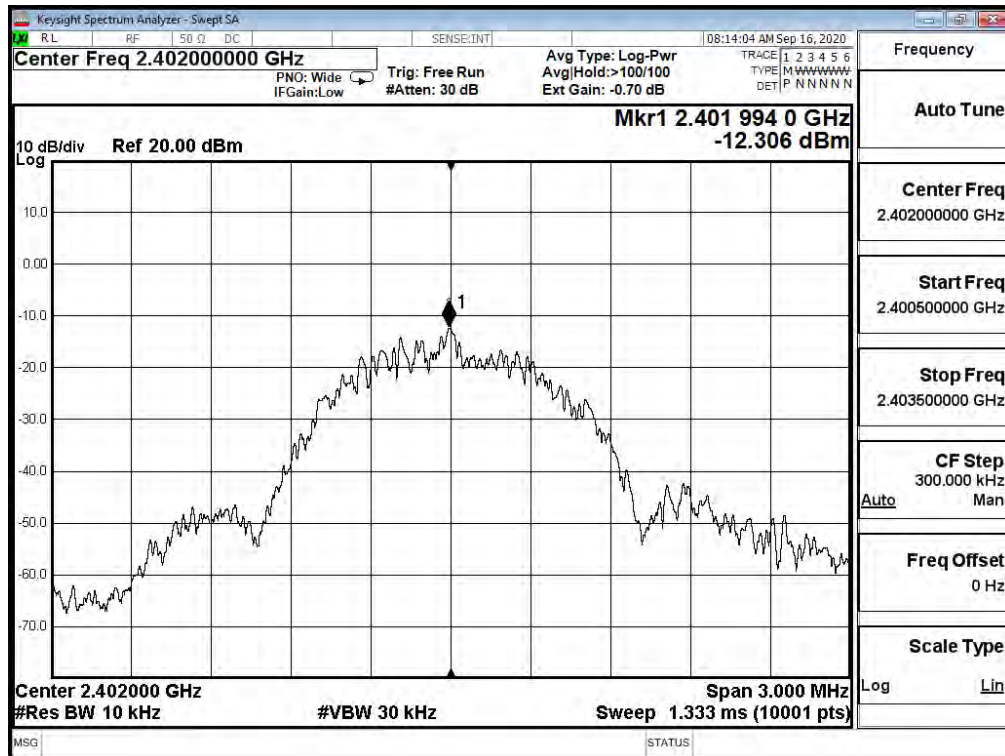

Channel 19

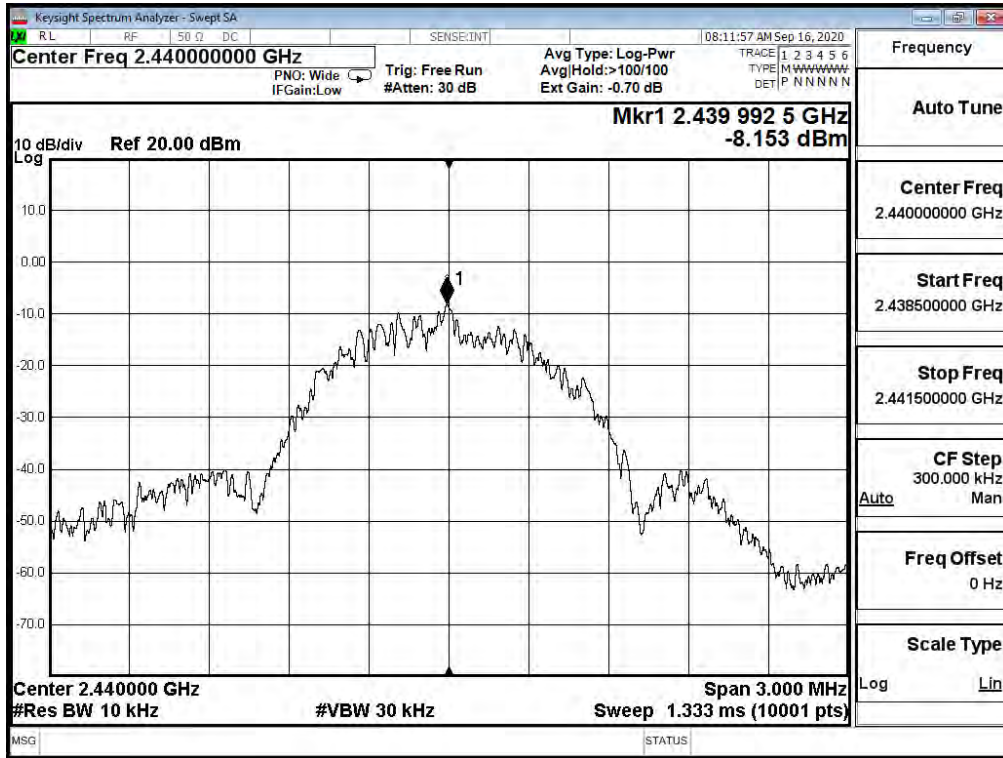

Channel 39

