



DATE: 23 January 2017

I.T.L. (PRODUCT TESTING) LTD.

FCC/IC Radio Test Report

for

Cardo Systems, Inc.

Equipment under test:

Bluetooth Communication System for Motorcycles

scala rider FREECOM2 scala rider FREECOM4* (BLE)

*See customer's Declaration on page 5

Tested by:

_____ 
A. Yizhak

Approved by:

_____ 
M. Zohar

This report must not be reproduced, except in full, without the written permission of I.T.L. (Product Testing) Ltd.

This report relates only to items tested.



Measurement/Technical Report for Cardo Systems, Inc.

Bluetooth Communication System for Motorcycles scala rider FREECOM2

FCC ID: Q95ER22

IC: 4668A-ER22

This report concerns:	Original Grant: X
	Class I Change:
	Class II Change:
 Equipment type:	Digital Transmission System IC: Spread Spectrum Digital Device (2400-2483.5)
 Limits used:	47CFR15 Section 15.247 RSS-247, Issue 1, May 2015 RSS Gen, Issue 4, November 2014

Measurement procedure used is KDB 558074 D01 v03r05 and ANSI C63.10:2013.

Application for Certification prepared by:	Applicant for this device: (different from "prepared by")
R. Pinchuck	Avi Moato
ITL (Product Testing) Ltd.	Cardo Systems Inc.
1 Bat Sheva Street	1204 Parkway View Drive
Lod 7116002	Pittsburgh, Pennsylvania, USA 15205
Israel	Tel: +972-3-7353111
e-mail Rpinchuck@itl.co.il	Fax: +972-3-5623360
	Email: moato@cardosystems.com



TABLE OF CONTENTS

1.	GENERAL INFORMATION	5
1.1	Administrative Information	5
1.2	List of Accreditations	7
1.3	Product Description	8
1.4	Test Methodology	8
1.5	Test Facility	8
1.6	Measurement Uncertainty	8
2.	SYSTEM TEST CONFIGURATION	9
2.1	Justification	9
2.2	EUT Exercise Software	9
2.3	Special Accessories	9
2.4	Equipment Modifications	9
2.5	Configuration of Tested System	10
3.	CONDUCTED & RADIATED MEASUREMENT TEST SET-UP PHOTOS	11
4.	CONDUCTED EMISSION FROM AC MAINS	14
4.1	Test Specification	14
4.2	Test Procedure	14
4.3	Test Limit	14
4.4	Test Results	15
4.5	Test Equipment Used; Conducted Emission	20
5.	6 DB MINIMUM BANDWIDTH	21
5.1	Test Specification	21
5.2	Test Procedure	21
5.3	Test Results	21
5.4	Test Equipment Used; 6dB Bandwidth	23
6.	99% OCCUPIED BANDWIDTH	24
6.1	Test Specification	24
6.2	Test Procedure	24
6.3	Test Results	24
6.4	Test Equipment Used; Occupied Bandwidth	26
7.	MAXIMUM TRANSMITTED PEAK POWER OUTPUT	27
7.1	Test Specification	27
7.2	Test Procedure	27
7.3	Test Results	27
7.4	Test Equipment Used; Maximum Peak Power Output	29
8.	BAND EDGE SPECTRUM	30
8.1	Test Specification	30
8.2	Test Procedure	30
8.3	Test Results	30
8.4	Test Equipment Used; Band Edge Spectrum	32
10.	EMISSIONS IN RESTRICTED FREQUENCY BANDS	36
10.1	Test Specification	36
10.2	Test Procedure	36
10.3	Test Results	37
10.4	Test Instrumentation Used; Emissions in Restricted Frequency Bands	40
11.	TRANSMITTED POWER DENSITY	41
11.1	Test Specification	41
11.2	Test Procedure	41
11.3	Test Results	41
11.4	Test Equipment Used; Transmitted Power Density	43
12.	AVG. FACTOR CALCULATION	44
13.	ANTENNA GAIN/INFORMATION	46



14.	R.F EXPOSURE/SAFETY	47
15.	APPENDIX A - CORRECTION FACTORS	49
15.1	Correction factors for CABLE from EMI receiver	49
15.2	Correction factor for RF CABLE for Semi Anechoic Chamber	50
15.3	Correction factors for Low Loss CABLE	51
15.4	Correction factors for ACTIVE LOOP ANTENNA	52
15.5	Correction factors for Biconical Antenna	53
15.6	Correction factors for Log Periodic Antenna	54
15.7	Correction factors for Horn ANTENNA	55



1. General Information

1.1 Administrative Information

Manufacturer: Cardo Systems, Inc.

Manufacturer's Address: 1204 Parkway View Drive
Pittsburgh, Pennsylvania, 15205
USA
Tel: +972-3-735-3111
Fax: +972-3-562-3360

Manufacturer's Representative: Avi Moato

Equipment Under Test (E.U.T): Bluetooth Communication System
for Motorcycles

Product Marketing Name (PMN): scala rider FREECOM2
scala rider FREECOM4*

Equipment Serial No.: Not designated

HVIN: 1

Date of Receipt of E.U.T: November 1, 2016

Start of Test: November 2, 2016

End of Test: November 21, 2016

Test Laboratory Location: I.T.L (Product Testing) Ltd.
1 Batsheva St.,
Lod
ISRAEL 7120101

Test Specifications: FCC Part 15, Subpart C
RSS-247, Issue 1, May 2015
RSS Gen Issue 4, November 2014

*See customer's Declaration on following page.



DECLARATION

Date: December 25, 2016

I HEREBY DECLARE THE FOLLOWING REGARDING THE BELOW MODELS:

- 1) **PMN: Scala Rider Freecom2**
- 2) **PMN: Scala Rider Freecom4**

1. **The above models are identical physically, mechanically and electronically except for the below differences which are controlled by software.**
2. **Number of simultaneously connected devices:**
Freecom2 – Rider device + one (1) device;
Freecom4- - Rider device +three (3) devices
3. **Feature Voice Menu:**
Only the Freecom4 has this feature.

Please relate to them (from a RADIO point of view) as the same product.

Thank you,

Avi Moato

Director of R&D

Cardo Systems, Inc.
1204 Parkway View Drive
Pittsburgh, PA 15205

Cardo Systems, Inc.
1204 Parkway View Drive
Pittsburgh, PA 15205 USA
www.cardosystems.com
Tel: +1 (412) 788.4533
Fax: +1 (412) 788.0270
✉ support@cardosystems.com



1.2 List of Accreditations

The EMC laboratory of I.T.L. is accredited by the following bodies:

1. The American Association for Laboratory Accreditation (A2LA) (U.S.A.), Certificate No. 1152.01.
2. The Federal Communications Commission (FCC) (U.S.A.), FCC Designation No. IL1005.
3. The Israel Ministry of the Environment (Israel), Registration No. 1104/01.
4. The Voluntary Control Council for Interference by Information Technology Equipment (VCCI) (Japan), Registration Numbers: C-3006, R-2729, T-1877, G-245.
5. Industry Canada (Canada), IC File No.: 46405-4025; Site Nos. IC 4025A-1, IC 4025A-2.

I.T.L. Product Testing Ltd. is accredited by the American Association for Laboratory Accreditation (A2LA) and the results shown in this test report have been determined in accordance with I.T.L.'s terms of accreditation unless stated otherwise in the report.



1.3 Product Description

This product is a class 1 Bluetooth headset, Bluetooth intercom for motorbikes.

- Audio streaming via devices supporting Bluetooth Stereo A2DP and AVRCP
- profiles, Music Sharing: Rider and Passenger can enjoy the same stereo music (via A2DP)
- Built-in FM Radio with 6 station presets and automatic tuning

Working voltage	3.1-4.2V DC battery operated
Mode of operation	Transceiver
Modulations	GFSK
Frequency Range	2402MHz-2480MHz
Transmit power	~18dBm
Antenna Gain	-2.0 dBi
Modulation BW	>500kHz
Temperature (°C)/ Humidity (%RH)	25°C/44%

1.4 Test Methodology

Both conducted and radiated testing was performed according to the procedures in KDB 558074 D01 v03r05 and ANSI C63.10: 2013. Radiated testing was performed at an antenna to EUT distance of 3 meters.

1.5 Test Facility

Emissions tests were performed at I.T.L.'s testing facility in Lod, Israel. I.T.L.'s EMC Laboratory is accredited by A2LA, certificate No. 1152.01 and its FCC Designation Number is IL1005.

1.6 Measurement Uncertainty

Conducted Emission

(CISPR 11, EN 55011, CISPR 22, EN 55022, ANSI C63.4)

0.15 – 30 MHz:

Expanded Uncertainty (95% Confidence, K=2):

± 3.44 dB

Radiated Emission

(CISPR 11, EN 55011, CISPR 22, EN 55022, ANSI C63.4) for open site 30-1000MHz:

Expanded Uncertainty (95% Confidence, K=2):

± 4.98 dB

2. System Test Configuration

2.1 Justification

Exploratory emission testing was performed in 3 orthogonal polarities to determine the “worst case”.

The fundamental results are shown in the below table:

Frequency	X				Y				Z			
	Field Strength	2 rd H	3 th H	Band Edge	Field Strength	2 rd H	3 th H	Band Edge	Field Strength	2 rd H	3 th H	Band Edge
	(dBuV/m)	(dBuV/m)	(dBuV/m)	(dBuV/m)	(dBuV/m)	(dBuV/m)	(dBuV/m)	(dBuV/m)	(dBuV/m)	(dBuV/m)	(dBuV/m)	(dBuV/m)
2402.0	97.83	57.9	57.30	53.5	96.1.0	64.1	68.8	52.2	95.4	59.9	59.1	53.1
2440.0	98.8	60.0	57.9	-	97.1	63.5	64.5	-	95.8	62.8	59.2	-
2480.0	100.14	62.4	57.2.3	49.4	97.2	63.1	60.3	52.1	96.3	62.8	59.6	52.1

Figure 1. Screening Results

According to above results the worst case was the X axis.

The unit was evaluated while transmitting at the low channel (2402MHz), the mid channel (2440MHz) and the high channel (2480MHz) in BLE technology.

2.2 EUT Exercise Software

No special exercise software was used.

2.3 Special Accessories

No special accessories were needed to achieve compliance.

2.4 Equipment Modifications

No modifications were necessary in order to achieve compliance.

2.5 Configuration of Tested System

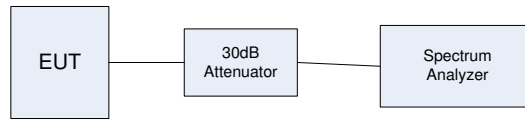

Figure 2. Configuration of Tested System – Conducted Emission on Antenna Ports

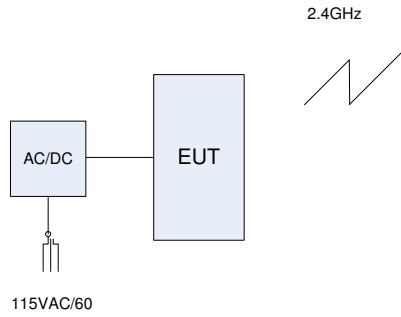

Figure 3. Configuration of Tested System – Conducted Emission on AC Line

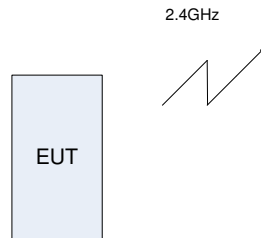

Figure 4. Configuration of Tested System – Radiated Emission

3. Conducted & Radiated Measurement Test Set-Up Photos



Figure 5. Conducted Emission From Antenna Ports Test Set-Up



Figure 6. Conducted Emission From AC Mains

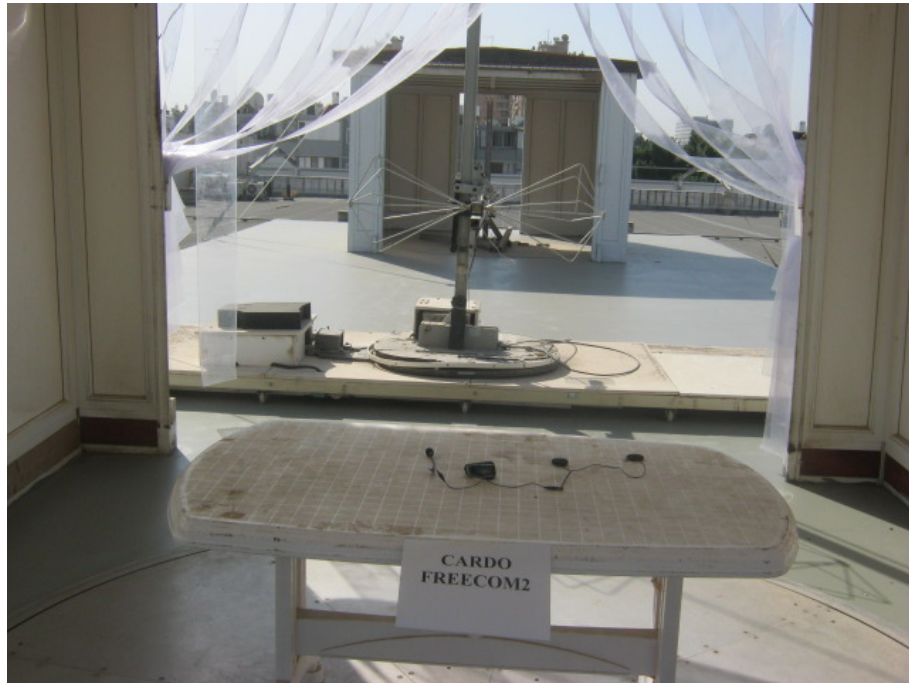

Figure 7. Radiated Emission Test

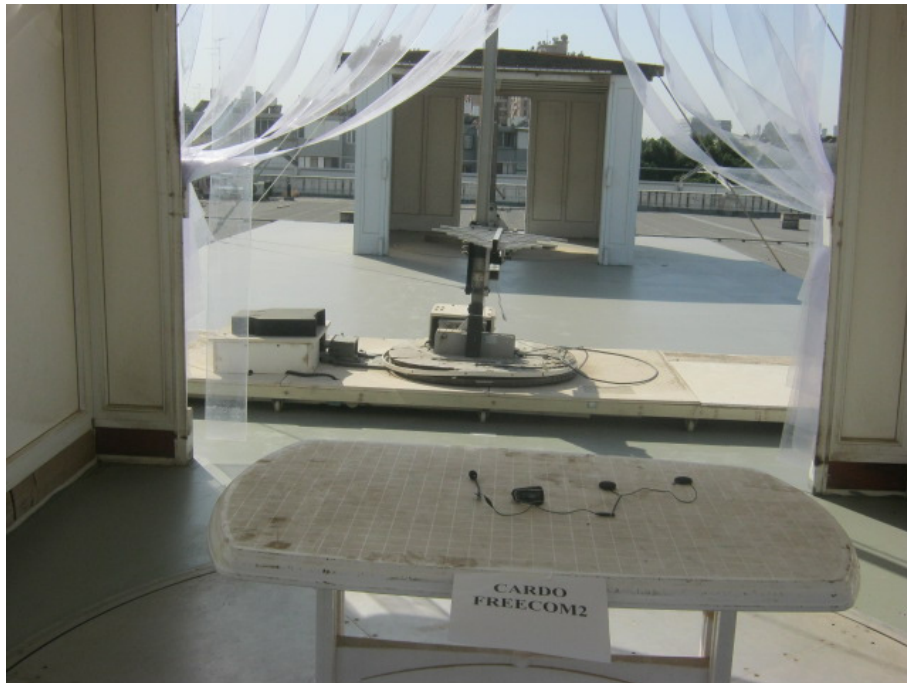

Figure 8. Radiated Emission Test

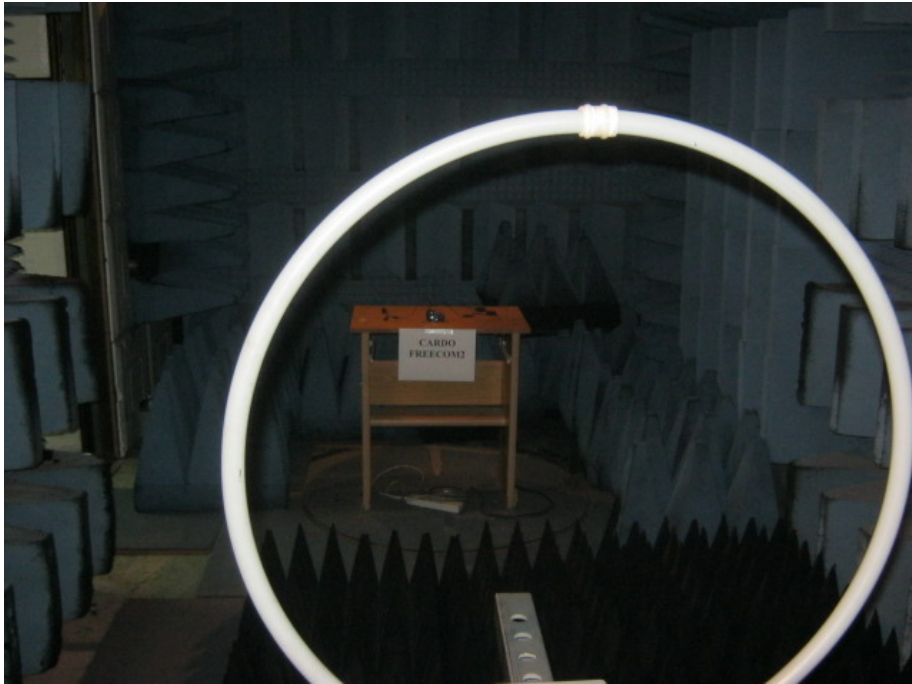

Figure 9. Radiated Emission Test



Figure 10. Radiated Emission Test

4. Conducted Emission From AC Mains

4.1 Test Specification

FCC Part 15, Subpart C, Section 15.207
RSS Gen, Issue 4, Clause 8.8

4.2 Test Procedure

(Temperature (24°C)/ Humidity (40%RH))

The E.U.T operation mode and test setup are as described in Section 2 of this report. In order to minimize background noise interference, the conducted emission testing was performed inside a shielded room, with the E.U.T placed on a 0.8 meter high wooden table, 0.4 meter from the room's vertical wall. In the case of a floor-standing E.U.T., it was placed on the horizontal ground plane.

The E.U.T was powered from 115 V AC / 60 Hz via 50 Ohm / 50 μ Hn Line Impedance Stabilization Network (LISN) on the phase and neutral lines. The LISN's were grounded to the shielded room ground plane (floor), and were kept at least 0.8 meters from the nearest boundary of the E.U.T

The center of the E.U.T.'s AC cable was folded back and forth, in order to form a bundle less than 0.40 meters and a total cable length of 1 meter.

The effect of varying the position of the cables was investigated to find the configuration that produces maximum emission. The configuration tested is shown in the photograph, *Figure 6. Conducted Emission From AC Mains.*

The emission voltages at the LISN's outputs were measured using a computerized receiver, complying with CISPR 16 requirements. The specification limits are loaded to the receiver and are displayed on the receiver's spectrum display.

The E.U.T was evaluated in TX operation mode

A frequency scan between 0.15 and 30 MHz was performed at 9 kHz I.F. band width, using peak detection.

The spectral components having the highest level on each line were measured using a quasi-peak and average detector.

4.3 Test Limit

Frequency of emission (MHz)	Conducted limit (dB μ V)	
	Quasi-peak	Average
0.15-0.5	66 to 56*	56 to 46*
0.5-5	56	46
5-30	60	50

* Decreases with the logarithm of the frequency.



4.4 Test Results

JUDGEMENT: Passed by 28.64 dB

The margin between the emission levels and the specification limit is, in the worst case, 29.31 dB for the phase line at 0.298 MHz and 28.64 dB at 27.62 MHz for the neutral line.

The EUT met the F.C.C. Part 15, Subpart C and RSS Gen, Issue 4, Clause 8.8 specification requirements.

The details of the highest emissions are given in *Figure 11* to *Figure 14*.



Conducted Emission

E.U.T Description Bluetooth Communication
System for Motorcycles
Type scala rider FREECOM2
Serial Number: Not designated

Specification: FCC Part 15, Subpart C
Lead: Phase
Detectors: : Peak, Quasi-peak, Average
Power Operation AC/DC adapter

EDIT PEAK LIST (Final Measurement Results)				
Trace1:	CE22BQP			
Trace2:	CE22BAP			
Trace3:	---			
	TRACE	FREQUENCY	LEVEL dBµV	DELTA LIMIT dB
2	Average	222 kHz	12.33	-40.41
1	Quasi Peak	238 kHz	25.45	-36.71
1	Quasi Peak	298 kHz	30.98	-29.31
2	Average	298 kHz	14.23	-36.06
1	Quasi Peak	454 kHz	25.61	-31.18
2	Average	574 kHz	10.37	-35.62
2	Average	774 kHz	9.50	-36.49
1	Quasi Peak	1.166 MHz	21.71	-34.28
1	Quasi Peak	1.478 MHz	23.37	-32.62
2	Average	1.546 MHz	11.53	-34.46
1	Quasi Peak	2.358 MHz	22.41	-33.58
2	Average	3.062 MHz	9.08	-36.91
1	Quasi Peak	3.65 MHz	16.35	-39.64
2	Average	3.97 MHz	5.57	-40.42
1	Quasi Peak	7.638 MHz	14.19	-45.81
2	Average	10.326 MHz	6.34	-43.65
1	Quasi Peak	10.822 MHz	13.75	-46.25
2	Average	16.534 MHz	6.74	-43.25
2	Average	22.598 MHz	12.61	-37.38
1	Quasi Peak	27.574 MHz	17.99	-42.00

Date: 21.NOV.2016 15:43:14

Figure 11. Detectors: Peak, Quasi-peak, Average

Note: QP Delta/Av Delta refers to the test results obtained minus specified requirement; thus a positive number indicates failure, and a negative result indicates that the product passes the test.

Conducted Emission

E.U.T Description Bluetooth Communication
System for Motorcycles
Type scala rider FREECOM2
Serial Number: Not designated

Specification: FCC Part 15, Subpart C
Lead: Phase
Detectors: Peak, Quasi-peak, Average
Power Operation AC/DC adapter

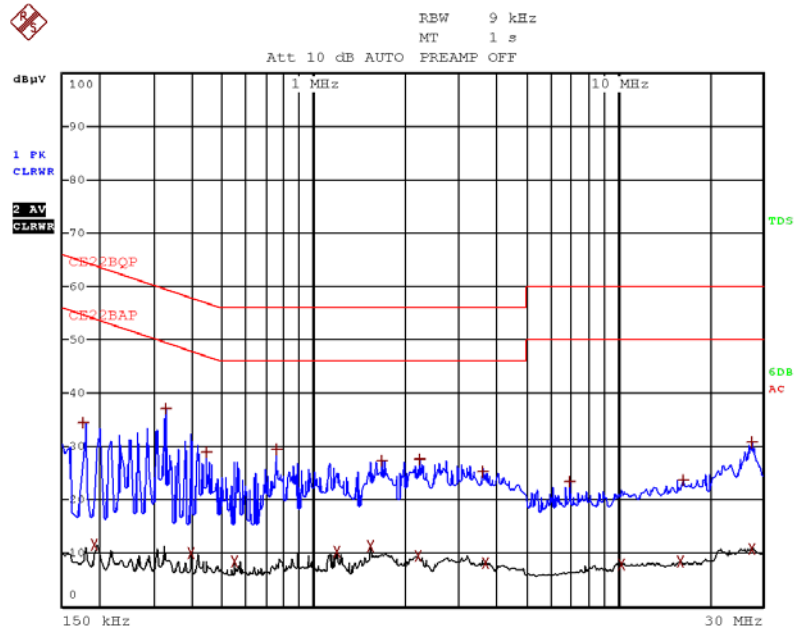

Date: 21.NOV.2016 15:50:34

Figure 12. Detectors: Peak, Quasi-peak, Average



Conducted Emission

E.U.T Description Bluetooth Communication System for Motorcycles
Type scala rider FREECOM2
Serial Number: Not designated

Specification: FCC Part 15, Subpart C
Lead: Neutral
Detectors: Peak, Quasi-peak, Average
Power Operation AC/DC adapter

EDIT PEAK LIST (Final Measurement Results)			
TRACE	FREQUENCY	LEVEL dBμV	DELTA LIMIT dB
Trace1:	CE22BQP		
Trace2:	CE22BAF		
Trace3:	---		
2 Average	198 kHz	13.17	-40.52
1 Quasi Peak	250 kHz	20.85	-40.90
1 Quasi Peak	322 kHz	24.08	-35.57
2 Average	330 kHz	17.00	-32.44
1 Quasi Peak	438 kHz	21.78	-35.31
2 Average	734 kHz	11.33	-34.67
1 Quasi Peak	890 kHz	18.29	-37.71
2 Average	890 kHz	10.27	-35.72
1 Quasi Peak	1.422 MHz	14.53	-41.46
2 Average	1.546 MHz	10.44	-35.55
2 Average	3.122 MHz	9.99	-36.00
1 Quasi Peak	3.474 MHz	18.84	-37.15
1 Quasi Peak	3.61 MHz	18.93	-37.06
2 Average	3.61 MHz	8.79	-37.20
2 Average	9.418 MHz	7.65	-42.34
1 Quasi Peak	9.966 MHz	15.39	-44.60
1 Quasi Peak	15.53 MHz	18.31	-41.68
2 Average	17.474 MHz	9.19	-40.81
1 Quasi Peak	27.622 MHz	31.35	-28.64
2 Average	27.834 MHz	19.34	-30.66

Date: 21.NOV.2016 15:58:01

Figure 13. Detectors: Peak, Quasi-peak, Average

Note: QP Delta/Av Delta refers to the test results obtained minus specified requirement; thus a positive number indicates failure, and a negative result indicates that the product passes the test.

Conducted Emission

E.U.T Description Bluetooth Communication System for Motorcycles
 Type scala rider FREECOM2
 Serial Number: Not designated

Specification: FCC Part 15, Subpart C
 Lead: Neutral
 Detectors: Peak, Quasi-peak, Average
 Power Operation AC/DC adapter

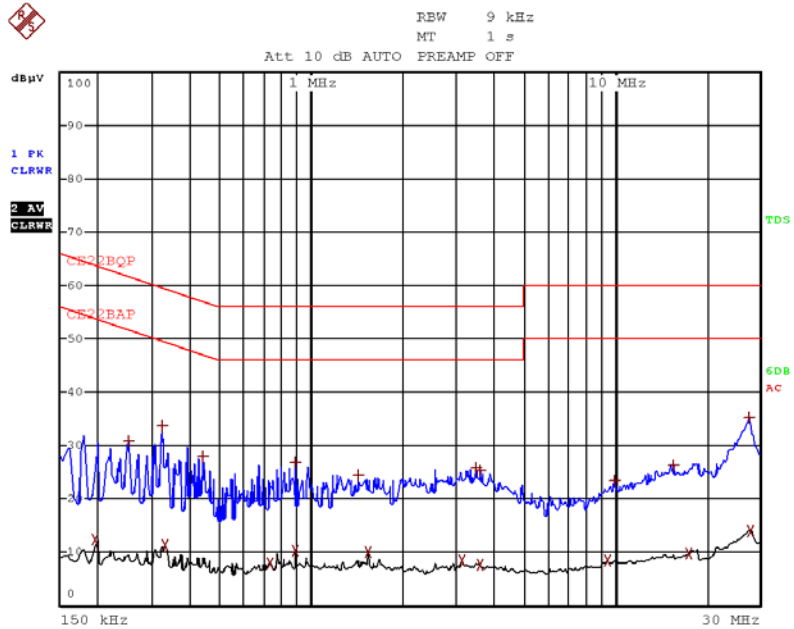

Date: 21.NOV.2016 15:56:28

Figure 14 Detectors: Peak, Quasi-peak, Average



4.5 Test Equipment Used; Conducted Emission

Instrument	Manufacturer	Model	Serial No.	Last Calibration Date	Next Calibration Due
LISN	Fischer	FCC-LISN-25A	127	June 23, 2016	June 23, 2017
Transient Limiter	HP	11947A	3107A03041	June 15, 2016	June 15, 2017
EMI Receiver	Rohde & Schwarz	ESCI7	100724	February 29, 2016	March 1, 2017
Low Loss Cable	Huber Suhner	-	705A009301 EIM	May 30, 2016	May 30, 2017

Figure 15 Test Equipment Used

5. 6 dB Minimum Bandwidth

5.1 Test Specification

FCC Part 15, Subpart C, Section 247(a)(2)
RSS 247, Issue 1, 2015, Section 5.2

5.2 Test Procedure

(Temperature (23°C)/ Humidity (60%RH))

The E.U.T operation mode and test set-up are as described in Section 2 of this report.

The E.U.T. antenna terminal was connected to the Spectrum Analyzer through an external attenuator and an appropriate coaxial cable (loss=31.0 dB). Special attention was taken to prevent Spectrum Analyzer RF input overload.

The spectrum bandwidth of the E.U.T. at the point of 6 dB below maximum peak power was measured and recorded. The RBW was set to 100 kHz.

5.3 Test Results

Operation Frequency (MHz)	Reading (MHz)	Specification (MHz)
2402	0.695	>0.5
2440	0.706	>0.5
2480	0.706	>0.5

Figure 16 6 dB Minimum Bandwidth

JUDGEMENT: Passed

For additional information see *Figure 17* to *Figure 19*.

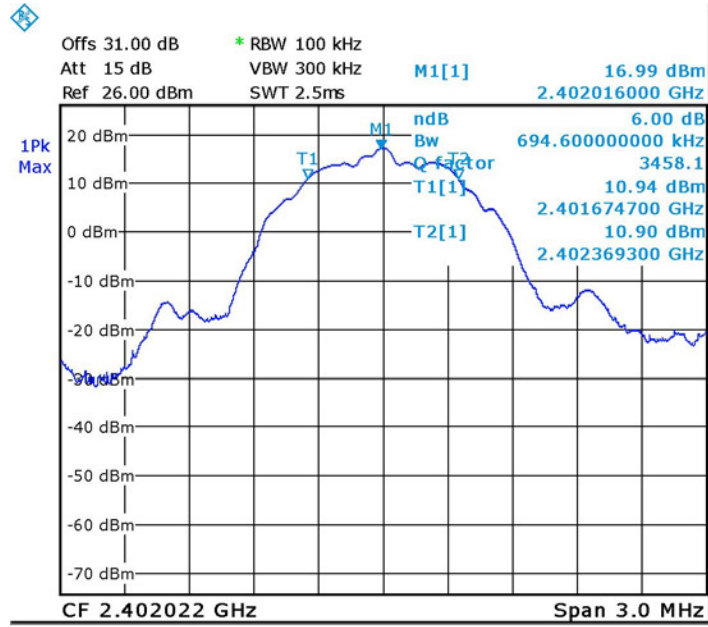

Date: 7.NOV.2016 11:11:19

Figure 17. 2402.0 MHz

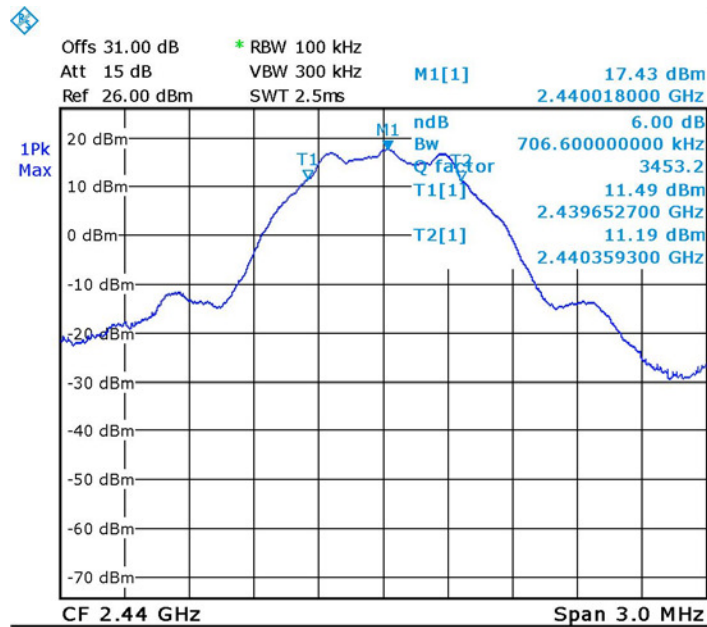

Date: 7.NOV.2016 11:58:47

Figure 18. 2440.0 MHz

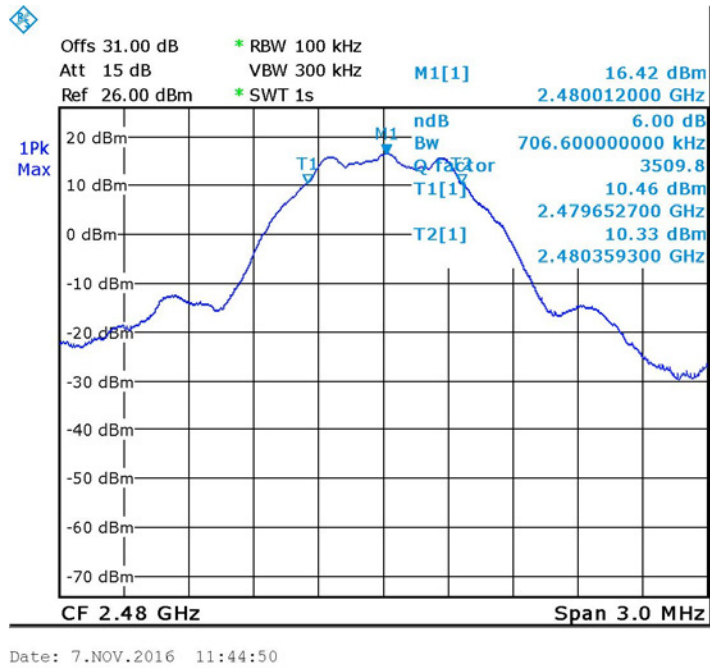

Figure 19. 2480.0 MHz

5.4 Test Equipment Used; 6dB Bandwidth

Instrument	Manufacturer	Model	Serial No.	Last Calibration Date	Next Calibration Due
Spectrum Analyzer	R&S	FSL6	100194	February 29, 2016	March 1, 2017
30dB Attenuator	Bird	8304-N30DB	533	June 1, 2016	June 1, 2017

Figure 20 Test Equipment Used

6. 99% Occupied Bandwidth

6.1 Test Specification

RSS Gen, Issue 4, Section 6.6

6.2 Test Procedure

(Temperature (23°C)/ Humidity (60%RH))

The E.U.T operation mode and test set-up are as described in Section 2 of this report.

The E.U.T. antenna terminal was connected to the Spectrum Analyzer through an external attenuator and an appropriate coaxial cable (loss=31.0 dB). Special attention was taken to prevent Spectrum Analyzer RF input overload.

The RBW was set to 100 kHz.

6.3 Test Results

Operation Frequency (MHz)	Reading (MHz)
2402	1.078
2440	1.078
2480	1.078

Figure 21 Occupied Bandwidth

JUDGEMENT: Passed

For additional information see *Figure 17* to *Figure 19*.

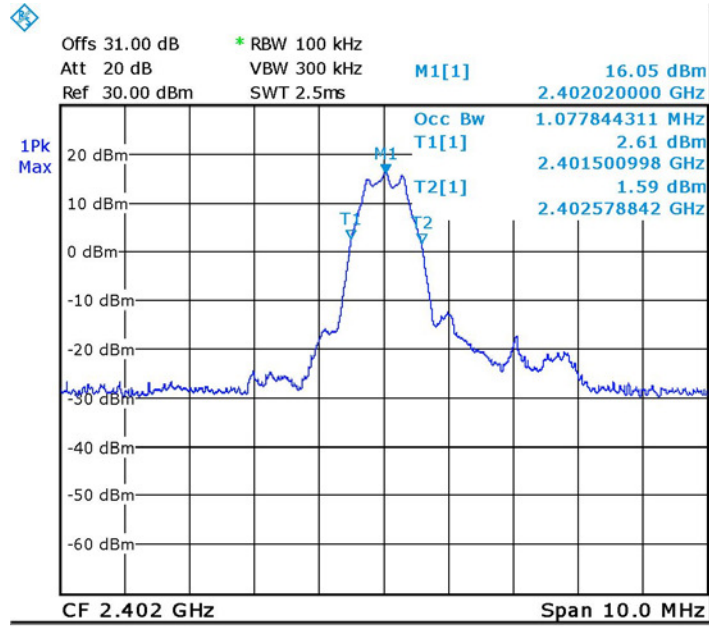

Date: 20.DEC.2016 08:03:17

Figure 22. 2402.0 MHz – Occupied Bandwidth

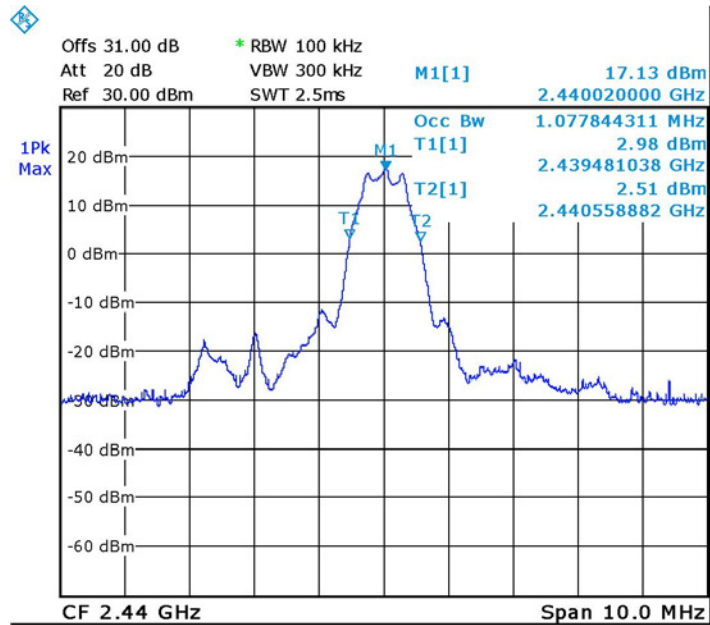

Date: 20.DEC.2016 08:04:49

Figure 23. 2440.0 MHz - Occupied Bandwidth

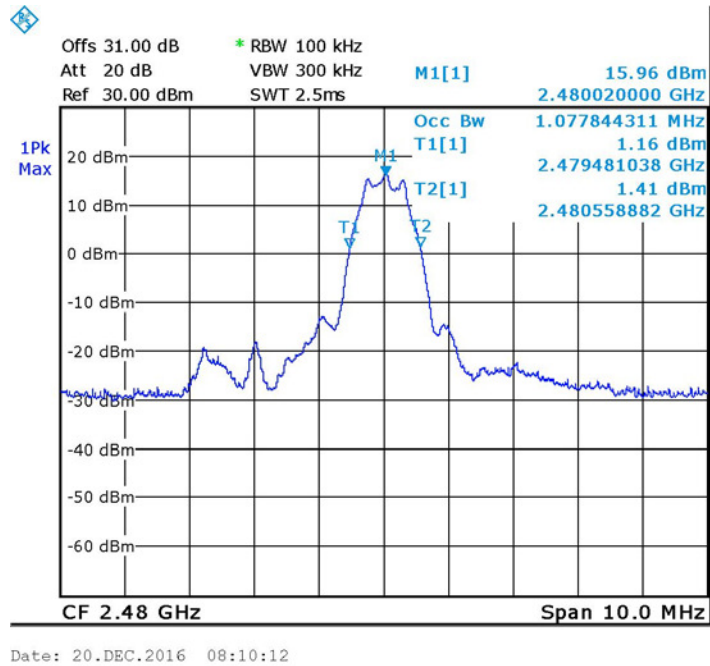

Figure 24. 2480.0 MHz – Occupied Bandwidth

6.4 Test Equipment Used; Occupied Bandwidth

Instrument	Manufacturer	Model	Serial No.	Last Calibration Date	Next Calibration Due
Spectrum Analyzer	R&S	FSL6	100194	February 29, 2016	March 1, 2017
30dB Attenuator	Bird	8304-N30DB	533	June 1, 2016	June 1, 2017

Figure 25 Test Equipment Used

7. Maximum Transmitted Peak Power Output

7.1 Test Specification

FCC, Part 15, Subpart C, Section 247(b)(3)
RSS-247, Issue 1, May 2015, Section 5.4.4

7.2 Test Procedure

(Temperature (23°C)/ Humidity (60%RH))

The E.U.T operation mode and test set-up are as described in Section 2 of this report.

The E.U.T. antenna terminal was connected to the Spectrum Analyzer through an external attenuator and an appropriate coaxial cable (loss=31.0 dB). Special attention was taken to prevent Spectrum Analyzer RF input overload.

The E.U.T was evaluated in 3 channels: Low (2402.0 MHz), Mid (2440.0 MHz) and High (2480 MHz).

7.3 Test Results

Operation Frequency (MHz)	Power (dBm)	Power (mW)	Limit (mW)	Margin (mW)
2402.0	17.40	54.95	1000.0	-945.05
2440.0	18.13	65.01	1000.0	-934.99
2480.0	16.55	45.19	1000.0	-954.81

Figure 26 Maximum Peak Power Output

JUDGEMENT: Passed by 934.99mW

For additional information see *Figure 27* to *Figure 29*.

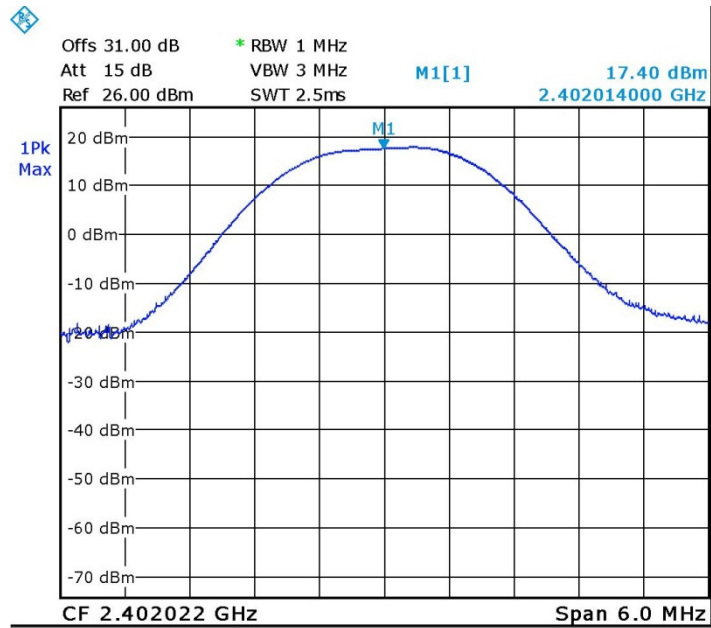

Date: 7.NOV.2016 11:14:10

Figure 27 2402.0 MHz

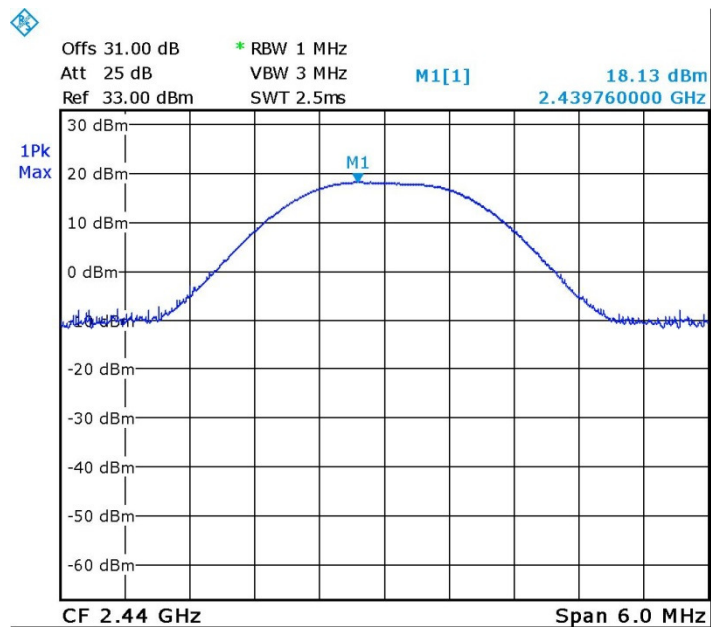

Date: 7.NOV.2016 12:03:45

Figure 28 2440.0 MHz

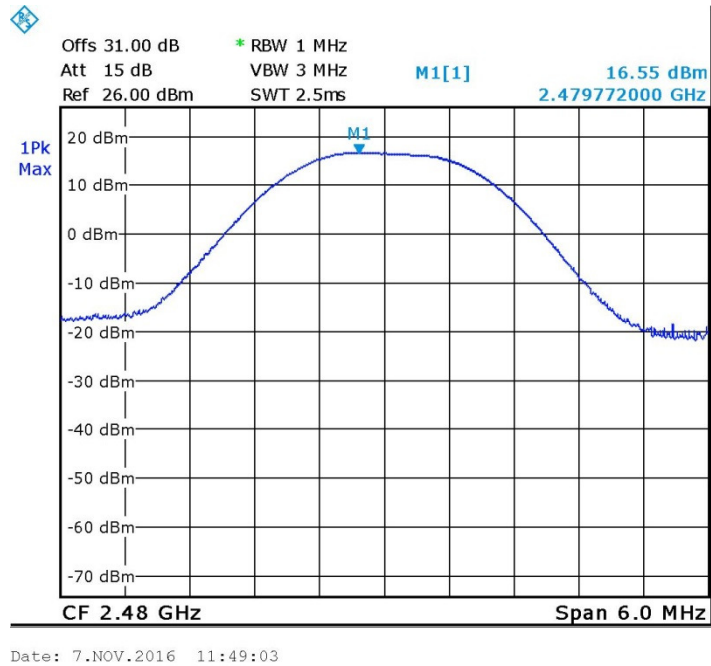

Figure 29 2480.0 MHz

7.4 Test Equipment Used; Maximum Peak Power Output

Instrument	Manufacturer	Model	Serial No.	Last Calibration Date	Next Calibration Due
Spectrum Analyzer	R&S	FSL6	100194	February 29, 2016	March 1, 2017
30dB Attenuator	Bird	8304-N30DB	533	June 1, 2016	June 1, 2017

Figure 30 Test Equipment Used

8. Band Edge Spectrum

8.1 Test Specification

FCC, Part 15, Subpart C, Section 247(d)
RSS-247, Issue 1, May 2015, Section 5.5

8.2 Test Procedure

(Temperature (23°C)/ Humidity (60%RH))

The E.U.T operation mode and test set-up are as described in Section 2.

The E.U.T. antenna terminal was connected to the Spectrum Analyzer through an external attenuator and an appropriate coaxial cable (loss=31.0 dB). Special attention was taken to prevent Spectrum Analyzer RF input overload.

The E.U.T was evaluated in 2 channels: Low and High.

The RBW was set to 100 kHz.

8.3 Test Results

Operation Frequency (MHz)	Modulation	Band Edge Frequency (MHz)	Spectrum Level (dBm)	Limit (dBm)	Margin (dB)
Low	BLE	2400.0	-28.49	-2.74	-25.75
High	BLE	2483.5	-33.96	-3.76	-30.20

Figure 31 Band Edge Spectrum

JUDGEMENT: Passed by 25.75 dB

For additional information see *Figure 32* and *Figure 33*.

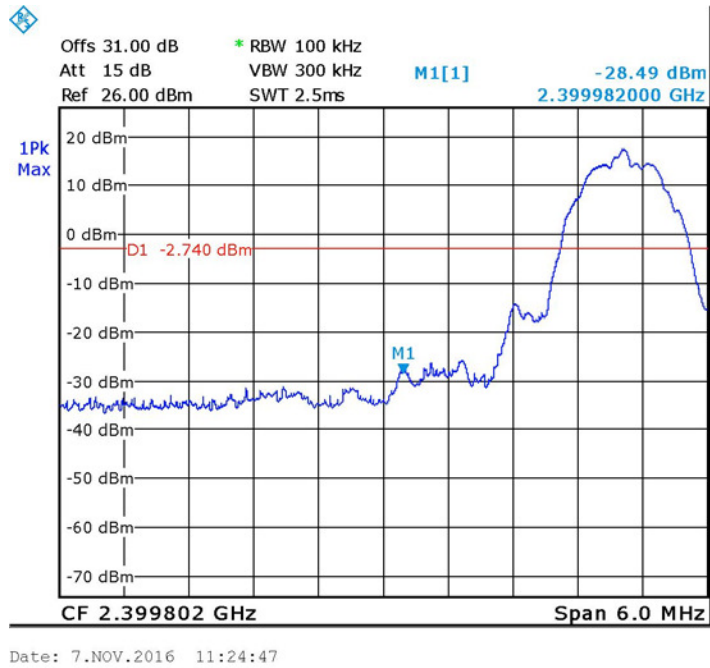

Figure 32 —Lower Band Edge

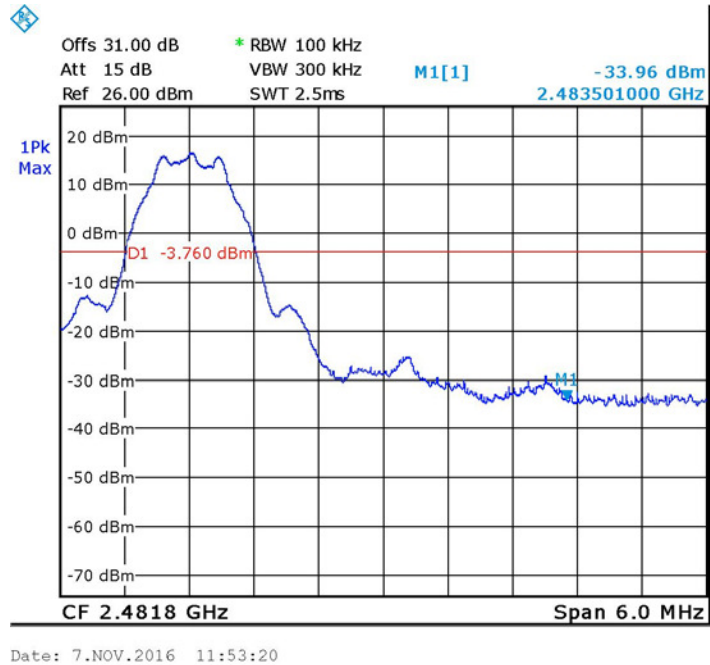

Figure 33 —Upper Band Edge



8.4 Test Equipment Used; Band Edge Spectrum

Instrument	Manufacturer	Model	Serial No.	Last Calibration Date	Next Calibration Due
Spectrum Analyzer	R&S	FSL6	100194	February 29, 2016	March 1, 2017
30dB Attenuator	Bird	8304-N30DB	533	June 1, 2016	June 1, 2017

Figure 34 Test Equipment Used



9. Emissions in Non-Restricted Frequency Bands

9.1 Test Specification

FCC, Part 15, Subpart C, Section 247(d)

RSS 247, Issue 1, Section 5.5

9.2 Test Procedure

(Temperature (24°C)/ Humidity (40%RH))

The E.U.T. antenna terminal was connected to the Spectrum Analyzer through an external attenuator and an appropriate coaxial cable.

The frequency range 0.009-25,000.0 MHz was scanned to find other emissions that don't fall in the restricted band

RBW was set to 100 kHz, detector set to max peak and trace to "max hold"

The E.U.T. was operated at the following frequencies: Low (2402 MHz), Mid (2440 MHz) and High (2480 MHz).

These frequencies were measured using a peak detector.

9.3 Test Limit

In any 100 kHz bandwidth outside the frequency band in which the spread spectrum or digitally modulated intentional radiator is operating, the radio frequency power that is produced by the intentional radiator shall be at least 20 dB below that in the 100 kHz bandwidth within the band that contains the highest level of the desired power.

9.4 Test Results

JUDGEMENT: Passed

The EUT met the requirements of the F.C.C. Part 15, Subpart C, Section 247 (d) specification.

For additional information see *Figure 35* to *Figure 37*.

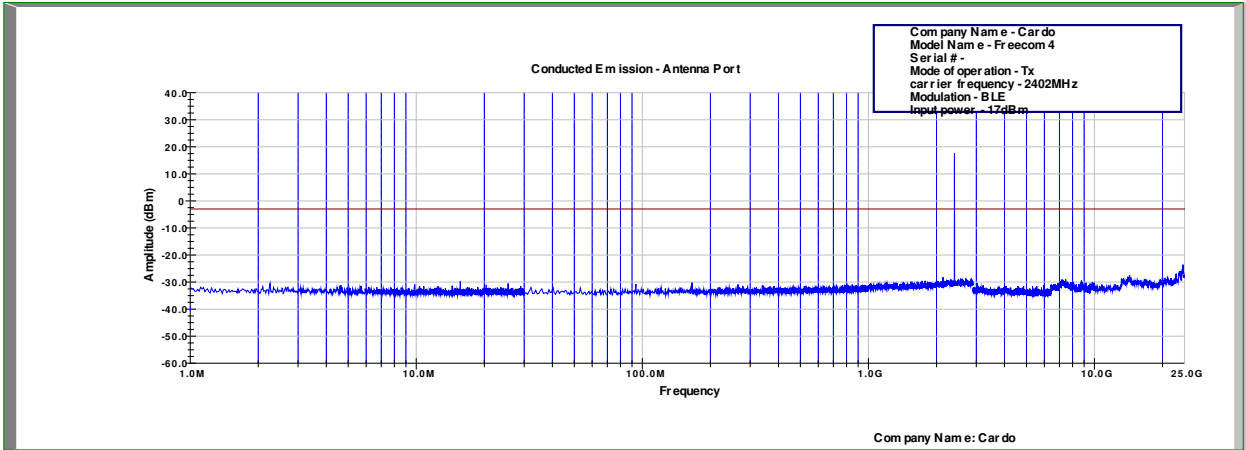

Figure 35 Conducted Spurious Emission – 2402 MHz

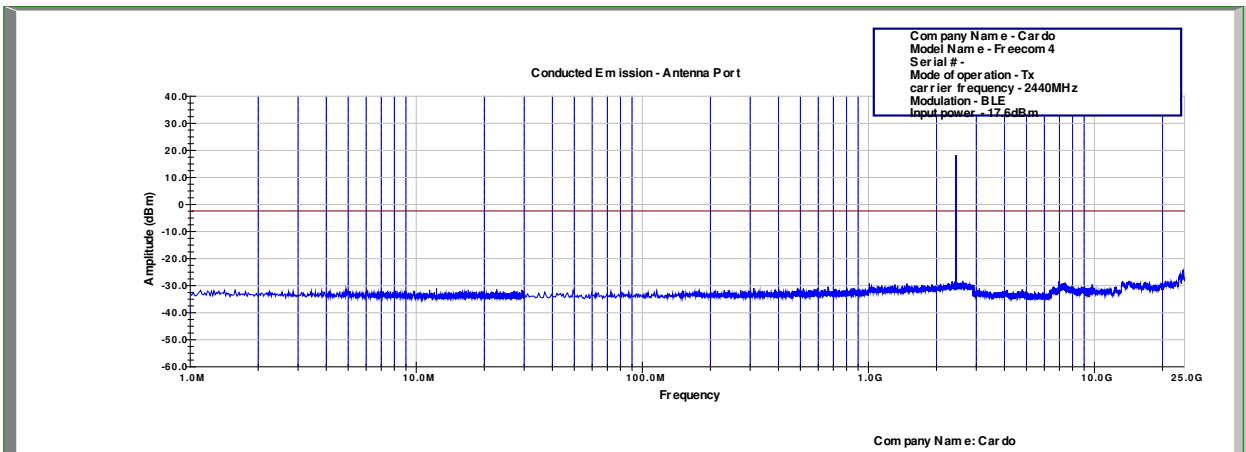

Figure 36 Conducted Spurious Emission - 2440 MHz

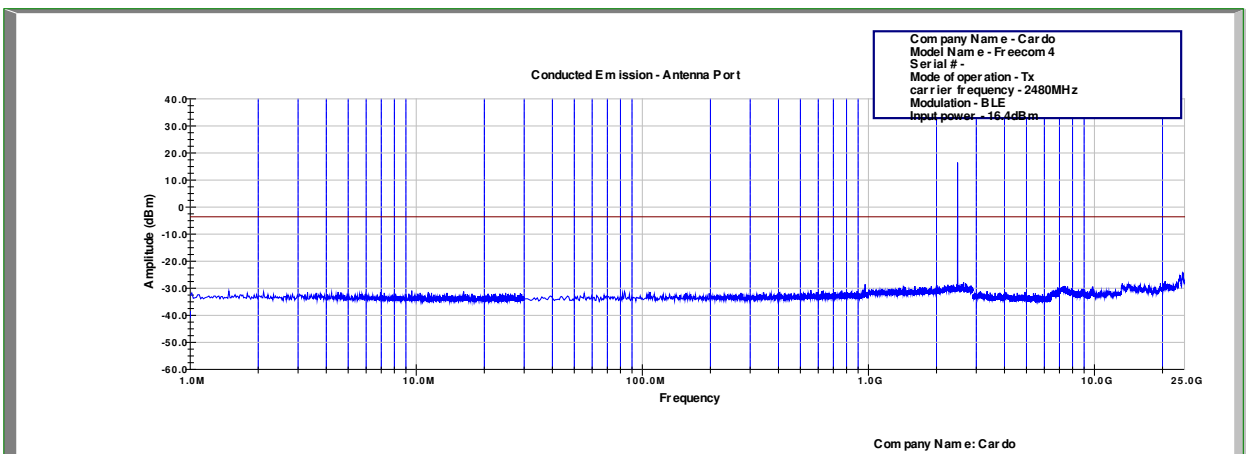

Figure 37 Conducted Spurious Emission – 2480 MHz



9.5 Test Equipment Used, Emissions in Non-Restricted Frequency Bands

Instrument	Manufacturer	Model	Serial Number	Last Calibration Date	Next Calibration Due
Spectrum Analyzer	Rodhe & Schwarz	FSL6	100194	February 29, 2016	March 1, 2017
30dB Attenuator	Bird	8304-N30DB	533	June 1, 2016	June 1, 2017

Figure 38 Test Equipment Used



10. Emissions in Restricted Frequency Bands

10.1 Test Specification

FCC, Part 15, Subpart C, Sections 15.209, 15.205, 15.247(d)
RSS GEN, Issue 4: 2014, Clause 8.9; 8.10

10.2 Test Procedure

(Temperature (23°C)/ Humidity (60%RH))

For measurements between 0.009MHz-30.0MHz:

The E.U.T was tested inside the chamber at a distance of 3 meters and the E.U.T was placed on a non-metallic table, 1.5 meters above the ground. The frequency range 0.009MHz-30MHz was scanned. The readings were maximized by the turntable azimuth between 0-360°, and the antenna polarization.

The emissions were measured at a distance of 3 meters.

For measurements between 30.0MHz-1.0GHz:

A preliminary measurement to characterize the E.U.T was performed inside the shielded room at a distance of 3 meters, using peak detection mode and broadband antennas. The preliminary measurements produced a list of the highest emissions. The E.U.T was then transferred to the open site, and placed on a remote-controlled turntable. The E.U.T was placed on a non-metallic table, 0.8 meters above the ground. The frequency range 30.0MHz -1.0GHz was scanned and the list of the highest emissions was verified and updated accordingly.

The readings were maximized by adjusting the antenna height between 1-4 meters, the turntable azimuth between 0-360°, and the antenna polarization.

The emissions were measured at a distance of 3 meters.

For 1000.0MHz-25,000.0MHz range:

The E.U.T was placed in the chamber and placed on a remote-controlled turntable. The E.U.T was placed on a non-metallic table, 1.5 meters above the ground. The configuration tested is shown in *Figure 4*.

The frequency range 1000 MHz-25000 MHz was scanned.

The readings were maximized by adjusting the turntable azimuth between 0-360°, and the antenna polarization.

The emissions were measured at a distance of 3 meters.

The E.U.T. was operated at the low, mid and high channels.
(2402, 2440, 2480 MHz).

The levels of the emissions within the frequency ranges of the restricted bands (Section 15.205 of FCC Part 15) were compared to the limits of the table in Section 15.209 (a), General Requirements.

Radiated emissions which fall in the restricted bands, as defined in §15.205(a), must also comply with the radiated emission limits specified in §15.209(a) (see §15.205(c)).

Frequency (MHz)	Field strength (microvolts/meter)	Measurement distance (meters)	Field strength* (dB μ V/m)	Field strength* (dB μ V/m)@3m
0.009-0.490	2400/F(kHz)	300	48.5-13.8	128.5-73.8
0.490-1.705	24000/F(kHz)	30	33.8-23.0	73.8-63.0
1.705-30.0	30	30	29.5	69.5
30-88	100	3	40.0	40.0
88-216	150	3	43.5	43.5
216-960	200	3	46.0	46.0
Above 960	500	3	54.0	54.0

*The emission limits shown in the above table are based on measurements employing a CISPR quasi-peak detector except for the frequency bands 9-90 kHz, 110-490 kHz and above 1000 MHz. Radiated emission limits in these three bands are based on measurements employing an average detector. For average radiated emission measurements above 1000 MHz, there is also a limit corresponding to 20 dB above the indicated values in the table is specified when measuring with peak detector function.

Figure 39 Table of Limits

10.3 Test Results

JUDGEMENT: Passed by 1.7 dB

For the operation frequency of 2402 MHz, the margin between the emission level and the specification limit is in the worst case 1.9 dB at the frequency of 7206.0MHz, vertical polarization.

For the operation frequency of 2440 MHz, the margin between the emission level and the specification limit is in the worst case 2.3 dB at the frequency of 7320.0 MHz, horizontal polarization.

For the operation frequency of 2480 MHz, the margin between the emission level and the specification limit is in the worst case 1.7 dB at the frequency of 7439.3 MHz, horizontal polarization.

The EUT met the requirements of the F.C.C. Part 15, Subpart C specification.

The details of the highest emissions are given in *Figure 40* to *Figure 41*.



Radiated Emission

E.U.T Description Bluetooth Communication System for Motorcycles
Type scala rider FREECOM2
Serial Number: Not designated

Specification: FCC, Part 15, Subpart C

Antenna Polarization: Horizontal/Vertical Frequency range: 9KHz to 25.0 GHz
Test Distance: 3 meters Detector: Peak

Operation Frequency (MHz)	Freq. (MHz)	Polarity (H/V)	Peak Reading (dB μ V/m)			Peak Limit (dB μ V/m)	Peak Margin (dB)
			X axis	Y axis	Z axis		
2402.0	2390.0	H	53.5	52.2	53.1	74.0	-20.5
2402.0	2390.0	V	53.3	52.7	53.1	74.0	-20.7
2402.0	4804.0	H	55.2	64.1	59.9	74.0	-9.9
2402.0	4804.0	V	57.9	63.8	59.6	74.0	-10.2
2402.0	7206.0	H	65.6	63.5	62.2	74.0	-8.4
2402.0	7206.0	V	57.3	60.6	59.1	74.0	-13.4
2402.0	9608.0	H	64.6	65.9	62.8	74.0	-8.1
2402.0	9608.0	V	55.6	63.1	57.9	74.0	-10.9
2440.0	4890.0	H	64.6	65.2	59.3	74.0	-8.8
2440.0	4890.0	V	63.9	60.0	62.0	74.0	-10.1
2440.0	7320.0	H	61.9	62.5	59.2	74.0	-12.1
2440.0	7320.0	V	57.9	61.5	60.8	74.0	-12.5
2480.0	4960.3	H	60.3	64.1	59.0	74.0	-9.9
2480.0	4960.0	V	62.4	57.0	62.8	74.0	-11.2
2480.0	7439.2	H	61.0	60.2	57.9	74.0	-13.0
2480.0	7439.4	V	57.2	60.3	59.6	74.0	-13.7
2480.0	2483.5	H	50.2	53.0	50.2	74.0	-21.0
2480.0	2483.5	V	48.4	52.1	52.1	74.0	-21.9

Figure 40. Radiated Emission. Antenna Polarization: HORIZONTAL / VERTICAL. Detector: Peak

Notes:

Margin refers to the test results obtained minus specified requirement; thus a positive number indicates failure, and a negative result indicates that the product passes the test.

“Peak Amp” includes correction factor.

* “Correction Factor” = Antenna Factor + Cable Loss- Low Noise Amplifier Gain



Radiated Emission

E.U.T Description Bluetooth Communication System for Motorcycles
Type scala rider FREECOM2
Serial Number: Not designated

Specification: FCC, Part 15, Subpart C

Antenna Polarization: Horizontal/Vertical
Test Distance: 3 meters

Frequency range: 9KHz to 25.0 GHz
Detector: Average

Operation Frequency (MHz)	Freq. (MHz)	Polarity (H/V)	Average Reading (dB μ V/m)			Average Limit (dB μ V/m)	Average Margin (dB)
			X axis	Y axis	Z axis		
2402.0	2390.0	H	40.7	39.5	39.4	54.0	-13.3
2402.0	2390.0	V	39.7	39.5	43.3	54.0	-10.7
2402.0	4804.0	H	39.0	40.2	46.1	54.0	-7.9
2402.0	4804.0	V	36.5	42.9	51.1	54.0	-2.9
2402.0	7206.0	H	46.2	42.8	40.4	54.0	-7.8
2402.0	7206.0	V	52.1	49.0	40.5	54.0	-1.9
2402.0	9608.0	H	45.8	39.2	39.8	54.0	-8.2
2402.0	9608.0	V	48.5	42.3	44.1	54.0	-5.5
2440.0	4880.0	H	35.27	42.3	43.3	54.0	-10.7
2440.0	4880.0	V	39.9	41.5	42.8	54.0	-11.2
2440.0	7320.0	H	51.2	51.7	44.1	54.0	-2.3
2440.0	7320.0	V	43.2	37.1	44.7	54.0	-9.3
2480.0	4960.3	H	33.95	43.5	44.1	54.0	-9.9
2480.0	4960.0	V	38.76	37.7	45.1	54.0	-8.9
2480.0	7439.3	H	52.3	43.2	42.8	54.0	-1.7
2480.0	7439.3	V	44.2	34.6	37.6	54.0	-9.8
2480.0	2483.5	H	39.9	43.1	39.2	54.0	-10.9
2480.0	2483.5	V	37.7	42.2	42.3	54.0	-11.7

Figure 41. Radiated Emission. Antenna Polarization: HORIZONTAL / VERTICAL. Detector: Average

Notes:

Margin refers to the test results obtained minus specified requirement; thus a positive number indicates failure, and a negative result indicates that the product passes the test.

“Average Amp” includes correction factor.

* Correction Factor = Antenna Factor + Cable Loss- Low Noise Amplifier Gain



10.4 Test Instrumentation Used; Emissions in Restricted Frequency Bands

Instrument	Manufacturer	Model	Serial No.	Last Calibration Date	Next Calibration Due
EMI Receiver	R&S	ESCI7	100724	February 29, 2016	March 1, 2017
Spectrum Analyzer	HP	8592L	3826A01204	March 13, 2016	March 13, 2017
EMI Receiver	HP	8542E	3906A00276	March 3, 2016	March 3, 2017
RF Filter Section	HP	85420E	3705A00248	March 3, 2016	March 3, 2017
Spectrum Analyzer	HP	8564E	3442A00275	March 10, 2016	March 10, 2017
Biconical Antenna	EMCO	3110B	9912-3337	March 24, 2016	March 24, 2018
Log Periodic Antenna	EMCO	3146	9505-4081	April 23, 2016	April 23, 2017
Horn Antenna	ETS	3115	29845	May 19, 2015	May 19, 2018
Active Loop Antenna	EMCO	6502	9506-2950	November 4, 2015	November 30, 2016
Low Noise Amplifier	Narda	DBS-0411N313	13	August 8, 2016	August 8, 2017
Low Noise Amplifier	Sophia Wireless	LNA28-B	232	August 8, 2016	August 8, 2017
Spectrum Analyzer	HP	8593EM	3536A00120 ADI	March 10, 2016	March 10, 2017
Semi Anechoic Civil Chamber	ETS	S81	SL 11643	N/A	N/A
Antenna Mast	ETS	2070-2	9608-1497	N/A	N/A
Turntable	ETS	2087	-	N/A	N/A
Mast & Table Controller	ETS/EMCO	2090	9608-1456	N/A	N/A

Figure 42 Test Equipment Used

11. Transmitted Power Density

11.1 Test Specification

FCC, Part 15, Subpart C, Section 247(e)
RSS-247, Issue 1:2015, Clause 5.2(2)

11.2 Test Procedure

(Temperature (23°C)/ Humidity (60%RH))

The E.U.T operation mode and test set-up are as described in Section 2 of this report.

The E.U.T. antenna terminal was connected to the Spectrum Analyzer through an external attenuator and an appropriate coaxial cable (loss=31.0 dB). Special attention was taken to prevent Spectrum Analyzer RF input overload.

The spectrum analyzer was set to 3 kHz RBW and VBW to 10 kHz.

The E.U.T was evaluated in 3 channels: Low (2402.0MHz), Mid (2440.0MHz) and High (2480.0MHz).

11.3 Test Results

Operation Frequency (MHz)	Reading Spectrum Analyzer (dBm)	Limit (dBm)	Margin (dB)
2402.0	1.62	8.0	-6.38
2440.0	1.98	8.0	-6.02
2480.0	0.85	8.0	-7.15

Figure 43 Test Results

JUDGEMENT: Passed by 6.02 dB

For additional information see *Figure 44* to *Figure 46*.

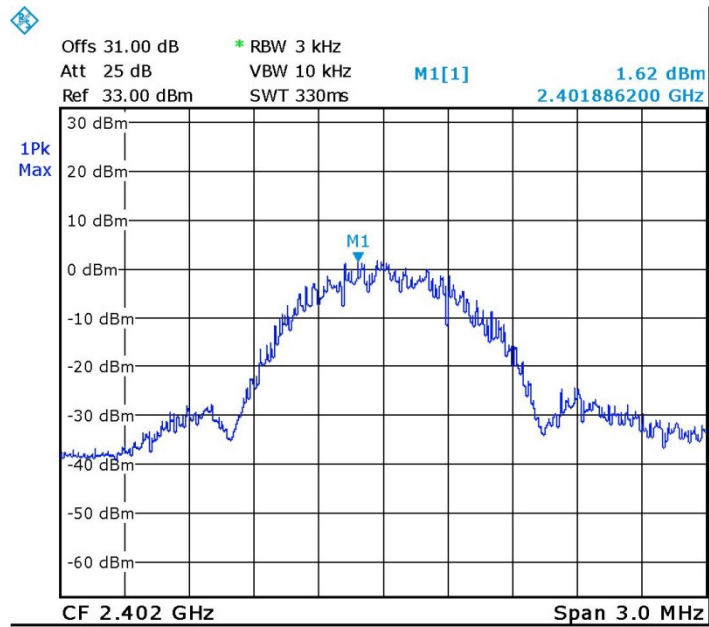

Date: 7.NOV.2016 12:31:34

Figure 44 — 2402.0 MHz

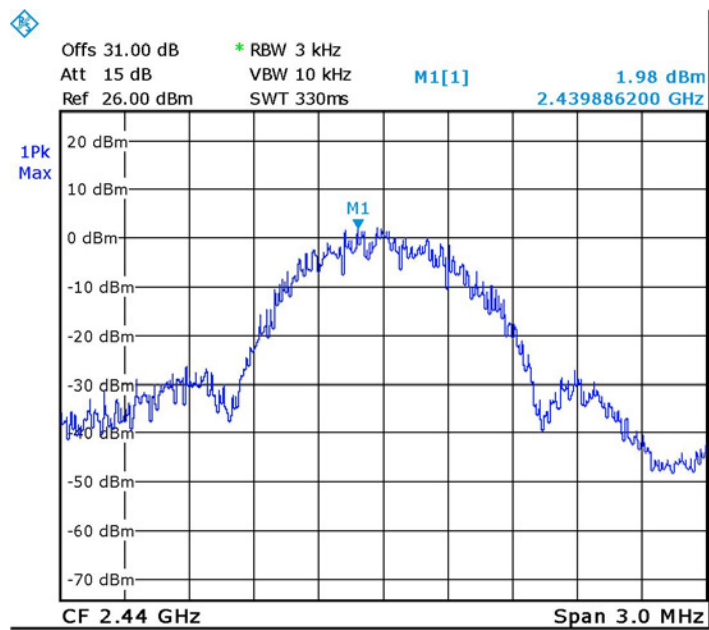

Date: 7.NOV.2016 12:01:09

Figure 45 — 2440.0 MHz

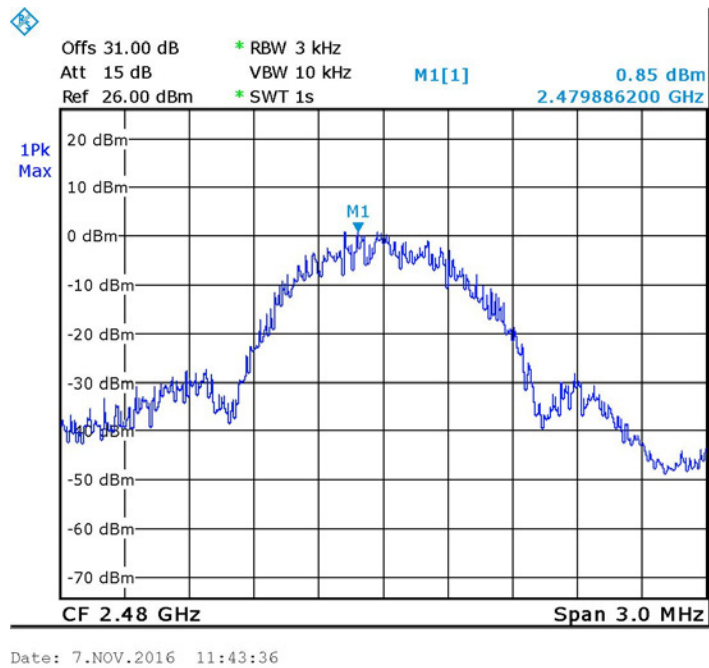

Figure 46 — 2480.0 MHz

11.4 Test Equipment Used; Transmitted Power Density

Instrument	Manufacturer	Model	Serial No.	Last Calibration Date	Next Calibration Due
Spectrum Analyzer	R&S	FSL6	100194	February 29, 2016	March 1, 2017
30dB Attenuator	Bird	8304-N30DB	533	June 1, 2016	June 1, 2017

Figure 47 Test Equipment Used



12. AVG. Factor Calculation

1. Pulse period = 1msec (worst scenario)
2. Pulse duration = 1msec (worst scenario)
3. Burst duration = 0.3971msec
4. Time between bursts = 0.24msec
5. Average Factor = $20 \log \left[\frac{\text{Pulse duration}}{\text{Pulse period}} \times \frac{\text{burst duration}}{100\text{msec}} \times \text{Num of burst within 100msec} \right]$

$$\text{Average Factor} = 20 \log \left[1 * \frac{0.397}{100} * 150 \right] = -4.5dB$$

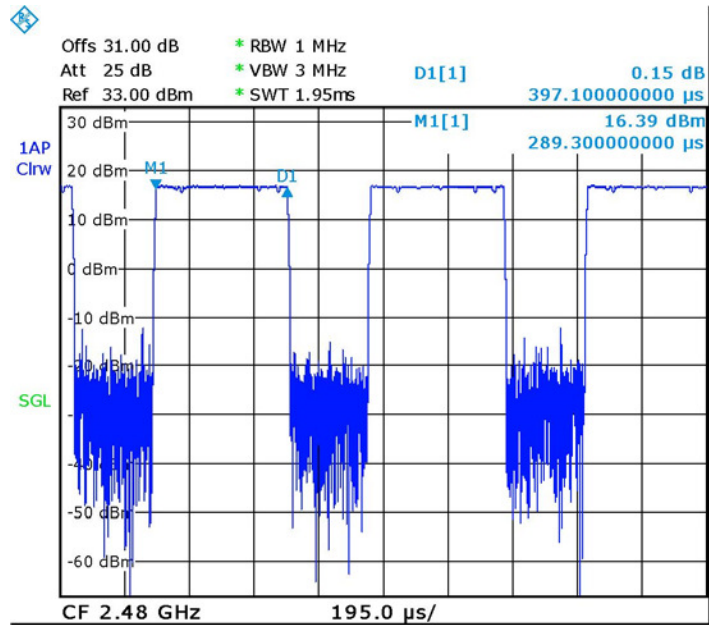

Date: 7.NOV.2016 17:24:42

Figure 48. Burst Duration

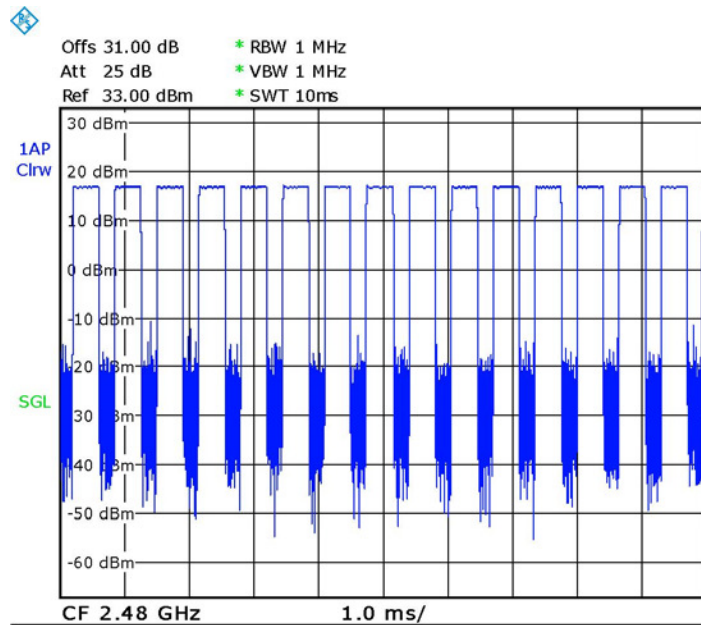

Date: 7.NOV.2016 17:33:47

Figure 49. Number of bursts in 10msec=15



13. Antenna Gain/Information

The antenna gain is -2.0 dBi, integral.



14. R.F Exposure/Safety

The typical placement of the E.U.T. is on a motorcycle helmet. The typical distance between the E.U.T. and the user is 4cm. See photos on following page.

SAR Testing Exclusion Based on Section 4.3.1 and Appendix A of KDB447498 D01 V05 and RSS 102, Issue 5, Section 2.5.2 Requirements

For FCC

Section 4.3.1 and Appendix A of KDB447498 D01 V05 was used as the guidance as follows:

Peak power output = 18.13 dBm taking into consideration average factor of -4.5db (page 44) maximum power = $18.13 - 4.5 = 13.63 \text{ dBm} = 23.1 \text{ mW}$

$[(\text{max. power of channel, including tune-up tolerance, mW}) / (\text{min. test separation distance, mm})] * [\sqrt{f(\text{GHz})}] = 23.1 / 40 * 1.55 = 0.89$ this value is less than 3.0 for 1-g SAR and ≤ 7.5 for 10-g extremity SAR.

The SAR measurement is not necessary.

For IC

(a) For IC per Table 1 of RSS 102 Issue 5, SAR exemption based on IC limit of 173.0mW at a separation distance of 40mm = 4.0cm at 2450 MHz.

EUT power transmission is 18.13 dBm = 65mW.

18.13 dBm taking into consideration average factor of -4.5db (page 44) maximum power = $18.13 - 4.5 = 13.63 \text{ dBm} = 23.1 \text{ mW}$

This is below the 173.0mW SAR exemption limits.

See photos on following page.

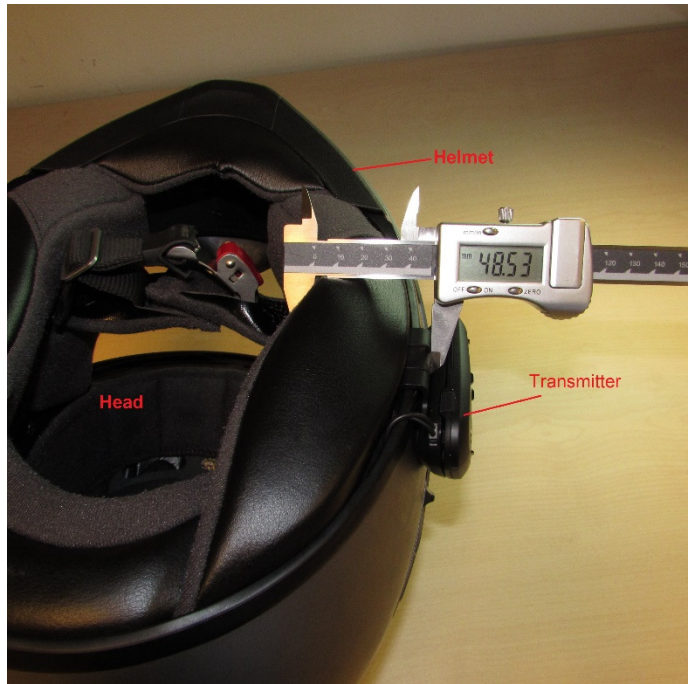



15. APPENDIX A - CORRECTION FACTORS

15.1 Correction factors for CABLE from EMI receiver to test antenna at 3 meter range.

Frequency (MHz)	Cable Loss (dB)
0.010	0.4
0.015	0.2
0.020	0.2
0.030	0.3
0.050	0.3
0.075	0.3
0.100	0.2
0.150	0.2
0.200	0.3
0.500	0.4
1.00	0.4
1.50	0.5
2.00	0.5
5.00	0.6
10.00	0.8
15.00	0.9
20.00	0.8

Frequency (MHz)	Cable Loss (dB)
50.00	1.2
100.00	0.7
150.00	2.1
200.00	2.3
300.00	2.9
500.00	3.8
750.00	4.8
1000.00	5.4
1500.00	6.7
2000.00	9.0
2500.00	9.4
3000.00	9.9
3500.00	10.2
4000.00	11.2
4500.00	12.1
5000.00	13.1
5500.00	13.5
6000.00	14.5

NOTES:

1. The cable type is SPUMA400 RF-11N(X2) and 39m long
2. The cable is manufactured by Huber + Suhner



15.2 Correction factor for RF CABLE for Semi Anechoic Chamber

FREQ (MHz)	LOSS (dB)
1000.0	1.5
2000.0	2.1
3000.0	2.7
4000.0	3.1
5000.0	3.5
6000.0	4.1
7000.0	4.6
8000.0	4.9
9000.0	5.7
10000.0	5.7
11000.0	6.1
12000.0	6.1
13000.0	6.2
14000.0	6.7
15000.0	7.4
16000.0	7.5
17000.0	7.9
18000.0	8.1
19000.0	8.8
20000.0	9.1

NOTES:

- 1. The cable is manufactured by Commscope*
- 2. The cable type is 0623 WBC-400, serial # G020132 and 10m long*
- 3. ITL # 1840*



15.3 Correction factors for Low Loss CABLE

Huber Suner #1696

Serial No. 705A009301 EIM

FREQ (MHz)	INPUT (dBm)	OUTPUT (dBm)	LOSS (dB)
1000.0	-10	-10.7	0.7
2000.0	-10	-10.7	0.7
3000.0	-10	-10.6	0.6
4000.0	-10	-10.5	0.5
5000.0	-10	-10.7	0.7
6000.0	-10	-10.8	0.8
7000.0	-10	-10.8	0.8
8000.0	-10	-11.0	1.0
9000.0	-10	-10.5	0.5
10000.0	-10	-10.3	0.3
11000.0	-10	-10.5	0.5
12000.0	-10	-11.3	1.3
13000.0	-10	-11.6	1.6
14000.0	-10	-11.8	1.8
15000.0	-10	-11.0	1.0
16000.0	-10	-10.6	0.6
17000.0	-10	-12.0	2.0
18000.0	-10	-11.6	1.6



15.4 Correction factors for ACTIVE LOOP ANTENNA

**Model 6502
S/N 9506-2950**

f(MHz)	MAF(dBs/m)	AF(dB/m)
0.01	-33.1	18.4
0.02	-37.2	14.3
0.03	-38.2	13.3
0.05	-39.8	11.7
0.1	-40.1	11.4
0.2	-40.3	11.2
0.3	-40.3	11.2
0.5	-40.3	11.2
0.7	-40.3	11.2
1	-40.1	11.4
2	-40	11.5
3	-40	11.5
4	-40.1	11.4
5	-40.2	11.3
6	-40.4	11.1
7	-40.4	11.1
8	-40.4	11.1
9	-40.5	11
10	-40.5	11
20	-41.5	10
30	-43.5	8



15.5 Correction factors for Biconical Antenna

**EMCO, Model 3110B,
Serial #9912-3337**

Frequency [MHz]	AF [dB/m]
30.0	14.18
35.0	13.95
40.0	12.84
45.0	11.23
50.0	11.10
60.0	10.39
70.0	9.34
80.0	9.02
90.0	9.31
100.0	8.95
120.0	11.53
140.0	12.20
160.0	12.56
180.0	13.49
200.0	15.27



15.6 Correction factors for Log Periodic Antenna
EMCO, Model 3146,
Serial #9505-4081

Frequency [MHz]	AF [dB/m]
200.0	11.47
250.0	12.06
300.0	14.77
400.0	15.77
500.0	18.01
600.0	18.84
700.0	20.93
800.0	21.27
900.0	22.44
1000.0	24.10



15.7 Correction factors for Horn ANTENNA.

Model: 3115

Antenna serial number: 29845

3 meter range

f(GHz)	AF(dB/m)	GA(dB)
0.75	25	3
1G	23.5	7
1.5G	26	8
2G	29	7
2.5G	27.5	10
3G	30	10
3.5G	31.5	10
4G	32.5	9.5
4.5G	32.5	10.5
5G	33	10.5
5.5G	35	10.5
6G	36.5	9.5
6.5G	36.5	10
7G	37.5	10
7.5G	37.5	10
8G	37.5	11
8.5G	38	11
9G	37.5	11.5
9.5G	38	11.5
10G	38.5	11.5
10.5G	38.5	12
11G	38.5	12.5
11.5G	38.5	13
12G	38	13.5
12.5G	38.5	13
13G	40	12
13.5G	41	12
14G	40	13
14.5G	39	14
15G	38	15.5
15.5G	37.5	16
16G	37.5	16
16.5G	39	15
17G	40	15
17.5G	42	13.5
18G	42.5	13