



# TEST REPORT

## FCC PART 15.249

Report Reference No. ....: **CTL1605161723-WF**

|  |                                     |                   |
|--|-------------------------------------|-------------------|
| Compiled by:<br>( position+printed name+signature) | Jacky Chen<br>(File administrators) | <u>Jacky Chen</u> |
| Tested by:<br>( position+printed name+signature)   | Allen Wang<br>(Test Engineer)       | <u>Allen Wang</u> |
| Approved by:<br>( position+printed name+signature) | Tracy Qi<br>(Manager)               | <u>Tracy Qi</u>   |

|                                   |  |
|-----------------------------------|--|
| <b>Product Name</b> .....         | Bluetooth speaker  |
| <b>Model/Type reference</b> ..... | BT28S  |
| <b>List Model(s)</b> .....        | N/A  |
| <b>Trade Mark</b> .....           | W-king   |
| <b>FCC ID</b> .....               | Q8W-BT28S  |
| <b>Applicant's name</b> .....     | <b>SHENZHEN WEIKING TECHNOLOGY CO., LTD.</b>   |
| <b>Address of applicant</b> ..... | W-king Technology Park, NO.431, Huating Road, Dalang Street, Longhua Town, Baoan District, Shenzhen City, China      |
| <b>Test Firm</b> .....            | <b>Shenzhen CTL Testing Technology Co., Ltd.</b>   |
| <b>Address of Test Firm</b> ..... | Floor 1-A, Baisha Technology Park, No.3011, Shaheqi Road, Nanshan District, Shenzhen, China 518055                   |
| <b>Test specification</b> .....   |  |
| Standard.....                     | <b>FCC Part 15.249:</b> Operation within the bands 920-928 MHz, 2400-2483.5 MHz, 5725-5850 MHz and 24.0 - 24.25 GHz. |
| TRF Originator .....              | Shenzhen CTL Testing Technology Co., Ltd.  |
| Master TRF .....                  | Dated 2011-01  |
| <b>Date of Receipt</b> .....      | May 16, 2016   |
| <b>Date of Test Date</b> .....    | May 22, 2016 – May 25, 2016  |
| <b>Data of Issue</b> .....        | May 26, 2016   |
| <b>Result</b> .....               | Pass   |

**Shenzhen CTL Testing Technology Co., Ltd. All rights reserved.**  
This publication may be reproduced in whole or in part for non-commercial purposes as long as the Shenzhen CTL Testing Technology Co., Ltd. is acknowledged as copyright owner and source of the material. Shenzhen CTL Testing Technology Co., Ltd. takes no responsibility for and will not assume liability for damages resulting from the reader's interpretation of the reproduced material due to its placement and context.

# TEST REPORT

|                          |                         |  |
|--------------------------|-------------------------|--|
| <b>Test Report No. :</b> | <b>CTL1605161723-WF</b> | May 26, 2016<br>-----<br>Date of issue |
|--------------------------|-------------------------|--|

Equipment under Test : Bluetooth speaker

Model /Type : BT28S

Listed Models : N/A

**Applicant** : **SHENZHEN WEIKING TECHNOLOGY CO., LTD.**

Address : W-king Technology Park, NO.431, Huating Road,  
Dalang Street, Longhua Town, Baoan District,  
Shenzhen City, China

**Manufacturer** : **SHENZHEN WEIKING TECHNOLOGY CO., LTD.**

Address : W-king Technology Park, NO.431, Huating Road,  
Dalang Street, Longhua Town, Baoan District,  
Shenzhen City, China

|                    |               |
|--------------------|---------------|
| <b>Test result</b> | <b>Pass *</b> |
|--------------------|---------------|

\* In the configuration tested, the EUT complied with the standards specified page 5.

The test report merely corresponds to the test sample.

It is not permitted to copy extracts of these test result without the written permission of the test laboratory.



Table of Contents

Page

- 1. SUMMARY..... 5
  - 1.1. TEST STANDARDS.....5
  - 1.2. TEST DESCRIPTION.....5
  - 1.3. TEST FACILITY .....6
  - 1.4. STATEMENT OF THE MEASUREMENT UNCERTAINTY.....6
- 2. GENERAL INFORMATION..... 7
  - 2.1. ENVIRONMENTAL CONDITIONS .....7
  - 2.2. GENERAL DESCRIPTION OF EUT .....7
  - 2.3. DESCRIPTION OF TEST MODES AND TEST FREQUENCY.....8
  - 2.4. EQUIPMENTS USED DURING THE TEST .....9
  - 2.5. RELATED SUBMITTAL(s) / GRANT(s).....9
  - 2.6. MODIFICATIONS.....9
- 3. TEST CONDITIONS AND RESULTS ..... 10
  - 3.1. CONDUCTED EMISSIONS TEST .....10
  - 3.2. RADIATED EMISSIONS AND BAND EDGE .....13
  - 3.3. OCCUPIED BANDWIDTH MEASUREMENT .....22
  - 3.4. ANTENNA REQUIREMENT .....27
- 4. TEST SETUP PHOTOS OF THE EUT ..... 28
- 5. EXTERNAL AND INTERNAL PHOTOS OF THE EUT ..... 30

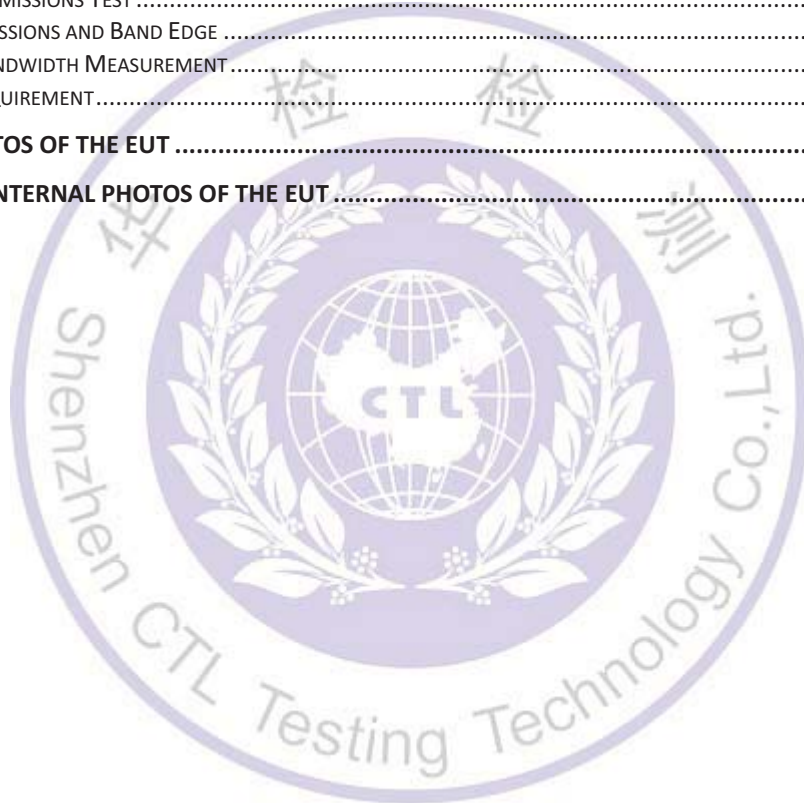

# 1. SUMMARY

## 1.1. TEST STANDARDS

The tests were performed according to following standards:

**FCC Rules Part 15.249:** Operation within the bands 902 - 928 MHz, 2400 - 2483.5 MHz, 5725 - 5875 MHz, and 24.0 - 24.25 GHz.

**ANSI C63.10:2013 :** American National Standard for Testing Unlicensed Wireless Devices

**ANSI C63.4: 2014:** –American National Standard for Methods of Measurement of Radio-Noise Emissions from Low-Voltage Electrical and Electronic Equipment in the Range of 9 kHz to 40GHz  
Range of 9 kHz to 40GHz

## 1.2. Test Description

| FCC PART 15.249    |                               |      |
|--------------------|-------------------------------|------|
| FCC Part 15.249(a) | Field Strength of Fundamental | PASS |
| FCC Part 15.209    | Spurious Emission             | PASS |
| FCC Part 15.209    | Band edge                     | PASS |
| FCC Part 15.215(c) | 20dB bandwidth                | PASS |
| FCC Part 15.207    | Conducted Emission            | PASS |
| FCC Part 15.203    | Antenna Requirement           | PASS |





## 1.3. Test Facility

### 1.3.1 Address of the test laboratory

Shenzhen CTL Testing Technology Co., Ltd.

Floor 1-A, Baisha Technology Park, No. 3011, Shahexi Road, Nanshan, Shenzhen 518055 China

There is one 3m semi-anechoic chamber and two line conducted labs for final test. The Test Sites meet the requirements in documents ANSI C63.4 and CISPR 22/EN 55022 requirements.

### 1.3.2 Laboratory accreditation

The test facility is recognized, certified, or accredited by the following organizations:

#### IC Registration No.: 9618B

The 3m alternate test site of Shenzhen CTL Testing Technology Co., Ltd. EMC Laboratory has been registered by Certification and Engineer Bureau of Industry Canada for the performance of with Registration No.: 9618B on November 13, 2013.

#### FCC-Registration No.: 970318

Shenzhen CTL Testing Technology Co., Ltd. EMC Laboratory has been registered and fully described in a report filed with the (FCC) Federal Communications Commission. The acceptance letter from the FCC is maintained in our files. Registration 970318, December 19, 2013.

## 1.4. Statement of the measurement uncertainty

The data and results referenced in this document are true and accurate. The reader is cautioned that there may be errors within the calibration limits of the equipment and facilities. The measurement uncertainty was calculated for all measurements listed in this test report acc. to CISPR 16 - 4 „Specification for radio disturbance and immunity measuring apparatus and methods – Part 4: Uncertainty in EMC Measurements“ and is documented in the Shenzhen CTL Testing Technology Co., Ltd. quality system acc. to DIN EN ISO/IEC 17025. Furthermore, component and process variability of devices similar to that tested may result in additional deviation. The manufacturer has the sole responsibility of continued compliance of the device.

Hereafter the best measurement capability for CTL laboratory is reported:

| Test                  | Range      | Measurement Uncertainty | Notes |
|-----------------------|------------|-------------------------|-------|
| Radiated Emission     | 30~1000MHz | 4.10dB                  | (1)   |
| Radiated Emission     | Above 1GHz | 4.32dB                  | (1)   |
| Conducted Disturbance | 0.15~30MHz | 3.20dB                  | (1)   |

(1) This uncertainty represents an expanded uncertainty expressed at approximately the 95% confidence level using a coverage factor of k=2.

## 2. GENERAL INFORMATION

### 2.1. Environmental conditions

During the measurement the environmental conditions were within the listed ranges:

|                     |         |
|---------------------|---------|
| Normal Temperature: | 25°C    |
| Relative Humidity:  | 55 %    |
| Air Pressure:       | 101 kPa |

### 2.2. General Description of EUT

|                       |                            |
|-----------------------|----------------------------|
| Product Name:         | Bluetooth Speaker          |
| Model/Type reference: | BT28S                      |
| Power supply:         | DC 7.4V from battery       |
| <b>Bluetooth</b>      |                            |
| Version:              | Supported BT3.0            |
| Modulation:           | GFSK, $\pi/4$ DQPSK, 8DPSK |
| Operation frequency:  | 2402MHz~2480MHz            |
| Channel number:       | 79                         |
| Channel separation:   | 1MHz                       |
| Antenna type:         | PCB Antenna                |
| Antenna gain:         | 0dBi                       |
| <b>Bluetooth</b>      |                            |
| Supported type:       | Version 4.0 for low Energy |
| Modulation:           | GFSK                       |
| Operation frequency:  | 2402MHz to 2480MHz         |
| Channel number:       | 40                         |
| Channel separation:   | 2 MHz                      |
| Antenna type:         | PCB Antenna                |
| Antenna gain:         | 0dBi                       |

Note: For more details, please refer to the user's manual of the EUT.

## 2.3. Description of Test Modes and Test Frequency

The Applicant provides communication tools software to control the EUT for staying in continuous transmitting (Duty Cycle more than 98%) and receiving mode for testing. There are 79 channels provided to the EUT and Channel 00/39/78 were selected for BT3.0 testing, and 40 channels provided to the EUT and Channel 00/19/39 were selected for BT4.0 testing.

### Operation Frequency BT3.0 :

| Channel   | Frequency (MHz) |
|-----------|-----------------|
| <b>00</b> | <b>2402</b>     |
| 01        | 2403            |
| ⋮         | ⋮               |
| 38        | 2440            |
| <b>39</b> | <b>2441</b>     |
| 40        | 2442            |
| ⋮         | ⋮               |
| 77        | 2479            |
| <b>78</b> | <b>2480</b>     |

### Operation Frequency List BT4.0 :

| Channel   | Frequency (MHz) |
|-----------|-----------------|
| <b>00</b> | <b>2402</b>     |
| 02        | 2404            |
| 03        | 2406            |
| ⋮         | ⋮               |
| <b>19</b> | <b>2440</b>     |
| ⋮         | ⋮               |
| 37        | 2476            |
| 38        | 2478            |
| <b>39</b> | <b>2480</b>     |

Note: The line display in grey is the channel selected to perform test.



## 2.4. Equipments Used during the Test

| Test Equipment             | Manufacturer         | Model No.                 | Serial No.   | Calibration Date | Calibration Due Date |
|----------------------------|----------------------|---------------------------|--------------|------------------|----------------------|
| LISN                       | R&S                  | ENV216                    | 3560.6550.12 | 2015/06/02       | 2016/06/01           |
| LISN                       | R&S                  | ESH2-Z5                   | 860014/010   | 2015/06/02       | 2016/06/01           |
| Bilog Antenna              | Sunol Sciences Corp. | JB1                       | A061713      | 2015/06/02       | 2016/06/01           |
| EMI Test Receiver          | R&S                  | ESCI                      | 103710       | 2015/06/02       | 2016/06/01           |
| Spectrum Analyzer          | Agilent              | E4407B                    | MY41440676   | 2016/05/21       | 2017/05/20           |
| Spectrum Analyzer          | Agilent              | N9020                     | US46220290   | 2016/01/17       | 2017/01/16           |
| Controller                 | EM Electronics       | Controller EM 1000        | N/A          | 2016/05/21       | 2017/05/20           |
| Horn Antenna               | Sunol Sciences Corp. | DRH-118                   | A062013      | 2016/05/19       | 2017/05/18           |
| Active Loop Antenna        | SCHWARZBECK          | FMZB1519                  | 1519-037     | 2016/05/19       | 2017/05/18           |
| Amplifier                  | Agilent              | 8349B                     | 3008A02306   | 2016/05/19       | 2017/05/18           |
| Amplifier                  | Agilent              | 8447D                     | 2944A10176   | 2016/05/19       | 2017/05/18           |
| Temperature/Humidity Meter | Gangxing             | CTH-608                   | 02           | 2016/05/20       | 2017/05/19           |
| High-Pass Filter           | K&L                  | 9SH10-2700/X<br>12750-O/O | N/A          | 2016/05/20       | 2017/05/19           |
| High-Pass Filter           | K&L                  | 41H10-1375/U<br>12750-O/O | N/A          | 2016/05/20       | 2017/05/19           |
| Coaxial Cables             | HUBER+SUHNER         | SUCOFLEX<br>104PEA-10M    | 10m          | 2015/06/02       | 2016/06/01           |
| Coaxial Cables             | HUBER+SUHNER         | SUCOFLEX<br>104PEA-3M     | 3m           | 2015/06/02       | 2016/06/01           |
| Coaxial Cables             | HUBER+SUHNER         | SUCOFLEX<br>104PEA-3M     | 3m           | 2015/06/02       | 2016/06/01           |
| RF Cable                   | Megalon              | RF-A303                   | N/A          | 2015/06/02       | 2016/06/01           |

The calibration interval was one year

## 2.5. Related Submittal(s) / Grant(s)

This submittal(s) (test report) is intended to comply with Section 15.249 of the FCC Part 15, Subpart C Rules.

## 2.6. Modifications

No modifications were implemented to meet testing criteria.

### 3. TEST CONDITIONS AND RESULTS

#### 3.1. Conducted Emissions Test

##### LIMIT

FCC CFR Title 47 Part 15 Subpart C Section 15.207

| Frequency range (MHz) | Limit (dBuV) |           |
|-----------------------|--------------|-----------|
|                       | Quasi-peak   | Average   |
| 0.15-0.5              | 66 to 56*    | 56 to 46* |
| 0.5-5                 | 56           | 46        |
| 5-30                  | 60           | 50        |

\* Decreases with the logarithm of the frequency.

##### TEST CONFIGURATION

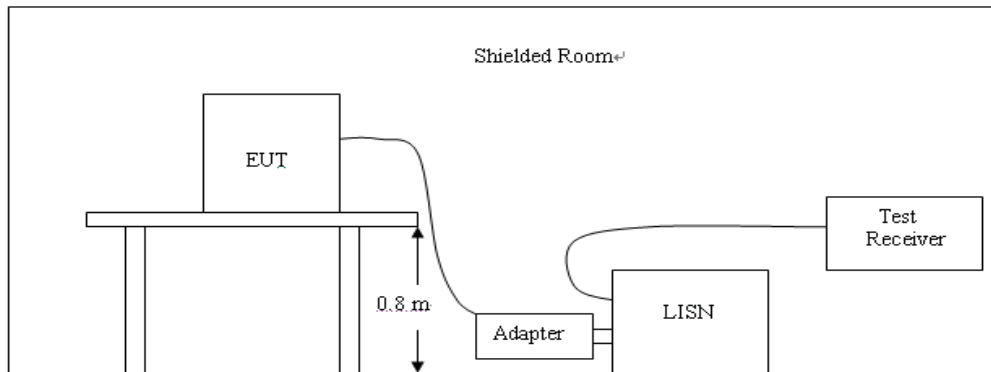

##### TEST PROCEDURE

1. The equipment was set up as per the test configuration to simulate typical actual usage per the user's manual. The EUT is a tabletop system; a wooden table with a height of 0.8 meters is used and is placed on the ground plane as per ANSI C63.10:2013.
2. Support equipment, if needed, was placed as per ANSI C63.10:2013.
3. All I/O cables were positioned to simulate typical actual usage as per ANSI C63.10:2013.
4. If a EUT received DC power from the USB Port of Notebook PC, the PC's adapter received AC120V/60Hz power through a Line Impedance Stabilization Network (LISN) which supplied power source and was grounded to the ground plane.
5. All support equipments received AC power from a second LISN, if any.
6. The EUT test program was started. Emissions were measured on each current carrying line of the EUT using a spectrum Analyzer / Receiver connected to the LISN powering the EUT. The LISN has two monitoring points: Line 1 (Hot Side) and Line 2 (Neutral Side). Two scans were taken: one with Line 1 connected to Analyzer / Receiver and Line 2 connected to a 50 ohm load; the second scan had Line 1 connected to a 50 ohm load and Line 2 connected to the Analyzer / Receiver.
7. Analyzer / Receiver scanned from 150 KHz to 30MHz for emissions in each of the test modes.
8. During the above scans, the emissions were maximized by cable manipulation.

**TEST RESULTS**

Remark: All modes of GFSK, Pi/4 DQPSK, 8DPSK and BLE were test at Low, Middle, and High channel; only the worst result of 8DPSK High Channel was reported as below:

**SCAN TABLE: "Voltage (9K-30M) FIN"**  
 Short Description: 150K-30M Voltage

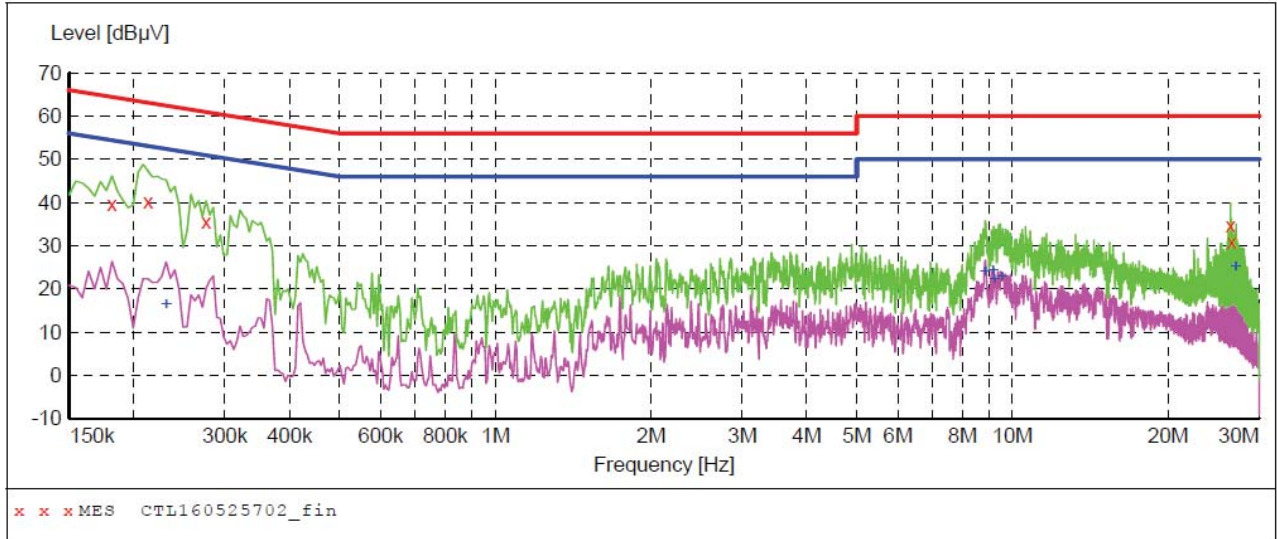

**MEASUREMENT RESULT: "CTL160525702\_fin"**

5/25/2016 2:55PM

| Frequency<br>MHz | Level<br>dBµV | Transd<br>dB | Limit<br>dBµV | Margin<br>dB | Detector | Line | PE  |
|------------------|---------------|--------------|---------------|--------------|----------|------|-----|
| 0.181501         | 39.50         | 10.2         | 64            | 24.9         | QP       | L1   | GND |
| 0.213001         | 40.30         | 10.2         | 63            | 22.8         | QP       | L1   | GND |
| 0.276001         | 35.40         | 10.2         | 61            | 25.5         | QP       | L1   | GND |
| 26.412001        | 34.60         | 11.2         | 60            | 25.4         | QP       | L1   | GND |
| 26.533501        | 30.90         | 11.2         | 60            | 29.1         | QP       | L1   | GND |

**MEASUREMENT RESULT: "CTL160525702\_fin2"**

5/25/2016 2:55PM

| Frequency<br>MHz | Level<br>dBµV | Transd<br>dB | Limit<br>dBµV | Margin<br>dB | Detector | Line | PE  |
|------------------|---------------|--------------|---------------|--------------|----------|------|-----|
| 0.231001         | 16.30         | 10.2         | 52            | 36.1         | AV       | L1   | GND |
| 8.844001         | 23.80         | 10.6         | 50            | 26.2         | AV       | L1   | GND |
| 9.159001         | 24.10         | 10.6         | 50            | 25.9         | AV       | L1   | GND |
| 9.217501         | 22.00         | 10.6         | 50            | 28.0         | AV       | L1   | GND |
| 9.528001         | 22.60         | 10.6         | 50            | 27.4         | AV       | L1   | GND |
| 27.015001        | 25.00         | 11.2         | 50            | 25.0         | AV       | L1   | GND |

**SCAN TABLE: "Voltage (9K-30M)FIN"**

Short Description: 150K-30M Voltage

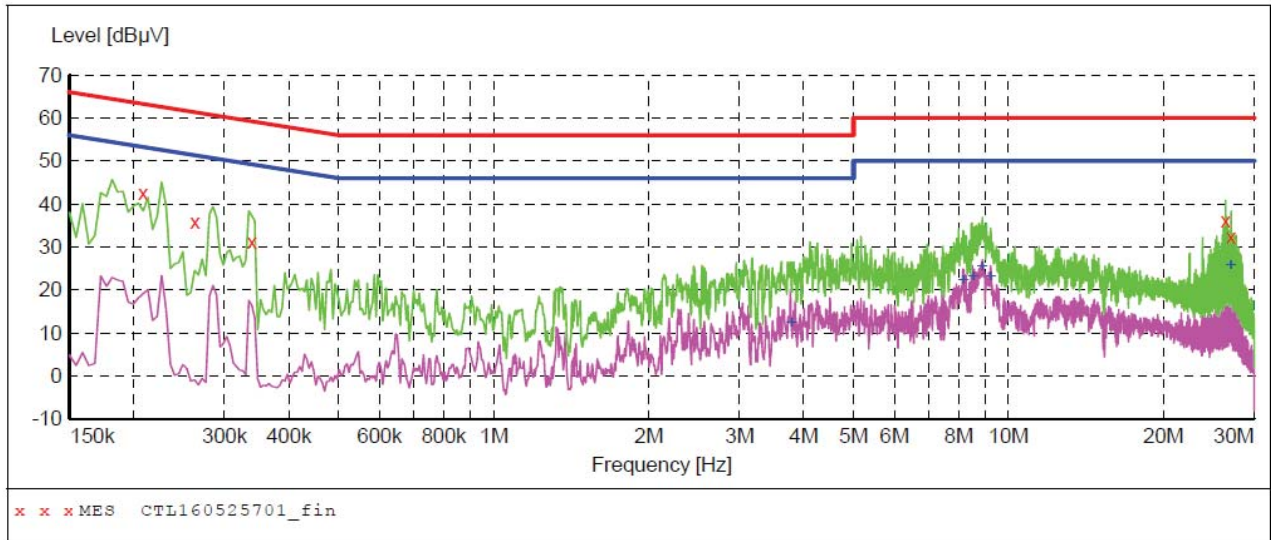

**MEASUREMENT RESULT: "CTL160525701\_fin"**

5/25/2016 2:52PM

| Frequency<br>MHz | Level<br>dBµV | Transd<br>dB | Limit<br>dBµV | Margin<br>dB | Detector | Line | PE  |
|------------------|---------------|--------------|---------------|--------------|----------|------|-----|
| 0.208501         | 42.50         | 10.2         | 63            | 20.8         | QP       | N    | GND |
| 0.262501         | 35.90         | 10.2         | 61            | 25.5         | QP       | N    | GND |
| 0.339001         | 31.20         | 10.2         | 59            | 28.0         | QP       | N    | GND |
| 26.412001        | 36.10         | 11.2         | 60            | 23.9         | QP       | N    | GND |
| 27.073501        | 32.40         | 11.2         | 60            | 27.6         | QP       | N    | GND |

**MEASUREMENT RESULT: "CTL160525701\_fin2"**

5/25/2016 2:52PM

| Frequency<br>MHz | Level<br>dBµV | Transd<br>dB | Limit<br>dBµV | Margin<br>dB | Detector | Line | PE  |
|------------------|---------------|--------------|---------------|--------------|----------|------|-----|
| 3.786001         | 12.30         | 10.4         | 46            | 33.7         | AV       | N    | GND |
| 8.164501         | 22.10         | 10.5         | 50            | 27.9         | AV       | N    | GND |
| 8.542501         | 23.00         | 10.6         | 50            | 27.0         | AV       | N    | GND |
| 8.880001         | 25.40         | 10.6         | 50            | 24.6         | AV       | N    | GND |
| 9.222001         | 22.90         | 10.6         | 50            | 27.1         | AV       | N    | GND |
| 27.015001        | 25.70         | 11.2         | 50            | 24.3         | AV       | N    | GND |



### 3.2. Radiated Emissions and Band Edge

#### Limit

According 15.249, the field strength of emissions from intentional radiators operated within 2400MHz-2483.5 MHz shall not exceed 94dBμV/m (50mV/m):

FCC PART 15.249(d) Emissions radiated outside of the specified frequency bands, except for harmonics, shall be attenuated by at least 50 dB below the level of the fundamental or to the general radiated emission limits in §15.209, whichever is the lesser attenuation.

In addition, radiated emissions which fall in the restricted bands, as defined in §15.205(a), must also comply with the radiated emission limits specified in §15.209(a)

Radiated emission limits

| Frequency (MHz) | Distance (Meters) | Radiated (dBμV/m)                           | Radiated (μV/m)       |
|-----------------|-------------------|---|-----------------------|
| 0.009-0.49      | 3                 | $20\log(2400/F(\text{KHz}))+40\log(300/3)$  | $2400/F(\text{KHz})$  |
| 0.49-1.705      | 3                 | $20\log(24000/F(\text{KHz}))+ 40\log(30/3)$ | $24000/F(\text{KHz})$ |
| 1.705-30        | 3                 | $20\log(30)+ 40\log(30/3)$                  | 30                    |
| 30-88           | 3                 | 40.0  | 100                   |
| 88-216          | 3                 | 43.5  | 150                   |
| 216-960         | 3                 | 46.0  | 200                   |
| Above 960       | 3                 | 54.0  | 500                   |

#### TEST CONFIGURATION

(A) Radiated Emission Test Set-Up, Frequency Below 30MHz

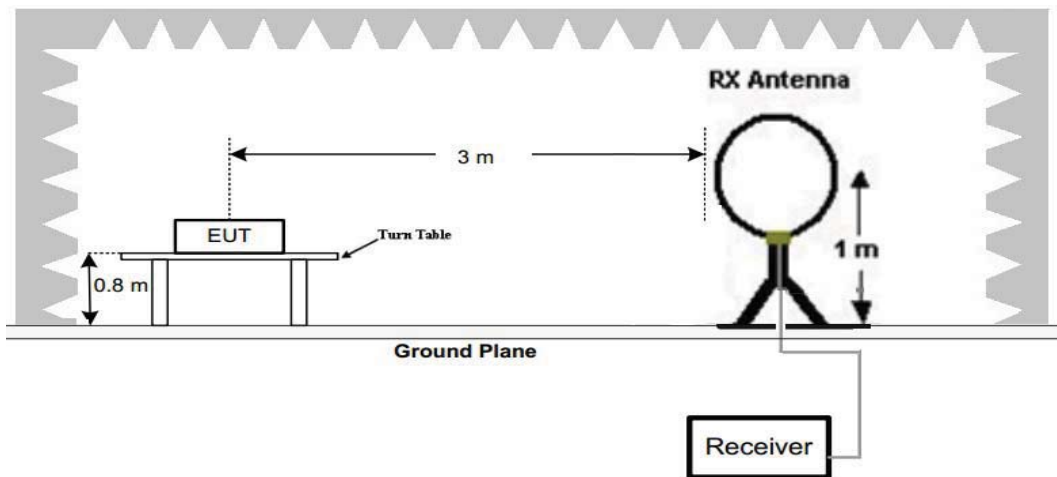

(B) Radiated Emission Test Set-Up, Frequency below 1000MHz

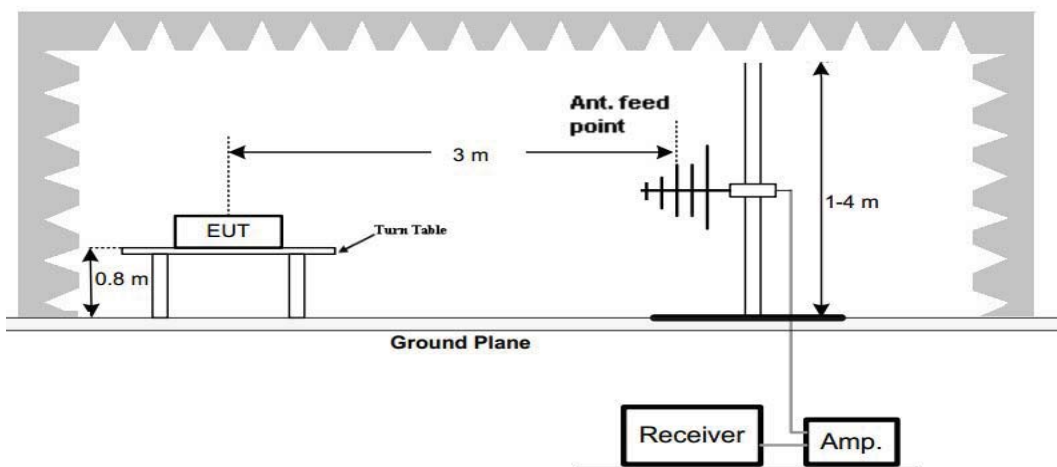

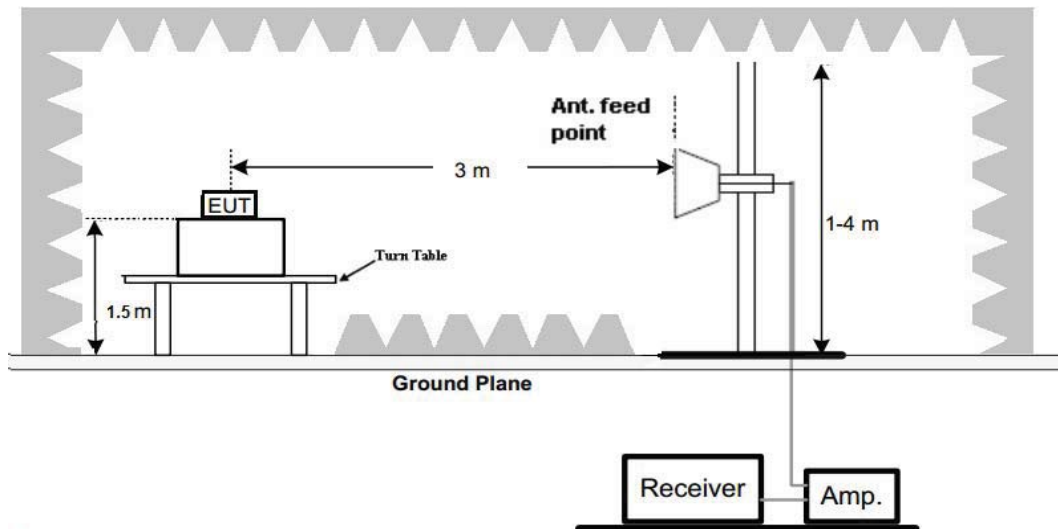

## (C) Radiated Emission Test Set-Up, Frequency above 1000MHz

**Test Procedure**

1. Below 1GHz measurement the EUT is placed on a turntable which is 0.8m above ground plane, and above 1GHz measurement EUT was placed on a low permittivity and low loss tangent turn table which is 1.5m above ground plane.
2. Maximum procedure was performed by raising the receiving antenna from 1m to 4m and rotating the turn table from 0° to 360° to acquire the highest emissions from EUT
3. And also, each emission was to be maximized by changing the polarization of receiving antenna both horizontal and vertical.
4. Repeat above procedures until all frequency measurements have been completed.

**TEST RESULTS**

## Remark:

1. All modes of GFSK, Pi/4 DQPSK, 8DPSK and BLE were test at Low, Middle, and High channel; only the worst result of GFSK DH5 low Channel was reported for below 1GHz test.
2. For BT3.0 above 1GHz test all modes of GFSK, Pi/4 DQPSK, and 8DPSK were test at Low, Middle, and High channel; only the worst result of GFSK DH5 was reported.
3. By preliminary testing and verifying three axis (X, Y and Z) position of EUT transmitted status, it was found that "Z axis" position was the worst, and test data recorded in this report.
4. Radiated emission test from 9KHz to 10th harmonic of fundamental was verified, and no emission found except system noise floor in 9KHz to 30MHz and not recorded in this report.

For 30MHz-1GHz

Horizontal

**SWEEP TABLE: "test (30M-1G)"**

| Short Description: |         | Field Strength |            |           |            |
|--------------------|---------|----------------|------------|-----------|------------|
| Start              | Stop    | Detector       | Meas. Time | IF Bandw. | Transducer |
| 30.0 MHz           | 1.0 GHz | MaxPeak        | 300.0 ms   | 120 kHz   | JB1        |

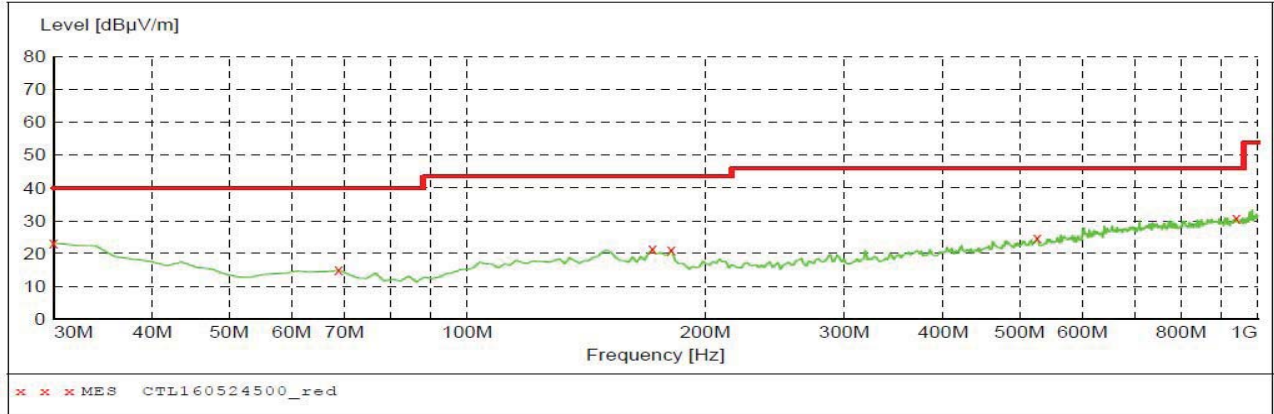

Note : PK test curve are much lower than QP limit

Vertical

**SWEEP TABLE: "test (30M-1G)"**

| Short Description: |         | Field Strength |            |           |            |
|--------------------|---------|----------------|------------|-----------|------------|
| Start              | Stop    | Detector       | Meas. Time | IF Bandw. | Transducer |
| 30.0 MHz           | 1.0 GHz | MaxPeak        | 300.0 ms   | 120 kHz   | JB1        |

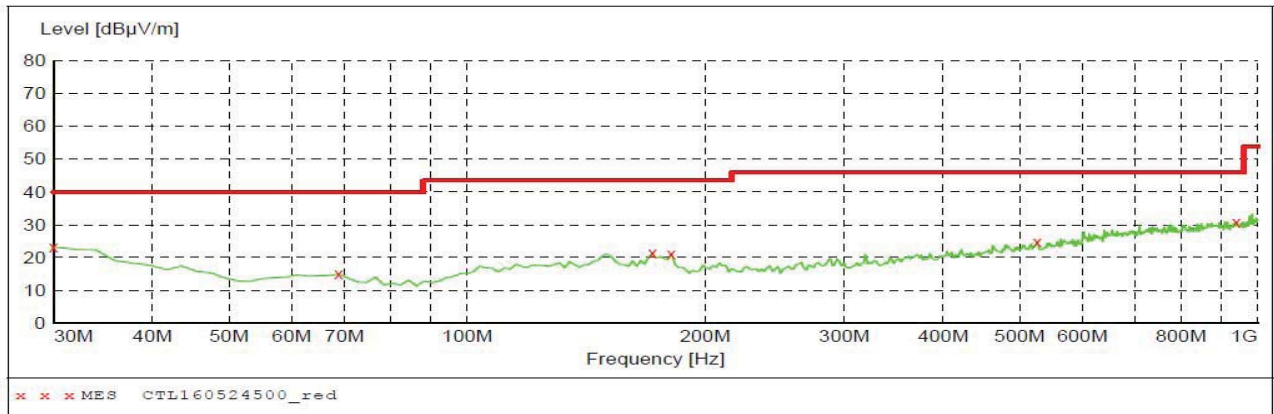

Note : PK test curve are much lower than QP limit

## For 1GHz to 25GHz

## BT3.0 GFSK Mode (above 1GHz)

| Frequency(MHz): |                 |                         |    | 2402           |             | Polarity:        |                       |                   | HORIZONTAL         |                          |
|-----------------|-----------------|-------------------------|----|----------------|-------------|------------------|-----------------------|-------------------|--------------------|--------------------------|
| No.             | Frequency (MHz) | Emission Level (dBuV/m) |    | Limit (dBuV/m) | Margin (dB) | Raw Value (dBuV) | Antenna Factor (dB/m) | Cable Factor (dB) | Pre-amplifier (dB) | Correction Factor (dB/m) |
| 1               | 2402.00         | 96.66                   | PK | 114            | 17.34       | 63.26            | 28.78                 | 4.61              | 0.00               | 33.40                    |
| 1               | 2402.00         | 91.25                   | AV | 94             | 2.75        | 57.85            | 28.78                 | 4.61              | 0.00               | 33.40                    |
| 2               | 2390.00         | 39.25                   | PK | 74             | 34.75       | 5.93             | 28.72                 | 4.60              | 0.00               | 33.32                    |
| 2               | 2390.00         | --                      | AV | 54             | --          | --               | --                    | --                | --                 | --                       |
| 3               | 2400.00         | 47.85                   | PK | 74             | 26.15       | 14.46            | 28.78                 | 4.61              | 0.00               | 33.39                    |
| 3               | 2400.00         | --                      | AV | 54             | --          | --               | --                    | --                | --                 | --                       |
| 4               | 4804.00         | 55.22                   | PK | 74             | 18.78       | 50.71            | 33.49                 | 6.91              | 35.89              | 4.51                     |
| 4               | 4804.00         | 47.54                   | AV | 54             | 6.46        | 43.03            | 33.49                 | 6.91              | 35.89              | 4.51                     |
| 5               | 5375.50         | 43.25                   | PK | 74             | 30.75       | 35.65            | 34.72                 | 7.25              | 34.37              | 7.60                     |
| 5               | 5375.50         | --                      | AV | 54             | --          | --               | --                    | --                | --                 | --                       |
| 6               | 7206.00         | 41.21                   | PK | 74             | 32.79       | 30.10            | 36.95                 | 9.18              | 35.03              | 11.11                    |
| 6               | 7206.00         | --                      | AV | 54             | --          | --               | --                    | --                | --                 | --                       |

| Frequency(MHz): |                 |                         |    | 2402           |             | Polarity:        |                       |                   | VERTICAL           |                          |
|-----------------|-----------------|-------------------------|----|----------------|-------------|------------------|-----------------------|-------------------|--------------------|--------------------------|
| No.             | Frequency (MHz) | Emission Level (dBuV/m) |    | Limit (dBuV/m) | Margin (dB) | Raw Value (dBuV) | Antenna Factor (dB/m) | Cable Factor (dB) | Pre-amplifier (dB) | Correction Factor (dB/m) |
| 1               | 2402.00         | 97.14                   | PK | 114            | 16.86       | 63.74            | 28.78                 | 4.61              | 0.00               | 33.40                    |
| 1               | 2402.00         | 90.21                   | AV | 94             | 3.79        | 56.81            | 28.78                 | 4.61              | 0.00               | 33.40                    |
| 2               | 2390.00         | 40.25                   | PK | 74             | 33.75       | 6.93             | 28.72                 | 4.60              | 0.00               | 33.32                    |
| 2               | 2390.00         | --                      | AV | 54             | --          | --               | --                    | --                | --                 | --                       |
| 3               | 2400.00         | 47.55                   | PK | 74             | 26.45       | 14.16            | 28.78                 | 4.61              | 0.00               | 33.39                    |
| 3               | 2400.00         | --                      | AV | 54             | --          | --               | --                    | --                | --                 | --                       |
| 4               | 4804.00         | 56.21                   | PK | 74             | 17.79       | 51.70            | 33.49                 | 6.91              | 35.89              | 4.51                     |
| 4               | 4804.00         | 48.24                   | AV | 54             | 5.76        | 43.73            | 33.49                 | 6.91              | 35.89              | 4.51                     |
| 5               | 5050.75         | 42.52                   | PK | 74             | 31.48       | 35.55            | 34.16                 | 7.06              | 34.25              | 6.97                     |
| 5               | 5050.75         | --                      | AV | 54             | --          | --               | --                    | --                | --                 | --                       |
| 6               | 7206.00         | 43.26                   | PK | 74             | 30.74       | 32.15            | 36.95                 | 9.18              | 35.03              | 11.11                    |
| 6               | 7206.00         | --                      | AV | 54             | --          | --               | --                    | --                | --                 | --                       |

## REMARKS:

1. Emission level (dBuV/m) =Raw Value (dBuV)+Correction Factor (dB/m)
2. Correction Factor (dB/m) = Antenna Factor (dB/m)+Cable Factor (dB)-Pre-amplifier Factor
3. Margin value = Limit value- Emission level.
4. -- Mean the PK detector measured value is below average limit.
5. The other emission levels were very low against the limit.
6. RBW1MHz VBW3MHz Peak detector is for PK value; RBW 1MHz VBW10Hz Peak detector is for AV value.
7. For fundamental frequency, RBW 3MHz VBW 3MHz Peak detector is for PK Value ; RMS detector is for AV value.

| Frequency(MHz): |                 |                         |    | 2441           |             | Polarity:        |                       |                   | HORIZONTAL         |                          |
|-----------------|-----------------|-------------------------|----|----------------|-------------|------------------|-----------------------|-------------------|--------------------|--------------------------|
| No.             | Frequency (MHz) | Emission Level (dBuV/m) |    | Limit (dBuV/m) | Margin (dB) | Raw Value (dBuV) | Antenna Factor (dB/m) | Cable Factor (dB) | Pre-amplifier (dB) | Correction Factor (dB/m) |
| 1               | 2441.00         | 96.48                   | PK | 114            | 17.52       | 62.97            | 28.85                 | 4.66              | 0.00               | 33.51                    |
| 1               | 2441.00         | 90.36                   | AV | 94             | 3.64        | 56.85            | 28.85                 | 4.66              | 0.00               | 33.51                    |
| 2               | 3755.50         | 42.21                   | PK | 74             | 31.79       | 38.06            | 33.00                 | 6.13              | 34.97              | 4.15                     |
| 2               | 3755.50         | --                      | AV | 54             | --          | --               | --                    | --                | --                 | --                       |
| 3               | 4882.00         | 55.45                   | PK | 74             | 18.55       | 49.09            | 33.60                 | 6.95              | 34.19              | 6.36                     |
| 3               | 4882.00         | 48.29                   | AV | 54             | 5.71        | 41.93            | 33.60                 | 6.95              | 34.19              | 6.36                     |
| 4               | 5075.25         | 41.15                   | PK | 74             | 32.85       | 34.02            | 34.24                 | 7.08              | 34.19              | 7.13                     |
| 4               | 5075.25         | --                      | AV | 54             | --          | --               | --                    | --                | --                 | --                       |
| 5               | 7323.00         | 42.74                   | PK | 74             | 31.26       | 31.04            | 37.46                 | 9.23              | 35.00              | 11.70                    |
| 5               | 7323.00         | --                      | AV | 54             | --          | --               | --                    | --                | --                 | --                       |

| Frequency(MHz): |                 |                         |    | 2441           |             | Polarity:        |                       |                   | VERTICAL           |                          |
|-----------------|-----------------|-------------------------|----|----------------|-------------|------------------|-----------------------|-------------------|--------------------|--------------------------|
| No.             | Frequency (MHz) | Emission Level (dBuV/m) |    | Limit (dBuV/m) | Margin (dB) | Raw Value (dBuV) | Antenna Factor (dB/m) | Cable Factor (dB) | Pre-amplifier (dB) | Correction Factor (dB/m) |
| 1               | 2441.00         | 97.63                   | PK | 114            | 16.37       | 64.12            | 28.85                 | 4.66              | 0.00               | 33.51                    |
| 1               | 2441.00         | 90.24                   | AV | 94             | 3.76        | 56.73            | 28.85                 | 4.66              | 0.00               | 33.51                    |
| 2               | 3985.75         | 42.51                   | PK | 74             | 31.49       | 37.80            | 33.14                 | 6.38              | 34.81              | 4.71                     |
| 2               | 3985.75         | --                      | AV | 54             | --          | --               | --                    | --                | --                 | --                       |
| 3               | 4882.00         | 55.22                   | PK | 74             | 18.78       | 48.86            | 33.60                 | 6.95              | 34.19              | 6.36                     |
| 3               | 4882.00         | 47.89                   | AV | 54             | 6.11        | 41.53            | 33.60                 | 6.95              | 34.19              | 6.36                     |
| 4               | 5075.50         | 41.41                   | PK | 74             | 32.59       | 34.28            | 34.24                 | 7.08              | 34.19              | 7.13                     |
| 4               | 5075.50         | --                      | AV | 54             | --          | --               | --                    | --                | --                 | --                       |
| 5               | 7323.00         | 43.74                   | PK | 74             | 30.26       | 32.04            | 37.46                 | 9.23              | 35.00              | 11.70                    |
| 5               | 7323.00         | --                      | AV | 54             | --          | --               | --                    | --                | --                 | --                       |

## REMARKS:

1. Emission level (dBuV/m) =Raw Value (dBuV)+Correction Factor (dB/m)
2. Correction Factor (dB/m) = Antenna Factor (dB/m)+Cable Factor (dB)-Pre-amplifier Factor
3. Margin value = Limit value- Emission level.
4. -- Mean the PK detector measured value is below average limit.
5. The other emission levels were very low against the limit.
6. RBW1MHz VBW3MHz Peak detector is for PK value; RBW 1MHz VBW10Hz Peak detector is for AV value.
7. For fundamental frequency, RBW 3MHz VBW 3MHz Peak detector is for PK Value ; RMS detector is for AV value.



| Frequency(MHz): |                 |                         |    | 2480           |             | Polarity:        |                       |                   | HORIZONTAL         |                          |
|-----------------|-----------------|-------------------------|----|----------------|-------------|------------------|-----------------------|-------------------|--------------------|--------------------------|
| No.             | Frequency (MHz) | Emission Level (dBuV/m) |    | Limit (dBuV/m) | Margin (dB) | Raw Value (dBuV) | Antenna Factor (dB/m) | Cable Factor (dB) | Pre-amplifier (dB) | Correction Factor (dB/m) |
| 1               | 2480.00         | 96.69                   | PK | 114            | 17.31       | 63.07            | 28.92                 | 4.70              | 0.00               | 33.62                    |
| 1               | 2480.00         | 90.54                   | AV | 94             | 3.46        | 56.92            | 28.92                 | 4.70              | 0.00               | 33.62                    |
| 2               | 2483.50         | 46.32                   | PK | 74             | 27.68       | 12.69            | 28.93                 | 4.70              | 0.00               | 33.63                    |
| 2               | 2483.50         | --                      | AV | 54             | --          | --               | --                    | --                | --                 | --                       |
| 3               | 2500.00         | 40.51                   | PK | 74             | 33.49       | 6.83             | 28.96                 | 4.72              | 0.00               | 33.68                    |
| 3               | 2500.00         | --                      | AV | 54             | --          | --               | --                    | --                | --                 | --                       |
| 4               | 4960.00         | 56.14                   | PK | 74             | 17.86       | 51.22            | 33.84                 | 7.00              | 35.92              | 4.92                     |
| 4               | 4960.00         | 46.39                   | AV | 54             | 7.61        | 41.47            | 33.84                 | 7.00              | 35.92              | 4.92                     |
| 5               | 5322.25         | 43.70                   | PK | 74             | 30.3        | 36.17            | 34.66                 | 7.21              | 34.35              | 7.53                     |
| 5               | 5322.25         | --                      | AV | 54             | --          | --               | --                    | --                | --                 | --                       |
| 6               | 7440.00         | 40.48                   | PK | 74             | 33.52       | 28.53            | 37.64                 | 9.28              | 34.97              | 11.95                    |
| 6               | 7440.00         | --                      | AV | 54             | --          | --               | --                    | --                | --                 | --                       |

| Frequency(MHz): |                 |                         |    | 2480           |             | Polarity:        |                       |                   | VERTICAL           |                          |
|-----------------|-----------------|-------------------------|----|----------------|-------------|------------------|-----------------------|-------------------|--------------------|--------------------------|
| No.             | Frequency (MHz) | Emission Level (dBuV/m) |    | Limit (dBuV/m) | Margin (dB) | Raw Value (dBuV) | Antenna Factor (dB/m) | Cable Factor (dB) | Pre-amplifier (dB) | Correction Factor (dB/m) |
| 1               | 2480.00         | 96.70                   | PK | 114            | 17.3        | 63.08            | 28.92                 | 4.70              | 0.00               | 33.62                    |
| 1               | 2480.00         | 90.36                   | AV | 94             | 3.64        | 56.74            | 28.92                 | 4.70              | 0.00               | 33.62                    |
| 2               | 2483.50         | 40.41                   | PK | 74             | 33.59       | 6.78             | 28.93                 | 4.70              | 0.00               | 33.63                    |
| 2               | 2483.50         | --                      | AV | 54             | --          | --               | --                    | --                | --                 | --                       |
| 3               | 2500.00         | 38.75                   | PK | 74             | 35.25       | 5.07             | 28.96                 | 4.72              | 0.00               | 33.68                    |
| 3               | 2500.00         | --                      | AV | 54             | --          | --               | --                    | --                | --                 | --                       |
| 4               | 4960.00         | 56.24                   | PK | 74             | 17.76       | 51.32            | 33.84                 | 7.00              | 35.92              | 4.92                     |
| 4               | 4960.00         | 47.68                   | AV | 54             | 6.32        | 42.76            | 33.84                 | 7.00              | 35.92              | 4.92                     |
| 5               | 5785.50         | 42.44                   | PK | 74             | 31.56       | 34.68            | 34.80                 | 7.47              | 34.51              | 7.76                     |
| 5               | 5785.50         | --                      | AV | 54             | --          | --               | --                    | --                | --                 | --                       |
| 6               | 7440.00         | 43.21                   | PK | 74             | 30.79       | 31.26            | 37.64                 | 9.28              | 34.97              | 11.95                    |
| 6               | 7440.00         | --                      | AV | 54             | --          | --               | --                    | --                | --                 | --                       |

## REMARKS:

1. Emission level (dBuV/m) =Raw Value (dBuV)+Correction Factor (dB/m)
2. Correction Factor (dB/m) = Antenna Factor (dB/m)+Cable Factor (dB)-Pre-amplifier Factor
3. Margin value = Limit value- Emission level.
4. -- Mean the PK detector measured value is below average limit.
5. The other emission levels were very low against the limit.
6. RBW1MHz VBW3MHz Peak detector is for PK value; RBW 1MHz VBW10Hz Peak detector is for AV value.
7. For fundamental frequency, RBW 3MHz VBW 3MHz Peak detector is for PK Value ; RMS detector is for AV value.



**BT4.0 GFSK Mode (above 1GHz)**

| Frequency(MHz): |                 |                         |    | 2402           |             | Polarity:        |                       |                   | HORIZONTAL         |                          |
|-----------------|-----------------|-------------------------|----|----------------|-------------|------------------|-----------------------|-------------------|--------------------|--------------------------|
| No.             | Frequency (MHz) | Emission Level (dBuV/m) |    | Limit (dBuV/m) | Margin (dB) | Raw Value (dBuV) | Antenna Factor (dB/m) | Cable Factor (dB) | Pre-amplifier (dB) | Correction Factor (dB/m) |
| 1               | 2402.00         | 88.59                   | PK | 114            | 25.41       | 55.19            | 28.78                 | 4.61              | 0.00               | 33.40                    |
| 1               | 2402.00         | 78.54                   | AV | 94             | 15.46       | 45.14            | 28.78                 | 4.61              | 0.00               | 33.40                    |
| 2               | 2390.00         | 36.32                   | PK | 74             | 37.68       | 3.00             | 28.72                 | 4.60              | 0.00               | 33.32                    |
| 2               | 2390.00         | --                      | AV | 54             | --          | --               | --                    | --                | --                 | --                       |
| 3               | 2400.00         | 40.15                   | PK | 74             | 33.85       | 6.76             | 28.78                 | 4.61              | 0.00               | 33.39                    |
| 3               | 2400.00         | --                      | AV | 54             | --          | --               | --                    | --                | --                 | --                       |
| 4               | 4804.00         | 48.69                   | PK | 74             | 25.31       | 44.18            | 33.49                 | 6.91              | 35.89              | 4.51                     |
| 4               | 4804.00         | --                      | AV | 54             | --          | --               | --                    | --                | --                 | --                       |
| 5               | 5322.75         | 41.24                   | PK | 74             | 32.76       | 33.71            | 34.66                 | 7.21              | 34.35              | 7.53                     |
| 5               | 5322.75         | --                      | AV | 54             | --          | --               | --                    | --                | --                 | --                       |
| 6               | 7206.00         | 43.29                   | PK | 74             | 30.71       | 32.18            | 36.95                 | 9.18              | 35.03              | 11.11                    |
| 6               | 7206.00         | --                      | AV | 54             | --          | --               | --                    | --                | --                 | --                       |

| Frequency(MHz): |                 |                         |    | 2402           |             | Polarity:        |                       |                   | VERTICAL           |                          |
|-----------------|-----------------|-------------------------|----|----------------|-------------|------------------|-----------------------|-------------------|--------------------|--------------------------|
| No.             | Frequency (MHz) | Emission Level (dBuV/m) |    | Limit (dBuV/m) | Margin (dB) | Raw Value (dBuV) | Antenna Factor (dB/m) | Cable Factor (dB) | Pre-amplifier (dB) | Correction Factor (dB/m) |
| 1               | 2402.00         | 88.69                   | PK | 114            | 25.31       | 55.29            | 28.78                 | 4.61              | 0.00               | 33.40                    |
| 1               | 2402.00         | 80.15                   | AV | 94             | 13.85       | 46.75            | 28.78                 | 4.61              | 0.00               | 33.40                    |
| 2               | 2390.00         | 37.58                   | PK | 74             | 36.42       | 4.26             | 28.72                 | 4.60              | 0.00               | 33.32                    |
| 2               | 2390.00         | --                      | AV | 54             | --          | --               | --                    | --                | --                 | --                       |
| 3               | 2400.00         | 39.24                   | PK | 74             | 34.76       | 5.85             | 28.78                 | 4.61              | 0.00               | 33.39                    |
| 3               | 2400.00         | --                      | AV | 54             | --          | --               | --                    | --                | --                 | --                       |
| 4               | 4804.00         | 45.46                   | PK | 74             | 28.54       | 40.95            | 33.49                 | 6.91              | 35.89              | 4.51                     |
| 4               | 4804.00         | --                      | AV | 54             | --          | --               | --                    | --                | --                 | --                       |
| 5               | 5322.50         | 40.78                   | PK | 74             | 33.22       | 33.25            | 34.66                 | 7.21              | 34.35              | 7.53                     |
| 5               | 5322.50         | --                      | AV | 54             | --          | --               | --                    | --                | --                 | --                       |
| 6               | 7206.00         | 39.71                   | PK | 74             | 34.29       | 28.60            | 36.95                 | 9.18              | 35.03              | 11.11                    |
| 6               | 7206.00         | --                      | AV | 54             | --          | --               | --                    | --                | --                 | --                       |

**REMARKS:**

1. Emission level (dBuV/m) =Raw Value (dBuV)+Correction Factor (dB/m)
2. Correction Factor (dB/m) = Antenna Factor (dB/m)+Cable Factor (dB)-Pre-amplifier Factor
3. Margin value = Limit value- Emission level.
4. -- Mean the PK detector measured value is below average limit.
5. The other emission levels were very low against the limit.
6. RBW1MHz VBW3MHz Peak detector is for PK value; RBW 1MHz VBW10Hz Peak detector is for AV value.
7. For fundamental frequency, RBW 3MHz VBW 3MHz Peak detector is for PK Value ; RMS detector is for AV value.

| Frequency(MHz): |                 |                         |    | 2440           |             | Polarity:        |                       |                   | HORIZONTAL         |                          |
|-----------------|-----------------|-------------------------|----|----------------|-------------|------------------|-----------------------|-------------------|--------------------|--------------------------|
| No.             | Frequency (MHz) | Emission Level (dBuV/m) |    | Limit (dBuV/m) | Margin (dB) | Raw Value (dBuV) | Antenna Factor (dB/m) | Cable Factor (dB) | Pre-amplifier (dB) | Correction Factor (dB/m) |
| 1               | 2440.00         | 88.75                   | PK | 114            | 25.25       | 55.24            | 28.85                 | 4.65              | 0.00               | 33.51                    |
| 1               | 2440.00         | 79.33                   | AV | 94             | 14.67       | 45.82            | 28.85                 | 4.65              | 0.00               | 33.51                    |
| 2               | 3875.50         | 36.51                   | PK | 74             | 37.49       | 31.85            | 33.29                 | 6.26              | 34.89              | 4.66                     |
| 2               | 3875.50         | --                      | AV | 54             | --          | --               | --                    | --                | --                 | --                       |
| 3               | 4880.00         | 40.41                   | PK | 74             | 33.59       | 34.05            | 33.60                 | 6.95              | 34.19              | 6.36                     |
| 3               | 4880.00         | --                      | AV | 54             | --          | --               | --                    | --                | --                 | --                       |
| 4               | 5435.50         | 42.75                   | PK | 74             | 31.25       | 34.71            | 34.74                 | 7.28              | 33.98              | 8.04                     |
| 4               | 5435.50         | --                      | AV | 54             | --          | --               | --                    | --                | --                 | --                       |
| 5               | 7320.00         | 45.50                   | PK | 74             | 28.5        | 33.81            | 37.46                 | 9.23              | 35.00              | 11.69                    |
| 5               | 7320.00         | --                      | AV | 54             | --          | --               | --                    | --                | --                 | --                       |

| Frequency(MHz): |                 |                         |    | 2440           |             | Polarity:        |                       |                   | VERTICAL           |                          |
|-----------------|-----------------|-------------------------|----|----------------|-------------|------------------|-----------------------|-------------------|--------------------|--------------------------|
| No.             | Frequency (MHz) | Emission Level (dBuV/m) |    | Limit (dBuV/m) | Margin (dB) | Raw Value (dBuV) | Antenna Factor (dB/m) | Cable Factor (dB) | Pre-amplifier (dB) | Correction Factor (dB/m) |
| 1               | 2440.00         | 89.49                   | PK | 114            | 24.51       | 55.98            | 28.85                 | 4.65              | 0.00               | 33.51                    |
| 1               | 2440.00         | 80.54                   | AV | 94             | 13.46       | 47.03            | 28.85                 | 4.65              | 0.00               | 33.51                    |
| 2               | 3789.75         | 39.65                   | PK | 74             | 34.35       | 35.21            | 33.21                 | 6.17              | 34.95              | 4.44                     |
| 2               | 3789.75         | --                      | AV | 54             | --          | --               | --                    | --                | --                 | --                       |
| 3               | 4880.00         | 43.24                   | PK | 74             | 30.76       | 36.88            | 33.60                 | 6.95              | 34.19              | 6.36                     |
| 3               | 4880.00         | --                      | AV | 54             | --          | --               | --                    | --                | --                 | --                       |
| 4               | 5150.25         | 40.58                   | PK | 74             | 33.42       | 33.17            | 34.44                 | 7.12              | 34.14              | 7.41                     |
| 4               | 5150.25         | --                      | AV | 54             | --          | --               | --                    | --                | --                 | --                       |
| 5               | 7320.00         | 43.41                   | PK | 74             | 30.59       | 31.72            | 37.46                 | 9.23              | 35.00              | 11.69                    |
| 5               | 7320.00         | --                      | AV | 54             | --          | --               | --                    | --                | --                 | --                       |

## REMARKS:

1. Emission level (dBuV/m) =Raw Value (dBuV)+Correction Factor (dB/m)
2. Correction Factor (dB/m) = Antenna Factor (dB/m)+Cable Factor (dB)-Pre-amplifier Factor
3. Margin value = Limit value- Emission level.
4. -- Mean the PK detector measured value is below average limit.
5. The other emission levels were very low against the limit.
6. RBW1MHz VBW3MHz Peak detector is for PK value; RBW 1MHz VBW10Hz Peak detector is for AV value.
7. For fundamental frequency, RBW 3MHz VBW 3MHz Peak detector is for PK Value ; RMS detector is for AV value.

| Frequency(MHz): |                 |                         |    | 2480           |             | Polarity:        |                       |                   | HORIZONTAL         |                          |
|-----------------|-----------------|-------------------------|----|----------------|-------------|------------------|-----------------------|-------------------|--------------------|--------------------------|
| No.             | Frequency (MHz) | Emission Level (dBuV/m) |    | Limit (dBuV/m) | Margin (dB) | Raw Value (dBuV) | Antenna Factor (dB/m) | Cable Factor (dB) | Pre-amplifier (dB) | Correction Factor (dB/m) |
| 1               | 2480.00         | 88.28                   | PK | 114            | 25.72       | 54.66            | 28.92                 | 4.70              | 0.00               | 33.62                    |
| 1               | 2480.00         | 80.33                   | AV | 94             | 13.67       | 46.71            | 28.92                 | 4.70              | 0.00               | 33.62                    |
| 2               | 2483.50         | 39.41                   | PK | 74             | 34.59       | 5.78             | 28.93                 | 4.70              | 0.00               | 33.63                    |
| 2               | 2483.50         | --                      | AV | 54             | --          | --               | --                    | --                | --                 | --                       |
| 3               | 2500.00         | 36.21                   | PK | 74             | 37.79       | 2.53             | 28.96                 | 4.72              | 0.00               | 33.68                    |
| 3               | 2500.00         | --                      | AV | 54             | --          | --               | --                    | --                | --                 | --                       |
| 4               | 4960.00         | 49.15                   | PK | 74             | 24.85       | 44.23            | 33.84                 | 7.00              | 35.92              | 4.92                     |
| 4               | 4960.00         | --                      | AV | 54             | --          | --               | --                    | --                | --                 | --                       |
| 5               | 5332.75         | 43.21                   | PK | 74             | 30.79       | 35.67            | 34.67                 | 7.22              | 34.35              | 7.54                     |
| 5               | 5332.75         | --                      | AV | 54             | --          | --               | --                    | --                | --                 | --                       |
| 6               | 7440.00         | 40.33                   | PK | 74             | 33.67       | 28.38            | 37.64                 | 9.28              | 34.97              | 11.95                    |
| 6               | 7440.00         | --                      | AV | 54             | --          | --               | --                    | --                | --                 | --                       |

| Frequency(MHz): |                 |                         |    | 2480           |             | Polarity:        |                       |                   | VERTICAL           |                          |
|-----------------|-----------------|-------------------------|----|----------------|-------------|------------------|-----------------------|-------------------|--------------------|--------------------------|
| No.             | Frequency (MHz) | Emission Level (dBuV/m) |    | Limit (dBuV/m) | Margin (dB) | Raw Value (dBuV) | Antenna Factor (dB/m) | Cable Factor (dB) | Pre-amplifier (dB) | Correction Factor (dB/m) |
| 1               | 2480.00         | 88.79                   | PK | 114            | 25.21       | 55.17            | 28.92                 | 4.70              | 0.00               | 33.62                    |
| 1               | 2480.00         | 78.21                   | AV | 94             | 15.79       | 44.59            | 28.92                 | 4.70              | 0.00               | 33.62                    |
| 2               | 2483.50         | 40.31                   | PK | 74             | 33.69       | 6.68             | 28.93                 | 4.70              | 0.00               | 33.63                    |
| 2               | 2483.50         | --                      | AV | 54             | --          | --               | --                    | --                | --                 | --                       |
| 3               | 2500.00         | 38.25                   | PK | 74             | 35.75       | 4.57             | 28.96                 | 4.72              | 0.00               | 33.68                    |
| 3               | 2500.00         | --                      | AV | 54             | --          | --               | --                    | --                | --                 | --                       |
| 4               | 4960.00         | 46.15                   | PK | 74             | 27.85       | 41.23            | 33.84                 | 7.00              | 35.92              | 4.92                     |
| 4               | 4960.00         | --                      | AV | 54             | --          | --               | --                    | --                | --                 | --                       |
| 5               | 5275.50         | 41.33                   | PK | 74             | 32.67       | 33.86            | 34.62                 | 7.19              | 34.33              | 7.47                     |
| 5               | 5275.50         | --                      | AV | 54             | --          | --               | --                    | --                | --                 | --                       |
| 6               | 7440.00         | 42.12                   | PK | 74             | 31.88       | 30.17            | 37.64                 | 9.28              | 34.97              | 11.95                    |
| 6               | 7440.00         | --                      | AV | 54             | --          | --               | --                    | --                | --                 | --                       |

## REMARKS:

1. Emission level (dBuV/m) =Raw Value (dBuV)+Correction Factor (dB/m)
2. Correction Factor (dB/m) = Antenna Factor (dB/m)+Cable Factor (dB)-Pre-amplifier Factor
3. Margin value = Limit value- Emission level.
4. -- Mean the PK detector measured value is below average limit.
5. The other emission levels were very low against the limit.
6. RBW1MHz VBW3MHz Peak detector is for PK value; RBW 1MHz VBW10Hz Peak detector is for AV value.
7. For fundamental frequency, RBW 3MHz VBW 3MHz Peak detector is for PK Value ; RMS detector is for AV value.

### 3.3. Occupied Bandwidth Measurement

#### Limit

N/A

#### Test Configuration

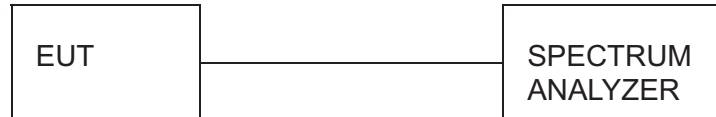

#### Test Procedure

The transmitter output was connected to the spectrum analyzer through an attenuator. The bandwidth of the fundamental frequency was measured by spectrum analyzer with 30 KHz RBW and 100 KHz VBW.

The 20dB bandwidth is defined as the total spectrum the power of which is higher than peak power minus 20dB.

#### Test Results

##### **BT3.0**

| Modulation    | Channel | 99% OBW (MHz) | 20dB bandwidth (MHz) | Result |
|---------------|---------|---------------|----------------------|--------|
| GFSK          | CH00    | 0.855         | 0.924                | Pass   |
|               | CH39    | 0.861         | 0.925                |        |
|               | CH78    | 0.860         | 0.924                |        |
| $\pi/4$ DQPSK | CH00    | 1.165         | 1.262                |        |
|               | CH39    | 1.168         | 1.266                |        |
|               | CH78    | 1.165         | 1.231                |        |
| 8DPSK         | CH00    | 1.166         | 1.280                |        |
|               | CH39    | 1.166         | 1.264                |        |
|               | CH78    | 1.160         | 1.278                |        |

##### **BT4.0**

| Modulation | Channel | 99% OBW (MHz) | 20dB bandwidth (MHz) | Result |
|------------|---------|---------------|----------------------|--------|
| GFSK       | CH00    | 1.027         | 1.091                | Pass   |
|            | CH19    | 1.023         | 1.087                |        |
|            | CH39    | 1.025         | 1.083                |        |

Test plot as follows:



**BT3.0**  
**GFSK Modulation**



**CH00**



**CH39**

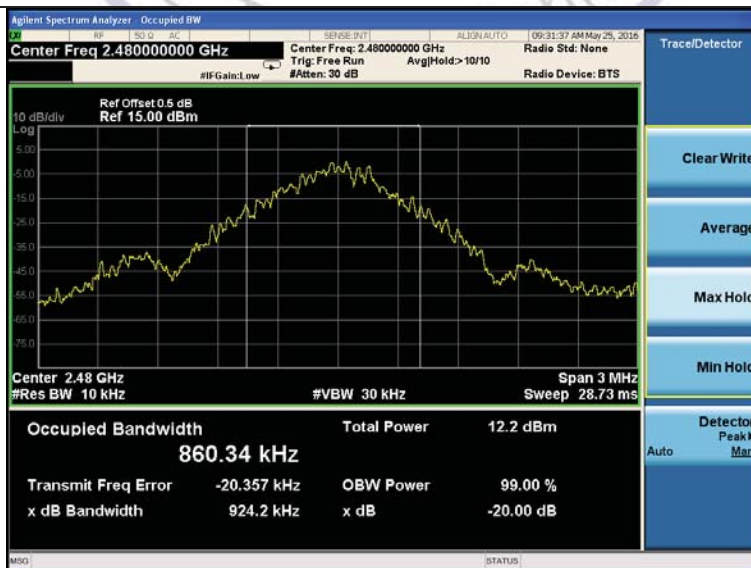

**CH78**



$\pi/4$  DQPSK Modulation

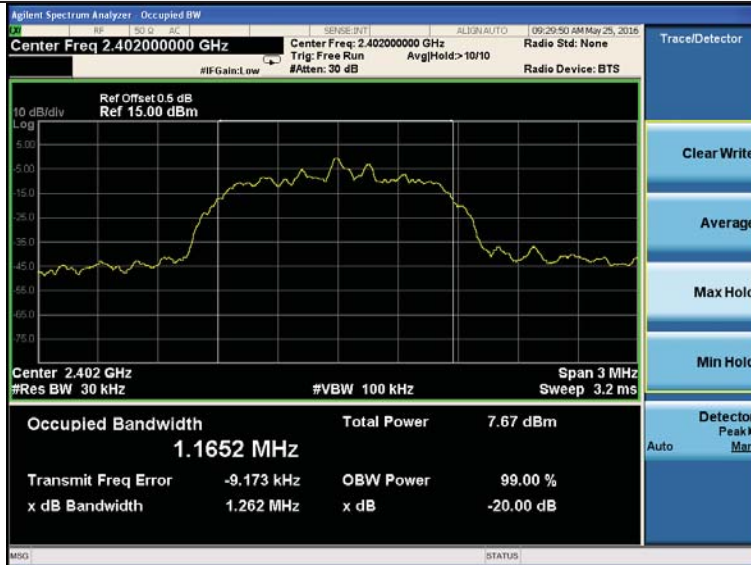

CH00

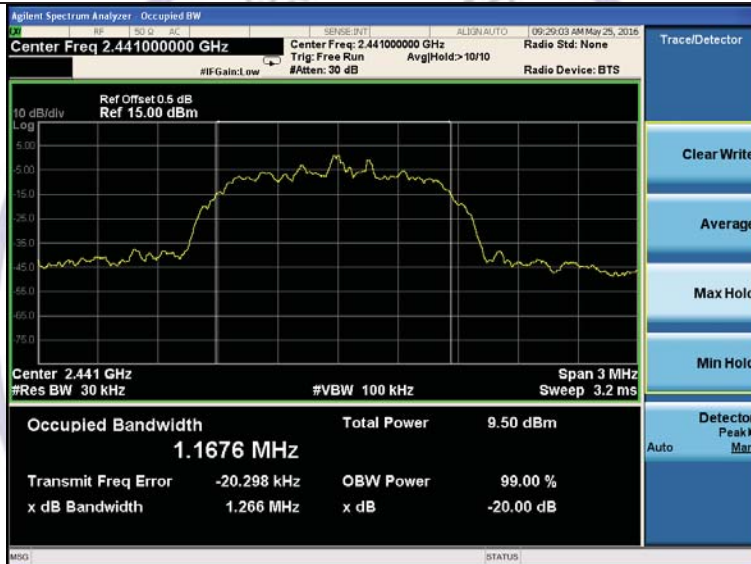

CH39

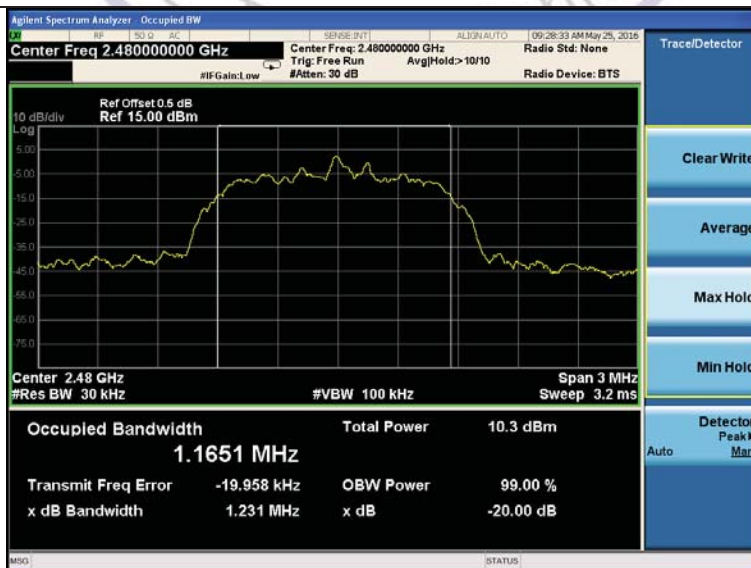

CH78

8DPSK Modulation

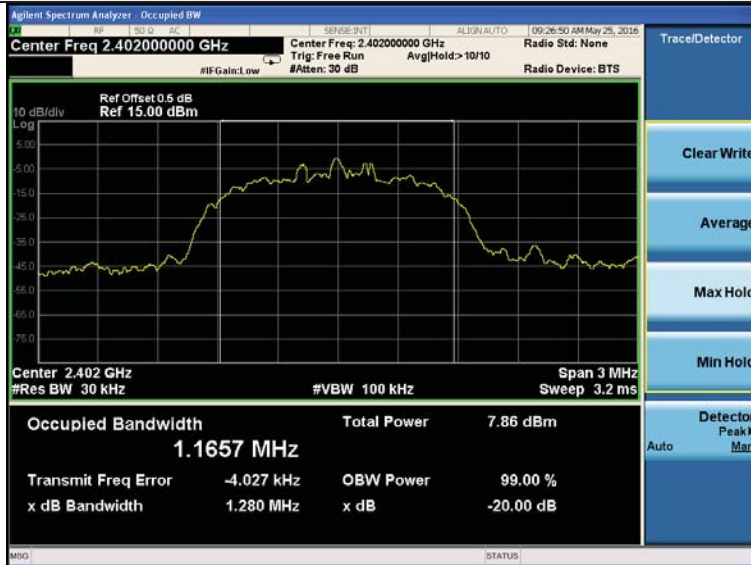

CH00

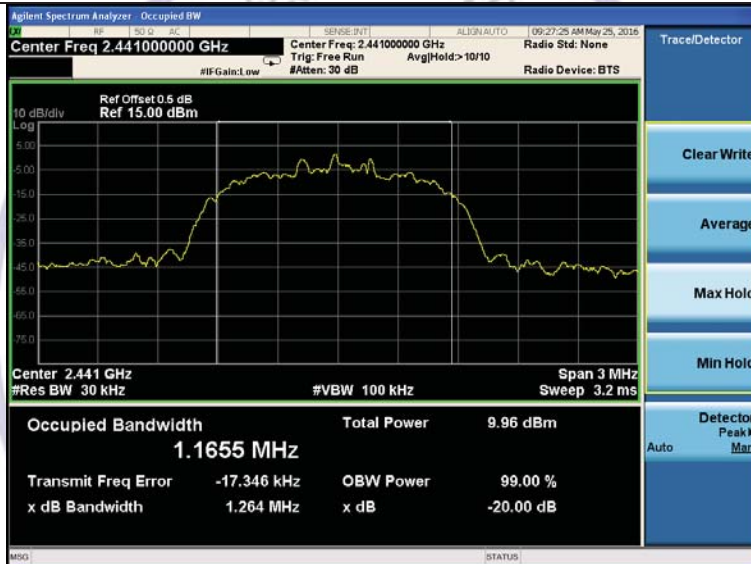

CH39

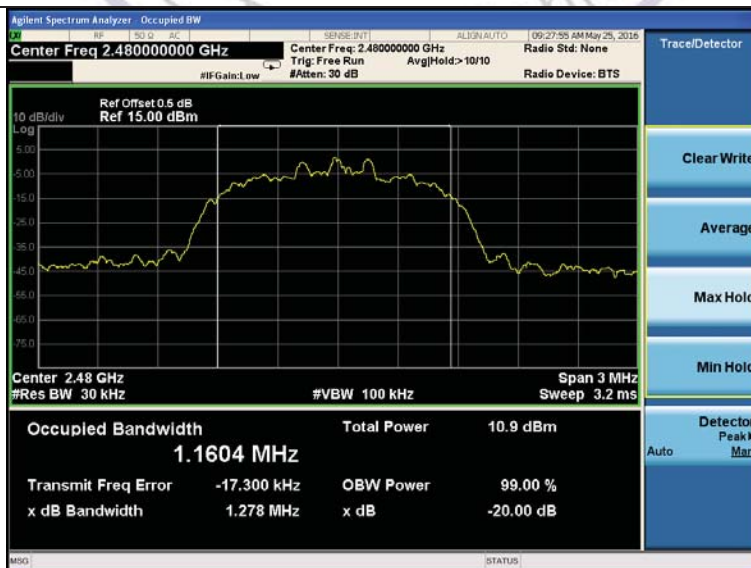

CH78

**BT4.0**  
GFSK Modulation



**CH00**



**CH19**



**CH39**

### 3.4. Antenna Requirement

#### Standard Applicable

For intentional device, according to FCC 47 CFR Section 15.203, an intentional radiator shall be designed to ensure that no antenna other than that furnished by the responsible party shall be used with the device.

#### **Refer to statement below for compliance.**

The manufacturer may design the unit so that the user can replace a broken antenna, but the use of a standard antenna jack or electrical connector is prohibited. Further, this requirement does not apply to intentional radiators that must be professionally installed.

#### Antenna Connected Construction

The antenna used in this product is an internal Antenna, The directional gains of antenna used for transmitting is 0 dBi.





### 4. Test Setup Photos of the EUT

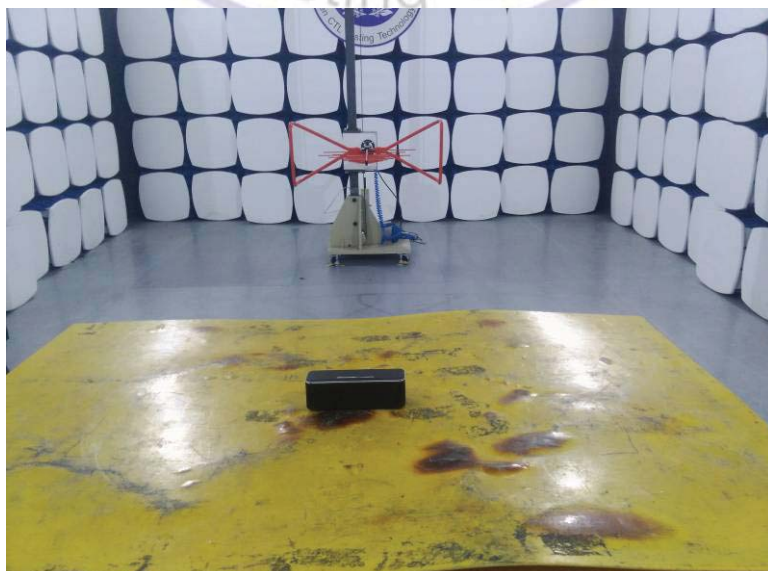
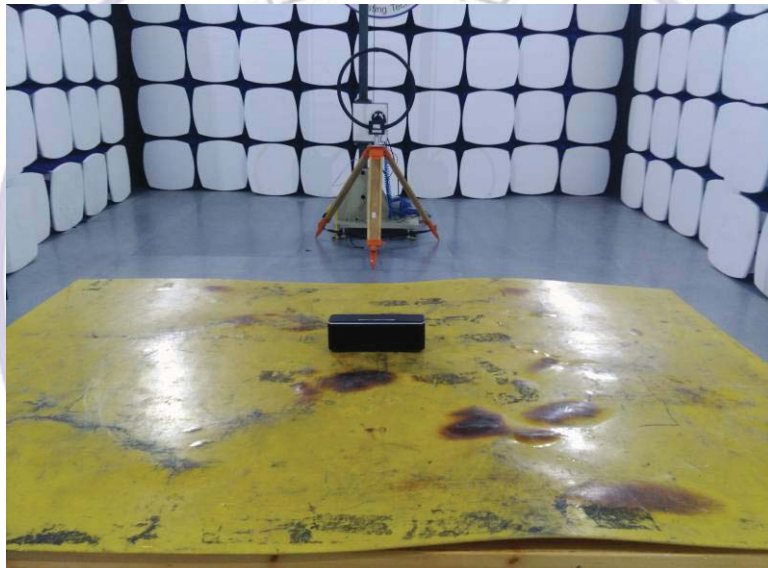
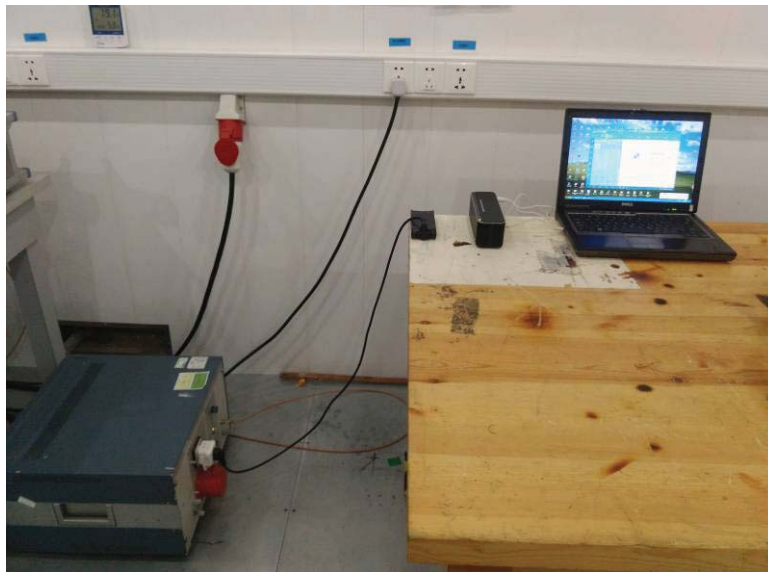

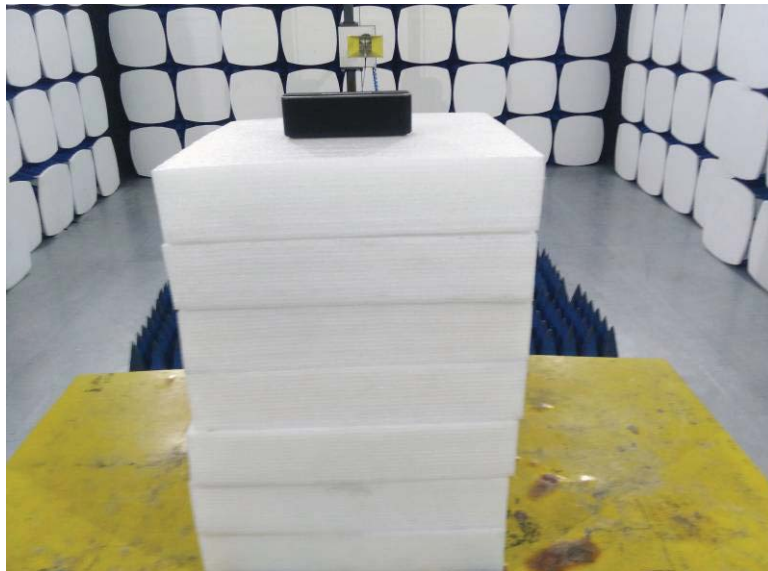

## 5. External and Internal Photos of the EUT

### External Photos of EUT











Internal Photos of EUT

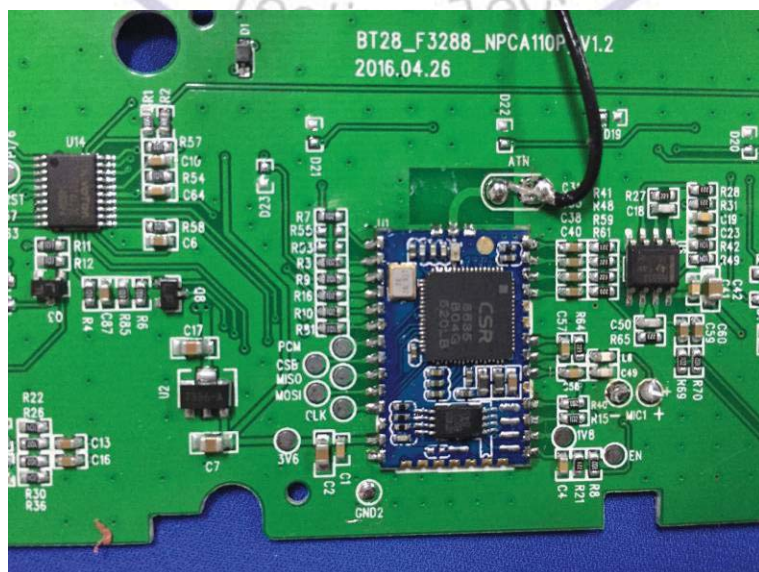
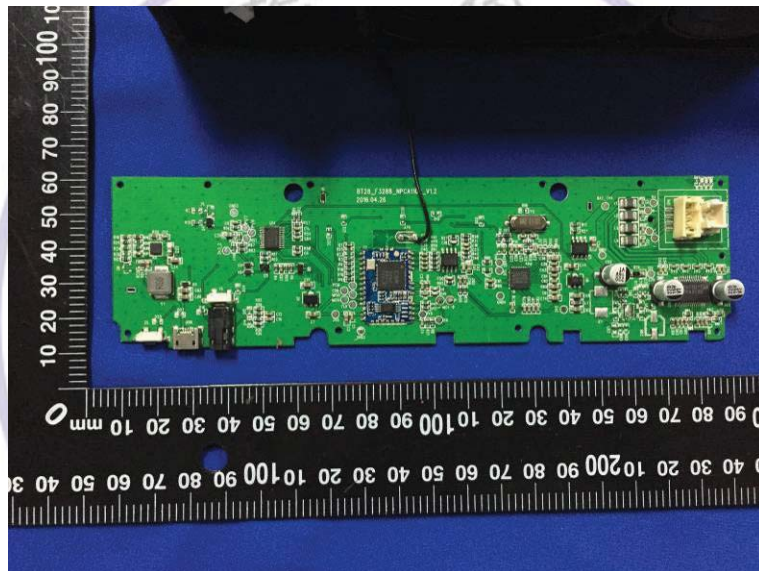
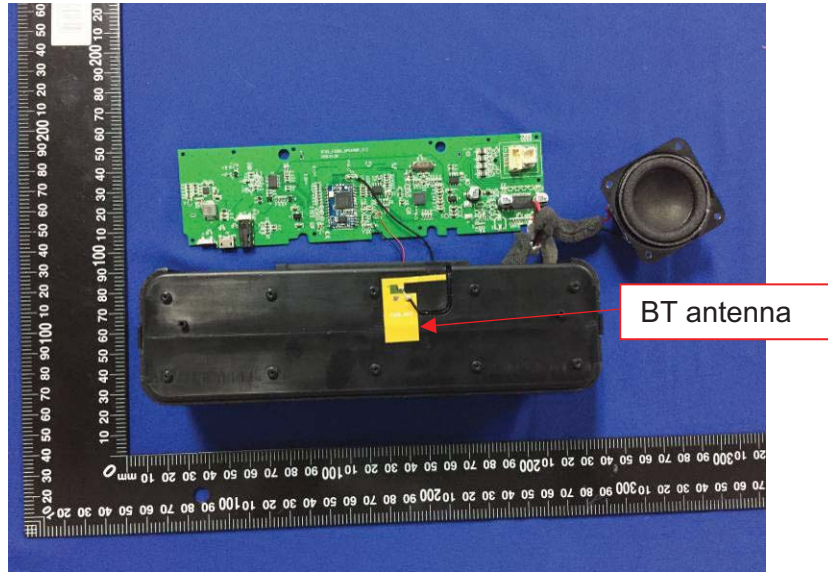

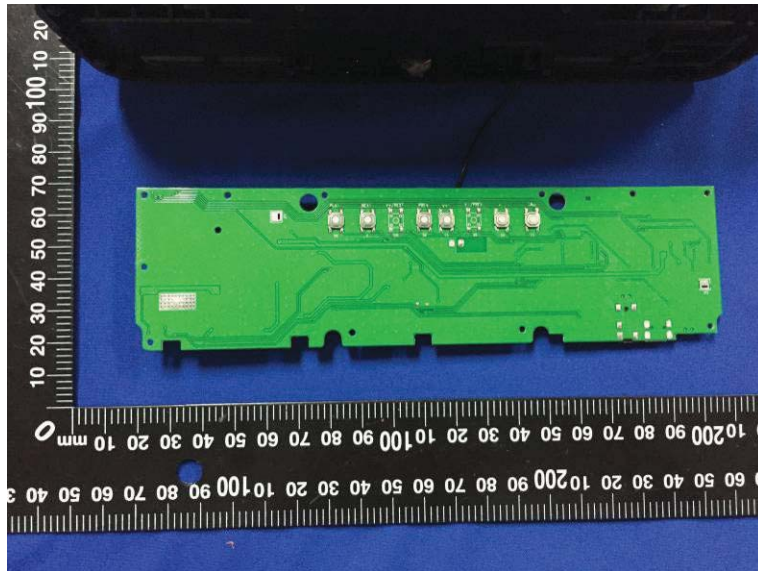

\*\*\*\*\* End of Report \*\*\*\*\*

