

User Guide

Accessories:

1. Micro USB Cable (for charging)
2. 3.5mm Audio cable (AUX-in cable)
3. User Manual

Highlights :

BT19S is a compact Bluetooth speaker that can be wirelessly connected to Bluetooth devices such as smartphones, tablets and computers to playback any music collection stored on them. Thanks to its powerful battery, the system delivers full stereo sound, separate from any mains supply, for up to 4-7 hours and is the perfect companion for the park, whilst camping or on the beach. Process control, can get rid of complicated connections and wiring distance constraints, the user can enjoy high quality music .

Bluetooth Connection:





Turn the speaker on by switching the power switch to 'ON' position. Followed by a tone, the blue led light flashes quickly and the speaker's voice instructions has been activated and it will tell you the speaker have been turned on and ready to use. The speaker now has entered the Bluetooth pairing mode.

Connect to mobile phones/tablet PCs/computers:

1. Activate your phone's Bluetooth
2. Go to your phone's Bluetooth settings , scan for new Bluetooth devices
3. Upon device found (BT-19S), click the device name and pair with it
4. If your phone ask for pairing code , please enter "0000" and confirm
5. The speaker will have voice instructions to remind that pairing is successful.(Pairing time is around 1 minutes which is varied by the devices)
6. After successful pairing, your speaker will sound a prompt tone and the power LED lights blue.

Note: Memory function: It only need to pair both Bluetooth device for initial use. It will remember the previous devices name and searching for last device and pair automatically.

Handsfree function:

Speaker will have the voice instruction for incoming call.Short Press  to answer the call and talk to speaker directly.Short press  to end the call and back to play status. Long press  to reject the incoming call.Long press  to dial back the last dialed phone no if no phone conversation.

Low power indication: Speaker will have voice instruction if battery is low(battery voltage is below 3.3V). User need to charge the speaker timely.

AUX audio-in connector:

The speaker also features 1x AUX audio in port, simply connect the speaker with your non-bluetooth mobile phone/MP3 player/PC/laptop with the 3.5' jack audio cable, then you can play music via wired connection

Charging and computer connection :

Connect the micro USB charging cable to a computer or USB charger, red Led indication for charging status.

Red LED goes off upon charging finished. (2~3 hours for charging time.)

Specifications:

Speaker Interfaces:

Audio input connector: 3.5mm

AUX cable : support aux external audio input.

Charging interface: Micro USB

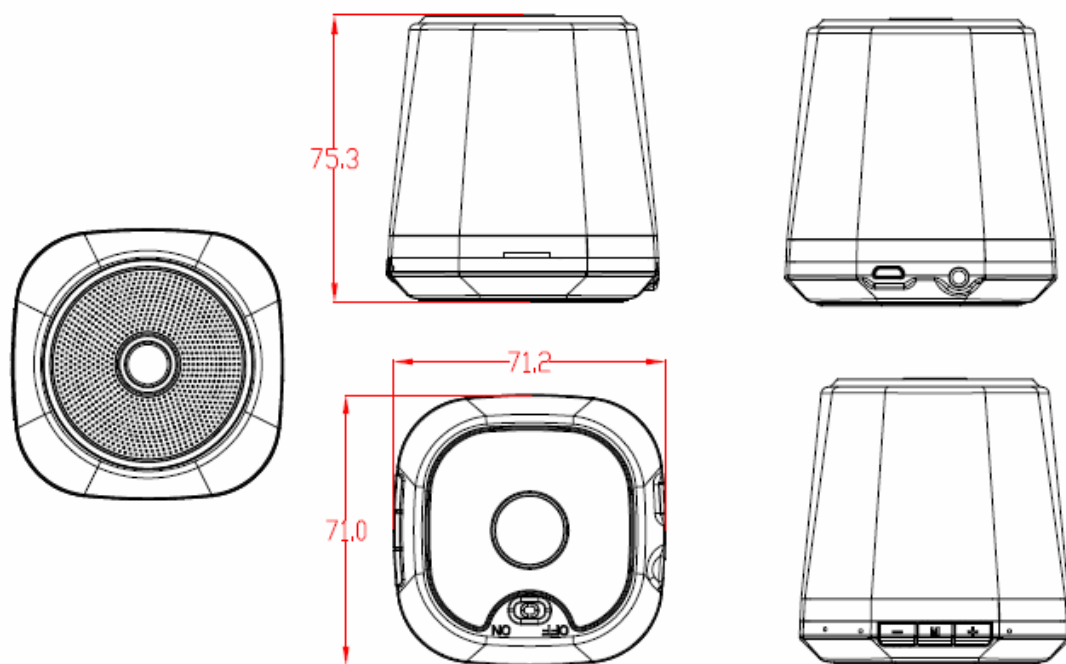

Dimensions And Basic Parameters:

DIAMETER: $71.2 \pm 0.5\text{MM}$ (MAX) * HEIGHT: $75.3 \pm 0.5\text{MM}$

Material: ABS plastic

Weight: $212\text{g} \pm 5\text{g}$

Electrical Specifications:

Compatibility:

Compliance with Bluetooth 2.1 Class II, support A2DP V1.2, AVRCP V1.4 profiles agreement.

Transmission distance: up to 10 m (transmission distance may different according to environmental factors and other device's functional range)

Support handsfree function.

Maximum output power: 3W

signal to noise ratio S / N: $\geq 80\text{dB}$

Frequency Range: 180Hz-20KHz

Distortion THD: $\leq 1\%$

speaker unit: outer diameter 40mm, inner magnet, 4 ohms, 3W

Parameters of power:







Rated voltage: 3.7V DC

Battery: built-in lithium battery, 3.7V/500mA

Charge voltage: $5\text{V} \pm 0.25\text{V}$

Charging time: 2~3 hours

Handsfree , volume, operations(under Bluetooth connection) :

Function	Operation
M	Long press to disconnect the current Bluetooth connection and searching for another new device and pairing
 For incoming call:	short press  key to answer the phone, short press again to end call and back to play music long press  to refuse the call
 For music playing	Short press  for play and pause
Redial a call	Long press  key for 2~3 sec to redial the last call phone number.
Powering ON	Switch the power switch to ON position
Powering OFF	Switch the power switch to OFF position
Volume +	Long or short Press + key to increase volume
Volume -	Long or short Press - key to decrease volume

Note :

1. Under Bluetooth mode when the 3.5mm audio plug is inserted in, the speaker will switch to line in status automatically;
2. Please switch off the speaker if don't use to save power

LED status:

1. Bluetooth status: blue light flashing
2. Line in mode: green light on
3. Charging status: red light on
4. Charging completed: red light off

Trouble shootings:

- 1. My mobile phone can't find any new Bluetooth device?*
 - a) Make sure the bluetooth speaker has entered pairing mode;
 - b) Ensure the speaker is within the effective working range;

- 2. Bluetooth devices can't pair up*
 - a) Make sure your mobile phone allows new connection, did not reach the maximum allowed connection number, please ref to your mobile's user manual
 - b) Make sure the pairing password entered is "0000". If your are using a Bluetooth transmitter device, please ensure the responding password of your Bluetooth transmitter supports "0000" code.

- 3. My mini speaker does not play music / answer call when it connected to a Bluetooth mobile phone?*
 - a) Make sure your Bluetooth mobile phone supports A2DP and HSF(handsfree) profile;
 - b) Ensure your Bluetooth cell phone is within effective working range.

- 4. When paired with my computer, windows ask for new driver? Can you supply?*
 - a) We can't supply. The bluetooth A2DP/HSF drivers may required to play stereo sound via bluetooth connection. But the driver is actually needed for the bluetooth module on your PC, instead of the speaker. Different bluetooth module may require different drivers. Please contact your PC or bluetooth module's manufacturer for driver update.

- 5. Why can't I remotely control the pause, play, previous song and skip track functions with the speaker when playing music?*
 - a) When you are using 3.5mm AUX audio in connection, you can't pause, change volume or skip tracks with the buttons on the speaker;
 - b) This feature needs the Bluetooth devices paired with the speaker to support AVRCP (Audio/Video Remote Control Profile). Please make sure your cell phone or other Bluetooth device supports AVRCP.

Safety Notices:

Read the following recommendations before using the bluetooth speaker.

- a) Keep it dry and don't take it to damp places to avoid the product's internal circuit being affected.
- b) Keep the product away from direct sunlight or hot places. High temperatures will shorten the life of electronic devices, destroy the battery or distort certain plastic parts.
- c) Don't expose the product to extremely cold area. It may damage the internal circuit board.
- d) Don't try to disassemble the product as it may get damaged if you are not professional.
- e) Don't let it fall down onto the floor or other hard surfaces. The internal circuit might get damaged.
- f) Don't use intensive chemical products or detergent to clean the product.
- g) Don't scratch the surface with sharp tips.

Federal Communications Commission (FCC) Statement

This device complies with part 15 of the FCC Rules. Operation is subject to the following two conditions: (1) This device may not cause harmful interference, and (2) this device must accept any interference received, including interference that may cause undesired operation.

Note: This equipment has been tested and found to comply with the limits for a Class B digital device, pursuant to part 15 of the FCC Rules. These limits are designed to provide reasonable protection against harmful interference in a residential installation. This equipment generates, uses and can radiate radio frequency energy and, if not installed and used in accordance with the instructions, may cause harmful interference to radio communications. However, there is no guarantee that interference will not occur in a particular installation. If this equipment does cause harmful interference to radio or television reception, which can be determined by turning the equipment off and on, the user is encouraged to try to correct the interference by one or more of the following measures:

- Reorient or relocate the receiving antenna.
- Increase the separation between the equipment and receiver.
- Connect the equipment into an outlet on a circuit different from that to which the receiver is connected.
- Consult the dealer or an experienced radio/TV technician for help.

Warning: Changes or modifications made to this device not expressly approved by **SHENZHEN WEIKING TECHNOLOGY CO., LTD.** may void the FCC authorization to operate this device.

Note: The manufacturer is not responsible for any radio or tv interference caused by unauthorized modifications to this equipment. Such modifications could void the user's

authority to operate the equipment.