



FCC PART 15 SUBPART C TEST REPORT

FCC Part 15.249

Report Reference No.....: CTL1407141612-WF

Compiled by

(position+printed name+signature)...: File administrators Jacky Chen

Name of the organization performing the tests

Test Engineer Tracy Qi

(position+printed name+signature)...:

Approved by

(position+printed name+signature)...: Manager Tracy Qi

Date of issue.....: July 28, 2014

Test Firm.....: Shenzhen CTL Testing Technology Co., Ltd.

Address.....: Floor 1-A, Baisha Technology Park, No. 3011, Shahexi Road, Nanshan, Shenzhen 518055 China.

Applicant's name.....: SHENZHEN WEIKING TECHNOLOGY CO.,LTD

Address.....: W-king Technology Park, NO.431, Huating Road, Dalang Street, Longhua Town, Baoan District, Shenzhen, China

Test specification:

Standard.....: **FCC Part 15.249:** Operation within the bands 920-928 MHz, 2400-2483.5 MHz, 5725-5850 MHz and 24.0 - 24.25 GHz.

TRF Originator.....: Shenzhen CTL Testing Technology Co., Ltd.

Master TRF.....: Dated 2011-01

Shenzhen CTL Testing Technology Co., Ltd. All rights reserved.

This publication may be reproduced in whole or in part for non-commercial purposes as long as the Shenzhen CTL Testing Technology Co., Ltd. is acknowledged as copyright owner and source of the material. Shenzhen CTL Testing Technology Co., Ltd. takes no responsibility for and will not assume liability for damages resulting from the reader's interpretation of the reproduced material due to its placement and context.

Test item description : Bluetooth Speaker

Trade Mark

 : N/A

Models/Type reference.....

 : PBT503

Modulation

 : FHSS

Work Frequency.....

 : 2402 MHz~2480 MHz

Antenna Type.....

 : internal

FCC ID

 : Q8W-BT12S

Result.....

 : **Positive**

TEST REPORT

Test Report No. :	CTL1407141612-WF	July 28, 2014
		Date of issue

Equipment under Test : Bluetooth Speaker

Model /Type : PBT503

Applicant : **SHENZHEN WEIKING TECHNOLOGY CO.,LTD**

Address : W-king Technology Park, NO.431, Huating Road, Dalang Street, Longhua Town, Baoan District, Shenzhen, China

Manufacturer **SHENZHEN WEIKING TECHNOLOGY CO.,LTD**

Address W-king Technology Park, NO.431, Huating Road, Dalang Street, Longhua Town, Baoan District, Shenzhen, China

Test Result according to the standards on page 4:	Positive
--	-----------------

The test report merely corresponds to the test sample.
It is not permitted to copy extracts of these test result without the written permission of the test laboratory.



Contents

1.	<u>TEST STANDARDS</u>	<u>4</u>
2.	<u>SUMMARY</u>	<u>5</u>
2.1.	General Remarks	5
2.2.	Equipment Under Test	5
2.3.	Short description of the Equipment under Test (EUT)	5
2.4.	EUT operation mode	6
2.5.	EUT configuration	6
2.6.	Related Submittal(s) / Grant (s)	6
2.7.	Modifications	6
3.	<u>TEST ENVIRONMENT</u>	<u>7</u>
3.1.	Address of the test laboratory	7
3.2.	Test Facility	7
3.3.	Environmental conditions	7
3.4.	Configuration of Tested System	7
3.5.	Statement of the measurement uncertainty	8
3.6.	Equipments Used during the Test	9
4.	<u>TEST CONDITIONS AND RESULTS</u>	<u>10</u>
4.1.	Conducted Emissions Test	10
4.2.	Radiated Emission Test	13
4.3.	Band Edge Measurement	18
4.4.	Occupied Bandwidth Measurement	22
5.	<u>ANTENNA REQUIREMENT</u>	<u>24</u>
6.	<u>TEST SETUP PHOTOS OF THE EUT</u>	<u>25</u>
7.	<u>EXTERNAL AND INTERNAL PHOTOS OF THE EUT</u>	<u>28</u>

1. TEST STANDARDS

The tests were performed according to following standards:

[FCC Rules Part 15.249](#): Operation within the bands 902 - 928 MHz, 2400 - 2483.5 MHz, 5725 - 5875 MHz, and 24.0 - 24.25 GHz.

[ANSI C63.4-2009](#)



2. SUMMARY

2.1. General Remarks

Date of receipt of test sample : July 14, 2014

Testing commenced on : July 14, 2014

Testing concluded on : July 28, 2014

2.2. Equipment Under Test

Power supply system utilised

Power supply voltage : 120V / 60 Hz 115V / 60Hz
 12 V DC 24 V DC
 Other (specified in blank below)

DC 3.7V from battery

2.3. Short description of the Equipment under Test (EUT)

The EUT is a Bluetooth Speaker work at 2402~2480 MHz.

Channel List:

Channel	Frequency (MHz)	Channel	Frequency (MHz)	Channel	Frequency (MHz)
00	2402	27	2429	54	2456
01	2403	28	2430	55	2457
02	2404	29	2431	56	2458
03	2405	30	2432	57	2459
04	2406	31	2433	58	2460
05	2407	32	2434	59	2461
06	2408	33	2435	60	2462
07	2409	34	2436	61	2463
08	2410	35	2437	62	2464
09	2411	36	2438	63	2465
10	2412	37	2439	64	2466
11	2413	38	2440	65	2467
12	2414	39	2441	66	2468
13	2415	40	2442	67	2469
14	2416	41	2443	68	2470
15	2417	42	2444	69	2471
16	2418	43	2445	70	2472
17	2419	44	2446	71	2473
18	2420	45	2447	72	2474
19	2421	46	2448	73	2475
20	2422	47	2449	74	2476
21	2423	48	2450	75	2477
22	2424	49	2451	76	2478
23	2425	50	2452	77	2479
24	2426	51	2453	78	2480
25	2427	52	2454		
26	2428	53	2455		

Modulation: 1Mbps(GFSK), 2Mbps(Pi/4 DQPSK), 3Mbps(8DPSK)

For more details, refer to the user's manual of the EUT.

Serial number: Prototype

2.4. EUT operation mode

Test Mode(TM)	Description	Remark
TM1	Bottom Channel Transmitting	/
TM2	Middle Channel Transmitting	/
TM3	Top Channel Transmitting	/
TM4	Charging and keeping TX	USB power by PC

The field strength of radiation emission was measured in the following position: EUT stand-up position (Y axis), lie-down position (X, Z axis).

The following data show only with the worst case setup.

The worst case of Y axis was reported.

Based on client request, all normal using modes of the normal function were tested but only the worst test data of the worst mode is reported by this report.

Remark: The worst case mode is TM1(1Mbps) reported for unwanted emission and band edge test.

2.5. EUT configuration

The following peripheral devices and interface cables were connected during the measurement:

- - supplied by the manufacturer
- - supplied by the lab

- Notebook PC

Manufacturer : DELL

Model No. : PP18L

2.6. Related Submittal(s) / Grant (s)

This submittal(s) (test report) is intended for **FCC ID: Q8W-BT12S** filing to comply with Section 15.249 of the FCC Part 15, Subpart C Rules.

2.7. Modifications

No modifications were implemented to meet testing criteria.

3. TEST ENVIRONMENT

3.1. Address of the test laboratory

Shenzhen CTL Testing Technology Co., Ltd.
 Floor 1-A, Baisha Technology Park, No. 3011, Shahexi Road, Nanshan, Shenzhen 518055 China

There is one 3m semi-anechoic chamber and two line conducted labs for final test. The Test Sites meet the requirements in documents ANSI C63.4 and CISPR 22/EN 55022 requirements.

3.2. Test Facility

The test facility is recognized, certified, or accredited by the following organizations:

IC Registration No.: 9618B

The 3m alternate test site of Shenzhen CTL Testing Technology Co., Ltd. EMC Laboratory has been registered by Certification and Engineer Bureau of Industry Canada for the performance of with Registration No.: 9618B on November 13, 2013.

FCC-Registration No.: 970318

Shenzhen CTL Testing Technology Co., Ltd. EMC Laboratory has been registered and fully described in a report filed with the (FCC) Federal Communications Commission. The acceptance letter from the FCC is maintained in our files. Registration 970318, December 19, 2013.

3.3. Environmental conditions

During the measurement the environmental conditions were within the listed ranges:

Temperature: 15-35 ° C

Humidity: 30-60 %

Atmospheric pressure: 950-1050mbar

3.4. Configuration of Tested System

Fig. 2-1 Configuration of Tested System

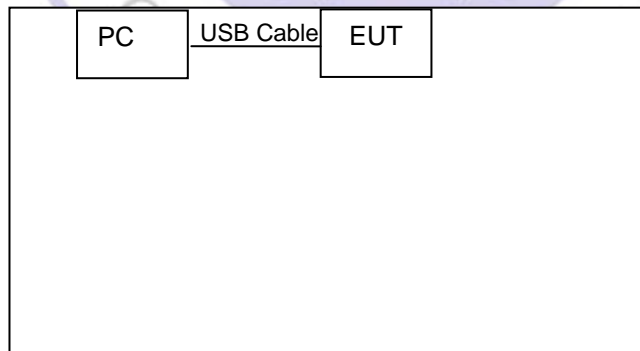

Cable List and Details

Cable Description	Length (M)	Shielded/Unshielded	With Core/Without Core
USB Cable	1.2	Unshielded	Without Core

3.5. Statement of the measurement uncertainty

The data and results referenced in this document are true and accurate. The reader is cautioned that there may be errors within the calibration limits of the equipment and facilities. The measurement uncertainty was calculated for all measurements listed in this test report acc. to CISPR 16 - 4 „Specification for radio disturbance and immunity measuring apparatus and methods – Part 4: Uncertainty in EMC Measurements“ and is documented in the Shenzhen CTL Testing Technology Co., Ltd. quality system acc. to DIN EN ISO/IEC 17025. Furthermore, component and process variability of devices similar to that tested may result in additional deviation. The manufacturer has the sole responsibility of continued compliance of the device.

Hereafter the best measurement capability for CTL laboratory is reported:

Test	Range	Measurement Uncertainty	Notes
Radiated Emission	30~1000MHz	4.10dB	(1)
Radiated Emission	1~26.5GHz	4.32dB	(1)
Conducted Disturbance	0.15~30MHz	3.20dB	(1)

- (1) This uncertainty represents an expanded uncertainty expressed at approximately the 95% confidence level using a coverage factor of k=2.



3.6. Equipments Used during the Test

Test Equipment	Manufacturer	Model No.	Serial No.	Calibration Date	Calibration Due Date
Bilog Antenna	Sunol Sciences Corp.	JB1	A061713	2014/07/12	2015/07/11
EMI Test Receiver	R&S	ESCI	103710	2014/07/10	2015/07/09
Spectrum Analyzer	Agilent	E4407B	MY45108355	2014/07/06	2015/07/05
Controller	EM Electronics	Controller EM 1000	N/A	2014/07/06	2015/07/05
Horn Antenna	Sunol Sciences Corp.	DRH-118	A062013	2014/07/12	2015/07/11
Horn Antenna	SCHWARZBECK	BBHA9170	1562	2014/07/12	2015/07/11
Active Loop Antenna	SCHWARZBECK	FMZB1519	1519-037	2014/07/12	2015/07/11
LISN	R&S	ENV216	101316	2014/07/10	2015/07/09
LISN	SCHWARZBECK	NSLK8127	8127687	2014/07/10	2015/07/09
Microwave Preamplifier	HP	8349B	3155A00882	2014/07/10	2015/07/09
Amplifier	HP	8447D	3113A07663	2014/07/10	2015/07/09
Transient Limiter	Com-Power	LIT-153	532226	2014/07/10	2015/07/09
Radio Communication Tester	R&S	CMU200	3655A03522	2014/07/06	2015/07/05
Temperature/Humidity Meter	zhicheng	ZC1-2	22522	2014/07/10	2015/07/09
SIGNAL GENERATOR	HP	8647A	3200A00852	2014/07/10	2015/07/09
Wideband Peak Power Meter	Anritsu	ML2495A	220.23.35	2014/07/06	2015/07/05
Climate Chamber	ESPEC	EL-10KA	A20120523	2014/07/06	2015/07/05
High-Pass Filter	K&L	9SH10-2700/X12750-O/O	/	2014/07/06	2015/07/05
High-Pass Filter	K&L	41H10-1375/U12750-O/O	/	2014/07/06	2015/07/05

4. TEST CONDITIONS AND RESULTS

4.1. Conducted Emissions Test

TEST CONFIGURATION

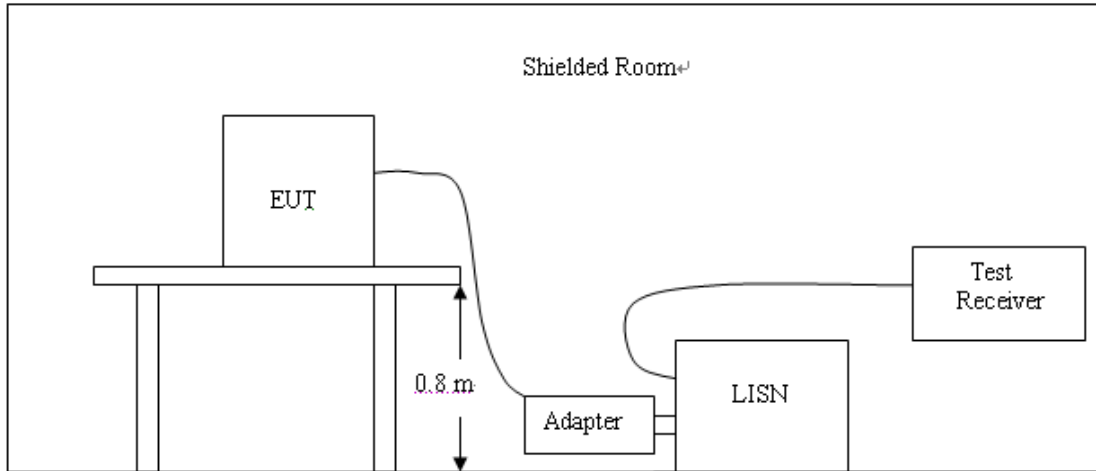

TEST PROCEDURE

- 1 The equipment was set up as per the test configuration to simulate typical actual usage per the user's manual. The EUT is a tabletop system, a wooden table with a height of 0.8 meters is used and is placed on the ground plane as per ANSI C63.4.
- 2 Support equipment, if needed, was placed as per ANSI C63.4.
- 3 All I/O cables were positioned to simulate typical actual usage as per ANSI C63.4.
- 4 If a EUT received DC power from the USB Port of Notebook PC, the PC's adapter received AC120V/60Hz power through a Line Impedance Stabilization Network (LISN) which supplied power source and was grounded to the ground plane.
- 5 All support equipments received AC power from a second LISN, if any.
- 6 The EUT test program was started. Emissions were measured on each current carrying line of the EUT using a spectrum Analyzer / Receiver connected to the LISN powering the EUT. The LISN has two monitoring points: Line 1 (Hot Side) and Line 2 (Neutral Side). Two scans were taken: one with Line 1 connected to Analyzer / Receiver and Line 2 connected to a 50 ohm load; the second scan had Line 1 connected to a 50 ohm load and Line 2 connected to the Analyzer / Receiver.
- 7 Analyzer / Receiver scanned from 150 KHz to 30MHz for emissions in each of the test modes.
- 8 During the above scans, the emissions were maximized by cable manipulation.

The RBW/VBW for 150KHz to 30MHz: 9KHz

CONDUCTED POWER LINE EMISSION LIMIT

For unintentional device, according to § 15.107(a) Line Conducted Emission Limits is as following :

Frequency (MHz)	Maximum RF Line Voltage (dBµV)			
	CLASS A		CLASS B	
	Q.P.	Ave.	Q.P.	Ave.
0.15 - 0.50	79	66	66-56*	56-46*
0.50 - 5.00	73	60	56	46
5.00 - 30.0	73	60	60	50

* Decreasing linearly with the logarithm of the frequency

For intentional device, according to §15.207(a) Line Conducted Emission Limit is same as above table.

TEST RESULTS

SCAN TABLE: "Voltage (9K-30M)FIN"
 Short Description: 150K-30M Voltage

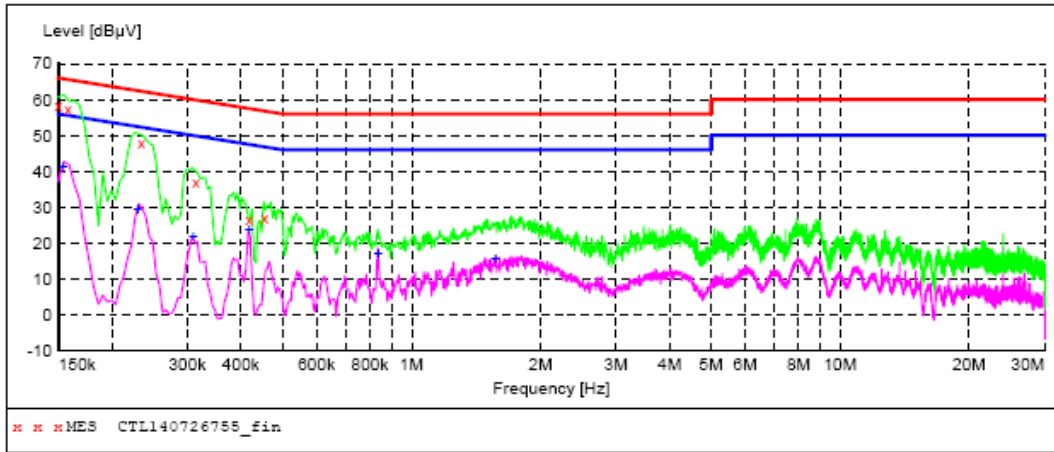

MEASUREMENT RESULT: "CTL140726755_fin"

7/26/2014 2:47PM

Frequency MHz	Level dBµV	Transd dB	Limit dBµV	Margin dB	Detector	Line	PE
0.150000	58.20	10.2	66	7.8	QP	L1	GND
0.158000	57.50	10.2	66	8.1	QP	L1	GND
0.234000	47.80	10.2	62	14.5	QP	L1	GND
0.314000	37.00	10.2	60	22.9	QP	L1	GND
0.418000	26.60	10.2	58	30.9	QP	L1	GND
0.454000	26.90	10.2	57	29.9	QP	L1	GND

MEASUREMENT RESULT: "CTL140726755_fin2"

7/26/2014 2:47PM

Frequency MHz	Level dBµV	Transd dB	Limit dBµV	Margin dB	Detector	Line	PE
0.154000	41.10	10.2	56	14.7	AV	L1	GND
0.230000	29.40	10.2	52	23.0	AV	L1	GND
0.310000	21.60	10.2	50	28.4	AV	L1	GND
0.418000	23.60	10.2	48	23.9	AV	L1	GND
0.836000	16.80	10.2	46	29.2	AV	L1	GND
1.568000	15.60	10.3	46	30.4	AV	L1	GND

SCAN TABLE: "Voltage (9K-30M)FIN"
 Short Description: 150K-30M Voltage

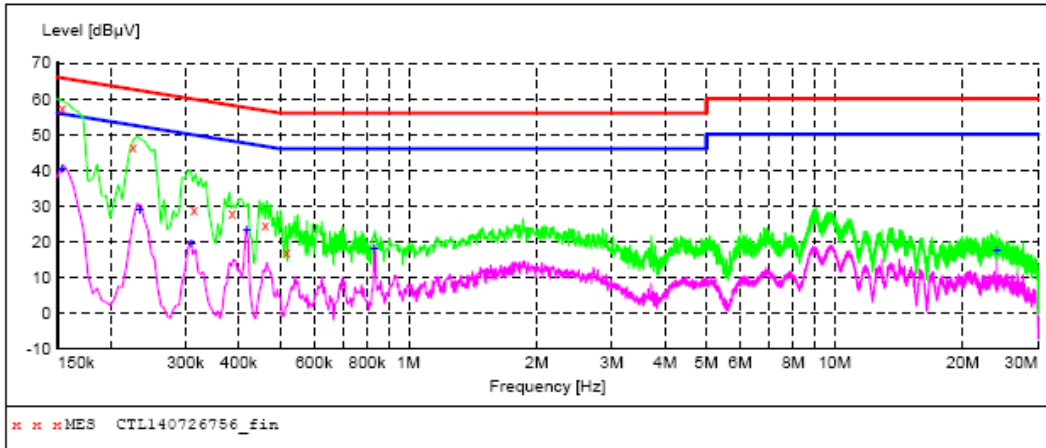

MEASUREMENT RESULT: "CTL140726756_fin"

7/26/2014 2:50PM

Frequency MHz	Level dBuV	Transd dB	Limit dBuV	Margin dB	Detector	Line	PE
0.154000	57.30	10.2	66	8.5	QP	N	GND
0.226000	46.60	10.2	63	16.0	QP	N	GND
0.314000	29.00	10.2	60	30.9	QP	N	GND
0.386000	27.80	10.2	58	30.3	QP	N	GND
0.462000	24.60	10.2	57	32.1	QP	N	GND
0.518000	17.00	10.2	56	39.0	QP	N	GND

MEASUREMENT RESULT: "CTL140726756_fin2"

7/26/2014 2:50PM

Frequency MHz	Level dBuV	Transd dB	Limit dBuV	Margin dB	Detector	Line	PE
0.154000	40.40	10.2	56	15.4	AV	N	GND
0.234000	29.00	10.2	52	23.3	AV	N	GND
0.310000	19.60	10.2	50	30.4	AV	N	GND
0.418000	23.10	10.2	48	24.4	AV	N	GND
0.830000	17.80	10.2	46	28.2	AV	N	GND
24.002000	17.50	11.1	50	32.5	AV	N	GND



4.2. Radiated Emission Test

TEST CONFIGURATION

(A) Radiated Emission Test Set-Up, Frequency Below 30MHz

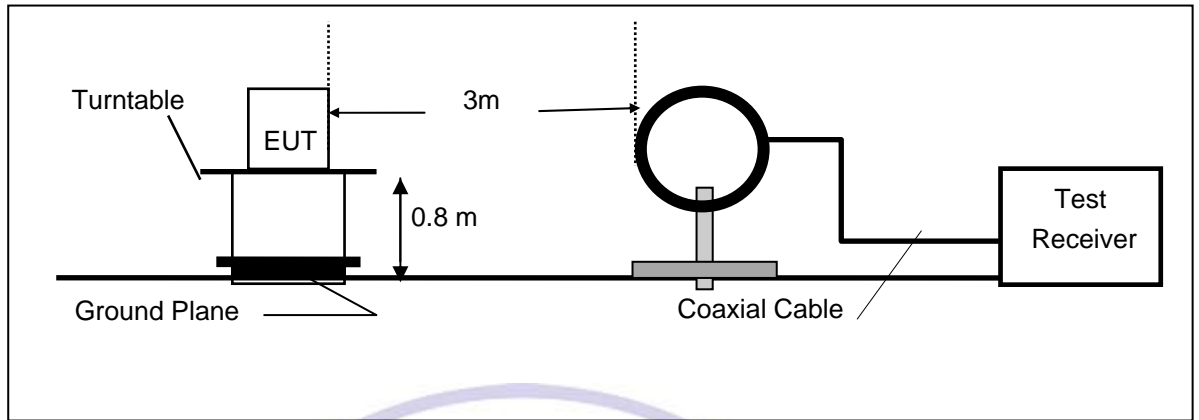

(B) Radiated Emission Test Set-Up, Frequency below 1000MHz

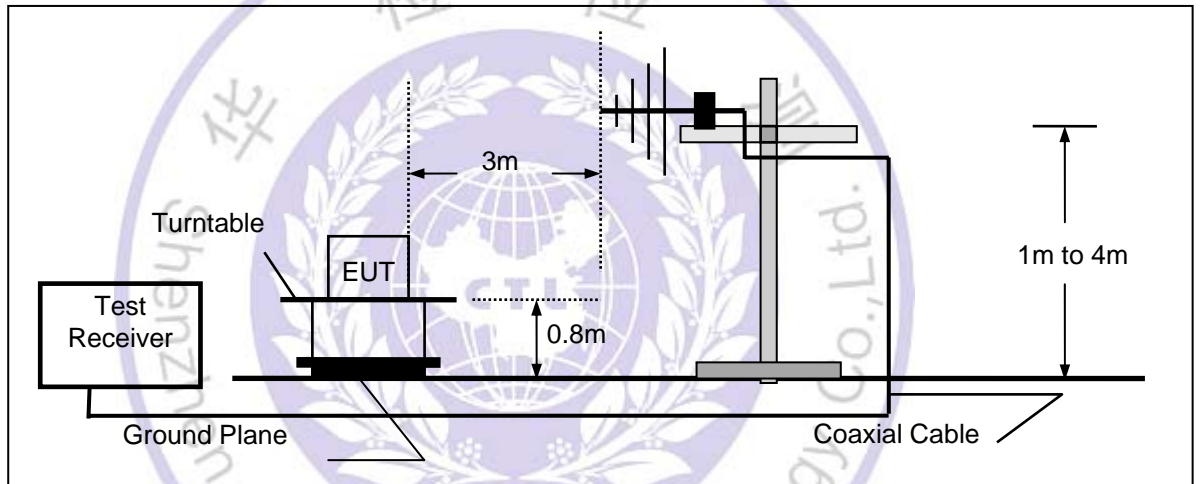

(C) Radiated Emission Test Set-Up, Frequency above 1000MHz

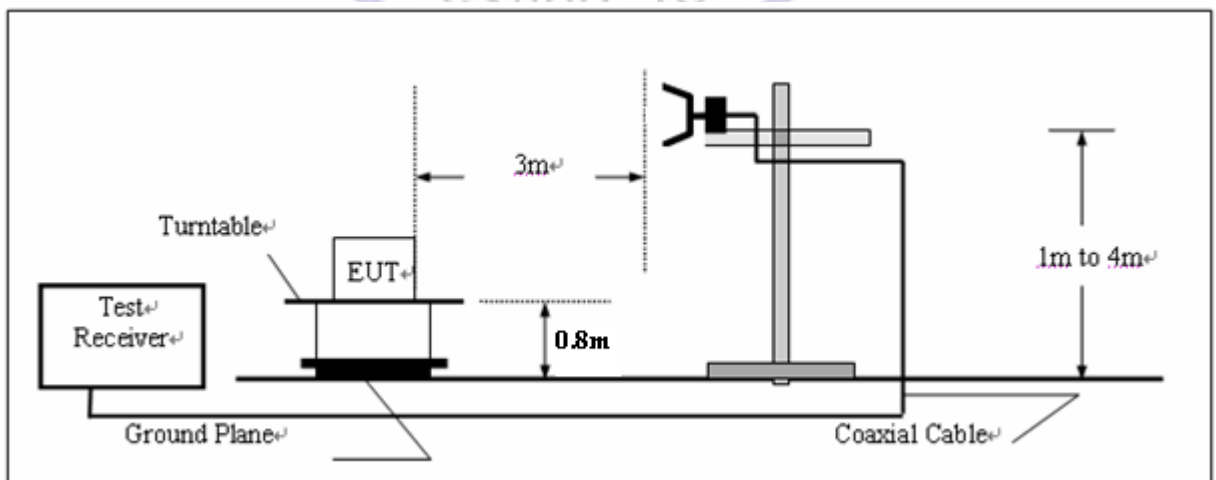

FIELD STRENGTH CALCULATION

The field strength is calculated by adding the Antenna Factor and Cable Factor and subtracting the Amplifier Gain and Duty Cycle Correction Factor(if any) from the measured reading. The basic equation with a sample calculation is as follows:

$$FS = RA + AF + CL - AG$$

Where FS = Field Strength	CL = Cable Attenuation Factor (Cable Loss)
RA = Reading Amplitude	AG = Amplifier Gain
AF = Antenna Factor	

RADIATION LIMIT

For unintentional device, according to § 15.109(a), except for Class A digital devices, the field strength of radiated emissions from unintentional radiators at a distance of 3 meters shall not exceed the following values:

Frequency (MHz)	Distance (Meters)	Radiated (dBµV/m)	Radiated (µV/m)
30-88	3	40.0	100
88-216	3	43.5	150
216-960	3	46.0	200
Above 960	3	54.0	500

For intentional device, according to § 15.209(a), the general requirement of field strength of radiated emissions from intentional radiators at a distance of 3 meters shall not exceed the above table.

TEST PROCEDURE

1. The EUT is placed on a turntable, which is 0.8m above ground plane.
2. The turntable shall be rotated for 360 degrees to determine the position of maximum emission level.
3. EUT is set 3m away from the receiving antenna, which is varied from 1m to 4m to find out the highest emissions.
4. Maximum procedure was performed on the six highest emissions to ensure EUT compliance.
5. And also, each emission was to be maximized by changing the polarization of receiving antenna both horizontal and vertical.
6. Repeat above procedures until the measurements for all frequencies are complete.
7. Based on the Frequency Generator in the device include 26MHz. The test frequency range from 9KHz to 25GHz per FCC PART 15.33(a).

Note:

Three axes are chosen for pretest, the Y axis is the worst mode for final test.

For battery operated equipment, the equipment tests shall be performed using a new battery.

TEST RESULTS

All the test modes (TM1, TM2, TM3 and TM4) completed for test. The worst case of Radiated Emission is TM1; the test data of this mode was reported.

Below 1GHz Test Results: QP detector for QP value

SWEEP TABLE: "test (30M-1G)"
 Short Description: Field Strength
 Start Stop Detector Meas. IF Transducer
 Frequency Frequency Time Bandw.
 30.0 MHz 1.0 GHz MaxPeak 300.0 ms 120 kHz JB1

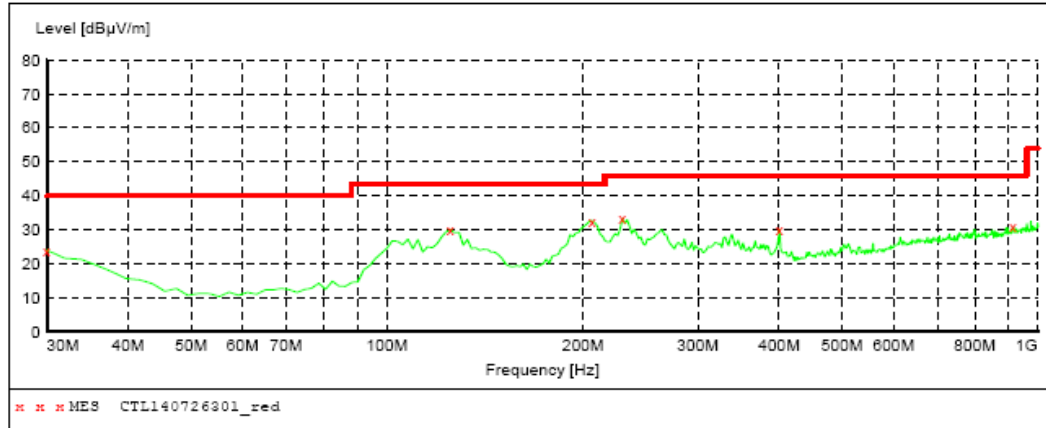

MEASUREMENT RESULT: "CTL140726301_red"

7/26/2014 2:56PM

Frequency MHz	Level dBµV/m	Transd dB	Limit dBµV/m	Margin dB	Det.	Height cm	Azimuth deg	Polarization
30.000000	24.00	21.1	40.0	16.0	---	0.0	0.00	HORIZONTAL
125.060000	29.90	15.0	43.5	13.6	---	0.0	0.00	HORIZONTAL
206.540000	32.70	14.3	43.5	10.8	---	0.0	0.00	HORIZONTAL
229.820000	33.40	14.1	46.0	12.6	---	0.0	0.00	HORIZONTAL
400.540000	30.00	18.1	46.0	16.0	---	0.0	0.00	HORIZONTAL
914.640000	30.80	26.2	46.0	15.2	---	0.0	0.00	HORIZONTAL

Remark:

- (1) Measuring frequencies from 9 KHz to the 1 GHz, Radiated emission test from 9KHz to 30MHz was verified, and no any emission was found except system noise floor.
- (2) * denotes emission frequency which appearing within the Restricted Bands specified in provision of 15.205, then the general radiated emission limits in 15.209 apply.
- (3) The IF bandwidth of EMI Test Receiver between 30MHz to 1GHz was 120KHz, 1 MHz for measuring above 1 GHz, below 30MHz was 10KHz.

SWEEP TABLE: "test (30M-1G)"

Short Description:		Field Strength			
Start	Stop	Detector	Meas.	IF	Transducer
Frequency	Frequency		Time	Bandw.	
30.0 MHz	1.0 GHz	MaxPeak	300.0 ms	120 kHz	JB1

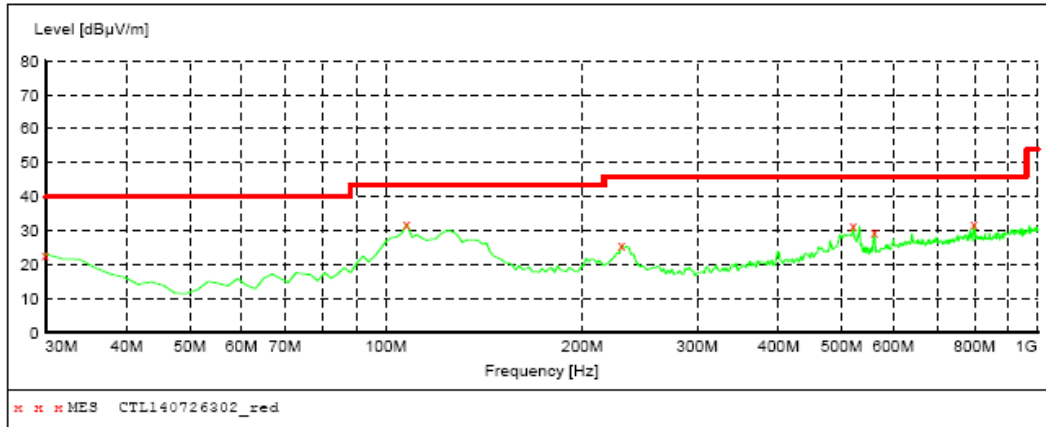

MEASUREMENT RESULT: "CTL140726302_red"

7/26/2014 2:59PM

Frequency MHz	Level dBµV/m	Transd dB	Limit dBµV/m	Margin dB	Det.	Height cm	Azimuth deg	Polarization
30.000000	23.10	21.1	40.0	16.9	---	0.0	0.00	VERTICAL
107.600000	32.10	13.3	43.5	11.4	---	0.0	0.00	VERTICAL
229.820000	25.70	14.1	46.0	20.3	---	0.0	0.00	VERTICAL
520.820000	31.40	20.5	46.0	14.6	---	0.0	0.00	VERTICAL
561.560000	29.60	21.2	46.0	16.4	---	0.0	0.00	VERTICAL
798.240000	31.80	24.8	46.0	14.2	---	0.0	0.00	VERTICAL

Remark:

- (1) Measuring frequencies from 9 KHz to the 1 GHz, Radiated emission test from 9KHz to 30MHz was verified, and no any emission was found except system noise floor.
- (2) * denotes emission frequency which appearing within the Restricted Bands specified in provision of 15.205, then the general radiated emission limits in 15.209 apply.
- (3) The IF bandwidth of EMI Test Receiver between 30MHz to 1GHz was 120KHz, 1 MHz for measuring above 1 GHz, below 30MHz was 10KHz.

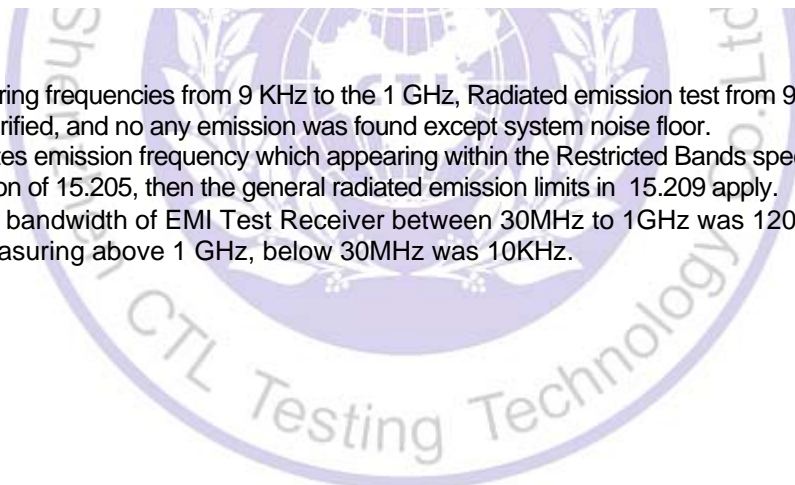

Above 1 GHz Test Results:

Freq. (MHz)	Ant.Pol. H/V	DetectorMode (PK/AV)	Reading (dBuV)	Ant./CL/ Amp. CF(dB)	Actual FS (dBuV/m)	Limit3m (dBuV/m)	Safe Margin (dB)
2480	V	Peak	76.15	-3.30	72.85	113.98	-41.13
2480	H	Peak	73.28	-3.30	69.98	113.98	-44.00
4960	V	Peak	49.51	3.90	53.41	74.00	-20.59
4960	H	Peak	44.80	3.90	48.70	74.00	-25.30
7440	V		---				
7440	H		---				
Others			---				

Freq. (MHz)	Ant.Pol. H/V	DetectorMode (PK/AV)	Reading (dBuV)	Ant./CL/ Amp. CF(dB)	Actual FS (dBuV/m)	Limit3m (dBuV/m)	Safe Margin (dB)
2441	V	Peak	76.51	-3.40	73.11	113.98	-40.87
2441	H	Peak	72.36	-3.40	68.96	113.98	-45.02
4882	V	Peak	49.04	3.70	52.74	74.00	-21.26
4882	H	Peak	46.14	3.70	49.84	74.00	-24.16
7323	V		---				
7323	H		---				
Others			---				

Freq. (MHz)	Ant.Pol. H/V	DetectorMode (PK/AV)	Reading (dBuV)	Ant./CL/ Amp. CF(dB)	Actual FS (dBuV/m)	Limit3m (dBuV/m)	Safe Margin (dB)
2402	V	Peak	75.82	-3.30	72.52	113.98	-41.46
2402	H	Peak	72.17	-3.30	68.87	113.98	-45.11
4804	V	Peak	48.91	3.50	52.41	74.00	-21.59
4804	H	Peak	45.43	3.50	48.93	74.00	-25.07
7206	V		---				
7206	H		---				
Others			---				

Remark:

- (1) Measuring frequencies from 1 GHz to the 25 GHz.
- (2) "F" denotes fundamental frequency; "H" denotes spurious frequency. "E" denotes band edge frequency.
- (3) * denotes emission frequency which appearing within the Restricted Bands specified in provision of 15.205, then the general radiated emission limits in 15.209 apply.
- (4) Data of measurement within this frequency range shown "---" in the table above means the reading of emissions are attenuated more than 20dB below the permissible limits or the field strength is too small to be measured.
- (5) The IF bandwidth of EMI Test Receiver between 30MHz to 1GHz was 120KHz, 1 MHz for measuring above 1 GHz, below 30MHz was 10KHz.
- (6) When the test results of Peak Detected below the limits of Average Detected, the Average Detected is not need completed. For example: Top Channel at Fundamental 73.11 dBuV/m(PK Value) <93.98(AV Limit), at harmonic 53.41 dBuV/m(PK Value) <54 dBuV/m(AV Limit), the Average Detected not need to completed.

4.3. Band Edge Measurement

TEST CONFIGURATION

Same as Section 4.2

TEST PROCEDURE

The band edge compliance of RF radiated emission should be measured by following the guidance in ANSI C63.4 with respect to maximizing the emission by rotating the EUT, measuring the emission while the EUT is situated in three orthogonal planes (if appropriate), adjusting the measurement antenna height and polarization etc. Set RBW to 1MHz and VBW to 3MHz to measure the peak field strength and set RBW to 1MHz and VBW to 10Hz to measure the average radiated field strength.

The conducted RF band edge was measured by using a spectrum analyzer. Set span wide enough to capture the highest in-band emission and the emission at the band edge. Set RBW to 100 KHz and VBW to 300 KHz, to measure the conducted peak band edge.

LIMIT

FCC PART 15.249(d) Emissions radiated outside of the specified frequency bands, except for harmonics, shall be attenuated by at least 50 dB below the level of the fundamental or to the general radiated emission limits in §15.209, whichever is the lesser attenuation.

TEST RESULTS

Radiated Test: Only worse case is shown as below , all frequency out of 2400 to 2483.5MHz all comply with 15.209

Operation Mode: TX on Bot Channel

Polarity: Hor.

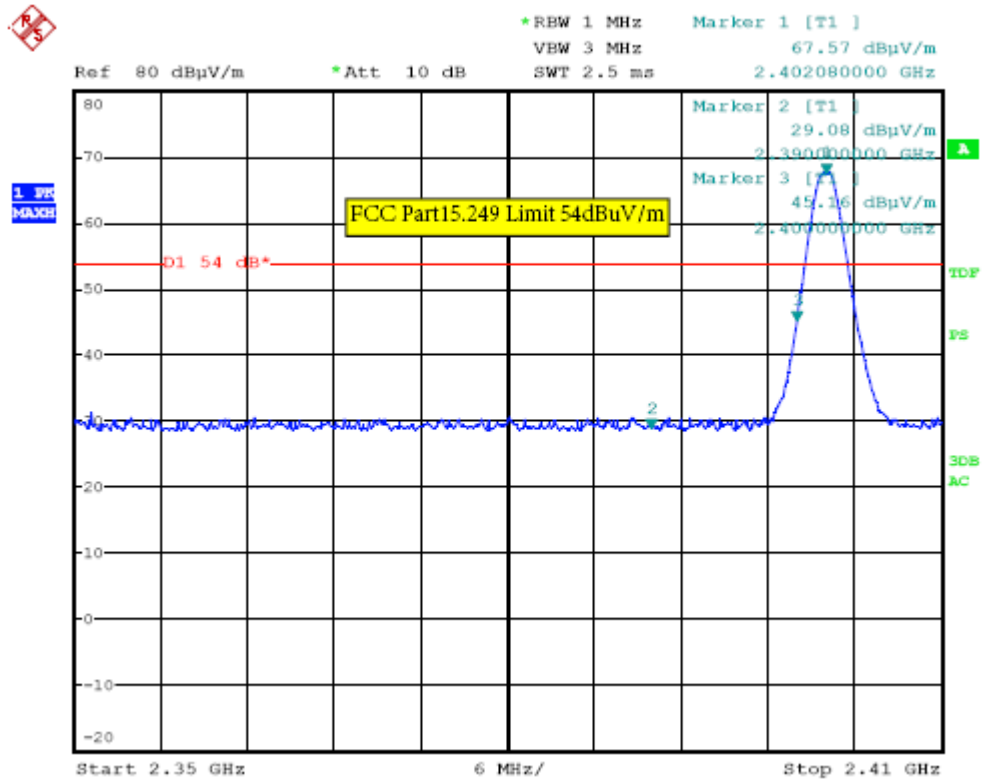

Operation Mode: TX on Bot Channel

Polarity: Ver.

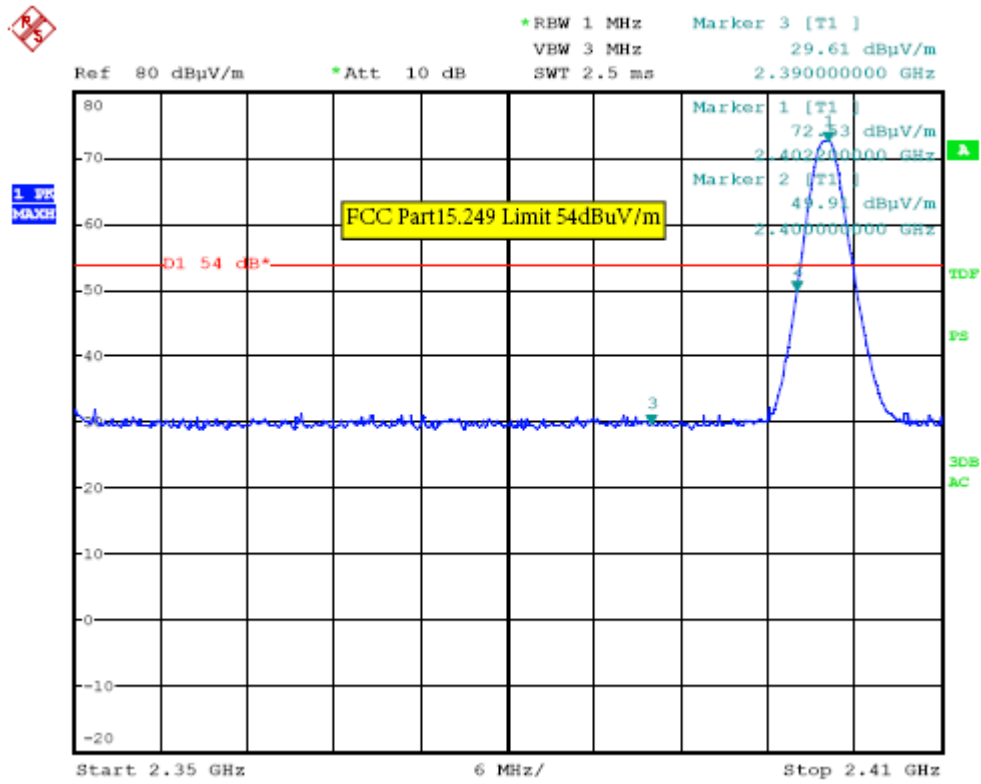

Note:

1. The field strength of any emissions which appear outside of this band shall not exceed the general radiated emission limits in Section 15.209.
2. The average measurement was not performed when the peak measured data under the limit of average detection.

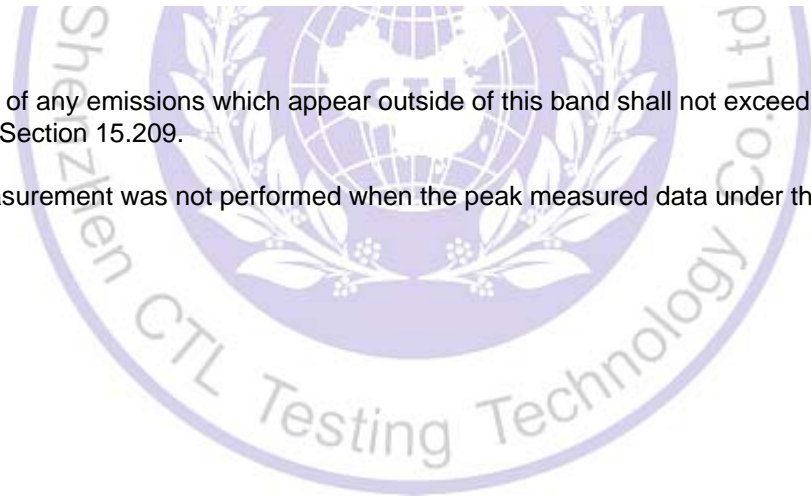

Operation Mode: TX on Top Channel

Polarity: Hor.

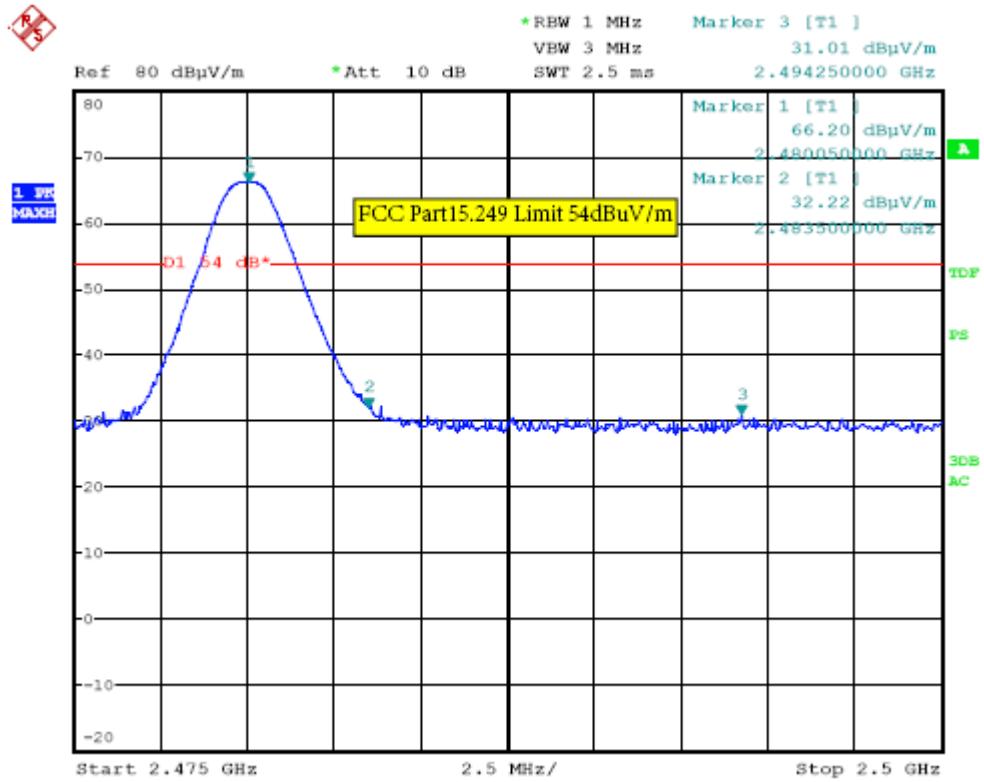

Operation Mode: TX on Top Channel

Polarity: Ver.

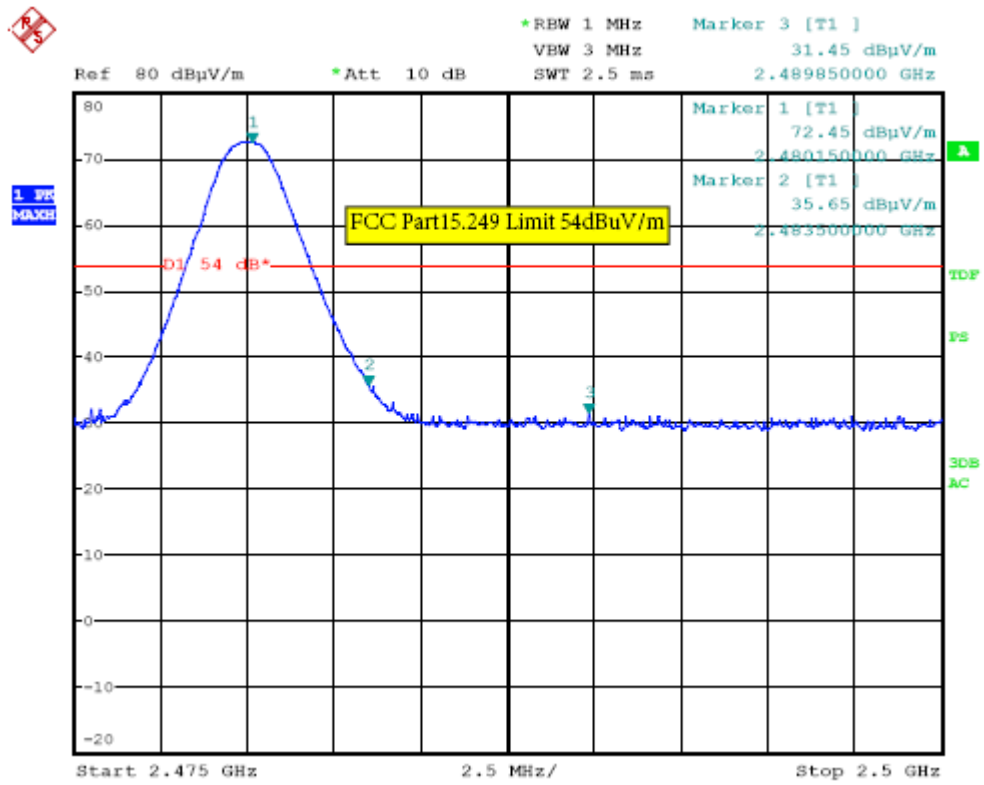

Note:

1. The field strength of any emissions which appear outside of this band shall not exceed the general radiated emission limits in Section 15.209.
2. The average measurement was not performed when the peak measured data under the limit of average detection.

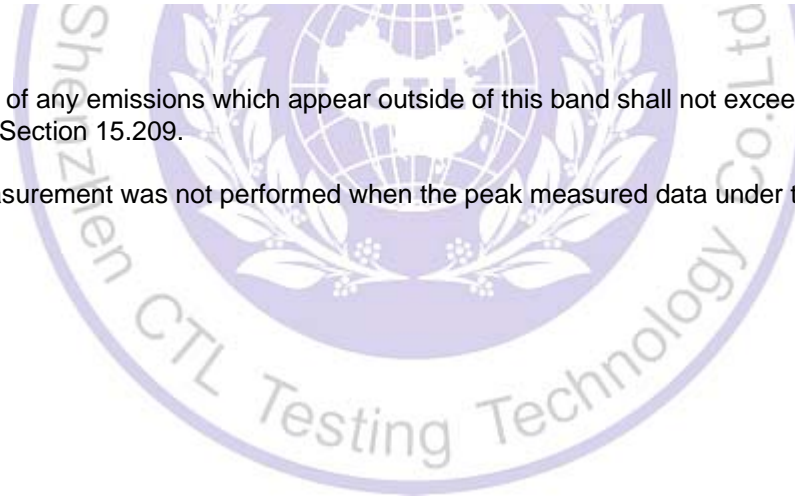

4.4. Occupied Bandwidth Measurement

Measurement Procedure

1. The EUT was placed on a turn table which is 0.8m above ground plane.
2. Set EUT as normal operation.
3. Based on FCC Part15 C Section 15.239(a): RBW= 10KHz. VBW= 30 KHz, Span=3MHz.
4. The useful radiated emission from the EUT was detected by the spectrum analyser with peak detector.

Test SET-UP (Block Diagram of Configuration)

Same as 4.2 Radiated Emission Measurement.

Measurement Equipment Used:

Same as 4.2 Radiated Emission Measurement.

Measurement Results

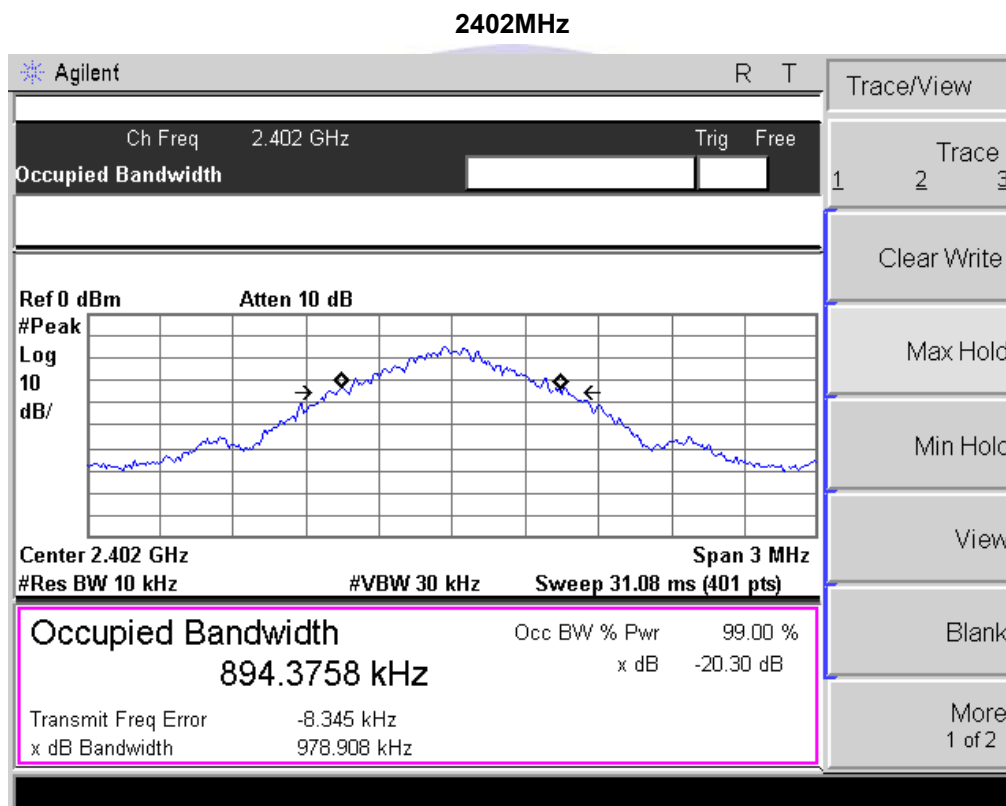

20dB Bandwidth: 978.908KHz

2441MHz

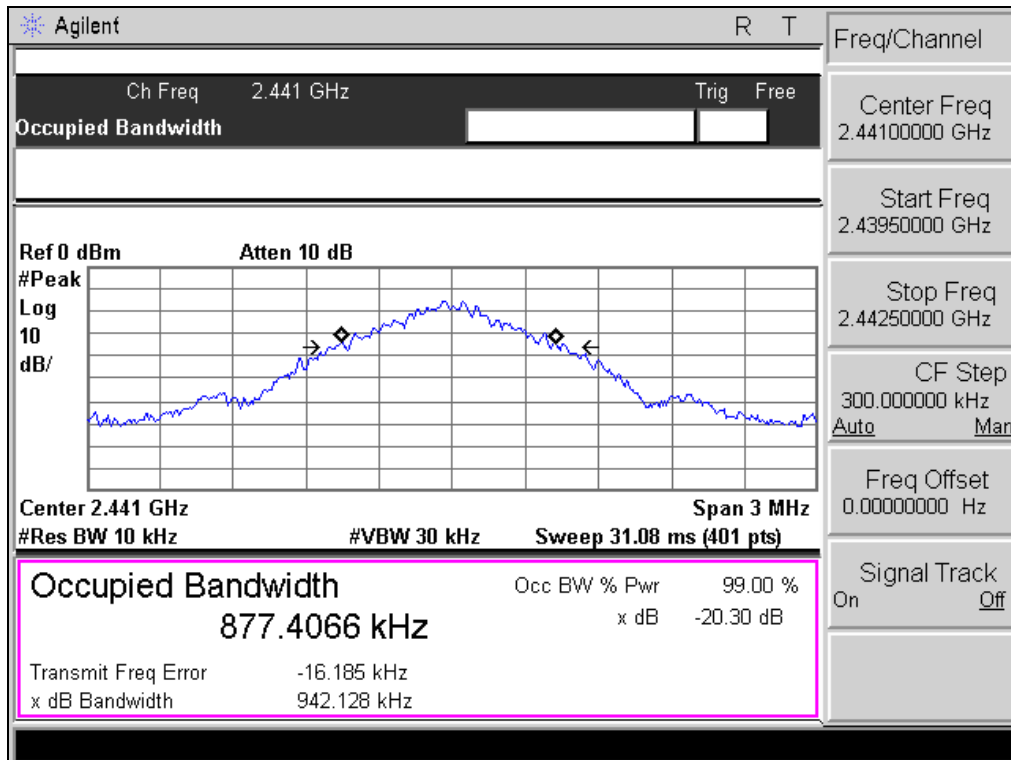

20dB Bandwidth: 942.128KHz

2480MHz

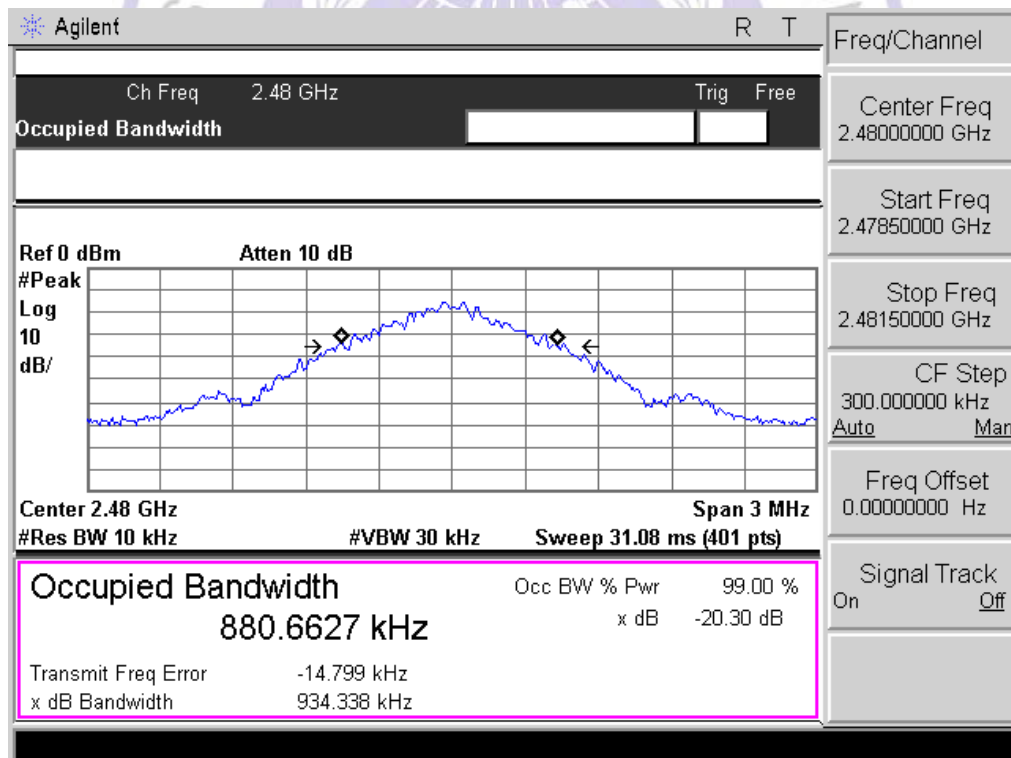

20dB Bandwidth: 934.338KHz

5. Antenna Requirement

Standard Applicable

For intentional device, according to FCC 47 CFR Section 15.203, an intentional radiator shall be designed to ensure that no antenna other than that furnished by the responsible party shall be used with the device.

And according to FCC 47 CFR Section 15.247 (c), if transmitting antennas of directional gain greater than 6dBi are used, the power shall be reduced by the amount in dB that the directional gain of the antenna exceeds 6dBi.

Refer to statement below for compliance.

The manufacturer may design the unit so that the user can replace a broken antenna, but the use of a standard antenna jack or electrical connector is prohibited. Further, this requirement does not apply to intentional radiators that must be professionally installed.

Antenna Connected Construction

The antenna used in this product is a PCB Antenna, The directional gains of antenna used for transmitting is 0 dBi.



6. Test Setup Photos of the EUT

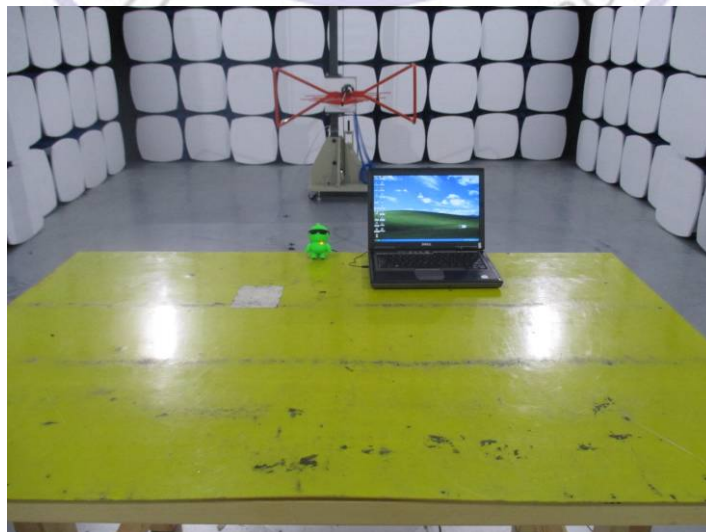
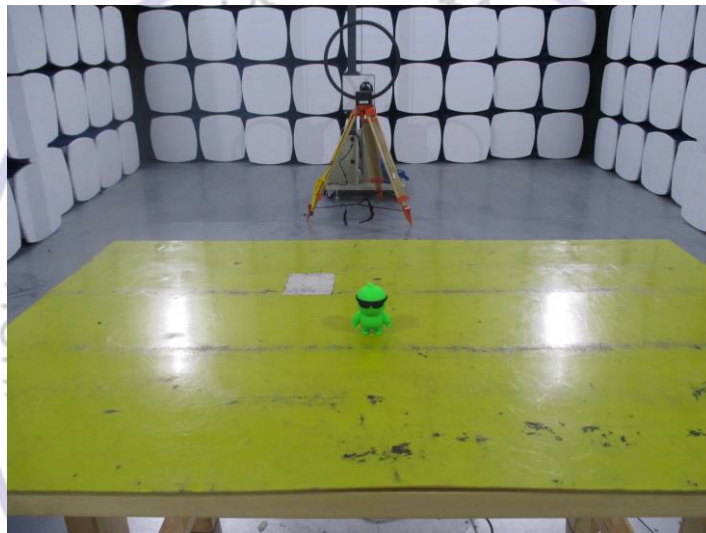
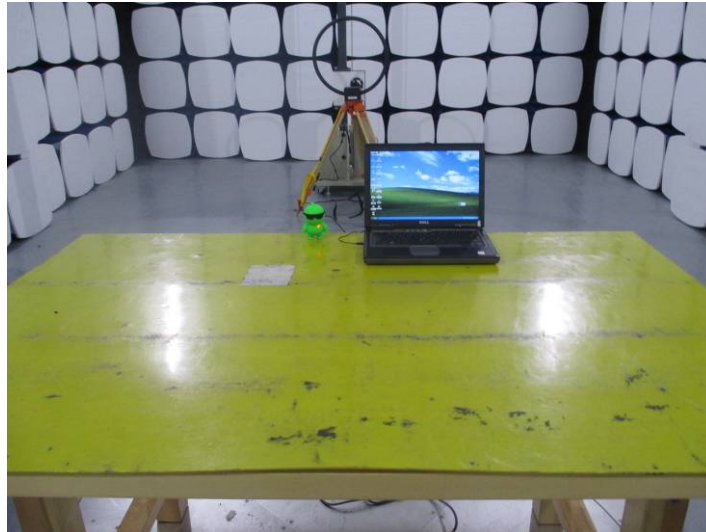

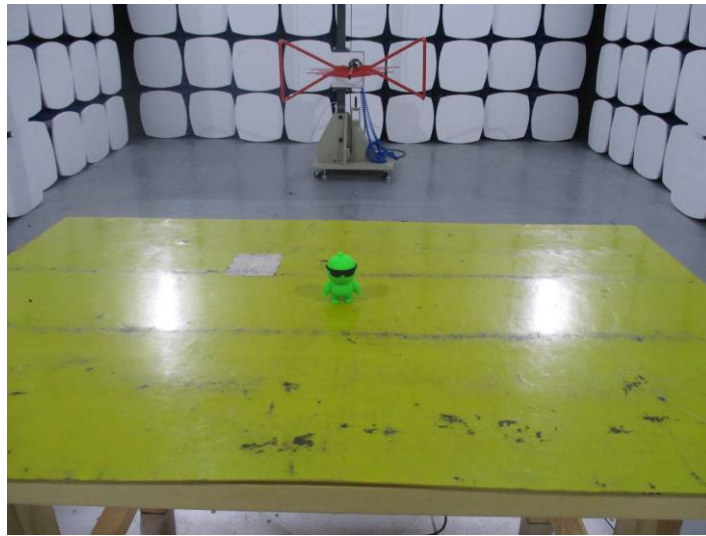



7. External and Internal Photos of the EUT

External Photos of EUT







Internal Photos of EUT

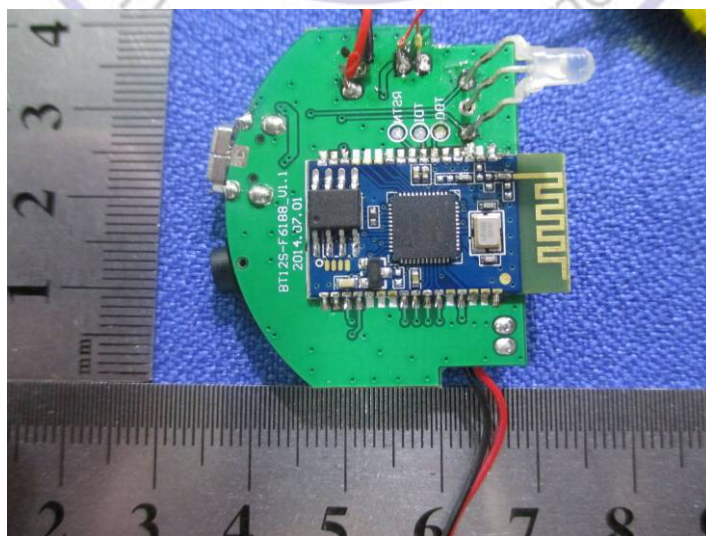
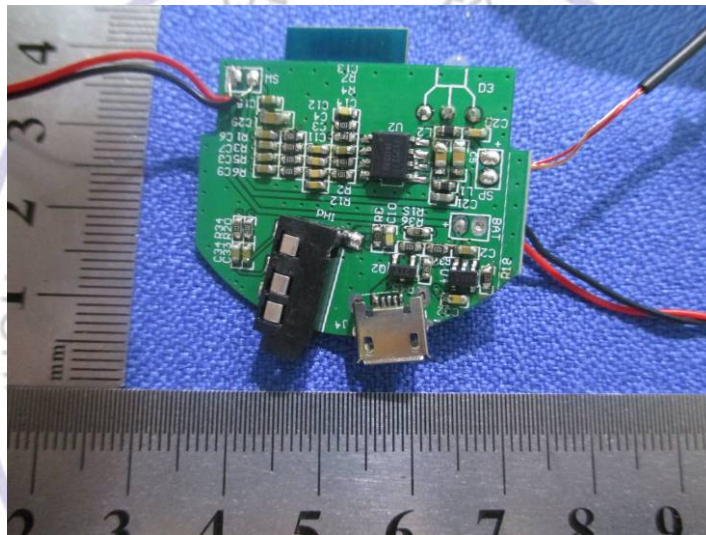

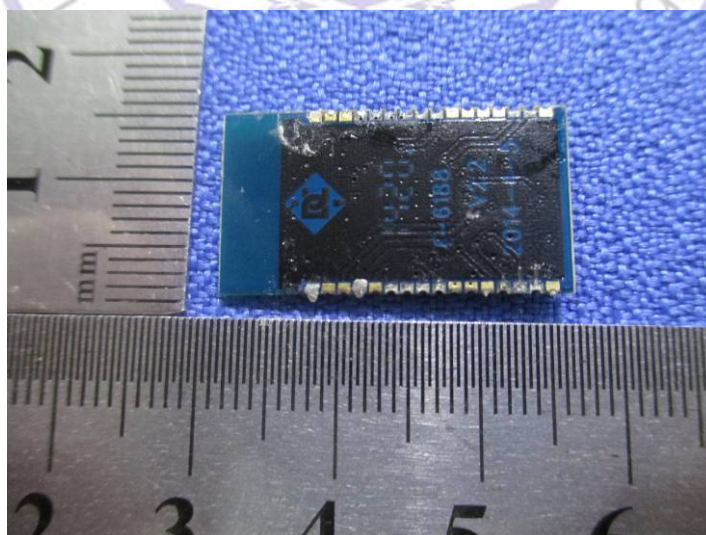
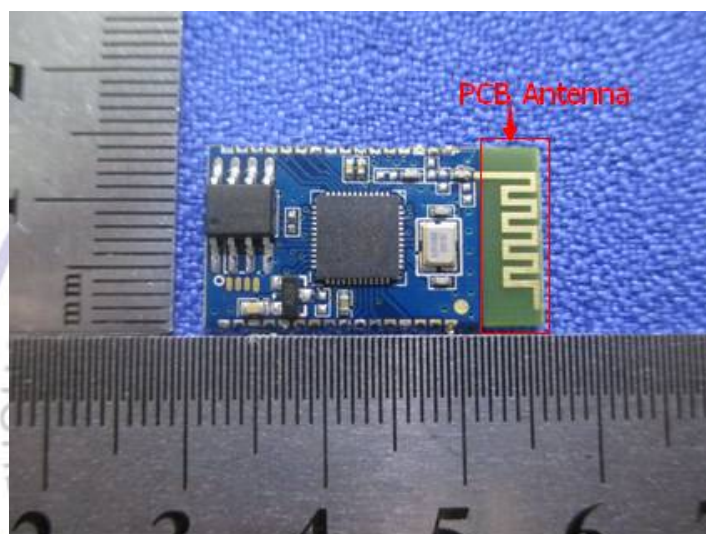
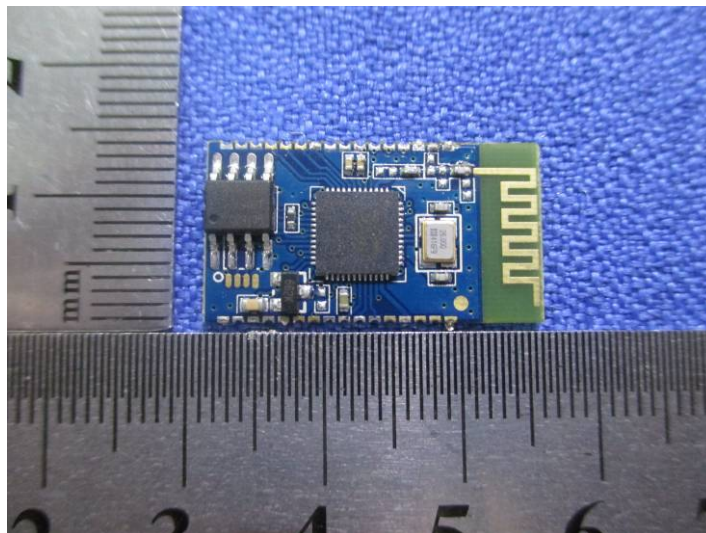

.....End of Report.....