



FCC TEST REPORT

REPORT NO.: RF940224L09

MODEL NO.: WUSB54GS ver. 2

RECEIVED: Feb. 16, 2005

TESTED: Feb. 16 ~ Feb. 25, 2005

ISSUED: Mar. 14, 2005

APPLICANT: Cisco-Linksys LLC

ADDRESS: 121 Theory Drive Irvine, CA 92617 (USA)

ISSUED BY: Advance Data Technology Corporation

LAB ADDRESS: No. 47, 14th Ling, Chia Pau Tsuen, Lin Kou Hsiang 244, Taipei Hsien, Taiwan, R.O.C.

TEST LOCATION: No. 19, Hwa Ya 2nd Rd., Wen Hwa Tsuen, Kwei Shan Hsiang, Taoyuan Hsien 333, Taiwan, R.O.C.

This test report consists of 63 pages in total. It may be duplicated completely for legal use with the approval of the applicant. It should not be reproduced except in full, without the written approval of our laboratory. The client should not use it to claim product endorsement by CNLA, A2LA or any government agencies. The test results in the report only apply to the tested sample.



0528
ILAC MRA



No. 2177-01



Table of Contents

| | | |
|-------|---------------------------------------------------------|----|
| 1. | CERTIFICATION | 4 |
| 2. | SUMMARY OF TEST RESULTS..... | 5 |
| 2.1 | MEASUREMENT UNCERTAINTY | 5 |
| 3. | GENERAL INFORMATION | 6 |
| 3.1 | GENERAL DESCRIPTION OF EUT | 6 |
| 3.2 | DESCRIPTION OF TEST MODES..... | 7 |
| 3.2.1 | CONFIGURATION OF SYSTEM UNDER TEST | 7 |
| 3.2.2 | TEST MODE APPLICABILITY AND TESTED CHANNEL DETAIL:..... | 8 |
| 3.3 | GENERAL DESCRIPTION OF APPLIED STANDARDS | 10 |
| 3.4 | DESCRIPTION OF SUPPORT UNITS | 10 |
| 4. | TEST TYPES AND RESULTS..... | 11 |
| 4.1 | CONDUCTED EMISSION MEASUREMENT | 11 |
| 4.1.1 | LIMITS OF CONDUCTED EMISSION MEASUREMENT..... | 11 |
| 4.1.2 | TEST INSTRUMENTS..... | 11 |
| 4.1.3 | TEST PROCEDURES | 12 |
| 4.1.4 | DEVIATION FROM TEST STANDARD | 12 |
| 4.1.5 | TEST SETUP | 13 |
| 4.1.6 | EUT OPERATING CONDITIONS | 13 |
| 4.1.7 | TEST RESULTS | 13 |
| 4.2 | RADIATED EMISSION MEASUREMENT | 20 |
| 4.2.1 | LIMITS OF RADIATED EMISSION MEASUREMENT..... | 20 |
| 4.2.2 | TEST INSTRUMENTS..... | 21 |
| 4.2.3 | TEST PROCEDURES | 22 |
| 4.2.4 | DEVIATION FROM TEST STANDARD | 22 |
| 4.2.5 | TEST SETUP | 23 |
| 4.2.6 | EUT OPERATING CONDITIONS | 23 |
| 4.2.7 | TEST RESULTS | 24 |
| 4.3 | 6dB BANDWIDTH MEASUREMENT | 32 |
| 4.3.1 | LIMITS OF 6dB BANDWIDTH MEASUREMENT | 32 |
| 4.3.2 | TEST INSTRUMENTS..... | 32 |
| 4.3.3 | TEST PROCEDURE..... | 33 |
| 4.3.4 | DEVIATION FROM TEST STANDARD | 33 |
| 4.3.5 | TEST SETUP | 33 |
| 4.3.6 | EUT OPERATING CONDITIONS | 33 |
| 4.3.7 | TEST RESULTS | 34 |
| 4.4 | MAXIMUM PEAK OUTPUT POWER | 40 |
| 4.4.1 | LIMITS OF MAXIMUM PEAK OUTPUT POWER MEASUREMENT | 40 |
| 4.4.2 | INSTRUMENTS..... | 40 |
| 4.4.3 | TEST PROCEDURES | 41 |



| | | |
|-------|----------------------------------------------------|----|
| 4.4.4 | DEVIATION FROM TEST STANDARD | 41 |
| 4.4.5 | TEST SETUP | 41 |
| 4.4.6 | EUT OPERATING CONDITIONS | 41 |
| 4.4.7 | TEST RESULTS | 42 |
| 4.5 | POWER SPECTRAL DENSITY MEASUREMENT | 43 |
| 4.5.1 | LIMITS OF POWER SPECTRAL DENSITY MEASUREMENT | 43 |
| 4.5.2 | TEST INSTRUMENTS..... | 43 |
| 4.5.3 | TEST PROCEDURE..... | 44 |
| 4.5.4 | DEVIATION FROM TEST STANDARD | 44 |
| 4.5.5 | TEST SETUP | 44 |
| 4.5.6 | EUT OPERATING CONDITION | 44 |
| 4.5.7 | TEST RESULTS | 45 |
| 4.6 | BAND EDGES MEASUREMENT | 51 |
| 4.6.1 | LIMITS OF BAND EDGES MEASUREMENT | 51 |
| 4.6.2 | TEST INSTRUMENTS..... | 51 |
| 4.6.3 | TEST PROCEDURE..... | 51 |
| 4.6.4 | DEVIATION FROM TEST STANDARD | 51 |
| 4.6.5 | EUT OPERATING CONDITION | 51 |
| 4.6.6 | TEST RESULTS | 52 |
| 4.6.7 | TEST RESULTS | 52 |
| 4.7 | ANTENNA REQUIREMENT | 60 |
| 4.7.1 | STANDARD APPLICABLE | 60 |
| 4.7.2 | ANTENNA CONNECTED CONSTRUCTION..... | 60 |
| 5. | PHOTOGRAPHS OF THE TEST CONFIGURATION..... | 61 |
| 6. | INFORMATION ON THE TESTING LABORATORIES..... | 63 |



1. CERTIFICATION

PRODUCT: Wireless-G USB Network Adapter with SpeedBooster
BRAND NAME: Linksys
MODEL NO.: WUSB54GS ver. 2
TEST SAMPLE: ENGINEERING SAMPLE
TESTED: Feb. 16 ~ Feb. 25, 2005
APPLICANT: Cisco-Linksys LLC
STANDARDS: FCC Part 15, Subpart C (Section 15.247),
ANSI C63.4-2003

The above equipment have been tested by **Advance Data Technology Corporation**, and found compliance with the requirement of the above standards. The test record, data evaluation & Equipment Under Test (EUT) configurations represented herein are true and accurate accounts of the measurements of the sample's EMC characteristics under the conditions specified in this report.

PREPARED BY : Candice Chen , **DATE:** Mar. 14, 2005
(Candice Chen)

TECHNICAL

ACCEPTANCE : Gary Chang , **DATE:** Mar. 14, 2005
Responsible for RF (Gary Chang)

APPROVED BY : Cody Chang , **DATE:** Mar. 14, 2005
(Cody Chang, Deputy Manager)

2. SUMMARY OF TEST RESULTS

The EUT has been tested according to the following specifications:

| APPLIED STANDARD: FCC Part 15, Subpart C | | | |
|-------------------------------------------------|----------------------------------------------------------------------------------------|---------------|-----------------------------------------------------------------------------------|
| Standard Section | Test Type and Limit | Result | Remark |
| 15.207 | AC Power Conducted Emission | PASS | Meet the requirement of limit. Minimum passing margin is -15.02dB at 0.158MHz |
| 15.247(a)(2) | Spectrum Bandwidth of a Direct Sequence Spread Spectrum System Limit: min. 500kHz | PASS | Meet the requirement of limit. |
| 15.247(b) | Maximum Peak Output Power Limit: max. 30dBm | PASS | Meet the requirement of limit. |
| 15.247(d) | Radiated Emissions Limit: Table 15.209 | PASS | Meet the requirement of limit. Minimum passing margin is -3.10dB at 9648.00MHz |
| 15.247(e) | Power Spectral Density Limit: max. 8dBm | PASS | Meet the requirement of limit. |
| 15.247(d) | Band Edge Measurement Limit: 20dB less than the peak value of fundamental frequency | PASS | Meet the requirement of limit. |

2.1 MEASUREMENT UNCERTAINTY

Where relevant, the following measurement uncertainty levels have been estimated for tests performed on the EUT as specified in CISPR 16-4:

| Measurement | Frequency | Uncertainty |
|---------------------|------------------|--------------------|
| Conducted emissions | 9kHz~30MHz | 2.44 dB |
| Radiated emissions | 30MHz ~ 200MHz | 3.73 dB |
| | 200MHz ~ 1000MHz | 3.74 dB |
| | 1GHz ~ 18GHz | 2.20 dB |
| | 18GHz ~ 40GHz | 1.88 dB |



3. GENERAL INFORMATION

3.1 GENERAL DESCRIPTION OF EUT

| | |
|---------------------------|-----------------------------------------------------------------|
| EUT | Wireless-G USB Network Adapter with SpeedBooster |
| MODEL NO. | WUSB54GS ver. 2 |
| POWER SUPPLY | 5Vdc from host equipment |
| MODULATION TYPE | CCK, DQPSK, DBPSK for DSSS 64QAM, 16QAM, QPSK, BPSK for OFDM |
| RADIO TECHNOLOGY | DSSS, OFDM |
| TRANSFER RATE | 802.11b: 11/5.5/2/1Mbps 802.11g: 54/48/36/24/18/12/9/6Mbps |
| FREQUENCY RANGE | 2412MHz ~ 2462MHz |
| NUMBER OF CHANNEL | 11 |
| OUTPUT POWER | 50.933mW |
| ANTENNA TYPE | Dipole antenna with 1dBi gain |
| DATA CABLE | 1.6m shielded cable without core |
| I/O PORTS | USB |
| ASSOCIATED DEVICES | NA |

NOTE:

1. The EUT complies with IEEE 802.11g standards and backwards compatible with IEEE 802.11b products.
2. The EUT operates in the 2.4GHz frequency spectrum with throughput of up to 54Mbps.
3. The above EUT information was declared by manufacturer and for more detailed features description, please refer to the manufacturer's specifications or User's Manual.



3.2 DESCRIPTION OF TEST MODES

Eleven channels are provided to this EUT.

| Channel | Frequency | Channel | Frequency |
|---------|-----------|---------|-----------|
| 1 | 2412 MHz | 7 | 2442 MHz |
| 2 | 2417 MHz | 8 | 2447 MHz |
| 3 | 2422 MHz | 9 | 2452 MHz |
| 4 | 2427 MHz | 10 | 2457 MHz |
| 5 | 2432 MHz | 11 | 2462 MHz |
| 6 | 2437 MHz | | |

3.2.1 CONFIGURATION OF SYSTEM UNDER TEST

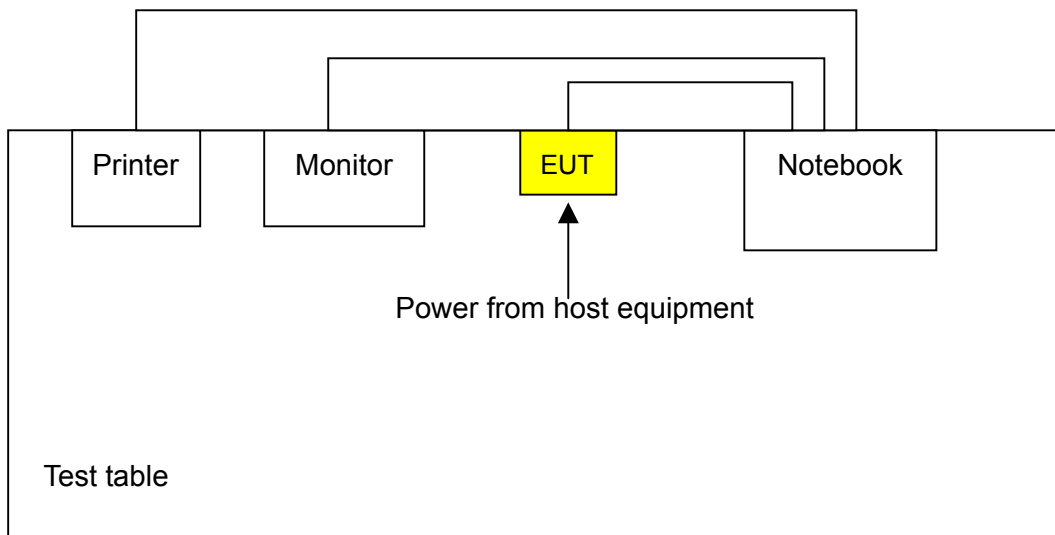



3.2.2 TEST MODE APPLICABILITY AND TESTED CHANNEL DETAIL:

| EUT configure mode | Applicable to | | | | Description |
|--------------------|---------------|-------|-------|------|-------------|
| | PLC | RE<1G | RE≥1G | APCM | |
| - | X | X | X | X | NA |

Where PLC: Power Line Conducted Emission RE<1G RE: Radiated Emission below 1GHz
 RE≥1G: Radiated Emission above 1GHz APCM: Antenna Port Conducted Measurement

Power Line Conducted Emission Test:

- Pre-Scan has been conducted to determine the worst-case mode from all possible combinations between available modulations, data rates and antenna ports (if EUT with antenna diversity architecture).
- Following channel(s) was (were) selected for the final test as listed below.

| Mode | Available Channel | Tested Channel | Modulation Technology | Modulation Type | Data Rate (Mbps) |
|---------|-------------------|----------------|-----------------------|-----------------|------------------|
| 802.11g | 1 to 11 | 1, 6, 11 | OFDM | BPSK | 6 |

Radiated Emission Test (Below 1 GHz):

- Pre-Scan has been conducted to determine the worst-case mode from all possible combinations between available modulations, data rates and antenna ports (if EUT with antenna diversity architecture).
- Following channel(s) was (were) selected for the final test as listed below.

| Mode | Available Channel | Tested Channel | Modulation Technology | Modulation Type | Data Rate (Mbps) |
|---------|-------------------|----------------|-----------------------|-----------------|------------------|
| 802.11g | 1 to 11 | 11 | OFDM | BPSK | 6 |

Radiated Emission Test (Above 1 GHz):

- Pre-Scan has been conducted to determine the worst-case mode from all possible combinations between available modulations, data rates and antenna ports (if EUT with antenna diversity architecture).
- Following channel(s) was (were) selected for the final test as listed below.

| Mode | Available Channel | Tested Channel | Modulation Technology | Modulation Type | Data Rate (Mbps) |
|---------|-------------------|----------------|-----------------------|-----------------|------------------|
| 802.11b | 1 to 11 | 1, 6, 11 | DSSS | CCK | 11 |
| 802.11g | 1 to 11 | 1, 6, 11 | OFDM | BPSK | 6 |



Bandedge Measurement:

- Pre-Scan has been conducted to determine the worst-case mode from all possible combinations between available modulations, data rates and antenna ports (if EUT with antenna diversity architecture).
- Following channel(s) was (were) selected for the final test as listed below.

| Mode | Available Channel | Tested Channel | Modulation Technology | Modulation Type | Data Rate (Mbps) |
|---------|-------------------|----------------|-----------------------|-----------------|------------------|
| 802.11b | 1 to 11 | 1, 11 | DSSS | CCK | 11 |
| 802.11g | 1 to 11 | 1, 11 | OFDM | BPSK | 6 |

Antenna Port Conducted Measurement:

- Pre-Scan has been conducted to determine the worst-case mode from all possible combinations between available modulations, data rates and antenna ports (if EUT with antenna diversity architecture).
- Following channel(s) was (were) selected for the final test as listed below.

| Mode | Available Channel | Tested Channel | Modulation Technology | Modulation Type | Data Rate (Mbps) |
|---------|-------------------|----------------|-----------------------|-----------------|------------------|
| 802.11b | 1 to 11 | 1, 6, 11 | DSSS | CCK | 11 |
| 802.11g | 1 to 11 | 1, 6, 11 | OFDM | BPSK | 6 |



3.3 GENERAL DESCRIPTION OF APPLIED STANDARDS

The EUT is a Wireless-G USB Network Adapter with SpeedBooster. According to the specifications of the manufacturer, it must comply with the requirements of the following standards:

FCC Part 15, Subpart C. (15.247)

ANSI C63.4- 2003

All test items have been performed and recorded as per the above standards.

NOTE: The EUT is also considered as a kind of computer peripheral, because the connection to computer is necessary for typical use. It has been verified to comply with the requirements of FCC Part 15, Subpart B, Class B (DoC). The test report has been issued separately.

3.4 DESCRIPTION OF SUPPORT UNITS

The EUT has been tested as an independent unit together with other necessary accessories or support units. The following support units or accessories were used to form a representative test configuration during the tests.

| NO. | PRODUCT | BRAND | MODEL NO. | SERIAL NO. | FCC ID |
|-----|-------------------|-------|-----------|-------------|------------------|
| 1 | NOTEBOOK COMPUTER | DELL | PP05L | 20838027664 | E2K24CLNS |
| 2 | PRINTER | EPSON | LQ-300+ | DCGY047265 | FCC DoC Approved |
| 3 | MODEM | ACEEX | 1414V/3 | 0401008248 | IFAXDM1414 |

| NO. | SIGNAL CABLE DESCRIPTION OF THE ABOVE SUPPORT UNITS |
|-----|-----------------------------------------------------|
| 1 | NA |
| 2 | 1.2 m shielded cable without core |
| 3 | 1.2 m shielded cable without core |

NOTE: All power cords of the above support units are non shielded (1.8m).



4. TEST TYPES AND RESULTS

4.1 CONDUCTED EMISSION MEASUREMENT

4.1.1 LIMITS OF CONDUCTED EMISSION MEASUREMENT

| FREQUENCY OF EMISSION (MHz) | CONDUCTED LIMIT (dB μ V) | |
|-----------------------------|------------------------------|----------|
| | Quasi-peak | Average |
| 0.15-0.5 | 66 to 56 | 56 to 46 |
| 0.5-5 | 56 | 46 |
| 5-30 | 60 | 50 |

- NOTE:**
1. The lower limit shall apply at the transition frequencies.
 2. The limit decreases in line with the logarithm of the frequency in the range of 0.15 to 0.50 MHz.
 3. All emanations from a class A/B digital device or system, including any network of conductors and apparatus connected thereto, shall not exceed the level of field strengths specified above.

4.1.2 TEST INSTRUMENTS

| DESCRIPTION & MANUFACTURER | MODEL NO. | SERIAL NO. | CALIBRATED UNTIL |
|----------------------------------|-------------|----------------|------------------|
| Test Receiver ROHDE & SCHWARZ | ESCS30 | 100288 | Nov. 06, 2005 |
| RF signal cable Woken | 5D-FB | Cable-HyC02-01 | Jan. 09, 2006 |
| LISN ROHDE & SCHWARZ | ESH2-Z5 | 100100 | Jan. 20, 2006 |
| LISN ROHDE & SCHWARZ | ESH3-Z5 | 100311 | Jan. 20, 2006 |
| Software ADT | ADT_Cond_V3 | NA | NA |

- NOTE:**
1. The calibration interval of the above test instruments is 12 months and the calibrations are traceable to NML/ROC and NIST/USA.
 2. The test was performed in HwaYa Shielded Room 3.
 3. The VCCI Site Registration No. is C-2047.



4.1.3 TEST PROCEDURES

- a. The EUT was placed 0.4 meters from the conducting wall of the shielded room with EUT being connected to the power mains through a line impedance stabilization network (LISN). Other support units were connected to the power mains through another LISN. The two LISNs provide 50 ohm/ 50uH of coupling impedance for the measuring instrument.
- b. Both lines of the power mains connected to the EUT were checked for maximum conducted interference.
- c. The frequency range from 150kHz to 30MHz was searched. Emission levels under (Limit - 20dB) was not recorded.

4.1.4 DEVIATION FROM TEST STANDARD

No deviation

4.1.5 TEST SETUP

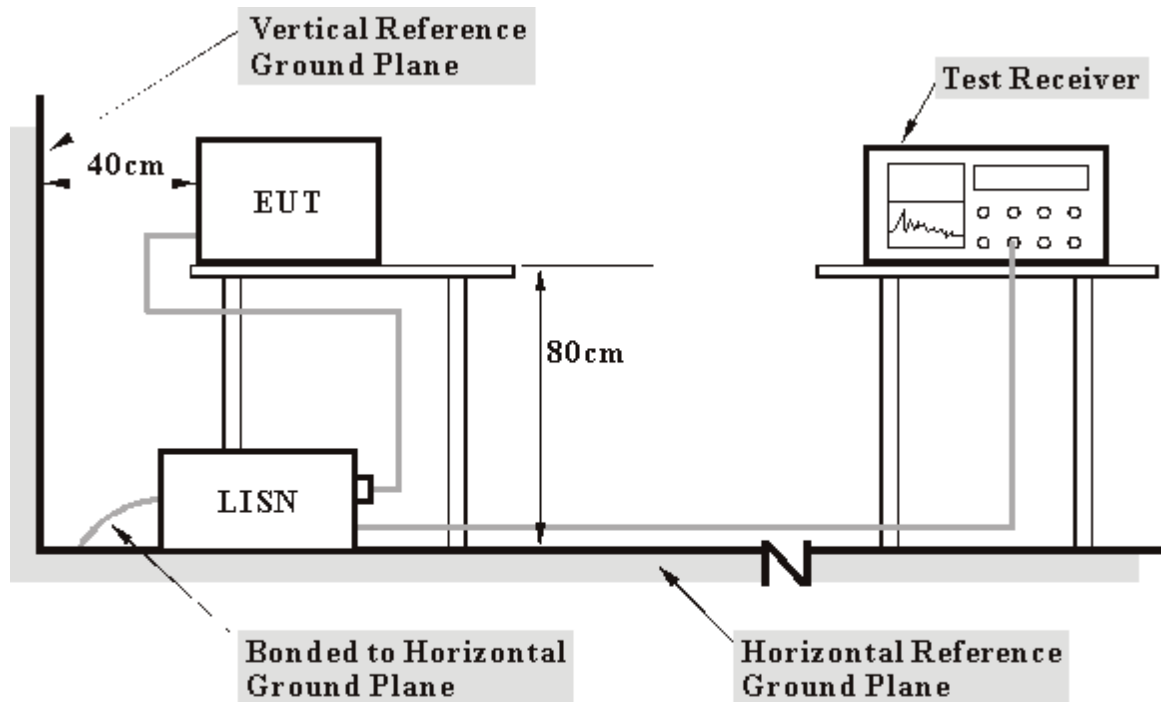

- Note:**
1. Support units were connected to second LISN.
 2. Both of LISNs (AMN) 80 cm from EUT and at the least 80 cm from other units and other metal planes support units.

For the actual test configuration, please refer to the related item – Photographs of the Test Configuration.

4.1.6 EUT OPERATING CONDITIONS

- a. Connected the EUT to the notebook system placed on a testing table.
- b. The notebook system ran a test program (provided by manufacturer) to enable EUT under transmission/receiving condition continuously at specific channel frequency.
- c. The notebook system sent "H" messages to its screen.
- d. The notebook system sent "H" messages to modem.
- e. The notebook system sent "H" messages to printer, and the printer printed them on paper.
- f. Steps c ~ e were repeated.



4.1.7 TEST RESULTS

Conducted Worst-Case Data

| | | | |
|---------------------------------|--------------------------------------------------|----------------------|-----------------|
| EUT | Wireless-G USB Network Adapter with SpeedBooster | MODEL | WUSB54GS ver. 2 |
| CHANNEL | Channel 1 | 6dB BANDWIDTH | 9 kHz |
| MODULATION TYPE | BPSK | TRANSFER RATE | 6Mbps |
| INPUT POWER (SYSTEM) | 120Vac, 60 Hz | PHASE | Line (L) |
| ENVIRONMENTAL CONDITIONS | 23deg. C, 65%RH, 991hPa | TESTED BY | Gary Chang |

| No | Freq. [MHz] | Corr. Factor (dB) | Reading Value [dB (uV)] | | Emission Level [dB (uV)] | | Limit [dB (uV)] | | Margin (dB) | |
|----|----------------|-------------------------|----------------------------|-------|-----------------------------|-------|--------------------|-------|----------------|--------|
| | | | Q.P. | AV. | Q.P. | AV. | Q.P. | AV. | Q.P. | AV. |
| | 1 | 0.213 | 0.10 | 47.18 | - | 47.28 | - | 63.11 | 53.11 | -15.83 |
| 2 | 0.213 | 0.10 | 47.00 | - | 47.10 | - | 63.11 | 53.11 | -16.01 | - |
| 3 | 0.240 | 0.10 | 44.25 | - | 44.35 | - | 62.10 | 52.10 | -17.75 | - |
| 4 | 0.302 | 0.11 | 36.70 | - | 36.81 | - | 60.18 | 50.18 | -23.37 | - |
| 5 | 1.762 | 0.16 | 33.19 | - | 33.35 | - | 56.00 | 46.00 | -22.65 | - |
| 6 | 10.539 | 0.35 | 31.25 | - | 31.60 | - | 60.00 | 50.00 | -28.40 | - |

- REMARKS:**
1. Q.P. and AV. are abbreviations of quasi-peak and average individually.
 2. "-": The Quasi-peak reading value also meets average limit and measurement with the average detector is unnecessary.
 3. The emission levels of other frequencies were very low against the limit.
 4. Margin value = Emission level - Limit value
 5. Correction factor = Insertion loss + Cable loss
 6. Emission Level = Correction Factor + Reading Value.

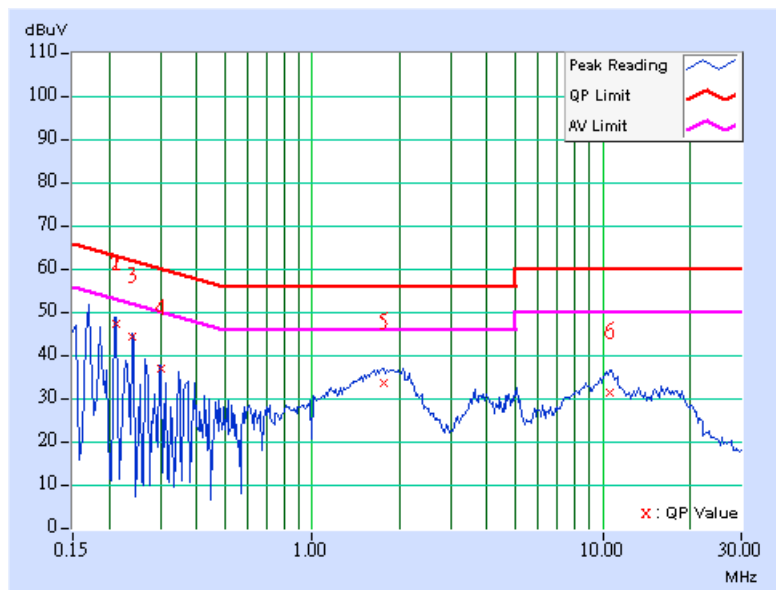



| | | | |
|---------------------------------|--------------------------------------------------|----------------------|-----------------|
| EUT | Wireless-G USB Network Adapter with SpeedBooster | MODEL | WUSB54GS ver. 2 |
| CHANNEL | Channel 1 | 6dB BANDWIDTH | 9 kHz |
| MODULATION TYPE | BPSK | TRANSFER RATE | 6Mbps |
| INPUT POWER (SYSTEM) | 120Vac, 60 Hz | PHASE | Neutral (N) |
| ENVIRONMENTAL CONDITIONS | 23deg. C, 65%RH, 991hPa | TESTED BY | Gary Chang |

| No | Freq. [MHz] | Corr. Factor (dB) | Reading Value [dB (uV)] | | Emission Level [dB (uV)] | | Limit [dB (uV)] | | Margin (dB) | |
|----|----------------|-------------------------|----------------------------|-------|-----------------------------|-------|--------------------|-------|----------------|-------|
| | | | Q.P. | AV. | Q.P. | AV. | Q.P. | AV. | Q.P. | AV. |
| | | | 1 | 0.158 | 0.10 | 50.46 | - | 50.56 | - | 65.58 |
| 2 | 0.181 | 0.10 | 48.09 | - | 48.19 | - | 64.43 | 54.43 | -16.24 | - |
| 3 | 0.216 | 0.10 | 45.27 | - | 45.37 | - | 62.96 | 52.96 | -17.58 | - |
| 4 | 0.236 | 0.10 | 43.60 | - | 43.70 | - | 62.24 | 52.24 | -18.54 | - |
| 5 | 1.977 | 0.15 | 32.64 | - | 32.79 | - | 56.00 | 46.00 | -23.21 | - |
| 6 | 10.434 | 0.30 | 31.73 | - | 32.03 | - | 60.00 | 50.00 | -27.97 | - |

- REMARKS:**
1. Q.P. and AV. are abbreviations of quasi-peak and average individually.
 2. "-": The Quasi-peak reading value also meets average limit and measurement with the average detector is unnecessary.
 3. The emission levels of other frequencies were very low against the limit.
 4. Margin value = Emission level - Limit value
 5. Correction factor = Insertion loss + Cable loss
 6. Emission Level = Correction Factor + Reading Value.

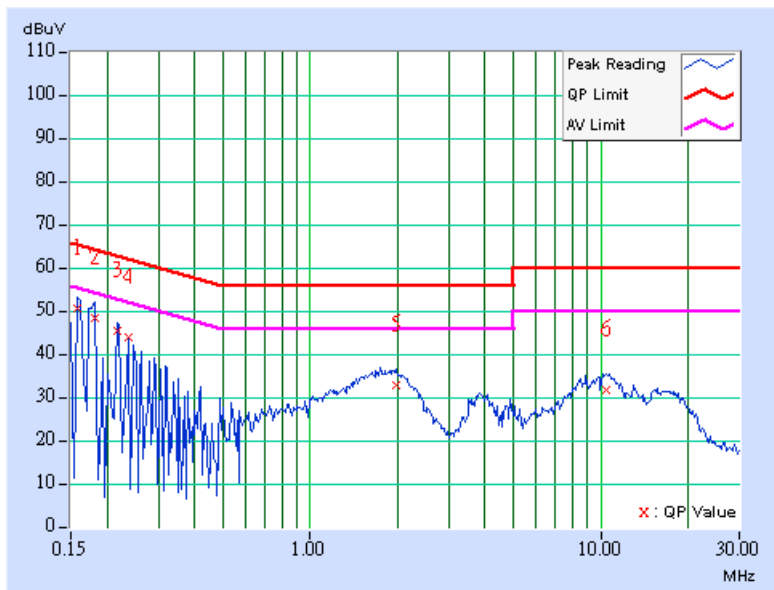



| | | | |
|---------------------------------|--------------------------------------------------|----------------------|-----------------|
| EUT | Wireless-G USB Network Adapter with SpeedBooster | MODEL | WUSB54GS ver. 2 |
| CHANNEL | Channel 6 | 6dB BANDWIDTH | 9 kHz |
| MODULATION TYPE | BPSK | TRANSFER RATE | 6Mbps |
| INPUT POWER (SYSTEM) | 120Vac, 60 Hz | PHASE | Line (L) |
| ENVIRONMENTAL CONDITIONS | 23deg. C, 65%RH, 991hPa | TESTED BY | Gary Chang |

| No | Freq. [MHz] | Corr. Factor (dB) | Reading Value [dB (uV)] | | Emission Level [dB (uV)] | | Limit [dB (uV)] | | Margin (dB) | |
|----|----------------|-------------------------|----------------------------|-------|-----------------------------|-------|--------------------|-------|----------------|-------|
| | | | Q.P. | AV. | Q.P. | AV. | Q.P. | AV. | Q.P. | AV. |
| | | | 1 | 0.162 | 0.10 | 43.15 | - | 43.25 | - | 65.38 |
| 2 | 0.209 | 0.10 | 39.58 | - | 39.68 | - | 63.26 | 53.26 | -23.58 | - |
| 3 | 0.224 | 0.10 | 43.25 | - | 43.35 | - | 62.66 | 52.66 | -19.31 | - |
| 4 | 0.279 | 0.11 | 29.15 | - | 29.26 | - | 60.85 | 50.85 | -31.59 | - |
| 5 | 1.668 | 0.16 | 30.68 | - | 30.84 | - | 56.00 | 46.00 | -25.16 | - |
| 6 | 10.156 | 0.34 | 34.20 | - | 34.54 | - | 60.00 | 50.00 | -25.46 | - |

- REMARKS:**
1. Q.P. and AV. are abbreviations of quasi-peak and average individually.
 2. "-": The Quasi-peak reading value also meets average limit and measurement with the average detector is unnecessary.
 3. The emission levels of other frequencies were very low against the limit.
 4. Margin value = Emission level - Limit value
 5. Correction factor = Insertion loss + Cable loss
 6. Emission Level = Correction Factor + Reading Value.

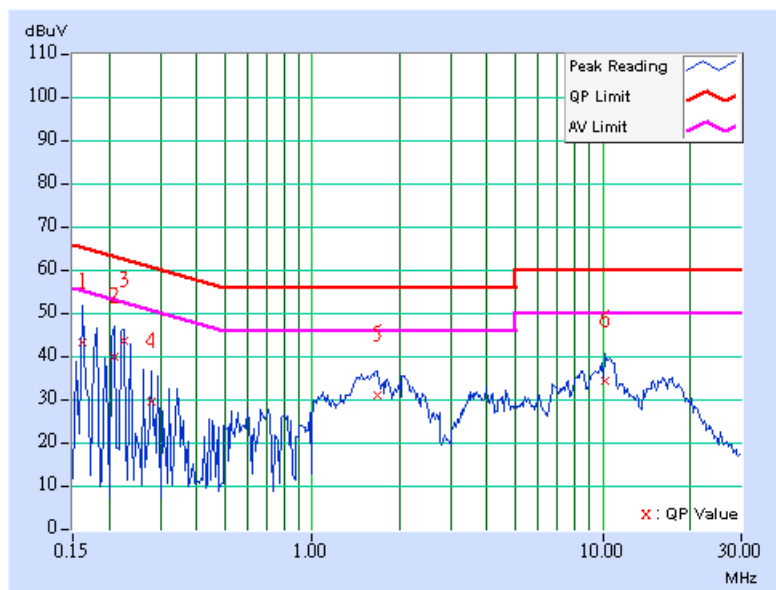



| | | | |
|---------------------------------|--------------------------------------------------|----------------------|-----------------|
| EUT | Wireless-G USB Network Adapter with SpeedBooster | MODEL | WUSB54GS ver. 2 |
| CHANNEL | Channel 6 | 6dB BANDWIDTH | 9 kHz |
| MODULATION TYPE | BPSK | TRANSFER RATE | 6Mbps |
| INPUT POWER (SYSTEM) | 120Vac, 60 Hz | PHASE | Neutral (N) |
| ENVIRONMENTAL CONDITIONS | 23deg. C, 65%RH, 991hPa | TESTED BY | Gary Chang |

| No | Freq. [MHz] | Corr. Factor (dB) | Reading Value [dB (uV)] | | Emission Level [dB (uV)] | | Limit [dB (uV)] | | Margin (dB) | |
|----|----------------|-------------------------|----------------------------|-------|-----------------------------|-------|--------------------|-------|----------------|-------|
| | | | Q.P. | AV. | Q.P. | AV. | Q.P. | AV. | Q.P. | AV. |
| | | | 1 | 0.162 | 0.10 | 42.55 | - | 42.65 | - | 65.38 |
| 2 | 0.173 | 0.10 | 41.28 | - | 41.38 | - | 64.79 | 54.79 | -23.42 | - |
| 3 | 0.213 | 0.11 | 40.30 | - | 40.40 | - | 63.11 | 53.11 | -22.71 | - |
| 4 | 1.922 | 0.15 | 30.63 | - | 30.78 | - | 56.00 | 46.00 | -25.22 | - |
| 5 | 10.566 | 0.30 | 34.89 | - | 35.19 | - | 60.00 | 50.00 | -24.81 | - |
| 6 | 15.652 | 0.37 | 29.24 | - | 29.61 | - | 60.00 | 50.00 | -30.39 | - |

- REMARKS:**
1. Q.P. and AV. are abbreviations of quasi-peak and average individually.
 2. "-": The Quasi-peak reading value also meets average limit and measurement with the average detector is unnecessary.
 3. The emission levels of other frequencies were very low against the limit.
 4. Margin value = Emission level - Limit value
 5. Correction factor = Insertion loss + Cable loss
 6. Emission Level = Correction Factor + Reading Value.

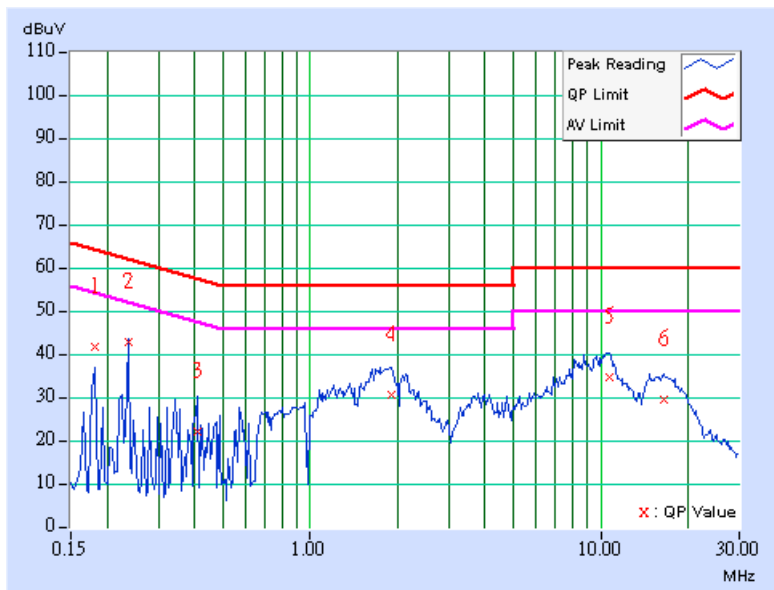



| | | | |
|---------------------------------|--------------------------------------------------|----------------------|-----------------|
| EUT | Wireless-G USB Network Adapter with SpeedBooster | MODEL | WUSB54GS ver. 2 |
| CHANNEL | Channel 11 | 6dB BANDWIDTH | 9 kHz |
| MODULATION TYPE | BPSK | TRANSFER RATE | 6Mbps |
| INPUT POWER (SYSTEM) | 120Vac, 60 Hz | PHASE | Line (L) |
| ENVIRONMENTAL CONDITIONS | 23deg. C, 65%RH, 991hPa | TESTED BY | Gary Chang |

| No | Freq. [MHz] | Corr. Factor (dB) | Reading Value [dB (uV)] | | Emission Level [dB (uV)] | | Limit [dB (uV)] | | Margin (dB) | |
|----|-------------|-------------------|-------------------------|-------|--------------------------|-------|-----------------|-------|-------------|-------|
| | | | Q.P. | AV. | Q.P. | AV. | Q.P. | AV. | Q.P. | AV. |
| | | | 1 | 0.154 | 0.10 | 43.56 | - | 43.66 | - | 65.79 |
| 2 | 0.170 | 0.10 | 41.77 | - | 41.87 | - | 64.98 | 54.98 | -23.11 | - |
| 3 | 0.232 | 0.10 | 42.76 | - | 42.86 | - | 62.38 | 52.38 | -19.51 | - |
| 4 | 1.477 | 0.15 | 30.85 | - | 31.00 | - | 56.00 | 46.00 | -25.00 | - |
| 5 | 10.637 | 0.35 | 34.23 | - | 34.58 | - | 60.00 | 50.00 | -25.42 | - |
| 6 | 16.484 | 0.57 | 29.65 | - | 30.22 | - | 60.00 | 50.00 | -29.78 | - |

- REMARKS:**
1. Q.P. and AV. are abbreviations of quasi-peak and average individually.
 2. "-": The Quasi-peak reading value also meets average limit and measurement with the average detector is unnecessary.
 3. The emission levels of other frequencies were very low against the limit.
 4. Margin value = Emission level - Limit value
 5. Correction factor = Insertion loss + Cable loss
 6. Emission Level = Correction Factor + Reading Value.

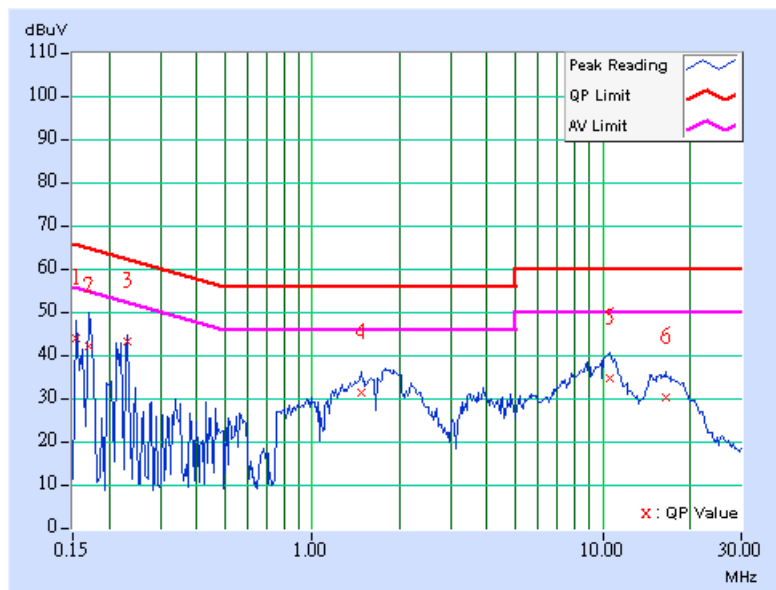



| | | | |
|---------------------------------|--------------------------------------------------|----------------------|-----------------|
| EUT | Wireless-G USB Network Adapter with SpeedBooster | MODEL | WUSB54GS ver. 2 |
| CHANNEL | Channel 11 | 6dB BANDWIDTH | 9 kHz |
| MODULATION TYPE | BPSK | TRANSFER RATE | 6Mbps |
| INPUT POWER (SYSTEM) | 120Vac, 60 Hz | PHASE | Neutral (N) |
| ENVIRONMENTAL CONDITIONS | 23deg. C, 65%RH, 991hPa | TESTED BY | Gary Chang |

| No | Freq. [MHz] | Corr. Factor (dB) | Reading Value [dB (uV)] | | Emission Level [dB (uV)] | | Limit [dB (uV)] | | Margin (dB) | |
|----|-------------|-------------------|-------------------------|-------|--------------------------|-------|-----------------|-------|-------------|-------|
| | | | Q.P. | AV. | Q.P. | AV. | Q.P. | AV. | Q.P. | AV. |
| | | | 1 | 0.166 | 0.10 | 42.45 | - | 42.55 | - | 65.18 |
| 2 | 0.205 | 0.10 | 38.04 | - | 38.14 | - | 63.42 | 53.42 | -25.28 | - |
| 3 | 0.232 | 0.10 | 42.76 | - | 42.86 | - | 62.38 | 52.38 | -19.51 | - |
| 4 | 0.283 | 0.11 | 28.47 | - | 28.58 | - | 60.73 | 50.73 | -32.16 | - |
| 5 | 1.680 | 0.15 | 30.20 | - | 30.35 | - | 56.00 | 46.00 | -25.65 | - |
| 6 | 10.621 | 0.30 | 34.69 | - | 34.99 | - | 60.00 | 50.00 | -25.01 | - |

- REMARKS:**
1. Q.P. and AV. are abbreviations of quasi-peak and average individually.
 2. "-": The Quasi-peak reading value also meets average limit and measurement with the average detector is unnecessary.
 3. The emission levels of other frequencies were very low against the limit.
 4. Margin value = Emission level - Limit value
 5. Correction factor = Insertion loss + Cable loss
 6. Emission Level = Correction Factor + Reading Value.

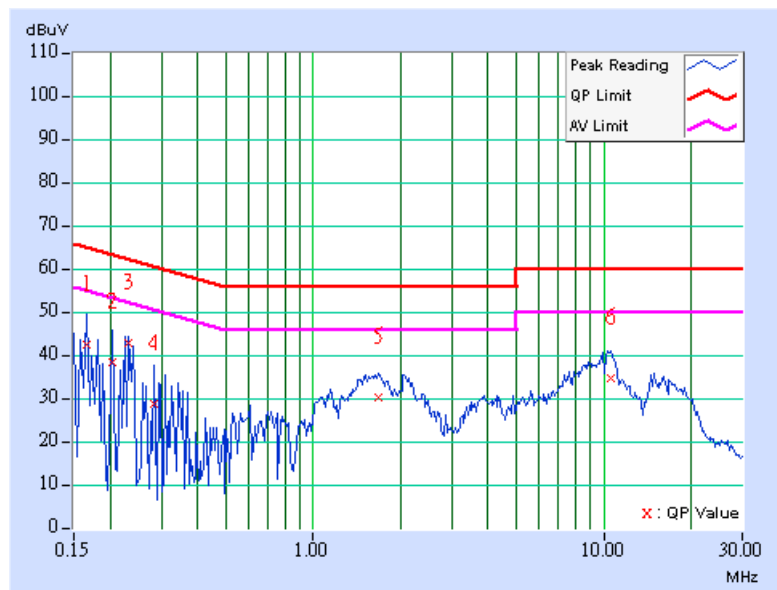



4.2 RADIATED EMISSION MEASUREMENT

4.2.1 LIMITS OF RADIATED EMISSION MEASUREMENT

Emissions radiated outside of the specified bands, shall be according to the general radiated limits in 15.209 as following:

| Frequencies (MHz) | Field strength (microvolts/meter) | Measurement distance (meters) |
|-------------------|-----------------------------------|-------------------------------|
| 0.009-0.490 | 2400/F(kHz) | 300 |
| 0.490-1.705 | 24000/F(kHz) | 30 |
| 1.705-30.0 | 30 | 30 |
| 30-88 | 100 | 3 |
| 88-216 | 150 | 3 |
| 216-960 | 200 | 3 |
| Above 960 | 500 | 3 |

NOTE:

1. The lower limit shall apply at the transition frequencies.
2. Emission level (dBuV/m) = 20 log Emission level (uV/m).
3. As shown in 15.35(b), for frequencies above 1000MHz, the field strength limits are based on average detector, however, the peak field strength of any emission shall not exceed the maximum permitted average limits, specified above by more than 20dB under any condition of modulation.



4.2.2 TEST INSTRUMENTS

| DESCRIPTION & MANUFACTURER | MODEL NO. | SERIAL NO. | CALIBRATED UNTIL |
|--------------------------------------|--------------------|--------------|------------------|
| Test Receiver ROHDE & SCHWARZ | ESIB7 | 100188 | Dec. 19, 2005 |
| Spectrum Analyzer ROHDE & SCHWARZ | FSP40 | 100039 | Nov. 21, 2005 |
| BILOG Antenna SCHWARZBECK | VULB9168 | 9168-157 | Jan. 22, 2006 |
| HORN Antenna SCHWARZBECK | BBHA 9120 D | 9120D-407 | Jan. 16, 2006 |
| HORN Antenna SCHWARZBECK | BBHA 9170 | BBHA 9170241 | Feb. 23, 2006 |
| Preamplifier Agilent | 8449B | 3008A01961 | Nov. 09, 2005 |
| Preamplifier Agilent | 8447D | 2944A10629 | Nov. 09, 2005 |
| RF signal cable HUBER+SUHNER | SUCOFLEX 104 | 218182/4 | Feb. 17, 2006 |
| RF signal cable HUBER+SUHNER | SUCOFLEX 104 | 218194/4 | Feb. 17, 2006 |
| Software ADT. | ADT_Radiated_V5.14 | NA | NA |
| Antenna Tower ADT. | AT100 | AT93021702 | NA |
| Turn Table ADT. | TT100. | TT93021702 | NA |
| Controller ADT. | SC100. | SC93021702 | NA |

- NOTE:**
1. The calibration interval of the above test instruments is 12 months and the calibrations are traceable to NML/ROC and NIST/USA.
 2. The test was performed in HwaYa Chamber 1.
 3. The horn antenna and HP preamplifier (model: 8449B) are used only for the measurement of emission frequency above 1GHz if tested.
 4. The IC Site Registration No. is IC4924-2.



4.2.3 TEST PROCEDURES

- a. The EUT was placed on the top of a rotating table 0.8 meters above the ground at a 3 meter semi-anechoic chamber. The table was rotated 360 degrees to determine the position of the highest radiation.
- b. The EUT was set 3 meters away from the interference-receiving antenna, which was mounted on the top of a variable-height antenna tower.
- c. The antenna is a broadband antenna, and its height is varied from one meter to four meters above the ground to determine the maximum value of the field strength. Both horizontal and vertical polarizations of the antenna are set to make the measurement.
- d. For each suspected emission, the EUT was arranged to its worst case and then the antenna was tuned to heights from 1 meter to 4 meters and the rotatable table was turned from 0 degrees to 360 degrees to find the maximum reading.
- e. The test-receiver system was set to Peak Detect Function and Specified Bandwidth with Maximum Hold Mode.
- f. If the emission level of the EUT in peak mode was 10 dB lower than the limit specified, then testing could be stopped and the peak values of the EUT would be reported. Otherwise the emissions that did not have 10 dB margin would be re-tested one by one using the quasi-peak method or average method as specified and then reported in Data sheet peak mode and QP mode.

NOTE:

1. The resolution bandwidth and video bandwidth of test receiver/spectrum analyzer is 120kHz for Quasi-peak detection at frequency below 1GHz.
2. The resolution bandwidth and video bandwidth of test receiver/spectrum analyzer is 1 MHz for Peak detection (PK) at frequency above 1GHz.
3. The resolution bandwidth of test receiver/spectrum analyzer is 1 MHz and the video bandwidth is 1 kHz for Average detection (AV) at frequency above 1GHz.

4.2.4 DEVIATION FROM TEST STANDARD

No deviation

4.2.5 TEST SETUP

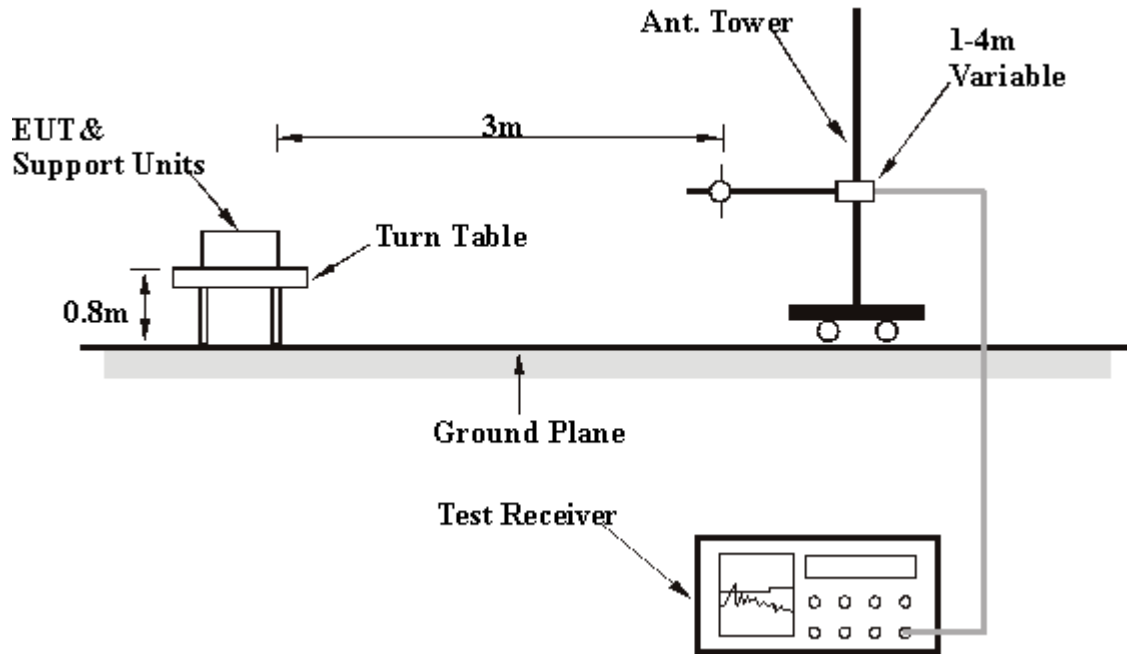

For the actual test configuration, please refer to the related item – Photographs of the Test Configuration.

4.2.6 EUT OPERATING CONDITIONS

Same as 4.1.6

4.2.7 TEST RESULTS

Below 1GHz Worst-Case Data

| | | | |
|---------------------------------|--------------------------------------------------|--------------------------|-----------------|
| EUT | Wireless-G USB Network Adapter with SpeedBooster | MODEL | WUSB54GS ver. 2 |
| CHANNEL | Channel 11 | FREQUENCY RANGE | Below 1000MHz |
| MODULATION TYPE | BPSK | TRANSFER RATE | 6Mbps |
| INPUT POWER (SYSTEM) | 120Vac, 60 Hz | DETECTOR FUNCTION | Quasi-Peak |
| ENVIRONMENTAL CONDITIONS | 24deg. C, 64%RH, 991hPa | TESTED BY | Match Tsui |

ANTENNA POLARITY & TEST DISTANCE: HORIZONTAL AT 3 M

| No. | Freq. (MHz) | Emission Level (dBuV/m) | Limit (dBuV/m) | Margin (dB) | Antenna Height (m) | Table Angle (Degree) | Raw Value (dBuV) | Correction Factor (dB/m) |
|-----|-------------|-------------------------|----------------|-------------|--------------------|----------------------|------------------|--------------------------|
| 1 | 53.33 | 25.05 QP | 40.00 | -14.95 | 2.00 H | 205 | 10.92 | 14.13 |
| 2 | 109.70 | 26.44 QP | 43.50 | -17.06 | 1.50 H | 61 | 14.70 | 11.74 |
| 3 | 158.30 | 27.28 QP | 43.50 | -16.22 | 1.25 H | 268 | 12.66 | 14.62 |
| 4 | 195.23 | 38.58 QP | 43.50 | -4.92 | 1.50 H | 193 | 27.07 | 11.51 |
| 5 | 224.39 | 27.82 QP | 46.00 | -18.18 | 1.25 H | 112 | 15.91 | 11.91 |
| 6 | 405.17 | 27.61 QP | 46.00 | -18.39 | 1.00 H | 88 | 10.85 | 16.77 |
| 7 | 465.43 | 24.54 QP | 46.00 | -21.46 | 1.75 H | 85 | 6.42 | 18.12 |
| 8 | 599.56 | 26.59 QP | 46.00 | -19.41 | 1.50 H | 250 | 5.71 | 20.88 |
| 9 | 665.65 | 28.60 QP | 46.00 | -17.40 | 1.25 H | 265 | 6.80 | 21.79 |
| 10 | 729.80 | 28.18 QP | 46.00 | -17.82 | 1.00 H | 229 | 5.24 | 22.94 |
| 11 | 803.67 | 28.96 QP | 46.00 | -17.04 | 1.00 H | 208 | 5.23 | 23.73 |
| 12 | 930.02 | 29.44 QP | 46.00 | -16.56 | 1.25 H | 295 | 4.03 | 25.41 |

- REMARKS:**
1. Emission level(dBuV/m)=Raw Value(dBuV) + Correction Factor(dB/m)
 2. Correction Factor(dB/m) = Antenna Factor (dB/m) + Cable Factor (dB)
 3. The other emission levels were very low against the limit.
 4. Margin value = Emission level – Limit value.



| | | | |
|---------------------------------|--------------------------------------------------|--------------------------|-----------------|
| EUT | Wireless-G USB Network Adapter with SpeedBooster | MODEL | WUSB54GS ver. 2 |
| CHANNEL | Channel 11 | FREQUENCY RANGE | Below 1000MHz |
| MODULATION TYPE | BPSK | TRANSFER RATE | 6Mbps |
| INPUT POWER (SYSTEM) | 120Vac, 60 Hz | DETECTOR FUNCTION | Quasi-Peak |
| ENVIRONMENTAL CONDITIONS | 24deg. C, 64%RH, 991hPa | TESTED BY | Match Tsui |

ANTENNA POLARITY & TEST DISTANCE: VERTICAL AT 3 M

| No. | Freq. (MHz) | Emission Level (dBuV/m) | Limit (dBuV/m) | Margin (dB) | Antenna Height (m) | Table Angle (Degree) | Raw Value (dBuV) | Correction Factor (dB/m) |
|-----|-------------|-------------------------|----------------|-------------|--------------------|----------------------|------------------|--------------------------|
| 1 | 64.99 | 28.90 QP | 40.00 | -11.10 | 1.00 V | 313 | 16.01 | 12.90 |
| 2 | 109.70 | 31.08 QP | 43.50 | -12.42 | 1.00 V | 346 | 19.33 | 11.74 |
| 3 | 125.25 | 30.94 QP | 43.50 | -12.56 | 1.00 V | 10 | 17.77 | 13.17 |
| 4 | 162.18 | 32.08 QP | 43.50 | -11.42 | 1.00 V | 199 | 17.64 | 14.45 |
| 5 | 195.23 | 30.22 QP | 43.50 | -13.28 | 1.75 V | 127 | 18.71 | 11.51 |
| 6 | 397.39 | 22.10 QP | 46.00 | -23.90 | 1.50 V | 271 | 5.53 | 16.58 |
| 7 | 467.37 | 23.17 QP | 46.00 | -22.83 | 1.25 V | 349 | 5.02 | 18.15 |
| 8 | 661.76 | 31.65 QP | 46.00 | -14.35 | 1.00 V | 70 | 9.91 | 21.74 |
| 9 | 731.74 | 30.54 QP | 46.00 | -15.46 | 1.50 V | 244 | 7.55 | 22.99 |
| 10 | 867.82 | 27.54 QP | 46.00 | -18.46 | 1.25 V | 349 | 3.06 | 24.47 |
| 11 | 928.08 | 28.64 QP | 46.00 | -17.36 | 1.00 V | 241 | 3.25 | 25.39 |

- REMARKS:**
1. Emission level(dBuV/m)=Raw Value(dBuV) + Correction Factor(dB/m)
 2. Correction Factor(dB/m) = Antenna Factor (dB/m) + Cable Factor (dB)
 3. The other emission levels were very low against the limit.
 4. Margin value = Emission level – Limit value.

**802.11b DSSS modulation**

| | | | |
|---------------------------------|--------------------------------------------------|--------------------------|--------------------------|
| EUT | Wireless-G USB Network Adapter with SpeedBooster | MODEL | WUSB54GS ver. 2 |
| CHANNEL | Channel 1 | FREQUENCY RANGE | 1 ~ 25GHz |
| MODULATION TYPE | CCK | TRANSFER RATE | 11Mbps |
| INPUT POWER (SYSTEM) | 120Vac, 60 Hz | DETECTOR FUNCTION | Peak(PK) Average (AV) |
| ENVIRONMENTAL CONDITIONS | 20deg. C, 72%RH, 991hPa | TESTED BY | Match Tsui |

ANTENNA POLARITY & TEST DISTANCE: HORIZONTAL AT 3 M

| No. | Freq. (MHz) | Emission Level (dBuV/m) | Limit (dBuV/m) | Margin (dB) | Antenna Height (m) | Table Angle (Degree) | Raw Value (dBuV) | Correction Factor (dB/m) |
|-----|-------------|-------------------------|----------------|-------------|--------------------|----------------------|------------------|--------------------------|
| 1 | 2390.00 | 52.91 PK | 74.00 | -21.09 | 1.10 H | 358 | 21.29 | 31.62 |
| 1 | 2390.00 | 44.04 AV | 54.00 | -9.96 | 1.10 H | 358 | 12.42 | 31.62 |
| 2 | *2412.00 | 104.98 PK | | | 1.10 H | 358 | 73.27 | 31.71 |
| 2 | *2412.00 | 97.86 AV | | | 1.10 H | 358 | 66.15 | 31.71 |
| 3 | 3216.00 | 45.98 PK | 74.00 | -28.02 | 1.00 H | 210 | 12.55 | 33.43 |
| 3 | 3216.00 | 40.19 AV | 54.00 | -13.81 | 1.00 H | 210 | 6.76 | 33.43 |
| 4 | 4824.00 | 46.69 PK | 74.00 | -27.31 | 1.17 H | 1 | 9.14 | 37.55 |
| 4 | 4824.00 | 35.66 AV | 54.00 | -18.34 | 1.17 H | 1 | -1.89 | 37.55 |
| 5 | 9648.00 | 56.07 PK | 74.00 | -17.93 | 1.10 H | 197 | 9.14 | 46.93 |
| 5 | 9648.00 | 43.97 AV | 54.00 | -10.03 | 1.10 H | 197 | -2.96 | 46.93 |

ANTENNA POLARITY & TEST DISTANCE: VERTICAL AT 3 M

| No. | Freq. (MHz) | Emission Level (dBuV/m) | Limit (dBuV/m) | Margin (dB) | Antenna Height (m) | Table Angle (Degree) | Raw Value (dBuV) | Correction Factor (dB/m) |
|----------|----------------|-------------------------|----------------|--------------|--------------------|----------------------|------------------|--------------------------|
| 1 | 2390.00 | 54.64 PK | 74.00 | -19.36 | 1.15 V | 22 | 23.02 | 31.62 |
| 1 | 2390.00 | 45.03 AV | 54.00 | -8.97 | 1.15 V | 22 | 13.41 | 31.62 |
| 2 | *2412.00 | 109.83 PK | | | 1.15 V | 22 | 78.12 | 31.71 |
| 2 | *2412.00 | 103.07 AV | | | 1.15 V | 22 | 71.36 | 31.71 |
| 3 | 3216.00 | 46.72 PK | 74.00 | -27.28 | 1.11 V | 318 | 13.29 | 33.43 |
| 3 | 3216.00 | 41.61 AV | 54.00 | -12.39 | 1.11 V | 318 | 8.18 | 33.43 |
| 4 | 4824.00 | 47.03 PK | 74.00 | -26.97 | 1.12 V | 54 | 9.48 | 37.55 |
| 4 | 4824.00 | 37.72 AV | 54.00 | -16.28 | 1.12 V | 54 | 0.17 | 37.55 |
| 5 | 9648.00 | 58.47 PK | 74.00 | -15.53 | 1.57 V | 345 | 11.54 | 46.93 |
| 5 | 9648.00 | 50.90 AV | 54.00 | -3.10 | 1.57 V | 345 | 3.97 | 46.93 |

- REMARKS:**
1. Emission level(dBuV/m)=Raw Value(dBuV) + Correction Factor(dB/m)
 2. Correction Factor(dB/m) = Antenna Factor (dB/m) + Cable Factor (dB)
 3. The other emission levels were very low against the limit.
 4. Margin value = Emission level – Limit value.
 5. " * " : Fundamental frequency



| | | | |
|---------------------------------|--------------------------------------------------|--------------------------|--------------------------|
| EUT | Wireless-G USB Network Adapter with SpeedBooster | MODEL | WUSB54GS ver. 2 |
| CHANNEL | Channel 6 | FREQUENCY RANGE | 1 ~ 25GHz |
| MODULATION TYPE | CCK | TRANSFER RATE | 11Mbps |
| INPUT POWER (SYSTEM) | 120Vac, 60 Hz | DETECTOR FUNCTION | Peak(PK) Average (AV) |
| ENVIRONMENTAL CONDITIONS | 20deg. C, 72%RH, 991hPa | TESTED BY | Match Tsui |

ANTENNA POLARITY & TEST DISTANCE: HORIZONTAL AT 3 M

| No. | Freq. (MHz) | Emission Level (dBuV/m) | Limit (dBuV/m) | Margin (dB) | Antenna Height (m) | Table Angle (Degree) | Raw Value (dBuV) | Correction Factor (dB/m) |
|-----|-------------|-------------------------|----------------|-------------|--------------------|----------------------|------------------|--------------------------|
| 1 | *2437.00 | 107.30 PK | | | 1.33 H | 231 | 75.48 | 31.82 |
| 1 | *2437.00 | 99.67 AV | | | 1.33 H | 231 | 67.85 | 31.82 |
| 2 | 3249.00 | 47.41 PK | 74.00 | -26.59 | 1.02 H | 7 | 13.95 | 33.46 |
| 2 | 3249.00 | 41.77 AV | 54.00 | -12.23 | 1.02 H | 7 | 8.31 | 33.46 |
| 3 | 9748.00 | 57.77 PK | 74.00 | -16.23 | 1.21 H | 121 | 10.74 | 47.03 |
| 3 | 9748.00 | 44.40 AV | 54.00 | -9.60 | 1.21 H | 121 | -2.63 | 47.03 |

ANTENNA POLARITY & TEST DISTANCE: VERTICAL AT 3 M

| No. | Freq. (MHz) | Emission Level (dBuV/m) | Limit (dBuV/m) | Margin (dB) | Antenna Height (m) | Table Angle (Degree) | Raw Value (dBuV) | Correction Factor (dB/m) |
|-----|-------------|-------------------------|----------------|-------------|--------------------|----------------------|------------------|--------------------------|
| 1 | *2437.00 | 111.01 PK | | | 1.16 V | 174 | 79.19 | 31.82 |
| 1 | *2437.00 | 103.48 AV | | | 1.16 V | 174 | 71.66 | 31.82 |
| 2 | 3249.00 | 46.73 PK | 74.00 | -27.27 | 1.11 V | 327 | 13.27 | 33.46 |
| 2 | 3249.00 | 40.93 AV | 54.00 | -13.07 | 1.11 V | 327 | 7.47 | 33.46 |
| 3 | 9748.00 | 57.57 PK | 74.00 | -16.43 | 1.00 V | 150 | 10.54 | 47.03 |
| 3 | 9748.00 | 48.97 AV | 54.00 | -5.03 | 1.00 V | 150 | 1.94 | 47.03 |

- REMARKS:**
1. Emission level(dBuV/m)=Raw Value(dBuV) + Correction Factor(dB/m)
 2. Correction Factor(dB/m) = Antenna Factor (dB/m) + Cable Factor (dB)
 3. The other emission levels were very low against the limit.
 4. Margin value = Emission level – Limit value.
 5. “ * “ : Fundamental frequency



| | | | |
|---------------------------------|--------------------------------------------------|--------------------------|--------------------------|
| EUT | Wireless-G USB Network Adapter with SpeedBooster | MODEL | WUSB54GS ver. 2 |
| CHANNEL | Channel 11 | FREQUENCY RANGE | 1 ~ 25GHz |
| MODULATION TYPE | CCK | TRANSFER RATE | 11Mbps |
| INPUT POWER (SYSTEM) | 120Vac, 60 Hz | DETECTOR FUNCTION | Peak(PK) Average (AV) |
| ENVIRONMENTAL CONDITIONS | 20deg. C, 72%RH, 991hPa | TESTED BY | Match Tsui |

ANTENNA POLARITY & TEST DISTANCE: HORIZONTAL AT 3 M

| No. | Freq. (MHz) | Emission Level (dBuV/m) | Limit (dBuV/m) | Margin (dB) | Antenna Height (m) | Table Angle (Degree) | Raw Value (dBuV) | Correction Factor (dB/m) |
|-----|-------------|-------------------------|----------------|-------------|--------------------|----------------------|------------------|--------------------------|
| 1 | *2462.00 | 108.12 PK | | | 1.32 H | 233 | 76.19 | 31.93 |
| 1 | *2462.00 | 100.66 AV | | | 1.32 H | 233 | 68.73 | 31.93 |
| 2 | 2483.50 | 54.76 PK | 74.00 | -19.24 | 1.32 H | 233 | 22.73 | 32.03 |
| 2 | 2483.50 | 45.04 AV | 54.00 | -8.96 | 1.32 H | 233 | 13.01 | 32.03 |
| 3 | 3282.00 | 46.29 PK | 74.00 | -27.71 | 1.00 H | 5 | 12.80 | 33.49 |
| 3 | 3282.00 | 41.10 AV | 54.00 | -12.90 | 1.00 H | 5 | 7.61 | 33.49 |
| 4 | 9848.00 | 56.31 PK | 74.00 | -17.69 | 1.43 H | 261 | 9.16 | 47.15 |
| 4 | 9848.00 | 45.53 AV | 54.00 | -8.47 | 1.43 H | 261 | -1.62 | 47.15 |

ANTENNA POLARITY & TEST DISTANCE: VERTICAL AT 3 M

| No. | Freq. (MHz) | Emission Level (dBuV/m) | Limit (dBuV/m) | Margin (dB) | Antenna Height (m) | Table Angle (Degree) | Raw Value (dBuV) | Correction Factor (dB/m) |
|-----|-------------|-------------------------|----------------|-------------|--------------------|----------------------|------------------|--------------------------|
| 1 | *2462.00 | 112.08 PK | | | 1.14 V | 28 | 80.15 | 31.93 |
| 1 | *2462.00 | 104.62 AV | | | 1.14 V | 28 | 72.69 | 31.93 |
| 2 | 2483.50 | 55.58 PK | 74.00 | -18.42 | 1.14 V | 28 | 23.55 | 32.03 |
| 2 | 2483.50 | 44.75 AV | 54.00 | -9.25 | 1.14 V | 28 | 12.72 | 32.03 |
| 3 | 3282.00 | 45.91 PK | 74.00 | -28.09 | 1.30 V | 348 | 12.42 | 33.49 |
| 3 | 3282.00 | 39.50 AV | 54.00 | -14.50 | 1.30 V | 348 | 6.01 | 33.49 |
| 4 | 9848.00 | 56.81 PK | 74.00 | -17.19 | 1.30 V | 250 | 9.66 | 47.15 |
| 4 | 9848.00 | 47.94 AV | 54.00 | -6.06 | 1.30 V | 250 | 0.79 | 47.15 |

- REMARKS:**
1. Emission level(dBuV/m)=Raw Value(dBuV) + Correction Factor(dB/m)
 2. Correction Factor(dB/m) = Antenna Factor (dB/m) + Cable Factor (dB)
 3. The other emission levels were very low against the limit.
 4. Margin value = Emission level – Limit value.
 5. " * " : Fundamental frequency

802.11g OFDM modulation

| | | | |
|---------------------------------|--------------------------------------------------|--------------------------|--------------------------|
| EUT | Wireless-G USB Network Adapter with SpeedBooster | MODEL | WUSB54GS ver. 2 |
| CHANNEL | Channel 1 | FREQUENCY RANGE | 1 ~ 25GHz |
| MODULATION TYPE | BPSK | TRANSFER RATE | 6Mbps |
| INPUT POWER (SYSTEM) | 120Vac, 60 Hz | DETECTOR FUNCTION | Peak(PK) Average (AV) |
| ENVIRONMENTAL CONDITIONS | 20deg. C, 72%RH, 991hPa | TESTED BY | Match Tsui |

ANTENNA POLARITY & TEST DISTANCE: HORIZONTAL AT 3 M

| No. | Freq. (MHz) | Emission Level (dBuV/m) | Limit (dBuV/m) | Margin (dB) | Antenna Height (m) | Table Angle (Degree) | Raw Value (dBuV) | Correction Factor (dB/m) |
|-----|-------------|-------------------------|----------------|-------------|--------------------|----------------------|------------------|--------------------------|
| 1 | 2390.00 | 54.29 PK | 74.00 | -19.71 | 1.10 H | 357 | 22.67 | 31.62 |
| 1 | 2390.00 | 44.03 AV | 54.00 | -9.97 | 1.10 H | 357 | 12.41 | 31.62 |
| 2 | *2412.00 | 100.07 PK | | | 1.10 H | 357 | 68.36 | 31.71 |
| 2 | *2412.00 | 91.48 AV | | | 1.10 H | 357 | 59.77 | 31.71 |
| 3 | 3216.00 | 46.37 PK | 74.00 | -27.63 | 1.03 H | 218 | 12.94 | 33.43 |
| 3 | 3216.00 | 40.89 AV | 54.00 | -13.11 | 1.03 H | 218 | 7.46 | 33.43 |
| 4 | 4824.00 | 45.68 PK | 74.00 | -28.32 | 1.07 H | 76 | 8.13 | 37.55 |
| 4 | 4824.00 | 32.61 AV | 54.00 | -21.39 | 1.07 H | 76 | -4.94 | 37.55 |

ANTENNA POLARITY & TEST DISTANCE: VERTICAL AT 3 M

| No. | Freq. (MHz) | Emission Level (dBuV/m) | Limit (dBuV/m) | Margin (dB) | Antenna Height (m) | Table Angle (Degree) | Raw Value (dBuV) | Correction Factor (dB/m) |
|-----|-------------|-------------------------|----------------|-------------|--------------------|----------------------|------------------|--------------------------|
| 1 | 2390.00 | 55.40 PK | 74.00 | -18.60 | 1.19 V | 359 | 23.78 | 31.62 |
| 1 | 2390.00 | 44.97 AV | 54.00 | -9.03 | 1.19 V | 359 | 13.35 | 31.62 |
| 2 | *2412.00 | 104.58 PK | | | 1.19 V | 359 | 72.87 | 31.71 |
| 2 | *2412.00 | 95.20 AV | | | 1.19 V | 359 | 63.49 | 31.71 |
| 3 | 3216.00 | 47.26 PK | 74.00 | -26.74 | 1.09 V | 251 | 13.83 | 33.43 |
| 3 | 3216.00 | 41.60 AV | 54.00 | -12.40 | 1.09 V | 251 | 8.17 | 33.43 |
| 4 | 4824.00 | 46.33 PK | 74.00 | -27.67 | 1.07 V | 229 | 8.78 | 37.55 |
| 4 | 4824.00 | 32.78 AV | 54.00 | -21.22 | 1.07 V | 229 | -4.77 | 37.55 |

- REMARKS:**
1. Emission level(dBuV/m)=Raw Value(dBuV) + Correction Factor(dB/m)
 2. Correction Factor(dB/m) = Antenna Factor (dB/m) + Cable Factor (dB)
 3. The other emission levels were very low against the limit.
 4. Margin value = Emission level – Limit value.
 5. “ * “ : Fundamental frequency



| | | | |
|---------------------------------|--------------------------------------------------|--------------------------|--------------------------|
| EUT | Wireless-G USB Network Adapter with SpeedBooster | MODEL | WUSB54GS ver. 2 |
| CHANNEL | Channel 6 | FREQUENCY RANGE | 1 ~ 25GHz |
| MODULATION TYPE | BPSK | TRANSFER RATE | 6Mbps |
| INPUT POWER (SYSTEM) | 120Vac, 60 Hz | DETECTOR FUNCTION | Peak(PK) Average (AV) |
| ENVIRONMENTAL CONDITIONS | 20deg. C, 72%RH, 991hPa | TESTED BY | Match Tsui |

ANTENNA POLARITY & TEST DISTANCE: HORIZONTAL AT 3 M

| No. | Freq. (MHz) | Emission Level (dBuV/m) | Limit (dBuV/m) | Margin (dB) | Antenna Height (m) | Table Angle (Degree) | Raw Value (dBuV) | Correction Factor (dB/m) |
|-----|-------------|-------------------------|----------------|-------------|--------------------|----------------------|------------------|--------------------------|
| 1 | *2437.00 | 101.29 PK | | | 1.33 H | 232 | 69.47 | 31.82 |
| 1 | *2437.00 | 91.74 AV | | | 1.33 H | 232 | 59.92 | 31.82 |
| 2 | 3249.00 | 47.61 PK | 74.00 | -26.39 | 1.39 H | 4 | 14.15 | 33.46 |
| 2 | 3249.00 | 43.15 AV | 54.00 | -10.85 | 1.39 H | 4 | 9.69 | 33.46 |
| 3 | 4874.00 | 45.78 PK | 74.00 | -28.22 | 1.00 H | 360 | 8.10 | 37.67 |
| 3 | 4874.00 | 33.42 AV | 54.00 | -20.58 | 1.00 H | 360 | -4.26 | 37.67 |

ANTENNA POLARITY & TEST DISTANCE: VERTICAL AT 3 M

| No. | Freq. (MHz) | Emission Level (dBuV/m) | Limit (dBuV/m) | Margin (dB) | Antenna Height (m) | Table Angle (Degree) | Raw Value (dBuV) | Correction Factor (dB/m) |
|-----|-------------|-------------------------|----------------|-------------|--------------------|----------------------|------------------|--------------------------|
| 1 | *2437.00 | 104.28 PK | | | 1.19 V | 304 | 72.46 | 31.82 |
| 1 | *2437.00 | 94.95 AV | | | 1.19 V | 304 | 63.13 | 31.82 |
| 2 | 3249.00 | 46.25 PK | 74.00 | -27.75 | 1.24 V | 234 | 12.79 | 33.46 |
| 2 | 3249.00 | 40.39 AV | 54.00 | -13.61 | 1.24 V | 234 | 6.93 | 33.46 |
| 3 | 4874.00 | 45.58 PK | 74.00 | -28.42 | 1.10 V | 80 | 7.90 | 37.67 |
| 3 | 4874.00 | 32.52 AV | 54.00 | -21.48 | 1.10 V | 80 | -5.16 | 37.67 |

- REMARKS:**
1. Emission level(dBuV/m)=Raw Value(dBuV) + Correction Factor(dB/m)
 2. Correction Factor(dB/m) = Antenna Factor (dB/m) + Cable Factor (dB)
 3. The other emission levels were very low against the limit.
 4. Margin value = Emission level – Limit value.
 5. “ * ” : Fundamental frequency



| | | | |
|---------------------------------|--------------------------------------------------|--------------------------|--------------------------|
| EUT | Wireless-G USB Network Adapter with SpeedBooster | MODEL | WUSB54GS ver. 2 |
| CHANNEL | Channel 11 | FREQUENCY RANGE | 1 ~ 25GHz |
| MODULATION TYPE | BPSK | TRANSFER RATE | 6Mbps |
| INPUT POWER (SYSTEM) | 120Vac, 60 Hz | DETECTOR FUNCTION | Peak(PK) Average (AV) |
| ENVIRONMENTAL CONDITIONS | 20deg. C, 72%RH, 991hPa | TESTED BY | Match Tsui |

ANTENNA POLARITY & TEST DISTANCE: HORIZONTAL AT 3 M

| No. | Freq. (MHz) | Emission Level (dBuV/m) | Limit (dBuV/m) | Margin (dB) | Antenna Height (m) | Table Angle (Degree) | Raw Value (dBuV) | Correction Factor (dB/m) |
|-----|-------------|-------------------------|----------------|-------------|--------------------|----------------------|------------------|--------------------------|
| 1 | *2462.00 | 99.69 PK | | | 1.12 H | 208 | 67.76 | 31.93 |
| 1 | *2462.00 | 90.30 AV | | | 1.12 H | 208 | 58.37 | 31.93 |
| 2 | 2483.50 | 53.38 PK | 74.00 | -20.62 | 1.12 H | 208 | 21.35 | 32.03 |
| 2 | 2483.50 | 44.76 AV | 54.00 | -9.24 | 1.12 H | 208 | 12.73 | 32.03 |
| 3 | 3282.00 | 45.74 PK | 74.00 | -28.26 | 1.00 H | 348 | 12.25 | 33.49 |
| 3 | 3282.00 | 39.81 AV | 54.00 | -14.19 | 1.00 H | 348 | 6.32 | 33.49 |
| 4 | 4924.00 | 46.74 PK | 74.00 | -27.26 | 1.04 H | 250 | 8.93 | 37.81 |
| 4 | 4924.00 | 33.83 AV | 54.00 | -20.17 | 1.04 H | 250 | -3.98 | 37.81 |

ANTENNA POLARITY & TEST DISTANCE: VERTICAL AT 3 M

| No. | Freq. (MHz) | Emission Level (dBuV/m) | Limit (dBuV/m) | Margin (dB) | Antenna Height (m) | Table Angle (Degree) | Raw Value (dBuV) | Correction Factor (dB/m) |
|-----|-------------|-------------------------|----------------|-------------|--------------------|----------------------|------------------|--------------------------|
| 1 | *2462.00 | 105.63 PK | | | 1.16 V | 26 | 73.70 | 31.93 |
| 1 | *2462.00 | 96.07 AV | | | 1.16 V | 26 | 64.14 | 31.93 |
| 2 | 2483.50 | 55.49 PK | 74.00 | -18.51 | 1.16 V | 26 | 23.46 | 32.03 |
| 2 | 2483.50 | 45.28 AV | 54.00 | -8.72 | 1.16 V | 26 | 13.25 | 32.03 |
| 3 | 3282.00 | 43.16 PK | 74.00 | -30.84 | 1.16 V | 140 | 9.67 | 33.49 |
| 3 | 3282.00 | 36.38 AV | 54.00 | -17.62 | 1.16 V | 140 | 2.89 | 33.49 |
| 4 | 4924.00 | 45.90 PK | 74.00 | -28.10 | 1.10 V | 250 | 8.09 | 37.81 |
| 4 | 4924.00 | 32.94 AV | 54.00 | -21.06 | 1.10 V | 250 | -4.87 | 37.81 |

- REMARKS:**
1. Emission level(dBuV/m)=Raw Value(dBuV) + Correction Factor(dB/m)
 2. Correction Factor(dB/m) = Antenna Factor (dB/m) + Cable Factor (dB)
 3. The other emission levels were very low against the limit.
 4. Margin value = Emission level – Limit value.
 5. " * " : Fundamental frequency



4.3 6dB BANDWIDTH MEASUREMENT

4.3.1 LIMITS OF 6dB BANDWIDTH MEASUREMENT

The minimum of 6dB Bandwidth Measurement is 0.5 MHz.

4.3.2 TEST INSTRUMENTS

| Description & Manufacturer | Model No. | Serial No. | Calibrated Until |
|----------------------------|-----------|------------|------------------|
| SPECTRUM ANALYZER | FSEK 30 | 100049 | Aug. 12, 2005 |

NOTE: The calibration interval of the above test instruments is 12 months and the calibrations are traceable to NML/ROC and NIST/USA.

4.3.3 TEST PROCEDURE

The transmitter output was connected to the spectrum analyzer through an attenuator. The bandwidth of the fundamental frequency was measured by spectrum analyzer with 100kHz RBW and 100kHz VBW. The 6dB bandwidth is defined as the total spectrum the power of which is higher than peak power minus 6dB.

4.3.4 DEVIATION FROM TEST STANDARD

No deviation

4.3.5 TEST SETUP

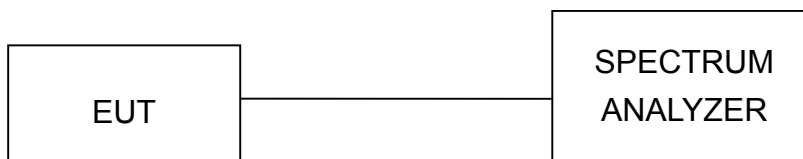

4.3.6 EUT OPERATING CONDITIONS

The software provided by client to enable the EUT under transmission condition continuously at lowest, middle and highest channel frequencies individually.



4.3.7 TEST RESULTS

802.11b DSSS modulation

| | | | |
|-----------------------------|--------------------------------------------------|---------------------------------|-------------------------|
| EUT | Wireless-G USB Network Adapter with SpeedBooster | MODEL | WUSB54GS ver. 2 |
| MODULATION TYPE | CCK | TRANSFER RATE | 11Mbps |
| INPUT POWER (SYSTEM) | 120Vac, 60 Hz | ENVIRONMENTAL CONDITIONS | 20deg. C, 72%RH, 991hPa |
| TESTED BY | Long Chen | | |

| CHANNEL | CHANNEL FREQUENCY (MHz) | 6dB BANDWIDTH (MHz) | MINIMUM LIMIT (MHz) | PASS/FAIL |
|----------------|--------------------------------|----------------------------|----------------------------|------------------|
| 1 | 2412 | 10.40 | 0.5 | PASS |
| 6 | 2437 | 11.12 | 0.5 | PASS |
| 11 | 2462 | 11.44 | 0.5 | PASS |



CH1

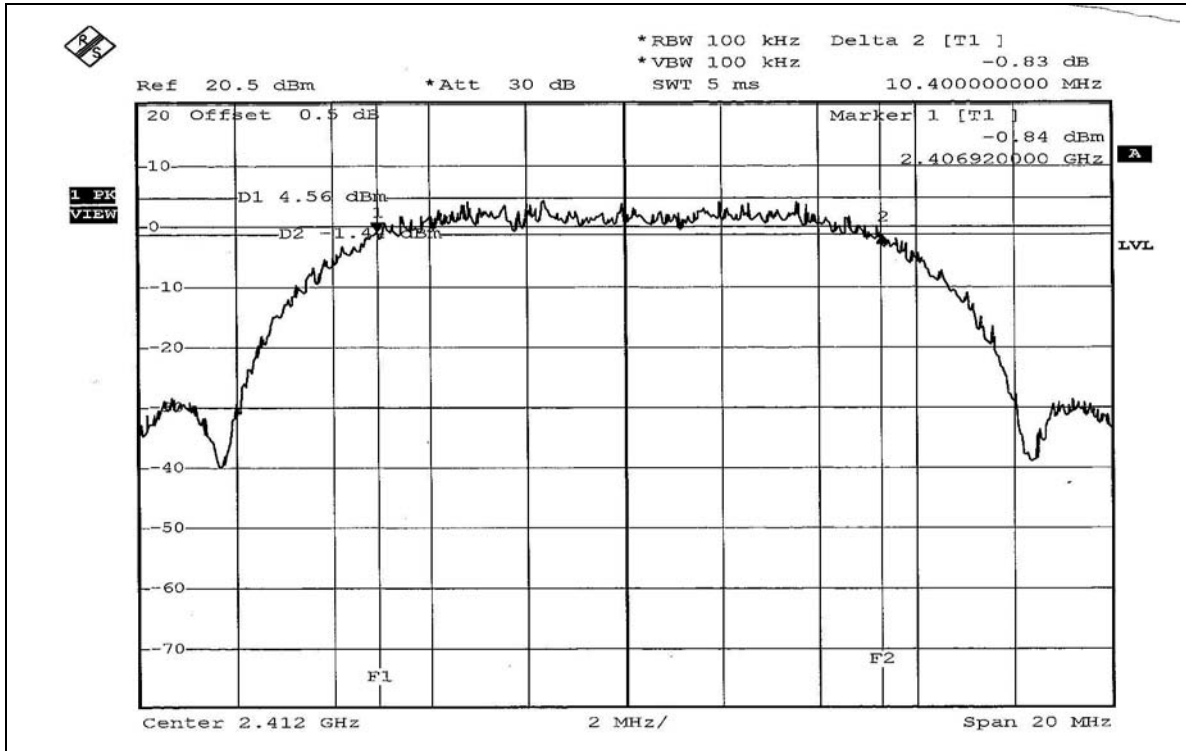

CH6

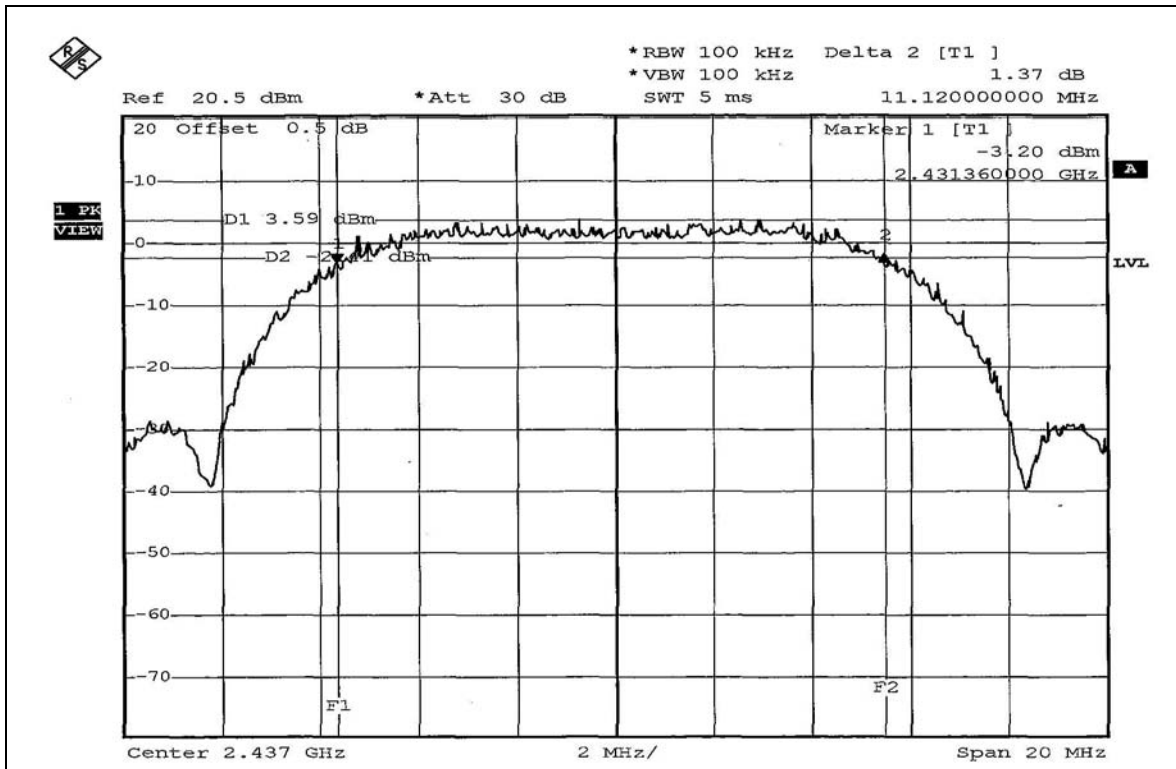



CH11

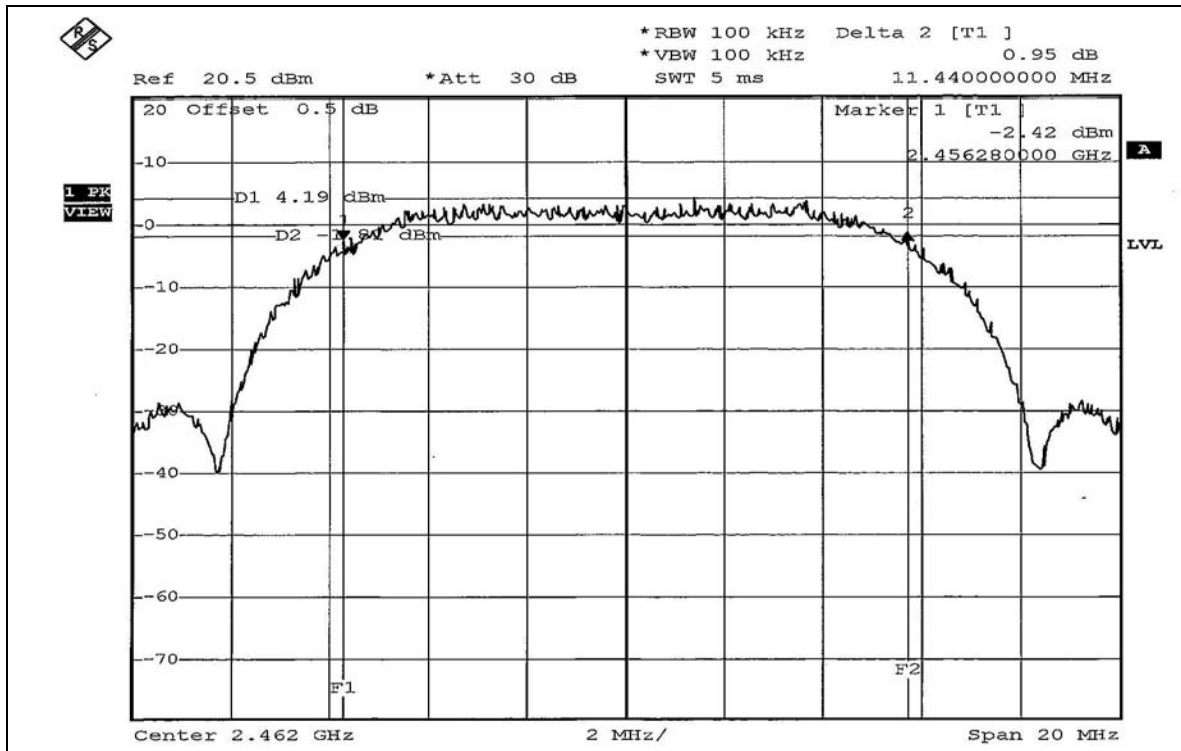

**802.11g OFDM modulation**

| | | | |
|-----------------------------|--------------------------------------------------|---------------------------------|-------------------------|
| EUT | Wireless-G USB Network Adapter with SpeedBooster | MODEL | WUSB54GS ver. 2 |
| MODULATION TYPE | BPSK | TRANSFER RATE | 6Mbps |
| INPUT POWER (SYSTEM) | 120Vac, 60 Hz | ENVIRONMENTAL CONDITIONS | 20deg. C, 72%RH, 991hPa |
| TESTED BY | Long Chen | | |

| CHANNEL | CHANNEL FREQUENCY (MHz) | 6dB BANDWIDTH (MHz) | MINIMUM LIMIT (MHz) | PASS/FAIL |
|----------------|--------------------------------|----------------------------|----------------------------|------------------|
| 1 | 2412 | 16.44 | 0.5 | PASS |
| 6 | 2437 | 16.40 | 0.5 | PASS |
| 11 | 2462 | 16.40 | 0.5 | PASS |



CH1

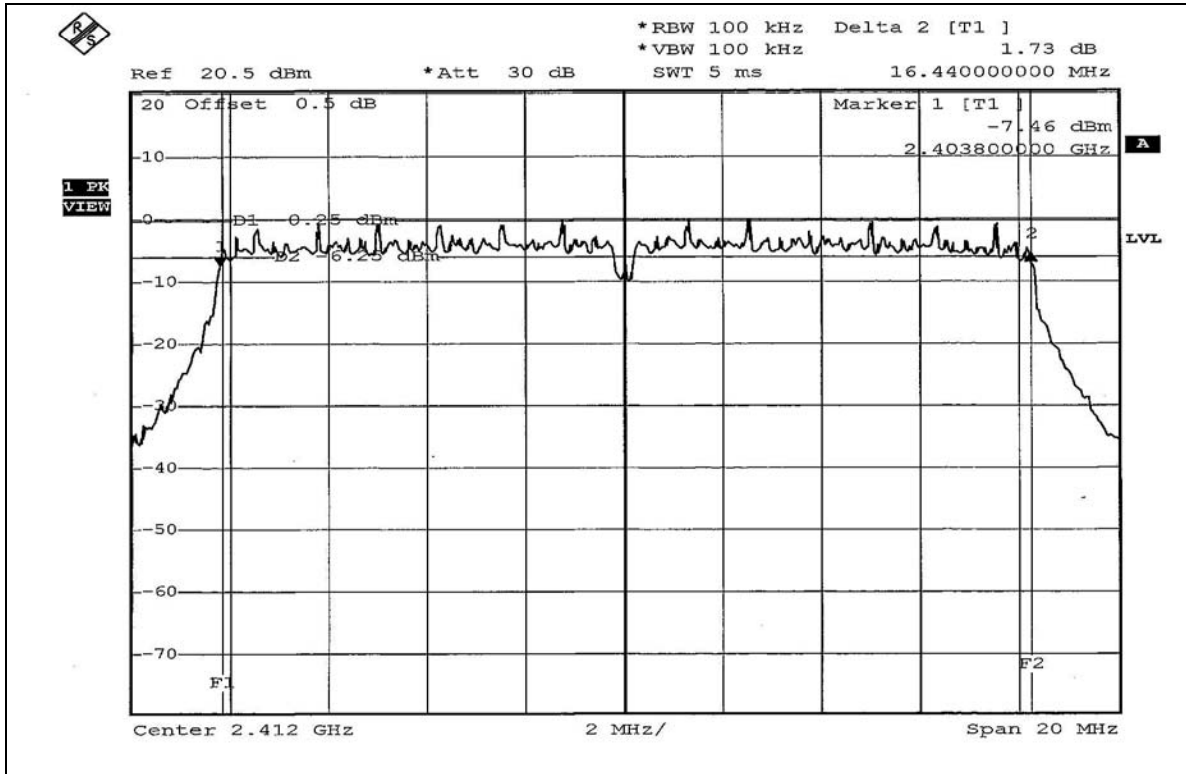

CH6

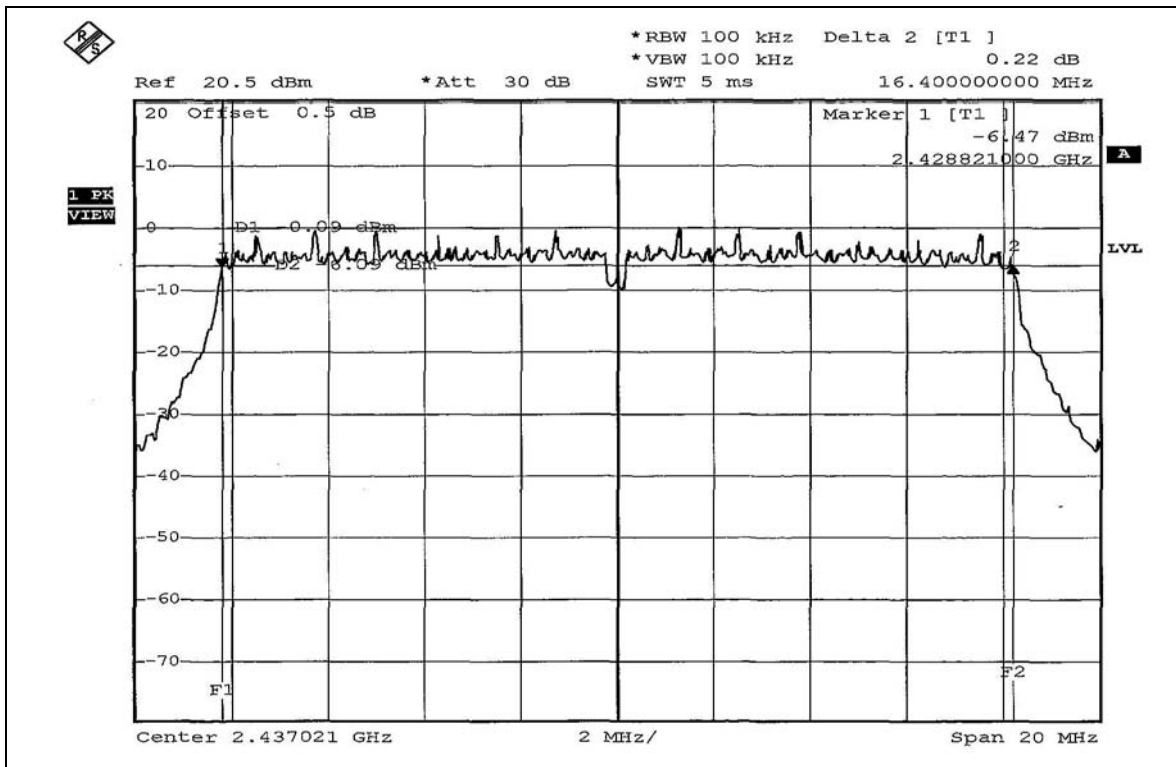



CH11

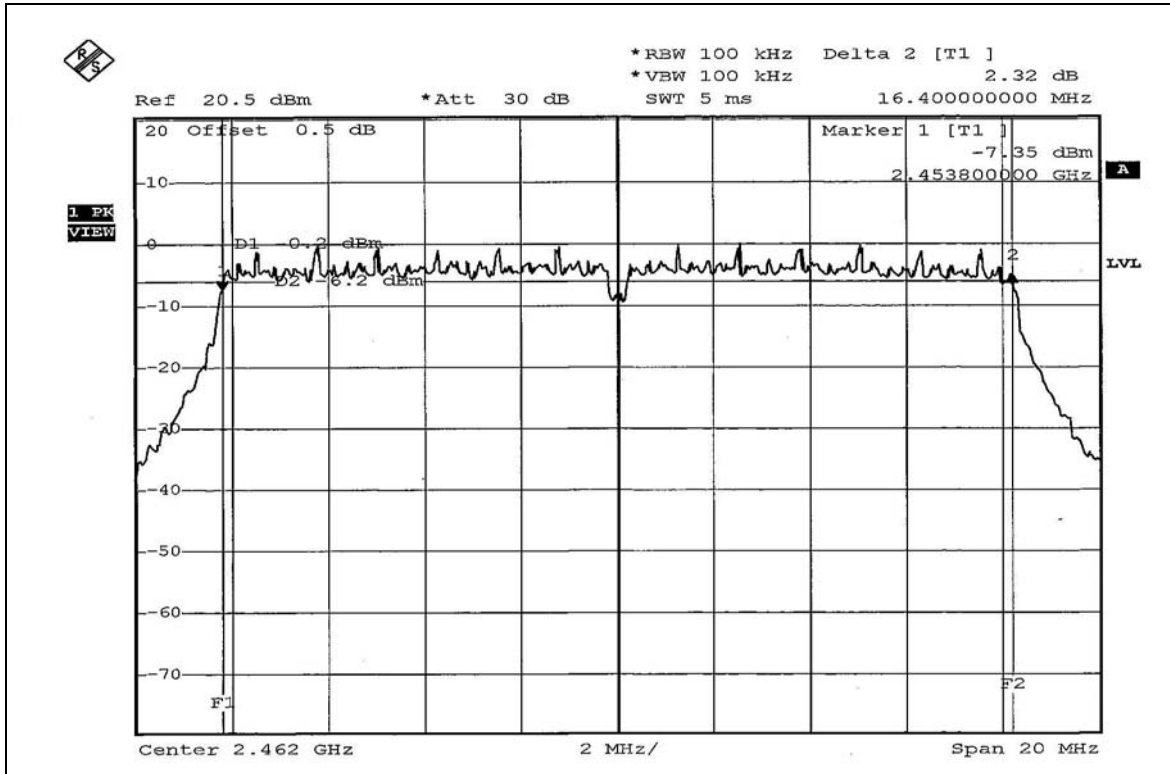



4.4 MAXIMUM PEAK OUTPUT POWER

4.4.1 LIMITS OF MAXIMUM PEAK OUTPUT POWER MEASUREMENT

The Maximum Peak Output Power Measurement is 30dBm.

4.4.2 INSTRUMENTS

| Description & Manufacturer | Model No. | Serial No. | Calibrated Until |
|----------------------------|-----------|------------|------------------|
| R&S SPECTRUM ANALYZER | FSEK30 | 100049 | Aug. 12, 2005 |
| AGILENT SIGNAL GENERATOR | E8257C | MY43320668 | Dec. 06, 2005 |
| DIGITAL RT OSCILLOSCOPE | TDS1012 | C037299 | Dec. 07, 2005 |
| NARDA DETECTOR | 4503A | FSCM99899 | NA |

NOTE:

The calibration interval of the above test instruments is 12 months and the calibrations are traceable to NML/ROC and NIST/USA..

4.4.3 TEST PROCEDURES

1. A detector was used on the output port of the EUT. An oscilloscope was used to read the response of the detector.
2. Replaced the EUT by the signal generator. The center frequency of the S.G was adjusted to the center frequency of the measured channel.
3. Adjusted the power to have the same reading on oscilloscope. Record the power level.

4.4.4 DEVIATION FROM TEST STANDARD

No deviation

4.4.5 TEST SETUP



4.4.6 EUT OPERATING CONDITIONS

Same as Item 4.3.6



4.4.7 TEST RESULTS

802.11b DSSS modulation

| | | | |
|-----------------------------|--------------------------------------------------|---------------------------------|-------------------------|
| EUT | Wireless-G USB Network Adapter with SpeedBooster | MODEL | WUSB54GS ver. 2 |
| MODULATION TYPE | CCK | TRANSFER RATE | 11Mbps |
| INPUT POWER (SYSTEM) | 120Vac, 60 Hz | ENVIRONMENTAL CONDITIONS | 20deg. C, 72%RH, 991hPa |
| TESTED BY | Long Chen | | |

| CHANNEL | CHANNEL FREQUENCY (MHz) | PEAK POWER OUTPUT (mW) | PEAK POWER OUTPUT (dBm) | PEAK POWER LIMIT (dBm) | PASS/FAIL |
|---------|-------------------------|------------------------|-------------------------|------------------------|-----------|
| 1 | 2412 | 50.933 | 17.07 | 30 | PASS |
| 6 | 2437 | 50.816 | 17.06 | 30 | PASS |
| 11 | 2462 | 50.466 | 17.03 | 30 | PASS |

802.11g OFDM modulation

| | | | |
|-----------------------------|--------------------------------------------------|---------------------------------|-------------------------|
| EUT | Wireless-G USB Network Adapter with SpeedBooster | MODEL | WUSB54GS ver. 2 |
| MODULATION TYPE | BPSK | TRANSFER RATE | 6Mbps |
| INPUT POWER (SYSTEM) | 120Vac, 60 Hz | ENVIRONMENTAL CONDITIONS | 20deg. C, 72%RH, 991hPa |
| TESTED BY | Long Chen | | |

| CHANNEL | CHANNEL FREQUENCY (MHz) | PEAK POWER OUTPUT (mW) | PEAK POWER OUTPUT (dBm) | PEAK POWER LIMIT (dBm) | PASS/FAIL |
|---------|-------------------------|------------------------|-------------------------|------------------------|-----------|
| 1 | 2412 | 25.293 | 14.03 | 30 | PASS |
| 6 | 2437 | 25.177 | 14.01 | 30 | PASS |
| 11 | 2462 | 25.527 | 14.07 | 30 | PASS |



4.5 POWER SPECTRAL DENSITY MEASUREMENT

4.5.1 LIMITS OF POWER SPECTRAL DENSITY MEASUREMENT

The Maximum of Power Spectral Density Measurement is 8dBm.

4.5.2 TEST INSTRUMENTS

| Description & Manufacturer | Model No. | Serial No. | Calibrated Until |
|----------------------------|-----------|------------|------------------|
| R&S SPECTRUM ANALYZER | FSEK30 | 100049 | Aug. 12, 2005 |

NOTE:

The calibration interval of the above test instruments is 12 months and the calibrations are traceable to NML/ROC and NIST/USA.

4.5.3 TEST PROCEDURE

The transmitter output was connected to the spectrum analyzer through an attenuator, the bandwidth of the fundamental frequency was measured with the spectrum analyzer using 3kHz RBW and 30kHz VBW, set sweep time = span/3kHz. The power spectral density was measured and recorded. The sweep time is allowed to be longer than span/3kHz for a full response of the mixer in the spectrum analyzer.

4.5.4 DEVIATION FROM TEST STANDARD

No deviation

4.5.5 TEST SETUP

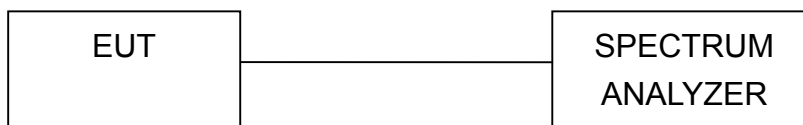

4.5.6 EUT OPERATING CONDITION

Same as Item 4.3.6



4.5.7 TEST RESULTS

802.11b DSSS modulation

| | | | |
|-----------------------------|--------------------------------------------------|---------------------------------|-------------------------|
| EUT | Wireless-G USB Network Adapter with SpeedBooster | MODEL | WUSB54GS ver. 2 |
| MODULATION TYPE | CCK | TRANSFER RATE | 11Mbps |
| INPUT POWER (SYSTEM) | 120Vac, 60 Hz | ENVIRONMENTAL CONDITIONS | 20deg. C, 72%RH, 991hPa |
| TESTED BY | Long Chen | | |

| CHANNEL | CHANNEL FREQUENCY (MHz) | RF POWER LEVEL IN 3kHz BW (dBm) | MAXIMUM LIMIT (dBm) | PASS/FAIL |
|----------------|---------------------------------|----------------------------------------|----------------------------|------------------|
| 1 | 2412 | -9.79 | 8 | PASS |
| 6 | 2437 | -9.94 | 8 | PASS |
| 11 | 2462 | -9.72 | 8 | PASS |



CH1

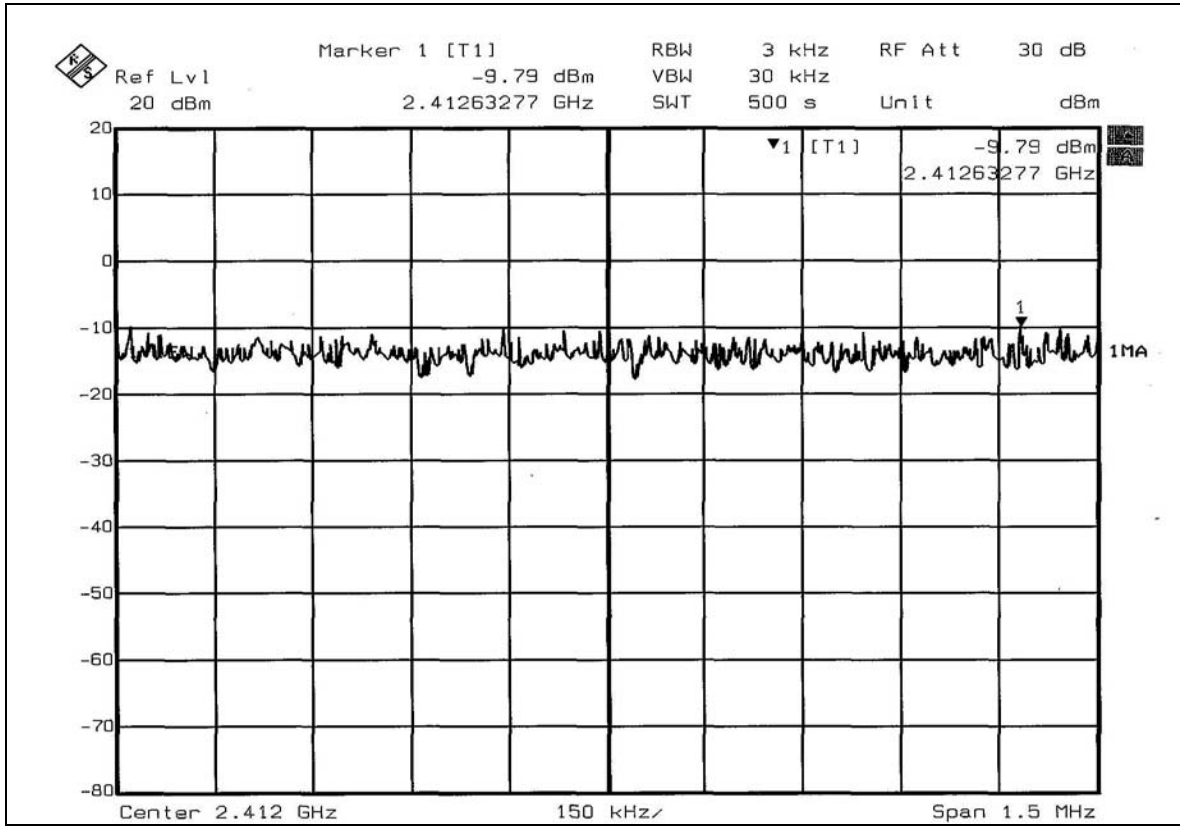

CH6

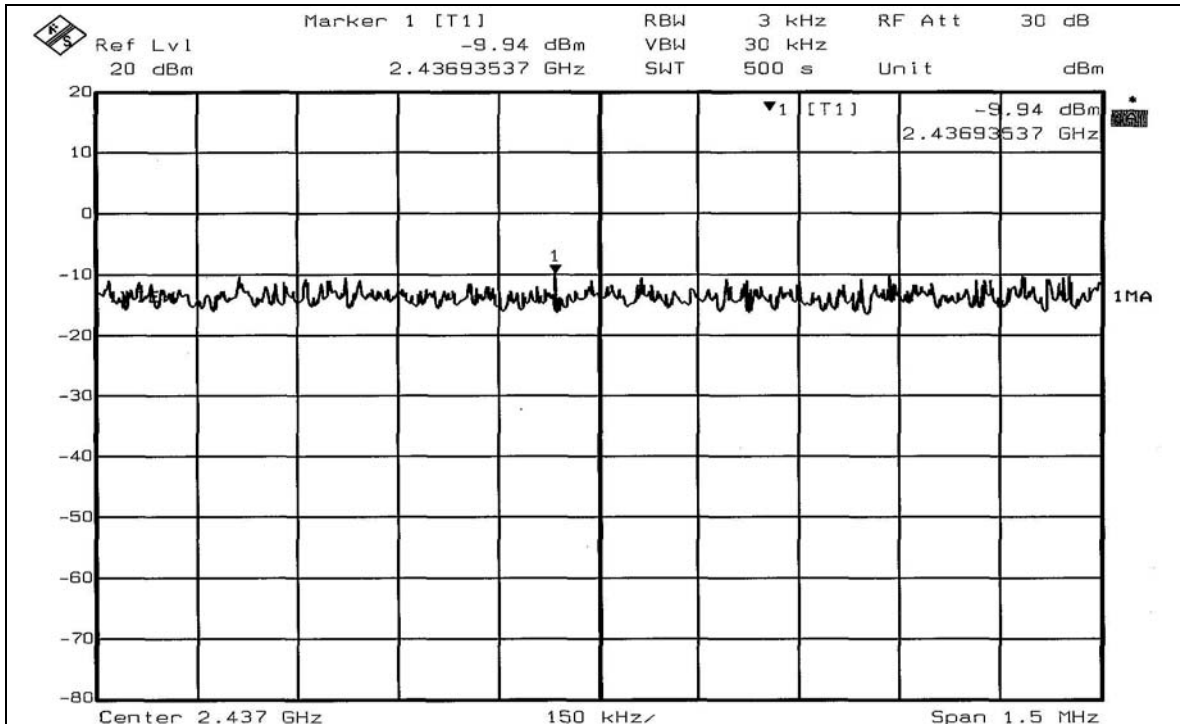



CH11

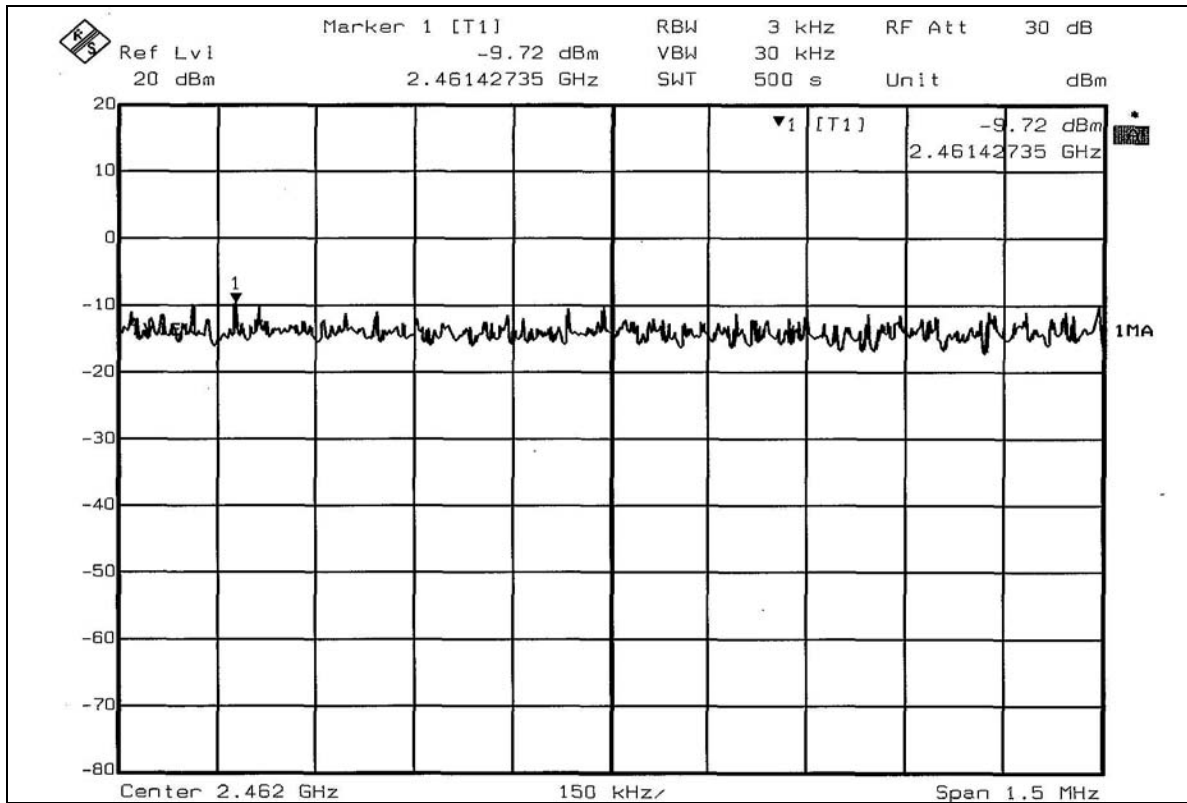

**802.11g OFDM modulation**

| | | | |
|-----------------------------|--------------------------------------------------|---------------------------------|-------------------------|
| EUT | Wireless-G USB Network Adapter with SpeedBooster | MODEL | WUSB54GS ver. 2 |
| MODULATION TYPE | BPSK | TRANSFER RATE | 6Mbps |
| INPUT POWER (SYSTEM) | 120Vac, 60 Hz | ENVIRONMENTAL CONDITIONS | 20deg. C, 72%RH, 991hPa |
| TESTED BY | Long Chen | | |

| CHANNEL | CHANNEL FREQUENCY (MHz) | RF POWER LEVEL IN 3kHz BW (dBm) | MAXIMUM LIMIT (dBm) | PASS/FAIL |
|----------------|---------------------------------|----------------------------------------|----------------------------|------------------|
| 1 | 2412 | -13.78 | 8 | PASS |
| 6 | 2437 | -13.63 | 8 | PASS |
| 11 | 2462 | -13.60 | 8 | PASS |



CH1

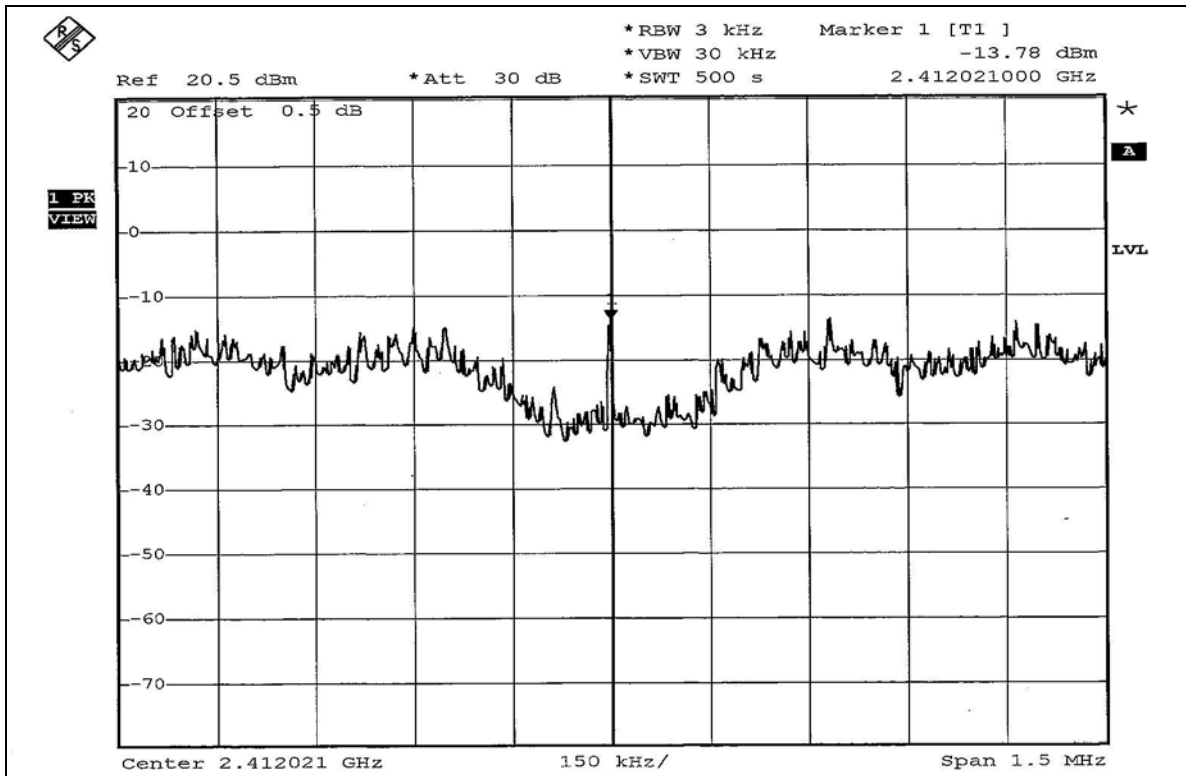

CH6

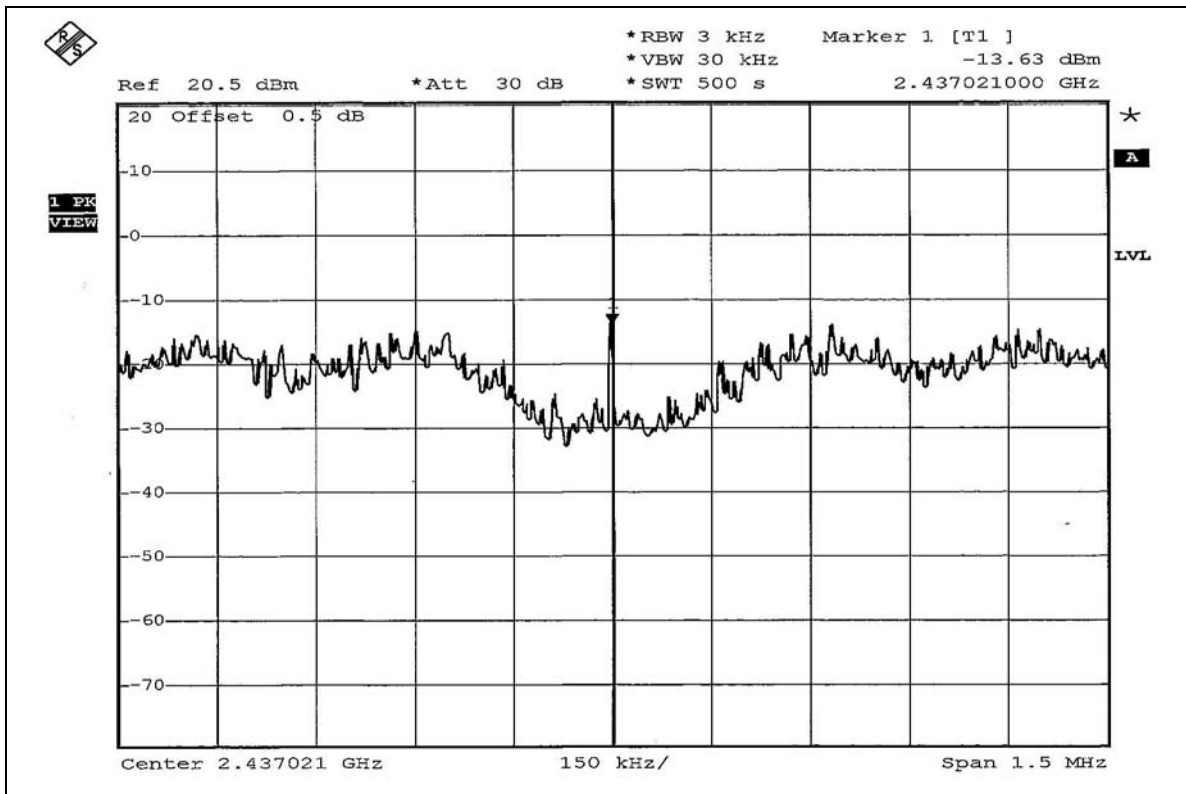



CH11

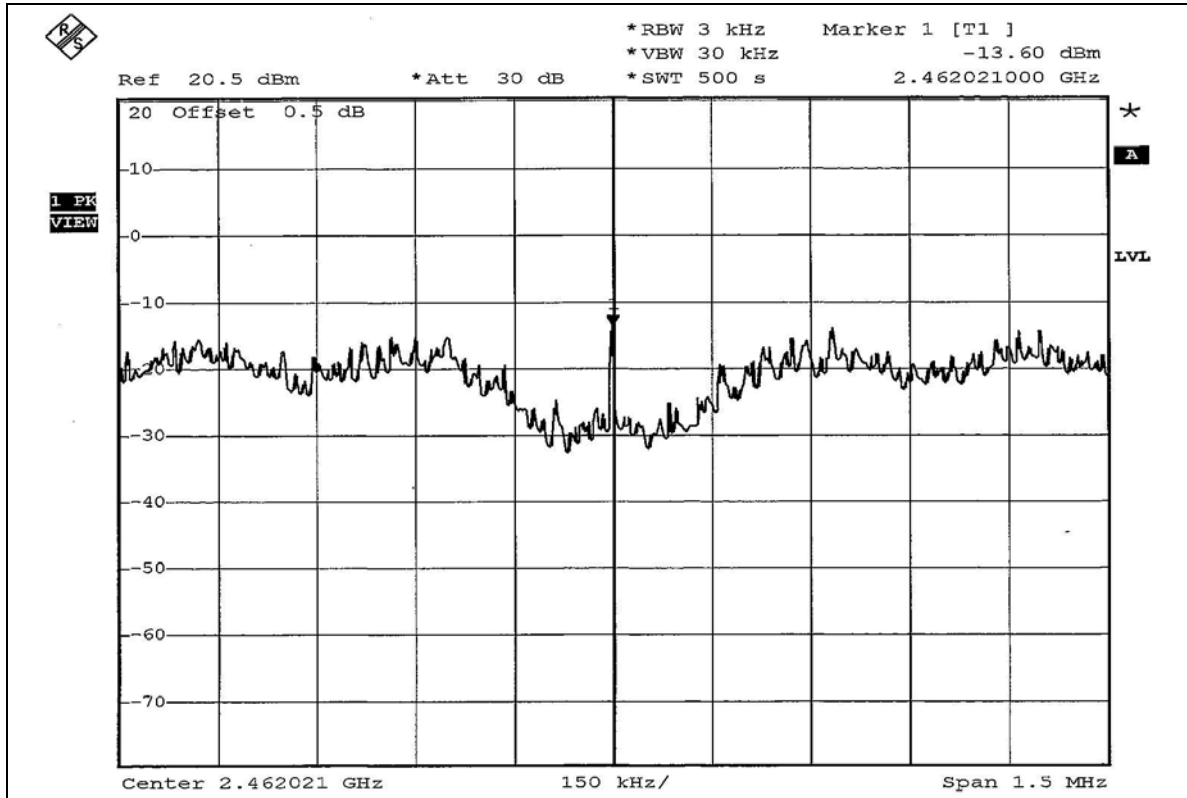



4.6 BAND EDGES MEASUREMENT

4.6.1 LIMITS OF BAND EDGES MEASUREMENT

Below –20dB of the highest emission level of operating band (in 100kHz Resolution Bandwidth).

4.6.2 TEST INSTRUMENTS

| Description & Manufacturer | Model No. | Serial No. | Calibrated Until |
|----------------------------|-----------|------------|------------------|
| R&S SPECTRUM ANALYZER | FSEK30 | 100049 | Aug. 12, 2005 |

NOTE: The calibration interval of the above test instruments is 12 months and the calibrations are traceable to NML/ROC and NIST/USA.

4.6.3 TEST PROCEDURE

The transmitter output was connected to the spectrum analyzer via a low lose cable. Set both RBW and VBW of spectrum analyzer to 100 kHz and 100 kHz with suitable frequency span including 100 MHz bandwidth from band edge. The band edges was measured and recorded.

The spectrum plots (Peak RBW=VBW=100kHz ; Average RBW=1MHz, VBW=1kHz) are attached on the following pages.

4.6.4 DEVIATION FROM TEST STANDARD

No deviation

4.6.5 EUT OPERATING CONDITION

Same as Item 4.3.6



4.6.6 TEST RESULTS

The spectrum plots are attached on the following 12 images. D2 line indicates the highest level, and D1 line indicates the 20dB offset below D2. It shows compliance with the requirement in part 15.247(d).

4.6.7 TEST RESULTS

802.11b DSSS modulation

NOTE 1: The band edge emission plot on page 54 show 51.89dBc delta between carrier maximum power and local maximum emission in restrict band (2.3818GHz). The emission of carrier strength list in the test result of channel 1 at the item 4.2.7 is 109.83dBuV/m (Peak), so the maximum field strength in restrict band is $109.83 - 51.89 = 57.94$ dBuV/m which is under 74dBuV/m limit.

The band edge emission plot on page 54 show 61.30dBc delta between carrier maximum power and local maximum emission in restrict band (2.3900GHz). The emission of carrier strength list in the test result of channel 1 at the item 4.2.7 is 103.07dBuV/m (Average), so the maximum field strength in restrict band is $103.07 - 61.30 = 41.77$ dBuV/m which is under 54dBuV/m limit.

NOTE 2: The band edge emission plot on the page 55 show 52.80dBc delta between carrier maximum power and local maximum emission in restrict band (2.4856GHz). The emission of carrier strength list in the test result of channel 11 at the item 4.2.7 is 112.08dBuV/m (Peak), so the maximum field strength in restrict band is $112.08 - 52.80 = 59.28$ dBuV/m which is under 74dBuV/m limit.

The band edge emission plot on the page 56 show 59.35dBc delta between carrier maximum power and local maximum emission in restrict band (2.4835GHz). The emission of carrier strength list in the test result of channel 11 at the item 4.2.7 is 104.62dBuV/m (Average), so the maximum field strength in restrict band is $104.62 - 59.35 = 45.27$ dBuV/m which is under 54dBuV/m limit.

**802.11g OFDM modulation**

NOTE 1: The band edge emission plot on page 57 show 46.75dBc delta between carrier maximum power and local maximum emission in restrict band (2.3824GHz). The emission of carrier strength list in the test result of channel 1 at the item 4.2.7 is 104.58dBuV/m (Peak), so the maximum field strength in restrict band is $104.58 - 46.75 = 57.83$ dBuV/m which is under 74dBuV/m limit.

The band edge emission plot on page 57 show 52.17dBc delta between carrier maximum power and local maximum emission in restrict band (2.3900GHz). The emission of carrier strength list in the test result of channel 1 at the item 4.2.7 is 95.20dBuV/m (Average), so the maximum field strength in restrict band is $95.20 - 52.17 = 43.03$ dBuV/m which is under 54dBuV/m limit.

NOTE 2: The band edge emission plot on page 58 show 48.24dBc delta between carrier maximum power and local maximum emission in restrict band (2.4880GHz). The emission of carrier strength list in the test result of channel 11 at the item 4.2.7 is 105.63dBuV/m (Peak), so the maximum field strength in restrict band is $105.63 - 48.24 = 57.39$ dBuV/m which is under 74dBuV/m limit.

The band edge emission plot on page 59 show 52.08dBc delta between carrier maximum power and local maximum emission in restrict band (2.4835GHz). The emission of carrier strength list in the test result of channel 11 at the item 4.2.7 is 96.07dBuV/m (Average), so the maximum field strength in restrict band is $96.07 - 52.08 = 43.99$ dBuV/m which is under 54dBuV/m limit.



802.11b DSSS modulation

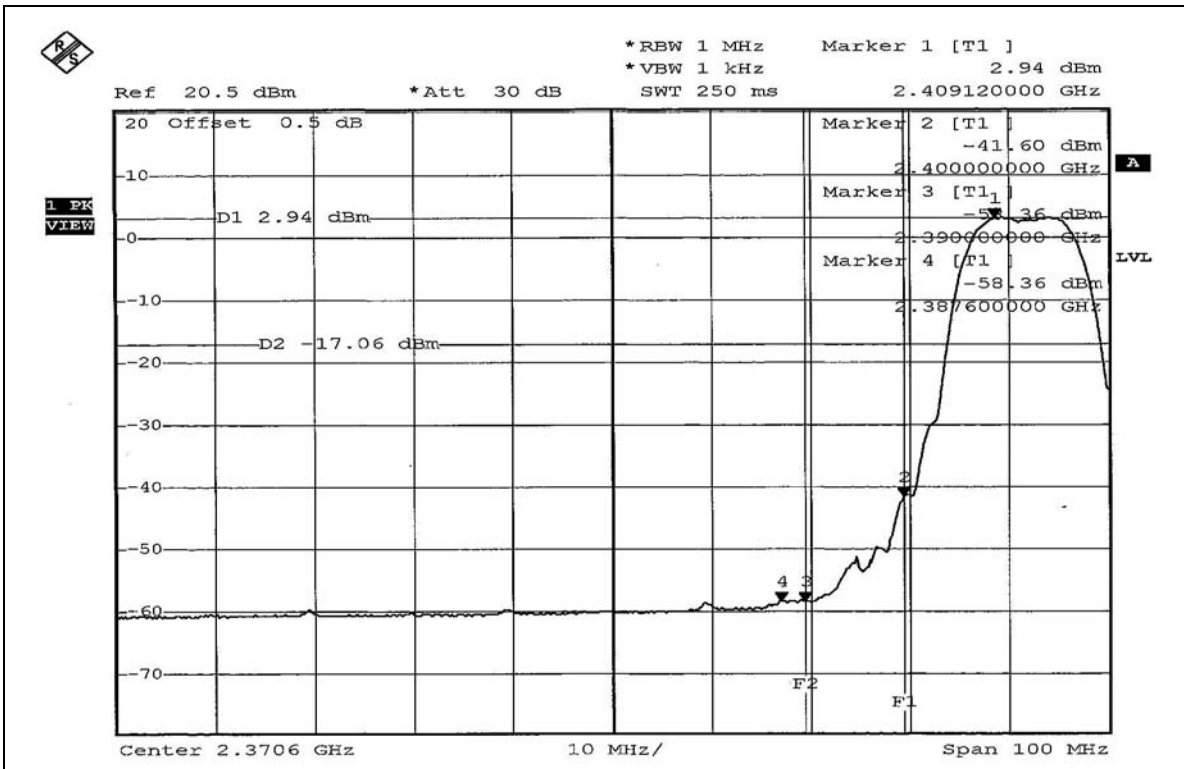
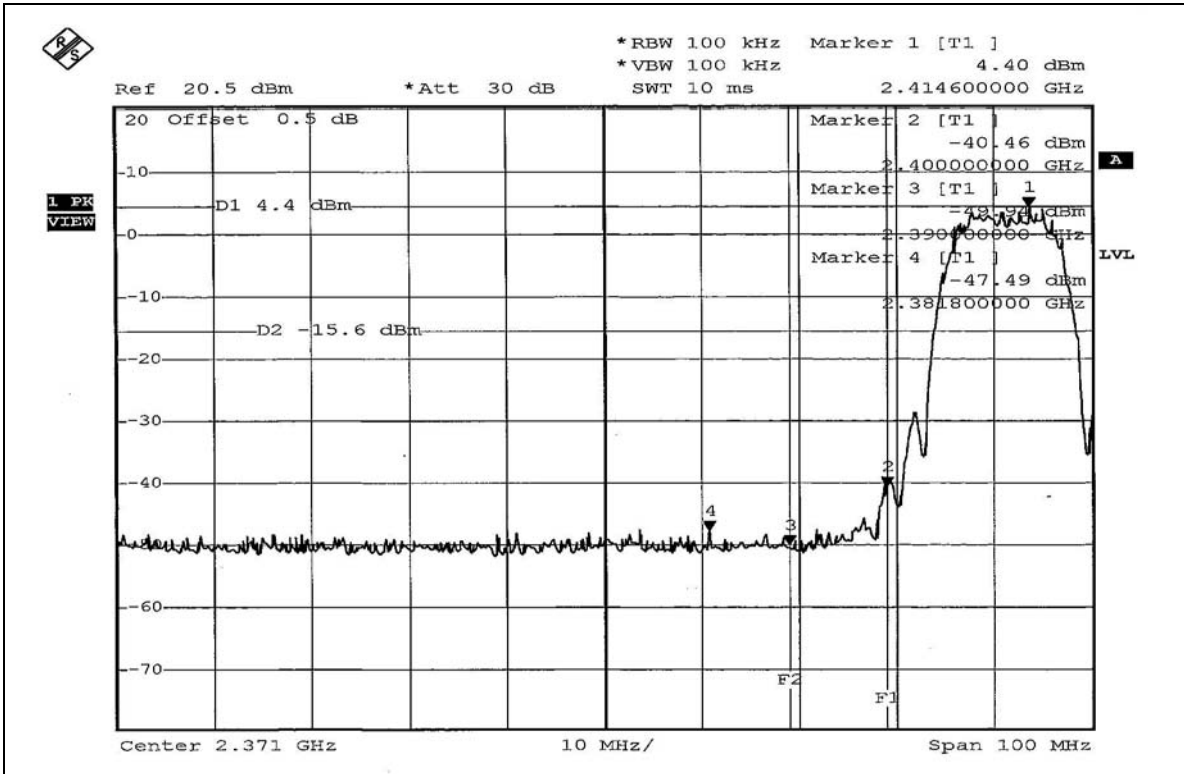

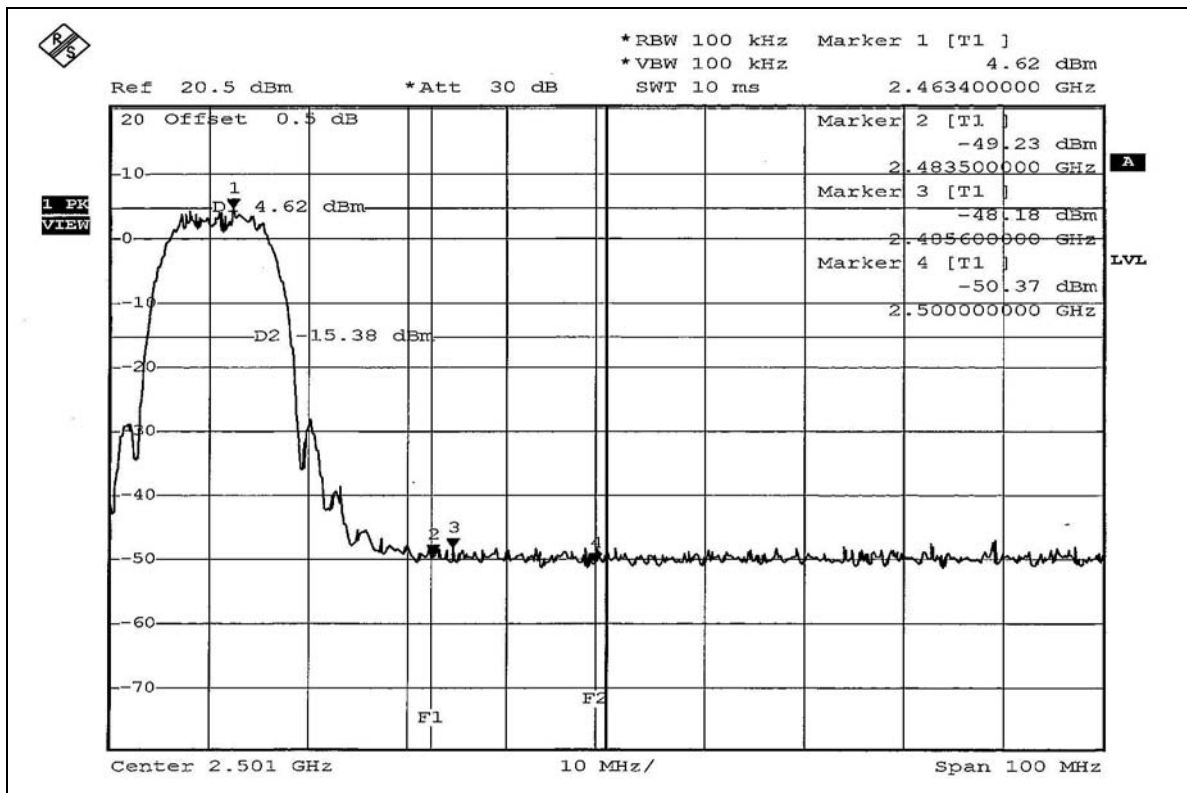
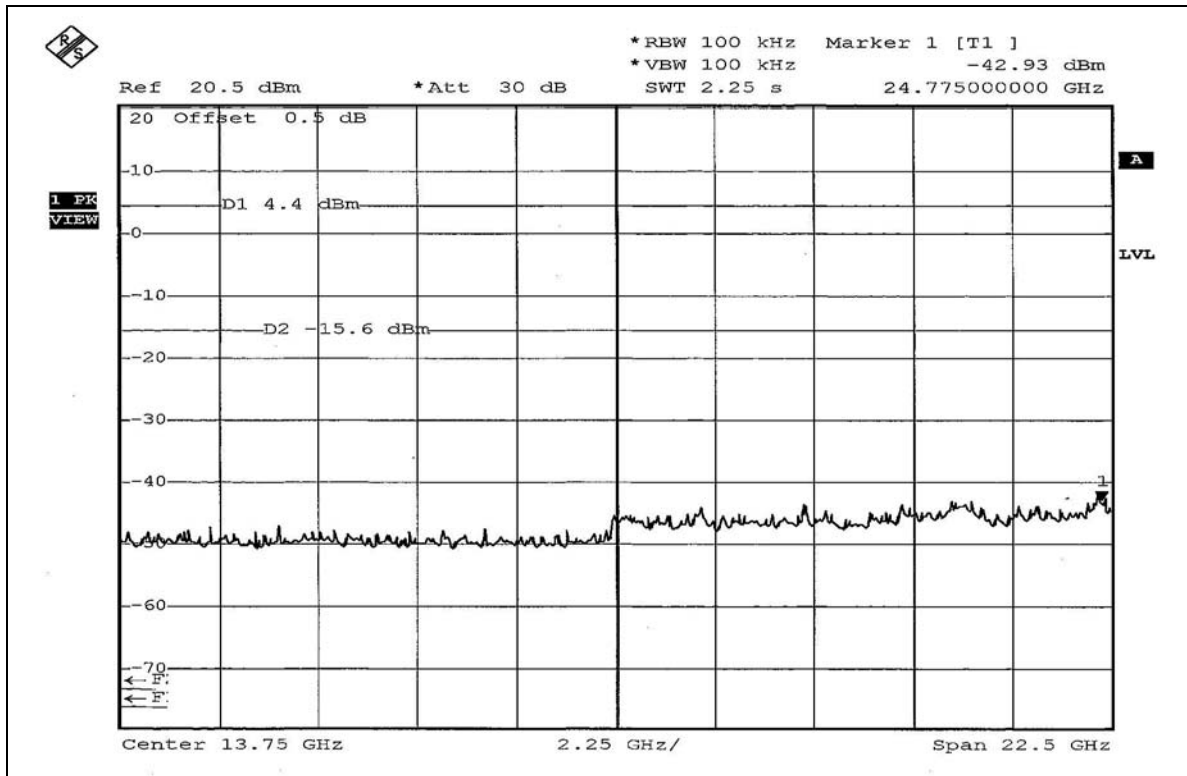

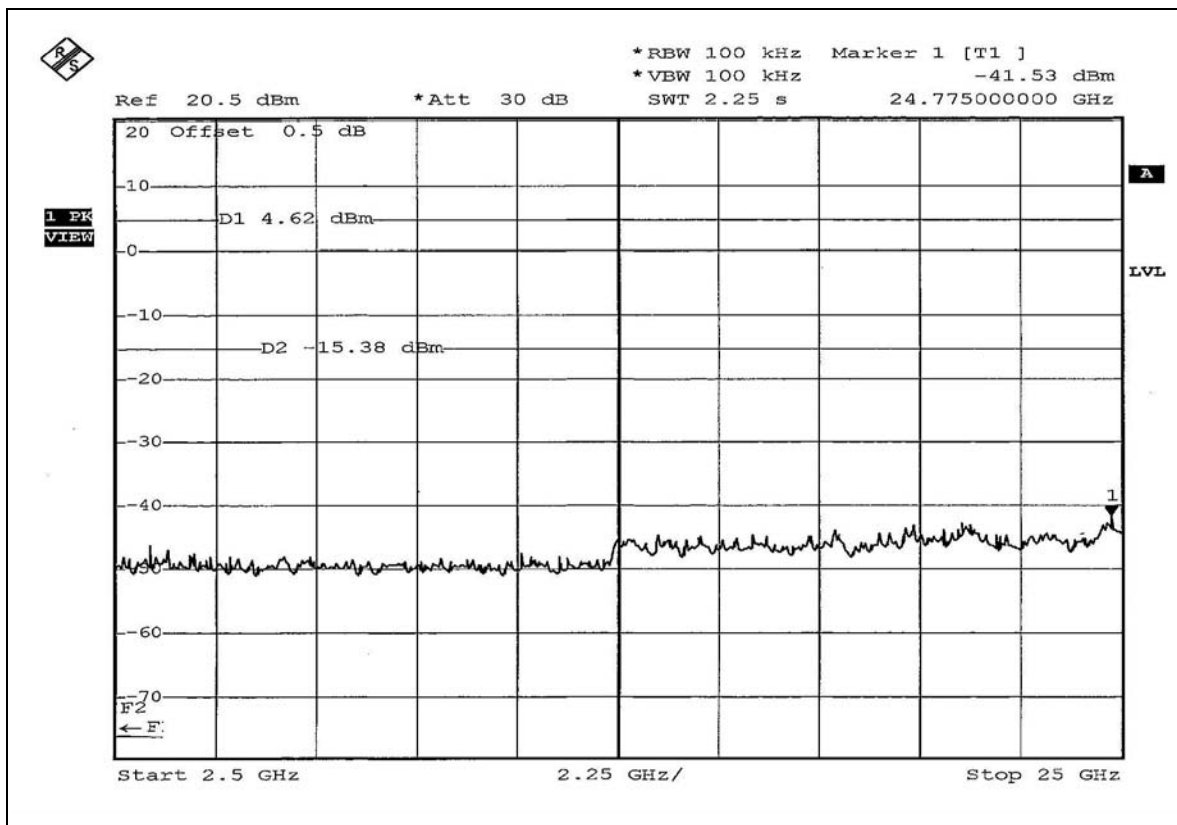
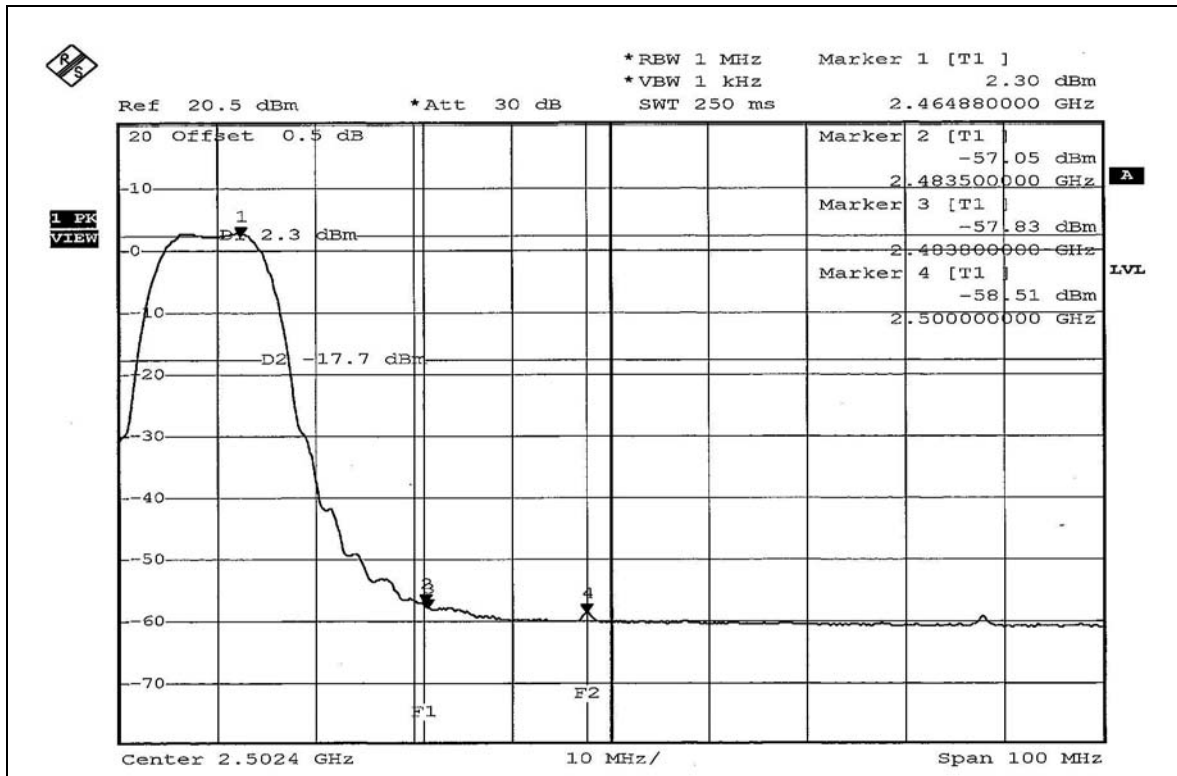



802.11g OFDM modulation

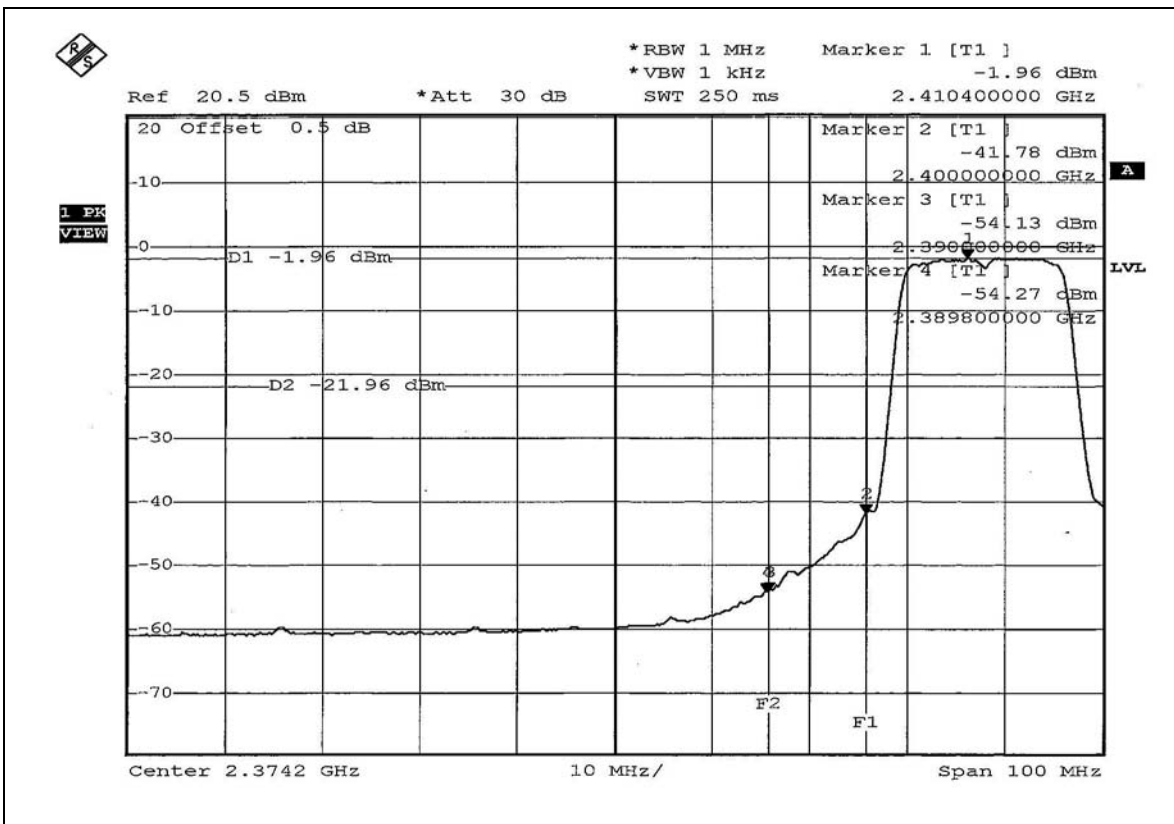
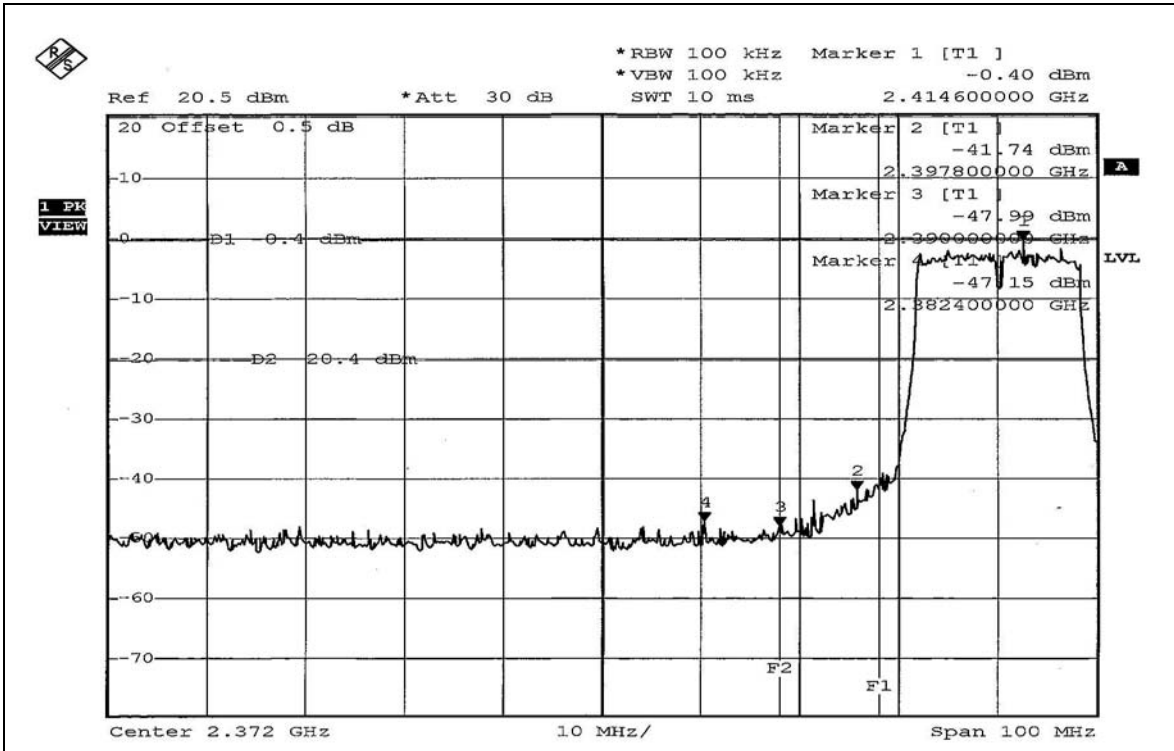

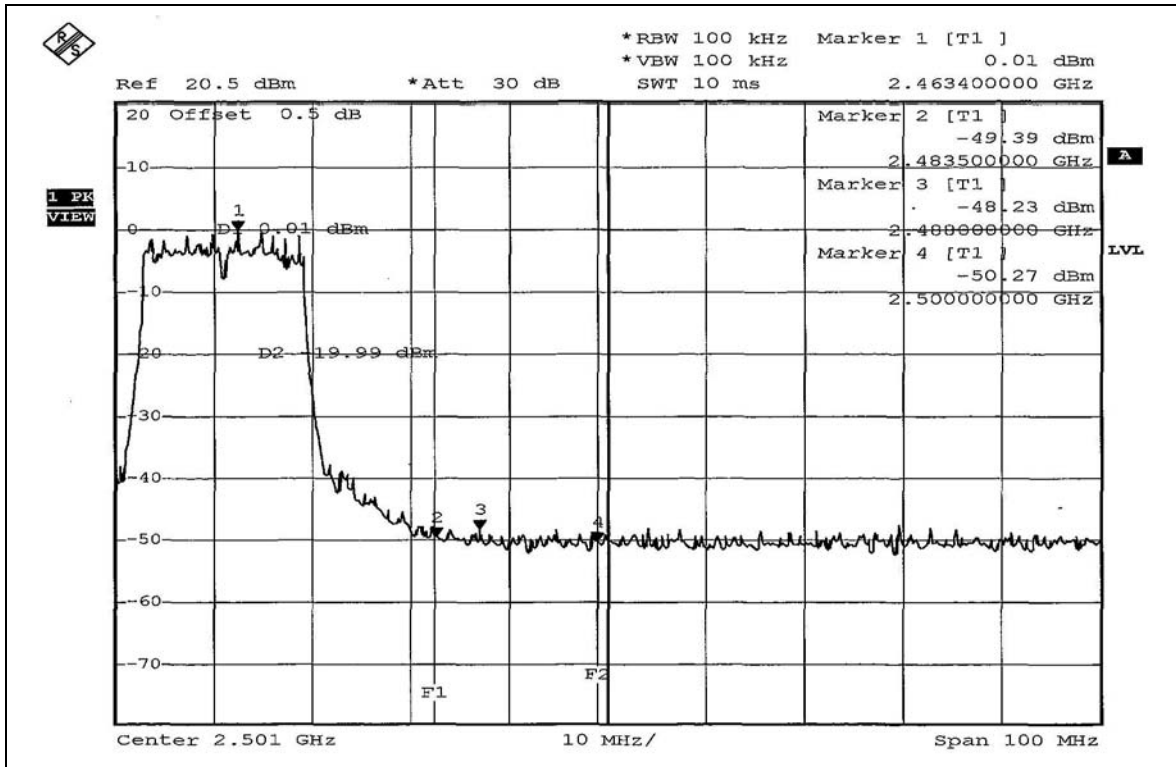
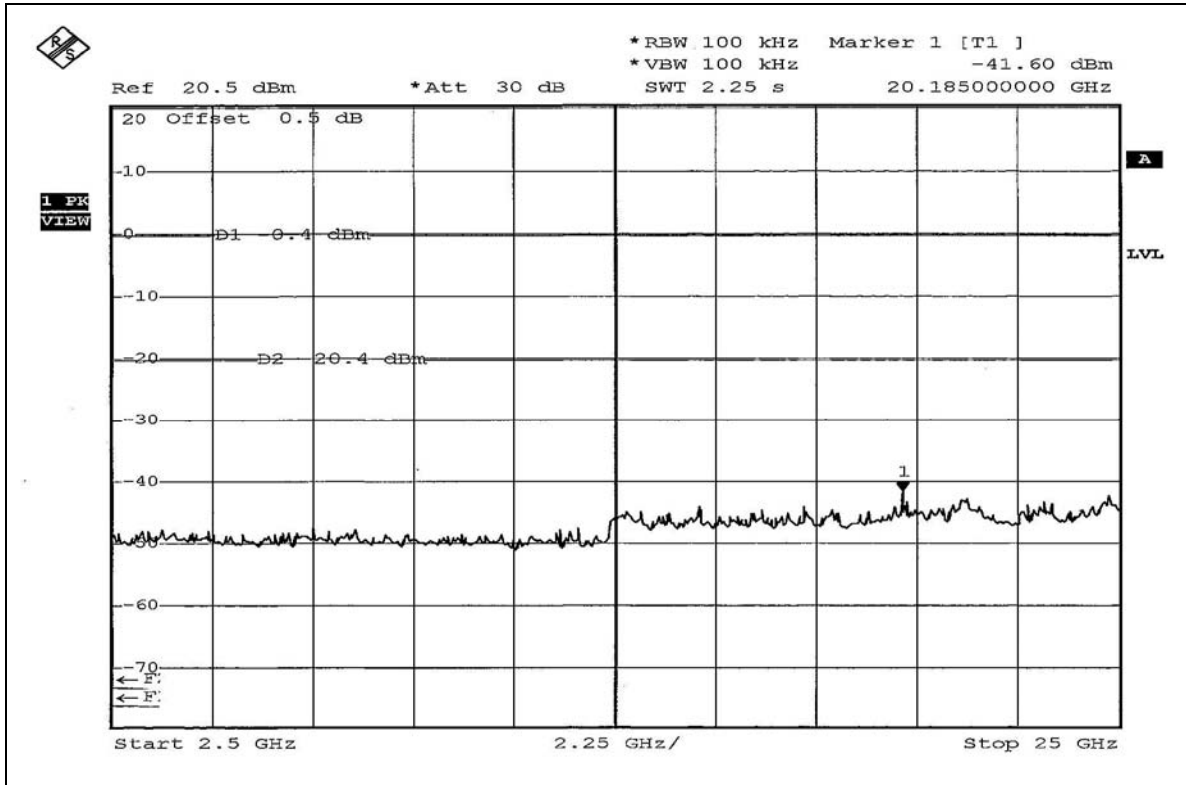

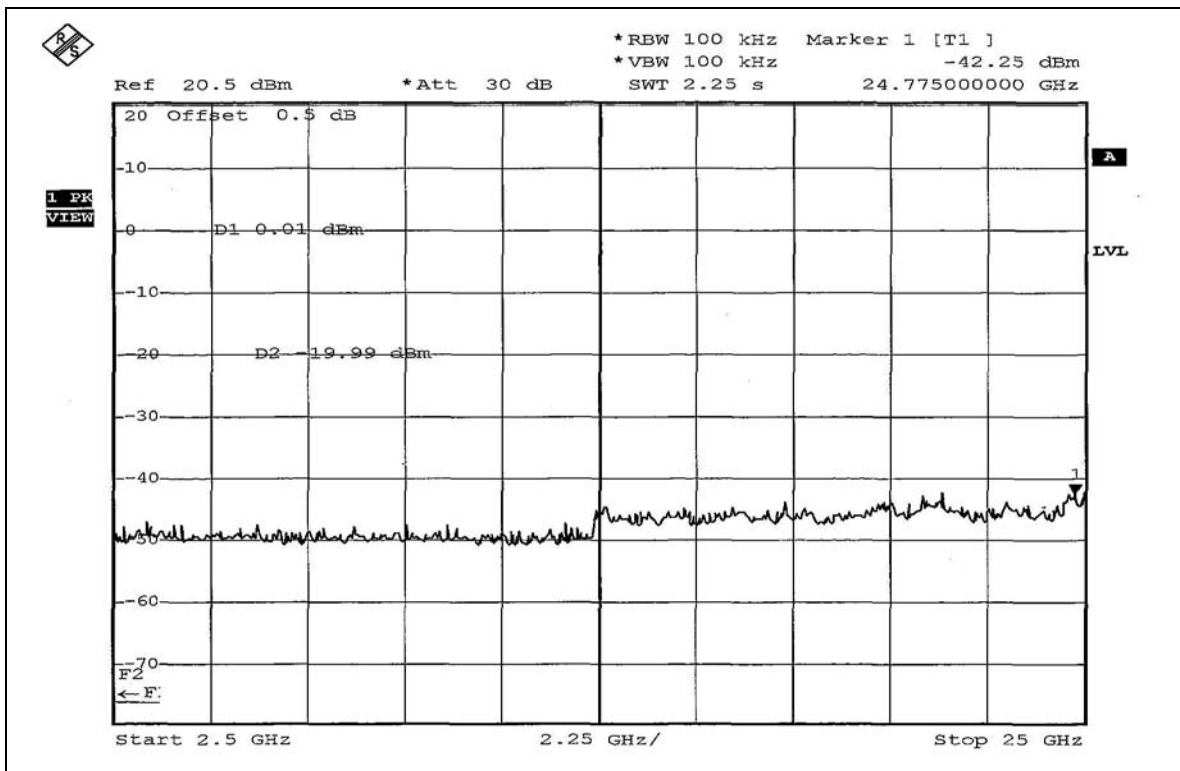
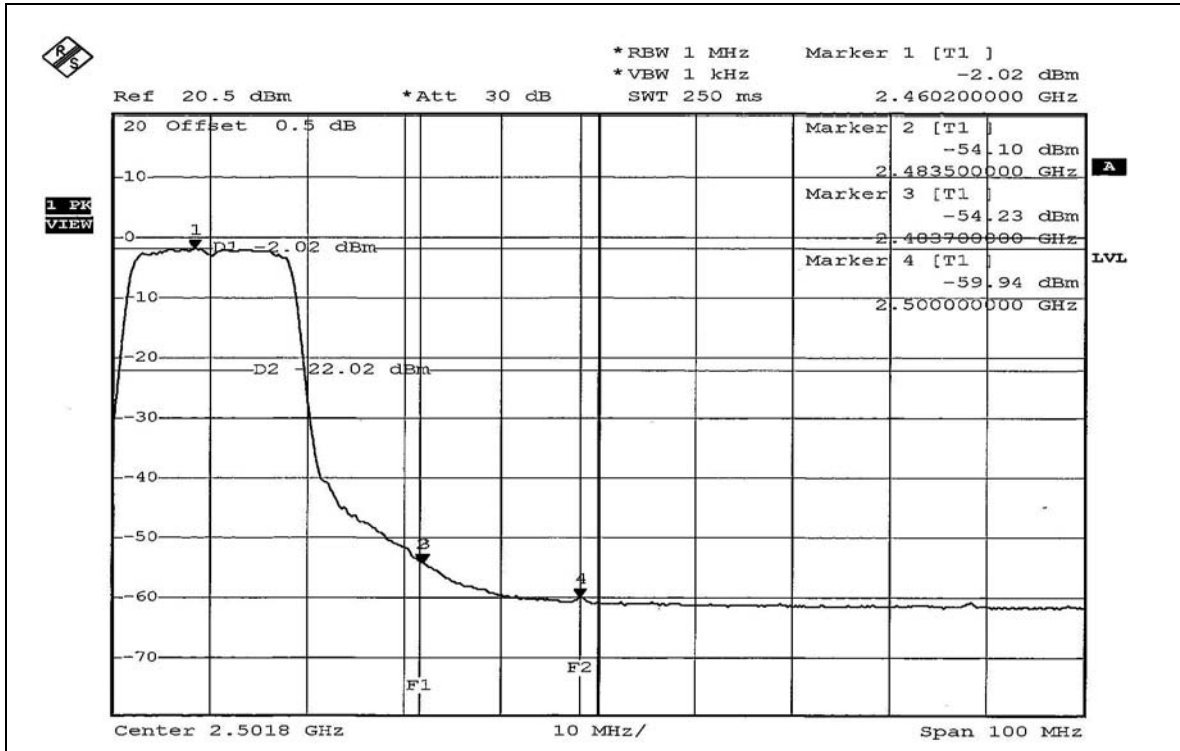



4.7 ANTENNA REQUIREMENT

4.7.1 STANDARD APPLICABLE

For intentional device, according to FCC 47 CFR Section 15.203, an intentional radiator shall be designed to ensure that no antenna other than that furnished by the responsible party shall be used with the device. And according to FCC 47 CFR Section 15.247 (b), if transmitting antennas of directional gain greater than 6dBi are used, the power shall be reduced by the amount in dB that the directional gain of the antenna exceeds 6dBi.

4.7.2 ANTENNA CONNECTED CONSTRUCTION

The antenna used in this product is Dipole antenna without antenna connector. The maximum Gain of the antenna is 1dBi.

5. PHOTOGRAPHS OF THE TEST CONFIGURATION

CONDUCTED EMISSION TEST



RADIATED EMISSION TEST

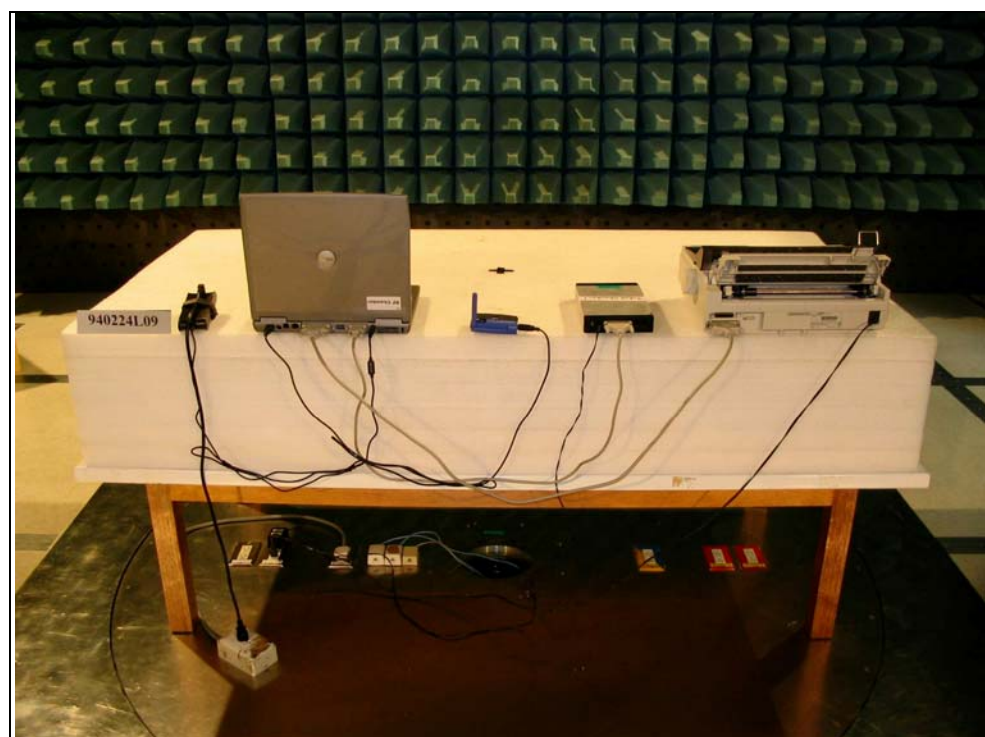



6. INFORMATION ON THE TESTING LABORATORIES

We, ADT Corp., were founded in 1988 to provide our best service in EMC, Radio, Telecom and Safety consultation. Our laboratories are accredited and approved by the following approval agencies according to ISO/IEC 17025.

| | |
|--------------------|-----------------------|
| USA | FCC, NVLAP, UL, A2LA |
| Germany | TUV Rheinland |
| Japan | VCCI |
| Norway | NEMKO |
| Canada | INDUSTRY CANADA , CSA |
| R.O.C. | CNLA, BSMI, DGT |
| Netherlands | Telefication |
| Singapore | PSB , GOST-ASIA(MOU) |
| Russia | CERTIS(MOU) |

Copies of accreditation certificates of our laboratories obtained from approval agencies can be downloaded from our web site:

www.adt.com.tw/index_5/phtml. If you have any comments, please feel free to contact us at the following:

Linko EMC/RF Lab:

Tel: 886-2-26052180

Fax: 886-2-26052943

Hsin Chu EMC/RF Lab:

Tel: 886-3-5935343

Fax: 886-3-5935342

Hwa Ya EMC/RF/Safety Telecom Lab:

Tel: 886-3-3183232

Fax: 886-3-3185050

Linko RF Lab.

Tel: 886-3-3270910

Fax: 886-3-3270892

Web Site: www.adt.com.tw

The address and road map of all our labs can be found in our web site also