



# FCC TEST REPORT

**REPORT NO.:** RF941125L02  
**MODEL NO.:** WUSB54GR  
**RECEIVED:** Dec. 05, 2005  
**TESTED:** Dec. 05 ~ Dec. 13, 2005  
**ISSUED:** Dec. 16, 2005

**APPLICANT:** Cisco-Linksys LLC  
**ADDRESS:** 121 Theory Drive Irvine, CA 92617 (USA)

**ISSUED BY:** Advance Data Technology Corporation  
**LAB ADDRESS:** 47 14<sup>th</sup> Lin, Chiapau Tsun, Linko, Taipei,  
Taiwan, R.O.C.  
**TEST LOCATION:** No. 19, Hwa Ya 2<sup>nd</sup> Rd., Kueishan, Taoyuan,  
Taiwan, R.O.C.

This test report consists of 65 pages in total. It may be duplicated completely for legal use with the approval of the applicant. It should not be reproduced except in full, without the written approval of our laboratory. The client should not use it to claim product endorsement by CNLA, A2LA or any government agencies. The test results in the report only apply to the tested sample.



No. 2177-01



0528  
ILAC MRA



## Table of Contents

1	CERTIFICATION.....	4
2	SUMMARY OF TEST RESULTS.....	5
2.1	MEASUREMENT UNCERTAINTY.....	5
3	GENERAL INFORMATION .....	6
3.1	GENERAL DESCRIPTION OF EUT .....	6
3.2	DESCRIPTION OF TEST MODES .....	7
3.2.1	CONFIGURATION OF SYSTEM UNDER TEST .....	7
3.2.2	TEST MODE APPLICABILITY AND TESTED CHANNEL DETAIL .....	8
3.3	GENERAL DESCRIPTION OF APPLIED STANDARDS.....	10
3.4	DESCRIPTION OF SUPPORT UNITS.....	10
4	TEST TYPES AND RESULTS.....	11
4.1	CONDUCTED EMISSION MEASUREMENT .....	11
4.1.1	LIMITS OF CONDUCTED EMISSION MEASUREMENT .....	11
4.1.2	TEST INSTRUMENTS.....	11
4.1.3	TEST PROCEDURES .....	12
4.1.4	DEVIATION FROM TEST STANDARD .....	12
4.1.5	TEST SETUP.....	13
4.1.6	EUT OPERATING CONDITIONS.....	13
4.1.7	TEST RESULTS .....	14
4.2	RADIATED EMISSION MEASUREMENT .....	20
4.2.1	LIMITS OF RADIATED EMISSION MEASUREMENT .....	20
4.2.2	TEST INSTRUMENTS.....	21
4.2.3	TEST PROCEDURES .....	22
4.2.4	DEVIATION FROM TEST STANDARD .....	22
4.2.5	TEST SETUP.....	23
4.2.6	EUT OPERATING CONDITIONS.....	23
4.2.7	TEST RESULTS .....	24
4.3	6dB BANDWIDTH MEASUREMENT .....	33
4.3.1	LIMITS OF 6dB BANDWIDTH MEASUREMENT .....	33
4.3.2	TEST INSTRUMENTS.....	33
4.3.3	TEST PROCEDURE.....	34
4.3.4	DEVIATION FROM TEST STANDARD .....	34
4.3.5	TEST SETUP.....	34
4.3.6	EUT OPERATING CONDITIONS.....	34
4.3.7	TEST RESULTS .....	35
4.4	MAXIMUM PEAK OUTPUT POWER.....	41
4.4.1	LIMITS OF MAXIMUM PEAK OUTPUT POWER MEASUREMENT .....	41
4.4.2	TEST INSTRUMENTS.....	41
4.4.3	TEST PROCEDURES .....	42
4.4.4	DEVIATION FROM TEST STANDARD .....	42
4.4.5	TEST SETUP.....	42
4.4.6	EUT OPERATING CONDITIONS.....	42



4.4.7	TEST RESULTS .....	43
4.5	POWER SPECTRAL DENSITY MEASUREMENT .....	44
4.5.1	LIMITS OF POWER SPECTRAL DENSITY MEASUREMENT .....	44
4.5.2	TEST INSTRUMENTS .....	44
4.5.3	TEST PROCEDURE .....	45
4.5.4	DEVIATION FROM TEST STANDARD .....	45
4.5.5	TEST SETUP .....	45
4.5.6	EUT OPERATING CONDITIONS .....	45
4.5.7	TEST RESULTS .....	46
4.6	BAND EDGES MEASUREMENT .....	52
4.6.1	LIMITS OF BAND EDGES MEASUREMENT .....	52
4.6.2	TEST INSTRUMENTS .....	52
4.6.3	TEST PROCEDURE .....	52
4.6.4	DEVIATION FROM TEST STANDARD .....	52
4.6.5	EUT OPERATING CONDITION .....	52
4.6.6	TEST RESULTS .....	53
4.7	ANTENNA REQUIREMENT .....	61
4.7.1	STANDARD APPLICABLE .....	61
4.7.2	ANTENNA CONNECTED CONSTRUCTION .....	61
5	PHOTOGRAPHS OF THE TEST CONFIGURATION .....	62
6	INFORMATION ON THE TESTING LABORATORIES .....	64
	APPENDIX-A .....	A-1



## 1 CERTIFICATION

**PRODUCT :** Wireless-G USB Network Adapter with RangeBooster  
**MODEL NO.:** WUSB54GR  
**BRAND:** Linksys  
**APPLICANT :** Cisco-Linksys LLC  
**TESTED:** Dec. 05 ~ Dec. 13, 2005  
**TEST SAMPLE:** ENGINEERING SAMPLE  
**STANDARDS :** FCC Part 15, Subpart C (Section 15.247),  
 ANSI C63.4-2003

The above equipment have been tested by **Advance Data Technology Corporation**, and found compliance with the requirement of the above standards. The test record, data evaluation & Equipment Under Test (EUT) configurations represented herein are true and accurate accounts of the measurements of the sample's EMC characteristics under the conditions specified in this report.

**PREPARED BY :**  , **DATE:** Dec. 16, 2005

Joanna Wang

**TECHNICAL ACCEPTANCE** :  , **DATE:** Dec. 16, 2005  
 Responsible for RF

Gary Chang

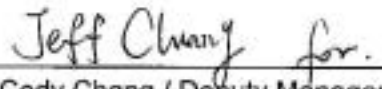
**APPROVED BY :**  , **DATE:** Dec. 16, 2005  
 Cody Chang / Deputy Manager

Cody Chang / Deputy Manager

## 2 SUMMARY OF TEST RESULTS

The EUT has been tested according to the following specifications:

<b>APPLIED STANDARD: FCC Part 15, Subpart C</b>			
<b>Standard Section</b>	<b>Test Type and Limit</b>	<b>Result</b>	<b>REMARK</b>
15.207	AC Power Conducted Emission	PASS	Meet the requirement of limit. Minimum passing margin is -18.34dB at 0.193MHz.
15.247(a)(2)	Spectrum Bandwidth of a Direct Sequence Spread Spectrum System Limit : min. 500kHz	PASS	Meet the requirement of limit.
15.247(b)	Maximum Peak Output Power Limit: max. 30dBm	PASS	Meet the requirement of limit.
15.247(d)	Transmitter Radiated Emissions Limit: Table 15.209	PASS	Meet the requirement of limit. Minimum passing margin is -1.16dB at 2492.00MHz.
15.247(e)	Power Spectral Density Limit: max. 8dBm	PASS	Meet the requirement of limit.
15.247(d)	Band Edge Measurement Limit: 20 dB less than the peak value of fundamental frequency	PASS	Meet the requirement of limit.

### 2.1 MEASUREMENT UNCERTAINTY

Where relevant, the following measurement uncertainty levels have been estimated for tests performed on the EUT as specified in CISPR 16-4:

<b>Measurement</b>	<b>Frequency</b>	<b>Uncertainty</b>
Conducted emissions	9kHz~30MHz	2.44 dB
	30MHz ~ 200MHz	3.63 dB
Radiated emissions	200MHz ~1000MHz	3.65 dB
	1GHz ~ 18GHz	2.20 dB
	18GHz ~ 40GHz	1.88 dB

This uncertainty represents an expanded uncertainty expressed at approximately the 95% confidence level using a coverage factor of k=2.



### 3 GENERAL INFORMATION

#### 3.1 GENERAL DESCRIPTION OF EUT

<b>PRODUCT</b>	Wireless-G USB Network Adapter with RangeBooster
<b>MODEL NO.</b>	WUSB54GR
<b>POWER SUPPLY</b>	5Vdc from host equipment
<b>MODULATION TYPE</b>	CCK, QPSK, BPSK for DSSS 64QAM, 16QAM, QPSK, BPSK FOR OFDM
<b>MODULATION TECHNOLOGY</b>	DSSS, OFDM
<b>TRANSFER RATE</b>	802.11b: 11/5.5/2/1Mbps 802.11g: 54/48/36/24/18/12/9/6Mbps
<b>FREQUENCY RANGE</b>	2412MHz ~ 2462MHz
<b>NUMBER OF CHANNEL</b>	11
<b>MAXIMUM OUTPUT POWER</b>	80.538mW
<b>ANTENNA TYPE</b>	Refer to Note 1
<b>DATA CABLE</b>	1.7 m shielded USB cable without core
<b>I/O PORTS</b>	USB
<b>ASSOCIATED DEVICES</b>	NA

**NOTE:**

1. The following antennas were provided to this EUT.

<b>ANT No.</b>	<b>Antenna Type</b>	<b>Gain (dBi)</b>
1	Printed dipole	0.5
2	PIFA	1.5

\*We chose PIFA antenna with 1.5dBi gain for the worst case and present in the test report.

- The EUT complies with IEEE 802.11g standards and backwards compatible with IEEE 802.11b products.
- The EUT operates in the 2.4GHz frequency spectrum with throughput of up to 54Mbps.
- The above EUT information was declared by manufacturer and for more detailed features description, please refer to the manufacturer's specifications or User's Manual.



### 3.2 DESCRIPTION OF TEST MODES

Eleven channels are provided to this EUT for normal mode.

Channel	Frequency	Channel	Frequency
1	2412 MHz	7	2442 MHz
2	2417 MHz	8	2447 MHz
3	2422 MHz	9	2452 MHz
4	2427 MHz	10	2457 MHz
5	2432 MHz	11	2462 MHz
6	2437 MHz		

#### 3.2.1 CONFIGURATION OF SYSTEM UNDER TEST

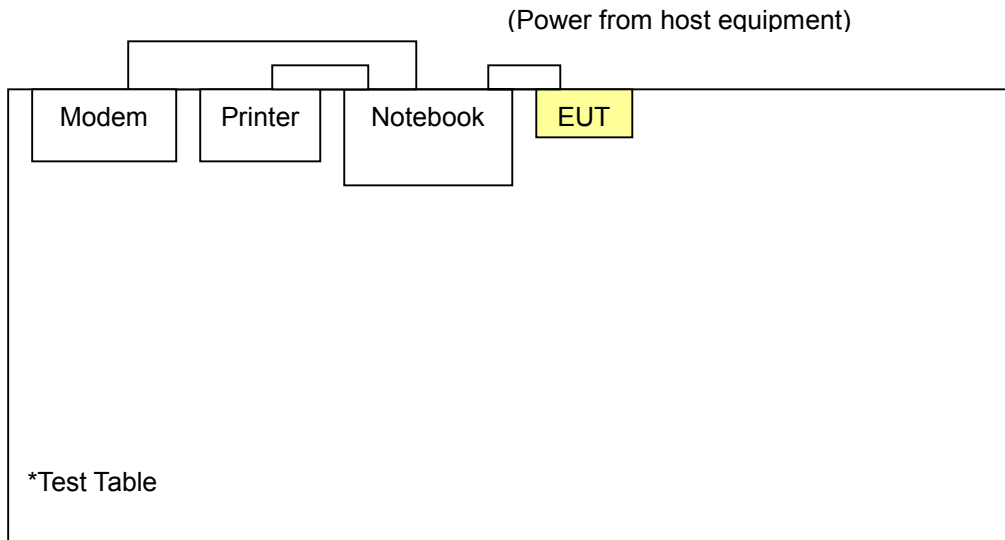



3.2.2 TEST MODE APPLICABILITY AND TESTED CHANNEL DETAIL

EUT configure mode	Applicable to				Description
	PLC	RE<1G	RE≥1G	APCM	
A	-	-	√	-	Antenna 1: Printed dipole antenna
B	√	√	√	√	Antenna 2: PIFA antenna

Where PLC: Power Line Conducted Emission RE<1G RE: Radiated Emission below 1GHz  
 RE≥1G: Radiated Emission above 1GHz APCM: Antenna Port Conducted Measurement

NOTE: “-” means no effect

**Power Line Conducted Emission Test:**

- Pre-Scan has been conducted to determine the worst-case mode from all possible combinations between available modulations, data rates and antenna ports (if EUT with antenna diversity architecture).
- Following channel(s) was (were) selected for the final test as listed below.

Mode	Available Channel	Tested Channel	Modulation Technology	Modulation Type	Data Rate (Mbps)
802.11g	1 to 11	1, 6, 11	OFDM	BPSK	6

**Radiated Emission Test (Below 1 GHz):**

- Pre-Scan has been conducted to determine the worst-case mode from all possible combinations between available modulations, data rates and antenna ports (if EUT with antenna diversity architecture).
- Following channel(s) was (were) selected for the final test as listed below.

EUT CONFIGURE MODE	Mode	Available Channel	Tested Channel	Modulation Technology	Modulation Type	Data Rate (Mbps)
B	802.11g	1 to 11	11	OFDM	BPSK	6





**Radiated Emission Test (Above 1 GHz):**

- Pre-Scan has been conducted to determine the worst-case mode from all possible combinations between available modulations, data rates and antenna ports (if EUT with antenna diversity architecture).
- Following channel(s) was (were) selected for the final test as listed below.

EUT CONFIGURE MODE	Mode	Available Channel	Tested Channel	Modulation Technology	Modulation Type	Data Rate (Mbps)
A	802.11b	1 to 11	6	DSSS	BPSK	1
A	802.11g	1 to 11	1	OFDM	BPSK	6
B	802.11b	1 to 11	1, 6, 11	DSSS	BPSK	1
B	802.11g	1 to 11	1, 6, 11	OFDM	BPSK	6

**Bandedge Measurement:**

- Pre-Scan has been conducted to determine the worst-case mode from all possible combinations between available modulations, data rates and antenna ports (if EUT with antenna diversity architecture).
- Following channel(s) was (were) selected for the final test as listed below.

Mode	Available Channel	Tested Channel	Modulation Technology	Modulation Type	Data Rate (Mbps)
802.11b	1 to 11	1, 11	DSSS	BPSK	1
802.11g	1 to 11	1, 11	OFDM	BPSK	6

**Antenna Port Conducted Measurement:**

- Pre-Scan has been conducted to determine the worst-case mode from all possible combinations between available modulations, data rates and antenna ports (if EUT with antenna diversity architecture).
- Following channel(s) was (were) selected for the final test as listed below.

Mode	Available Channel	Tested Channel	Modulation Technology	Modulation Type	Data Rate (Mbps)
802.11b	1 to 11	1, 6, 11	DSSS	BPSK	1
802.11g	1 to 11	1, 6, 11	OFDM	BPSK	6



### 3.3 GENERAL DESCRIPTION OF APPLIED STANDARDS

The EUT is a RF product, according to the specifications of the manufacturer, it must comply with the requirements of the following standards:

**FCC Part 15, Subpart C. (15.247)**  
**ANSI C63.4-2003**

All test items have been performed and recorded as per the above standards.

**NOTE:** The EUT is also considered as a kind of computer peripheral, because the connection to computer is necessary for typical use. It has been verified to comply with the requirements of FCC Part 15, Subpart B, Class B (DoC). The test report has been issued separately.

### 3.4 DESCRIPTION OF SUPPORT UNITS

The EUT has been tested as an independent unit together with other necessary accessories or support units. The following support units or accessories were used to form a representative test configuration during the tests.

NO.	PRODUCT	BRAND	MODEL NO.	SERIAL NO.	FCC ID
1	NOTEBOOK COMPUTER	DELL	PP05L	12130898320	E2K24CLNS
2	PRINTER	EPSON	LQ-300+	DCGY047265	FCC DoC Approved
3	MODEM	ACEEX	1414V/3	0401008248	IFAXDM1414

NO.	SIGNAL CABLE DESCRIPTION OF THE ABOVE SUPPORT UNITS
1	NA
2	1.2m shielded cable without core
3	1.2m shielded cable without core

**NOTE:** All power cords of the above support units are non shielded (1.8m).



## 4 TEST TYPES AND RESULTS

### 4.1 CONDUCTED EMISSION MEASUREMENT

#### 4.1.1 LIMITS OF CONDUCTED EMISSION MEASUREMENT

FREQUENCY OF EMISSION (MHz)	CONDUCTED LIMIT (dB $\mu$ V)	
	Quasi-peak	Average
0.15-0.5	66 to 56	56 to 46
0.5-5	56	46
5-30	60	50

- NOTE:**
1. The lower limit shall apply at the transition frequencies.
  2. The limit decreases in line with the logarithm of the frequency in the range of 0.15 to 0.50 MHz.
  3. All emanations from a class A/B digital device or system, including any network of conductors and apparatus connected thereto, shall not exceed the level of field strengths specified above.

#### 4.1.2 TEST INSTRUMENTS

DESCRIPTION & MANUFACTURER	MODEL NO.	SERIAL NO.	CALIBRATED UNTIL
Test Receiver ROHDE & SCHWARZ	ESCS30	100291	Nov. 11, 2006
RF signal cable Woken	5D-FB	Cable-HYC01-01	Jan. 09, 2006
LISN SCHWARZBECK	NNBL 8226-2	8226-142	May. 02, 2006
LISN ROHDE & SCHWARZ	ESH2-Z5	100104	Feb. 15, 2006
Software ADT	ADT_Cond_V3	NA	NA

- NOTE:**
1. The calibration interval of the above test instruments is 12 months and the calibrations are traceable to NML/ROC and NIST/USA.
  2. The test was performed in HwaYa Shielded Room 1.
  3. The VCCI Site Registration No. is C-2040.



#### 4.1.3 TEST PROCEDURES

- a. The EUT was placed 0.4 meters from the conducting wall of the shielded room with EUT being connected to the power mains through a line impedance stabilization network (LISN). Other support units were connected to the power mains through another LISN. The two LISNs provide 50 ohm/ 50uH of coupling impedance for the measuring instrument.
- b. Both lines of the power mains connected to the EUT were checked for maximum conducted interference.
- c. The frequency range from 150kHz to 30MHz was searched. Emission levels under Limit - 20dB was not recorded.

#### 4.1.4 DEVIATION FROM TEST STANDARD

No deviation

#### 4.1.5 TEST SETUP

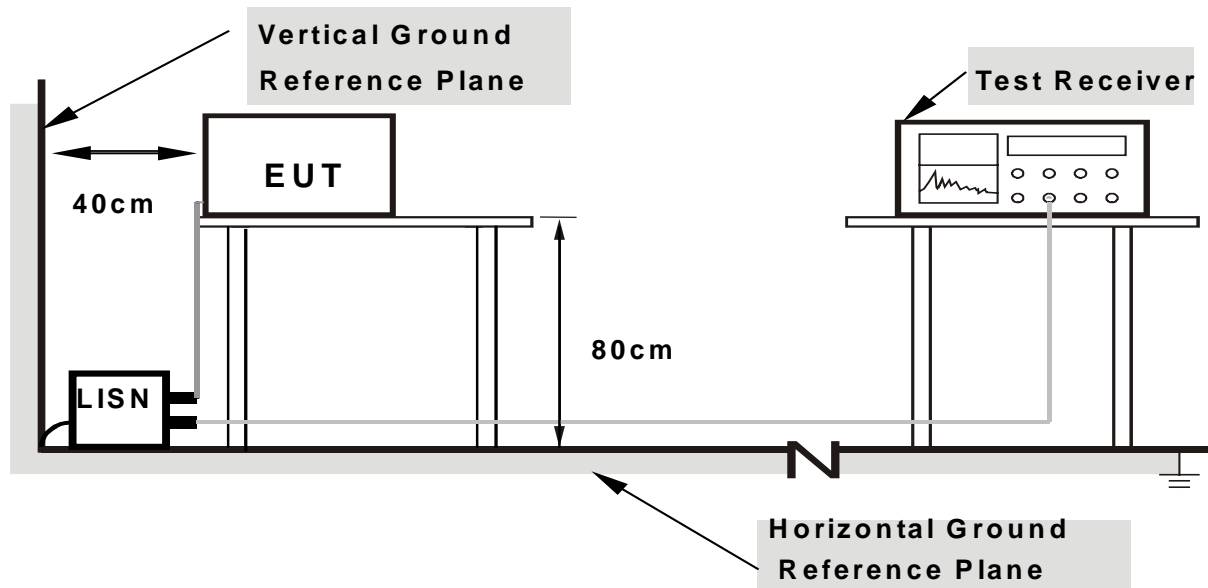

- Note:**
1. Support units were connected to second LISN.
  2. Both of LISNs (AMN) are 80 cm from EUT and at least 80 cm from other units and other metal planes

For the actual test configuration, please refer to the related item – Photographs of the Test Configuration.

#### 4.1.6 EUT OPERATING CONDITIONS

- a. Connected the EUT to a notebook system via USB cable and placed on a testing table.
- b. The notebook system ran a test program (provided by manufacturer) to enable EUT under transmission/receiving condition continuously at specific channel frequency.
- c. The notebook system sent "H" messages to its screen.
- d. The notebook system sent "H" messages to modem.
- e. The notebook system sent "H" messages to printer, and the printer printed them on paper.
- f. Steps c ~ e were repeated.



4.1.7 TEST RESULTS

**CONDUCTED WORST-CASE DATA**

<b>EUT</b>	Wireless-G USB Network Adapter with RangeBooster	<b>MEASUREMENT DETAIL</b>	
<b>MODEL</b>	WUSB54GR	<b>PHASE</b>	Line 1
<b>CHANNEL</b>	Channel 1	<b>6dB BANDWIDTH</b>	9 kHz
<b>MODULATION TYPE</b>	BPSK	<b>ENVIRONMENTAL CONDITIONS</b>	25deg. C, 65%RH, 991hPa
<b>TRANSFER RATE</b>	6Mbps	<b>INPUT POWER (SYSTEM)</b>	120Vac, 60 Hz
<b>TESTED BY</b>	Long Chen		

No	Freq. [MHz]	Corr. Factor (dB)	Reading Value [dB (uV)]		Emission Level [dB (uV)]		Limit [dB (uV)]		Margin (dB)	
			Q.P.	AV.	Q.P.	AV.	Q.P.	AV.	Q.P.	AV.
			1	0.196	0.11	44.56	-	44.67	-	63.76
2	0.291	0.11	33.09	-	33.20	-	60.51	50.51	-27.31	-
3	1.348	0.25	33.18	-	33.43	-	56.00	46.00	-22.57	-
4	3.625	0.37	25.30	-	25.67	-	56.00	46.00	-30.33	-
5	9.258	0.52	31.41	-	31.93	-	60.00	50.00	-28.07	-
6	13.754	0.55	32.64	-	33.19	-	60.00	50.00	-26.81	-

- REMARKS:**
1. Q.P. and AV. are abbreviations of quasi-peak and average individually.
  2. "-": The Quasi-peak reading value also meets average limit and measurement with the average detector is unnecessary.
  3. The emission levels of other frequencies were very low against the limit.
  4. Margin value = Emission level - Limit value
  5. Correction factor = Insertion loss + Cable loss
  6. Emission Level = Correction Factor + Reading Value.

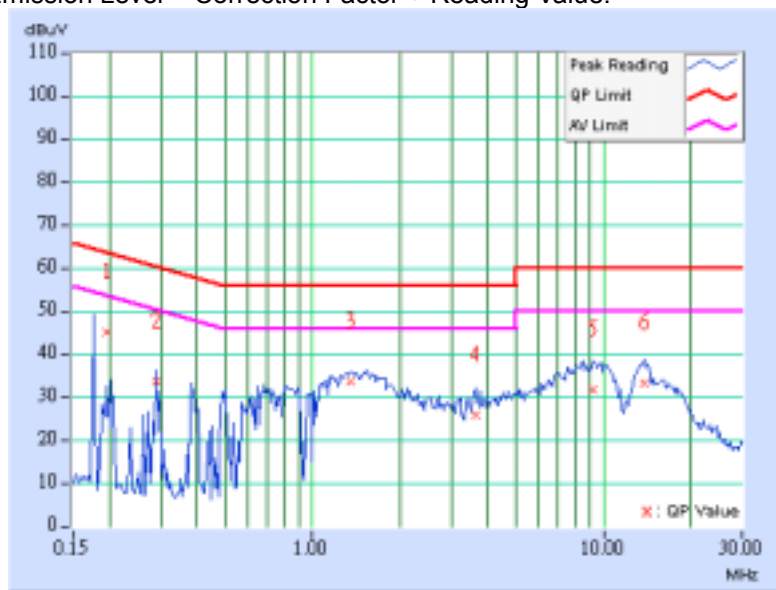



<b>EUT</b>	Wireless-G USB Network Adapter with RangeBooster	<b>MEASUREMENT DETAIL</b>	
<b>MODEL</b>	WUSB54GR	<b>PHASE</b>	Line 2
<b>CHANNEL</b>	Channel 1	<b>6dB BANDWIDTH</b>	9 kHz
<b>MODULATION TYPE</b>	BPSK	<b>ENVIRONMENTAL CONDITIONS</b>	25deg. C, 65%RH, 991hPa
<b>TRANSFER RATE</b>	6Mbps	<b>INPUT POWER (SYSTEM)</b>	120Vac, 60 Hz
<b>TESTED BY</b>	Long Chen		

No	Freq. [MHz]	Corr. Factor (dB)	Reading Value		Emission Level		Limit		Margin	
			[dB (uV)]		[dB (uV)]		[dB (uV)]		(dB)	
			Q.P.	AV.	Q.P.	AV.	Q.P.	AV.	Q.P.	AV.
1	0.193	0.11	45.46	-	45.57	-	63.91	53.91	-18.34	-
2	0.392	0.11	30.90	-	31.01	-	58.02	48.02	-27.01	-
3	1.156	0.24	30.02	-	30.26	-	56.00	46.00	-25.74	-
4	4.438	0.39	23.83	-	24.22	-	56.00	46.00	-31.78	-
5	9.844	0.44	30.84	-	31.28	-	60.00	50.00	-28.72	-
6	13.230	0.45	30.75	-	31.20	-	60.00	50.00	-28.80	-

- REMARKS:**
1. Q.P. and AV. are abbreviations of quasi-peak and average individually.
  2. "-": The Quasi-peak reading value also meets average limit and measurement with the average detector is unnecessary.
  3. The emission levels of other frequencies were very low against the limit.
  4. Margin value = Emission level - Limit value
  5. Correction factor = Insertion loss + Cable loss
  6. Emission Level = Correction Factor + Reading Value.

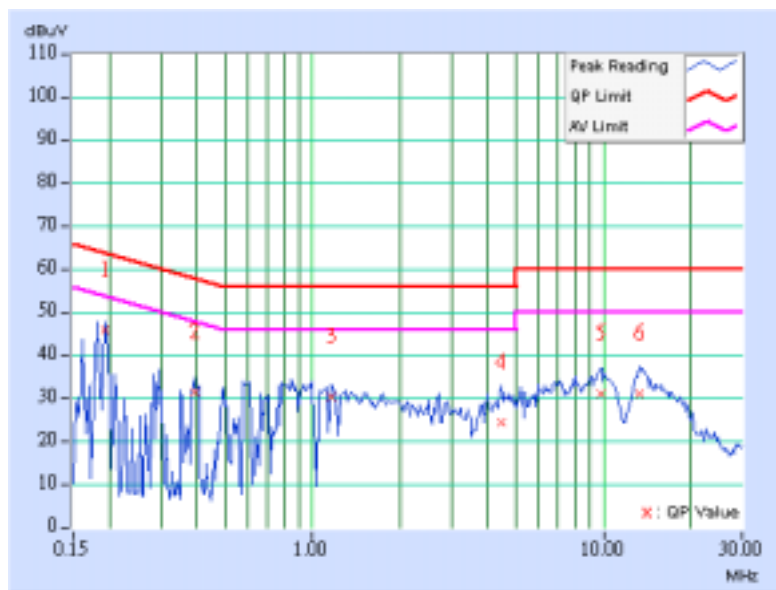



<b>EUT</b>	Wireless-G USB Network Adapter with RangeBooster	<b>MEASUREMENT DETAIL</b>	
<b>MODEL</b>	WUSB54GR	<b>PHASE</b>	Line 1
<b>CHANNEL</b>	Channel 6	<b>6dB BANDWIDTH</b>	9 kHz
<b>MODULATION TYPE</b>	BPSK	<b>ENVIRONMENTAL CONDITIONS</b>	25deg. C, 65%RH, 991hPa
<b>TRANSFER RATE</b>	6Mbps	<b>INPUT POWER (SYSTEM)</b>	120Vac, 60 Hz
<b>TESTED BY</b>	Long Chen		

No	Freq. [MHz]	Corr. Factor (dB)	Reading Value		Emission Level		Limit		Margin	
			[dB (uV)]		[dB (uV)]		[dB (uV)]		(dB)	
			Q.P.	AV.	Q.P.	AV.	Q.P.	AV.	Q.P.	AV.
1	0.198	0.11	44.33	-	44.44	-	63.70	53.70	-19.26	-
2	0.391	0.11	28.88	-	28.99	-	58.05	48.05	-29.06	-
3	1.516	0.25	32.63	-	32.88	-	56.00	46.00	-23.12	-
4	4.238	0.40	23.89	-	24.29	-	56.00	46.00	-31.71	-
5	9.813	0.54	31.84	-	32.38	-	60.00	50.00	-27.62	-
6	13.734	0.55	32.63	-	33.18	-	60.00	50.00	-26.82	-

- REMARKS:**
1. Q.P. and AV. are abbreviations of quasi-peak and average individually.
  2. "-": The Quasi-peak reading value also meets average limit and measurement with the average detector is unnecessary.
  3. The emission levels of other frequencies were very low against the limit.
  4. Margin value = Emission level - Limit value
  5. Correction factor = Insertion loss + Cable loss
  6. Emission Level = Correction Factor + Reading Value.

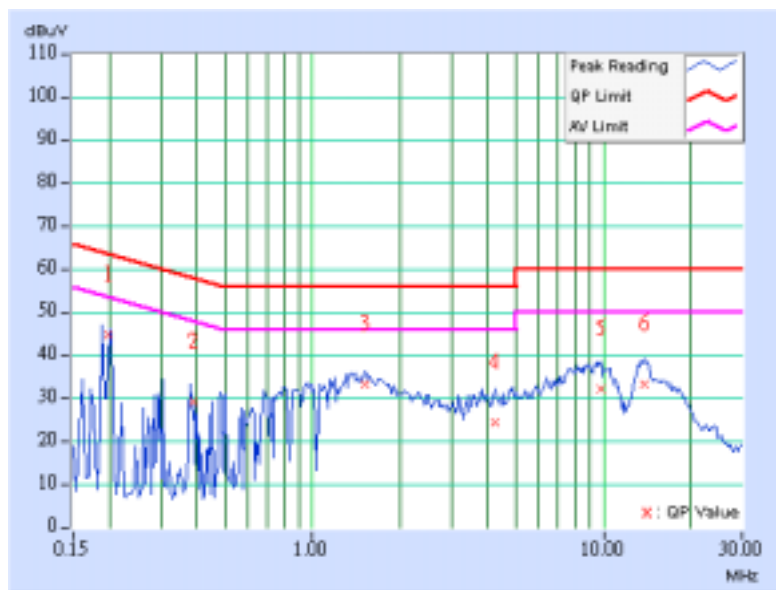





<b>EUT</b>	Wireless-G USB Network Adapter with RangeBooster	<b>MEASUREMENT DETAIL</b>	
<b>MODEL</b>	WUSB54GR	<b>PHASE</b>	Line 2
<b>CHANNEL</b>	Channel 6	<b>6dB BANDWIDTH</b>	9 kHz
<b>MODULATION TYPE</b>	BPSK	<b>ENVIRONMENTAL CONDITIONS</b>	25deg. C, 65%RH, 991hPa
<b>TRANSFER RATE</b>	6Mbps	<b>INPUT POWER (SYSTEM)</b>	120Vac, 60 Hz
<b>TESTED BY</b>	Long Chen		

No	Freq. [MHz]	Corr. Factor (dB)	Reading Value		Emission Level		Limit		Margin	
			[dB (uV)]		[dB (uV)]		[dB (uV)]		(dB)	
			Q.P.	AV.	Q.P.	AV.	Q.P.	AV.	Q.P.	AV.
1	0.189	0.11	44.37	-	44.48	-	64.08	54.08	-19.60	-
2	0.400	0.11	31.85	-	31.96	-	57.85	47.85	-25.89	-
3	0.880	0.21	29.18	-	29.39	-	56.00	46.00	-26.61	-
4	3.809	0.38	23.77	-	24.15	-	56.00	46.00	-31.85	-
5	9.867	0.44	30.90	-	31.34	-	60.00	50.00	-28.66	-
6	13.832	0.45	31.69	-	32.14	-	60.00	50.00	-27.86	-

- REMARKS:**
1. Q.P. and AV. are abbreviations of quasi-peak and average individually.
  2. "-": The Quasi-peak reading value also meets average limit and measurement with the average detector is unnecessary.
  3. The emission levels of other frequencies were very low against the limit.
  4. Margin value = Emission level - Limit value
  5. Correction factor = Insertion loss + Cable loss
  6. Emission Level = Correction Factor + Reading Value.

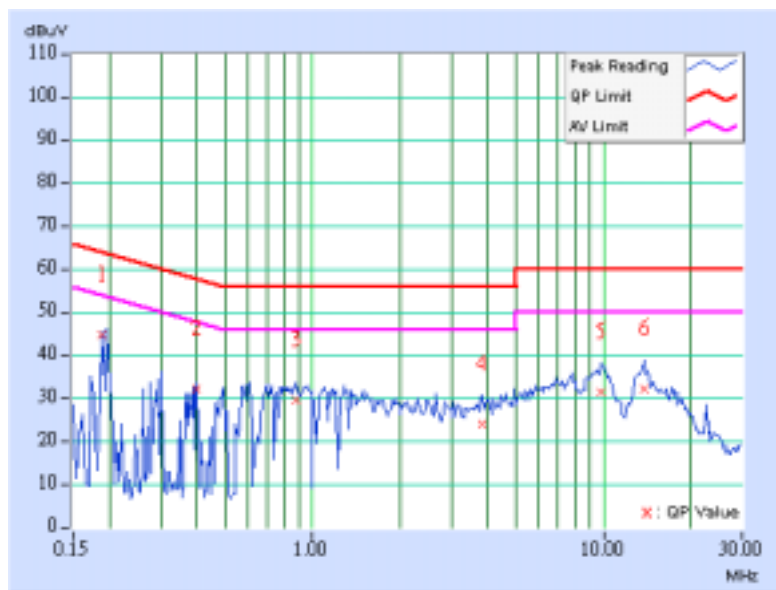



<b>EUT</b>	Wireless-G USB Network Adapter with RangeBooster	<b>MEASUREMENT DETAIL</b>	
<b>MODEL</b>	WUSB54GR	<b>PHASE</b>	Line 1
<b>CHANNEL</b>	Channel 11	<b>6dB BANDWIDTH</b>	9 kHz
<b>MODULATION TYPE</b>	BPSK	<b>ENVIRONMENTAL CONDITIONS</b>	25deg. C, 65%RH, 991hPa
<b>TRANSFER RATE</b>	6Mbps	<b>INPUT POWER (SYSTEM)</b>	120Vac, 60 Hz
<b>TESTED BY</b>	Long Chen		

No	Freq. [MHz]	Corr. Factor (dB)	Reading Value [dB (uV)]		Emission Level [dB (uV)]		Limit [dB (uV)]		Margin (dB)	
			Q.P.	AV.	Q.P.	AV.	Q.P.	AV.	Q.P.	AV.
			1	0.198	0.11	44.43	-	44.54	-	63.70
2	0.291	0.11	33.25	-	33.36	-	60.50	50.50	-27.14	-
3	1.387	0.25	32.85	-	33.10	-	56.00	46.00	-22.90	-
4	3.410	0.35	25.61	-	25.96	-	56.00	46.00	-30.04	-
5	9.996	0.54	31.81	-	32.35	-	60.00	50.00	-27.65	-
6	13.457	0.55	32.39	-	32.94	-	60.00	50.00	-27.06	-

- REMARKS:**
1. Q.P. and AV. are abbreviations of quasi-peak and average individually.
  2. "-": The Quasi-peak reading value also meets average limit and measurement with the average detector is unnecessary.
  3. The emission levels of other frequencies were very low against the limit.
  4. Margin value = Emission level - Limit value
  5. Correction factor = Insertion loss + Cable loss
  6. Emission Level = Correction Factor + Reading Value.

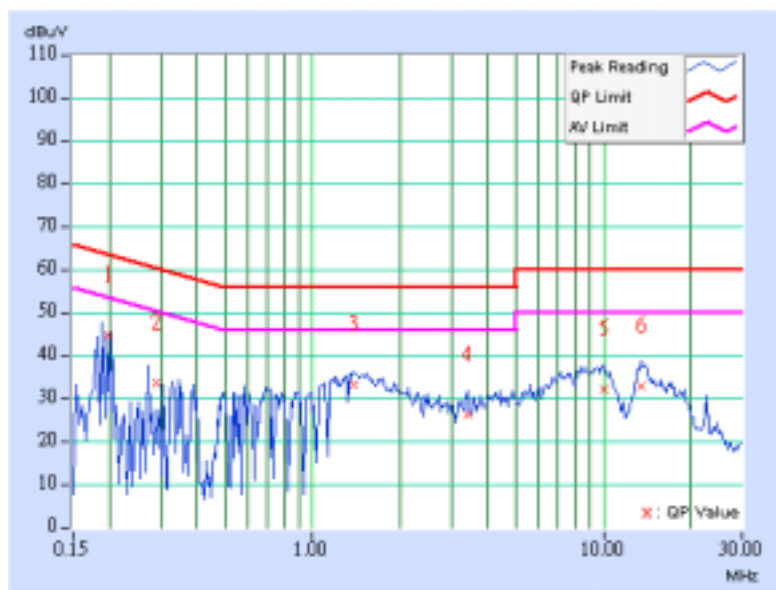



<b>EUT</b>	Wireless-G USB Network Adapter with RangeBooster	<b>MEASUREMENT DETAIL</b>	
<b>MODEL</b>	WUSB54GR	<b>PHASE</b>	Line 2
<b>CHANNEL</b>	Channel 11	<b>6dB BANDWIDTH</b>	9 kHz
<b>MODULATION TYPE</b>	BPSK	<b>ENVIRONMENTAL CONDITIONS</b>	25deg. C, 65%RH, 991hPa
<b>TRANSFER RATE</b>	6Mbps	<b>INPUT POWER (SYSTEM)</b>	120Vac, 60 Hz
<b>TESTED BY</b>	Long Chen		

No	Freq. [MHz]	Corr. Factor (dB)	Reading Value		Emission Level		Limit		Margin	
			[dB (uV)]		[dB (uV)]		[dB (uV)]		(dB)	
			Q.P.	AV.	Q.P.	AV.	Q.P.	AV.	Q.P.	AV.
1	0.193	0.11	45.23	-	45.34	-	63.91	53.91	-18.57	-
2	0.392	0.11	31.56	-	31.67	-	58.02	48.02	-26.35	-
3	1.469	0.25	27.92	-	28.17	-	56.00	46.00	-27.83	-
4	4.836	0.40	24.68	-	25.08	-	56.00	46.00	-30.92	-
5	10.168	0.44	30.70	-	31.14	-	60.00	50.00	-28.86	-
6	13.504	0.45	31.62	-	32.07	-	60.00	50.00	-27.93	-

- REMARKS:**
1. Q.P. and AV. are abbreviations of quasi-peak and average individually.
  2. "-": The Quasi-peak reading value also meets average limit and measurement with the average detector is unnecessary.
  3. The emission levels of other frequencies were very low against the limit.
  4. Margin value = Emission level - Limit value
  5. Correction factor = Insertion loss + Cable loss
  6. Emission Level = Correction Factor + Reading Value.

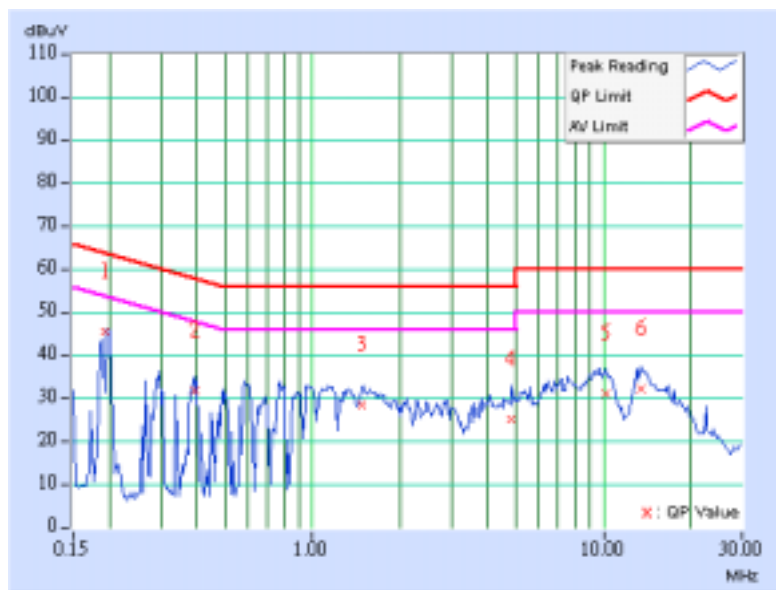



## 4.2 RADIATED EMISSION MEASUREMENT

### 4.2.1 LIMITS OF RADIATED EMISSION MEASUREMENT

Emissions radiated outside of the specified bands, shall be according to the general radiated limits in 15.209 as following:

Frequencies (MHz)	Field strength (microvolts/meter)	Measurement distance (meters)
0.009-0.490	2400/F(kHz)	300
0.490-1.705	24000/F(kHz)	30
1.705-30.0	30	30
30-88	100	3
88-216	150	3
216-960	200	3
Above 960	500	3

**NOTE:**

1. The lower limit shall apply at the transition frequencies.
2. Emission level (dBuV/m) = 20 log Emission level (uV/m).
3. As shown in 15.35(b), for frequencies above 1000MHz, the field strength limits are based on average detector, however, the peak field strength of any emission shall not exceed the maximum permitted average limits, specified above by more than 20dB under any condition of modulation.



#### 4.2.2 TEST INSTRUMENTS

DESCRIPTION & MANUFACTURER	MODEL NO.	SERIAL NO.	CALIBRATED UNTIL
Test Receiver ROHDE & SCHWARZ	ESI7	838496/016	Jan. 07, 2006
Spectrum Analyzer ROHDE & SCHWARZ	FSP40	100041	Dec. 04, 2006
BILOG Antenna SCHWARZBECK	VULB9168	9168-155	Jan. 22, 2006
HORN Antenna SCHWARZBECK	BBHA 9120D	9120D-404	Jan. 05, 2006
HORN Antenna SCHWARZBECK	BBHA 9170	BBHA 9170242	Jan. 23, 2006
Preamplifier Agilent	8449B	3008A01960	Nov. 09, 2006
RF signal cable HUBER+SUHNNER	SUCOFLEX 104	219272/4	Jan. 26, 2006
RF signal cable HUBER+SUHNNER	SUCOFLEX 104	219275/4	Jan. 26, 2006
Software ADT.	ADT_Radiated_V5.14	NA	NA
Antenna Tower inn-co GmbH	MA 4000	010303	NA
Antenna Tower Controller inn-co GmbH	CO2000	019303	NA
Turn Table ADT.	TT100.	TT93021704	NA
Turn Table Controller ADT.	SC100.	SC93021704	NA

- NOTE:**
1. The calibration interval of the above test instruments is 12 months and the calibrations are traceable to NML/ROC and NIST/USA.
  2. The test was performed in HwaYa Chamber 3.
  3. The horn antenna and HP preamplifier (model: 8449B) are used only for the measurement of emission frequency above 1GHz if tested.
  4. The IC Site Registration No. is IC4924-4.



#### 4.2.3 TEST PROCEDURES

- a. The EUT was placed on the top of a rotating table 0.8 meters above the ground at a 3 meter semi-anechoic chamber. The table was rotated 360 degrees to determine the position of the highest radiation.
- b. The EUT was set 3 meters away from the interference-receiving antenna, which was mounted on the top of a variable-height antenna tower.
- c. The antenna is a broadband antenna, and its height is varied from one meter to four meters above the ground to determine the maximum value of the field strength. Both horizontal and vertical polarizations of the antenna are set to make the measurement.
- d. For each suspected emission, the EUT was arranged to its worst case and then the antenna was tuned to heights from 1 meter to 4 meters and the rotatable table was turned from 0 degrees to 360 degrees to find the maximum reading.
- e. The test-receiver system was set to Peak Detect Function and Specified Bandwidth with Maximum Hold Mode.
- f. If the emission level of the EUT in peak mode was lower than the limit specified, then testing could be stopped and the peak values of the EUT would be reported. Otherwise the emissions would be re-tested one by one using peak, quasi-peak or average method as specified and then reported in a data sheet.

**NOTE:**

1. The resolution bandwidth and video bandwidth of test receiver/spectrum analyzer is 120kHz for Peak detection (PK) and Quasi-peak detection (QP) at frequency below 1GHz.
2. The resolution bandwidth and video bandwidth of test receiver/spectrum analyzer is 1 MHz for Peak detection at frequency above 1GHz.
3. The resolution bandwidth of test receiver/spectrum analyzer is 1 MHz and the video bandwidth is 10Hz for Average detection (AV) at frequency above 1GHz.

#### 4.2.4 DEVIATION FROM TEST STANDARD

No deviation

#### 4.2.5 TEST SETUP

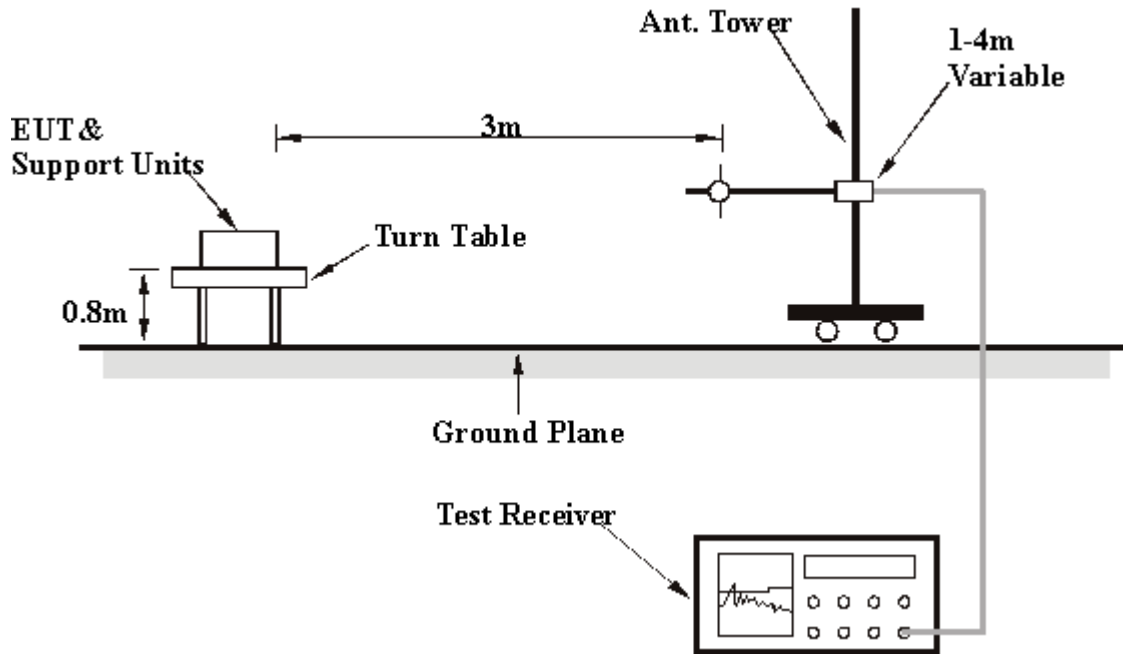

For the actual test configuration, please refer to the related item – Photographs of the Test Configuration.

#### 4.2.6 EUT OPERATING CONDITIONS

Same as 4.1.6



## 4.2.7 TEST RESULTS

**RADIATED WORST-CASE DATA: BELOW 1GHz**

<b>EUT</b>	Wireless-G USB Network Adapter with RangeBooster	<b>MEASUREMENT DETAIL</b>	
<b>MODEL</b>	WUSB54GR	<b>FREQUENCY RANGE</b>	Below 1000MHz
<b>CHANNEL</b>	Channel 11	<b>DETECTOR FUNCTION</b>	Quasi-Peak
<b>MODULATION TYPE</b>	BPSK	<b>ENVIRONMENTAL CONDITIONS</b>	22deg. C, 62%RH, 991hPa
<b>TRANSFER RATE</b>	6Mbps	<b>INPUT POWER (SYSTEM)</b>	120Vac, 60 Hz
<b>TESTED BY</b>	Brad Wu		

**ANTENNA POLARITY & TEST DISTANCE: HORIZONTAL AT 3 M**

No.	Freq. (MHz)	Emission Level (dBuV/m)	Limit (dBuV/m)	Margin (dB)	Antenna Height (m)	Table Angle (Degree)	Raw Value (dBuV)	Correction Factor (dB/m)
1	113.59	32.24 QP	43.50	-11.26	1.50 H	103	20.00	12.23
2	164.13	30.68 QP	43.50	-12.82	1.50 H	115	16.16	14.52
3	401.28	31.53 QP	46.00	-14.47	1.00 H	112	14.77	16.76
4	531.52	24.54 QP	46.00	-21.46	3.00 H	112	5.41	19.13
5	667.60	26.02 QP	46.00	-19.98	3.00 H	199	4.36	21.66
6	811.44	28.00 QP	46.00	-18.00	2.00 H	118	4.44	23.56

**ANTENNA POLARITY & TEST DISTANCE: VERTICAL AT 3 M**

No.	Freq. (MHz)	Emission Level (dBuV/m)	Limit (dBuV/m)	Margin (dB)	Antenna Height (m)	Table Angle (Degree)	Raw Value (dBuV)	Correction Factor (dB/m)
1	125.25	33.42 QP	43.50	-10.08	1.00 V	271	20.15	13.27
2	166.07	33.41 QP	43.50	-10.09	1.00 V	64	19.09	14.32
3	391.56	34.41 QP	46.00	-11.59	1.00 V	148	17.89	16.53
4	533.47	26.99 QP	46.00	-19.01	1.00 V	88	7.83	19.17
5	805.61	27.68 QP	46.00	-18.32	1.50 V	181	4.17	23.51
6	863.93	27.30 QP	46.00	-18.70	1.50 V	10	3.14	24.16

- REMARKS:**
1. Emission level(dBuV/m)=Raw Value(dBuV) + Correction Factor(dB/m)
  2. Correction Factor(dB/m) = Antenna Factor (dB/m) + Cable Factor (dB)
  3. The other emission levels were very low against the limit.
  4. Margin value = Emission level – Limit value.





### 802.11b DSSS MODULATION

<b>EUT</b>	Wireless-G USB Network Adapter with RangeBooster	<b>MEASUREMENT DETAIL</b>	
<b>MODEL</b>	WUSB54GR	<b>FREQUENCY RANGE</b>	1 ~ 25GHz
<b>CHANNEL</b>	Channel 6	<b>DETECTOR FUNCTION</b>	Peak(PK) Average (AV)
<b>MODULATION TYPE</b>	BPSK	<b>ENVIRONMENTAL CONDITIONS</b>	21deg. C, 64%RH, 991hPa
<b>TRANSFER RATE</b>	1Mbps	<b>INPUT POWER (SYSTEM)</b>	120Vac, 60 Hz
<b>TEST MODE</b>	A	<b>TESTED BY</b>	Brad Wu

#### ANTENNA POLARITY & TEST DISTANCE: HORIZONTAL AT 3 M

No.	Freq. (MHz)	Emission Level (dBuV/m)	Limit (dBuV/m)	Margin (dB)	Antenna Height (m)	Table Angle (Degree)	Raw Value (dBuV)	Correction Factor (dB/m)
1	1624.00	50.82 PK	74.00	-23.18	1.16 H	214	20.43	30.39
1	1624.00	49.13 AV	54.00	-4.87	1.16 H	214	18.74	30.39
2	2437.00	103.85 PK			1.44 H	50	71.18	32.67
2	2437.00	100.57 AV			1.44 H	50	67.90	32.67
3	4874.00	49.54 PK	74.00	-24.46	1.10 H	222	9.49	40.05
3	4874.00	39.02 AV	54.00	-14.98	1.10 H	222	-1.03	40.05

#### ANTENNA POLARITY & TEST DISTANCE: VERTICAL AT 3 M

No.	Freq. (MHz)	Emission Level (dBuV/m)	Limit (dBuV/m)	Margin (dB)	Antenna Height (m)	Table Angle (Degree)	Raw Value (dBuV)	Correction Factor (dB/m)
1	1624.00	45.73 PK	74.00	-28.27	1.25 V	186	15.34	30.39
1	1624.00	44.05 AV	54.00	-9.95	1.25 V	186	13.66	30.39
2	2437.00	108.22 PK			1.00 V	76	75.55	32.67
2	2437.00	104.22 AV			1.00 V	76	71.55	32.67
3	4874.00	49.16 PK	74.00	-24.84	1.01 V	203	9.11	40.05
3	4874.00	38.61 AV	54.00	-15.39	1.01 V	203	-1.44	40.05

- REMARKS:**
1. Emission level(dBuV/m)=Raw Value(dBuV) + Correction Factor(dB/m)
  2. Correction Factor(dB/m) = Antenna Factor (dB/m) + Cable Factor (dB)
  3. The other emission levels were very low against the limit.
  4. Margin value = Emission level – Limit value.
  5. “ \* “ : Fundamental frequency.



<b>EUT</b>	Wireless-G USB Network Adapter with RangeBooster	<b>MEASUREMENT DETAIL</b>	
<b>MODEL</b>	WUSB54GR	<b>FREQUENCY RANGE</b>	1 ~ 25GHz
<b>CHANNEL</b>	Channel 1	<b>DETECTOR FUNCTION</b>	Peak(PK) Average (AV)
<b>MODULATION TYPE</b>	BPSK	<b>ENVIRONMENTAL CONDITIONS</b>	22deg. C, 62%RH, 991hPa
<b>TRANSFER RATE</b>	1Mbps	<b>INPUT POWER (SYSTEM)</b>	120Vac, 60 Hz
<b>TEST MODE</b>	B	<b>TESTED BY</b>	Brad Wu

#### ANTENNA POLARITY & TEST DISTANCE: HORIZONTAL AT 3 M

No.	Freq. (MHz)	Emission Level (dBuV/m)	Limit (dBuV/m)	Margin (dB)	Antenna Height (m)	Table Angle (Degree)	Raw Value (dBuV)	Correction Factor (dB/m)
1	1608.00	47.36 PK	74.00	-26.64	1.09 H	322	17.02	30.34
1	1608.00	50.28 AV	54.00	-3.72	1.09 H	322	19.94	30.34
2	2390.00	54.02 PK	74.00	-19.98	1.27 H	355	21.46	32.56
2	2390.00	50.78 AV	54.00	-3.22	1.27 H	355	18.22	32.56
3	*2412.00	108.72 PK			1.27 H	355	76.11	32.61
3	*2412.00	104.48 AV			1.27 H	355	71.87	32.61
4	2492.00	61.29 PK	74.00	-12.71	1.30 H	354	28.48	32.81
4	<b>2492.00</b>	<b>52.84 AV</b>	<b>54.00</b>	<b>-1.16</b>	<b>1.30 H</b>	<b>354</b>	<b>20.03</b>	<b>32.81</b>
5	4824.00	51.48 PK	74.00	-22.52	1.01 H	14	11.64	39.84
5	4824.00	43.38 AV	54.00	-10.62	1.01 H	14	3.54	39.84

#### ANTENNA POLARITY & TEST DISTANCE: VERTICAL AT 3 M

No.	Freq. (MHz)	Emission Level (dBuV/m)	Limit (dBuV/m)	Margin (dB)	Antenna Height (m)	Table Angle (Degree)	Raw Value (dBuV)	Correction Factor (dB/m)
1	1608.00	54.65 PK	74.00	-19.35	1.00 V	323	24.31	30.34
1	1608.00	44.71 AV	54.00	-9.29	1.00 V	323	14.37	30.34
2	2390.00	48.63 PK	74.00	-25.37	1.29 V	197	16.07	32.56
2	2390.00	45.27 AV	54.00	-8.73	1.29 V	197	12.71	32.56
3	*2412.00	104.33 PK			1.29 V	197	71.72	32.61
3	*2412.00	100.97 AV			1.29 V	197	68.36	32.61
4	4824.00	51.95 PK	74.00	-22.05	1.08 V	166	12.11	39.84
4	4824.00	41.09 AV	54.00	-12.91	1.08 V	166	1.25	39.84

- REMARKS:**
1. Emission level(dBuV/m)=Raw Value(dBuV) + Correction Factor(dB/m)
  2. Correction Factor(dB/m) = Antenna Factor (dB/m) + Cable Factor (dB)
  3. The other emission levels were very low against the limit.
  4. Margin value = Emission level – Limit value.
  5. “ \* “ : Fundamental frequency.



<b>EUT</b>	Wireless-G USB Network Adapter with RangeBooster	<b>MEASUREMENT DETAIL</b>	
<b>MODEL</b>	WUSB54GR	<b>FREQUENCY RANGE</b>	1 ~ 25GHz
<b>CHANNEL</b>	Channel 6	<b>DETECTOR FUNCTION</b>	Peak(PK) Average (AV)
<b>MODULATION TYPE</b>	BPSK	<b>ENVIRONMENTAL CONDITIONS</b>	22deg. C, 62%RH, 991hPa
<b>TRANSFER RATE</b>	1Mbps	<b>INPUT POWER (SYSTEM)</b>	120Vac, 60 Hz
<b>TEST MODE</b>	B	<b>TESTED BY</b>	Brad Wu

#### ANTENNA POLARITY & TEST DISTANCE: HORIZONTAL AT 3 M

No.	Freq. (MHz)	Emission Level (dBuV/m)	Limit (dBuV/m)	Margin (dB)	Antenna Height (m)	Table Angle (Degree)	Raw Value (dBuV)	Correction Factor (dB/m)
1	1624.00	57.48 PK	74.00	-16.52	1.12 H	329	27.09	30.39
1	1624.00	50.42 AV	54.00	-3.58	1.12 H	329	20.03	30.39
2	2360.00	62.02 PK	74.00	-11.98	1.32 H	189	29.54	32.48
2	2360.00	52.77 AV	54.00	-1.23	1.32 H	189	20.29	32.48
3	*2437.00	110.82 PK			1.32 H	189	78.15	32.67
3	*2437.00	107.45 AV			1.32 H	189	74.78	32.67
4	4874.00	50.03 PK	74.00	-23.97	1.00 H	68	9.98	40.05
4	4874.00	39.45 AV	54.00	-14.55	1.00 H	68	-0.60	40.05

#### ANTENNA POLARITY & TEST DISTANCE: VERTICAL AT 3 M

No.	Freq. (MHz)	Emission Level (dBuV/m)	Limit (dBuV/m)	Margin (dB)	Antenna Height (m)	Table Angle (Degree)	Raw Value (dBuV)	Correction Factor (dB/m)
1	1624.00	55.72 PK	74.00	-18.28	1.02 V	335	25.33	30.39
1	1624.00	45.85 AV	54.00	-8.15	1.02 V	335	15.46	30.39
2	*2437.00	105.64 PK			1.30 V	199	72.97	32.67
2	*2437.00	102.32 AV			1.30 V	199	69.65	32.67
3	4874.00	52.14 PK	74.00	-21.86	1.10 V	168	12.09	40.05
3	4874.00	41.25 AV	54.00	-12.75	1.10 V	168	1.20	40.05

- REMARKS:**
1. Emission level(dBuV/m)=Raw Value(dBuV) + Correction Factor(dB/m)
  2. Correction Factor(dB/m) = Antenna Factor (dB/m) + Cable Factor (dB)
  3. The other emission levels were very low against the limit.
  4. Margin value = Emission level – Limit value.
  5. “ \* “ : Fundamental frequency.



<b>EUT</b>	Wireless-G USB Network Adapter with RangeBooster	<b>MEASUREMENT DETAIL</b>	
<b>MODEL</b>	WUSB54GR	<b>FREQUENCY RANGE</b>	1 ~ 25GHz
<b>CHANNEL</b>	Channel 11	<b>DETECTOR FUNCTION</b>	Peak(PK) Average (AV)
<b>MODULATION TYPE</b>	BPSK	<b>ENVIRONMENTAL CONDITIONS</b>	22deg. C, 62%RH, 991hPa
<b>TRANSFER RATE</b>	1Mbps	<b>INPUT POWER (SYSTEM)</b>	120Vac, 60 Hz
<b>TEST MODE</b>	B	<b>TESTED BY</b>	Brad Wu

#### ANTENNA POLARITY & TEST DISTANCE: HORIZONTAL AT 3 M

No.	Freq. (MHz)	Emission Level (dBuV/m)	Limit (dBuV/m)	Margin (dB)	Antenna Height (m)	Table Angle (Degree)	Raw Value (dBuV)	Correction Factor (dB/m)
1	1641.00	57.21 PK	87.42	-30.21	1.05 H	317	26.76	30.45
1	1641.00	50.17 AV	83.89	-33.72	1.05 H	317	19.72	30.45
2	2385.00	61.99 PK	74.00	-12.01	1.04 H	186	29.45	32.54
2	2385.00	52.61 AV	54.00	-1.39	1.04 H	186	20.07	32.54
3	*2462.00	107.42 PK			1.04 H	186	74.68	32.73
3	*2462.00	103.89 AV			1.04 H	186	71.15	32.73
4	2483.50	51.88 PK	74.00	-22.12	1.04 H	186	19.09	32.79
4	2483.50	48.35 AV	54.00	-5.65	1.04 H	186	15.56	32.79
5	4924.00	48.56 PK	74.00	-25.44	1.04 H	219	8.29	40.27
5	4924.00	40.35 AV	54.00	-13.65	1.04 H	219	0.08	40.27

#### ANTENNA POLARITY & TEST DISTANCE: VERTICAL AT 3 M

No.	Freq. (MHz)	Emission Level (dBuV/m)	Limit (dBuV/m)	Margin (dB)	Antenna Height (m)	Table Angle (Degree)	Raw Value (dBuV)	Correction Factor (dB/m)
1	1641.00	54.25 PK	83.15	-28.90	1.01 V	317	23.80	30.45
1	1641.00	44.29 AV	79.72	-35.43	1.01 V	317	13.84	30.45
2	*2462.00	103.15 PK			1.30 V	204	70.42	32.73
2	*2462.00	99.72 AV			1.30 V	204	66.98	32.73
3	2483.50	47.61 PK	74.00	-26.39	1.04 V	186	14.82	32.79
3	2483.50	44.18 AV	54.00	-9.82	1.04 V	186	11.39	32.79
4	4924.00	51.87 PK	74.00	-22.13	1.02 V	141	11.60	40.27
4	4924.00	40.95 AV	54.00	-13.05	1.02 V	141	0.68	40.27

- REMARKS:**
1. Emission level(dBuV/m)=Raw Value(dBuV) + Correction Factor(dB/m)
  2. Correction Factor(dB/m) = Antenna Factor (dB/m) + Cable Factor (dB)
  3. The other emission levels were very low against the limit.
  4. Margin value = Emission level – Limit value.
  5. “ \* “ : Fundamental frequency.



### 802.11g OFDM MODULATION

<b>EUT</b>	Wireless-G USB Network Adapter with RangeBooster	<b>MEASUREMENT DETAIL</b>	
<b>MODEL</b>	WUSB54GR	<b>FREQUENCY RANGE</b>	1 ~ 25GHz
<b>CHANNEL</b>	Channel 1	<b>DETECTOR FUNCTION</b>	Peak(PK) Average (AV)
<b>MODULATION TYPE</b>	BPSK	<b>ENVIRONMENTAL CONDITIONS</b>	21deg. C, 64%RH, 991hPa
<b>TRANSFER RATE</b>	6Mbps	<b>INPUT POWER (SYSTEM)</b>	120Vac, 60 Hz
<b>TEST MODE</b>	A	<b>TESTED BY</b>	Brad Wu

#### ANTENNA POLARITY & TEST DISTANCE: HORIZONTAL AT 3 M

No.	Freq. (MHz)	Emission Level (dBuV/m)	Limit (dBuV/m)	Margin (dB)	Antenna Height (m)	Table Angle (Degree)	Raw Value (dBuV)	Correction Factor (dB/m)
1	1608.00	48.21 PK	74.00	-25.79	1.04 H	132	17.87	30.34
1	1608.00	34.96 AV	54.00	-19.04	1.04 H	132	4.62	30.34
2	2390.00	57.22 PK	74.00	-16.78	1.45 H	52	24.66	32.56
2	2390.00	48.20 AV	54.00	-5.80	1.45 H	52	15.64	32.56
3	*2412.00	104.22 PK			1.45 H	52	71.61	32.61
3	*2412.00	94.55 AV			1.45 H	52	61.94	32.61
4	4824.00	53.26 PK	74.00	-20.74	1.12 H	215	13.42	39.84
4	4824.00	40.87 AV	54.00	-13.13	1.12 H	215	1.03	39.84

#### ANTENNA POLARITY & TEST DISTANCE: VERTICAL AT 3 M

No.	Freq. (MHz)	Emission Level (dBuV/m)	Limit (dBuV/m)	Margin (dB)	Antenna Height (m)	Table Angle (Degree)	Raw Value (dBuV)	Correction Factor (dB/m)
1	1608.00	46.05 PK	74.00	-27.95	1.00 V	170	15.72	30.34
1	1608.00	32.85 AV	54.00	-21.15	1.00 V	170	2.52	30.34
2	2390.00	62.50 PK	74.00	-11.50	1.59 V	2	29.94	32.56
2	2390.00	48.50 AV	54.00	-5.50	1.59 V	2	15.94	32.56
3	*2412.00	107.25 PK			1.59 V	2	74.64	32.61
3	*2412.00	98.90 AV			1.59 V	2	66.29	32.61
4	4824.00	51.05 PK	74.00	-22.95	1.03 V	145	11.21	39.84
4	4824.00	38.78 AV	54.00	-15.22	1.03 V	145	-1.06	39.84

- REMARKS:**
1. Emission level(dBuV/m)=Raw Value(dBuV) + Correction Factor(dB/m)
  2. Correction Factor(dB/m) = Antenna Factor (dB/m) + Cable Factor (dB)
  3. The other emission levels were very low against the limit.
  4. Margin value = Emission level – Limit value.
  5. “ \* “ : Fundamental frequency.



<b>EUT</b>	Wireless-G USB Network Adapter with RangeBooster	<b>MEASUREMENT DETAIL</b>	
<b>MODEL</b>	WUSB54GR	<b>FREQUENCY RANGE</b>	1 ~ 25GHz
<b>CHANNEL</b>	Channel 1	<b>DETECTOR FUNCTION</b>	Peak(PK) Average (AV)
<b>MODULATION TYPE</b>	BPSK	<b>ENVIRONMENTAL CONDITIONS</b>	22deg. C, 62%RH, 991hPa
<b>TRANSFER RATE</b>	6Mbps	<b>INPUT POWER (SYSTEM)</b>	120Vac, 60 Hz
<b>TEST MODE</b>	B	<b>TESTED BY</b>	Brad Wu

#### ANTENNA POLARITY & TEST DISTANCE: HORIZONTAL AT 3 M

No.	Freq. (MHz)	Emission Level (dBuV/m)	Limit (dBuV/m)	Margin (dB)	Antenna Height (m)	Table Angle (Degree)	Raw Value (dBuV)	Correction Factor (dB/m)
1	1608.00	44.21 PK	74.00	-29.79	1.12 H	317	15.43	28.78
1	1608.00	37.12 AV	54.00	-16.88	1.12 H	317	8.34	28.78
2	2337.00	59.15 PK	74.00	-14.85	1.25 H	147	27.35	31.80
2	2337.00	49.25 AV	54.00	-4.75	1.25 H	147	17.45	31.80
3	2390.00	65.55 PK	74.00	-8.45	1.24 H	330	33.51	32.04
3	2390.00	51.46 AV	54.00	-2.54	1.24 H	330	19.42	32.04
4	*2412.00	109.87 PK			1.24 H	161	77.74	32.13
4	*2412.00	100.87 AV			1.24 H	161	68.74	32.13
5	4824.00	63.66 PK	74.00	-10.34	1.08 H	166	25.46	38.20
5	4824.00	51.69 AV	54.00	-2.31	1.08 H	166	13.49	38.20

#### ANTENNA POLARITY & TEST DISTANCE: VERTICAL AT 3 M

No.	Freq. (MHz)	Emission Level (dBuV/m)	Limit (dBuV/m)	Margin (dB)	Antenna Height (m)	Table Angle (Degree)	Raw Value (dBuV)	Correction Factor (dB/m)
1	1608.00	44.11 PK	74.00	-29.89	1.03 V	342	15.33	28.78
1	1608.00	34.18 AV	54.00	-19.82	1.03 V	342	5.40	28.78
2	2337.00	52.28 PK	74.00	-21.72	1.44 V	346	20.48	31.80
2	2337.00	41.58 AV	54.00	-12.42	1.44 V	346	9.78	31.80
3	2390.00	57.75 PK	74.00	-16.25	1.13 V	0	25.71	32.04
3	2390.00	4.61 AV	54.00	-49.39	1.13 V	0	-27.43	32.04
4	*2412.00	105.65 PK			1.33 V	0	73.52	32.13
4	*2412.00	96.51 AV			1.33 V	0	64.38	32.13
5	4824.00	59.25 PK	74.00	-14.75	1.00 V	132	21.05	38.20
5	4824.00	46.70 AV	54.00	-7.30	1.00 V	132	8.50	38.20

- REMARKS:**
1. Emission level(dBuV/m)=Raw Value(dBuV) + Correction Factor(dB/m)
  2. Correction Factor(dB/m) = Antenna Factor (dB/m) + Cable Factor (dB)
  3. The other emission levels were very low against the limit.
  4. Margin value = Emission level – Limit value.
  5. “ \* “ : Fundamental frequency.



<b>EUT</b>	Wireless-G USB Network Adapter with RangeBooster	<b>MEASUREMENT DETAIL</b>	
<b>MODEL</b>	WUSB54GR	<b>FREQUENCY RANGE</b>	1 ~ 25GHz
<b>CHANNEL</b>	Channel 6	<b>DETECTOR FUNCTION</b>	Peak(PK) Average (AV)
<b>MODULATION TYPE</b>	BPSK	<b>ENVIRONMENTAL CONDITIONS</b>	22deg. C, 62%RH, 991hPa
<b>TRANSFER RATE</b>	6Mbps	<b>INPUT POWER (SYSTEM)</b>	120Vac, 60 Hz
<b>TEST MODE</b>	B	<b>TESTED BY</b>	Brad Wu

#### ANTENNA POLARITY & TEST DISTANCE: HORIZONTAL AT 3 M

No.	Freq. (MHz)	Emission Level (dBuV/m)	Limit (dBuV/m)	Margin (dB)	Antenna Height (m)	Table Angle (Degree)	Raw Value (dBuV)	Correction Factor (dB/m)
1	1624.00	44.05 PK	74.00	-29.95	1.08 H	325	15.24	28.81
1	1624.00	36.92 AV	54.00	-17.08	1.08 H	325	8.11	28.81
2	2362.00	58.17 PK	74.00	-15.83	1.00 H	98	26.26	31.91
2	2362.00	49.12 AV	54.00	-4.88	1.00 H	98	17.21	31.91
3	*2437.00	109.18 PK			1.16 H	301	76.93	32.25
3	*2437.00	100.36 AV			1.16 H	301	68.11	32.25
4	4874.00	60.56 PK	74.00	-13.44	1.05 H	293	22.24	38.32
4	4874.00	47.63 AV	54.00	-6.37	1.05 H	293	9.31	38.32

#### ANTENNA POLARITY & TEST DISTANCE: VERTICAL AT 3 M

No.	Freq. (MHz)	Emission Level (dBuV/m)	Limit (dBuV/m)	Margin (dB)	Antenna Height (m)	Table Angle (Degree)	Raw Value (dBuV)	Correction Factor (dB/m)
1	1624.00	44.23 PK	74.00	-29.77	1.05 V	317	15.42	28.81
1	1624.00	34.29 AV	54.00	-19.71	1.05 V	317	5.48	28.81
2	2363.00	57.37 PK	74.00	-16.63	1.10 V	330	25.45	31.92
2	2363.00	48.08 AV	54.00	-5.92	1.10 V	330	16.16	31.92
3	*2437.00	106.98 PK			1.07 V	335	74.73	32.25
3	*2437.00	98.00 AV			1.07 V	335	65.75	32.25
4	4874.00	58.93 PK	74.00	-15.07	1.13 V	150	20.61	38.32
4	4874.00	45.22 AV	54.00	-8.78	1.13 V	150	6.90	38.32

- REMARKS:**
1. Emission level(dBuV/m)=Raw Value(dBuV) + Correction Factor(dB/m)
  2. Correction Factor(dB/m) = Antenna Factor (dB/m) + Cable Factor (dB)
  3. The other emission levels were very low against the limit.
  4. Margin value = Emission level – Limit value.
  5. “ \* “ : Fundamental frequency.



<b>EUT</b>	Wireless-G USB Network Adapter with RangeBooster	<b>MEASUREMENT DETAIL</b>	
<b>MODEL</b>	WUSB54GR	<b>FREQUENCY RANGE</b>	1 ~ 25GHz
<b>CHANNEL</b>	Channel 11	<b>DETECTOR FUNCTION</b>	Peak(PK) Average (AV)
<b>MODULATION TYPE</b>	BPSK	<b>ENVIRONMENTAL CONDITIONS</b>	22deg. C, 62%RH, 991hPa
<b>TRANSFER RATE</b>	6Mbps	<b>INPUT POWER (SYSTEM)</b>	120Vac, 60 Hz
<b>TEST MODE</b>	B	<b>TESTED BY</b>	Brad Wu

#### ANTENNA POLARITY & TEST DISTANCE: HORIZONTAL AT 3 M

No.	Freq. (MHz)	Emission Level (dBuV/m)	Limit (dBuV/m)	Margin (dB)	Antenna Height (m)	Table Angle (Degree)	Raw Value (dBuV)	Correction Factor (dB/m)
1	1641.00	45.62 PK	89.70	-44.08	1.23 H	215	16.77	28.85
1	1641.00	38.35 AV	80.85	-42.50	1.23 H	215	9.50	28.85
2	2383.00	61.55 PK	74.00	-12.45	1.15 H	26	29.54	32.01
2	2383.00	51.36 AV	54.00	-2.64	1.15 H	26	19.35	32.01
3	*2462.00	109.70 PK			1.40 H	18	77.34	32.36
3	*2462.00	100.85 AV			1.40 H	18	68.49	32.36
4	2483.50	65.51 PK	74.00	-8.49	1.38 H	38	33.05	32.46
4	2483.50	51.48 AV	54.00	-2.52	1.38 H	38	19.02	32.46
5	4924.00	58.14 PK	74.00	-15.86	1.00 H	39	19.68	38.46
5	4924.00	45.34 AV	54.00	-8.66	1.00 H	39	6.88	38.46

#### ANTENNA POLARITY & TEST DISTANCE: VERTICAL AT 3 M

No.	Freq. (MHz)	Emission Level (dBuV/m)	Limit (dBuV/m)	Margin (dB)	Antenna Height (m)	Table Angle (Degree)	Raw Value (dBuV)	Correction Factor (dB/m)
1	1641.00	44.29 PK	84.58	-40.29	1.09 V	257	15.44	28.85
1	1641.00	34.36 AV	75.66	-41.30	1.09 V	257	5.51	28.85
2	2385.00	59.18 PK	74.00	-14.82	1.34 V	104	27.17	32.01
2	2385.00	49.36 AV	54.00	-4.64	1.34 V	104	17.35	32.01
3	*2462.00	104.58 PK			1.26 V	230	72.22	32.36
3	*2462.00	95.66 AV			1.26 V	230	63.30	32.36
4	2483.50	58.87 PK	74.00	-15.13	1.26 V	230	26.41	32.46
4	2483.50	48.02 AV	54.00	-5.98	1.26 V	230	15.56	32.46
5	4924.00	50.07 PK	74.00	-23.93	1.58 V	277	11.61	38.46
5	4924.00	37.01 AV	54.00	-16.99	1.58 V	277	-1.45	38.46

- REMARKS:**
1. Emission level(dBuV/m)=Raw Value(dBuV) + Correction Factor(dB/m)
  2. Correction Factor(dB/m) = Antenna Factor (dB/m) + Cable Factor (dB)
  3. The other emission levels were very low against the limit.
  4. Margin value = Emission level – Limit value.
  5. “ \* “ : Fundamental frequency.





### 4.3 6dB BANDWIDTH MEASUREMENT

#### 4.3.1 LIMITS OF 6dB BANDWIDTH MEASUREMENT

The minimum of 6dB Bandwidth Measurement is 0.5 MHz.

#### 4.3.2 TEST INSTRUMENTS

Description & Manufacturer	Model No.	Serial No.	Calibrated Until
SPECTRUM ANALYZER	FSEK30	100049	Aug. 14, 2006

**NOTE:** The calibration interval of the above test instruments is 12 months and the calibrations are traceable to NML/ROC and NIST/USA.

#### 4.3.3 TEST PROCEDURE

The transmitter output was connected to the spectrum analyzer through an attenuator. The bandwidth of the fundamental frequency was measured by spectrum analyzer with 100 kHz RBW and 100kHz VBW. The 6dB bandwidth is defined as the total spectrum the power of which is higher than peak power minus 6dB.

#### 4.3.4 DEVIATION FROM TEST STANDARD

No deviation

#### 4.3.5 TEST SETUP

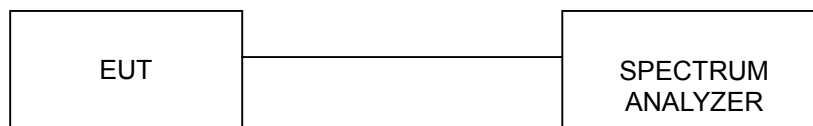

For the actual test configuration, please refer to the related Item – Photographs of the Test Configuration.

#### 4.3.6 EUT OPERATING CONDITIONS

The software provided by client to enable the EUT under transmission condition continuously at lowest, middle and highest channel frequencies individually.



4.3.7 TEST RESULTS

802.11b DSSS MODULATION

<b>EUT</b>	Wireless-G USB Network Adapter with RangeBooster	<b>MODEL</b>	WUSB54GR
<b>MODULATION TYPE</b>	BPSK	<b>TRANSFER RATE</b>	1Mbps
<b>INPUT POWER (SYSTEM)</b>	120Vac, 60 Hz	<b>ENVIRONMENTAL CONDITIONS</b>	23deg.C, 60%RH, 991hPa
<b>TESTED BY</b>	Brad Wu		

<b>CHANNEL</b>	<b>CHANNEL FREQUENCY (MHz)</b>	<b>6dB BANDWIDTH (MHz)</b>	<b>MINIMUM LIMIT (MHz)</b>	<b>PASS/FAIL</b>
1	2412	12.20	0.5	PASS
6	2437	12.00	0.5	PASS
11	2462	12.12	0.5	PASS



CH1

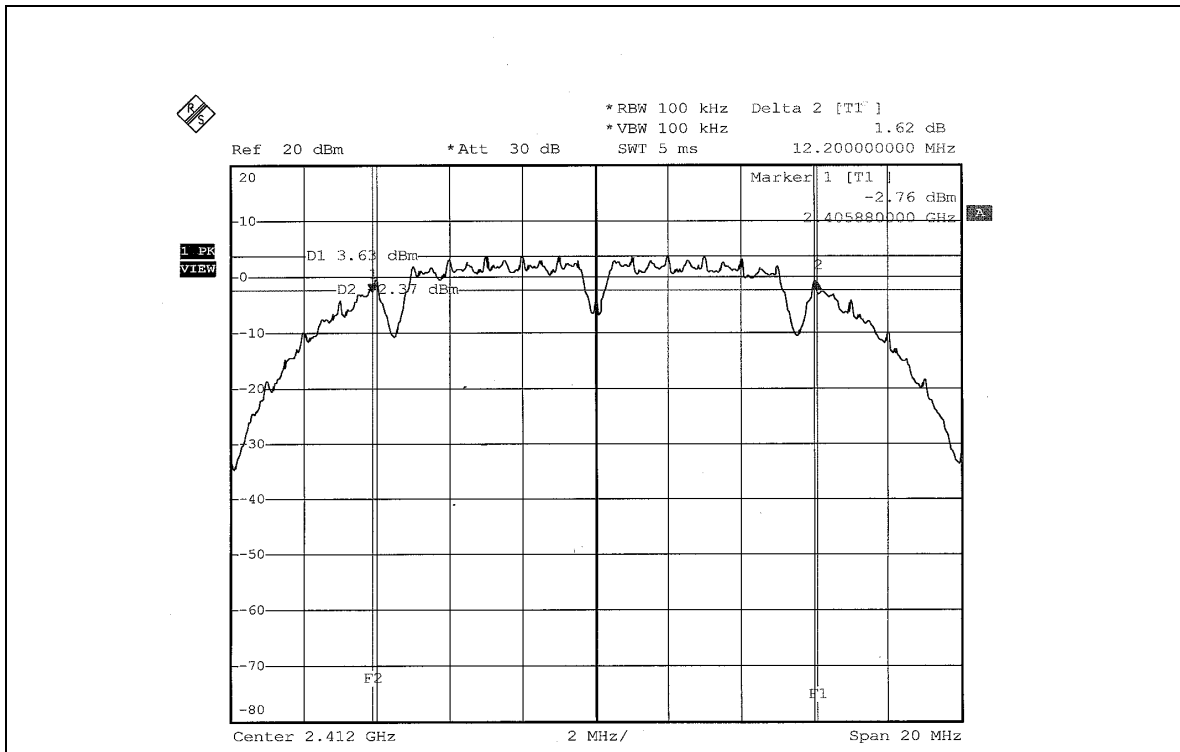

CH6

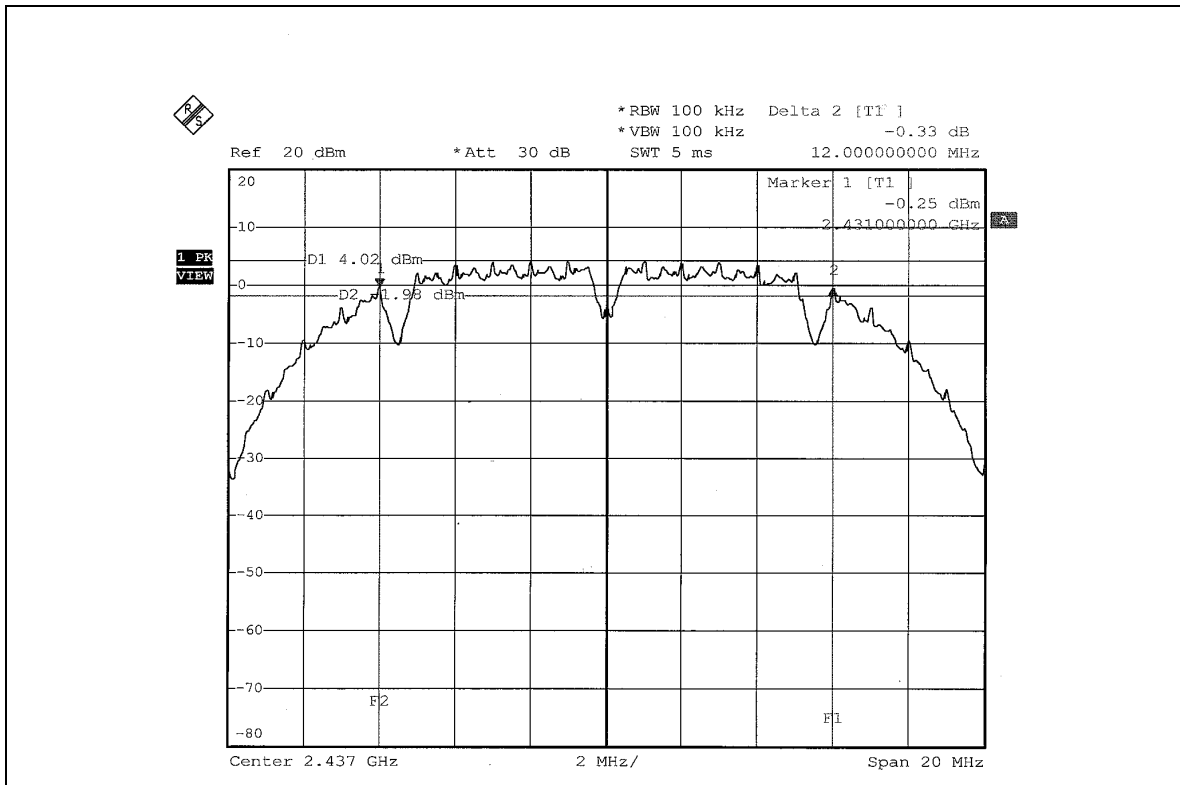



CH11

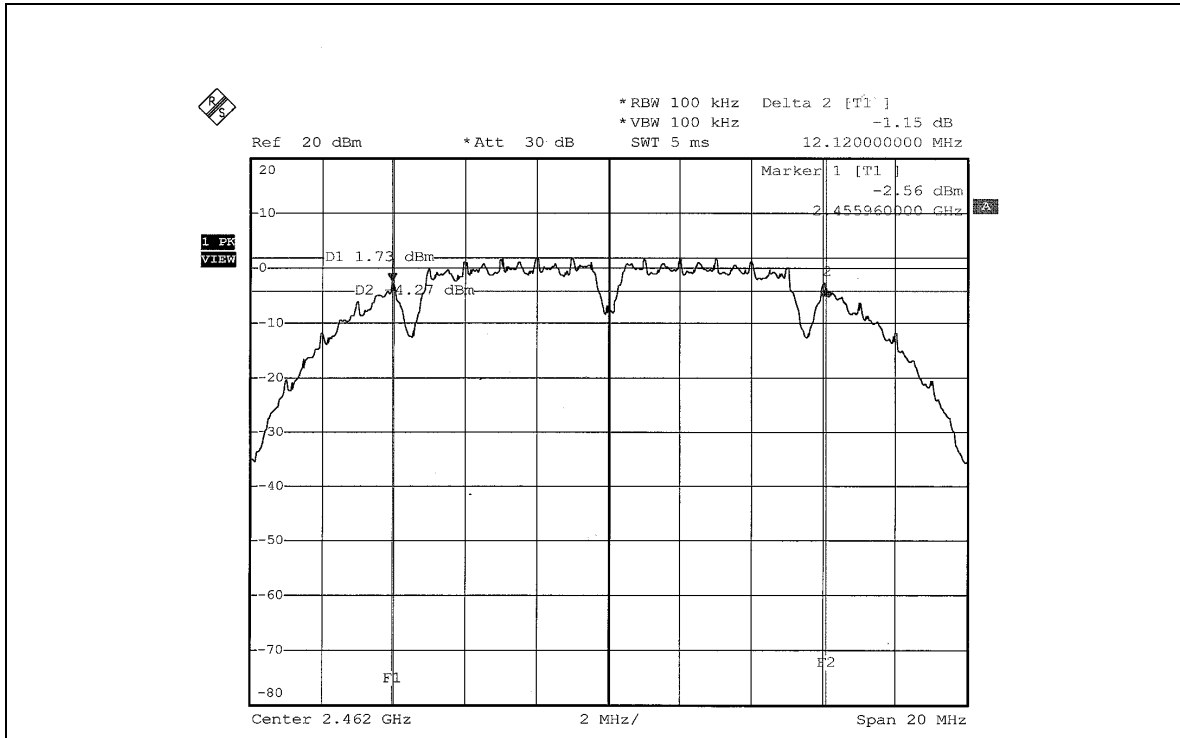

**802.11g OFDM MODULATION**

<b>EUT</b>	Wireless-G USB Network Adapter with RangeBooster	<b>MODEL</b>	WUSB54GR
<b>MODULATION TYPE</b>	BPSK	<b>TRANSFER RATE</b>	6Mbps
<b>INPUT POWER (SYSTEM)</b>	120Vac, 60 Hz	<b>ENVIRONMENTAL CONDITIONS</b>	23deg.C, 60%RH, 991hPa
<b>TESTED BY</b>	Brad Wu		

<b>CHANNEL</b>	<b>CHANNEL FREQUENCY (MHz)</b>	<b>6 dB BANDWIDTH (MHz)</b>	<b>MINIMUM LIMIT (MHz)</b>	<b>PASS/FAIL</b>
1	2412	16.48	0.5	PASS
6	2437	16.52	0.5	PASS
11	2462	16.52	0.5	PASS



CH1

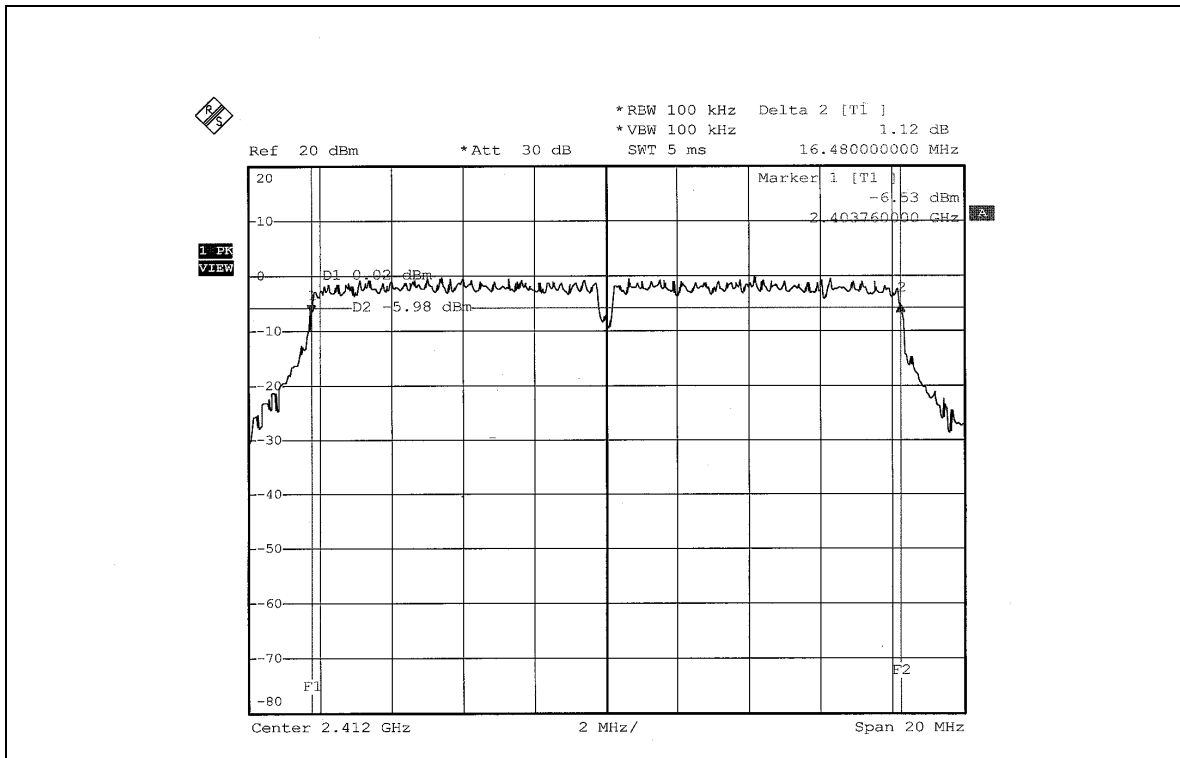

CH6

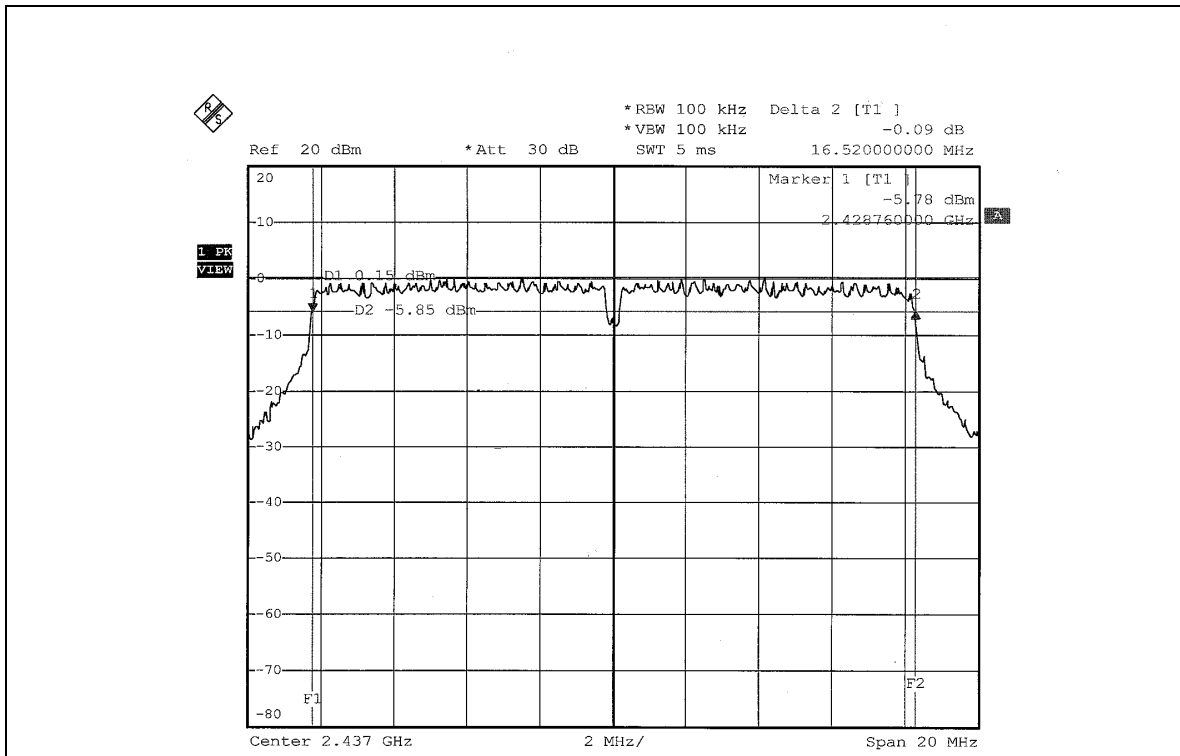



CH11

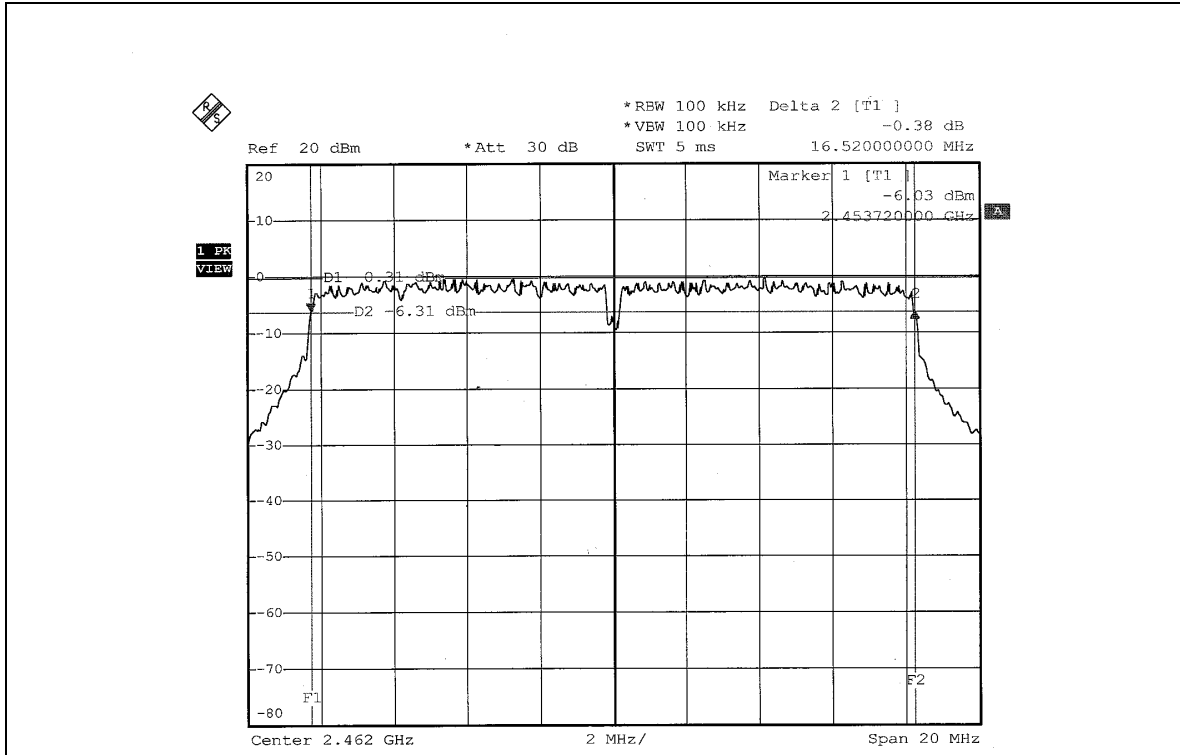





#### 4.4 MAXIMUM PEAK OUTPUT POWER

##### 4.4.1 LIMITS OF MAXIMUM PEAK OUTPUT POWER MEASUREMENT

The Maximum Peak Output Power Measurement is 30dBm. .

##### 4.4.2 TEST INSTRUMENTS

DESCRIPTION & MANUFACTURER	MODEL NO.	SERIAL NO.	CALIBRATED UNTIL
R&S SPECTRUM ANALYZER	FSEK30	100049	Aug. 14, 2006
AGILENT SIGNAL GENERATOR	E8257C	MY43320668	Dec. 07, 2006
DIGITAL RT OSCILLOSCOPE	TDS1012	C037299	Nov. 28, 2006
NARDA DETECTOR	4503A	FSCM99899	NA

**NOTE:**

The calibration interval of the above test instruments is 12 months and the calibrations are traceable to NML/ROC and NIST/USA.

#### 4.4.3 TEST PROCEDURES

1. A detector was used on the output port of the EUT. An oscilloscope was used to peak the response of the detector.
2. Replaced the EUT by the signal generator. The center frequency of the S.G was adjusted to the center frequency of the measured channel.
3. Adjusted the power to have the same peak reading on oscilloscope. Record the power level.

#### 4.4.4 DEVIATION FROM TEST STANDARD

No deviation

#### 4.4.5 TEST SETUP



#### 4.4.6 EUT OPERATING CONDITIONS

Same as Item 4.3.6



## 4.4.7 TEST RESULTS

## 802.11b DSSS MODULATION

<b>EUT</b>	Wireless-G USB Network Adapter with RangeBooster	<b>MODEL</b>	WUSB54GR
<b>MODULATION TYPE</b>	BPSK	<b>TRANSFER RATE</b>	1Mbps
<b>INPUT POWER (SYSTEM)</b>	120Vac, 60 Hz	<b>ENVIRONMENTAL CONDITIONS</b>	23deg.C, 60%RH, 991hPa
<b>TESTED BY</b>	Brad Wu		

CHANNEL	CHANNEL FREQUENCY (MHz)	PEAK POWER OUTPUT (mW)	PEAK POWER OUTPUT (dBm)	PEAK POWER LIMIT (dBm)	PASS/FAIL
1	2412	63.533	18.03	30	PASS
6	2437	80.538	19.06	30	PASS
11	2462	31.769	15.02	30	PASS

## 802.11g OFDM MODULATION

<b>EUT</b>	Wireless-G USB Network Adapter with RangeBooster	<b>MODEL</b>	WUSB54GR
<b>MODULATION TYPE</b>	BPSK	<b>TRANSFER RATE</b>	6Mbps
<b>INPUT POWER (SYSTEM)</b>	120Vac, 60 Hz	<b>ENVIRONMENTAL CONDITIONS</b>	23deg.C, 60%RH, 991hPa
<b>TESTED BY</b>	Brad Wu		

CHANNEL	CHANNEL FREQUENCY (MHz)	PEAK POWER OUTPUT (mW)	PEAK POWER OUTPUT (dBm)	PEAK POWER LIMIT (dBm)	PASS/FAIL
1	2412	50.350	17.02	30	PASS
6	2437	50.350	17.02	30	PASS
11	2462	50.234	17.01	30	PASS



## 4.5 POWER SPECTRAL DENSITY MEASUREMENT

### 4.5.1 LIMITS OF POWER SPECTRAL DENSITY MEASUREMENT

The Maximum of Power Spectral Density Measurement is 8dBm.

### 4.5.2 TEST INSTRUMENTS

Description & Manufacturer	Model No.	Serial No.	Calibrated Until
SPECTRUM ANALYZER	FSEK30	100049	Aug. 14, 2006

**NOTE:** The calibration interval of the above test instruments is 12 months and the calibrations are traceable to NML/ROC and NIST/USA.

#### 4.5.3 TEST PROCEDURE

The transmitter output was connected to the spectrum analyzer through an attenuator, the bandwidth of the fundamental frequency was measured with the spectrum analyzer using 3kHz RBW and 30kHz VBW, set sweep time=span/3kHz. The power spectral density was measured and recorded. The sweep time is allowed to be longer than span/3kHz for a full response of the mixer in the spectrum analyzer.

#### 4.5.4 DEVIATION FROM TEST STANDARD

No deviation

#### 4.5.5 TEST SETUP

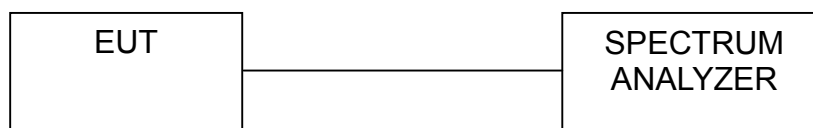

#### 4.5.6 EUT OPERATING CONDITIONS

Same as 4.3.6



## 4.5.7 TEST RESULTS

**802.11b DSSS MODULATION**

<b>EUT</b>	Wireless-G USB Network Adapter with RangeBooster	<b>MODEL</b>	WUSB54GR
<b>MODULATION TYPE</b>	BPSK	<b>TRANSFER RATE</b>	1Mbps
<b>INPUT POWER (SYSTEM)</b>	120Vac, 60 Hz	<b>ENVIRONMENTAL CONDITIONS</b>	23deg.C, 60%RH, 991hPa
<b>TESTED BY</b>	Brad Wu		

<b>CHANNEL</b>	<b>CHANNEL FREQUENCY (MHz)</b>	<b>RF POWER LEVEL IN 3 kHz BW (dBm)</b>	<b>MAXIMUM LIMIT (dBm)</b>	<b>PASS/FAIL</b>
1	2412	-12.50	8	PASS
6	2437	-11.29	8	PASS
11	2462	-15.55	8	PASS



CH1

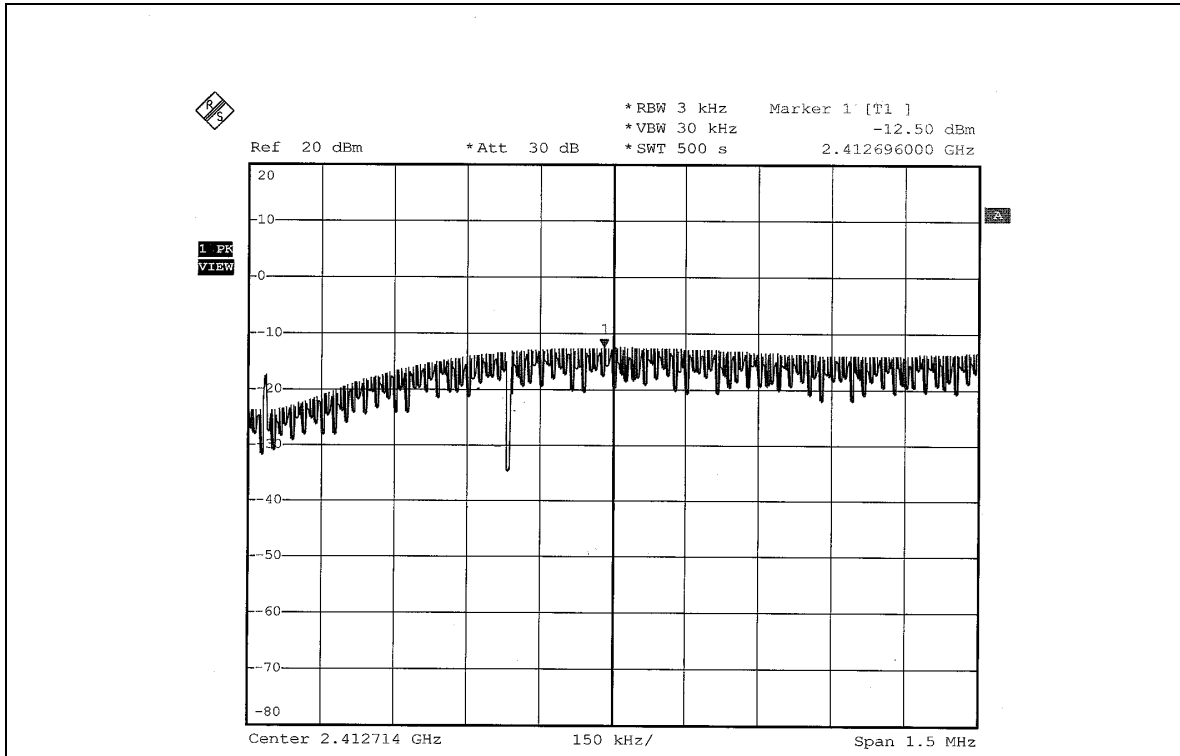

CH6

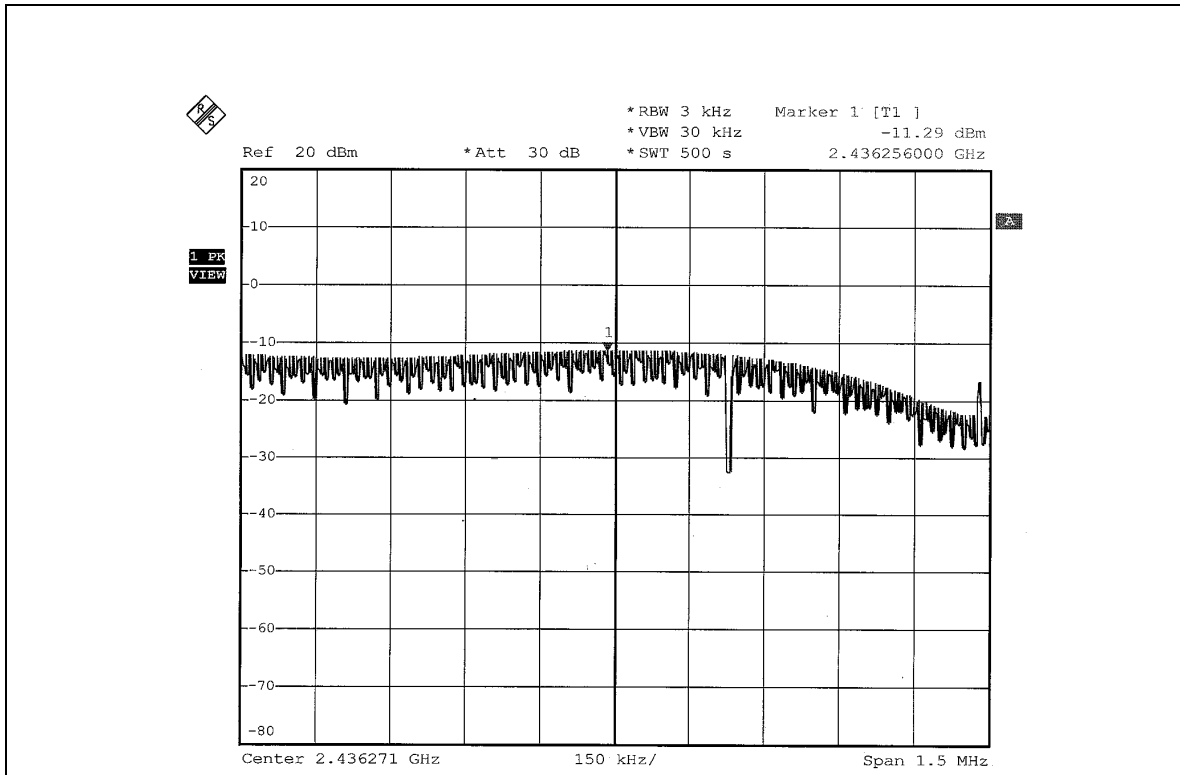



CH11

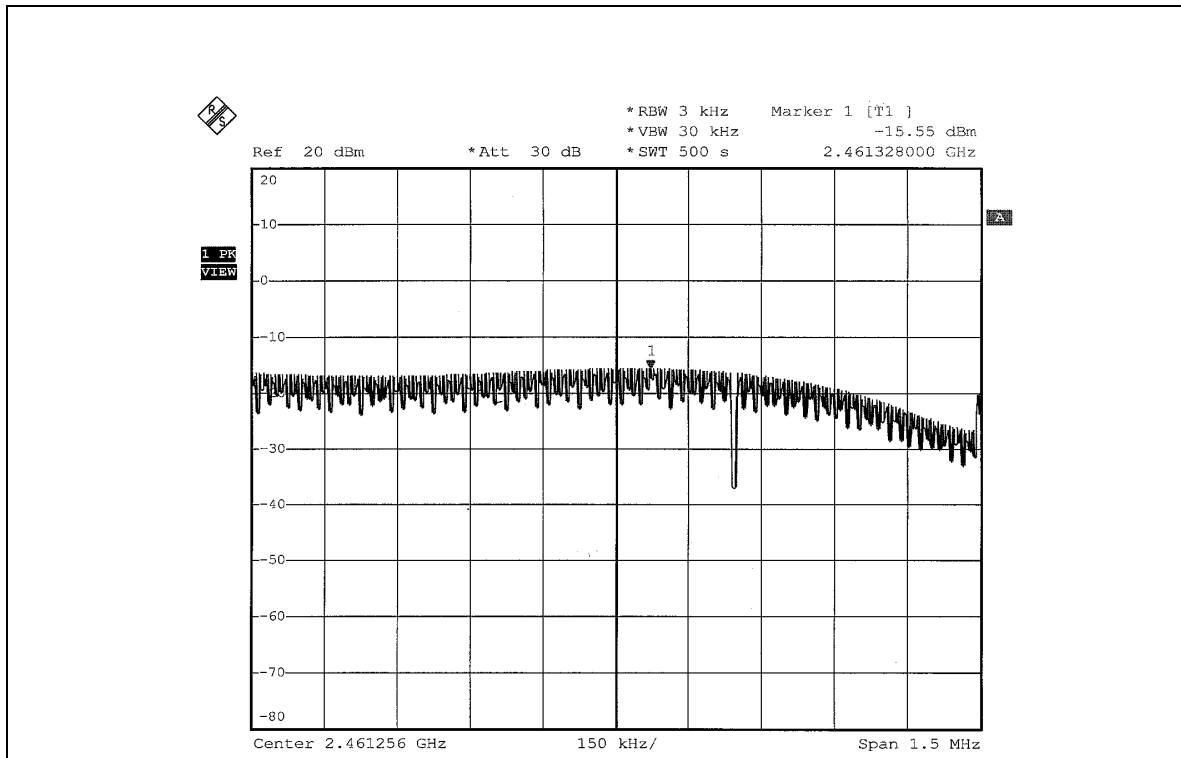



**802.11g OFDM MODULATION**

<b>EUT</b>	Wireless-G USB Network Adapter with RangeBooster	<b>MODEL</b>	WUSB54GR
<b>MODULATION TYPE</b>	BPSK	<b>TRANSFER RATE</b>	6Mbps
<b>INPUT POWER (SYSTEM)</b>	120Vac, 60 Hz	<b>ENVIRONMENTAL CONDITIONS</b>	23deg.C, 60%RH, 991hPa
<b>TESTED BY</b>	Brad Wu		

<b>CHANNEL</b>	<b>CHANNEL FREQUENCY (MHz )</b>	<b>RF POWER LEVEL IN 3 kHz BW (dBm)</b>	<b>MAXIMUM LIMIT (dBm)</b>	<b>PASS/FAIL</b>
1	2412	-14.98	8	PASS
6	2437	-14.83	8	PASS
11	2462	-14.87	8	PASS



CH1

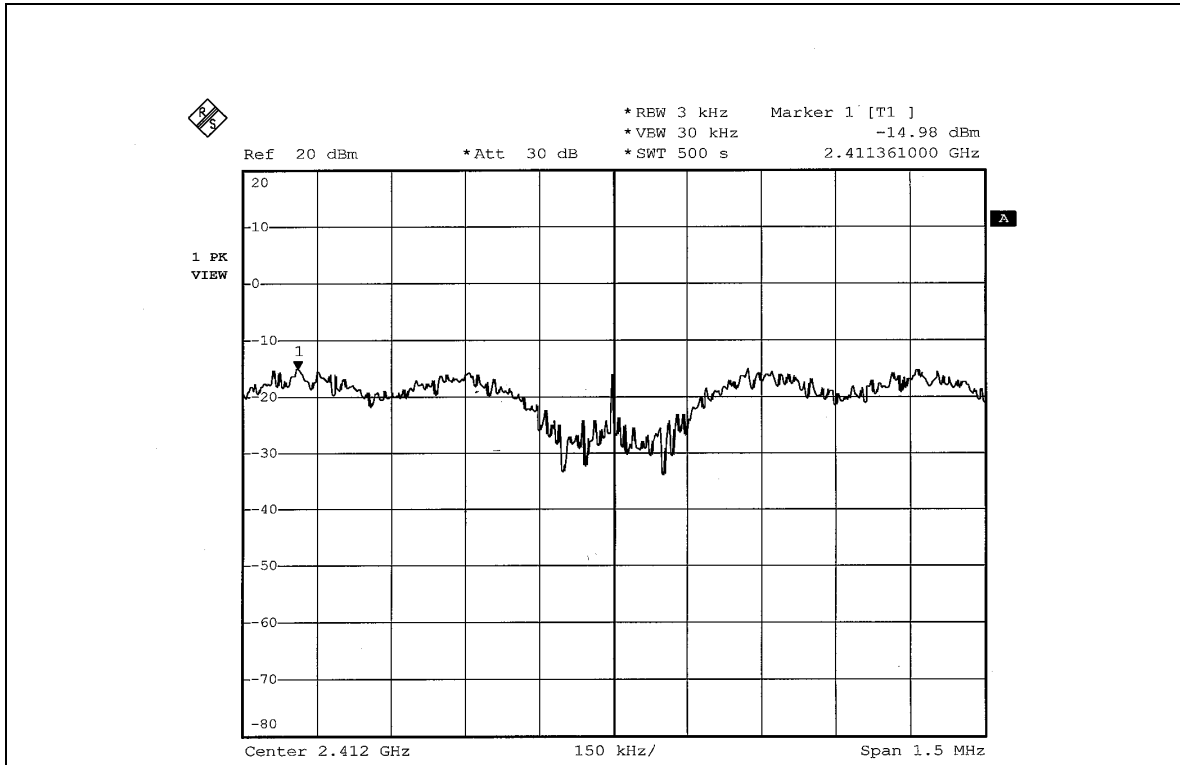

CH6

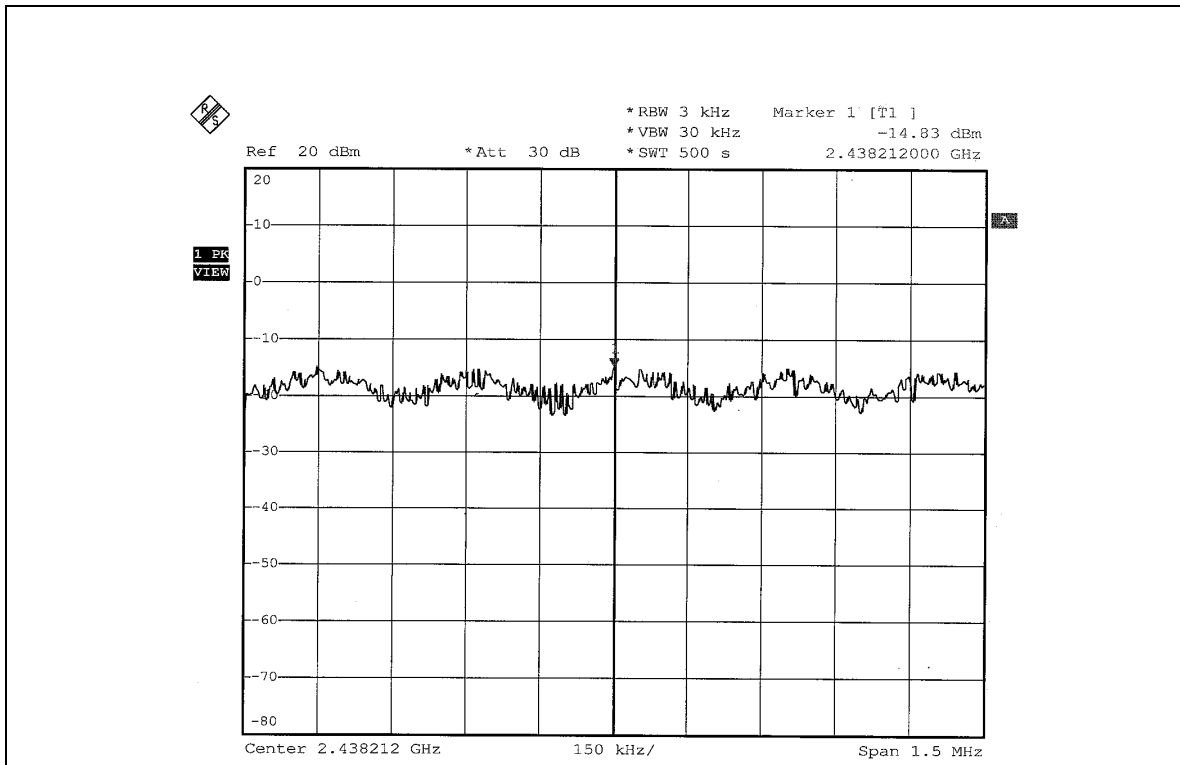



CH11

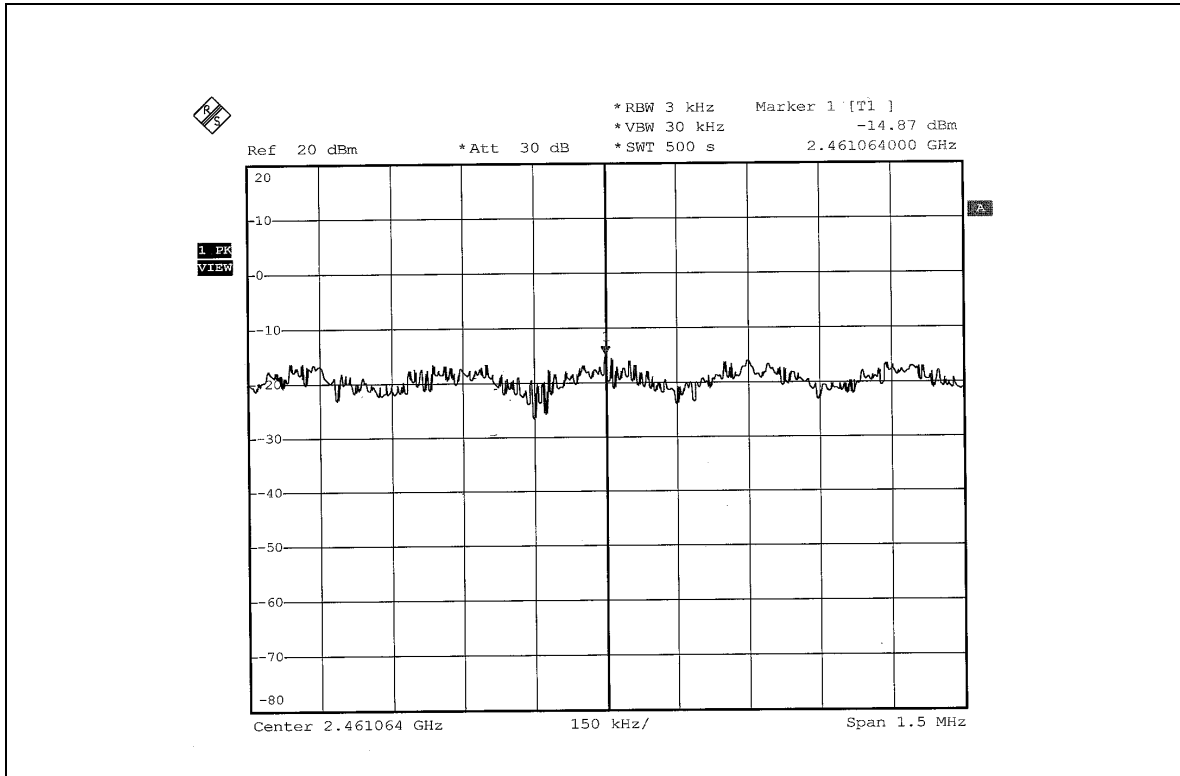



## 4.6 BAND EDGES MEASUREMENT

### 4.6.1 LIMITS OF BAND EDGES MEASUREMENT

Below -20dB of the highest emission level of operating band (in 100kHz Resolution Bandwidth).

### 4.6.2 TEST INSTRUMENTS

Description & Manufacturer	Model No.	Serial No.	Calibrated Until
SPECTRUM ANALYZER	FSEK30	100049	Aug. 14, 2006

**NOTE:** The calibration interval of the above test instruments is 12 months and the calibrations are traceable to NML/ROC and NIST/USA.

### 4.6.3 TEST PROCEDURE

The transmitter output was connected to the spectrum analyzer via a low lose cable. Set both RBW and VBW of spectrum analyzer to 100kHz with suitable frequency span including 100MHz bandwidth from band edge. The band edges was measured and recorded. The spectrum plots (Peak RBW=VBW=100kHz; Average RBW=1MHz, VBW=10Hz) are attached on the following pages.

### 4.6.4 DEVIATION FROM TEST STANDARD

No deviation

### 4.6.5 EUT OPERATING CONDITION

Same as Item 4.3.6



#### 4.6.6 TEST RESULTS

The spectrum plots are attached on the following 12 images. D1 line indicates the highest level, and D2 line indicates the 20dB offset below D1. It shows compliance with the requirement in part 15.247(d).

#### 802.11b DSSS MODULATION

**NOTE 1:** The band edge emission plot of DSSS technique on page 54 shows 47.21dBc between carrier maximum power and local maximum emission in restrict band (2.33492GHz). The emission of carrier strength list in the test result of channel 1 at the item 4.2.7 is 108.72dBuV/m (Peak), so the maximum field strength in restrict band is  $108.72-47.21=61.51$ dBuV/m which is under 74dBuV/m limit.

The band edge emission plot of DSSS technique on page 54 shows 52.35dBc between carrier maximum power and local maximum emission in restrict band (2.33452GHz). The emission of carrier strength list in the test result of channel 1 at the item 4.2.7 is 104.48dBuV/m (Average), so the maximum field strength in restrict band is  $104.48-52.35=52.13$ dBuV/m which is under 54dBuV/m limit.

**NOTE 2:** The band edge emission plot of DSSS technique on page 55 shows 48.54dBc between carrier maximum power and local maximum emission in restrict band (2.49570GHz). The emission of carrier strength list in the test result of channel 11 at the item 4.2.7 is 107.42dBuV/m (Peak), so the maximum field strength in restrict band is  $107.42-48.54=58.88$ dBuV/m which is under 74dBuV/m limit.

The band edge emission plot of DSSS technique on page 56 shows 58.58dBc between carrier maximum power and local maximum emission in restrict band (2.49890GHz). The emission of carrier strength list in the test result of channel 11 at the item 4.2.7 is 103.89dBuV/m (Average), so the maximum field strength in restrict band is  $103.89-58.58=45.31$ dBuV/m which is under 54dBuV/m limit.



802.11b DSSS MODULATION

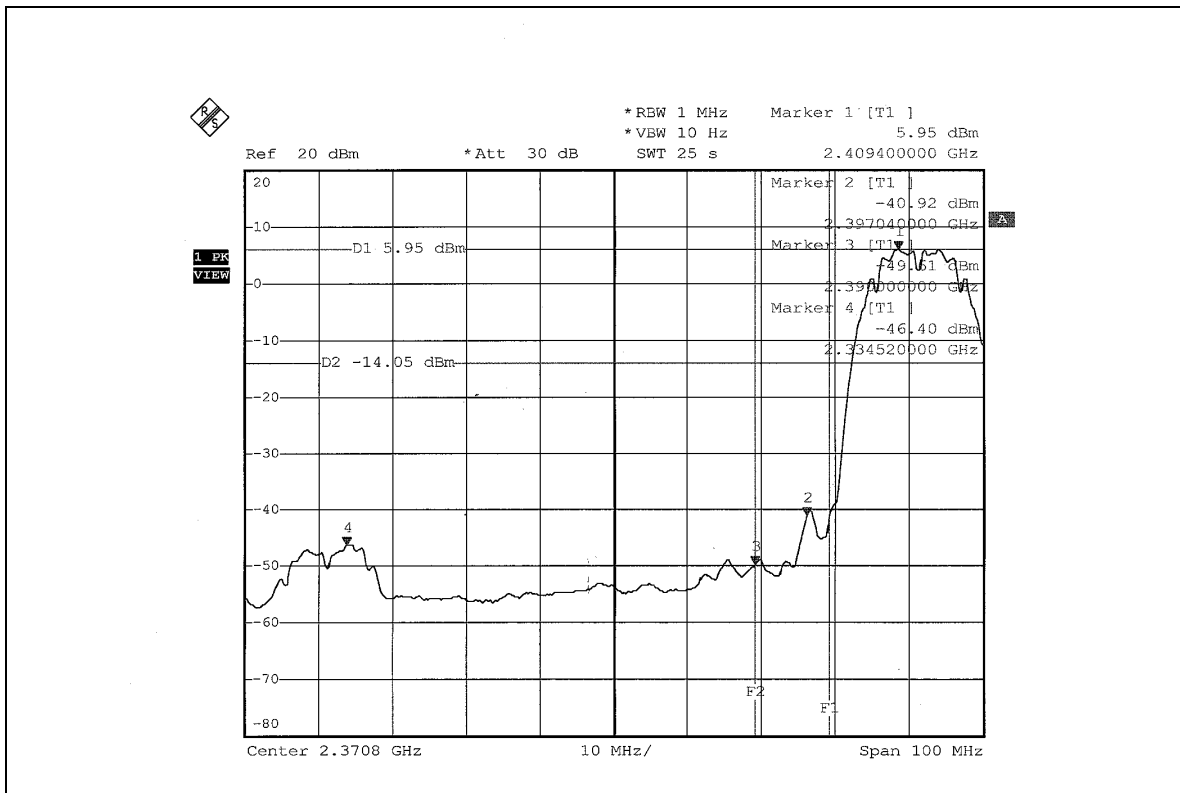
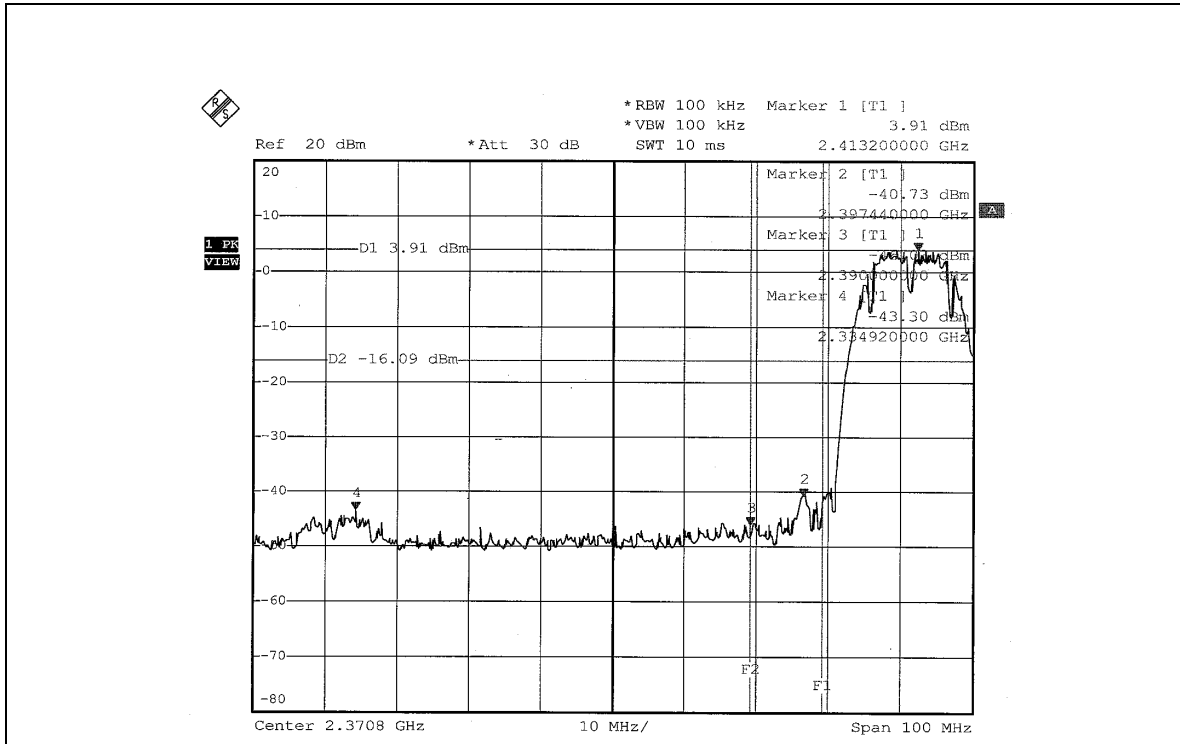

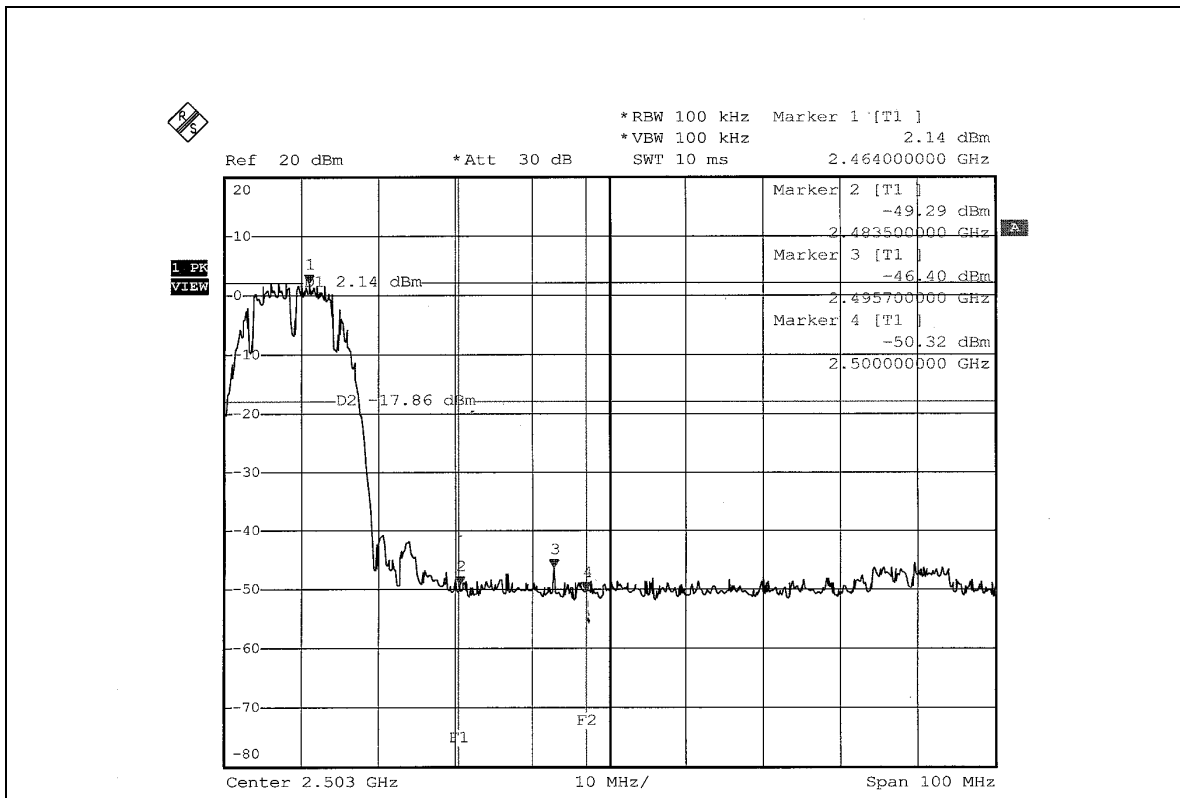
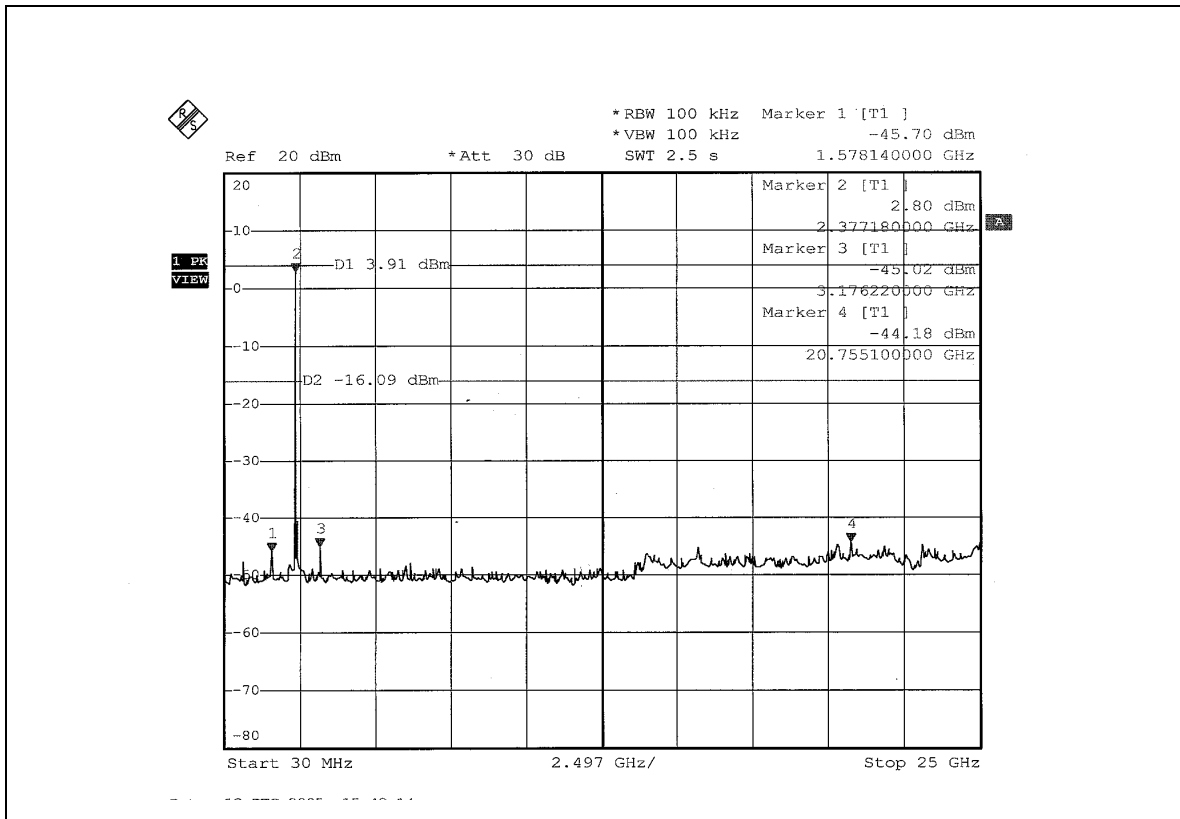

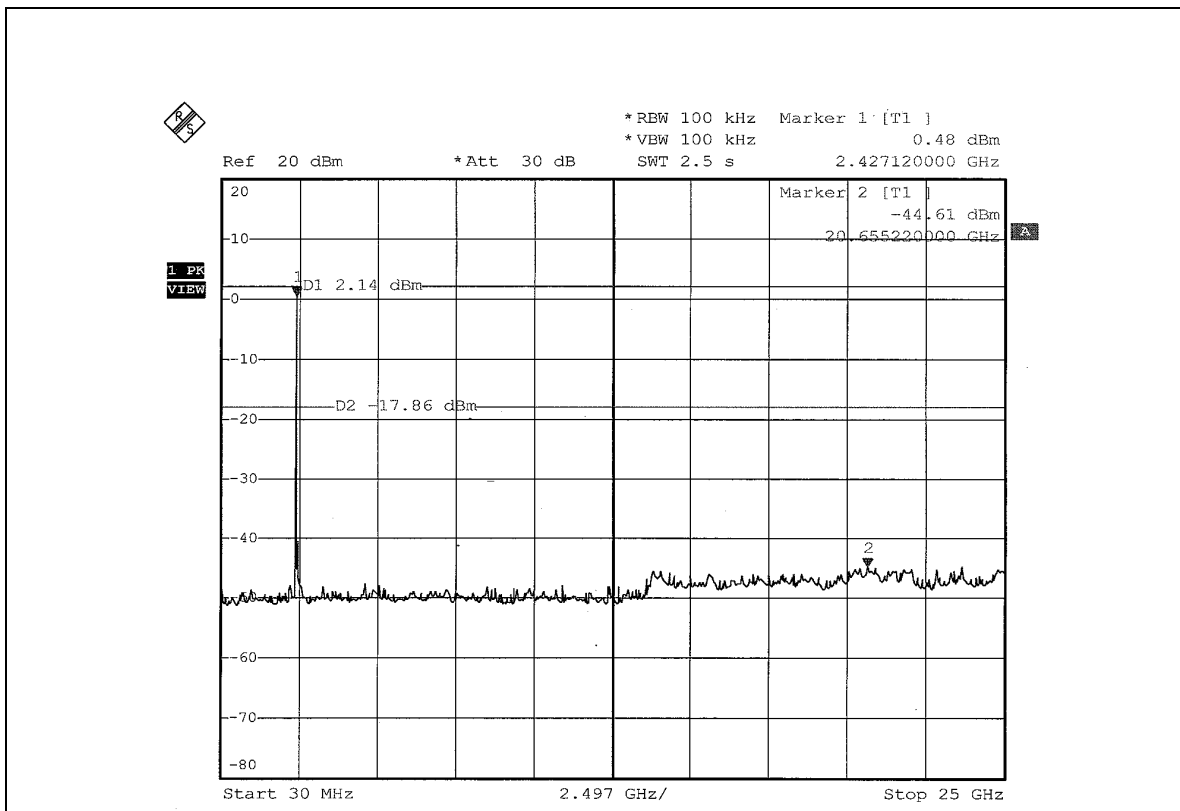
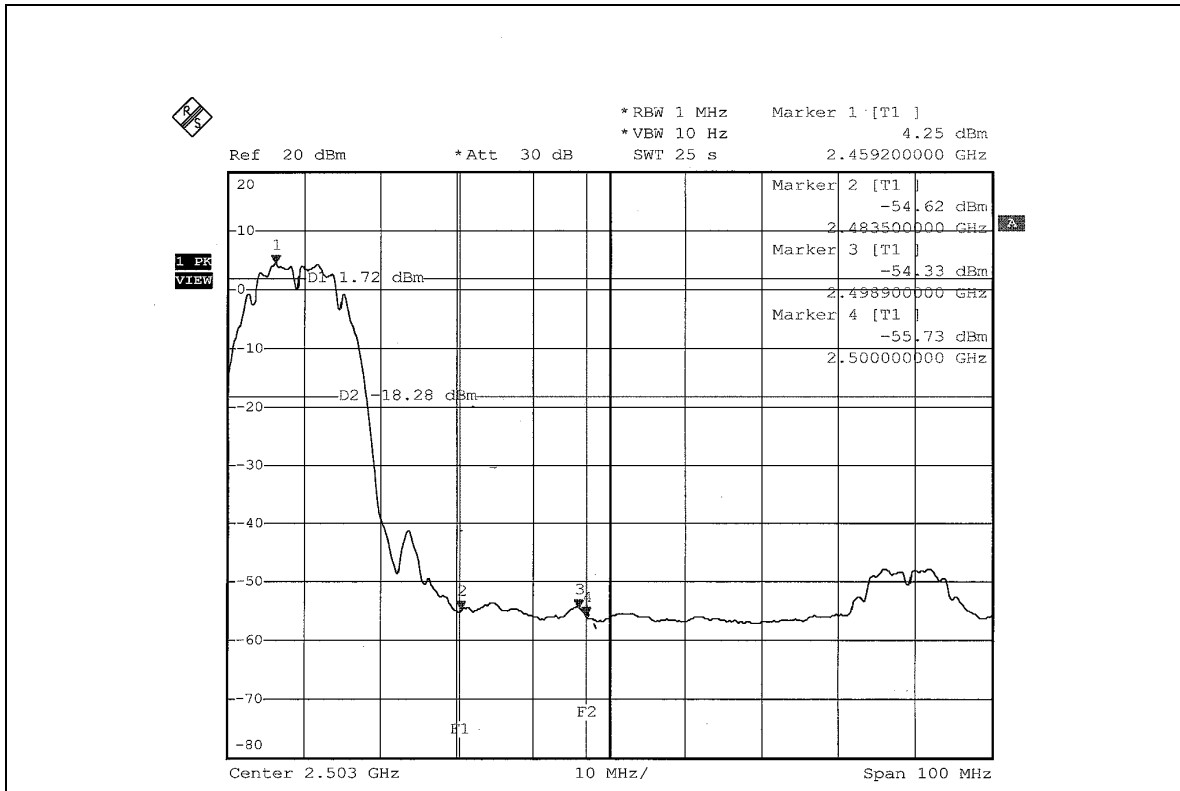





## 802.11g OFDM MODULATION

**NOTE 1:** The band edge emission plot of OFDM technique on page 58 shows 43.95dBc between carrier maximum power and local maximum emission in restrict band (2.3894GHz). The emission of carrier strength list in the test result of channel 1 at the item 4.2.7 is 109.87dBuV/m (Peak), so the maximum field strength in restrict band is  $109.87-43.95=65.92$ dBuV/m which is under 74dBuV/m limit.

The band edge emission plot of OFDM technique on page 58 shows 50.25dBc between carrier maximum power and local maximum emission in restrict band (2.3900GHz). The emission of carrier strength list in the test result of channel 1 at the item 4.2.7 is 100.87dBuV/m (Average), so the maximum field strength in restrict band is  $100.87-50.25=50.62$ dBuV/m which is under 54dBuV/m limit.

**NOTE 2:** The band edge emission plot of OFDM technique on page 59 shows 46.18dBc between carrier maximum power and local maximum emission in restrict band (2.4855GHz). The emission of carrier strength list in the test result of channel 11 at the item 4.2.7 is 109.70dBuV/m (Peak), so the maximum field strength in restrict band is  $109.70-46.18=63.52$ dBuV/m which is under 74dBuV/m limit.

The band edge emission plot of OFDM technique on page 60 shows 50.89dBc between carrier maximum power and local maximum emission in restrict band (2.4835GHz). The emission of carrier strength list in the test result of channel 11 at the item 4.2.7 is 100.85dBuV/m (Average), so the maximum field strength in restrict band is  $100.85-50.89=49.96$ dBuV/m which is under 54dBuV/m limit.



802.11g OFDM MODULATION

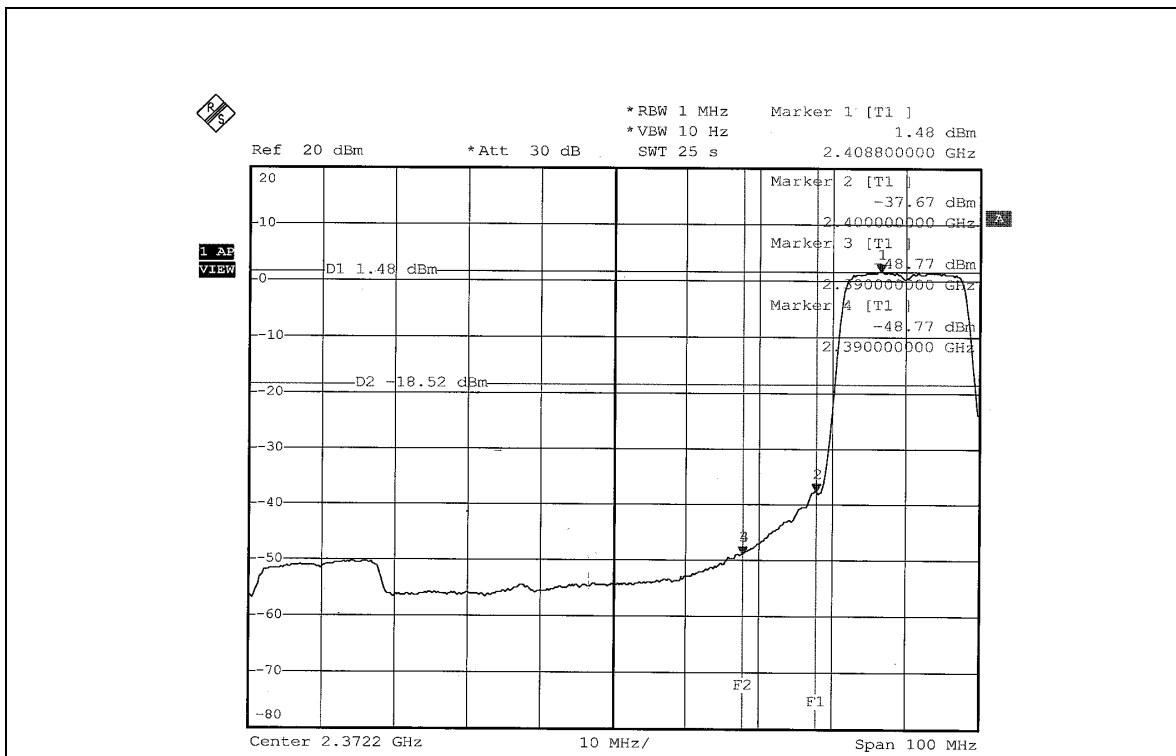
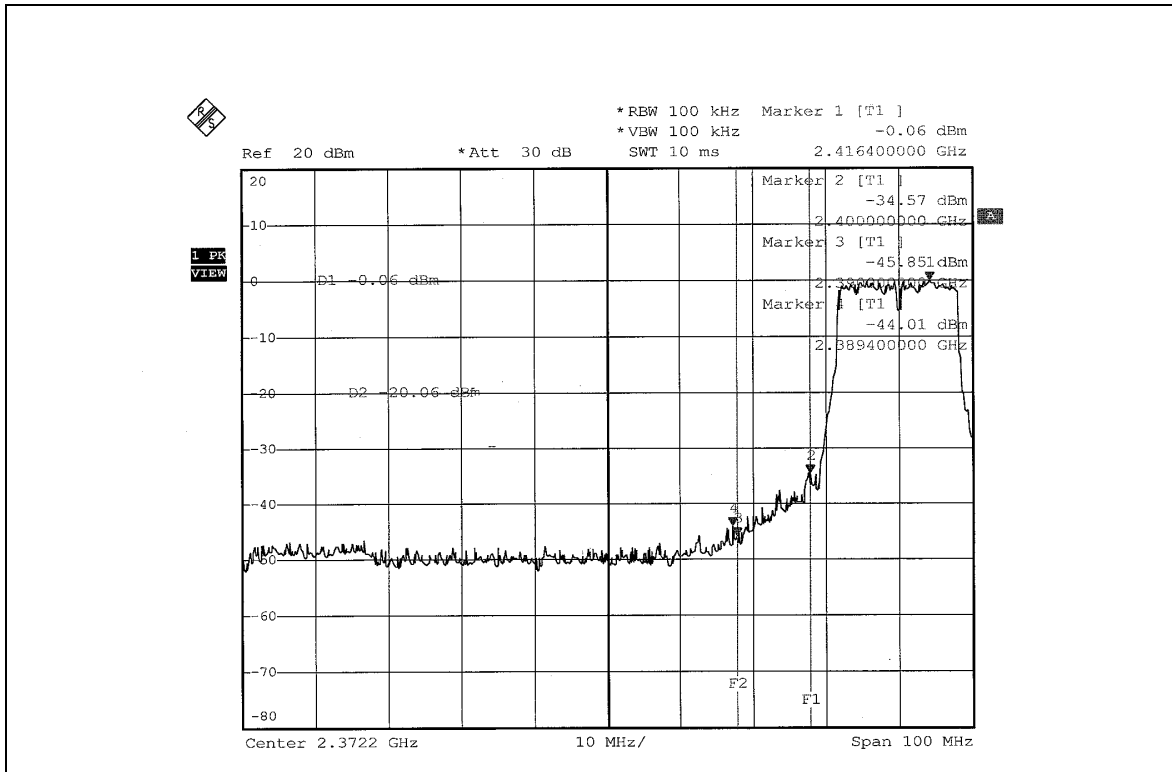

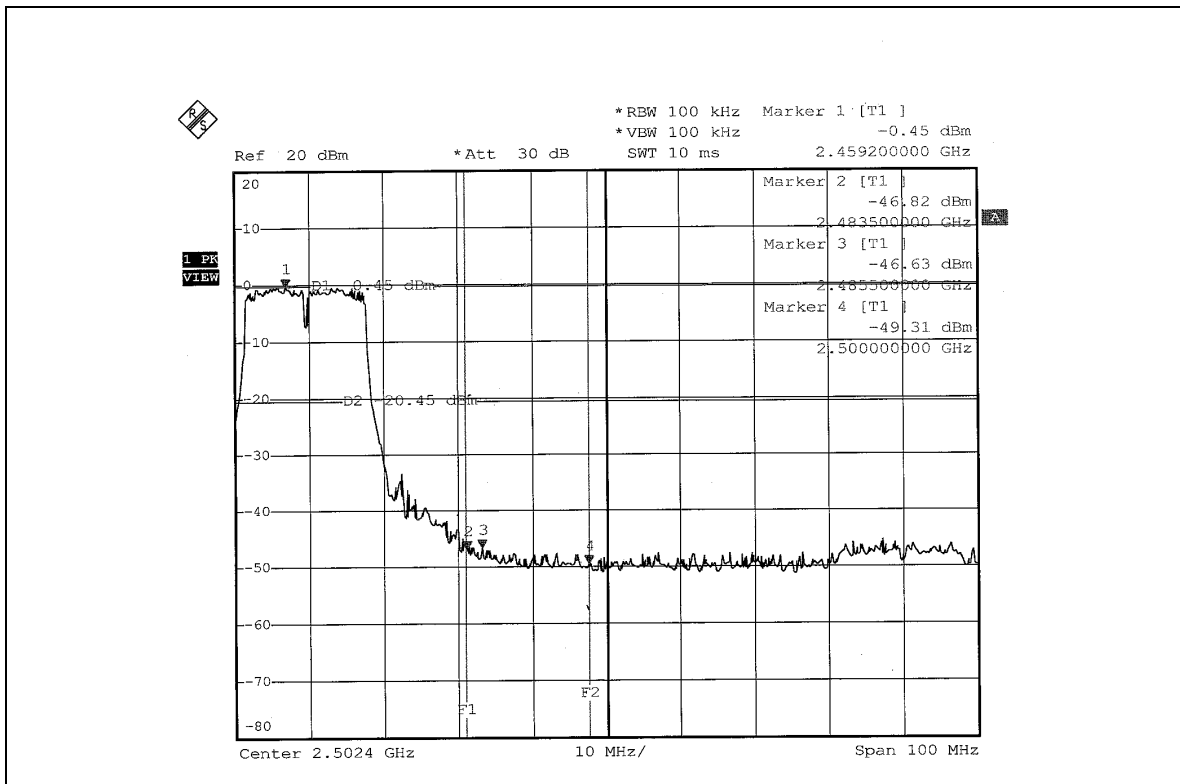
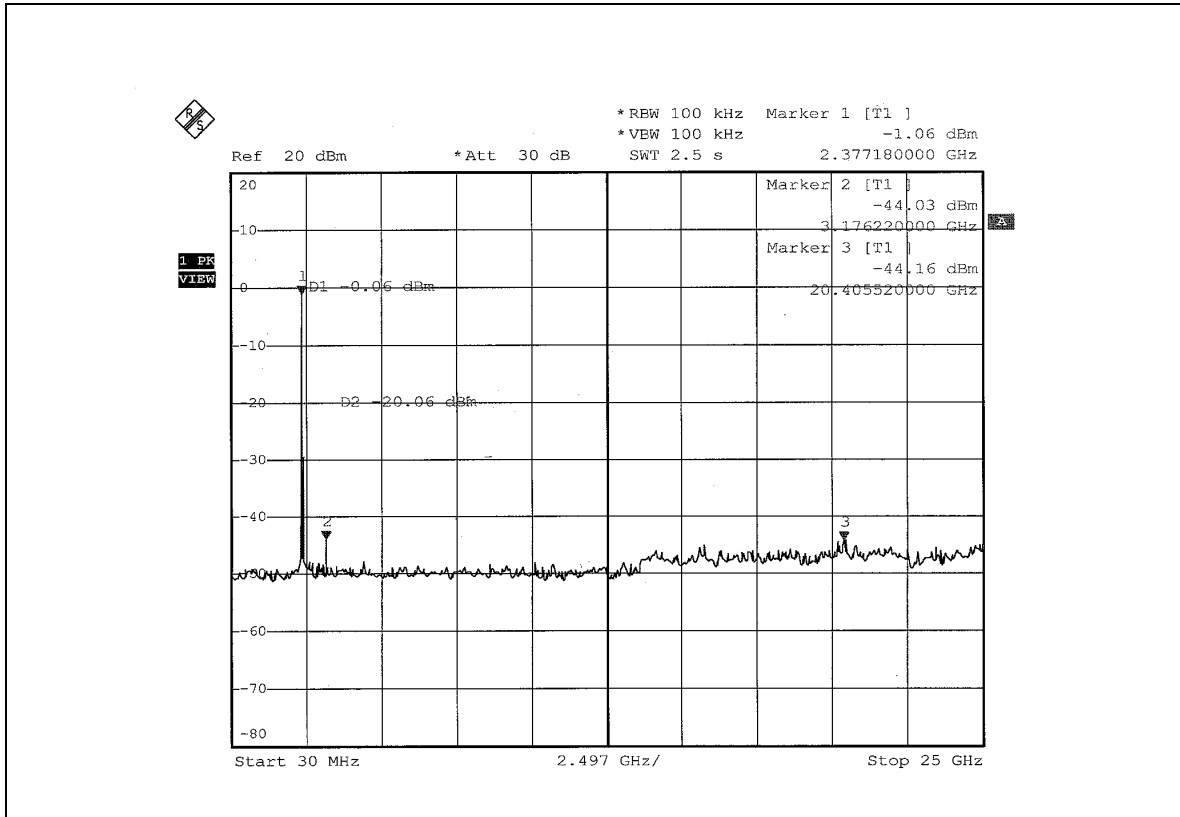

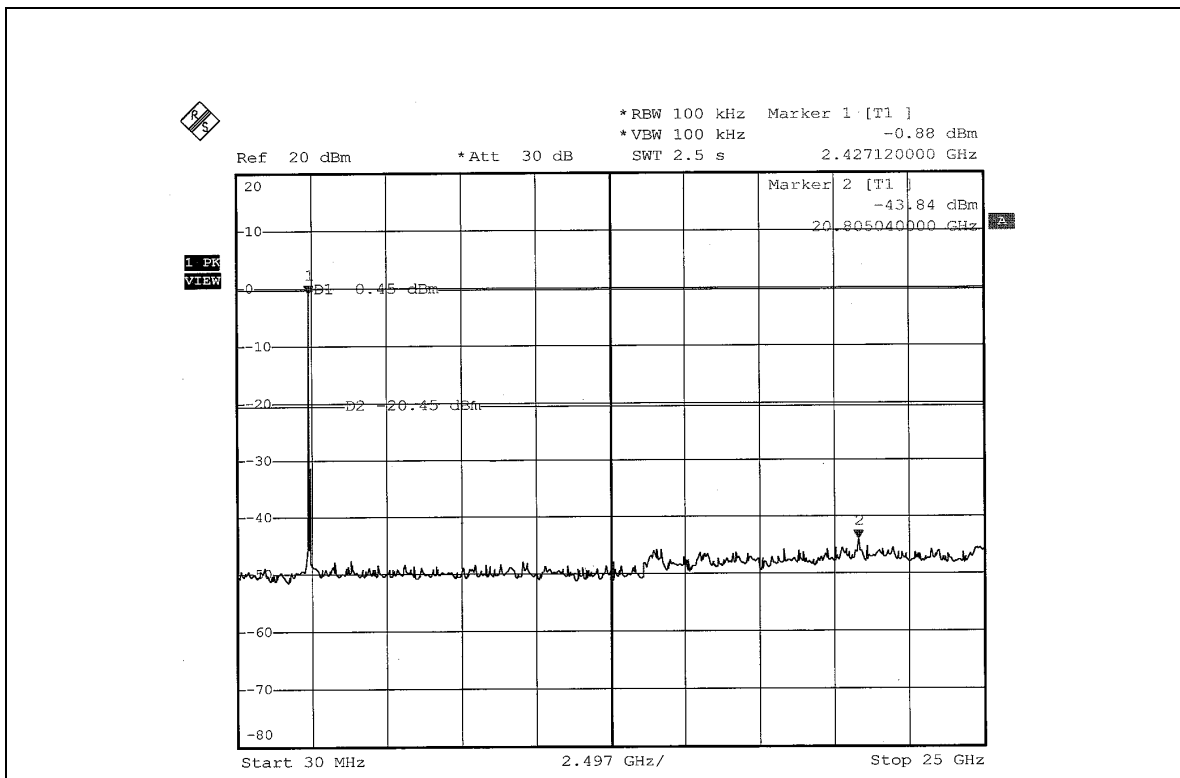
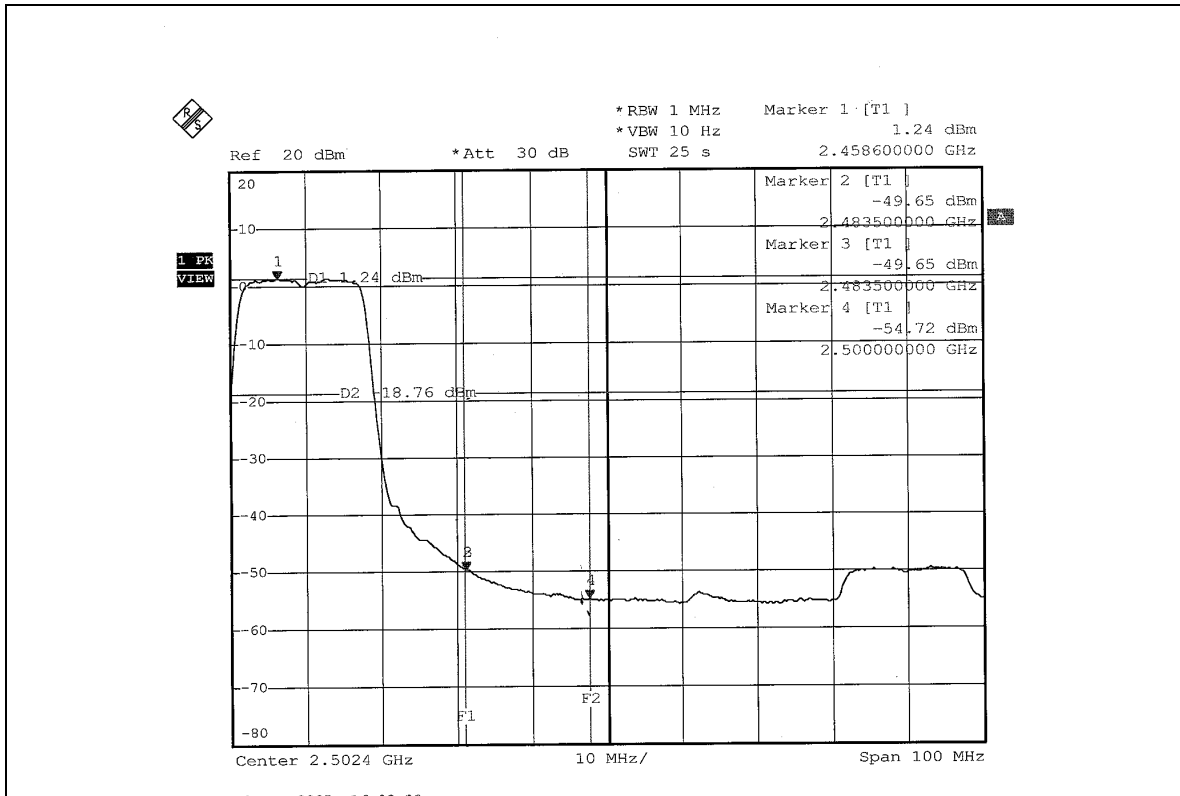



## **4.7 ANTENNA REQUIREMENT**

### **4.7.1 STANDARD APPLICABLE**

For intentional device, according to FCC 47 CFR Section 15.203, an intentional radiator shall be designed to ensure that no antenna other than that furnished by the responsible party shall be used with the device.

And according to FCC 47 CFR Section 15.247 (b), if transmitting antennas of directional gain greater than 6dBi are used, the power shall be reduced by the amount in dB that the directional gain of the antenna exceeds 6dBi.

### **4.7.2 ANTENNA CONNECTED CONSTRUCTION**

The antenna type used in this product are Printed dipole antenna without antenna connector and PIFA antenna without antenna connector. The maximum Gain of these antennas is 1.5dBi.

## 5 PHOTOGRAPHS OF THE TEST CONFIGURATION

### CONDUCTED EMISSION TEST



### RADIATED EMISSION TEST

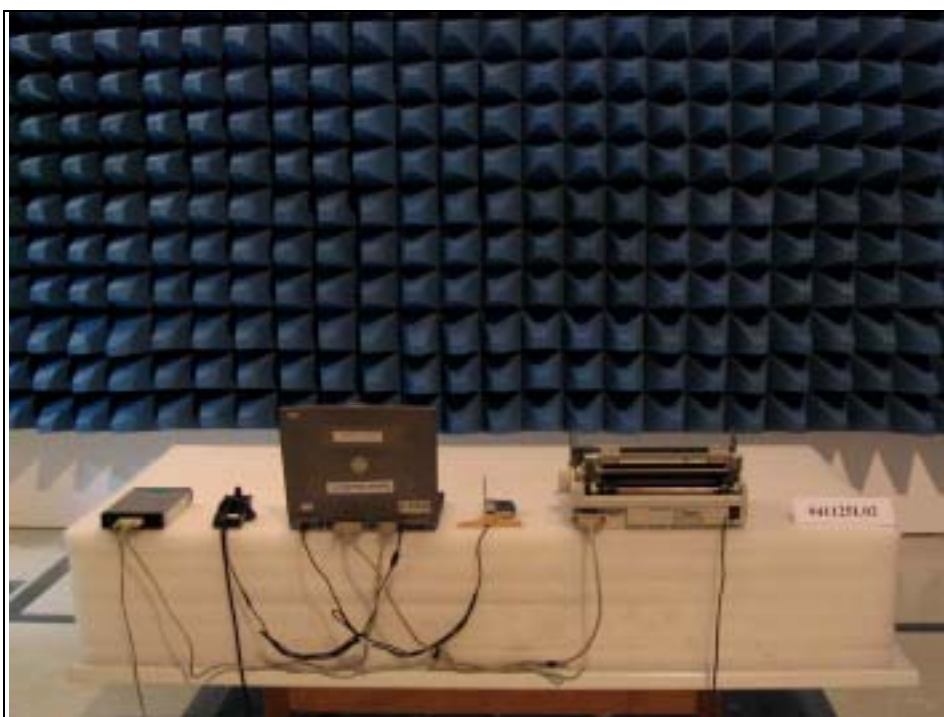
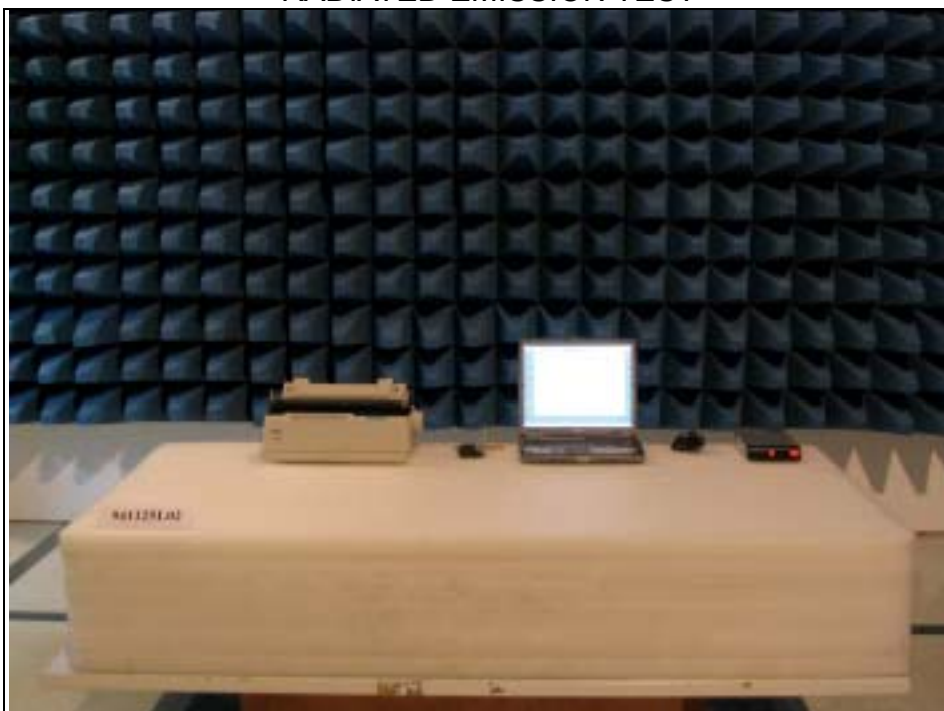



## 6 INFORMATION ON THE TESTING LABORATORIES

We, ADT Corp., were founded in 1988 to provide our best service in EMC, Radio, Telecom and Safety consultation. Our laboratories are accredited and approved by the following approval agencies according to ISO/IEC 17025

<b>USA</b>	FCC, NVLAP, UL, A2LA
<b>Germany</b>	TUV Rheinland
<b>Japan</b>	VCCI
<b>Norway</b>	NEMKO
<b>Canada</b>	INDUSTRY CANADA , CSA
<b>R.O.C.</b>	CNLA, BSMI, DGT
<b>Netherlands</b>	Telefication
<b>Singapore</b>	PSB , GOST-ASIA(MOU)
<b>Russia</b>	CERTIS(MOU)

Copies of accreditation certificates of our laboratories obtained from approval agencies can be downloaded from our web site:

[www.adt.com.tw/index.5/phtml](http://www.adt.com.tw/index.5/phtml). If you have any comments, please feel free to contact us at the following:

**Linko EMC/RF Lab:**

Tel: 886-2-26052180

Fax: 886-2-26052943

**Hsin Chu EMC/RF Lab:**

Tel: 886-3-5935343

Fax: 886-3-5935342

**Hwa Ya EMC/RF/Safety/Telecom Lab:**

Tel: 886-3-3183232

Fax: 886-3-3185050

**Linko RF Lab.**

Tel: 886-3-3270910

Fax: 886-3-3270892

**Web Site:** [www.adt.com.tw](http://www.adt.com.tw)

The address and road map of all our labs can be found in our web site also.





## **APPENDIX-A**

### **MODIFICATIONS RECORDERS FOR ENGINEERING CHANGES TO THE EUT BY THE LAB**

No any modifications are made to the EUT by the lab during the test.