



# FCC TEST REPORT

**REPORT NO.:** RF931104L06A

**MODEL NO.:** WUSB54AGP

**RECEIVED:** NA

**TESTED:** Nov. 11 ~ Nov. 18, 2004

**ISSUED DATE:** Dec. 14, 2004

**APPLICANT:** Cisco-Linksys, LLC

**ADDRESS:** 121 Theory Drive Irvine, CA 92612 (USA)

**ISSUED BY:** Advance Data Technology Corporation

**LAB ADDRESS:** No. 47, 14th Ling, Chia Pau Tsuen, Lin Kou Hsiang 244, Taipei Hsien, Taiwan, R.O.C.

**TEST LOCATION:** No. 19, Hwa Ya 2nd Rd., Wen Hwa Tsuen, Kwei Shan Hsiang, Taoyuan Hsien 333, Taiwan, R.O.C.

This test report consists of 160 pages in total. It may be duplicated completely for legal use with the approval of the applicant. It should not be reproduced except in full, without the written approval of our laboratory. The client should not use it to claim product endorsement by CNLA, A2LA or any government agencies. The test results in the report only apply to the tested sample.



0528  
ILAC MRA



No. 2177-01



## Table of Contents

1.	CERTIFICATION .....	6
2.	SUMMARY OF TEST RESULTS .....	7
2.1	MEASUREMENT UNCERTAINTY .....	9
3.	GENERAL INFORMATION.....	10
3.1	GENERAL DESCRIPTION OF EUT .....	10
3.2	DESCRIPTION OF TEST MODES .....	11
3.3	GENERAL DESCRIPTION OF APPLIED STANDARDS .....	11
3.4	DESCRIPTION OF SUPPORT UNITS .....	12
3.5	CONFIGURATION OF SYSTEM UNDER TEST .....	12
4.	TEST TYPES AND RESULTS (FOR PART 802.11B & 802.11G).....	13
4.1	CONDUCTED EMISSION MEASUREMENT .....	13
4.1.1	LIMITS OF CONDUCTED EMISSION MEASUREMENT .....	13
4.1.2	TEST INSTRUMENTS.....	13
4.1.3	TEST PROCEDURES .....	14
4.1.4	DEVIATION FROM TEST STANDARD .....	14
4.1.5	TEST SETUP .....	15
4.1.6	EUT OPERATING CONDITIONS .....	15
4.1.7	TEST RESULTS .....	16
4.2	RADIATED EMISSION MEASUREMENT .....	22
4.2.1	LIMITS OF RADIATED EMISSION MEASUREMENT.....	22
4.2.2	TEST INSTRUMENTS.....	23
4.2.3	TEST PROCEDURES .....	24
4.2.4	DEVIATION FROM TEST STANDARD .....	24
4.2.5	TEST SETUP .....	25
4.2.6	EUT OPERATING CONDITIONS .....	25
4.2.7	TEST RESULTS .....	26
4.3	6dB BANDWIDTH MEASUREMENT .....	34
4.3.1	LIMITS OF 6dB BANDWIDTH MEASUREMENT .....	34
4.3.2	TEST INSTRUMENTS.....	34
4.3.3	TEST PROCEDURE.....	35
4.3.4	DEVIATION FROM TEST STANDARD .....	35
4.3.5	TEST SETUP .....	35
4.3.6	EUT OPERATING CONDITIONS .....	35
4.3.7	TEST RESULTS .....	36
4.4	MAXIMUM PEAK OUTPUT POWER .....	44
4.4.1	LIMITS OF MAXIMUM PEAK OUTPUT POWER MEASUREMENT .....	44
4.4.2	INSTRUMENTS.....	44
4.4.1	TEST PROCEDURES .....	45
4.4.2	DEVIATION FROM TEST STANDARD .....	45
4.4.3	TEST SETUP .....	45
4.4.4	EUT OPERATING CONDITIONS .....	45
4.4.3	TEST RESULTS .....	46
4.5	POWER SPECTRAL DENSITY MEASUREMENT.....	47
4.5.1	LIMITS OF POWER SPECTRAL DENSITY MEASUREMENT .....	47
4.5.2	TEST INSTRUMENTS.....	47
4.5.3	TEST PROCEDURE.....	48
4.5.4	DEVIATION FROM TEST STANDARD .....	48
4.5.5	TEST SETUP .....	48
4.5.6	EUT OPERATING CONDITION .....	48



4.5.7 TEST RESULTS ..... 49

4.6 BAND EDGES MEASUREMENT ..... 57

4.6.1 LIMITS OF BAND EDGES MEASUREMENT ..... 57

4.6.2 TEST INSTRUMENTS..... 57

4.6.3 TEST PROCEDURE..... 57

4.6.4 DEVIATION FROM TEST STANDARD ..... 57

4.6.5 EUT OPERATING CONDITION ..... 57

4.6.6 TEST RESULTS ..... 57

4.7 ANTENNA REQUIREMENT ..... 67

4.7.1 STANDARD APPLICABLE ..... 67

4.7.2 ANTENNA CONNECTED CONSTRUCTION..... 67

5. TEST TYPES AND RESULTS (FOR PART 802.11a) ..... 68

FOR FREQUENCY 5.15~5.35GHZ..... 68

5.1 CONDUCTED EMISSION MEASUREMENT ..... 68

5.1.1 LIMITS OF CONDUCTED EMISSION MEASUREMENT..... 68

5.1.2 TEST INSTRUMENTS..... 68

5.1.3 TEST PROCEDURES ..... 69

5.1.4 DEVIATION FROM TEST STANDARD ..... 69

5.1.5 TEST SETUP ..... 70

5.1.6 EUT OPERATING CONDITIONS ..... 70

5.1.7 TEST RESULTS ..... 71

5.2 RADIATED EMISSION MEASUREMENT ..... 73

5.2.1 LIMITS OF RADIATED EMISSION MEASUREMENT..... 73

5.2.2 LIMITS OF UNWANTED EMISSION OUT OF THE RESTRICTED BANDS..... 74

5.2.3 TEST INSTRUMENTS..... 75

5.2.4 TEST PROCEDURES ..... 76

5.2.5 DEVIATION FROM TEST STANDARD ..... 76

5.2.6 TEST SETUP ..... 77

5.2.7 EUT OPERATING CONDITIONS ..... 77

5.2.8 TEST RESULTS ..... 78

5.3 PEAK TRANSMIT POWER MEASUREMENT ..... 84

5.3.1 LIMITS OF PEAK TRANSMIT POWER MEASUREMENT..... 84

5.3.2 TEST INSTRUMENTS..... 84

5.3.3 TEST PROCEDURE..... 85

5.3.4 DEVIATION FROM TEST STANDARD ..... 85

5.3.5 TEST SETUP ..... 85

5.3.6 EUT OPERATING CONDITIONS ..... 85

5.3.7 TEST RESULTS ..... 86

5.4 PEAK POWER EXCURSION MEASUREMENT ..... 95

5.4.1 LIMITS OF PEAK POWER EXCURSION MEASUREMENT..... 95

5.4.2 TEST INSTRUMENTS..... 95

5.4.3 TEST PROCEDURE..... 96

5.4.4 DEVIATION FROM TEST STANDARD ..... 96

5.4.5 TEST SETUP ..... 96

5.4.6 EUT OPERATING CONDITIONS ..... 96

5.4.7 TEST RESULTS ..... 97

5.5 PEAK power spectral density measurement ..... 102

5.5.1 LIMITS OF PEAK POWER SPECTRAL DENSITY MEASUREMENT..... 102

5.5.2 TEST INSTRUMENTS..... 102

5.5.3 TEST PROCEDURES ..... 103

5.5.4 DEVIATION FROM TEST STANDARD ..... 103

5.5.5 TEST SETUP ..... 103



5.5.6 EUT OPERATING CONDITIONS ..... 103

5.5.7 TEST RESULTS ..... 104

5.6 FREQUENCY STABILITY ..... 109

5.6.1 LIMITS OF FREQUENCY STABILITY MEASUREMENT ..... 109

5.6.2 TEST INSTRUMENTS..... 109

5.6.3 TEST PROCEDURE..... 109

5.6.4 DEVIATION FROM TEST STANDARD ..... 109

5.6.5 TEST SETUP ..... 110

5.6.6 EUT OPERATING CONDITION ..... 110

5.6.7 TEST RESULTS ..... 111

5.7 BAND EDGES MEASUREMENT ..... 112

5.7.1 TEST INSTRUMENTS..... 112

5.7.2 TEST PROCEDURE ..... 112

5.7.3 EUT OPERATING CONDITION ..... 112

5.7.4 TEST RESULTS ..... 112

5.8 ANTENNA REQUIREMENT ..... 120

5.8.1 STANDARD APPLICABLE ..... 120

5.8.2 ANTENNA CONNECTED CONSTRUCTION ..... 120

FOR FREQUENCY 5.725~5.850GHz ..... 121

5.9 CONDUCTED EMISSION MEASUREMENT ..... 121

5.9.1 LIMITS OF CONDUCTED EMISSION MEASUREMENT..... 121

5.9.2 TEST INSTRUMENTS..... 121

5.9.3 TEST PROCEDURES ..... 122

5.9.4 DEVIATION FROM TEST STANDARD ..... 122

5.9.5 TEST SETUP ..... 123

5.9.6 EUT OPERATING CONDITIONS ..... 123

5.9.7 TEST RESULTS ..... 124

5.10 RADIATED EMISSION MEASUREMENT ..... 126

5.10.1 LIMITS OF RADIATED EMISSION MEASUREMENT..... 126

5.10.2 TEST INSTRUMENTS..... 127

5.10.3 TEST PROCEDURES ..... 128

5.10.4 DEVIATION FROM TEST STANDARD ..... 129

5.10.5 TEST SETUP ..... 129

5.10.6 EUT OPERATING CONDITIONS ..... 130

5.10.7 TEST RESULTS ..... 131

5.11 6dB BANDWIDTH MEASUREMENT ..... 136

5.11.1 LIMITS OF 6dB BANDWIDTH MEASUREMENT ..... 136

5.11.2 TEST INSTRUMENTS..... 136

5.11.3 TEST PROCEDURE..... 137

5.11.4 DEVIATION FROM TEST STANDARD ..... 137

5.11.5 TEST SETUP ..... 137

5.11.6 EUT OPERATING CONDITIONS ..... 137

5.11.7 TEST RESULTS ..... 138

5.12 MAXIMUM PEAK OUTPUT POWER ..... 142

5.12.1 LIMITS OF MAXIMUM PEAK OUTPUT POWER MEASUREMENT ..... 142

5.12.2 INSTRUMENTS..... 142

5.12.3 TEST PROCEDURES ..... 143

5.12.4 DEVIATION FROM TEST STANDARD ..... 143

5.12.5 TEST SETUP ..... 143

5.12.6 EUT OPERATING CONDITIONS ..... 143

5.12.7 TEST RESULTS ..... 144

5.13 POWER SPECTRAL DENSITY MEASUREMENT ..... 145



5.13.1 LIMITS OF POWER SPECTRAL DENSITY MEASUREMENT ..... 145

5.13.2 TEST INSTRUMENTS..... 145

5.13.3 TEST PROCEDURE..... 146

5.13.4 DEVIATION FROM TEST STANDARD ..... 146

5.13.5 TEST SETUP ..... 146

5.13.6 EUT OPERATING CONDITION ..... 146

5.13.7 TEST RESULTS ..... 147

5.14 BAND EDGES MEASUREMENT ..... 151

5.14.1 LIMITS OF BAND EDGES MEASUREMENT ..... 151

5.14.2 TEST INSTRUMENTS..... 151

5.14.3 TEST PROCEDURE..... 151

5.14.4 DEVIATION FROM TEST STANDARD ..... 151

5.14.5 EUT OPERATING CONDITION ..... 152

5.14.6 TEST RESULTS ..... 152

5.15 ANTENNA REQUIREMENT ..... 157

5.15.1 STANDARD APPLICABLE ..... 157

5.15.2 ANTENNA CONNECTED CONSTRUCTION..... 157

6. PHOTOGRAPHS OF THE TEST CONFIGURATION..... 158

7. INFORMATION ON THE TESTING LABORATORIES ..... 160



## 1. CERTIFICATION

**PRODUCT:** Wireless A/G Portable USB Adapter  
**BRAND NAME:** Linksys  
**MODEL NO.:** WUSB54AGP  
**TEST SAMPLE:** Engineering Sample  
**APPLICANT:** Cisco-Linksys, LLC  
**STANDARDS:** FCC Part 15, Subpart C (Section 15.247),  
Subpart E (Section 15.407), ANSI C63.4-2003

The above equipment have been tested by **Advance Data Technology Corporation**, and found compliance with the requirement of the above standards. The test record, data evaluation & Equipment Under Test (EUT) configurations represented herein are true and accurate accounts of the measurements of the sample's EMC characteristics under the conditions specified in this report.

**PREPARED BY** : Andrea Hsia , **DATE:** Dec. 14, 2004  
(Andrea Hsia)

**TECHNICAL**  
**ACCEPTANCE** : Gary Chang , **DATE:** Dec. 14, 2004  
Responsible for  
RF  
(Gary Chang)

**APPROVED BY** : Cody Chang , **DATE:** Dec. 14, 2004  
(Cody Chang, Deputy  
Manager)

## 2. SUMMARY OF TEST RESULTS

The EUT has been tested according to the following specifications:

### For 2.4GHz band:

APPLIED STANDARD: FCC Part 15, Subpart C			
Standard Section	Test Type and Limit	Result	Remark
15.207	AC Power Conducted Emission	PASS	Meet the requirement of limit. Minimum passing margin is -17.63dB at 0.193MHz
15.247(a)(2)	Spectrum Bandwidth of a Direct Sequence Spread Spectrum System Limit: min. 500kHz	PASS	Meet the requirement of limit.
15.247(b)	Maximum Peak Output Power Limit: max. 30dBm	PASS	Meet the requirement of limit.
15.247(d)	Radiated Emissions Limit: Table 15.209	PASS	Meet the requirement of limit. Minimum passing margin is -2.04dB at 2483.50MHz
15.247(e)	Power Spectral Density Limit: max. 8dBm	PASS	Meet the requirement of limit.
15.247(d)	Band Edge Measurement Limit: 20dB less than the peak value of fundamental frequency	PASS	Meet the requirement of limit.



**For Freq. 5.15 ~ 5.35GHz:**

<b>APPLIED STANDARD: FCC Part 15, Subpart E</b>			
<b>Standard Section</b>	<b>Test Type</b>	<b>Result</b>	<b>Remark</b>
15.407(b)(5)	AC Power Conducted Emission	PASS	Meet the requirement of limit. Minimum passing margin is -17.86dB at 0.193MHz
15.407(b/1/2/3) (b)(5)	Electric Field Strength Spurious Emissions, 30MHz ~ 40000MHz	PASS	Meet the requirement of limit. Minimum passing margin is -5.60dB at 720.08MHz
15.407(a/1/2/3)	Peak Transmit Power	PASS	Meet the requirement of limit.
15.407(a)(6)	Peak Power Excursion	PASS	Meet the requirement of limit.
15.407(a/1/2/3)	Peak Power Spectral Density	PASS	Meet the requirement of limit.
15.407(g)	Frequency Stability	PASS	Meet the requirement of limit.



**For Freq. 5.725 ~ 5.850GHz :**

<b>APPLIED STANDARD: FCC Part 15, Subpart C</b>			
<b>Standard Section</b>	<b>Test Type and Limit</b>	<b>Result</b>	<b>Remark</b>
15.207	AC Power Conducted Emission	PASS	Meet the requirement of limit. Minimum passing margin is -17.86dB at 0.193MHz
15.247(a)(2)	Spectrum Bandwidth of a Direct Sequence Spread Spectrum System Limit: min. 500kHz	PASS	Meet the requirement of limit.
15.247(b)	Maximum Peak Output Power Limit: max. 30dBm	PASS	Meet the requirement of limit.
15.247(d)	Radiated Emissions Limit: Table 15.209	PASS	Meet the requirement of limit. Minimum passing margin is -1.11dB at 11650.00MHz
15.247(e)	Power Spectral Density Limit: max. 8dBm	PASS	Meet the requirement of limit.
15.247(d)	Band Edge Measurement Limit: 20dB less than the peak value of fundamental frequency	PASS	Meet the requirement of limit.

## 2.1 MEASUREMENT UNCERTAINTY

Where relevant, the following measurement uncertainty levels have been estimated for tests performed on the EUT as specified in CISPR 16-4:

<b>Measurement</b>	<b>Frequency</b>	<b>Uncertainty</b>
Conducted emissions	9kHz~30MHz	2.44 dB
Radiated emissions	30MHz ~ 200MHz	3.73 dB
	200MHz ~ 1000MHz	3.74 dB
	1GHz ~ 18GHz	2.20 dB



### 3. GENERAL INFORMATION

#### 3.1 GENERAL DESCRIPTION OF EUT

<b>EUT</b>	Wireless A/G Portable USB Adapter
<b>MODEL NO.</b>	WUSB54AGP
<b>POWER SUPPLY</b>	5Vdc from host equipment
<b>MODULATION TYPE</b>	CCK, DQPSK, DBPSK for DSSS, 64QAM, 16QAM, QPSK, BPSK for OFDM
<b>MODULATION TECHNOLOGY</b>	DSSS, OFDM
<b>TRANSFER RATE</b>	802.11b: 11/5.5/2/1Mbps 802.11g: 54/48/36/24/18/12/9/6Mbps 802.11a: 54/48/36/24/18/12/9/6Mbps
<b>FREQUENCY RANGE</b>	802.11b & 802.11g: 2412 ~ 2462MHz 802.11a: 5.15 ~ 5.35GHz and 5.725 ~ 5.850GHz
<b>NUMBER OF CHANNEL</b>	802.11b & 802.11g: 11 for Normal mode 802.11a: 13 for Normal mode
<b>CHANNEL SPACING</b>	802.11b & 802.11g: 5MHz 802.11a: 20MHz for Normal mode
<b>OUTPUT POWER</b>	802.11b: 40.458mW 802.11g: 40.272mW 802.11a: 32.211mW
<b>DATA CABLE</b>	NA
<b>ANTENNA TYPE</b>	Printed antenna with 0dBi gain for 2.4GHz band with -1.0dBi gain for 5GHz band
<b>I/O PORTS</b>	USB
<b>ASSOCIATED DEVICES</b>	NA

**NOTE:**

1. The EUT operates in both the 5GHz and 2.4GHz Bands and compatibility with 802.11a and 802.11b, 802.11g technology.
2. The above EUT information was declared by the manufacturer and for more detailed features description, please refer to the manufacturer's specifications or User's Manual.



### 3.2 DESCRIPTION OF TEST MODES

802.11b and 802.11g: Eleven channels are provided to this EUT.

Channel	Frequency	Channel	Frequency
1	2412 MHz	7	2442 MHz
2	2417 MHz	8	2447 MHz
3	2422 MHz	9	2452 MHz
4	2427 MHz	10	2457 MHz
5	2432 MHz	11	2462 MHz
6	2437 MHz		

**NOTE:**

1. Below 1GHz, the channel 1, 6, and 11 were pre-tested in chamber. The channel 11, worst case one, was chosen for final test.
2. Above 1GHz, the channel 1, 6, and 11 were tested individually.
3. From our experience and technical viewpoint, we have chosen data rates, 11Mbps with CCK technique and 6Mbps with OFDM technique, as the worst cases for the test among other data rates.

For 802.11a: Thirteen channels are provided to this EUT.

Channel	Frequency	Channel	Frequency
1	5180 MHz	8	5320 MHz
2	5200 MHz	9	5745 MHz
3	5220 MHz	10	5765 MHz
4	5240 MHz	11	5785 MHz
5	5260 MHz	12	5805 MHz
6	5280 MHz	13	5825 MHz
7	5300 MHz		

**NOTE:**

1. The EUT allows data rates of up to 54Mbps and was tested at 6Mbps data rate that produced the highest output power.
2. Channel 1, 4, 5, 8, 9, 11 and 13 are the closest frequencies to the band edge, were chosen for final test.

### 3.3 GENERAL DESCRIPTION OF APPLIED STANDARDS

The EUT is a Wireless A/G Portable USB Adapter. According to the specifications of the manufacturer, it must comply with the requirements of the following standards:

**FCC Part 15, Subpart C. (15.247),  
Subpart E (15.407). ANSI C63.4 : 2003**

All test items have been performed and recorded as per the above standards.

**NOTE:** The EUT is also considered as a kind of computer peripheral, because the connection to computer is necessary for typical use. It has been verified to comply with the requirements of FCC Part 15, Subpart B, Class B (DoC). The test report has been issued separately.

### 3.4 DESCRIPTION OF SUPPORT UNITS

The EUT has been tested as an independent unit together with other necessary accessories or support units. The following support units or accessories were used to form a representative test configuration during the tests.

NO.	PRODUCT	BRAND	MODEL NO.	SERIAL NO.	FCC ID
1	NOTEBOOK COMPUTER	DELL	PP05L	16484462992	E2K24CLNS
2	PRINTER	EPSON	LQ-300+	DCGY054147	FCC DoC Approved
3	MODEM	ACEEX	1414V/3	0401008269	IFAXDM1414

NO.	SIGNAL CABLE DESCRIPTION OF THE ABOVE SUPPORT UNITS
1	NA
2	1.2m braid shielded wire, terminated with DB25 and Centronics connector via metallic frame, w/o core
3	1.2 m braid shielded wire, terminated with DB25 and DB9 connector via metallic frame, w/o core.

**NOTE:** All power cords of the above support units are non shielded (1.8m).

### 3.5 CONFIGURATION OF SYSTEM UNDER TEST

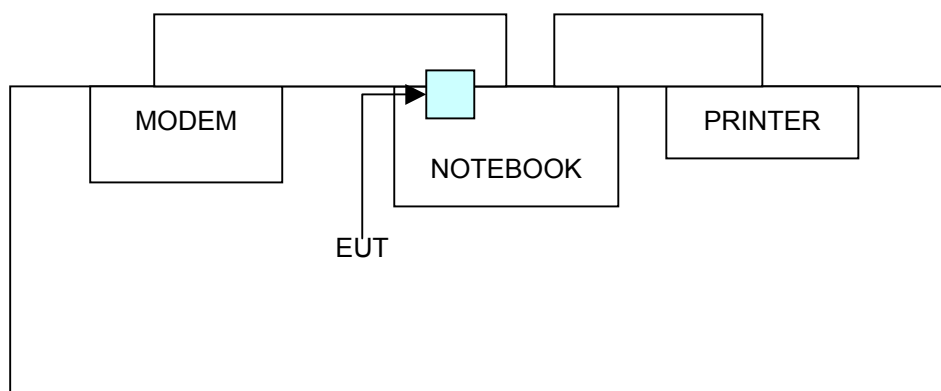



## 4. TEST TYPES AND RESULTS (FOR PART 802.11b & 802.11g)

### 4.1 CONDUCTED EMISSION MEASUREMENT

#### 4.1.1 LIMITS OF CONDUCTED EMISSION MEASUREMENT

FREQUENCY OF EMISSION (MHz)	CONDUCTED LIMIT (dB $\mu$ V)	
	Quasi-peak	Average
0.15-0.5	66 to 56	56 to 46
0.5-5	56	46
5-30	60	50

- NOTE:**
1. The lower limit shall apply at the transition frequencies.
  2. The limit decreases in line with the logarithm of the frequency in the range of 0.15 to 0.50 MHz.
  3. All emanations from a class A/B digital device or system, including any network of conductors and apparatus connected thereto, shall not exceed the level of field strengths specified above.

#### 4.1.2 TEST INSTRUMENTS

DESCRIPTION & MANUFACTURER	MODEL NO.	SERIAL NO.	CALIBRATED UNTIL
Test Receiver ROHDE & SCHWARZ	ESCS30	100291	Nov. 16, 2005
RF signal cable Woken	5D-FB	Cable-HYC01-01	Mar. 02, 2005
LISN ROHDE & SCHWARZ	ESH3-Z5	100312	Mar. 03, 2005
LISN ROHDE & SCHWARZ	ESH2-Z5	100104	Mar. 02, 2005
Software ADT	ADT_Cond_V3	NA	NA

- NOTE:**
1. The calibration interval of the above test instruments is 12 months and the calibrations are traceable to NML/ROC and NIST/USA.
  2. The test was performed in HwaYa Shielded Room 1.
  3. The VCCI Site Registration No. is C-2040.



#### 4.1.3 TEST PROCEDURES

- a. The EUT was placed 0.4 meters from the conducting wall of the shielded room with EUT being connected to the power mains through a line impedance stabilization network (LISN). Other support units were connected to the power mains through another LISN. The two LISNs provide 50 ohm/ 50uH of coupling impedance for the measuring instrument.
- b. Both lines of the power mains connected to the EUT were checked for maximum conducted interference.
- c. The frequency range from 150kHz to 30MHz was searched. Emission levels under (Limit - 20dB) was not recorded.

#### 4.1.4 DEVIATION FROM TEST STANDARD

No deviation

#### 4.1.5 TEST SETUP

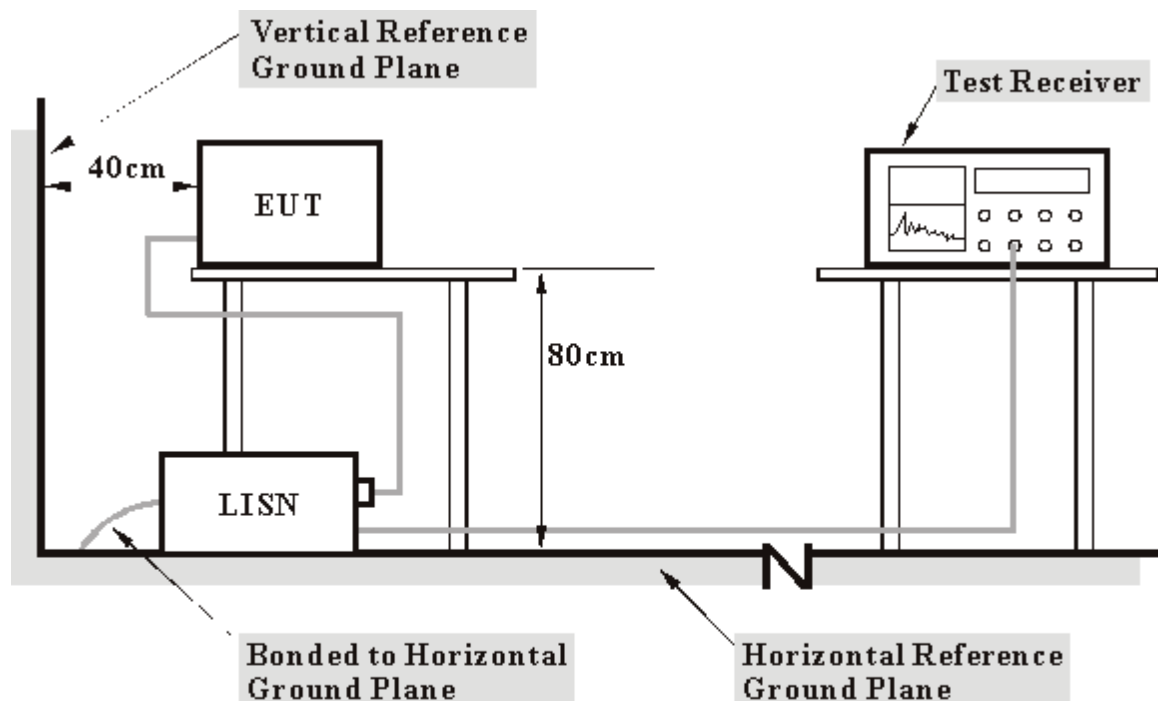

- Note:**
1. Support units were connected to second LISN.
  2. Both of LISNs (AMN) 80 cm from EUT and at the least 80 cm from other units and other metal planes support units.

For the actual test configuration, please refer to the related item – Photographs of the Test Configuration.

#### 4.1.6 EUT OPERATING CONDITIONS

- a. Connected the EUT to a notebook system placed on a testing table.
- b. The notebook system ran a test program (provided by manufacturer) to enable EUT under transmission/receiving condition continuously at specific channel frequency.
- c. The notebook system sent "H" messages to its screen.
- d. The notebook system sent "H" messages to modem.
- e. The notebook system sent "H" messages to printer, and the printer prints them on paper.
- f. Steps c-e are repeated.



4.1.7 TEST RESULTS

<b>EUT</b>	Wireless A/G Portable USB Adapter	<b>MODEL</b>	WUSB54AGP
<b>MODE</b>	Channel 1	<b>6dB BANDWIDTH</b>	9 kHz
<b>INPUT POWER (SYSTEM)</b>	120Vac, 60Hz	<b>PHASE</b>	Line (L)
<b>ENVIRONMENTAL CONDITIONS</b>	24deg. C, 64%RH, 991hPa	<b>TESTED BY:</b> Leo Hung	

No	Freq. [MHz]	Corr. Factor (dB)	Reading Value [dB (uV)]		Emission Level [dB (uV)]		Limit [dB (uV)]		Margin (dB)	
			Q.P.	AV.	Q.P.	AV.	Q.P.	AV.	Q.P.	AV.
	1	0.154	0.11	44.71	-	44.82	-	65.79	55.79	-20.97
2	0.224	0.12	42.01	-	42.13	-	62.66	52.66	-20.53	-
3	0.295	0.12	31.53	-	31.65	-	60.40	50.40	-28.74	-
4	1.566	0.16	29.66	-	29.82	-	56.00	46.00	-26.18	-
5	3.711	0.20	26.93	-	27.13	-	56.00	46.00	-28.87	-
6	10.492	0.35	35.31	-	35.66	-	60.00	50.00	-24.34	-

- REMARKS:**
1. Q.P. and AV. are abbreviations of quasi-peak and average individually.
  2. "-": The Quasi-peak reading value also meets average limit and measurement with the average detector is unnecessary.
  3. The emission levels of other frequencies were very low against the limit.
  4. Margin value = Emission level - Limit value
  5. Correction factor = Insertion loss + Cable loss
  6. Emission Level = Correction Factor + Reading Value.

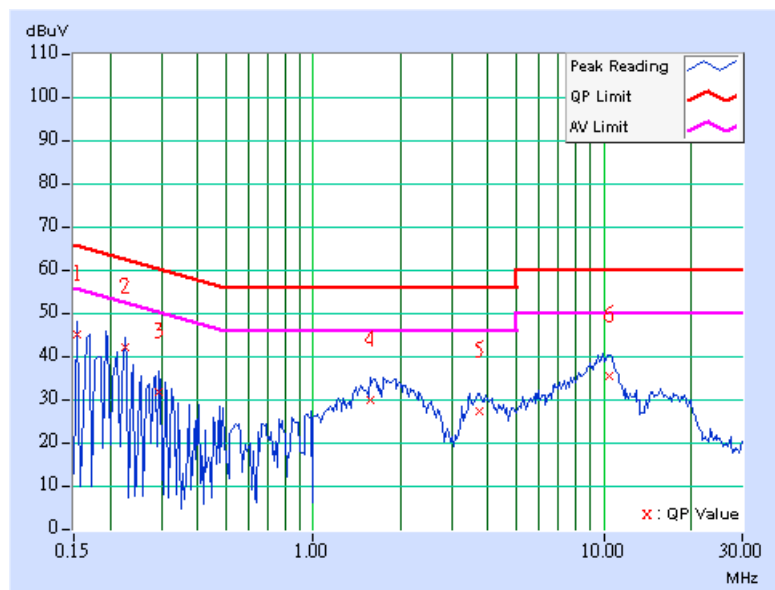





<b>EUT</b>	Wireless A/G Portable USB Adapter	<b>MODEL</b>	WUSB54AGP
<b>MODE</b>	Channel 1	<b>6dB BANDWIDTH</b>	9 kHz
<b>INPUT POWER (SYSTEM)</b>	120Vac, 60Hz	<b>PHASE</b>	Neutral (N)
<b>ENVIRONMENTAL CONDITIONS</b>	24deg. C, 64%RH, 991hPa	<b>TESTED BY:</b> Leo Hung	

No	Freq. [MHz]	Corr. Factor (dB)	Reading Value [dB (uV)]		Emission Level [dB (uV)]		Limit [dB (uV)]		Margin (dB)	
			Q.P.	AV.	Q.P.	AV.	Q.P.	AV.	Q.P.	AV.
			1	0.193	0.11	46.17	-	46.28	-	63.91
2	0.224	0.11	42.34	-	42.45	-	62.66	52.66	-20.21	-
3	1.797	0.16	31.21	-	31.37	-	56.00	46.00	-24.63	-
4	3.801	0.20	24.79	-	24.99	-	56.00	46.00	-31.01	-
5	7.363	0.28	28.56	-	28.84	-	60.00	50.00	-31.16	-
6	10.223	0.30	35.31	-	35.61	-	60.00	50.00	-24.39	-

- REMARKS:**
1. Q.P. and AV. are abbreviations of quasi-peak and average individually.
  2. "-": The Quasi-peak reading value also meets average limit and measurement with the average detector is unnecessary.
  3. The emission levels of other frequencies were very low against the limit.
  4. Margin value = Emission level - Limit value
  5. Correction factor = Insertion loss + Cable loss
  6. Emission Level = Correction Factor + Reading Value.

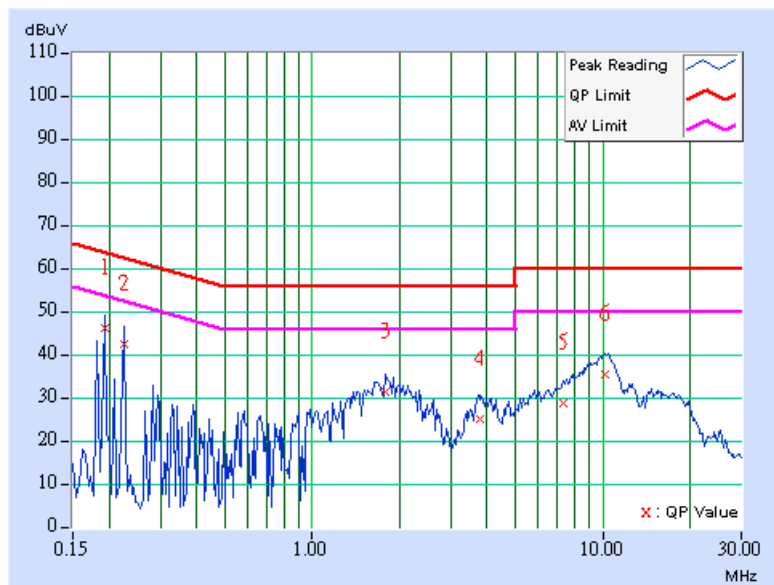



<b>EUT</b>	Wireless A/G Portable USB Adapter	<b>MODEL</b>	WUSB54AGP
<b>MODE</b>	Channel 6	<b>6dB BANDWIDTH</b>	9 kHz
<b>INPUT POWER (SYSTEM)</b>	120Vac, 60Hz	<b>PHASE</b>	Line (L)
<b>ENVIRONMENTAL CONDITIONS</b>	24deg. C, 64%RH, 991hPa	<b>TESTED BY:</b> Leo Hung	

No	Freq. [MHz]	Corr. Factor (dB)	Reading Value [dB (uV)]		Emission Level [dB (uV)]		Limit [dB (uV)]		Margin (dB)	
			Q.P.	AV.	Q.P.	AV.	Q.P.	AV.	Q.P.	AV.
	1	0.158	0.11	43.46	-	43.57	-	65.58	55.58	-22.01
2	0.216	0.12	43.25	-	43.37	-	62.96	52.96	-19.59	-
3	1.645	0.16	31.25	-	31.41	-	56.00	46.00	-24.59	-
4	3.539	0.20	25.82	-	26.02	-	56.00	46.00	-29.98	-
5	6.848	0.29	27.55	-	27.84	-	60.00	50.00	-32.16	-
6	10.527	0.35	35.31	-	35.66	-	60.00	50.00	-24.34	-

- REMARKS:**
1. Q.P. and AV. are abbreviations of quasi-peak and average individually.
  2. "-": The Quasi-peak reading value also meets average limit and measurement with the average detector is unnecessary.
  3. The emission levels of other frequencies were very low against the limit.
  4. Margin value = Emission level - Limit value
  5. Correction factor = Insertion loss + Cable loss
  6. Emission Level = Correction Factor + Reading Value.

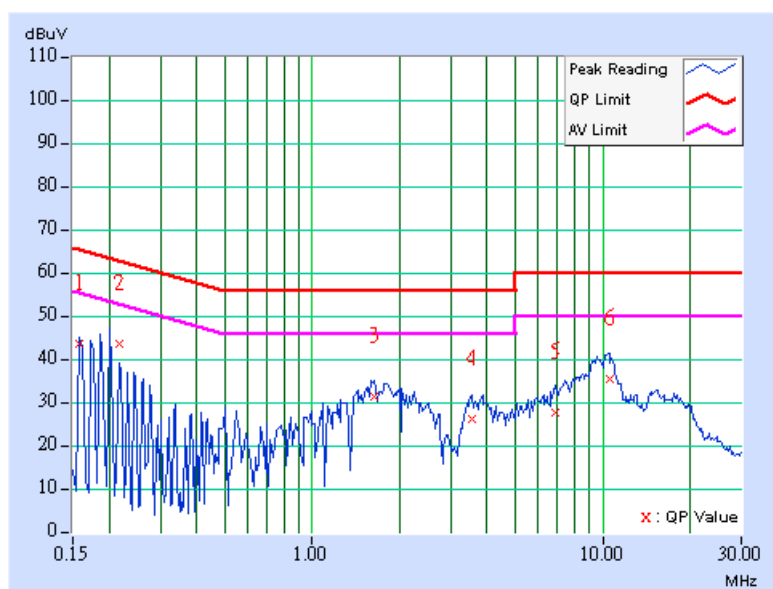



<b>EUT</b>	Wireless A/G Portable USB Adapter	<b>MODEL</b>	WUSB54AGP
<b>MODE</b>	Channel 6	<b>6dB BANDWIDTH</b>	9 kHz
<b>INPUT POWER (SYSTEM)</b>	120Vac, 60Hz	<b>PHASE</b>	Neutral (N)
<b>ENVIRONMENTAL CONDITIONS</b>	24deg. C, 64%RH, 991hPa	<b>TESTED BY:</b> Leo Hung	

No	Freq. [MHz]	Corr. Factor (dB)	Reading Value [dB (uV)]		Emission Level [dB (uV)]		Limit [dB (uV)]		Margin (dB)	
			Q.P.	AV.	Q.P.	AV.	Q.P.	AV.	Q.P.	AV.
			1	0.197	0.11	45.95	-	46.06	-	63.74
2	0.216	0.11	43.66	-	43.77	-	62.96	52.96	-19.19	-
3	0.435	0.12	24.33	-	24.45	-	57.15	47.15	-32.71	-
4	1.785	0.16	30.68	-	30.84	-	56.00	46.00	-25.16	-
5	5.680	0.24	25.87	-	26.11	-	60.00	50.00	-33.89	-
6	10.262	0.30	35.70	-	36.00	-	60.00	50.00	-24.00	-

- REMARKS:**
1. Q.P. and AV. are abbreviations of quasi-peak and average individually.
  2. "-": The Quasi-peak reading value also meets average limit and measurement with the average detector is unnecessary.
  3. The emission levels of other frequencies were very low against the limit.
  4. Margin value = Emission level - Limit value
  5. Correction factor = Insertion loss + Cable loss
  6. Emission Level = Correction Factor + Reading Value.

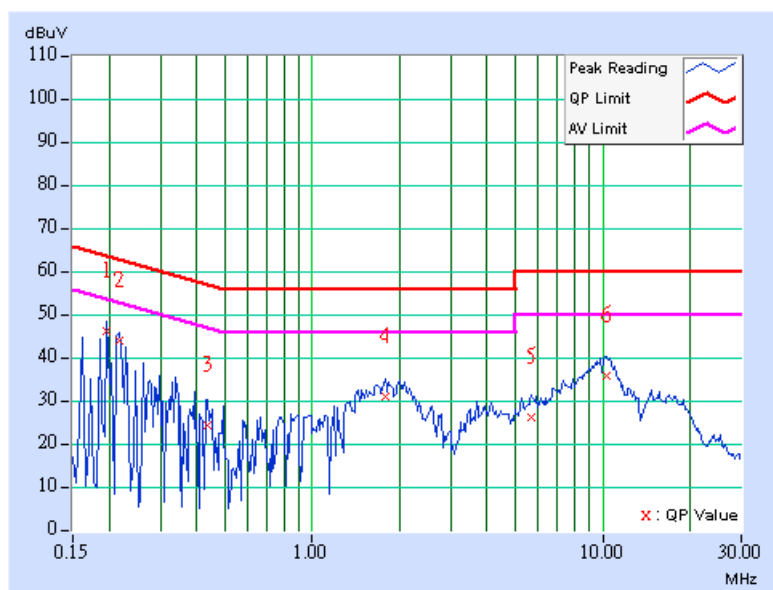



<b>EUT</b>	Wireless A/G Portable USB Adapter	<b>MODEL</b>	WUSB54AGP
<b>MODE</b>	Channel 11	<b>6dB BANDWIDTH</b>	9 kHz
<b>INPUT POWER (SYSTEM)</b>	120Vac, 60Hz	<b>PHASE</b>	Line (L)
<b>ENVIRONMENTAL CONDITIONS</b>	24deg. C, 64%RH, 991hPa	<b>TESTED BY:</b> Leo Hung	

No	Freq. [MHz]	Corr. Factor (dB)	Reading Value		Emission Level		Limit		Margin	
			[dB (uV)]		[dB (uV)]		[dB (uV)]		(dB)	
			Q.P.	AV.	Q.P.	AV.	Q.P.	AV.	Q.P.	AV.
1	0.173	0.11	41.24	-	41.35	-	64.79	54.79	-23.44	-
2	0.193	0.12	46.12	-	46.24	-	63.91	53.91	-17.67	-
3	0.298	0.12	30.76	-	30.88	-	60.29	50.29	-29.40	-
4	1.820	0.16	30.84	-	31.00	-	56.00	46.00	-25.00	-
5	3.930	0.21	27.03	-	27.24	-	56.00	46.00	-28.76	-
6	10.254	0.32	35.45	-	35.77	-	60.00	50.00	-24.23	-

- REMARKS:**
1. Q.P. and AV. are abbreviations of quasi-peak and average individually.
  2. "-": The Quasi-peak reading value also meets average limit and measurement with the average detector is unnecessary.
  3. The emission levels of other frequencies were very low against the limit.
  4. Margin value = Emission level - Limit value
  5. Correction factor = Insertion loss + Cable loss
  6. Emission Level = Correction Factor + Reading Value.

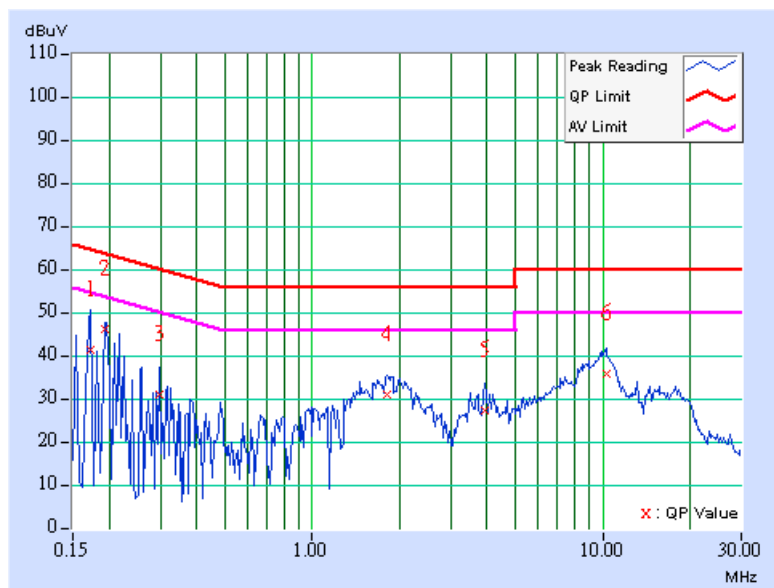



<b>EUT</b>	Wireless A/G Portable USB Adapter	<b>MODEL</b>	WUSB54AGP
<b>MODE</b>	Channel 11	<b>6dB BANDWIDTH</b>	9 kHz
<b>INPUT POWER (SYSTEM)</b>	120Vac, 60Hz	<b>PHASE</b>	Neutral (N)
<b>ENVIRONMENTAL CONDITIONS</b>	24deg. C, 64%RH, 991hPa	<b>TESTED BY:</b> Leo Hung	

No	Freq. [MHz]	Corr. Factor (dB)	Reading Value [dB (uV)]		Emission Level [dB (uV)]		Limit [dB (uV)]		Margin (dB)	
			Q.P.	AV.	Q.P.	AV.	Q.P.	AV.	Q.P.	AV.
			1	0.185	0.11	44.93	-	45.04	-	64.25
2	0.213	0.11	42.32	-	42.43	-	63.11	53.11	-20.68	-
3	0.396	0.12	26.98	-	27.10	-	57.93	47.93	-30.84	-
4	1.676	0.16	31.03	-	31.19	-	56.00	46.00	-24.81	-
5	3.820	0.20	23.84	-	24.04	-	56.00	46.00	-31.96	-
6	10.668	0.33	35.10	-	35.43	-	60.00	50.00	-24.57	-

- REMARKS:**
1. Q.P. and AV. are abbreviations of quasi-peak and average individually.
  2. "-": The Quasi-peak reading value also meets average limit and measurement with the average detector is unnecessary.
  3. The emission levels of other frequencies were very low against the limit.
  4. Margin value = Emission level - Limit value
  5. Correction factor = Insertion loss + Cable loss
  6. Emission Level = Correction Factor + Reading Value.

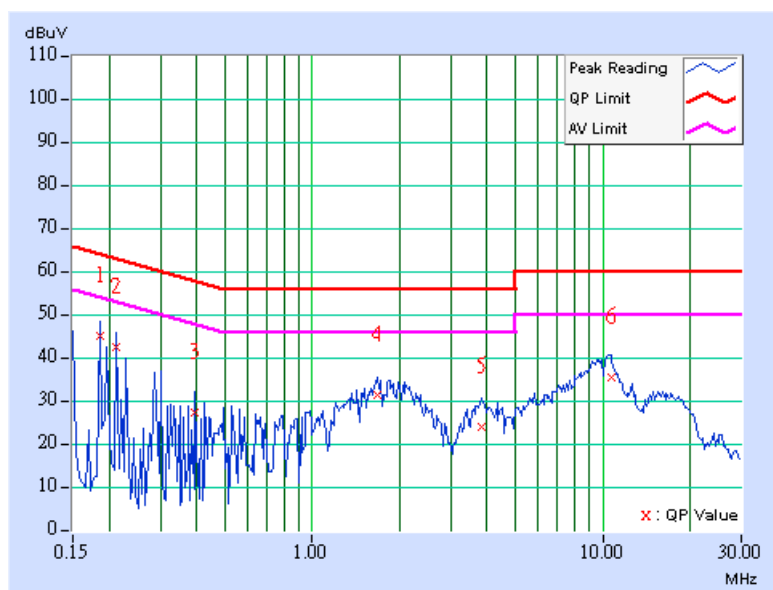



## 4.2 RADIATED EMISSION MEASUREMENT

### 4.2.1 LIMITS OF RADIATED EMISSION MEASUREMENT

Emissions radiated outside of the specified bands, shall be according to the general radiated limits in 15.209 as following:

Frequencies (MHz)	Field strength (microvolts/meter)	Measurement distance (meters)
0.009-0.490	2400/F(kHz)	300
0.490-1.705	24000/F(kHz)	30
1.705-30.0	30	30
30-88	100	3
88-216	150	3
216-960	200	3
Above 960	500	3

**NOTE:**

1. The lower limit shall apply at the transition frequencies.
2. Emission level (dBuV/m) = 20 log Emission level (uV/m).
3. As shown in 15.35(b), for frequencies above 1000MHz, the field strength limits are based on average detector, however, the peak field strength of any emission shall not exceed the maximum permitted average limits, specified above by more than 20dB under any condition of modulation.



## 4.2.2 TEST INSTRUMENTS

DESCRIPTION & MANUFACTURER	MODEL NO.	SERIAL NO.	CALIBRATED UNTIL
Test Receiver ROHDE & SCHWARZ	ESIB7	100188	Jan. 13, 2005
Spectrum Analyzer ROHDE & SCHWARZ	FSP40	100039	Nov. 21, 2005
BILOG Antenna SCHWARZBECK	VULB9168	9168-157	Feb. 03, 2005
HORN Antenna SCHWARZBECK	BBHA 9120 D	9120D-407	Feb. 03, 2005
HORN Antenna SCHWARZBECK	BBHA 9170	BBHA 9170241	Feb. 23, 2005
Preamplifier Agilent	8449B	3008A01961	Nov. 09, 2005
Preamplifier Agilent	8447D	2944A10629	Nov. 09, 2005
RF signal cable HUBER+SUHNER	SUCOFLEX 104	218182/4	Mar. 04, 2005
RF signal cable HUBER+SUHNER	SUCOFLEX 104	218194/4	Mar. 04, 2005
Software ADT.	ADT_Radiated_V5.14	NA	NA
Antenna Tower ADT.	AT100	AT93021702	NA
Turn Table ADT.	TT100.	TT93021702	NA
Controller ADT.	SC100.	SC93021702	NA

- NOTE:** 1. The calibration interval of the above test instruments is 12 months and the calibrations are traceable to NML/ROC and NIST/USA.
2. The test was performed in HwaYa Chamber 1.
3. The horn antenna and HP preamplifier (model: 8449B) are used only for the measurement of emission frequency above 1GHz if tested.
4. The IC Site Registration No. is IC4924-2.



#### 4.2.3 TEST PROCEDURES

- a. The EUT was placed on the top of a rotating table 0.8 meters above the ground at a 3 meter semi-anechoic chamber. The table was rotated 360 degrees to determine the position of the highest radiation.
- b. The EUT was set 3 meters away from the interference-receiving antenna, which was mounted on the top of a variable-height antenna tower.
- c. The antenna is a broadband antenna, and its height is varied from one meter to four meters above the ground to determine the maximum value of the field strength. Both horizontal and vertical polarizations of the antenna are set to make the measurement.
- d. For each suspected emission, the EUT was arranged to its worst case and then the antenna was tuned to heights from 1 meter to 4 meters and the rotatable table was turned from 0 degrees to 360 degrees to find the maximum reading.
- e. The test-receiver system was set to Peak Detect Function and Specified Bandwidth with Maximum Hold Mode.
- f. If the emission level of the EUT in peak mode was 10 dB lower than the limit specified, then testing could be stopped and the peak values of the EUT would be reported. Otherwise the emissions that did not have 10 dB margin would be re-tested one by one using the quasi-peak method or average method as specified and then reported in Data sheet peak mode and QP mode.

**NOTE:**

1. The resolution bandwidth and video bandwidth of test receiver/spectrum analyzer is 120kHz for Quasi-peak detection at frequency below 1GHz.
2. The resolution bandwidth and video bandwidth of test receiver/spectrum analyzer is 1 MHz for Peak detection (PK) at frequency above 1GHz.
3. The resolution bandwidth of test receiver/spectrum analyzer is 1 MHz and the video bandwidth is 10 Hz for Average detection (AV) at frequency above 1GHz.

#### 4.2.4 DEVIATION FROM TEST STANDARD

No deviation



#### 4.2.5 TEST SETUP

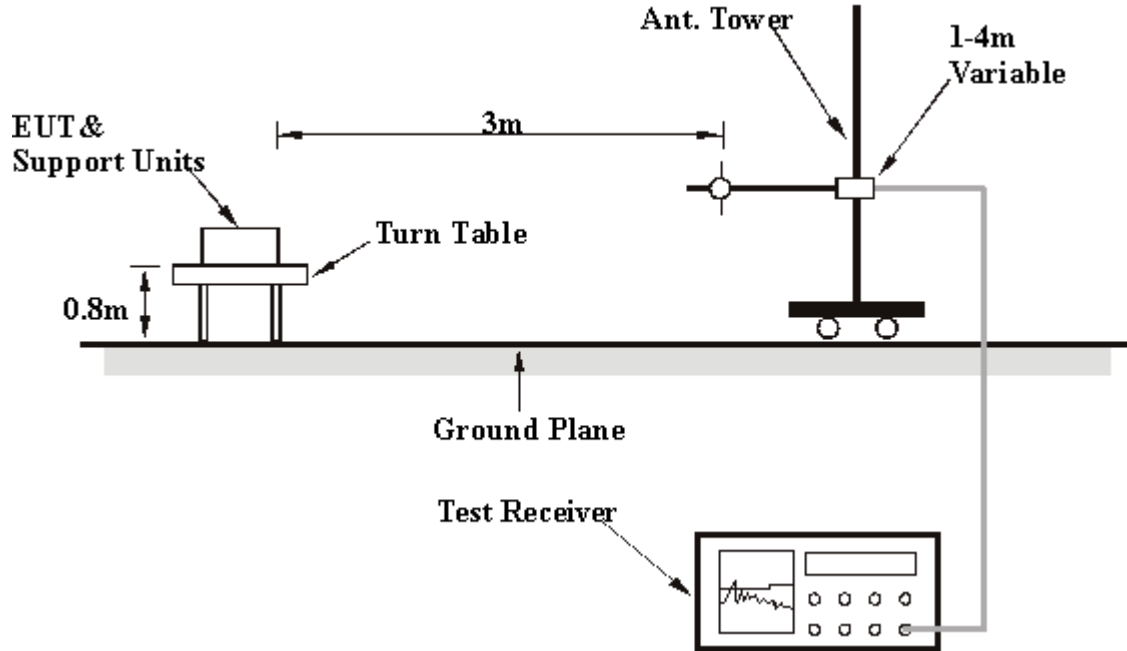

For the actual test configuration, please refer to the related item – Photographs of the Test Configuration.

#### 4.2.6 EUT OPERATING CONDITIONS

Same as 4.1.6



## 4.2.7 TEST RESULTS

<b>EUT</b>	Wireless A/G Portable USB Adapter	<b>MODEL</b>	WUSB54AGP
<b>CHANNEL</b>	Channel 11	<b>FREQUENCY RANGE</b>	Below 1000MHz
<b>INPUT POWER (SYSTEM)</b>	120Vac, 60 Hz	<b>DETECTOR FUNCTION</b>	Quasi-Peak
<b>ENVIRONMENTAL CONDITIONS</b>	25deg. C, 55%RH, 991hPa	<b>TESTED BY:</b> Match Tsui	

<b>ANTENNA POLARITY &amp; TEST DISTANCE: HORIZONTAL AT 3 M</b>								
No.	Freq. (MHz)	Emission Level (dBuV/m)	Limit (dBuV/m)	Margin (dB)	Antenna Height (m)	Table Angle (Degree)	Raw Value (dBuV)	Correction Factor (dB/m)
1	117.47	32.58 QP	43.50	-10.92	1.50 H	88	19.81	12.77
2	164.13	30.86 QP	43.50	-12.64	1.50 H	265	16.37	14.49
3	239.94	34.24 QP	46.00	-11.76	1.50 H	220	21.17	13.07
4	319.64	34.54 QP	46.00	-11.46	1.00 H	217	19.59	14.95
5	383.79	34.67 QP	46.00	-11.33	1.00 H	283	18.28	16.39
6	440.16	37.04 QP	46.00	-8.96	2.00 H	76	19.23	17.81
7	519.86	37.21 QP	46.00	-8.79	1.50 H	247	18.10	19.11
8	560.68	33.93 QP	46.00	-12.07	1.50 H	163	13.96	19.97
9	599.56	36.02 QP	46.00	-9.98	1.50 H	232	15.02	21.00
10	640.38	37.48 QP	46.00	-8.52	1.50 H	175	15.92	21.55
11	720.08	40.40 QP	46.00	-5.60	1.00 H	220	17.60	22.79
12	760.90	34.52 QP	46.00	-11.48	1.00 H	205	10.93	23.59
13	799.78	36.31 QP	46.00	-9.69	2.00 H	214	12.49	23.82
14	840.60	36.60 QP	46.00	-9.40	1.00 H	208	12.48	24.12
15	920.30	36.44 QP	46.00	-9.56	1.50 H	211	11.12	25.33

- REMARKS:**
1. Emission level(dBuV/m)=Raw Value(dBuV) + Correction Factor(dB)
  2. Correction Factor(dB/m) = Antenna Factor (dB/m) + Cable Factor (dB)
  3. The other emission levels were very low against the limit.
  4. Margin value = Emission level – Limit value.



<b>EUT</b>	Wireless A/G Portable USB Adapter	<b>MODEL</b>	WUSB54AGP
<b>CHANNEL</b>	Channel 11	<b>FREQUENCY RANGE</b>	Below 1000MHz
<b>INPUT POWER (SYSTEM)</b>	120Vac, 60 Hz	<b>DETECTOR FUNCTION</b>	Quasi-Peak
<b>ENVIRONMENTAL CONDITIONS</b>	25deg. C, 55%RH, 991hPa	<b>TESTED BY:</b> Match Tsui	

#### ANTENNA POLARITY & TEST DISTANCE: VERTICAL AT 3 M

No.	Freq. (MHz)	Emission Level (dBuV/m)	Limit (dBuV/m)	Margin (dB)	Antenna Height (m)	Table Angle (Degree)	Raw Value (dBuV)	Correction Factor (dB/m)
1	64.99	27.93 QP	40.00	-12.07	1.00 V	34	14.78	13.15
2	127.19	32.93 QP	43.50	-10.57	1.00 V	31	19.40	13.53
3	177.74	35.74 QP	43.50	-7.76	1.00 V	250	22.56	13.18
4	370.18	26.99 QP	46.00	-19.01	2.00 V	154	10.89	16.09
5	401.28	27.24 QP	46.00	-18.76	1.50 V	133	10.45	16.78
6	440.16	31.61 QP	46.00	-14.39	2.00 V	151	13.80	17.81
7	465.43	27.08 QP	46.00	-18.92	1.00 V	151	8.81	18.27
8	519.86	30.28 QP	46.00	-15.72	1.50 V	139	11.16	19.11
9	560.68	28.96 QP	46.00	-17.04	1.50 V	160	8.99	19.97
10	599.56	31.74 QP	46.00	-14.26	1.50 V	142	10.74	21.00
11	640.38	32.79 QP	46.00	-13.21	1.50 V	130	11.24	21.55
12	667.60	30.39 QP	46.00	-15.61	1.00 V	79	8.49	21.90
13	720.08	33.99 QP	46.00	-12.01	2.00 V	127	11.19	22.79
14	799.78	34.63 QP	46.00	-11.37	2.00 V	136	10.81	23.82
15	920.30	31.05 QP	46.00	-14.95	1.50 V	133	5.73	25.33

- REMARKS:**
1. Emission level(dBuV/m)=Raw Value(dBuV) + Correction Factor(dB)
  2. Correction Factor(dB/m) = Antenna Factor (dB/m) + Cable Factor (dB)
  3. The other emission levels were very low against the limit.
  4. Margin value = Emission level – Limit value.



<b>EUT</b>	Wireless A/G Portable USB Adapter	<b>MODEL</b>	WUSB54AGP
<b>CHANNEL</b>	Channel 1	<b>FREQUENCY RANGE</b>	1 ~ 25GHz
<b>MODE</b>	CCK		
<b>INPUT POWER (SYSTEM)</b>	120Vac, 60 Hz	<b>DETECTOR FUNCTION</b>	Peak(PK) Average (AV)
<b>ENVIRONMENTAL CONDITIONS</b>	25deg. C, 60%RH, 991hPa	<b>TESTED BY:</b> Leo Hung	

<b>ANTENNA POLARITY &amp; TEST DISTANCE: HORIZONTAL AT 3 M</b>								
No.	Freq. (MHz)	Emission Level (dBuV/m)	Limit (dBuV/m)	Margin (dB)	Antenna Height (m)	Table Angle (Degree)	Raw Value (dBuV)	Correction Factor (dB/m)
1	2390.00	55.87 PK	74.00	-18.13	1.06 H	360	24.07	31.80
1	2390.00	48.75 AV	54.00	-5.25	1.06 H	360	16.95	31.80
2	*2412.00	113.40 PK			1.06 H	360	81.53	31.87
2	*2412.00	106.28 AV			1.06 H	360	74.41	31.87
3	2688.00	45.64 PK	74.00	-28.36	1.19 H	224	12.74	32.90
4	4824.00	54.47 PK	74.00	-19.53	1.17 H	72	16.36	38.11
4	4824.00	46.65 AV	54.00	-7.35	1.17 H	72	8.54	38.11

<b>ANTENNA POLARITY &amp; TEST DISTANCE: VERTICAL AT 3 M</b>								
No.	Freq. (MHz)	Emission Level (dBuV/m)	Limit (dBuV/m)	Margin (dB)	Antenna Height (m)	Table Angle (Degree)	Raw Value (dBuV)	Correction Factor (dB/m)
1	2390.00	49.66 PK	74.00	-24.34	1.17 V	177	17.86	31.80
1	2390.00	42.13 AV	54.00	-11.87	1.17 V	177	10.33	31.80
2	*2412.00	107.19 PK			1.17 V	177	75.32	31.87
2	*2412.00	99.66 AV			1.17 V	177	67.79	31.87
3	2688.00	43.71 PK	74.00	-30.29	1.01 V	211	10.81	32.90
4	4824.00	50.55 PK	74.00	-23.45	1.22 V	28	12.44	38.11
4	4824.00	41.46 AV	54.00	-12.54	1.22 V	28	3.35	38.11

- REMARKS:**
1. Emission level(dBuV/m)=Raw Value(dBuV) + Correction Factor(dB/m)
  2. Correction Factor(dB/m) = Antenna Factor (dB/m) + Cable Factor (dB)
  3. The other emission levels were very low against the limit.
  4. Margin value = Emission level – Limit value.
  5. The limit value is defined as per 15.247
  6. " \* " : Fundamental frequency



<b>EUT</b>	Wireless A/G Portable USB Adapter	<b>MODEL</b>	WUSB54AGP
<b>CHANNEL</b>	Channel 6	<b>FREQUENCY RANGE</b>	1 ~ 25GHz
<b>MODE</b>	CCK		
<b>INPUT POWER (SYSTEM)</b>	120Vac, 60 Hz	<b>DETECTOR FUNCTION</b>	Peak(PK) Average (AV)
<b>ENVIRONMENTAL CONDITIONS</b>	25deg. C, 60%RH, 991hPa	<b>TESTED BY:</b> Leo Hung	

#### ANTENNA POLARITY & TEST DISTANCE: HORIZONTAL AT 3 M

No.	Freq. (MHz)	Emission Level (dBuV/m)	Limit (dBuV/m)	Margin (dB)	Antenna Height (m)	Table Angle (Degree)	Raw Value (dBuV)	Correction Factor (dB/m)
1	*2437.00	115.54 PK			1.06 H	336	83.59	31.95
1	*2437.00	105.42 AV			1.06 H	336	73.47	31.95
2	2688.00	44.32 PK	74.00	-29.68	1.22 H	112	11.42	32.90
3	4874.00	51.32 PK	74.00	-22.68	1.00 H	9	13.04	38.28
3	4874.00	41.47 AV	54.00	-12.53	1.00 H	9	3.19	38.28

#### ANTENNA POLARITY & TEST DISTANCE: VERTICAL AT 3 M

No.	Freq. (MHz)	Emission Level (dBuV/m)	Limit (dBuV/m)	Margin (dB)	Antenna Height (m)	Table Angle (Degree)	Raw Value (dBuV)	Correction Factor (dB/m)
1	*2437.00	108.26 PK			1.27 V	7	76.31	31.95
1	*2437.00	100.06 AV			1.27 V	7	68.11	31.95
2	2688.00	43.48 PK	74.00	-30.52	1.10 V	221	10.58	32.90
3	4974.00	52.16 PK	74.00	-21.84	1.00 V	360	13.43	38.73
3	4974.00	44.25 AV	54.00	-9.75	1.00 V	360	5.52	38.73

- REMARKS:**
1. Emission level(dBuV/m)=Raw Value(dBuV) + Correction Factor(dB/m)
  2. Correction Factor(dB/m) = Antenna Factor (dB/m) + Cable Factor (dB)
  3. The other emission levels were very low against the limit.
  4. Margin value = Emission level – Limit value.
  5. The limit value is defined as per 15.247
  6. “ \* “ : Fundamental frequency



<b>EUT</b>	Wireless A/G Portable USB Adapter	<b>MODEL</b>	WUSB54AGP
<b>CHANNEL</b>	Channel 11	<b>FREQUENCY RANGE</b>	1 ~ 25GHz
<b>MODE</b>	CCK		
<b>INPUT POWER (SYSTEM)</b>	120Vac, 60 Hz	<b>DETECTOR FUNCTION</b>	Peak(PK) Average (AV)
<b>ENVIRONMENTAL CONDITIONS</b>	25deg. C, 60%RH, 991hPa	<b>TESTED BY:</b> Leo Hung	

### ANTENNA POLARITY & TEST DISTANCE: HORIZONTAL AT 3 M

No.	Freq. (MHz)	Emission Level (dBuV/m)	Limit (dBuV/m)	Margin (dB)	Antenna Height (m)	Table Angle (Degree)	Raw Value (dBuV)	Correction Factor (dB/m)
1	*2462.00	112.64 PK			1.06 H	15	80.62	32.02
1	*2462.00	105.95 AV			1.06 H	15	73.93	32.02
2	2483.50	53.59 PK	74.00	-20.41	1.06 H	15	21.50	32.09
2	2483.50	46.90 AV	54.00	-7.10	1.06 H	15	14.81	32.09
3	2688.00	46.65 PK	74.00	-27.35	1.25 H	221	13.75	32.90
4	4924.00	54.58 PK	74.00	-19.42	1.16 H	88	16.09	38.49
4	4924.00	46.99 AV	54.00	-7.01	1.16 H	88	8.50	38.49

### ANTENNA POLARITY & TEST DISTANCE: VERTICAL AT 3 M

No.	Freq. (MHz)	Emission Level (dBuV/m)	Limit (dBuV/m)	Margin (dB)	Antenna Height (m)	Table Angle (Degree)	Raw Value (dBuV)	Correction Factor (dB/m)
1	*2462.00	107.10 PK			1.13 V	152	75.08	32.02
1	*2462.00	99.58 AV			1.13 V	152	67.56	32.02
2	2483.50	48.07 PK	74.00	-25.93	1.13 V	152	15.98	32.09
2	2483.50	40.53 AV	54.00	-13.47	1.13 V	152	8.44	32.09
3	2688.00	43.40 PK	74.00	-30.60	1.00 V	328	10.50	32.90
4	4924.00	51.53 PK	74.00	-22.47	1.13 V	69	13.04	38.49
4	4924.00	42.93 AV	54.00	-11.07	1.13 V	69	4.44	38.49

- REMARKS:**
1. Emission level(dBuV/m)=Raw Value(dBuV) + Correction Factor(dB/m)
  2. Correction Factor(dB/m) = Antenna Factor (dB/m) + Cable Factor (dB)
  3. The other emission levels were very low against the limit.
  4. Margin value = Emission level – Limit value.
  5. The limit value is defined as per 15.247
  6. “ \* “ : Fundamental frequency



<b>EUT</b>	Wireless A/G Portable USB Adapter	<b>MODEL</b>	WUSB54AGP
<b>CHANNEL</b>	Channel 1	<b>FREQUENCY RANGE</b>	1 ~ 25GHz
<b>MODE</b>	OFDM		
<b>INPUT POWER (SYSTEM)</b>	120Vac, 60 Hz	<b>DETECTOR FUNCTION</b>	Peak(PK) Average (AV)
<b>ENVIRONMENTAL CONDITIONS</b>	25deg. C, 60%RH, 991hPa	<b>TESTED BY:</b> Leo Hung	

### ANTENNA POLARITY & TEST DISTANCE: HORIZONTAL AT 3 M

No.	Freq. (MHz)	Emission Level (dBuV/m)	Limit (dBuV/m)	Margin (dB)	Antenna Height (m)	Table Angle (Degree)	Raw Value (dBuV)	Correction Factor (dB/m)
1	2390.00	60.62 PK	74.00	-13.38	1.08 H	360	28.82	31.80
1	2390.00	49.91 AV	54.00	-4.09	1.08 H	360	18.11	31.80
2	*2412.00	111.12 PK			1.08 H	360	79.25	31.87
2	*2412.00	100.41 AV			1.08 H	360	68.54	31.87
3	2688.00	44.38 PK	74.00	-29.62	1.00 H	357	11.48	32.90
4	4824.00	50.42 PK	74.00	-23.58	1.11 H	7	12.31	38.11
4	4824.00	37.35 AV	54.00	-16.65	1.11 H	7	-0.76	38.11

### ANTENNA POLARITY & TEST DISTANCE: VERTICAL AT 3 M

No.	Freq. (MHz)	Emission Level (dBuV/m)	Limit (dBuV/m)	Margin (dB)	Antenna Height (m)	Table Angle (Degree)	Raw Value (dBuV)	Correction Factor (dB/m)
1	2390.00	52.51 PK	74.00	-21.49	1.14 V	252	20.71	31.80
1	2390.00	43.46 AV	54.00	-10.54	1.14 V	252	11.66	31.80
2	*2412.00	103.01 PK			1.14 V	252	71.14	31.87
2	*2412.00	93.96 AV			1.14 V	252	62.09	31.87
3	2688.00	43.34 PK	74.00	-30.66	1.08 V	2	10.44	32.90
4	4824.00	48.45 PK	74.00	-25.55	1.10 V	112	10.34	38.11

- REMARKS:**
1. Emission level(dBuV/m)=Raw Value(dBuV) + Correction Factor(dB/m)
  2. Correction Factor(dB/m) = Antenna Factor (dB/m) + Cable Factor (dB)
  3. The other emission levels were very low against the limit.
  4. Margin value = Emission level – Limit value.
  5. The limit value is defined as per 15.247
  6. “ \* “ : Fundamental frequency



<b>EUT</b>	Wireless A/G Portable USB Adapter	<b>MODEL</b>	WUSB54AGP
<b>CHANNEL</b>	Channel 6	<b>FREQUENCY RANGE</b>	1 ~ 25GHz
<b>MODE</b>	OFDM		
<b>INPUT POWER (SYSTEM)</b>	120Vac, 60 Hz	<b>DETECTOR FUNCTION</b>	Peak(PK) Average (AV)
<b>ENVIRONMENTAL CONDITIONS</b>	25deg. C, 60%RH, 991hPa	<b>TESTED BY:</b> Leo Hung	

#### ANTENNA POLARITY & TEST DISTANCE: HORIZONTAL AT 3 M

No.	Freq. (MHz)	Emission Level (dBuV/m)	Limit (dBuV/m)	Margin (dB)	Antenna Height (m)	Table Angle (Degree)	Raw Value (dBuV)	Correction Factor (dB/m)
1	*2437.00	110.59 PK			1.08 H	14	78.64	31.95
1	*2437.00	101.19 AV			1.08 H	14	69.24	31.95
2	2688.00	46.61 PK	74.00	-27.39	1.00 H	360	13.71	32.90
3	4874.00	49.16 PK	74.00	-24.84	1.04 H	112	10.88	38.28

#### ANTENNA POLARITY & TEST DISTANCE: VERTICAL AT 3 M

No.	Freq. (MHz)	Emission Level (dBuV/m)	Limit (dBuV/m)	Margin (dB)	Antenna Height (m)	Table Angle (Degree)	Raw Value (dBuV)	Correction Factor (dB/m)
1	*2437.00	104.92 PK			1.33 V	345	72.97	31.95
1	*2437.00	95.75 AV			1.33 V	345	63.80	31.95
2	2688.00	45.38 PK	74.00	-28.62	1.09 V	235	12.48	32.90
3	4874.00	48.83 PK	74.00	-25.17	1.00 V	112	10.55	38.28

- REMARKS:**
1. Emission level(dBuV/m)=Raw Value(dBuV) + Correction Factor(dB/m)
  2. Correction Factor(dB/m) = Antenna Factor (dB/m) + Cable Factor (dB)
  3. The other emission levels were very low against the limit.
  4. Margin value = Emission level – Limit value.
  5. The limit value is defined as per 15.247
  6. “ \* “ : Fundamental frequency





<b>EUT</b>	Wireless A/G Portable USB Adapter	<b>MODEL</b>	WUSB54AGP
<b>CHANNEL</b>	Channel 11	<b>FREQUENCY RANGE</b>	1 ~ 25GHz
<b>MODE</b>	OFDM		
<b>INPUT POWER (SYSTEM)</b>	120Vac, 60 Hz	<b>DETECTOR FUNCTION</b>	Peak(PK) Average (AV)
<b>ENVIRONMENTAL CONDITIONS</b>	25deg. C, 60%RH, 991hPa	<b>TESTED BY:</b> Leo Hung	

#### ANTENNA POLARITY & TEST DISTANCE: HORIZONTAL AT 3 M

No.	Freq. (MHz)	Emission Level (dBuV/m)	Limit (dBuV/m)	Margin (dB)	Antenna Height (m)	Table Angle (Degree)	Raw Value (dBuV)	Correction Factor (dB/m)
1	*2462.00	110.59 PK			1.05 H	360	78.57	32.02
1	*2462.00	99.64 AV			1.05 H	360	67.62	32.02
2	2483.50	62.91 PK	74.00	-11.09	1.05 H	360	30.82	32.09
<b>2</b>	<b>2483.50</b>	<b>51.96 AV</b>	<b>54.00</b>	<b>-2.04</b>	<b>1.05 H</b>	<b>360</b>	<b>19.87</b>	<b>32.09</b>
3	2688.00	45.55 PK	74.00	-28.45	1.00 H	7	12.65	32.90
4	4924.00	50.23 PK	74.00	-23.77	1.06 H	322	11.74	38.49
4	4924.00	37.25 AV	54.00	-16.75	1.06 H	322	-1.24	38.49

#### ANTENNA POLARITY & TEST DISTANCE: VERTICAL AT 3 M

No.	Freq. (MHz)	Emission Level (dBuV/m)	Limit (dBuV/m)	Margin (dB)	Antenna Height (m)	Table Angle (Degree)	Raw Value (dBuV)	Correction Factor (dB/m)
1	*2462.00	104.91 PK			1.11 V	154	72.89	32.02
1	*2462.00	95.57 AV			1.11 V	154	63.55	32.02
2	2483.50	57.23 PK	74.00	-16.77	1.11 V	154	25.14	32.09
2	2483.50	47.13 AV	54.00	-6.87	1.11 V	154	15.04	32.09
3	2688.00	45.32 PK	74.00	-28.68	1.02 V	211	12.42	32.90
4	4924.00	49.18 PK	74.00	-24.82	1.00 V	55	10.69	38.49

- REMARKS:**
1. Emission level(dBuV/m)=Raw Value(dBuV) + Correction Factor(dB/m)
  2. Correction Factor(dB/m) = Antenna Factor (dB/m) + Cable Factor (dB)
  3. The other emission levels were very low against the limit.
  4. Margin value = Emission level – Limit value.
  5. The limit value is defined as per 15.247
  6. “ \* “ : Fundamental frequency



### 4.3 6dB BANDWIDTH MEASUREMENT

#### 4.3.1 LIMITS OF 6dB BANDWIDTH MEASUREMENT

The minimum of 6dB Bandwidth Measurement is 0.5 MHz.

#### 4.3.2 TEST INSTRUMENTS

Description & Manufacturer	Model No.	Serial No.	Calibrated Until
SPECTRUM ANALYZER	FSEK 30	100049	Aug. 12, 2005

**NOTE:** The calibration interval of the above test instruments is 12 months and the calibrations are traceable to NML/ROC and NIST/USA.

#### 4.3.3 TEST PROCEDURE

The transmitter output was connected to the spectrum analyzer through an attenuator. The bandwidth of the fundamental frequency was measured by spectrum analyzer with 100kHz RBW and 100kHz VBW. The 6dB bandwidth is defined as the total spectrum the power of which is higher than peak power minus 6dB.

#### 4.3.4 DEVIATION FROM TEST STANDARD

No deviation

#### 4.3.5 TEST SETUP



#### 4.3.6 EUT OPERATING CONDITIONS

The software provided by client to enable the EUT under transmission condition continuously at lowest, middle and highest channel frequencies individually.



4.3.7 TEST RESULTS

<b>EUT</b>	Wireless A/G Portable USB Adapter	<b>MODEL</b>	WUSB54AGP
<b>MODE</b>	CCK	<b>INPUT POWER (SYSTEM)</b>	120Vac, 60 Hz
<b>ENVIRONMENTAL CONDITIONS</b>	23deg. C, 67%RH, 991hPa	<b>TESTED BY</b>	Leo Hung

<b>CHANNEL</b>	<b>CHANNEL FREQUENCY (MHz)</b>	<b>6dB BANDWIDTH (MHz)</b>	<b>MINIMUM LIMIT (MHz)</b>	<b>PASS/FAIL</b>
1	2412	12.00	0.5	PASS
6	2437	11.80	0.5	PASS
11	2462	12.08	0.5	PASS



CH1

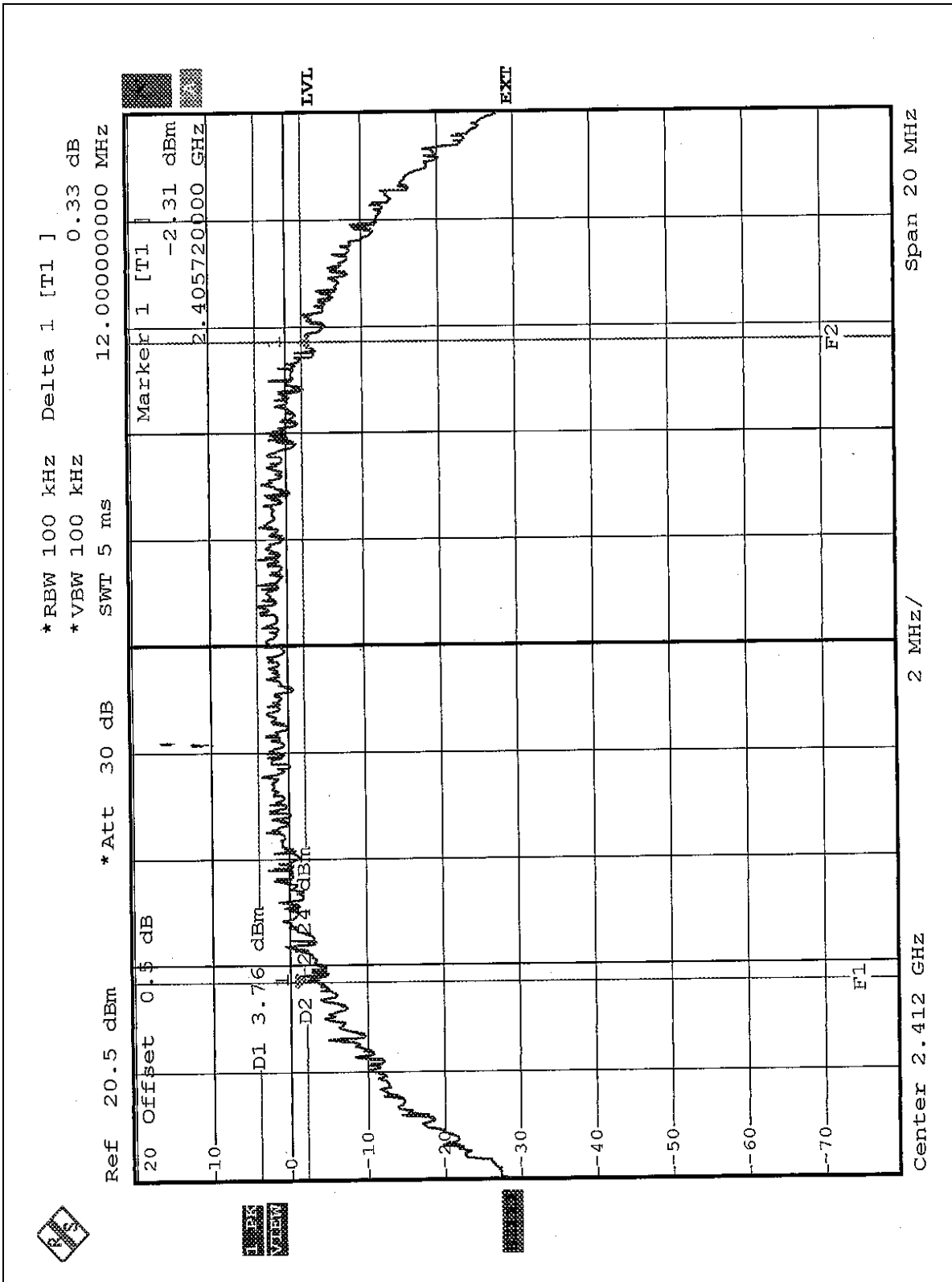



CH6

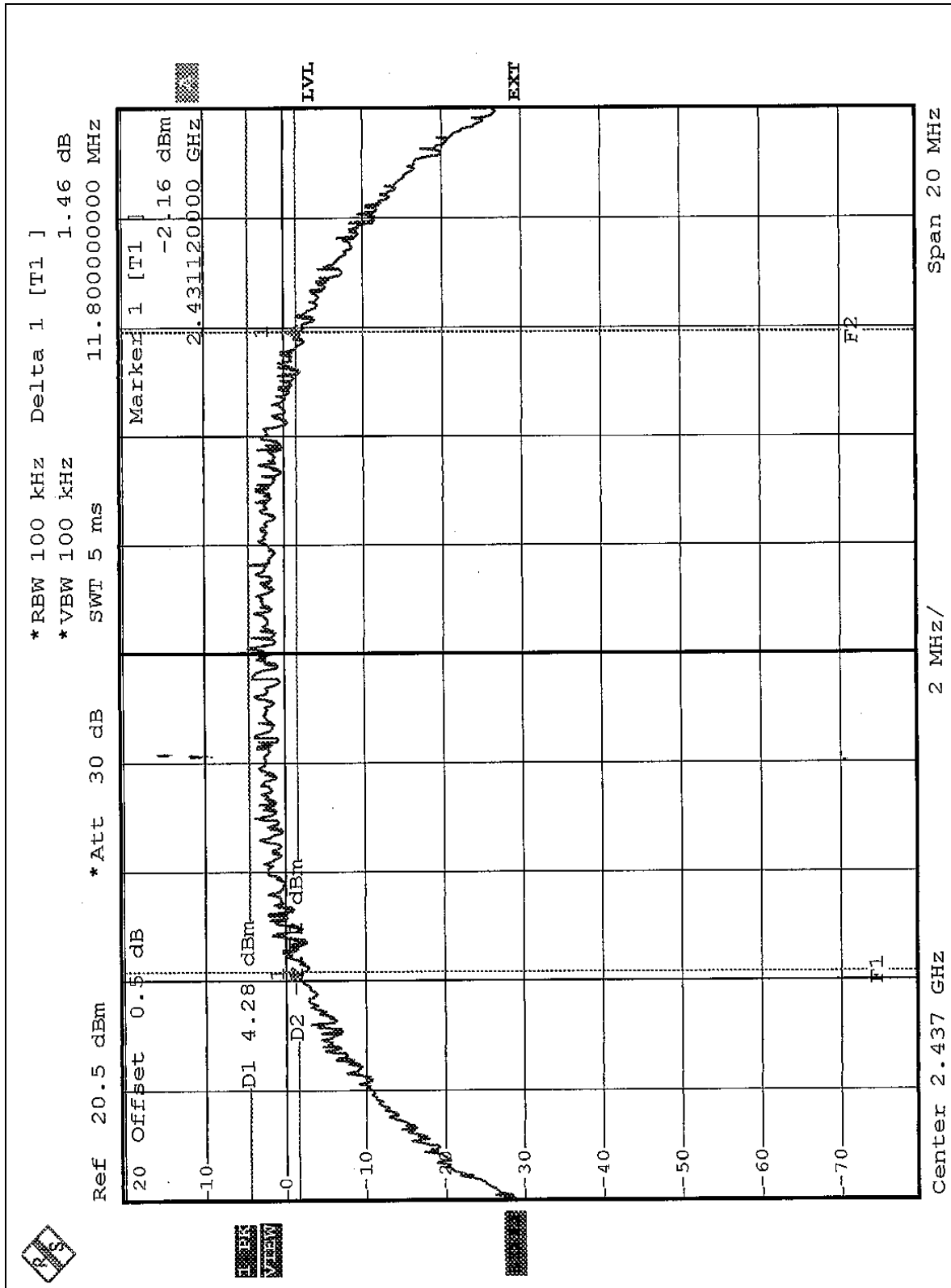



CH11

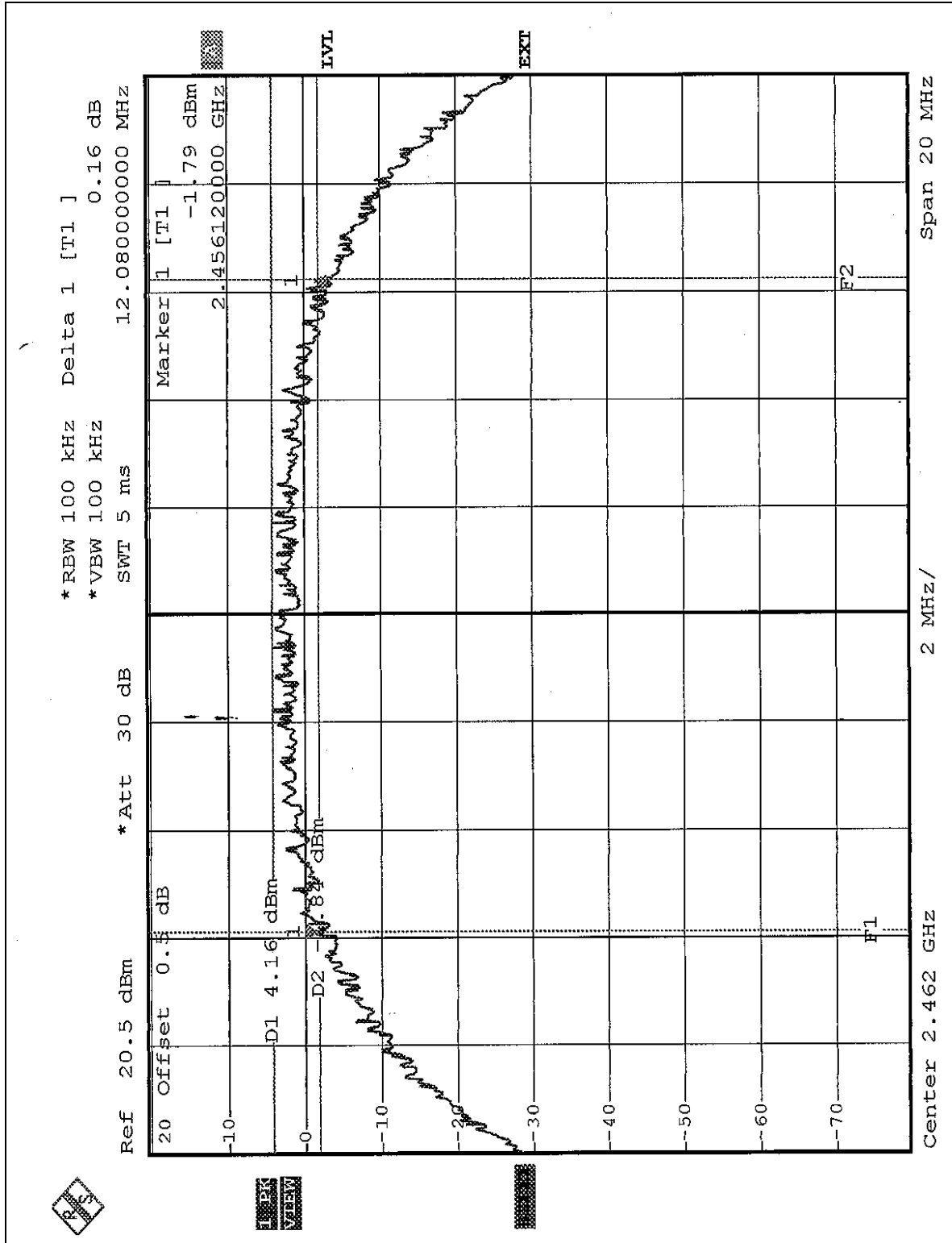



<b>EUT</b>	Wireless A/G Portable USB Adapter	<b>MODEL</b>	WUSB54AGP
<b>MODE</b>	OFDM	<b>INPUT POWER (SYSTEM)</b>	120Vac, 60 Hz
<b>ENVIRONMENTAL CONDITIONS</b>	23deg. C, 67%RH, 991hPa	<b>TESTED BY</b>	Leo Hung

<b>CHANNEL</b>	<b>CHANNEL FREQUENCY (MHz)</b>	<b>6dB BANDWIDTH (MHz)</b>	<b>MINIMUM LIMIT (MHz)</b>	<b>PASS/FAIL</b>
1	2412	16.40	0.5	PASS
6	2437	16.36	0.5	PASS
11	2462	16.44	0.5	PASS





CH1

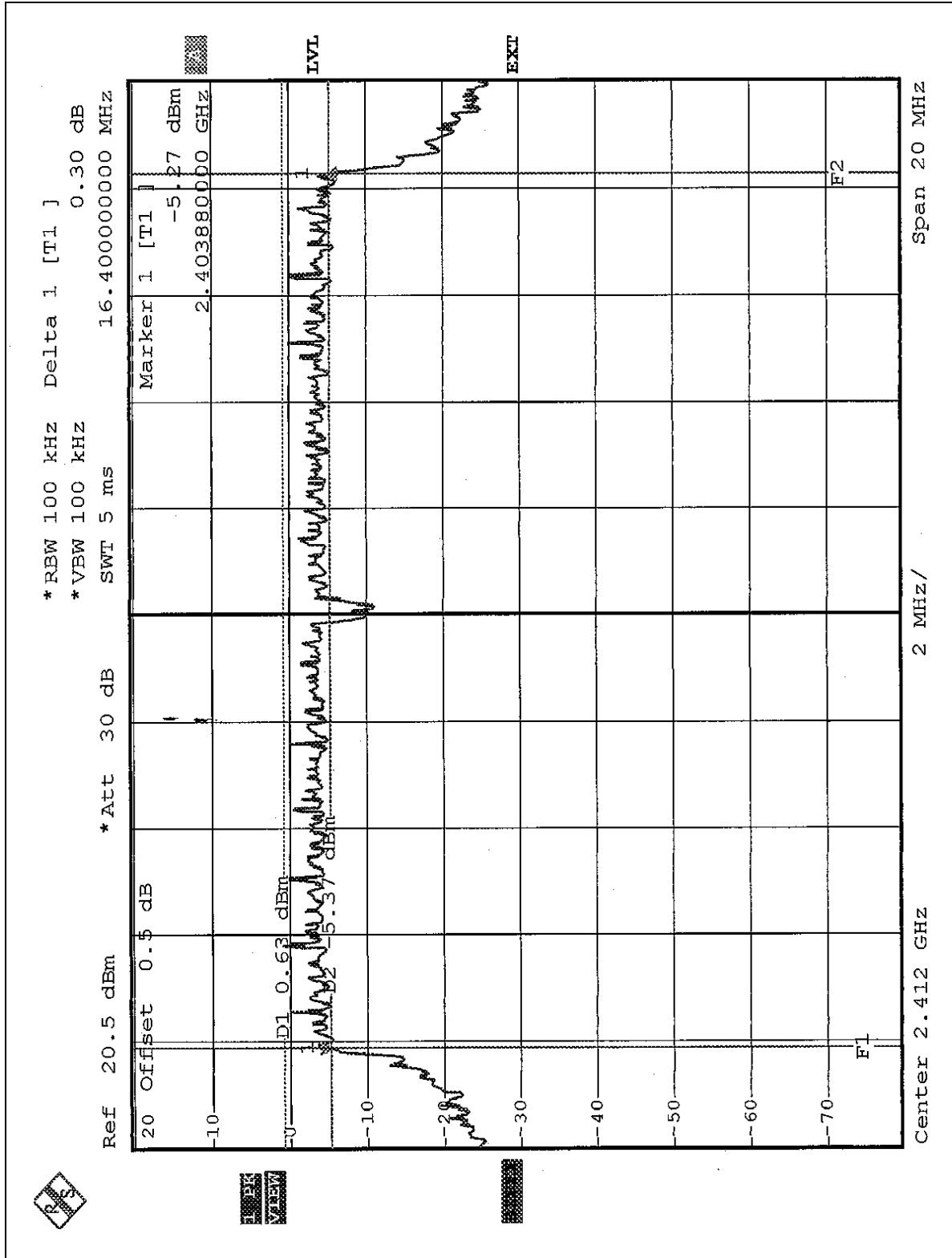



CH6

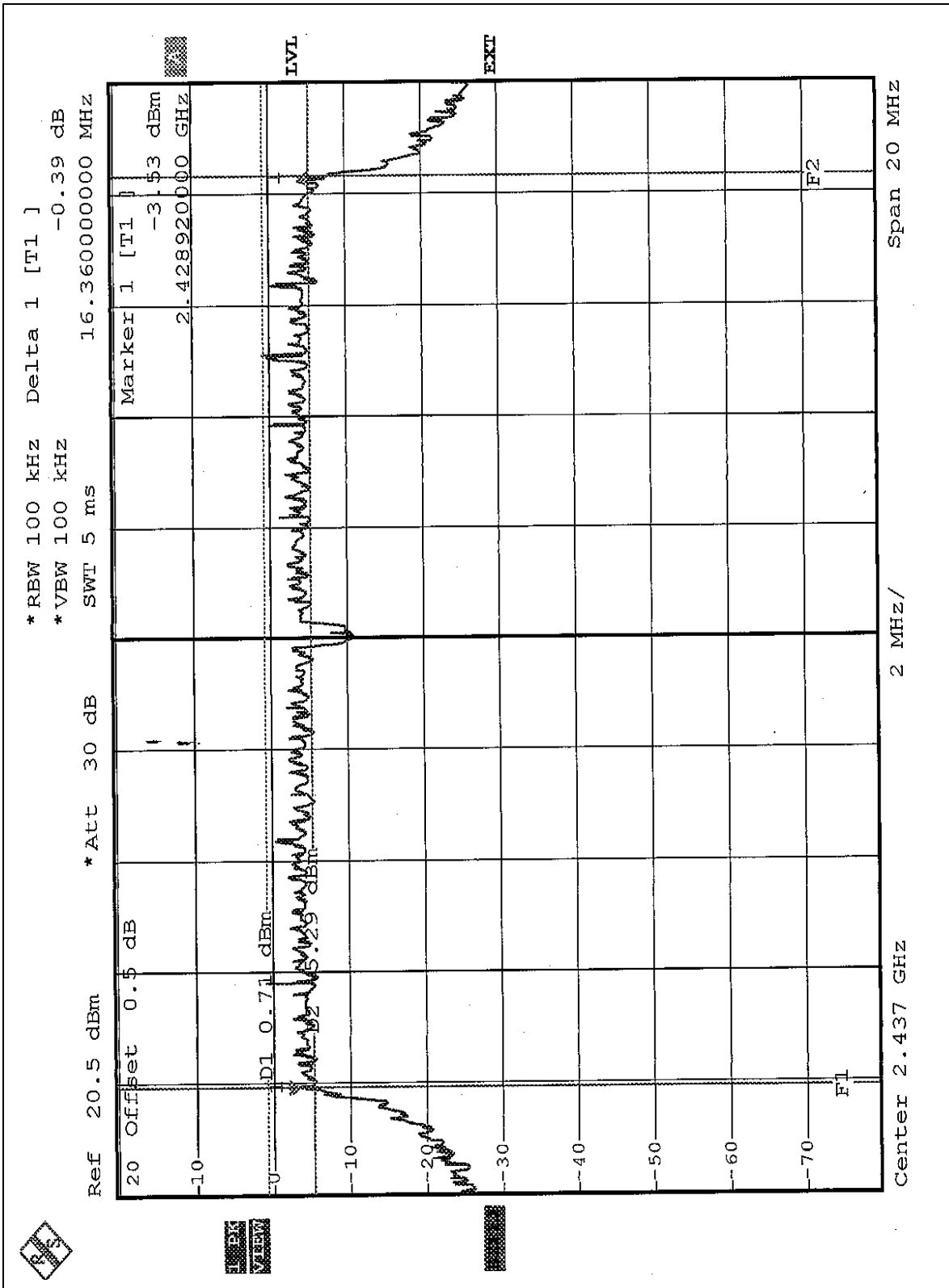



CH11

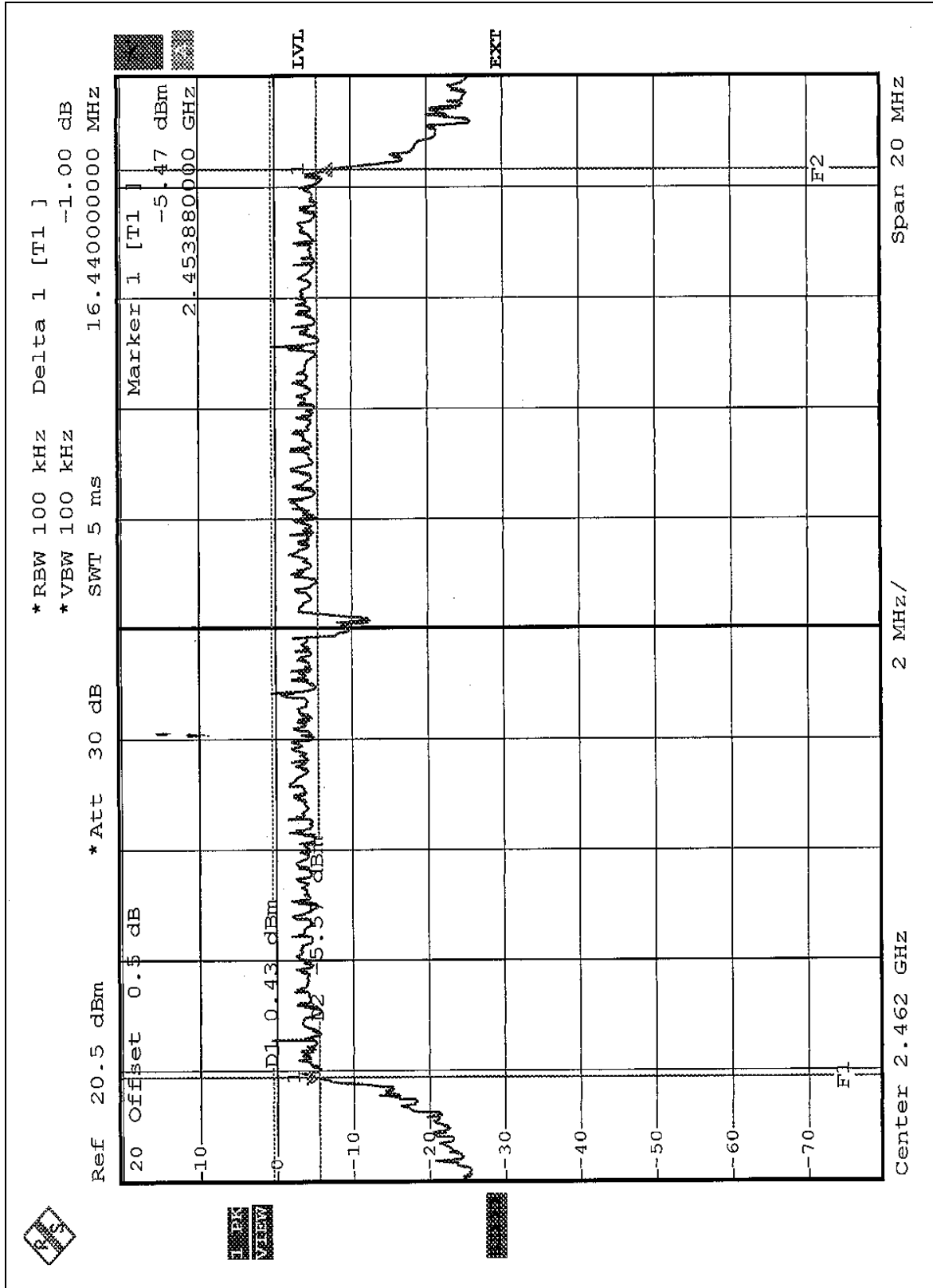



#### 4.4 MAXIMUM PEAK OUTPUT POWER

##### 4.4.1 LIMITS OF MAXIMUM PEAK OUTPUT POWER MEASUREMENT

The Maximum Peak Output Power Measurement is 30dBm.

##### 4.4.2 INSTRUMENTS

Description & Manufacturer	Model No.	Serial No.	Calibrated Until
R&S SPECTRUM ANALYZER	FSEK30	100049	Aug. 12, 2005
AGILENT SIGNAL GENERATOR	E8257C	MY43320668	Dec. 31, 2004
TEKTRONIX OSCILLOSCOPE	TDS 1012	C019167	Feb. 01, 2005
NARDA DETECTOR	4503A	FSCM99899	NA

**NOTE:**

The calibration interval of the above test instruments is 12 months and the calibrations are traceable to NML/ROC and NIST/USA..



#### 4.4.1 TEST PROCEDURES

1. A detector was used on the output port of the EUT. An oscilloscope was used to read the response of the detector.
2. Replaced the EUT by the signal generator . The center frequency of the S.G was adjusted to the center frequency of the measured channel.
3. Adjusted the power to have the same reading on oscilloscope. Record the power level.

#### 4.4.2 DEVIATION FROM TEST STANDARD

No deviation

#### 4.4.3 TEST SETUP



#### 4.4.4 EUT OPERATING CONDITIONS

Same as Item 4.3.6



4.4.3 TEST RESULTS

<b>EUT</b>	Wireless A/G Portable USB Adapter	<b>MODEL</b>	WUSB54AGP
<b>INPUT POWER (SYSTEM)</b>	120Vac, 60Hz	<b>ENVIRONMENTAL CONDITIONS</b>	23deg.C, 67%RH, 991hPa
<b>MODE</b>	CCK	<b>TESTED BY</b>	Leo Hung

CHANNEL	CHANNEL FREQUENCY (MHz)	PEAK POWER OUTPUT (mW)	PEAK POWER OUTPUT (dBm)	PEAK POWER LIMIT (dBm)	PASS/FAIL
1	2412	40.087	16.03	30	PASS
6	2437	40.458	16.07	30	PASS
11	2462	40.179	16.04	30	PASS

<b>EUT</b>	Wireless A/G Portable USB Adapter	<b>MODEL</b>	WUSB54AGP
<b>INPUT POWER (SYSTEM)</b>	120Vac, 60Hz	<b>ENVIRONMENTAL CONDITIONS</b>	23deg.C, 67%RH, 991hPa
<b>MODE</b>	OFDM	<b>TESTED BY</b>	Leo Hung

CHANNEL	CHANNEL FREQUENCY (MHz)	PEAK POWER OUTPUT (mW)	PEAK POWER OUTPUT (dBm)	PEAK POWER LIMIT (dBm)	PASS/FAIL
1	2412	39.994	16.02	30	PASS
6	2437	39.994	16.02	30	PASS
11	2462	40.272	16.05	30	PASS



## 4.5 POWER SPECTRAL DENSITY MEASUREMENT

### 4.5.1 LIMITS OF POWER SPECTRAL DENSITY MEASUREMENT

The Maximum of Power Spectral Density Measurement is 8dBm.

### 4.5.2 TEST INSTRUMENTS

Description & Manufacturer	Model No.	Serial No.	Calibrated Until
R&S SPECTRUM ANALYZER	FSEK30	100049	Aug. 12, 2005

**NOTE:**

The calibration interval of the above test instruments is 12 months and the calibrations are traceable to NML/ROC and NIST/USA.

#### 4.5.3 TEST PROCEDURE

The transmitter output was connected to the spectrum analyzer through an attenuator, the bandwidth of the fundamental frequency was measured with the spectrum analyzer using 3kHz RBW and 30kHz VBW, set sweep time = span/3kHz. The power spectral density was measured and recorded. The sweep time is allowed to be longer than span/3kHz for a full response of the mixer in the spectrum analyzer.

#### 4.5.4 DEVIATION FROM TEST STANDARD

No deviation

#### 4.5.5 TEST SETUP

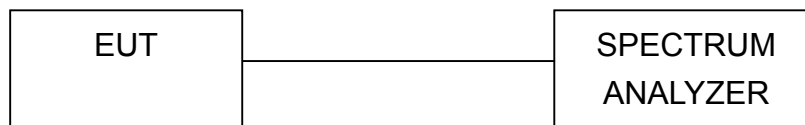

#### 4.5.6 EUT OPERATING CONDITION

Same as Item 4.3.6





## 4.5.7 TEST RESULTS

<b>EUT</b>	Wireless A/G Portable USB Adapter	<b>MODEL</b>	WUSB54AGP
<b>INPUT POWER (SYSTEM)</b>	120Vac, 60Hz	<b>ENVIRONMENTAL CONDITIONS</b>	23deg.C, 67%RH, 991hPa
<b>MODE</b>	CCK	<b>TESTED BY</b>	Leo Hung

<b>CHANNEL</b>	<b>CHANNEL FREQUENCY (MHz )</b>	<b>RF POWER LEVEL IN 3kHz BW (dBm)</b>	<b>MAXIMUM LIMIT (dBm)</b>	<b>PASS/FAIL</b>
1	2412	-9.43	8	PASS
6	2437	-9.36	8	PASS
11	2462	-9.41	8	PASS



CH1

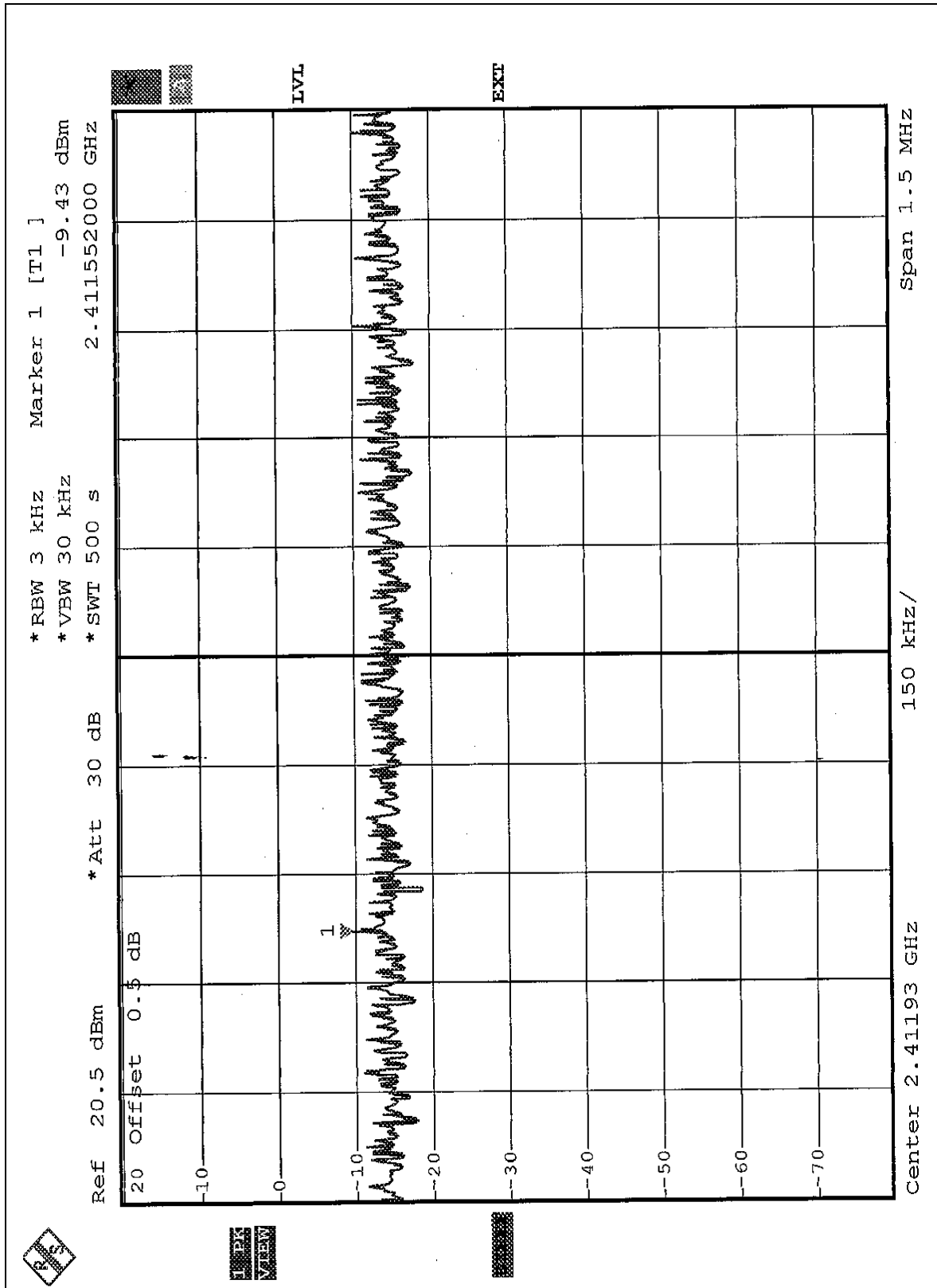



CH6

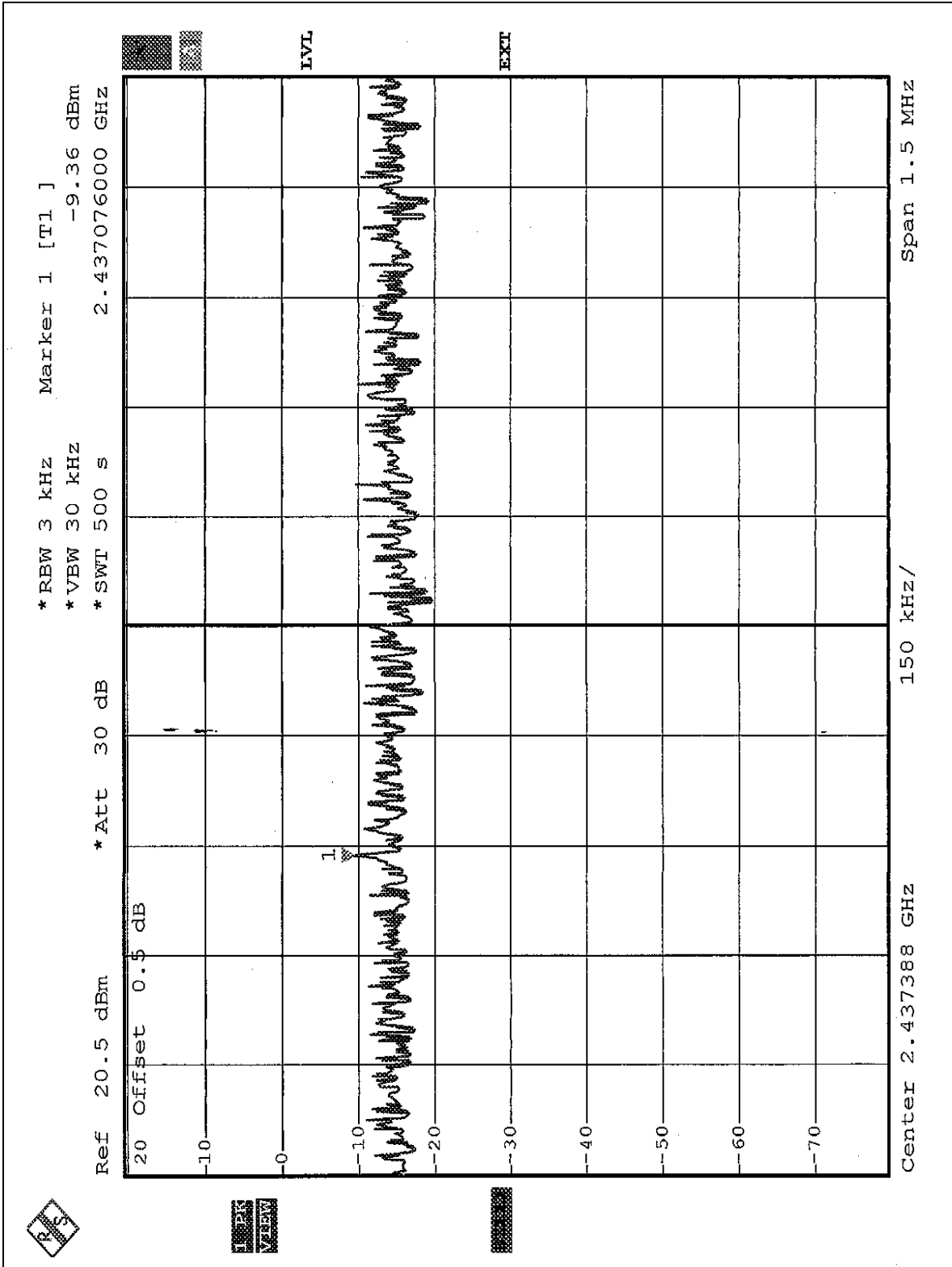



CH11

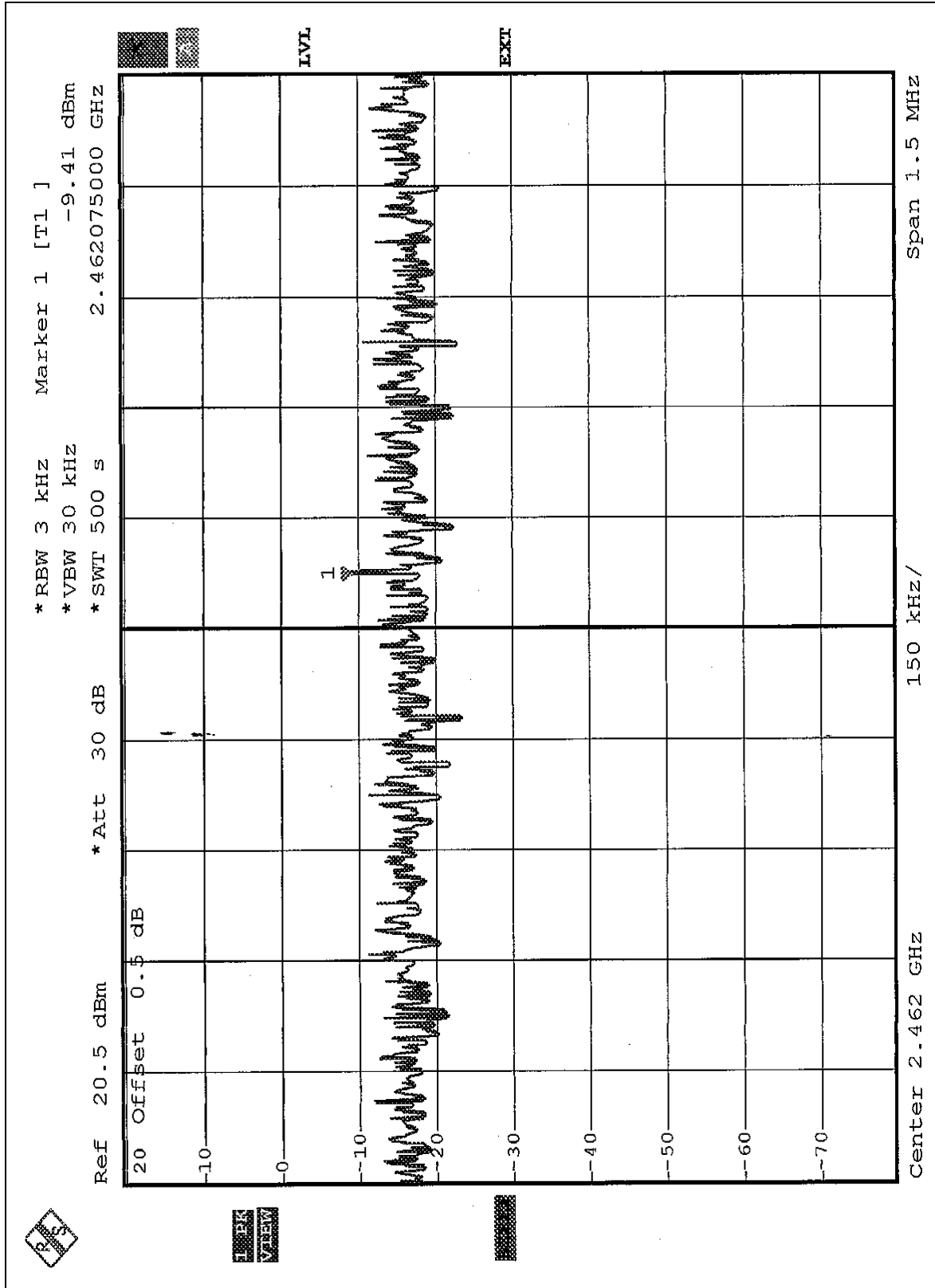



<b>EUT</b>	Wireless A/G Portable USB Adapter	<b>MODEL</b>	WUSB54AGP
<b>INPUT POWER (SYSTEM)</b>	120Vac, 60Hz	<b>ENVIRONMENTAL CONDITIONS</b>	23deg.C, 67%RH, 991hPa
<b>MODE</b>	OFDM	<b>TESTED BY</b>	Leo Hung

<b>CHANNEL</b>	<b>CHANNEL FREQUENCY (MHz )</b>	<b>RF POWER LEVEL IN 3kHz BW (dBm)</b>	<b>MAXIMUM LIMIT (dBm)</b>	<b>PASS/FAIL</b>
1	2412	-13.15	8	PASS
6	2437	-12.84	8	PASS
11	2462	-13.80	8	PASS



CH1

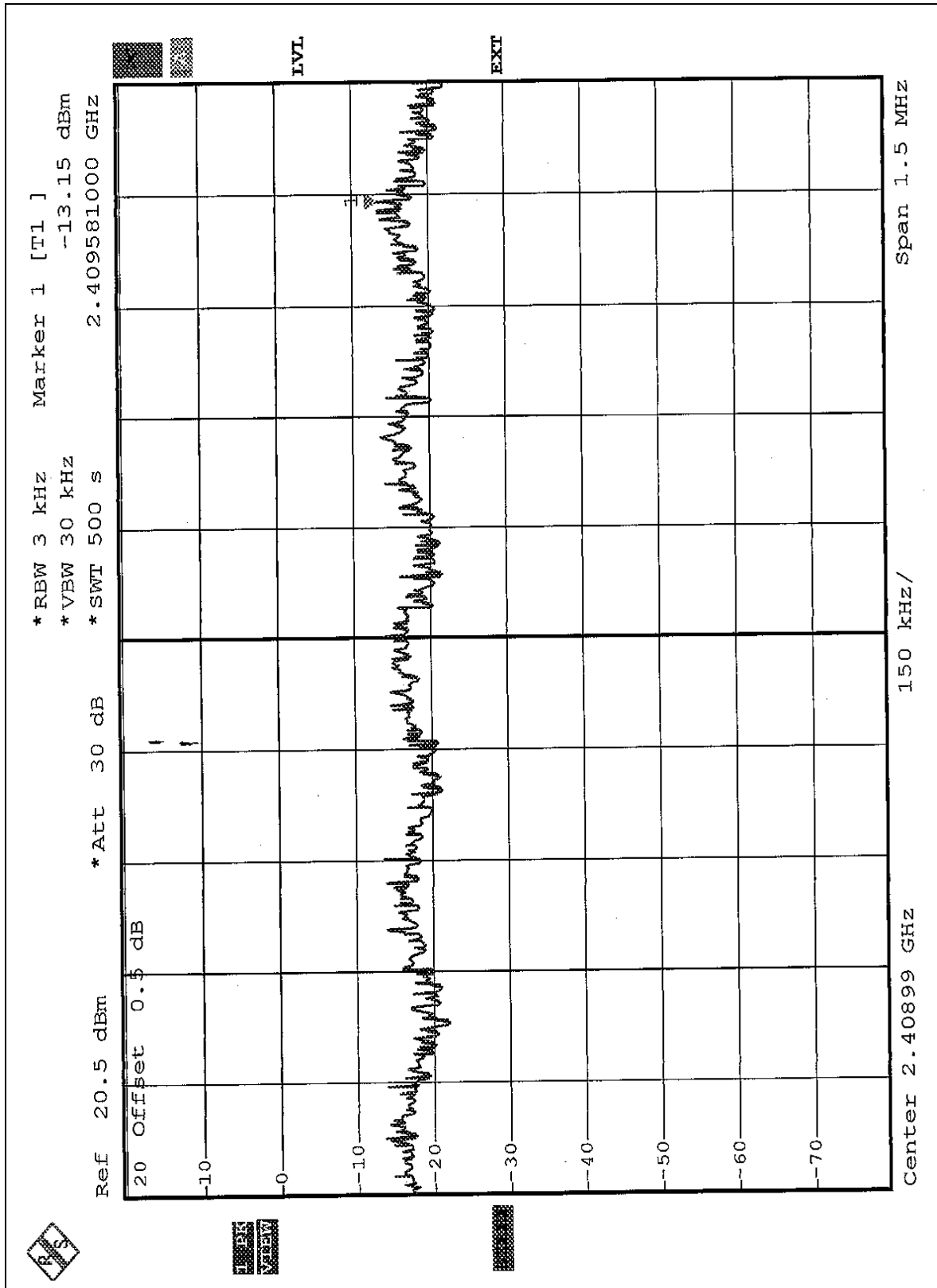



CH6

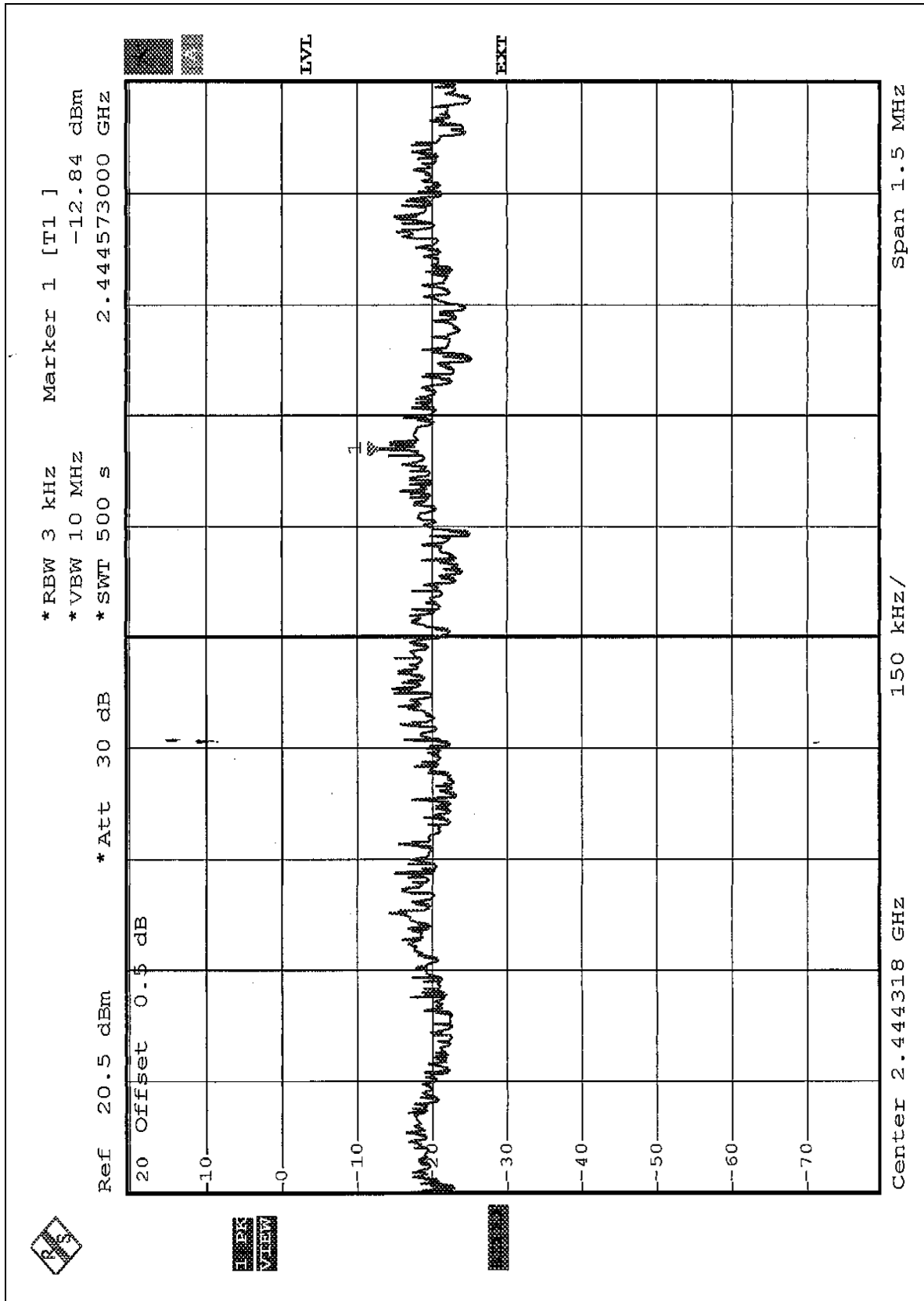



CH11

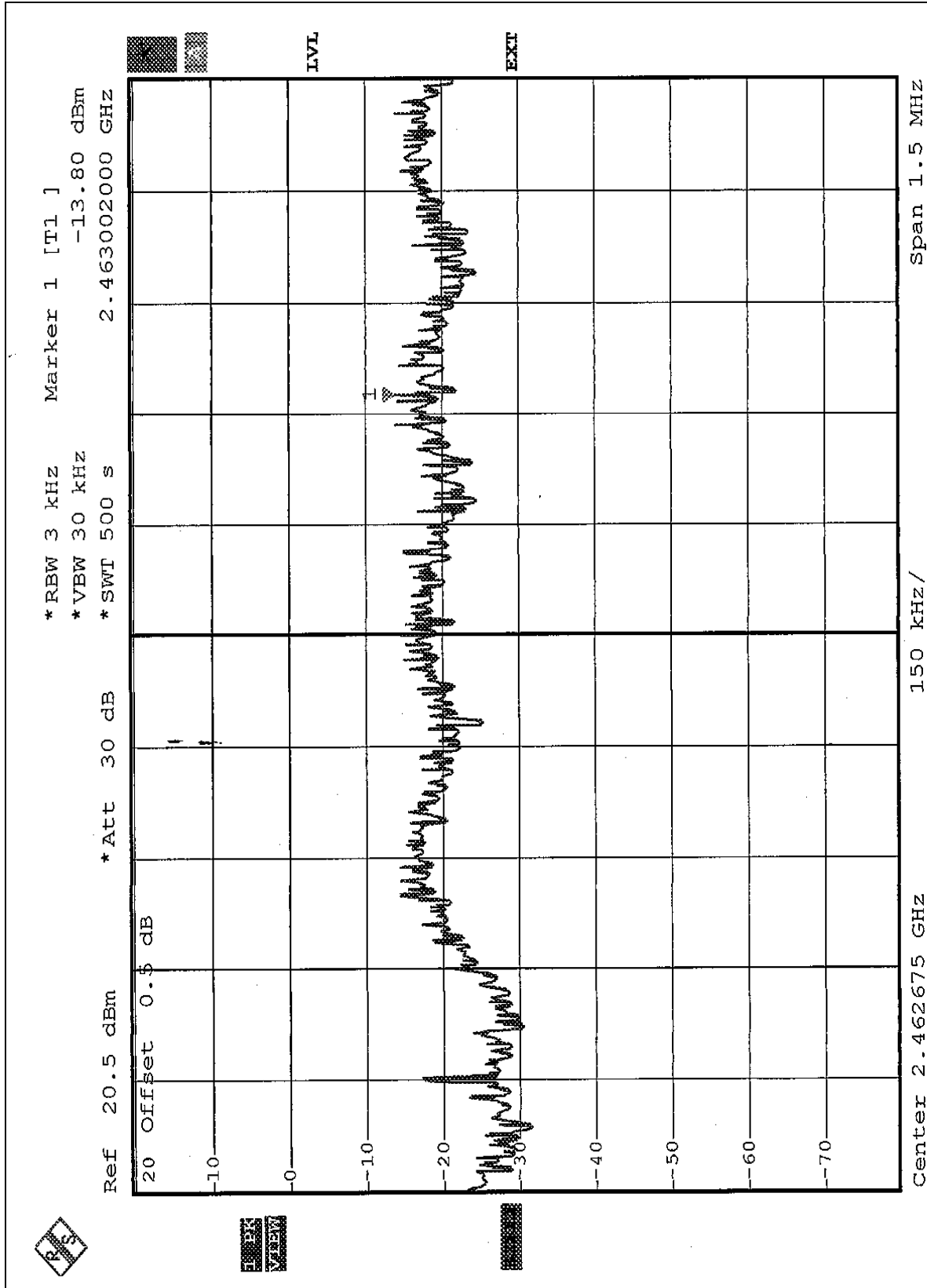





## 4.6 BAND EDGES MEASUREMENT

### 4.6.1 LIMITS OF BAND EDGES MEASUREMENT

Below  $-20\text{dB}$  of the highest emission level of operating band (in 100kHz Resolution Bandwidth).

### 4.6.2 TEST INSTRUMENTS

Description & Manufacturer	Model No.	Serial No.	Calibrated Until
R&S SPECTRUM ANALYZER	FSEK30	100049	Aug. 12, 2005

**NOTE:** The calibration interval of the above test instruments is 12 months and the calibrations are traceable to NML/ROC and NIST/USA.

### 4.6.3 TEST PROCEDURE

The transmitter output was connected to the spectrum analyzer via a low lose cable. Set both RBW and VBW of spectrum analyzer to 1MHz and 10Hz with suitable frequency span including 100 MHz bandwidth from band edge. The band edges was measured and recorded.

### 4.6.4 DEVIATION FROM TEST STANDARD

No deviation

### 4.6.5 EUT OPERATING CONDITION

Same as Item 4.3.6

### 4.6.6 TEST RESULTS

The spectrum plots are attached on the following 8 pages. D2 line indicates the highest level, and D1 line indicates the 20dB offset below D2. It shows compliance with the requirement in part 15.247(d).



**NOTE 1:** The band edge emission plot of CCK technique on page 59 show 57.50dB delta between carrier maximum power and local maximum emission in restrict band (2.3864GHz). The emission of carrier strength list in the test result of channel 1 at the item 4.2.7 is 106.28dBuV/m, so the maximum field strength in restrict band is  $106.28 - 57.50 = 48.78$ dBuV/m which is under 54dBuV/m limit.

**NOTE 2:** The band edge emission plot of CCK technique on page 61 show 58.15dB delta between carrier maximum power and local maximum emission in restrict band (2.4877GHz). The emission of carrier strength list in the test result of channel 11 at the item 4.2.7 is 105.95dBuV/m, so the maximum field strength in restrict band is  $105.95 - 58.15 = 47.80$ dBuV/m which is under 54dBuV/m limit.

**NOTE 3:** The band edge emission plot of OFDM technique on page 63 show 50.67dB delta between carrier maximum power and local maximum emission in restrict band (2.3900GHz). The emission of carrier strength list in the test result of channel 1 at the item 4.2.7 is 100.41dBuV/m, so the maximum field strength in restrict band is  $100.41 - 50.67 = 49.74$ dBuV/m which is under 54dBuV/m limit.

**NOTE 4:** The band edge emission plot of OFDM technique on page 65 show 47.74dB delta between carrier maximum power and local maximum emission in restrict band (2.4837GHz). The emission of carrier strength list in the test result of channel 11 at the item 4.2.7 is 99.64dBuV/m, so the maximum field strength in restrict band is  $99.64 - 47.74 = 51.90$ dBuV/m which is under 54dBuV/m limit.



CCK mode:

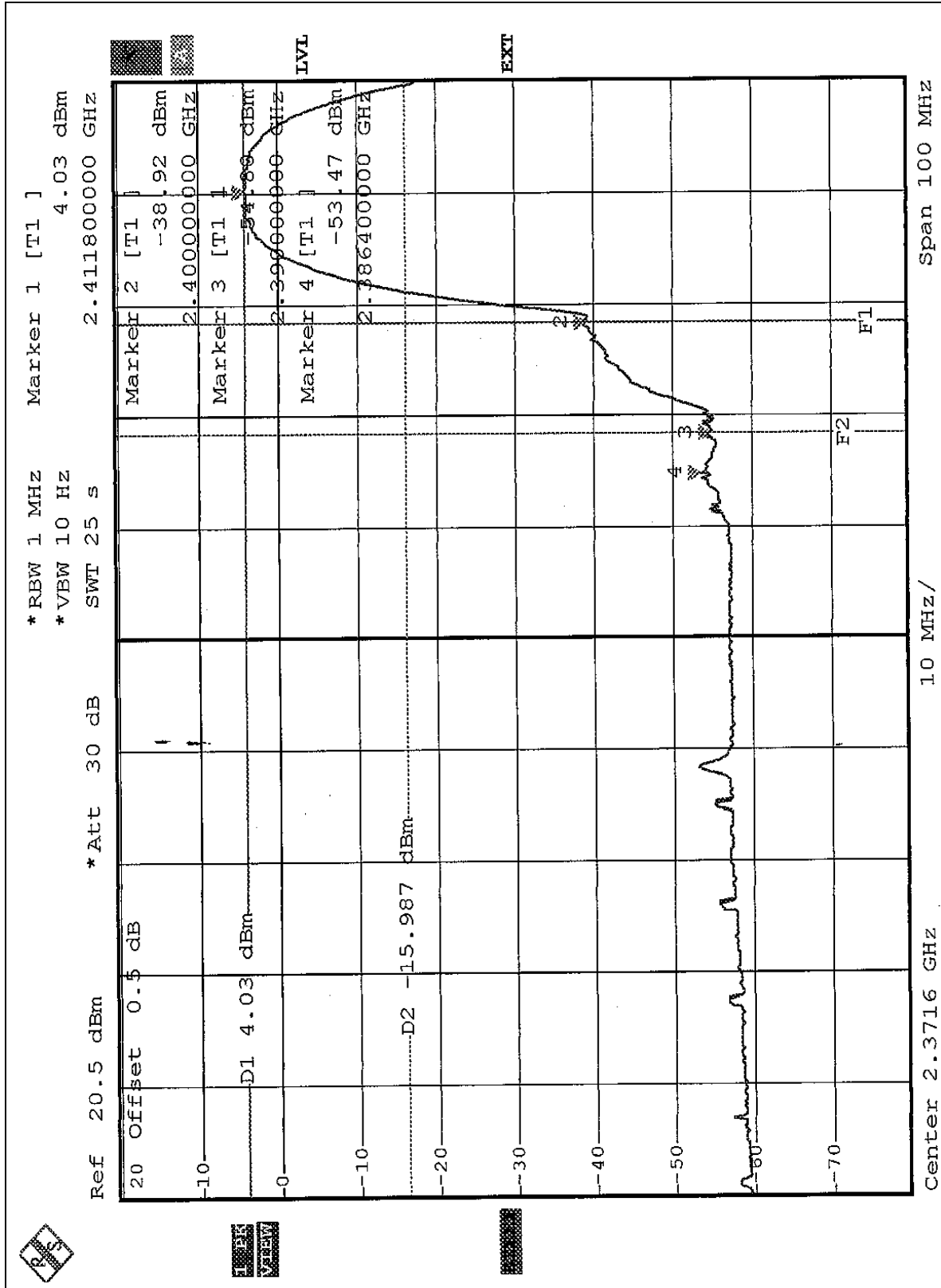

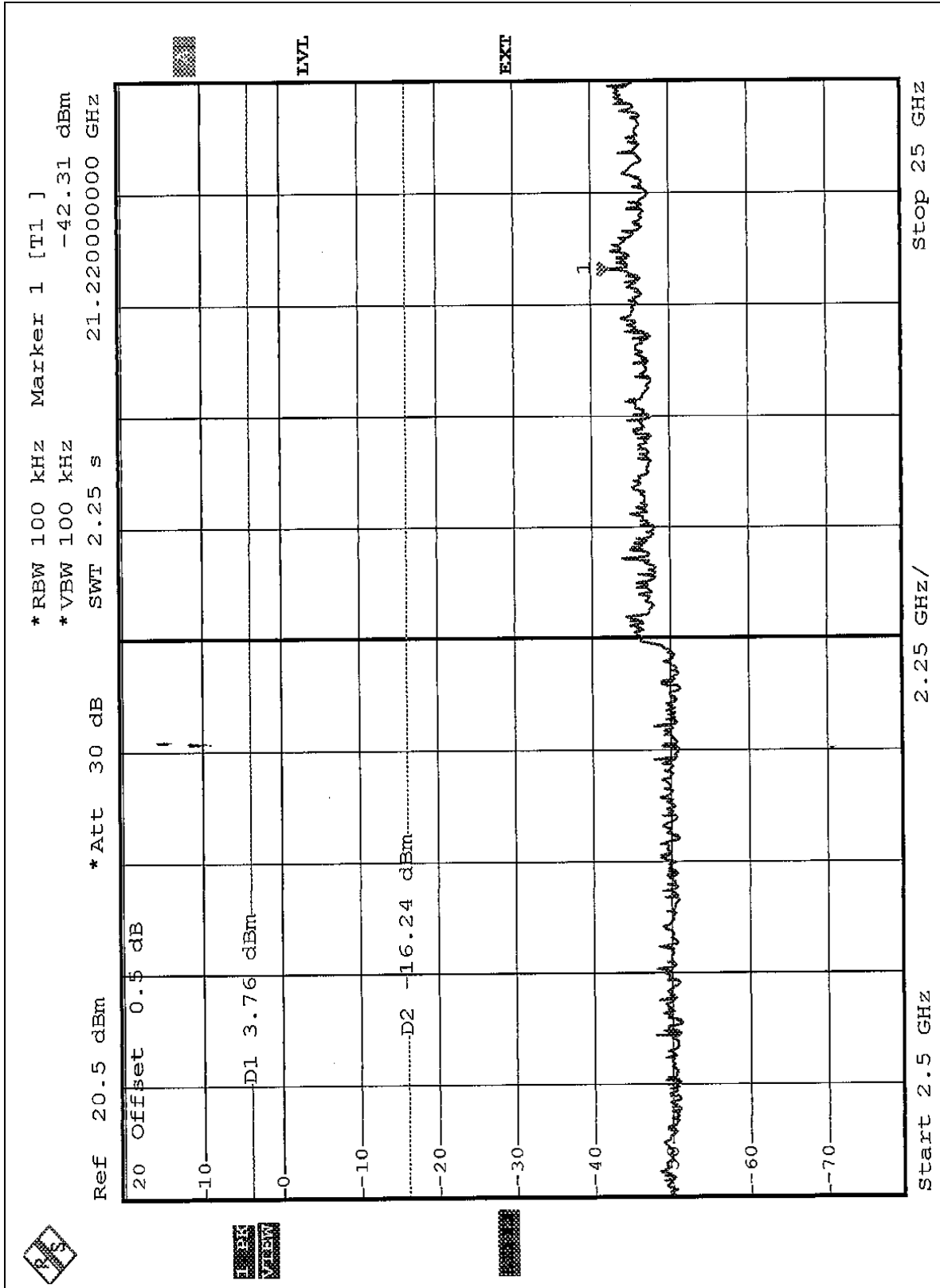

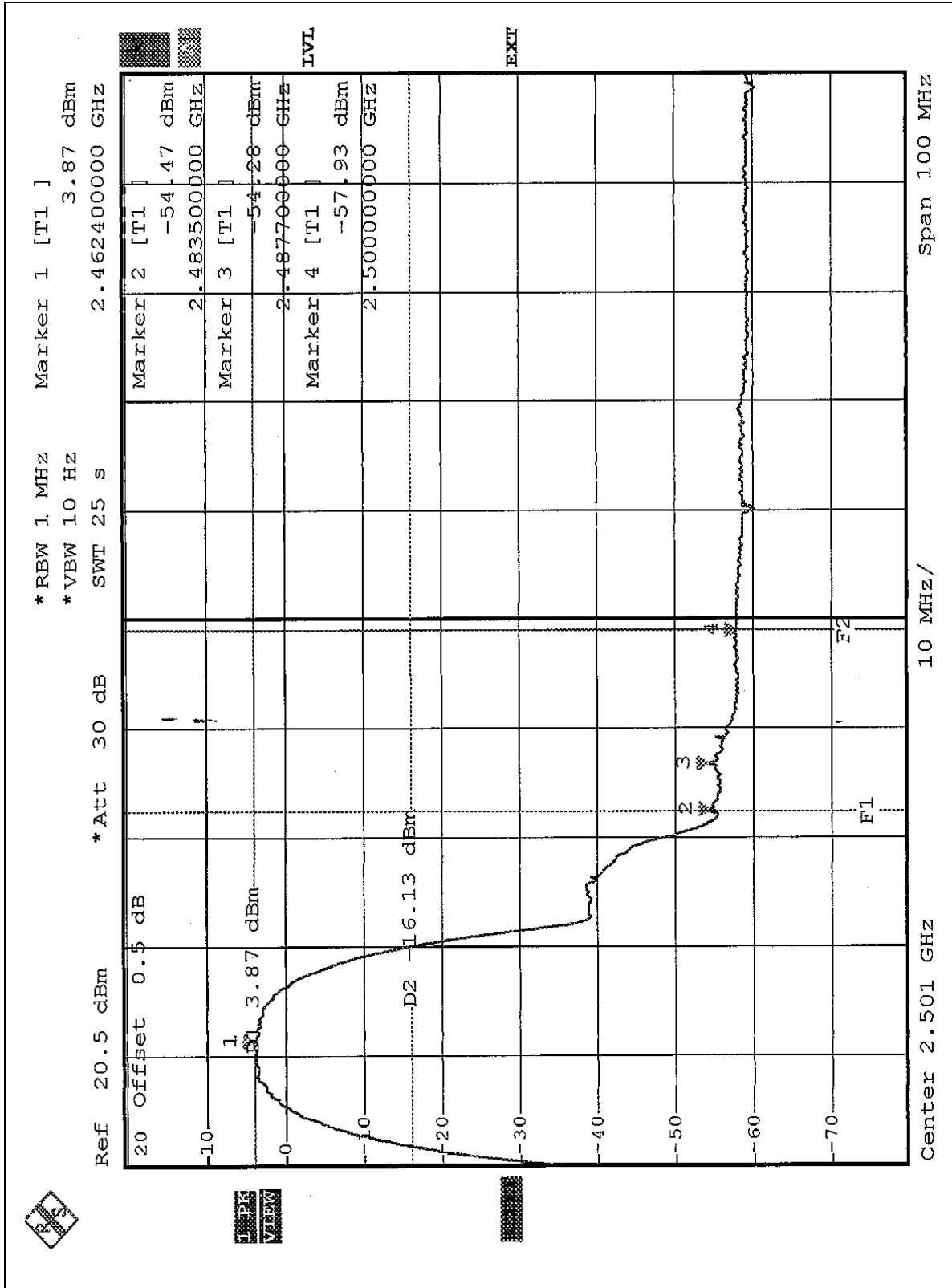

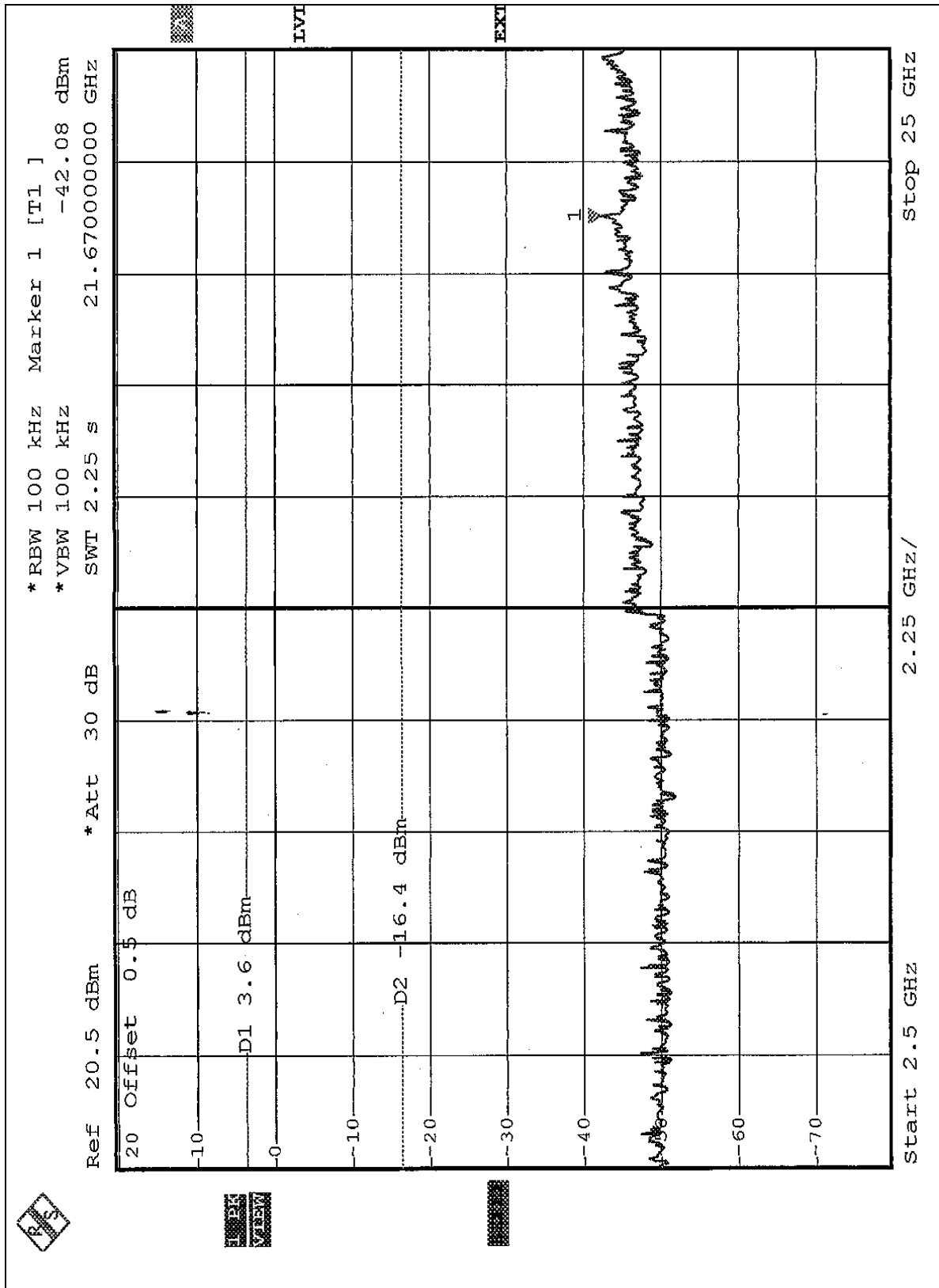



OFDM mode:

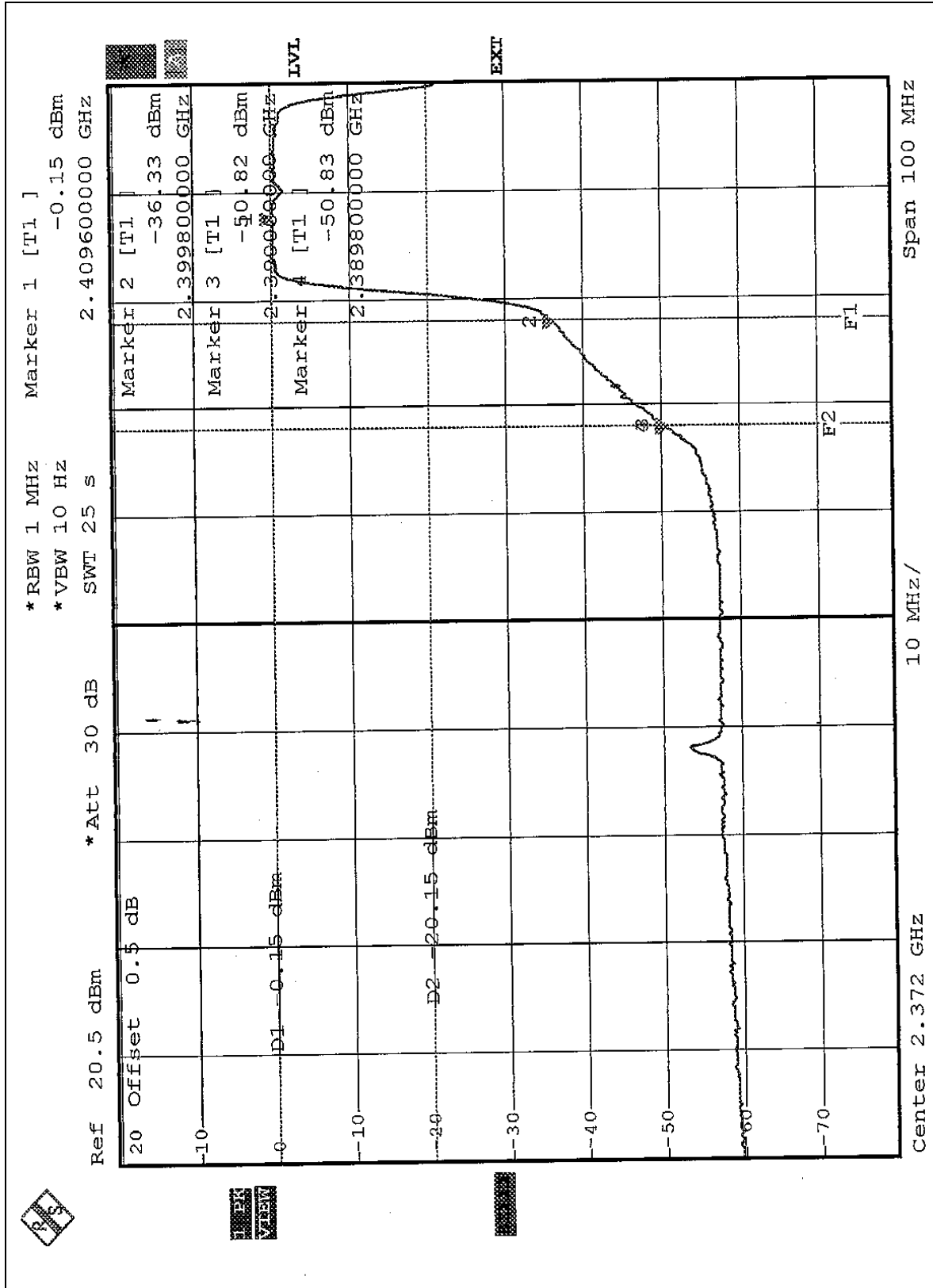

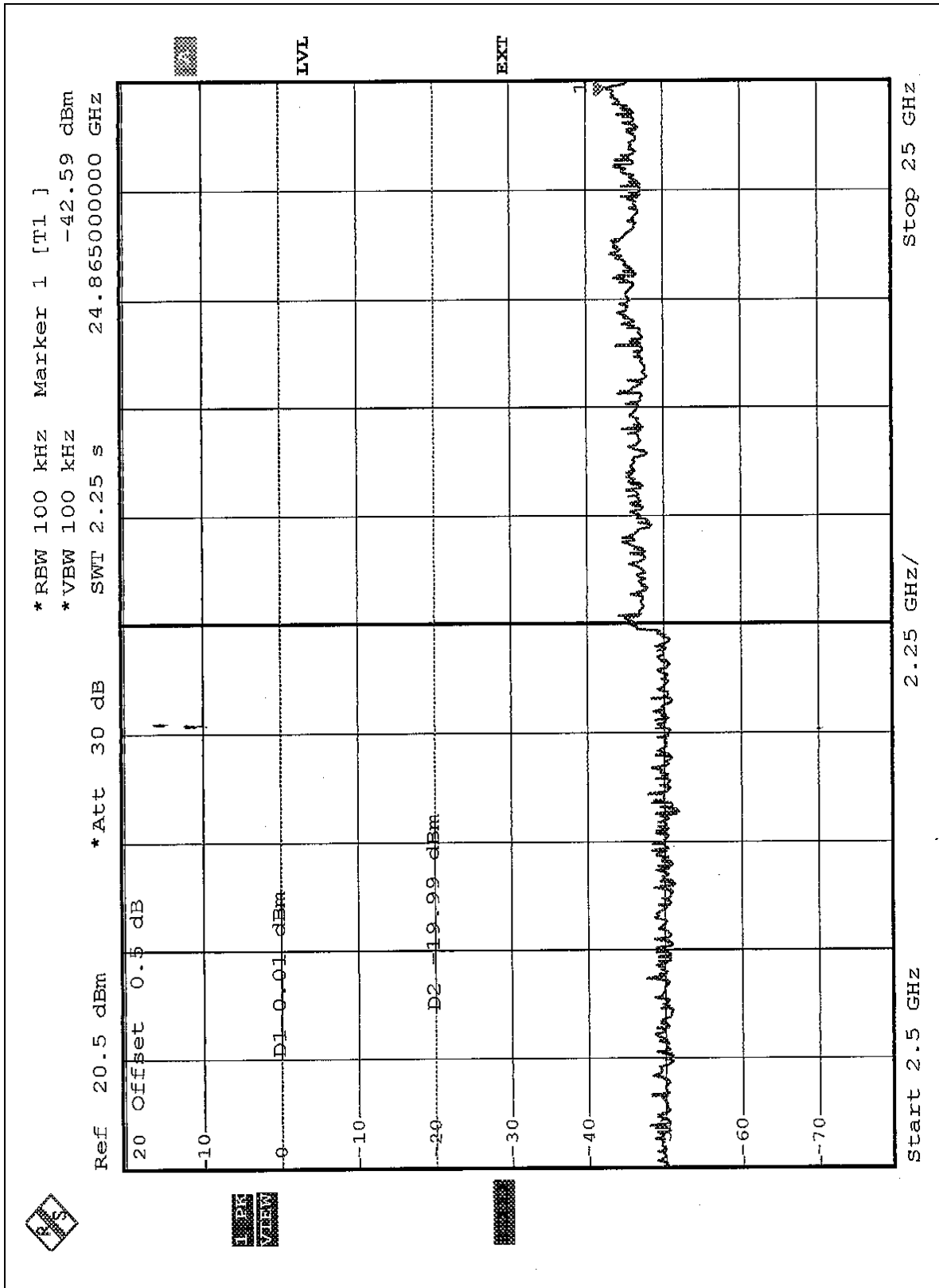



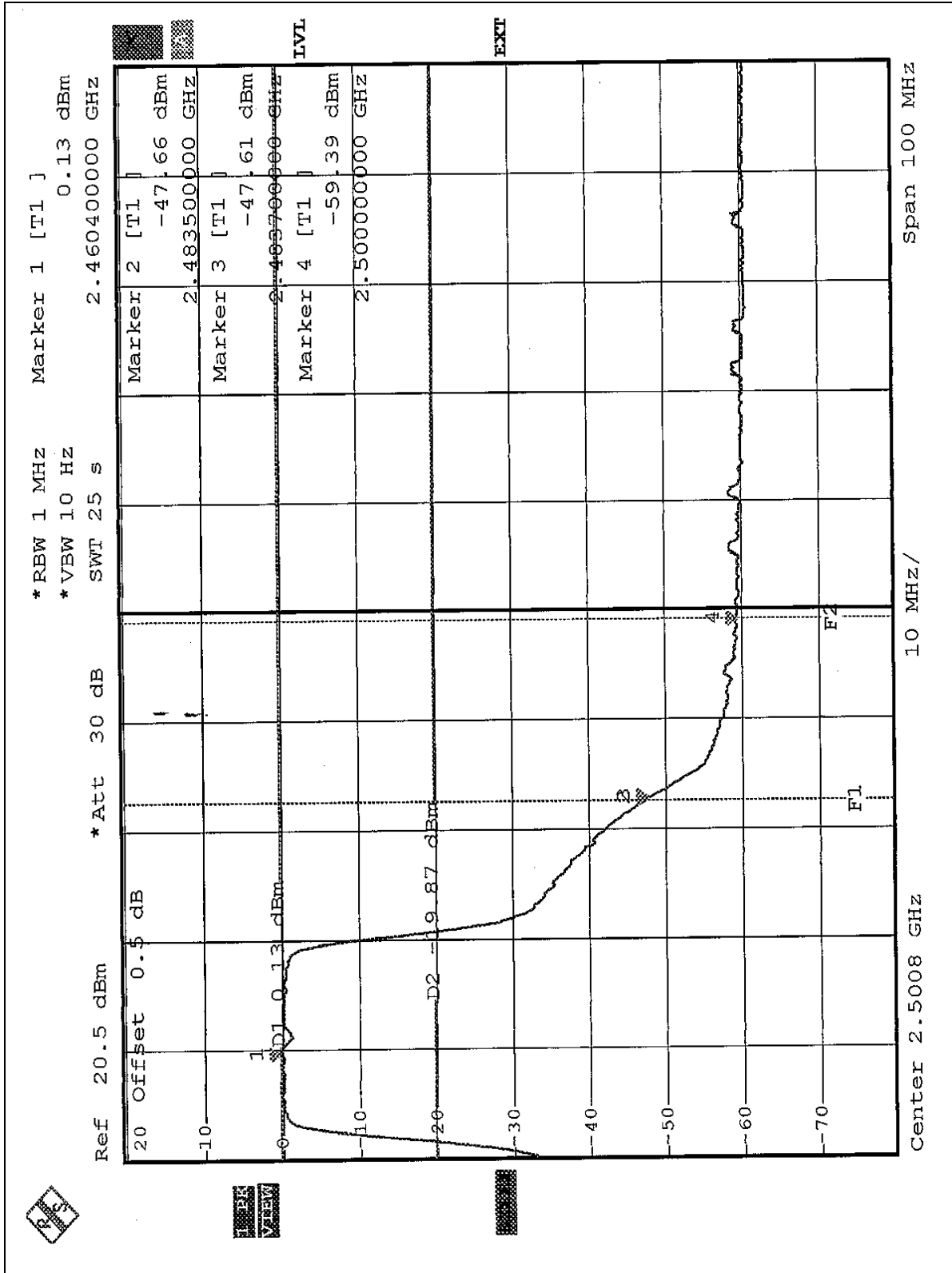

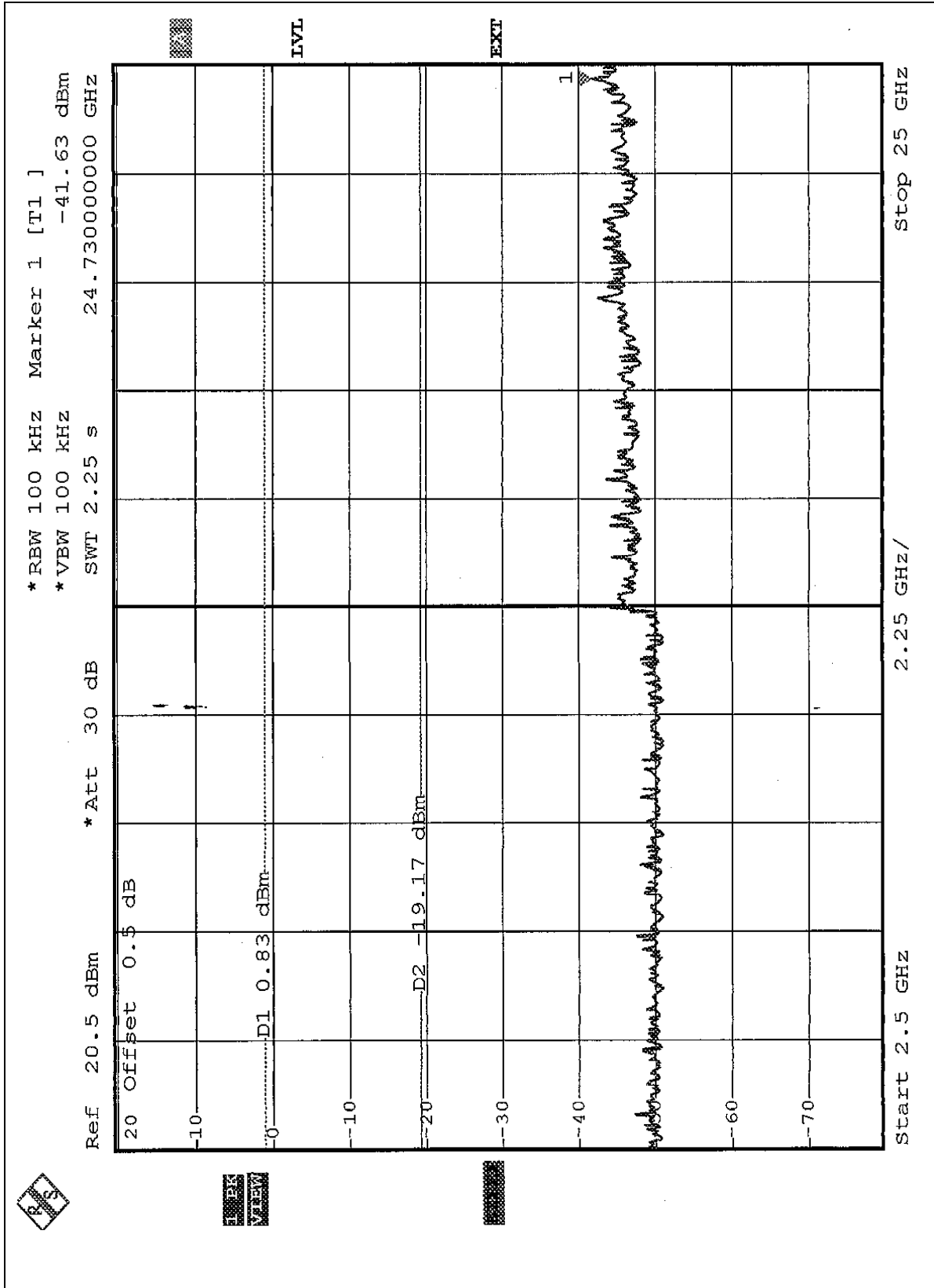



## **4.7 ANTENNA REQUIREMENT**

### **4.7.1 STANDARD APPLICABLE**

For intentional device, according to FCC 47 CFR Section 15.203, an intentional radiator shall be designed to ensure that no antenna other than that furnished by the responsible party shall be used with the device. And according to FCC 47 CFR Section 15.247 (b), if transmitting antennas of directional gain greater than 6dBi are used, the power shall be reduced by the amount in dB that the directional gain of the antenna exceeds 6dBi.

### **4.7.2 ANTENNA CONNECTED CONSTRUCTION**

The antenna used in this product is Printed antenna without connector. The maximum Gain of the antenna is 0dBi.



## 5. TEST TYPES AND RESULTS (FOR PART 802.11a)

### FOR FREQUENCY 5.15~5.35GHz

#### 5.1 CONDUCTED EMISSION MEASUREMENT

##### 5.1.1 LIMITS OF CONDUCTED EMISSION MEASUREMENT

FREQUENCY OF EMISSION (MHz)	CONDUCTED LIMIT (dB $\mu$ V)	
	Quasi-peak	Average
0.15-0.5	66 to 56	56 to 46
0.5-5	56	46
5-30	60	50

- NOTE:**
1. The lower limit shall apply at the transition frequencies.
  2. The limit decreases in line with the logarithm of the frequency in the range of 0.15 to 0.50 MHz.
  3. All emanations from a class A/B digital device or system, including any network of conductors and apparatus connected thereto, shall not exceed the level of field strengths specified above.

##### 5.1.2 TEST INSTRUMENTS

DESCRIPTION & MANUFACTURER	MODEL NO.	SERIAL NO.	CALIBRATED UNTIL
Test Receiver ROHDE & SCHWARZ	ESCS30	100291	Nov. 16, 2005
RF signal cable Woken	5D-FB	Cable-HYC01-01	Mar. 02, 2005
LISN ROHDE & SCHWARZ	ESH3-Z5	100312	Mar. 03, 2005
LISN ROHDE & SCHWARZ	ESH2-Z5	100104	Mar. 02, 2005
Software ADT	ADT_Cond_V3	NA	NA

- NOTE:**
1. The calibration interval of the above test instruments is 12 months and the calibrations are traceable to NML/ROC and NIST/USA.
  2. The test was performed in HwaYa Shielded Room 1.
  3. The VCCI Site Registration No. is C-2040.



### 5.1.3 TEST PROCEDURES

- a. The EUT was placed 0.4 meters from the conducting wall of the shielded room with EUT being connected to the power mains through a line impedance stabilization network (LISN). Other support units were connected to the power mains through another LISN. The two LISNs provide 50 ohm/ 50uH of coupling impedance for the measuring instrument.
- b. Both lines of the power mains connected to the EUT were checked for maximum conducted interference.
- c. The frequency range from 150kHz to 30MHz was searched. Emission levels under ( Limit - 20dB) was not recorded.

### 5.1.4 DEVIATION FROM TEST STANDARD

No deviation

### 5.1.5 TEST SETUP

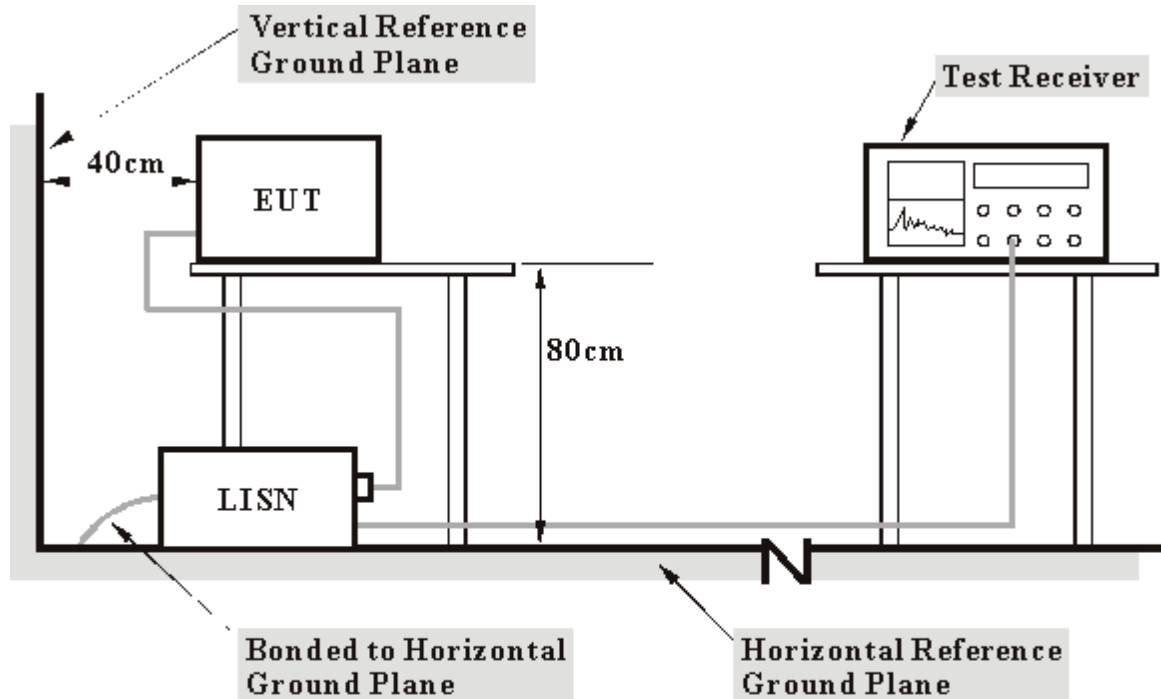

- Note:**
1. Support units were connected to second LISN.
  2. Both of LISNs (AMN) 80 cm from EUT and at the least 80 cm from other units and other metal planes support units.

For the actual test configuration, please refer to the related item – Photographs of the Test Configuration.

### 5.1.6 EUT OPERATING CONDITIONS

Same as 4.1.6



5.1.7 TEST RESULTS

<b>EUT</b>	Wireless A/G Portable USB Adapter	<b>MODEL</b>	WUSB54AGP
		<b>6dB BANDWIDTH</b>	9 kHz
<b>INPUT POWER (SYSTEM)</b>	120Vac, 60 Hz	<b>PHASE</b>	Line (L)
<b>ENVIRONMENTAL CONDITIONS</b>	24deg. C, 64%RH, 991hPa	<b>TESTED BY:</b> Leo Hung	

No	Freq. [MHz]	Corr. Factor (dB)	Reading Value [dB (uV)]		Emission Level [dB (uV)]		Limit [dB (uV)]		Margin (dB)	
			Q.P.	AV.	Q.P.	AV.	Q.P.	AV.	Q.P.	AV.
			1	0.173	0.11	40.67	-	40.78	-	64.79
2	0.220	0.12	42.58	-	42.70	-	62.81	52.81	-20.11	-
3	0.466	0.13	22.37	-	22.50	-	56.58	46.58	-34.08	-
4	1.613	0.16	31.50	-	31.66	-	56.00	46.00	-24.34	-
5	3.969	0.21	26.46	-	26.67	-	56.00	46.00	-29.33	-
6	10.086	0.31	35.46	-	35.77	-	60.00	50.00	-24.23	-

- REMARKS:**
1. Q.P. and AV. are abbreviations of quasi-peak and average individually.
  2. "-": The Quasi-peak reading value also meets average limit and measurement with the average detector is unnecessary.
  3. The emission levels of other frequencies were very low against the limit.
  4. Margin value = Emission level - Limit value
  5. Correction factor = Insertion loss + Cable loss
  6. Emission Level = Correction Factor + Reading Value.

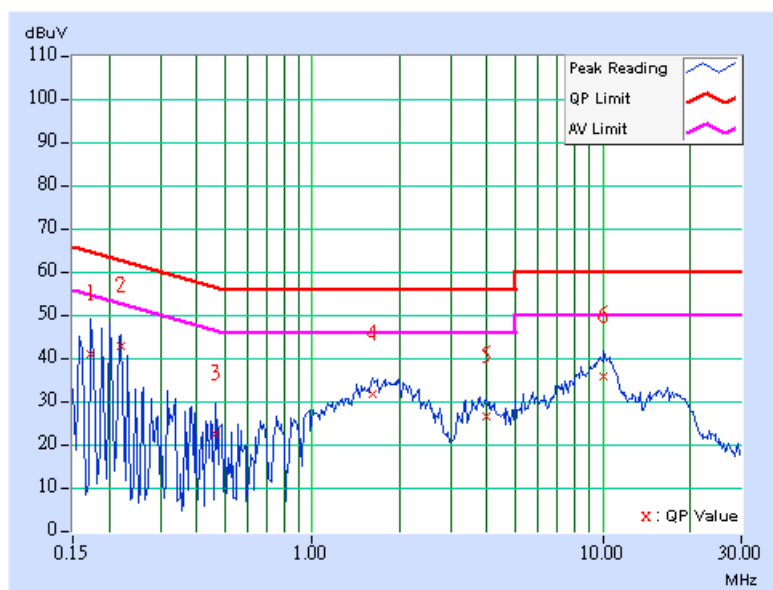



<b>EUT</b>	Wireless A/G Portable USB Adapter	<b>MODEL</b>	WUSB54AGP
		<b>6dB BANDWIDTH</b>	9 kHz
<b>INPUT POWER (SYSTEM)</b>	120Vac, 60 Hz	<b>PHASE</b>	Neutral (N)
<b>ENVIRONMENTAL CONDITIONS</b>	24deg. C, 64%RH, 991hPa	<b>TESTED BY:</b> Leo Hung	

No	Freq. [MHz]	Corr. Factor (dB)	Reading Value [dB (uV)]		Emission Level [dB (uV)]		Limit [dB (uV)]		Margin (dB)	
			Q.P.	AV.	Q.P.	AV.	Q.P.	AV.	Q.P.	AV.
			1	0.166	0.10	41.88	-	41.98	-	65.18
2	<b>0.193</b>	<b>0.11</b>	<b>45.94</b>	-	<b>46.05</b>	-	<b>63.91</b>	<b>53.91</b>	<b>-17.86</b>	-
3	0.373	0.12	26.54	-	26.66	-	58.44	48.44	-31.79	-
4	1.875	0.16	30.85	-	31.01	-	56.00	46.00	-24.99	-
5	3.797	0.20	24.67	-	24.87	-	56.00	46.00	-31.13	-
6	10.410	0.31	35.37	-	35.68	-	60.00	50.00	-24.32	-

- REMARKS:**
1. Q.P. and AV. are abbreviations of quasi-peak and average individually.
  2. "-": The Quasi-peak reading value also meets average limit and measurement with the average detector is unnecessary.
  3. The emission levels of other frequencies were very low against the limit.
  4. Margin value = Emission level - Limit value
  5. Correction factor = Insertion loss + Cable loss
  6. Emission Level = Correction Factor + Reading Value.

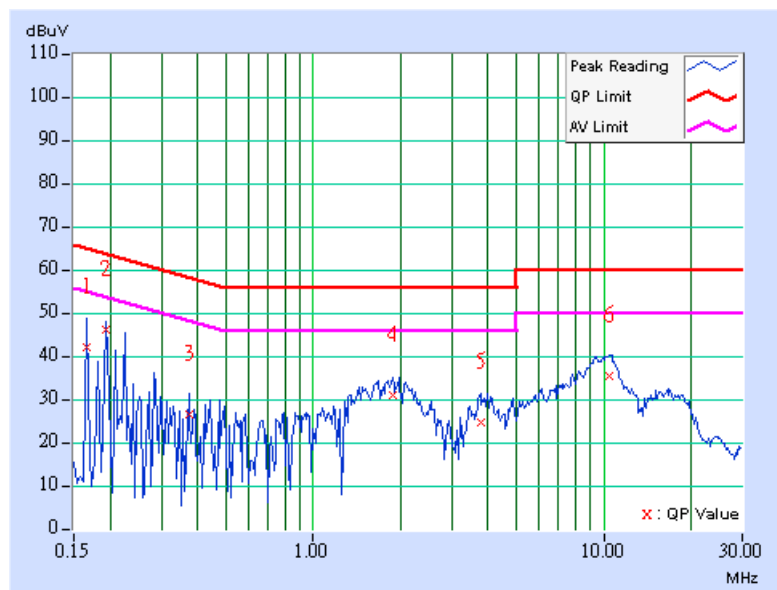





## 5.2 RADIATED EMISSION MEASUREMENT

### 5.2.1 LIMITS OF RADIATED EMISSION MEASUREMENT

Emissions radiated outside of the specified bands, shall be according to the general radiated limits in 15.209 as following:

Frequencies (MHz)	Field strength (microvolts/meter)	Measurement distance (meters)
0.009-0.490	2400/F(kHz)	300
0.490-1.705	24000/F(kHz)	30
1.705-30.0	30	30
30-88	100	3
88-216	150	3
216-960	200	3
Above 960	500	3

**NOTE:**

1. The lower limit shall apply at the transition frequencies.
2. Emission level (dBuV/m) = 20 log Emission level (uV/m).
3. As shown in 15.35(b), for frequencies above 1000MHz, the field strength limits are based on average detector, however, the peak field strength of any emission shall not exceed the maximum permitted average limits, specified above by more than 20dB under any condition of modulation.



## 5.2.2 LIMITS OF UNWANTED EMISSION OUT OF THE RESTRICTED BANDS

Frequencies (MHz)	EIRP Limit (dBm)	Equivalent Field Strength at 3m (dB $\mu$ V/m) *note 3
5150~5250	-27	68.3
5250~5350	-27	68.3
5725~5825	-27 *note 1	68.3
	-17 *note 2	78.3

### NOTE:

1. For frequencies 10MHz or greater above or below the band edge.
2. All emissions within the frequency range from the band edge to 10MHz above or below the band edge.
3. The following formula is used to convert the equipment isotropic radiated power (eirp) to field strength

$$E = \frac{1000000\sqrt{30P}}{3} \mu\text{V/m, where P is the eirp (Watts)}$$



## 5.2.3 TEST INSTRUMENTS

DESCRIPTION & MANUFACTURER	MODEL NO.	SERIAL NO.	CALIBRATED UNTIL
Test Receiver ROHDE & SCHWARZ	ESIB7	100188	Jan. 13, 2005
Spectrum Analyzer ROHDE & SCHWARZ	FSP40	100039	Nov. 21, 2005
BILOG Antenna SCHWARZBECK	VULB9168	9168-157	Feb. 03, 2005
HORN Antenna SCHWARZBECK	BBHA 9120 D	9120D-407	Feb. 03, 2005
HORN Antenna SCHWARZBECK	BBHA 9170	BBHA 9170241	Feb. 23, 2005
Preamplifier Agilent	8449B	3008A01961	Nov. 09, 2005
Preamplifier Agilent	8447D	2944A10629	Nov. 09, 2005
RF signal cable HUBER+SUHNER	SUCOFLEX 104	218182/4	Mar. 04, 2005
RF signal cable HUBER+SUHNER	SUCOFLEX 104	218194/4	Mar. 04, 2005
Software ADT.	ADT_Radiated_V5.14	NA	NA
Antenna Tower ADT.	AT100	AT93021702	NA
Turn Table ADT.	TT100.	TT93021702	NA
Controller ADT.	SC100.	SC93021702	NA

- NOTE:** 1. The calibration interval of the above test instruments is 12 months and the calibrations are traceable to NML/ROC and NIST/USA.
2. The test was performed in HwaYa Chamber 1.
3. The horn antenna and HP preamplifier (model: 8449B) are used only for the measurement of emission frequency above 1GHz if tested.
4. The IC Site Registration No. is IC4924-2.



#### 5.2.4 TEST PROCEDURES

- a. The EUT was placed on the top of a rotating table 0.8 meters above the ground at a 3 meter semi-anechoic chamber. The table was rotated 360 degrees to determine the position of the highest radiation.
- b. The EUT was set 3 meters away from the interference-receiving antenna, which was mounted on the top of a variable-height antenna tower.
- c. The antenna is a broadband antenna, and its height is varied from one meter to four meters above the ground to determine the maximum value of the field strength. Both horizontal and vertical polarizations of the antenna are set to make the measurement.
- d. For each suspected emission, the EUT was arranged to its worst case and then the antenna was tuned to heights from 1 meter to 4 meters and the rotatable table was turned from 0 degrees to 360 degrees to find the maximum reading.
- e. The test-receiver system was set to Peak Detect Function and Specified Bandwidth with Maximum Hold Mode.
- f. If the emission level of the EUT in peak mode was 10dB lower than the limit specified, then testing could be stopped and the peak values of the EUT would be reported. Otherwise the emissions that did not have 10dB margin would be re-tested one by one using peak, quasi-peak or average method as specified and then reported in a data sheet.

**NOTE:**

1. The resolution bandwidth and video bandwidth of test receiver/spectrum analyzer is 120kHz for Peak detection (PK) and Quasi-peak detection (QP) at frequency below 1GHz.
2. The resolution bandwidth and video bandwidth of test receiver/spectrum analyzer is 1 MHz for Peak detection at frequency above 1GHz.
3. The resolution bandwidth of test receiver/spectrum analyzer is 1 MHz and the video bandwidth is 10 Hz for Average detection (AV) at frequency above 1GHz.

#### 5.2.5 DEVIATION FROM TEST STANDARD

No deviation

### 5.2.6 TEST SETUP

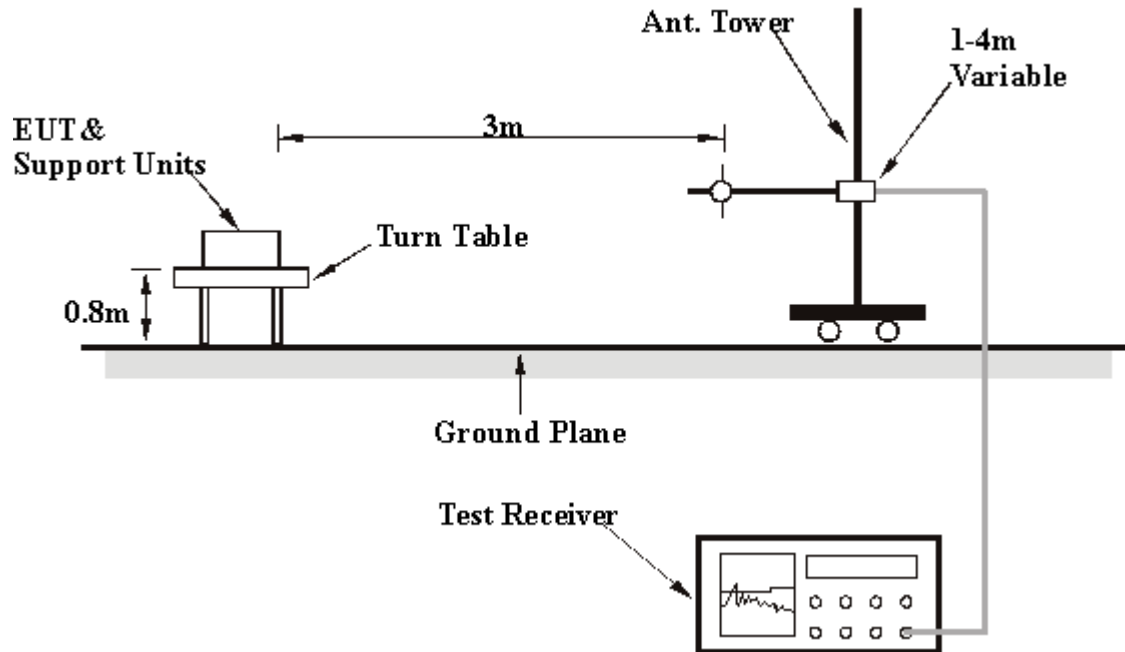

For the actual test configuration, please refer to the related item – Photographs of the Test Configuration.

### 5.2.7 EUT OPERATING CONDITIONS

Same as 4.1.6



## 5.2.8 TEST RESULTS

<b>EUT</b>	Wireless A/G Portable USB Adapter	<b>MODEL</b>	WUSB54AGP
<b>CHANNEL</b>	Channel 5	<b>FREQUENCY RANGE</b>	Below 1000MHz
<b>INPUT POWER (SYSTEM)</b>	120Vac, 60 Hz	<b>DETECTOR FUNCTION</b>	Quasi-Peak
<b>ENVIRONMENTAL CONDITIONS</b>	25deg. C, 55%RH, 991hPa	<b>TESTED BY:</b> Match Tsui	

**ANTENNA POLARITY & TEST DISTANCE: HORIZONTAL AT 3 M**

No.	Freq. (MHz)	Emission Level (dBuV/m)	Limit (dBuV/m)	Margin (dB)	Antenna Height (m)	Table Angle (Degree)	Raw Value (dBuV)	Correction Factor (dB/m)
1	117.47	32.58 QP	43.50	-10.92	1.50 H	88	19.81	12.77
2	164.13	30.86 QP	43.50	-12.64	1.50 H	265	16.37	14.49
3	239.94	34.24 QP	46.00	-11.76	1.50 H	220	21.17	13.07
4	319.64	34.54 QP	46.00	-11.46	1.00 H	217	19.59	14.95
5	383.79	34.67 QP	46.00	-11.33	1.00 H	283	18.28	16.39
6	440.16	37.04 QP	46.00	-8.96	2.00 H	76	19.23	17.81
7	519.86	37.21 QP	46.00	-8.79	1.50 H	247	18.10	19.11
8	560.68	33.93 QP	46.00	-12.07	1.50 H	163	13.96	19.97
9	599.56	36.02 QP	46.00	-9.98	1.50 H	232	15.02	21.00
10	640.38	37.48 QP	46.00	-8.52	1.50 H	175	15.92	21.55
<b>11</b>	<b>720.08</b>	<b>40.40 QP</b>	<b>46.00</b>	<b>-5.60</b>	<b>1.00 H</b>	<b>220</b>	<b>17.60</b>	<b>22.79</b>
12	760.90	34.52 QP	46.00	-11.48	1.00 H	205	10.93	23.59
13	799.78	36.31 QP	46.00	-9.69	2.00 H	214	12.49	23.82
14	840.60	36.60 QP	46.00	-9.40	1.00 H	208	12.48	24.12
15	920.30	36.44 QP	46.00	-9.56	1.50 H	211	11.12	25.33

- REMARKS:**
1. Emission level(dBuV/m)=Raw Value(dBuV) + Correction Factor(dB)
  2. Correction Factor(dB/m) = Antenna Factor (dB/m) + Cable Factor (dB)
  3. The other emission levels were very low against the limit.
  4. Margin value = Emission level – Limit value.



<b>EUT</b>	Wireless A/G Portable USB Adapter	<b>MODEL</b>	WUSB54AGP
<b>CHANNEL</b>	Channel 5	<b>FREQUENCY RANGE</b>	Below 1000MHz
<b>INPUT POWER (SYSTEM)</b>	120Vac, 60 Hz	<b>DETECTOR FUNCTION</b>	Quasi-Peak
<b>ENVIRONMENTAL CONDITIONS</b>	25deg. C, 55%RH, 991hPa	<b>TESTED BY:</b> Match Tsui	

#### ANTENNA POLARITY & TEST DISTANCE: VERTICAL AT 3 M

No.	Freq. (MHz)	Emission Level (dBuV/m)	Limit (dBuV/m)	Margin (dB)	Antenna Height (m)	Table Angle (Degree)	Raw Value (dBuV)	Correction Factor (dB/m)
1	64.99	27.93 QP	40.00	-12.07	1.00 V	34	14.78	13.15
2	127.19	32.93 QP	43.50	-10.57	1.00 V	31	19.40	13.53
3	177.74	35.74 QP	43.50	-7.76	1.00 V	250	22.56	13.18
4	370.18	26.99 QP	46.00	-19.01	2.00 V	154	10.89	16.09
5	401.28	27.24 QP	46.00	-18.76	1.50 V	133	10.45	16.78
6	440.16	31.61 QP	46.00	-14.39	2.00 V	151	13.80	17.81
7	465.43	27.08 QP	46.00	-18.92	1.00 V	151	8.81	18.27
8	519.86	30.28 QP	46.00	-15.72	1.50 V	139	11.16	19.11
9	560.68	28.96 QP	46.00	-17.04	1.50 V	160	8.99	19.97
10	599.56	31.74 QP	46.00	-14.26	1.50 V	142	10.74	21.00
11	640.38	32.79 QP	46.00	-13.21	1.50 V	130	11.24	21.55
12	667.60	30.39 QP	46.00	-15.61	1.00 V	79	8.49	21.90
13	720.08	33.99 QP	46.00	-12.01	2.00 V	127	11.19	22.79
14	799.78	34.63 QP	46.00	-11.37	2.00 V	136	10.81	23.82
15	920.30	31.05 QP	46.00	-14.95	1.50 V	133	5.73	25.33

- REMARKS:**
1. Emission level(dBuV/m)=Raw Value(dBuV) + Correction Factor(dB)
  2. Correction Factor(dB/m) = Antenna Factor (dB/m) + Cable Factor (dB)
  3. The other emission levels were very low against the limit.
  4. Margin value = Emission level – Limit value.



<b>EUT</b>	Wireless A/G Portable USB Adapter	<b>MODEL</b>	WUSB54AGP
<b>CHANNEL</b>	1	<b>FREQUENCY RANGE</b>	1 ~ 40 GHz
<b>INPUT POWER (SYSTEM)</b>	120Vac, 60Hz	<b>DETECTOR FUNCTION</b>	Peak(PK) Average (AV)
<b>ENVIRONMENTAL CONDITIONS</b>	24deg. C, 64%RH, 991hPa	<b>TESTED BY</b>	Leo Hung

#### ANTENNA POLARITY & TEST DISTANCE: HORIZONTAL AT 3 M

No.	Freq. (MHz)	Emission Level (dBuV/m)	Limit (dBuV/m)	Margin (dB)	Antenna Height (m)	Table Angle (Degree)	Raw Value (dBuV)	Correction Factor (dB/m)
1	3453.00	53.92 PK	68.30	-14.38	1.00 H	193	18.34	35.58
2	#5150.00	56.31 PK	74.00	-17.69	1.43 H	199	17.21	39.10
2	#5150.00	45.74 AV	54.00	-8.26	1.43 H	199	6.64	39.10
3	*5180.00	112.67 PK			1.43 H	199	73.50	39.17
3	*5180.00	102.10 AV			1.43 H	199	62.93	39.17
4	6906.00	49.75 PK	68.30	-18.55	1.07 H	14	8.24	41.51
5	10360.00	55.67 PK	68.30	-12.63	1.02 H	5	10.38	45.29

#### ANTENNA POLARITY & TEST DISTANCE: VERTICAL AT 3 M

No.	Freq. (MHz)	Emission Level (dBuV/m)	Limit (dBuV/m)	Margin (dB)	Antenna Height (m)	Table Angle (Degree)	Raw Value (dBuV)	Correction Factor (dB/m)
1	3453.00	56.01 PK	68.30	-12.29	1.00 V	246	20.43	35.58
2	#5150.00	45.57 PK	74.00	-28.43	1.00 V	219	6.47	39.10
2	#5150.00	35.76 AV	54.00	-18.24	1.00 V	219	6.47	39.10
3	*5180.00	101.93 PK			1.00 V	219	62.76	39.17
3	*5180.00	92.12 AV			1.00 V	219	52.95	39.17
4	6906.00	53.21 PK	68.30	-15.09	1.08 V	165	11.70	41.51
5	10360.00	55.34 PK	68.30	-12.96	1.00 V	219	10.05	45.29

#### NOTE:

1. Emission level = Raw value + Correction Factor
2. Correction Factor = Ant. Factor + Cable loss
3. Margin value = Emission level - Limit value
4. The other emission levels were very low against the limit.
5. "\*" : Fundamental frequency
6. "#" The radiated frequency falling in the restricted band.





<b>EUT</b>	Wireless A/G Portable USB Adapter	<b>MODEL</b>	WUSB54AGP
<b>CHANNEL</b>	4	<b>FREQUENCY RANGE</b>	1 ~ 40 GHz
<b>INPUT POWER (SYSTEM)</b>	120Vac, 60Hz	<b>DETECTOR FUNCTION</b>	Peak(PK) Average (AV)
<b>ENVIRONMENTAL CONDITIONS</b>	24deg. C, 64%RH, 991hPa	<b>TESTED BY</b>	Leo Hung

#### ANTENNA POLARITY & TEST DISTANCE: HORIZONTAL AT 3 M

No.	Freq. (MHz)	Emission Level (dBuV/m)	Limit (dBuV/m)	Margin (dB)	Antenna Height (m)	Table Angle (Degree)	Raw Value (dBuV)	Correction Factor (dB/m)
1	3493.00	54.80 PK	68.30	-13.50	1.06 H	229	19.11	35.70
2	*5240.00	113.75 PK			1.42 H	199	74.57	39.18
2	*5240.00	103.60 AV			1.42 H	199	64.42	39.18
3	6986.00	54.63 PK	68.30	-13.67	1.43 H	226	12.93	41.70
4	10480.00	55.49 PK	68.30	-12.81	1.42 H	199	9.40	46.08

#### ANTENNA POLARITY & TEST DISTANCE: VERTICAL AT 3 M

No.	Freq. (MHz)	Emission Level (dBuV/m)	Limit (dBuV/m)	Margin (dB)	Antenna Height (m)	Table Angle (Degree)	Raw Value (dBuV)	Correction Factor (dB/m)
1	3493.00	54.09 PK	68.30	-14.21	1.07 V	173	18.40	35.70
2	*5240.00	102.25 PK			1.06 V	112	63.07	39.18
2	*5240.00	92.68 AV			1.06 V	112	53.50	39.18
3	6986.00	53.77 PK	68.30	-14.53	1.02 V	18	12.07	41.70
4	10480.00	55.98 PK	68.30	-12.32	1.00 V	240	9.89	46.08

#### NOTE:

1. Emission level = Raw value + Correction Factor
2. Correction Factor = Ant. Factor + Cable loss
3. Margin value = Emission level - Limit value
4. The other emission levels were very low against the limit.
5. "\*" : Fundamental frequency
6. "#" The radiated frequency falling in the restricted band.



<b>EUT</b>	Wireless A/G Portable USB Adapter	<b>MODEL</b>	WUSB54AGP
<b>CHANNEL</b>	5	<b>FREQUENCY RANGE</b>	1 ~ 40 GHz
<b>INPUT POWER (SYSTEM)</b>	120Vac, 60Hz	<b>DETECTOR FUNCTION</b>	Peak(PK) Average (AV)
<b>ENVIRONMENTAL CONDITIONS</b>	24deg. C, 64%RH, 991hPa	<b>TESTED BY</b>	Leo Hung

#### ANTENNA POLARITY & TEST DISTANCE: HORIZONTAL AT 3 M

No.	Freq. (MHz)	Emission Level (dBuV/m)	Limit (dBuV/m)	Margin (dB)	Antenna Height (m)	Table Angle (Degree)	Raw Value (dBuV)	Correction Factor (dB/m)
1	3506.00	55.32 PK	68.30	-12.98	1.06 H	188	19.58	35.73
2	*5260.00	112.29 PK			1.40 H	195	73.13	39.16
2	*5260.00	102.60 AV			1.40 H	195	63.44	39.16
3	7013.00	53.74 PK	68.30	-14.56	1.43 H	10	11.89	41.85
4	10520.00	55.98 PK	68.30	-12.32	1.00 H	314	9.83	46.16

#### ANTENNA POLARITY & TEST DISTANCE: VERTICAL AT 3 M

No.	Freq. (MHz)	Emission Level (dBuV/m)	Limit (dBuV/m)	Margin (dB)	Antenna Height (m)	Table Angle (Degree)	Raw Value (dBuV)	Correction Factor (dB/m)
1	3506.00	55.70 PK	68.30	-12.60	1.04 V	117	19.96	35.73
2	*5260.00	103.35 PK			1.47 V	154	64.19	39.16
2	*5260.00	93.43 AV			1.47 V	154	54.27	39.16
3	7013.00	53.60 PK	68.30	-14.70	1.40 V	38	11.75	41.85
4	10520.00	56.32 PK	68.30	-11.98	1.09 V	111	10.17	46.16

#### NOTE:

1. Emission level = Raw value + Correction Factor
2. Correction Factor = Ant. Factor + Cable loss
3. Margin value = Emission level - Limit value
4. The other emission levels were very low against the limit.
5. "\*" : Fundamental frequency
6. "#": The radiated frequency falling in the restricted band.



<b>EUT</b>	Wireless A/G Portable USB Adapter	<b>MODEL</b>	WUSB54AGP
<b>CHANNEL</b>	8	<b>FREQUENCY RANGE</b>	1 ~ 40 GHz
<b>INPUT POWER (SYSTEM)</b>	120Vac, 60Hz	<b>DETECTOR FUNCTION</b>	Peak(PK) Average (AV)
<b>ENVIRONMENTAL CONDITIONS</b>	24deg. C, 64%RH, 991hPa	<b>TESTED BY</b>	Leo Hung

#### ANTENNA POLARITY & TEST DISTANCE: HORIZONTAL AT 3 M

No.	Freq. (MHz)	Emission Level (dBuV/m)	Limit (dBuV/m)	Margin (dB)	Antenna Height (m)	Table Angle (Degree)	Raw Value (dBuV)	Correction Factor (dB/m)
1	3546.00	54.15 PK	68.30	-14.15	1.00 H	189	18.30	35.85
2	*5320.00	112.34 PK			1.00 H	195	73.19	39.15
2	*5320.00	101.24 AV			1.00 H	195	62.09	39.15
3	#5350.00	56.95 PK	74.00	-17.05	1.00 H	195	17.75	39.20
3	#5350.00	45.85 AV	54.00	-8.15	1.00 H	195	6.65	39.20
4	7093.00	53.73 PK	68.30	-14.57	1.00 H	301	11.21	42.52
5	#10640.00	55.41 PK	74.00	-18.59	1.00 H	322	9.18	46.23
5	#10640.00	44.09 AV	54.00	-9.91	1.00 H	322	-2.14	46.23

#### ANTENNA POLARITY & TEST DISTANCE: VERTICAL AT 3 M

No.	Freq. (MHz)	Emission Level (dBuV/m)	Limit (dBuV/m)	Margin (dB)	Antenna Height (m)	Table Angle (Degree)	Raw Value (dBuV)	Correction Factor (dB/m)
1	3546.00	55.88 PK	68.30	-12.42	1.48 V	178	20.03	35.85
2	*5320.00	102.54 PK			1.00 V	244	63.39	39.15
2	*5320.00	93.65 AV			1.00 V	244	54.50	39.15
3	#5350.00	55.39 PK	74.00	-18.61	1.00 V	244	16.19	39.20
3	#5350.00	38.26 AV	54.00	-15.74	1.00 V	244	-0.94	39.20
4	7093.00	53.82 PK	68.30	-14.48	1.16 V	237	11.30	42.52
5	#10640.00	58.32 PK	74.00	-15.68	1.10 V	220	12.09	46.23
5	#10640.00	46.73 AV	54.00	-7.27	1.10 V	220	0.50	46.23

#### NOTE:

1. Emission level = Raw value + Correction Factor
2. Correction Factor = Ant. Factor + Cable loss
3. Margin value = Emission level - Limit value
4. The other emission levels were very low against the limit.
5. "\*" : Fundamental frequency
6. "#" The radiated frequency falling in the restricted band.



### 5.3 PEAK TRANSMIT POWER MEASUREMENT

#### 5.3.1 LIMITS OF PEAK TRANSMIT POWER MEASUREMENT

Frequency Band	Limit
5.15 – 5.25GHz	The lesser of 50mW (17dBm) or 4dBm + 10logB
5.25 – 5.35GHz	The lesser of 250mW (24dBm) or 11dBm + 10logB
5.725 – 5.825GHz	The lesser of 1W (30dBm) or 17dBm + 10logB

**NOTE:** Where B is the 26dB emission bandwidth in MHz.

#### 5.3.2 TEST INSTRUMENTS

Description & Manufacturer	Model No.	Serial No.	Calibrated Until
R&S SPECTRUM ANALYZER	FSEK30	100049	Aug. 12, 2005

**NOTE:** The calibration interval of the above test instruments is 12 months and the calibrations are traceable to NML/ROC and NIST/USA.



### 5.3.3 TEST PROCEDURE

1. The transmitter output was connected to the spectrum analyzer.
2. Set span to encompass the entire emission bandwidth of the signal.
3. Set RBW to 1MHz, VBW to 300kHz.
4. Using the spectrum analyzer's channel power measurement function to measure the output power.

### 5.3.4 DEVIATION FROM TEST STANDARD

No deviation

### 5.3.5 TEST SETUP



### 5.3.6 EUT OPERATING CONDITIONS

The software provided by client to enable the EUT under transmission condition continuously at specific channel frequencies individually.



## 5.3.7 TEST RESULTS

<b>EUT</b>	Wireless A/G Portable USB Adapter	<b>MODEL</b>	WUSB54AGP
<b>INPUT POWER (SYSTEM)</b>	120Vac, 60 Hz	<b>ENVIRONMENTAL CONDITIONS</b>	23deg. C, 67%RH, 991hPa
<b>TESTED BY</b>	Leo Hung		

<b>CHANNEL</b>	<b>CHANNEL FREQUENCY (MHz)</b>	<b>PEAK POWER OUTPUT (mW)</b>	<b>PEAK POWER OUTPUT (dBm)</b>	<b>PEAK POWER LIMIT (dBm)</b>	<b>26dBc Occupied Bandwidth (MHz)</b>	<b>PASS/FAIL</b>
1	5180	31.915	15.04	17.00	28.00	PASS
4	5240	32.211	15.08	17.00	27.30	PASS
5	5260	32.137	15.07	24.00	28.42	PASS
8	5320	31.989	15.05	24.00	25.97	PASS

**NOTE:** The 26dBc Occupied Bandwidth plot, please refer to the following pages.



Peak Power Output:  
CH1

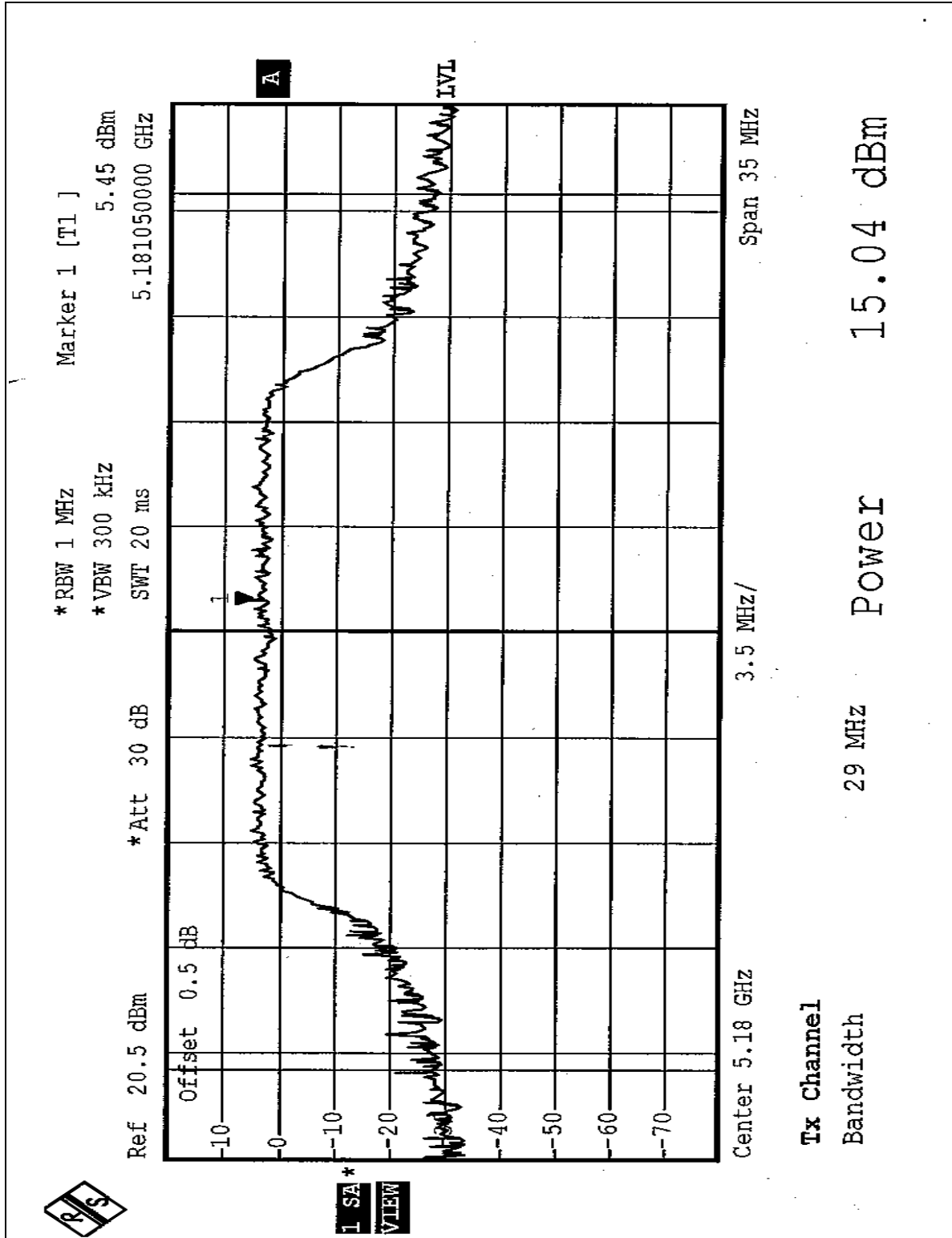



CH4

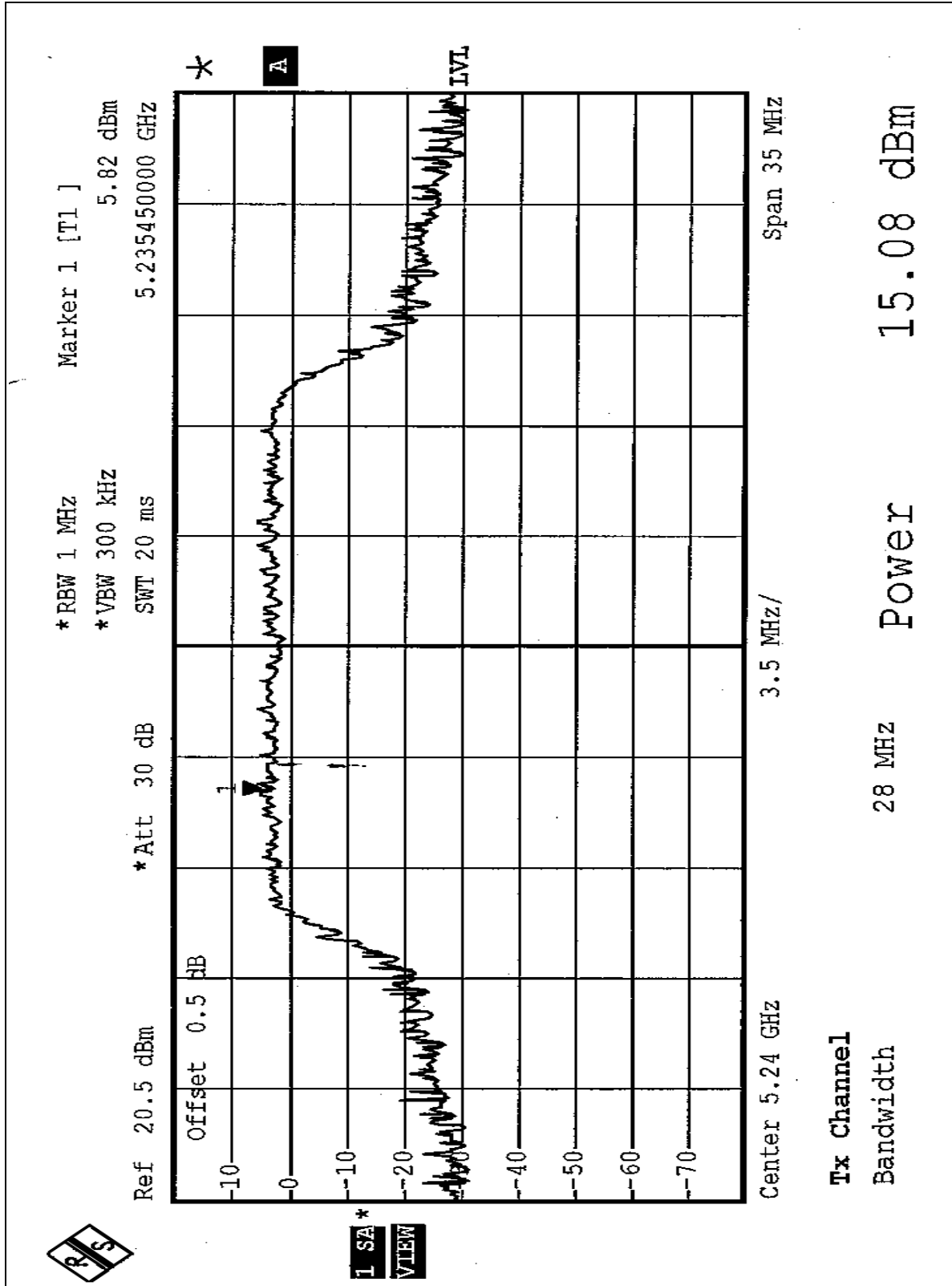





CH5

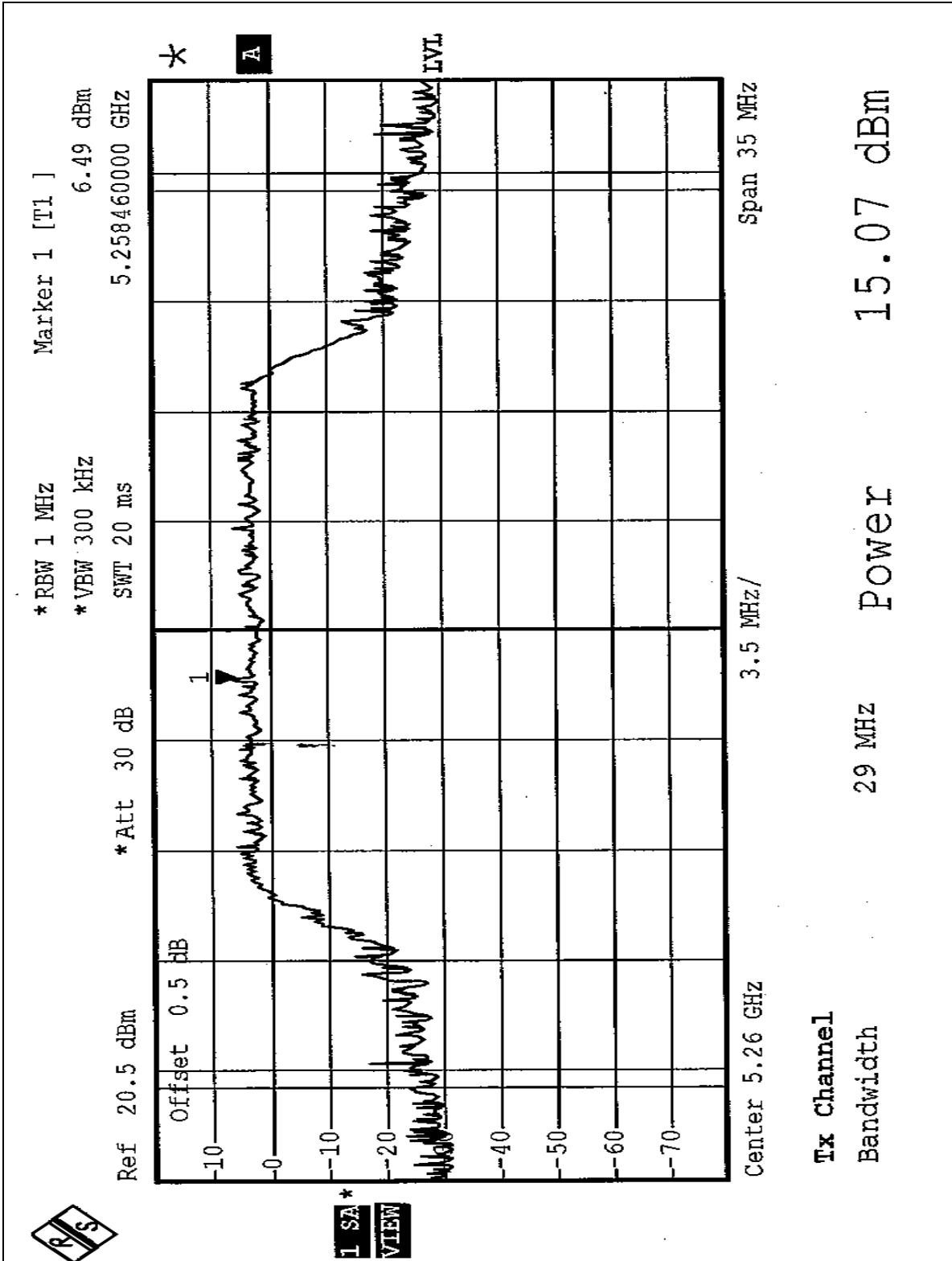



CH8

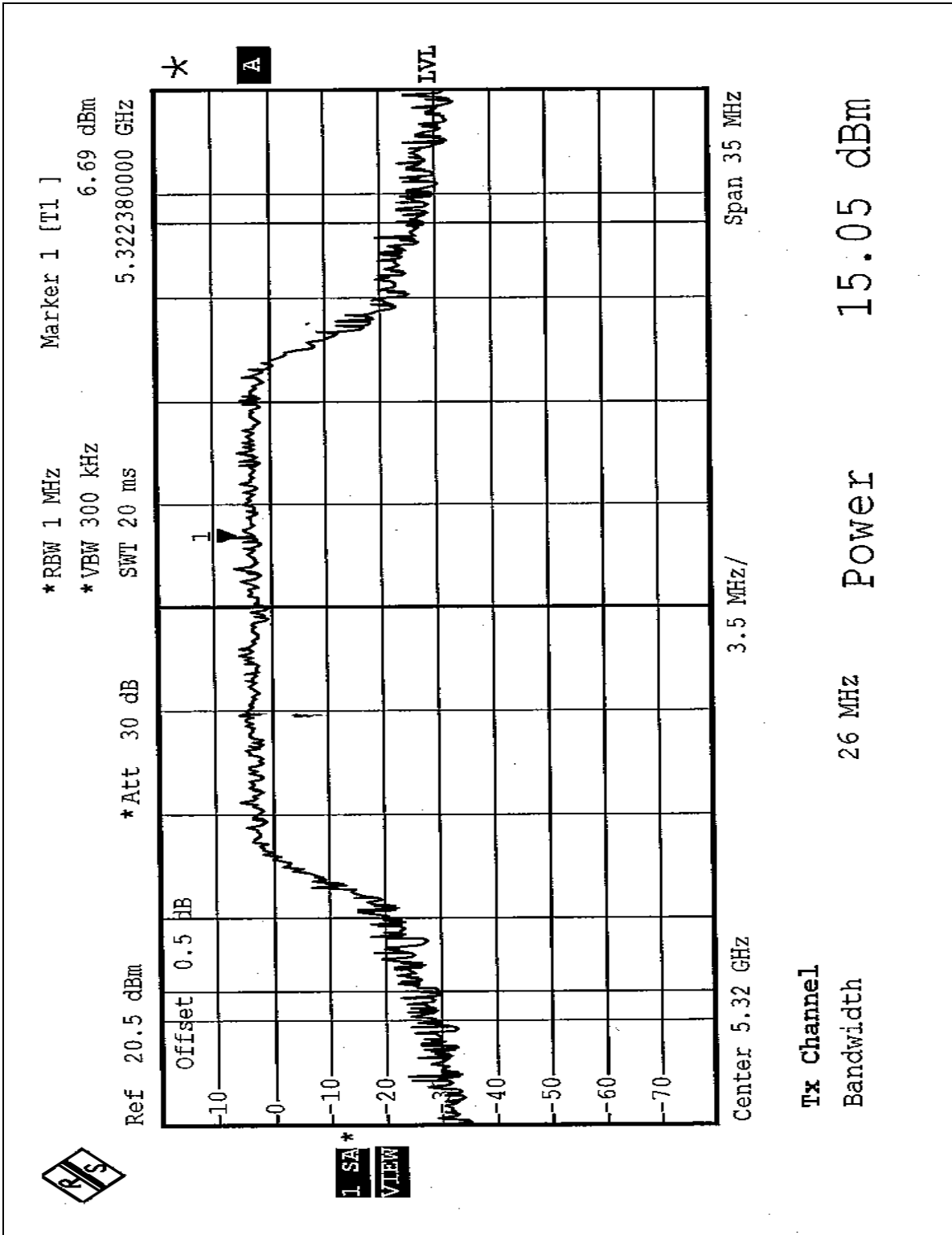



26dB Occupied Bandwidth:  
CH1

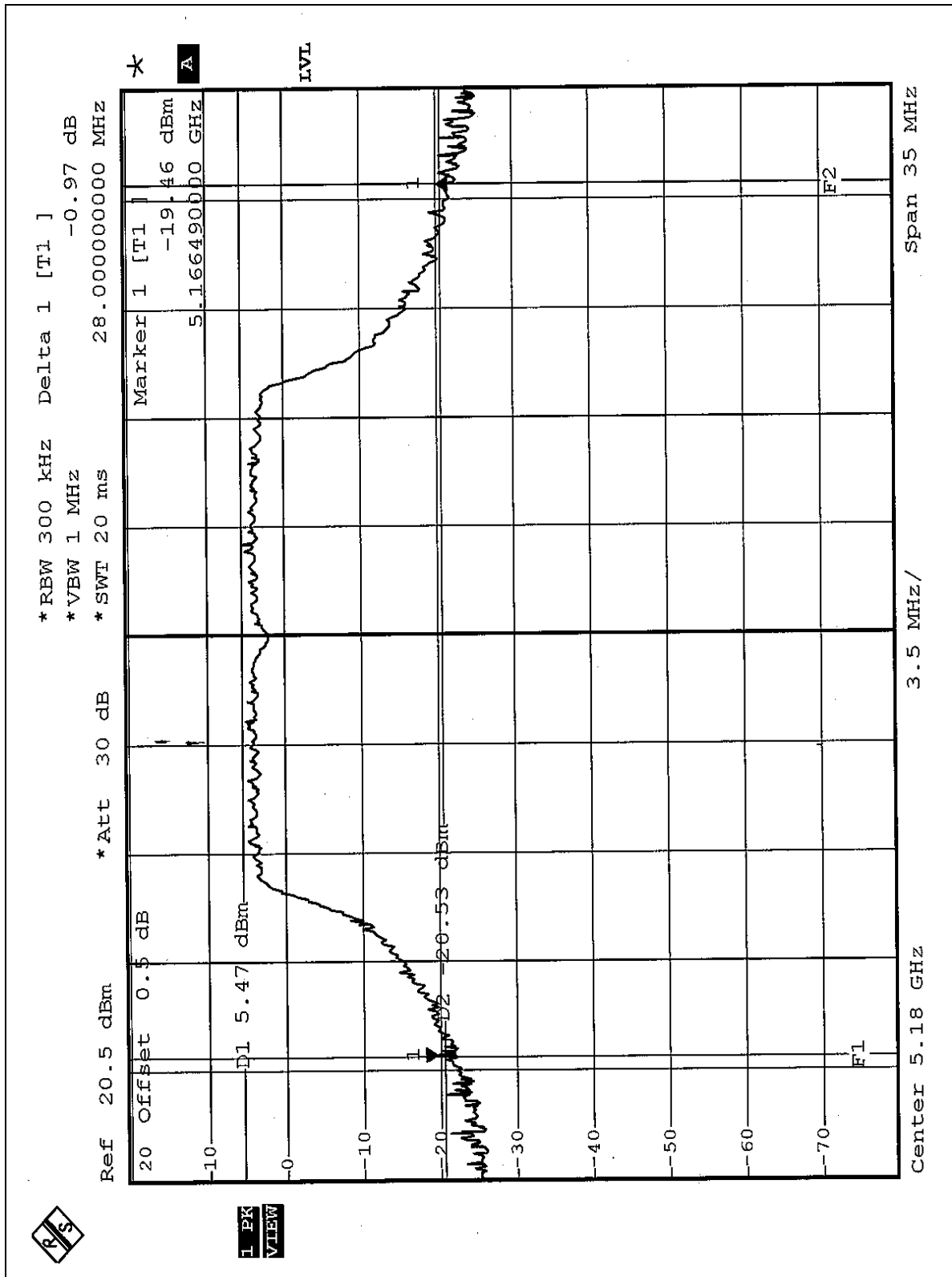



CH4

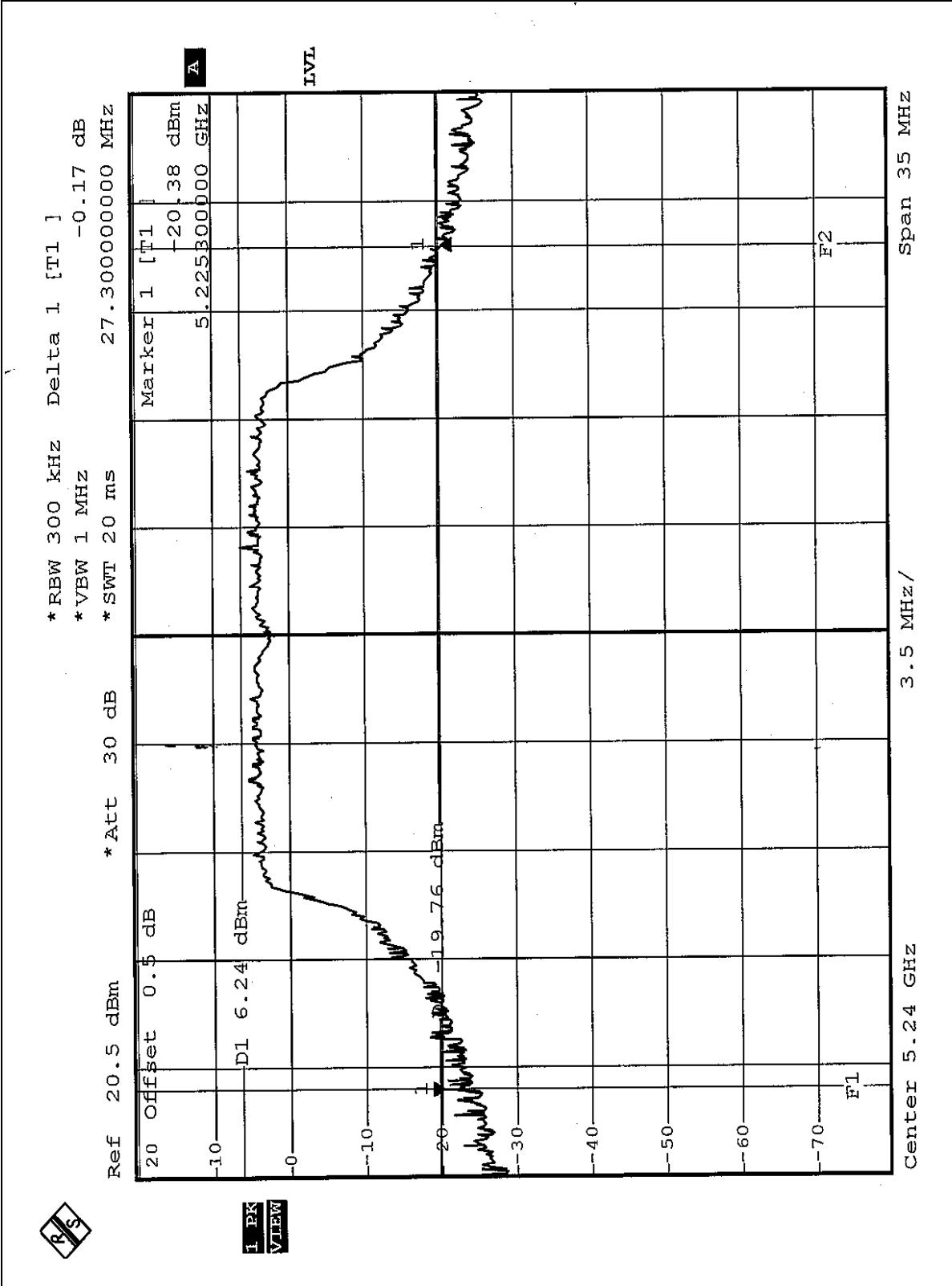



CH5

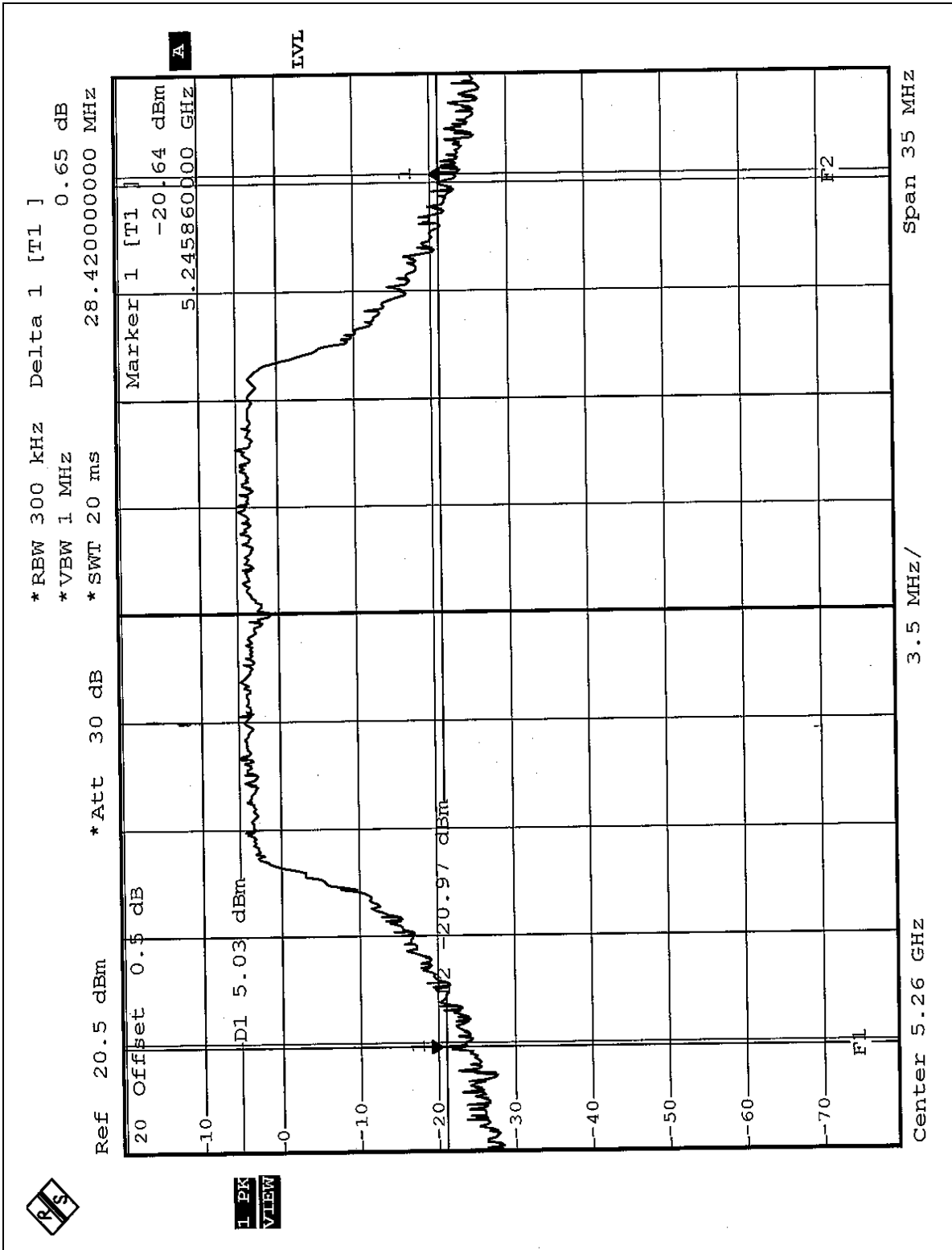



CH8

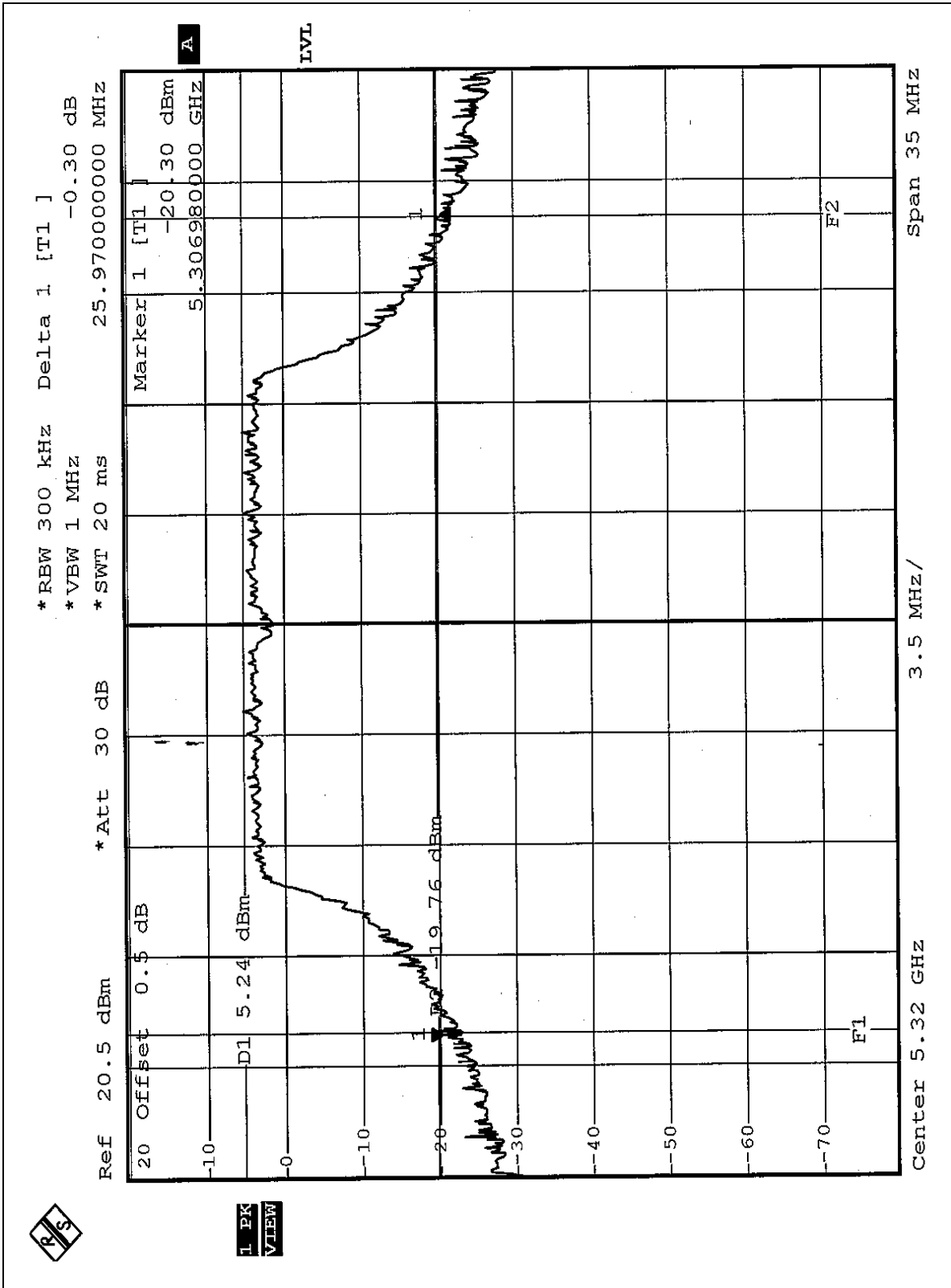



## 5.4 PEAK POWER EXCURSION MEASUREMENT

### 5.4.1 LIMITS OF PEAK POWER EXCURSION MEASUREMENT

Frequency Band	Limit
5.15 – 5.25 GHz	13dB
5.25 – 5.35 GHz	13dB
5.725 – 5.825 GHz	13dB

### 5.4.2 TEST INSTRUMENTS

Description & Manufacturer	Model No.	Serial No.	Calibrated Until
SPECTRUM ANALYZER	FSEK30	100049	Aug. 12, 2005

**NOTE:** The calibration interval of the above test instruments is 12 months and the calibrations are traceable to NML/ROC and NIST/USA.



### 5.4.3 TEST PROCEDURE

1. The transmitter output was connected to the spectrum analyzer.
2. Set the spectrum bandwidth span to view the entire spectrum.
3. Using peak detector and Max-hold function for Trace 1 (RB=1MHz, VB=3MHz) and 2 (RB=1MHz, VB=300KHz).
4. The largest difference between Trace 1 and Trace 2 in any 1MHz band on any frequency was recorded.

### 5.4.4 DEVIATION FROM TEST STANDARD

No deviation

### 5.4.5 TEST SETUP

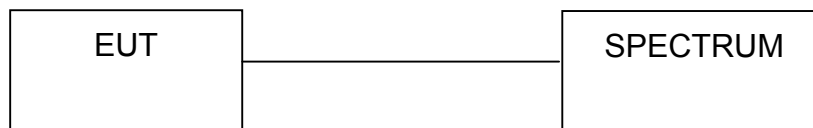

### 5.4.6 EUT OPERATING CONDITIONS

The software provided by client to enable the EUT under transmission condition continuously at specific channel frequencies individually.





5.4.7 TEST RESULTS

<b>EUT</b>	Wireless A/G Portable USB Adapter	<b>MODEL</b>	WUSB54AGP
<b>INPUT POWER (SYSTEM)</b>	120Vac, 60 Hz	<b>ENVIRONMENTAL CONDITIONS</b>	23deg. C, 67%RH, 991hPa
<b>TESTED BY</b>	Leo Hung		

<b>CHANNEL</b>	<b>CHANNEL FREQUENCY (MHz)</b>	<b>PEAK POWER EXCURSION (dB)</b>	<b>PEAK to AVERAGE EXCURSION LIMIT (dB)</b>	<b>PASS/FAIL</b>
1	5180	6.55	13	PASS
4	5240	7.56	13	PASS
5	5260	6.64	13	PASS
8	5320	7.34	13	PASS



CH1

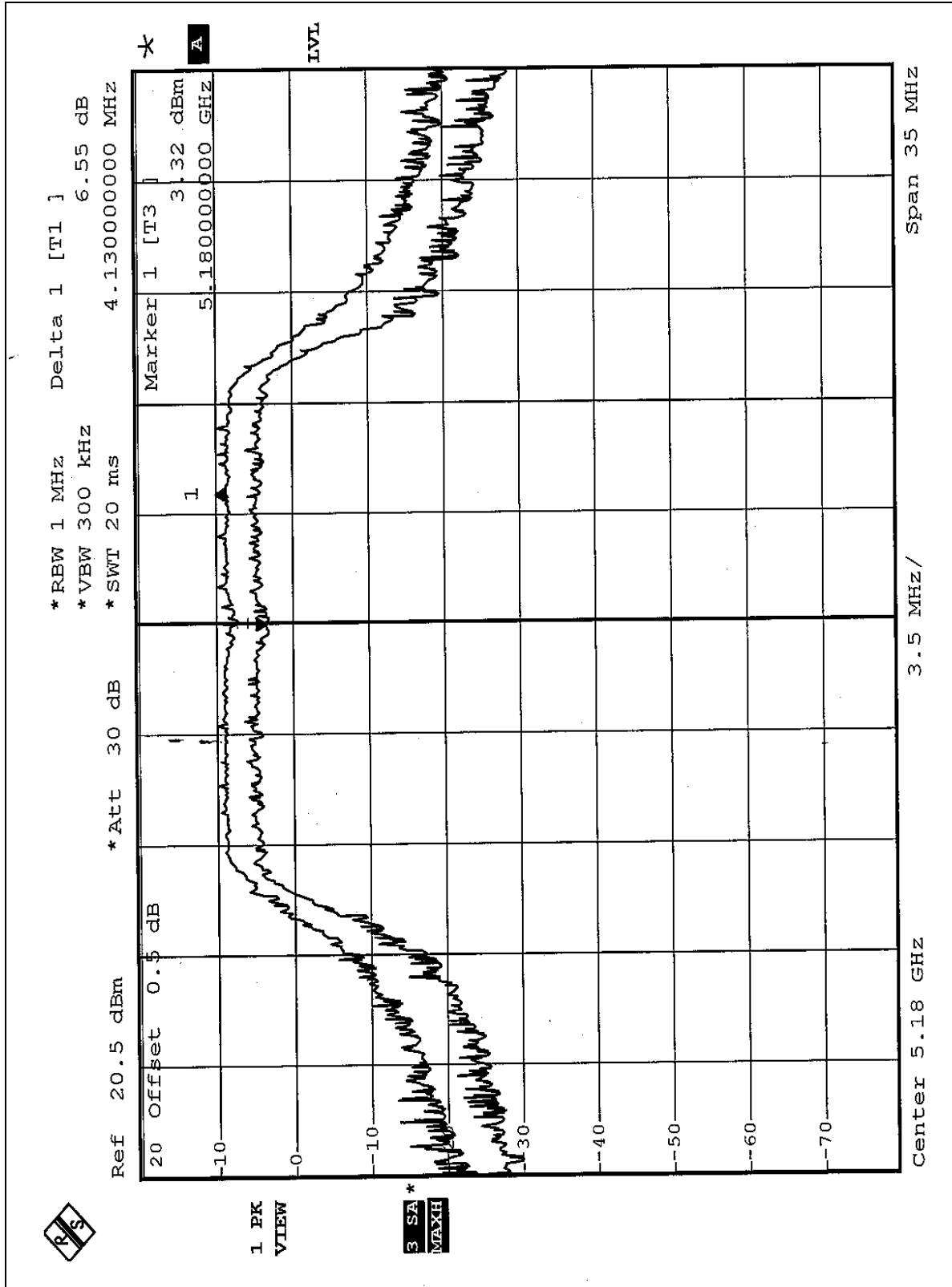



CH4

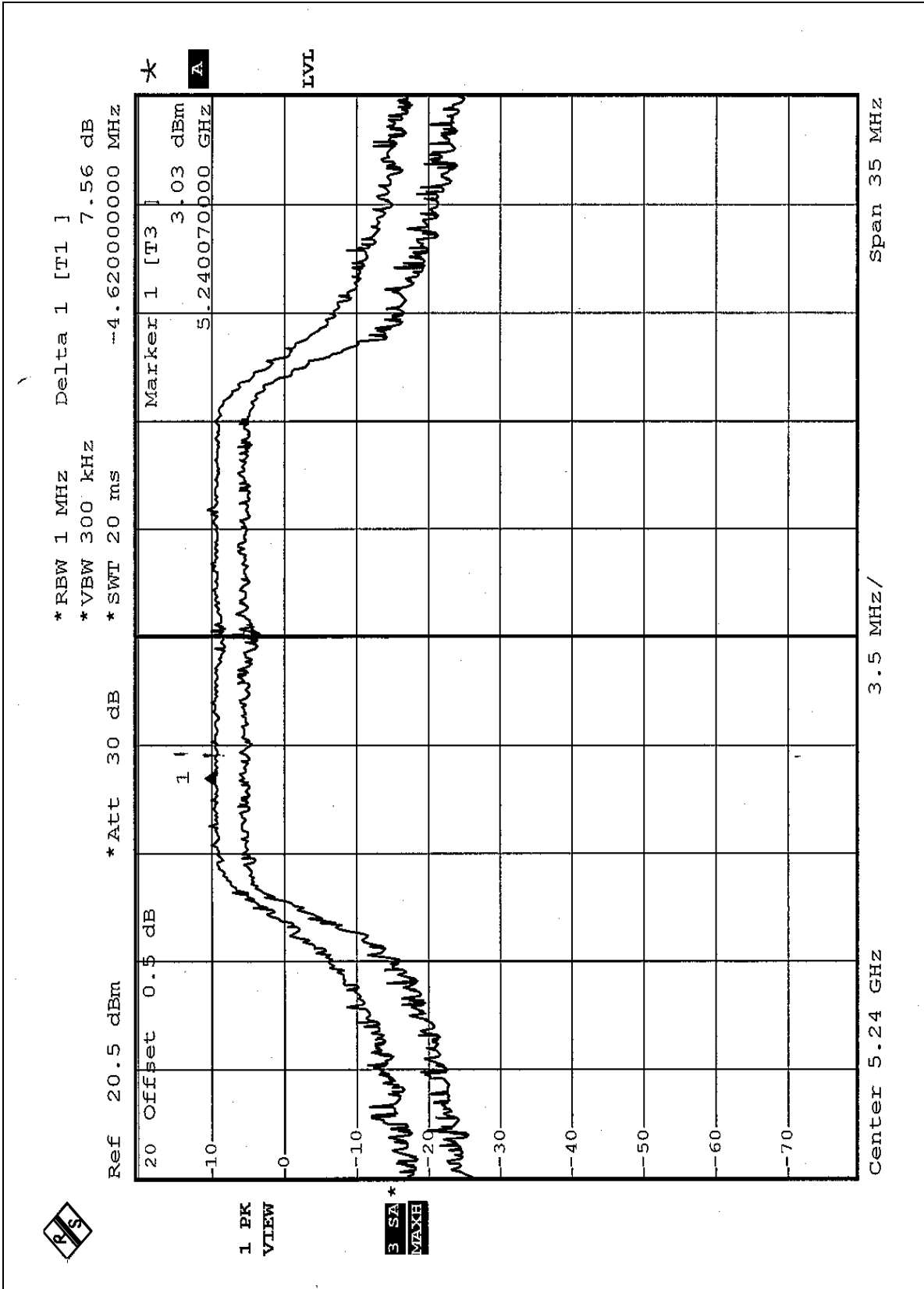



CH5

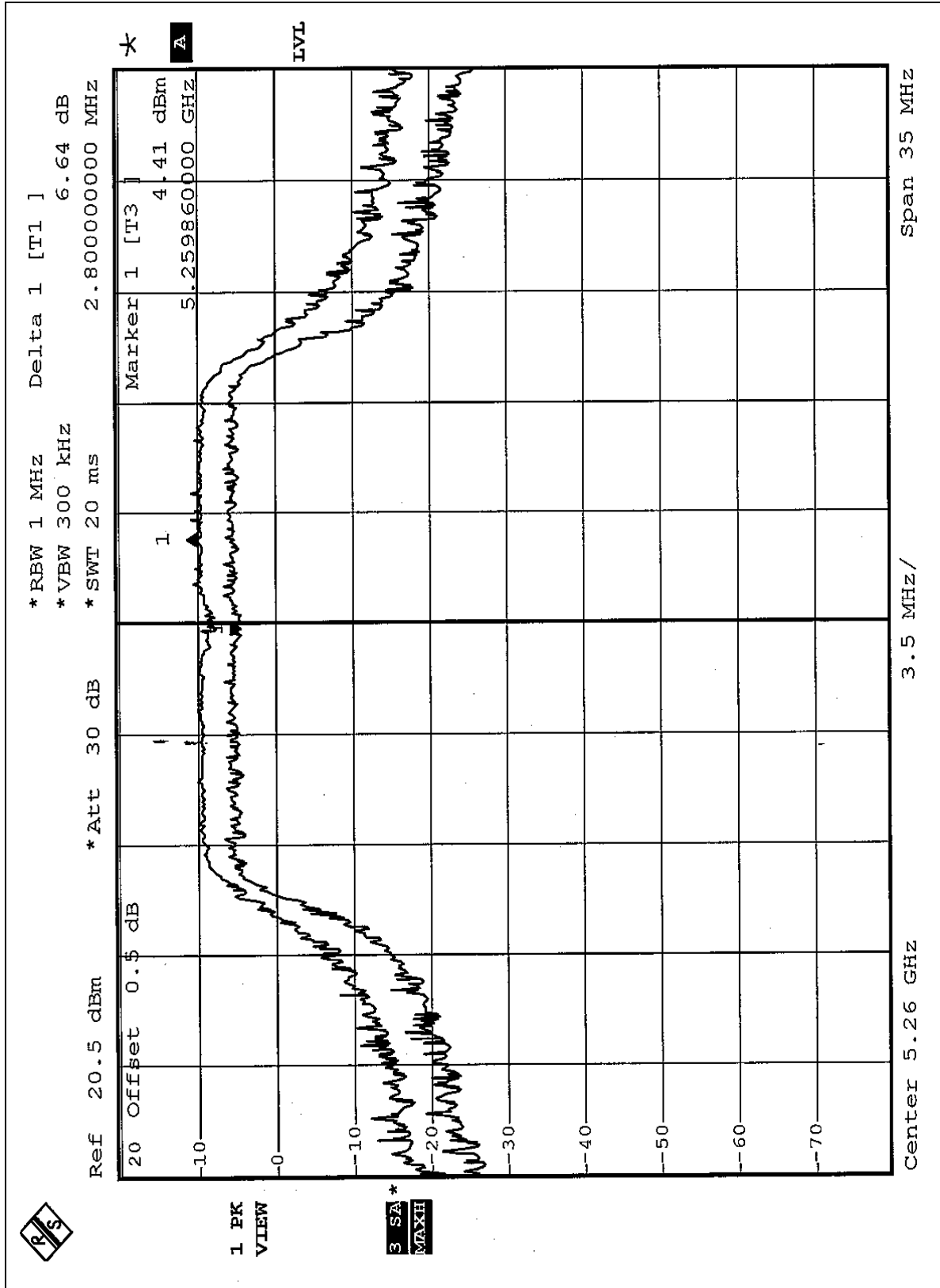



CH8

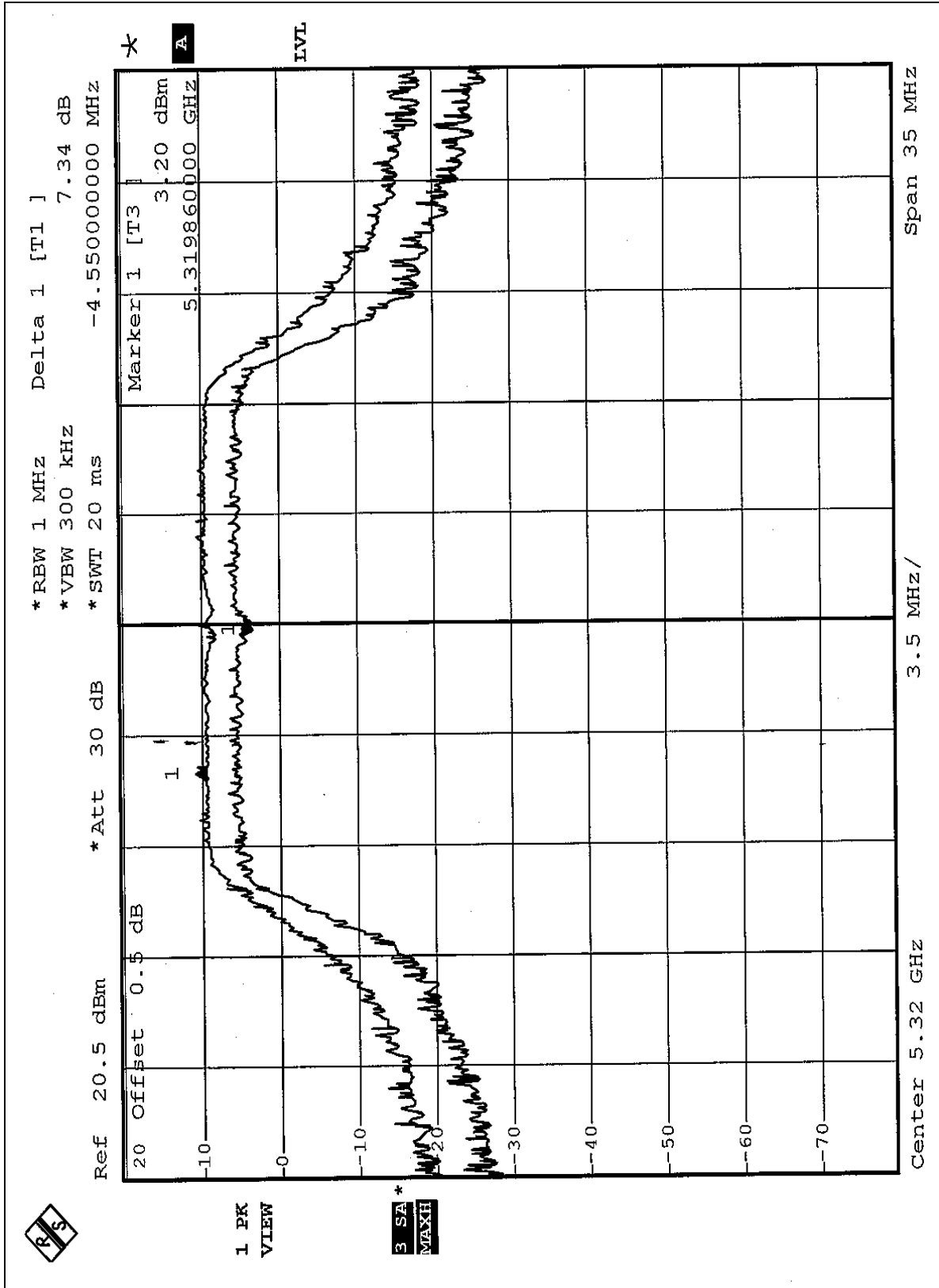



## 5.5 PEAK POWER SPECTRAL DENSITY MEASUREMENT

### 5.5.1 LIMITS OF PEAK POWER SPECTRAL DENSITY MEASUREMENT

Frequency Band	Limit
5.15 – 5.25GHz	4dBm
5.25 – 5.35GHz	11dBm
5.725 – 5.825GHz	17dBm

### 5.5.2 TEST INSTRUMENTS

Description & Manufacturer	Model No.	Serial No.	Calibrated Until
SPECTRUM ANALYZER	FSEK30	100049	Aug. 12, 2005

**NOTE:** The calibration interval of the above test instruments is 12 months and the calibrations are traceable to NML/ROC and NIST/USA.

### 5.5.3 TEST PROCEDURES

1. The transmitter output was connected to the spectrum analyzer.
2. Set RBW=1MHz, VBW=3MHz. The PPSD is the highest level found across the emission in any 1MHz band.

### 5.5.4 DEVIATION FROM TEST STANDARD

No deviation

### 5.5.5 TEST SETUP



### 5.5.6 EUT OPERATING CONDITIONS

Same as 5.3.6



5.5.7 TEST RESULTS

<b>EUT</b>	Wireless A/G Portable USB Adapter	<b>MODEL</b>	WUSB54AGP
<b>INPUT POWER (SYSTEM)</b>	120Vac, 60 Hz	<b>ENVIRONMENTAL CONDITIONS</b>	24deg. C, 64%RH, 991hPa
<b>TESTED BY</b>	Leo Hung		

<b>CHANNEL</b>	<b>CHANNEL FREQUENCY (MHz )</b>	<b>RF POWER LEVEL IN 1MHz BW (dBm)</b>	<b>MAXIMUM LIMIT (dBm)</b>	<b>PASS/FAIL</b>
1	5180	-0.10	4	PASS
4	5240	-0.35	4	PASS
5	5260	-0.43	11	PASS
8	5320	-0.32	11	PASS





CH1

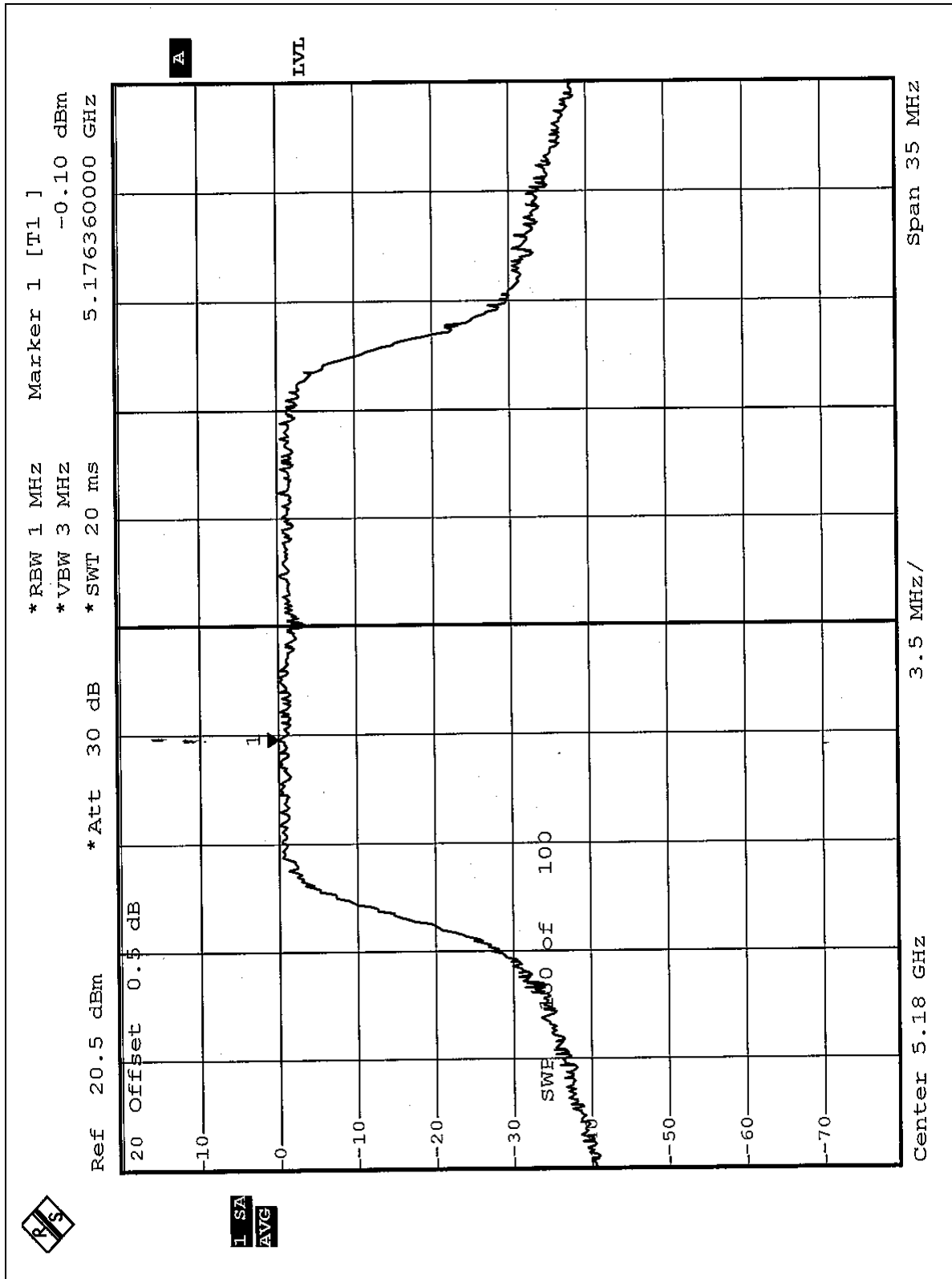



CH4

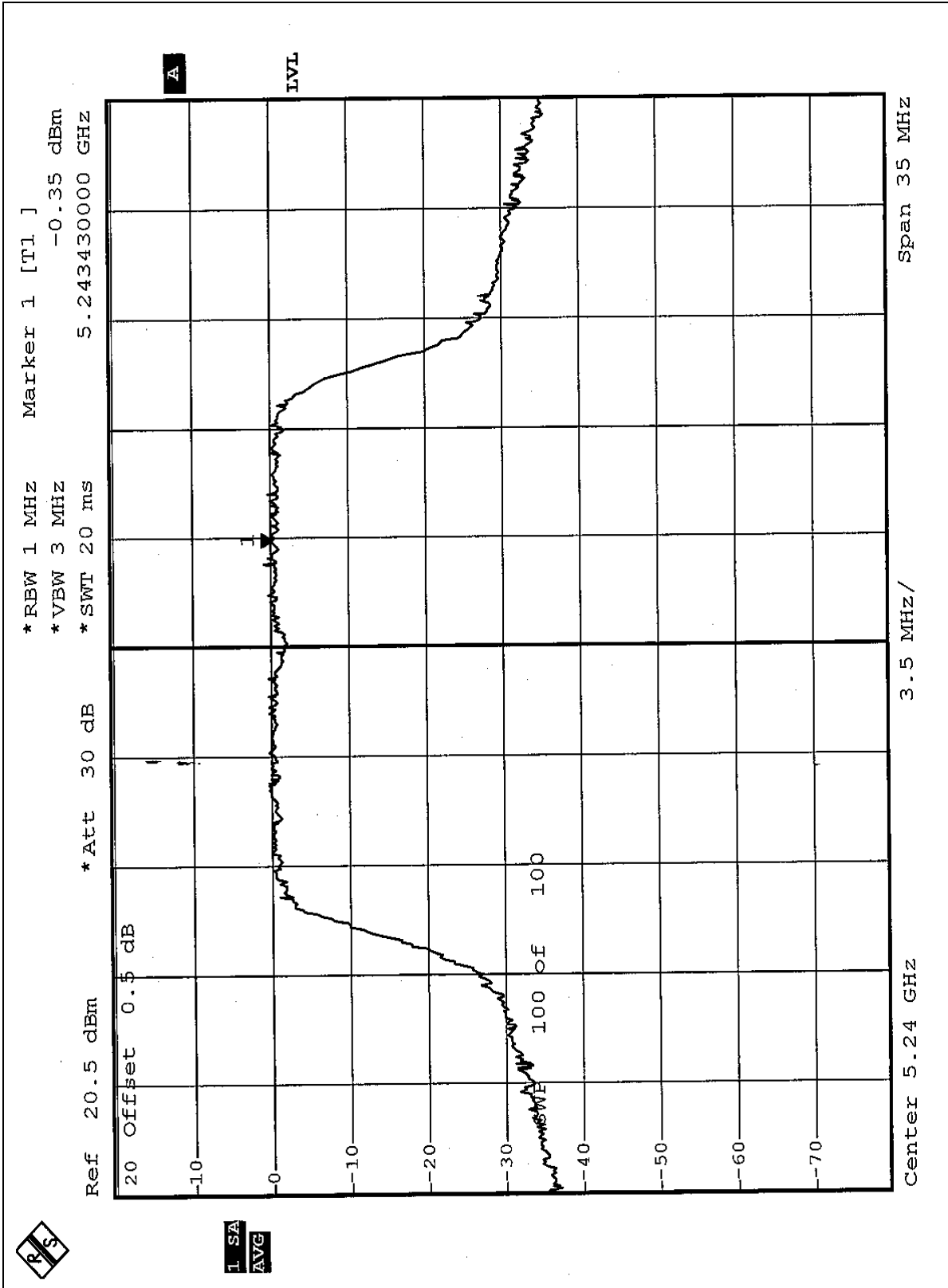



CH5

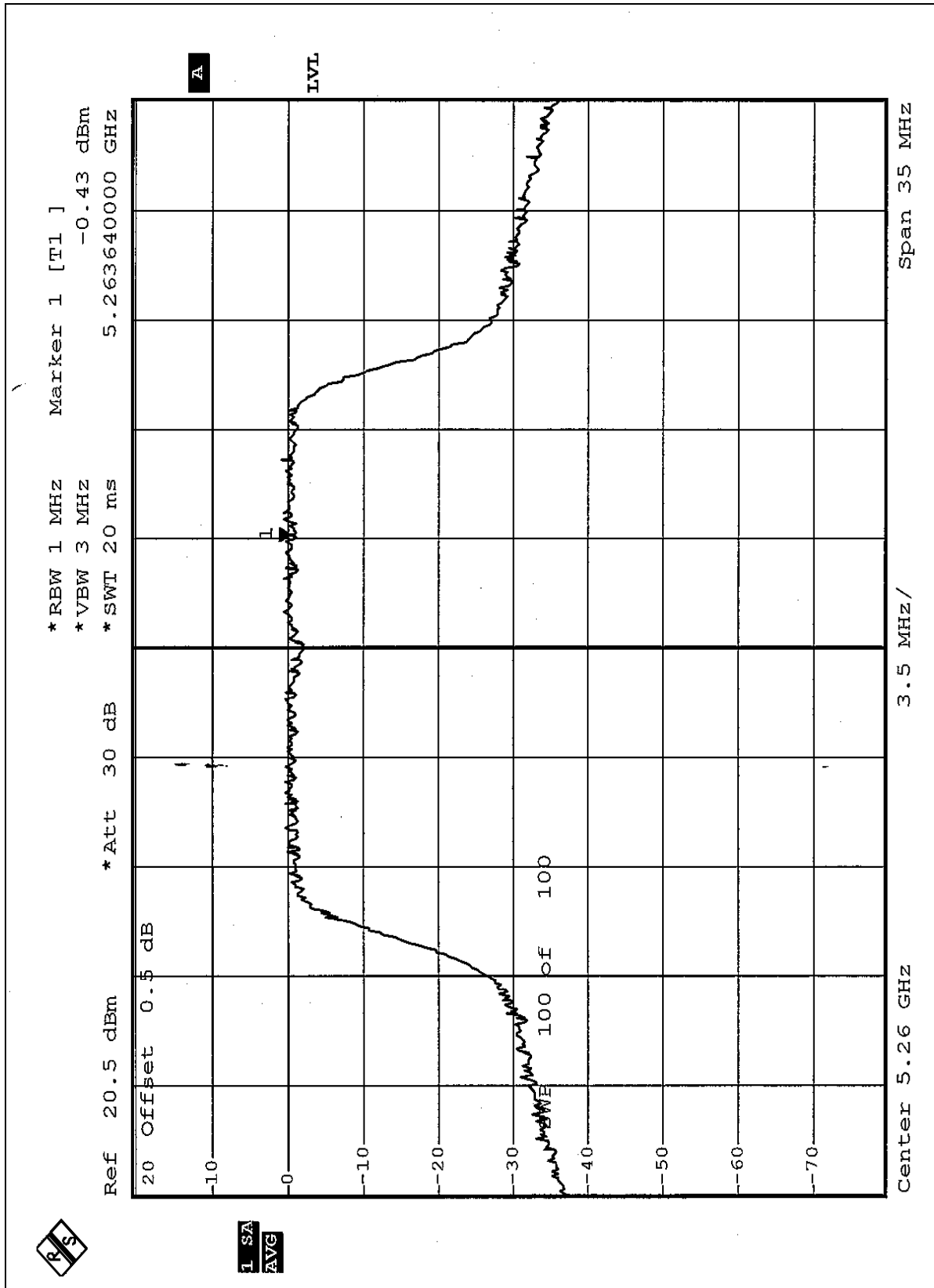



CH8

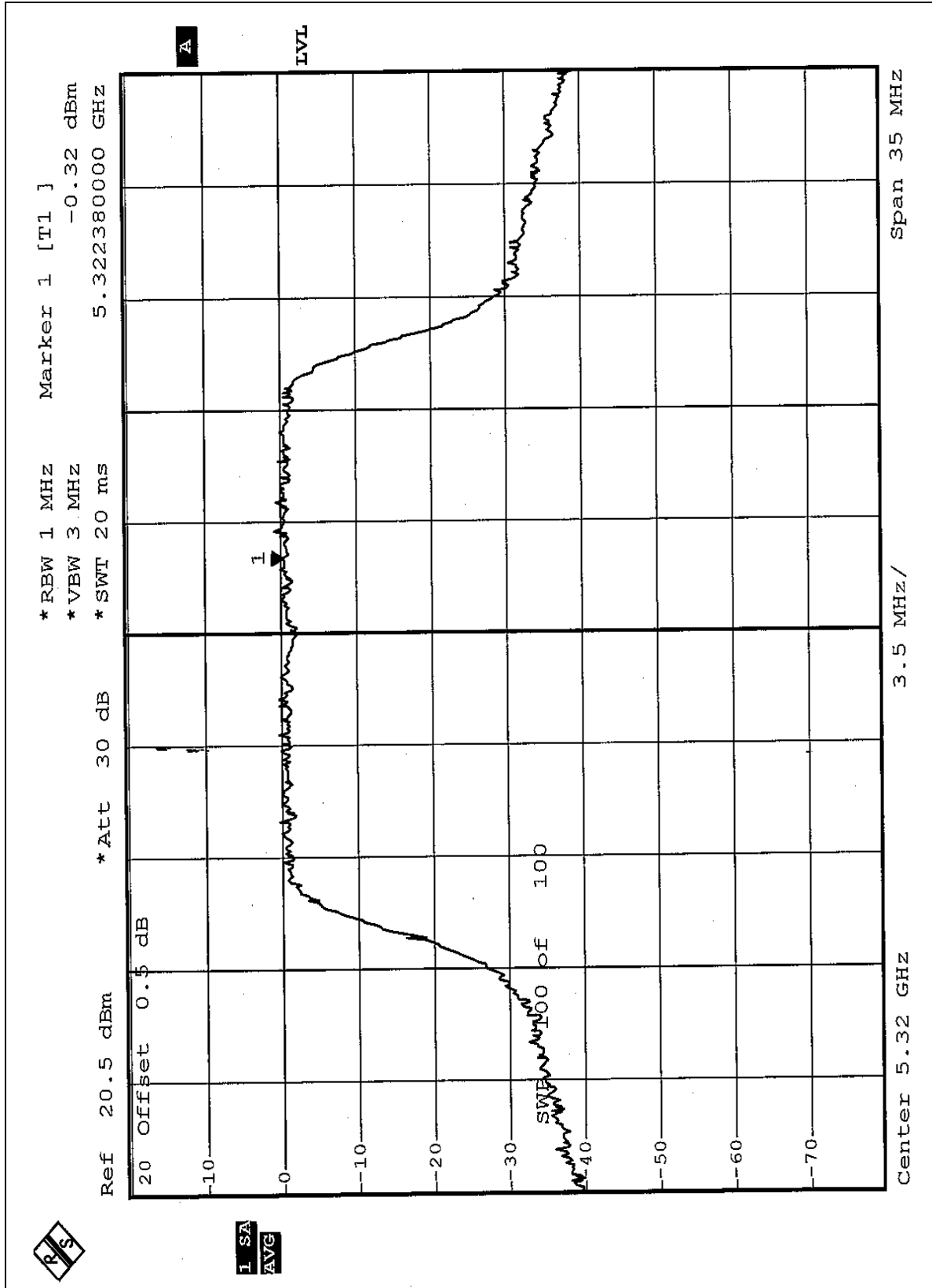



## 5.6 FREQUENCY STABILITY

### 5.6.1 LIMITS OF FREQUENCY STABILITY MEASUREMENT

The frequency tolerance of the carrier signal shall be maintained within +/- 0.02% of the operating frequency over a temperature variation of -30 degrees to 50 degrees C at normal supply voltage, and for a variation in the primary supply voltage from 85% to 115% of the rated supply voltage at a temperature of 20 degrees C.

### 5.6.2 TEST INSTRUMENTS

Description & Manufacturer	Model No.	Serial No.	Calibrated Until
ANRITSU SPECTRUM ANALYZER	MS2667C	M10281	Aug. 12, 2005
WIT STANDARD TEMPERATURE AND HUMIDITY CHAMBER	TH-4S-C	W901030	Aug. 12, 2005

**NOTE:** The calibration interval of the above test instruments is 12 months and the calibrations are traceable to NML/ROC and NIST/USA.

### 5.6.3 TEST PROCEDURE

1. The EUT was placed inside the environmental test chamber and powered by nominal DC voltage.
2. Turn the EUT on and couple its output to a spectrum analyzer.
3. Turn the EUT off and set the chamber to the highest temperature specified.
4. Allow sufficient time (approximately 30 min) for the temperature of the chamber to stabilize, turn the EUT on and measure the operating frequency after 2, 5, and 10 minutes.
5. Repeat step 2 and 3 with the temperature chamber set to the lowest temperature.
6. The test chamber was allowed to stabilize at +20 degree C for a minimum of 30 minutes. The supply voltage was then adjusted on the EUT from 85% to 115% and the frequency record.

### 5.6.4 DEVIATION FROM TEST STANDARD

No deviation

### 5.6.5 TEST SETUP

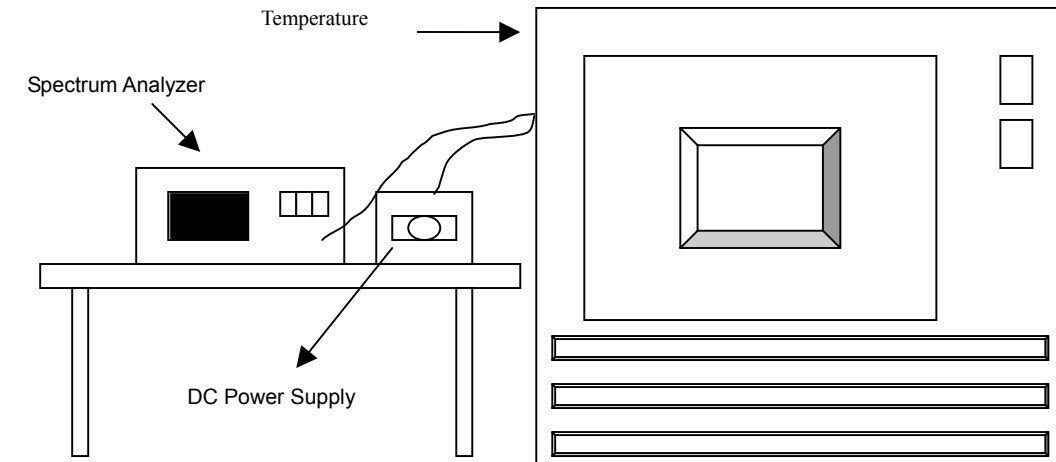

### 5.6.6 EUT OPERATING CONDITION

Same as Item 4.1.6



## 5.6.7 TEST RESULTS

		Operating frequency: 5320MHz				Limit : $\pm 0.01\%$	
Temp. (°C)	Power supply (Vac)	2 minute		5 minute		10 minute	
		(MHz)	(%)	(MHz)	(%)	(MHz)	(%)
50	102	5319.9907	-0.0001748	5319.9885	-0.0002162	5319.9989	-0.0000207
	120	5319.9976	-0.0000451	5319.9982	-0.0000338	5319.9989	-0.0000207
	138	5319.9998	-0.0000038	5319.9985	-0.0000282	5319.9998	-0.0000038
40	102	5319.9860	-0.0002632	5319.9863	-0.0002575	5319.9863	-0.0002575
	120	5319.9863	-0.0002575	5319.9863	-0.0002575	5319.9863	-0.0002575
	138	5319.9863	-0.0002575	5319.9860	-0.0002632	5319.9863	-0.0002575
30	102	5319.9810	-0.0003571	5319.9810	-0.0003571	5319.9810	-0.0003571
	120	5319.9810	-0.0003571	5319.9810	-0.0003571	5319.9810	-0.0003571
	138	5319.9810	-0.0003571	5319.9810	-0.0003571	5319.9810	-0.0003571
20	102	5319.9845	-0.0002914	5319.9826	-0.0003271	5319.9819	-0.0003402
	120	5319.9835	-0.0003102	5319.9826	-0.0003271	5319.9823	-0.0003327
	138	5319.9829	-0.0003214	5319.9823	-0.0003327	5319.9819	-0.0003402
10	102	5319.9835	-0.0003102	5319.9838	-0.0003045	5319.9841	-0.0002989
	120	5319.9835	-0.0003102	5319.9838	-0.0003045	5319.9841	-0.0002989
	138	5319.9835	-0.0003102	5319.9838	-0.0003045	5319.9841	-0.0002989
0	102	5319.9910	-0.0001692	5319.9920	-0.0001504	5319.9923	-0.0001447
	120	5319.9920	-0.0001504	5319.9920	-0.0001504	5319.9926	-0.0001391
	138	5319.9920	-0.0001504	5319.9923	-0.0001447	5319.9926	-0.0001391
-10	102	5320.0004	0.0000075	5320.0007	0.0000132	5320.0017	0.0000320
	120	5320.0007	0.0000132	5320.0014	0.0000263	5320.0020	0.0000376
	138	5320.0007	0.0000132	5320.0017	0.0000320	5320.0020	0.0000376
-20	102	5320.0079	0.0001485	5320.0079	0.0001485	5320.0076	0.0001429
	120	5320.0073	0.0001372	5320.0076	0.0001429	5320.0078	0.0001466
	138	5320.0073	0.0001372	5320.0079	0.0001485	5320.0080	0.0001504
-30	102	5320.0138	0.0002594	5320.0142	0.0002669	5320.0148	0.0002782
	120	5320.0129	0.0002425	5320.0145	0.0002726	5320.0151	0.0002838
	138	5320.0142	0.0002669	5320.0151	0.0002838	5320.0148	0.0002782



## 5.7 BAND EDGES MEASUREMENT

### 5.7.1 TEST INSTRUMENTS

Description & Manufacturer	Model No.	Serial No.	Calibrated Until
SPECTRUM ANALYZER	FSEK30	100049	Aug. 12, 2005

**NOTE:** The calibration interval of the above test instruments is 12 months and the calibrations are traceable to NML/ROC and NIST/USA.

### 5.7.2 TEST PROCEDURE

The transmitter output was connected to the spectrum analyzer via a low loss cable. Set both RBW and VBW of spectrum analyzer to 1MHz with suitable frequency span including 100 MHz bandwidth from band edge. The band edges was measured and recorded.

### 5.7.3 EUT OPERATING CONDITION

The software provided by client to enable the EUT under transmission condition continuously at specific channel frequencies individually.

### 5.7.4 TEST RESULTS

For signals in the restricted bands above and below the 5.15 to 5.35GHz allocated band a measurement was made of the amplitude of the spurious emissions with respect to the intentional signals. The relative amplitude, in dBc, was applied to the average and peak field strength of the intentional signal made on the OATS to calculate the field strength of the unintentional signals.

The spectrum plots (Peak RBW=VBW=1MHz; Average RBW=1MHz, VBW=10Hz) are attached on the following pages.



**Channel 1 (5180MHz)**

The band edge emission plot on the pages 114 ~ 116 shows 44.04dBc (Peak) / 53.34Bc (Average) between carrier maximum power and local maximum emission in restrict band. The emission of carrier strength list in the test result of channel 1 is 102.10dBuV/m, so the maximum field strength in restrict band is  $102.10-53.34=48.76$ dBuV/m which is under 54dBuV/m limit.

**Channel 8 (5320MHz)**

The band edge emission plot on the pages 117 ~ 119 shows 45.52dBc (Peak) / 54.75dBc (Average) between carrier maximum power and local maximum emission in restrict band. The emission of carrier strength list in the test result of channel 8 is 101.24BuV/m, so the maximum field strength in restrict band is  $101.24-54.75=46.49$ dBuV/m which is under 54dBuV/m limit.



Channel 1 (5180MHz)

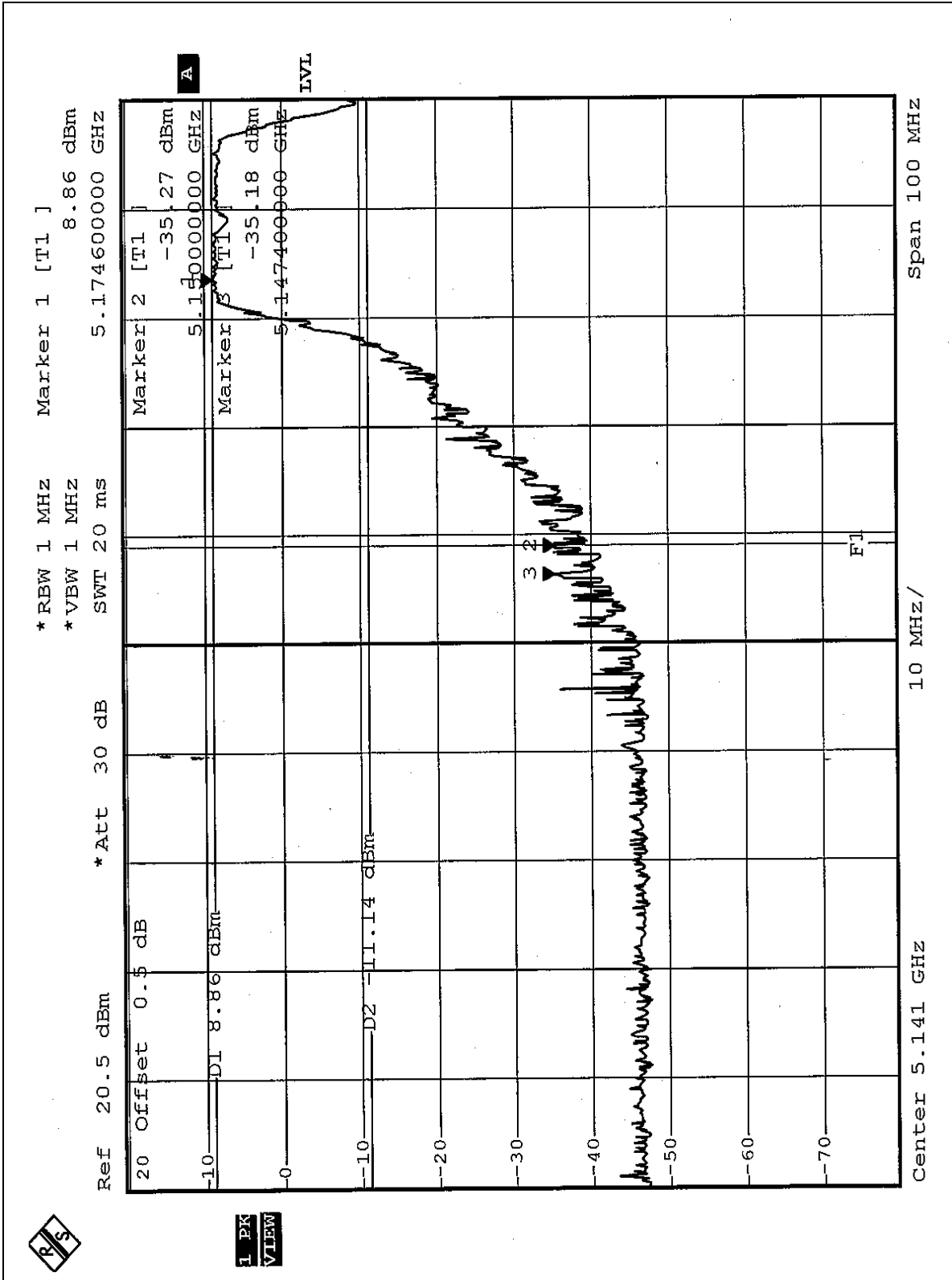

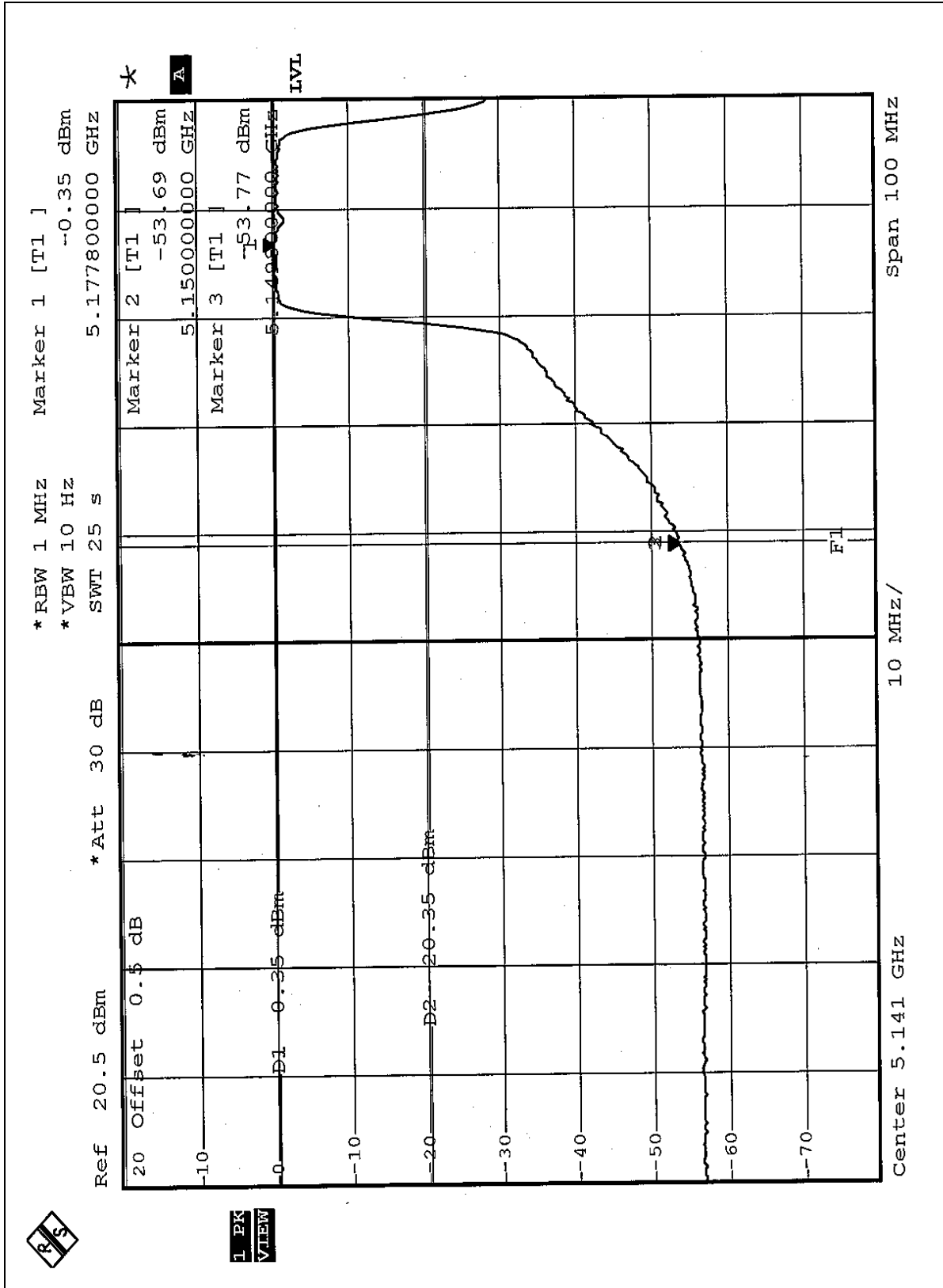

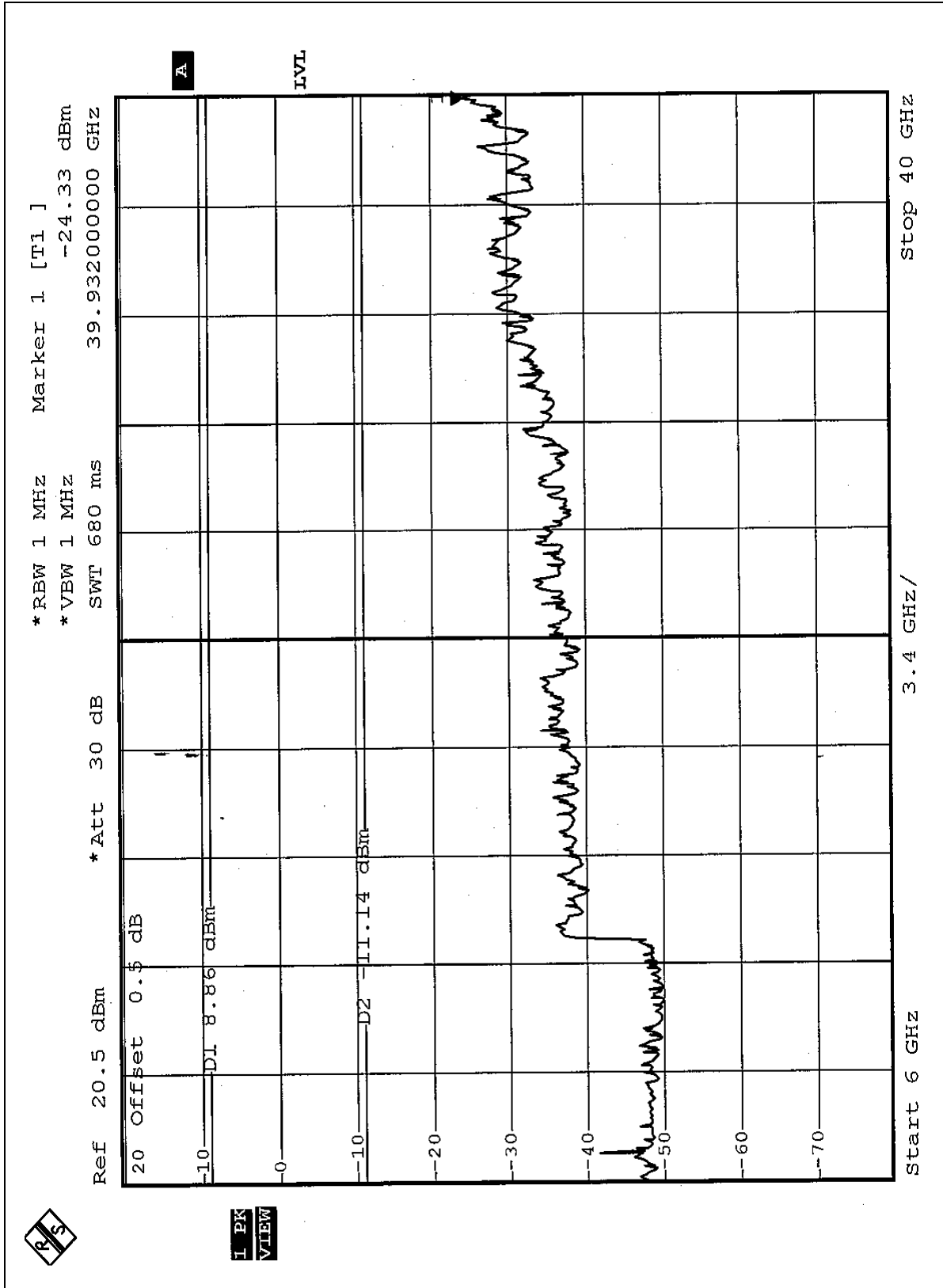



Channel 8 (5320MHz)

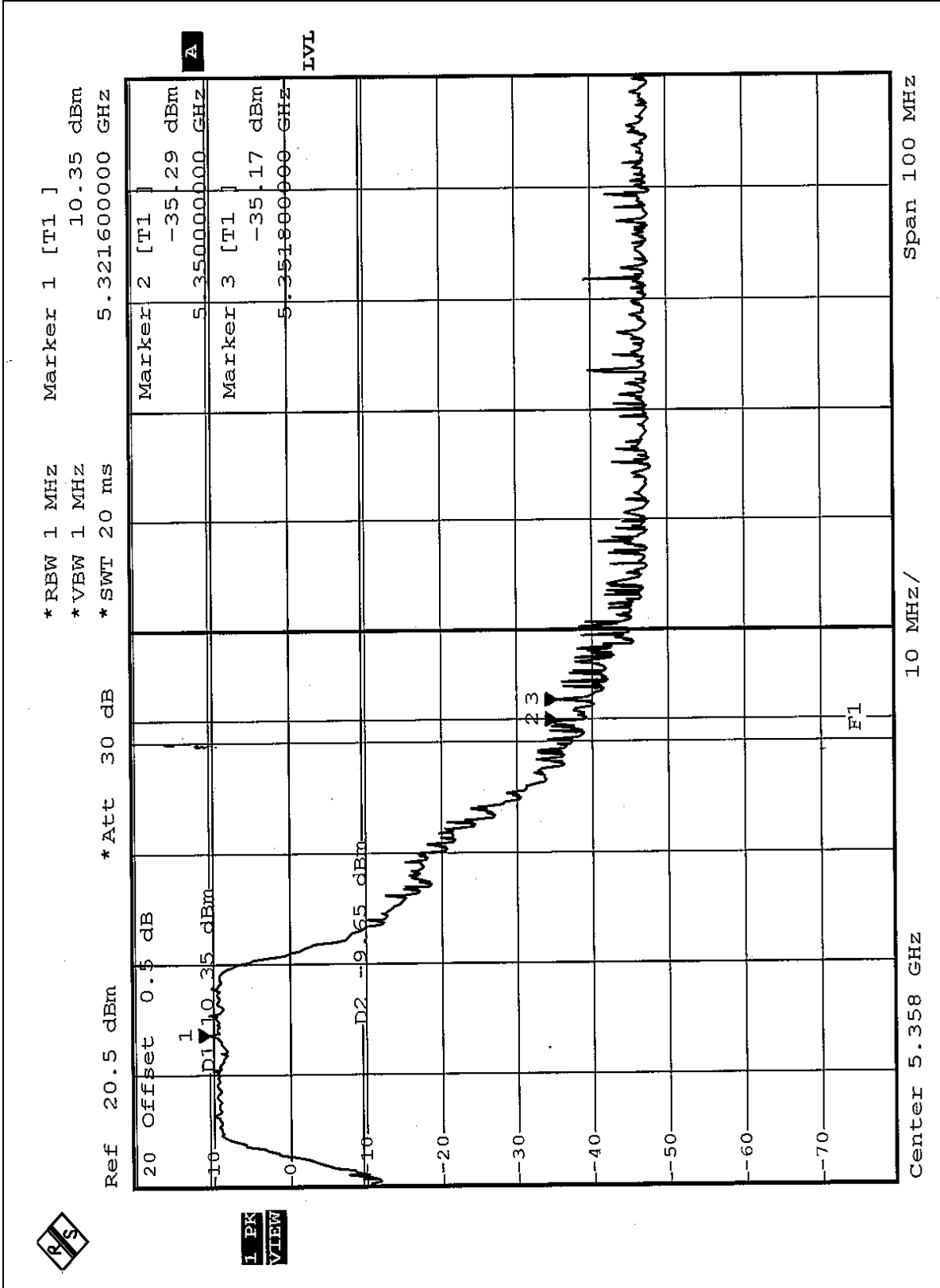

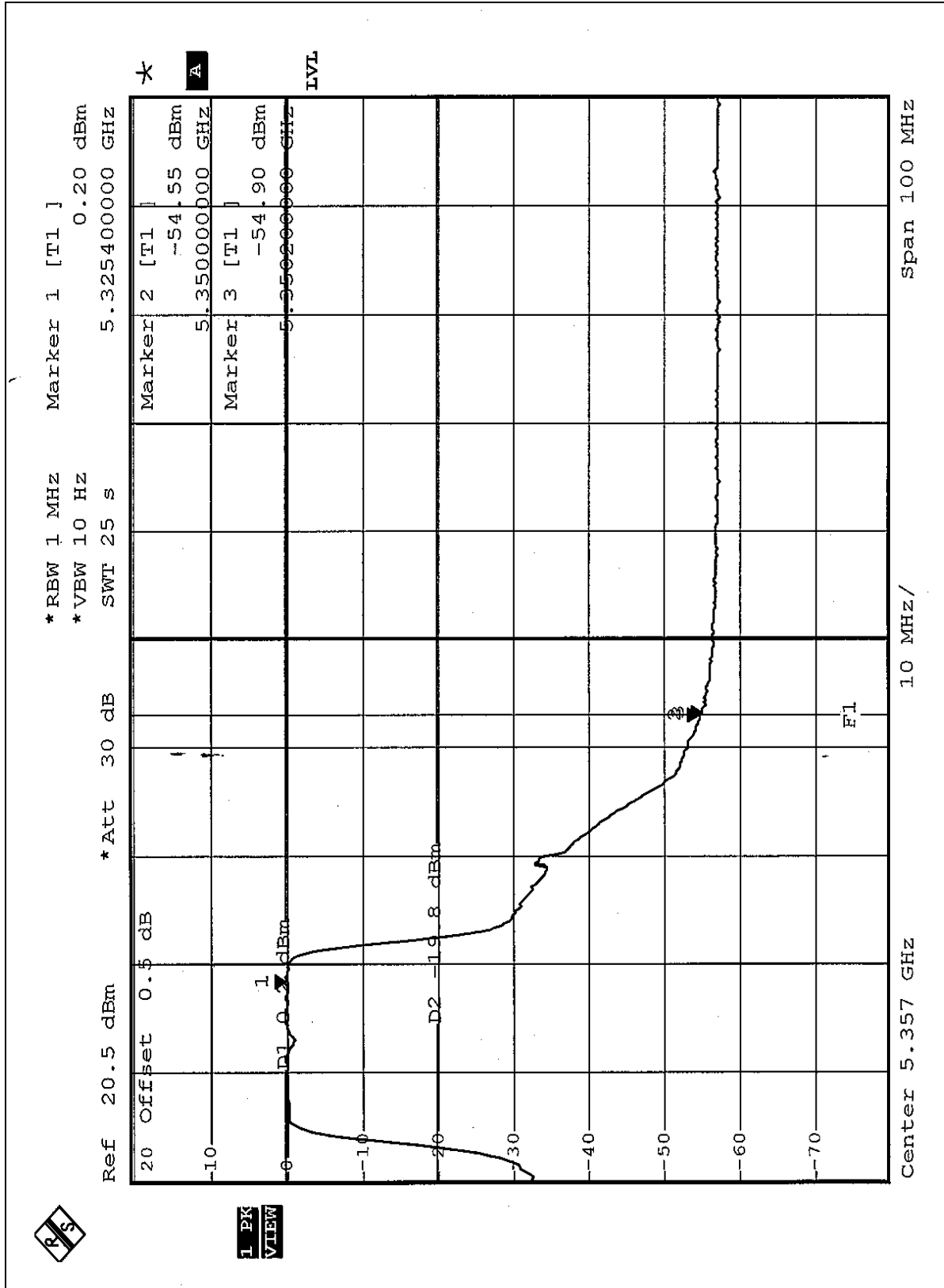

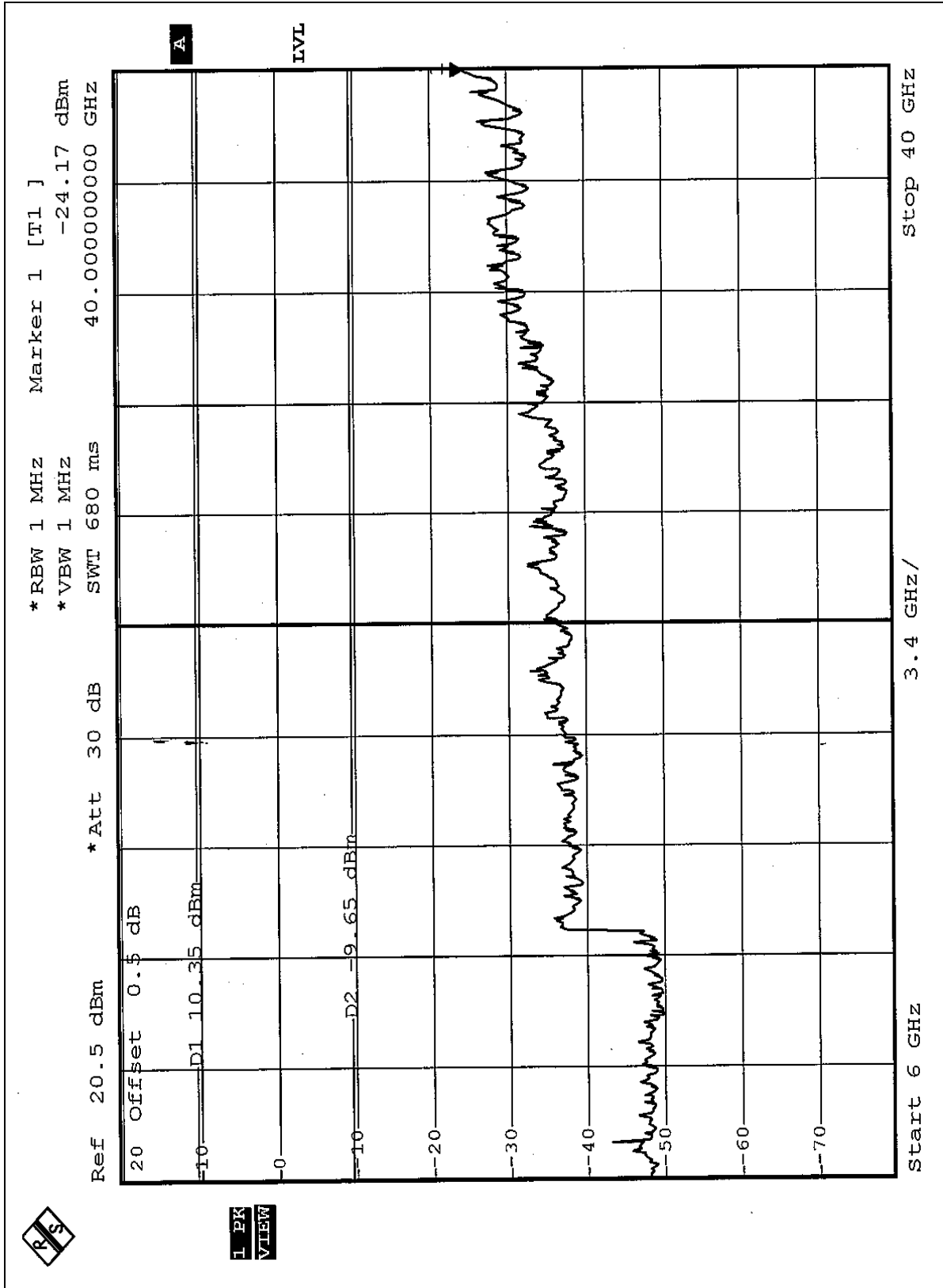



## **5.8 ANTENNA REQUIREMENT**

### **5.8.1 STANDARD APPLICABLE**

For intentional device, according to FCC 47 CFR Section 15.203, an intentional radiator shall be designed to ensure that no antenna other than that furnished by the responsible party shall be used with the device.

And according to FCC 47 CFR Section 15.407(a), if transmitting antennas of directional gain greater than 6dBi are used, the power shall be reduced by the amount in dB that the directional gain of the antenna exceeds 6dBi.

### **5.8.2 ANTENNA CONNECTED CONSTRUCTION**

The antenna used in this product is Printed antenna without antenna connector. The maximum Gain of the antenna is  $-1.0\text{dBi}$ .





## FOR FREQUENCY 5.725~5.850GHz

### 5.9 CONDUCTED EMISSION MEASUREMENT

#### 5.9.1 LIMITS OF CONDUCTED EMISSION MEASUREMENT

FREQUENCY OF EMISSION (MHz)	CONDUCTED LIMIT (dB $\mu$ V)	
	Quasi-peak	Average
0.15-0.5	66 to 56	56 to 46
0.5-5	56	46
5-30	60	50

- NOTE:**
1. The lower limit shall apply at the transition frequencies.
  2. The limit decreases in line with the logarithm of the frequency in the range of 0.15 to 0.50 MHz.
  3. All emanations from a class A/B digital device or system, including any network of conductors and apparatus connected thereto, shall not exceed the level of field strengths specified above.

#### 5.9.2 TEST INSTRUMENTS

DESCRIPTION & MANUFACTURER	MODEL NO.	SERIAL NO.	CALIBRATED UNTIL
Test Receiver ROHDE & SCHWARZ	ESCS30	100291	Nov. 16, 2005
RF signal cable Woken	5D-FB	Cable-HYC01-01	Mar. 02, 2005
LISN ROHDE & SCHWARZ	ESH3-Z5	100312	Mar. 03, 2005
LISN ROHDE & SCHWARZ	ESH2-Z5	100104	Mar. 02, 2005
Software ADT	ADT_Cond_V3	NA	NA

- NOTE:**
1. The calibration interval of the above test instruments is 12 months and the calibrations are traceable to NML/ROC and NIST/USA.
  2. The test was performed in HwaYa Shielded Room 1.
  3. The VCCI Site Registration No. is C-2040.



### 5.9.3 TEST PROCEDURES

- d. The EUT was placed 0.4 meters from the conducting wall of the shielded room with EUT being connected to the power mains through a line impedance stabilization network (LISN). Other support units were connected to the power mains through another LISN. The two LISNs provide 50 ohm/ 50uH of coupling impedance for the measuring instrument.
- e. Both lines of the power mains connected to the EUT were checked for maximum conducted interference.
- f. The frequency range from 150kHz to 30MHz was searched. Emission levels under ( Limit - 20dB) was not recorded.

### 5.9.4 DEVIATION FROM TEST STANDARD

No deviation

### 5.9.5 TEST SETUP

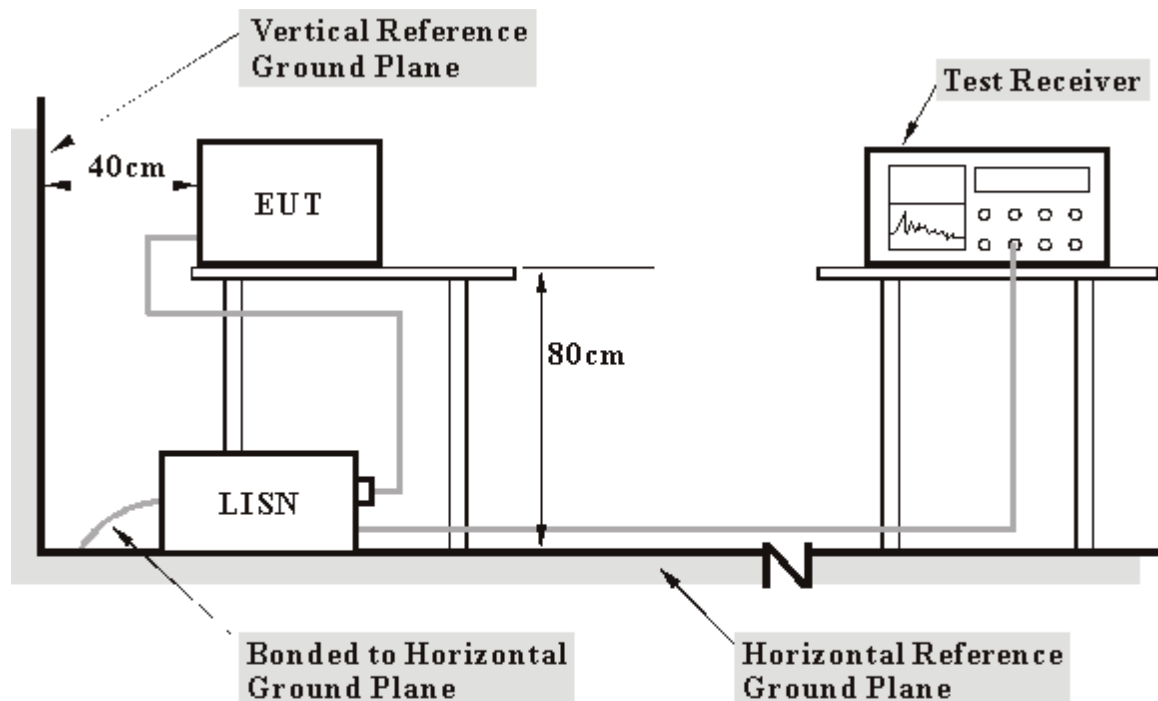

- Note:** 1. Support units were connected to second LISN.  
2. Both of LISNs (AMN) 80 cm from EUT and at the least 80 cm from other units and other metal planes support units.

For the actual test configuration, please refer to the related item – Photographs of the Test Configuration.

### 5.9.6 EUT OPERATING CONDITIONS

Same as 4.1.6



5.9.7 TEST RESULTS

<b>EUT</b>	Wireless A/G Portable USB Adapter	<b>MODEL</b>	WUSB54AGP
		<b>6dB BANDWIDTH</b>	9 kHz
<b>INPUT POWER (SYSTEM)</b>	120Vac, 60 Hz	<b>PHASE</b>	Line (L)
<b>ENVIRONMENTAL CONDITIONS</b>	24deg. C, 64%RH, 991hPa	<b>TESTED BY:</b> Leo Hung	

No	Freq. [MHz]	Corr. Factor (dB)	Reading Value [dB (uV)]		Emission Level [dB (uV)]		Limit [dB (uV)]		Margin (dB)	
			Q.P.	AV.	Q.P.	AV.	Q.P.	AV.	Q.P.	AV.
			1	0.173	0.11	40.67	-	40.78	-	64.79
2	0.220	0.12	42.58	-	42.70	-	62.81	52.81	-20.11	-
3	0.466	0.13	22.37	-	22.50	-	56.58	46.58	-34.08	-
4	1.613	0.16	31.50	-	31.66	-	56.00	46.00	-24.34	-
5	3.969	0.21	26.46	-	26.67	-	56.00	46.00	-29.33	-
6	10.086	0.31	35.46	-	35.77	-	60.00	50.00	-24.23	-

- REMARKS:**
1. Q.P. and AV. are abbreviations of quasi-peak and average individually.
  2. "-": The Quasi-peak reading value also meets average limit and measurement with the average detector is unnecessary.
  3. The emission levels of other frequencies were very low against the limit.
  4. Margin value = Emission level - Limit value
  5. Correction factor = Insertion loss + Cable loss
  6. Emission Level = Correction Factor + Reading Value.

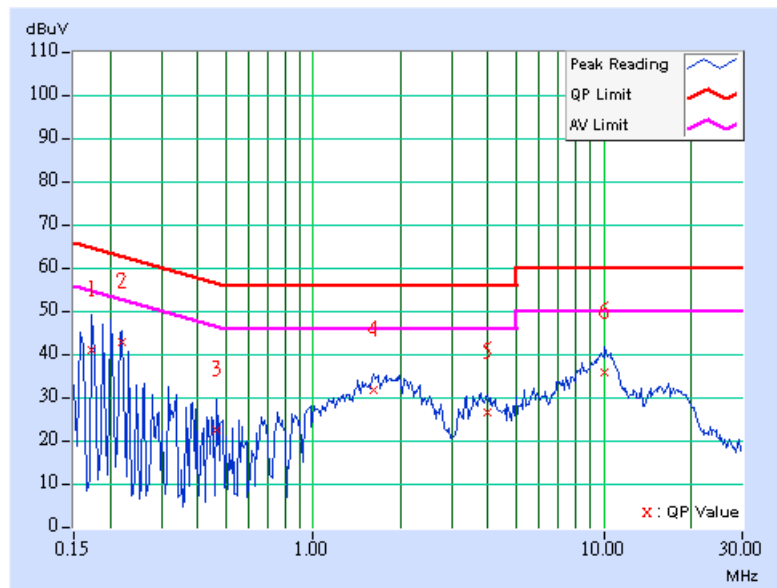



<b>EUT</b>	Wireless A/G Portable USB Adapter	<b>MODEL</b>	WUSB54AGP
		<b>6dB BANDWIDTH</b>	9 kHz
<b>INPUT POWER (SYSTEM)</b>	120Vac, 60 Hz	<b>PHASE</b>	Neutral (N)
<b>ENVIRONMENTAL CONDITIONS</b>	24deg. C, 64%RH, 991hPa	<b>TESTED BY:</b> Leo Hung	

No	Freq. [MHz]	Corr. Factor (dB)	Reading Value [dB (uV)]		Emission Level [dB (uV)]		Limit [dB (uV)]		Margin (dB)	
			Q.P.	AV.	Q.P.	AV.	Q.P.	AV.	Q.P.	AV.
			1	0.166	0.10	41.88	-	41.98	-	65.18
2	<b>0.193</b>	<b>0.11</b>	<b>45.94</b>	-	<b>46.05</b>	-	<b>63.91</b>	<b>53.91</b>	<b>-17.86</b>	-
3	0.373	0.12	26.54	-	26.66	-	58.44	48.44	-31.79	-
4	1.875	0.16	30.85	-	31.01	-	56.00	46.00	-24.99	-
5	3.797	0.20	24.67	-	24.87	-	56.00	46.00	-31.13	-
6	10.410	0.31	35.37	-	35.68	-	60.00	50.00	-24.32	-

- REMARKS:**
1. Q.P. and AV. are abbreviations of quasi-peak and average individually.
  2. "-": The Quasi-peak reading value also meets average limit and measurement with the average detector is unnecessary.
  3. The emission levels of other frequencies were very low against the limit.
  4. Margin value = Emission level - Limit value
  5. Correction factor = Insertion loss + Cable loss
  6. Emission Level = Correction Factor + Reading Value.

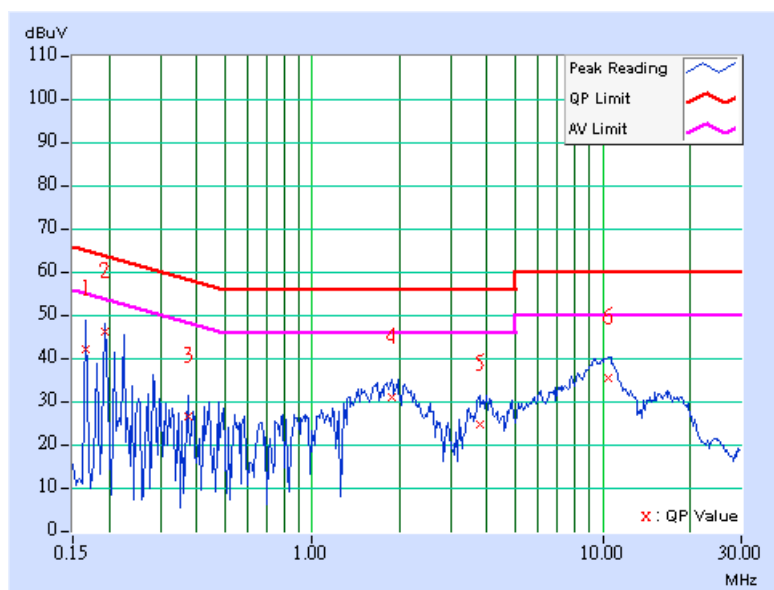



## 5.10 RADIATED EMISSION MEASUREMENT

### 5.10.1 LIMITS OF RADIATED EMISSION MEASUREMENT

Emissions radiated outside of the specified bands, shall be according to the general radiated limits in 15.209 as following:

Frequencies (MHz)	Field strength (microvolts/meter)	Measurement distance (meters)
0.009-0.490	2400/F(kHz)	300
0.490-1.705	24000/F(kHz)	30
1.705-30.0	30	30
30-88	100	3
88-216	150	3
216-960	200	3
Above 960	500	3

**NOTE:**

1. The lower limit shall apply at the transition frequencies.
2. Emission level (dBuV/m) = 20 log Emission level (uV/m).
3. As shown in 15.35(b), for frequencies above 1000MHz, the field strength limits are based on average detector, however, the peak field strength of any emission shall not exceed the maximum permitted average limits, specified above by more than 20dB under any condition of modulation.



## 5.10.2 TEST INSTRUMENTS

DESCRIPTION & MANUFACTURER	MODEL NO.	SERIAL NO.	CALIBRATED UNTIL
Test Receiver ROHDE & SCHWARZ	ESIB7	100186	Dec. 12, 2005
Test Receiver ROHDE & SCHWARZ	ESIB7	100187	Dec. 06, 2005
BILOG Antenna SCHWARZBECK	VULB9168	9168-148	Feb. 03, 2005
BILOG Antenna SCHWARZBECK	VULB9168	9168-149	Feb. 03, 2005
Preamplifier Agilent	8447D	2944A10636	Dec. 06, 2005
Preamplifier Agilent	8447D	2944A10637	Dec. 06, 2005
RF signal cable Woken	8D-FB	Cable-Hych1-01	Feb. 16, 2005
RF signal cable Woken	8D-FB	Cable-Hych1-02	Feb. 16, 2005
Software ADT	ADT_Radiated_V7	NA	NA
Antenna Tower HD Deisel GmbH	MA240	11030	NA
Antenna Tower HD Deisel GmbH	MA240	12030	NA
Turn Table HD Deisel GmbH	DS430	50303	NA
Controller HD Deisel GmbH	HD2000	18303	NA

**NOTE:** 1. The calibration interval of the above test instruments is 12 months and the calibrations are traceable to NML/ROC and NIST/USA.

2. The test was performed in HwaYa Chamber 1.

3. The VCCI Site Registration No. is R-1893.

4. The IC Site Registration No. is IC4924-1.



### 5.10.3 TEST PROCEDURES

- g. The EUT was placed on the top of a rotating table 0.8 meters above the ground at a 3 meter semi-anechoic chamber. The table was rotated 360 degrees to determine the position of the highest radiation.
- h. The EUT was set 3 meters away from the interference-receiving antenna, which was mounted on the top of a variable-height antenna tower.
- i. The antenna is a broadband antenna, and its height is varied from one meter to four meters above the ground to determine the maximum value of the field strength. Both horizontal and vertical polarizations of the antenna are set to make the measurement.
- j. For each suspected emission, the EUT was arranged to its worst case and then the antenna was tuned to heights from 1 meter to 4 meters and the rotatable table was turned from 0 degrees to 360 degrees to find the maximum reading.
- k. The test-receiver system was set to Peak Detect Function and Specified Bandwidth with Maximum Hold Mode.
- l. If the emission level of the EUT in peak mode was 10dB lower than the limit specified, then testing could be stopped and the peak values of the EUT would be reported. Otherwise the emissions that did not have 10dB margin would be re-tested one by one using peak, quasi-peak or average method as specified and then reported in a data sheet.

**NOTE:**

4. The resolution bandwidth and video bandwidth of test receiver/spectrum analyzer is 120kHz for Peak detection (PK) and Quasi-peak detection (QP) at frequency below 1GHz.
5. The resolution bandwidth and video bandwidth of test receiver/spectrum analyzer is 1 MHz for Peak detection at frequency above 1GHz.
6. The resolution bandwidth of test receiver/spectrum analyzer is 1 MHz and the video bandwidth is 10 Hz for Average detection (AV) at frequency above 1GHz.



### 5.10.4 DEVIATION FROM TEST STANDARD

No deviation

### 5.10.5 TEST SETUP

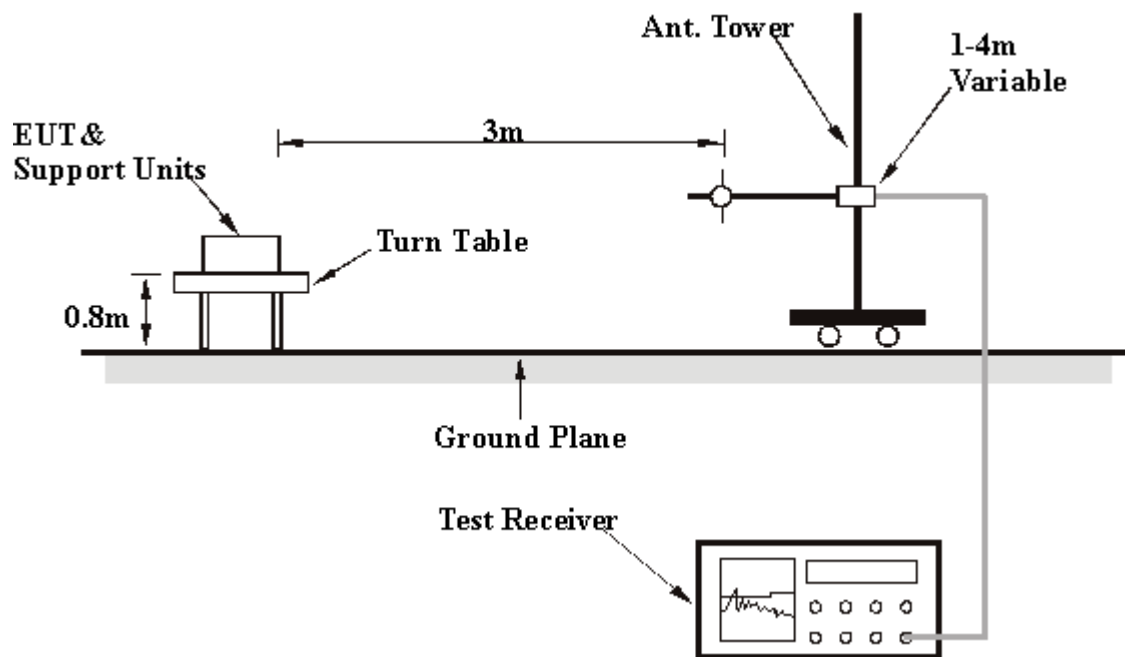

For the actual test configuration, please refer to the related item – Photographs of the Test Configuration.



## 5.10.6 EUT OPERATING CONDITIONS

Same as 4.1.6



## 5.10.7 TEST RESULTS

<b>EUT</b>	Wireless A/G Portable USB Adapter	<b>MODEL</b>	WUSB54AGP
<b>CHANNEL</b>	Channel 11	<b>FREQUENCY RANGE</b>	Below 1000MHz
<b>INPUT POWER (SYSTEM)</b>	120Vac, 60 Hz	<b>DETECTOR FUNCTION</b>	Quasi-Peak
<b>ENVIRONMENTAL CONDITIONS</b>	25deg. C, 63%RH, 991hPa	<b>TESTED BY:</b> Match Tsui	

**ANTENNA POLARITY & TEST DISTANCE: HORIZONTAL AT 3 M**

No.	Freq. (MHz)	Emission Level (dBuV/m)	Limit (dBuV/m)	Margin (dB)	Antenna Height (m)	Table Angle (Degree)	Raw Value (dBuV)	Correction Factor (dB/m)
1	118.20	33.48 QP	43.50	-10.02	1.50 H	100	7.40	26.08
2	165.10	31.29 QP	43.50	-12.21	1.50 H	300	5.21	26.08
3	240.13	35.36 QP	46.00	-10.64	1.50 H	120	9.28	26.08
4	319.89	35.89 QP	46.00	-10.11	1.00 H	129	9.81	26.08
5	384.09	35.26 QP	46.00	-10.74	1.00 H	298	9.18	26.08
6	440.00	38.14 QP	46.00	-7.86	1.25 H	78	12.06	26.08
7	520.03	38.61 QP	46.00	-7.39	1.25 H	183	12.53	26.08
8	580.10	35.64 QP	46.00	-10.36	1.50 H	78	9.56	26.08
9	640.21	38.11 QP	46.00	-7.89	1.75 H	200	12.03	26.08
10	719.69	41.11 QP	46.00	-4.89	2.00 H	260	15.03	26.08
11	759.69	35.01 QP	46.00	-10.99	1.75 H	160	8.93	26.08
12	840.11	37.11 QP	46.00	-8.89	2.00 H	147	10.96	26.15
13	919.81	36.59 QP	46.00	-9.41	1.50 H	200	10.31	26.28

- REMARKS:**
1. Emission level(dBuV/m)=Raw Value(dBuV) + Correction Factor(dB)
  2. Correction Factor(dB/m) = Antenna Factor (dB/m) + Cable Factor (dB)
  3. The other emission levels were very low against the limit.
  4. Margin value = Emission level – Limit value.



<b>EUT</b>	Wireless A/G Portable USB Adapter	<b>MODEL</b>	WUSB54AGP
<b>CHANNEL</b>	Channel 11	<b>FREQUENCY RANGE</b>	Below 1000MHz
<b>INPUT POWER (SYSTEM)</b>	120Vac, 60 Hz	<b>DETECTOR FUNCTION</b>	Quasi-Peak
<b>ENVIRONMENTAL CONDITIONS</b>	25deg. C, 63%RH, 991hPa	<b>TESTED BY:</b> Match Tsui	

#### ANTENNA POLARITY & TEST DISTANCE: VERTICAL AT 3 M

No.	Freq. (MHz)	Emission Level (dBuV/m)	Limit (dBuV/m)	Margin (dB)	Antenna Height (m)	Table Angle (Degree)	Raw Value (dBuV)	Correction Factor (dB/m)
1	64.26	28.06 QP	40.00	-11.94	1.00 V	360	1.98	26.08
2	128.14	33.26 QP	43.50	-10.24	1.00 V	350	7.18	26.08
3	169.80	34.52 QP	43.50	-8.98	1.25 V	120	8.44	26.08
4	369.90	27.19 QP	46.00	-18.81	1.50 V	180	1.11	26.08
5	400.10	28.70 QP	46.00	-17.30	1.75 V	350	2.62	26.08
6	520.03	31.59 QP	46.00	-14.41	2.00 V	146	5.51	26.08
7	600.11	32.43 QP	46.00	-13.57	1.25 V	256	6.35	26.08
8	640.20	33.57 QP	46.00	-12.43	1.00 V	130	7.49	26.08
9	719.68	34.22 QP	46.00	-11.78	1.25 V	140	8.14	26.08
10	800.10	35.90 QP	46.00	-10.10	2.00 V	253	9.82	26.08
11	920.14	32.74 QP	46.00	-13.26	1.00 V	133	6.46	26.28

- REMARKS:**
1. Emission level(dBuV/m)=Raw Value(dBuV) + Correction Factor(dB)
  2. Correction Factor(dB/m) = Antenna Factor (dB/m) + Cable Factor (dB)
  3. The other emission levels were very low against the limit.
  4. Margin value = Emission level – Limit value.



<b>EUT</b>	Wireless A/G Portable USB Adapter	<b>MODEL</b>	WUSB54AGP
<b>CHANNEL</b>	9	<b>FREQUENCY RANGE</b>	1 ~ 40 GHz
<b>INPUT POWER (SYSTEM)</b>	120Vac, 60Hz	<b>DETECTOR FUNCTION</b>	Peak(PK) Average (AV)
<b>ENVIRONMENTAL CONDITIONS</b>	24deg. C, 64%RH, 991hPa	<b>TESTED BY</b>	Leo Hung

#### ANTENNA POLARITY & TEST DISTANCE: HORIZONTAL AT 3 M

No.	Freq. (MHz)	Emission Level (dBuV/m)	Limit (dBuV/m)	Margin (dB)	Antenna Height (m)	Table Angle (Degree)	Raw Value (dBuV)	Correction Factor (dB/m)
1	#3830.00	51.57 PK	74.00	-22.43	1.00 H	81	15.23	36.34
1	#3830.00	43.69 AV	54.00	-10.31	1.00 H	81	7.35	36.34
2	*5745.00	111.44 PK			1.29 H	30	70.54	40.90
2	*5745.00	100.81 AV			1.29 H	30	59.91	40.90
3	#11490.00	62.46 PK	74.00	-11.54	1.27 H	250	15.08	47.38
3	#11490.00	49.92 AV	54.00	-4.08	1.27 H	250	2.54	47.38
4	17235.00	69.17 PK	91.44	-22.27	1.30 H	29	16.85	52.32
4	17235.00	54.50 AV	80.81	-26.31	1.30 H	29	2.18	52.32

#### ANTENNA POLARITY & TEST DISTANCE: VERTICAL AT 3 M

No.	Freq. (MHz)	Emission Level (dBuV/m)	Limit (dBuV/m)	Margin (dB)	Antenna Height (m)	Table Angle (Degree)	Raw Value (dBuV)	Correction Factor (dB/m)
1	#3830.00	50.92 PK	74.00	-23.08	1.05 V	85	14.58	36.34
1	#3830.00	44.12AV	54.00	-9.88	1.05 V	85	7.78	36.34
2	*5745.00	107.80 PK			1.32 V	350	66.90	40.90
2	*5745.00	98.70 AV			1.32 V	350	57.80	40.90
3	#11490.00	58.74 PK	74.00	-15.26	1.10 V	260	11.36	47.38
3	#11490.00	46.58 AV	54.00	-7.42	1.10 V	260	-0.80	47.38
4	17235.00	67.28 PK	87.80	-20.52	1.26 V	71	14.96	52.32
4	17235.00	54.26 AV	78.70	-24.44	1.26 V	71	1.94	52.32

#### NOTE:

1. Emission level(dBuV/m)=Raw Value(dBuV) + Correction Factor(dB).
2. Correction Factor(dB/m) = Antenna Factor (dB/m) + Cable Factor (dB).
3. The other emission levels were very low against the limit.
4. Margin value = Emission level – Limit value.
5. “ \* ” : Fundamental frequency.
6. “#”The radiated frequency falling in the restricted band.
7. The limit value is defined as per 15.247



<b>EUT</b>	Wireless A/G Portable USB Adapter	<b>MODEL</b>	WUSB54AGP
<b>CHANNEL</b>	11	<b>FREQUENCY RANGE</b>	1 ~ 40 GHz
<b>INPUT POWER (SYSTEM)</b>	120Vac, 60Hz	<b>DETECTOR FUNCTION</b>	Peak(PK) Average (AV)
<b>ENVIRONMENTAL CONDITIONS</b>	24deg. C, 64%RH, 991hPa	<b>TESTED BY</b>	Leo Hung

#### ANTENNA POLARITY & TEST DISTANCE: HORIZONTAL AT 3 M

No.	Freq. (MHz)	Emission Level (dBuV/m)	Limit (dBuV/m)	Margin (dB)	Antenna Height (m)	Table Angle (Degree)	Raw Value (dBuV)	Correction Factor (dB/m)
1	#3856.00	50.31 PK	74.00	-23.69	1.00 H	81	13.88	36.43
1	#3856.00	43.33 AV	54.00	-10.67	1.00 H	81	6.90	36.43
2	*5785.00	109.42 PK			1.19 H	144	68.37	41.05
2	*5785.00	99.49 AV			1.19 H	144	58.44	41.05
3	#11570.00	64.47 PK	74.00	-9.53	1.39 H	46	17.00	47.47
3	#11570.00	51.82 AV	54.00	-2.18	1.39 H	46	4.35	47.47
4	17355.00	67.57 PK	89.42	-21.95	1.42 H	249	14.47	53.10
4	17355.00	54.88 AV	79.49	-24.61	1.42 H	249	1.78	53.10

#### ANTENNA POLARITY & TEST DISTANCE: VERTICAL AT 3 M

No.	Freq. (MHz)	Emission Level (dBuV/m)	Limit (dBuV/m)	Margin (dB)	Antenna Height (m)	Table Angle (Degree)	Raw Value (dBuV)	Correction Factor (dB/m)
1	#3856.00	50.94 PK	74.00	-23.06	1.05 V	82	14.51	36.43
1	#3856.00	44.12 AV	54.00	-9.88	1.05 V	82	7.69	36.43
2	*5785.00	105.54 PK			1.23 V	353	64.49	41.05
2	*5785.00	96.24 AV			1.23 V	353	55.19	41.05
3	#11570.00	62.64 PK	74.00	-11.36	1.38 V	156	15.17	47.47
3	#11570.00	49.73 AV	54.00	-4.27	1.38 V	156	2.26	47.47
4	17355.00	65.73 PK	85.54	-19.81	1.38 V	252	12.63	53.10
4	17355.00	53.67 AV	76.24	-22.57	1.38 V	252	0.57	53.10

#### NOTE:

1. Emission level(dBuV/m)=Raw Value(dBuV) + Correction Factor(dB).
2. Correction Factor(dB/m) = Antenna Factor (dB/m) + Cable Factor (dB).
3. The other emission levels were very low against the limit.
4. Margin value = Emission level – Limit value.
5. “ \* “ : Fundamental frequency.
6. “#” The radiated frequency falling in the restricted band.
7. The limit value is defined as per 15.247



<b>EUT</b>	Wireless A/G Portable USB Adapter	<b>MODEL</b>	WUSB54AGP
<b>CHANNEL</b>	13	<b>FREQUENCY RANGE</b>	1 ~ 40 GHz
<b>INPUT POWER (SYSTEM)</b>	120Vac, 60Hz	<b>DETECTOR FUNCTION</b>	Peak(PK) Average (AV)
<b>ENVIRONMENTAL CONDITIONS</b>	24deg. C, 64%RH, 991hPa	<b>TESTED BY</b>	Leo Hung

### ANTENNA POLARITY & TEST DISTANCE: HORIZONTAL AT 3 M

No.	Freq. (MHz)	Emission Level (dBuV/m)	Limit (dBuV/m)	Margin (dB)	Antenna Height (m)	Table Angle (Degree)	Raw Value (dBuV)	Correction Factor (dB/m)
1	#3883.00	52.16 PK	74.00	-21.84	1.13 H	136	15.64	36.52
1	#3883.00	45.62 AV	54.00	-8.38	1.13 H	136	9.10	36.52
2	*5825.00	108.29 PK			1.04 H	137	67.34	40.95
2	*5825.00	98.49 AV			1.04 H	137	57.54	40.95
3	#11650.00	65.60 PK	74.00	-8.40	1.26 H	44	17.88	47.72
<b>3</b>	<b>#11650.00</b>	<b>52.89 AV</b>	<b>54.00</b>	<b>-1.11</b>	<b>1.26 H</b>	<b>44</b>	<b>5.17</b>	<b>47.72</b>
4	17475.00	69.03 PK	88.29	-19.26	1.23 H	192	15.63	53.40
4	17475.00	56.13 AV	78.49	-22.36	1.23 H	192	2.73	53.40

### ANTENNA POLARITY & TEST DISTANCE: VERTICAL AT 3 M

No.	Freq. (MHz)	Emission Level (dBuV/m)	Limit (dBuV/m)	Margin (dB)	Antenna Height (m)	Table Angle (Degree)	Raw Value (dBuV)	Correction Factor (dB/m)
1	#3883.00	45.30 PK	74.00	-28.70	1.10 V	293	8.78	36.52
1	#3883.00	42.67 AV	54.00	-11.33	1.10 V	293	6.15	36.52
2	*5825.00	105.12 PK	74.00	31.12	1.01 V	307	64.17	40.95
2	*5825.00	96.01 AV	54.00	42.01	1.01 V	307	55.06	40.95
3	#11650.00	60.76 PK	74.00	-13.24	1.11 V	47	13.04	47.72
3	#11650.00	48.49 AV	54.00	-5.51	1.11 V	47	0.77	47.72
4	17475.00	66.04 PK	85.12	-19.08	1.01 V	264	12.65	53.40
4	17475.00	53.86 AV	76.01	-22.15	1.01 V	264	0.47	53.40

#### NOTE:

1. Emission level(dBuV/m)=Raw Value(dBuV) + Correction Factor(dB).
2. Correction Factor(dB/m) = Antenna Factor (dB/m) + Cable Factor (dB).
3. The other emission levels were very low against the limit.
4. Margin value = Emission level – Limit value.
5. “ \* “ : Fundamental frequency.
6. “#” The radiated frequency falling in the restricted band.
7. The limit value is defined as per 15.247



## 5.11 6dB BANDWIDTH MEASUREMENT

### 5.11.1 LIMITS OF 6dB BANDWIDTH MEASUREMENT

The minimum of 6dB Bandwidth Measurement is 0.5 MHz.

### 5.11.2 TEST INSTRUMENTS

Description & Manufacturer	Model No.	Serial No.	Calibrated Until
R&S SPECTRUM ANALYZER	FSEK30	100049	Aug. 12, 2005

**NOTES:** The calibration interval of the above test instruments is 12 months and the calibrations are traceable to NML/ROC and NIST/USA.



### 5.11.3 TEST PROCEDURE

The transmitter output was connected to the spectrum analyzer through an attenuator. The bandwidth of the fundamental frequency was measured by spectrum analyzer with 100kHz RBW and 100kHz VBW. The 6dB bandwidth is defined as the total spectrum the power of which is higher than peak power minus 6dB.

### 5.11.4 DEVIATION FROM TEST STANDARD

No deviation

### 5.11.5 TEST SETUP

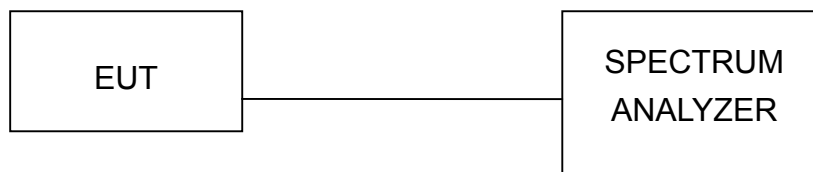

### 5.11.6 EUT OPERATING CONDITIONS

The software provided by client to enable the EUT under transmission condition continuously at lowest, middle and highest channel frequencies individually.



5.11.7 TEST RESULTS

<b>EUT</b>	Wireless A/G Portable USB Adapter	<b>MODEL</b>	WUSB54AGP
<b>INPUT POWER (SYSTEM)</b>	120Vac, 60 Hz	<b>ENVIRONMENTAL CONDITIONS</b>	24deg. C, 64%RH, 991 hPa
<b>TESTED BY</b>	Leo Hung		

<b>CHANNEL</b>	<b>CHANNEL FREQUENCY (MHz)</b>	<b>6dB BANDWIDTH (MHz)</b>	<b>MINIMUM LIMIT (MHz)</b>	<b>PASS/FAIL</b>
9	5745	16.44	0.5	PASS
11	5785	16.52	0.5	PASS
13	5825	16.40	0.5	PASS



CH9

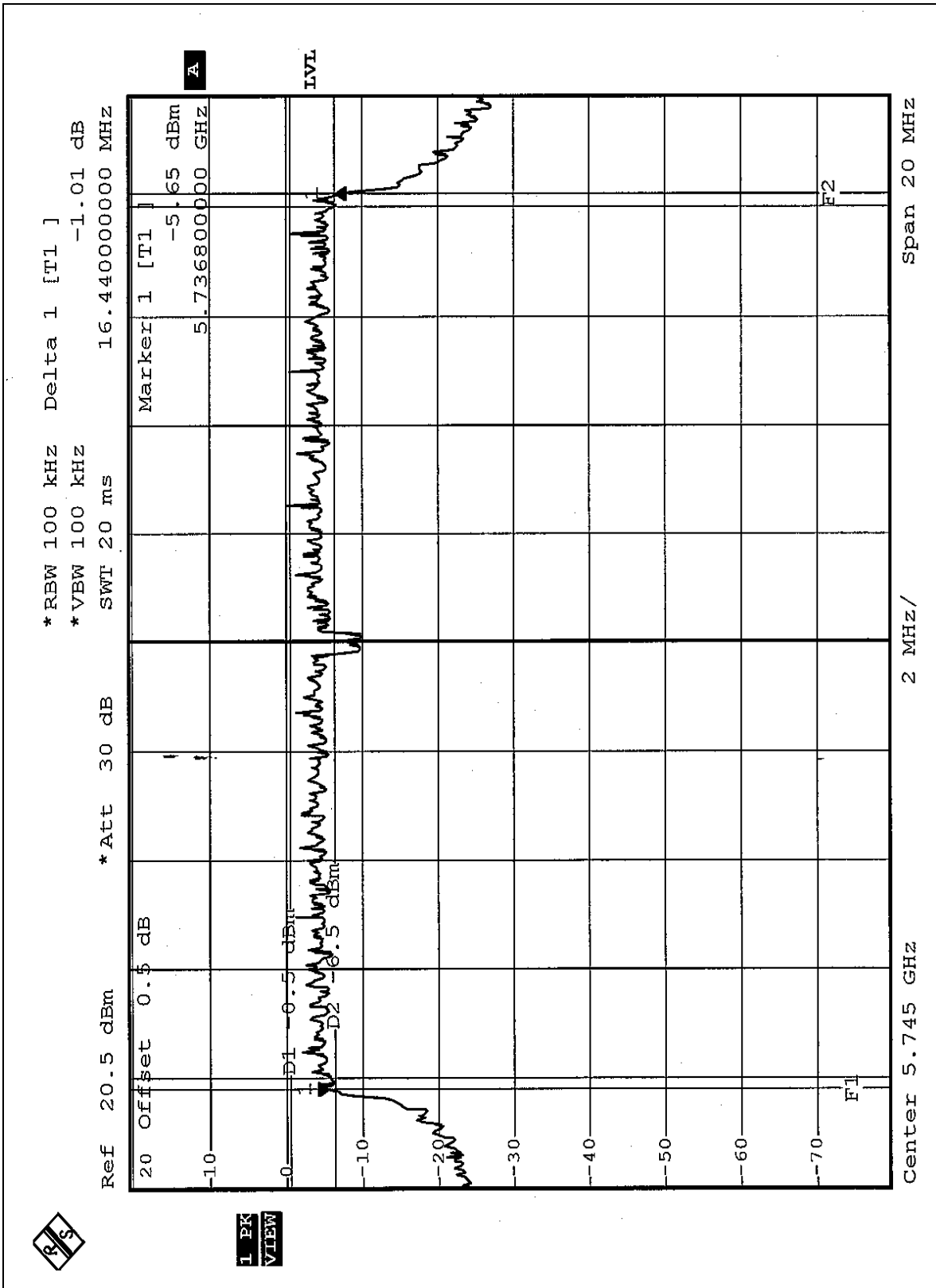



CH11

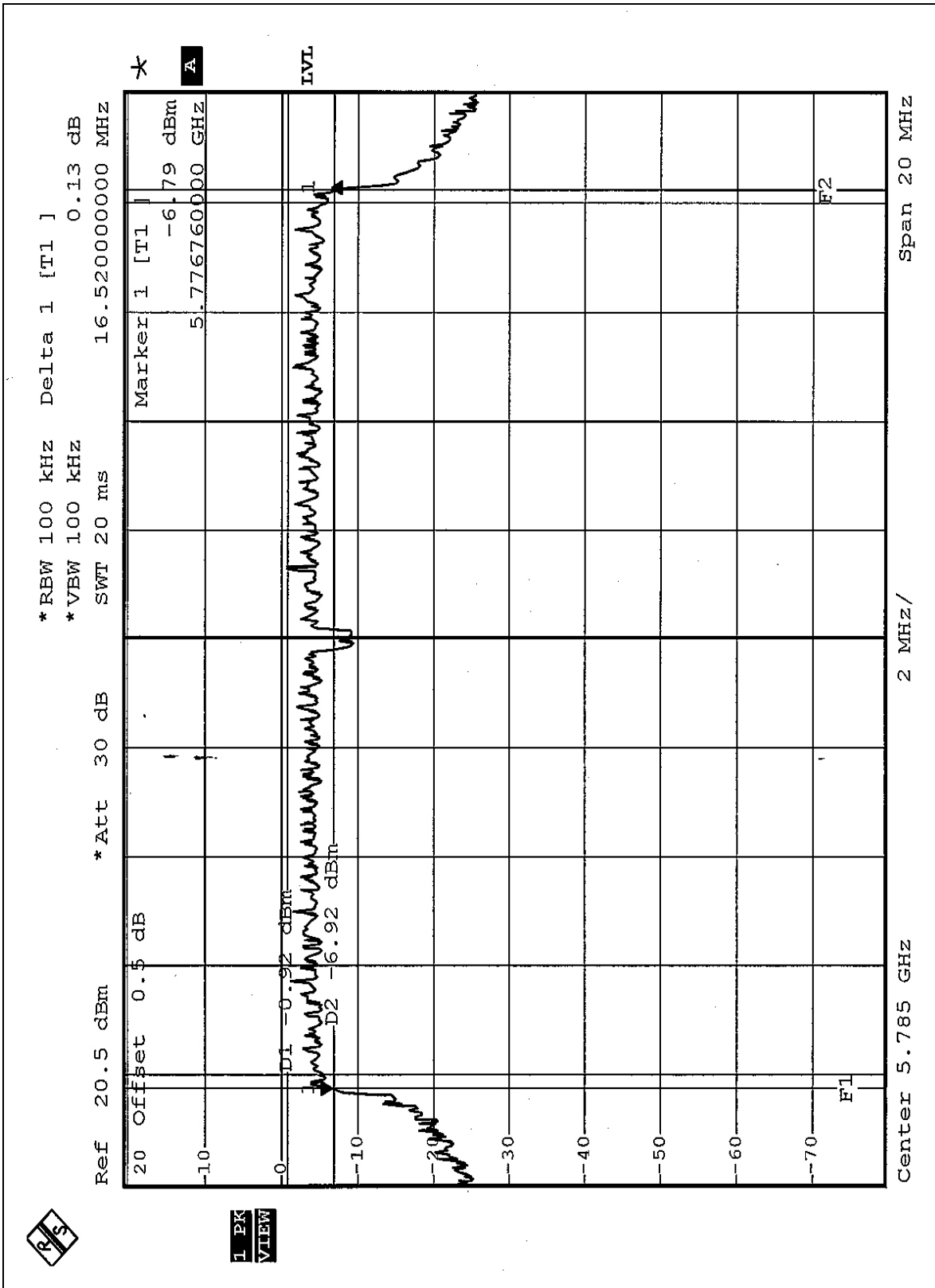



CH13

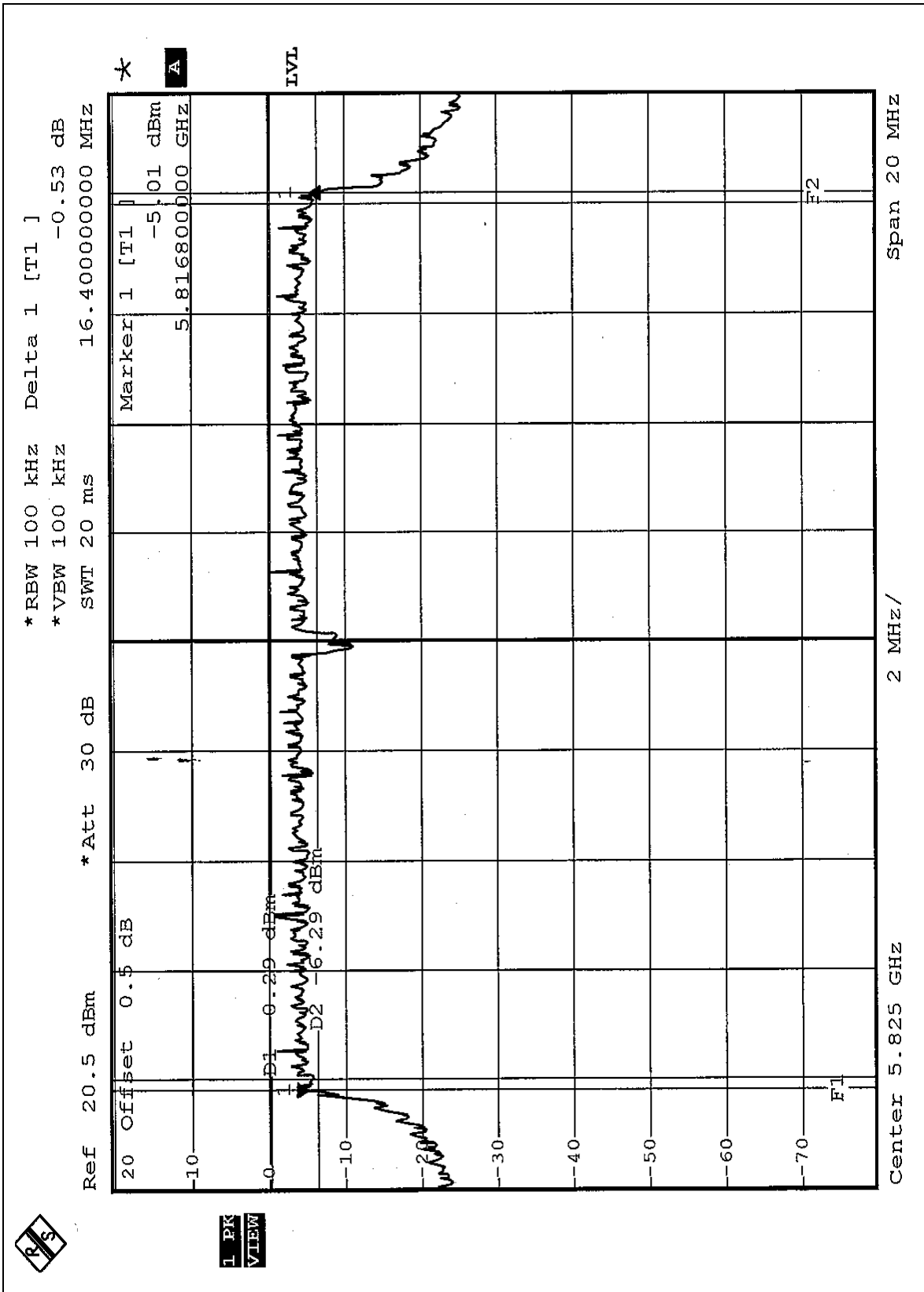

1 PK VIEW



## 5.12 MAXIMUM PEAK OUTPUT POWER

### 5.12.1 LIMITS OF MAXIMUM PEAK OUTPUT POWER MEASUREMENT

The Maximum Peak Output Power Measurement is 30dBm.

### 5.12.2 INSTRUMENTS

Description & Manufacturer	Model No.	Serial No.	Calibrated Until
R&S SPECTRUM ANALYZER	FSEK30	100049	Aug. 12, 2005
AGILENT SIGNAL GENERATOR	E8257C	MY43320668	Dec. 31, 2004
TEKTRONIX OSCILLOSCOPE	TDS 1012	C019167	Feb. 01, 2005
NARDA DETECTOR	4503A	FSCM99899	NA

**NOTE:**

The calibration interval of the above test instruments is 12 months and the calibrations are traceable to NML/ROC and NIST/USA..



### 5.12.3 TEST PROCEDURES

2. A detector was used on the output port of the EUT. An oscilloscope was used to read the response of the detector.
3. Replaced the EUT by the signal generator. The center frequency of the S.G was adjusted to the center frequency of the measured channel.
4. Adjusted the power to have the same reading on oscilloscope. Record the power level.

### 5.12.4 DEVIATION FROM TEST STANDARD

No deviation

### 5.12.5 TEST SETUP



### 5.12.6 EUT OPERATING CONDITIONS

Same as Item 5.9.6



## 5.12.7 TEST RESULTS

<b>EUT</b>	Wireless A/G Portable USB Adapter	<b>MODEL</b>	WUSB54AGP
<b>INPUT POWER (SYSTEM)</b>	120Vac, 60 Hz	<b>ENVIRONMENTAL CONDITIONS</b>	24deg. C, 64%RH, 991 hPa
<b>TESTED BY</b>	Leo Hung		

<b>CHANNEL</b>	<b>CHANNEL FREQUENCY (MHz)</b>	<b>PEAK POWER OUTPUT (mW)</b>	<b>PEAK POWER OUTPUT (dBm)</b>	<b>PEAK POWER LIMIT (dBm)</b>	<b>PASS/FAIL</b>
9	5745	31.769	15.02	30	PASS
11	5785	31.989	15.05	30	PASS
13	5825	31.915	15.04	30	PASS





## 5.13 POWER SPECTRAL DENSITY MEASUREMENT

### 5.13.1 LIMITS OF POWER SPECTRAL DENSITY MEASUREMENT

The Maximum of Power Spectral Density Measurement is 8dBm.

### 5.13.2 TEST INSTRUMENTS

Description & Manufacturer	Model No.	Serial No.	Calibrated Until
R&S SPECTRUM ANALYZER	FSEK30	100049	Aug. 12, 2005

**NOTES:**

The calibration interval of the above test instruments is 12 months and the calibrations are traceable to NML/ROC and NIST/USA.

### 5.13.3 TEST PROCEDURE

The transmitter output was connected to the spectrum analyzer through an attenuator, the bandwidth of the fundamental frequency was measured with the spectrum analyzer using 3 kHz RBW and 30 kHz VBW, set sweep time = span/3 kHz. The power spectral density was measured and recorded.

The sweep time is allowed to be longer than span/3 kHz for a full response of the mixer in the spectrum analyzer.

### 5.13.4 DEVIATION FROM TEST STANDARD

No deviation

### 5.13.5 TEST SETUP

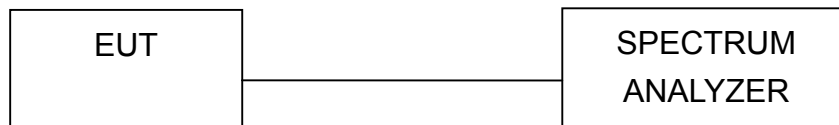

### 5.13.6 EUT OPERATING CONDITION

Same as Item 5.9.6



5.13.7 TEST RESULTS

<b>EUT</b>	Wireless A/G Portable USB Adapter	<b>MODEL</b>	WUSB54AGP
<b>INPUT POWER (SYSTEM)</b>	120Vac, 60 Hz	<b>ENVIRONMENTAL CONDITIONS</b>	24deg. C, 64%RH, 991 hPa
<b>TESTED BY</b>	Leo Hung		

<b>CHANNEL</b>	<b>CHANNEL FREQUENCY (MHz )</b>	<b>RF POWER LEVEL IN 3 kHz BW (dBm)</b>	<b>MAXIMUM LIMIT (dBm)</b>	<b>PASS/FAIL</b>
9	5745	-13.69	8	PASS
11	5785	-13.27	8	PASS
13	5825	-13.02	8	PASS



CH9

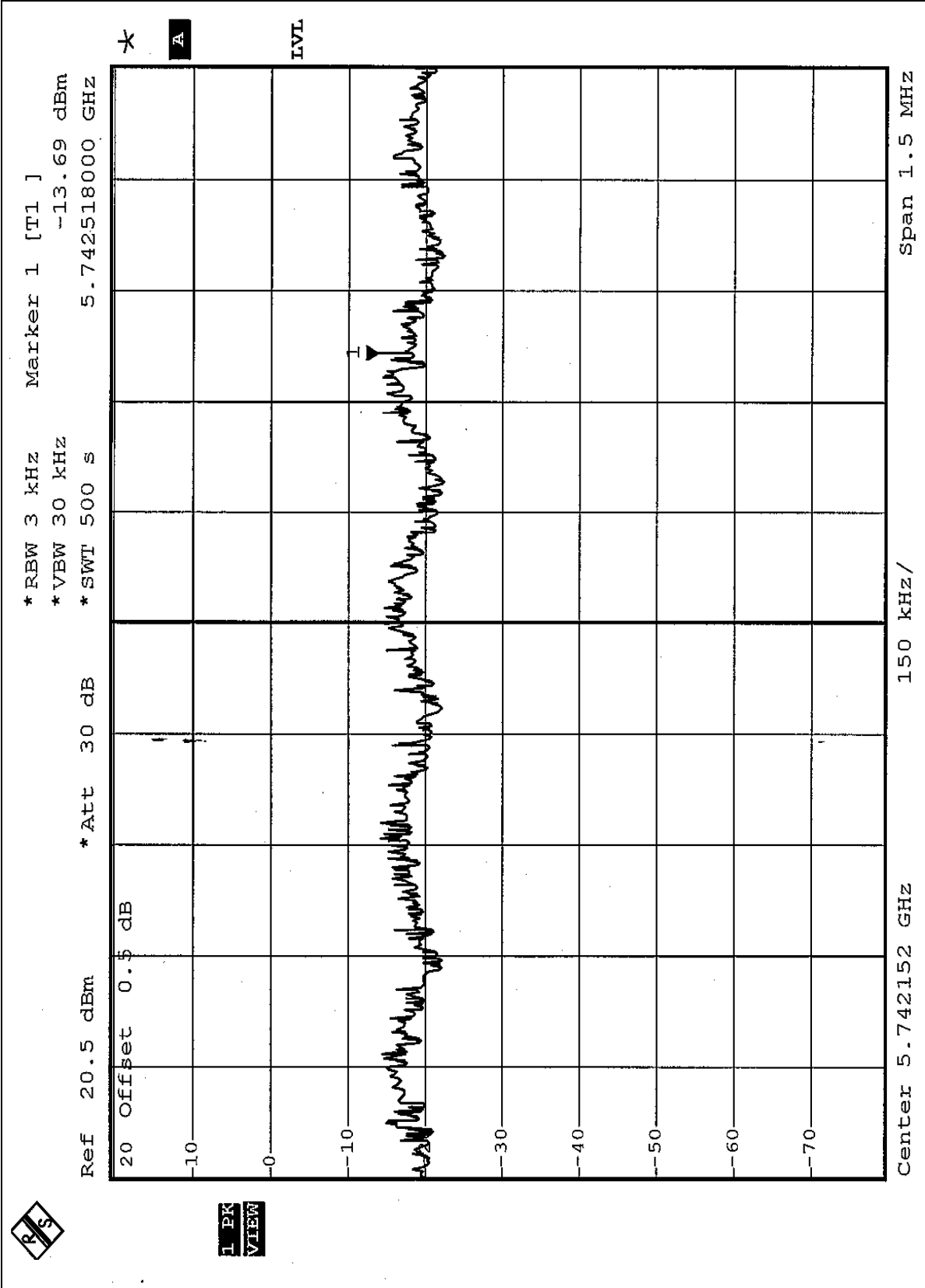



CH11

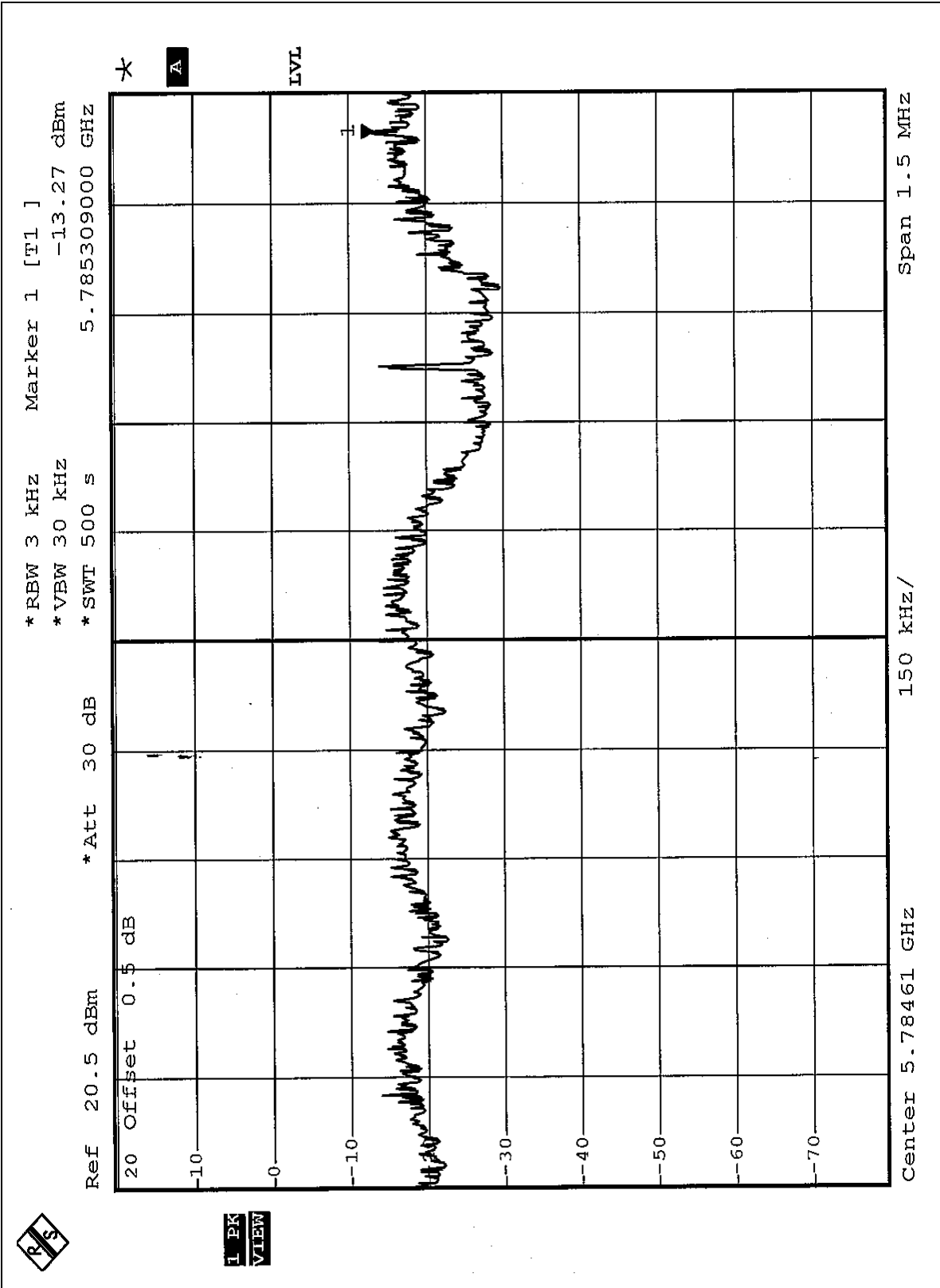



CH13

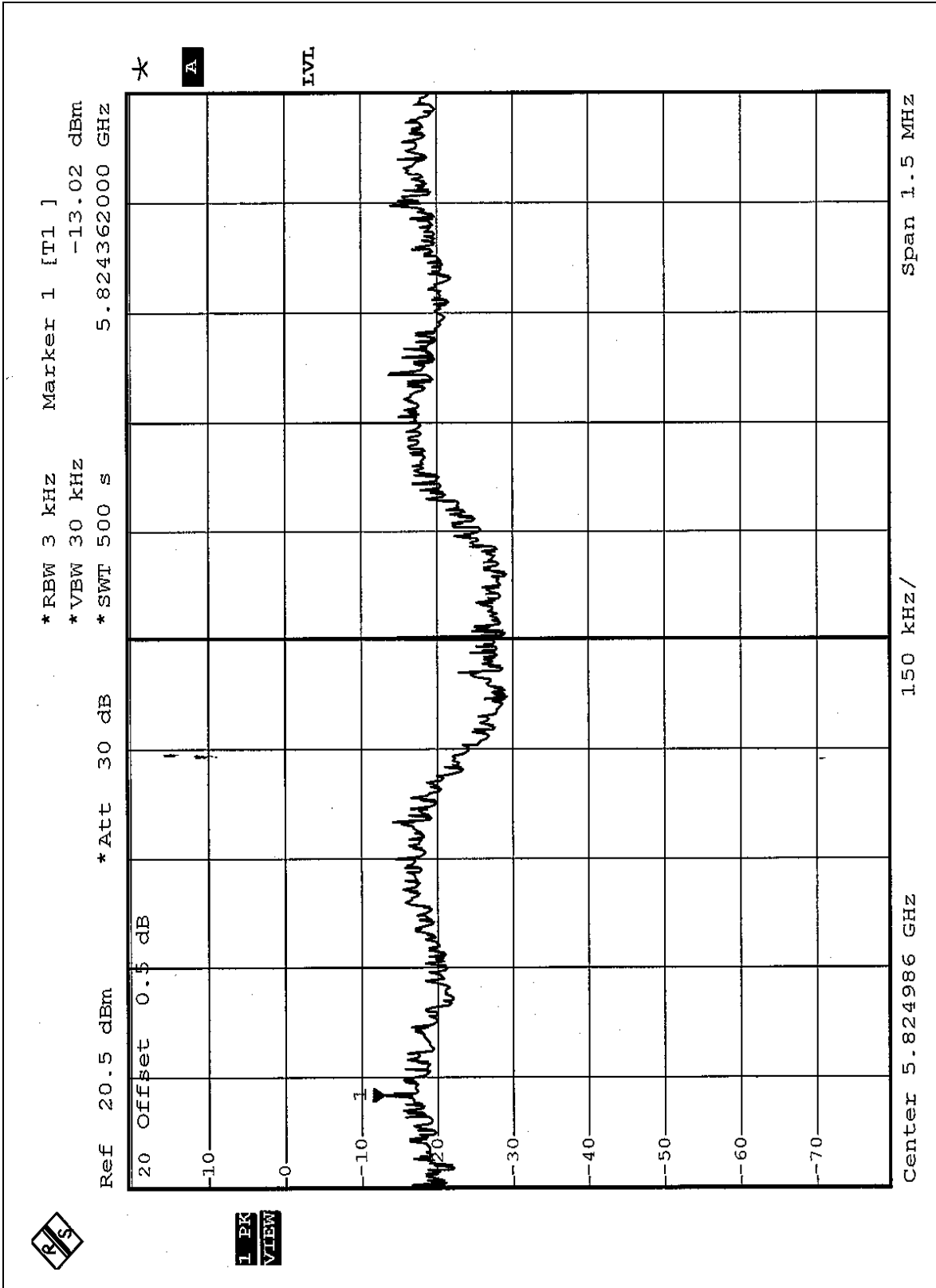



## 5.14 BAND EDGES MEASUREMENT

### 5.14.1 LIMITS OF BAND EDGES MEASUREMENT

Below  $-20\text{dB}$  of the highest emission level of operating band (in 100kHz Resolution Bandwidth).

### 5.14.2 TEST INSTRUMENTS

Description & Manufacturer	Model No.	Serial No.	Calibrated Until
R&S SPECTRUM ANALYZER	FSEK30	100049	Aug. 12, 2005

#### NOTES:

The calibration interval of the above test instruments is 12 months and the calibrations are traceable to NML/ROC and NIST/USA.

### 5.14.3 TEST PROCEDURE

The transmitter output was connected to the spectrum analyzer via a low loss cable. Set both RBW and VBW of spectrum analyzer to 100 kHz with suitable frequency span including 100 MHz bandwidth from band edge. The band edges was measured and recorded.

### 5.14.4 DEVIATION FROM TEST STANDARD

No deviation



#### 5.14.5 EUT OPERATING CONDITION

Same as Item 5.9.6

#### 5.14.6 TEST RESULTS

The spectrum plots are attached on the following pages. D2 line indicates the highest level, D1 line indicates the 20dB offset below D2. It shows compliance with the requirement in part 15.247(d).



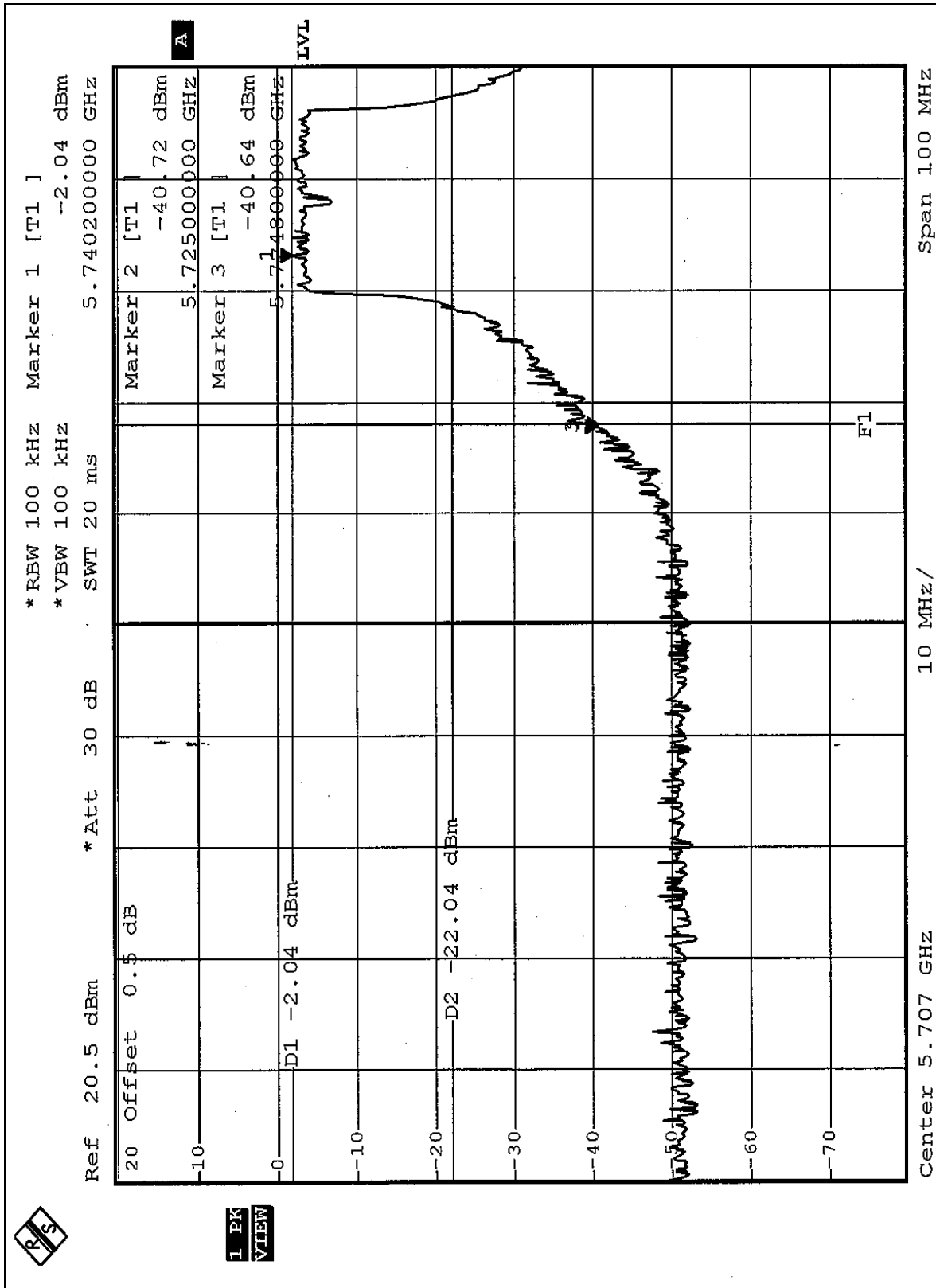

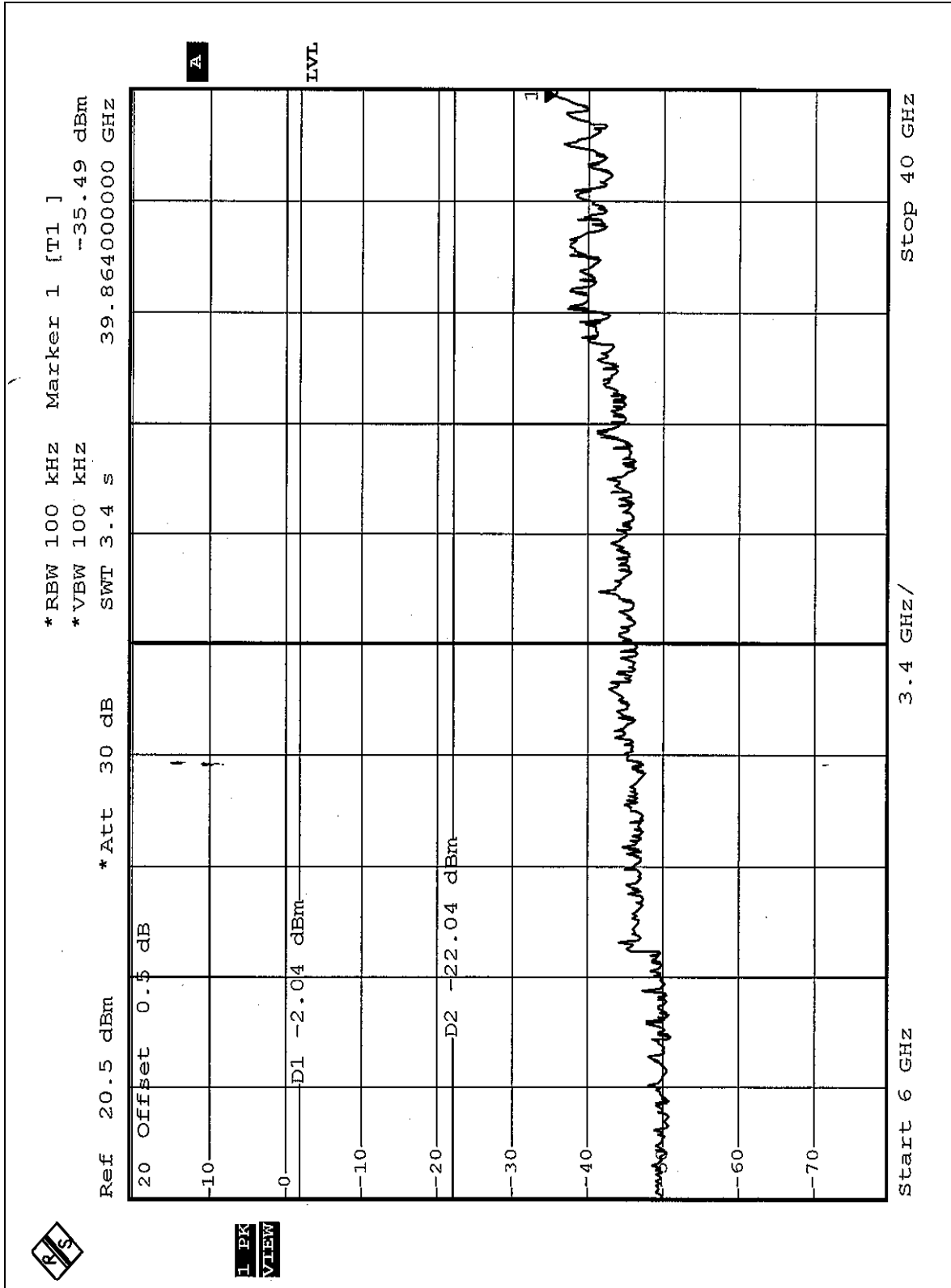

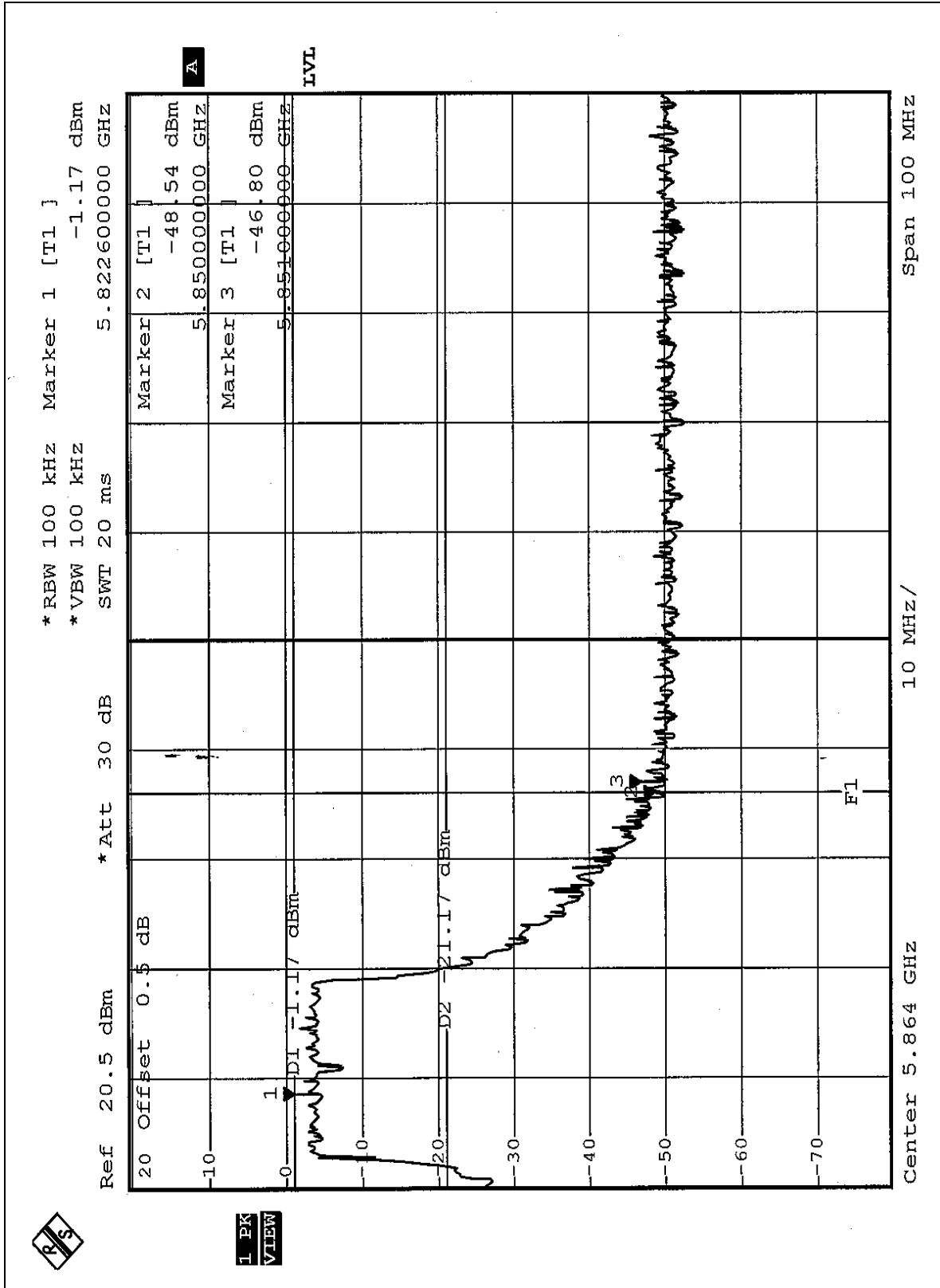

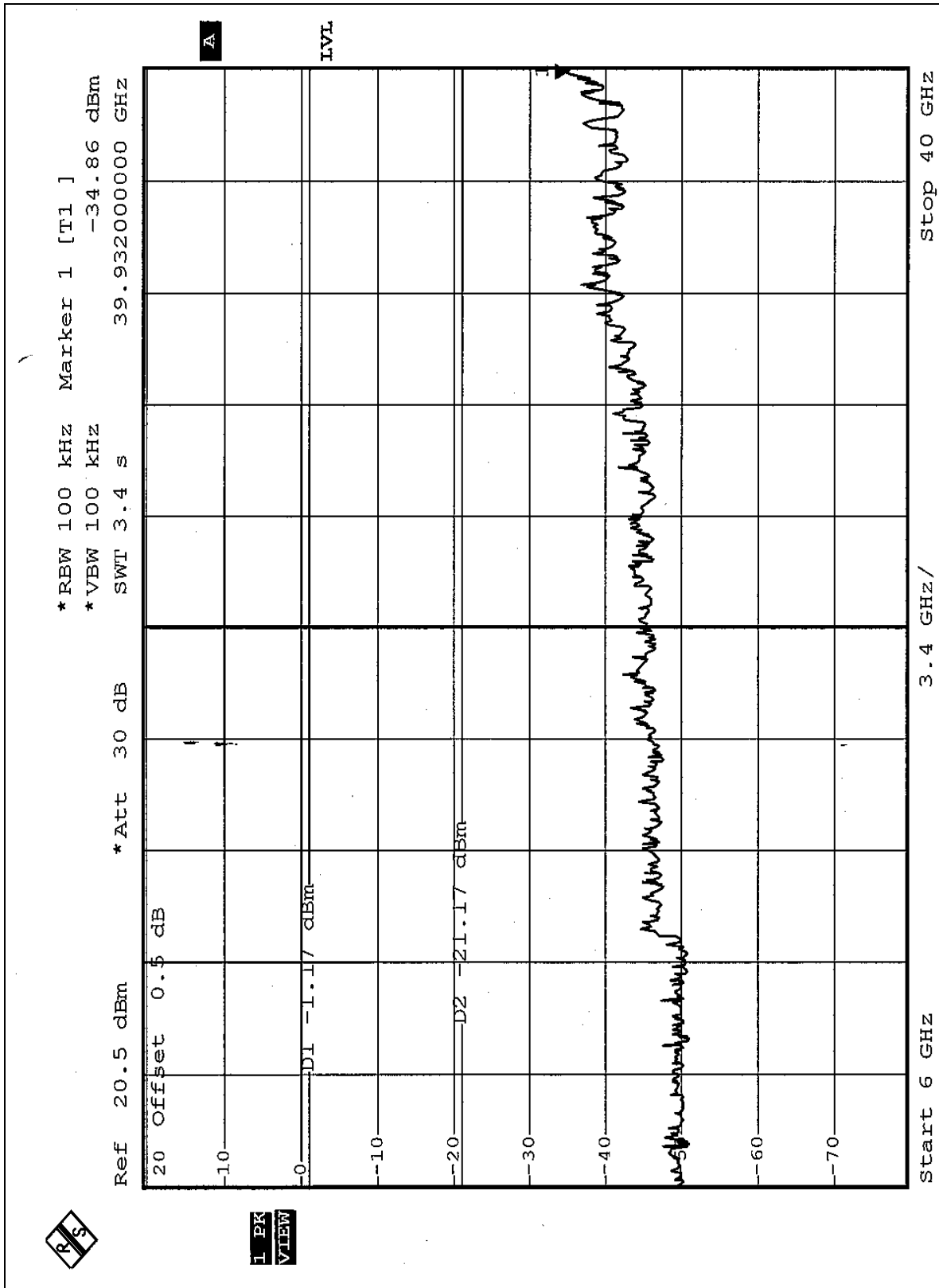



## **5.15 ANTENNA REQUIREMENT**

### **5.15.1 STANDARD APPLICABLE**

For intentional device, according to FCC 47 CFR Section 15.203, an intentional radiator shall be designed to ensure that no antenna other than that furnished by the responsible party shall be used with the device. And according to FCC 47 CFR Section 15.247 (b), if transmitting antennas of directional gain greater than 6dBi are used, the power shall be reduced by the amount in dB that the directional gain of the antenna exceeds 6dBi.

### **5.15.2 ANTENNA CONNECTED CONSTRUCTION**

The antenna used in this product is Printed antenna without antenna connector. The maximum Gain of the antenna is  $-1.0\text{dBi}$ .

## 6. PHOTOGRAPHS OF THE TEST CONFIGURATION CONDUCTED EMISSION TEST



### RADIATED EMISSION TEST

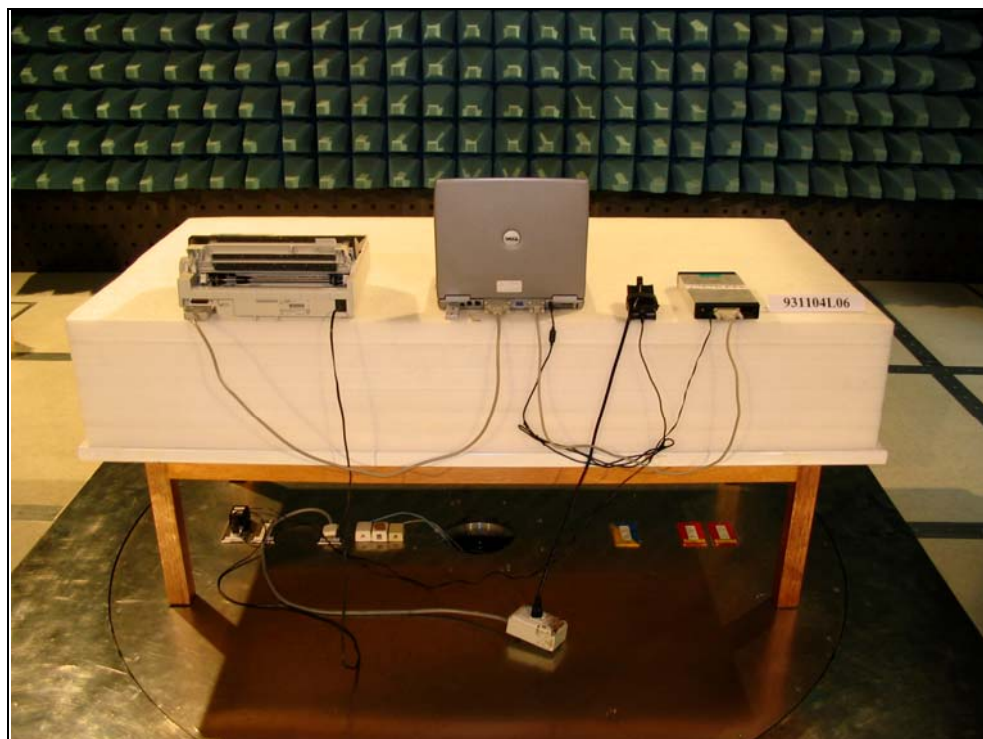
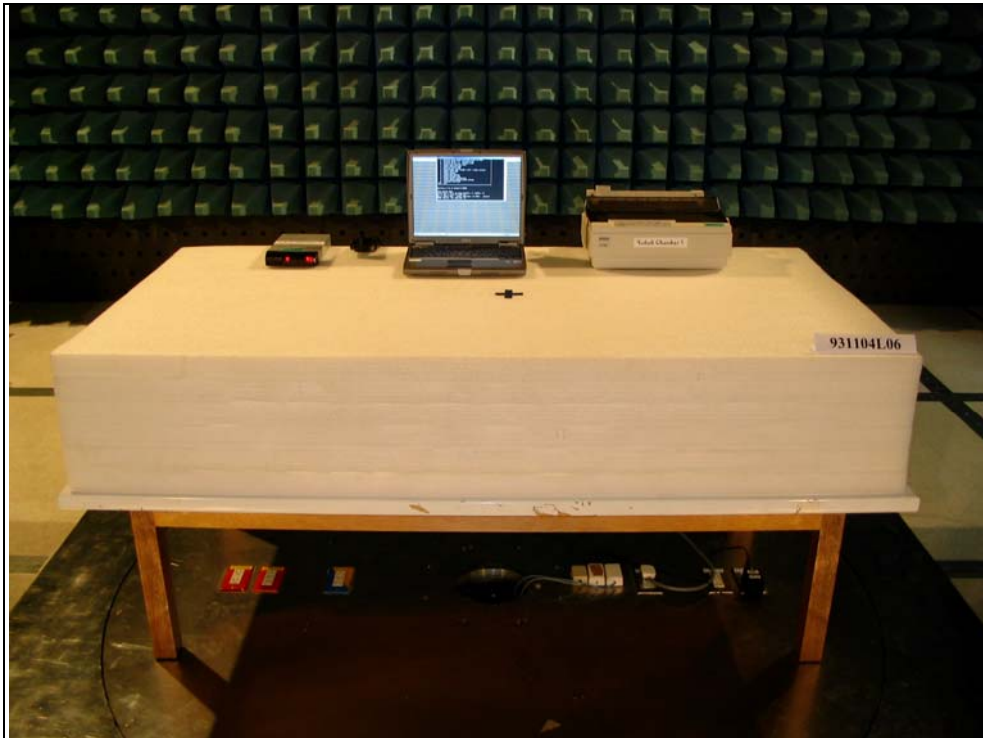



## 7. INFORMATION ON THE TESTING LABORATORIES

We, ADT Corp., were founded in 1988 to provide our best service in EMC, Radio, Telecom and Safety consultation. Our laboratories are accredited and approved by the following approval agencies according to ISO/IEC 17025:

<b>USA</b>	FCC, NVLAP, UL, A2LA
<b>Germany</b>	TUV Rheinland
<b>Japan</b>	VCCI
<b>Norway</b>	NEMKO
<b>Canada</b>	INDUSTRY CANADA , CSA
<b>R.O.C.</b>	CNLA, BSMI, DGT
<b>Netherlands</b>	Telefication
<b>Singapore</b>	PSB , GOST-ASIA(MOU)
<b>Russia</b>	CERTIS(MOU)

Copies of accreditation certificates of our laboratories obtained from approval agencies can be downloaded from our web site:

[www.adt.com.tw/index.5/phtml](http://www.adt.com.tw/index.5/phtml). If you have any comments, please feel free to contact us at the following:

**Linko EMC/RF Lab:**

Tel: 886-2-26052180

Fax: 886-2-26052943

**Hsin Chu EMC/RF Lab:**

Tel: 886-3-5935343

Fax: 886-3-5935342

**Hwa Ya EMC/RF/Safety Telecom Lab:**

Tel: 886-3-3183232

Fax: 886-3-3185050

**Linko RF Lab.**

Tel: 886-3-3270910

Fax: 886-3-3270892

**Email:** [service@mail.adt.com.tw](mailto:service@mail.adt.com.tw)

**Web Site:** [www.adt.com.tw](http://www.adt.com.tw)

The address and road map of all our labs can be found in our web site also