



FCC TEST REPORT

REPORT NO.: RF930629L11A

MODEL NO.: WUSB54GP ver. 4

RECEIVED: Oct. 11, 2004

TESTED: Oct. 11 ~ Nov. 07, 2004

APPLICANT: Cisco-Linksys, LLC

ADDRESS: 121 Theory Drive Irvine, CA 92612, U.S.A.

ISSUED BY: Advance Data Technology Corporation

LAB ADDRESS: No. 47, 14th Ling, Chia Pau Tsuen, Lin Kou
Hsiang 244, Taipei Hsien, Taiwan, R.O.C.

TEST LOCATION: No. 19, Hwa Ya 2nd Rd., Wen Hwa Tsuen, Kwei
Shan Hsiang, Taoyuan Hsien 333, Taiwan,
R.O.C.

This test report consists of 77 pages in total. It may be duplicated completely for legal use with the approval of the applicant. It should not be reproduced except in full, without the written approval of our laboratory. The client should not use it to claim product endorsement by CNLA, A2LA or any government agencies. The test results in the report only apply to the tested sample.



No. 2177-01



0528
ILAC MRA



Table of Contents

1	CERTIFICATION	4
2	SUMMARY OF TEST RESULTS	5
2.1	MEASUREMENT UNCERTAINTY	5
3	GENERAL INFORMATION	6
3.1	GENERAL DESCRIPTION OF EUT	6
3.2	DESCRIPTION OF TEST MODES.....	7
3.3	GENERAL DESCRIPTION OF APPLIED STANDARDS.....	7
3.4	DESCRIPTION OF SUPPORT UNITS	8
3.5	CONFIGURATION OF SYSTEM UNDER TEST.....	8
4	TEST TYPES AND RESULTS	9
4.1	CONDUCTED EMISSION MEASUREMENT	9
4.1.1	LIMITS OF CONDUCTED EMISSION MEASUREMENT	9
4.1.2	TEST INSTRUMENTS	10
4.1.3	TEST PROCEDURES	11
4.1.4	DEVIATION FROM TEST STANDARD	11
4.1.5	TEST SETUP	12
4.1.6	EUT OPERATING CONDITIONS	12
4.1.7	TEST RESULTS.....	13
4.2	RADIATED EMISSION MEASUREMENT	25
4.2.1	LIMITS OF RADIATED EMISSION MEASUREMENT	25
4.2.2	TEST INSTRUMENTS	26
4.2.3	TEST PROCEDURES	27
4.2.4	DEVIATION FROM TEST STANDARD	27
4.2.5	TEST SETUP	28
4.2.6	EUT OPERATING CONDITIONS	28
4.2.7	TEST RESULTS.....	29
4.2.8	TEST RESULTS (A)	33
4.2.9	TEST RESULTS (B).....	36
4.3	6dB BANDWIDTH MEASUREMENT	39
4.3.1	LIMITS OF 6dB BANDWIDTH MEASUREMENT	39
4.3.2	TEST INSTRUMENTS	39
4.3.3	TEST PROCEDURE	40
4.3.4	DEVIATION FROM TEST STANDARD	40
4.3.5	TEST SETUP	40
4.3.6	EUT OPERATING CONDITIONS	40



4.3.7	TEST RESULTS (A)	41
4.3.8	TEST RESULTS (B).....	45
4.4	MAXIMUM PEAK OUTPUT POWER	49
4.4.1	LIMITS OF MAXIMUM PEAK OUTPUT POWER MEASUREMENT	49
4.4.2	TEST INSTRUMENTS	49
4.4.3	TEST PROCEDURES	50
4.4.4	DEVIATION FROM TEST STANDARD	50
4.4.5	TEST SETUP	50
4.4.6	EUT OPERATING CONDITIONS	50
4.4.7	TEST RESULTS (A)	51
4.4.8	TEST RESULTS (B).....	51
4.5	POWER SPECTRAL DENSITY MEASUREMENT	52
4.5.1	LIMITS OF POWER SPECTRAL DENSITY MEASUREMENT	52
4.5.2	TEST INSTRUMENTS	52
4.5.3	TEST PROCEDURE.....	53
4.5.4	DEVIATION FROM TEST STANDARD	53
4.5.5	TEST SETUP	53
4.5.6	EUT OPERATING CONDITIONS	53
4.5.7	TEST RESULTS (A)	54
4.5.8	TEST RESULTS (B).....	58
4.6	BAND EDGES MEASUREMENT.....	62
4.6.1	LIMITS OF BAND EDGES MEASUREMENT	62
4.6.2	TEST INSTRUMENTS	62
4.6.3	TEST PROCEDURE.....	62
4.6.4	DEVIATION FROM TEST STANDARD	62
4.6.5	EUT OPERATING CONDITION.....	62
4.6.6	TEST RESULTS.....	63
4.6.7	TEST RESULTS(A)	63
4.6.8	TEST RESULTS(B).....	63
4.7	ANTENNA REQUIREMENT	72
4.7.1	STANDARD APPLICABLE.....	72
4.7.2	ANTENNA CONNECTED CONSTRUCTION.....	72
5	PHOTOGRAPHS OF THE TEST CONFIGURATION	73
6	INFORMATION ON THE TESTING LABORATORIES.....	77



1 CERTIFICATION

PRODUCT : Wireless-G Portable USB Adapter
BRAND NAME : Linksys
MODEL NO. : WUSB54GP ver. 4
APPLICANT : Cisco-Linksys, LLC
TESTED : Oct. 11 ~ Nov. 07, 2004
TEST SAMPLE : ENGINEERING SAMPLE
STANDARDS : FCC Part 15, Subpart C (Section 15.247),
ANSI C63.4-2003

The above equipment has been tested by **Advance Data Technology Corporation**, and found compliance with the requirement of the above standards. The test record, data evaluation & Equipment Under Test (EUT) configurations represented herein are true and accurate accounts of the measurements of the sample's EMC characteristics under the conditions specified in this report.

PREPARED BY : Windy Chou , **DATE:** Nov. 10, 2004
(Windy Chou)

TECHNICAL ACCEPTANCE : Gary Chang , **DATE:** Nov. 10, 2004
Responsible for RF (Gary Chang)

APPROVED BY : Cody Chang , **DATE:** Nov. 10, 2004
(Cody Chang, Deputy Manager)

2 SUMMARY OF TEST RESULTS

The EUT has been tested according to the following specifications:

APPLIED STANDARD: FCC Part 15, Subpart C			
Standard Section	Test Type and Limit	Result	REMARK
15.207	AC Power Conducted Emission	PASS	Meet the requirement of limit. Minimum passing margin is -6.36dB at 0.661MHz
15.247(a)(2)	Spectrum Bandwidth of a Direct Sequence Spread Spectrum System Limit: min. 500kHz	PASS	Meet the requirement of limit.
15.247(b)	Maximum Peak Output Power Limit: max. 30dBm	PASS	Meet the requirement of limit.
15.247(d)	Transmitter Radiated Emissions Limit: Table 15.209	PASS	Meet the requirement of limit. Minimum passing margin is -1.28dB at 3180.00MHz
15.247(e)	Power Spectral Density Limit: max. 8dBm	PASS	Meet the requirement of limit.
15.247(d)	Band Edge Measurement Limit: 20 dB less than the peak value of fundamental frequency	PASS	Meet the requirement of limit.

2.1 MEASUREMENT UNCERTAINTY

Where relevant, the following measurement uncertainty levels have been estimated for tests performed on the EUT as specified in CISPR 16-4:

Measurement	Frequency	Uncertainty
Conducted emissions	9k~30MHz	2.44 dB
Radiated emissions	30MHz ~ 200MHz	3.73 dB
	200MHz ~ 1000MHz	3.74 dB
	1GHz ~ 18GHz	2.20 dB
	18GHz ~ 40GHz	1.88 dB



3 GENERAL INFORMATION

3.1 GENERAL DESCRIPTION OF EUT

PRODUCT	Wireless-G Portable USB Adapter
MODEL NO.	WUSB54GP ver. 4
POWER SUPPLY	5.0Vdc from host equipment
MODULATION TYPE	BPSK, QPSK, CCK, 16QAM, 64QAM
RADIO TECHNOLOGY	DSSS, OFDM
TRANSFER RATE	802.11b: 11/5.5/2/1Mbps 802.11g: 54/48/36/24/18/12/9/6Mbps
FREQUENCY RANGE	2412MHz ~ 2462MHz
NUMBER OF CHANNEL	11
MAXIMUM OUTPUT POWER	37.584mW
ANTENNA TYPE	Dipole antenna with 1dBi gain
DATA CABLE	1.8m shielded cable without core
I/O PORTS	USB
ASSOCIATED DEVICES	NA

NOTE:

1. This report is prepared for FCC Class II permissive change.
2. This report is issued as a supplementary report to the original ADT report no. 930629L11. The difference compared with the original design is changing PA type. All test data had been re-tested.
3. The EUT operates in the 2.4GHz frequency spectrum with throughput of up to 54Mbps.
4. The EUT complies with IEEE 802.11g standards, and backwards compatible with IEEE 802.11b products.
5. The above EUT information was declared by manufacturer and for more detailed features description, please refer to the manufacturer's specifications or User's Manual.



3.2 DESCRIPTION OF TEST MODES

Eleven channels are provided to this EUT.

Channel	Frequency	Channel	Frequency
1	2412 MHz	7	2442 MHz
2	2417 MHz	8	2447 MHz
3	2422 MHz	9	2452 MHz
4	2427 MHz	10	2457 MHz
5	2432 MHz	11	2462 MHz
6	2437 MHz		

NOTE:

1. Below 1GHz, the channel 1, 6, and 11 were pre-tested in chamber. The channel 11, the worst case, was chosen for final test.
2. Above 1GHz, the channel 1, 6, and 11 were tested individually.
3. From our experience and technical viewpoint, we have chosen data rates 11Mbps for CCK technique and 6Mbps for OFDM technique, as the worst cases for the test among other data rates.
4. Two test results were presented in the following sections. The test result A was for CCK technique and the test result B was for OFDM technique.
5. For conducted emission and radiated emission measurement below 1GHz test, there are two test modes provided to EUT. The test mode 1 is for the EUT connected with NB directly and the test mode 2 is for the EUT connected with NB via USB cable.

3.3 GENERAL DESCRIPTION OF APPLIED STANDARDS

The EUT is a Wireless-G Portable USB Adapter. According to the specifications of the manufacturer, it must comply with the requirements of the following standards:

FCC Part 15, Subpart C. (15.247)
ANSI C63.4-2003

All test items have been performed and recorded as per the above standards.

NOTE: The EUT is also considered as a kind of computer peripheral, because the connection to computer is necessary for typical use. It has been verified to comply with the requirements of FCC Part 15, Subpart B, Class B (DoC). The test report has been issued separately.



3.4 DESCRIPTION OF SUPPORT UNITS

The EUT has been tested as an independent unit together with other necessary accessories or support units. The following support units or accessories were used to form a representative test configuration during the tests.

NO.	PRODUCT	BRAND	MODEL NO.	SERIAL NO.	FCC ID
1	NOTEBOOK COMPUTER	DELL	PP05L	16484462992	E2K24CLNS
2	PRINTER	EPSON	LQ-300+	DCGY054147	FCC DoC Approved
3	MODEM	ACEEX	1414V/3	0401008269	IFAXDM1414

NO.	SIGNAL CABLE DESCRIPTION OF THE ABOVE SUPPORT UNITS
1	NA
2	1.2 shielded cable without core
3	1.2 shielded cable without core

NOTE: All power cords of the above support units are non shielded (1.8m).

3.5 CONFIGURATION OF SYSTEM UNDER TEST

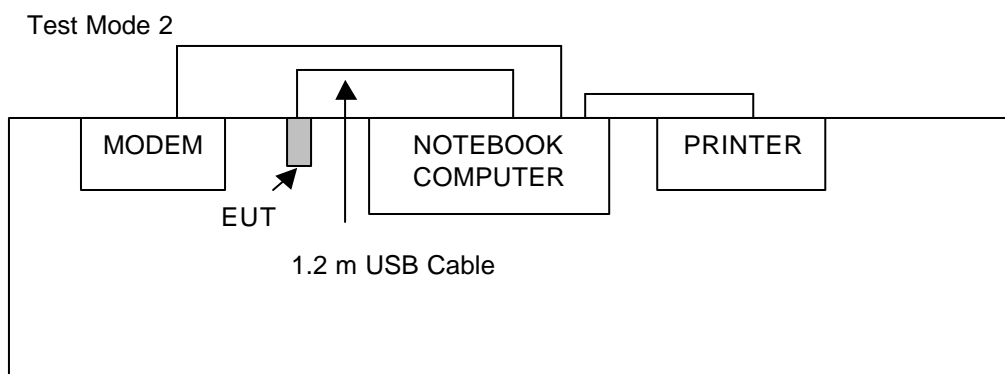
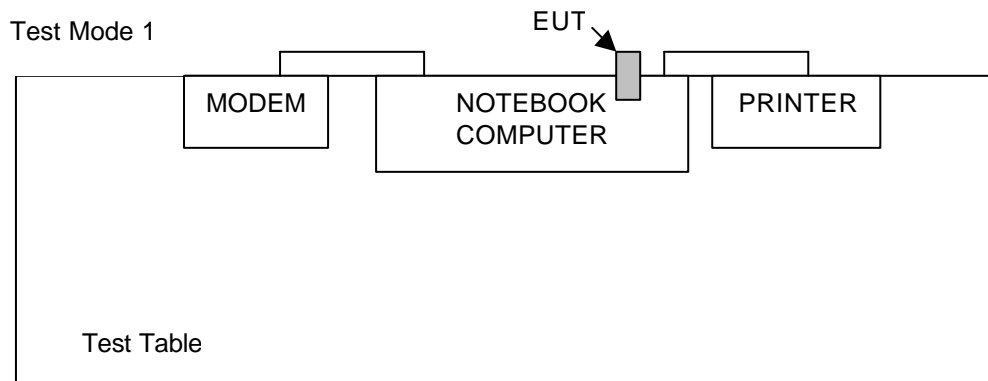



4 TEST TYPES AND RESULTS

4.1 CONDUCTED EMISSION MEASUREMENT

4.1.1 LIMITS OF CONDUCTED EMISSION MEASUREMENT

FREQUENCY OF EMISSION (MHz)	CONDUCTED LIMIT (dB μ V)	
	Quasi-peak	Average
0.15-0.5	66 to 56	56 to 46
0.5-5	56	46
5-30	60	50

- NOTE:**
1. The lower limit shall apply at the transition frequencies.
 2. The limit decreases in line with the logarithm of the frequency in the range of 0.15 to 0.50 MHz.
 3. All emanations from a class A/B digital device or system, including any network of conductors and apparatus connected thereto, shall not exceed the level of field strengths specified above.



4.1.2 TEST INSTRUMENTS

DESCRIPTION & MANUFACTURER	MODEL NO.	SERIAL NO.	CALIBRATED UNTIL
Test Receiver ROHDE & SCHWARZ	ESCS30	100291	Dec. 12, 2004
RF signal cable Woken	5D-FB	Cable-HYC01-01	Mar. 02, 2005
LISN ROHDE & SCHWARZ	ESH3-Z5	100312	Mar. 03, 2005
LISN ROHDE & SCHWARZ	ESH2-Z5	100104	Mar. 02, 2005
Software ADT	ADT_Cond_V3	NA	NA

- NOTE:** 1. The calibration interval of the above test instruments is 12 months and the calibrations are traceable to NML/ROC and NIST/USA.
 2. The test was performed in HwaYa Shielded Room 1. (For Mode 1)
 3. The VCCI Site Registration No. is C-2040.

DESCRIPTION & MANUFACTURER	MODEL NO.	SERIAL NO.	CALIBRATED UNTIL
Test Receiver ROHDE & SCHWARZ	ESCS30	100289	Dec. 10, 2004
RF signal cable Woken	5D-FB	Cable-HyC02-01	Mar. 07, 2005
LISN ROHDE & SCHWARZ	ESH2-Z5	100100	Mar. 10, 2005
LISN ROHDE & SCHWARZ	ESH3-Z5	100311	Mar. 04, 2005
Software ADT	ADT_Cond_V3	NA	NA

- NOTE:** 1. The calibration interval of the above test instruments is 12 months and the calibrations are traceable to NML/ROC and NIST/USA.
 2. The test was performed in HwaYa Shielded Room 2. (For Mode 2)
 3. The VCCI Site Registration No. is C-2047.



4.1.3 TEST PROCEDURES

- a. The EUT was placed 0.4 meters from the conducting wall of the shielded room with EUT being connected to the power mains through a line impedance stabilization network (LISN). Other support units were connected to the power mains through another LISN. The two LISNs provide 50 ohm/ 50uH of coupling impedance for the measuring instrument.
- b. Both lines of the power mains connected to the EUT were checked for maximum conducted interference.
- c. The frequency range from 150kHz to 30MHz was searched. Emission levels under Limit - 20dB was not recorded.

4.1.4 DEVIATION FROM TEST STANDARD

No deviation

4.1.5 TEST SETUP

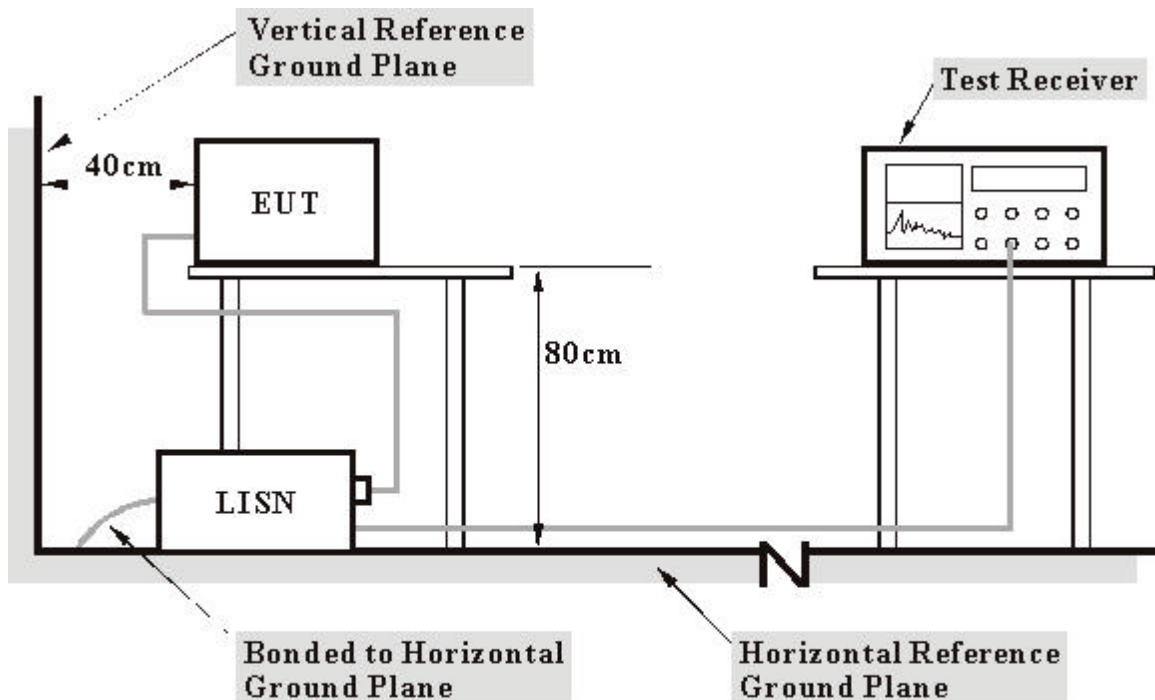

- Note:**
1. Support units were connected to second LISN.
 2. Both of LISNs (AMN) 80 cm from EUT and at the least 80 cm from other units and other metal planes support units.

For the actual test configuration, please refer to the related item – Photographs of the Test Configuration.

4.1.6 EUT OPERATING CONDITIONS

- a. Connected the EUT to a notebook system placed on a testing table.
- b. The notebook system ran a test program (provided by manufacturer) to enable EUT under transmission/receiving condition continuously at specific channel frequency.
- c. The notebook system sent "H" messages to its screen.
- d. The notebook system sent "H" messages to modem.
- e. The notebook system sent "H" messages to printer, and the printer printed them on paper.
- f. Steps c ~ e were repeated.



4.1.7 TEST RESULTS

EUT	Wireless-G Portable USB Adapter	MODEL	WUSB54GP ver. 4
CHANNEL	1	6dB BANDWIDTH	9 kHz
INPUT POWER (SYSTEM)	120 Vac, 60 Hz	PHASE	Line (L)
ENVIRONMENTAL CONDITIONS	24 deg. C, 64% RH, 991 hPa	TEST MODE	1
TESTED BY	Leo Hung		

No	Freq. [MHz]	Corr. Factor (dB)	Reading Value [dB (uV)]		Emission Level [dB (uV)]		Limit [dB (uV)]		Margin (dB)	
			Q.P.	AV.	Q.P.	AV.	Q.P.	AV.	Q.P.	AV.
1	0.181	0.11	38.47	-	38.58	-	64.43	54.43	-25.84	-
2	0.213	0.12	45.27	-	45.39	-	63.11	53.11	-17.72	-
3	0.439	0.13	30.42	-	30.55	-	57.08	47.08	-26.53	-
4	2.277	0.17	27.84	-	28.01	-	56.00	46.00	-27.99	-
5	5.602	0.25	24.82	-	25.07	-	60.00	50.00	-34.93	-
6	10.055	0.31	32.05	-	32.36	-	60.00	50.00	-27.64	-

- REMARKS:**
1. Q.P. and AV. are abbreviations of quasi-peak and average individually.
 2. "-": The Quasi-peak reading value also meets average limit and measurement with the average detector is unnecessary.
 3. The emission levels of other frequencies were very low against the limit.
 4. Margin value = Emission level - Limit value
 5. Correction factor = Insertion loss + Cable loss
 6. Emission Level = Correction Factor + Reading Value.

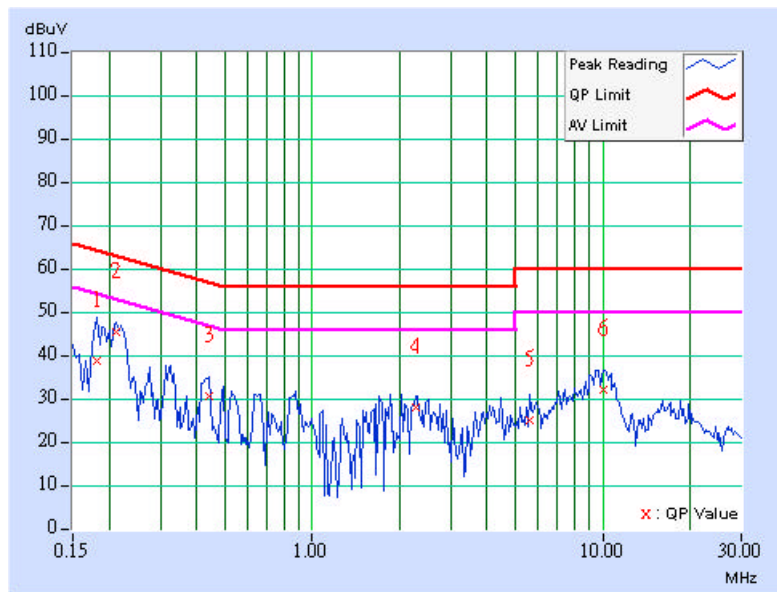



EUT	Wireless-G Portable USB Adapter	MODEL	WUSB54GP ver. 4
CHANNEL	1	6dB BANDWIDTH	9 kHz
INPUT POWER (SYSTEM)	120 Vac, 60 Hz	PHASE	Neutral (N)
ENVIRONMENTAL CONDITIONS	24 deg. C, 64% RH, 991 hPa	TEST MODE	1
TESTED BY	Leo Hung		

No	Freq. [MHz]	Corr. Factor (dB)	Reading Value [dB (uV)]		Emission Level [dB (uV)]		Limit [dB (uV)]		Margin (dB)	
			Q.P.	AV.	Q.P.	AV.	Q.P.	AV.	Q.P.	AV.
1	0.177	0.11	42.50	-	42.61	-	64.61	54.61	-22.00	-
2	0.216	0.11	44.63	-	44.74	-	62.96	52.96	-18.22	-
3	0.318	0.11	33.65	-	33.76	-	59.76	49.76	-26.00	-
4	2.082	0.16	30.07	-	30.23	-	56.00	46.00	-25.77	-
5	3.664	0.19	26.55	-	26.74	-	56.00	46.00	-29.26	-
6	9.758	0.28	32.18	-	32.46	-	60.00	50.00	-27.54	-

- REMARKS:**
1. Q.P. and AV. are abbreviations of quasi-peak and average individually.
 2. "-": The Quasi-peak reading value also meets average limit and measurement with the average detector is unnecessary.
 3. The emission levels of other frequencies were very low against the limit.
 4. Margin value = Emission level - Limit value
 5. Correction factor = Insertion loss + Cable loss
 6. Emission Level = Correction Factor + Reading Value.

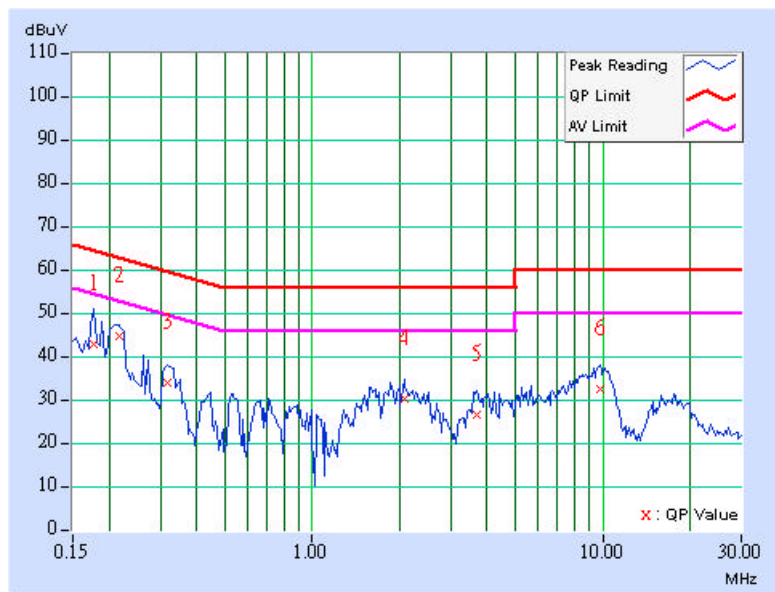



EUT	Wireless-G Portable USB Adapter	MODEL	WUSB54GP ver. 4
CHANNEL	6	6dB BANDWIDTH	9 kHz
INPUT POWER (SYSTEM)	120 Vac, 60 Hz	PHASE	Line (L)
ENVIRONMENTAL CONDITIONS	24 deg. C, 64% RH, 991 hPa	TEST MODE	1
TESTED BY	Leo Hung		

No	Freq. [MHz]	Corr. Factor [dB]	Reading Value [dB (uV)]		Emission Level [dB (uV)]		Limit [dB (uV)]		Margin (dB)	
			Q.P.	AV.	Q.P.	AV.	Q.P.	AV.	Q.P.	AV.
			1	0.209	0.12	44.54	-	44.66	-	63.26
2	0.322	0.12	33.65	-	33.77	-	59.66	49.66	-25.88	-
3	0.658	0.13	30.39	-	30.52	-	56.00	46.00	-25.48	-
4	2.098	0.16	28.78	-	28.94	-	56.00	46.00	-27.06	-
5	6.156	0.27	23.96	-	24.23	-	60.00	50.00	-35.77	-
6	10.121	0.31	32.03	-	32.34	-	60.00	50.00	-27.66	-

- REMARKS:**
1. Q.P. and AV. are abbreviations of quasi-peak and average individually.
 2. "-": The Quasi-peak reading value also meets average limit and measurement with the average detector is unnecessary.
 3. The emission levels of other frequencies were very low against the limit.
 4. Margin value = Emission level - Limit value
 5. Correction factor = Insertion loss + Cable loss
 6. Emission Level = Correction Factor + Reading Value.

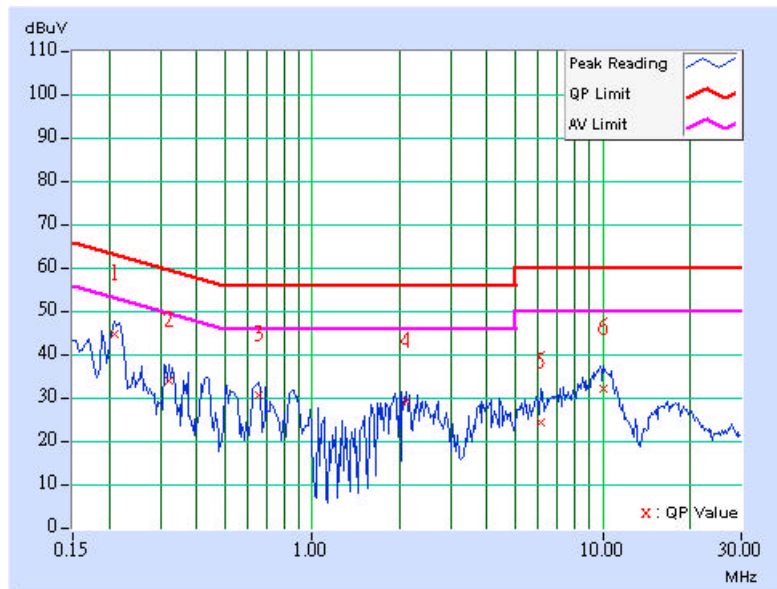



EUT	Wireless-G Portable USB Adapter	MODEL	WUSB54GP ver. 4
CHANNEL	6	6dB BANDWIDTH	9 kHz
INPUT POWER (SYSTEM)	120 Vac, 60 Hz	PHASE	Neutral (N)
ENVIRONMENTAL CONDITIONS	24 deg. C, 64% RH, 991 hPa	TEST MODE	1
TESTED BY	Leo Hung		

No	Freq. [MHz]	Corr. Factor (dB)	Reading Value		Emission Level		Limit		Margin	
			[dB (uV)]		[dB (uV)]		[dB (uV)]		(dB)	
			Q.P.	AV.	Q.P.	AV.	Q.P.	AV.	Q.P.	AV.
1	0.173	0.10	42.59	-	42.69	-	64.79	54.79	-22.10	-
2	0.213	0.11	45.19	-	45.30	-	63.11	53.11	-17.81	-
3	0.322	0.11	32.62	-	32.73	-	59.66	49.66	-26.92	-
4	2.043	0.16	29.54	-	29.70	-	56.00	46.00	-26.30	-
5	4.660	0.21	24.30	-	24.51	-	56.00	46.00	-31.49	-
6	10.152	0.29	32.20	-	32.49	-	60.00	50.00	-27.51	-

- REMARKS:**
1. Q.P. and AV. are abbreviations of quasi-peak and average individually.
 2. "-": The Quasi-peak reading value also meets average limit and measurement with the average detector is unnecessary.
 3. The emission levels of other frequencies were very low against the limit.
 4. Margin value = Emission level - Limit value
 5. Correction factor = Insertion loss + Cable loss
 6. Emission Level = Correction Factor + Reading Value.

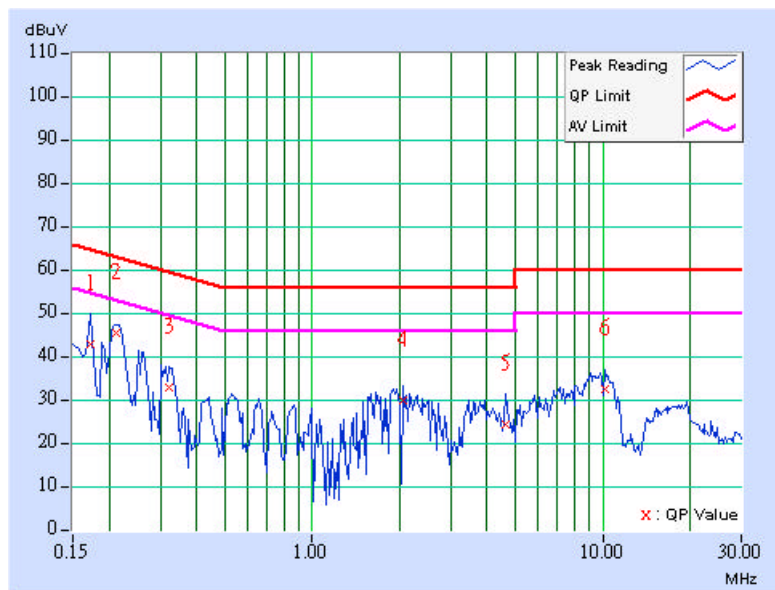



EUT	Wireless-G Portable USB Adapter	MODEL	WUSB54GP ver. 4
CHANNEL	11	6dB BANDWIDTH	9 kHz
INPUT POWER (SYSTEM)	120 Vac, 60 Hz	PHASE	Line (L)
ENVIRONMENTAL CONDITIONS	24 deg. C, 64% RH, 991 hPa	TEST MODE	1
TESTED BY	Leo Hung		

No	Freq. [MHz]	Corr. Factor (dB)	Reading Value [dB (uV)]		Emission Level [dB (uV)]		Limit [dB (uV)]		Margin (dB)	
			Q.P.	AV.	Q.P.	AV.	Q.P.	AV.	Q.P.	AV.
			1	0.166	0.11	45.18	-	45.29	-	65.18
2	0.216	0.12	44.93	-	45.05	-	62.96	52.96	-17.91	-
3	0.646	0.13	29.48	-	29.61	-	56.00	46.00	-26.39	-
4	1.852	0.16	28.28	-	28.44	-	56.00	46.00	-27.56	-
5	4.063	0.21	25.40	-	25.61	-	56.00	46.00	-30.39	-
6	9.840	0.30	31.80	-	32.10	-	60.00	50.00	-27.90	-

- REMARKS:**
1. Q.P. and AV. are abbreviations of quasi-peak and average individually.
 2. "-": The Quasi-peak reading value also meets average limit and measurement with the average detector is unnecessary.
 3. The emission levels of other frequencies were very low against the limit.
 4. Margin value = Emission level - Limit value
 5. Correction factor = Insertion loss + Cable loss
 6. Emission Level = Correction Factor + Reading Value.

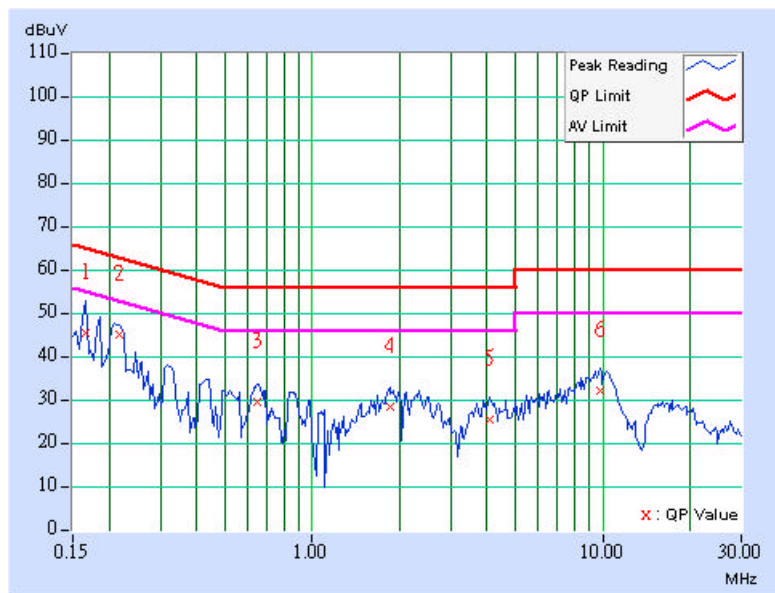



EUT	Wireless-G Portable USB Adapter	MODEL	WUSB54GP ver. 4
CHANNEL	11	6dB BANDWIDTH	9 kHz
INPUT POWER (SYSTEM)	120 Vac, 60 Hz	PHASE	Netural (N)
ENVIRONMENTAL CONDITIONS	24 deg. C, 64% RH, 991 hPa	TEST MODE	1
TESTED BY	Leo Hung		

No	Freq. [MHz]	Corr. Factor [dB]	Reading Value [dB (uV)]		Emission Level [dB (uV)]		Limit [dB (uV)]		Margin (dB)	
			Q.P.	AV.	Q.P.	AV.	Q.P.	AV.	Q.P.	AV.
			1	0.173	0.10	42.97	-	43.07	-	64.79
2	0.275	0.11	25.12	-	25.23	-	60.97	50.97	-35.73	-
3	0.517	0.12	25.85	-	25.97	-	56.00	46.00	-30.03	-
4	2.078	0.16	30.09	-	30.25	-	56.00	46.00	-25.75	-
5	5.176	0.23	27.08	-	27.31	-	60.00	50.00	-32.69	-
6	10.371	0.31	31.86	-	32.17	-	60.00	50.00	-27.83	-

- REMARKS:**
1. Q.P. and AV. are abbreviations of quasi-peak and average individually.
 2. "-": The Quasi-peak reading value also meets average limit and measurement with the average detector is unnecessary.
 3. The emission levels of other frequencies were very low against the limit.
 4. Margin value = Emission level - Limit value
 5. Correction factor = Insertion loss + Cable loss
 6. Emission Level = Correction Factor + Reading Value.

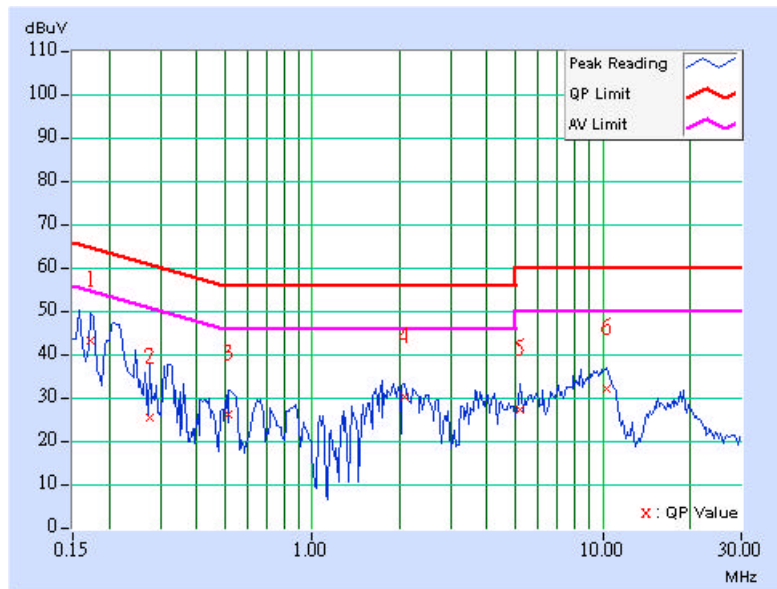



EUT	Wireless-G Portable USB Adapter	MODEL	WUSB54GP ver. 4
CHANNEL	1	6dB BANDWIDTH	9 kHz
INPUT POWER (SYSTEM)	120 Vac, 60 Hz	PHASE	Line (L)
ENVIRONMENTAL CONDITIONS	24 deg. C, 64% RH, 991 hPa	TEST MODE	2
TESTED BY	Leo Hung		

No	Freq. [MHz]	Corr. Factor (dB)	Reading Value [dB (uV)]		Emission Level [dB (uV)]		Limit [dB (uV)]		Margin (dB)	
			Q.P.	AV.	Q.P.	AV.	Q.P.	AV.	Q.P.	AV.
			1	0.170	0.10	48.03	-	48.13	-	64.98
2	0.447	0.12	48.67	35.84	48.79	35.96	56.93	46.93	-8.14	-10.97
3	0.853	0.22	44.21	-	44.43	-	56.00	46.00	-11.57	-
4	2.508	0.27	40.34	-	40.61	-	56.00	46.00	-15.39	-
5	9.742	0.52	39.25	-	39.77	-	60.00	50.00	-20.23	-
6	16.797	0.78	34.52	-	35.30	-	60.00	50.00	-24.70	-

- REMARKS:**
1. Q.P. and AV. are abbreviations of quasi-peak and average individually.
 2. "-": The Quasi-peak reading value also meets average limit and measurement with the average detector is unnecessary.
 3. The emission levels of other frequencies were very low against the limit.
 4. Margin value = Emission level - Limit value
 5. Correction factor = Insertion loss + Cable loss
 6. Emission Level = Correction Factor + Reading Value.

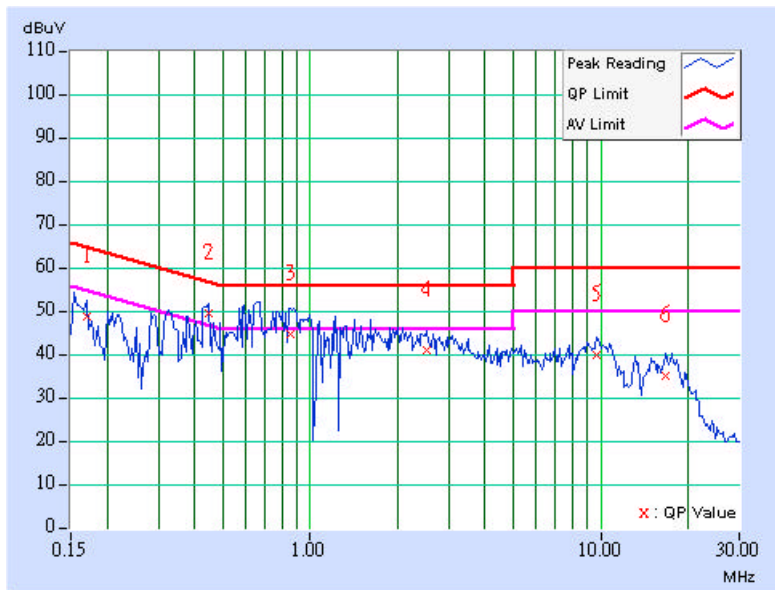



EUT	Wireless-G Portable USB Adapter	MODEL	WUSB54GP ver. 4
CHANNEL	1	6dB BANDWIDTH	9 kHz
INPUT POWER (SYSTEM)	120 Vac, 60 Hz	PHASE	Neutral (N)
ENVIRONMENTAL CONDITIONS	24 deg. C, 64% RH, 991 hPa	TEST MODE	2
TESTED BY	Leo Hung		

No	Freq. [MHz]	Corr. Factor (dB)	Reading Value [dB (uV)]		Emission Level [dB (uV)]		Limit [dB (uV)]		Margin (dB)	
			Q.P.	AV.	Q.P.	AV.	Q.P.	AV.	Q.P.	AV.
			1	0.158	0.10	47.36	-	47.46	-	65.58
2	0.341	0.11	42.64	-	42.75	-	59.17	49.17	-16.42	-
3	0.748	0.18	44.86	-	45.04	-	56.00	46.00	-10.96	-
4	1.320	0.24	43.50	-	43.74	-	56.00	46.00	-12.26	-
5	3.352	0.29	39.40	-	39.69	-	56.00	46.00	-16.31	-
6	9.879	0.49	39.98	-	40.47	-	60.00	50.00	-19.53	-

- REMARKS:**
1. Q.P. and AV. are abbreviations of quasi-peak and average individually.
 2. "-": The Quasi-peak reading value also meets average limit and measurement with the average detector is unnecessary.
 3. The emission levels of other frequencies were very low against the limit.
 4. Margin value = Emission level - Limit value
 5. Correction factor = Insertion loss + Cable loss
 6. Emission Level = Correction Factor + Reading Value.

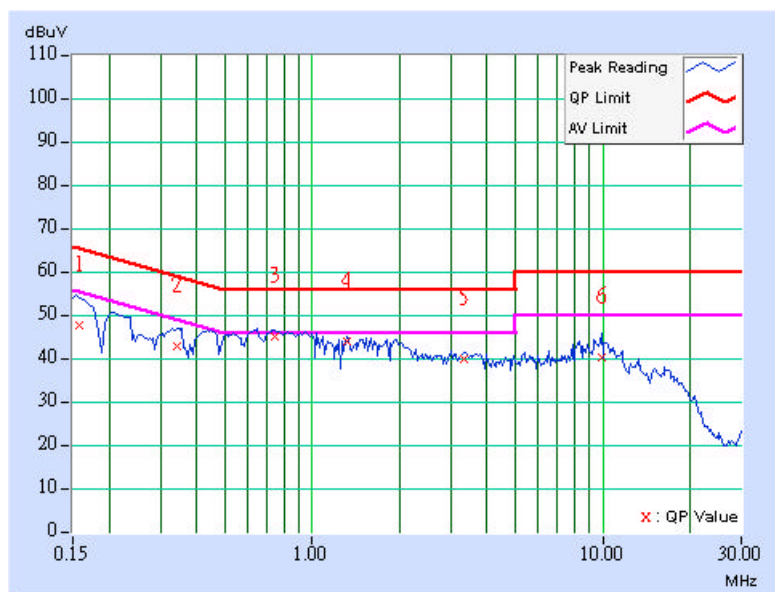



EUT	Wireless-G Portable USB Adapter	MODEL	WUSB54GP ver. 4
CHANNEL	6	6dB BANDWIDTH	9 kHz
INPUT POWER (SYSTEM)	120 Vac, 60 Hz	PHASE	Line (L)
ENVIRONMENTAL CONDITIONS	24 deg. C, 64% RH, 991 hPa	TEST MODE	2
TESTED BY	Leo Hung		

No	Freq. [MHz]	Corr. Factor [dB]	Reading Value [dB (uV)]		Emission Level [dB (uV)]		Limit [dB (uV)]		Margin (dB)	
			Q.P.	AV.	Q.P.	AV.	Q.P.	AV.	Q.P.	AV.
			1	0.197	0.10	47.93	-	48.03	-	63.74
2	0.435	0.12	47.64	37.36	47.76	37.48	57.15	47.15	-9.39	-9.67
3	0.861	0.22	47.27	35.34	47.49	35.56	56.00	46.00	-8.51	-10.44
4	1.688	0.26	42.62	-	42.88	-	56.00	46.00	-13.12	-
5	3.605	0.30	38.35	-	38.65	-	56.00	46.00	-17.35	-
6	10.367	0.54	39.56	-	40.10	-	60.00	50.00	-19.90	-

- REMARKS:**
1. Q.P. and AV. are abbreviations of quasi-peak and average individually.
 2. "-": The Quasi-peak reading value also meets average limit and measurement with the average detector is unnecessary.
 3. The emission levels of other frequencies were very low against the limit.
 4. Margin value = Emission level - Limit value
 5. Correction factor = Insertion loss + Cable loss
 6. Emission Level = Correction Factor + Reading Value.

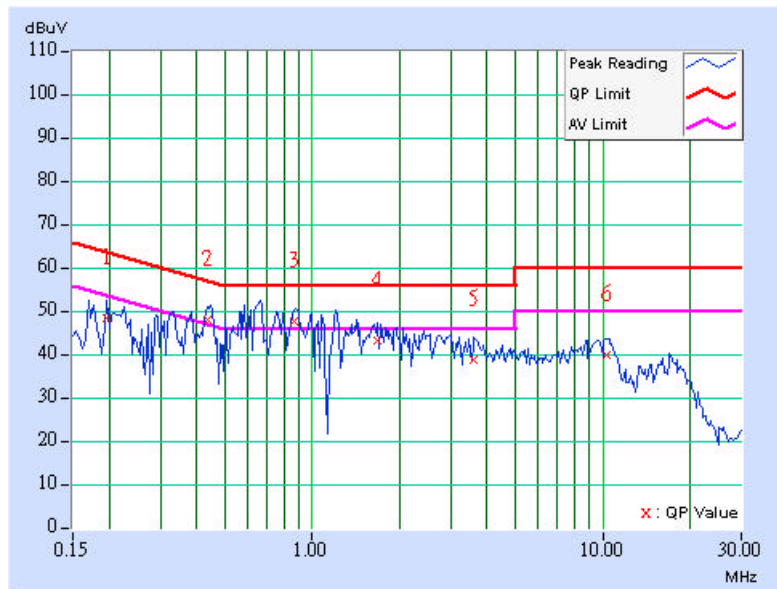



EUT	Wireless-G Portable USB Adapter	MODEL	WUSB54GP ver. 4
CHANNEL	6	6dB BANDWIDTH	9 kHz
INPUT POWER (SYSTEM)	120 Vac, 60 Hz	PHASE	Neutral (N)
ENVIRONMENTAL CONDITIONS	24 deg. C, 64% RH, 991 hPa	TEST MODE	2
TESTED BY	Leo Hung		

No	Freq. [MHz]	Corr. Factor (dB)	Reading Value		Emission Level		Limit		Margin	
			[dB (uV)]		[dB (uV)]		[dB (uV)]		(dB)	
			Q.P.	AV.	Q.P.	AV.	Q.P.	AV.	Q.P.	AV.
1	0.193	0.10	47.69	-	47.79	-	63.91	53.91	-16.12	-
2	0.443	0.12	49.05	38.75	49.17	38.87	57.01	47.01	-7.83	-8.13
3	0.880	0.21	47.29	36.49	47.50	36.70	56.00	46.00	-8.50	-9.30
4	1.516	0.25	43.58	-	43.83	-	56.00	46.00	-12.17	-
5	3.160	0.28	39.58	-	39.86	-	56.00	46.00	-16.14	-
6	10.402	0.50	40.04	-	40.54	-	60.00	50.00	-19.46	-

- REMARKS:**
1. Q.P. and AV. are abbreviations of quasi-peak and average individually.
 2. "-": The Quasi-peak reading value also meets average limit and measurement with the average detector is unnecessary.
 3. The emission levels of other frequencies were very low against the limit.
 4. Margin value = Emission level - Limit value
 5. Correction factor = Insertion loss + Cable loss
 6. Emission Level = Correction Factor + Reading Value.

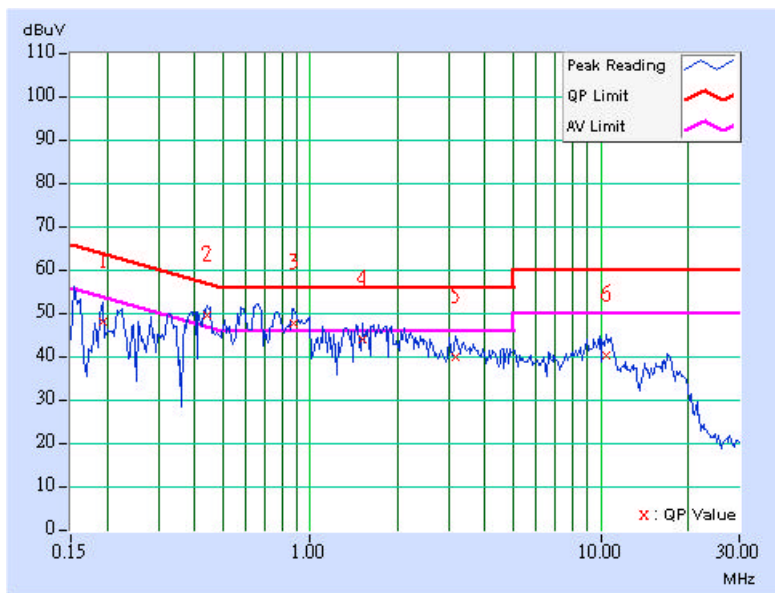



EUT	Wireless-G Portable USB Adapter	MODEL	WUSB54GP ver. 4
CHANNEL	11	6dB BANDWIDTH	9 kHz
INPUT POWER (SYSTEM)	120 Vac, 60 Hz	PHASE	Line (L)
ENVIRONMENTAL CONDITIONS	24 deg. C, 64% RH, 991 hPa	TEST MODE	2
TESTED BY	Leo Hung		

No	Freq. [MHz]	Corr. Factor (dB)	Reading Value		Emission Level		Limit		Margin	
			[dB (uV)]		[dB (uV)]		[dB (uV)]		(dB)	
			Q.P.	AV.	Q.P.	AV.	Q.P.	AV.	Q.P.	AV.
1	0.162	0.10	46.79	-	46.89	-	65.38	55.38	-18.48	-
2	0.388	0.11	46.98	-	47.09	-	58.10	48.10	-11.01	-
3	0.658	0.17	49.12	36.34	49.29	36.51	56.00	46.00	-6.71	-9.49
4	1.438	0.25	45.44	-	45.69	-	56.00	46.00	-10.31	-
5	5.367	0.37	36.67	-	37.04	-	60.00	50.00	-22.96	-
6	10.406	0.54	39.49	-	40.03	-	60.00	50.00	-19.97	-

- REMARKS:**
1. Q.P. and AV. are abbreviations of quasi-peak and average individually.
 2. "-": The Quasi-peak reading value also meets average limit and measurement with the average detector is unnecessary.
 3. The emission levels of other frequencies were very low against the limit.
 4. Margin value = Emission level - Limit value
 5. Correction factor = Insertion loss + Cable loss
 6. Emission Level = Correction Factor + Reading Value.

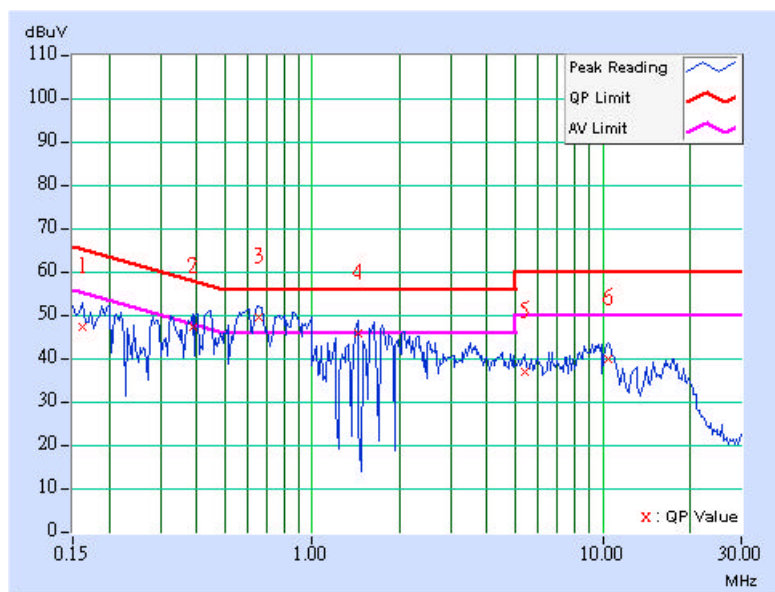



EUT	Wireless-G Portable USB Adapter	MODEL	WUSB54GP ver. 4
CHANNEL	11	6dB BANDWIDTH	9 kHz
INPUT POWER (SYSTEM)	120 Vac, 60 Hz	PHASE	Netural (N)
ENVIRONMENTAL CONDITIONS	24 deg. C, 64% RH, 991 hPa	TEST MODE	2
TESTED BY	Leo Hung		

No	Freq. [MHz]	Corr. Factor [dB]	Reading Value [dB (uV)]		Emission Level [dB (uV)]		Limit [dB (uV)]		Margin (dB)	
			Q.P.	AV.	Q.P.	AV.	Q.P.	AV.	Q.P.	AV.
			1	0.166	0.10	47.59	-	47.69	-	65.18
2	0.330	0.11	47.69	-	47.80	-	59.46	49.46	-11.66	-
3	0.662	0.16	49.48	37.12	49.64	37.28	56.00	46.00	-6.36	-8.72
4	1.234	0.24	46.10	32.54	46.34	32.78	56.00	46.00	-9.66	-13.22
5	3.234	0.28	39.54	-	39.82	-	56.00	46.00	-16.18	-
6	10.078	0.49	40.28	-	40.77	-	60.00	50.00	-19.23	-

- REMARKS:**
1. Q.P. and AV. are abbreviations of quasi-peak and average individually.
 2. "-": The Quasi-peak reading value also meets average limit and measurement with the average detector is unnecessary.
 3. The emission levels of other frequencies were very low against the limit.
 4. Margin value = Emission level - Limit value
 5. Correction factor = Insertion loss + Cable loss
 6. Emission Level = Correction Factor + Reading Value.

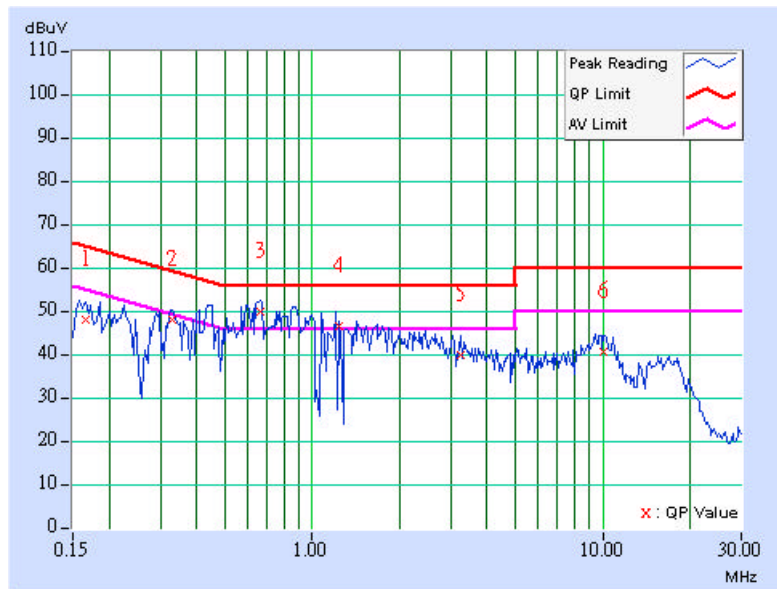



4.2 RADIATED EMISSION MEASUREMENT

4.2.1 LIMITS OF RADIATED EMISSION MEASUREMENT

Emissions radiated outside of the specified bands, shall be according to the general radiated limits in 15.209 as following:

Frequencies (MHz)	Field strength (microvolts/meter)	Measurement distance (meters)
0.009-0.490	2400/F(kHz)	300
0.490-1.705	24000/F(kHz)	30
1.705-30.0	30	30
30-88	100	3
88-216	150	3
216-960	200	3
Above 960	500	3

NOTE:

1. The lower limit shall apply at the transition frequencies.
2. Emission level (dBuV/m) = 20 log Emission level (uV/m).
3. As shown in 15.35(b), for frequencies above 1000MHz, the field strength limits are based on average detector, however, the peak field strength of any emission shall not exceed the maximum permitted average limits, specified above by more than 20dB under any condition of modulation.



4.2.2 TEST INSTRUMENTS

DESCRIPTION & MANUFACTURER	MODEL NO.	SERIAL NO.	CALIBRATED UNTIL
Test Receiver ROHDE & SCHWARZ	ESIB7	100188	Jan. 13, 2005
Spectrum Analyzer ROHDE & SCHWARZ	FSP40	100039	Dec. 15, 2004
BILOG Antenna SCHWARZBECK	VULB9168	9168-157	Feb. 03, 2005
HORN Antenna SCHWARZBECK	BBHA 9120 D	9120D-407	Feb. 03, 2005
HORN Antenna SCHWARZBECK	BBHA 9170	BBHA 9170241	Feb. 23, 2005
Preamplifier Agilent	8449B	3008A01959	Jan. 11, 2005
Preamplifier Agilent	8447D	2944A10738	Oct. 10, 2005
RF signal cable HUBER+SUHNER	SUCOFLEX 104	218182/4	Mar. 04, 2005
RF signal cable HUBER+SUHNER	SUCOFLEX 104	218194/4	Mar. 04, 2005
Software ADT.	ADT_Radiated_V5.14	NA	NA
Antenna Tower ADT.	AT100	AT93021702	NA
Turn Table ADT.	TT100.	TT93021702	NA
Controller ADT.	SC100.	SC93021702	NA

- NOTE:**
1. The calibration interval of the above test instruments is 12 months and the calibrations are traceable to NML/ROC and NIST/USA.
 2. The test was performed in HwaYa Chamber 1.
 3. The horn antenna and HP preamplifier (model: 8449B) are used only for the measurement of emission frequency above 1GHz if tested.
 4. The IC Site Registration No. is IC4924-2..

4.2.3 TEST PROCEDURES

- a. The EUT was placed on the top of a rotating table 0.8 meters above the ground at a 3 meter semi-anechoic chamber. The table was rotated 360 degrees to determine the position of the highest radiation.
- b. The EUT was set 3 meters away from the interference-receiving antenna, which was mounted on the top of a variable-height antenna tower.
- c. The antenna is a broadband antenna, and its height is varied from one meter to four meters above the ground to determine the maximum value of the field strength. Both horizontal and vertical polarizations of the antenna are set to make the measurement.
- d. For each suspected emission, the EUT was arranged to its worst case and then the antenna was tuned to heights from 1 meter to 4 meters and the rotatable table was turned from 0 degrees to 360 degrees to find the maximum reading.
- e. The test-receiver system was set to Peak Detect Function and Specified Bandwidth with Maximum Hold Mode.
- f. If the emission level of the EUT in peak mode was 10 dB lower than the limit specified, then testing could be stopped and the peak values of the EUT would be reported. Otherwise the emissions that did not have 10 dB margin would be re-tested one by one using peak, quasi-peak or average method as specified and then reported in a data sheet.

NOTE:

1. The resolution bandwidth and video bandwidth of test receiver/spectrum analyzer is 120kHz for Peak detection (PK) and Quasi-peak detection (QP) at frequency below 1GHz.
2. The resolution bandwidth and video bandwidth of test receiver/spectrum analyzer is 1 MHz for Peak detection at frequency above 1GHz.
3. The resolution bandwidth of test receiver/spectrum analyzer is 1 MHz and the video bandwidth is 10 Hz for Average detection (AV) at frequency above 1GHz.

4.2.4 DEVIATION FROM TEST STANDARD

No deviation

4.2.5 TEST SETUP

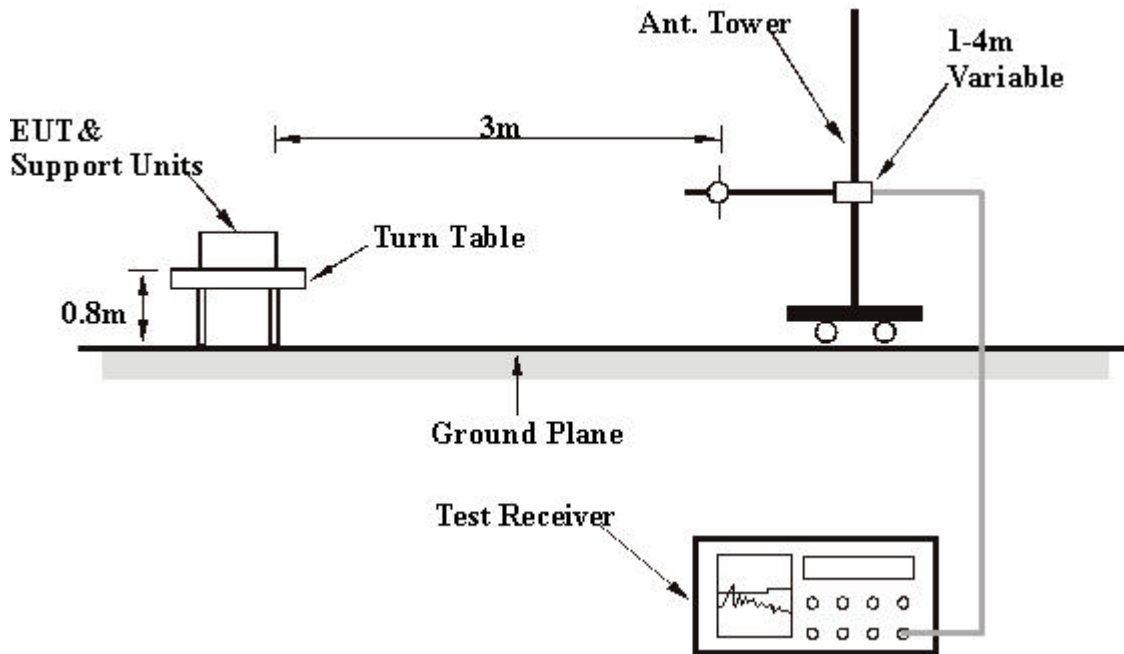

For the actual test configuration, please refer to the related item – Photographs of the Test Configuration.

4.2.6 EUT OPERATING CONDITIONS

Same as 4.1.6



4.2.7 TEST RESULTS

EUT	Wireless-G Portable USB Adapter	MODEL	WUSB54GP ver. 4
CHANNEL	11	FREQUENCY RANGE	Below 1000 MHz
INPUT POWER (SYSTEM)	120 Vac, 60Hz	DETECTOR FUNCTION	Quasi-Peak
ENVIRONMENTAL CONDITIONS	25 deg. C, 60% RH, 991 hPa	TEST MODE	1
TESTED BY	Match Tsui		

ANTENNA POLARITY & TEST DISTANCE: HORIZONTAL AT 3 M								
No.	Freq. (MHz)	Emission Level (dBuV/m)	Limit (dBuV/m)	Margin (dB)	Antenna Height (m)	Table Angle (Degree)	Raw Value (dBuV)	Correction Factor (dB/m)
1	105.81	25.46 QP	43.50	-18.04	1.75 H	151	13.89	11.58
2	164.13	36.45 QP	43.50	-7.05	1.50 H	148	21.96	14.49
3	199.12	34.39 QP	43.50	-9.11	1.50 H	187	22.93	11.46
4	239.94	32.45 QP	46.00	-13.55	1.00 H	31	19.37	13.07
5	360.46	38.94 QP	46.00	-7.06	1.00 H	229	23.06	15.88
6	420.72	36.57 QP	46.00	-9.43	1.75 H	250	19.27	17.30
7	467.37	38.06 QP	46.00	-7.94	1.75 H	85	19.76	18.30
8	601.50	33.91 QP	46.00	-12.09	1.25 H	331	12.88	21.03
9	665.65	31.56 QP	46.00	-14.44	1.00 H	40	9.69	21.87
10	720.08	35.75 QP	46.00	-10.25	1.00 H	37	12.95	22.79
11	832.83	32.44 QP	46.00	-13.56	1.00 H	43	8.38	24.06
12	935.85	30.82 QP	46.00	-15.18	1.50 H	316	5.33	25.49

- REMARKS:**
1. Emission level(dBuV/m)=Raw Value(dBuV) + Correction Factor(dB/m)
 2. Correction Factor(dB/m) = Antenna Factor (dB/m) + Cable Factor (dB)
 3. The other emission levels were very low against the limit.
 4. Margin value = Emission level – Limit value.



EUT	Wireless-G Portable USB Adapter	MODEL	WUSB54GP ver. 4
CHANNEL	11	FREQUENCY RANGE	Below 1000 MHz
INPUT POWER (SYSTEM)	120 Vac, 60Hz	DETECTOR FUNCTION	Quasi-Peak
ENVIRONMENTAL CONDITIONS	25 deg. C, 60% RH, 991 hPa	TEST MODE	1
TESTED BY	Match Tsui		

ANTENNA POLARITY & TEST DISTANCE: VERTICAL AT 3 M

No.	Freq. (MHz)	Emission Level (dBuV/m)	Limit (dBuV/m)	Margin (dB)	Antenna Height (m)	Table Angle (Degree)	Raw Value (dBuV)	Correction Factor (dB/m)
1	45.55	32.72 QP	40.00	-7.28	1.00 V	313	17.49	15.23
2	66.93	35.08 QP	40.00	-4.92	1.00 V	343	22.15	12.93
3	99.98	29.25 QP	43.50	-14.25	1.25 V	259	18.27	10.98
4	127.19	27.71 QP	43.50	-15.79	1.25 V	121	14.18	13.53
5	156.35	29.79 QP	43.50	-13.71	1.00 V	283	14.98	14.80
6	199.12	29.40 QP	43.50	-14.10	2.00 V	112	17.94	11.46
7	360.46	30.82 QP	46.00	-15.18	2.50 V	277	14.94	15.88
8	405.17	31.23 QP	46.00	-14.77	2.50 V	10	14.35	16.89
9	597.62	29.73 QP	46.00	-16.27	1.00 V	205	8.78	20.95
10	665.65	31.39 QP	46.00	-14.61	1.75 V	79	9.51	21.87
11	720.08	31.70 QP	46.00	-14.30	2.00 V	316	8.90	22.79
12	832.83	32.76 QP	46.00	-13.24	1.25 V	319	8.70	24.06
13	906.69	31.96 QP	46.00	-14.04	2.00 V	220	6.78	25.18

- REMARKS:**
1. Emission level(dBuV/m)=Raw Value(dBuV) + Correction Factor(dB/m)
 2. Correction Factor(dB/m) = Antenna Factor (dB/m) + Cable Factor (dB)
 3. The other emission levels were very low against the limit.
 4. Margin value = Emission level – Limit value.



EUT	Wireless-G Portable USB Adapter	MODEL	WUSB54GP ver. 4
CHANNEL	11	FREQUENCY RANGE	Below 1000 MHz
INPUT POWER (SYSTEM)	120 Vac, 60Hz	DETECTOR FUNCTION	Quasi-Peak
ENVIRONMENTAL CONDITIONS	24 deg. C, 62% RH, 991 hPa	TEST MODE	2
TESTED BY	Steven Lu		

ANTENNA POLARITY & TEST DISTANCE: HORIZONTAL AT 3 M								
No.	Freq. (MHz)	Emission Level (dBuV/m)	Limit (dBuV/m)	Margin (dB)	Antenna Height (m)	Table Angle (Degree)	Raw Value (dBuV)	Correction Factor (dB/m)
1	111.64	37.57 QP	43.50	-5.93	3.00 H	73	25.40	12.17
2	199.12	28.92 QP	43.50	-14.58	1.50 H	259	17.46	11.46
3	329.36	34.82 QP	46.00	-11.18	1.25 H	334	19.64	15.18
4	360.46	36.79 QP	46.00	-9.21	1.25 H	196	20.91	15.88
5	424.61	31.81 QP	46.00	-14.19	2.00 H	160	14.41	17.40
6	554.85	33.00 QP	46.00	-13.00	1.50 H	148	13.19	19.82
7	665.65	33.83 QP	46.00	-12.17	1.50 H	148	11.96	21.87
8	733.69	34.04 QP	46.00	-11.96	1.00 H	325	10.91	23.13
9	865.87	30.63 QP	46.00	-15.37	1.00 H	157	6.15	24.48

- REMARKS:**
1. Emission level(dBuV/m)=Raw Value(dBuV) + Correction Factor(dB/m)
 2. Correction Factor(dB/m) = Antenna Factor (dB/m) + Cable Factor (dB)
 3. The other emission levels were very low against the limit.
 4. Margin value = Emission level – Limit value.



EUT	Wireless-G Portable USB Adapter	MODEL	WUSB54GP ver. 4
CHANNEL	11	FREQUENCY RANGE	Below 1000 MHz
INPUT POWER (SYSTEM)	120 Vac, 60Hz	DETECTOR FUNCTION	Quasi-Peak
ENVIRONMENTAL CONDITIONS	24 deg. C, 62% RH, 991 hPa	TEST MODE	2
TESTED BY	Steven Lu		

ANTENNA POLARITY & TEST DISTANCE: VERTICAL AT 3 M

No.	Freq. (MHz)	Emission Level (dBuV/m)	Limit (dBuV/m)	Margin (dB)	Antenna Height (m)	Table Angle (Degree)	Raw Value (dBuV)	Correction Factor (dB/m)
1	45.55	34.31 QP	40.00	-5.69	1.00 V	25	19.08	15.23
2	66.93	34.59 QP	40.00	-5.41	1.00 V	340	21.66	12.93
3	127.19	35.82 QP	43.50	-7.68	1.00 V	73	22.29	13.53
4	160.24	31.25 QP	43.50	-12.25	1.00 V	295	16.39	14.87
5	208.84	28.86 QP	43.50	-14.64	1.00 V	340	17.27	11.59
6	360.46	31.67 QP	46.00	-14.33	1.25 V	358	15.79	15.88
7	455.71	34.50 QP	46.00	-11.50	1.00 V	310	16.35	18.15
8	500.42	31.87 QP	46.00	-14.13	1.00 V	328	13.13	18.74
9	533.47	30.04 QP	46.00	-15.96	1.25 V	337	10.66	19.37
10	768.68	31.64 QP	46.00	-14.36	1.50 V	259	8.00	23.64
11	990.28	31.96 QP	54.00	-22.04	1.00 V	181	6.20	25.77

- REMARKS:**
1. Emission level(dBuV/m)=Raw Value(dBuV) + Correction Factor(dB/m)
 2. Correction Factor(dB/m) = Antenna Factor (dB/m) + Cable Factor (dB)
 3. The other emission levels were very low against the limit.
 4. Margin value = Emission level – Limit value.



4.2.8 TEST RESULTS (A)

EUT	Wireless-G Portable USB Adapter	MODEL	WUSB54GP ver. 4
CHANNEL	1	FREQUENCY RANGE	1~25 GHz
INPUT POWER (SYSTEM)	120 Vac, 60 Hz	DETECTOR FUNCTION	Peak (PK) Average (AV)
ENVIRONMENTAL CONDITIONS	25 deg. C, 60% RH, 991 hPa	TESTED BY	Match Tsui

ANTENNA POLARITY & TEST DISTANCE: HORIZONTAL AT 3 M

No.	Freq. (MHz)	Emission Level (dBuV/m)	Limit (dBuV/m)	Margin (dB)	Antenna Height (m)	Table Angle (Degree)	Raw Value (dBuV)	Correction Factor (dB/m)
1	2390.00	40.80 PK	74.00	-33.20	1.00 H	24	9.00	31.80
1	2390.00	33.18 AV	54.00	-20.82	1.00 H	24	1.38	31.80
2	*2412.00	99.07 PK			1.00 H	24	67.20	31.87
2	*2412.00	91.45 AV			1.00 H	24	59.58	31.87
3	2786.00	51.03 PK	74.00	-22.97	1.11 H	17	17.72	33.31
3	2786.00	47.76 AV	54.00	-6.24	1.11 H	17	14.45	33.31
4	4824.00	48.87 PK	74.00	-25.13	1.00 H	165	10.76	38.11
4	4824.00	36.79 AV	54.00	-17.21	1.00 H	165	-1.32	38.11

ANTENNA POLARITY & TEST DISTANCE: VERTICAL AT 3 M

No.	Freq. (MHz)	Emission Level (dBuV/m)	Limit (dBuV/m)	Margin (dB)	Antenna Height (m)	Table Angle (Degree)	Raw Value (dBuV)	Correction Factor (dB/m)
1	2390.00	50.89 PK	74.00	-23.11	1.13 V	72	19.09	31.80
1	2390.00	43.37 AV	54.00	-10.63	1.13 V	72	11.57	31.80
2	*2412.00	109.16 PK			1.13 V	72	77.29	31.87
2	*2412.00	101.64 AV			1.13 V	72	69.77	31.87
3	2786.00	51.03 PK	74.00	-22.97	1.02 V	292	17.72	33.31
3	2786.00	47.75 AV	54.00	-6.25	1.02 V	292	14.44	33.31
4	3162.00	62.31 PK	89.16	-26.85	1.04 V	29	27.49	34.82
4	3162.00	54.80 AV	81.64	-26.84	1.04 V	29	19.98	34.82
5	4824.00	49.74 PK	74.00	-24.26	1.08 V	243	11.63	38.11
5	4824.00	36.79 AV	54.00	-17.21	1.08 V	243	-1.32	38.11

- REMARKS:**
1. Emission level(dBuV/m)=Raw Value(dBuV) + Correction Factor(dB/m)
 2. Correction Factor(dB/m) = Antenna Factor (dB/m) + Cable Factor (dB)
 3. The other emission levels were very low against the limit.
 4. Margin value = Emission level – Limit value.
 5. “ * ” : Fundamental frequency.



EUT	Wireless-G Portable USB Adapter	MODEL	WUSB54GP ver. 4
CHANNEL	6	FREQUENCY RANGE	1~25 GHz
INPUT POWER (SYSTEM)	120 Vac, 60 Hz	DETECTOR FUNCTION	Peak(PK) Average (AV)
ENVIRONMENTAL CONDITIONS	25 deg. C, 60% RH, 991 hPa	TESTED BY	Match Tsui

ANTENNA POLARITY & TEST DISTANCE: HORIZONTAL AT 3 M

No.	Freq. (MHz)	Emission Level (dBuV/m)	Limit (dBuV/m)	Margin (dB)	Antenna Height (m)	Table Angle (Degree)	Raw Value (dBuV)	Correction Factor (dB/m)
1	*2437.00	99.29 PK			1.23 H	223	67.34	31.95
1	*2437.00	91.87 AV			1.23 H	223	59.92	31.95
2	2811.00	50.40 PK	74.00	-23.60	1.06 H	226	16.99	33.41
2	2811.00	47.42 AV	54.00	-6.58	1.06 H	226	14.01	33.41
3	4874.00	49.68 PK	74.00	-24.32	1.02 H	56	11.40	38.28
3	4874.00	36.53 AV	54.00	-17.47	1.02 H	56	-1.75	38.28

ANTENNA POLARITY & TEST DISTANCE: VERTICAL AT 3 M

No.	Freq. (MHz)	Emission Level (dBuV/m)	Limit (dBuV/m)	Margin (dB)	Antenna Height (m)	Table Angle (Degree)	Raw Value (dBuV)	Correction Factor (dB/m)
1	*2437.00	108.33 PK			1.12 V	177	76.38	31.95
1	*2437.00	100.83 AV			1.12 V	177	68.88	31.95
2	2811.00	50.50 PK	74.00	-23.50	1.01 V	293	17.09	33.41
2	2811.00	47.48 AV	54.00	-6.52	1.01 V	293	14.07	33.41
3	3187.00	64.05 PK	88.33	-24.28	1.02 V	203	29.13	34.92
3	3187.00	56.08 AV	80.33	-24.75	1.02 V	203	21.16	34.92
4	4874.00	49.23 PK	74.00	-24.77	1.03 V	339	10.95	38.28
4	4874.00	36.89 AV	54.00	-17.11	1.03 V	339	-1.39	38.28

- REMARKS:**
1. Emission level(dBuV/m)=Raw Value(dBuV) + Correction Factor(dB/m)
 2. Correction Factor(dB/m) = Antenna Factor (dB/m) + Cable Factor (dB)
 3. The other emission levels were very low against the limit.
 4. Margin value = Emission level – Limit value.
 5. “ * ” : Fundamental frequency.



EUT	Wireless-G Portable USB Adapter	MODEL	WUSB54GP ver. 4
CHANNEL	11	FREQUENCY RANGE	1~25 GHz
INPUT POWER (SYSTEM)	120 Vac, 60 Hz	DETECTOR FUNCTION	Peak(PK) Average (AV)
ENVIRONMENTAL CONDITIONS	25 deg. C, 60% RH, 991 hPa	TESTED BY	Match Tsui

ANTENNA POLARITY & TEST DISTANCE: HORIZONTAL AT 3 M

No.	Freq. (MHz)	Emission Level (dBuV/m)	Limit (dBuV/m)	Margin (dB)	Antenna Height (m)	Table Angle (Degree)	Raw Value (dBuV)	Correction Factor (dB/m)
1	*2462.00	99.10 PK			1.00 H	24	67.08	32.02
1	*2462.00	92.10 AV			1.00 H	24	60.08	32.02
2	2483.50	39.51 PK	74.00	-34.49	1.00 H	24	7.42	32.09
2	2483.50	32.51 AV	54.00	-21.49	1.00 H	24	0.42	32.09
3	2836.00	49.67 PK	74.00	-24.33	1.07 H	8	16.17	33.50
3	2836.00	46.28 AV	54.00	-7.72	1.07 H	8	12.78	33.50
4	4924.00	48.52 PK	74.00	-25.48	1.05 H	1	10.03	38.49
4	4924.00	36.74 AV	54.00	-17.26	1.05 H	1	-1.75	38.49

ANTENNA POLARITY & TEST DISTANCE: VERTICAL AT 3 M

No.	Freq. (MHz)	Emission Level (dBuV/m)	Limit (dBuV/m)	Margin (dB)	Antenna Height (m)	Table Angle (Degree)	Raw Value (dBuV)	Correction Factor (dB/m)
1	*2462.00	108.10 PK			1.11 V	182	76.08	32.02
1	*2462.00	100.10 AV			1.11 V	182	68.08	32.02
2	2483.50	48.51 PK	74.00	-25.49	1.11 V	182	16.42	32.09
2	2483.50	40.51 AV	54.00	-13.49	1.11 V	182	8.42	32.09
3	2836.00	49.82 PK	74.00	-24.18	1.00 V	293	16.32	33.50
3	2836.00	46.53 AV	54.00	-7.47	1.00 V	293	13.03	33.50
4	3212.00	61.77 PK	88.10	-26.33	1.21 V	17	26.79	34.98
4	3212.00	54.55 AV	80.10	-25.55	1.21 V	17	19.57	34.98
5	4924.00	49.12 PK	74.00	-24.88	1.04 V	8	10.63	38.49
5	4924.00	37.06 AV	54.00	-16.94	1.04 V	8	-1.43	38.49

- REMARKS:**
1. Emission level(dBuV/m)=Raw Value(dBuV) + Correction Factor(dB/m)
 2. Correction Factor(dB/m) = Antenna Factor (dB/m) + Cable Factor (dB)
 3. The other emission levels were very low against the limit.
 4. Margin value = Emission level – Limit value.
 5. " * " : Fundamental frequency.



4.2.9 TEST RESULTS (B)

EUT	Wireless-G Portable USB Adapter	MODEL	WUSB54GP ver. 4
CHANNEL	1	FREQUENCY RANGE	1~25 GHz
INPUT POWER (SYSTEM)	120 Vac, 60 Hz	DETECTOR FUNCTION	Peak(PK) Average (AV)
ENVIRONMENTAL CONDITIONS	25 deg. C, 60% RH, 991 hPa	TESTED BY	Match Tsui

ANTENNA POLARITY & TEST DISTANCE: HORIZONTAL AT 3 M

No.	Freq. (MHz)	Emission Level (dBuV/m)	Limit (dBuV/m)	Margin (dB)	Antenna Height (m)	Table Angle (Degree)	Raw Value (dBuV)	Correction Factor (dB/m)
1	2390.00	48.31 PK	74.00	-25.69	1.29 H	206	16.51	31.80
1	2390.00	39.06 AV	54.00	-14.94	1.29 H	206	7.26	31.80
2	*2412.00	99.56 PK			1.29 H	206	67.69	31.87
2	*2412.00	90.31 AV			1.29 H	206	58.44	31.87
3	2786.00	50.68 PK	74.00	-23.32	1.05 H	10	17.37	33.31
3	2786.00	47.08 AV	54.00	-6.92	1.05 H	10	13.77	33.31
4	4824.00	50.08 PK	74.00	-23.92	1.01 H	203	11.97	38.11
4	4824.00	36.63 AV	54.00	-17.37	1.01 H	203	-1.48	38.11

ANTENNA POLARITY & TEST DISTANCE: VERTICAL AT 3 M

No.	Freq. (MHz)	Emission Level (dBuV/m)	Limit (dBuV/m)	Margin (dB)	Antenna Height (m)	Table Angle (Degree)	Raw Value (dBuV)	Correction Factor (dB/m)
1	2390.00	56.24 PK	74.00	-17.76	1.14 V	70	24.44	31.80
1	2390.00	46.98 AV	54.00	-7.02	1.14 V	70	15.18	31.80
2	*2412.00	107.49 PK			1.14 V	70	75.62	31.87
2	*2412.00	98.23 AV			1.14 V	70	66.36	31.87
3	2786.00	50.58 PK	74.00	-23.42	1.01 V	293	17.27	33.31
3	2786.00	47.11 AV	54.00	-6.89	1.01 V	293	13.80	33.31
4	3166.00	58.90 PK	74.00	-15.10	1.00 V	60	24.06	34.83
4	3166.00	49.85 AV	54.00	-4.15	1.00 V	60	15.01	34.83
5	4824.00	49.25 PK	74.00	-24.75	1.04 V	198	11.14	38.11
5	4824.00	37.07 AV	54.00	-16.93	1.04 V	198	-1.04	38.11

- REMARKS:**
1. Emission level(dBuV/m)=Raw Value(dBuV) + Correction Factor(dB/m)
 2. Correction Factor(dB/m) = Antenna Factor (dB/m) + Cable Factor (dB)
 3. The other emission levels were very low against the limit.
 4. Margin value = Emission level – Limit value.
 5. “ * ” : Fundamental frequency.



EUT	Wireless-G Portable USB Adapter	MODEL	WUSB54GP ver. 4
CHANNEL	6	FREQUENCY RANGE	1~25 GHz
INPUT POWER (SYSTEM)	120 Vac, 60 Hz	DETECTOR FUNCTION	Peak(PK) Average (AV)
ENVIRONMENTAL CONDITIONS	25 deg. C, 60% RH, 991 hPa	TESTED BY	Match Tsui

ANTENNA POLARITY & TEST DISTANCE: HORIZONTAL AT 3 M

No.	Freq. (MHz)	Emission Level (dBuV/m)	Limit (dBuV/m)	Margin (dB)	Antenna Height (m)	Table Angle (Degree)	Raw Value (dBuV)	Correction Factor (dB/m)
1	*2437.00	98.34 PK			1.31 H	103	66.39	31.95
1	*2437.00	89.38 AV			1.31 H	103	57.43	31.95
2	2811.00	50.35 PK	74.00	-23.65	1.08 H	227	16.94	33.41
2	2811.00	47.25 AV	54.00	-6.75	1.08 H	227	13.84	33.41
3	4874.00	49.05 PK	74.00	-24.95	1.04 H	335	10.77	38.28
3	4874.00	36.27 AV	54.00	-17.73	1.04 H	335	-2.01	38.28

ANTENNA POLARITY & TEST DISTANCE: VERTICAL AT 3 M

No.	Freq. (MHz)	Emission Level (dBuV/m)	Limit (dBuV/m)	Margin (dB)	Antenna Height (m)	Table Angle (Degree)	Raw Value (dBuV)	Correction Factor (dB/m)
1	*2437.00	106.54 PK			1.09 V	256	74.59	31.95
1	*2437.00	97.26 AV			1.09 V	256	65.31	31.95
2	2811.00	50.89 PK	74.00	-23.11	1.01 V	292	17.48	33.41
2	2811.00	47.50 AV	54.00	-6.50	1.01 V	292	14.09	33.41
3	3180.00	62.23 PK	74.00	-11.77	1.00 V	214	27.34	34.89
3	3180.00	52.72 AV	54.00	-1.28	1.00 V	214	17.83	34.89
4	4874.00	49.13 PK	74.00	-24.87	1.07 V	283	10.85	38.28
4	4874.00	36.88 AV	54.00	-17.12	1.07 V	283	-1.40	38.28

- REMARKS:**
1. Emission level(dBuV/m)=Raw Value(dBuV) + Correction Factor(dB/m)
 2. Correction Factor(dB/m) = Antenna Factor (dB/m) + Cable Factor (dB)
 3. The other emission levels were very low against the limit.
 4. Margin value = Emission level – Limit value.
 5. " * " : Fundamental frequency.



EUT	Wireless-G Portable USB Adapter	MODEL	WUSB54GP ver. 4
CHANNEL	11	FREQUENCY RANGE	1~25 GHz
INPUT POWER (SYSTEM)	120 Vac, 60 Hz	DETECTOR FUNCTION	Peak(PK) Average (AV)
ENVIRONMENTAL CONDITIONS	25 deg. C, 60% RH, 991 hPa	TESTED BY	Match Tsui

ANTENNA POLARITY & TEST DISTANCE: HORIZONTAL AT 3 M

No.	Freq. (MHz)	Emission Level (dBuV/m)	Limit (dBuV/m)	Margin (dB)	Antenna Height (m)	Table Angle (Degree)	Raw Value (dBuV)	Correction Factor (dB/m)
1	*2462.00	98.10 PK			1.02 H	26	66.08	32.02
1	*2462.00	88.50 AV			1.02 H	26	56.48	32.02
2	2836.00	50.87 PK	74.00	-23.13	1.08 H	16	17.37	33.50
2	2836.00	47.95 AV	54.00	-6.05	1.08 H	16	14.45	33.50
3	4924.00	49.60 PK	74.00	-24.40	1.02 H	133	11.11	38.49
3	4924.00	36.70 AV	54.00	-17.30	1.02 H	133	-1.79	38.49

ANTENNA POLARITY & TEST DISTANCE: VERTICAL AT 3 M

No.	Freq. (MHz)	Emission Level (dBuV/m)	Limit (dBuV/m)	Margin (dB)	Antenna Height (m)	Table Angle (Degree)	Raw Value (dBuV)	Correction Factor (dB/m)
1	*2462.00	106.12 PK			1.09 V	253	74.10	32.02
1	*2462.00	95.56 AV			1.09 V	253	63.54	32.02
2	2483.50	56.44 PK	74.00	-17.56	1.09 V	253	24.35	32.09
2	2483.50	46.28 AV	54.00	-7.72	1.09 V	253	14.19	32.09
3	2836.00	49.83 PK	74.00	-24.17	1.00 V	292	16.33	33.50
3	2836.00	46.62 AV	54.00	-7.38	1.00 V	292	13.12	33.50
4	3211.00	59.98 PK	74.00	-14.02	1.02 V	297	25.00	34.98
4	3211.00	50.84 AV	54.00	-3.16	1.02 V	297	15.86	34.98
5	4924.00	49.50 PK	74.00	-24.50	1.06 V	95	11.01	38.49
5	4924.00	37.02 AV	54.00	-16.98	1.06 V	95	-1.47	38.49

- REMARKS:**
1. Emission level(dBuV/m)=Raw Value(dBuV) + Correction Factor(dB/m)
 2. Correction Factor(dB/m) = Antenna Factor (dB/m) + Cable Factor (dB)
 3. The other emission levels were very low against the limit.
 4. Margin value = Emission level – Limit value.
 5. “ * “ : Fundamental frequency.



4.3 6dB BANDWIDTH MEASUREMENT

4.3.1 LIMITS OF 6dB BANDWIDTH MEASUREMENT

The minimum of 6dB Bandwidth Measurement is 0.5 MHz.

4.3.2 TEST INSTRUMENTS

Description & Manufacturer	Model No.	Serial No.	Calibrated Until
SPECTRUM ANALYZER	FSEK30	100049	Aug. 12, 2005

NOTE: The calibration interval of the above test instruments is 12 months and the calibrations are traceable to NML/ROC and NIST/USA.

4.3.3 TEST PROCEDURE

The transmitter output was connected to the spectrum analyzer through an attenuator. The bandwidth of the fundamental frequency was measured by spectrum analyzer with 100 kHz RBW and 100kHz VBW. The 6dB bandwidth is defined as the total spectrum the power of which is higher than peak power minus 6dB.

4.3.4 DEVIATION FROM TEST STANDARD

No deviation

4.3.5 TEST SETUP

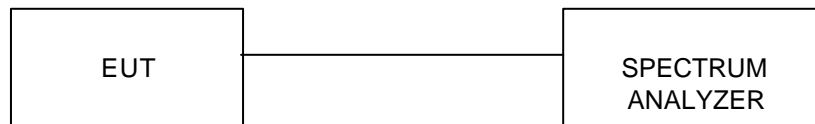

For the actual test configuration, please refer to the related Item – Photographs of the Test Configuration.

4.3.6 EUT OPERATING CONDITIONS

The software provided by client to enable the EUT under transmission condition continuously at lowest, middle and highest channel frequencies individually.



4.3.7 TEST RESULTS (A)

EUT	Wireless-G Portable USB Adapter	MODEL	WUSB54GP ver. 4
INPUT POWER (SYSTEM)	120 Vac, 60 Hz	ENVIRONMENTAL CONDITIONS	24 deg. C, 67% RH, 991 hPa
TESTED BY	Steven Lu		

CHANNEL	CHANNEL FREQUENCY (MHz)	6dB BANDWIDTH (MHz)	MINIMUM LIMIT (MHz)	PASS/FAIL
1	2412	11.42	0.5	PASS
6	2437	11.74	0.5	PASS
11	2462	11.86	0.5	PASS



CH 1

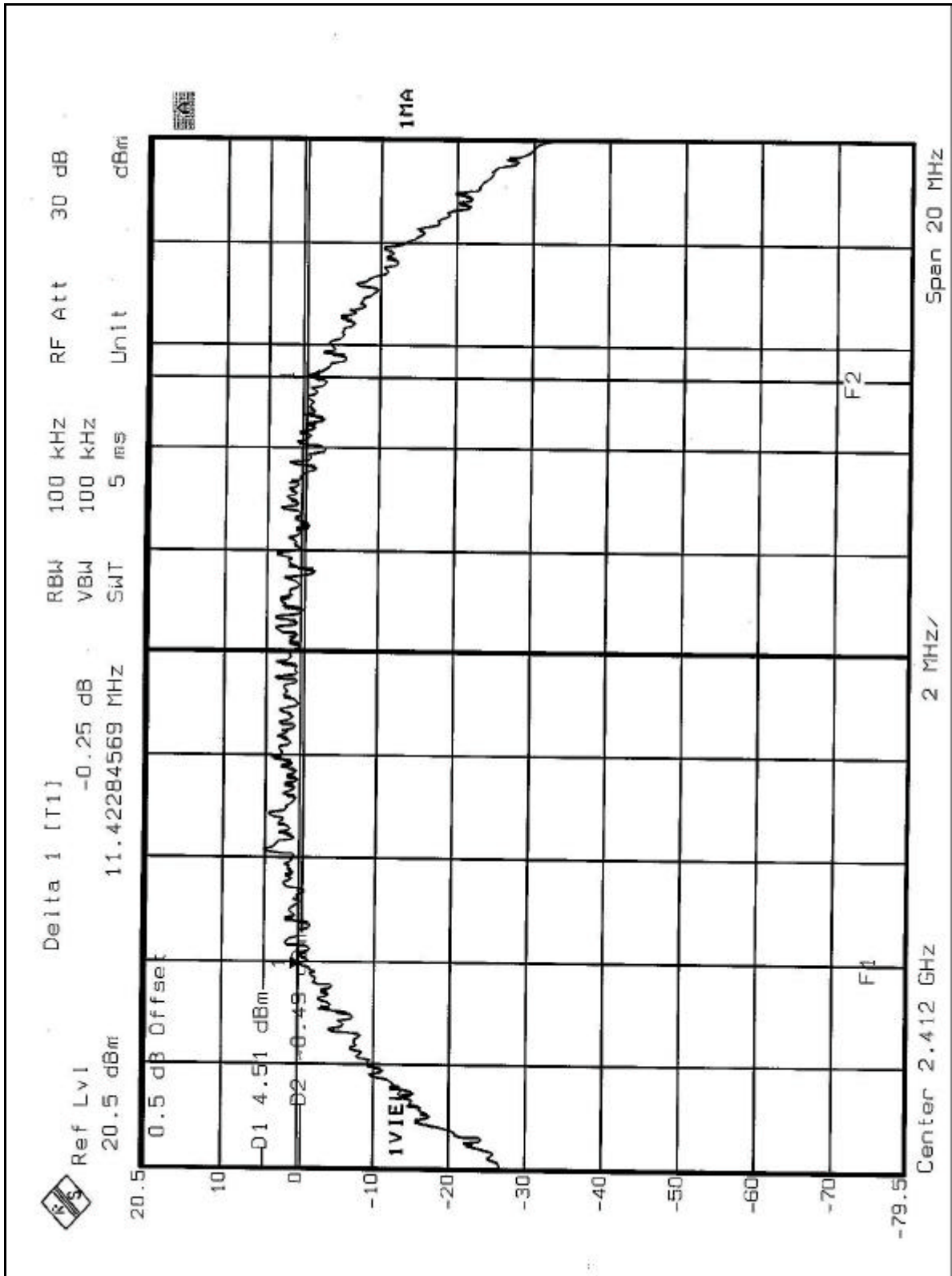



CH 6

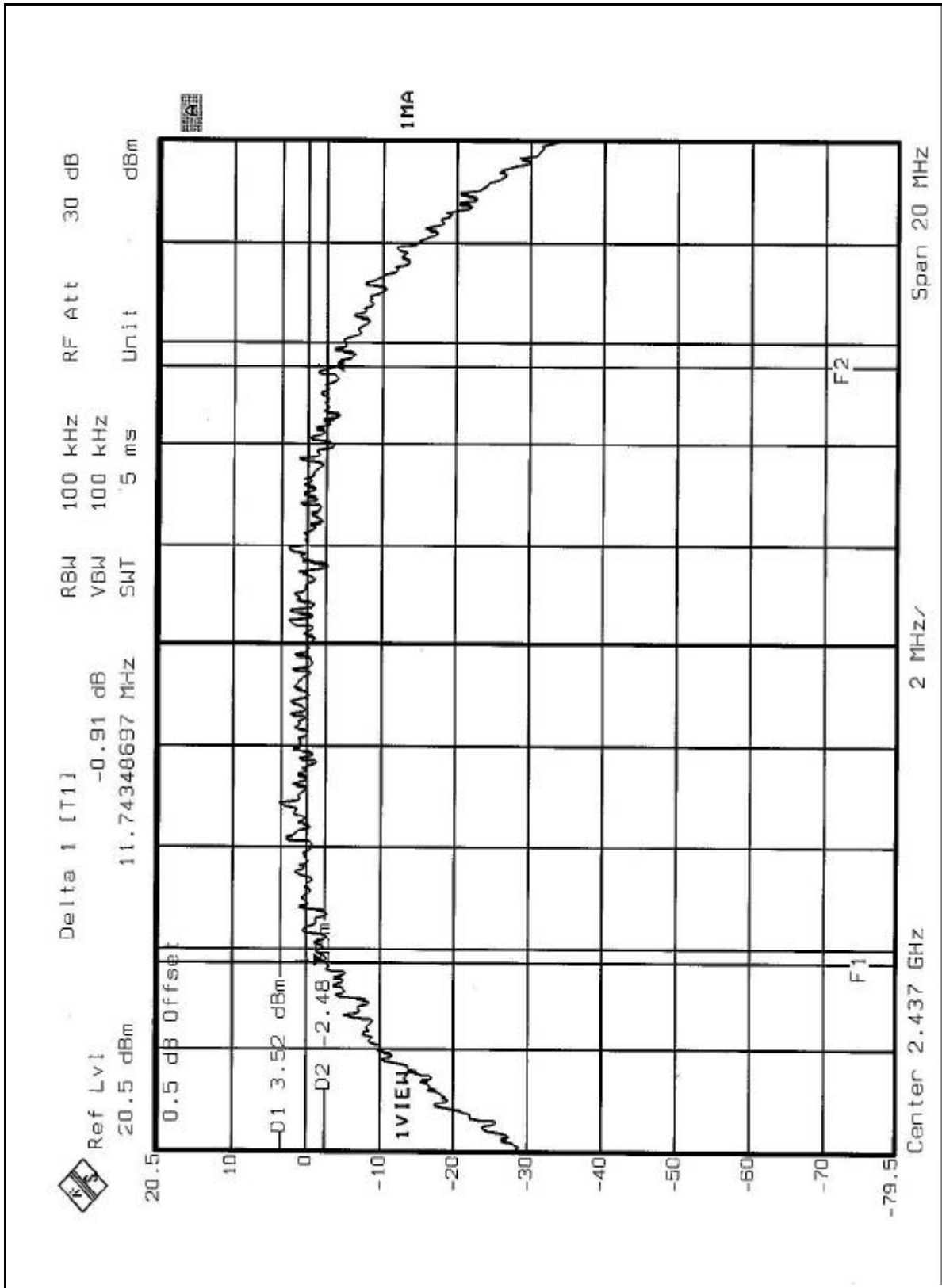



CH 11

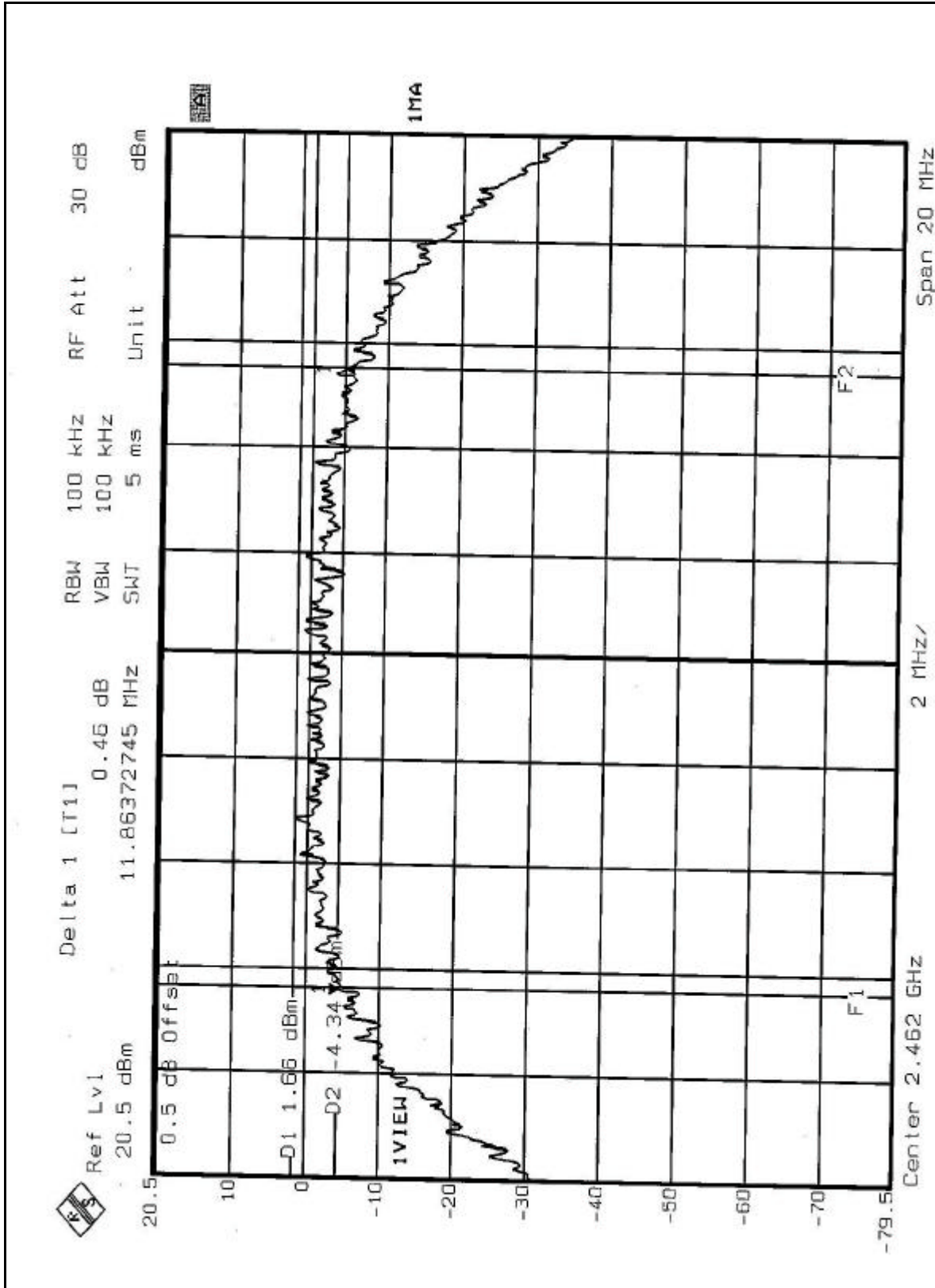



4.3.8 TEST RESULTS (B)

EUT	Wireless-G Portable USB Adapter	MODEL	WUSB54GP VER. 4
INPUT POWER (SYSTEM)	120 Vac, 60 Hz	ENVIRONMENTAL CONDITIONS	24 deg. C, 67% RH, 991 hPa
TESTED BY	Steven Lu		

CHANNEL	CHANNEL FREQUENCY (MHz)	6 dB BANDWIDTH (MHz)	MINIMUM LIMIT (MHz)	PASS/FAIL
1	2412	16.47	0.5	PASS
6	2437	16.47	0.5	PASS
11	2462	16.47	0.5	PASS



CH 1

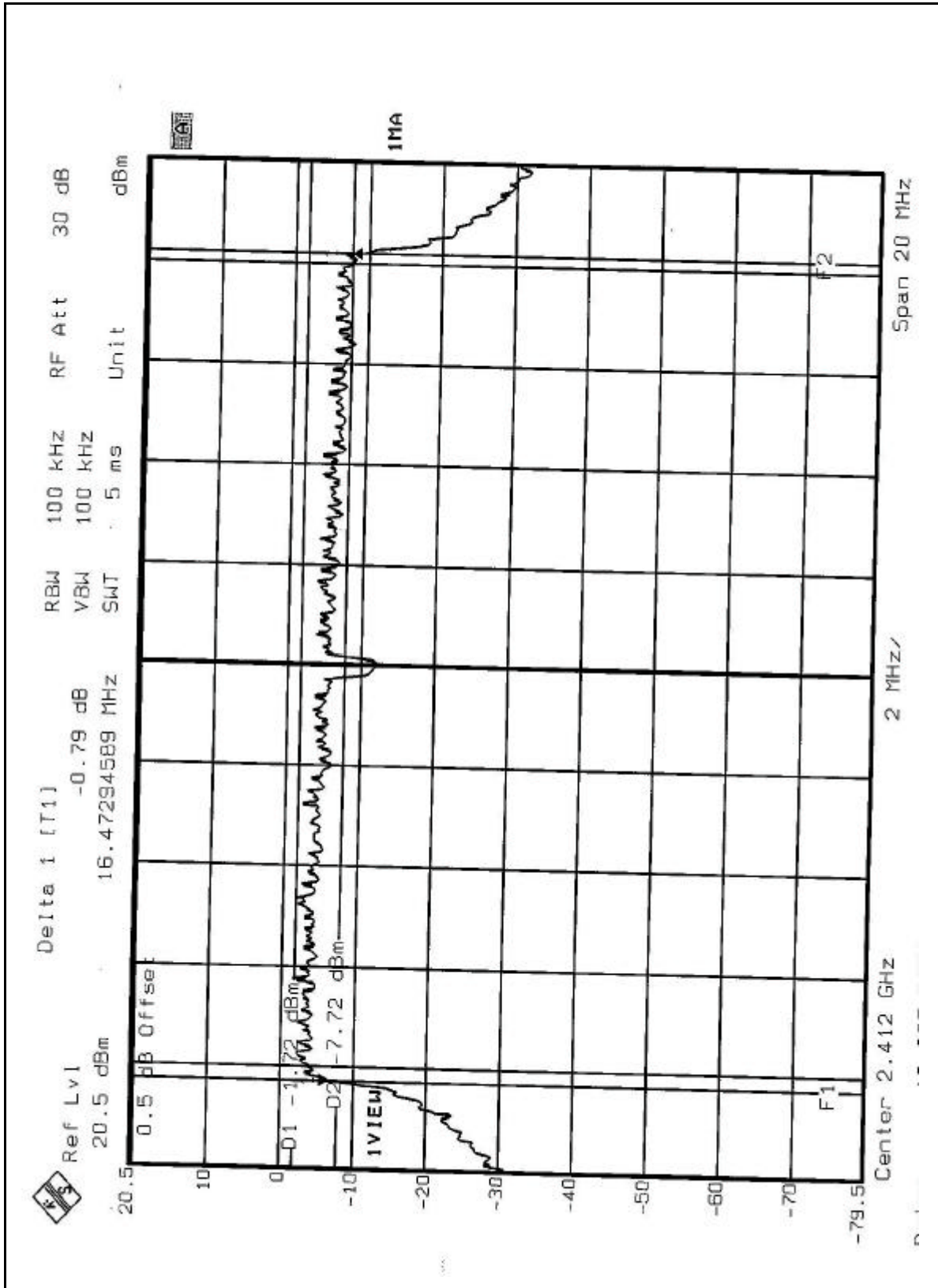



CH 6

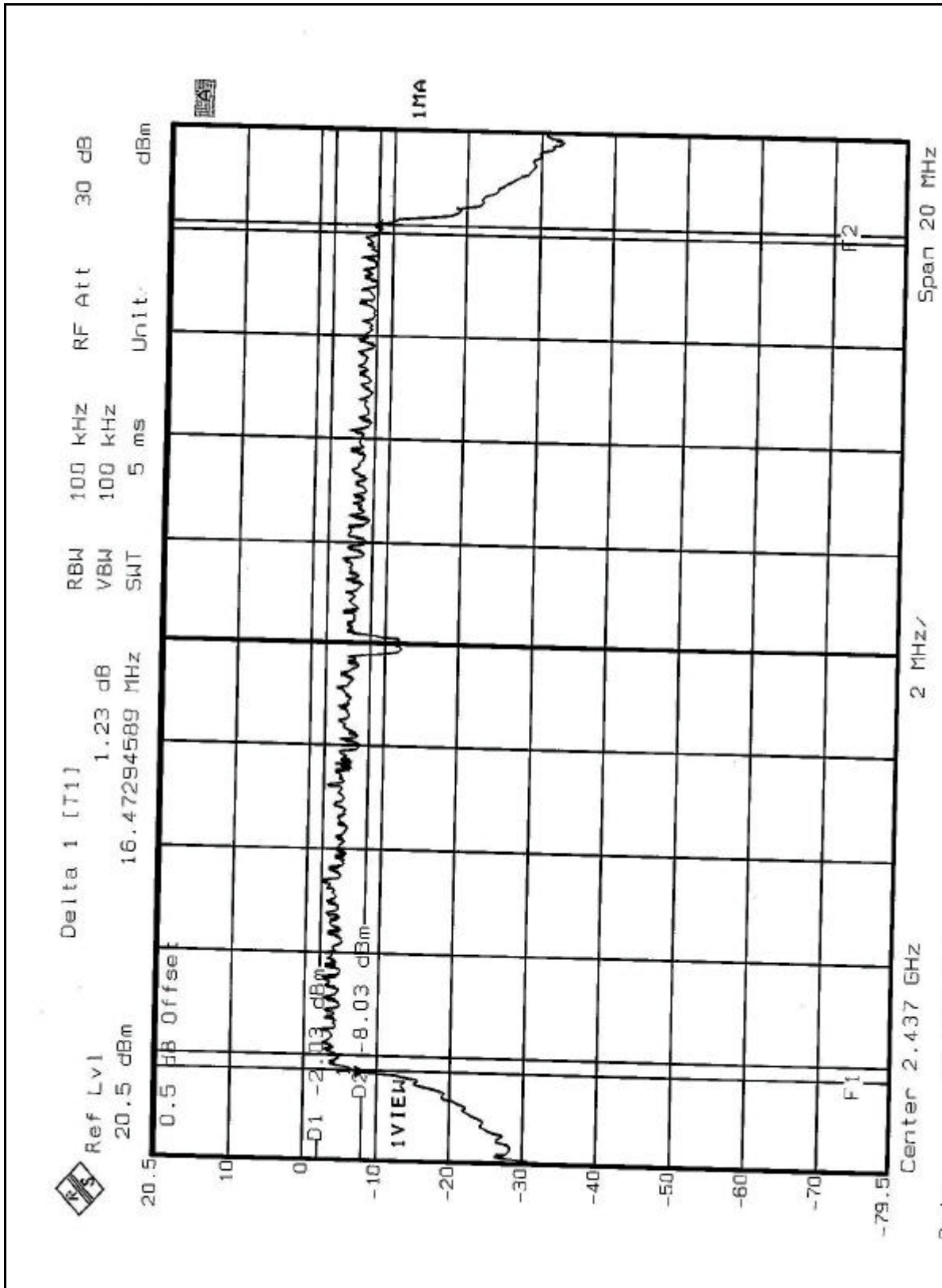



CH 11

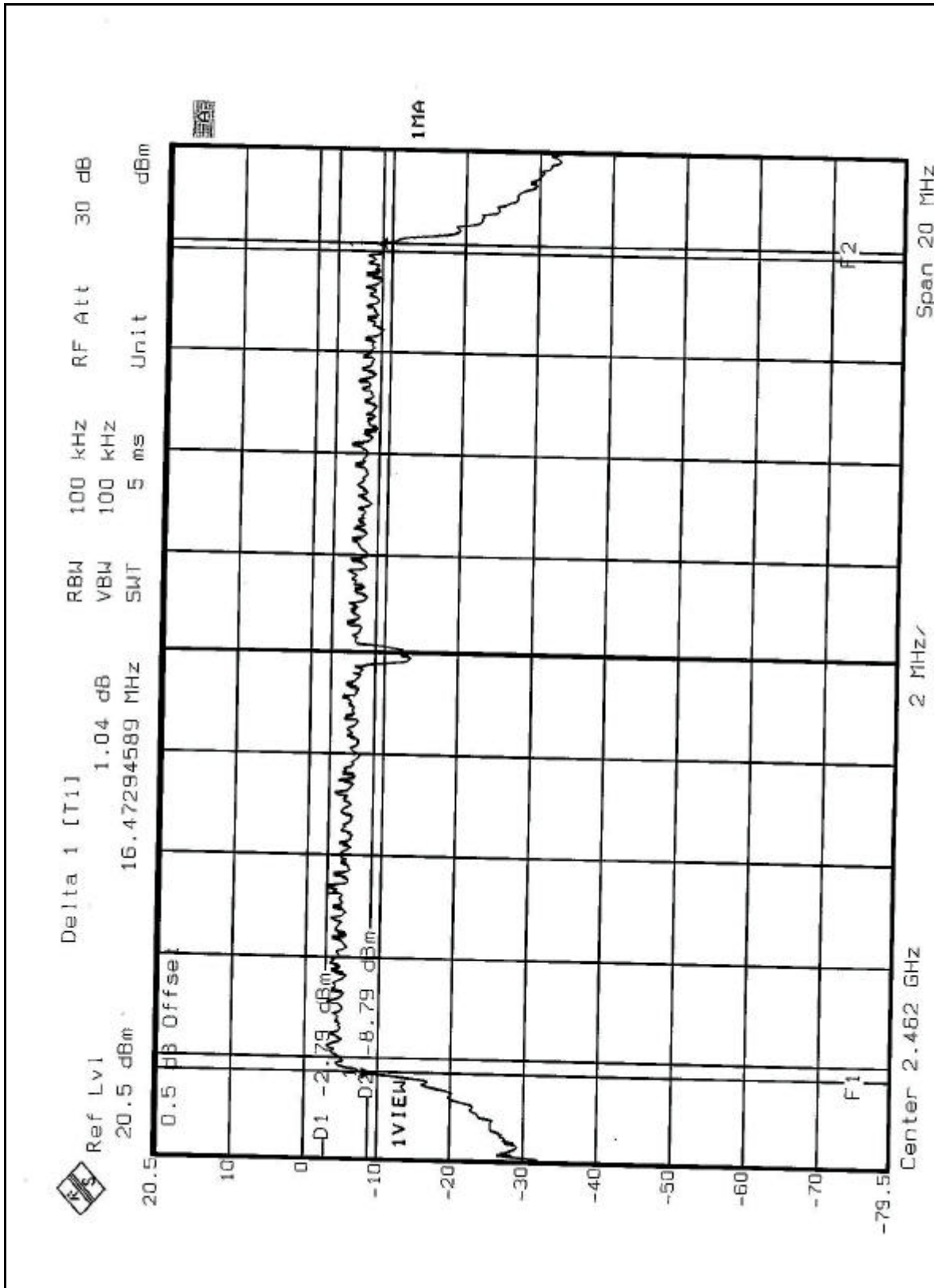

4.4 MAXIMUM PEAK OUTPUT POWER

4.4.1 LIMITS OF MAXIMUM PEAK OUTPUT POWER MEASUREMENT

The Maximum Peak Output Power Measurement is 30dBm.

4.4.2 TEST INSTRUMENTS

Description & Manufacturer	Model No.	Serial No.	Calibrated Until
R&S SPECTRUM ANALYZER	FSEK30	100049	Aug. 12, 2005
AGILENT SIGNAL GENERATOR	E8257C	MY43320668	Dec. 31, 2004
TEKTRONIX OSCILLOSCOPE	TDS 220	C019167	Feb. 1, 2005
NARDA DETECTOR	4503A	FSCM99899	NA

NOTE:

The calibration interval of the above test instruments is 12 months and the calibrations are traceable to NML/ROC and NIST/USA.



4.4.3 TEST PROCEDURES

1. A detector was used on the output port of the EUT. An oscilloscope was used to peak the response of the detector.
2. Replaced the EUT by the signal generator. The center frequency of the S.G was adjusted to the center frequency of the measured channel.
3. Adjusted the power to have the same peak reading on oscilloscope. Record the power level.

4.4.4 DEVIATION FROM TEST STANDARD

No deviation

4.4.5 TEST SETUP



4.4.6 EUT OPERATING CONDITIONS

Same as Item 4.3.6



4.4.7 TEST RESULTS (A)

EUT	Wireless-G Portable USB Adapter	MODEL	WUSB54GP ver. 4
INPUT POWER (SYSTEM)	120 Vac, 60 Hz	ENVIRONMENTAL CONDITIONS	24 deg. C, 67% RH, 991 hPa
TESTED BY	Steven Lu		

CHANNEL	CHANNEL FREQUENCY (MHz)	PEAK POWER OUTPUT (mW)	PEAK POWER OUTPUT (dBm)	PEAK POWER LIMIT (dBm)	PASS/FAIL
1	2412	33.113	15.20	30	PASS
6	2437	31.623	15.00	30	PASS
11	2462	32.359	15.10	30	PASS

4.4.8 TEST RESULTS (B)

EUT	Wireless-G Portable USB Adapter	MODEL	WUSB54GP VER. 4
INPUT POWER (SYSTEM)	120 Vac, 60 Hz	ENVIRONMENTAL CONDITIONS	24 deg. C, 65% RH, 991 hPa
TESTED BY	Leo Hung		

CHANNEL	CHANNEL FREQUENCY (MHz)	PEAK POWER OUTPUT (mW)	PEAK POWER OUTPUT (dBm)	PEAK POWER LIMIT (dBm)	PASS/FAIL
1	2412	36.308	15.60	30	PASS
6	2437	37.584	15.75	30	PASS
11	2462	37.154	15.70	30	PASS



4.5 POWER SPECTRAL DENSITY MEASUREMENT

4.5.1 LIMITS OF POWER SPECTRAL DENSITY MEASUREMENT

The Maximum of Power Spectral Density Measurement is 8dBm.

4.5.2 TEST INSTRUMENTS

Description & Manufacturer	Model No.	Serial No.	Calibrated Until
SPECTRUM ANALYZER	FSEK30	100049	Aug. 12, 2005

NOTE: The calibration interval of the above test instruments is 12 months and the calibrations are traceable to NML/ROC and NIST/USA.

4.5.3 TEST PROCEDURE

The transmitter output was connected to the spectrum analyzer through an attenuator, the bandwidth of the fundamental frequency was measured with the spectrum analyzer using 3kHz RBW and 30kHz VBW, set sweep time=span/3kHz. The power spectral density was measured and recorded. The sweep time is allowed to be longer than span/3kHz for a full response of the mixer in the spectrum analyzer.

4.5.4 DEVIATION FROM TEST STANDARD

No deviation

4.5.5 TEST SETUP

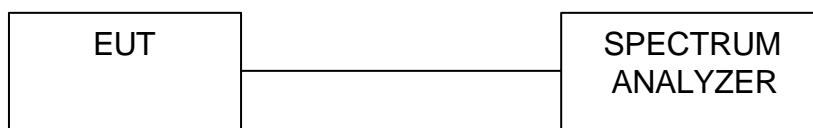

4.5.6 EUT OPERATING CONDITIONS

Same as 4.3.6



4.5.7 TEST RESULTS (A)

EUT	Wireless-G Portable USB Adapter	MODEL	WUSB54GP ver. 4
INPUT POWER (SYSTEM)	120 Vac, 60 Hz	ENVIRONMENTAL CONDITIONS	24 deg. C, 67% RH, 991 hPa
TESTED BY	Steven Lu		

CHANNEL NUMBER	CHANNEL FREQUENCY (MHz)	RF POWER LEVEL IN 3KHz BW (dBm)	MAXIMUM LIMIT (dBm)	PASS/FAIL
1	2412	-11.10	8	PASS
6	2437	-11.51	8	PASS
11	2462	-11.54	8	PASS



CH 1

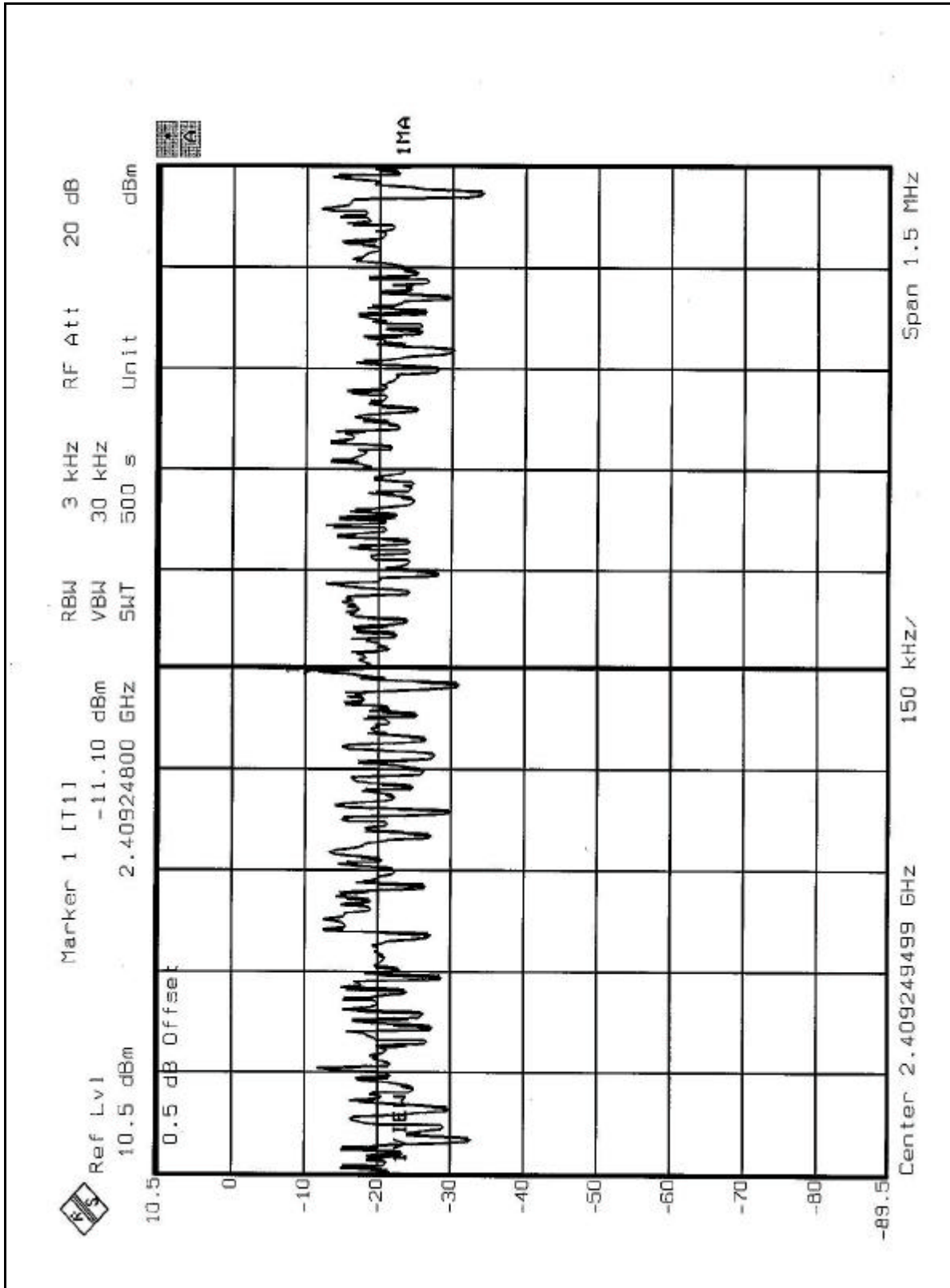



CH 6

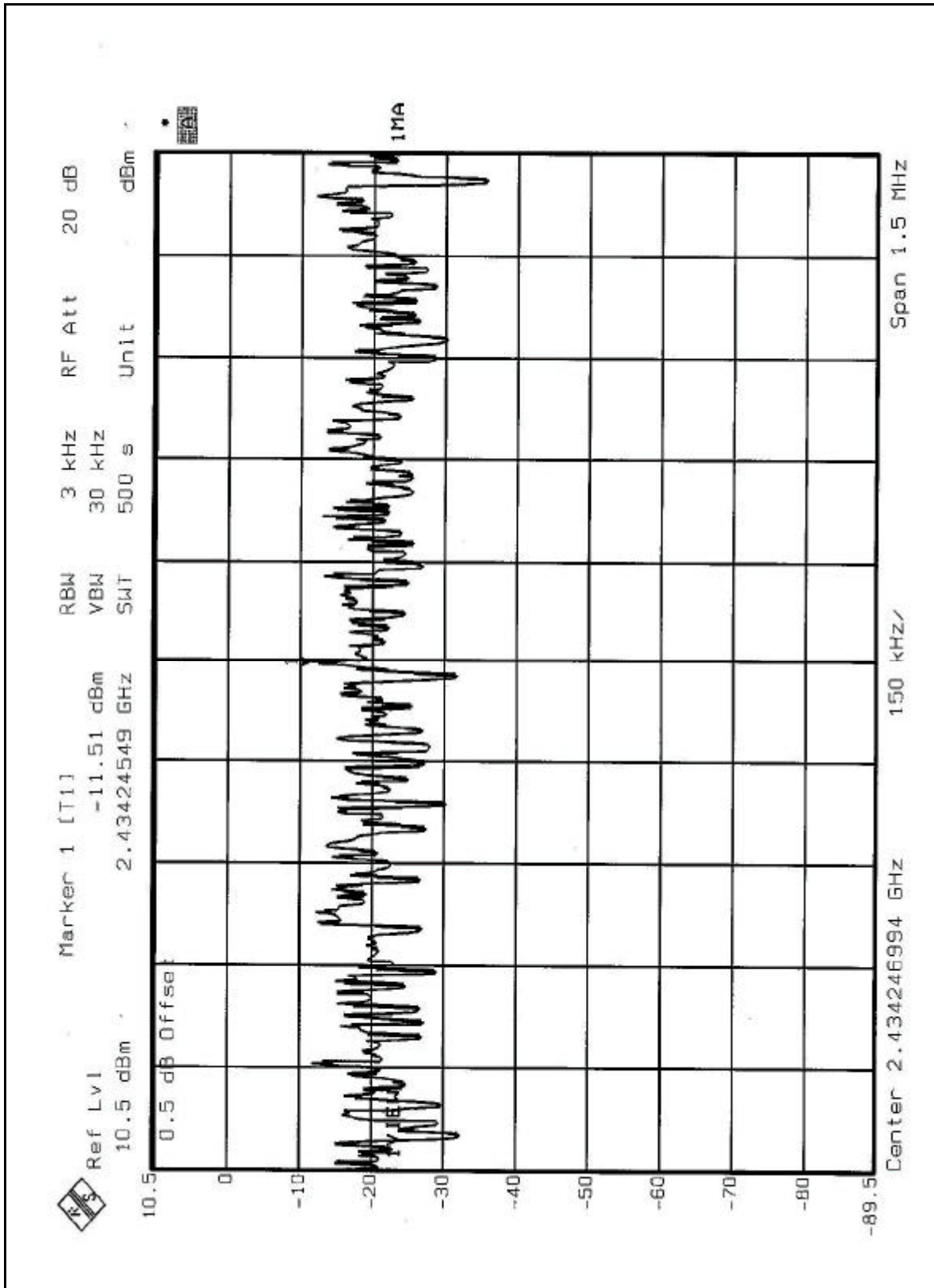



CH 11

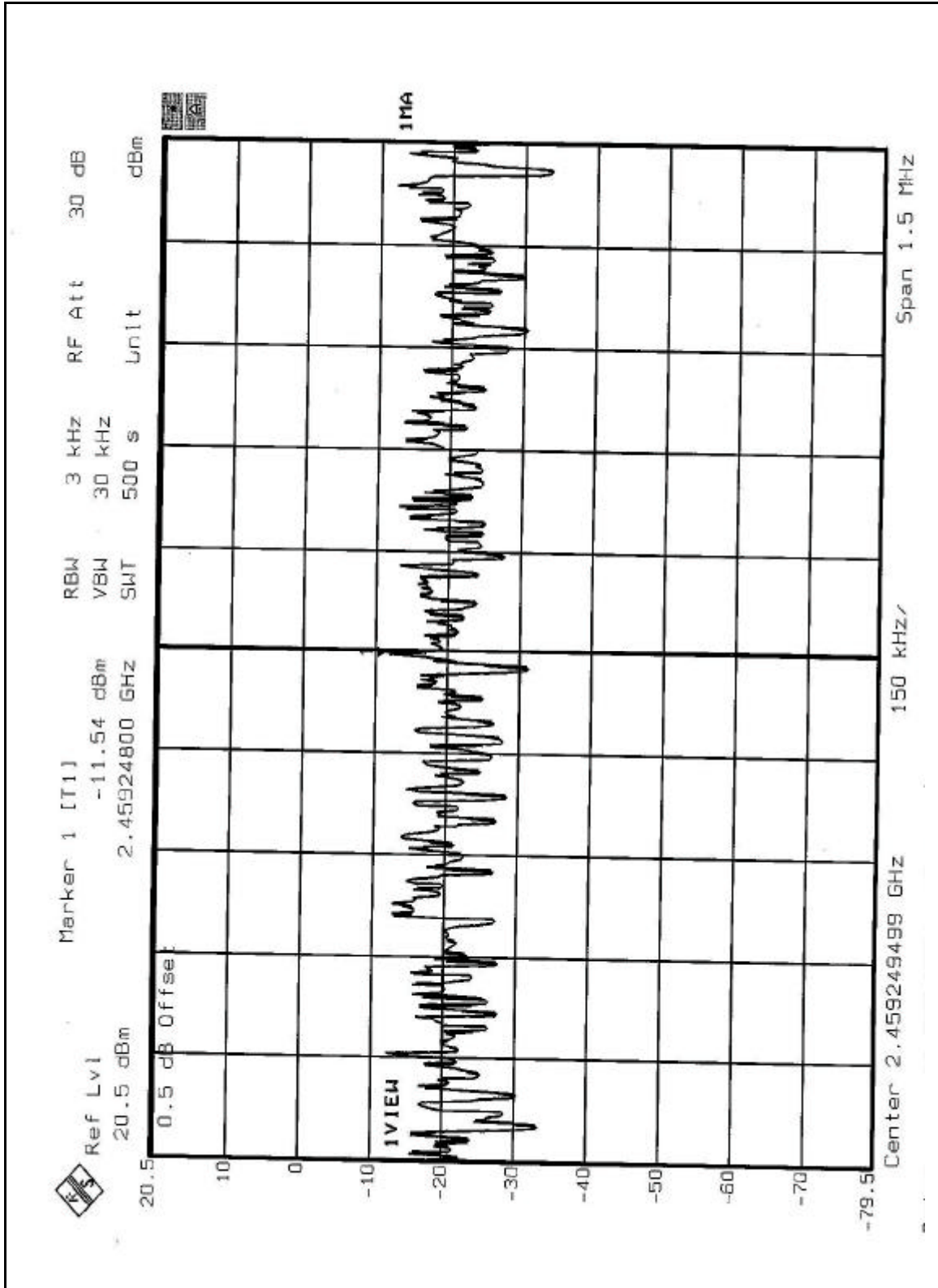



4.5.8 TEST RESULTS (B)

EUT	Wireless-G Portable USB Adapter	MODEL	WUSB54GP VER. 4
INPUT POWER (SYSTEM)	120 Vac, 60 Hz	ENVIRONMENTAL CONDITIONS	24 deg. C, 67% RH, 991 hPa
TESTED BY	Steven Lu		

CHANNEL NUMBER	CHANNEL FREQUENCY (MHz)	RF POWER LEVEL IN 3KHz BW (dBm)	MAXIMUM LIMIT (dBm)	PASS/FAIL
1	2412	-15.83	8	PASS
6	2437	-15.76	8	PASS
11	2462	-15.56	8	PASS



CH 1

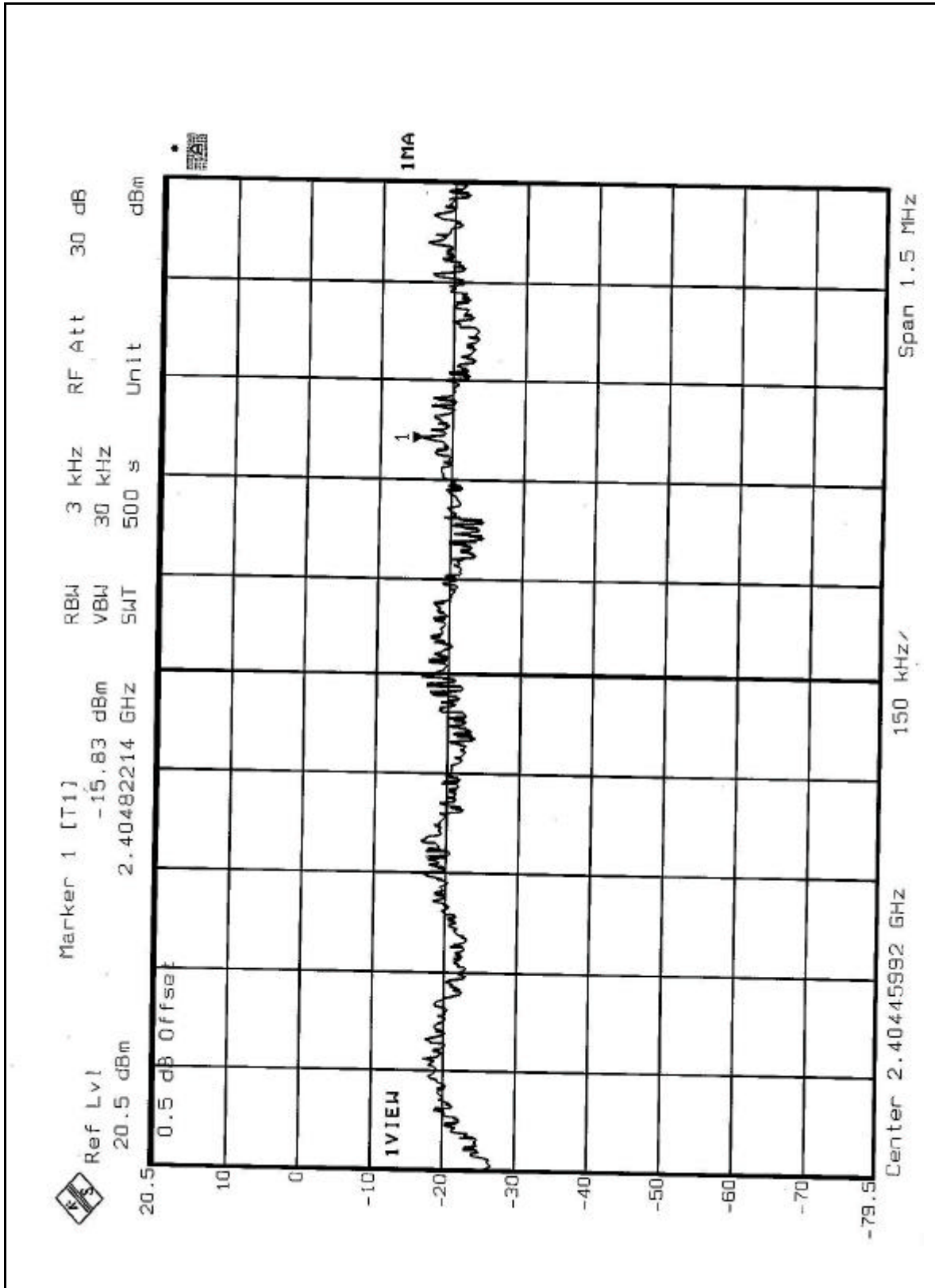



CH 6

