



# FCC TEST REPORT

**REPORT NO.:** RF960227H03  
**MODEL NO.:** WRTU54G-TM  
**RECEIVED:** Feb. 27, 2007  
**TESTED:** May 30 to June 23, 2007  
**ISSUED:** June 29, 2007

**APPLICANT:** Cisco-Linksys LLC

**ADDRESS:** 121 Theory Drive Irvine, CA 92617(USA)

**ISSUED BY:** Advance Data Technology Corporation

**LAB LOCATION:** No. 81-1, Lu Liao Keng, 9 Ling, Wu Lung Tsuen,  
Chiung Lin Hsiang, Hsin Chu Hsien,  
Taiwan, R.O.C.

This test report consists of 65 pages in total. It may be duplicated completely for legal use with the approval of the applicant. It should not be reproduced except in full, without the written approval of our laboratory. The client should not use it to claim product endorsement by CNLA, A2LA or any government agencies. The test results in the report only apply to the tested sample.





## Table of Contents

1	CERTIFICATION .....	4
2	SUMMARY OF TEST RESULTS .....	5
2.1	MEASUREMENT UNCERTAINTY .....	5
3	GENERAL INFORMATION.....	6
3.1	GENERAL DESCRIPTION OF EUT .....	6
3.2	DESCRIPTION OF TEST MODES .....	7
3.3	TEST MODE APPLICABILITY AND TESTED CHANNEL DETAIL: .....	8
3.4	GENERAL DESCRIPTION OF APPLIED STANDARDS .....	10
3.5	DESCRIPTION OF SUPPORT UNITS .....	11
3.6	CONFIGURATION OF SYSTEM UNDER TEST .....	12
4	TEST TYPES AND RESULTS .....	13
4.1	CONDUCTED EMISSION MEASUREMENT .....	13
4.1.1	LIMITS OF CONDUCTED EMISSION MEASUREMENT .....	13
4.1.2	TEST INSTRUMENTS.....	13
4.1.3	TEST PROCEDURES .....	14
4.1.4	TEST SETUP .....	14
4.1.5	EUT OPERATING CONDITIONS .....	15
4.1.6	TEST RESULTS .....	16
4.2	RADIATED EMISSION MEASUREMENT .....	18
4.2.1	LIMITS OF RADIATED EMISSION MEASUREMENT .....	18
4.2.2	TEST INSTRUMENTS.....	19
4.2.3	TEST PROCEDURES .....	20
4.2.4	TEST SETUP .....	21
4.2.5	EUT OPERATING CONDITIONS .....	21
4.2.6	TEST RESULTS .....	22
4.2.7	TEST RESULTS - DSSS .....	23
4.2.8	TEST RESULTS - OFDM .....	30
4.3	6DB BANDWIDTH MEASUREMENT .....	37
4.3.1	LIMITS OF 6DB BANDWIDTH MEASUREMENT.....	37
4.3.2	TEST INSTRUMENTS.....	37
4.3.3	TEST PROCEDURE.....	38
4.3.4	TEST SETUP .....	38
4.3.5	EUT OPERATING CONDITIONS .....	38
4.3.6	TEST RESULTS –DSSS .....	39
4.3.7	TEST RESULTS-OFDM .....	42
4.4	MAXIMUM PEAK OUTPUT POWER.....	45
4.4.1	LIMITS OF MAXIMUM PEAK OUTPUT POWER MEASUREMENT .....	45
4.4.2	TEST INSTRUMENTS.....	45



4.4.3	TEST PROCEDURES .....	46
4.4.4	TEST SETUP .....	46
4.4.5	EUT OPERATING CONDITIONS .....	46
4.4.6	TEST RESULTS – DSSS .....	47
4.4.7	TEST RESULTS –OFDM.....	48
4.5	POWER SPECTRAL DENSITY MEASUREMENT .....	49
4.5.1	LIMITS OF POWER SPECTRAL DENSITY MEASUREMENT.....	49
4.5.2	TEST INSTRUMENTS.....	49
4.5.3	TEST PROCEDURE.....	50
4.5.4	TEST SETUP .....	50
4.5.5	EUT OPERATING CONDITIONS .....	50
4.5.6	TEST RESULTS –DSSS .....	51
4.5.7	TEST RESULTS –OFDM.....	54
4.6	CONDUCTED EMISSION AND BAND EDGES MEASUREMENT .....	57
4.6.1	LIMITS OF CONDTCTED EMISSION AND BAND EDGES MEASUREMENT 57	
4.6.2	TEST INSTRUMENTS.....	57
4.6.3	TEST PROCEDURE.....	57
4.6.4	DEVIATION FROM TEST STANDARD.....	57
4.6.5	EUT OPERATING CONDITION.....	57
4.6.6	TEST RESULTS .....	58
4.7	ANTENNA REQUIREMENT .....	63
4.7.1	STANDARD APPLICABLE .....	63
4.7.2	ANTENNA CONNECTED CONSTRUCTION .....	63
5	INFORMATION ON THE TESTING LABORATORIES .....	64
6	APPENDIX A – MODIFICATIONS RECORDERS FOR ENGINEERING CHANGES TO THE EUT BY THE LAB .....	65



# 1 CERTIFICATION

**PRODUCT :** Wireless-G Broadband Router with 2 Phone Ports  
**BRAND NAME :** Linksys  
**MODEL NO. :** WRTU54G-TM  
**TESTED:** May 30 to June 23, 2007  
**APPLICANT :** Cisco-Linksys LLC  
**TEST ITEM:** ENGINEERING SAMPLE  
**STANDARDS :** 47 CFR Part 15, Subpart C (Section 15.247)  
ANSI C63.4-2003

The above equipment (Model: WRTU54G-TM) has been tested by **Advance Data Technology Corporation**, and found compliance with the requirement of the above standards. The test record, data evaluation & Equipment Under Test (EUT) configurations represented herein are true and accurate accounts of the measurements of the sample's EMC characteristics under the conditions specified in this report.

**PREPARED BY :**  , **DATE:** June 29, 2007  
( Sunny Wen, Specialist )

**TECHNICAL ACCEPTANCE :**  , **DATE:** June 29, 2007  
Responsible for RF ( Hank Chung, Deputy Manager )

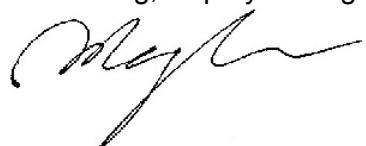
**APPROVED BY :**  , **DATE:** June 29, 2007  
( May Chen, Deputy Manager )

## 2 SUMMARY OF TEST RESULTS

The EUT has been tested according to the following specifications:

<b>APPLIED STANDARD: 47 CFR Part 15, Subpart C</b>			
<b>Standard Section</b>	<b>Test Type and Limit</b>	<b>Result</b>	<b>REMARK</b>
15.207	AC Power Conducted Emission	PASS	Meet the requirement of limit Minimum passing margin is -16.19 dB at 8.105 MHz
15.247(a)(2)	Spectrum Bandwidth of a Direct Sequence Spread Spectrum System Limit: min. 500kHz	PASS	Meet the requirement of limit
15.247(b)	Maximum Peak Output Power Limit: max. 30dBm	PASS	Meet the requirement of limit
15.247(c)	Transmitter Radiated Emissions Limit: Table 15.209	PASS	Meet the requirement of limit Minimum passing margin is -0.21 dB at 2483.50 MHz
15.247(d)	Power Spectral Density Limit: max. 8dBm	PASS	Meet the requirement of limit
15.247(c)	Band Edge Measurement Limit: 20 dB less than the peak value of fundamental frequency	PASS	Meet the requirement of limit

### 2.1 MEASUREMENT UNCERTAINTY

Where relevant, the following measurement uncertainty levels have been estimated for tests performed on the EUT as specified in CISPR 16-4:

This uncertainty represents an expanded uncertainty expressed at approximately the 95% confidence level using a coverage factor of k=2.

<b>Measurement</b>	<b>Value</b>
Conducted emissions	2.41 dB
Radiated emissions (30MHz-1GHz)	3.89 dB
Radiated emissions (1GHz -18GHz)	2.21 dB
Radiated emissions (18GHz -40GHz)	1.88 dB

### 3 GENERAL INFORMATION

#### 3.1 GENERAL DESCRIPTION OF EUT

<b>PRODUCT</b>	Wireless-G Broadband Router with 2 Phone Ports
<b>MODEL NO.</b>	WRTU54G-TM
<b>FCC ID</b>	Q87-WRTU54G
<b>POWER SUPPLY</b>	DC 12V from power adapter
<b>MODULATION TYPE</b>	CCK, DQPSK, DBPSK for DSSS 64QAM, 16QAM, QPSK, BPSK for OFDM
<b>RADIO TECHNOLOGY</b>	DSSS, OFDM
<b>TRANSFER RATE</b>	802.11b: 11/5.5/2/1Mbps 802.11g: 54/48/36/24/18/12/9/6Mbps
<b>FREQUENCY RANGE</b>	2412MHz ~ 2462MHz
<b>NUMBER OF CHANNEL</b>	11
<b>CHANNEL SPACING</b>	5MHz
<b>OUTPUT POWER</b>	802.11b: 112.202mW 802.11g: 131.826mW
<b>ANTENNA TYPE</b>	Monopole antenna with Reversed-SMA connector (Antenna gain : 3.0dB)
<b>DATA CABLE</b>	NA
<b>I/O PORT</b>	Internet port x 1, Ethernet port x 4, Phone port x 2

#### NOTE:

1. The EUT could be supplied with the following power adapters:

<b>Brand:</b>	PHIHONG
<b>Model No.:</b>	PSA18R-120P
<b>Input power :</b>	AC 100-240V, 0.5A, 50-60Hz
<b>Output power :</b>	DC 12V, 1.5A Cable : 1.8m/Shielded/with one core

2. The EUT operates in the 2.4GHz frequency spectrum with throughput of up to 54Mbps.
3. The EUT complies with IEEE 802.11g standards, and backwards compatible with IEEE 802.11b products.
4. The above EUT information was declared by the manufacturer and for more detailed features description, please refer to the manufacturer's specifications or User's Manual.

### 3.2 DESCRIPTION OF TEST MODES

Operated in 2400 ~ 2483.5MHz band:

For 802.11b/g normal mode: Eleven channels are provided to this EUT.

Channel	Frequency	Channel	Frequency
1	2412 MHz	7	2442 MHz
2	2417 MHz	8	2447 MHz
3	2422 MHz	9	2452 MHz
4	2427 MHz	10	2457 MHz
5	2432 MHz	11	2462 MHz
6	2437 MHz		

### 3.3 TEST MODE APPLICABILITY AND TESTED CHANNEL DETAIL:

EUT configure mode	Applicable to				Description
	PLC	RE<1G	RE≥1G	APCM	
-	√	√	√	√	NA

Where PLC: Power Line Conducted Emission RE<1G: Radiated Emission below 1GHz  
 RE≥1G: Radiated Emission above 1GHz APCM: Antenna Port Conducted Measurement

#### **Power Line Conducted Emission Test:**

- Pre-Scan has been conducted to determine the worst-case mode from all possible combinations between available modulations, data rates and antenna ports (if EUT with antenna diversity architecture).
- Following channel(s) was (were) selected for the final test as listed below.

Mode	Available Channel	Tested Channel	Modulation Technology	Modulation Type	Data Rate (Mbps)
802.11g	1 to 11	11	OFDM	BPSK	6

#### **Radiated Emission Test (Below 1 GHz):**

- Pre-Scan has been conducted to determine the worst-case mode from all possible combinations between available modulations, data rates and antenna ports (if EUT with antenna diversity architecture).
- Following channel(s) was (were) selected for the final test as listed below.

Mode	Available Channel	Tested Channel	Modulation Technology	Modulation Type	Data Rate (Mbps)
802.11b	1 to 11	1	DSSS	CCK	1

#### **Radiated Emission Test (Above 1 GHz):**

- Pre-Scan has been conducted to determine the worst-case mode from all possible combinations between available modulations, data rates and antenna ports (if EUT with antenna diversity architecture).
- Following channel(s) was (were) selected for the final test as listed below.

Mode	Available Channel	Tested Channel	Modulation Technology	Modulation Type	Data Rate (Mbps)
802.11b	1 to 11	1, 6, 11	DSSS	CCK	1
802.11g	1 to 11	1, 6, 11	OFDM	BPSK	6



**Bandedge Measurement:**

Pre-Scan has been conducted to determine the worst-case mode from all possible combinations between available modulations, data rates and antenna ports (if EUT with antenna diversity architecture).

Following channel(s) was (were) selected for the final test as listed below.

Mode	Available Channel	Tested Channel	Modulation Technology	Modulation Type	Data Rate (Mbps)
802.11b	1 to 11	1, 11	DSSS	CCK	1
802.11g	1 to 11	1, 11	OFDM	BPSK	6

**Antenna Port Conducted Measurement:**

Pre-Scan has been conducted to determine the worst-case mode from all possible combinations between available modulations, data rates and antenna ports (if EUT with antenna diversity architecture).

Following channel(s) was (were) selected for the final test as listed below.

Mode	Available Channel	Tested Channel	Modulation Technology	Modulation Type	Data Rate (Mbps)
802.11b	1 to 11	1, 6, 11	DSSS	CCK	11
802.11g	1 to 11	1, 6, 11	OFDM	BPSK	6



### **3.4 GENERAL DESCRIPTION OF APPLIED STANDARDS**

The EUT is a Wireless-G Broadband Router with 2 Phone Ports. According to the specifications of the manufacturer, it must comply with the requirements of the following standards:

**47 CFR Part 15, Subpart C. (15.247)**  
**ANSI C63.4 : 2003**

All tests have been performed and recorded as per the above standards.



### 3.5 DESCRIPTION OF SUPPORT UNITS

The EUT has been tested as an independent unit together with other necessary accessories or support units. The following support units or accessories were used to form a representative test configuration during the tests.

No.	Product	Brand	Model No.	Serial No.	FCC ID
1	NOTEBOOK COMPUTER	DELL	PP18L	6976685584	DoC
2	NOTEBOOK COMPUTER	DELL	PP19L	CN-OHC416-70166-5CA-0448	PIW632500516610
3	TELEPHONE	ROMEO	TE-812	97280903	NA
4	TELEPHONE	HTT	HTT-806	9545065	DoC
5	HUB	AVSYS	110H8	01-20E-000002	DoC

No.	Signal cable description
1	NA
2	NA
3	1.6 m nonshielded telephone wire, terminated with RJ11 connector, w/o core.
4	1.6 m nonshielded telephone wire, terminated with RJ11 connector, w/o core.
5	NA

**NOTE:** All power cords of the above support units are non-shielded (1.8m).

### 3.6 CONFIGURATION OF SYSTEM UNDER TEST

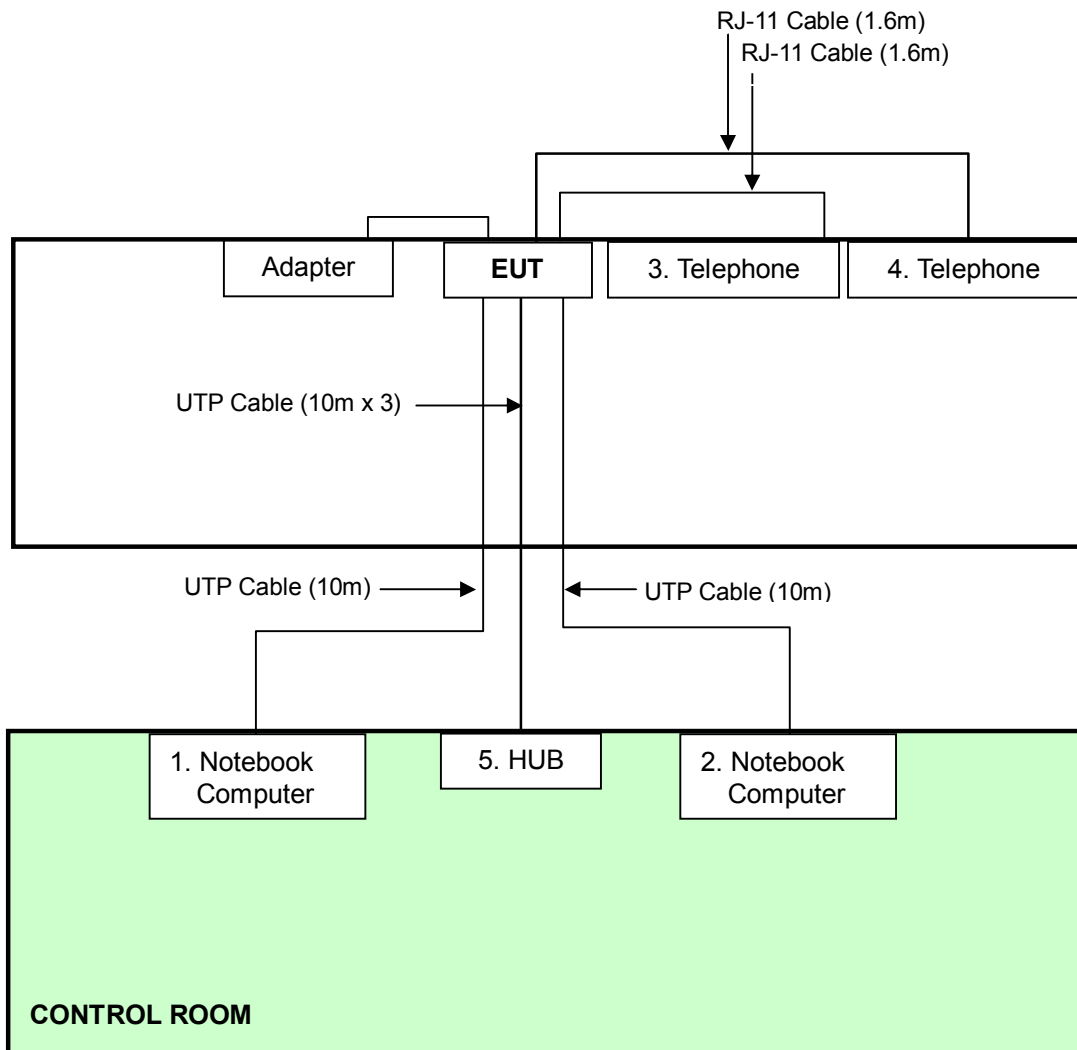



## 4 TEST TYPES AND RESULTS

### 4.1 CONDUCTED EMISSION MEASUREMENT

#### 4.1.1 LIMITS OF CONDUCTED EMISSION MEASUREMENT

FREQUENCY OF EMISSION (MHz)	CONDUCTED LIMIT (dB $\mu$ V)	
	Quasi-peak	Average
0.15-0.5	66 to 56	56 to 46
0.5-5	56	46
5-30	60	50

**NOTE:**

1. The lower limit shall apply at the transition frequencies.
2. All emanations from a class B digital device or system, including any network of conductors and apparatus connected thereto, shall not exceed the level of field strengths specified above.

#### 4.1.2 TEST INSTRUMENTS

DESCRIPTION & MANUFACTURER	MODEL NO.	SERIAL NO.	CALIBRATED UNTIL
Test Receiver	ESCS 30	847124/029	Mar. 28, 2008
Line-Impedance Stabilization Network(for EUT)	ENV-216	100071	Nov. 26, 2007
Line-Impedance Stabilization Network(for Peripheral)	ESH3-Z5	848773/004	Oct. 26, 2007
RF Cable (JETBAO)	RG233/U	Cable_CB_01	Dec. 09, 2007
Terminator	50	2	Oct. 30, 2007
Software	ADT_Cond_V7.3.2	NA	NA

- NOTE: 1. The calibration interval of the above test instruments is 12 months and the calibrations are traceable to NML/ROC and NIST/USA.  
 2. The test was performed in ADT Shielded Room No. B.  
 3. The VCCI Con B Registration No. is C-2193.

#### 4.1.3 TEST PROCEDURES

- a. The EUT/HOST was placed 0.4 meters from the conducting wall of the shielded room with EUT/HOST being connected to the power mains through a line impedance stabilization network (LISN). Other support units were connected to the power mains through another LISN. The two LISNs provide 50 ohm/ 50uH of coupling impedance for the measuring instrument.
- b. Both lines of the power mains connected to the EUT/HOST were checked for maximum conducted interference.
- c. The frequency range from 150 kHz to 30 MHz was searched. Emission levels over 10dB under the prescribed limits could not be reported

#### 4.1.4 TEST SETUP

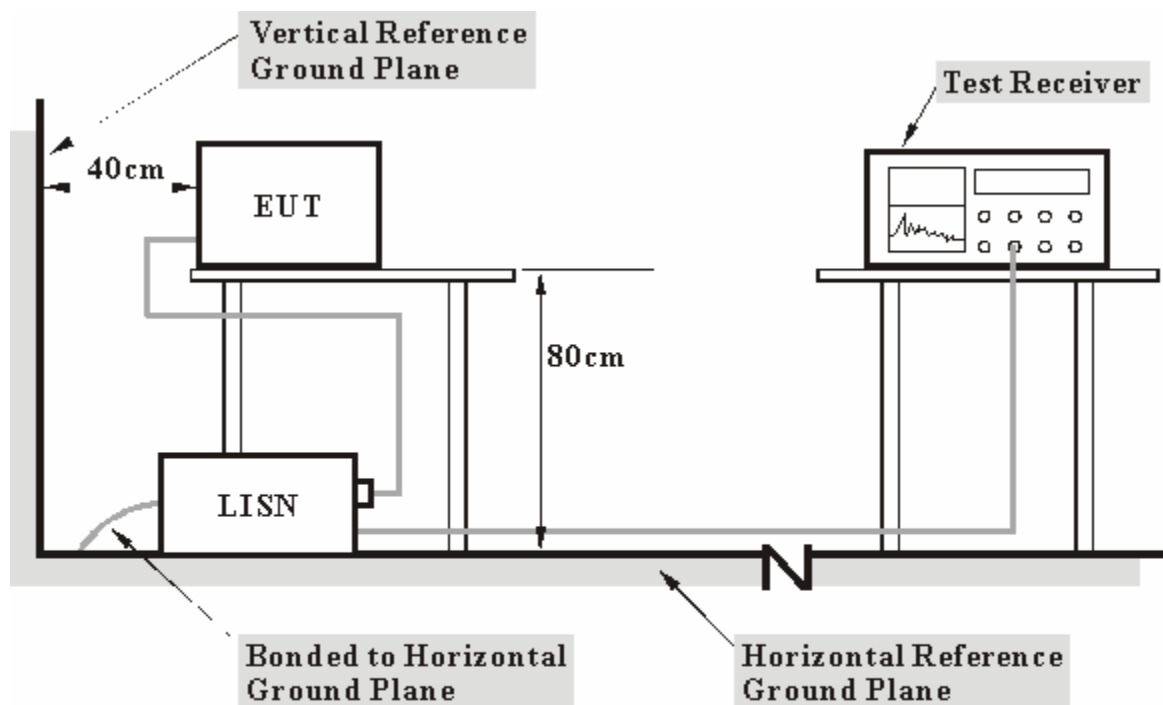

- Note:**
1. Support units were connected to second LISN.
  2. Both of LISNs (AMIN) 80 cm from EUT and at the least 80 cm from other units and other metal planes support units.

For the actual test configuration, please refer to the related item – Photographs of the Test Configuration.

#### 4.1.5 EUT OPERATING CONDITIONS

- a. Placed the EUT on the testing table.
- b. Prepared other computer systems (support unit 1 and 2) to act as communication partners and placed them outside of testing area.
- c. The communication partners run test program” Console command ” to enable EUT under transmission/receiving condition continuously at specific channel frequency via UTP cables and wireless.
- d. Support unit 3 and support unit 4 as dummy-load to connect with EUT.

#### 4.1.6 TEST RESULTS

<b>INPUT POWER (SYSTEM)</b>	120Vac, 60 Hz	<b>6dB BANDWIDTH</b>	9 kHz
<b>PHASE</b>	Line (L)	<b>TRANSFER RATE</b>	6Mbps
<b>ENVIRONMENTAL CONDITIONS</b>	20deg. C, 60%RH, 966hPa	<b>TESTED BY</b>	Eric Lee

No	Freq. [MHz]	Corr. Factor (dB)	Reading Value		Emission Level		Limit		Margin	
			[dB (uV)]		[dB (uV)]		[dB (uV)]		(dB)	
			Q.P.	AV.	Q.P.	AV.	Q.P.	AV.	Q.P.	AV.
1	0.201	9.60	33.13	-	42.73	-	63.58	53.58	-20.85	-
2	0.334	9.60	25.19	-	34.79	-	59.36	49.36	-24.57	-
3	0.548	9.60	28.12	-	37.72	-	56.00	46.00	-18.28	-
4	2.724	9.70	29.35	-	39.05	-	56.00	46.00	-16.95	-
5	8.440	9.85	33.83	-	43.68	-	60.00	50.00	-16.32	-
6	11.301	9.95	29.28	-	39.23	-	60.00	50.00	-20.77	-

- REMARKS:**
1. Q.P. and AV. are abbreviations of quasi-peak and average individually.
  2. "-": The Quasi-peak reading value also meets average limit and measurement with the average detector is unnecessary.
  3. The emission levels of other frequencies were very low against the limit.
  4. Margin value = Emission level - Limit value
  5. Correction factor = Insertion loss + Cable loss
  6. Emission Level = Correction Factor + Reading Value.

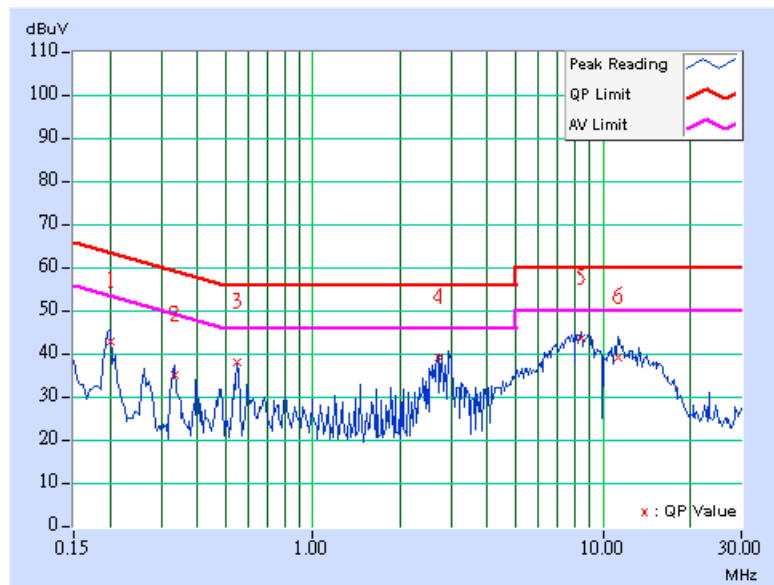



<b>INPUT POWER (SYSTEM)</b>	120Vac, 60 Hz	<b>6dB BANDWIDTH</b>	9 kHz
<b>PHASE</b>	Neutral (N)	<b>TRANSFER RATE</b>	6Mbps
<b>ENVIRONMENTAL CONDITIONS</b>	20deg. C, 60%RH, 966hPa	<b>TESTED BY</b>	Eric Lee

No	Freq. [MHz]	Corr. Factor (dB)	Reading Value		Emission Level		Limit		Margin	
			[dB (uV)]		[dB (uV)]		[dB (uV)]		(dB)	
			Q.P.	AV.	Q.P.	AV.	Q.P.	AV.	Q.P.	AV.
1	0.201	9.60	33.25	-	42.85	-	63.58	53.58	-20.73	-
2	0.334	9.60	25.08	-	34.68	-	59.36	49.36	-24.68	-
3	0.529	9.60	18.99	-	28.59	-	56.00	46.00	-27.41	-
4	2.724	9.70	28.61	-	38.31	-	56.00	46.00	-17.69	-
<b>5</b>	<b>8.105</b>	<b>9.84</b>	<b>33.97</b>	-	<b>43.81</b>	-	<b>60.00</b>	<b>50.00</b>	<b>-16.19</b>	-
6	11.629	9.93	31.49	-	41.42	-	60.00	50.00	-18.58	-

- REMARKS:**
1. Q.P. and AV. are abbreviations of quasi-peak and average individually.
  2. "-": The Quasi-peak reading value also meets average limit and measurement with the average detector is unnecessary.
  3. The emission levels of other frequencies were very low against the limit.
  4. Margin value = Emission level - Limit value
  5. Correction factor = Insertion loss + Cable loss
  6. Emission Level = Correction Factor + Reading Value.

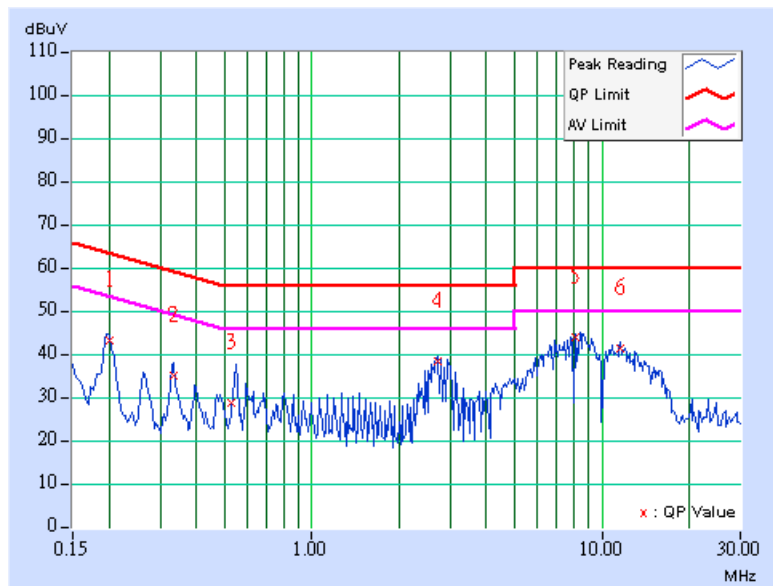

## 4.2 RADIATED EMISSION MEASUREMENT

### 4.2.1 LIMITS OF RADIATED EMISSION MEASUREMENT

Emissions radiated outside of the specified bands, shall be according to the general radiated limits in 15.209 as following:

Frequencies (MHz)	Field strength (microvolts/meter)	Measurement distance (meters)
0.009-0.490	2400/F(kHz)	300
0.490-1.705	24000/F(kHz)	30
1.705-30.0	30	30
30-88	100	3
88-216	150	3
216-960	200	3
Above 960	500	3

**NOTE:**

1. The lower limit shall apply at the transition frequencies.
2. Emission level (dBuV/m) = 20 log Emission level (uV/m).
3. As shown in 15.35(b), for frequencies above 1000MHz, the field strength limits are based on average detector, however, the peak field strength of any emission shall not exceed the maximum permitted average limits, specified above by more than 20dB under any condition of modulation.



#### 4.2.2 TEST INSTRUMENTS

DESCRIPTION & MANUFACTURER	MODEL NO.	SERIAL NO.	CALIBRATED UNTIL
ADVANTEST Spectrum Analyzer	R3271A	85060311	July 03, 2007
HP Pre_Amplifier	8449B	3008A01922	Sep. 18, 2007
ROHDE & SCHWARZ Test Receiver	ESCS30	100375	Sep. 20, 2007
CHASE Broadband Antenna	VULB 9168	138	July 17, 2007
Schwarzbeck Horn_Antenna	BBHA9120	D124	Jan. 01, 2008
Schwarzbeck Horn_Antenna	BBHA 9170	BBHA9170153	Jan. 25, 2008
SCHWARZBECK Biconical Antenna	VHBA9123	459	Jun. 08, 2009
SCHWARZBECK Periodic Antenna	UPA6108	1148	Jun. 08, 2009
R&S Loop Antenna	HFH2-Z2	881058/15	Nov. 29, 2007
RF Switches (ARNITSU)	CS-201	1565157	NA
RF CABLE (Chaintek)	SF102	22054-2	Nov. 14. 2007
RF Cable(RICHTEC)	9913-30M N-N Cable	STCCAB-30M-1 GHz	Jul. 15, 2007
Software	ADT_Radiated_V 7.6.15.7	NA	NA
CHANCE MOST Antenna Tower	AT-100	0203	NA
CHANCE MOST Turn Table	TT-100	0203	NA

- Note: 1. The calibration interval of the above test instruments is 12 months (36 months for Biconical and Periodic Antenna) and the calibrations are traceable to NML/ROC and NIST/USA.
2. The horn antenna, HP preamplifier (model: 8449B) and Spectrum Analyzer (model: R3271A) are used only for the measurement of emission frequency above 1GHz if tested.
  3. The test was performed in ADT Open Site No. C.
  4. The FCC Site Registration No. is 656396.
  5. The VCCI Site Registration No. is R-1626.
  6. The CANADA Site Registration No. is IC 4824A-3.
  7. Loop antenna was used for all emissions below 30 MHz.

#### 4.2.3 TEST PROCEDURES

- a. The EUT was placed on the top of a rotating table 0.8 meters above the ground at a 10 meter open area test site. The table was rotated 360 degrees to determine the position of the highest radiation.
- b. The EUT was set 3 meters away from the interference-receiving antenna, which was mounted on the top of a variable-height antenna tower.
- c. The antenna is a broadband antenna, and its height is varied from one meter to four meters above the ground to determine the maximum value of the field strength. Both horizontal and vertical polarizations of the antenna are set to make the measurement.
- d. For each suspected emission, the EUT was arranged to its worst case and then the antenna was tuned to heights from 1 meter to 4 meters and the rotatable table was turned from 0 degrees to 360 degrees to find the maximum reading.
- e. The test-receiver system was set to Peak Detect Function and Specified Bandwidth with Maximum Hold Mode.
- f. If the emission level of the EUT in peak mode was 10 dB lower than the limit specified, then testing could be stopped and the peak values of the EUT would be reported. Otherwise the emissions that did not have 10 dB margin would be re-tested one by one using peak, quasi-peak or average method as specified and then reported in a data sheet.

**NOTE:**

1. The resolution bandwidth and video bandwidth of test receiver/spectrum analyzer is 120kHz for Quasi-peak detection at frequency below 1GHz.
2. The resolution bandwidth is 1MHz and video bandwidth of test receiver/spectrum analyzer is 3MHz for Peak detection at frequency above 1GHz.
3. The resolution bandwidth of test receiver/spectrum analyzer is 1 MHz and the video bandwidth is 10 Hz for Average detection (AV) at frequency above 1GHz.

#### 4.2.4 TEST SETUP

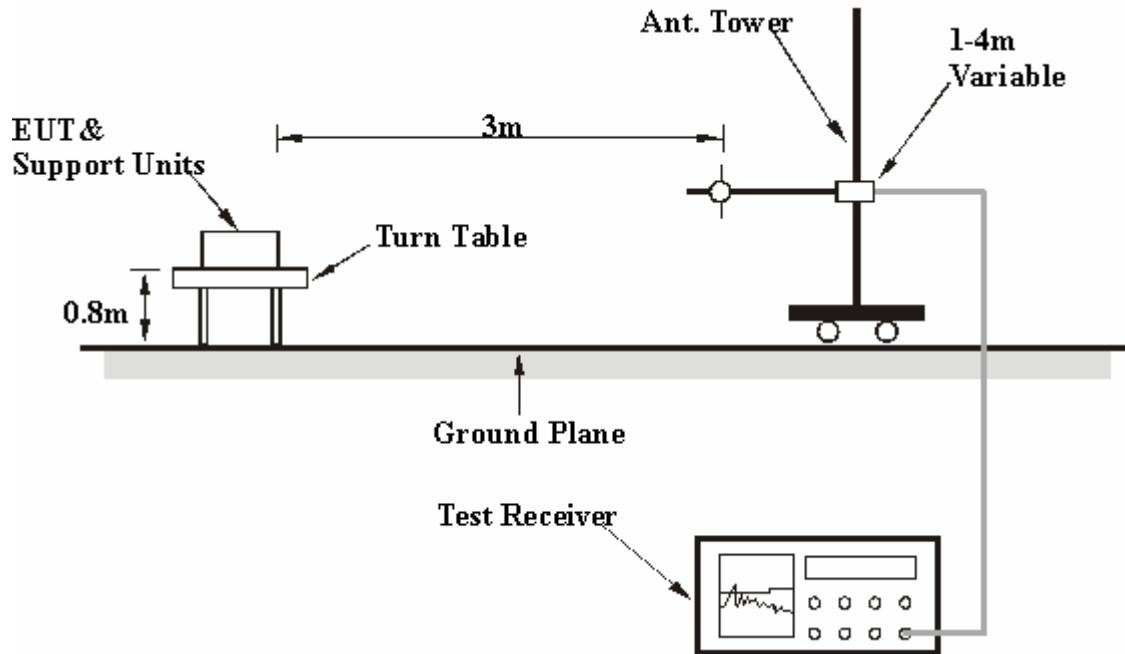

For the actual test configuration, please refer to the related item – Photographs of the Test Configuration.

#### 4.2.5 EUT OPERATING CONDITIONS

Same as 4.1.5

## 4.2.6 TEST RESULTS

### Below 1GHz Worst-Case Data

<b>MODULATION TYPE</b>	DSSS	<b>CHANNEL</b>	Channel 1
<b>INPUT POWER (SYSTEM)</b>	120Vac, 60 Hz	<b>FREQUENCY RANGE</b>	30-1000 MHz
<b>ENVIRONMENTAL CONDITIONS</b>	24deg. C, 72%RH, 966hPa	<b>TRANSFER RATE</b>	1Mbps
<b>TESTED BY</b>	Wen Yu	<b>DETECTOR FUNCTION</b>	Quasi-Peak, 120kHz

### ANTENNA POLARITY & TEST DISTANCE: HORIZONTAL AT 3 M

No.	Freq. (MHz)	Emission Level (dBuV/m)	Limit (dBuV/m)	Margin (dB)	Antenna Height (m)	Table Angle (Degree)	Raw Value (dBuV)	Correction Factor (dB/m)
1	125.00	25.98 QP	43.50	-17.52	2.43 H	274	13.76	12.22
2	200.00	27.06 QP	43.50	-16.44	1.88 H	280	15.46	11.60
3	225.00	29.39 QP	46.00	-16.61	1.00 H	271	16.70	12.69
4	249.99	34.64 QP	46.00	-11.36	1.00 H	287	20.86	13.78
5	300.00	28.75 QP	46.00	-17.25	1.05 H	311	11.92	16.83
6	375.03	39.86 QP	46.00	-6.14	1.00 H	285	21.66	18.20
7	500.04	35.93 QP	46.00	-10.07	1.63 H	325	14.17	21.76
8	625.08	37.23 QP	46.00	-8.77	1.00 H	242	12.47	24.76
9	750.10	41.70 QP	46.00	-4.30	1.00 H	310	14.35	27.35
10	799.99	31.41 QP	46.00	-14.59	1.79 H	350	3.85	27.56

### ANTENNA POLARITY & TEST DISTANCE: VERTICAL AT 3 M

No.	Freq. (MHz)	Emission Level (dBuV/m)	Limit (dBuV/m)	Margin (dB)	Antenna Height (m)	Table Angle (Degree)	Raw Value (dBuV)	Correction Factor (dB/m)
1	62.95	30.37 QP	40.00	-9.63	1.00 V	242	17.00	13.37
2	190.95	33.05 QP	43.50	-10.45	1.00 V	282	20.83	12.22
3	250.04	32.44 QP	46.00	-13.56	1.00 V	1	18.66	13.78
4	375.05	42.96 QP	46.00	-3.04	1.18 V	263	24.76	18.20
5	500.04	33.85 QP	46.00	-12.15	1.70 V	21	12.09	21.76
6	625.04	39.05 QP	46.00	-6.95	1.00 V	100	14.29	24.76
7	699.99	33.04 QP	46.00	-12.96	1.00 V	287	7.24	25.80
8	750.06	40.93 QP	46.00	-5.07	1.00 V	87	13.58	27.35
9	799.99	39.07 QP	46.00	-6.93	1.00 V	358	11.51	27.56
10	849.99	33.19 QP	46.00	-12.81	1.58 V	354	4.79	28.40

- REMARKS:**
1. Emission level(dBuV/m)=Raw Value(dBuV) + Correction Factor(dB/m)
  2. Correction Factor(dB/m) = Antenna Factor (dB/m) + Cable Factor (dB)
  3. The other emission levels were very low against the limit.
  4. Margin value = Emission level – Limit value.

#### 4.2.7 TEST RESULTS - DSSS

##### 802.11b DSSS modulation

<b>MODE</b>	Channel 1	<b>FREQUENCY RANGE</b>	1000~25000MHz
<b>INPUT POWER (SYSTEM)</b>	120Vac, 60 Hz	<b>DETECTOR FUNCTION &amp; BANDWIDTH</b>	Peak (PK) Average (AV) 1 MHz
<b>ENVIRONMENTAL CONDITIONS</b>	22 deg. C, 70%RH, 966hPa	<b>TESTED BY</b>	Wen Yu

#### ANTENNA POLARITY & TEST DISTANCE: HORIZONTAL AT 3 M

No.	Freq. (MHz)	Emission Level (dBuV/m)	Limit (dBuV/m)	Margin (dB)	Antenna Height (m)	Table Angle (Degree)	Raw Value (dBuV)	Correction Factor (dB/m)
1	2386.00	58.57 PK	74.00	-15.43	1.56 H	87	28.19	30.38
2	2386.00	47.50 AV	54.00	-6.50	1.56 H	87	17.12	30.38
3	*2412.00	105.70 PK			1.53 H	86	75.21	30.49
4	*2412.00	100.95 AV			1.53 H	86	70.46	30.49
5	4824.00	50.88 PK	74.00	-23.12	1.16 H	277	15.19	35.69
6	4824.00	45.42 AV	54.00	-8.58	1.16 H	277	9.73	35.69
7	7236.00	55.72 PK	74.00	-18.28	1.55 H	72	13.48	42.24
8	7236.00	45.13 AV	54.00	-8.87	1.55 H	72	2.89	42.24

#### ANTENNA POLARITY & TEST DISTANCE: VERTICAL AT 3 M

No.	Freq. (MHz)	Emission Level (dBuV/m)	Limit (dBuV/m)	Margin (dB)	Antenna Height (m)	Table Angle (Degree)	Raw Value (dBuV)	Correction Factor (dB/m)
1	2386.00	62.52 PK	74.00	-11.48	1.51 V	282	32.14	30.38
2	2386.00	51.53 AV	54.00	-2.47	1.51 V	282	21.15	30.38
3	*2412.00	110.61 PK			1.50 V	77	80.12	30.49
4	*2412.00	106.40 AV			1.50 V	77	75.91	30.49
5	4824.00	54.16 PK	74.00	-19.84	1.19 V	258	18.47	35.69
6	4824.00	50.74 AV	54.00	-3.26	1.19 V	258	15.05	35.69
7	7236.00	55.34 PK	74.00	-18.66	1.58 V	69	13.10	42.24
8	7236.00	44.32 AV	54.00	-9.68	1.58 V	69	2.08	42.24

- REMARKS:**
1. Emission level(dBuV/m)=Raw Value(dBuV) + Correction Factor(dB/m)
  2. Correction Factor(dB/m) = Antenna Factor (dB/m) + Cable Factor (dB)
  3. The other emission levels were very low against the limit.
  4. Margin value = Emission level – Limit value.
  5. The limit value is defined as per 15.247
  6. “ \* “ : Fundamental frequency

<b>MODE</b>	Channel 6	<b>FREQUENCY RANGE</b>	1000~25000MHz
<b>INPUT POWER (SYSTEM)</b>	120Vac, 60 Hz	<b>DETECTOR FUNCTION &amp; BANDWIDTH</b>	Peak (PK) Average (AV) 1 MHz
<b>ENVIRONMENTAL CONDITIONS</b>	20 deg. C, 65%RH, 966hPa	<b>TESTED BY</b>	Phoenix Huang

#### ANTENNA POLARITY & TEST DISTANCE: HORIZONTAL AT 3 M

No.	Freq. (MHz)	Emission Level (dBuV/m)	Limit (dBuV/m)	Margin (dB)	Antenna Height (m)	Table Angle (Degree)	Raw Value (dBuV)	Correction Factor (dB/m)
1	*2437.00	105.00 PK			1.22 H	272	74.39	30.61
2	*2437.00	99.50 AV			1.22 H	272	68.89	30.61
3	4874.00	52.10 PK	74.00	-21.90	1.22 H	102	16.30	35.80
4	4874.00	45.20 AV	54.00	-8.80	1.22 H	102	9.40	35.80
5	7311.00	56.30 PK	74.00	-17.70	1.06 H	45	13.78	42.52
6	7311.00	47.90 AV	54.00	-6.10	1.06 H	45	5.38	42.52

#### ANTENNA POLARITY & TEST DISTANCE: VERTICAL AT 3 M

No.	Freq. (MHz)	Emission Level (dBuV/m)	Limit (dBuV/m)	Margin (dB)	Antenna Height (m)	Table Angle (Degree)	Raw Value (dBuV)	Correction Factor (dB/m)
1	*2437.00	114.00 PK			1.29 V	96	83.39	30.61
2	*2437.00	108.60 AV			1.29 V	96	77.99	30.61
3	4874.00	54.70 PK	74.00	-19.30	1.16 V	253	18.90	35.80
4	4874.00	48.30 AV	54.00	-5.70	1.16 V	253	12.50	35.80
5	7311.00	57.50 PK	74.00	-16.50	1.57 V	86	14.98	42.52
6	7311.00	48.50 AV	54.00	-5.50	1.57 V	86	5.98	42.52

- REMARKS:**
1. Emission level(dBuV/m)=Raw Value(dBuV) + Correction Factor(dB/m)
  2. Correction Factor(dB/m) = Antenna Factor (dB/m) + Cable Factor (dB)
  3. The other emission levels were very low against the limit.
  4. Margin value = Emission level – Limit value.
  5. The limit value is defined as per 15.247
  6. “ \* “ : Fundamental frequency



<b>MODE</b>	Channel 11	<b>FREQUENCY RANGE</b>	1000~25000MHz
<b>INPUT POWER (SYSTEM)</b>	120Vac, 60 Hz	<b>DETECTOR FUNCTION &amp; BANDWIDTH</b>	Peak (PK) Average (AV) 1 MHz
<b>ENVIRONMENTAL CONDITIONS</b>	20 deg. C, 65%RH, 965hPa	<b>TESTED BY</b>	Wen Yu

**ANTENNA POLARITY & TEST DISTANCE: HORIZONTAL AT 3 M**

No.	Freq. (MHz)	Emission Level (dBuV/m)	Limit (dBuV/m)	Margin (dB)	Antenna Height (m)	Table Angle (Degree)	Raw Value (dBuV)	Correction Factor (dB/m)
1	*2462.00	104.43 PK			1.55 H	265	73.71	30.72
2	*2462.00	99.81 AV			1.55 H	265	69.09	30.72
3	2484.00	58.29 PK	74.00	-15.71	1.55 H	266	27.47	30.82
4	2484.00	46.30 AV	54.00	-7.70	1.55 H	266	15.48	30.82
5	4924.00	51.05 PK	74.00	-22.95	1.17 H	268	15.15	35.90
6	4924.00	45.63 AV	54.00	-8.37	1.17 H	268	9.73	35.90
7	7386.00	55.89 PK	74.00	-18.11	1.56 H	83	13.09	42.80
8	7386.00	45.28 AV	54.00	-8.72	1.56 H	83	2.48	42.80

**ANTENNA POLARITY & TEST DISTANCE: VERTICAL AT 3 M**

No.	Freq. (MHz)	Emission Level (dBuV/m)	Limit (dBuV/m)	Margin (dB)	Antenna Height (m)	Table Angle (Degree)	Raw Value (dBuV)	Correction Factor (dB/m)
1	*2462.00	111.81 PK			1.03 V	310	81.09	30.72
2	*2462.00	107.13 AV			1.03 V	310	76.41	30.72
3	2484.00	60.80 PK	74.00	-13.20	1.01 V	49	29.98	30.82
4	2484.00	49.40 AV	54.00	-4.60	1.01 V	49	18.58	30.82
5	4924.00	52.74 PK	74.00	-21.26	1.16 V	239	16.84	35.90
6	4924.00	48.76 AV	54.00	-5.24	1.16 V	239	12.86	35.90
7	7386.00	56.52 PK	74.00	-17.48	1.60 V	104	13.72	42.80
8	7386.00	44.76 AV	54.00	-9.24	1.60 V	104	1.96	42.80

- REMARKS:**
1. Emission level(dBuV/m)=Raw Value(dBuV) + Correction Factor(dB/m)
  2. Correction Factor(dB/m) = Antenna Factor (dB/m) + Cable Factor (dB)
  3. The other emission levels were very low against the limit.
  4. Margin value = Emission level – Limit value.
  5. The limit value is defined as per 15.247
  6. “ \* “ : Fundamental frequency

RESTRICTED BANDEDGE (802.11b MODE, CH1, HORIZONTAL)

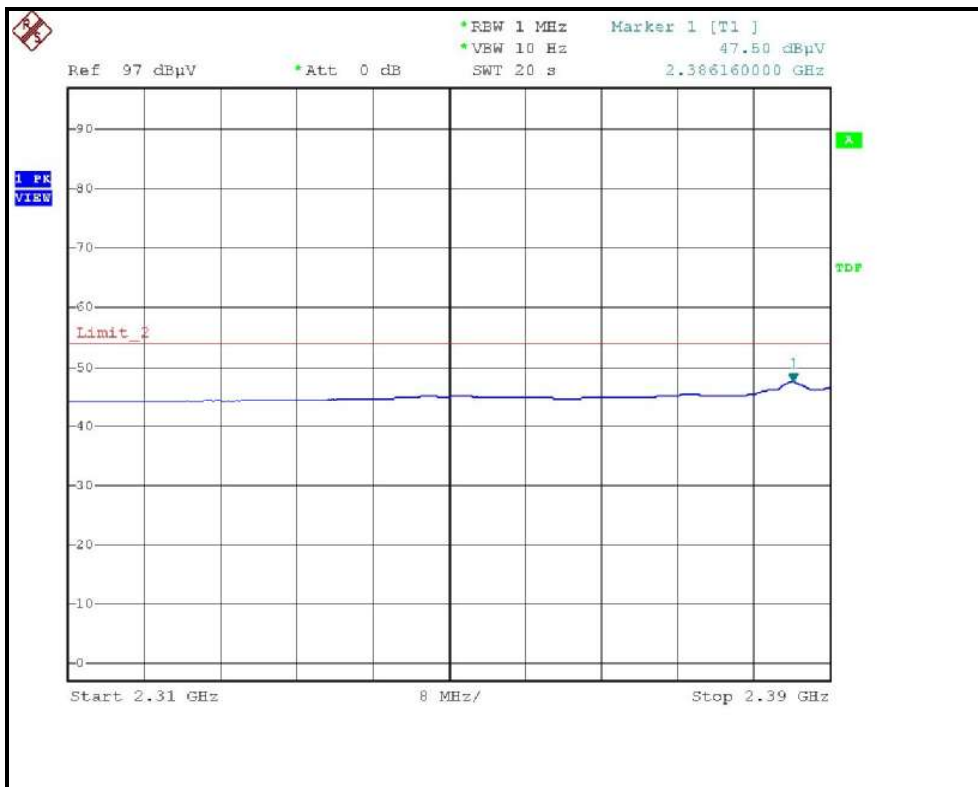
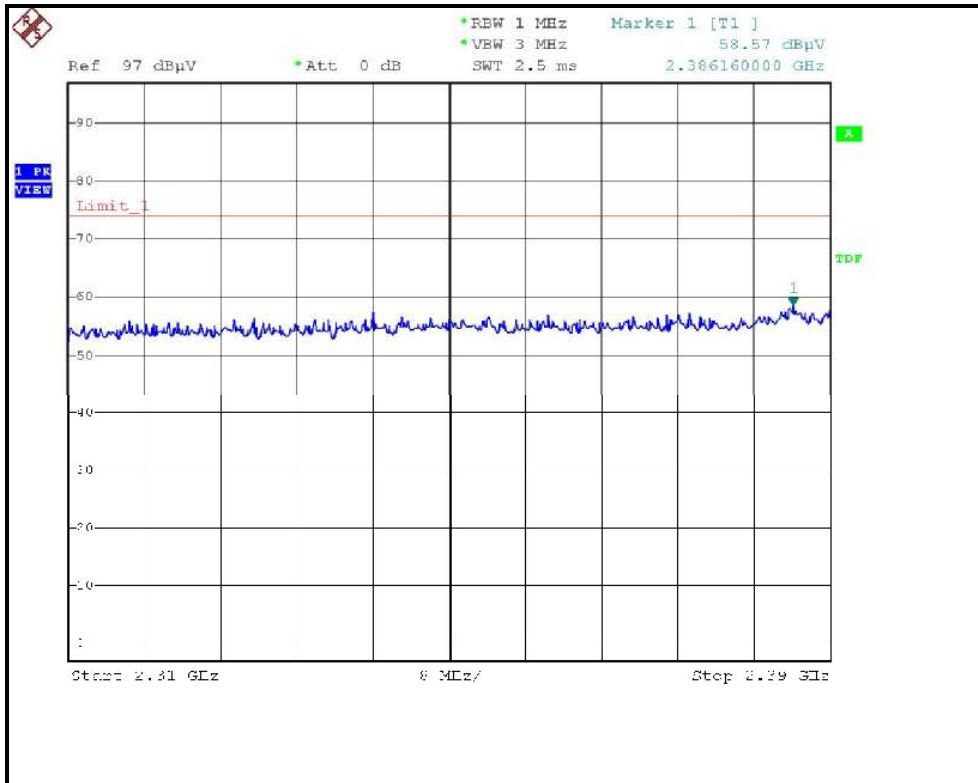

RESTRICTED BANDEDGE (802.11b MODE, CH1, VERTICAL)

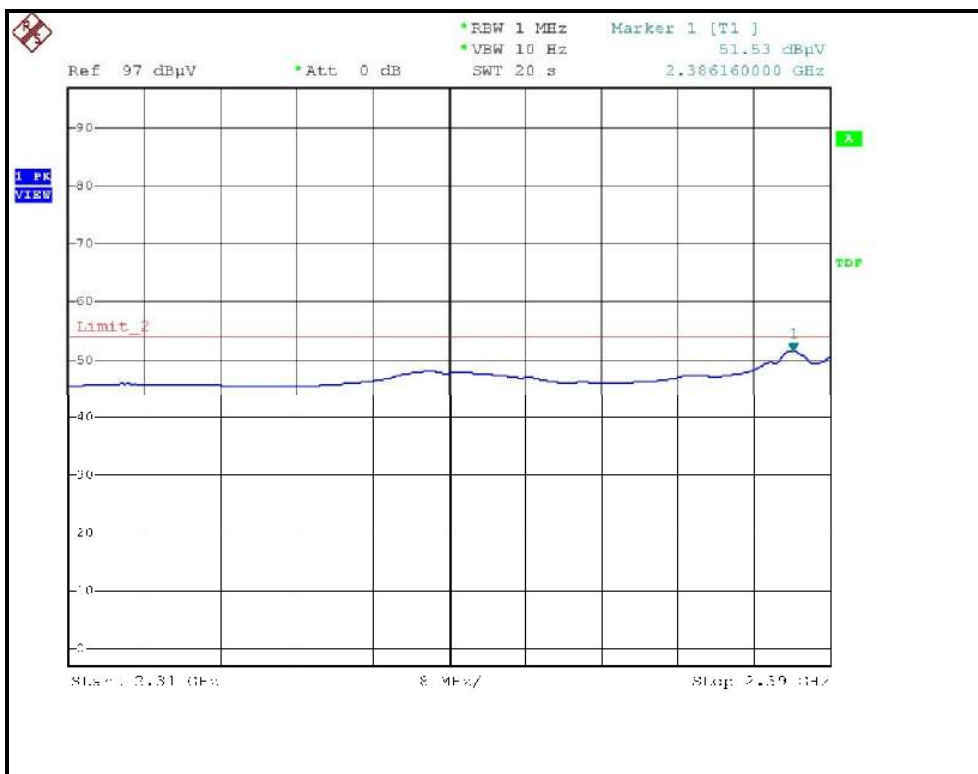
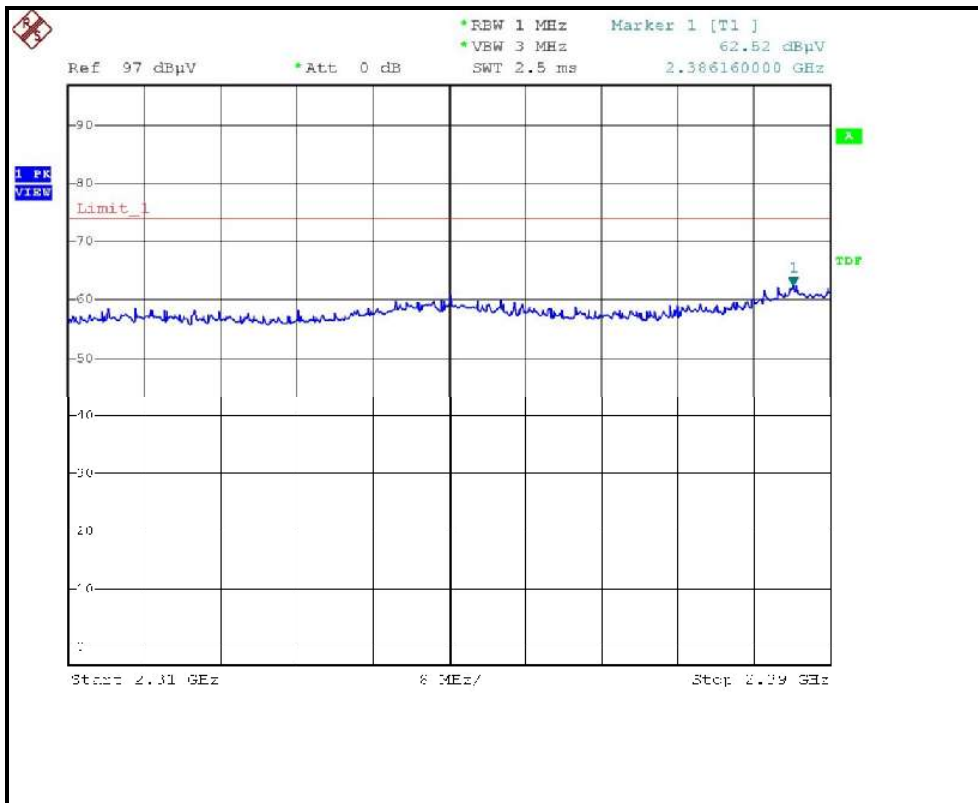

RESTRICTED BANDEDGE (802.11b MODE, CH11, HORIZONTAL)

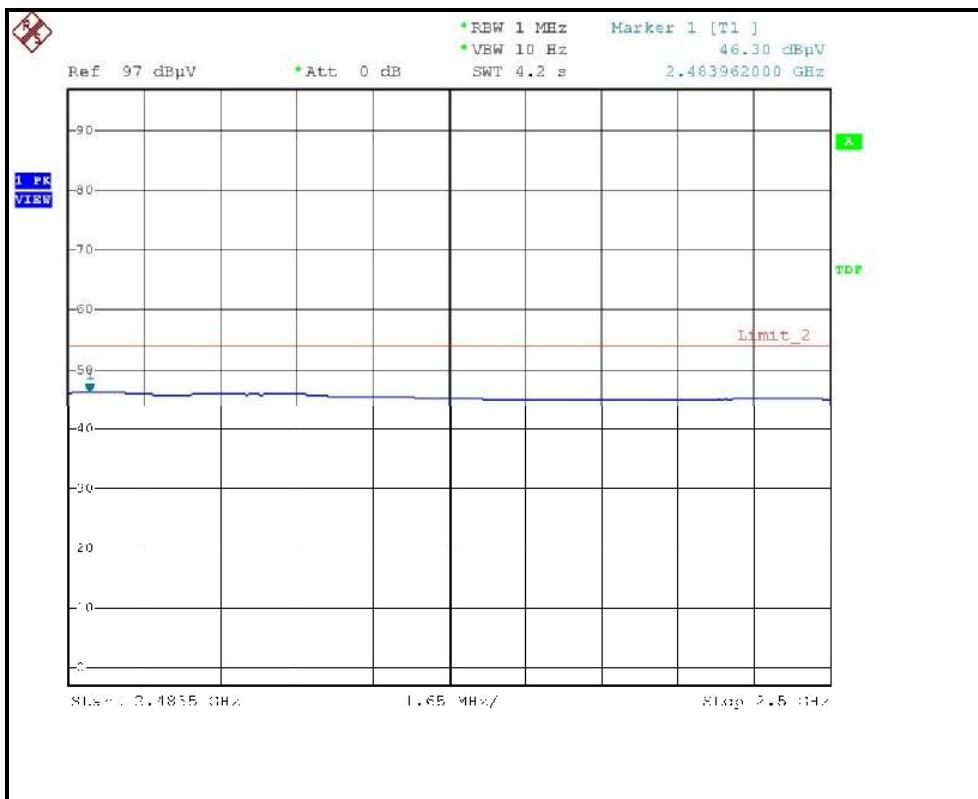
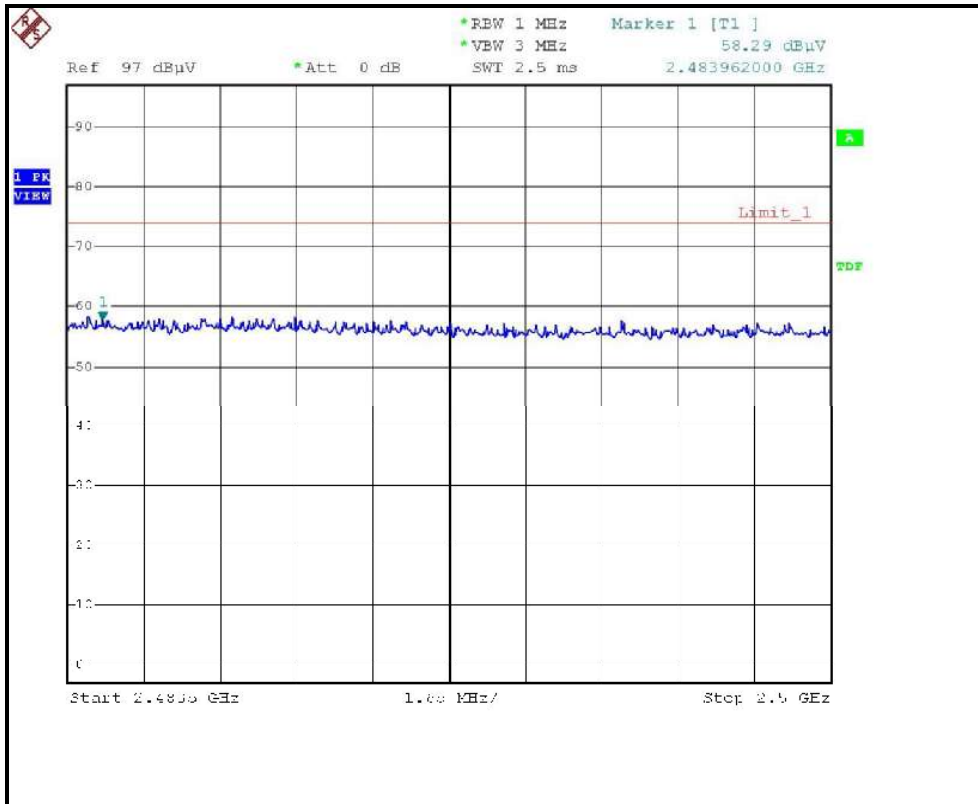

RESTRICTED BANDEDGE (802.11b MODE, CH11, VERTICAL)

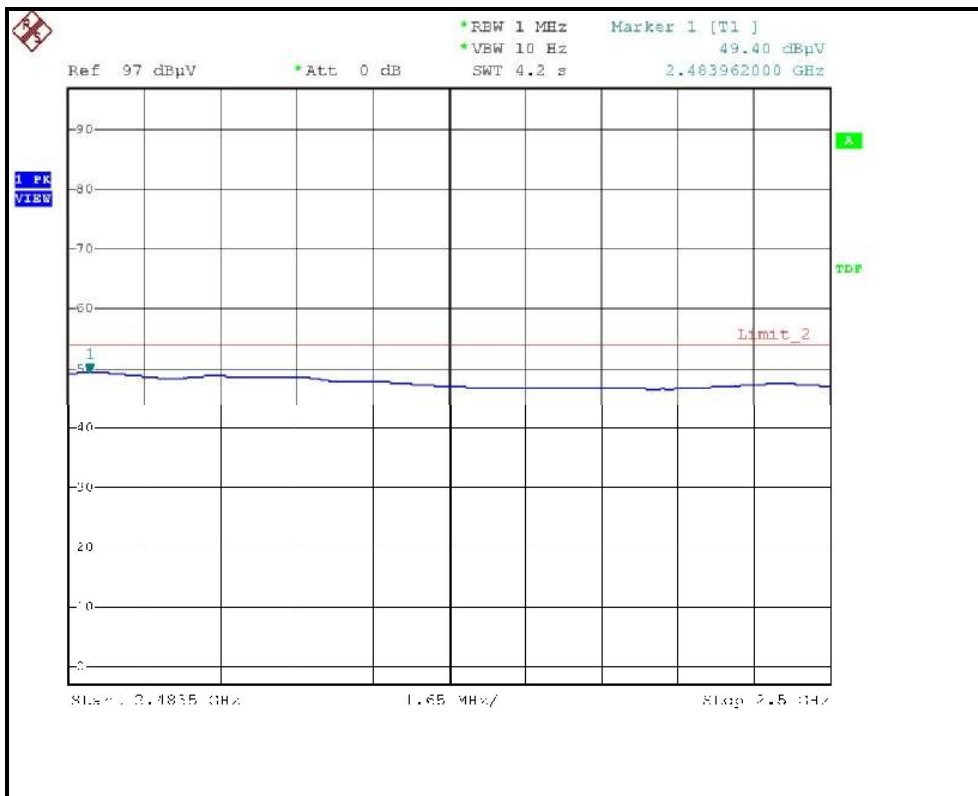
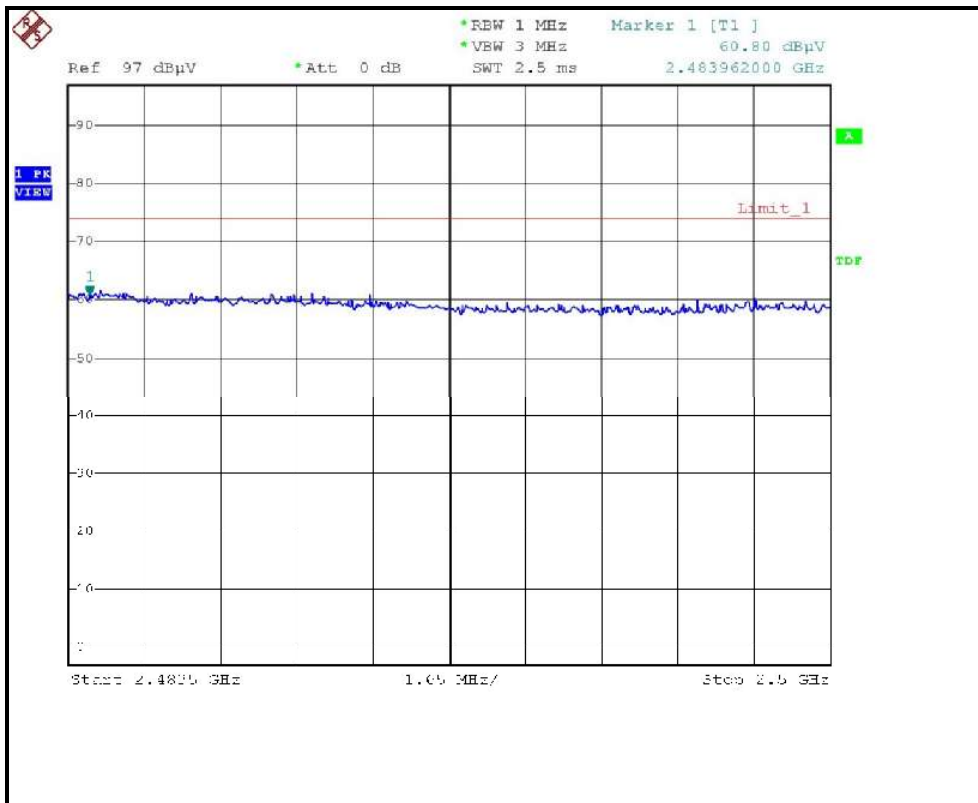

#### 4.2.8 TEST RESULTS - OFDM 802.11g OFDM modulation

<b>MODE</b>	Channel 1	<b>FREQUENCY RANGE</b>	1000~25000MHz
<b>INPUT POWER (SYSTEM)</b>	120Vac, 60 Hz	<b>DETECTOR FUNCTION &amp; BANDWIDTH</b>	Peak (PK) Average (AV) 1 MHz
<b>ENVIRONMENTAL CONDITIONS</b>	25 deg. C, 65%RH, 966hPa	<b>TESTED BY</b>	Wen Yu

#### ANTENNA POLARITY & TEST DISTANCE: HORIZONTAL AT 3 M

No.	Freq. (MHz)	Emission Level (dBuV/m)	Limit (dBuV/m)	Margin (dB)	Antenna Height (m)	Table Angle (Degree)	Raw Value (dBuV)	Correction Factor (dB/m)
1	2390.00	66.05 PK	74.00	-7.95	1.67 H	82	35.65	30.40
2	2390.00	48.38 AV	54.00	-5.62	1.67 H	82	17.98	30.40
3	*2412.00	107.08 PK			1.31 H	88	76.59	30.49
4	*2412.00	96.09 AV			1.31 H	88	65.60	30.49
5	4824.00	48.74 PK	74.00	-25.26	1.17 H	283	13.05	35.69
6	4824.00	34.43 AV	54.00	-19.57	1.17 H	283	-1.26	35.69
7	7236.00	57.92 PK	74.00	-16.08	1.64 H	73	15.68	42.24
8	7236.00	42.71 AV	54.00	-11.29	1.64 H	73	0.47	42.24

#### ANTENNA POLARITY & TEST DISTANCE: VERTICAL AT 3 M

No.	Freq. (MHz)	Emission Level (dBuV/m)	Limit (dBuV/m)	Margin (dB)	Antenna Height (m)	Table Angle (Degree)	Raw Value (dBuV)	Correction Factor (dB/m)
1	2390.00	72.24 PK	74.00	-1.76	1.04 V	347	41.84	30.40
2	2390.00	53.04 AV	54.00	-0.96	1.04 V	347	22.64	30.40
3	*2412.00	114.42 PK			1.01 V	44	83.93	30.49
4	*2412.00	103.04 AV			1.01 V	44	72.55	30.49
5	4824.00	49.84 PK	74.00	-24.16	1.58 V	82	14.15	35.69
6	4824.00	36.04 AV	54.00	-17.96	1.58 V	82	0.35	35.69
7	7236.00	57.66 PK	74.00	-16.34	1.58 V	107	15.42	42.24
8	7236.00	42.50 AV	54.00	-11.50	1.58 V	107	0.26	42.24

- REMARKS:**
1. Emission level(dBuV/m)=Raw Value(dBuV) + Correction Factor(dB/m)
  2. Correction Factor(dB/m) = Antenna Factor (dB/m) + Cable Factor (dB)
  3. The other emission levels were very low against the limit.
  4. Margin value = Emission level – Limit value.
  5. The limit value is defined as per 15.247
  6. " \* " : Fundamental frequency



<b>MODE</b>	Channel 6	<b>FREQUENCY RANGE</b>	1000~25000MHz
<b>INPUT POWER (SYSTEM)</b>	120Vac, 60 Hz	<b>DETECTOR FUNCTION &amp; BANDWIDTH</b>	Peak (PK) Average (AV) 1 MHz
<b>ENVIRONMENTAL CONDITIONS</b>	25 deg. C, 65%RH, 966hPa	<b>TESTED BY</b>	Wen Yu

#### ANTENNA POLARITY & TEST DISTANCE: HORIZONTAL AT 3 M

No.	Freq. (MHz)	Emission Level (dBuV/m)	Limit (dBuV/m)	Margin (dB)	Antenna Height (m)	Table Angle (Degree)	Raw Value (dBuV)	Correction Factor (dB/m)
1	*2437.00	109.17 PK			1.30 H	89	78.56	30.61
2	*2437.00	98.12 AV			1.30 H	89	67.51	30.61
3	4874.00	49.38 PK	74.00	-24.62	1.17 H	22	13.58	35.80
4	4874.00	35.42 AV	54.00	-18.58	1.17 H	22	-0.38	35.80
5	7311.00	59.13 PK	74.00	-14.87	1.64 H	78	16.61	42.52
6	7311.00	43.86 AV	54.00	-10.14	1.64 H	78	1.34	42.52

#### ANTENNA POLARITY & TEST DISTANCE: VERTICAL AT 3 M

No.	Freq. (MHz)	Emission Level (dBuV/m)	Limit (dBuV/m)	Margin (dB)	Antenna Height (m)	Table Angle (Degree)	Raw Value (dBuV)	Correction Factor (dB/m)
1	*2437.00	116.39 PK			1.04 V	19	85.78	30.61
2	*2437.00	105.13 AV			1.04 V	19	74.52	30.61
3	4874.00	50.96 PK	74.00	-23.04	1.58 V	197	15.16	35.80
4	4874.00	37.15 AV	54.00	-16.85	1.58 V	197	1.35	35.80
5	7311.00	58.73 PK	74.00	-15.27	1.55 V	117	16.21	42.52
6	7311.00	43.68 AV	54.00	-10.32	1.55 V	117	1.16	42.52

- REMARKS:**
1. Emission level(dBuV/m)=Raw Value(dBuV) + Correction Factor(dB/m)
  2. Correction Factor(dB/m) = Antenna Factor (dB/m) + Cable Factor (dB)
  3. The other emission levels were very low against the limit.
  4. Margin value = Emission level – Limit value.
  5. The limit value is defined as per 15.247
  6. “ \* “ : Fundamental frequency

<b>MODE</b>	Channel 11	<b>FREQUENCY RANGE</b>	1000~25000MHz
<b>INPUT POWER (SYSTEM)</b>	120Vac, 60 Hz	<b>DETECTOR FUNCTION &amp; BANDWIDTH</b>	Peak (PK) Average (AV) 1 MHz
<b>ENVIRONMENTAL CONDITIONS</b>	25 deg. C, 65%RH, 966hPa	<b>TESTED BY</b>	Wen Yu

#### ANTENNA POLARITY & TEST DISTANCE: HORIZONTAL AT 3 M

No.	Freq. (MHz)	Emission Level (dBuV/m)	Limit (dBuV/m)	Margin (dB)	Antenna Height (m)	Table Angle (Degree)	Raw Value (dBuV)	Correction Factor (dB/m)
1	*2462.00	106.26 PK			1.34 H	88	75.54	30.72
2	*2462.00	95.23 AV			1.34 H	88	64.51	30.72
3	2483.50	64.75 PK	74.00	-9.25	1.24 H	89	33.93	30.82
4	2483.50	47.95 AV	54.00	-6.05	1.24 H	89	17.13	30.82
5	4924.00	49.27 PK	74.00	-24.73	1.16 H	205	13.37	35.90
6	4924.00	34.96 AV	54.00	-19.04	1.16 H	205	-0.94	35.90
7	7386.00	58.43 PK	74.00	-15.57	1.66 H	72	15.63	42.80
8	7386.00	43.26 AV	54.00	-10.74	1.66 H	72	0.46	42.80

#### ANTENNA POLARITY & TEST DISTANCE: VERTICAL AT 3 M

No.	Freq. (MHz)	Emission Level (dBuV/m)	Limit (dBuV/m)	Margin (dB)	Antenna Height (m)	Table Angle (Degree)	Raw Value (dBuV)	Correction Factor (dB/m)
1	*2462.00	114.93 PK			1.03 V	51	84.21	30.72
2	*2462.00	103.81 AV			1.03 V	51	73.09	30.72
3	2483.50	72.40 PK	74.00	-1.60	1.00 V	51	41.58	30.82
<b>4</b>	<b>2483.50</b>	<b>53.79 AV</b>	<b>54.00</b>	<b>-0.21</b>	<b>1.00 V</b>	<b>51</b>	<b>22.97</b>	<b>30.82</b>
5	4924.00	50.36 PK	74.00	-23.64	1.57 V	89	14.46	35.90
6	4924.00	36.61 AV	54.00	-17.39	1.57 V	89	0.71	35.90
7	7386.00	58.12 PK	74.00	-15.88	1.56 V	108	15.32	42.80
8	7386.00	43.07 AV	54.00	-10.93	1.56 V	108	0.27	42.80

- REMARKS:**
1. Emission level(dBuV/m)=Raw Value(dBuV) + Correction Factor(dB/m)
  2. Correction Factor(dB/m) = Antenna Factor (dB/m) + Cable Factor (dB)
  3. The other emission levels were very low against the limit.
  4. Margin value = Emission level – Limit value.
  5. The limit value is defined as per 15.247
  6. “ \* “ : Fundamental frequency



RESTRICTED BANDEDGE (802.11g MODE, CH1, HORIZONTAL)

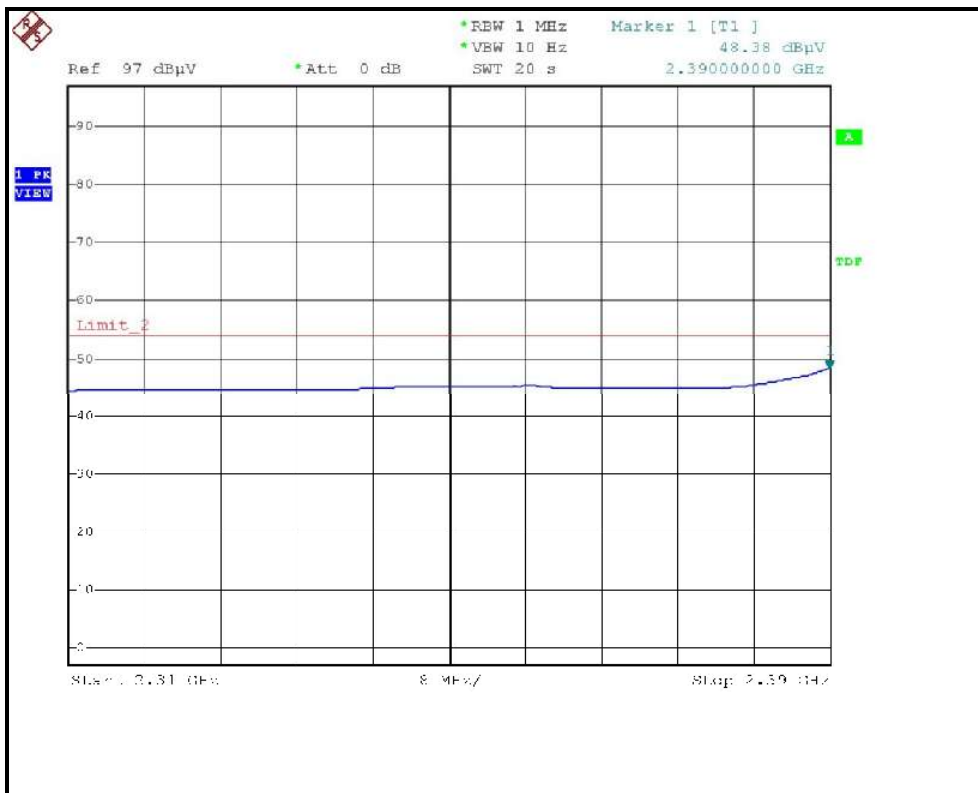
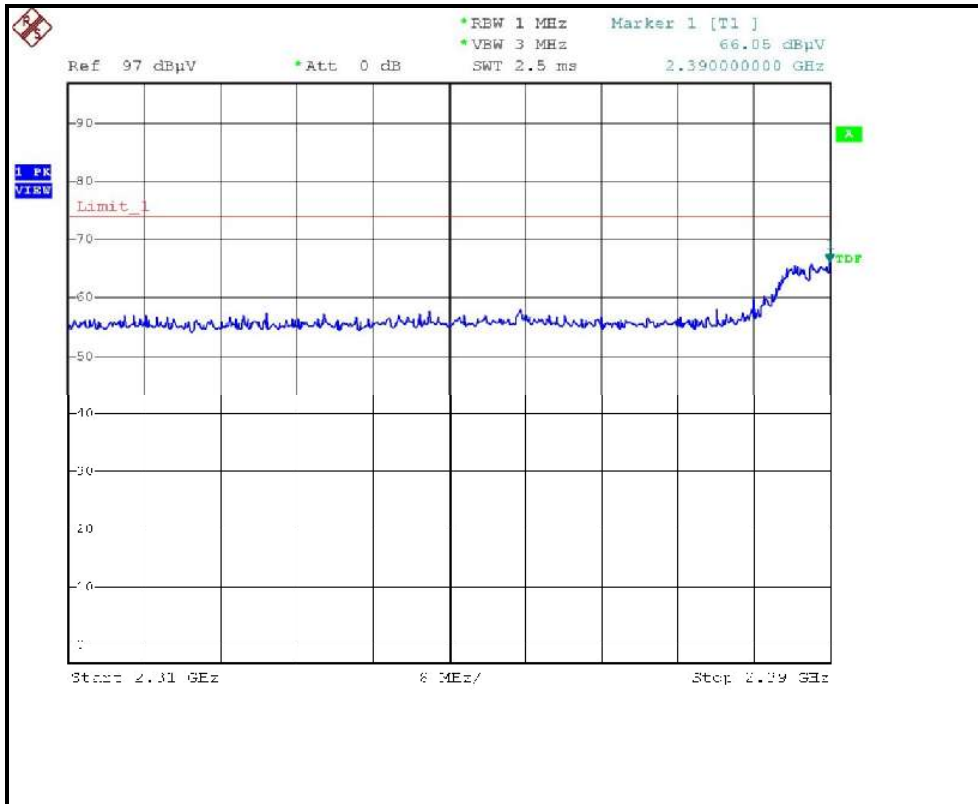

RESTRICTED BANDEDGE (802.11g MODE, CH1, VERTICAL)

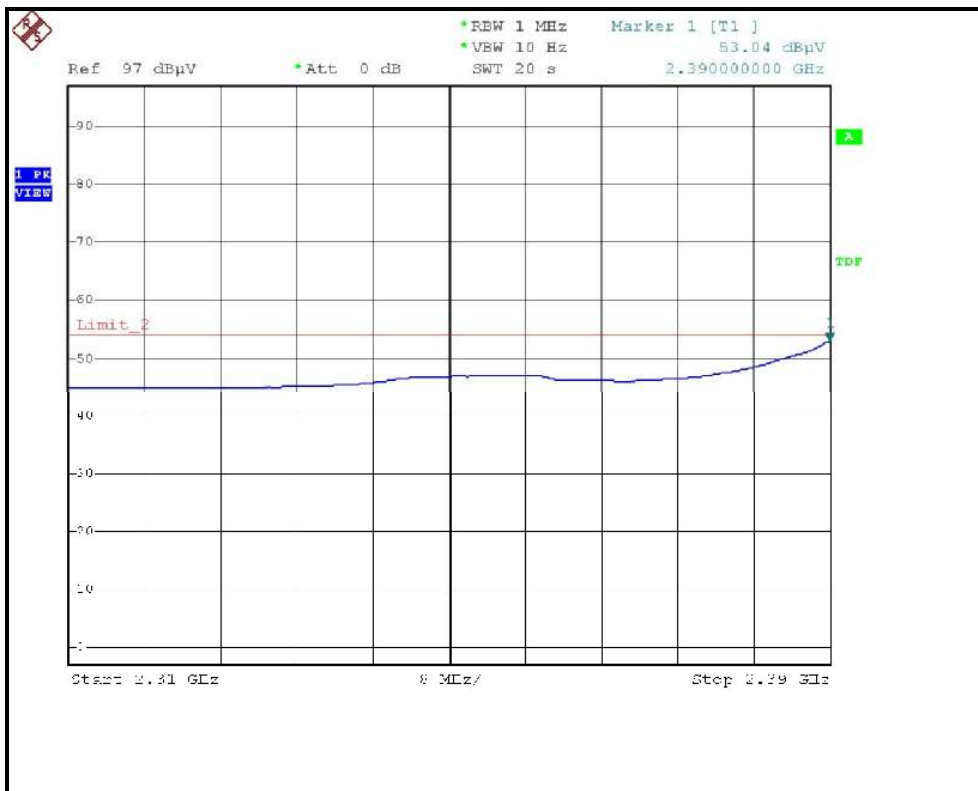
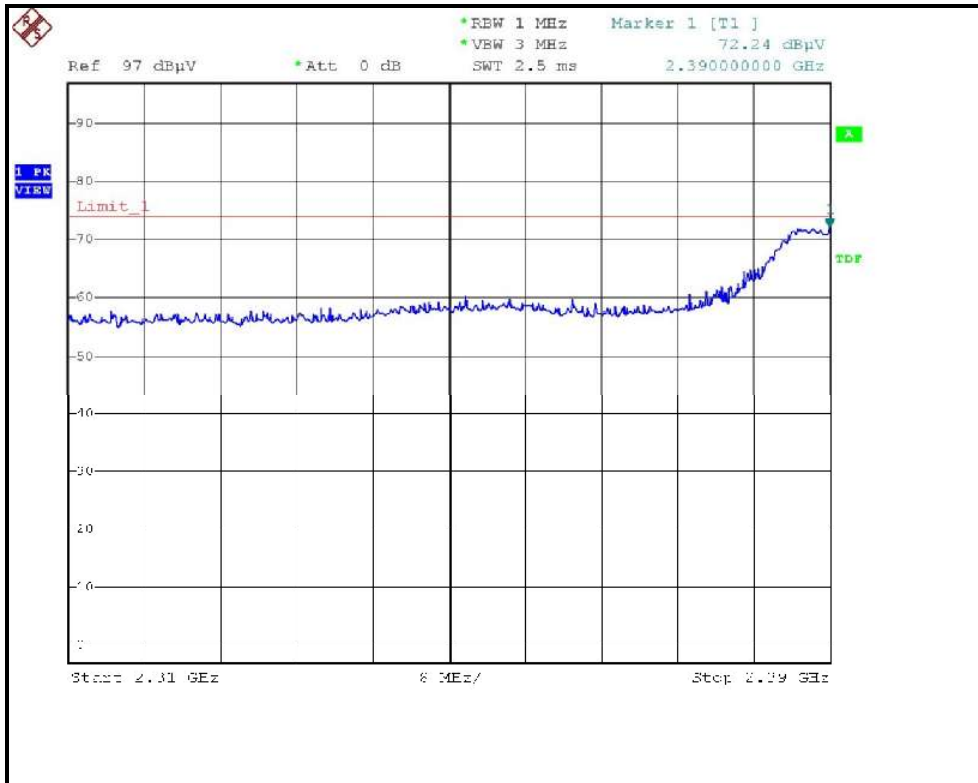

RESTRICTED BANDEDGE (802.11g MODE, CH11, HORIZONTAL)

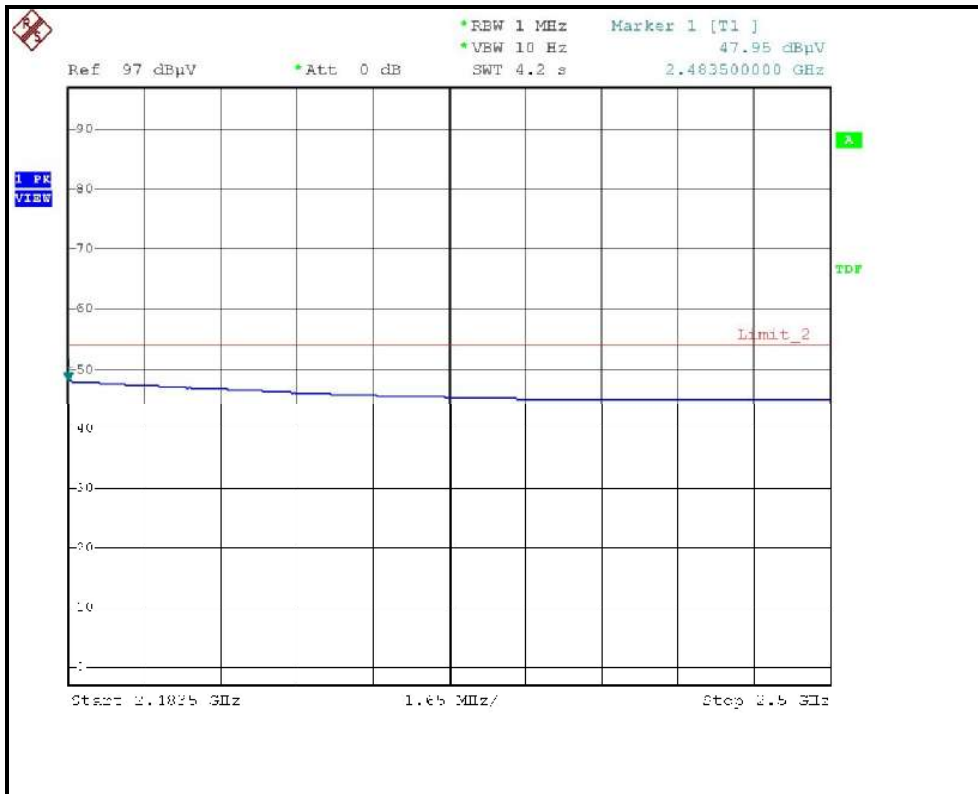
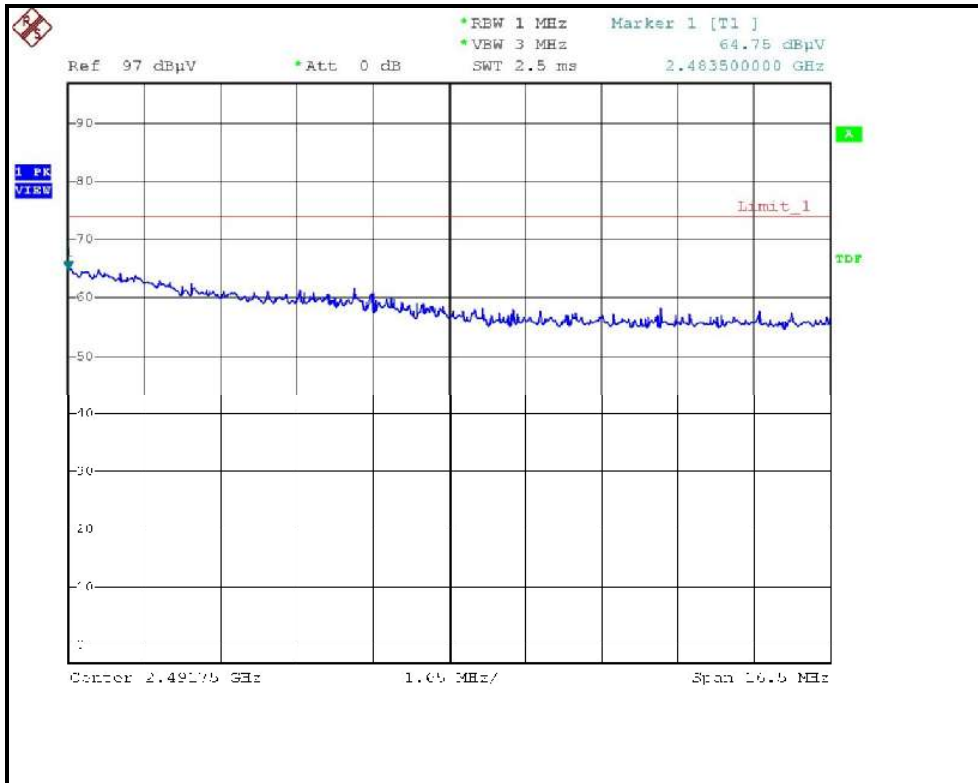

RESTRICTED BANDEDGE (802.11g MODE, CH11, VERTICAL)

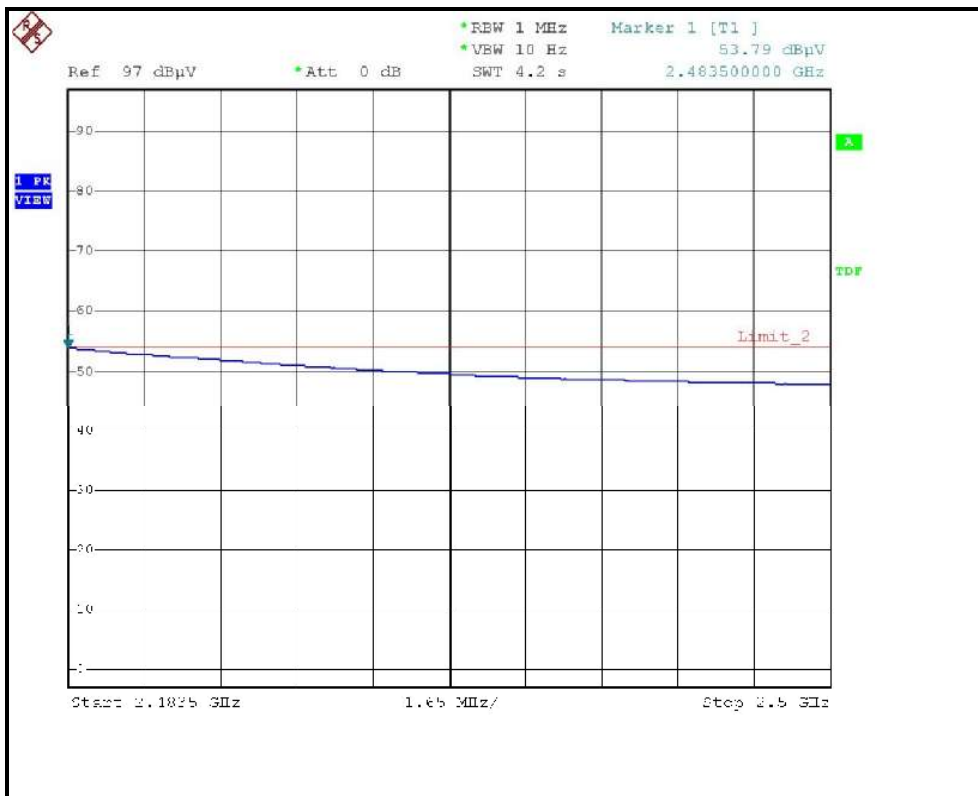
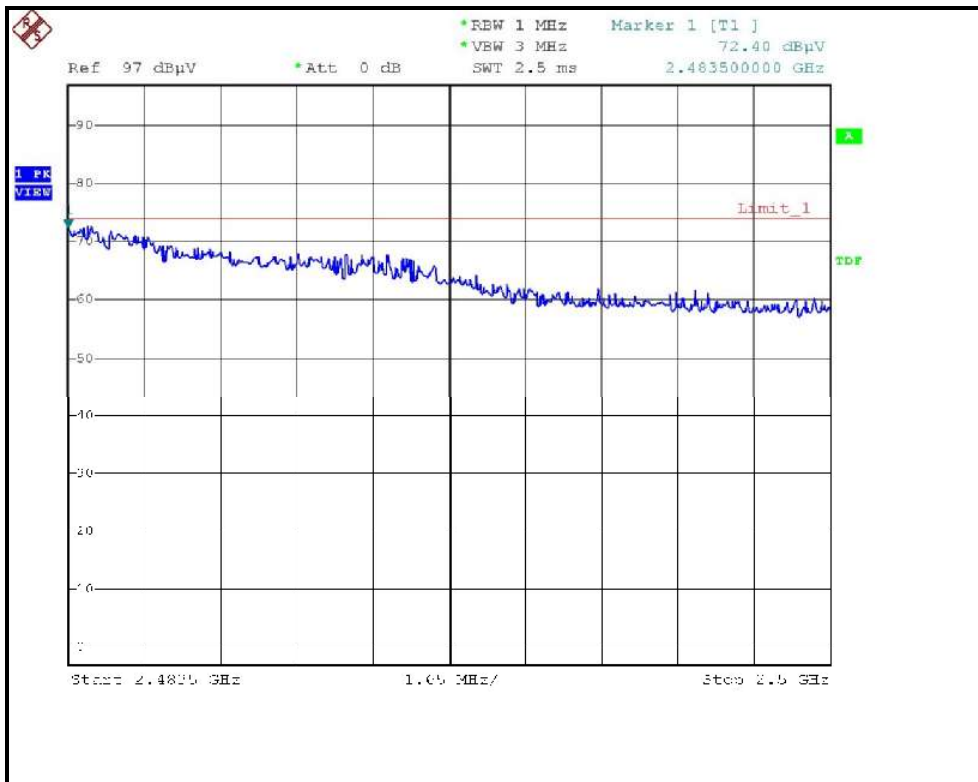

### 4.3 6dB BANDWIDTH MEASUREMENT

#### 4.3.1 LIMITS OF 6dB BANDWIDTH MEASUREMENT

The minimum of 6dB Bandwidth Measurement is 0.5 MHz.

#### 4.3.2 TEST INSTRUMENTS

Description & Manufacturer	Model No.	Serial No.	Calibrated Until
R&S SPECTRUM ANALYZER	FSP40	100036	Dec. 09, 2007

**NOTE:**

- 1.The measurement uncertainty is less than +/- 2.6dB, which is calculated as per the NAMAS document NIS81.
- 2.The calibration interval of the above test instruments is 12 months and the calibrations are traceable to NML/ROC and NIST/USA.

### 4.3.3 TEST PROCEDURE

The transmitter output was connected to the spectrum analyzer through an attenuator. The bandwidth of the fundamental frequency was measured by spectrum analyzer with 100 kHz RBW and 100 kHz VBW. The 6 dB bandwidth is defined as the total spectrum the power of which is higher than peak power minus 6 dB.

### 4.3.4 TEST SETUP



For the actual test configuration, please refer to the related Item – Photographs of the Test Configuration.

### 4.3.5 EUT OPERATING CONDITIONS

The software provided by client to enable the EUT under transmission condition continuously at lowest, middle and highest channel frequencies individually.



#### 4.3.6 TEST RESULTS –DSSS

##### 802.11b DSSS modulation

<b>MODULATION TYPE</b>	CCK	<b>TRANSFER RATE</b>	1Mbps
<b>INPUT POWER (SYSTEM)</b>	120Vac, 60 Hz	<b>ENVIRONMENTAL CONDITIONS</b>	28deg. C, 62%RH, 966hPa
<b>TESTED BY</b>	Tony Chen		

<b>CHANNEL</b>	<b>CHANNEL FREQUENCY (MHz)</b>	<b>6 dB BANDWIDTH (MHz)</b>	<b>MINIMUM LIMIT (MHz)</b>	<b>PASS/FAIL</b>
1	2412	12.3	0.5	PASS
6	2437	12.2	0.5	PASS
11	2462	12.2	0.5	PASS

CH1



CH6





CH11

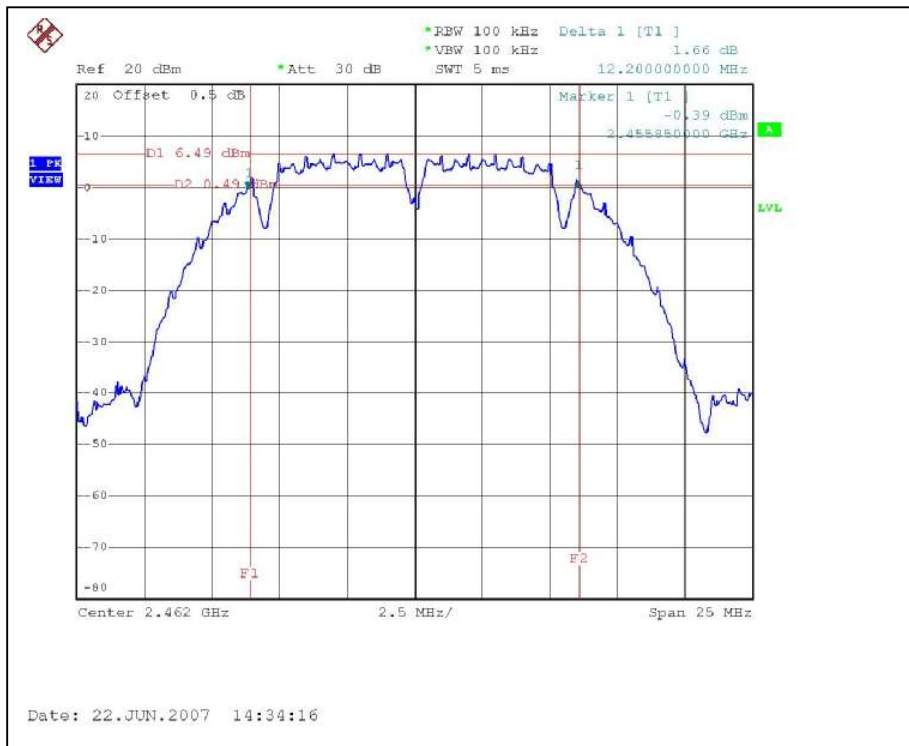



### 4.3.7 TEST RESULTS-OFDM

#### 802.11g OFDM modulation

<b>MODULATION TYPE</b>	BPSK	<b>TRANSFER RATE</b>	6Mbps
<b>INPUT POWER (SYSTEM)</b>	120Vac, 60 Hz	<b>ENVIRONMENTAL CONDITIONS</b>	28deg. C, 62%RH, 966hPa
<b>TESTED BY</b>	Tony Chen		

<b>CHANNEL</b>	<b>CHANNEL FREQUENCY (MHz)</b>	<b>6 dB BANDWIDTH (MHz)</b>	<b>MINIMUM LIMIT (MHz)</b>	<b>PASS/FAIL</b>
1	2412	16.35	0.5	PASS
6	2437	16.5	0.5	PASS
11	2462	16.3	0.5	PASS

### CH1

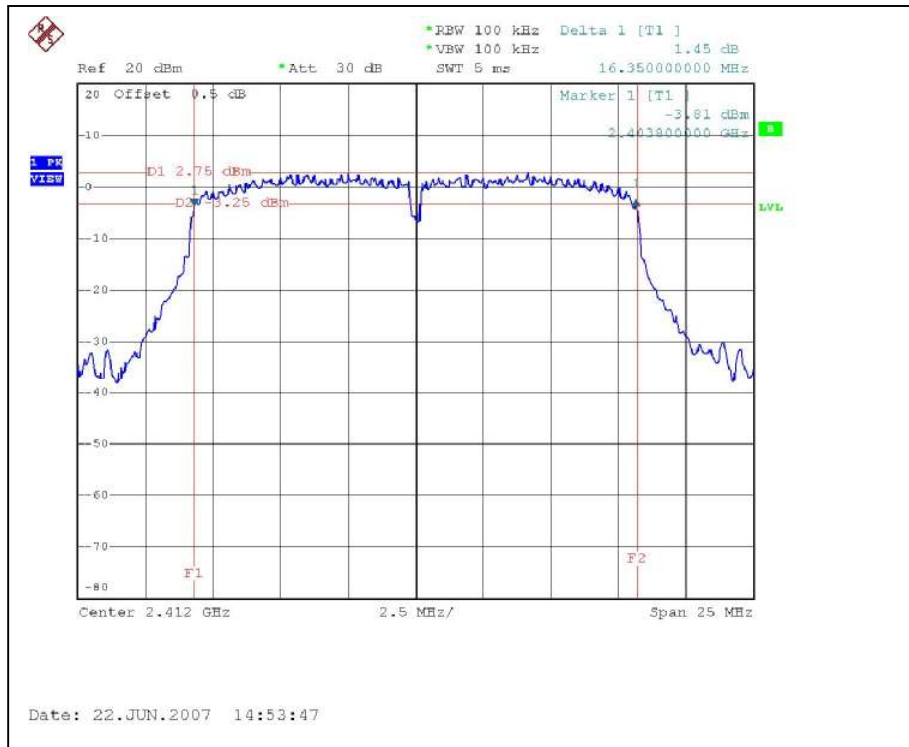

### CH6

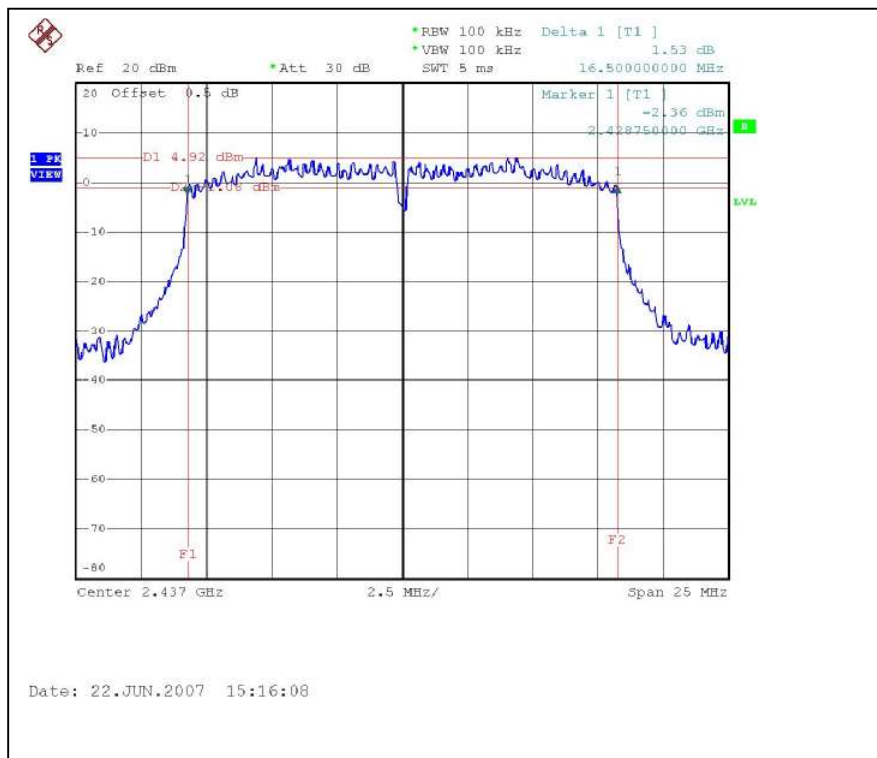

CH11

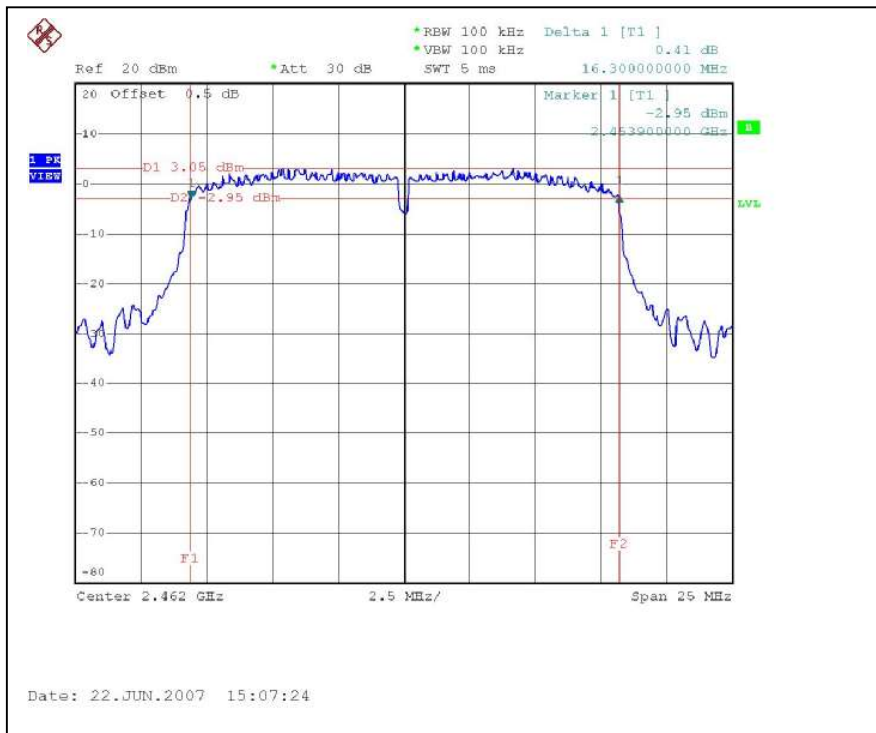



#### 4.4 MAXIMUM PEAK OUTPUT POWER

##### 4.4.1 LIMITS OF MAXIMUM PEAK OUTPUT POWER MEASUREMENT

The Maximum Peak Output Power Measurement is 30dBm.

##### 4.4.2 TEST INSTRUMENTS

Description & Manufacturer	Model No.	Serial No.	Calibrated Until
R&S SPECTRUM ANALYZER	FSP40	100036	Dec. 09, 2007
Agilent SIGNAL GENERATOR	E8257C	MY43320668	Dec. 07, 2007
TEKTRONIX OSCILLOSCOPE	TDS380	B016335	Jul. 04, 2007
NARDA DETECTOR	4503A	FSCM99899	NA

**NOTE:**

The calibration interval of the above test instruments is 12 months and the calibrations are traceable to NML/ROC and NIST/USA.

#### 4.4.3 TEST PROCEDURES

1. A detector was used on the output port of the EUT. An oscilloscope was used to read the peak response of the detector.
2. Replaced the EUT by the signal generator. The center frequency of the S.G was adjusted to the center frequency of the measured channel.
3. Adjusted the power to have the same peak reading on oscilloscope. Record the power level.

#### 4.4.4 TEST SETUP

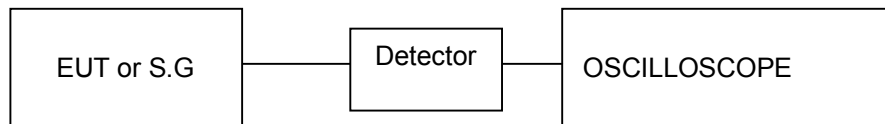

#### 4.4.5 EUT OPERATING CONDITIONS

Same as Item 4.3.5



#### 4.4.6 TEST RESULTS – DSSS

##### 802.11b DSSS modulation

<b>MODULATION TYPE</b>	CCK	<b>TRANSFER RATE</b>	11Mbps
<b>INPUT POWER (SYSTEM)</b>	120Vac, 60Hz	<b>ENVIRONMENTAL CONDITIONS</b>	28deg. C, 62%RH, 966hPa
<b>TESTED BY</b>	Tony Chen		

<b>CHANNEL</b>	<b>CHANNEL FREQUENCY (MHz)</b>	<b>PEAK POWER OUTPUT (mW)</b>	<b>PEAK POWER OUTPUT (dBm)</b>	<b>PEAK POWER LIMIT (dBm)</b>	<b>PASS/FAIL</b>
1	2412	100.000	20.00	30	PASS
6	2437	112.202	20.50	30	PASS
11	2462	102.329	20.10	30	PASS



#### 4.4.7 TEST RESULTS –OFDM

##### 802.11g OFDM modulation

<b>MODULATION TYPE</b>	BPSK	<b>TRANSFER RATE</b>	6Mbps
<b>INPUT POWER (SYSTEM)</b>	120Vac, 60Hz	<b>ENVIRONMENTAL CONDITIONS</b>	28deg. C, 62%RH, 966hPa
<b>TESTED BY</b>	Tony Chen		

<b>CHANNEL</b>	<b>CHANNEL FREQUENCY (MHz)</b>	<b>PEAK POWER OUTPUT (mW)</b>	<b>PEAK POWER OUTPUT (dBm)</b>	<b>PEAK POWER LIMIT (dBm)</b>	<b>PASS/FAIL</b>
1	2412	117.490	20.70	30	PASS
6	2437	131.826	21.20	30	PASS
11	2462	123.027	20.90	30	PASS



## 4.5 POWER SPECTRAL DENSITY MEASUREMENT

### 4.5.1 LIMITS OF POWER SPECTRAL DENSITY MEASUREMENT

The Maximum of Power Spectral Density Measurement is 8dBm.

### 4.5.2 TEST INSTRUMENTS

Description & Manufacturer	Model No.	Serial No.	Calibrated Until
R&S SPECTRUM ANALYZER	FSP40	100036	Dec. 09, 2007

**NOTE:**

- 1.The measurement uncertainty is less than +/- 2.6dB, which is calculated as per the NAMAS document NIS81.
- 2.The calibration interval of the above test instruments is 12 months and the calibrations are traceable to NML/ROC and NIST/USA.

#### 4.5.3 TEST PROCEDURE

The transmitter output was connected to the spectrum analyzer through an attenuator, the bandwidth of the fundamental frequency was measured with the spectrum analyzer using 3 kHz RBW and 30 kHz VBW, set sweep time= $\text{span}/3\text{kHz}$ . The power spectral density was measured and recorded. The sweep time is allowed to be longer than  $\text{span}/3\text{kHz}$  for a full response of the mixer in the spectrum analyzer.

#### 4.5.4 TEST SETUP

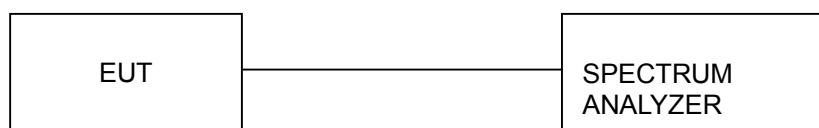

#### 4.5.5 EUT OPERATING CONDITIONS

Same as 4.3.5



#### 4.5.6 TEST RESULTS –DSSS

##### 802.11b DSSS modulation

<b>MODULATION TYPE</b>	CCK	<b>TRANSFER RATE</b>	11Mbps
<b>INPUT POWER (SYSTEM)</b>	120Vac, 60Hz	<b>ENVIRONMENTAL CONDITIONS</b>	28deg. C, 62%RH, 966hPa
<b>TESTED BY</b>	Tony Chen		

<b>CHANNEL NUMBER</b>	<b>CHANNEL FREQUENCY (MHz )</b>	<b>RF POWER LEVEL IN 3 KHz BW (dBm)</b>	<b>MAXIMUM LIMIT (dBm)</b>	<b>PASS/FAIL</b>
1	2412	-6.36	8	PASS
6	2437	-5.65	8	PASS
11	2462	-5.81	8	PASS

### CH1

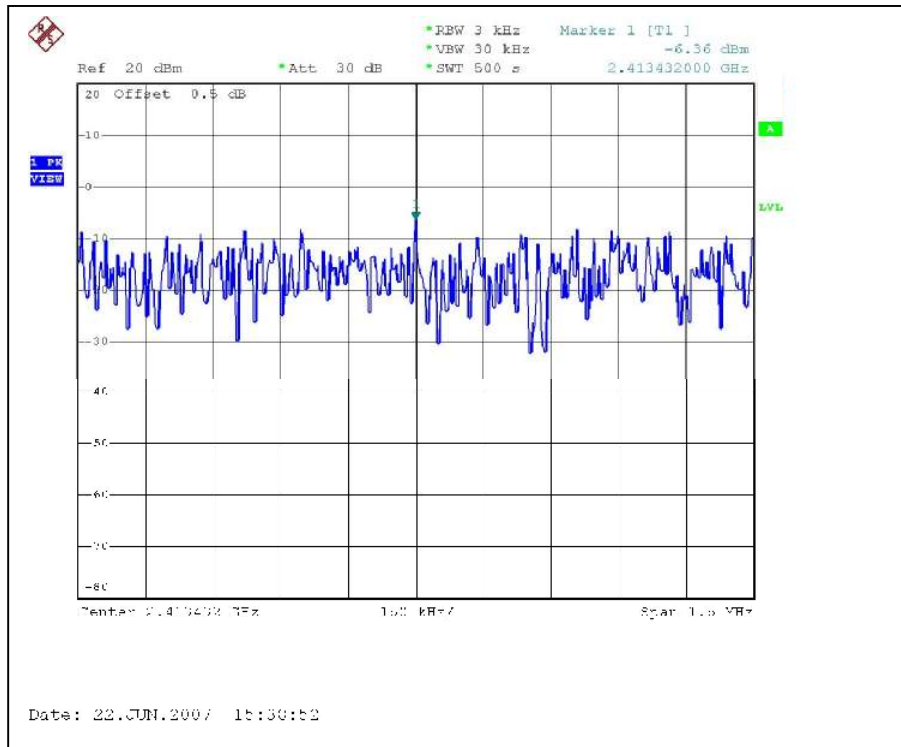

### CH6

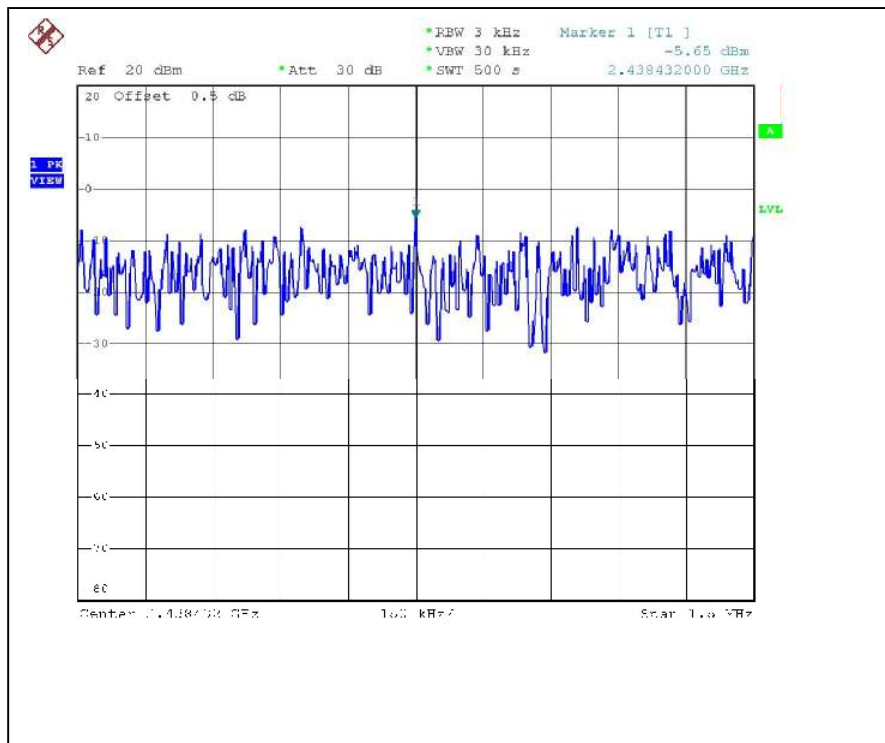

CH11

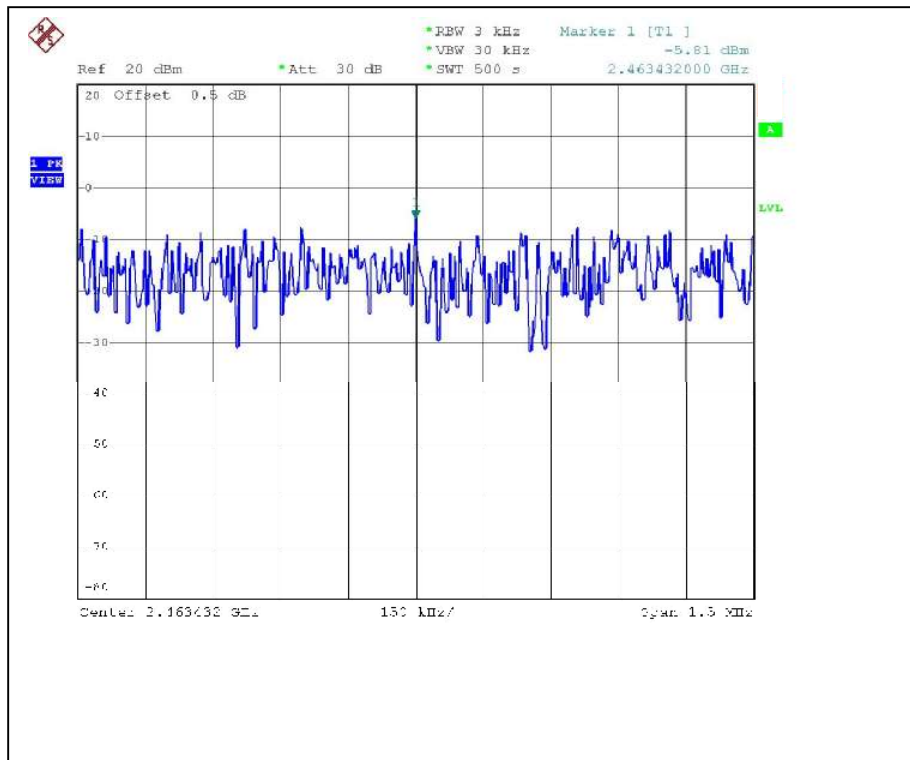



#### 4.5.7 TEST RESULTS –OFDM

##### 802.11g OFDM modulation

<b>MODULATION TYPE</b>	BPSK	<b>TRANSFER RATE</b>	6Mbps
<b>INPUT POWER (SYSTEM)</b>	120Vac, 60Hz	<b>ENVIRONMENTAL CONDITIONS</b>	28deg. C, 62%RH, 966hPa
<b>TESTED BY</b>	Tony Chen		

<b>CHANNEL NUMBER</b>	<b>CHANNEL FREQUENCY (MHz )</b>	<b>RF POWER LEVEL IN 3 KHz BW (dBm)</b>	<b>MAXIMUM LIMIT (dBm)</b>	<b>PASS/FAIL</b>
1	2412	-11.79	8	PASS
6	2437	-9.08	8	PASS
11	2462	-11.35	8	PASS

CH1

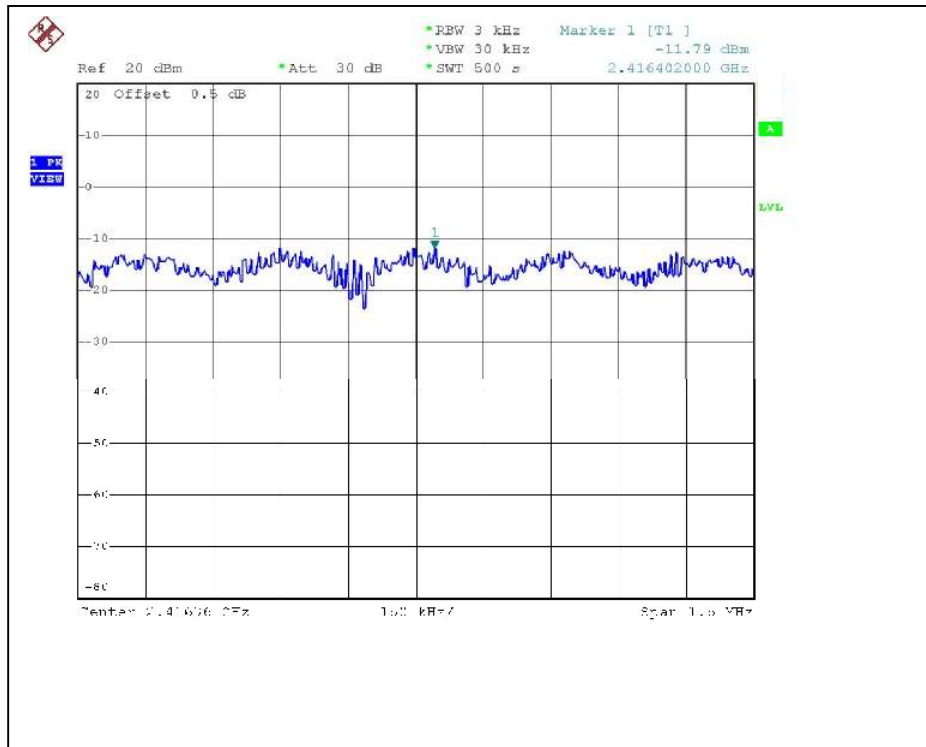

CH6

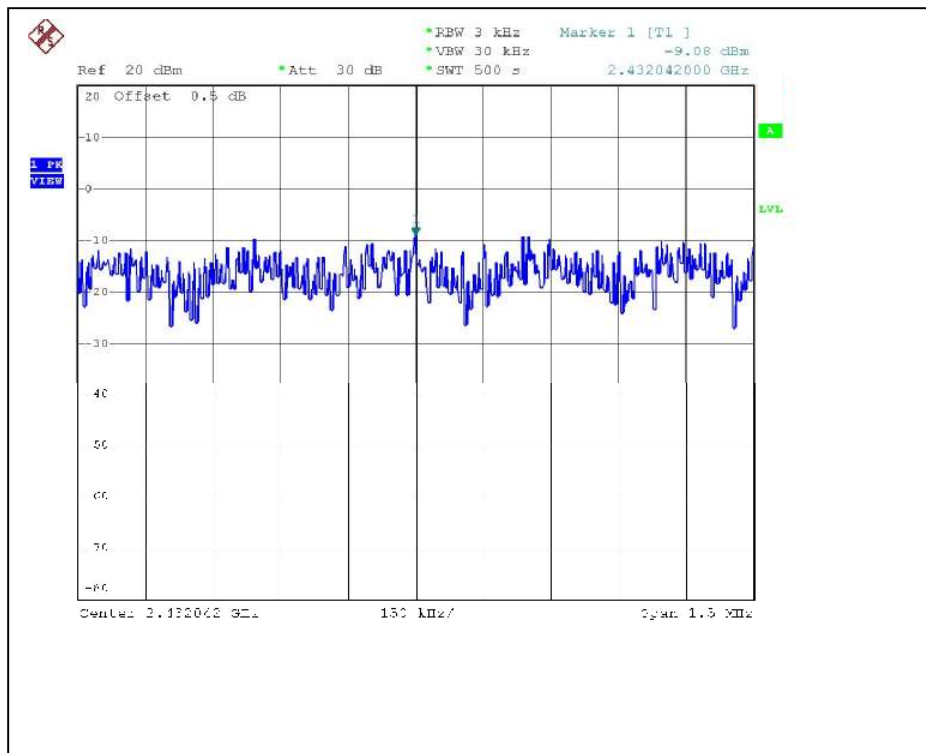

# CH11

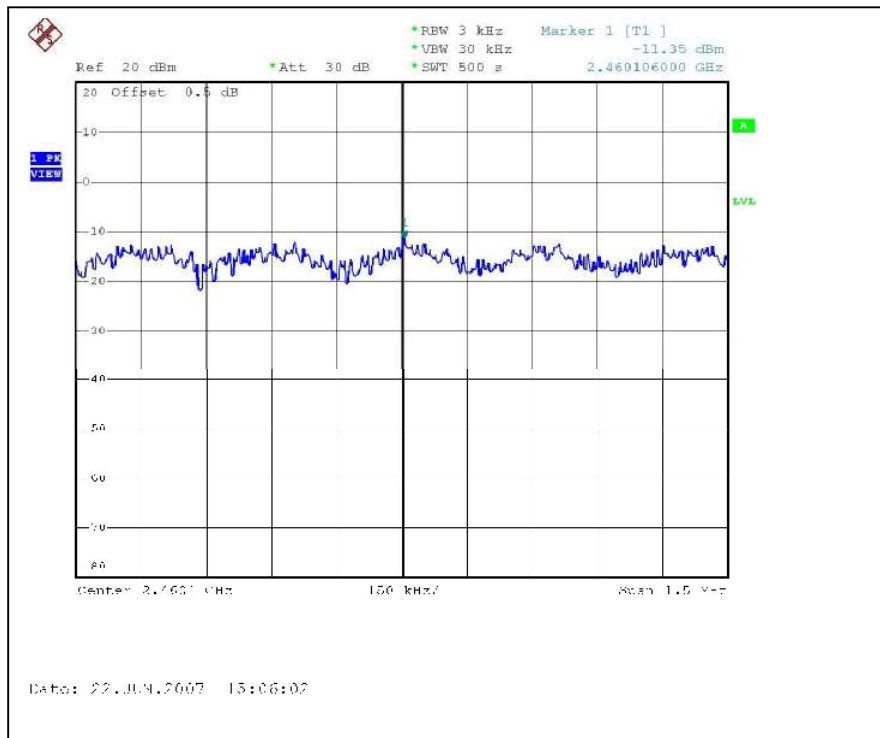



## 4.6 CONDUCTED EMISSION AND BAND EDGES MEASUREMENT

### 4.6.1 LIMITS OF CONDUCTED EMISSION AND BAND EDGES MEASUREMENT

Below  $-20\text{dB}$  of the highest emission level of operating band (in 100kHz Resolution Bandwidth).

### 4.6.2 TEST INSTRUMENTS

Description & Manufacturer	Model No.	Serial No.	Calibrated Until
R&S SPECTRUM ANALYZER	FSP40	100036	Dec. 09, 2007

**NOTE:**

1. The measurement uncertainty is less than  $\pm 2.6\text{dB}$ , which is calculated as per the NAMAS document NIS81.
2. The calibration interval of the above test instruments is 12 months and the calibrations are traceable to NML/ROC and NIST/USA.

### 4.6.3 TEST PROCEDURE

The transmitter output was connected to the spectrum analyzer via a low loss cable. Set both RBW and VBW of spectrum analyzer to 100kHz with suitable frequency span including 100 MHz bandwidth from band edge. The band edges was measured and recorded.

The spectrum plots (RBW = VBW = 100kHz) are attached on the following pages.

### 4.6.4 DEVIATION FROM TEST STANDARD

No deviation

### 4.6.5 EUT OPERATING CONDITION

Same as Item 4.3.5



#### 4.6.6 TEST RESULTS

The spectrum plots are attached on the following pages. D1 line indicates the highest level, and D2 line indicates the 20dB offset below D1. It shows compliance with the requirement in part 15.247(d).

## 802.11b DSSS MODULATION: CH1

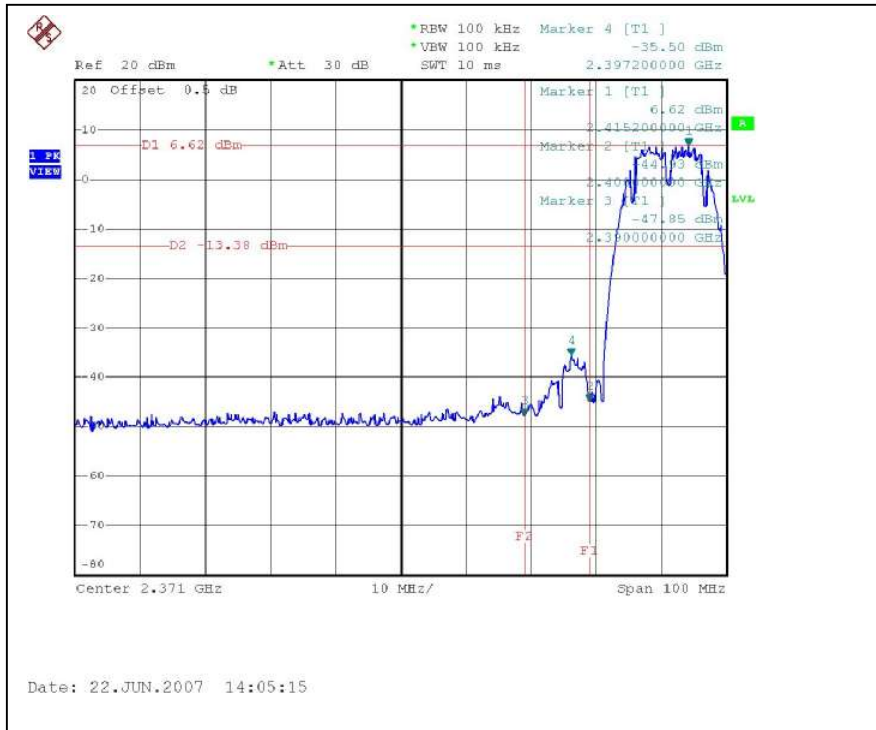

## CH11

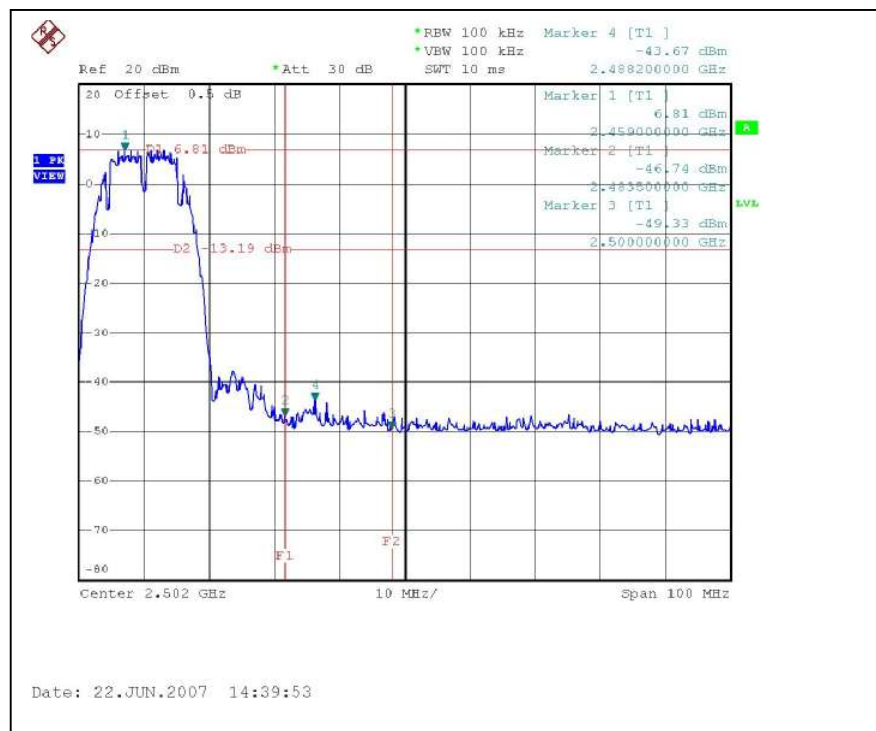

CH1

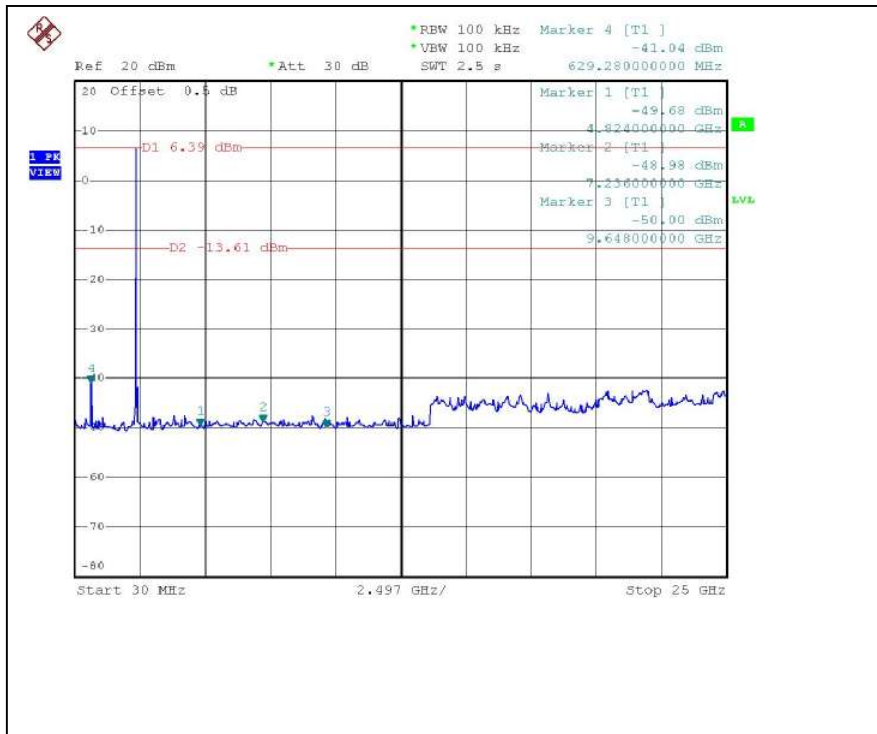

CH11

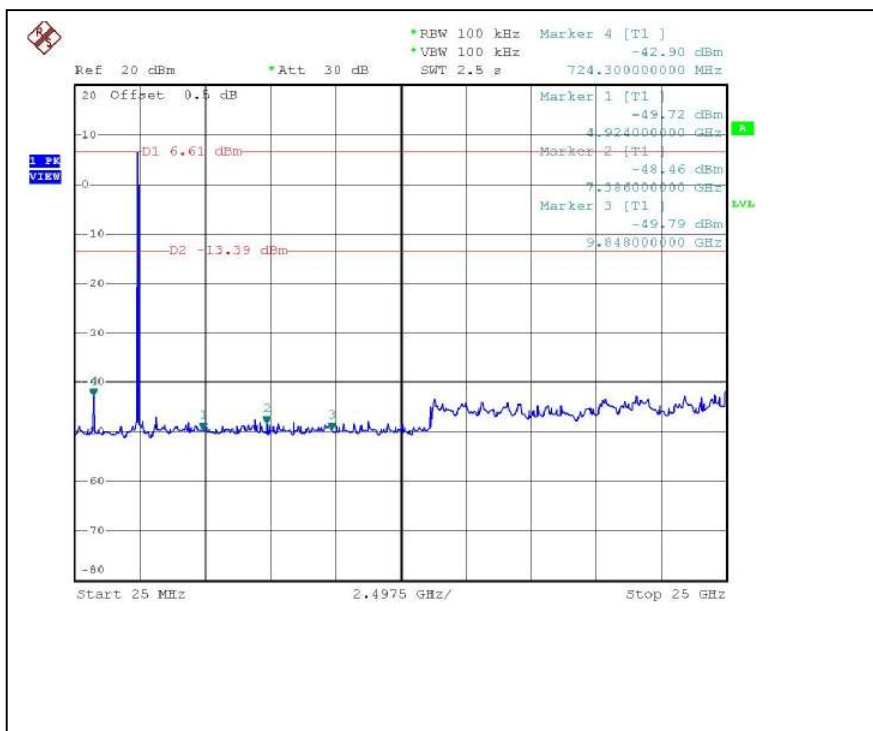

### 802.11g OFDM MODULATION: CH1

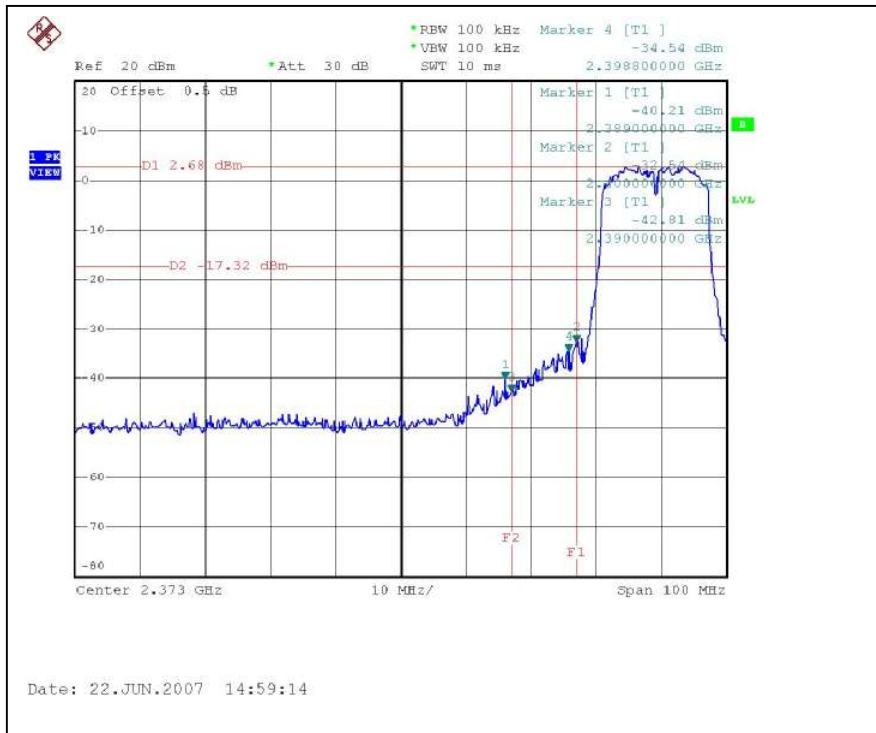

### CH11

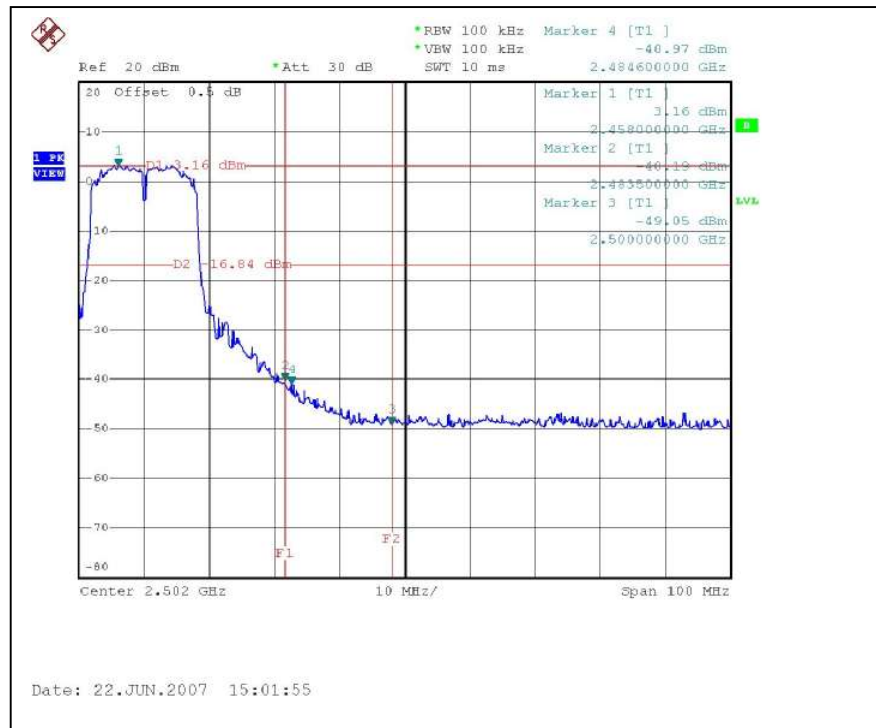

CH1

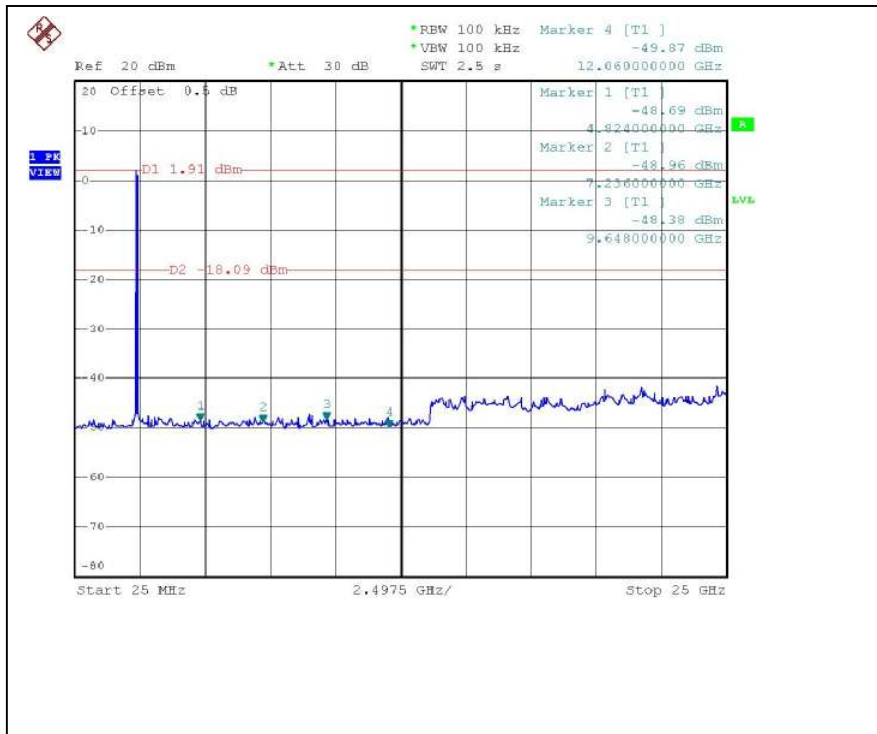

CH11

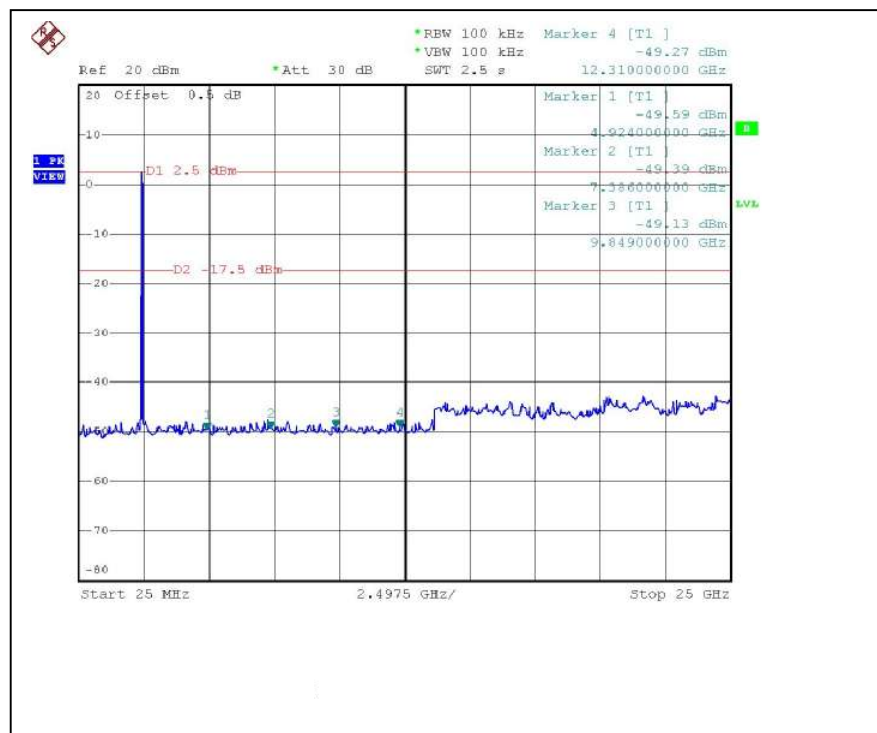



## **4.7 ANTENNA REQUIREMENT**

### **4.7.1 STANDARD APPLICABLE**

For intentional device, according to FCC 47 CFR Section 15.203, an intentional radiator shall be designed to ensure that no antenna other than that furnished by the responsible party shall be used with the device.

And according to FCC 47 CFR Section 15.247 (b), if transmitting antennas of directional gain greater than 6dBi are used, the power shall be reduced by the amount in dB that the directional gain of the antenna exceeds 6dBi.

### **4.7.2 ANTENNA CONNECTED CONSTRUCTION**

The antenna used in this product is Monopole antenna with Reversed-SMA connector. The maximum Gain of the antenna is 3dBi



## 5 INFORMATION ON THE TESTING LABORATORIES

We, ADT Corp., were founded in 1988 to provide our best service in EMC, Radio, Telecom and Safety consultation. Our laboratories are accredited and approved by the following approval agencies according to ISO/IEC 17025:

<b>USA</b>	FCC, UL, A2LA
<b>Germany</b>	TUV Rheinland
<b>Japan</b>	VCCI
<b>Norway</b>	NEMKO
<b>Canada</b>	INDUSTRY CANADA, CSA
<b>R.O.C.</b>	CNLA, BSMI, NCC
<b>Netherlands</b>	Telefication
<b>Singapore</b>	PSB, GOST-ASIA (MOU)
<b>Russia</b>	CERTIS (MOU)

Copies of accreditation certificates of our laboratories obtained from approval agencies can be downloaded from our web site: [www.adt.com.tw/index.5/phtml](http://www.adt.com.tw/index.5/phtml).

If you have any comments, please feel free to contact us at the following:

**Linko EMC/RF Lab:**

Tel: 886-2-26052180

Fax: 886-2-26052943

**Hsin Chu EMC/RF Lab:**

Tel: 886-3-5935343

Fax: 886-3-5935342

**Hwa Ya EMC/RF/Safety/Telecom Lab:**

Tel: 886-3-3183232

Fax: 886-3-3185050

**Email:** [service@adt.com.tw](mailto:service@adt.com.tw)

**Web Site:** [www.adt.com.tw](http://www.adt.com.tw)

The address and road map of all our labs can be found in our web site also.



## **6 APPENDIX A – MODIFICATIONS RECORDERS FOR ENGINEERING CHANGES TO THE EUT BY THE LAB**

No any modifications are made to the EUT by the lab during the test.