



FCC TEST REPORT (15.247)

REPORT NO.: RF970423H02B

MODEL NO.: WRT610N V1

RECEIVED: April 23, 2008

TESTED: April 30 to May 22, 2008,
Aug. 15 to 16, 2008

ISSUED: Aug. 18, 2008

APPLICANT: Cisco-Linksys LLC

ADDRESS: 121 Theory Drive Irvine, CA 92617(USA)

ISSUED BY: Advance Data Technology Corporation

TEST LOCATION: No. 81-1, Lu Liao Keng, 9 Ling, Wu Lung
Tsuen, Chiung Lin Hsiang, Hsin Chu Hsien,
Taiwan, R.O.C.

This test report consists of 190 pages in total. It may be duplicated completely for legal use with the approval of the applicant. It should not be reproduced except in full, without the written approval of our laboratory. The client should not use it to claim product endorsement by TAF or any government agencies. The test results in the report only apply to the tested sample.



Table of Contents

1.	CERTIFICATION	6
2.	SUMMARY OF TEST RESULTS	7
2.1	MEASUREMENT UNCERTAINTY	9
3.	GENERAL INFORMATION	10
3.1	GENERAL DESCRIPTION OF EUT	10
3.2	DESCRIPTION OF TEST MODES	13
3.2.1	TEST MODE APPLICABILITY AND TESTED CHANNEL DETAIL:	14
3.3	GENERAL DESCRIPTION OF APPLIED STANDARDS	19
3.4	DESCRIPTION OF SUPPORT UNITS	20
3.5	CONFIGURATION OF SYSTEM UNDER TEST	21
4.	TEST TYPES AND RESULTS (802.11b & g, 2400 ~ 2483.5MHz Band)	22
4.1	CONDUCTED EMISSION MEASUREMENT	22
4.1.1	LIMITS OF CONDUCTED EMISSION MEASUREMENT	22
4.1.2	TEST INSTRUMENTS	22
4.1.3	TEST PROCEDURES	23
4.1.4	DEVIATION FROM TEST STANDARD	23
4.1.5	TEST SETUP	24
4.1.6	EUT OPERATING CONDITIONS	24
4.1.7	TEST RESULTS - Adapter 1	25
4.1.8	TEST RESULTS - Adapter 2	27
4.1.9	TEST RESULTS - Adapter 3	29
4.1.10	TEST RESULTS - Adapter 4	31
4.2	RADIATED EMISSION MEASUREMENT	33
4.2.1	LIMITS OF RADIATED EMISSION MEASUREMENT	33
4.2.2	TEST INSTRUMENTS	34
4.2.3	TEST PROCEDURES	35
4.2.4	DEVIATION FROM TEST STANDARD	35
4.2.5	TEST SETUP	36
4.2.6	EUT OPERATING CONDITIONS	36
	Below 1GHz Test Data	37
4.2.7	TEST RESULTS	37
	Above 1GHz Test Data	38
4.2.8	TEST RESULTS	38
4.3	6dB BANDWIDTH MEASUREMENT	66
4.3.1	LIMITS OF 6dB BANDWIDTH MEASUREMENT	66
4.3.2	TEST INSTRUMENTS	66

4.3.3	TEST PROCEDURE	67
4.3.4	DEVIATION FROM TEST STANDARD	67
4.3.5	TEST SETUP	67
4.3.6	EUT OPERATING CONDITIONS.....	67
4.3.7	TEST RESULTS.....	68
4.4	MAXIMUM PEAK OUTPUT POWER	82
4.4.1	LIMITS OF MAXIMUM PEAK OUTPUT POWER MEASUREMENT	82
4.4.2	INSTRUMENTS	82
4.4.3	TEST PROCEDURES.....	83
4.4.4	DEVIATION FROM TEST STANDARD	83
4.4.5	TEST SETUP	83
4.4.6	EUT OPERATING CONDITIONS.....	83
4.4.7	TEST RESULTS.....	84
4.5	POWER SPECTRAL DENSITY MEASUREMENT.....	86
4.5.1	LIMITS OF POWER SPECTRAL DENSITY MEASUREMENT	86
4.5.2	TEST INSTRUMENTS	86
4.5.3	TEST PROCEDURE	87
4.5.4	DEVIATION FROM TEST STANDARD	87
4.5.5	TEST SETUP	87
4.5.6	EUT OPERATING CONDITION	87
4.5.7	TEST RESULTS.....	88
4.6	BAND EDGES MEASUREMENT	102
4.6.1	LIMITS OF BAND EDGES MEASUREMENT	102
4.6.2	TEST INSTRUMENTS	102
4.6.3	TEST PROCEDURE	102
4.6.4	DEVIATION FROM TEST STANDARD	103
4.6.5	EUT OPERATING CONDITION	103
4.6.6	TEST RESULTS.....	103
4.7	ANTENNA REQUIREMENT	118
4.7.1	STANDARD APPLICABLE	118
4.7.2	ANTENNA CONNECTED CONSTRUCTION.....	118
5.	TEST TYPES AND RESULTS (802.11a, 5725~5850MHz Band)	119
5.1	CONDUCTED EMISSION MEASUREMENT	119
5.1.1	LIMITS OF CONDUCTED EMISSION MEASUREMENT.....	119
5.1.2	TEST INSTRUMENTS	119
5.1.3	TEST PROCEDURES.....	120
5.1.4	DEVIATION FROM TEST STANDARD	120
5.1.5	TEST SETUP	121



5.1.6	EUT OPERATING CONDITIONS.....	121
5.1.7	TEST RESULTS – Adapter 1.....	122
5.1.8	TEST RESULTS – Adapter 2.....	124
5.1.9	TEST RESULTS – Adapter 3.....	126
5.1.10	TEST RESULTS – Adapter 4.....	128
5.2	RADIATED EMISSION MEASUREMENT	130
5.2.1	LIMITS OF RADIATED EMISSION MEASUREMENT.....	130
5.2.2	TEST INSTRUMENTS	131
5.2.3	TEST PROCEDURES.....	133
5.2.4	DEVIATION FROM TEST STANDARD	133
5.2.5	TEST SETUP	134
5.2.6	EUT OPERATING CONDITIONS.....	134
	Below 1GHz Test Data	135
5.2.7	TEST RESULTS.....	135
	Above 1GHz Test Data.....	136
5.2.8	TEST RESULTS.....	136
5.3	6dB BANDWIDTH MEASUREMENT	144
5.3.1	LIMITS OF 6dB BANDWIDTH MEASUREMENT	144
5.3.2	TEST INSTRUMENTS	144
5.3.3	TEST PROCEDURE	145
5.3.4	DEVIATION FROM TEST STANDARD	145
5.3.5	TEST SETUP	145
5.3.6	EUT OPERATING CONDITIONS.....	145
5.3.7	TEST RESULTS.....	146
5.4	MAXIMUM PEAK OUTPUT POWER	157
5.4.1	LIMITS OF MAXIMUM PEAK OUTPUT POWER MEASUREMENT	157
5.4.2	INSTRUMENTS	157
5.4.3	TEST PROCEDURES.....	158
5.4.4	DEVIATION FROM TEST STANDARD	158
5.4.5	TEST SETUP	158
5.4.6	EUT OPERATING CONDITIONS.....	158
5.4.7	TEST RESULTS.....	159
5.5	POWER SPECTRAL DENSITY MEASUREMENT.....	161
5.5.1	LIMITS OF POWER SPECTRAL DENSITY MEASUREMENT	161
5.5.2	TEST INSTRUMENTS	161
5.5.3	TEST PROCEDURE	162
5.5.4	DEVIATION FROM TEST STANDARD	162
5.5.5	TEST SETUP	162



5.5.6	EUT OPERATING CONDITION	162
5.5.7	TEST RESULTS.....	163
5.6	BAND EDGES MEASUREMENT	174
5.6.1	LIMITS OF BAND EDGES MEASUREMENT	174
5.6.2	TEST INSTRUMENTS	174
5.6.3	TEST PROCEDURE	175
5.6.4	DEVIATION FROM TEST STANDARD	175
5.6.5	EUT OPERATING CONDITION	175
5.6.6	TEST RESULTS.....	176
5.7	ANTENNA REQUIREMENT	189
5.7.1	STANDARD APPLICABLE	189
5.7.2	ANTENNA CONNECTED CONSTRUCTION.....	189
6.	INFORMATION ON THE TESTING LABORATORIES	190
7.	APPENDIX-A- MODIFICATIONS RECORDERS FOR ENGINEERING CHANGES TO THE EUT BY THE LAB.....	191



1. CERTIFICATION

PRODUCT: Simultaneous Dual-N Band Wireless Router
BRAND NAME: Linksys
MODEL NO.: WRT610N V1
TEST SAMPLE: ENGINEERING SAMPLE
April 30 to May 22, 2008,
TESTED: Aug. 15 to 16, 2008
APPLICANT: Cisco-Linksys LLC
STANDARDS: FCC Part 15, Subpart C (Section 15.247),
ANSI C63.4-2003

The above equipment (Model: WRT610N V1) has been tested by **Advance Data Technology Corporation**, and found compliance with the requirement of the above standards. The test record, data evaluation & Equipment Under Test (EUT) configurations represented herein are true and accurate accounts of the measurements of the sample's EMC characteristics under the conditions specified in this report.

PREPARED BY : Claire Kuan , **DATE:** Aug 18, 2008
(Claire Kuan, Specialist)

TECHNICAL ACCEPTANCE : Hank Chung , **DATE:** Aug 18, 2008
Responsible for RF (Hank Chung, Deputy Manager)

APPROVED BY : May Chen , **DATE:** Aug 18, 2008
(May Chen, Deputy Manager)

2. SUMMARY OF TEST RESULTS

The EUT has been tested according to the following specifications:

For 802.11b & g, 2412~2462MHz Band

APPLIED STANDARD: FCC Part 15, Subpart C (Section 15.247)			
Standard Section	Test Type and Limit	Result	Remark
15.207	AC Power Conducted Emission	PASS	Meet the requirement of limit. Minimum passing margin is -2.78dB at 0.195MHz
15.247(a)(2)	Spectrum Bandwidth of a Direct Sequence Spread Spectrum System Limit: min. 500kHz	PASS	Meet the requirement of limit.
15.247(b)	Maximum Peak Output Power Limit: max. 30dBm	PASS	Meet the requirement of limit.
15.247(d)	Radiated Emissions Limit: Table 15.209	PASS	Meet the requirement of limit. Minimum passing margin is -1.05dB at 72.95MHz
15.247(e)	Power Spectral Density Limit: max. 8dBm	PASS	Meet the requirement of limit.
15.247(d)	Band Edge Measurement Limit: 20dB less than the peak value of fundamental frequency	PASS	Meet the requirement of limit.

For 802.11a, 5725~5850MHz Band

APPLIED STANDARD: FCC Part 15, Subpart C (Section 15.247)			
Standard Section	Test Type and Limit	Result	Remark
15.207	AC Power Conducted Emission	PASS	Meet the requirement of limit. Minimum passing margin is -3.02dB at 0.380MHz
15.247(a)(2)	Spectrum Bandwidth of a Direct Sequence Spread Spectrum System Limit: min. 500kHz	PASS	Meet the requirement of limit.
15.247(b)	Maximum Peak Output Power Limit: max. 30dBm	PASS	Meet the requirement of limit.
15.247(d)	Radiated Emissions Limit: Table 15.209	PASS	Meet the requirement of limit. Minimum passing margin is -2.89dB at 125.00MHz
15.247(e)	Power Spectral Density Limit: max. 8dBm	PASS	Meet the requirement of limit.
15.247(d)	Band Edge Measurement Limit: 20dB less than the peak value of fundamental frequency	PASS	Meet the requirement of limit.

NOTE:

1. The EUT was operating in 2.400 ~ 2.483.5GHz, 5.15~5.25GHz and 5.725~5.850GHz frequencies band. This report was recorded the RF parameters including 2.400 ~ 2.483.5GHz and 5.725 ~ 5.850GHz. For the 5.15~5.25GHz RF parameters was recorded in another test report.

2.1 MEASUREMENT UNCERTAINTY

Where relevant, the following measurement uncertainty levels have been estimated for tests performed on the EUT as specified in CISPR 16-4:

This uncertainty represents an expanded uncertainty expressed at approximately the 95% confidence level using a coverage factor of $k=2$.

Measurement	Value
Conducted emissions	2.44 dB
Radiated emissions (30MHz-1GHz)	3.94 dB
Radiated emissions (1GHz -18GHz)	2.33 dB
Radiated emissions (18GHz -40GHz)	2.55 dB

3. GENERAL INFORMATION

3.1 GENERAL DESCRIPTION OF EUT

PRODUCT	Simultaneous Dual-N Band Wireless Router
MODEL NO.	WRT610N V1
FCC ID	Q87-WRT610NV1
POWER SUPPLY	DC 12V from power adapter
MODULATION TYPE	CCK, DQPSK, DBPSK for DSSS 64QAM, 16QAM, QPSK, BPSK for OFDM
MODULATION TECHNOLOGY	DSSS, OFDM
TRANSFER RATE	802.11b: 11 / 5.5 / 2 / 1Mbps 802.11g: 54 / 48 / 36 / 24 / 18 / 12 / 9 / 6Mbps 802.11a: 54 / 48 / 36 / 24 / 18 / 12 / 9 / 6Mbps Draft 802.11n (20MHz): 130 / 117 / 104 / 78 / 65 / 58.5 / 52 / 39 / 26 / 19.5 / 13 / 6.5Mbps Draft 802.11n (40MHz): 270 / 243 / 216 / 162 / 135 / 121.5 / 108 / 81 / 54 / 40.5 / 27 / 13.5Mbps
FREQUENCY RANGE	For 15.407 802.11a: 5.18 ~ 5.24GHz For 15.247 802.11b & 802.11g: 2412 ~ 2462MHz 802.11a: 5.745 ~ 5.805GHz
NUMBER OF CHANNEL	For 15.407 4 for 802.11a, draft 802.11n (20MHz) 2 for draft 802.11n (40MHz) For 15.247(2.4GHz) 11 for 802.11b, 802.11g, draft 802.11n (20MHz) 7 for draft 802.11n (40MHz) For 15.247(5GHz) 4 for 802.11a, draft 802.11n (20MHz) 3 for draft 802.11n (40MHz)

MAXIMUM OUTPUT POWER	For 15.407 802.11a: 29.076mW draft 802.11n (20MHz): 21.611mW draft 802.11n (40MHz): 32.431mW
	For 15.247(2.4GHz) 802.11b: 66.069mW 802.11g: 117.800mW draft 802.11n (20MHz): 117.768mW draft 802.11n (40MHz): 113.778mW
	For 15.247(5GHz) 802.11a: 433.159mW draft 802.11n (20MHz): 437.398mW draft 802.11n (40MHz): 440.855mW
ANTENNA TYPE	Please see note 1
DATA CABLE	NA
I/O PORT	WAN port x 1, LAN port x 4, USB port x 1

NOTE:

1. There three antennas provided to this EUT, please refer to the following table:

Transmitter Circuit	Antenna Type	For 2.4GHz Gain (dBi)	For 5GHz Gain (dBi)	Antenna Connector	Note
Chain(0)	PIFA	0.75	3	NA	TX & RX function
Chain(1)	PIFA	1.5	2.23	NA	TX & RX function
Chain(2)	PIFA	3.5	2.5	NA	Only RX function

2. For radiated test : The EUT was pre-tested in chamber under the following modes:

Test Mode	Description
Mode A	Level-set (Put on tabletop)
Mode B	Tower-set (Wall-mounted)

From the above modes, the radiated worst cases were found in **Mode B**. Therefore only the test data of the modes were recorded in this report.

3. The EUT must be supplied with a power adapter and following four different models could be chosen :

Adapter 1	
Brand:	Enertronix
Model No.:	EXA0604UB-1
Input power :	AC 100-240V, 50/60Hz, 0.8A
Output power :	DC 12V, 1.5A Cable:1.8m/unshielded/without core
Adapter 2	
Brand:	FOXLINK
Model No.:	FA-1201500SU
Input power :	AC 100-240V, 50/60Hz, 0.6A
Output power :	DC 12V, 1.5A Cable:1.8m/unshielded/without core
Adapter 3	
Brand:	Hon-Kwang
Model No.:	HK-I118-A12
Input power :	AC 100-240V, 50/60Hz, 0.6A
Output power :	DC 12V, 1.5A Cable:1.8m/unshielded/without core
Adapter 4	
Brand:	LINKSYS
Model No.:	LS120V15ALE
Input power :	AC 100-240V, 50/60Hz, 0.5A Cable:0.5m/unshielded/without core
Output power :	DC 12V, 1.5A Cable:1.8m/unshielded/without core

4. The EUT incorporates a MIMO function with 802.11a, 802.11b, 802.11g, draft 802.11n. Physically, the EUT provides two completed transmit and two completed receivers.
5. The EUT is 2 * 2 spatial MIMO (2Tx & 2Rx) without beam forming function. The antenna configurations are two transmitter antennas and two receiver antennas, as there are 3 PIFA antennas. Spatial multiplexing modes for simultaneous transmission using 2 antennas, and for simultaneous receiver using 2 antennas. The 11b legacy mode is limited to single transmitter only.
6. When the EUT operating in draft 802.11n, the software operation, which is defined by manufacturer, MCS (Modulation and Coding Schemes) from 0 to 15.
7. The EUT complies with draft 802.11n standards and backwards compatible with 802.11a, 802.11b, 802.11g products.
8. The above EUT information was declared by manufacturer and for more detailed features description, please refer to the manufacturer's specifications or user's manual.

3.2 DESCRIPTION OF TEST MODES

Operated in 2400 ~ 2483.5MHz band:

Eleven channels are provided for 802.11b, 802.11g, draft 802.11n (20MHz):

CHANNEL	FREQUENCY	CHANNEL	FREQUENCY
1	2412MHz	7	2442MHz
2	2417MHz	8	2447MHz
3	2422MHz	9	2452MHz
4	2427MHz	10	2457MHz
5	2432MHz	11	2462MHz
6	2437MHz		

Seven channels are provided for draft 802.11n (40MHz):

CHANNEL	FREQUENCY	CHANNEL	FREQUENCY
1	2422MHz	5	2442MHz
2	2427MHz	6	2447MHz
3	2432MHz	7	2452MHz
4	2437MHz		

Operated in 5725 ~ 5850MHz band:

Five channels are provided for 802.11a, draft 802.11n (20MHz):

CHANNEL	FREQUENCY	CHANNEL	FREQUENCY
1	5745 MHz	3	5785 MHz
2	5765 MHz	4	5805 MHz

Three channels are provided for draft 802.11n (40MHz):

CHANNEL	FREQUENCY
1	5755 MHz
2	5775 MHz
3	5795 MHz

3.2.1 TEST MODE APPLICABILITY AND TESTED CHANNEL DETAIL:

EUT CONFIGURE MODE	APPLICABLE TO				DESCRIPTION
	PLC	RE < 1G	RE ≥ 1G	APCM	
-	√	√	√	√	-

Where **PLC**: Power Line Conducted Emission

RE < 1G: Radiated Emission below 1GHz

RE ≥ 1G: Radiated Emission above 1GHz

APCM: Antenna Port Conducted Measurement

ANTENNA COMBINATION MODE:

COMBINATION MODE	OPERATION MODE	CHAIN(0) (TX)	CHAIN(1) (TX)
A	802.11a, b, g	√	
B	802.11a, b, g		√
C	802.11a, g	√	√
D	DRAFT 802.11n(20MHz)	√	
E	DRAFT 802.11n(20MHz)		√
F	DRAFT 802.11n(20MHz)	√	√
G	DRAFT 802.11n(40MHz)	√	
H	DRAFT 802.11n(40MHz)		√
I	DRAFT 802.11n(40MHz)	√	√

Note:

1. The above information was declared by manufacturer and for more detailed features description, please refer to the manufacturer's specifications or user's manual.
2. Antenna 1 and Antenna 2 are PIFA antennas.
3. From above mode, the different modes were chosen for pretest.
4. Mode B, C, F & I the worst modes, was selected as representative mode for the report.

POWER LINE CONDUCTED EMISSION TEST:

- Pre-Scan has been conducted to determine the worst-case mode from all possible combinations between available modulations, data rates and antenna ports (if EUT with antenna diversity architecture).
- Following channel(s) was (were) selected for the final test as listed below.

MODE	AVAILABLE CHANNEL	TESTED CHANNEL	MODULATION TECHNOLOGY	MODULATION TYPE	DATA RATE (Mbps)	TX COMBINATION
For 2.4 GHz 802.11g	1 to 11	6	OFDM	BPSK	6	C
For 5 GHz 802.11a	1 to 4	4	OFDM	BPSK	6	C

- The EUT was tested as the following test modes:

Test Mode	Description
Mode 1	With Adapter 1
Mode 2	With Adapter 2
Mode 3	With Adapter 3
Mode 4	With Adapter 4

RADIATED EMISSION TEST (BELOW 1 GHz):

- Pre-Scan has been conducted to determine the worst-case mode from all possible combinations between available modulations, data rates and antenna ports (if EUT with antenna diversity architecture).
- Following channel(s) was (were) selected for the final test as listed below.

MODE	AVAILABLE CHANNEL	TESTED CHANNEL	MODULATION TECHNOLOGY	MODULATION TYPE	DATA RATE (Mbps)	TX COMBINATION
For 2.4 GHz 802.11g	1 to 11	1	OFDM	BPSK	6	C
For 5 GHz 802.11a	1 to 4	1	OFDM	BPSK	6	C

- The EUT was Pre-tested as the following test modes:

Test Mode	Description
Mode 1	With Adapter 1
Mode 2	With Adapter 2
Mode 3	With Adapter 3
Mode 4	With Adapter 4

Mode 1, the worse case one, was chosen for final test.

RADIATED EMISSION TEST (ABOVE 1 GHz):

- Pre-Scan has been conducted to determine the worst-case mode from all possible combinations between available modulations, data rates and antenna ports (if EUT with antenna diversity architecture).
- Following channel(s) was (were) selected for the final test as listed below.

MODE	AVAILABLE CHANNEL	TESTED CHANNEL	MODULATION TECHNOLOGY	MODULATION TYPE	DATA RATE (Mbps)	TX COMBINATION
802.11b	1 to 11	1, 6, 11	DSSS	DBPSK	1	B
802.11g	1 to 11	1, 6, 11	OFDM	BPSK	6	C
For 2.4 GHz Draft 802.11n (20MHz)	1 to 11	1, 6, 11	OFDM	BPSK	13	F
For 2.4 GHz Draft 802.11n (40MHz)	1 to 7	1, 4, 7	OFDM	BPSK	27	I
802.11a	1 to 4	1,3, 4	OFDM	BPSK	6	C
For 5 GHz Draft 802.11n (20MHz)	1 to 4	1, 3, 4	OFDM	BPSK	13	F
For 5 GHz Draft 802.11n (40MHz)	1 to 3	1, 3	OFDM	BPSK	27	I

- The EUT was Pre-tested as the following test modes:

Test Mode	Description
Mode 1	With Adapter 1
Mode 2	With Adapter 2
Mode 3	With Adapter 3
Mode 4	With Adapter 4

Mode 1, the worse case one, was chosen for final test.

BANDEDGE MEASUREMENT:

- Pre-Scan has been conducted to determine the worst-case mode from all possible combinations between available modulations, data rates and antenna ports (if EUT with antenna diversity architecture).
- Following channel(s) was (were) selected for the final test as listed below.

MODE	AVAILABLE CHANNEL	TESTED CHANNEL	MODULATION TECHNOLOGY	MODULATION TYPE	DATA RATE (Mbps)	TX COMBINATION
802.11b	1 to 11	1, 11	DSSS	DBPSK	1	B
802.11g	1 to 11	1, 11	OFDM	BPSK	6	C
For 2.4 GHz Draft 802.11n (20MHz)	1 to 11	1, 11	OFDM	BPSK	13	F
For 2.4 GHz Draft 802.11n (40MHz)	1 to 7	1, 7	OFDM	BPSK	27	I
802.11a	1 to 4	1, 4	OFDM	BPSK	6	C
For 5 GHz Draft 802.11n (20MHz)	1 to 4	1, 4	OFDM	BPSK	13	F
For 5 GHz Draft 802.11n (40MHz)	1 to 3	1, 3	OFDM	BPSK	27	I

ANTENNA PORT CONDUCTED MEASUREMENT:

- Pre-Scan has been conducted to determine the worst-case mode from all possible combinations between available modulations, data rates and antenna ports (if EUT with antenna diversity architecture).
- Following channel(s) was (were) selected for the final test as listed below.

MODE	AVAILABLE CHANNEL	TESTED CHANNEL	MODULATION TECHNOLOGY	MODULATION TYPE	DATA RATE (Mbps)	TX COMBINATION
802.11b	1 to 11	1, 6, 11	DSSS	DBPSK	1	B
802.11g	1 to 11	1, 6, 11	OFDM	BPSK	6	C
For 2.4 GHz Draft 802.11n (20MHz)	1 to 11	1, 6, 11	OFDM	BPSK	13	F
For 2.4 GHz Draft 802.11n (40MHz)	1 to 7	1, 4, 7	OFDM	BPSK	27	I
802.11a	1 to 4	1, 3, 4	OFDM	BPSK	6	C
For 5 GHz Draft 802.11n (20MHz)	1 to 4	1, 3, 4	OFDM	BPSK	13	F
For 5 GHz Draft 802.11n (40MHz)	1 to 3	1, 3	OFDM	BPSK	27	I



3.3 GENERAL DESCRIPTION OF APPLIED STANDARDS

The EUT is a Simultaneous Dual-N Band Wireless Router. According to the specifications of the manufacturer, it must comply with the requirements of the following standards:

FCC Part 15, Subpart C. (15.247)

ANSI C63.4-2003

All test items have been performed and recorded as per the above standards.

NOTE: The EUT is also considered as a kind of computer peripheral, because the connection to computer is necessary for typical use. It has been verified to comply with the requirements of FCC Part 15, Subpart B, Class B (DoC). The test report has been issued separately.



3.4 DESCRIPTION OF SUPPORT UNITS

The EUT has been tested as an independent unit together with other necessary accessories or support units. The following support units or accessories were used to form a representative test configuration during the tests.

NO.	PRODUCT	BRAND	MODEL NO.	SERIAL NO.	FCC ID
1	NOTEBOOK COMPUTER	DELL	PP18L	6976685584	FCC DoC
2	NOTEBOOK COMPUTER	DELL	PP19L	CN-OHC416-70166-5CA-0448	PIW632500516610
3	HUB	AVSYS	110H8	01-20E-000002	FCC DoC
4	USB Flash Drive	SanDisk	SDCZ2-512-A10	5391912401	FCC DoC

NO.	SIGNAL CABLE DESCRIPTION OF THE ABOVE SUPPORT UNITS
1	NA
2	NA
3	NA
4	NA

NOTE: All power cords of the above support units are non shielded (1.8m).

3.5 CONFIGURATION OF SYSTEM UNDER TEST

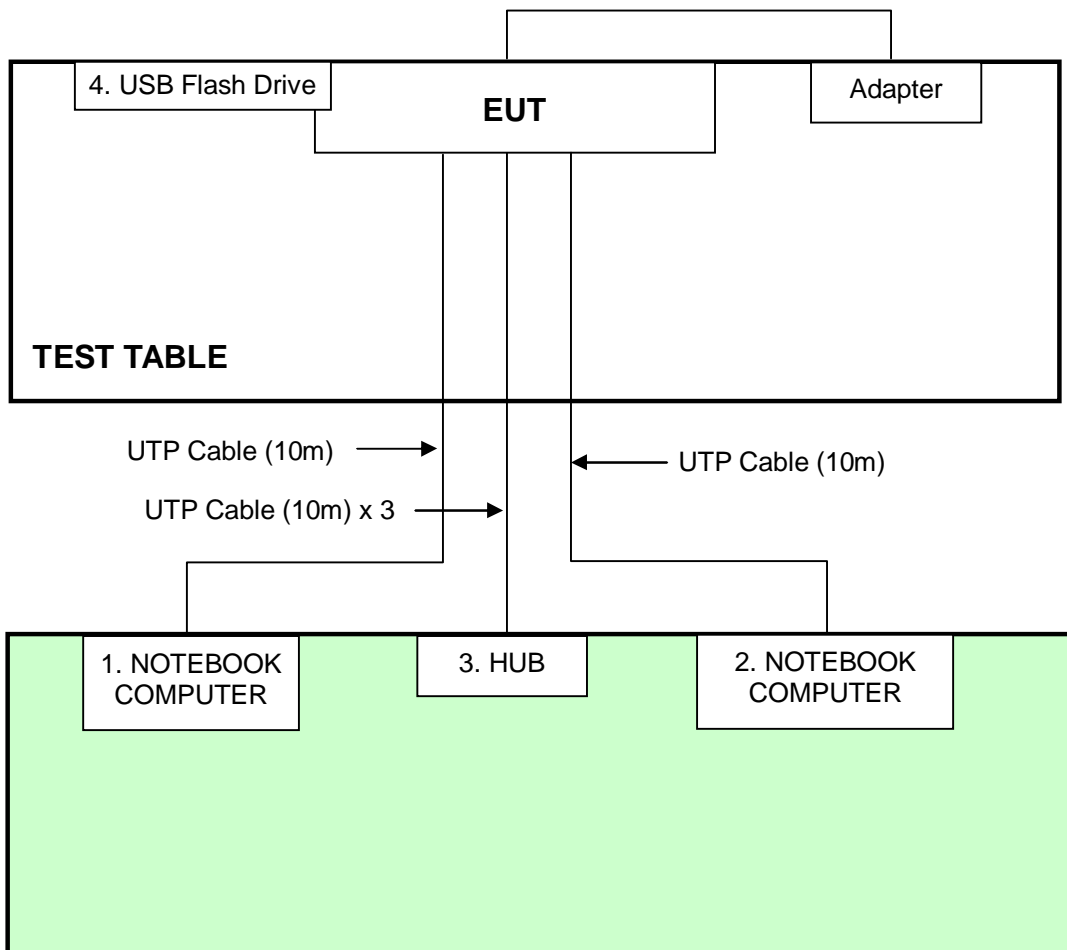

4. TEST TYPES AND RESULTS (802.11b & g, 2400 ~ 2483.5MHz Band)

4.1 CONDUCTED EMISSION MEASUREMENT

4.1.1 LIMITS OF CONDUCTED EMISSION MEASUREMENT

FREQUENCY OF EMISSION (MHz)	CONDUCTED LIMIT (dB μ V)	
	Quasi-peak	Average
0.15-0.5	66 to 56	56 to 46
0.5-5	56	46
5-30	60	50

- NOTE:**
1. The lower limit shall apply at the transition frequencies.
 2. The limit decreases in line with the logarithm of the frequency in the range of 0.15 to 0.50 MHz.
 3. All emanations from a class A/B digital device or system, including any network of conductors and apparatus connected thereto, shall not exceed the level of field strengths specified above.

4.1.2 TEST INSTRUMENTS

DESCRIPTION & MANUFACTURER	MODEL NO.	SERIAL NO.	CALIBRATED UNTIL
ROHDE & SCHWARZ Test Receiver	ESCS 30	100287	Mar. 10, 2009
Line-Impedance Stabilization Network(for EUT)	KNW-407	8-1395-12	Aug. 19, 2008
Line-Impedance Stabilization Network(for Peripheral)	ENV-216	100072	Nov. 08, 2008
RF Cable (JETBAO)	RG5B/U-6m	COACAB-9KHz-3 0MHz	Aug. 15, 2008
50 ohms Terminator	50	3	Nov. 15, 2008
Software	ADT_Cond_V7.3.2	NA	NA

- NOTE:**
1. The calibration interval of the above test instruments is 12 months and the calibrations are traceable to NML/ROC and NIST/USA.
 2. The test was performed in ADT Shielded Room No. A.
 3. The VCCI Con A Registration No. is C-817.

4.1.3 TEST PROCEDURES

- a. The EUT was placed 0.4 meters from the conducting wall of the shielded room with EUT being connected to the power mains through a line impedance stabilization network (LISN). Other support units were connected to the power mains through another LISN. The two LISNs provide 50 ohm/ 50uH of coupling impedance for the measuring instrument.
- b. Both lines of the power mains connected to the EUT were checked for maximum conducted interference.
- c. The frequency range from 150kHz to 30MHz was searched. Emission levels under (Limit - 20dB) were not recorded.

4.1.4 DEVIATION FROM TEST STANDARD

No deviation

4.1.5 TEST SETUP

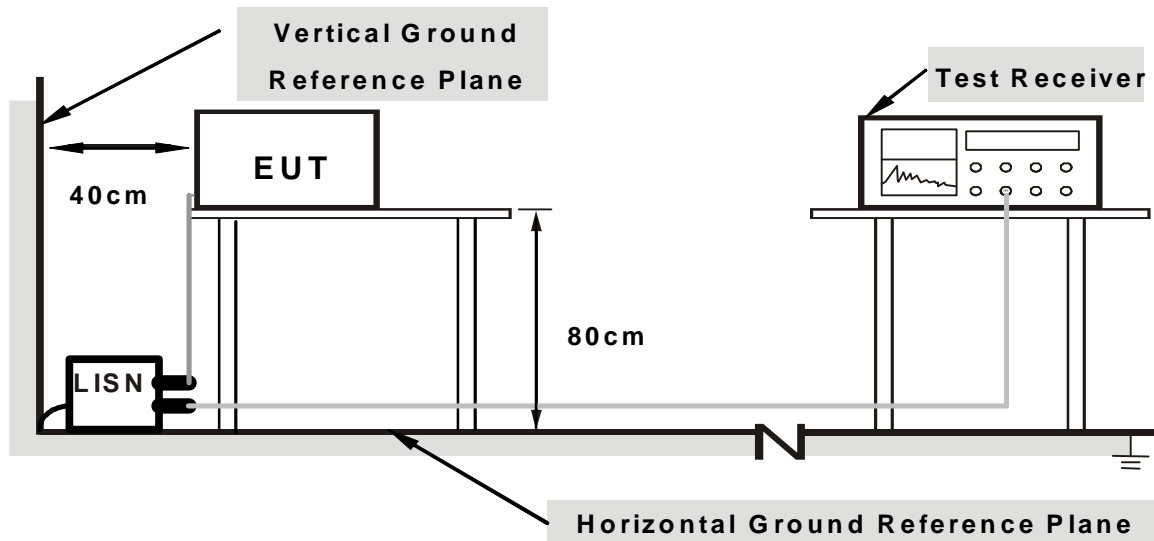

Note: 1. Support units were connected to second LISN.

2. Both of LISNs (AMN) are 80 cm from EUT and at least 80 from other units and other metal planes

For the actual test configuration, please refer to the related item – Photographs of the Test Configuration.

4.1.6 EUT OPERATING CONDITIONS

- a. Placed the EUT on testing table.
- b. Prepared other computer systems (support unit 1 ~ 2) to act as communication partners and placed them outside of testing area.
- c. The communication partners run test program “MFGTEST .exe” to enable EUT under transmission/receiving condition continuously via wireless transmission.

4.1.7 TEST RESULTS - Adapter 1

802.11g OFDM MODULATION :

EUT TEST CONDITION		MEASUREMENT DETAIL	
CHANNEL	Channel 6	PHASE	Line (L)
MODULATION TYPE	BPSK	6dB BANDWIDTH	9 kHz
TRANSFER RATE	6Mbps	INPUT POWER	120Vac, 60 Hz
ENVIRONMENTAL CONDITIONS	25deg. C, 75%RH, 971hPa	TESTED BY	Andy Ho

No	Freq. [MHz]	Corr. Factor (dB)	Reading Value [dB (uV)]		Emission Level [dB (uV)]		Limit [dB (uV)]		Margin (dB)	
			Q.P.	AV.	Q.P.	AV.	Q.P.	AV.	Q.P.	AV.
			1	0.196	0.34	56.48	48.94	56.82	49.28	63.77
2	0.263	0.27	45.83	-	46.10	-	61.35	51.35	-15.26	-
3	0.326	0.19	41.88	-	42.07	-	59.56	49.56	-17.49	-
4	0.455	0.12	41.96	-	42.08	-	56.79	46.79	-14.71	-
5	9.773	0.54	40.24	-	40.78	-	60.00	50.00	-19.22	-
6	21.381	0.90	35.80	-	36.70	-	60.00	50.00	-23.30	-

- REMARKS:**
1. Q.P. and AV. are abbreviations of quasi-peak and average individually.
 2. "-": The Quasi-peak reading value also meets average limit and measurement with the average detector is unnecessary.
 3. The emission levels of other frequencies were very low against the limit.
 4. Margin value = Emission level - Limit value
 5. Correction factor = Insertion loss + Cable loss
 6. Emission Level = Correction Factor + Reading Value.

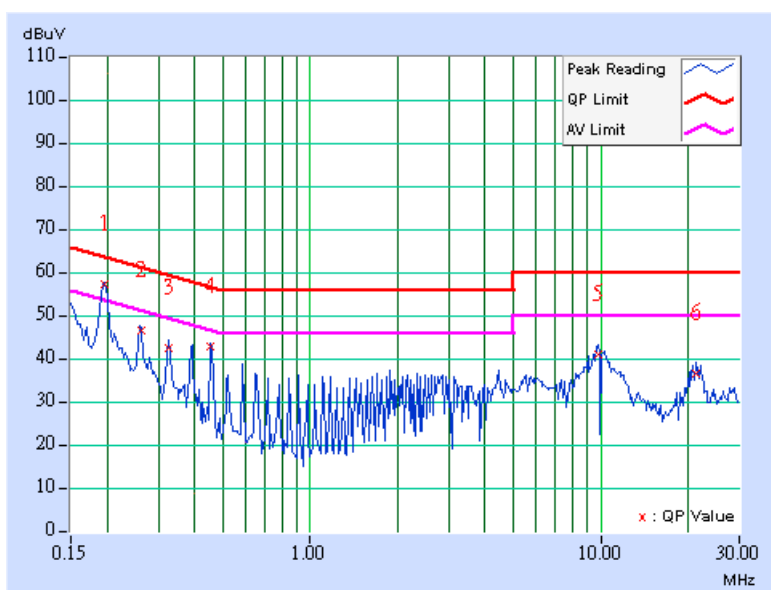

EUT TEST CONDITION		MEASUREMENT DETAIL	
CHANNEL	Channel 6	PHASE	Neutral (N)
MODULATION TYPE	BPSK	6dB BANDWIDTH	9 kHz
TRANSFER RATE	6Mbps	INPUT POWER	120Vac, 60 Hz
ENVIRONMENTAL CONDITIONS	25deg. C, 75%RH, 971hPa	TESTED BY	Andy Ho

No	Freq. [MHz]	Corr. Factor (dB)	Reading Value [dB (uV)]		Emission Level [dB (uV)]		Limit [dB (uV)]		Margin (dB)	
			Q.P.	AV.	Q.P.	AV.	Q.P.	AV.	Q.P.	AV.
	1	0.181	0.37	38.95	-	39.32	-	64.43	54.43	-25.11
2	0.195	0.36	57.84	50.67	58.20	51.03	63.81	53.81	-5.61	-2.78
3	0.262	0.28	47.66	-	47.94	-	61.38	51.38	-13.45	-
4	0.392	0.10	40.39	-	40.49	-	58.02	48.02	-17.53	-
5	10.036	0.54	37.95	-	38.49	-	60.00	50.00	-21.51	-
6	21.175	0.89	35.50	-	36.39	-	60.00	50.00	-23.61	-

- REMARKS:**
1. Q.P. and AV. are abbreviations of quasi-peak and average individually.
 2. "-": The Quasi-peak reading value also meets average limit and measurement with the average detector is unnecessary.
 3. The emission levels of other frequencies were very low against the limit.
 4. Margin value = Emission level - Limit value
 5. Correction factor = Insertion loss + Cable loss
 6. Emission Level = Correction Factor + Reading Value.

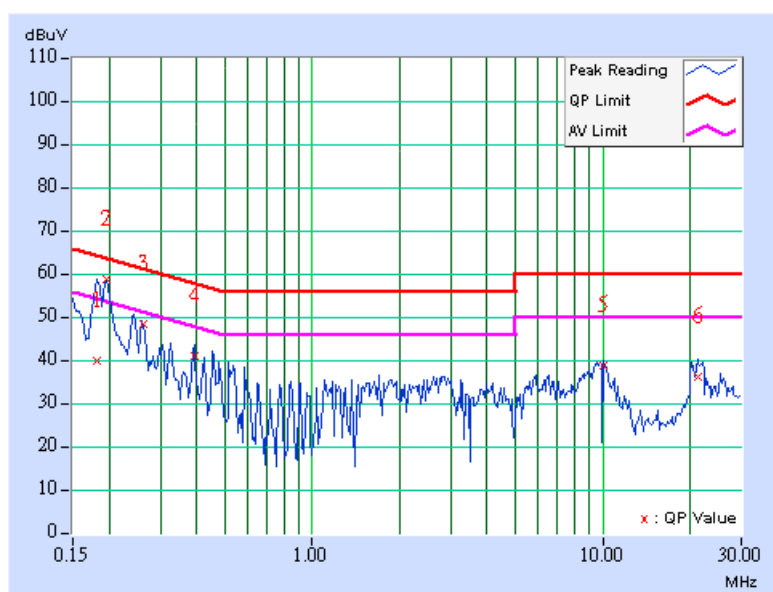

4.1.8 TEST RESULTS - Adapter 2

802.11g OFDM MODULATION :

EUT TEST CONDITION		MEASUREMENT DETAIL	
CHANNEL	Channel 6	PHASE	Line (L)
MODULATION TYPE	BPSK	6dB BANDWIDTH	9 kHz
TRANSFER RATE	6Mbps	INPUT POWER	120Vac, 60 Hz
ENVIRONMENTAL CONDITIONS	25deg. C, 75%RH, 971hPa	TESTED BY	Andy Ho

No	Freq. [MHz]	Corr. Factor (dB)	Reading Value [dB (uV)]		Emission Level [dB (uV)]		Limit [dB (uV)]		Margin (dB)	
			Q.P.	AV.	Q.P.	AV.	Q.P.	AV.	Q.P.	AV.
	1	0.166	0.22	55.15	38.68	55.37	38.90	65.18	55.18	-9.81
2	0.185	0.25	53.38	-	53.63	-	64.25	54.25	-10.62	-
3	0.236	0.25	45.74	-	45.99	-	62.24	52.24	-16.24	-
4	1.740	0.35	22.98	-	23.33	-	56.00	46.00	-32.67	-
5	9.548	0.69	37.65	-	38.34	-	60.00	50.00	-21.66	-
6	15.074	1.15	37.51	-	38.66	-	60.00	50.00	-21.34	-

- REMARKS:**
1. Q.P. and AV. are abbreviations of quasi-peak and average individually.
 2. "-": The Quasi-peak reading value also meets average limit and measurement with the average detector is unnecessary.
 3. The emission levels of other frequencies were very low against the limit.
 4. Margin value = Emission level - Limit value
 5. Correction factor = Insertion loss + Cable loss
 6. Emission Level = Correction Factor + Reading Value.

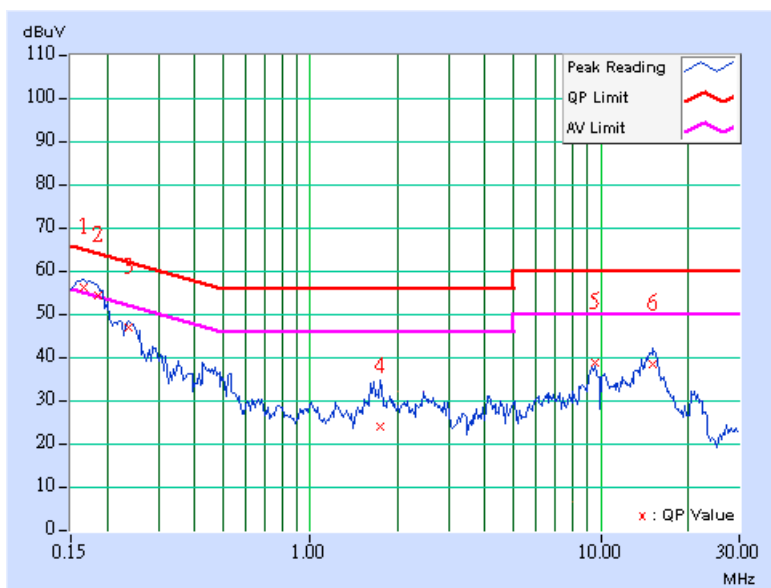

EUT TEST CONDITION		MEASUREMENT DETAIL	
CHANNEL	Channel 6	PHASE	Neutral (N)
MODULATION TYPE	BPSK	6dB BANDWIDTH	9 kHz
TRANSFER RATE	6Mbps	INPUT POWER	120Vac, 60 Hz
ENVIRONMENTAL CONDITIONS	25deg. C, 75%RH, 971hPa	TESTED BY	Andy Ho

No	Freq. [MHz]	Corr. Factor (dB)	Reading Value [dB (uV)]		Emission Level [dB (uV)]		Limit [dB (uV)]		Margin (dB)	
			Q.P.	AV.	Q.P.	AV.	Q.P.	AV.	Q.P.	AV.
			1	0.150	0.20	53.72	-	53.92	-	66.00
2	0.173	0.23	54.42	-	54.65	-	64.82	54.82	-10.17	-
3	0.185	0.25	53.60	-	53.85	-	64.25	54.25	-10.40	-
4	0.240	0.25	45.84	-	46.09	-	62.10	52.10	-16.01	-
5	9.547	0.79	37.39	-	38.18	-	60.00	50.00	-21.82	-
6	15.504	1.26	33.27	-	34.53	-	60.00	50.00	-25.47	-

- REMARKS:**
1. Q.P. and AV. are abbreviations of quasi-peak and average individually.
 2. "-": The Quasi-peak reading value also meets average limit and measurement with the average detector is unnecessary.
 3. The emission levels of other frequencies were very low against the limit.
 4. Margin value = Emission level - Limit value
 5. Correction factor = Insertion loss + Cable loss
 6. Emission Level = Correction Factor + Reading Value.

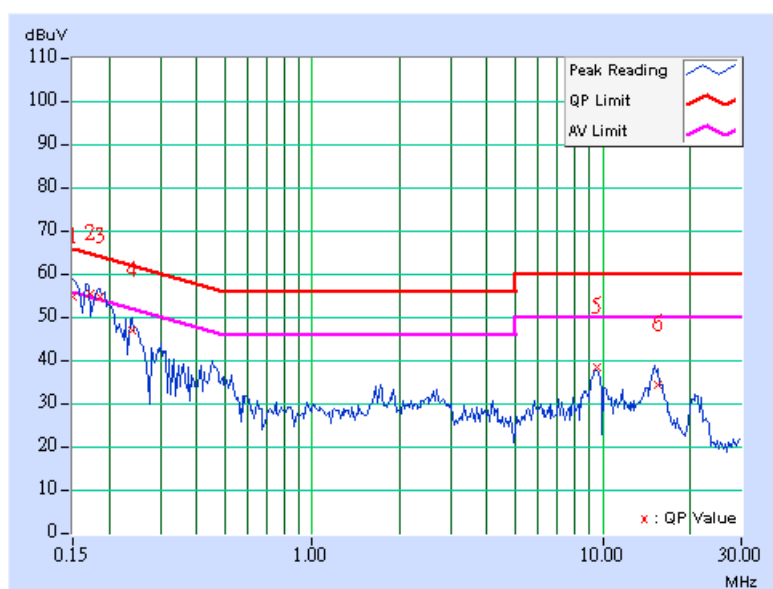

4.1.9 TEST RESULTS - Adapter 3

802.11g OFDM MODULATION :

EUT TEST CONDITION		MEASUREMENT DETAIL	
CHANNEL	Channel 6	PHASE	Line (L)
MODULATION TYPE	BPSK	6dB BANDWIDTH	9 kHz
TRANSFER RATE	6Mbps	INPUT POWER	120Vac, 60 Hz
ENVIRONMENTAL CONDITIONS	25deg. C, 75%RH, 971hPa	TESTED BY	Andy Ho

No	Freq. [MHz]	Corr. Factor (dB)	Reading Value [dB (uV)]		Emission Level [dB (uV)]		Limit [dB (uV)]		Margin (dB)	
			Q.P.	AV.	Q.P.	AV.	Q.P.	AV.	Q.P.	AV.
	1	0.193	0.27	55.51	46.13	55.78	46.40	63.91	53.91	-8.13
2	0.255	0.24	50.68	-	50.92	-	61.59	51.59	-10.67	-
3	0.370	0.15	52.39	42.16	52.54	42.31	58.50	48.50	-5.96	-6.19
4	0.440	0.15	42.52	-	42.67	-	57.06	47.06	-14.39	-
5	2.326	0.36	41.99	-	42.35	-	56.00	46.00	-13.65	-
6	2.400	0.36	45.02	-	45.38	-	56.00	46.00	-10.62	-
7	2.841	0.38	44.91	-	45.29	-	56.00	46.00	-10.71	-

- REMARKS:**
1. Q.P. and AV. are abbreviations of quasi-peak and average individually.
 2. "-": The Quasi-peak reading value also meets average limit and measurement with the average detector is unnecessary.
 3. The emission levels of other frequencies were very low against the limit.
 4. Margin value = Emission level - Limit value
 5. Correction factor = Insertion loss + Cable loss
 6. Emission Level = Correction Factor + Reading Value.

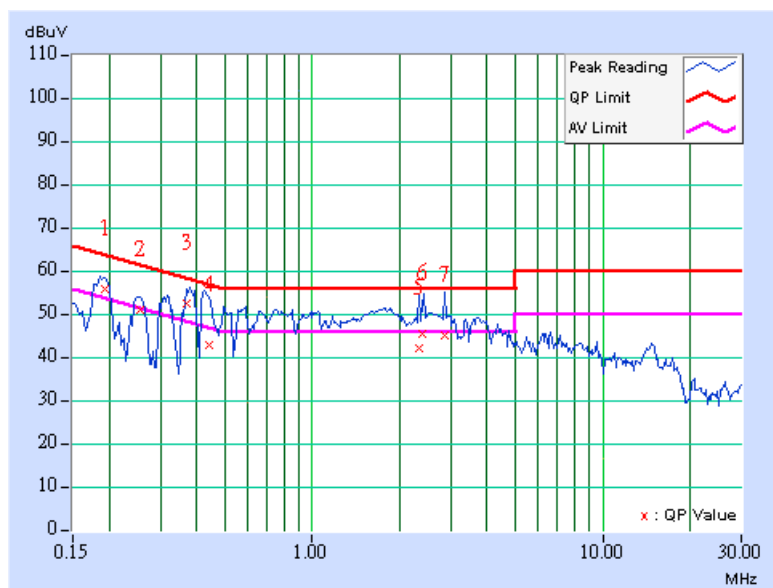

EUT TEST CONDITION		MEASUREMENT DETAIL	
CHANNEL	Channel 6	PHASE	Neutral (N)
MODULATION TYPE	BPSK	6dB BANDWIDTH	9 kHz
TRANSFER RATE	6Mbps	INPUT POWER	120Vac, 60 Hz
ENVIRONMENTAL CONDITIONS	25deg. C, 75%RH, 971hPa	TESTED BY	Andy Ho

No	Freq. [MHz]	Corr. Factor (dB)	Reading Value [dB (uV)]		Emission Level [dB (uV)]		Limit [dB (uV)]		Margin (dB)	
			Q.P.	AV.	Q.P.	AV.	Q.P.	AV.	Q.P.	AV.
			1	0.189	0.26	54.93	45.17	55.19	45.43	64.07
2	0.254	0.24	49.32	-	49.56	-	61.63	51.63	-12.07	-
3	0.379	0.15	51.18	44.58	51.33	44.73	58.30	48.30	-6.97	-3.57
4	0.500	0.17	47.79	39.44	47.96	39.61	56.00	46.00	-8.04	-6.39
5	0.580	0.20	47.35	39.23	47.55	39.43	56.00	46.00	-8.45	-6.57
6	0.849	0.32	46.47	35.03	46.79	35.35	56.00	46.00	-9.21	-10.65
7	1.786	0.35	46.85	36.60	47.20	36.95	56.00	46.00	-8.80	-9.05
8	2.572	0.40	45.53	-	45.93	-	56.00	46.00	-10.07	-
9	3.602	0.50	44.71	-	45.21	-	56.00	46.00	-10.79	-

- REMARKS:**
1. Q.P. and AV. are abbreviations of quasi-peak and average individually.
 2. "-": The Quasi-peak reading value also meets average limit and measurement with the average detector is unnecessary.
 3. The emission levels of other frequencies were very low against the limit.
 4. Margin value = Emission level - Limit value
 5. Correction factor = Insertion loss + Cable loss
 6. Emission Level = Correction Factor + Reading Value.

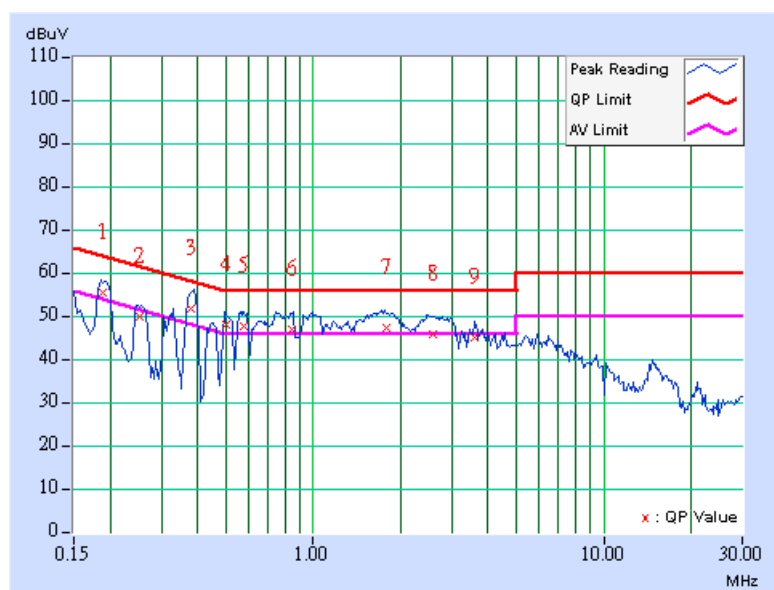

4.1.10 TEST RESULTS - Adapter 4

802.11g OFDM MODULATION :

EUT TEST CONDITION		MEASUREMENT DETAIL	
CHANNEL	Channel 6	PHASE	Line (L)
MODULATION TYPE	BPSK	6dB BANDWIDTH	9 kHz
TRANSFER RATE	6Mbps	INPUT POWER	120Vac, 60 Hz
ENVIRONMENTAL CONDITIONS	24deg. C, 67%RH, 971hPa	TESTED BY	Phoenix Huang

No	Freq. [MHz]	Corr. Factor (dB)	Reading Value [dB (uV)]		Emission Level [dB (uV)]		Limit [dB (uV)]		Margin (dB)	
			Q.P.	AV.	Q.P.	AV.	Q.P.	AV.	Q.P.	AV.
	1	0.187	9.65	43.25	-	52.90	-	64.15	54.15	-11.25
2	0.248	9.65	37.17	-	46.82	-	61.84	51.84	-15.01	-
3	0.440	9.67	32.72	-	42.39	-	57.07	47.07	-14.68	-
4	0.502	9.68	33.65	-	43.33	-	56.00	46.00	-12.67	-
5	2.380	9.84	27.34	-	37.18	-	56.00	46.00	-18.82	-
6	10.719	10.15	33.70	-	43.85	-	60.00	50.00	-16.15	-

- REMARKS:**
1. Q.P. and AV. are abbreviations of quasi-peak and average individually.
 2. "-": The Quasi-peak reading value also meets average limit and measurement with the average detector is unnecessary.
 3. The emission levels of other frequencies were very low against the limit.
 4. Margin value = Emission level - Limit value
 5. Correction factor = Insertion loss + Cable loss
 6. Emission Level = Correction Factor + Reading Value.

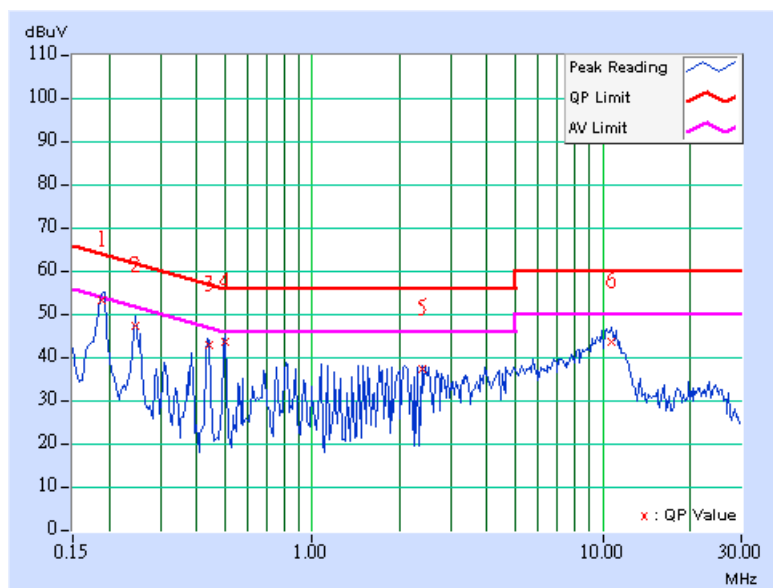

EUT TEST CONDITION		MEASUREMENT DETAIL	
CHANNEL	Channel 6	PHASE	Neutral (N)
MODULATION TYPE	BPSK	6dB BANDWIDTH	9 kHz
TRANSFER RATE	6Mbps	INPUT POWER	120Vac, 60 Hz
ENVIRONMENTAL CONDITIONS	24deg. C, 67%RH, 971hPa	TESTED BY	Phoenix Huang

No	Freq. [MHz]	Corr. Factor (dB)	Reading Value [dB (uV)]		Emission Level [dB (uV)]		Limit [dB (uV)]		Margin (dB)	
			Q.P.	AV.	Q.P.	AV.	Q.P.	AV.	Q.P.	AV.
	1	0.189	9.65	42.50	-	52.15	-	64.08	54.08	-11.93
2	0.244	9.65	32.45	-	42.10	-	61.97	51.97	-19.87	-
3	0.435	9.66	32.58	-	42.24	-	57.15	47.15	-14.92	-
4	0.502	9.67	32.67	-	42.34	-	56.00	46.00	-13.66	-
5	0.818	9.72	26.49	-	36.21	-	56.00	46.00	-19.79	-
6	11.805	10.21	26.84	-	37.05	-	60.00	50.00	-22.95	-

- REMARKS:**
1. Q.P. and AV. are abbreviations of quasi-peak and average individually.
 2. "-": The Quasi-peak reading value also meets average limit and measurement with the average detector is unnecessary.
 3. The emission levels of other frequencies were very low against the limit.
 4. Margin value = Emission level - Limit value
 5. Correction factor = Insertion loss + Cable loss
 6. Emission Level = Correction Factor + Reading Value.

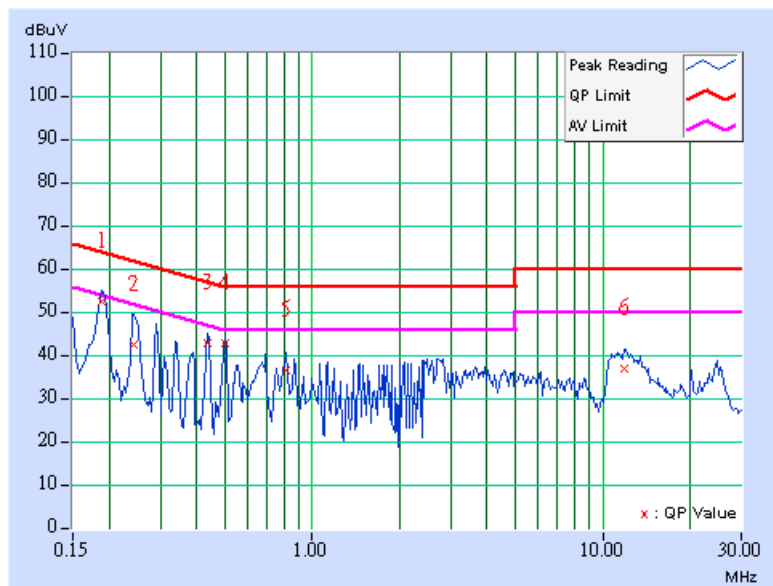

4.2 RADIATED EMISSION MEASUREMENT

4.2.1 LIMITS OF RADIATED EMISSION MEASUREMENT

Emissions radiated outside of the specified bands, shall be according to the general radiated limits in 15.209 as following:

Frequencies (MHz)	Field strength (microvolts/meter)	Measurement distance (meters)
0.009-0.490	2400/F(kHz)	300
0.490-1.705	24000/F(kHz)	30
1.705-30.0	30	30
30-88	100	3
88-216	150	3
216-960	200	3
Above 960	500	3

NOTE:

1. The lower limit shall apply at the transition frequencies.
2. Emission level (dBuV/m) = 20 log Emission level (uV/m).
3. As shown in 15.35(b), for frequencies above 1000MHz, the field strength limits are based on average detector, however, the peak field strength of any emission shall not exceed the maximum permitted average limits, specified above by more than 20dB under any condition of modulation.



4.2.2 TEST INSTRUMENTS

DESCRIPTION & MANUFACTURER	MODEL NO.	SERIAL NO.	CALIBRATED UNTIL
ADVANTEST Spectrum Analyzer	R3271A	85060311	July 15, 2008
HP Pre_Amplifier	8449B	3008A01922	Oct. 04, 2008
ROHDE & SCHWARZ Test Receiver	ESCS30	100375	Mar. 31, 2009
SCHWARZBECK TRILOG Broadband Antenna	VULB 9168	138	July 26, 2008
Schwarzbeck Horn_Antenna	BBHA9120	D124	Dec. 16, 2008
Schwarzbeck Horn_Antenna	BBHA 9170	BBHA9170153	Jan. 27, 2009
RF Switches (ARNITSU)	CS-201	1565157	Aug. 13, 2008
RF CABLE (Chaintek)	SF102	22054-2	Dec. 06. 2008
RF Cable(RICHTEC)	9913-30M N-N Cable	STCCAB-30M-1 GHz	Aug. 13, 2008
Software	ADT_Radiated_V 7.6.15.8	NA	NA
CHANCE MOST Antenna Tower	AT-100	0203	NA
CHANCE MOST Turn Table	TT-100	0203	NA

- Note: 1. The calibration interval of the above test instruments is 12 months and the calibrations are traceable to NML/ROC and NIST/USA.
 2. The horn antenna, HP preamplifier (model: 8449B) and Spectrum Analyzer (model: R3271A) are used only for the measurement of emission frequency above 1GHz if tested.
 3. The test was performed in ADT Open Site No. C.
 4. The FCC Site Registration No. is 656396.
 5. The VCCI Site Registration No. is R-1626.
 6. The CANADA Site Registration No. is IC 3789C-3.

4.2.3 TEST PROCEDURES

- a. The EUT was placed on the top of a rotating table 0.8 meters above the ground at a 10 meter open area test site. The table was rotated 360 degrees to determine the position of the highest radiation.
- b. The EUT was set 3 meters away from the interference-receiving antenna, which was mounted on the top of a variable-height antenna tower.
- c. The antenna is a broadband antenna, and its height is varied from one meter to four meters above the ground to determine the maximum value of the field strength. Both horizontal and vertical polarizations of the antenna are set to make the measurement.
- d. For each suspected emission, the EUT was arranged to its worst case and then the antenna was tuned to heights from 1 meter to 4 meters and the rotatable table was turned from 0 degrees to 360 degrees to find the maximum reading.
- e. The test-receiver system was set to Peak Detect Function and Specified Bandwidth with Maximum Hold Mode.
- f. If the emission level of the EUT in peak mode was 10dB lower than the limit specified, then testing could be stopped and the peak values of the EUT would be reported. Otherwise the emissions that did not have 10dB margin would be re-tested one by one using peak, quasi-peak or average method as specified and then reported in a data sheet.

NOTE:

1. The resolution bandwidth and video bandwidth of test receiver/spectrum analyzer is 120kHz for Peak detection (PK) and Quasi-peak detection (QP) at frequency below 1GHz.
2. The resolution bandwidth of test receiver/spectrum analyzer is 1 MHz and the video bandwidth is 3 MHz for Peak detection (PK) at frequency above 1GHz.
3. The resolution bandwidth of test receiver/spectrum analyzer is 1 MHz and the video bandwidth is 10 Hz for Average detection (AV) at frequency above 1GHz.

4.2.4 DEVIATION FROM TEST STANDARD

No deviation

4.2.5 TEST SETUP

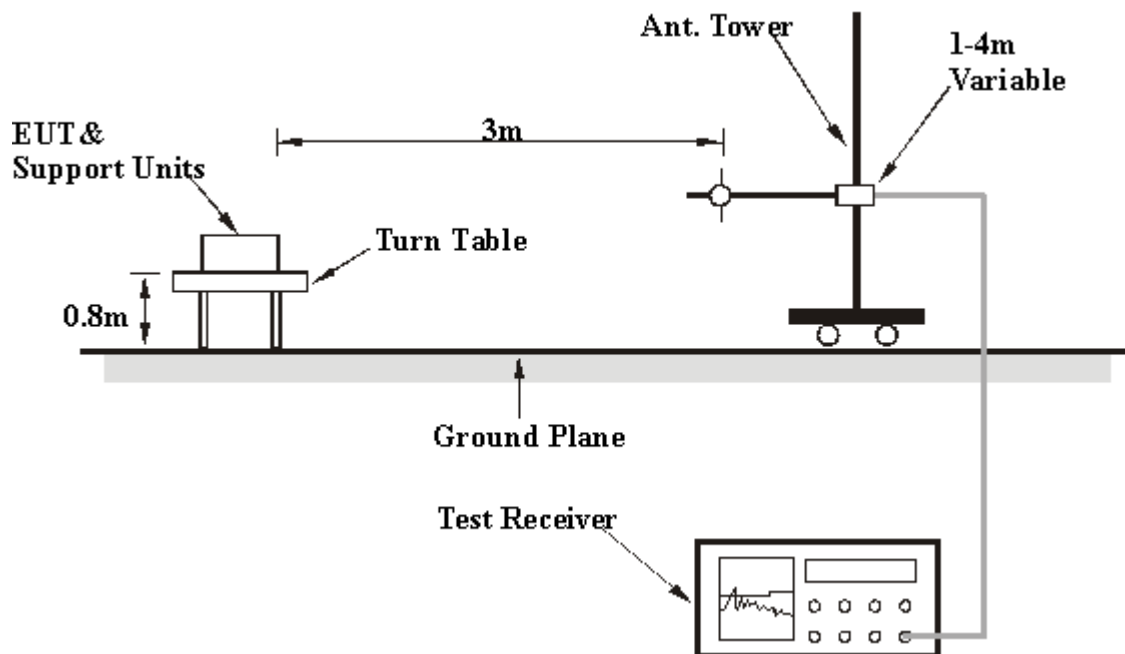

For the actual test configuration, please refer to the related item – Photographs of the Test Configuration.

4.2.6 EUT OPERATING CONDITIONS

Same as the 4.1.6

Below 1GHz Test Data

4.2.7 TEST RESULTS

BELOW 1GHz WORST-CASE DATA : 802.11g OFDM MODULATION

EUT TEST CONDITION		MEASUREMENT DETAIL	
CHANNEL	Channel 1	FREQUENCY RANGE	Below 1000MHz
INPUT POWER	120Vac, 60 Hz	DETECTOR FUNCTION	Quasi-Peak
ENVIRONMENTAL CONDITIONS	25deg. C, 75%RH 965hPa	TESTED BY	Frank Liu

ANTENNA POLARITY & TEST DISTANCE: HORIZONTAL AT 3 M								
NO.	FREQ. (MHz)	EMISSION LEVEL (dBuV/m)	LIMIT (dBuV/m)	MARGIN (dB)	ANTENNA HEIGHT (m)	TABLE ANGLE (Degree)	RAW VALUE (dBuV)	CORRECTION FACTOR (dB/m)
1	125.00	39.72 QP	43.50	-3.78	1.35 H	85	26.49	13.23
2	201.90	30.33 QP	43.50	-13.17	1.44 H	82	18.27	12.06
3	250.01	35.44 QP	46.00	-10.56	1.00 H	260	22.61	12.83
4	300.00	36.88 QP	46.00	-9.12	1.00 H	282	20.29	16.59
5	375.01	33.87 QP	46.00	-12.13	1.03 H	213	16.39	17.48
6	450.00	32.46 QP	46.00	-13.54	1.82 H	12	12.58	19.88
7	500.00	33.46 QP	46.00	-12.54	1.56 H	190	12.41	21.05
8	625.02	34.42 QP	46.00	-11.58	1.71 H	86	10.42	24.00
9	900.00	35.13 QP	46.00	-10.87	1.80 H	43	5.46	29.67
ANTENNA POLARITY & TEST DISTANCE: VERTICAL AT 3 M								
NO.	FREQ. (MHz)	EMISSION LEVEL (dBuV/m)	LIMIT (dBuV/m)	MARGIN (dB)	ANTENNA HEIGHT (m)	TABLE ANGLE (Degree)	RAW VALUE (dBuV)	CORRECTION FACTOR (dB/m)
1	46.49	37.18 QP	40.00	-2.82	1.00 V	34	21.28	15.90
2	125.00	40.35 QP	43.50	-3.15	1.00 V	221	27.12	13.23
3	250.00	33.95 QP	46.00	-12.05	1.00 V	216	21.12	12.83
4	375.00	37.64 QP	46.00	-8.36	1.00 V	327	20.16	17.48
5	384.02	33.92 QP	46.00	-12.08	1.06 V	157	16.23	17.69
6	500.00	34.30 QP	46.00	-11.70	1.00 V	351	13.25	21.05
7	625.00	37.63 QP	46.00	-8.37	1.21 V	347	13.63	24.00
8	750.00	35.40 QP	46.00	-10.60	1.23 V	304	8.14	27.26

- REMARKS:**
1. Emission level (dBuV/m) = Raw Value (dBuV) + Correction Factor (dB/m).
 2. Correction Factor (dB/m) = Antenna Factor (dB/m) + Cable Factor (dB).
 3. The other emission levels were very low against the limit.
 4. Margin value = Emission level – Limit value.

Above 1GHz Test Data

4.2.8 TEST RESULTS

802.11b DSSS MODULATION

EUT TEST CONDITION		MEASUREMENT DETAIL	
CHANNEL	Channel 1	FREQUENCY RANGE	1 ~ 25GHz
INPUT POWER	120Vac, 60 Hz	DETECTOR FUNCTION	Peak (PK) Average (AV)
ENVIRONMENTAL CONDITIONS	25deg. C, 75%RH 965hPa	TESTED BY	Sky Liao

ANTENNA POLARITY & TEST DISTANCE: HORIZONTAL AT 3 M								
NO.	FREQ. (MHz)	EMISSION LEVEL (dBuV/m)	LIMIT (dBuV/m)	MARGIN (dB)	ANTENNA HEIGHT (m)	TABLE ANGLE (Degree)	RAW VALUE (dBuV)	CORRECTION FACTOR (dB/m)
1	2390.00	60.07 PK	74.00	-13.93	1.73 H	72	29.75	30.32
2	2390.00	49.68 AV	54.00	-4.32	1.73 H	72	19.36	30.32
3	*2412.00	111.30 PK			1.42 H	344	80.89	30.41
4	*2412.00	106.90 AV			1.42 H	344	76.49	30.41
5	4824.00	52.30 PK	74.00	-21.70	1.36 H	298	16.51	35.79
6	4824.00	46.80 AV	54.00	-7.20	1.36 H	298	11.01	35.79
7	7236.00	56.40 PK	74.00	-17.60	1.29 H	290	14.80	41.60
8	7236.00	44.40 AV	54.00	-9.60	1.29 H	290	2.80	41.60
9	14472.00	64.40 PK	74.00	-9.60	1.20 H	108	14.39	50.01
10	14472.00	52.50 AV	54.00	-1.50	1.20 H	108	2.49	50.01

ANTENNA POLARITY & TEST DISTANCE: VERTICAL AT 3 M								
NO.	FREQ. (MHz)	EMISSION LEVEL (dBuV/m)	LIMIT (dBuV/m)	MARGIN (dB)	ANTENNA HEIGHT (m)	TABLE ANGLE (Degree)	RAW VALUE (dBuV)	CORRECTION FACTOR (dB/m)
1	2390.00	56.55 PK	74.00	-17.45	1.05 V	160	26.23	30.32
2	2390.00	45.52 AV	54.00	-8.48	1.05 V	160	15.20	30.32
3	*2412.00	105.50 PK			1.05 V	160	75.09	30.41
4	*2412.00	100.90 AV			1.05 V	160	70.49	30.41
5	4824.00	49.00 PK	74.00	-25.00	1.03 V	253	13.21	35.79
6	4824.00	40.30 AV	54.00	-13.70	1.03 V	253	4.51	35.79
7	7236.00	53.40 PK	85.50	-32.10	1.00 V	269	11.80	41.60
8	7236.00	39.80 AV	80.90	-41.10	1.00 V	269	-1.80	41.60
9	14472.00	62.90 PK	74.00	-11.10	1.16 V	3	12.89	50.01
10	14472.00	48.20 AV	54.00	-5.80	1.16 V	3	-1.81	50.01

REMARKS: 1. Emission level (dBuV/m) = Raw Value (dBuV) + Correction Factor (dB/m).

2. Correction Factor (dB/m) = Antenna Factor (dB/m) + Cable Factor (dB).

3. The other emission levels were very low against the limit.

4. Margin value = Emission level – Limit value.

5. “ * “: Fundamental frequency.

EUT TEST CONDITION		MEASUREMENT DETAIL	
CHANNEL	Channel 6	FREQUENCY RANGE	1 ~ 25GHz
INPUT POWER	120Vac, 60 Hz	DETECTOR FUNCTION	Peak (PK) Average (AV)
ENVIRONMENTAL CONDITIONS	25deg. C, 75%RH 965hPa	TESTED BY	Sky Liao

ANTENNA POLARITY & TEST DISTANCE: HORIZONTAL AT 3 M								
NO.	FREQ. (MHz)	EMISSION LEVEL (dBuV/m)	LIMIT (dBuV/m)	MARGIN (dB)	ANTENNA HEIGHT (m)	TABLE ANGLE (Degree)	RAW VALUE (dBuV)	CORRECTION FACTOR (dB/m)
1	*2437.00	112.30 PK			1.40 H	346	81.78	30.52
2	*2437.00	107.70 AV			1.40 H	346	77.18	30.52
3	4874.00	50.80 PK	74.00	-23.20	1.22 H	300	14.88	35.92
4	4874.00	45.30 AV	54.00	-8.70	1.22 H	300	9.38	35.92
5	7311.00	55.80 PK	74.00	-18.20	1.42 H	301	13.99	41.81
6	7311.00	44.50 AV	54.00	-9.50	1.42 H	301	2.69	41.81
ANTENNA POLARITY & TEST DISTANCE: VERTICAL AT 3 M								
NO.	FREQ. (MHz)	EMISSION LEVEL (dBuV/m)	LIMIT (dBuV/m)	MARGIN (dB)	ANTENNA HEIGHT (m)	TABLE ANGLE (Degree)	RAW VALUE (dBuV)	CORRECTION FACTOR (dB/m)
1	*2437.00	105.20 PK			1.02 V	166	74.68	30.52
2	*2437.00	100.80 AV			1.02 V	166	70.28	30.52
3	4874.00	49.60 PK	74.00	-24.40	1.05 V	220	13.68	35.92
4	4874.00	40.80 AV	54.00	-13.20	1.05 V	220	4.88	35.92
5	7311.00	53.80 PK	74.00	-20.20	1.00 V	185	11.99	41.81
6	7311.00	40.20 AV	54.00	-13.80	1.00 V	185	-1.61	41.81

- REMARKS:**
1. Emission level (dBuV/m) = Raw Value (dBuV) + Correction Factor (dB/m).
 2. Correction Factor (dB/m) = Antenna Factor (dB/m) + Cable Factor (dB).
 3. The other emission levels were very low against the limit.
 4. Margin value = Emission level – Limit value.
 5. “ * “: Fundamental frequency.



EUT TEST CONDITION		MEASUREMENT DETAIL	
CHANNEL	Channel 11	FREQUENCY RANGE	1 ~ 25GHz
INPUT POWER	120Vac, 60 Hz	DETECTOR FUNCTION	Peak (PK) Average (AV)
ENVIRONMENTAL CONDITIONS	25deg. C, 75%RH 965hPa	TESTED BY	Sky Liao

ANTENNA POLARITY & TEST DISTANCE: HORIZONTAL AT 3 M								
NO.	FREQ. (MHz)	EMISSION LEVEL (dBuV/m)	LIMIT (dBuV/m)	MARGIN (dB)	ANTENNA HEIGHT (m)	TABLE ANGLE (Degree)	RAW VALUE (dBuV)	CORRECTION FACTOR (dB/m)
1	*2462.00	113.40 PK			1.42 H	341	82.77	30.63
2	*2462.00	108.80 AV			1.42 H	341	78.17	30.63
3	2483.50	61.65 PK	74.00	-12.35	1.49 H	291	30.93	30.72
4	2483.50	50.91 AV	54.00	-3.09	1.49 H	291	20.19	30.72
5	4924.00	51.30 PK	74.00	-22.70	1.40 H	299	15.24	36.06
6	4924.00	44.70 AV	54.00	-9.30	1.40 H	299	8.64	36.06
7	7388.00	55.40 PK	74.00	-18.60	1.34 H	312	13.38	42.02
8	7388.00	43.80 AV	54.00	-10.20	1.34 H	312	1.78	42.02
ANTENNA POLARITY & TEST DISTANCE: VERTICAL AT 3 M								
NO.	FREQ. (MHz)	EMISSION LEVEL (dBuV/m)	LIMIT (dBuV/m)	MARGIN (dB)	ANTENNA HEIGHT (m)	TABLE ANGLE (Degree)	RAW VALUE (dBuV)	CORRECTION FACTOR (dB/m)
1	*2462.00	104.20 PK			1.00 V	182	73.57	30.63
2	*2462.00	100.00 AV			1.00 V	182	69.37	30.63
3	2483.50	58.54 PK	74.00	-15.46	1.00 V	182	27.82	30.72
4	2483.50	45.97 AV	54.00	-8.03	1.00 V	182	15.25	30.72
5	4824.00	49.40 PK	74.00	-24.60	1.05 V	202	13.61	35.79
6	4824.00	40.50 AV	54.00	-13.50	1.05 V	202	4.71	35.79
7	7386.00	53.50 PK	74.00	-20.50	1.02 V	175	11.49	42.01
8	7386.00	40.00 AV	54.00	-14.00	1.02 V	175	-2.01	42.01

- REMARKS:**
1. Emission level (dBuV/m) = Raw Value (dBuV) + Correction Factor (dB/m).
 2. Correction Factor (dB/m) = Antenna Factor (dB/m) + Cable Factor (dB).
 3. The other emission levels were very low against the limit.
 4. Margin value = Emission level – Limit value.
 5. “ * “: Fundamental frequency.

RESTRICTED BANDEDGE (802.11b MODE, CH1, HORIZONTAL)

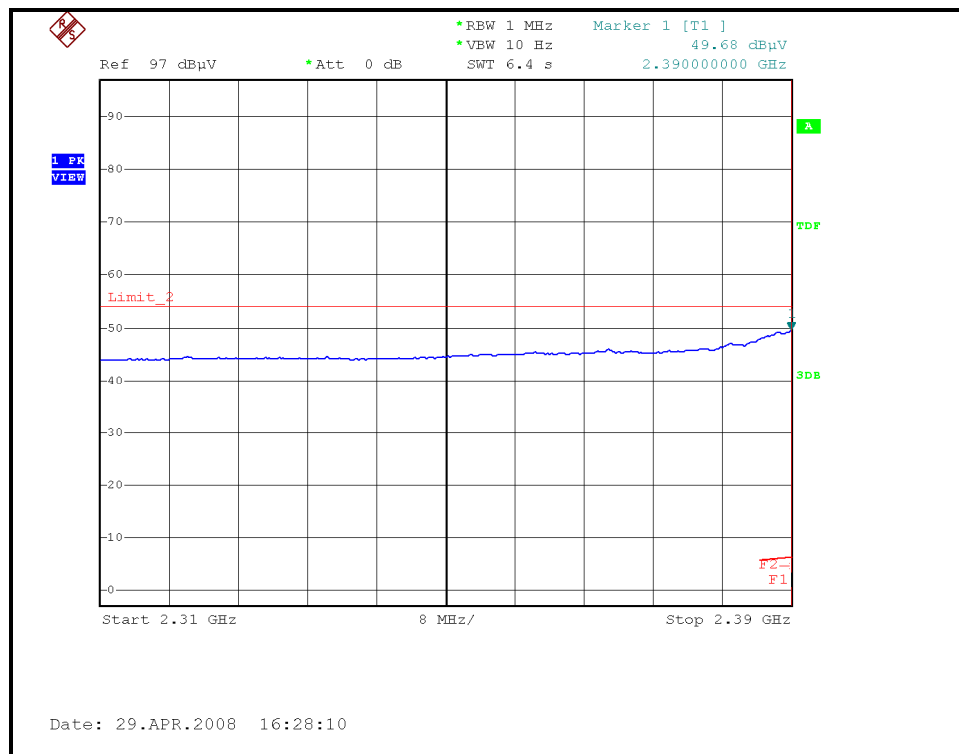
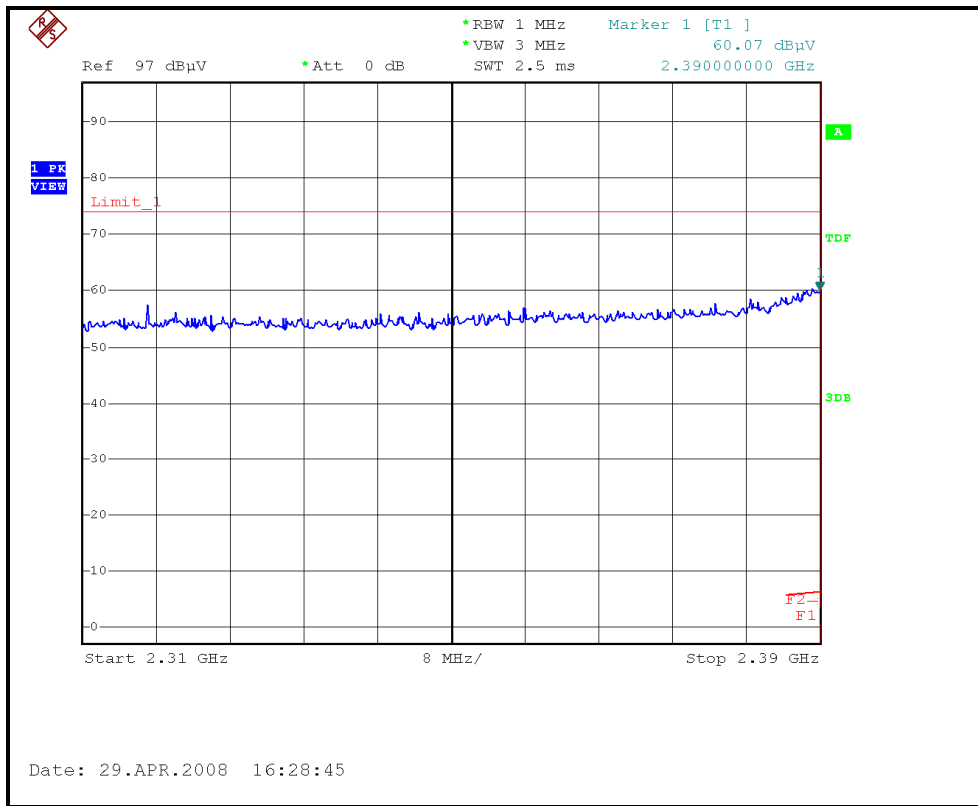

RESTRICTED BANDEDGE (802.11b MODE, CH1, VERTICAL)

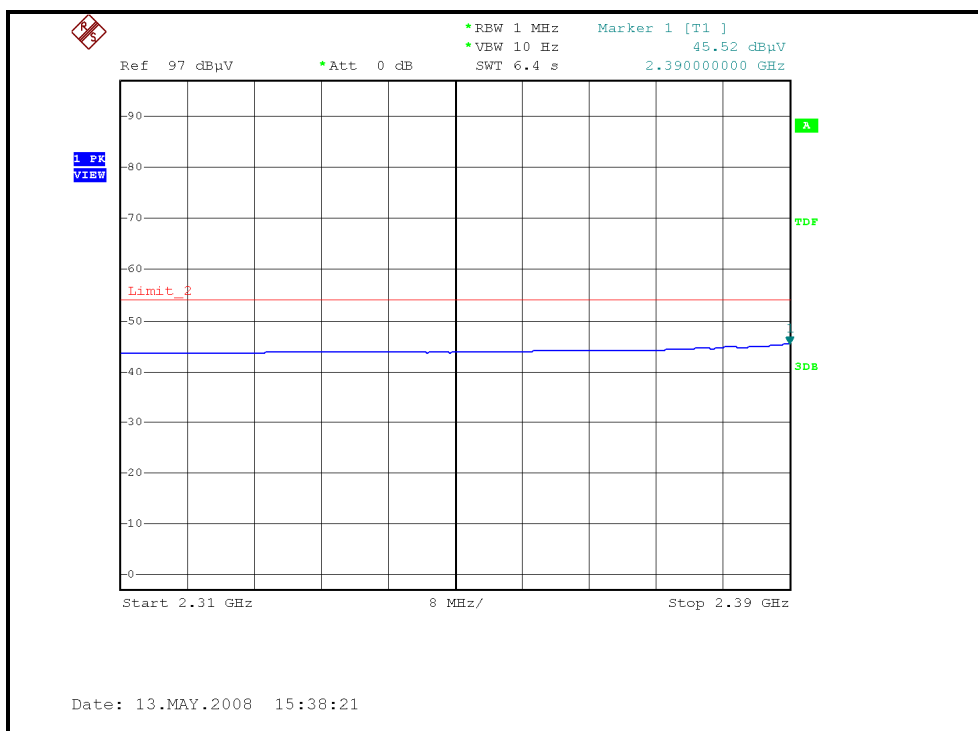
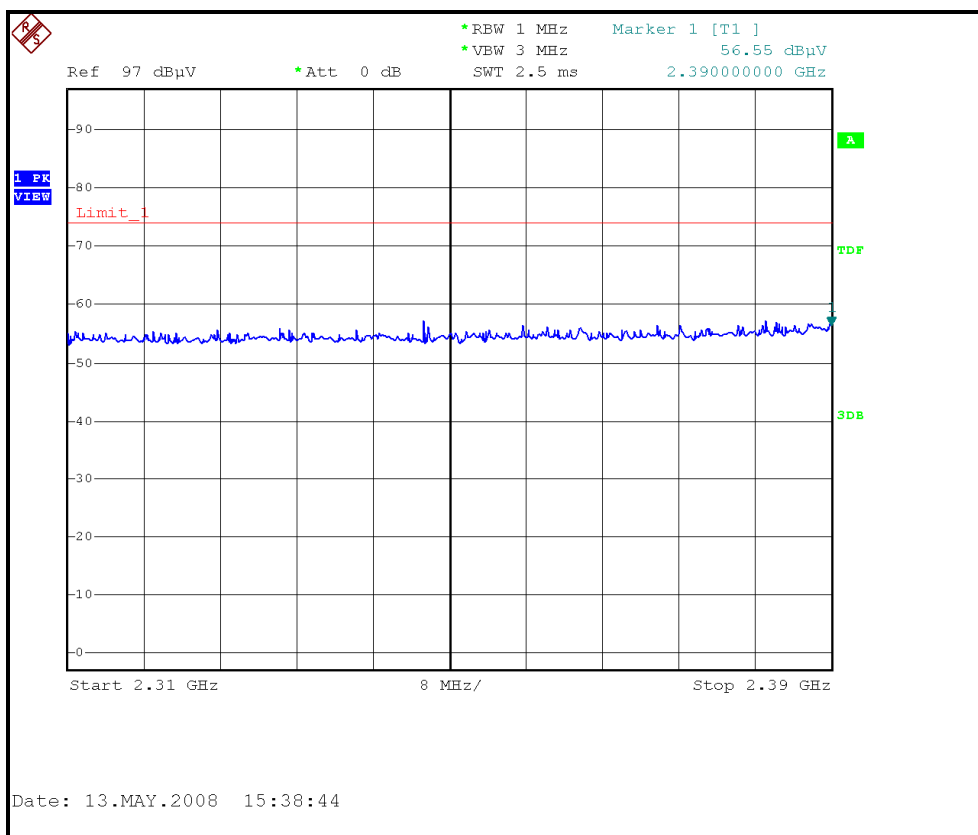



RESTRICTED BANDEDGE (802.11b MODE,CH11, HORIZONTAL)

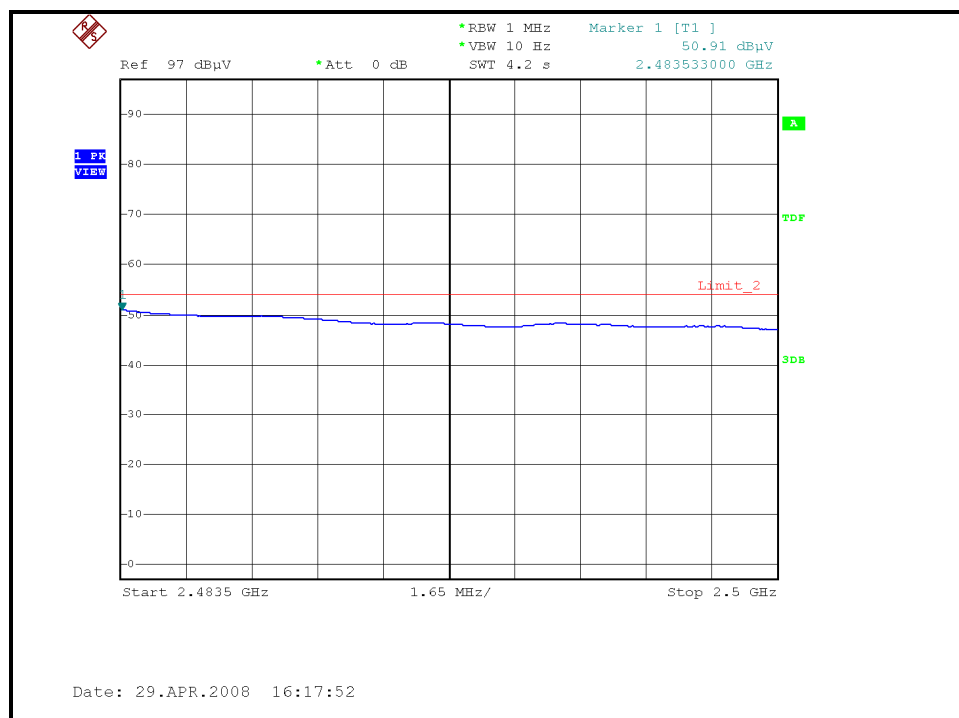
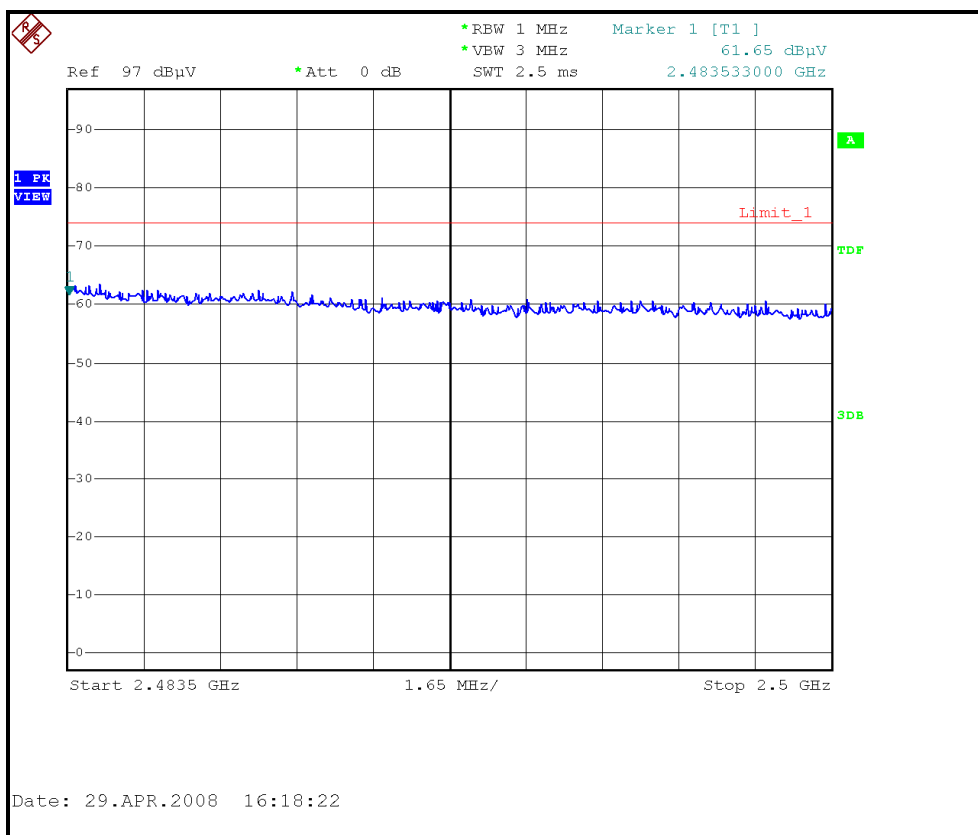

RESTRICTED BANDEDGE (802.11b MODE, CH11, VERTICAL)

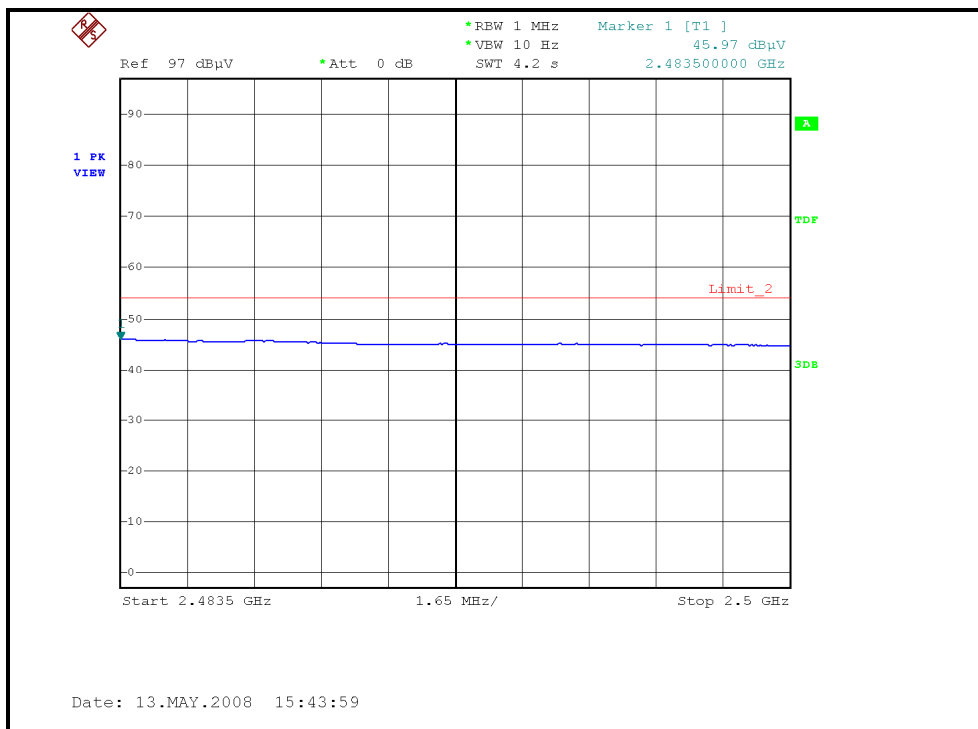
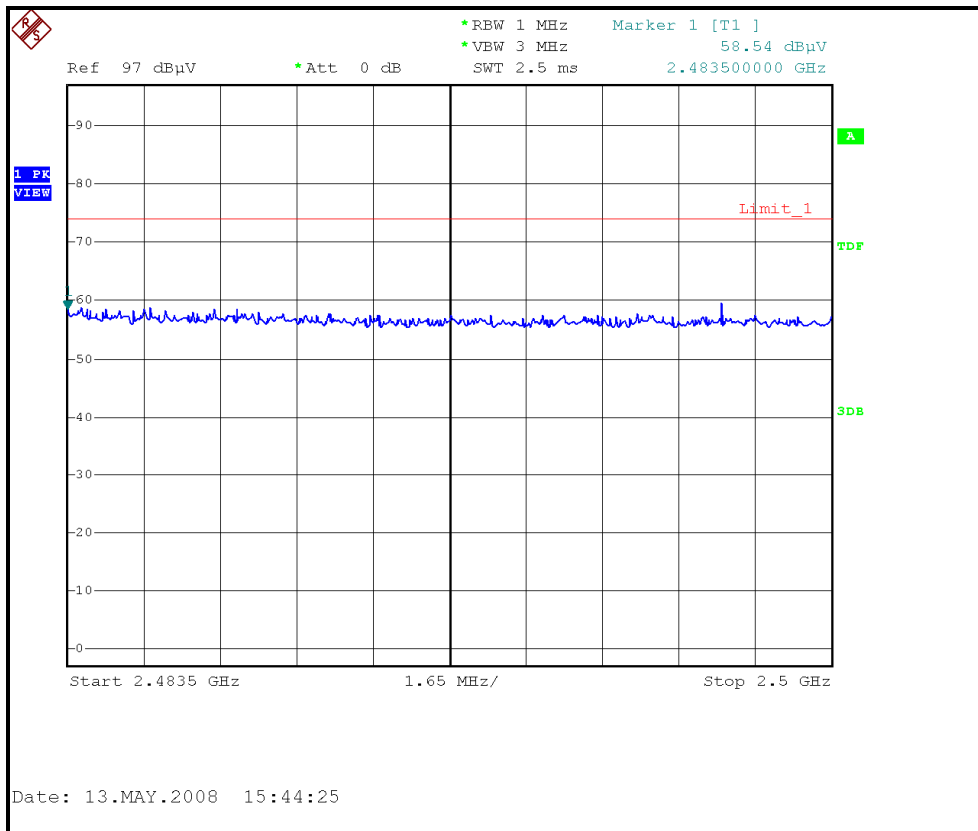

802.11g OFDM MODULATION

EUT TEST CONDITION		MEASUREMENT DETAIL	
CHANNEL	Channel 1	FREQUENCY RANGE	1 ~ 25GHz
INPUT POWER	120Vac, 60 Hz	DETECTOR FUNCTION	Peak (PK) Average (AV)
ENVIRONMENTAL CONDITIONS	25deg. C, 75%RH 965hPa	TESTED BY	Sky Liao

ANTENNA POLARITY & TEST DISTANCE: HORIZONTAL AT 3 M								
NO.	FREQ. (MHz)	EMISSION LEVEL (dBuV/m)	LIMIT (dBuV/m)	MARGIN (dB)	ANTENNA HEIGHT (m)	TABLE ANGLE (Degree)	RAW VALUE (dBuV)	CORRECTION FACTOR (dB/m)
1	2390.00	72.95 PK	74.00	-1.05	1.40 H	255	42.63	30.32
2	2390.00	50.64 AV	54.00	-3.36	1.40 H	255	20.32	30.32
3	*2412.00	114.70 PK			1.72 H	246	84.29	30.41
4	*2412.00	102.70 AV			1.72 H	246	72.29	30.41
5	4824.00	51.20 PK	74.00	-22.80	1.48 H	102	15.41	35.79
6	4824.00	37.20 AV	54.00	-16.80	1.48 H	102	1.41	35.79
7	7236.00	54.20 PK	94.70	-40.50	1.30 H	215	12.60	41.60
8	7236.00	40.80 AV	82.70	-41.90	1.30 H	215	-0.80	41.60
ANTENNA POLARITY & TEST DISTANCE: VERTICAL AT 3 M								
NO.	FREQ. (MHz)	EMISSION LEVEL (dBuV/m)	LIMIT (dBuV/m)	MARGIN (dB)	ANTENNA HEIGHT (m)	TABLE ANGLE (Degree)	RAW VALUE (dBuV)	CORRECTION FACTOR (dB/m)
1	2390.00	62.81 PK	74.00	-11.19	1.00 V	2	32.49	30.32
2	2390.00	45.31 AV	54.00	-8.69	1.00 V	2	14.99	30.32
3	*2412.00	106.40 PK			1.00 V	2	75.99	30.41
4	*2412.00	94.70 AV			1.00 V	2	64.29	30.41
5	4824.00	54.20 PK	74.00	-19.80	1.10 V	2	18.41	35.79
6	4824.00	37.80 AV	54.00	-16.20	1.10 V	2	2.01	35.79
7	7236.00	53.00 PK	86.40	-33.40	1.36 V	72	11.40	41.60
8	7236.00	39.50 AV	74.70	-35.20	1.36 V	72	-2.10	41.60

- REMARKS:**
1. Emission level (dBuV/m) = Raw Value (dBuV) + Correction Factor (dB/m).
 2. Correction Factor (dB/m) = Antenna Factor (dB/m) + Cable Factor (dB).
 3. The other emission levels were very low against the limit.
 4. Margin value = Emission level – Limit value.
 5. “ * “: Fundamental frequency.

EUT TEST CONDITION		MEASUREMENT DETAIL	
CHANNEL	Channel 6	FREQUENCY RANGE	1 ~ 25GHz
INPUT POWER	120Vac, 60 Hz	DETECTOR FUNCTION	Peak (PK) Average (AV)
ENVIRONMENTAL CONDITIONS	25deg. C, 75%RH 965hPa	TESTED BY	Sky Liao

ANTENNA POLARITY & TEST DISTANCE: HORIZONTAL AT 3 M								
NO.	FREQ. (MHz)	EMISSION LEVEL (dBuV/m)	LIMIT (dBuV/m)	MARGIN (dB)	ANTENNA HEIGHT (m)	TABLE ANGLE (Degree)	RAW VALUE (dBuV)	CORRECTION FACTOR (dB/m)
1	*2437.00	114.80 PK			1.70 H	244	84.28	30.52
2	*2437.00	102.80 AV			1.70 H	244	72.28	30.52
3	4874.00	51.00 PK	74.00	-23.00	1.44 H	110	15.08	35.92
4	4874.00	37.40 AV	54.00	-16.60	1.44 H	110	1.48	35.92
5	7311.00	53.90 PK	74.00	-20.10	1.32 H	208	12.09	41.81
6	7311.00	40.80 AV	54.00	-13.20	1.32 H	208	-1.01	41.81
ANTENNA POLARITY & TEST DISTANCE: VERTICAL AT 3 M								
NO.	FREQ. (MHz)	EMISSION LEVEL (dBuV/m)	LIMIT (dBuV/m)	MARGIN (dB)	ANTENNA HEIGHT (m)	TABLE ANGLE (Degree)	RAW VALUE (dBuV)	CORRECTION FACTOR (dB/m)
1	*2437.00	106.60 PK			1.00 V	0	76.08	30.52
2	*2437.00	94.80 AV			1.00 V	0	64.28	30.52
3	4874.00	54.20 PK	74.00	-19.80	1.13 V	262	18.28	35.92
4	4874.00	37.90 AV	54.00	-16.10	1.13 V	262	1.98	35.92
5	7311.00	53.20 PK	74.00	-20.80	1.48 V	92	11.39	41.81
6	7311.00	39.80 AV	54.00	-14.20	1.48 V	92	-2.01	41.81

- REMARKS:**
1. Emission level (dBuV/m) = Raw Value (dBuV) + Correction Factor (dB/m).
 2. Correction Factor (dB/m) = Antenna Factor (dB/m) + Cable Factor (dB).
 3. The other emission levels were very low against the limit.
 4. Margin value = Emission level – Limit value.
 5. “ * “: Fundamental frequency.

EUT TEST CONDITION		MEASUREMENT DETAIL	
CHANNEL	Channel 11	FREQUENCY RANGE	1 ~ 25GHz
INPUT POWER	120Vac, 60 Hz	DETECTOR FUNCTION	Peak (PK) Average (AV)
ENVIRONMENTAL CONDITIONS	25deg. C, 75%RH 965hPa	TESTED BY	Sky Liao

ANTENNA POLARITY & TEST DISTANCE: HORIZONTAL AT 3 M								
NO.	FREQ. (MHz)	EMISSION LEVEL (dBuV/m)	LIMIT (dBuV/m)	MARGIN (dB)	ANTENNA HEIGHT (m)	TABLE ANGLE (Degree)	RAW VALUE (dBuV)	CORRECTION FACTOR (dB/m)
1	*2462.00	113.30 PK			1.44 H	248	82.67	30.63
2	*2462.00	101.80 AV			1.44 H	248	71.17	30.63
3	2483.50	72.83 PK	74.00	-1.17	1.40 H	164	42.11	30.72
4	2483.50	50.64 AV	54.00	-3.36	1.40 H	164	19.92	30.72
5	4924.00	50.50 PK	74.00	-23.50	1.38 H	108	14.44	36.06
6	4924.00	36.80 AV	54.00	-17.20	1.38 H	108	0.74	36.06
7	7386.00	53.20 PK	74.00	-20.80	1.44 H	195	11.19	42.01
8	7386.00	40.20 AV	54.00	-13.80	1.44 H	195	-1.81	42.01
ANTENNA POLARITY & TEST DISTANCE: VERTICAL AT 3 M								
NO.	FREQ. (MHz)	EMISSION LEVEL (dBuV/m)	LIMIT (dBuV/m)	MARGIN (dB)	ANTENNA HEIGHT (m)	TABLE ANGLE (Degree)	RAW VALUE (dBuV)	CORRECTION FACTOR (dB/m)
1	*2462.00	106.00 PK			1.00 V	2	75.37	30.63
2	*2462.00	94.70 AV			1.00 V	2	64.07	30.63
3	2483.50	60.19 PK	74.00	-13.81	1.00 V	2	29.47	30.72
4	2483.50	45.56 AV	54.00	-8.44	1.00 V	2	14.84	30.72
5	4924.00	53.60 PK	74.00	-20.40	1.18 V	250	17.54	36.06
6	4924.00	37.20 AV	54.00	-16.80	1.18 V	250	1.14	36.06
7	7386.00	52.60 PK	74.00	-21.40	1.25 V	83	10.59	42.01
8	7386.00	39.50 AV	54.00	-14.50	1.25 V	83	-2.51	42.01

- REMARKS:**
1. Emission level (dBuV/m) = Raw Value (dBuV) + Correction Factor (dB/m).
 2. Correction Factor (dB/m) = Antenna Factor (dB/m) + Cable Factor (dB).
 3. The other emission levels were very low against the limit.
 4. Margin value = Emission level – Limit value.
 5. “ * “: Fundamental frequency.

RESTRICTED BANDEDGE (802.11g MODE, CH1, HORIZONTAL)

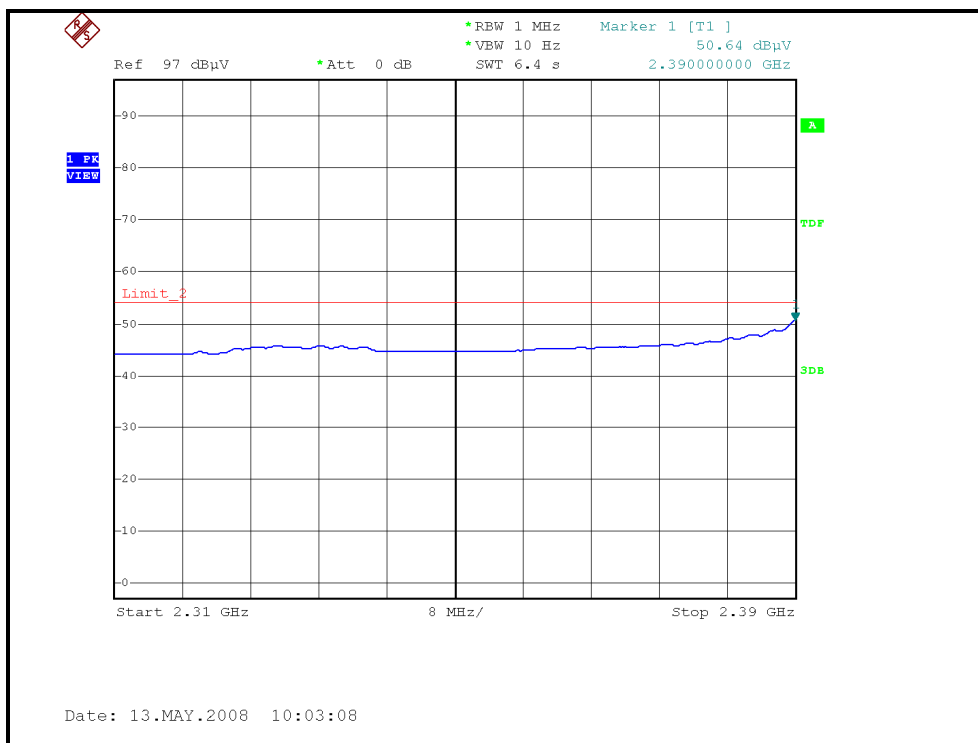
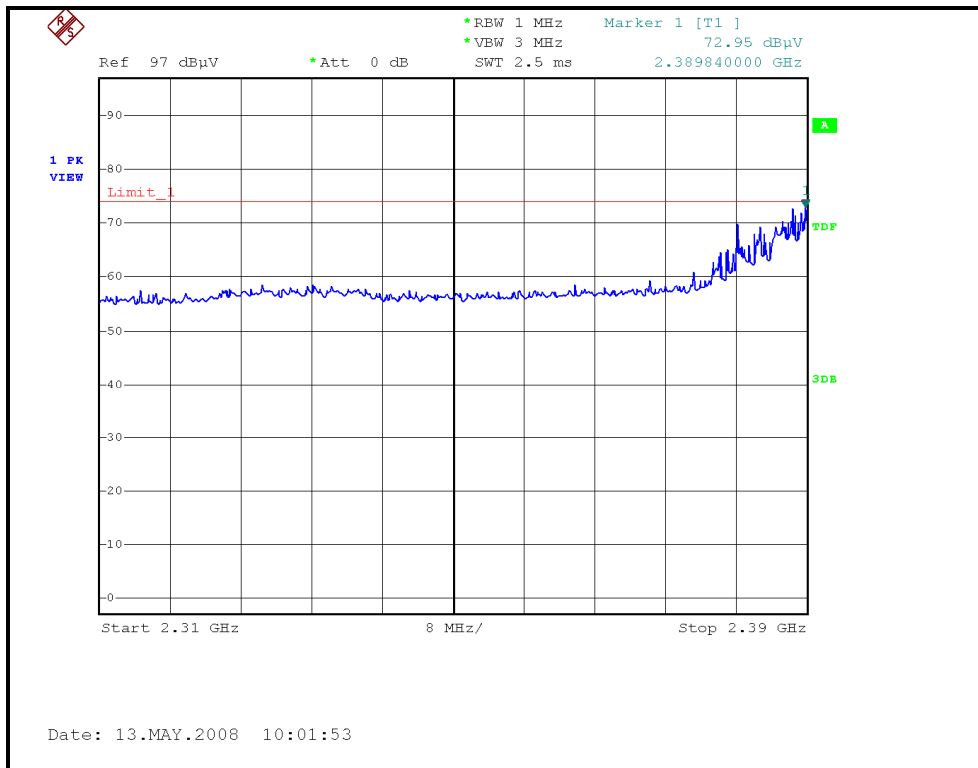

RESTRICTED BANDEDGE (802.11g MODE, CH1, VERTICAL)

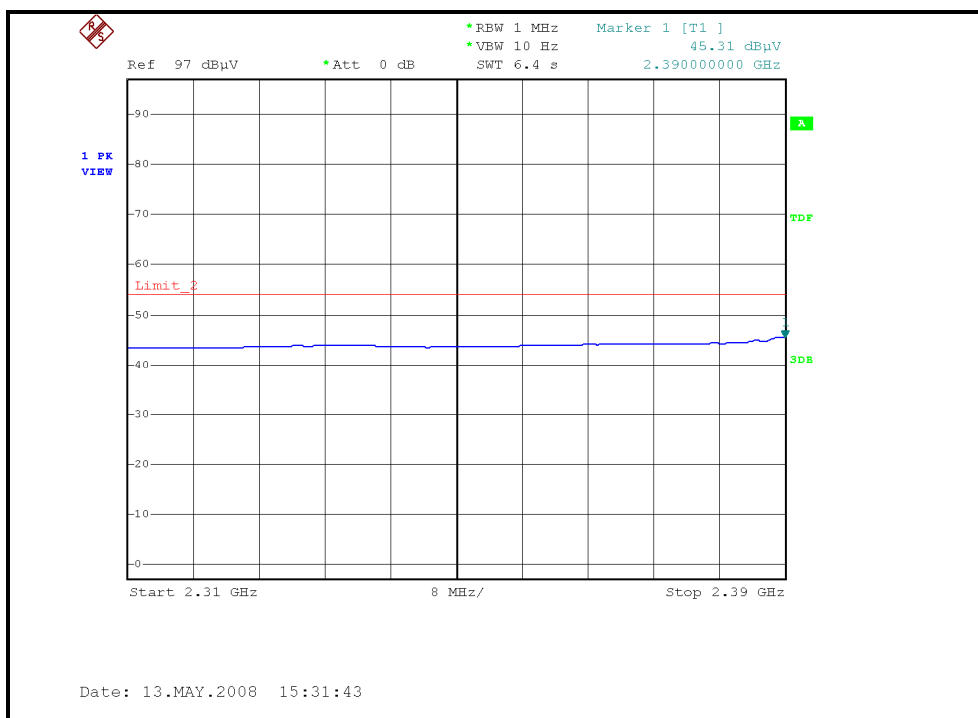
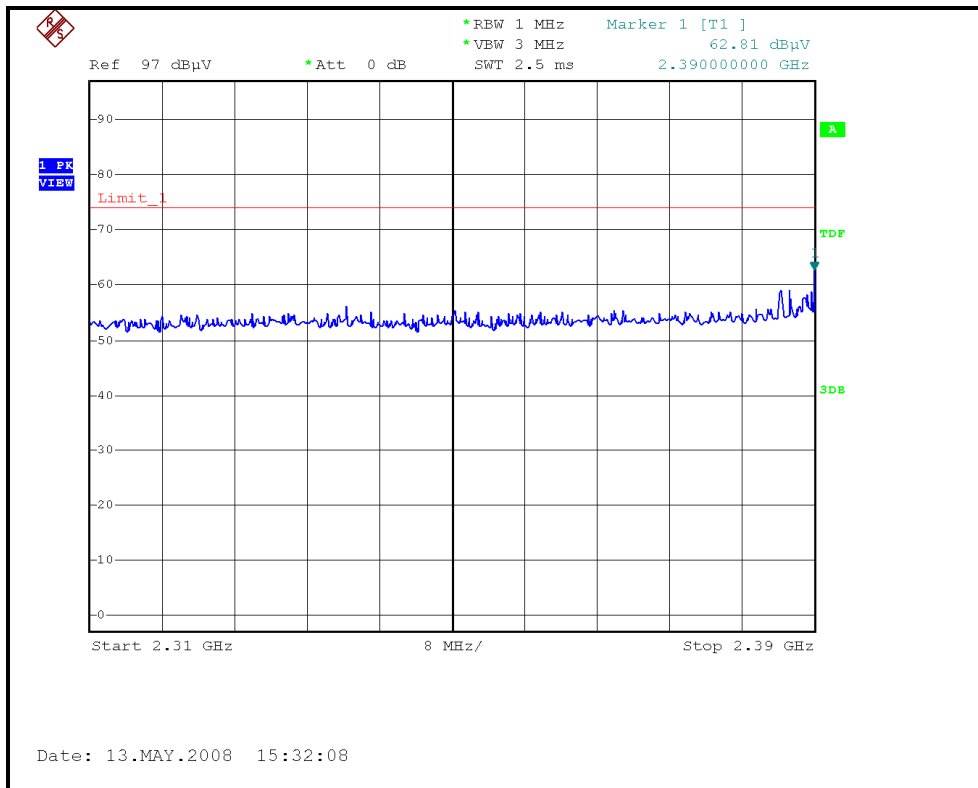

RESTRICTED BANDEDGE (802.11g MODE,CH11, VERTICAL)

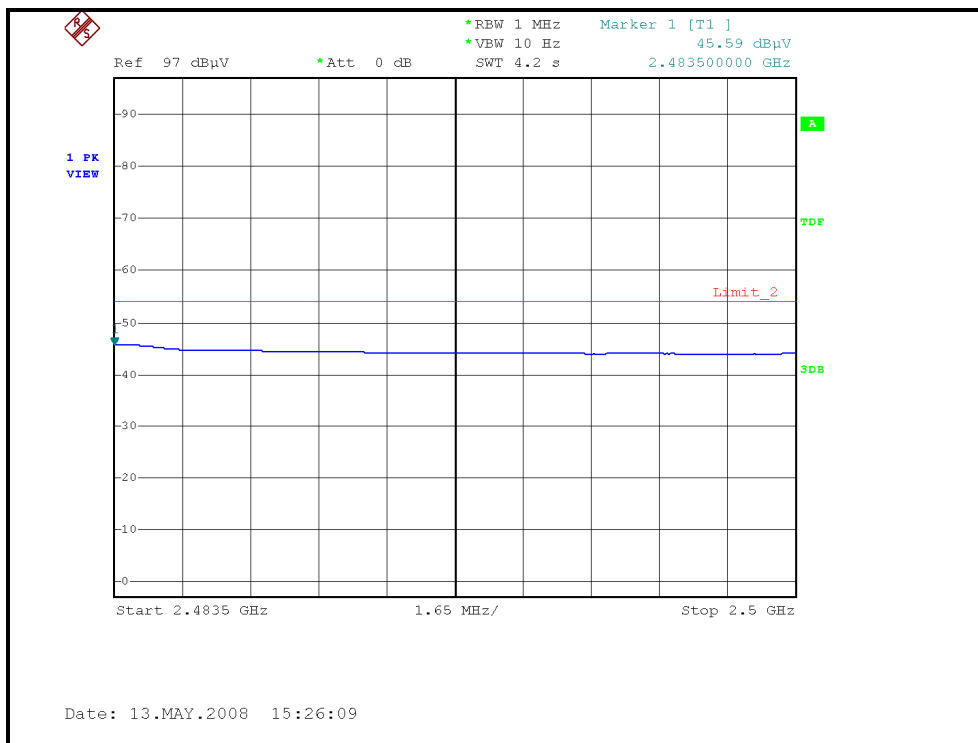
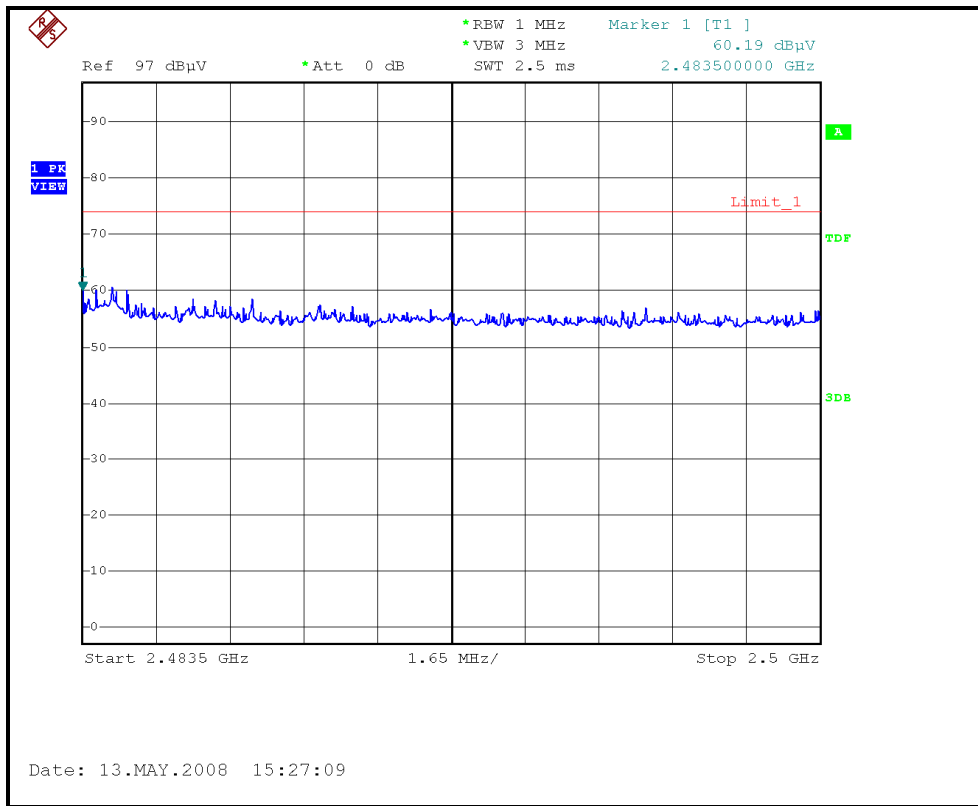

DRAFT 802.11n (20MHz) OFDM MODULATION

EUT TEST CONDITION		MEASUREMENT DETAIL	
CHANNEL	Channel 1	FREQUENCY RANGE	1 ~ 25GHz
INPUT POWER	120Vac, 60 Hz	DETECTOR FUNCTION	Peak (PK) Average (AV)
ENVIRONMENTAL CONDITIONS	25deg. C, 75%RH 965hPa	TESTED BY	Sky Liao

ANTENNA POLARITY & TEST DISTANCE: HORIZONTAL AT 3 M								
NO.	FREQ. (MHz)	EMISSION LEVEL (dBuV/m)	LIMIT (dBuV/m)	MARGIN (dB)	ANTENNA HEIGHT (m)	TABLE ANGLE (Degree)	RAW VALUE (dBuV)	CORRECTION FACTOR (dB/m)
1	2390.00	72.88 PK	74.00	-1.12	1.44 H	70	42.56	30.32
2	2390.00	51.96 AV	54.00	-2.04	1.44 H	70	21.64	30.32
3	*2412.00	114.90 PK			1.42 H	70	84.49	30.41
4	*2412.00	101.40 AV			1.42 H	70	70.99	30.41
5	4824.00	51.40 PK	74.00	-22.60	1.48 H	104	15.61	35.79
6	4824.00	37.20 AV	54.00	-16.80	1.48 H	104	1.41	35.79
7	7236.00	53.40 PK	94.90	-41.50	1.35 H	225	11.80	41.60
8	7236.00	40.40 AV	81.40	-41.00	1.35 H	225	-1.20	41.60
ANTENNA POLARITY & TEST DISTANCE: VERTICAL AT 3 M								
NO.	FREQ. (MHz)	EMISSION LEVEL (dBuV/m)	LIMIT (dBuV/m)	MARGIN (dB)	ANTENNA HEIGHT (m)	TABLE ANGLE (Degree)	RAW VALUE (dBuV)	CORRECTION FACTOR (dB/m)
1	2390.00	62.90 PK	74.00	-11.10	1.00 V	208	32.58	30.32
2	2390.00	46.17 AV	54.00	-7.83	1.00 V	208	15.85	30.32
3	*2412.00	106.30 PK			1.00 V	208	75.89	30.41
4	*2412.00	93.50 AV			1.00 V	208	63.09	30.41
5	4824.00	53.60 PK	74.00	-20.40	1.05 V	155	17.81	35.79
6	4824.00	37.40 AV	54.00	-16.60	1.05 V	155	1.61	35.79
7	7236.00	53.20 PK	86.30	-33.10	1.22 V	72	11.60	41.60
8	7236.00	39.80 AV	73.50	-33.70	1.22 V	72	-1.80	41.60

- REMARKS:**
1. Emission level (dBuV/m) = Raw Value (dBuV) + Correction Factor (dB/m).
 2. Correction Factor (dB/m) = Antenna Factor (dB/m) + Cable Factor (dB).
 3. The other emission levels were very low against the limit.
 4. Margin value = Emission level – Limit value.
 5. “ * “: Fundamental frequency.

EUT TEST CONDITION		MEASUREMENT DETAIL	
CHANNEL	Channel 6	FREQUENCY RANGE	1 ~ 25GHz
INPUT POWER	120Vac, 60 Hz	DETECTOR FUNCTION	Peak (PK) Average (AV)
ENVIRONMENTAL CONDITIONS	25deg. C, 75%RH 965hPa	TESTED BY	Sky Liao

ANTENNA POLARITY & TEST DISTANCE: HORIZONTAL AT 3 M								
NO.	FREQ. (MHz)	EMISSION LEVEL (dBuV/m)	LIMIT (dBuV/m)	MARGIN (dB)	ANTENNA HEIGHT (m)	TABLE ANGLE (Degree)	RAW VALUE (dBuV)	CORRECTION FACTOR (dB/m)
1	*2437.00	115.00 PK			1.42 H	70	84.48	30.52
2	*2437.00	101.60 AV			1.42 H	70	71.08	30.52
3	4874.00	51.20 PK	74.00	-22.80	1.50 H	115	15.28	35.92
4	4874.00	37.20 AV	54.00	-16.80	1.50 H	115	1.28	35.92
5	7311.00	53.60 PK	74.00	-20.40	1.33 H	212	11.79	41.81
6	7311.00	40.50 AV	54.00	-13.50	1.33 H	212	-1.31	41.81
ANTENNA POLARITY & TEST DISTANCE: VERTICAL AT 3 M								
NO.	FREQ. (MHz)	EMISSION LEVEL (dBuV/m)	LIMIT (dBuV/m)	MARGIN (dB)	ANTENNA HEIGHT (m)	TABLE ANGLE (Degree)	RAW VALUE (dBuV)	CORRECTION FACTOR (dB/m)
1	*2437.00	106.80 PK			1.00 V	2	76.28	30.52
2	*2437.00	93.80 AV			1.00 V	2	63.28	30.52
3	4874.00	54.00 PK	74.00	-20.00	1.10 V	165	18.08	35.92
4	4874.00	37.60 AV	54.00	-16.40	1.10 V	165	1.68	35.92
5	7311.00	53.30 PK	74.00	-20.70	1.38 V	85	11.49	41.81
6	7311.00	39.80 AV	54.00	-14.20	1.38 V	85	-2.01	41.81

- REMARKS:**
1. Emission level (dBuV/m) = Raw Value (dBuV) + Correction Factor (dB/m).
 2. Correction Factor (dB/m) = Antenna Factor (dB/m) + Cable Factor (dB).
 3. The other emission levels were very low against the limit.
 4. Margin value = Emission level – Limit value.
 5. “ * “: Fundamental frequency.

EUT TEST CONDITION		MEASUREMENT DETAIL	
CHANNEL	Channel 11	FREQUENCY RANGE	1 ~ 25GHz
INPUT POWER	120Vac, 60 Hz	DETECTOR FUNCTION	Peak (PK) Average (AV)
ENVIRONMENTAL CONDITIONS	25deg. C, 75%RH 965hPa	TESTED BY	Sky Liao

ANTENNA POLARITY & TEST DISTANCE: HORIZONTAL AT 3 M								
NO.	FREQ. (MHz)	EMISSION LEVEL (dBuV/m)	LIMIT (dBuV/m)	MARGIN (dB)	ANTENNA HEIGHT (m)	TABLE ANGLE (Degree)	RAW VALUE (dBuV)	CORRECTION FACTOR (dB/m)
1	*2462.00	114.50 PK			1.44 H	68	83.87	30.63
2	*2462.00	101.00 AV			1.44 H	68	70.37	30.63
3	2483.50	72.68 PK	74.00	-1.32	1.42 H	230	41.96	30.72
4	2483.50	51.43 AV	54.00	-2.57	1.42 H	230	20.71	30.72
5	4924.00	50.80 PK	74.00	-23.20	1.52 H	108	14.74	36.06
6	4924.00	36.80 AV	54.00	-17.20	1.52 H	108	0.74	36.06
7	7386.00	53.00 PK	74.00	-21.00	1.36 H	242	10.99	42.01
8	7386.00	40.20 AV	54.00	-13.80	1.36 H	242	-1.81	42.01
ANTENNA POLARITY & TEST DISTANCE: VERTICAL AT 3 M								
NO.	FREQ. (MHz)	EMISSION LEVEL (dBuV/m)	LIMIT (dBuV/m)	MARGIN (dB)	ANTENNA HEIGHT (m)	TABLE ANGLE (Degree)	RAW VALUE (dBuV)	CORRECTION FACTOR (dB/m)
1	*2462.00	105.50 PK			1.00 V	2	74.87	30.63
2	*2462.00	92.40 AV			1.00 V	2	61.77	30.63
3	2483.50	62.67 PK	74.00	-11.33	1.00 V	2	31.95	30.72
4	2483.50	45.67 AV	54.00	-8.33	1.00 V	2	14.95	30.72
5	4924.00	53.20 PK	74.00	-20.80	1.06 V	170	17.14	36.06
6	4924.00	37.00 AV	54.00	-17.00	1.06 V	170	0.94	36.06
7	7386.00	52.60 PK	74.00	-21.40	1.32 V	92	10.59	42.01
8	7386.00	39.20 AV	54.00	-14.80	1.32 V	92	-2.81	42.01

- REMARKS:**
1. Emission level (dBuV/m) = Raw Value (dBuV) + Correction Factor (dB/m).
 2. Correction Factor (dB/m) = Antenna Factor (dB/m) + Cable Factor (dB).
 3. The other emission levels were very low against the limit.
 4. Margin value = Emission level – Limit value.
 5. “ * “: Fundamental frequency.

RESTRICTED BANDEDGE (DRAFT 802.11n (20MHz) MODE,CH1, HORIZONTAL)

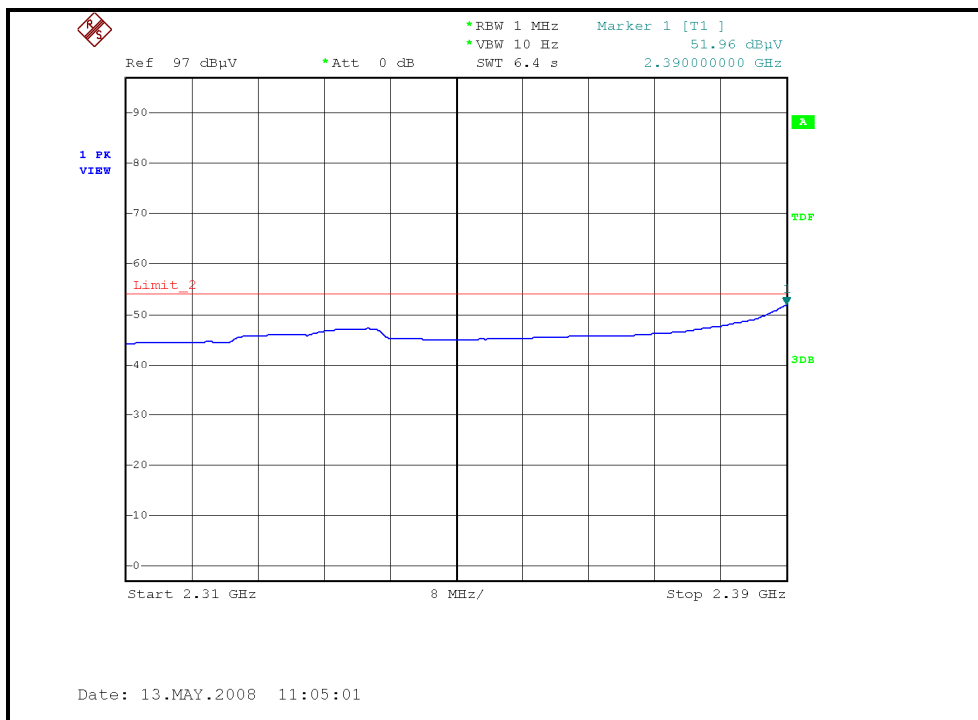
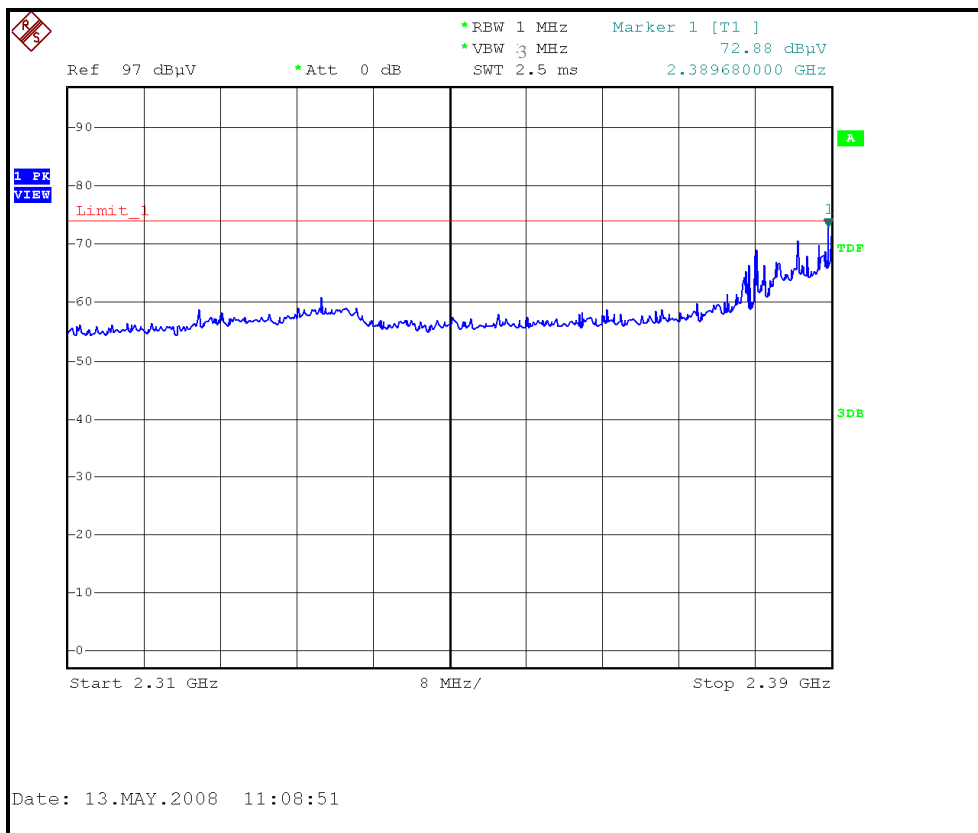

RESTRICTED BANDEDGE (DRAFT 802.11n (20MHz) MODE,CH1, VERTICAL)

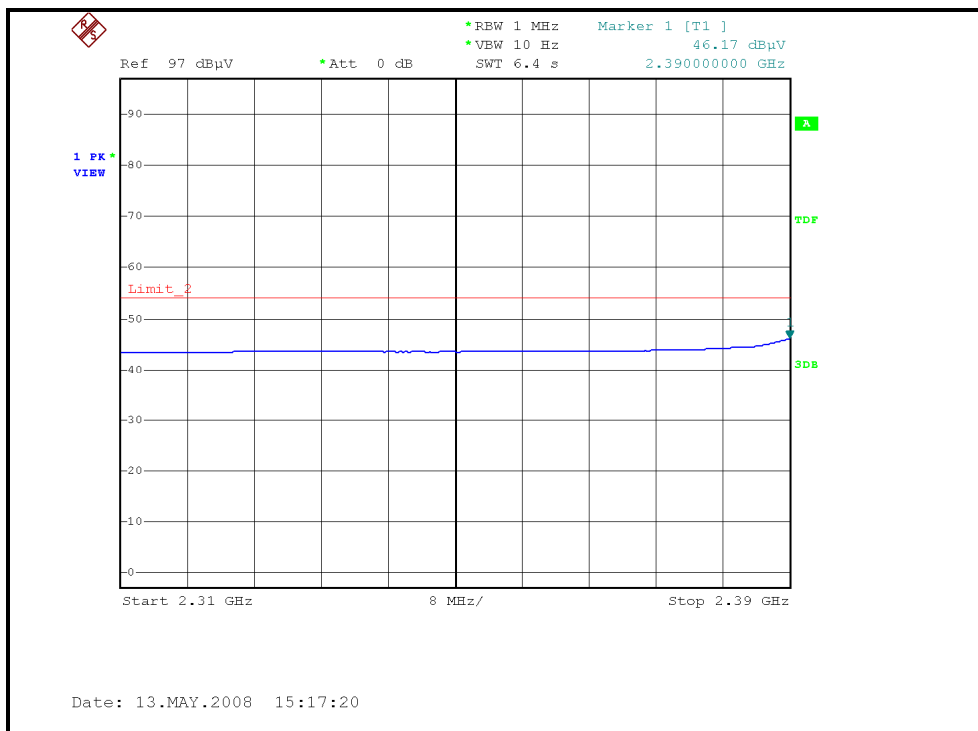
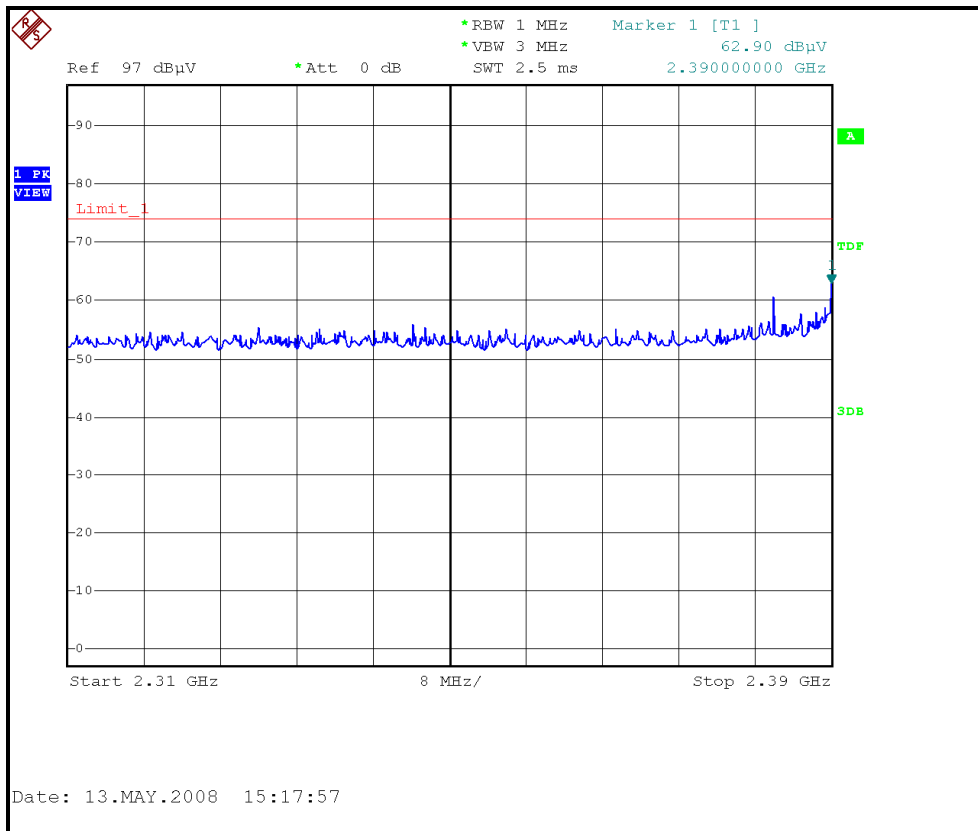

RESTRICTED BANDEDGE (DRAFT 802.11n (20MHz) MODE, CH11, HORIZONTAL)

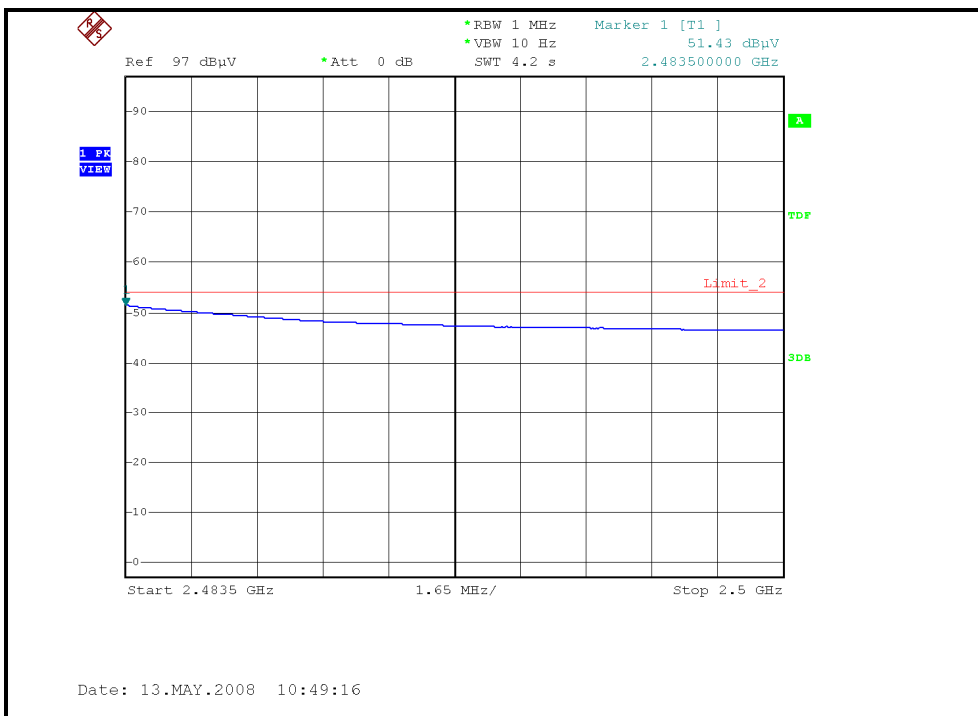
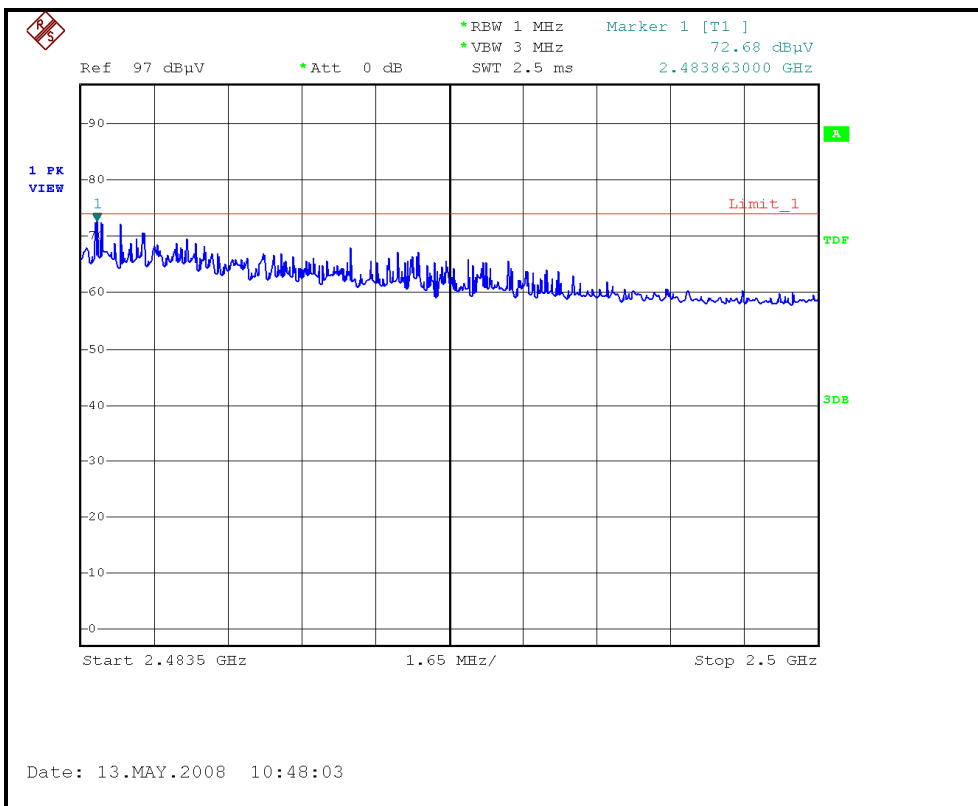



RESTRICTED BANDEDGE (DRAFT 802.11n (20MHz) MODE,CH11, VERTICAL)

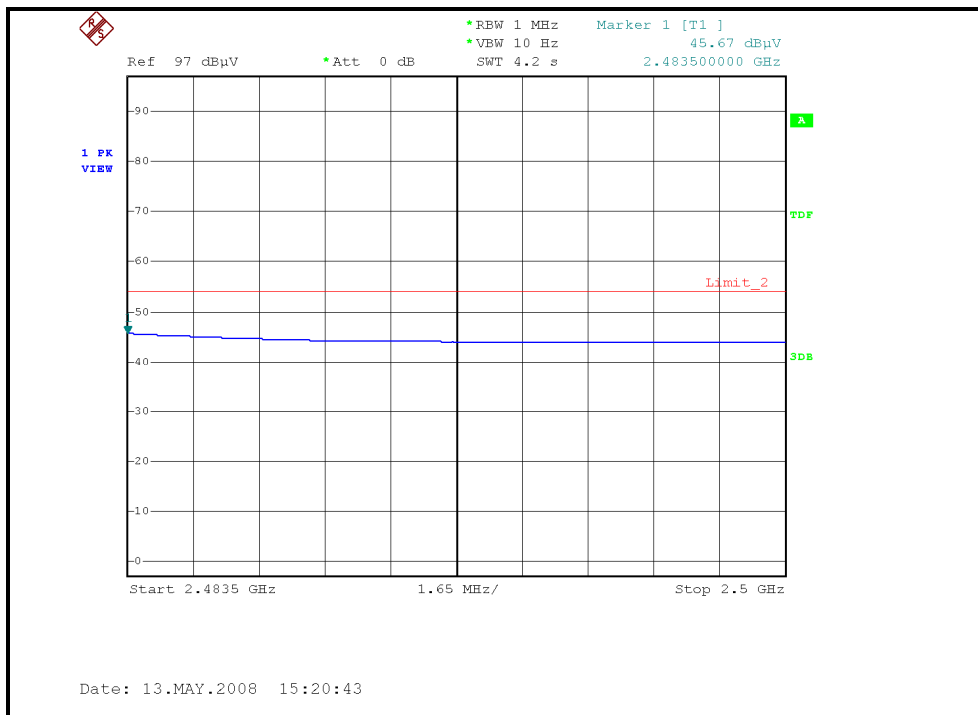
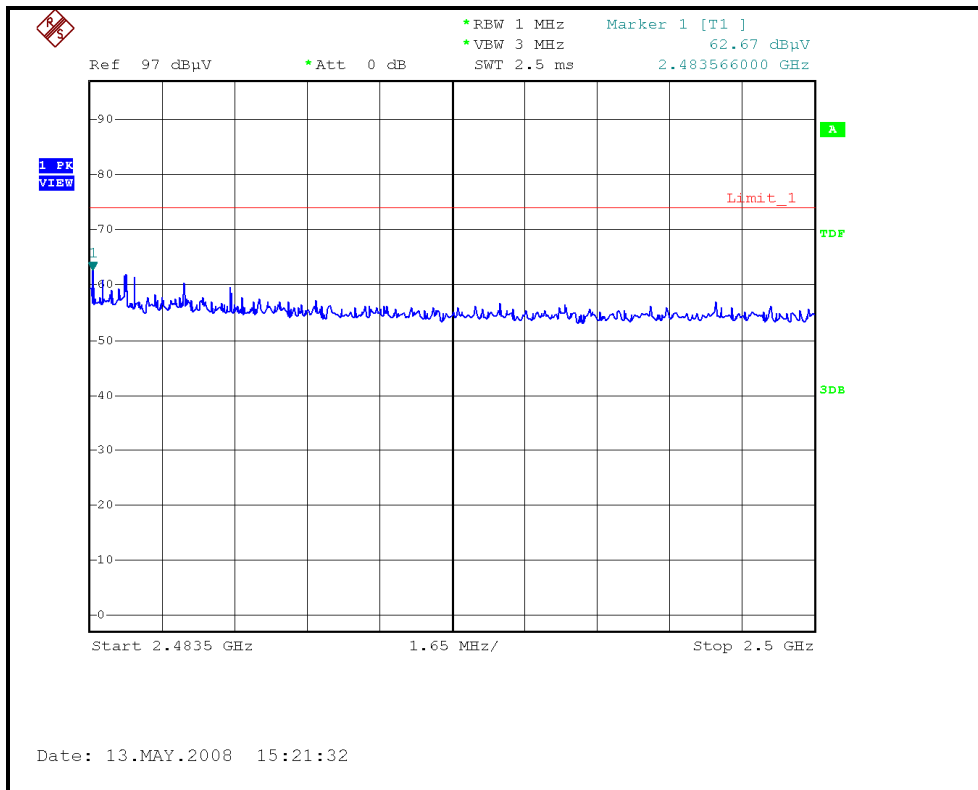

DRAFT 802.11n (40MHz) OFDM MODULATION

EUT TEST CONDITION		MEASUREMENT DETAIL	
CHANNEL	Channel 1	FREQUENCY RANGE	1 ~ 25GHz
INPUT POWER	120Vac, 60 Hz	DETECTOR FUNCTION	Peak (PK) Average (AV)
ENVIRONMENTAL CONDITIONS	25deg. C, 75%RH 965hPa	TESTED BY	Sky Liao

ANTENNA POLARITY & TEST DISTANCE: HORIZONTAL AT 3 M								
NO.	FREQ. (MHz)	EMISSION LEVEL (dBuV/m)	LIMIT (dBuV/m)	MARGIN (dB)	ANTENNA HEIGHT (m)	TABLE ANGLE (Degree)	RAW VALUE (dBuV)	CORRECTION FACTOR (dB/m)
1	2390.00	66.96 PK	74.00	-7.04	1.42 H	72	36.64	30.32
2	2390.00	52.57 AV	54.00	-1.43	1.42 H	72	22.25	30.32
3	*2422.00	111.10 PK			1.44 H	70	80.65	30.45
4	*2422.00	97.30 AV			1.44 H	70	66.85	30.45
5	4844.00	51.20 PK	74.00	-22.80	1.66 H	125	15.36	35.84
6	4844.00	36.20 AV	54.00	-17.80	1.66 H	125	0.36	35.84
7	7266.00	53.20 PK	74.00	-20.80	1.33 H	115	11.52	41.68
8	7266.00	39.50 AV	54.00	-14.50	1.33 H	115	-2.18	41.68
ANTENNA POLARITY & TEST DISTANCE: VERTICAL AT 3 M								
NO.	FREQ. (MHz)	EMISSION LEVEL (dBuV/m)	LIMIT (dBuV/m)	MARGIN (dB)	ANTENNA HEIGHT (m)	TABLE ANGLE (Degree)	RAW VALUE (dBuV)	CORRECTION FACTOR (dB/m)
1	2390.00	59.42 PK	74.00	-14.58	1.00 V	0	29.10	30.32
2	2390.00	46.79 AV	54.00	-7.21	1.00 V	0	16.47	30.32
3	*2422.00	102.50 PK			1.00 V	0	72.05	30.45
4	*2422.00	89.90 AV			1.00 V	0	59.45	30.45
5	4844.00	49.20 PK	74.00	-24.80	1.14 V	212	13.36	35.84
6	4844.00	35.00 AV	54.00	-19.00	1.14 V	212	-0.84	35.84
7	7266.00	52.00 PK	74.00	-22.00	1.05 V	36	10.32	41.68
8	7266.00	39.20 AV	54.00	-14.80	1.05 V	36	-2.48	41.68

- REMARKS:**
1. Emission level (dBuV/m) = Raw Value (dBuV) + Correction Factor (dB/m).
 2. Correction Factor (dB/m) = Antenna Factor (dB/m) + Cable Factor (dB).
 3. The other emission levels were very low against the limit.
 4. Margin value = Emission level – Limit value.
 5. “ * “: Fundamental frequency.

EUT TEST CONDITION		MEASUREMENT DETAIL	
CHANNEL	Channel 4	FREQUENCY RANGE	1 ~ 25GHz
INPUT POWER	120Vac, 60 Hz	DETECTOR FUNCTION	Peak (PK) Average (AV)
ENVIRONMENTAL CONDITIONS	25deg. C, 75%RH 965hPa	TESTED BY	Sky Liao

ANTENNA POLARITY & TEST DISTANCE: HORIZONTAL AT 3 M								
NO.	FREQ. (MHz)	EMISSION LEVEL (dBuV/m)	LIMIT (dBuV/m)	MARGIN (dB)	ANTENNA HEIGHT (m)	TABLE ANGLE (Degree)	RAW VALUE (dBuV)	CORRECTION FACTOR (dB/m)
1	*2437.00	112.70 PK			1.44 H	70	82.18	30.52
2	*2437.00	99.10 AV			1.44 H	70	68.58	30.52
3	4874.00	51.80 PK	74.00	-22.20	1.75 H	110	15.88	35.92
4	4874.00	36.90 AV	54.00	-17.10	1.75 H	110	0.98	35.92
5	7311.00	53.60 PK	74.00	-20.40	1.30 H	110	11.79	41.81
6	7311.00	39.80 AV	54.00	-14.20	1.30 H	110	-2.01	41.81
ANTENNA POLARITY & TEST DISTANCE: VERTICAL AT 3 M								
NO.	FREQ. (MHz)	EMISSION LEVEL (dBuV/m)	LIMIT (dBuV/m)	MARGIN (dB)	ANTENNA HEIGHT (m)	TABLE ANGLE (Degree)	RAW VALUE (dBuV)	CORRECTION FACTOR (dB/m)
1	*2437.00	104.80 PK			1.00 V	2	74.28	30.52
2	*2437.00	91.20 AV			1.00 V	2	60.68	30.52
3	4874.00	49.90 PK	74.00	-24.10	1.16 V	202	13.98	35.92
4	4874.00	35.80 AV	54.00	-18.20	1.16 V	202	-0.12	35.92
5	7311.00	52.80 PK	74.00	-21.20	1.07 V	20	10.99	41.81
6	7311.00	39.50 AV	54.00	-14.50	1.07 V	20	-2.31	41.81

- REMARKS:**
1. Emission level (dBuV/m) = Raw Value (dBuV) + Correction Factor (dB/m).
 2. Correction Factor (dB/m) = Antenna Factor (dB/m) + Cable Factor (dB).
 3. The other emission levels were very low against the limit.
 4. Margin value = Emission level – Limit value.
 5. “ * “: Fundamental frequency.

EUT TEST CONDITION		MEASUREMENT DETAIL	
CHANNEL	Channel 7	FREQUENCY RANGE	1 ~ 25GHz
INPUT POWER	120Vac, 60 Hz	DETECTOR FUNCTION	Peak (PK) Average (AV)
ENVIRONMENTAL CONDITIONS	25deg. C, 75%RH 965hPa	TESTED BY	Sky Liao

ANTENNA POLARITY & TEST DISTANCE: HORIZONTAL AT 3 M								
NO.	FREQ. (MHz)	EMISSION LEVEL (dBuV/m)	LIMIT (dBuV/m)	MARGIN (dB)	ANTENNA HEIGHT (m)	TABLE ANGLE (Degree)	RAW VALUE (dBuV)	CORRECTION FACTOR (dB/m)
1	*2452.00	111.00 PK			1.42 H	70	80.42	30.58
2	*2452.00	97.40 AV			1.42 H	70	66.82	30.58
3	2483.50	68.90 PK	74.00	-5.10	1.42 H	70	38.18	30.72
4	2483.50	52.29 AV	54.00	-1.71	1.42 H	70	21.57	30.72
5	4904.00	51.20 PK	74.00	-22.80	1.65 H	115	15.20	36.00
6	4904.00	36.20 AV	54.00	-17.80	1.65 H	115	0.20	36.00
7	7356.00	53.00 PK	74.00	-21.00	1.33 H	120	11.07	41.93
8	7356.00	39.20 AV	54.00	-14.80	1.33 H	120	-2.73	41.93
ANTENNA POLARITY & TEST DISTANCE: VERTICAL AT 3 M								
NO.	FREQ. (MHz)	EMISSION LEVEL (dBuV/m)	LIMIT (dBuV/m)	MARGIN (dB)	ANTENNA HEIGHT (m)	TABLE ANGLE (Degree)	RAW VALUE (dBuV)	CORRECTION FACTOR (dB/m)
1	*2452.00	102.50 PK			1.00 V	0	71.92	30.58
2	*2452.00	89.80 AV			1.00 V	0	59.22	30.58
3	2483.50	60.58 PK	74.00	-13.42	1.00 V	0	29.86	30.72
4	2483.50	47.61 AV	54.00	-6.39	1.00 V	0	16.89	30.72
5	4904.00	49.00 PK	74.00	-25.00	1.06 V	208	13.00	36.00
6	4904.00	35.20 AV	54.00	-18.80	1.06 V	208	-0.80	36.00
7	7356.00	52.40 PK	74.00	-21.60	1.17 V	25	10.47	41.93
8	7356.00	39.20 AV	54.00	-14.80	1.17 V	25	-2.73	41.93

- REMARKS:**
1. Emission level (dBuV/m) = Raw Value (dBuV) + Correction Factor (dB/m).
 2. Correction Factor (dB/m) = Antenna Factor (dB/m) + Cable Factor (dB).
 3. The other emission levels were very low against the limit.
 4. Margin value = Emission level – Limit value.
 5. “ * “: Fundamental frequency.

RESTRICTED BANDEDGE (DRAFT 802.11n (40MHz) MODE,CH1, HORIZONTAL)

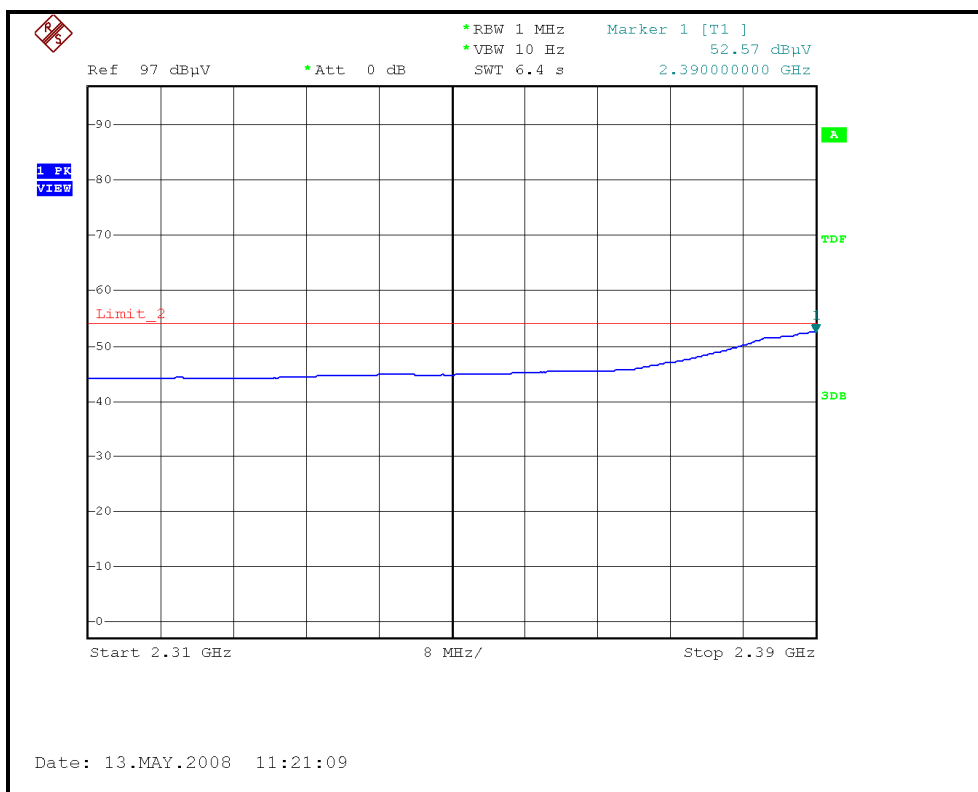
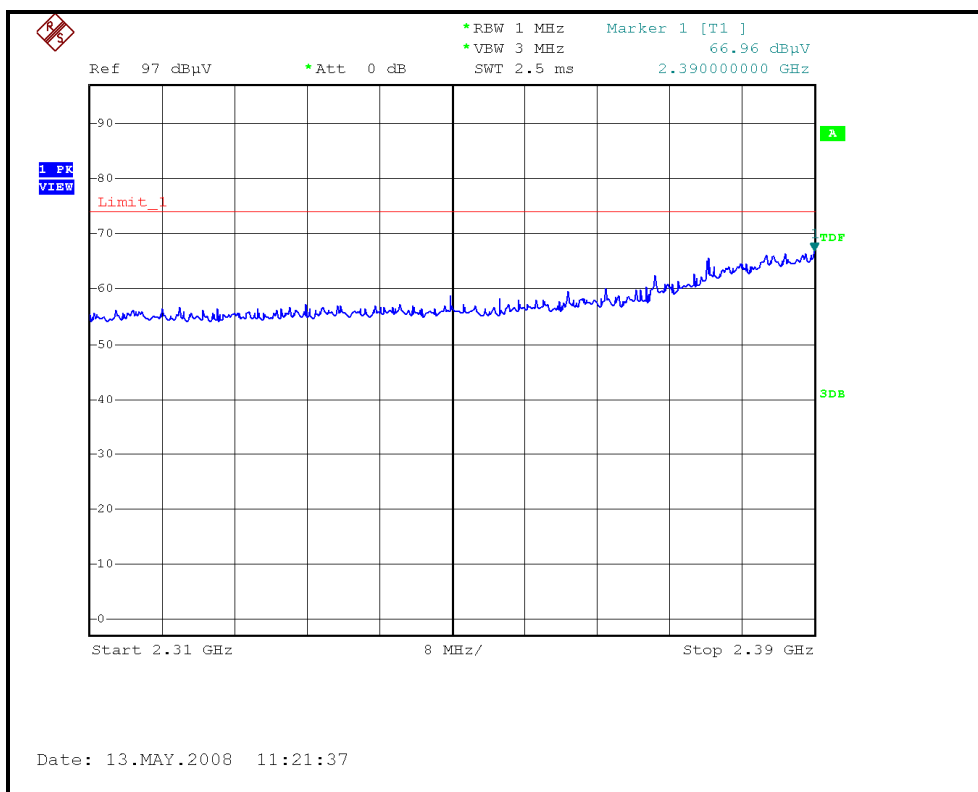

RESTRICTED BANDEDGE (DRAFT 802.11n (40MHz) MODE, CH1, VERTICAL)

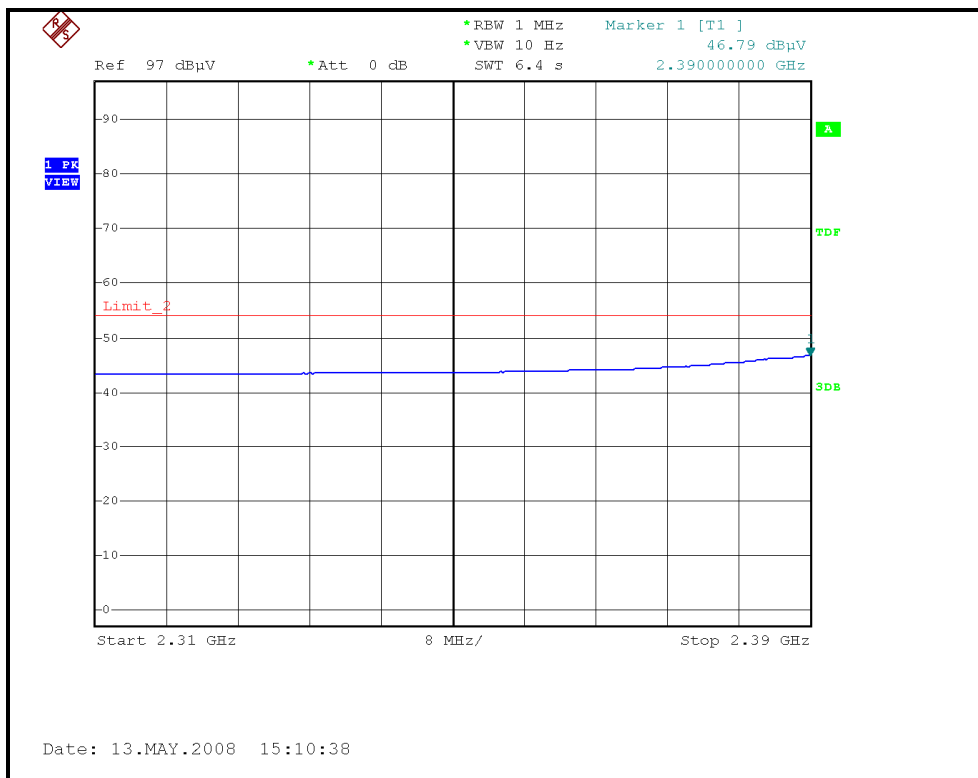
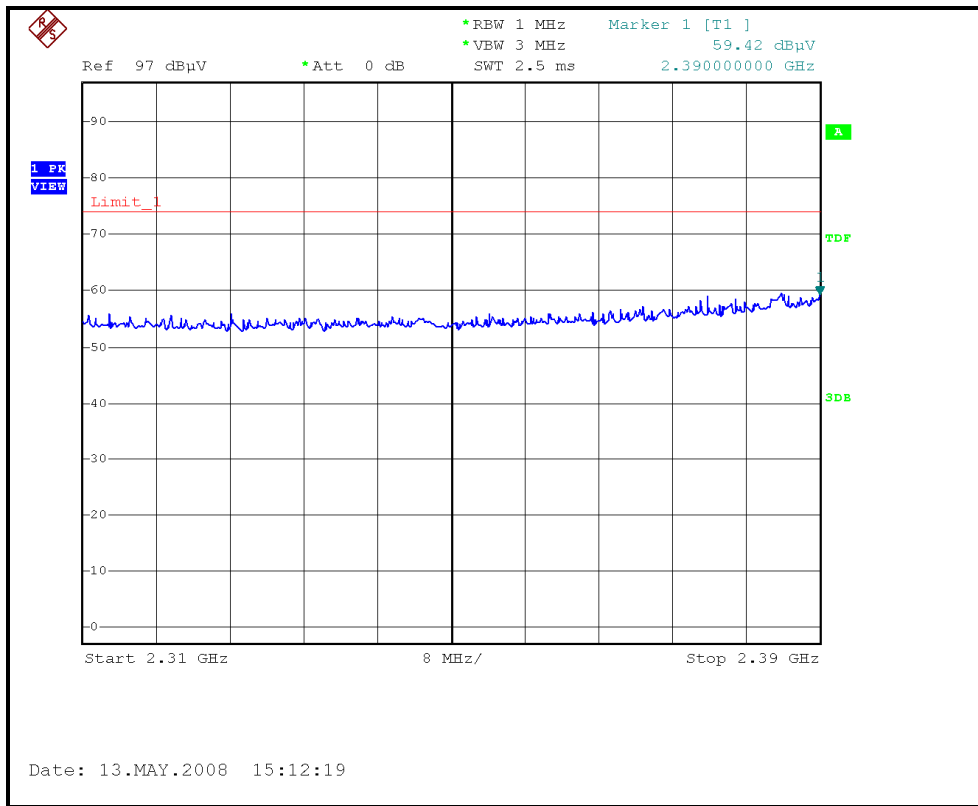

RESTRICTED BANDEDGE (DRAFT 802.11n (40MHz) MODE, CH7, HORIZONTAL)

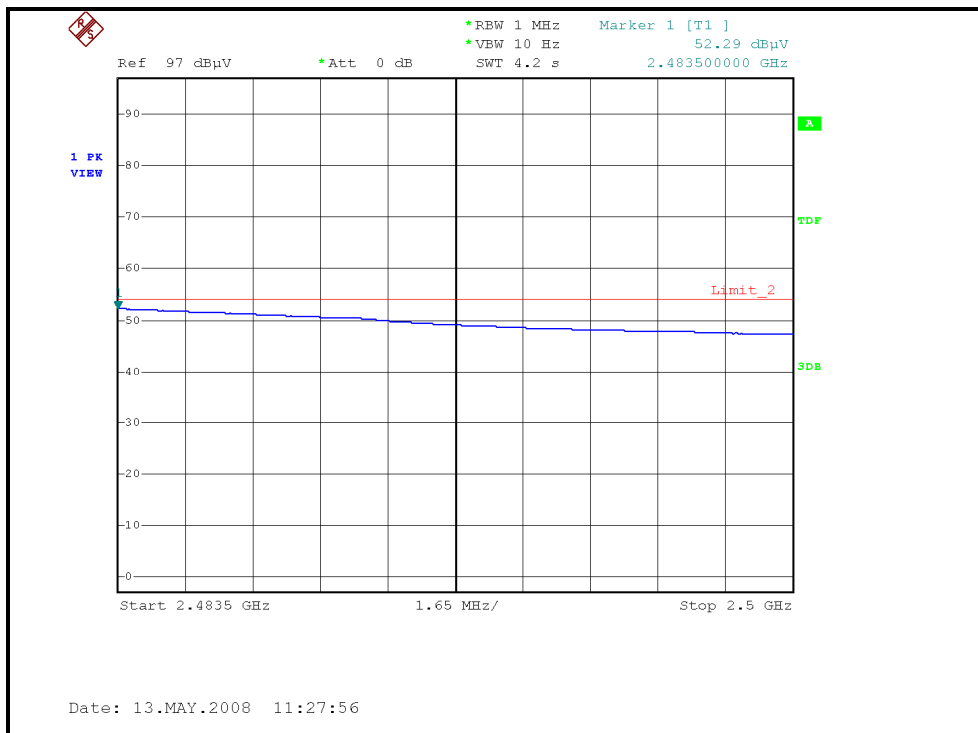
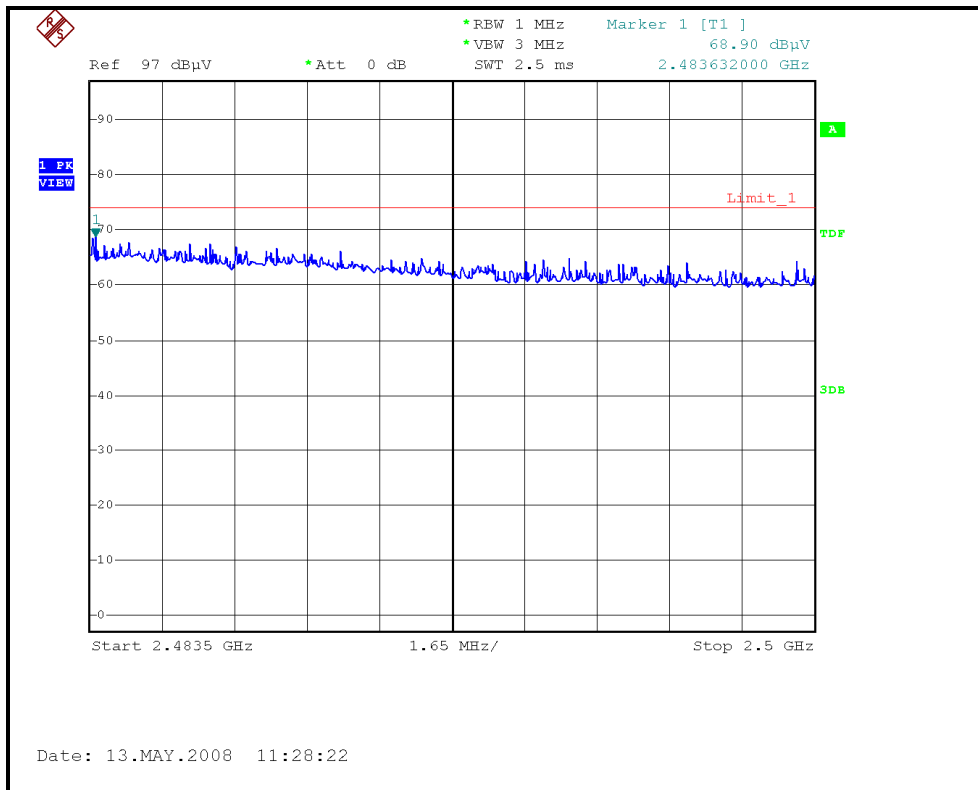

RESTRICTED BANDEDGE (DRAFT 802.11n (40MHz) MODE,CH7, VERTICAL)

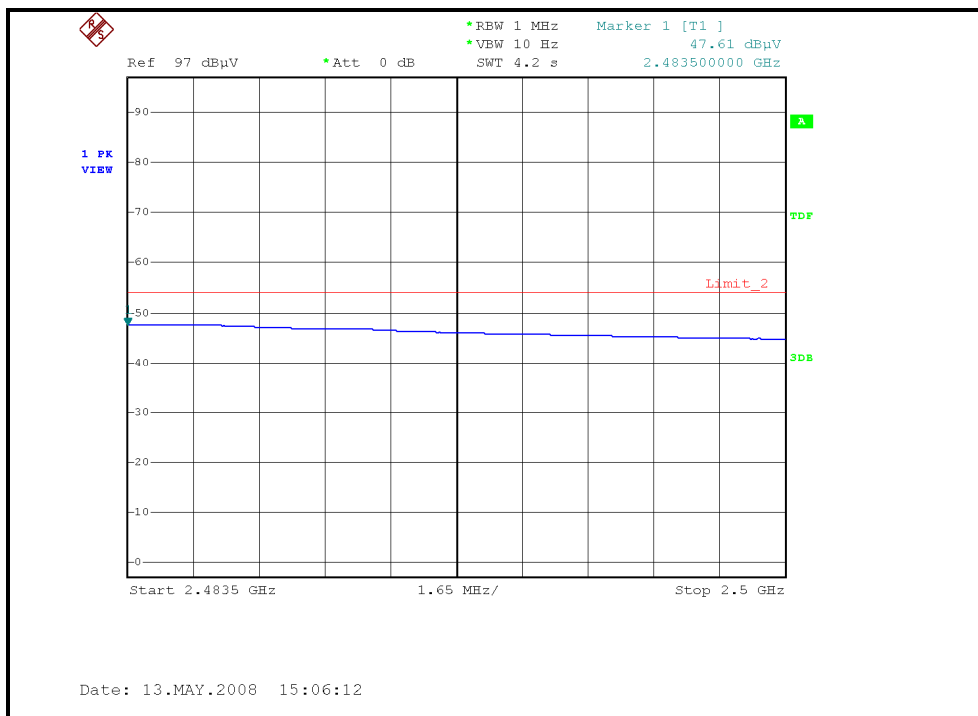
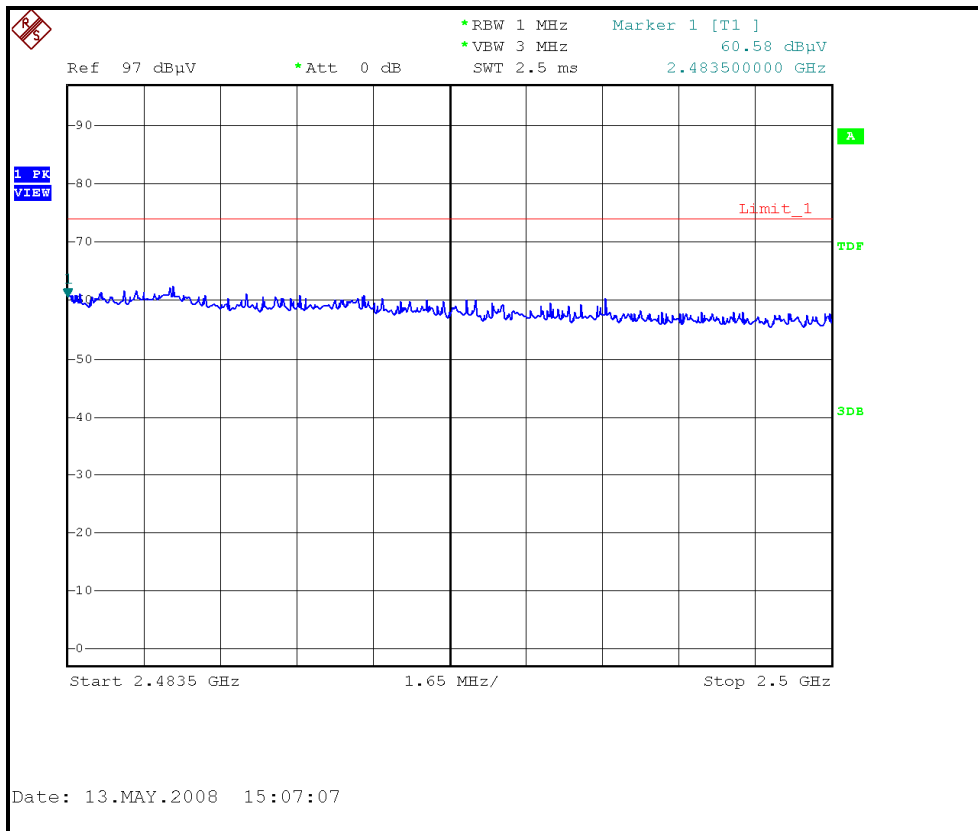



4.3 6dB BANDWIDTH MEASUREMENT

4.3.1 LIMITS OF 6dB BANDWIDTH MEASUREMENT

The minimum of 6dB Bandwidth Measurement is 0.5 MHz.

4.3.2 TEST INSTRUMENTS

Description & Manufacturer	Model No.	Serial No.	Calibrated Until
R&S SPECTRUM ANALYZER	FSP40	100037	Aug. 12, 2008

NOTE:

- 1.The measurement uncertainty is less than +/- 2.6dB, which is calculated as per the NAMAS document NIS81. This uncertainty represents an expanded uncertainty expressed at approximately the 95% confidence level using a coverage factor of k=2.
- 2.The calibration interval of the above test instruments is 12 months and the calibrations are traceable to NML/ROC and NIST/USA.

4.3.3 TEST PROCEDURE

The transmitter output was connected to the spectrum analyzer through an attenuator. The bandwidth of the fundamental frequency was measured by spectrum analyzer with 100kHz RBW and 100kHz VBW. The 6dB bandwidth is defined as the total spectrum the power of which is higher than peak power minus 6dB.

4.3.4 DEVIATION FROM TEST STANDARD

No deviation

4.3.5 TEST SETUP



4.3.6 EUT OPERATING CONDITIONS

The software provided by client to enable the EUT under transmission condition continuously at lowest, middle and highest channel frequencies individually.

4.3.7 TEST RESULTS

802.11b DSSS MODULATION:

MODULATION TYPE	DBPSK	TRANSFER RATE	1Mbps
INPUT POWER	120Vac, 60 Hz	ENVIRONMENTAL CONDITIONS	25deg.C, 60%RH, 971hPa
TESTED BY	Rex Huang		

CHANNEL	CHANNEL FREQUENCY (MHz)	6dB BANDWIDTH (MHz)	MINIMUM LIMIT (MHz)	PASS / FAIL
1	2412	10.71	0.5	PASS
6	2437	10.72	0.5	PASS
11	2462	11.48	0.5	PASS

CH1

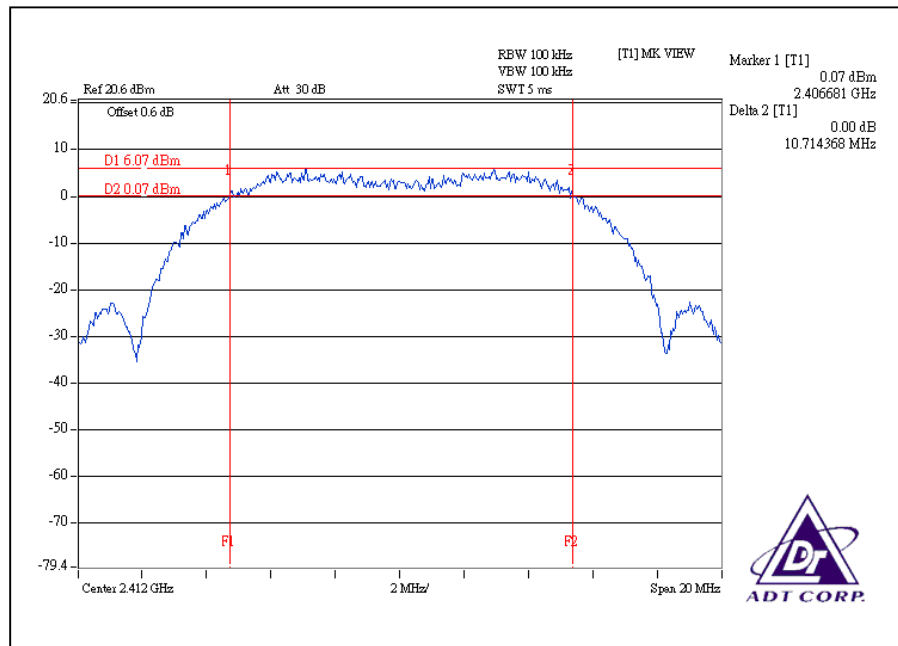

CH6

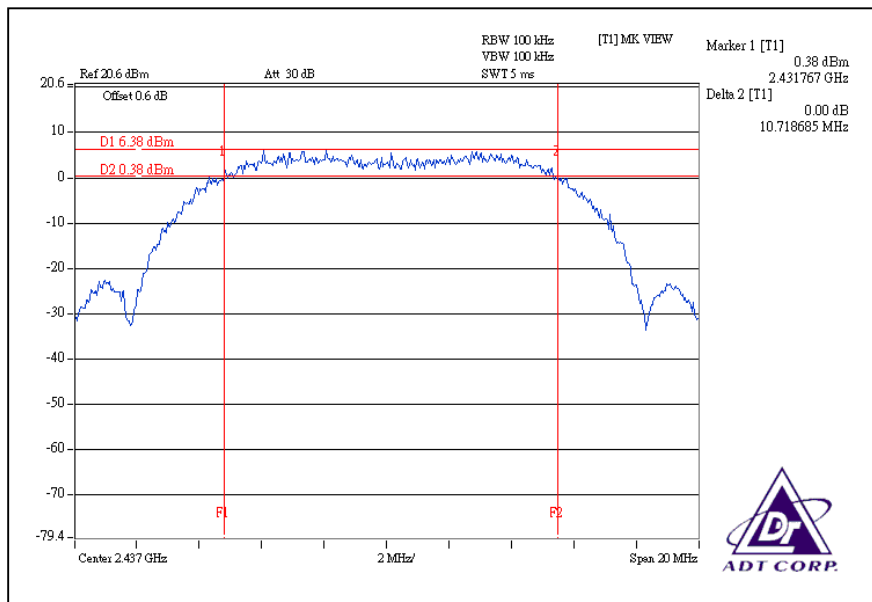

CH11

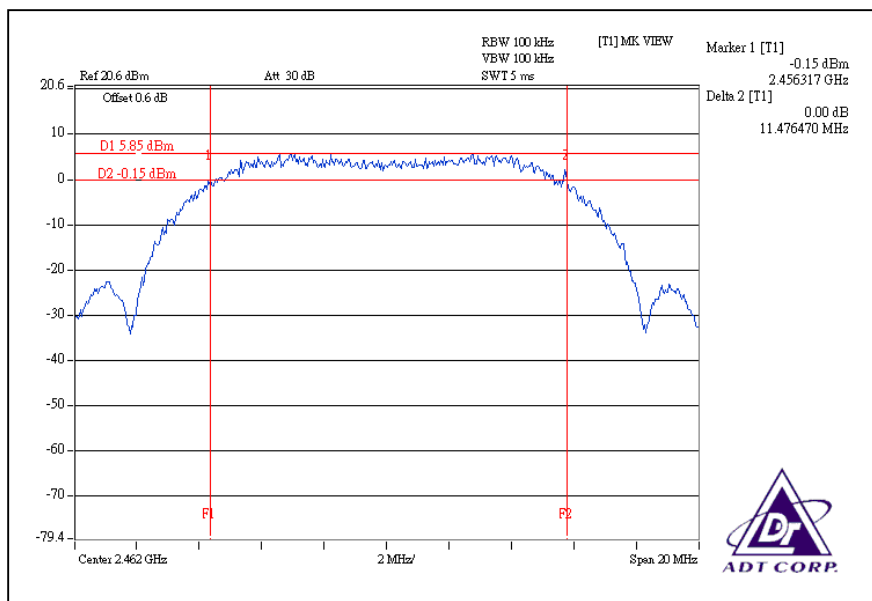

802.11g OFDM MODULATION:

MODULATION TYPE	BPSK	TRANSFER RATE	6Mbps
INPUT POWER	120Vac, 60 Hz	ENVIRONMENTAL CONDITIONS	25deg.C, 60%RH, 971hPa
TESTED BY	Rex Huang		

CHANNEL	CHANNEL FREQUENCY (MHz)	6dB BANDWIDTH (MHz)		MINIMUM LIMIT (MHz)	PASS / FAIL
		CHAIN(0)	CHAIN(1)		
1	2412	16.43	16.44	0.5	PASS
6	2437	16.46	16.49	0.5	PASS
11	2462	16.42	16.45	0.5	PASS

For Chain(0): CH1

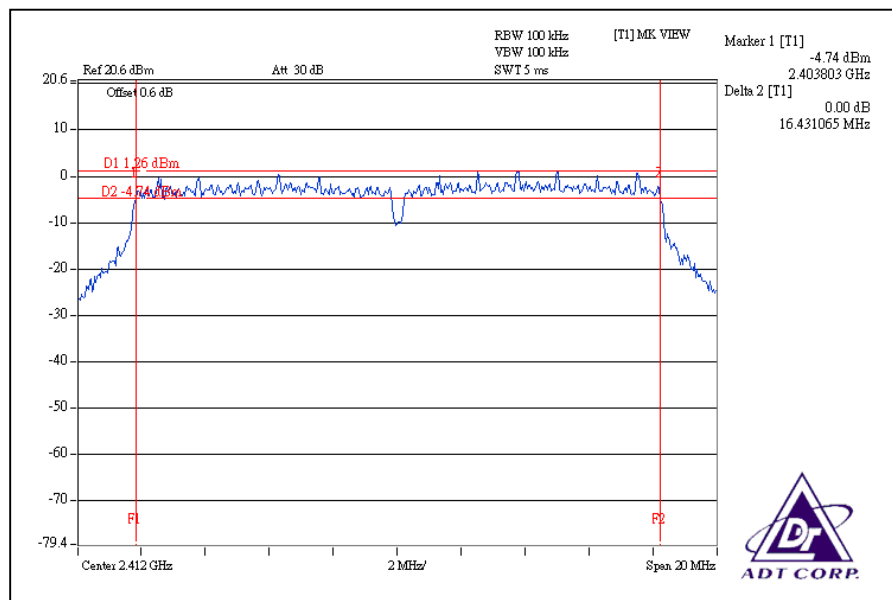

CH6

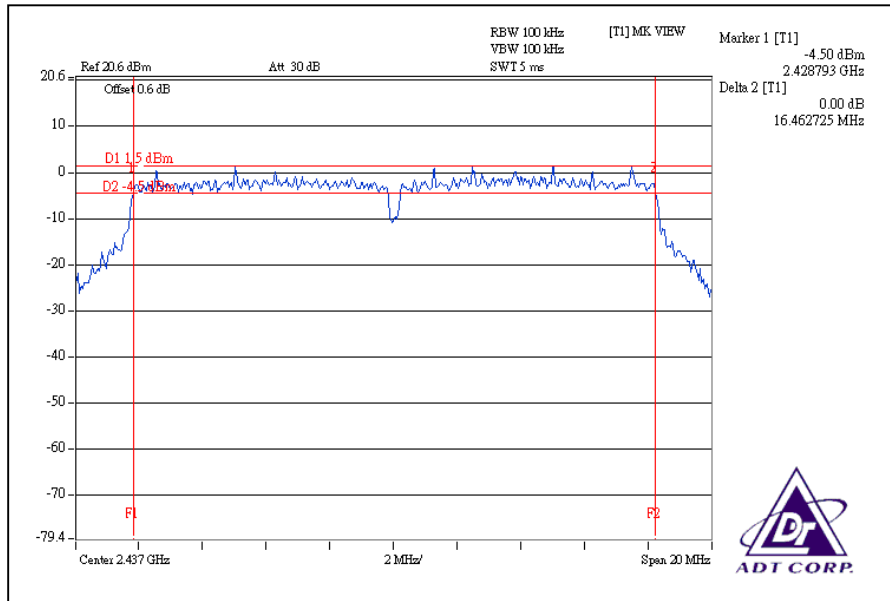

CH11

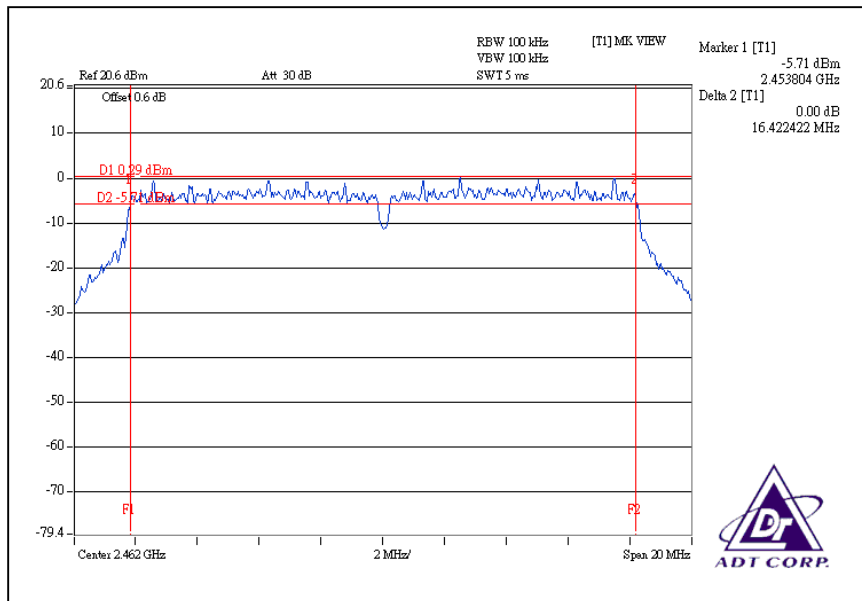

For CHAIN(1): CH1

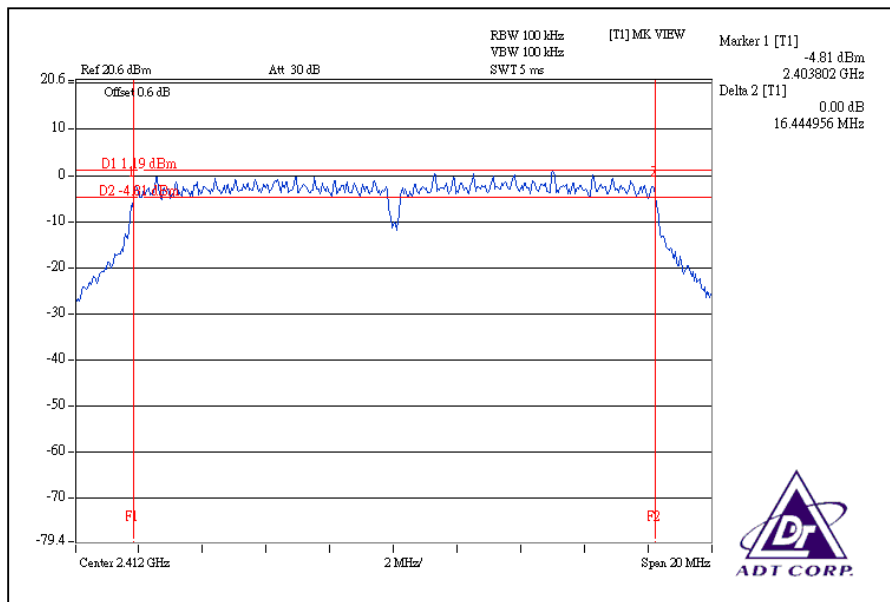

CH6

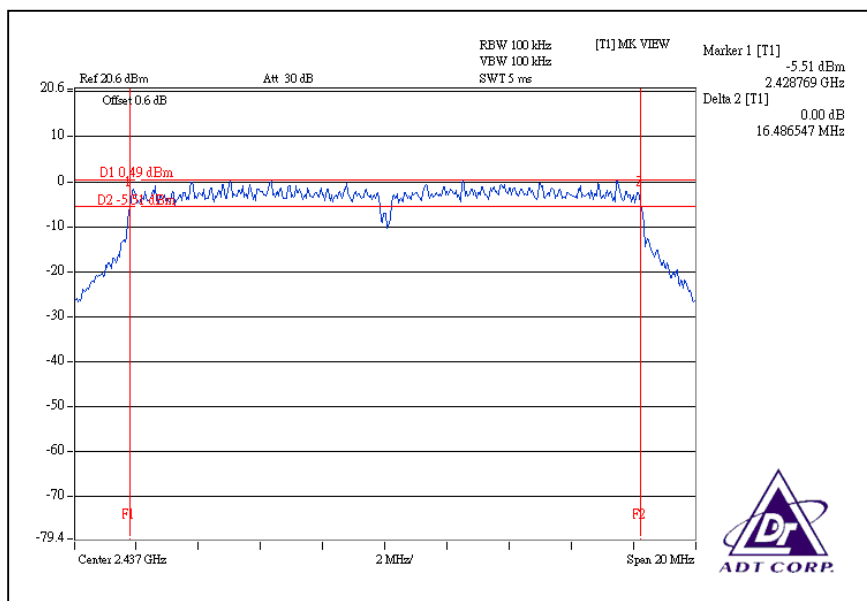

CH11

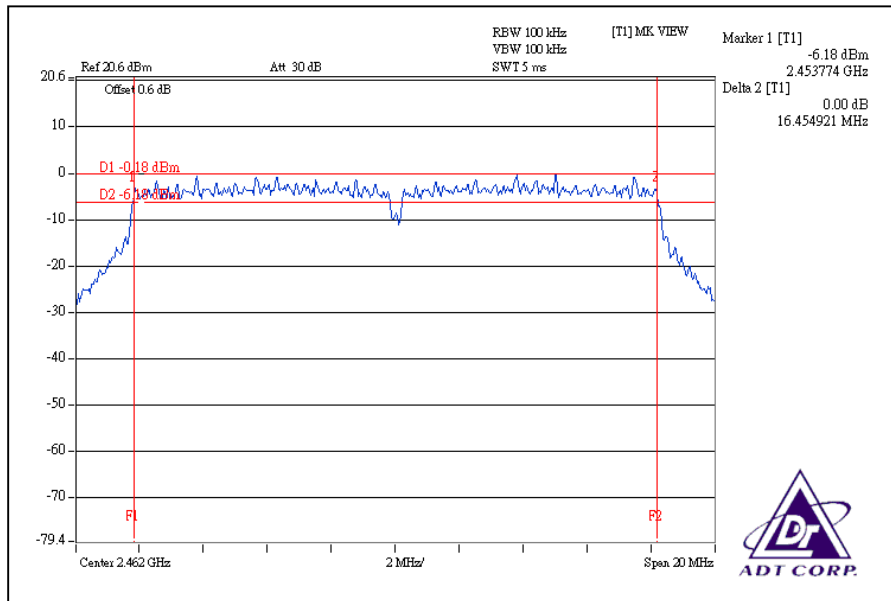

DRAFT 802.11n (20MHz) OFDM MODULATION:

MODULATION TYPE	BPSK	TRANSFER RATE	13Mbps
INPUT POWER	120Vac, 60 Hz	ENVIRONMENTAL CONDITIONS	25deg.C, 60%RH, 971hPa
TESTED BY	Rex Huang		

CHANNEL	CHANNEL FREQUENCY (MHz)	6dB BANDWIDTH (MHz)		MINIMUM LIMIT (MHz)	PASS / FAIL
		CHAIN(0)	CHAIN(1)		
1	2412	17.66	17.67	0.5	PASS
6	2437	17.65	17.69	0.5	PASS
11	2462	17.66	17.69	0.5	PASS

For Chain(0): CH1

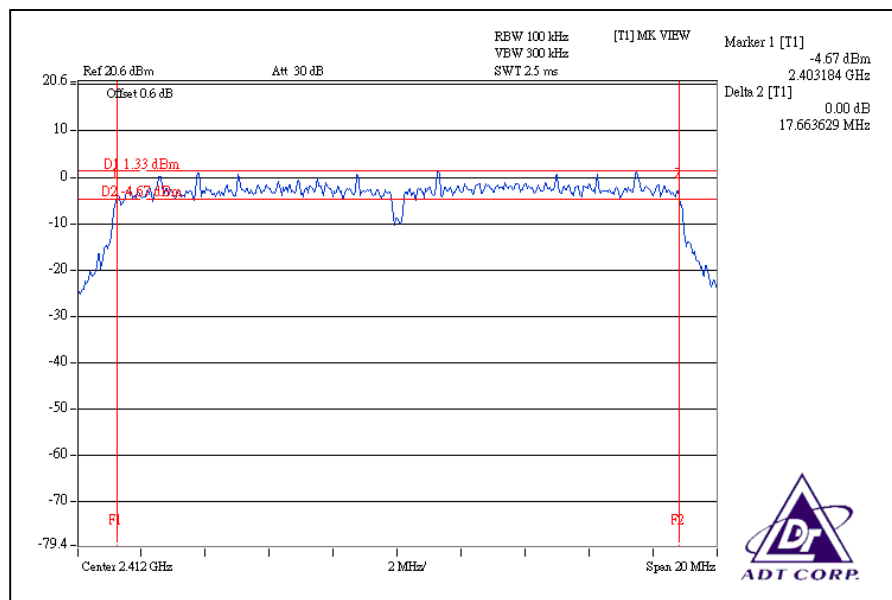

CH6

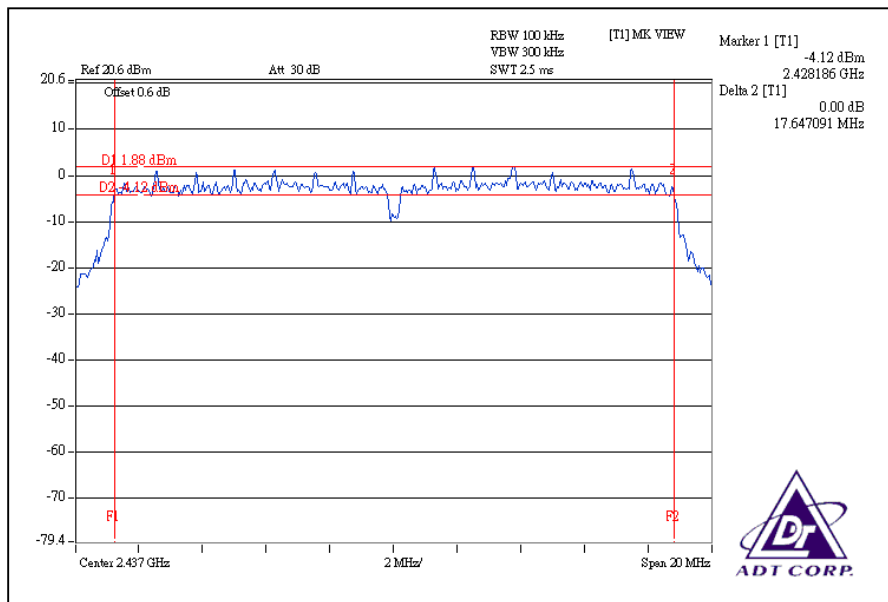

CH11

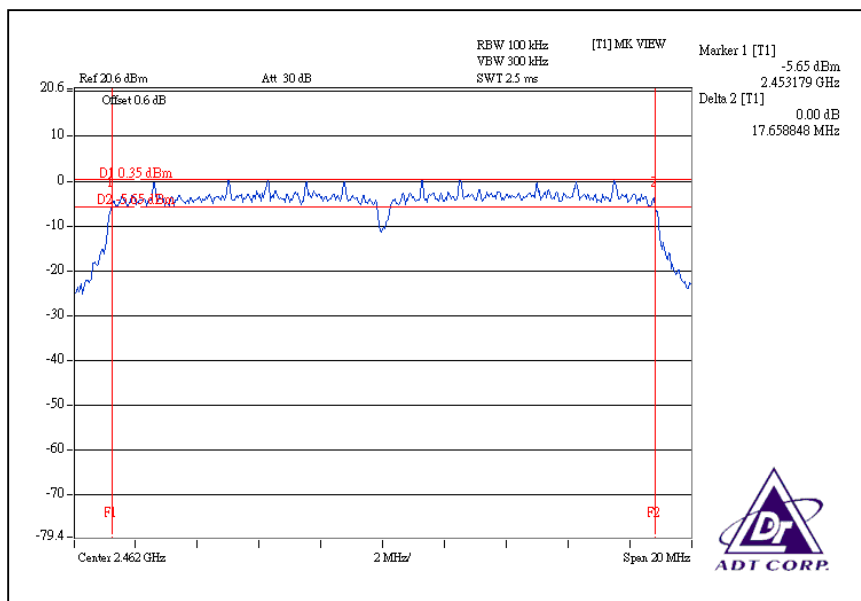

For CHAIN(1): CH1

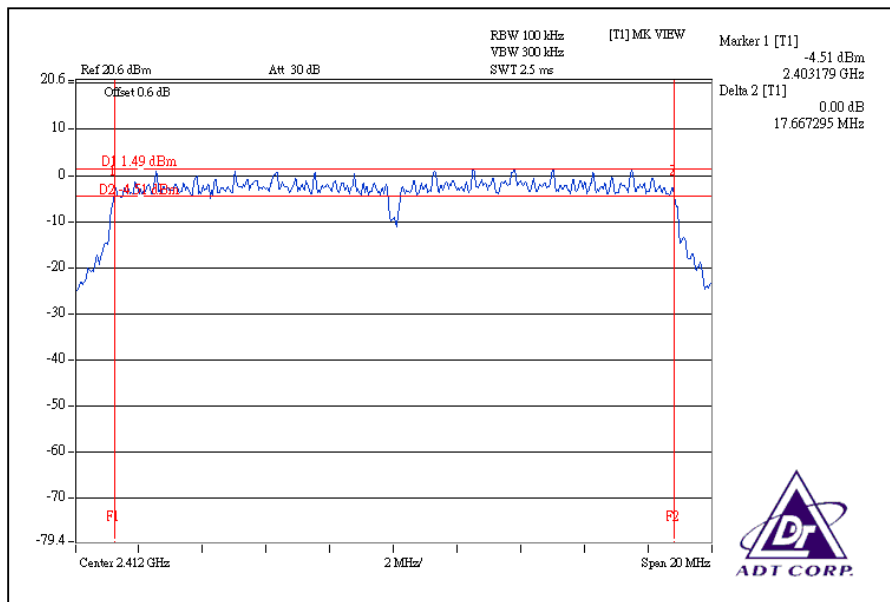

CH6

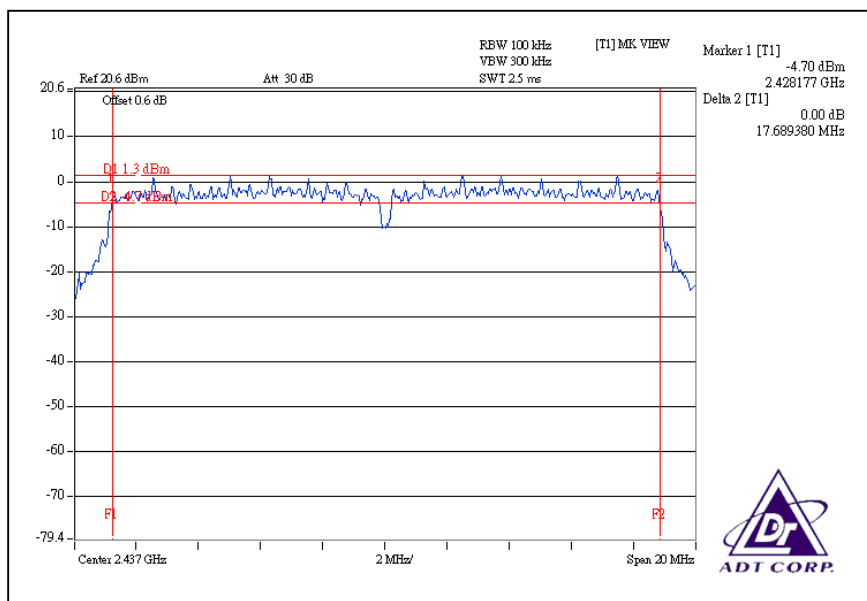

CH11

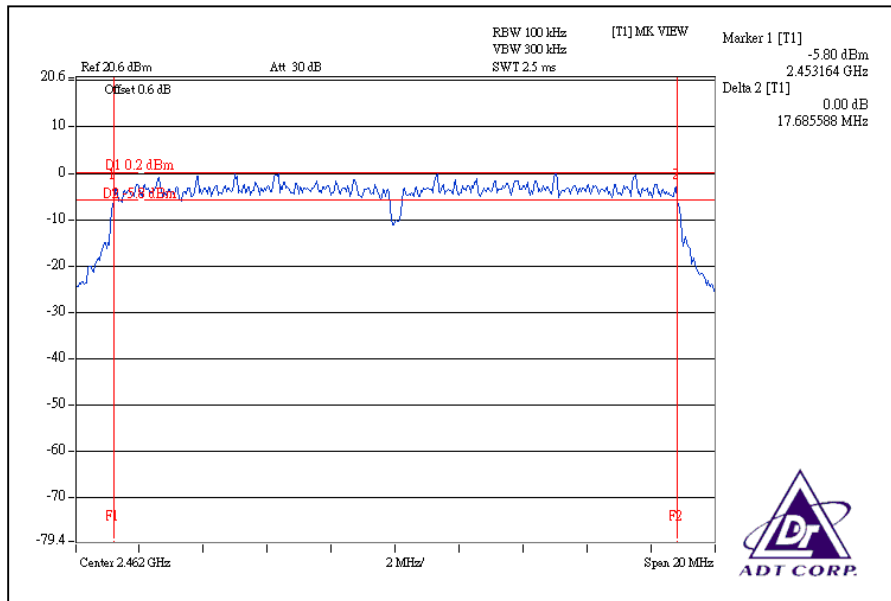

DRAFT 802.11n (40MHz) OFDM MODULATION:

MODULATION TYPE	BPSK	TRANSFER RATE	27Mbps
INPUT POWER	120Vac, 60 Hz	ENVIRONMENTAL CONDITIONS	25deg.C, 60%RH, 971hPa
TESTED BY	Rex Huang		

CHANNEL	CHANNEL FREQUENCY (MHz)	6dB BANDWIDTH (MHz)		MINIMUM LIMIT (MHz)	PASS / FAIL
		CHAIN(0)	CHAIN(1)		
1	2422	36.40	36.46	0.5	PASS
4	2437	36.20	36.46	0.5	PASS
7	2452	36.43	36.32	0.5	PASS

For Chain (0): CH1

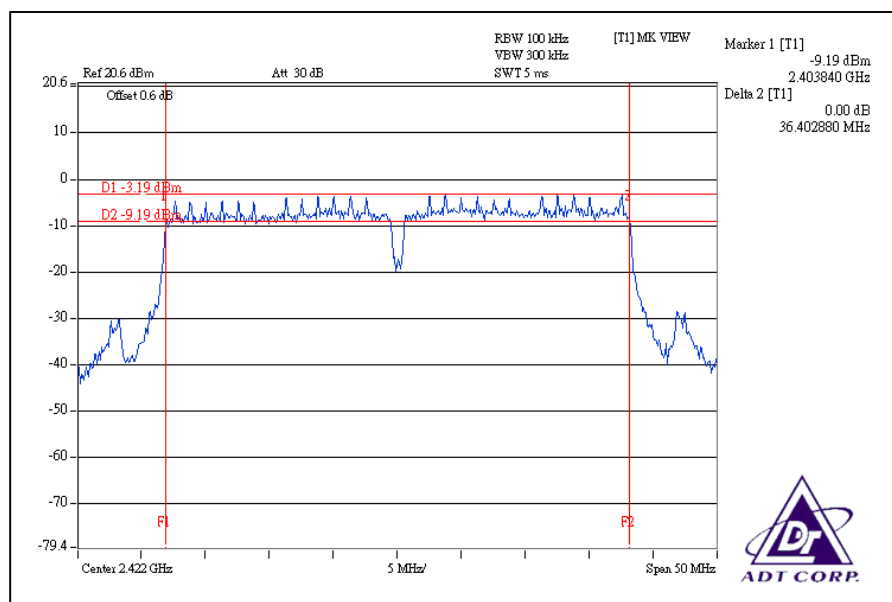

CH4

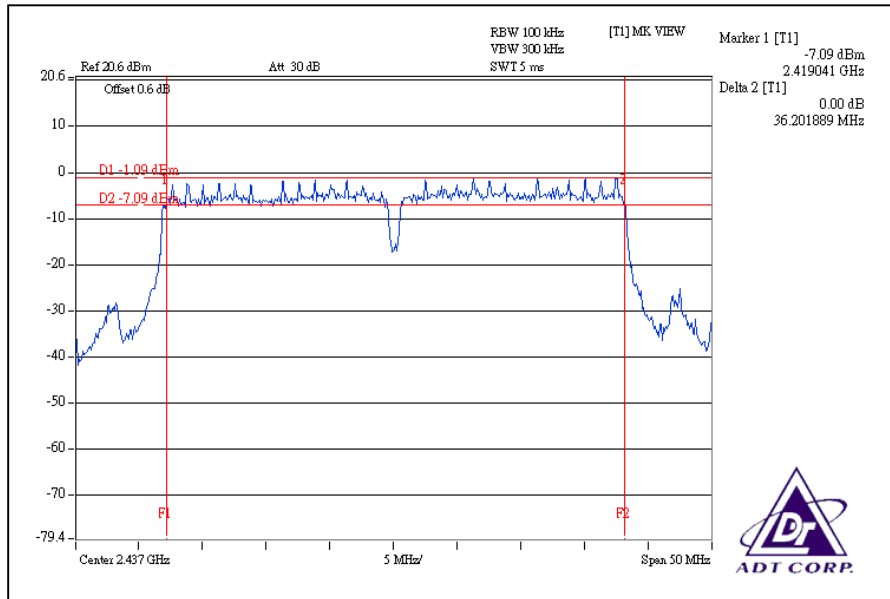

CH7

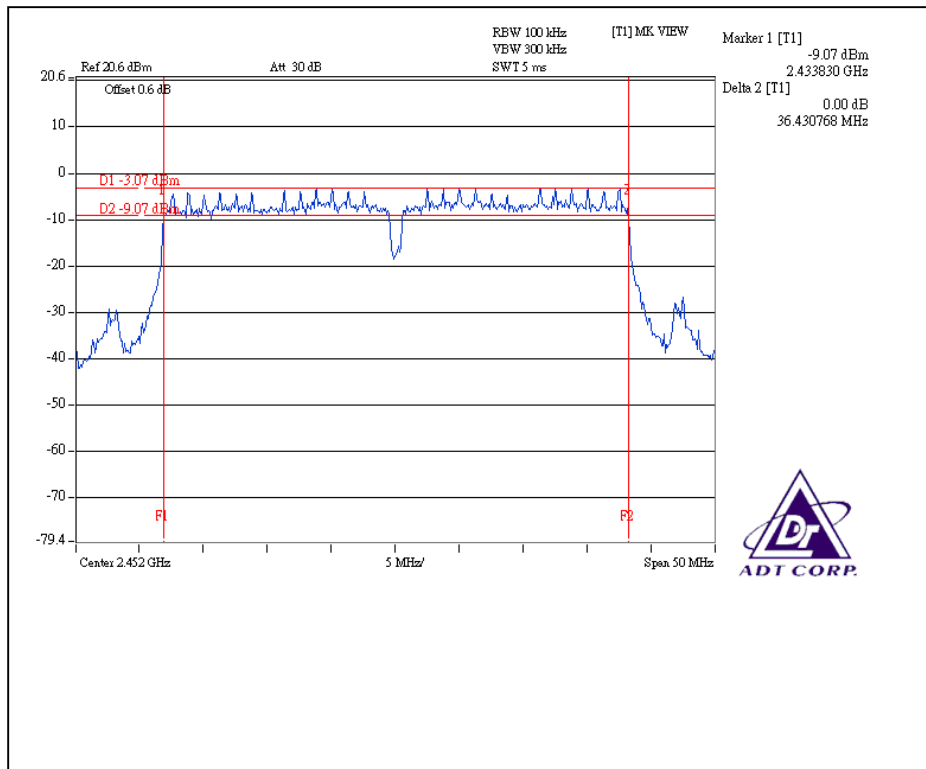

For Chain (1): CH1

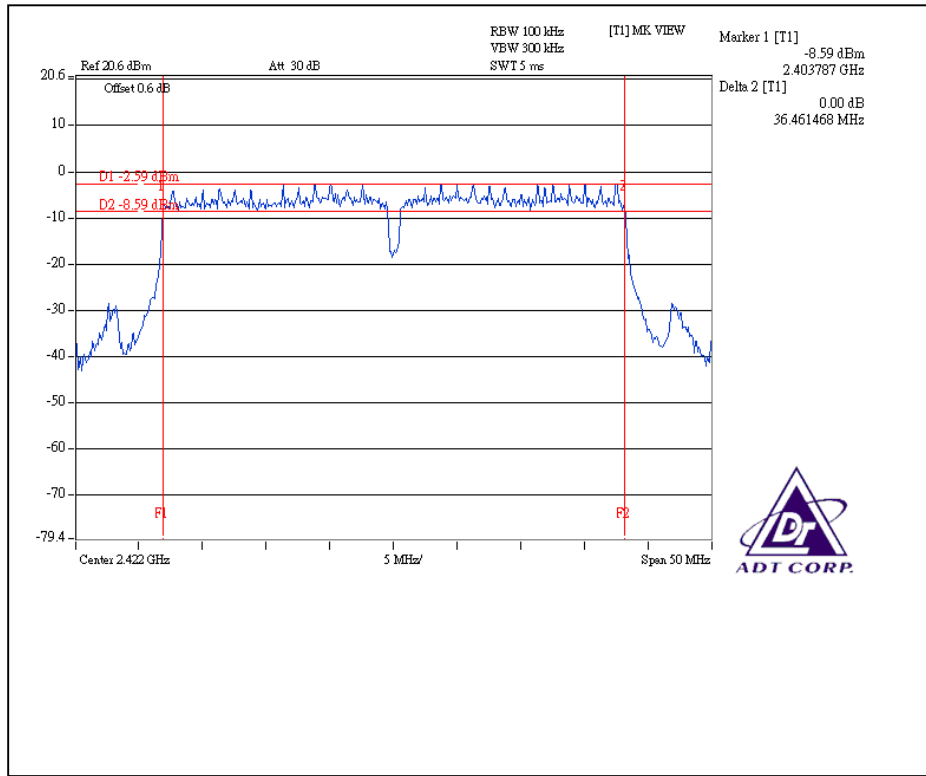

CH4

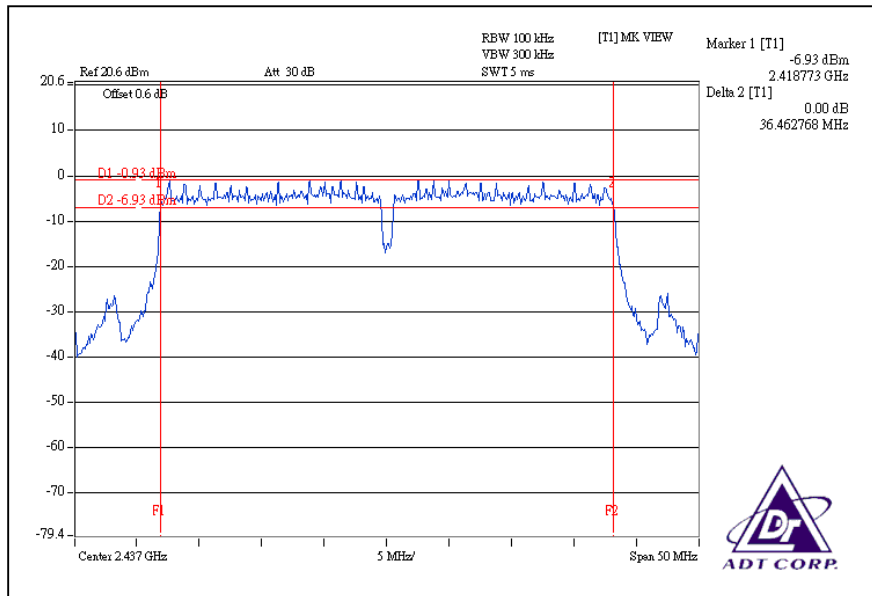

CH7

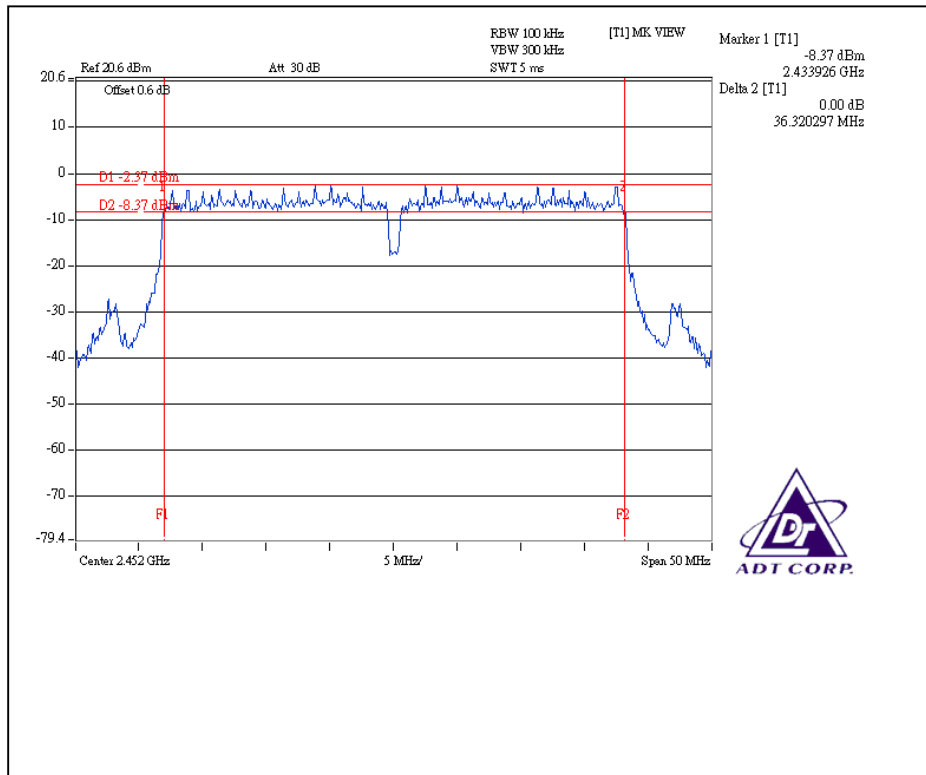

4.4 MAXIMUM PEAK OUTPUT POWER

4.4.1 LIMITS OF MAXIMUM PEAK OUTPUT POWER MEASUREMENT

The Maximum Peak Output Power Measurement is 30dBm.

4.4.2 INSTRUMENTS

Description & Manufacturer	Model No.	Serial No.	Calibrated Until
R&S SPECTRUM ANALYZER	FSP40	100037	Aug. 12, 2008
Agilent SIGNAL GENERATOR	E8257C	MY43320668	Dec. 25, 2008
TEKTRONIX OSCILLOSCOPE	TDS380	B016335	Aug. 15, 2008
NARDA DETECTOR	4503A	FSCM99899	NA

NOTE:

The calibration interval of the above test instruments is 12 months and the calibrations are traceable to NML/ROC and NIST/USA.

4.4.3 TEST PROCEDURES

1. A detector was used on the output port of the EUT. An oscilloscope was used to read the response of the detector.
2. Replaced the EUT by the signal generator. The center frequency of the S.G was adjusted to the center frequency of the measured channel.
3. Adjusted the power to have the same reading on oscilloscope. Record the power level.

4.4.4 DEVIATION FROM TEST STANDARD

No deviation

4.4.5 TEST SETUP



4.4.6 EUT OPERATING CONDITIONS

Same as Item 4.3.6

4.4.7 TEST RESULTS

802.11b DSSS MODULATION:

MODULATION TYPE	DBPSK	TRANSFER RATE	1Mbps
INPUT POWER	120Vac, 60 Hz	ENVIRONMENTAL CONDITIONS	25deg.C, 60%RH, 971hPa
TESTED BY	Rex Huang		

CHANNEL	CHANNEL FREQUENCY (MHz)	PEAK POWER OUTPUT (mW)	PEAK POWER OUTPUT (dBm)	PEAK POWER LIMIT (dBm)	PASS / FAIL
1	2412	47.863	16.80	30	PASS
6	2437	63.096	18.00	30	PASS
11	2462	66.069	18.20	30	PASS

802.11g OFDM MODULATION:

MODULATION TYPE	BPSK	TRANSFER RATE	6Mbps
INPUT POWER	120Vac, 60 Hz	ENVIRONMENTAL CONDITIONS	25deg.C, 60%RH, 971hPa
TESTED BY	Rex Huang		

CHANNEL	CHANNEL FREQUENCY (MHz)	PEAK POWER OUTPUT (mW)		PEAK POWER OUTPUT (dBm)		TOTAL PEAK POWER (mW)	TOTAL PEAK POWER (dBm)	PEAK POWER LIMIT (dBm)	PASS / FAIL
		CHAIN(0)	CHAIN(1)	CHAIN(0)	CHAIN(1)				
1	2412	57.544	56.234	17.60	17.50	113.778	20.56	30	PASS
6	2437	60.256	57.544	17.80	17.60	117.800	20.71	30	PASS
11	2462	44.668	44.668	16.50	16.50	89.336	19.51	30	PASS

DRAFT 802.11n (20MHz) OFDM MODULATION:

MODULATION TYPE	BPSK	TRANSFER RATE	13Mbps
INPUT POWER	120Vac, 60 Hz	ENVIRONMENTAL CONDITIONS	25deg.C, 60%RH, 971hPa
TESTED BY	Rex Huang		

CHANNEL	CHANNEL FREQUENCY (MHz)	PEAK POWER OUTPUT (mW)		PEAK POWER OUTPUT (dBm)		TOTAL PEAK POWER (mW)	TOTAL PEAK POWER (dBm)	PEAK POWER LIMIT (dBm)	PASS / FAIL
		CHAIN(0)	CHAIN(1)	CHAIN(0)	CHAIN(1)				
1	2412	54.954	56.234	17.40	17.50	111.188	20.46	30	PASS
6	2437	58.884	58.884	17.70	17.70	117.768	20.71	30	PASS
11	2462	44.668	45.709	16.50	16.60	90.377	19.56	30	PASS

DRAFT 802.11n (40MHz) OFDM MODULATION:

MODULATION TYPE	BPSK	TRANSFER RATE	27Mbps
INPUT POWER	120Vac, 60 Hz	ENVIRONMENTAL CONDITIONS	25deg.C, 60%RH, 971hPa
TESTED BY	Rex Huang		

CHANNEL	CHANNEL FREQUENCY (MHz)	PEAK POWER OUTPUT (mW)		PEAK POWER OUTPUT (dBm)		TOTAL PEAK POWER (mW)	TOTAL PEAK POWER (dBm)	PEAK POWER LIMIT (dBm)	PASS / FAIL
		CHAIN(0)	CHAIN(1)	CHAIN(0)	CHAIN(1)				
1	2422	35.481	35.481	15.50	15.50	70.962	18.51	30	PASS
4	2437	57.544	56.234	17.60	17.50	113.778	20.56	30	PASS
7	2452	36.308	42.658	15.60	16.30	78.966	18.97	30	PASS



4.5 POWER SPECTRAL DENSITY MEASUREMENT

4.5.1 LIMITS OF POWER SPECTRAL DENSITY MEASUREMENT

The Maximum of Power Spectral Density Measurement is 8dBm.

4.5.2 TEST INSTRUMENTS

Description & Manufacturer	Model No.	Serial No.	Calibrated Until
R&S SPECTRUM ANALYZER	FSP40	100037	Aug. 12, 2008

NOTE:

- 1.The measurement uncertainty is less than +/- 2.6dB, which is calculated as per the NAMAS document NIS81. This uncertainty represents an expanded uncertainty expressed at approximately the 95% confidence level using a coverage factor of k=2.
- 2.The calibration interval of the above test instruments is 12 months and the calibrations are traceable to NML/ROC and NIST/USA.

4.5.3 TEST PROCEDURE

The transmitter output was connected to the spectrum analyzer through an attenuator, the bandwidth of the fundamental frequency was measured with the spectrum analyzer using 3kHz RBW and 30kHz VBW, set sweep time = span/3kHz. The power spectral density was measured and recorded. The sweep time is allowed to be longer than span/3kHz for a full response of the mixer in the spectrum analyzer.

4.5.4 DEVIATION FROM TEST STANDARD

No deviation

4.5.5 TEST SETUP

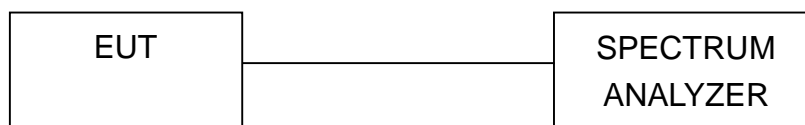

4.5.6 EUT OPERATING CONDITION

Same as Item 4.3.6

4.5.7 TEST RESULTS

802.11b DSSS MODULATION:

MODULATION TYPE	DBPSK	TRANSFER RATE	1Mbps
INPUT POWER	120Vac, 60 Hz	ENVIRONMENTAL CONDITIONS	25deg.C, 60%RH, 971hPa
TESTED BY	Rex Huang		

CHANNEL	CHANNEL FREQUENCY (MHz)	RF POWER LEVEL IN 3kHz BW (dBm)	MAXIMUM LIMIT (dBm)	PASS / FAIL
1	2412	-8.07	8	PASS
6	2437	-7.91	8	PASS
11	2462	-8.58	8	PASS

CH1

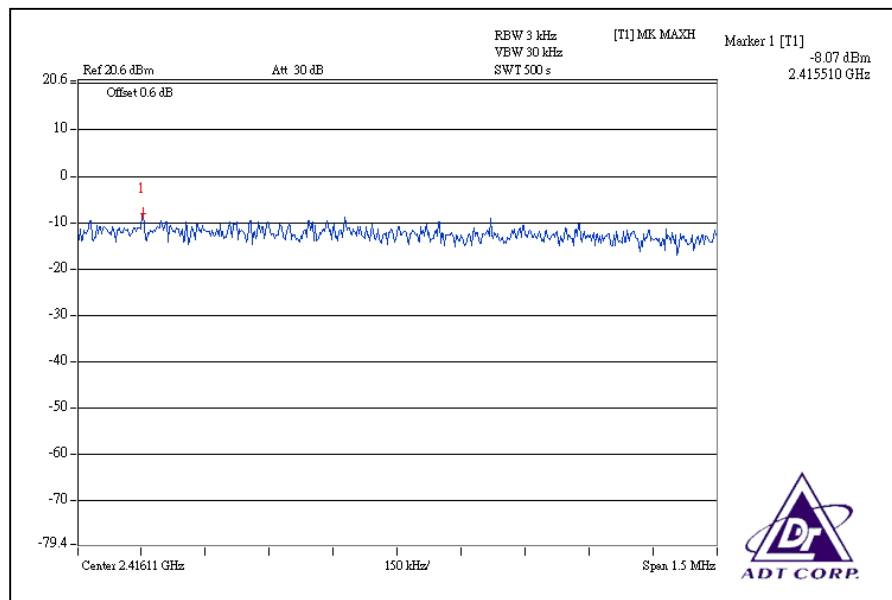

CH6

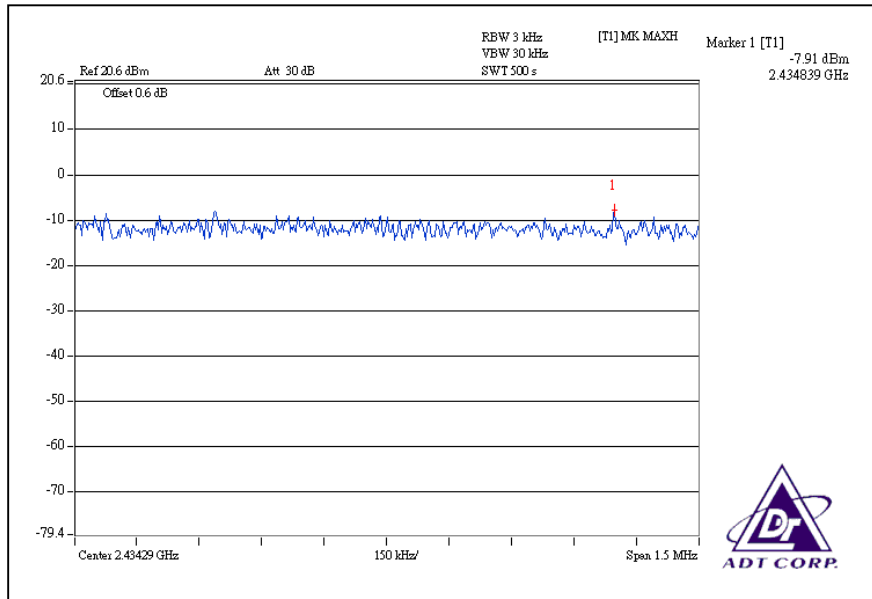

CH11

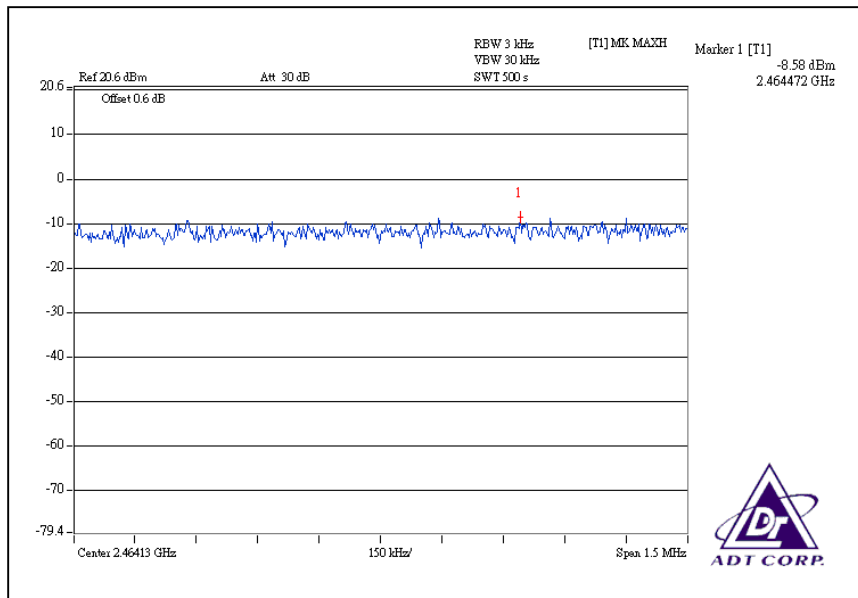

802.11g OFDM MODULATION:

MODULATION TYPE	BPSK	TRANSFER RATE	6Mbps
INPUT POWER	120Vac, 60 Hz	ENVIRONMENTAL CONDITIONS	25deg.C, 60%RH, 971hPa
TESTED BY	Rex Huang		

CHANNEL	CHANNEL FREQUENCY (MHz)	RF POWER LEVEL IN 3kHz BW (mW)		RF POWER LEVEL IN 3kHz BW (dBm)		TOTAL POWER DENSITY (mW)	TOTAL POWER DENSITY (dBm)	MAXIMUM LIMIT (dBm)	PASS / FAIL
		CHAIN(0)	CHAIN(1)	CHAIN(0)	CHAIN(1)				
1	2412	0.060	0.052	-12.21	-12.87	0.112	-9.51	8	PASS
6	2437	0.051	0.059	-12.90	-12.26	0.110	-9.59	8	PASS
11	2462	0.068	0.043	-11.70	-13.70	0.111	-9.55	8	PASS

For Chain(0): CH1

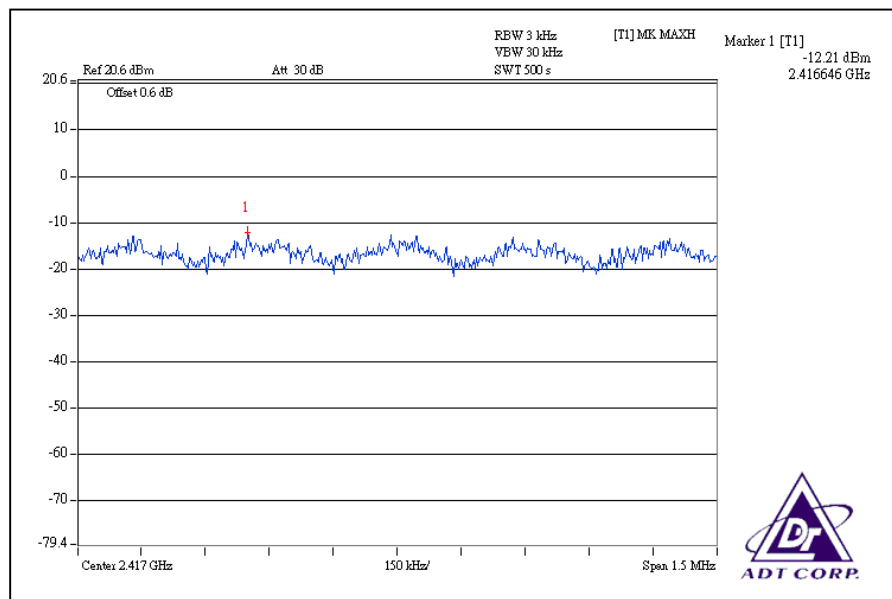

CH6

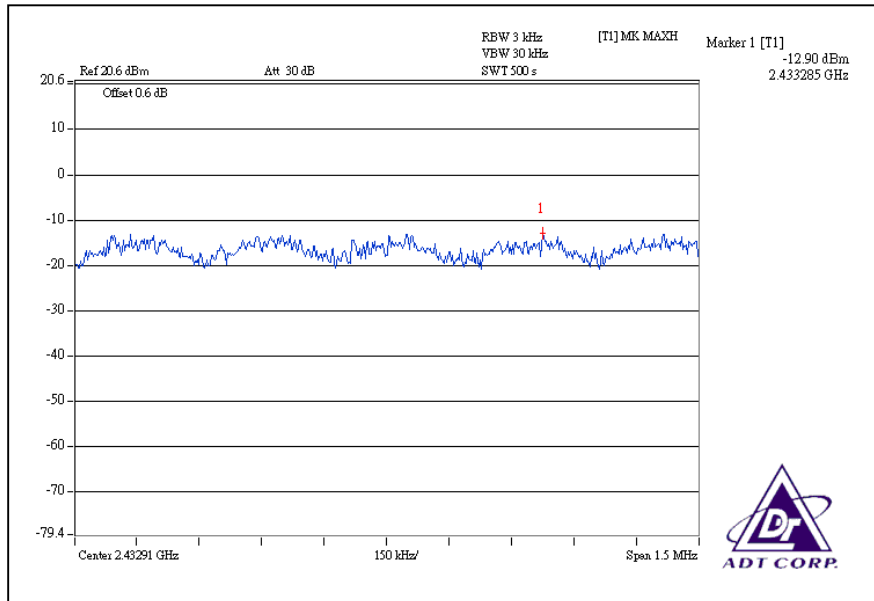

CH11

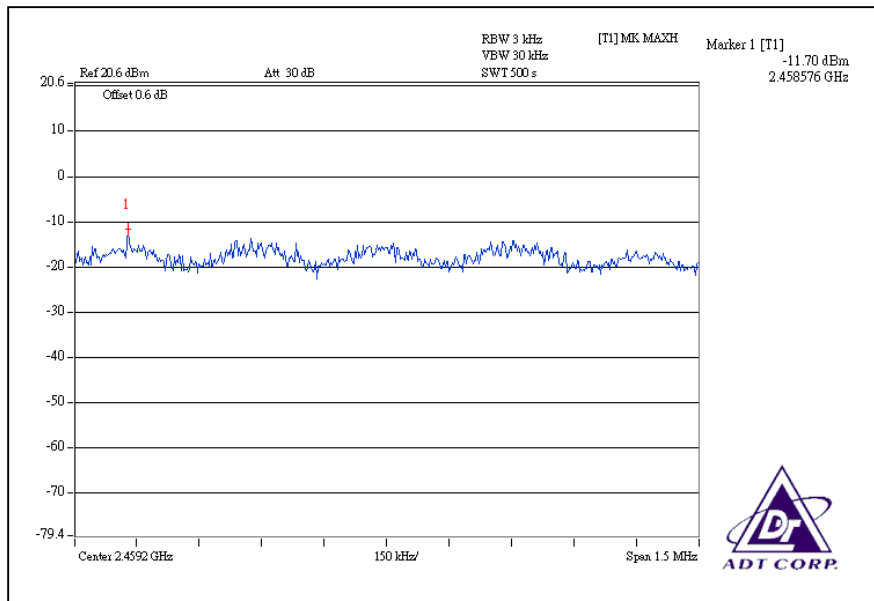

For Chain (1): CH1

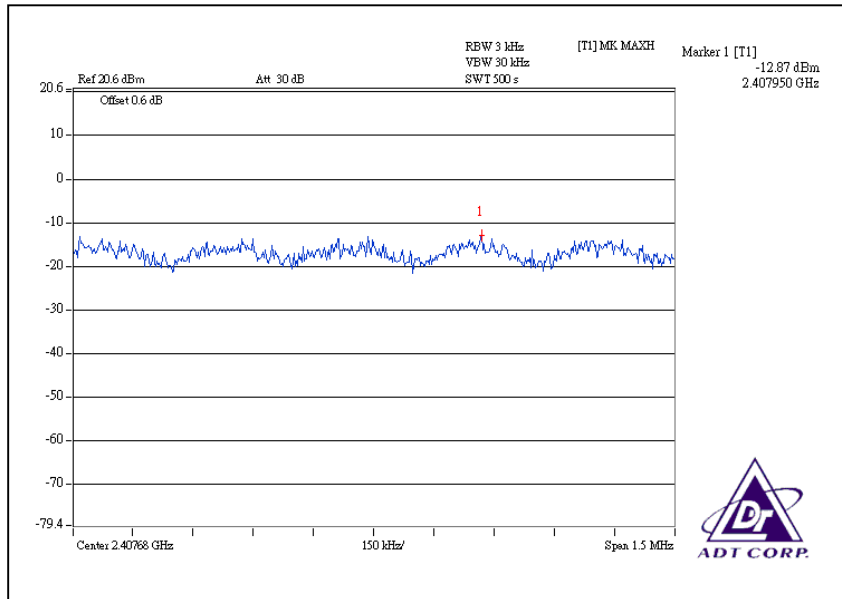

CH6

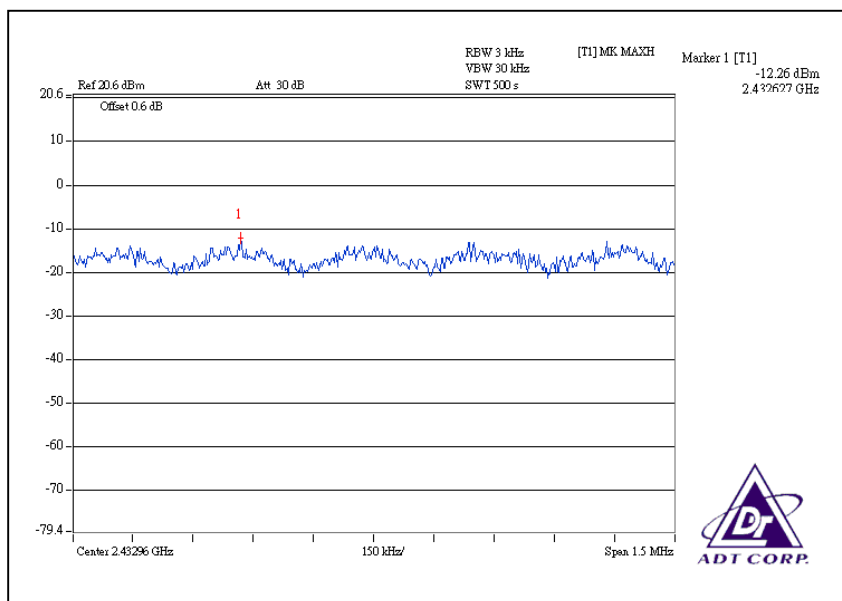

CH11

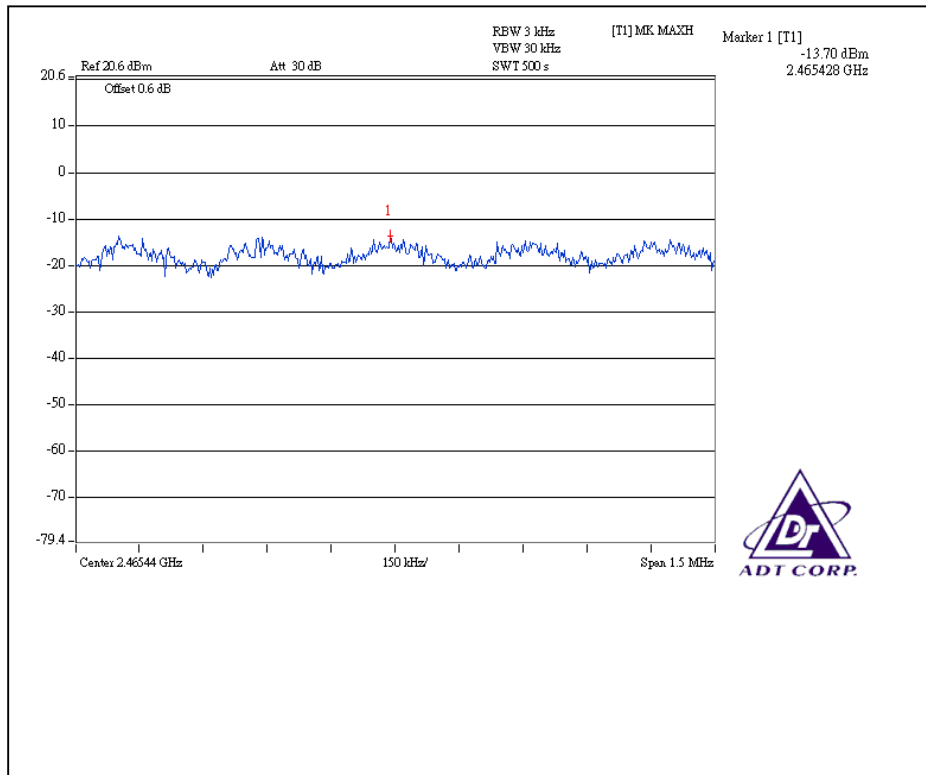

DRAFT 802.11n (20MHz) OFDM MODULATION:

MODULATION TYPE	BPSK	TRANSFER RATE	13Mbps
INPUT POWER	120Vac, 60 Hz	ENVIRONMENTAL CONDITIONS	25 deg.C, 60%RH, 971hPa
TESTED BY	Rex Huang		

CHANNEL	CHANNEL FREQUENCY (MHz)	RF POWER LEVEL IN 3kHz BW (mW)		RF POWER LEVEL IN 3kHz BW (dBm)		TOTAL POWER DENSITY (mW)	TOTAL POWER DENSITY (dBm)	MAXIMUM LIMIT (dBm)	PASS / FAIL
		CHAIN(0)	CHAIN(1)	CHAIN(0)	CHAIN(1)				
1	2412	0.048	0.055	-13.22	-12.63	0.103	-9.87	8	PASS
6	2437	0.073	0.055	-11.35	-12.62	0.128	-8.93	8	PASS
11	2462	0.052	0.048	-12.85	-13.22	0.100	-10.00	8	PASS

For Chain(0): CH1

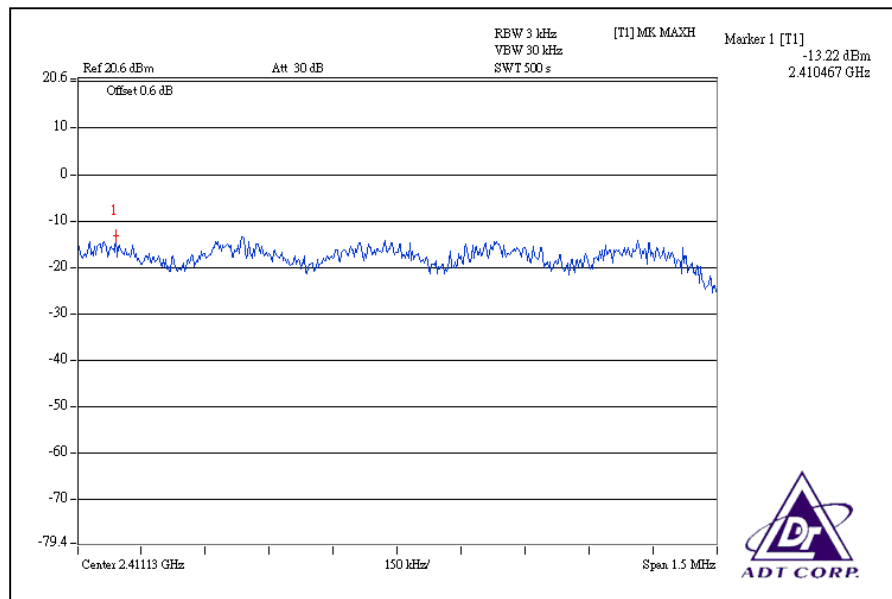

CH6

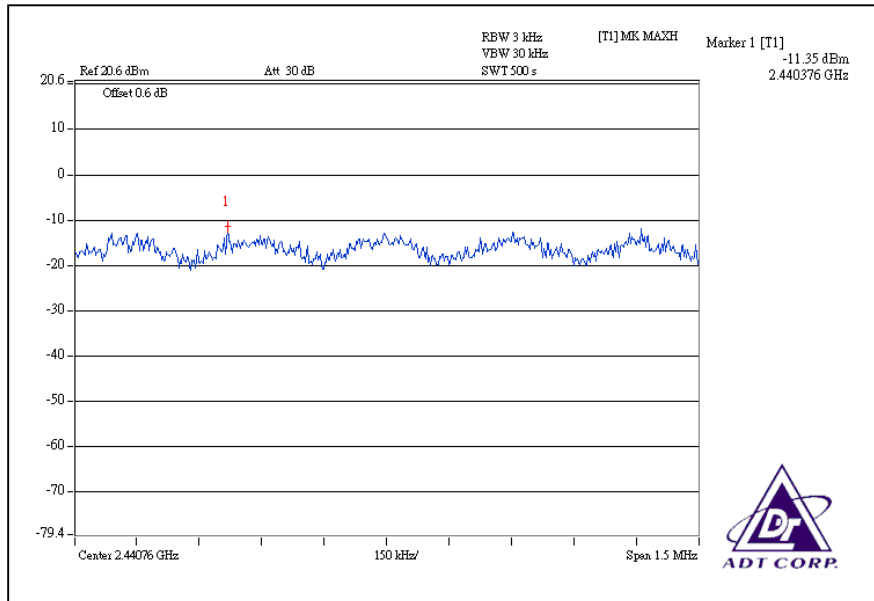

CH11

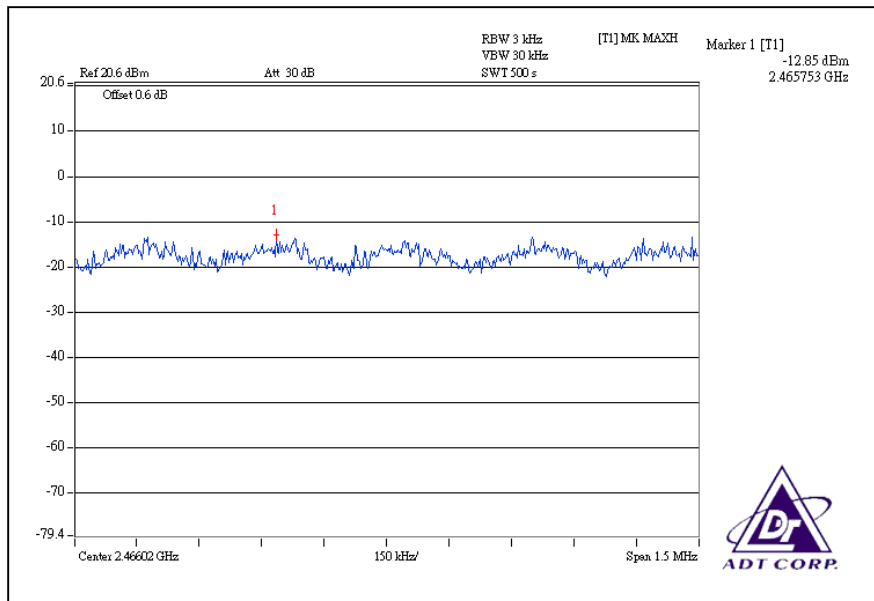

For Chain (1): CH1

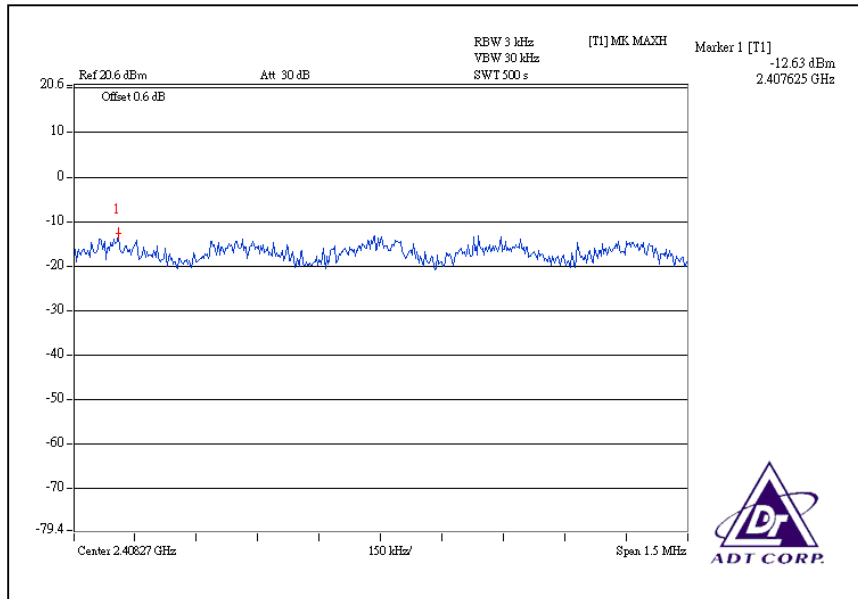

CH6

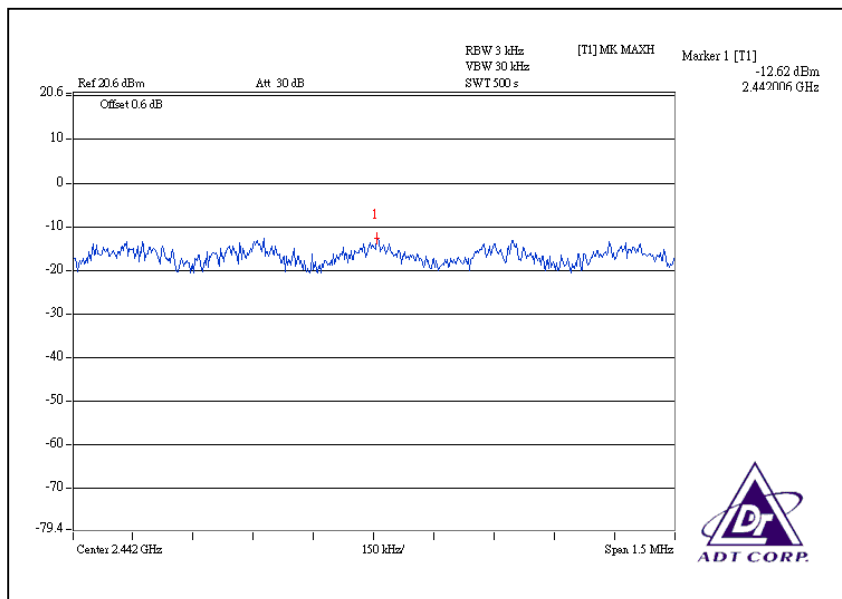

CH11

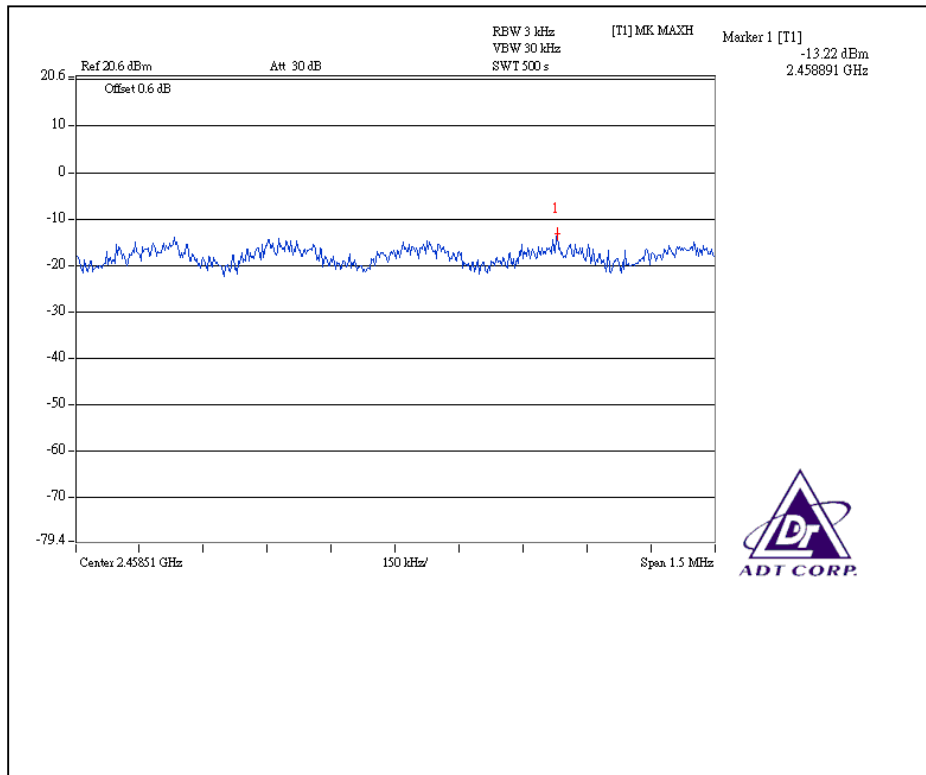

DRAFT 802.11n (40MHz) OFDM MODULATION:

MODULATION TYPE	BPSK	TRANSFER RATE	27Mbps
INPUT POWER	120Vac, 60 Hz	ENVIRONMENTAL CONDITIONS	25deg.C, 60%RH, 971hPa
TESTED BY	Rex Huang		

CHANNEL	CHANNEL FREQUENCY (MHz)	RF POWER LEVEL IN 3kHz BW (mW)		RF POWER LEVEL IN 3kHz BW (dBm)		TOTAL POWER DENSITY (mW)	TOTAL POWER DENSITY (dBm)	MAXIMUM LIMIT (dBm)	PASS / FAIL
		CHAIN(0)	CHAIN(1)	CHAIN(0)	CHAIN(1)				
1	2422	0.015	0.043	-18.21	-13.63	0.058	-12.37	8	PASS
4	2437	0.028	0.029	-15.50	-15.42	0.057	-12.44	8	PASS
7	2452	0.018	0.030	-17.49	-15.29	0.048	-13.19	8	PASS

For Chain (0): CH1

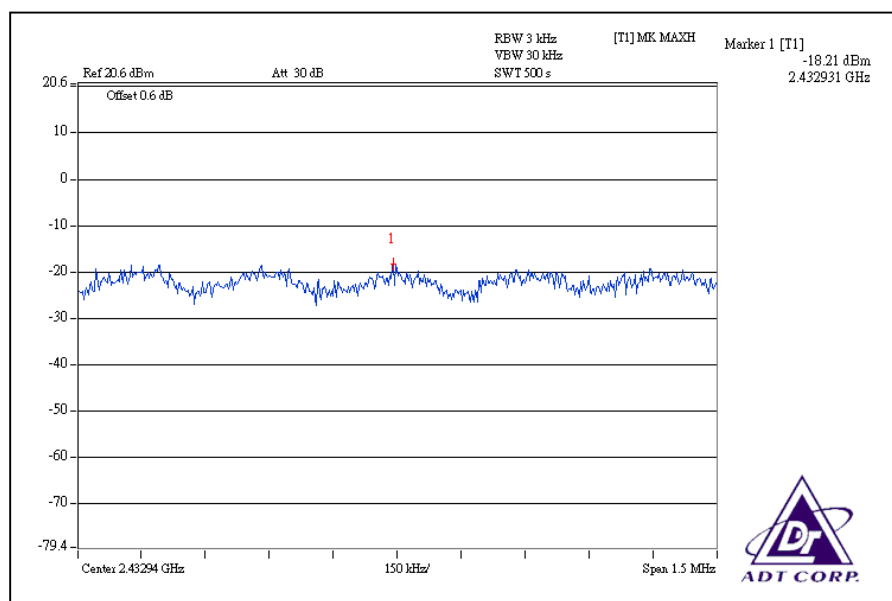

CH4

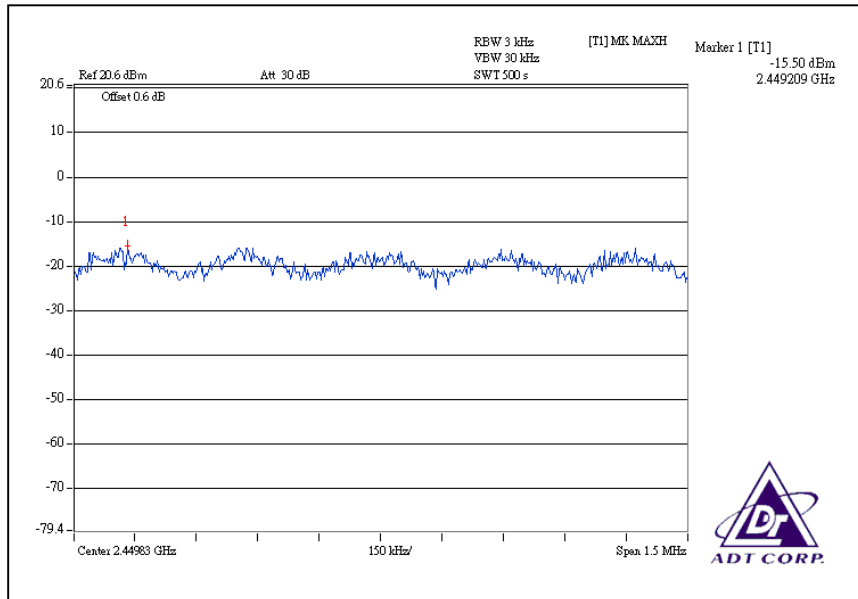

CH7

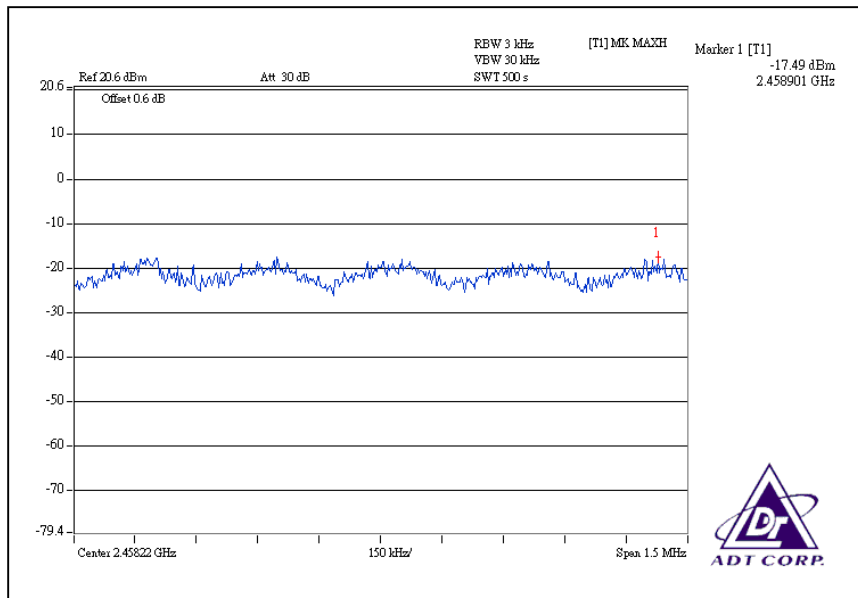

For Chain (1): CH1

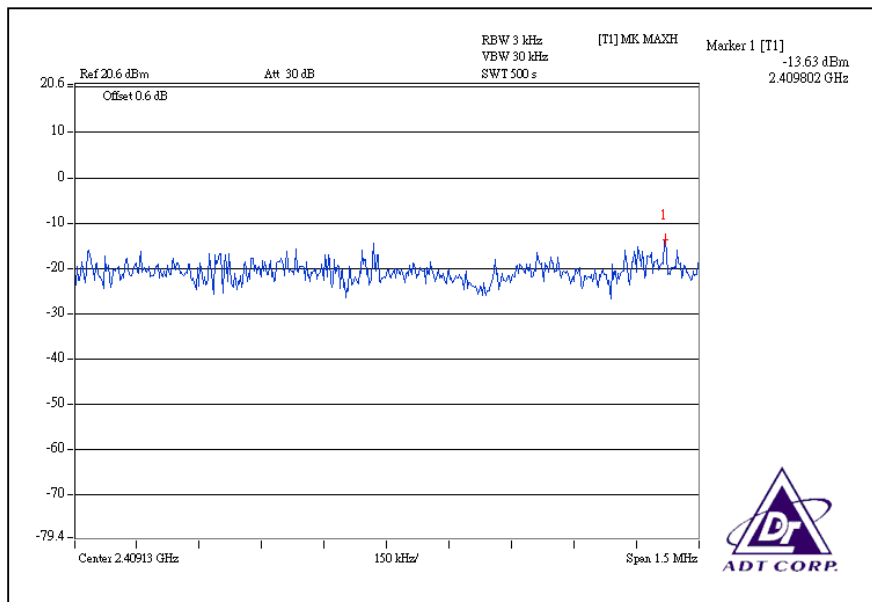

CH4

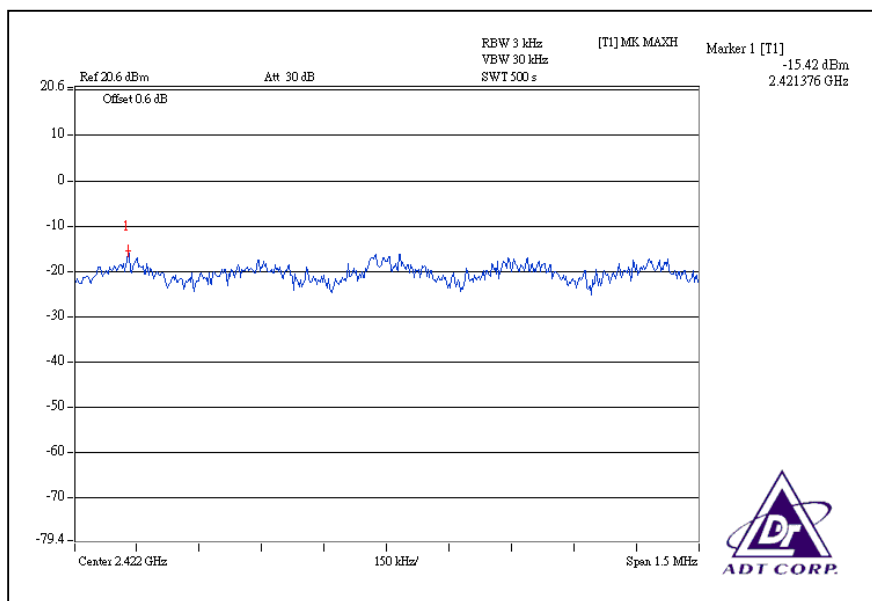

CH7

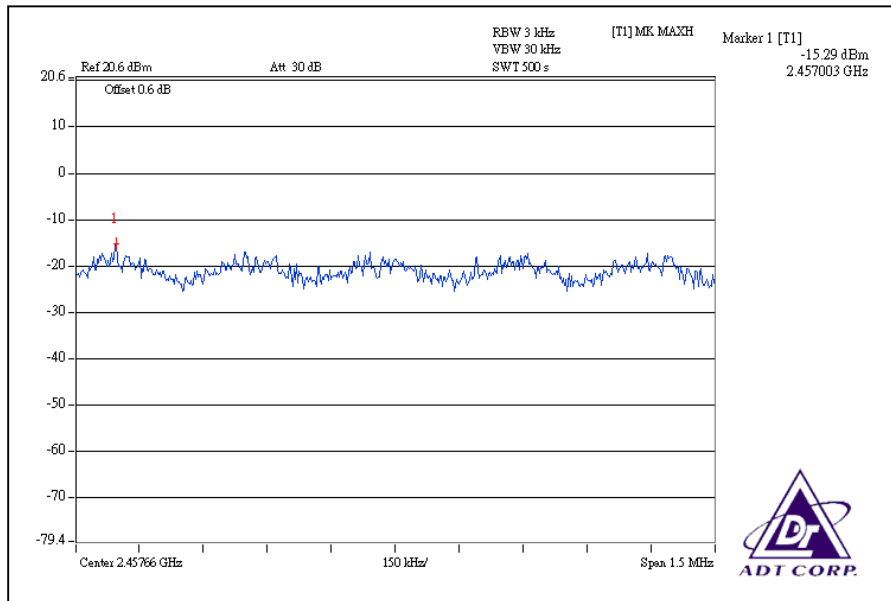

4.6 BAND EDGES MEASUREMENT

4.6.1 LIMITS OF BAND EDGES MEASUREMENT

Below -20dB of the highest emission level of operating band (in 100KHz Resolution Bandwidth).

4.6.2 TEST INSTRUMENTS

Description & Manufacturer	Model No.	Serial No.	Calibrated Until
R&S SPECTRUM ANALYZER	FSP40	100037	Aug. 12, 2008

NOTE:

- 1.The measurement uncertainty is less than $\pm 2.6\text{dB}$, which is calculated as per the NAMAS document NIS81. This uncertainty represents an expanded uncertainty expressed at approximately the 95% confidence level using a coverage factor of $k=2$.
- 2.The calibration interval of the above test instruments is 12 months and the calibrations are traceable to NML/ROC and NIST/USA.

4.6.3 TEST PROCEDURE

The transmitter output was connected to the spectrum analyzer via a low loss cable. Set RBW of spectrum analyzer to 100kHz and VBW of spectrum analyzer to 300kHz with suitable frequency span including 100 MHz bandwidth from band edge. The band edges was measured and recorded.

The spectrum plots (RBW = 100kHz, VBW = 300kHz) are attached on the following pages.

4.6.4 DEVIATION FROM TEST STANDARD

No deviation

4.6.5 EUT OPERATING CONDITION

Same as Item 4.3.6

4.6.6 TEST RESULTS

The spectrum plots are attached on the following images. D1 line indicates the highest level, and D2 line indicates the 20dB offset below D1. It shows compliance with the requirement in part 15.247(d).

802.11b DSSS MODULATION: CH1

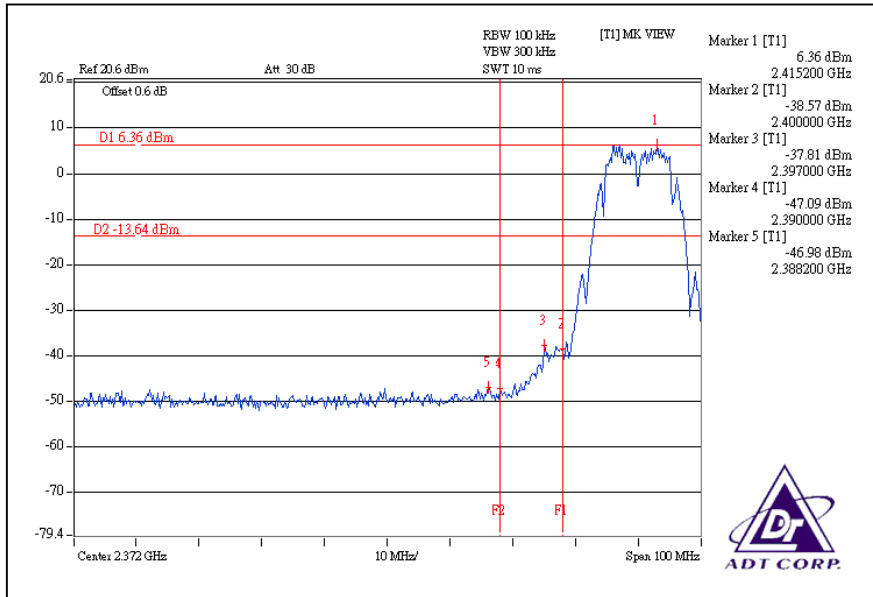

CH11

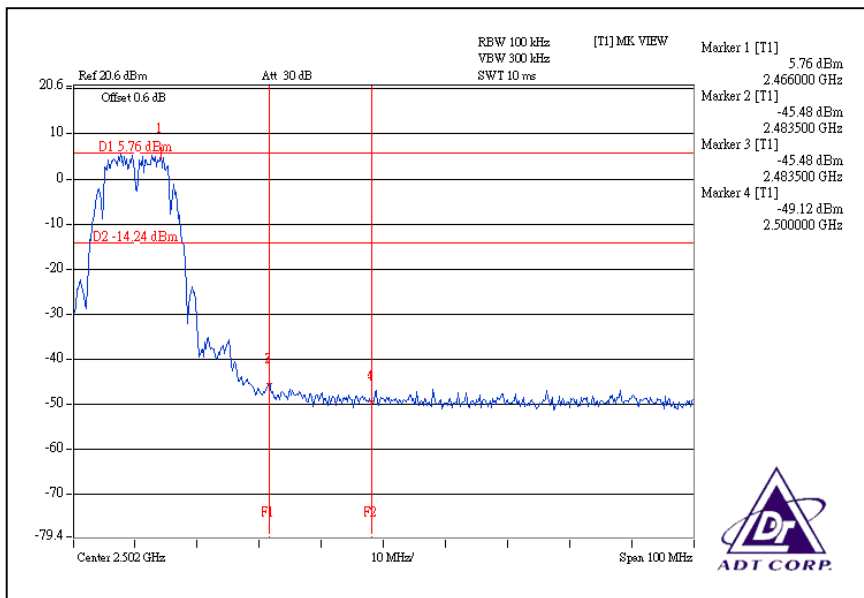

CH1

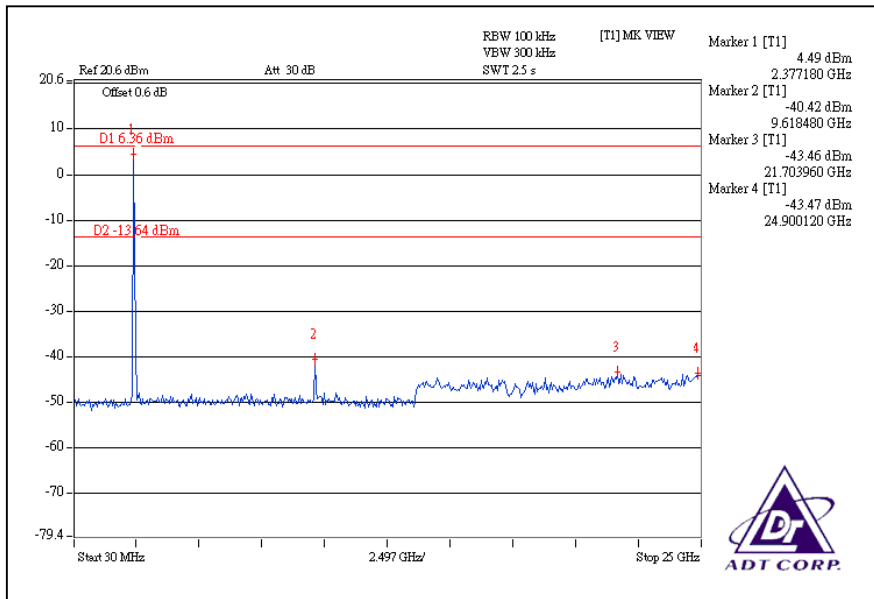

CH11

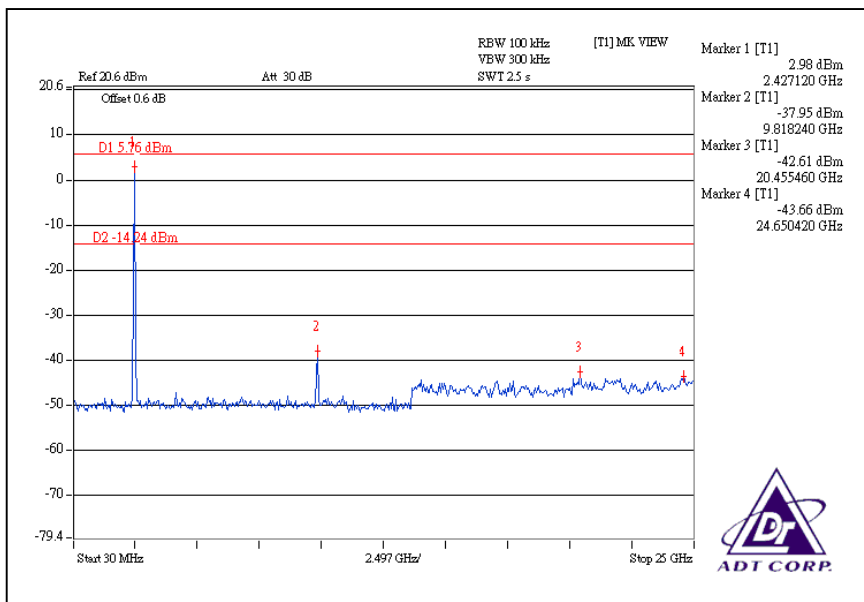

802.11g OFDM MODULATION:

For Chain (0):CH1

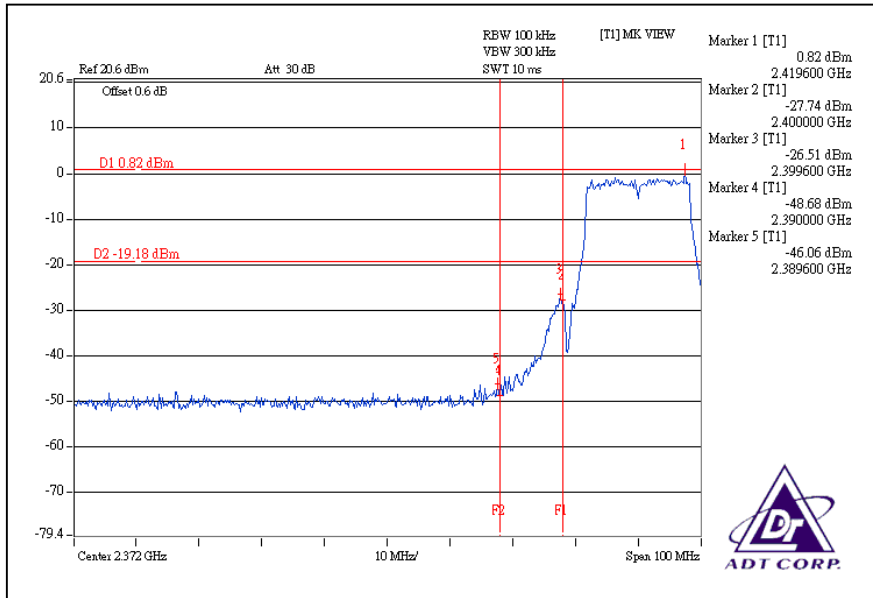

CH11

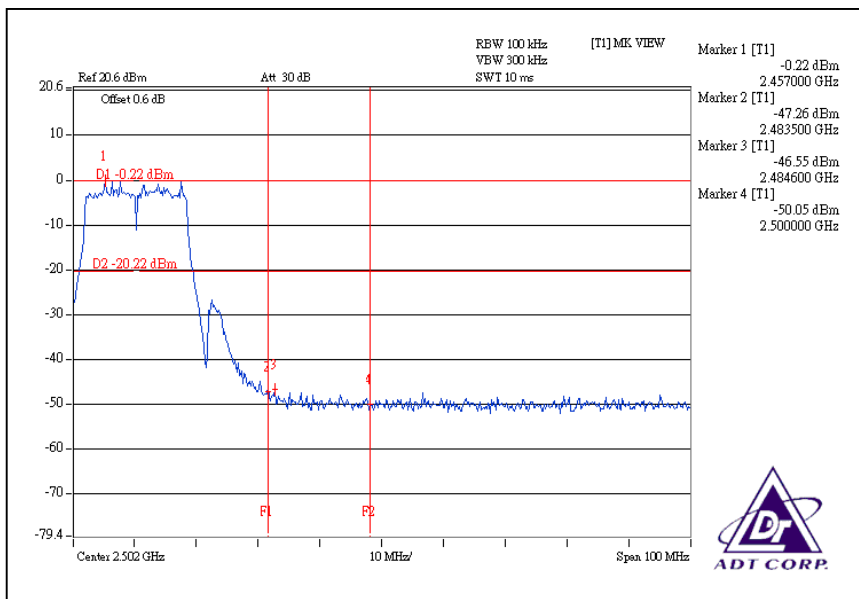

CH1

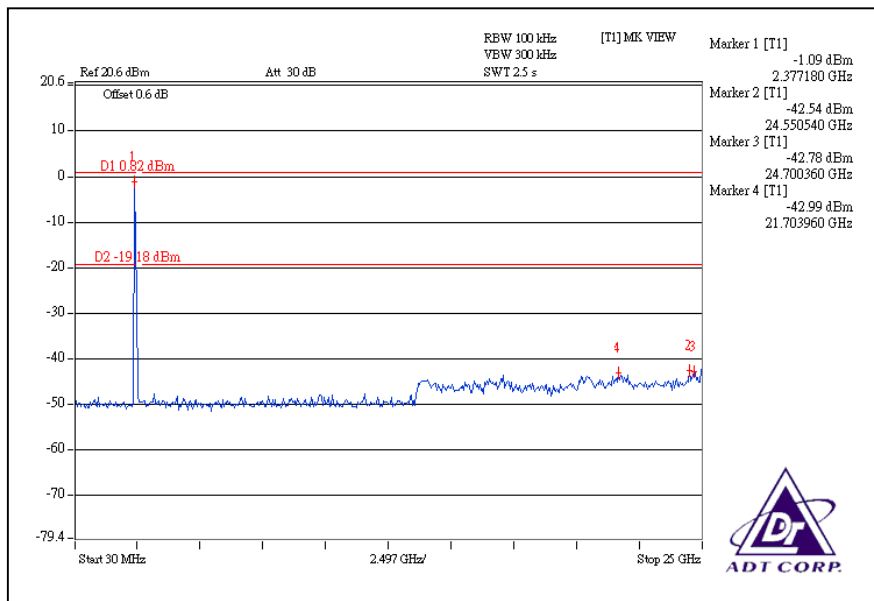

CH11

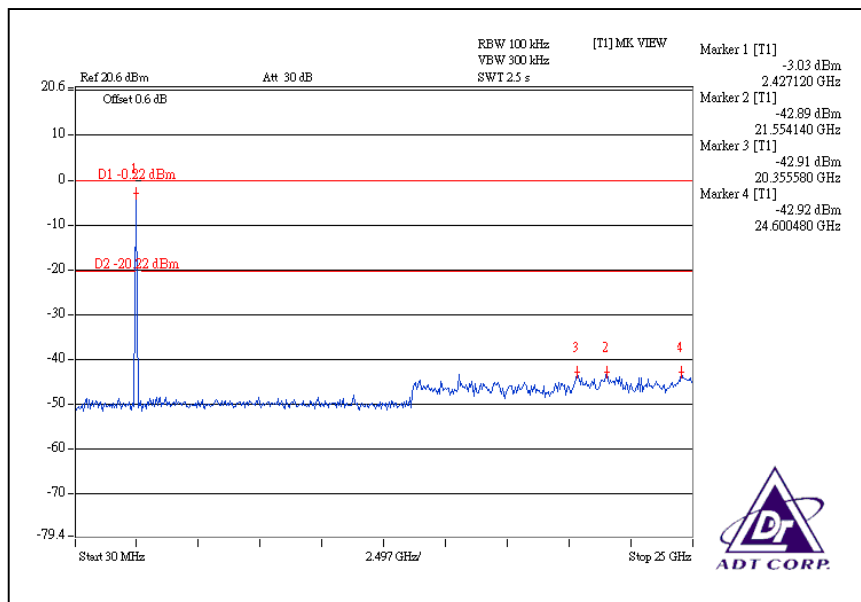

For Chain (1):CH1

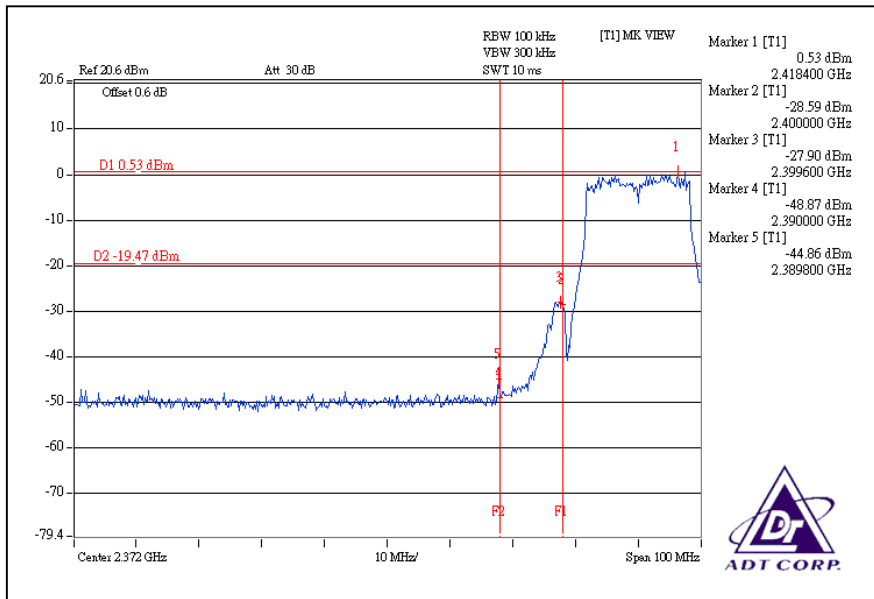

CH11

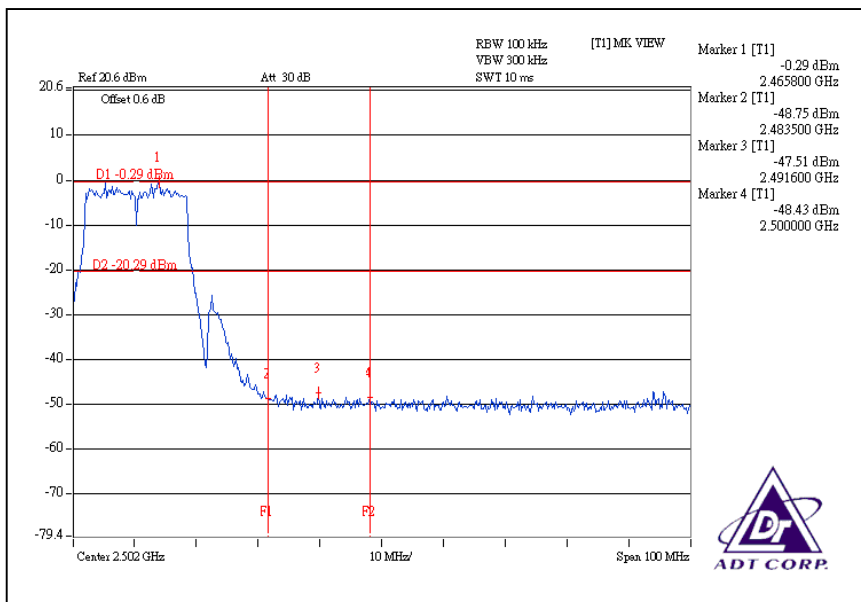

CH1

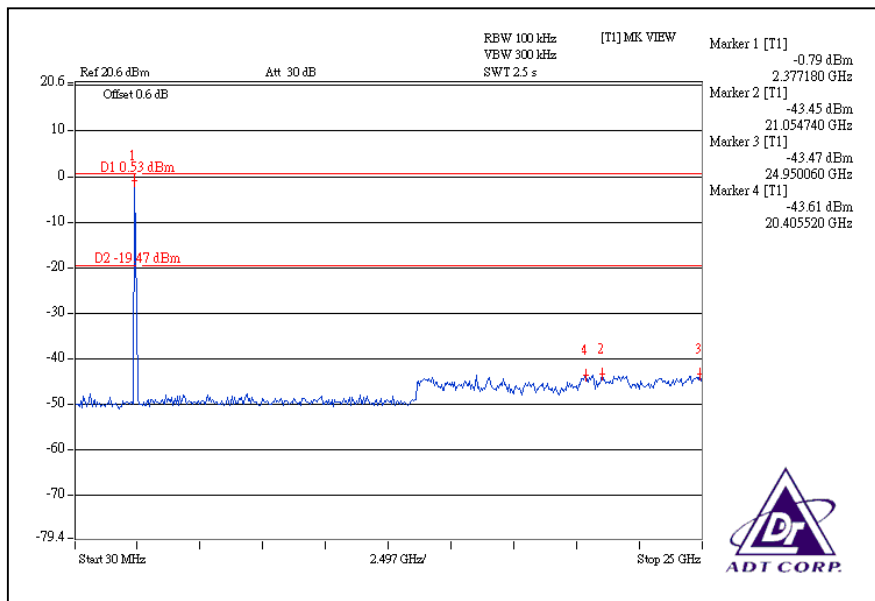

CH11

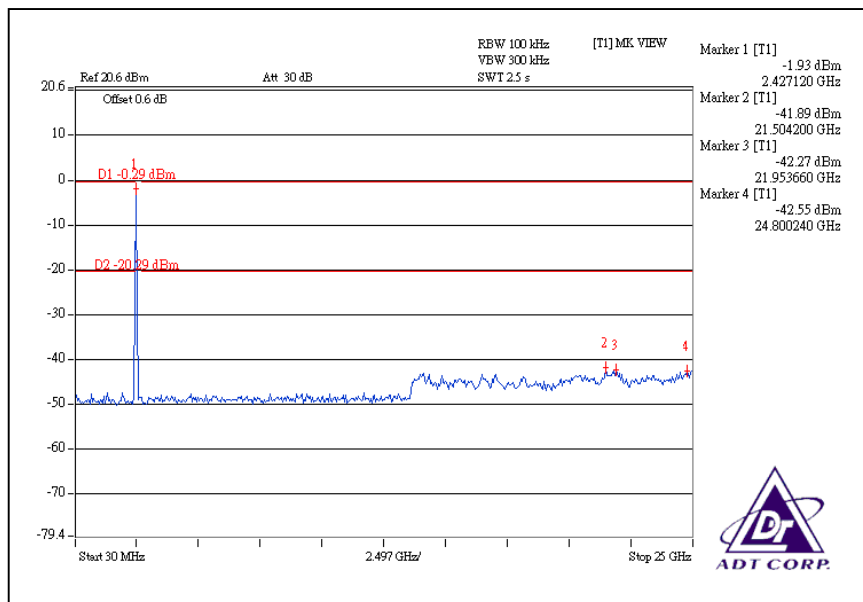

DRAFT 802.11n (20MHz) OFDM MODULATION:
For Chain (0):CH1

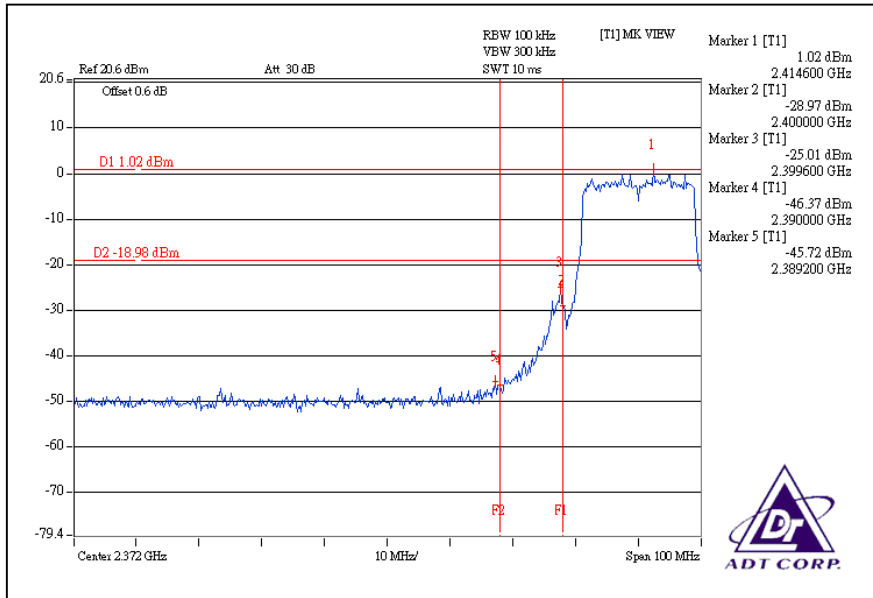

CH11

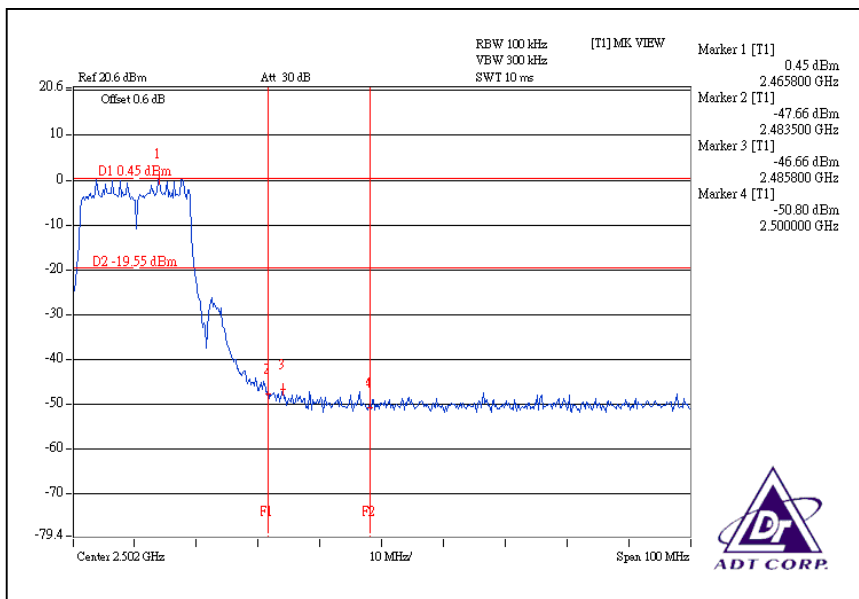

CH1

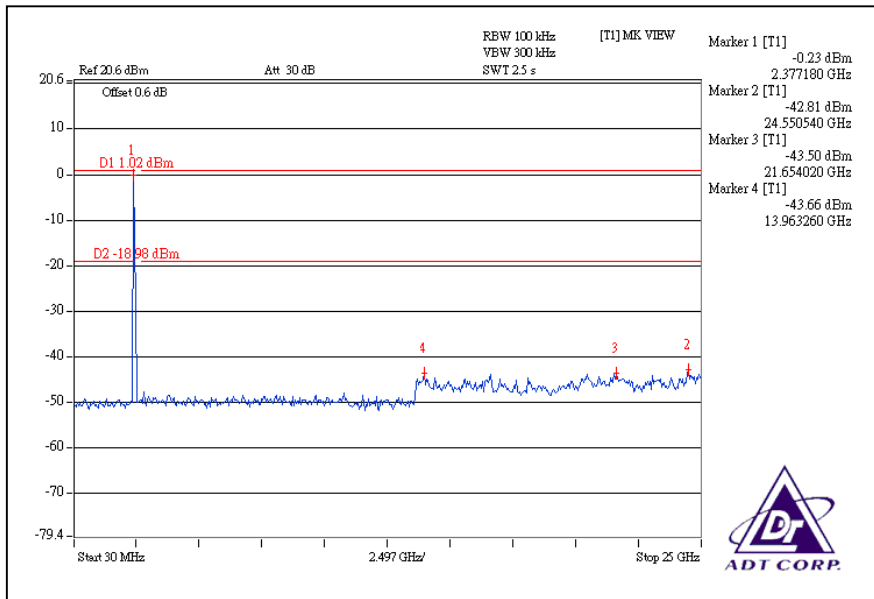

CH11

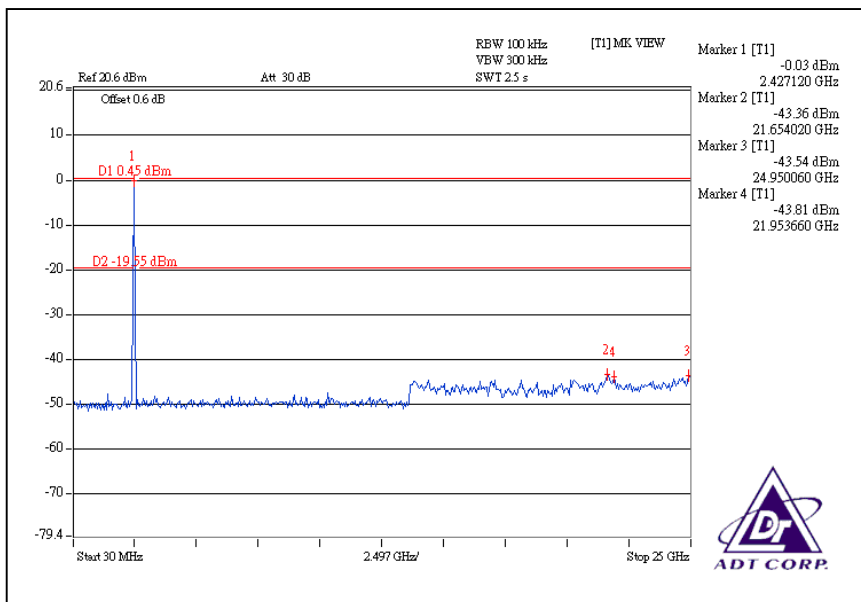

For Chain (1):CH1

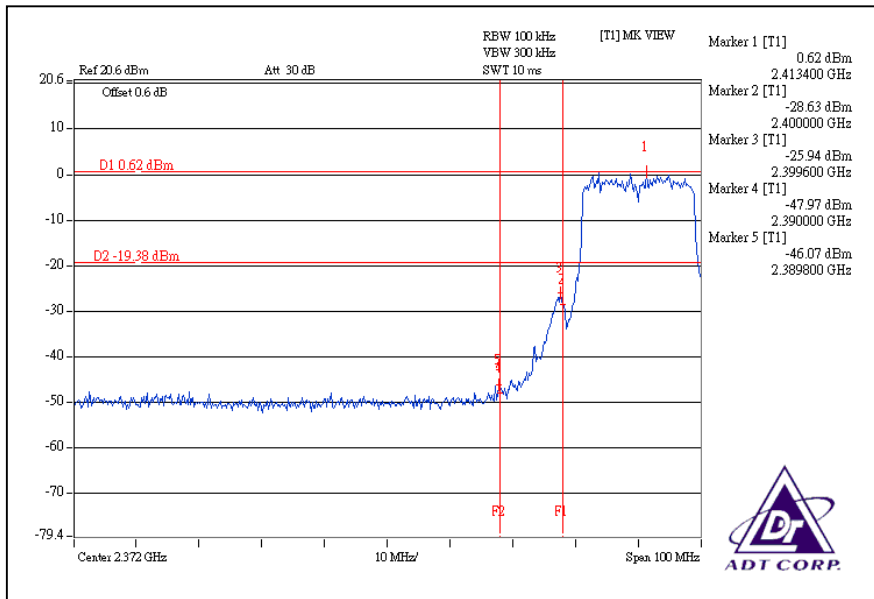

CH11

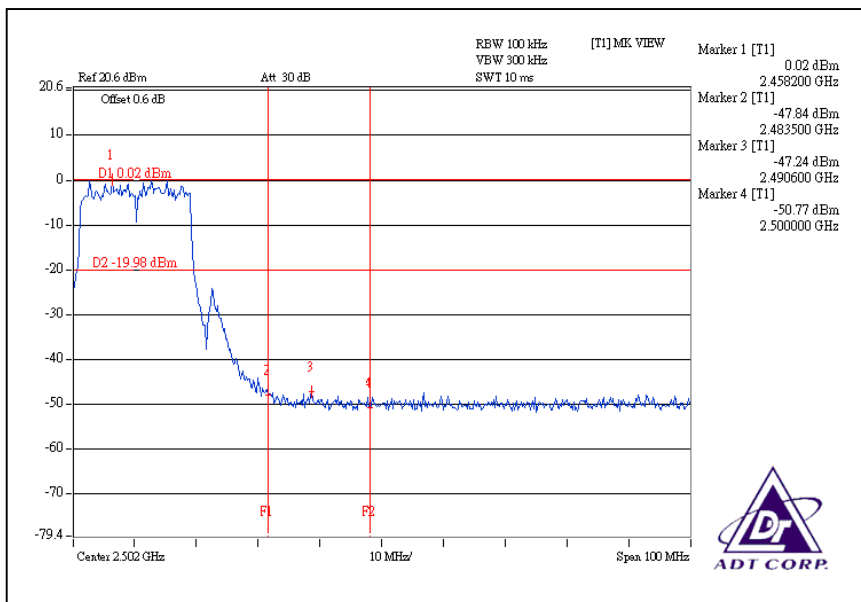

CH1

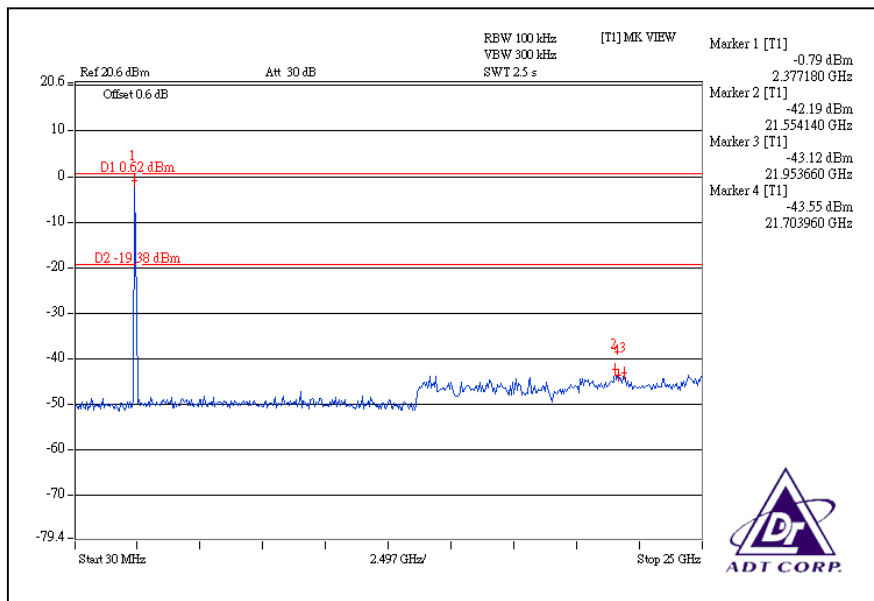

CH11

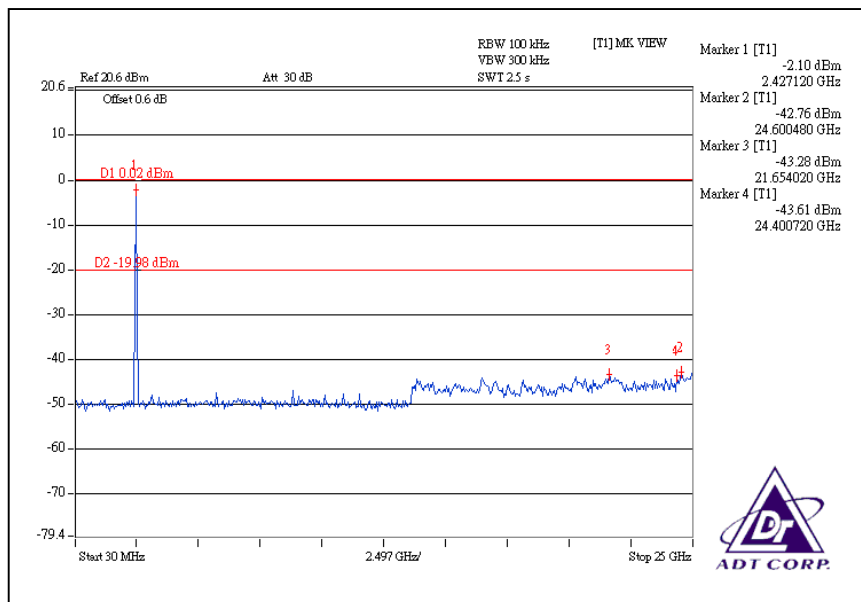

DRAFT 802.11n (40MHz) OFDM MODULATION:
For Chain (0):CH1

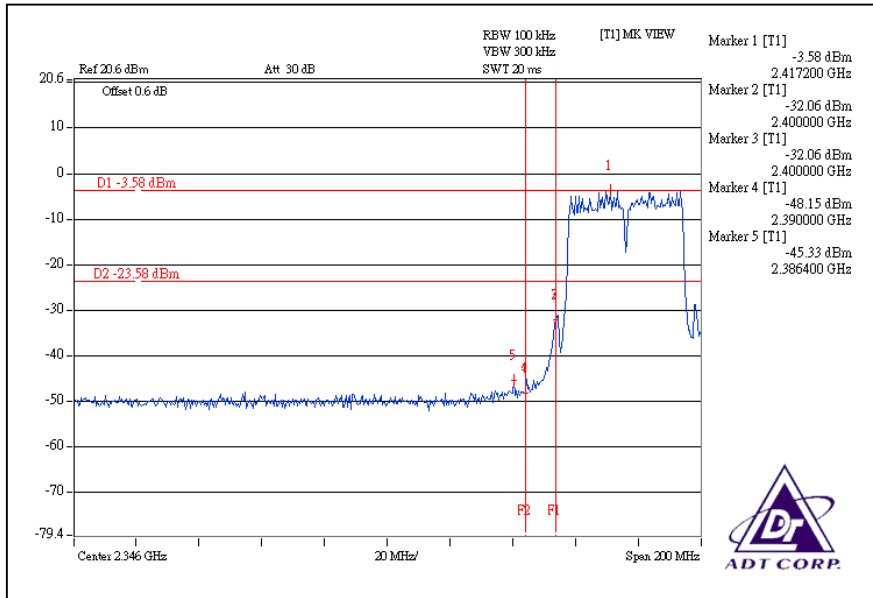

CH7

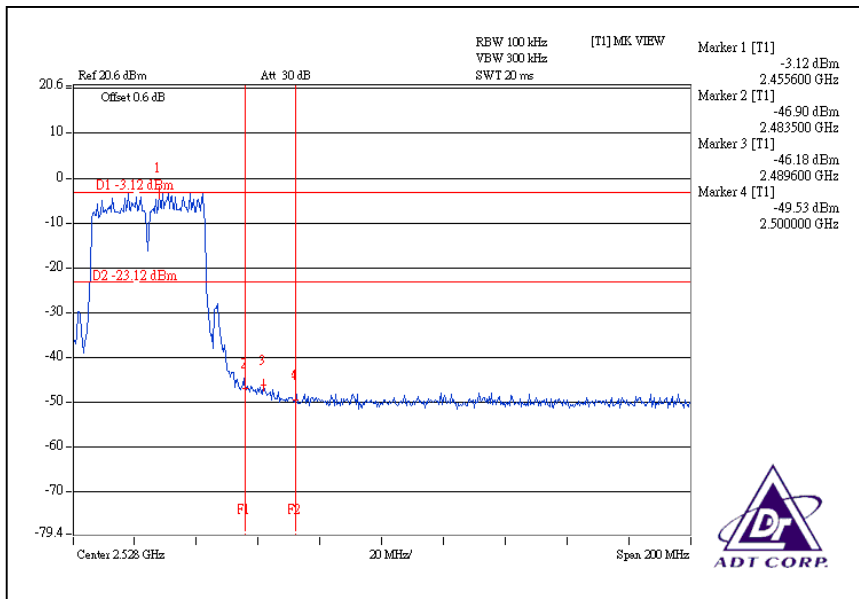

CH1

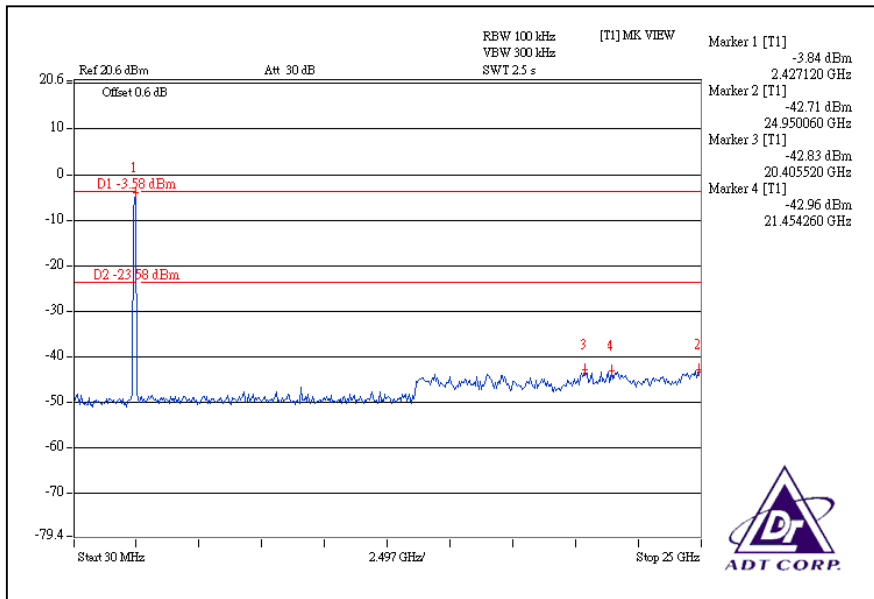

CH7

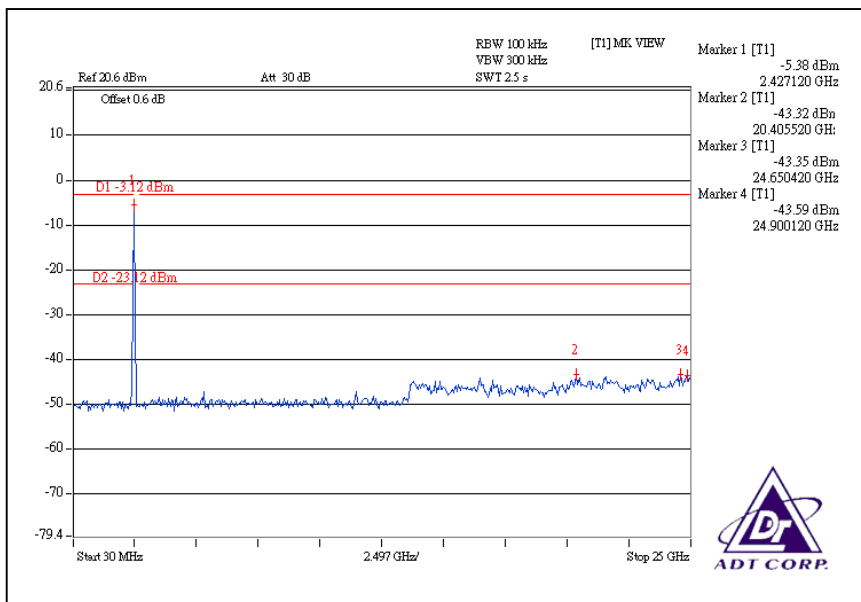

For Chain (1):CH1

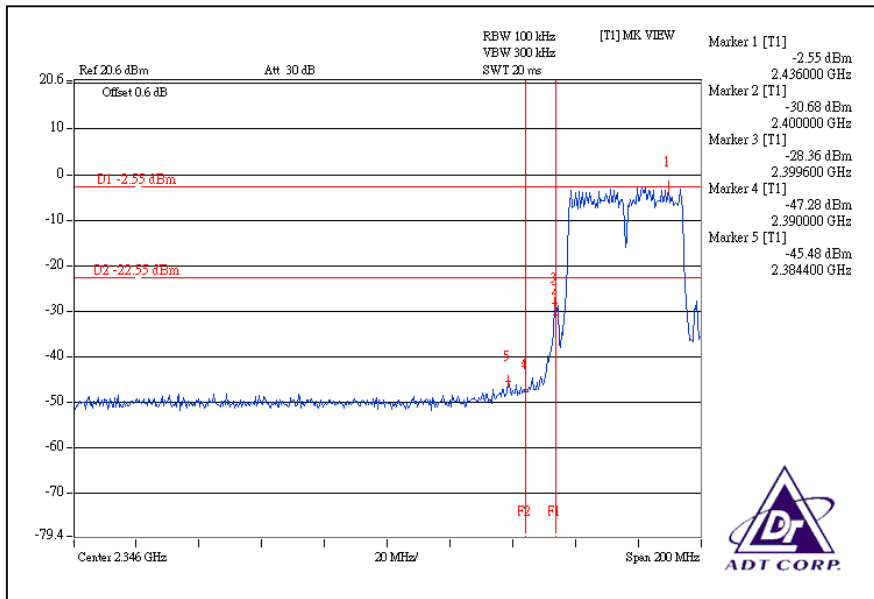

CH7

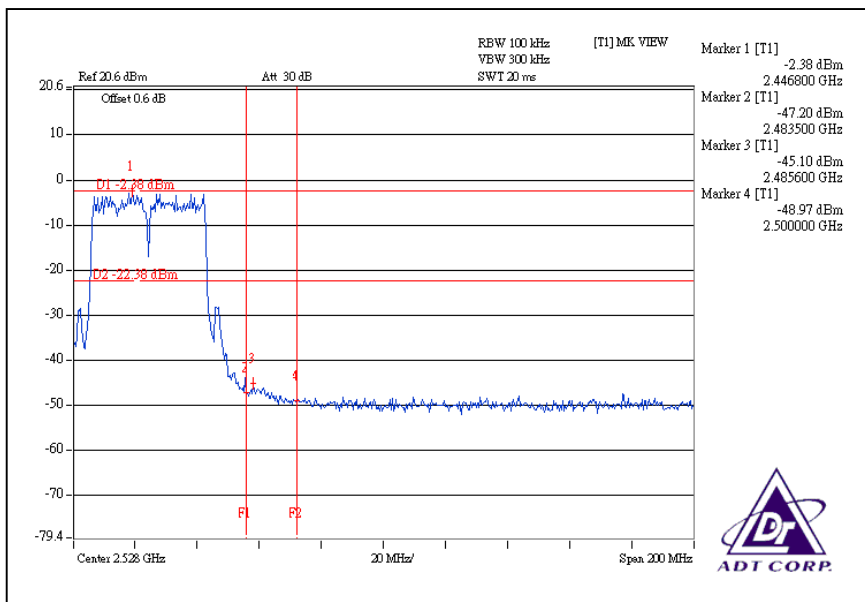

CH1

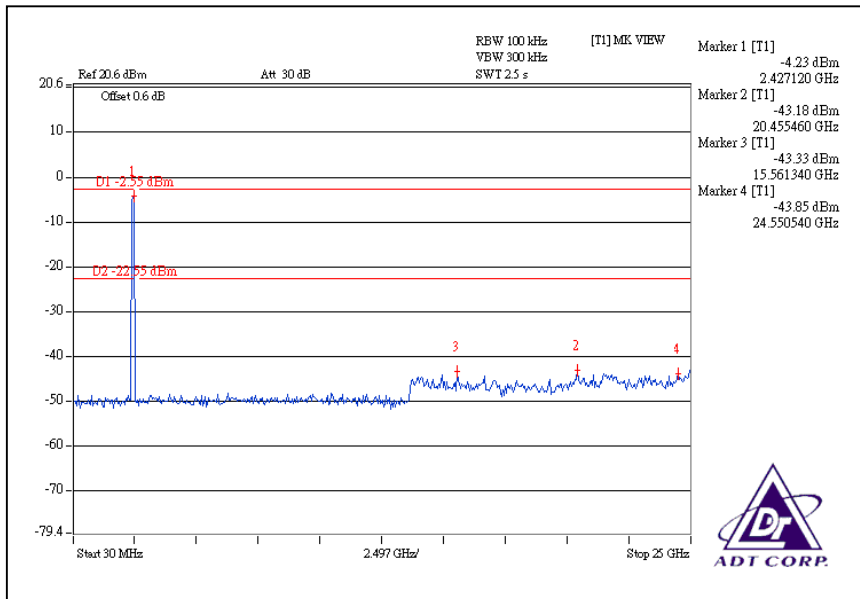

CH7

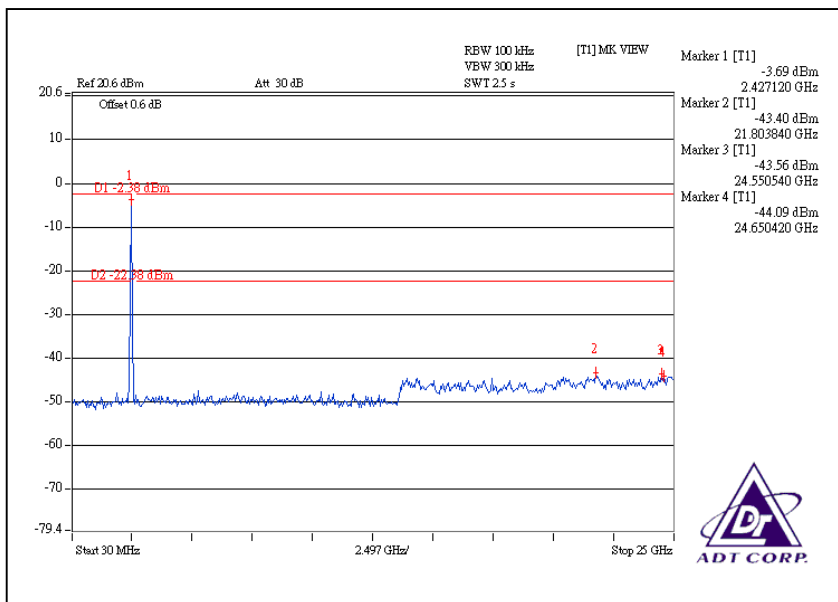

4.7 ANTENNA REQUIREMENT

4.7.1 STANDARD APPLICABLE

For intentional device, according to FCC 47 CFR Section 15.203, an intentional radiator shall be designed to ensure that no antenna other than that furnished by the responsible party shall be used with the device. And according to FCC 47 CFR Section 15.247 (b), if transmitting antennas of directional gain greater than 6dBi are used, the power shall be reduced by the amount in dB that the directional gain of the antenna exceeds 6dBi.

4.7.2 ANTENNA CONNECTED CONSTRUCTION

There three antennas provided to this EUT, please refer to the following table:

Transmitter Circuit	Antenna Type	For 2.4GHz Gain (dBi)	For 5GHz Gain (dBi)	Antenna Connector	Note
Chain(0)	PIFA	0.75	3	NA	TX & RX function
Chain(1)	PIFA	1.5	2.23	NA	TX & RX function
Chain(2)	PIFA	3.5	2.5	NA	Only RX function

5. TEST TYPES AND RESULTS (802.11a, 5725~5850MHz Band)

5.1 CONDUCTED EMISSION MEASUREMENT

5.1.1 LIMITS OF CONDUCTED EMISSION MEASUREMENT

FREQUENCY OF EMISSION (MHz)	CONDUCTED LIMIT (dB μ V)	
	Quasi-peak	Average
0.15-0.5	66 to 56	56 to 46
0.5-5	56	46
5-30	60	50

- NOTE:**
1. The lower limit shall apply at the transition frequencies.
 2. The limit decreases in line with the logarithm of the frequency in the range of 0.15 to 0.50 MHz.
 3. All emanations from a class A/B digital device or system, including any network of conductors and apparatus connected thereto, shall not exceed the level of field strengths specified above.

5.1.2 TEST INSTRUMENTS

DESCRIPTION & MANUFACTURER	MODEL NO.	SERIAL NO.	CALIBRATED UNTIL
ROHDE & SCHWARZ Test Receiver	ESCS 30	100287	Mar. 10, 2009
Line-Impedance Stabilization Network(for EUT)	KNW-407	8-1395-12	Aug. 19, 2008
Line-Impedance Stabilization Network(for Peripheral)	ENV-216	100072	Nov. 08, 2008
RF Cable (JETBAO)	RG5B/U-6m	COACAB-9KHz-3 0MHz	Aug. 15, 2008
50 ohms Terminator	50	3	Nov. 15, 2008
Software	ADT_Cond_V7.3.2	NA	NA

- NOTE:**
1. The calibration interval of the above test instruments is 12 months and the calibrations are traceable to NML/ROC and NIST/USA.
 2. The test was performed in ADT Shielded Room No. A.
 3. The VCCI Con A Registration No. is C-817.

5.1.3 TEST PROCEDURES

- a. The EUT was placed 0.4 meters from the conducting wall of the shielded room with EUT being connected to the power mains through a line impedance stabilization network (LISN). Other support units were connected to the power mains through another LISN. The two LISNs provide 50 ohm/50uH of coupling impedance for the measuring instrument.
- b. Both lines of the power mains connected to the EUT were checked for maximum conducted interference.
- c. The frequency range from 150kHz to 30MHz was searched. Emission levels under (Limit – 20dB) were not recorded.

5.1.4 DEVIATION FROM TEST STANDARD

No deviation

5.1.5 TEST SETUP

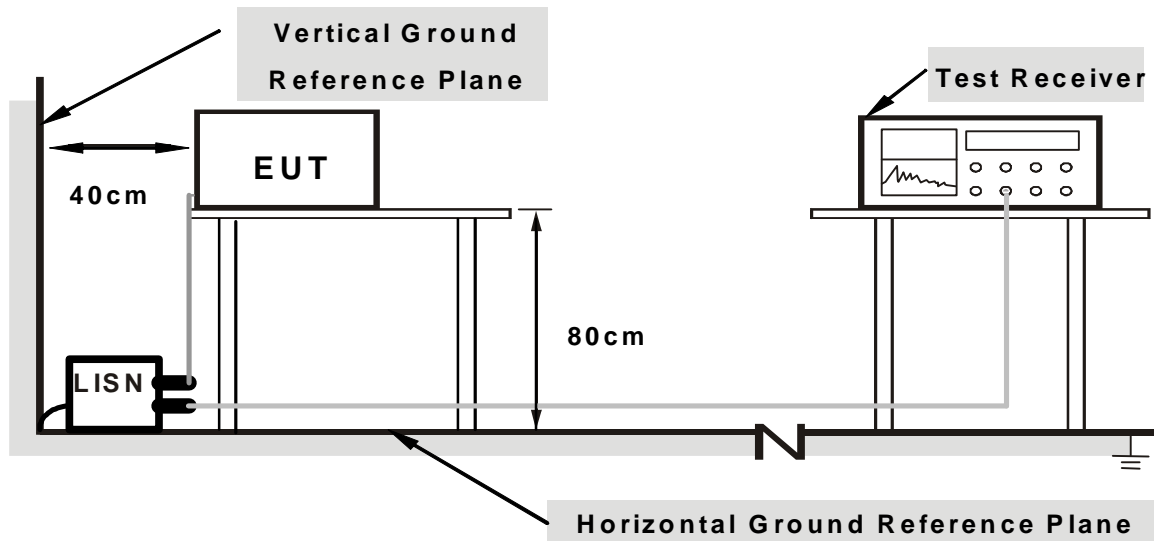

Note: 1. Support units were connected to second LISN.

2. Both of LISNs (AMN) are 80 cm from EUT and at least 80 from other units and other metal planes

For the actual test configuration, please refer to the related item – Photographs of the Test Configuration.

5.1.6 EUT OPERATING CONDITIONS

Same as the 4.1.6

5.1.7 TEST RESULTS – Adapter 1

802.11a OFDM MODULATION:

EUT TEST CONDITION		MEASUREMENT DETAIL	
CHANNEL	Channel 4	PHASE	Line (L)
MODULATION TYPE	BPSK	6dB BANDWIDTH	9 kHz
TRANSFER RATE	6Mbps	INPUT POWER	120Vac, 60 Hz
ENVIRONMENTAL CONDITIONS	25deg. C, 70%RH, 971hPa	TESTED BY	Mike Hsieh

No	Freq. [MHz]	Corr. Factor (dB)	Reading Value [dB (uV)]		Emission Level [dB (uV)]		Limit [dB (uV)]		Margin (dB)	
			Q.P.	AV.	Q.P.	AV.	Q.P.	AV.	Q.P.	AV.
			1	0.193	0.34	53.46	-	53.80	-	63.90
2	0.255	0.27	47.46	-	47.73	-	61.58	51.58	-13.84	-
3	0.447	0.12	39.29	-	39.41	-	56.94	46.94	-17.53	-
4	0.512	0.14	40.45	-	40.59	-	56.00	46.00	-15.41	-
5	9.898	0.55	38.28	-	38.83	-	60.00	50.00	-21.17	-
6	22.824	0.93	29.18	-	30.11	-	60.00	50.00	-29.89	-

- REMARKS:**
1. Q.P. and AV. are abbreviations of quasi-peak and average individually.
 2. "-": The Quasi-peak reading value also meets average limit and measurement with the average detector is unnecessary.
 3. The emission levels of other frequencies were very low against the limit.
 4. Margin value = Emission level - Limit value
 5. Correction factor = Insertion loss + Cable loss
 6. Emission Level = Correction Factor + Reading Value.

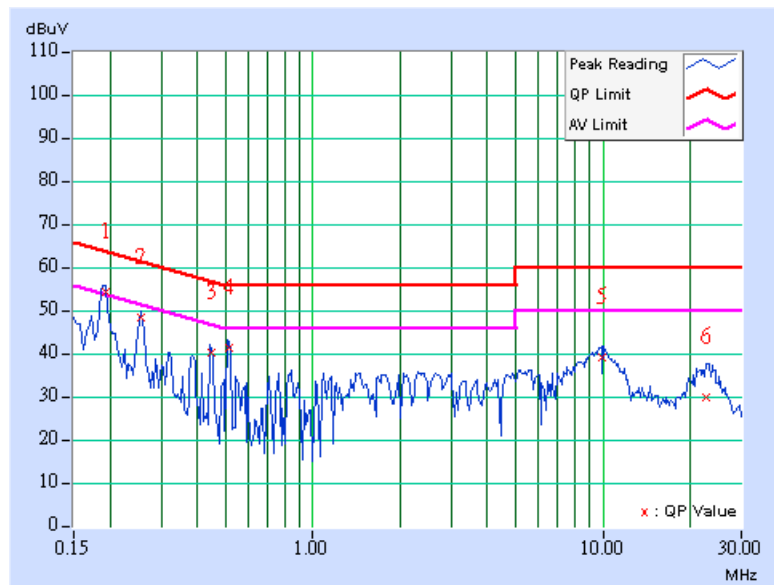

EUT TEST CONDITION		MEASUREMENT DETAIL	
CHANNEL	Channel 4	PHASE	Neutral (N)
MODULATION TYPE	BPSK	6dB BANDWIDTH	9 kHz
TRANSFER RATE	6Mbps	INPUT POWER	120Vac, 60 Hz
ENVIRONMENTAL CONDITIONS	25deg. C, 70%RH, 971hPa	TESTED BY	Mike Hsieh

No	Freq. [MHz]	Corr. Factor (dB)	Reading Value		Emission Level		Limit		Margin	
			[dB (uV)]		[dB (uV)]		[dB (uV)]		(dB)	
			Q.P.	AV.	Q.P.	AV.	Q.P.	AV.	Q.P.	AV.
1	0.192	0.36	53.68	46.06	54.04	46.42	63.96	53.96	-9.92	-7.54
2	0.254	0.29	46.57	-	46.86	-	61.61	51.61	-14.75	-
3	0.448	0.11	39.83	-	39.94	-	56.92	46.92	-16.98	-
4	0.513	0.13	38.68	-	38.81	-	56.00	46.00	-17.19	-
5	9.218	0.52	36.81	-	37.33	-	60.00	50.00	-22.67	-
6	22.621	0.92	30.56	-	31.48	-	60.00	50.00	-28.52	-

- REMARKS:**
1. Q.P. and AV. are abbreviations of quasi-peak and average individually.
 2. "-": The Quasi-peak reading value also meets average limit and measurement with the average detector is unnecessary.
 3. The emission levels of other frequencies were very low against the limit.
 4. Margin value = Emission level - Limit value
 5. Correction factor = Insertion loss + Cable loss
 6. Emission Level = Correction Factor + Reading Value.

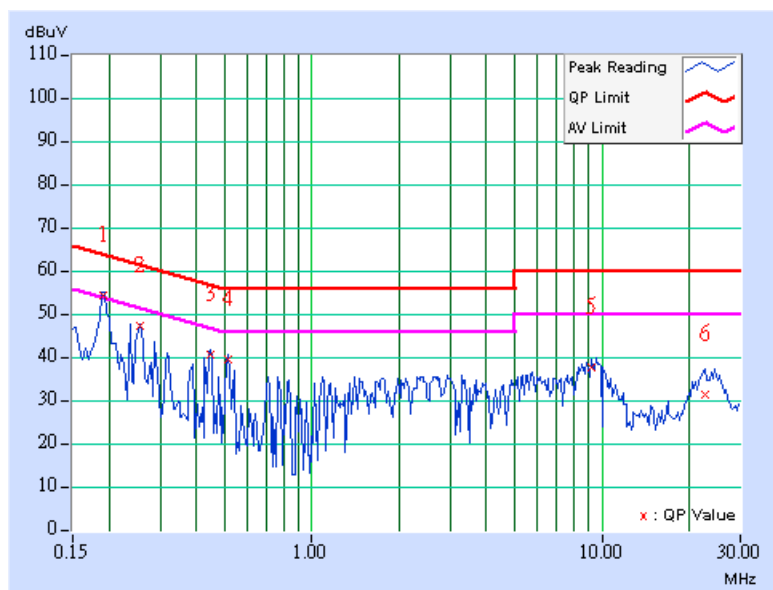

5.1.8 TEST RESULTS – Adapter 2

802.11a OFDM MODULATION:

EUT TEST CONDITION		MEASUREMENT DETAIL	
CHANNEL	Channel 4	PHASE	Line (L)
MODULATION TYPE	BPSK	6dB BANDWIDTH	9 kHz
TRANSFER RATE	6Mbps	INPUT POWER	120Vac, 60 Hz
ENVIRONMENTAL CONDITIONS	25deg. C, 70%RH, 971hPa	TESTED BY	Mike Hsieh

No	Freq. [MHz]	Corr. Factor (dB)	Reading Value		Emission Level		Limit		Margin	
			[dB (uV)]		[dB (uV)]		[dB (uV)]		(dB)	
			Q.P.	AV.	Q.P.	AV.	Q.P.	AV.	Q.P.	AV.
1	0.185	0.34	53.82	-	54.16	-	64.25	54.25	-10.09	-
2	0.242	0.29	46.41	-	46.70	-	62.01	52.01	-15.31	-
3	0.299	0.22	39.42	-	39.64	-	60.26	50.26	-20.62	-
4	0.451	0.12	38.81	-	38.93	-	56.86	46.86	-17.93	-
5	9.289	0.53	35.53	-	36.06	-	60.00	50.00	-23.94	-
6	15.109	0.86	35.21	-	36.07	-	60.00	50.00	-23.93	-

- REMARKS:**
1. Q.P. and AV. are abbreviations of quasi-peak and average individually.
 2. "-": The Quasi-peak reading value also meets average limit and measurement with the average detector is unnecessary.
 3. The emission levels of other frequencies were very low against the limit.
 4. Margin value = Emission level - Limit value
 5. Correction factor = Insertion loss + Cable loss
 6. Emission Level = Correction Factor + Reading Value.

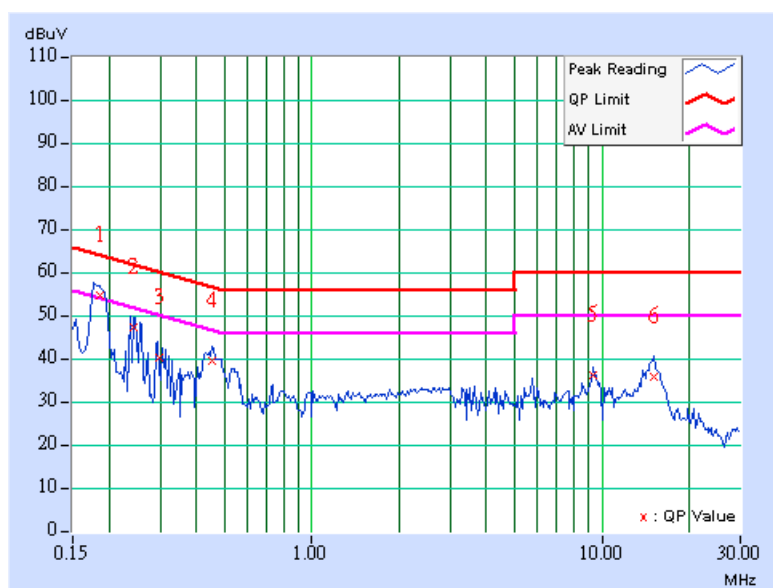

EUT TEST CONDITION		MEASUREMENT DETAIL	
CHANNEL	Channel 4	PHASE	Neutral (N)
MODULATION TYPE	BPSK	6dB BANDWIDTH	9 kHz
TRANSFER RATE	6Mbps	INPUT POWER	120Vac, 60 Hz
ENVIRONMENTAL CONDITIONS	25deg. C, 70%RH, 971hPa	TESTED BY	Mike Hsieh

No	Freq. [MHz]	Corr. Factor (dB)	Reading Value [dB (uV)]		Emission Level [dB (uV)]		Limit [dB (uV)]		Margin (dB)	
			Q.P.	AV.	Q.P.	AV.	Q.P.	AV.	Q.P.	AV.
			1	0.173	0.37	55.19	38.15	55.56	38.52	64.79
2	0.232	0.32	47.44	-	47.76	-	62.38	52.38	-14.62	-
3	0.298	0.23	40.19	-	40.42	-	60.29	50.29	-19.87	-
4	0.474	0.12	37.62	-	37.74	-	56.44	46.44	-18.70	-
5	2.904	0.34	26.12	-	26.46	-	56.00	46.00	-29.54	-
6	15.281	0.86	38.70	-	39.56	-	60.00	50.00	-20.44	-

- REMARKS:**
1. Q.P. and AV. are abbreviations of quasi-peak and average individually.
 2. "-": The Quasi-peak reading value also meets average limit and measurement with the average detector is unnecessary.
 3. The emission levels of other frequencies were very low against the limit.
 4. Margin value = Emission level - Limit value
 5. Correction factor = Insertion loss + Cable loss
 6. Emission Level = Correction Factor + Reading Value.

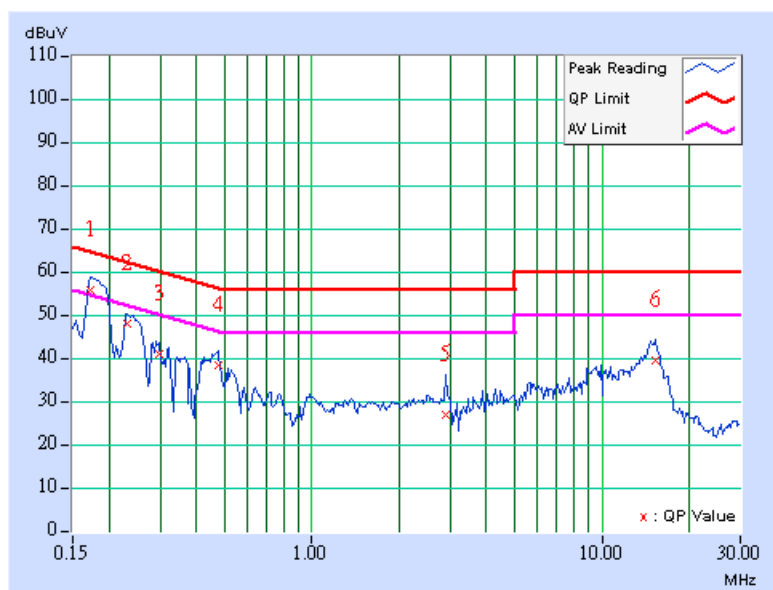

5.1.9 TEST RESULTS – Adapter 3

802.11a OFDM MODULATION:

EUT TEST CONDITION		MEASUREMENT DETAIL	
CHANNEL	Channel 4	PHASE	Line (L)
MODULATION TYPE	BPSK	6dB BANDWIDTH	9 kHz
TRANSFER RATE	6Mbps	INPUT POWER	120Vac, 60 Hz
ENVIRONMENTAL CONDITIONS	25deg. C, 70%RH, 971hPa	TESTED BY	Mike Hsieh

No	Freq. [MHz]	Corr. Factor (dB)	Reading Value		Emission Level		Limit		Margin	
			[dB (uV)]		[dB (uV)]		[dB (uV)]		(dB)	
			Q.P.	AV.	Q.P.	AV.	Q.P.	AV.	Q.P.	AV.
1	0.189	0.34	52.43	-	52.77	-	64.08	54.08	-11.30	-
2	0.259	0.27	48.84	-	49.11	-	61.45	51.45	-12.34	-
3	0.259	0.27	48.80	-	49.07	-	61.45	51.45	-12.38	-
4	0.384	0.12	54.31	44.91	54.43	45.03	58.18	48.18	-3.76	-3.16
5	0.494	0.13	43.40	-	43.53	-	56.10	46.10	-12.57	-
6	0.584	0.17	49.20	40.56	49.37	40.73	56.00	46.00	-6.63	-5.27
7	0.658	0.19	47.36	35.26	47.55	35.45	56.00	46.00	-8.45	-10.55
8	0.740	0.22	44.36	-	44.58	-	56.00	46.00	-11.42	-
9	0.849	0.26	46.93	35.89	47.19	36.15	56.00	46.00	-8.81	-9.85
10	1.568	0.30	45.06	-	45.36	-	56.00	46.00	-10.64	-
11	2.353	0.30	44.38	-	44.68	-	56.00	46.00	-11.32	-
12	3.926	0.41	42.33	-	42.74	-	56.00	46.00	-13.26	-

- REMARKS:**
1. Q.P. and AV. are abbreviations of quasi-peak and average individually.
 2. "-": The Quasi-peak reading value also meets average limit and measurement with the average detector is unnecessary.
 3. The emission levels of other frequencies were very low against the limit.
 4. Margin value = Emission level - Limit value
 5. Correction factor = Insertion loss + Cable loss
 6. Emission Level = Correction Factor + Reading Value.

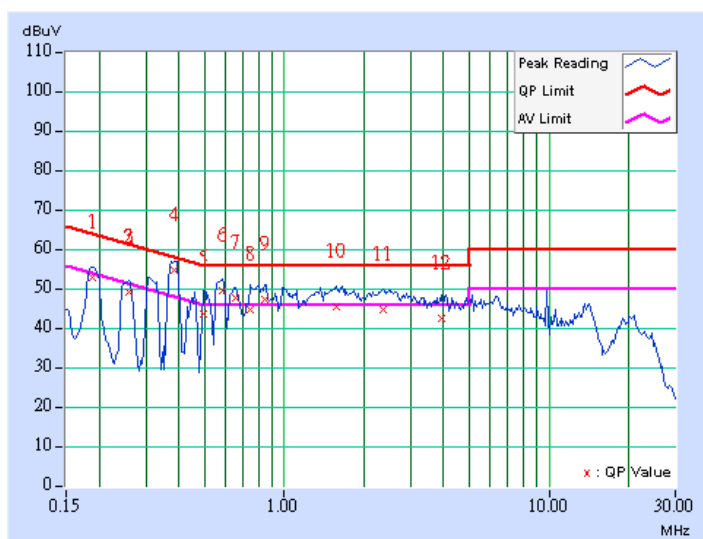

EUT TEST CONDITION		MEASUREMENT DETAIL	
CHANNEL	Channel 4	PHASE	Neutral (N)
MODULATION TYPE	BPSK	6dB BANDWIDTH	9 kHz
TRANSFER RATE	6Mbps	INPUT POWER	120Vac, 60 Hz
ENVIRONMENTAL CONDITIONS	25deg. C, 70%RH, 971hPa	TESTED BY	Mike Hsieh

No	Freq. [MHz]	Corr. Factor (dB)	Reading Value [dB (uV)]		Emission Level [dB (uV)]		Limit [dB (uV)]		Margin (dB)	
			Q.P.	AV.	Q.P.	AV.	Q.P.	AV.	Q.P.	AV.
			1	0.193	0.36	51.44	-	51.80	-	63.91
2	0.267	0.27	49.18	-	49.45	-	61.20	51.20	-11.76	-
3	0.310	0.21	52.29	43.85	52.50	44.06	59.97	49.97	-7.46	-5.90
4	0.380	0.12	53.79	45.13	53.91	45.25	58.27	48.27	-4.36	-3.02
5	0.399	0.09	54.51	42.04	54.60	42.13	57.88	47.88	-3.28	-5.75
6	0.509	0.13	42.73	-	42.86	-	56.00	46.00	-13.14	-
7	0.591	0.16	49.76	39.10	49.92	39.26	56.00	46.00	-6.08	-6.74
8	0.662	0.19	46.64	33.88	46.83	34.07	56.00	46.00	-9.17	-11.93
9	0.755	0.23	43.31	-	43.54	-	56.00	46.00	-12.46	-
10	0.861	0.27	46.07	34.09	46.34	34.36	56.00	46.00	-9.66	-11.64
11	1.388	0.30	45.96	35.87	46.26	36.17	56.00	46.00	-9.74	-9.83
12	2.201	0.29	44.26	-	44.55	-	56.00	46.00	-11.45	-
13	2.986	0.34	42.72	-	43.06	-	56.00	46.00	-12.94	-

- REMARKS:**
1. Q.P. and AV. are abbreviations of quasi-peak and average individually.
 2. "-": The Quasi-peak reading value also meets average limit and measurement with the average detector is unnecessary.
 3. The emission levels of other frequencies were very low against the limit.
 4. Margin value = Emission level - Limit value
 5. Correction factor = Insertion loss + Cable loss
 6. Emission Level = Correction Factor + Reading Value.

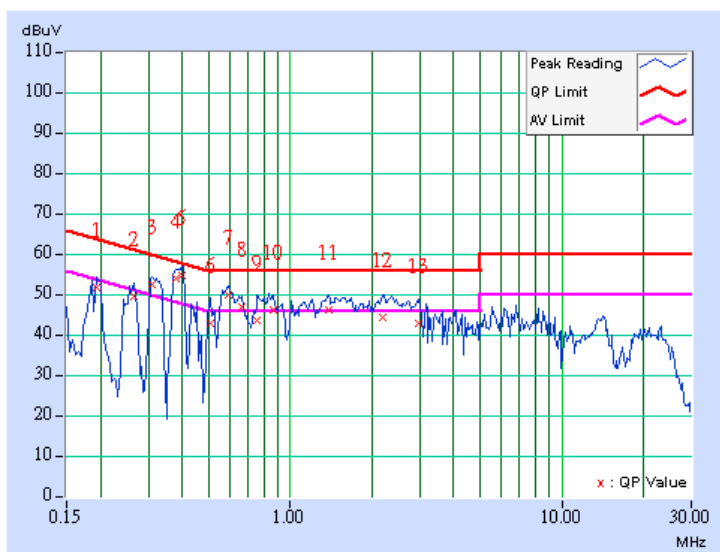

5.1.10 TEST RESULTS – Adapter 4

802.11a OFDM MODULATION:

EUT TEST CONDITION		MEASUREMENT DETAIL	
CHANNEL	Channel 4	PHASE	Line (L)
MODULATION TYPE	BPSK	6dB BANDWIDTH	9 kHz
TRANSFER RATE	6Mbps	INPUT POWER	120Vac, 60 Hz
ENVIRONMENTAL CONDITIONS	25deg. C, 70%RH, 971hPa	TESTED BY	Mike Hsieh

No	Freq. [MHz]	Corr. Factor (dB)	Reading Value [dB (uV)]		Emission Level [dB (uV)]		Limit [dB (uV)]		Margin (dB)	
			Q.P.	AV.	Q.P.	AV.	Q.P.	AV.	Q.P.	AV.
			1	0.189	0.34	53.64	-	53.98	-	64.08
2	0.252	0.28	46.29	-	46.57	-	61.71	51.71	-15.14	-
3	0.314	0.20	38.10	-	38.30	-	59.86	49.86	-21.56	-
4	0.504	0.14	39.87	-	40.01	-	56.00	46.00	-15.99	-
5	2.966	0.34	33.95	-	34.29	-	56.00	46.00	-21.71	-
6	24.453	0.96	35.36	-	36.32	-	60.00	50.00	-23.68	-

- REMARKS:**
1. Q.P. and AV. are abbreviations of quasi-peak and average individually.
 2. "-": The Quasi-peak reading value also meets average limit and measurement with the average detector is unnecessary.
 3. The emission levels of other frequencies were very low against the limit.
 4. Margin value = Emission level - Limit value
 5. Correction factor = Insertion loss + Cable loss
 6. Emission Level = Correction Factor + Reading Value.

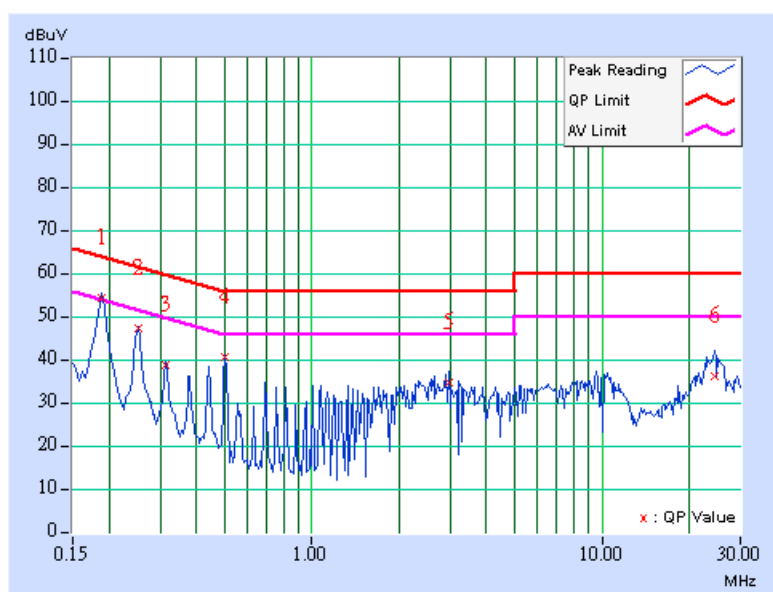

EUT TEST CONDITION		MEASUREMENT DETAIL	
CHANNEL	Channel 4	PHASE	Neutral (N)
MODULATION TYPE	BPSK	6dB BANDWIDTH	9 kHz
TRANSFER RATE	6Mbps	INPUT POWER	120Vac, 60 Hz
ENVIRONMENTAL CONDITIONS	25deg. C, 70%RH, 971hPa	TESTED BY	Mike Hsieh

No	Freq. [MHz]	Corr. Factor (dB)	Reading Value		Emission Level		Limit		Margin	
			[dB (uV)]		[dB (uV)]		[dB (uV)]		(dB)	
			Q.P.	AV.	Q.P.	AV.	Q.P.	AV.	Q.P.	AV.
1	0.189	0.36	54.38	46.89	54.74	47.25	64.08	54.08	-9.33	-6.82
2	0.252	0.29	47.74	-	48.03	-	61.71	51.71	-13.68	-
3	0.442	0.11	39.61	-	39.72	-	57.03	47.03	-17.32	-
4	0.504	0.13	41.83	-	41.96	-	56.00	46.00	-14.04	-
5	9.418	0.53	36.46	-	36.99	-	60.00	50.00	-23.01	-
6	11.024	0.61	37.84	-	38.45	-	60.00	50.00	-21.55	-

- REMARKS:**
1. Q.P. and AV. are abbreviations of quasi-peak and average individually.
 2. "-": The Quasi-peak reading value also meets average limit and measurement with the average detector is unnecessary.
 3. The emission levels of other frequencies were very low against the limit.
 4. Margin value = Emission level - Limit value
 5. Correction factor = Insertion loss + Cable loss
 6. Emission Level = Correction Factor + Reading Value.

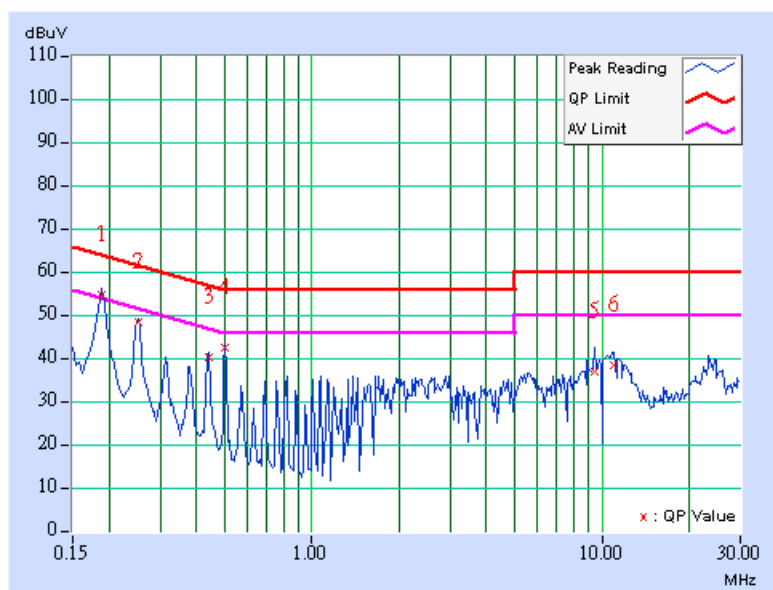

5.2 RADIATED EMISSION MEASUREMENT

5.2.1 LIMITS OF RADIATED EMISSION MEASUREMENT

Emissions radiated outside of the specified bands, shall be according to the general radiated limits in 15.209 as following:

Frequencies (MHz)	Field strength (microvolts/meter)	Measurement distance (meters)
0.009-0.490	2400/F(kHz)	300
0.490-1.705	24000/F(kHz)	30
1.705-30.0	30	30
30-88	100	3
88-216	150	3
216-960	200	3
Above 960	500	3

NOTE:

1. The lower limit shall apply at the transition frequencies.
2. Emission level (dBuV/m) = 20 log Emission level (uV/m).
3. As shown in 15.35(b), for frequencies above 1000MHz, the field strength limits are based on average detector, however, the peak field strength of any emission shall not exceed the maximum permitted average limits, specified above by more than 20dB under any condition of modulation.



5.2.2 TEST INSTRUMENTS

For below 1GHz:

DESCRIPTION & MANUFACTURER	MODEL NO.	SERIAL NO.	CALIBRATED UNTIL
ADVANTEST Spectrum Analyzer	R3271A	85060311	July 15, 2008
HP Pre_Amplifier	8449B	3008A01922	Oct. 04, 2008
ROHDE & SCHWARZ Test Receiver	ESCS30	100375	Mar. 31, 2009
SCHWARZBECK TRILOG Broadband Antenna	VULB 9168	138	July 26, 2008
Schwarzbeck Horn_Antenna	BBHA9120	D124	Dec. 16, 2008
Schwarzbeck Horn_Antenna	BBHA 9170	BBHA9170153	Jan. 27, 2009
RF Switches (ARNITSU)	CS-201	1565157	Aug. 13, 2008
RF CABLE (Chaintek)	SF102	22054-2	Dec. 06. 2008
RF Cable(RICHTEC)	9913-30M N-N Cable	STCCAB-30M-1 GHz	Aug. 13, 2008
Software	ADT_Radiated_V 7.6.15.8	NA	NA
CHANCE MOST Antenna Tower	AT-100	0203	NA
CHANCE MOST Turn Table	TT-100	0203	NA

- Note: 1. The calibration interval of the above test instruments is 12 months and the calibrations are traceable to NML/ROC and NIST/USA.
2. The horn antenna, HP preamplifier (model: 8449B) and Spectrum Analyzer (model: R3271A) are used only for the measurement of emission frequency above 1GHz if tested.
3. The test was performed in ADT Open Site No. C.
4. The FCC Site Registration No. is 656396.
5. The VCCI Site Registration No. is R-1626.
6. The CANADA Site Registration No. is IC 3789C-3.



For Above 1GHz:

DESCRIPTION & MANUFACTURER	MODEL NO.	SERIAL NO.	CALIBRATED UNTIL
ADVANTEST Spectrum Analyzer	R3271A	85060311	July 15, 2009
HP Pre_Amplifier	8449B	3008A01922	Oct. 04, 2008
ROHDE & SCHWARZ Test Receiver	ESCS30	100375	Mar. 31, 2009
SCHWARZBECK TRILOG Broadband Antenna	VULB 9168	138	April 29, 2009
Schwarzbeck Horn_Antenna	BBHA9120	D124	Dec. 16, 2008
Schwarzbeck Horn_Antenna	BBHA 9170	BBHA9170153	Jan. 27, 2009
R&S Loop Antenna	HFH2-Z2	100070	Jan. 13, 2009
RF Switches (ARNITSU)	CS-201	1565157	Aug. 13, 2009
RF CABLE	SF102	22054-2	Dec. 06. 2008
RF Cable	8DFB	STCCAB-30M-1 GHz	Oct. 09, 2008
Software	ADT_Radiated_V 7.6.15.8	NA	NA
CHANCE MOST Antenna Tower	AT-100	0203	NA
CHANCE MOST Turn Table	TT-100	0203	NA

- Note: 1. The calibration interval of the above test instruments is 12 months and the calibrations are traceable to NML/ROC and NIST/USA.
 2. The horn antenna, HP preamplifier (model: 8449B) and Spectrum Analyzer (model: R3271A) are used only for the measurement of emission frequency above 1GHz if tested.
 3. The test was performed in ADT Open Site No. C.
 4. The FCC Site Registration No. is 656396.
 5. The VCCI Site Registration No. is R-1626.
 6. The CANADA Site Registration No. is IC 3789C-3.

5.2.3 TEST PROCEDURES

- a. The EUT was placed on the top of a rotating table 0.8 meters above the ground at a 3 meter semi-anechoic chamber. The table was rotated 360 degrees to determine the position of the highest radiation.
- b. The EUT was set 3 meters away from the interference-receiving antenna, which was mounted on the top of a variable-height antenna tower.
- c. The antenna is a broadband antenna, and its height is varied from one meter to four meters above the ground to determine the maximum value of the field strength. Both horizontal and vertical polarizations of the antenna are set to make the measurement.
- d. For each suspected emission, the EUT was arranged to its worst case and then the antenna was tuned to heights from 1 meter to 4 meters and the rotatable table was turned from 0 degrees to 360 degrees to find the maximum reading.
- e. The test-receiver system was set to Peak Detect Function and Specified Bandwidth with Maximum Hold Mode.
- f. If the emission level of the EUT in peak mode was 10dB lower than the limit specified, then testing could be stopped and the peak values of the EUT would be reported. Otherwise the emissions that did not have 10dB margin would be re-tested one by one using peak, quasi-peak or average method as specified and then reported in a data sheet.

NOTE:

1. The resolution bandwidth and video bandwidth of test receiver/spectrum analyzer is 120kHz for Peak detection (PK) and Quasi-peak detection (QP) at frequency below 1GHz.
2. The resolution bandwidth of test receiver/spectrum analyzer is 1 MHz and the video bandwidth is 3 MHz for Peak detection (PK) at frequency above 1GHz.
3. The resolution bandwidth of test receiver/spectrum analyzer is 1 MHz and the video bandwidth is 10 Hz for Average detection (AV) at frequency above 1GHz.

5.2.4 DEVIATION FROM TEST STANDARD

No deviation

5.2.5 TEST SETUP

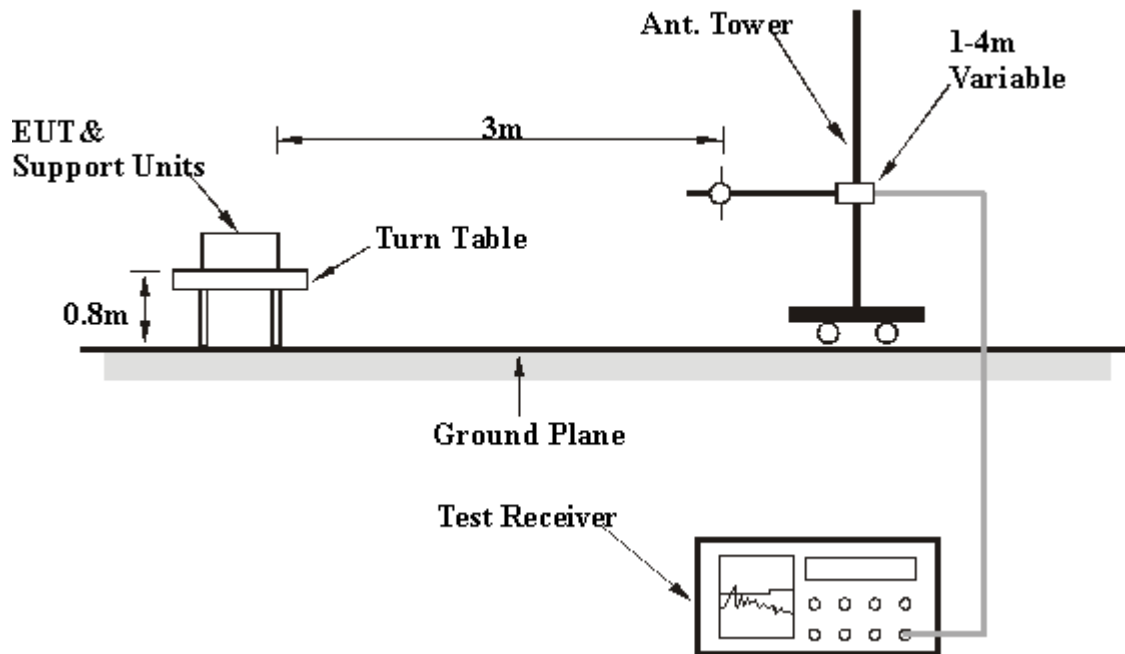

For the actual test configuration, please refer to the related item – Photographs of the Test Configuration.

5.2.6 EUT OPERATING CONDITIONS

Same as the 4.1.6



Below 1GHz Test Data

5.2.7 TEST RESULTS

BELOW 1GHz WORST-CASE DATA : 802.11a OFDM MODULATION

EUT TEST CONDITION		MEASUREMENT DETAIL	
CHANNEL	Channel 1	FREQUENCY RANGE	Below 1000MHz
INPUT POWER	120Vac, 60 Hz	DETECTOR FUNCTION	Quasi-Peak
ENVIRONMENTAL CONDITIONS	25deg. C, 75%RH 965hPa	TESTED BY	Frank Liu

ANTENNA POLARITY & TEST DISTANCE: HORIZONTAL AT 3 M								
NO.	FREQ. (MHz)	EMISSION LEVEL (dBuV/m)	LIMIT (dBuV/m)	MARGIN (dB)	ANTENNA HEIGHT (m)	TABLE ANGLE (Degree)	RAW VALUE (dBuV)	CORRECTION FACTOR (dB/m)
1	125.00	38.90 QP	43.50	-4.60	1.35 H	85	25.67	13.23
2	201.90	31.97 QP	43.50	-11.53	1.44 H	82	19.91	12.06
3	250.01	37.85 QP	46.00	-8.15	1.00 H	260	25.02	12.83
4	300.00	37.24 QP	46.00	-8.76	1.00 H	282	20.65	16.59
5	375.01	34.85 QP	46.00	-11.15	1.03 H	213	17.37	17.48
6	450.00	33.68 QP	46.00	-12.32	1.82 H	12	13.80	19.88
7	500.00	32.23 QP	46.00	-13.77	1.56 H	190	11.18	21.05
8	625.02	33.21 QP	46.00	-12.79	1.71 H	86	9.21	24.00
9	900.00	34.67 QP	46.00	-11.33	1.80 H	43	5.00	29.67

ANTENNA POLARITY & TEST DISTANCE: VERTICAL AT 3 M								
NO.	FREQ. (MHz)	EMISSION LEVEL (dBuV/m)	LIMIT (dBuV/m)	MARGIN (dB)	ANTENNA HEIGHT (m)	TABLE ANGLE (Degree)	RAW VALUE (dBuV)	CORRECTION FACTOR (dB/m)
1	46.45	36.63 QP	40.00	-3.37	1.00 V	1	20.73	15.90
2	125.00	40.61 QP	43.50	-2.89	1.00 V	224	27.38	13.23
3	250.00	33.13 QP	46.00	-12.87	1.14 V	173	20.30	12.83
4	375.00	37.88 QP	46.00	-8.12	1.29 V	224	20.40	17.48
5	384.01	33.29 QP	46.00	-12.71	1.14 V	178	15.60	17.69
6	500.01	34.02 QP	46.00	-11.98	1.00 V	333	12.97	21.05
7	625.01	37.31 QP	46.00	-8.69	1.00 V	15	13.31	24.00
8	750.00	35.17 QP	46.00	-10.83	1.28 V	296	7.91	27.26

- REMARKS:**
1. Emission level (dBuV/m) = Raw Value (dBuV) + Correction Factor (dB/m).
 2. Correction Factor (dB/m) = Antenna Factor (dB/m) + Cable Factor (dB).
 3. The other emission levels were very low against the limit.
 4. Margin value = Emission level – Limit value.

Above 1GHz Test Data

5.2.8 TEST RESULTS

802.11a OFDM MODULATION

EUT TEST CONDITION		MEASUREMENT DETAIL	
CHANNEL	Channel 1	FREQUENCY RANGE	1 ~ 40GHz
INPUT POWER	120Vac, 60 Hz	DETECTOR FUNCTION	Peak (PK) Average (AV)
ENVIRONMENTAL CONDITIONS	25deg. C, 75%RH 965hPa	TESTED BY	Rex Huang

ANTENNA POLARITY & TEST DISTANCE: HORIZONTAL AT 3 M								
NO.	FREQ. (MHz)	EMISSION LEVEL (dBuV/m)	LIMIT (dBuV/m)	MARGIN (dB)	ANTENNA HEIGHT (m)	TABLE ANGLE (Degree)	RAW VALUE (dBuV)	CORRECTION FACTOR (dB/m)
1	*5745.00	118.13 PK			1.19 H	73	80.92	37.21
2	*5745.00	107.20 AV			1.19 H	73	69.99	37.21
3	#11490.00	60.18 PK	74.00	-13.82	1.31 H	348	13.15	47.03
4	#11490.00	46.75 AV	54.00	-7.25	1.31 H	348	-0.28	47.03
ANTENNA POLARITY & TEST DISTANCE: VERTICAL AT 3 M								
NO.	FREQ. (MHz)	EMISSION LEVEL (dBuV/m)	LIMIT (dBuV/m)	MARGIN (dB)	ANTENNA HEIGHT (m)	TABLE ANGLE (Degree)	RAW VALUE (dBuV)	CORRECTION FACTOR (dB/m)
1	*5745.00	110.89 PK			1.00 V	185	73.68	37.21
2	*5745.00	101.80 AV			1.00 V	185	64.59	37.21
3	#11490.00	59.76 PK	74.00	-14.24	1.21 V	55	12.73	47.03
4	#11490.00	46.12 AV	54.00	-7.88	1.21 V	55	-0.91	47.03

- REMARKS:**
1. Emission level (dBuV/m) = Raw Value (dBuV) + Correction Factor (dB/m).
 2. Correction Factor (dB/m) = Antenna Factor (dB/m) + Cable Factor (dB).
 3. The other emission levels were very low against the limit.
 4. Margin value = Emission level – Limit value.
 5. “ * ”: Fundamental frequency.
 6. “ # ”: The radiated frequency falling in the restricted band.
 7. The limit value is defined as per 15.247.

EUT TEST CONDITION		MEASUREMENT DETAIL	
CHANNEL	Channel 3	FREQUENCY RANGE	1 ~ 40GHz
INPUT POWER (SYSTEM)	120Vac, 60 Hz	DETECTOR FUNCTION	Peak (PK) Average (AV)
ENVIRONMENTAL CONDITIONS	25deg. C, 66%RH 967hPa	TESTED BY	Frank Liu

ANTENNA POLARITY & TEST DISTANCE: HORIZONTAL AT 3 M								
NO.	FREQ. (MHz)	EMISSION LEVEL (dBuV/m)	LIMIT (dBuV/m)	MARGIN (dB)	ANTENNA HEIGHT (m)	TABLE ANGLE (Degree)	RAW VALUE (dBuV)	CORRECTION FACTOR (dB/m)
1	*5785.00	118.00 PK			1.18 H	79	80.69	37.31
2	*5785.00	107.00 AV			1.18 H	79	69.69	37.31
3	#11570.00	60.00 PK	74.00	-14.00	1.36 H	356	13.03	46.97
4	#11570.00	45.70 AV	54.00	-8.30	1.36 H	356	-1.27	46.97
ANTENNA POLARITY & TEST DISTANCE: VERTICAL AT 3 M								
NO.	FREQ. (MHz)	EMISSION LEVEL (dBuV/m)	LIMIT (dBuV/m)	MARGIN (dB)	ANTENNA HEIGHT (m)	TABLE ANGLE (Degree)	RAW VALUE (dBuV)	CORRECTION FACTOR (dB/m)
1	*5785.00	110.70 PK			1.01 V	182	73.39	37.31
2	*5785.00	99.20 AV			1.01 V	182	61.89	37.31
3	#11570.00	62.30 PK	74.00	-11.70	1.25 V	57	15.33	46.97
4	#11570.00	47.20 AV	54.00	-6.80	1.25 V	57	0.23	46.97

- REMARKS:**
1. Emission level (dBuV/m) = Raw Value (dBuV) + Correction Factor (dB/m).
 2. Correction Factor (dB/m) = Antenna Factor (dB/m) + Cable Factor (dB).
 3. The other emission levels were very low against the limit.
 4. Margin value = Emission level – Limit value.
 5. “ * ”: Fundamental frequency.
 6. “ # ”: The radiated frequency falling in the restricted band.
 7. The limit value is defined as per 15.247.



EUT TEST CONDITION		MEASUREMENT DETAIL	
CHANNEL	Channel 4	FREQUENCY RANGE	1 ~ 40GHz
INPUT POWER (SYSTEM)	120Vac, 60 Hz	DETECTOR FUNCTION	Peak (PK) Average (AV)
ENVIRONMENTAL CONDITIONS	25deg. C, 66%RH 967hPa	TESTED BY	Frank Liu

ANTENNA POLARITY & TEST DISTANCE: HORIZONTAL AT 3 M								
NO.	FREQ. (MHz)	EMISSION LEVEL (dBuV/m)	LIMIT (dBuV/m)	MARGIN (dB)	ANTENNA HEIGHT (m)	TABLE ANGLE (Degree)	RAW VALUE (dBuV)	CORRECTION FACTOR (dB/m)
1	*5805.00	118.50 PK			1.15 H	275	81.13	37.37
2	*5805.00	106.40 AV			1.15 H	275	69.03	37.37
3	#11610.00	60.30 PK	74.00	-13.70	1.00 H	135	13.37	46.93
4	#11610.00	46.20 AV	54.00	-7.80	1.00 H	135	-0.73	46.93
ANTENNA POLARITY & TEST DISTANCE: VERTICAL AT 3 M								
NO.	FREQ. (MHz)	EMISSION LEVEL (dBuV/m)	LIMIT (dBuV/m)	MARGIN (dB)	ANTENNA HEIGHT (m)	TABLE ANGLE (Degree)	RAW VALUE (dBuV)	CORRECTION FACTOR (dB/m)
1	*5805.00	110.00 PK			1.00 V	184	72.63	37.37
2	*5805.00	98.40 AV			1.00 V	184	61.03	37.37
3	#11610.00	64.20 PK	74.00	-9.80	1.19 V	54	17.27	46.93
4	#11610.00	49.70 AV	54.00	-4.30	1.19 V	54	2.77	46.93

- REMARKS:**
1. Emission level (dBuV/m) = Raw Value (dBuV) + Correction Factor (dB/m).
 2. Correction Factor (dB/m) = Antenna Factor (dB/m) + Cable Factor (dB).
 3. The other emission levels were very low against the limit.
 4. Margin value = Emission level – Limit value.
 5. “ * “: Fundamental frequency.
 6. “ # “: The radiated frequency falling in the restricted band.
 7. The limit value is defined as per 15.247.



DRAFT 802.11n (20MHz) OFDM MODULATION

EUT TEST CONDITION		MEASUREMENT DETAIL	
CHANNEL	Channel 1	FREQUENCY RANGE	1 ~ 40GHz
INPUT POWER (SYSTEM)	120Vac, 60 Hz	DETECTOR FUNCTION	Peak (PK) Average (AV)
ENVIRONMENTAL CONDITIONS	25deg. C, 66%RH 967hPa	TESTED BY	Frank Liu

ANTENNA POLARITY & TEST DISTANCE: HORIZONTAL AT 3 M								
NO.	FREQ. (MHz)	EMISSION LEVEL (dBuV/m)	LIMIT (dBuV/m)	MARGIN (dB)	ANTENNA HEIGHT (m)	TABLE ANGLE (Degree)	RAW VALUE (dBuV)	CORRECTION FACTOR (dB/m)
1	*5745.00	119.10 PK			1.19 H	75	81.89	37.21
2	*5745.00	104.70 AV			1.19 H	75	67.49	37.21
3	#11490.00	60.00 PK	74.00	-14.00	1.37 H	348	12.97	47.03
4	#11490.00	45.80 AV	54.00	-8.20	1.37 H	348	-1.23	47.03
ANTENNA POLARITY & TEST DISTANCE: VERTICAL AT 3 M								
NO.	FREQ. (MHz)	EMISSION LEVEL (dBuV/m)	LIMIT (dBuV/m)	MARGIN (dB)	ANTENNA HEIGHT (m)	TABLE ANGLE (Degree)	RAW VALUE (dBuV)	CORRECTION FACTOR (dB/m)
1	*5745.00	111.20 PK			1.00 V	171	73.99	37.21
2	*5745.00	97.80 AV			1.00 V	171	60.59	37.21
3	#11490.00	61.20 PK	74.00	-12.80	1.22 V	52	14.17	47.03
4	#11490.00	46.30 AV	54.00	-7.70	1.22 V	52	-0.73	47.03

- REMARKS:**
1. Emission level (dBuV/m) = Raw Value (dBuV) + Correction Factor (dB/m).
 2. Correction Factor (dB/m) = Antenna Factor (dB/m) + Cable Factor (dB).
 3. The other emission levels were very low against the limit.
 4. Margin value = Emission level – Limit value.
 5. “ * “: Fundamental frequency.
 6. “ # “: The radiated frequency falling in the restricted band.
 7. The limit value is defined as per 15.247.

EUT TEST CONDITION		MEASUREMENT DETAIL	
CHANNEL	Channel 3	FREQUENCY RANGE	1 ~ 40GHz
INPUT POWER (SYSTEM)	120Vac, 60 Hz	DETECTOR FUNCTION	Peak (PK) Average (AV)
ENVIRONMENTAL CONDITIONS	25deg. C, 66%RH 967hPa	TESTED BY	Frank Liu

ANTENNA POLARITY & TEST DISTANCE: HORIZONTAL AT 3 M								
NO.	FREQ. (MHz)	EMISSION LEVEL (dBuV/m)	LIMIT (dBuV/m)	MARGIN (dB)	ANTENNA HEIGHT (m)	TABLE ANGLE (Degree)	RAW VALUE (dBuV)	CORRECTION FACTOR (dB/m)
1	*5785.00	118.20 PK			1.20 H	84	80.89	37.31
2	*5785.00	104.50 AV			1.20 H	84	67.19	37.31
3	#11570.00	62.40 PK	74.00	-11.60	1.20 H	84	15.43	46.97
4	#11570.00	47.50 AV	54.00	-6.50	1.20 H	84	0.53	46.97
ANTENNA POLARITY & TEST DISTANCE: VERTICAL AT 3 M								
NO.	FREQ. (MHz)	EMISSION LEVEL (dBuV/m)	LIMIT (dBuV/m)	MARGIN (dB)	ANTENNA HEIGHT (m)	TABLE ANGLE (Degree)	RAW VALUE (dBuV)	CORRECTION FACTOR (dB/m)
1	*5785.00	111.80 PK			1.09 V	145	74.49	37.31
2	*5785.00	98.20 AV			1.09 V	145	60.89	37.31
3	#11570.00	63.80 PK	74.00	-10.20	1.26 V	60	16.83	46.97
4	#11570.00	49.70 AV	54.00	-4.30	1.26 V	60	2.73	46.97

- REMARKS:**
1. Emission level (dBuV/m) = Raw Value (dBuV) + Correction Factor (dB/m).
 2. Correction Factor (dB/m) = Antenna Factor (dB/m) + Cable Factor (dB).
 3. The other emission levels were very low against the limit.
 4. Margin value = Emission level – Limit value.
 5. “ * “: Fundamental frequency.
 6. “ # “: The radiated frequency falling in the restricted band.
 7. The limit value is defined as per 15.247.



EUT TEST CONDITION		MEASUREMENT DETAIL	
CHANNEL	Channel 4	FREQUENCY RANGE	1 ~ 40GHz
INPUT POWER (SYSTEM)	120Vac, 60 Hz	DETECTOR FUNCTION	Peak (PK) Average (AV)
ENVIRONMENTAL CONDITIONS	25deg. C, 66%RH 967hPa	TESTED BY	Frank Liu

ANTENNA POLARITY & TEST DISTANCE: HORIZONTAL AT 3 M								
NO.	FREQ. (MHz)	EMISSION LEVEL (dBuV/m)	LIMIT (dBuV/m)	MARGIN (dB)	ANTENNA HEIGHT (m)	TABLE ANGLE (Degree)	RAW VALUE (dBuV)	CORRECTION FACTOR (dB/m)
1	*5805.00	117.80 PK			1.28 H	86	80.43	37.37
2	*5805.00	104.30 AV			1.28 H	86	66.93	37.37
3	#11610.00	59.70 PK	74.00	-14.30	1.00 H	136	12.77	46.93
4	#11610.00	45.70 AV	54.00	-8.30	1.00 H	136	-1.23	46.93

ANTENNA POLARITY & TEST DISTANCE: VERTICAL AT 3 M								
NO.	FREQ. (MHz)	EMISSION LEVEL (dBuV/m)	LIMIT (dBuV/m)	MARGIN (dB)	ANTENNA HEIGHT (m)	TABLE ANGLE (Degree)	RAW VALUE (dBuV)	CORRECTION FACTOR (dB/m)
1	*5805.00	112.00 PK			1.08 V	155	74.63	37.37
2	*5805.00	98.30 AV			1.08 V	155	60.93	37.37
3	#11610.00	63.60 PK	74.00	-10.40	1.19 V	57	16.67	46.93
4	#11610.00	49.10 AV	54.00	-4.90	1.19 V	57	2.17	46.93

- REMARKS:**
1. Emission level (dBuV/m) = Raw Value (dBuV) + Correction Factor (dB/m).
 2. Correction Factor (dB/m) = Antenna Factor (dB/m) + Cable Factor (dB).
 3. The other emission levels were very low against the limit.
 4. Margin value = Emission level – Limit value.
 5. “ * “: Fundamental frequency.
 6. “ # “: The radiated frequency falling in the restricted band.
 7. The limit value is defined as per 15.247.

DRAFT 802.11n (40MHz) OFDM MODULATION

EUT TEST CONDITION		MEASUREMENT DETAIL	
CHANNEL	Channel 1	FREQUENCY RANGE	1 ~ 40GHz
INPUT POWER (SYSTEM)	120Vac, 60 Hz	DETECTOR FUNCTION	Peak (PK) Average (AV)
ENVIRONMENTAL CONDITIONS	25deg. C, 66%RH 967hPa	TESTED BY	Frank Liu

ANTENNA POLARITY & TEST DISTANCE: HORIZONTAL AT 3 M								
NO.	FREQ. (MHz)	EMISSION LEVEL (dBuV/m)	LIMIT (dBuV/m)	MARGIN (dB)	ANTENNA HEIGHT (m)	TABLE ANGLE (Degree)	RAW VALUE (dBuV)	CORRECTION FACTOR (dB/m)
1	*5755.00	115.30 PK			1.28 H	279	78.07	37.23
2	*5755.00	101.01 AV			1.28 H	279	63.78	37.23
3	#11510.00	57.10 PK	74.00	-16.90	1.01 H	132	10.08	47.02
4	#11510.00	44.10 AV	54.00	-9.90	1.01 H	132	-2.92	47.02
ANTENNA POLARITY & TEST DISTANCE: VERTICAL AT 3 M								
NO.	FREQ. (MHz)	EMISSION LEVEL (dBuV/m)	LIMIT (dBuV/m)	MARGIN (dB)	ANTENNA HEIGHT (m)	TABLE ANGLE (Degree)	RAW VALUE (dBuV)	CORRECTION FACTOR (dB/m)
1	*5755.00	108.10 PK			1.20 V	170	70.87	37.23
2	*5755.00	94.10 AV			1.20 V	170	56.87	37.23
3	#11510.00	58.90 PK	74.00	-15.10	1.15 V	52	11.88	47.02
4	#11510.00	45.60 AV	54.00	-8.40	1.15 V	52	-1.42	47.02

- REMARKS:**
1. Emission level (dBuV/m) = Raw Value (dBuV) + Correction Factor (dB/m).
 2. Correction Factor (dB/m) = Antenna Factor (dB/m) + Cable Factor (dB).
 3. The other emission levels were very low against the limit.
 4. Margin value = Emission level – Limit value.
 5. “ * “: Fundamental frequency.
 6. “ # “: The radiated frequency falling in the restricted band.
 7. The limit value is defined as per 15.247.



EUT TEST CONDITION		MEASUREMENT DETAIL	
CHANNEL	Channel 3	FREQUENCY RANGE	1 ~ 40GHz
INPUT POWER (SYSTEM)	120Vac, 60 Hz	DETECTOR FUNCTION	Peak (PK) Average (AV)
ENVIRONMENTAL CONDITIONS	25deg. C, 66%RH 967hPa	TESTED BY	Frank Liu

ANTENNA POLARITY & TEST DISTANCE: HORIZONTAL AT 3 M								
NO.	FREQ. (MHz)	EMISSION LEVEL (dBuV/m)	LIMIT (dBuV/m)	MARGIN (dB)	ANTENNA HEIGHT (m)	TABLE ANGLE (Degree)	RAW VALUE (dBuV)	CORRECTION FACTOR (dB/m)
1	*5795.00	115.80 PK			1.28 H	280	78.46	37.34
2	*5795.00	101.30 AV			1.28 H	280	63.96	37.34
3	#11590.00	58.20 PK	74.00	-15.80	1.06 H	137	11.25	46.95
4	#11590.00	44.90 AV	54.00	-9.10	1.06 H	137	-2.05	46.95
ANTENNA POLARITY & TEST DISTANCE: VERTICAL AT 3 M								
NO.	FREQ. (MHz)	EMISSION LEVEL (dBuV/m)	LIMIT (dBuV/m)	MARGIN (dB)	ANTENNA HEIGHT (m)	TABLE ANGLE (Degree)	RAW VALUE (dBuV)	CORRECTION FACTOR (dB/m)
1	*5795.00	109.70 PK			1.08 V	161	72.36	37.34
2	*5795.00	95.20 AV			1.08 V	161	57.86	37.34
3	#11510.00	60.10 PK	74.00	-13.90	1.14 V	53	13.08	47.02
4	#11510.00	46.60 AV	54.00	-7.40	1.14 V	53	-0.42	47.02

- REMARKS:**
1. Emission level (dBuV/m) = Raw Value (dBuV) + Correction Factor (dB/m).
 2. Correction Factor (dB/m) = Antenna Factor (dB/m) + Cable Factor (dB).
 3. The other emission levels were very low against the limit.
 4. Margin value = Emission level – Limit value.
 5. “ * “: Fundamental frequency.
 6. “ # “: The radiated frequency falling in the restricted band.
 7. The limit value is defined as per 15.247.

5.3 6dB BANDWIDTH MEASUREMENT

5.3.1 LIMITS OF 6dB BANDWIDTH MEASUREMENT

The minimum of 6dB Bandwidth Measurement is 0.5 MHz.

5.3.2 TEST INSTRUMENTS

Description & Manufacturer	Model No.	Serial No.	Calibrated Until
R&S SPECTRUM ANALYZER	FSP40	100037	Aug. 12, 2009

NOTE:

- 1.The measurement uncertainty is less than +/- 2.6dB, which is calculated as per the NAMAS document NIS81. This uncertainty represents an expanded uncertainty expressed at approximately the 95% confidence level using a coverage factor of k=2.
- 2.The calibration interval of the above test instruments is 12 months and the calibrations are traceable to NML/ROC and NIST/USA.

5.3.3 TEST PROCEDURE

The transmitter output was connected to the spectrum analyzer through an attenuator. The bandwidth of the fundamental frequency was measured by spectrum analyzer with 100kHz RBW and 100kHz VBW. The 6dB bandwidth is defined as the total spectrum the power of which is higher than peak power minus 6dB.

5.3.4 DEVIATION FROM TEST STANDARD

No deviation

5.3.5 TEST SETUP



5.3.6 EUT OPERATING CONDITIONS

The software provided by client to enable the EUT under transmission condition continuously at lowest, middle and highest channel frequencies individually.

5.3.7 TEST RESULTS

802.11a OFDM MODULATION:

MODULATION TYPE	BPSK	TRANSFER RATE	6Mbps
INPUT POWER	120Vac, 60 Hz	ENVIRONMENTAL CONDITIONS	25deg. C, 60%RH, 955hPa
TESTED BY	Rex Huang		

CHANNEL	CHANNEL FREQUENCY (MHz)	6dB BANDWIDTH (MHz)		MINIMUM LIMIT (MHz)	PASS / FAIL
		CHAIN(0)	CHAIN(1)		
1	5745	16.43	16.42	0.5	PASS
3	5785	16.39	16.36	0.5	PASS
4	5805	16.39	16.40	0.5	PASS

For Chain (0): CH1

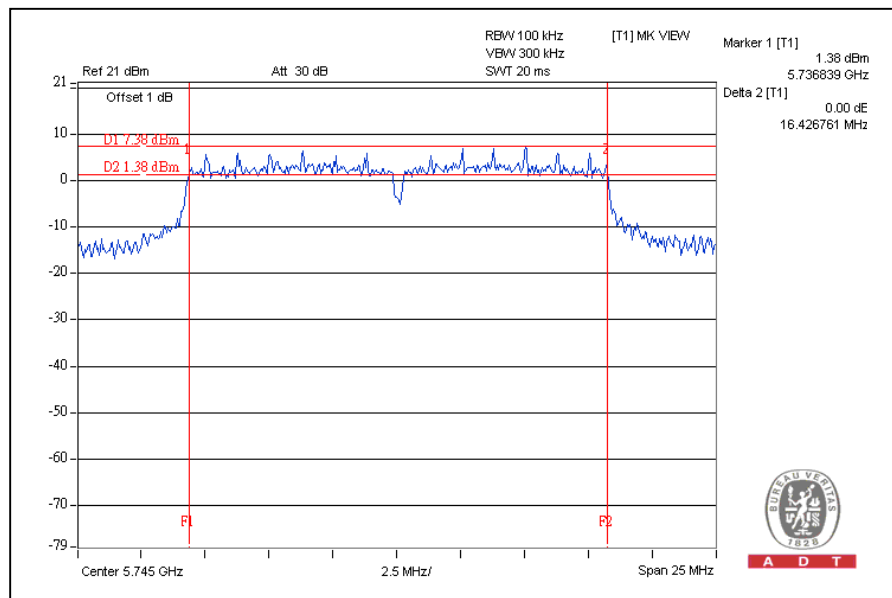

CH3

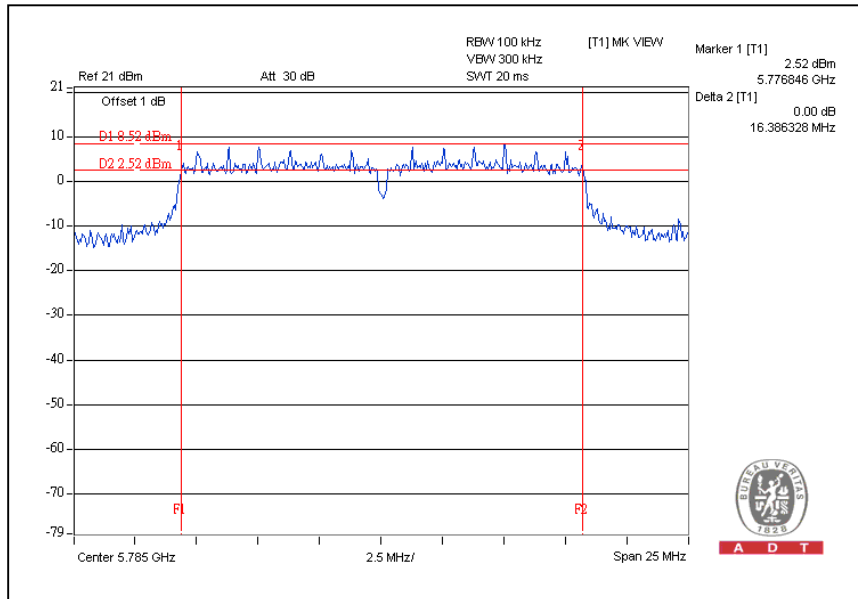

CH4

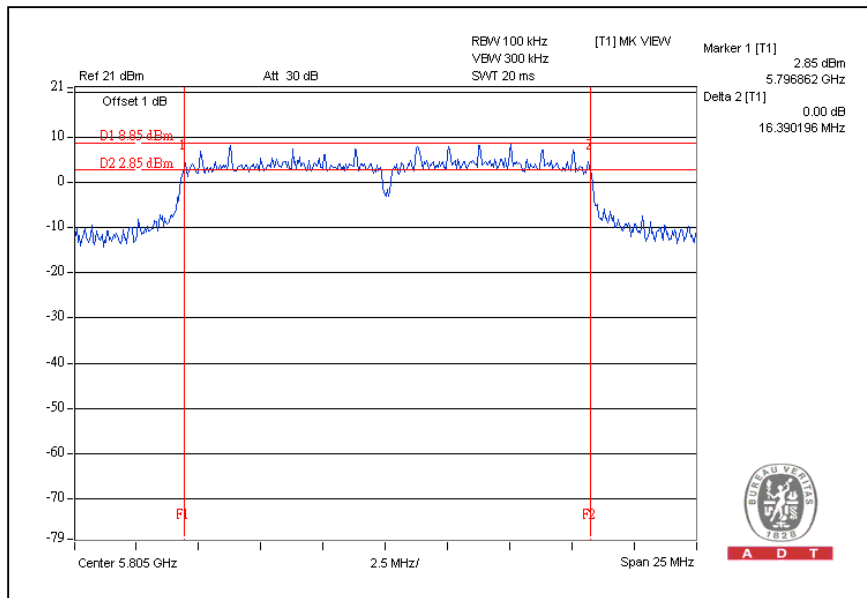

For Chain (1): CH1

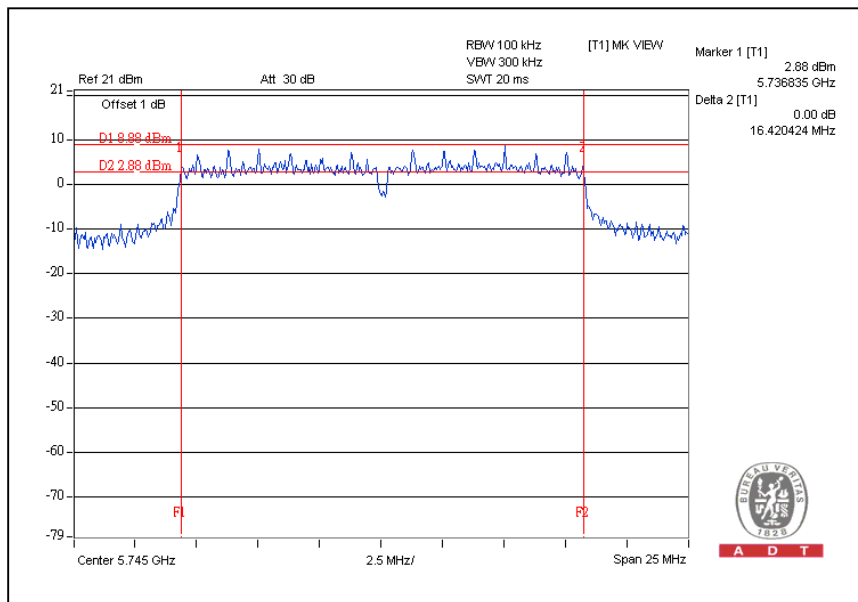

CH3

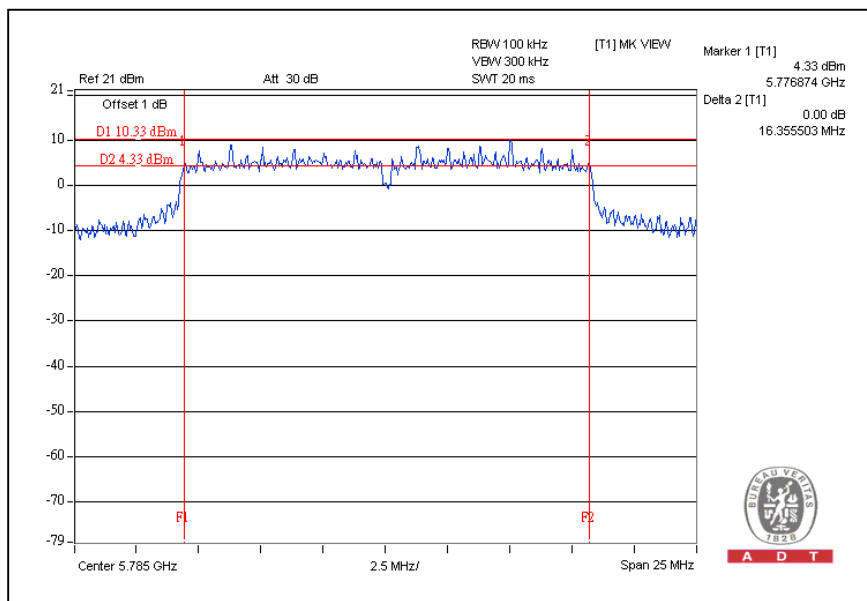

CH4

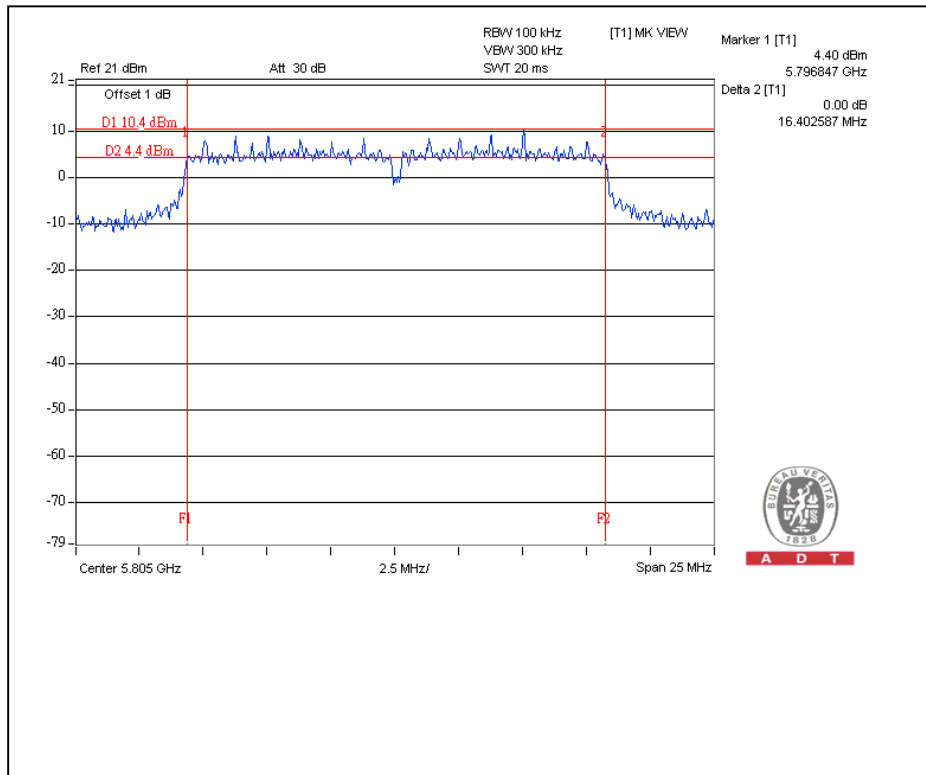

CH3

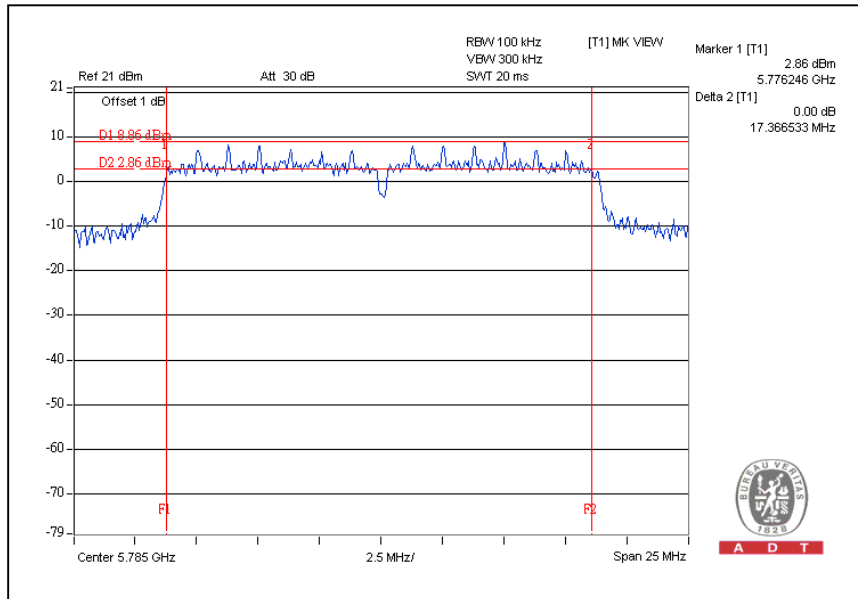

CH4

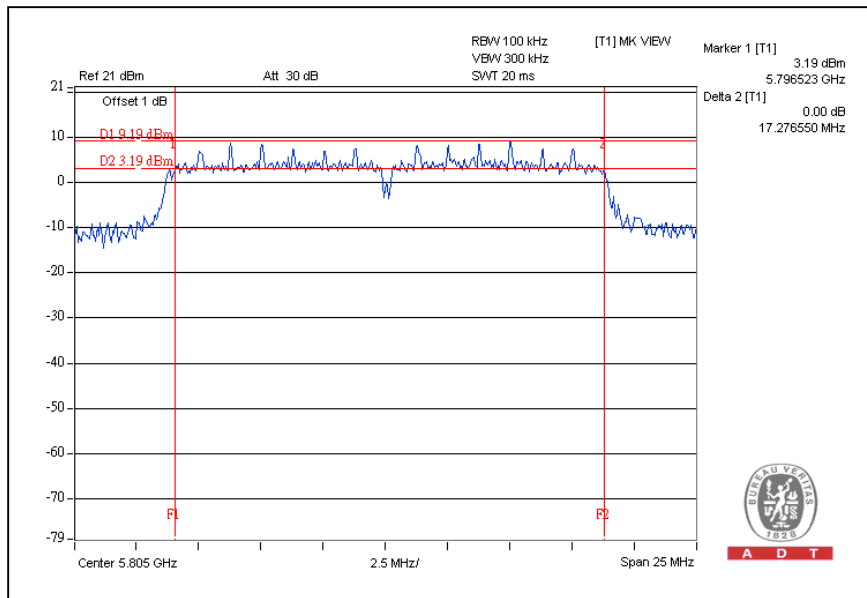

For Chain (1): CH1

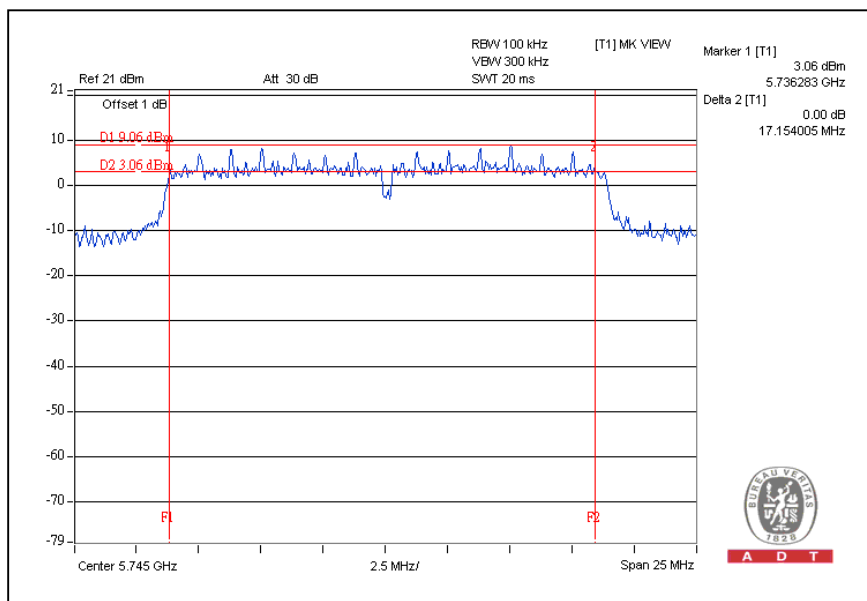

CH3

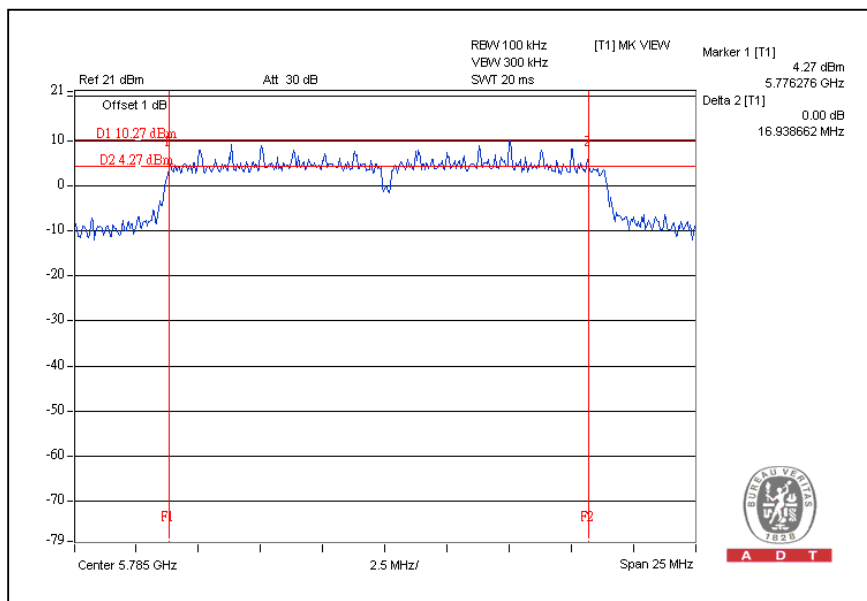

CH4

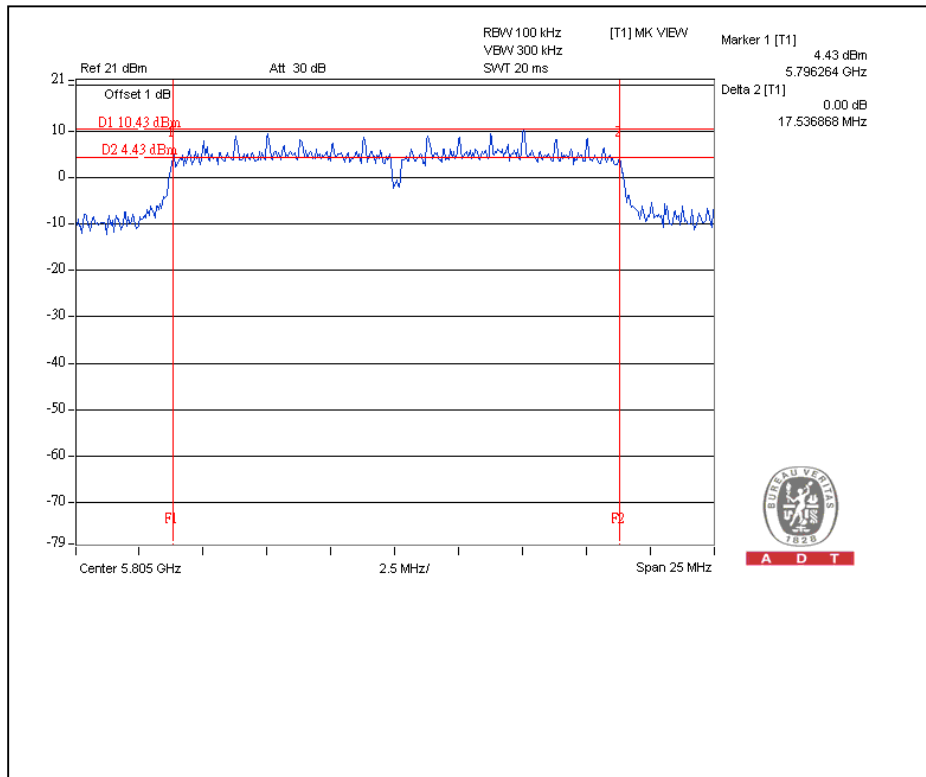



DRAFT 802.11n (40MHz) OFDM MODULATION:

MODULATION TYPE	BPSK	TRANSFER RATE	27Mbps
INPUT POWER	120Vac, 60 Hz	ENVIRONMENTAL CONDITIONS	25deg. C, 60%RH, 955hPa
TESTED BY	Rex Huang		

CHANNEL	CHANNEL FREQUENCY (MHz)	6dB BANDWIDTH (MHz)		MINIMUM LIMIT (MHz)	PASS / FAIL
		CHAIN(0)	CHAIN(1)		
1	5755	36.10	36.42	0.5	PASS
3	5795	36.11	36.54	0.5	PASS

For Chain (0): CH1

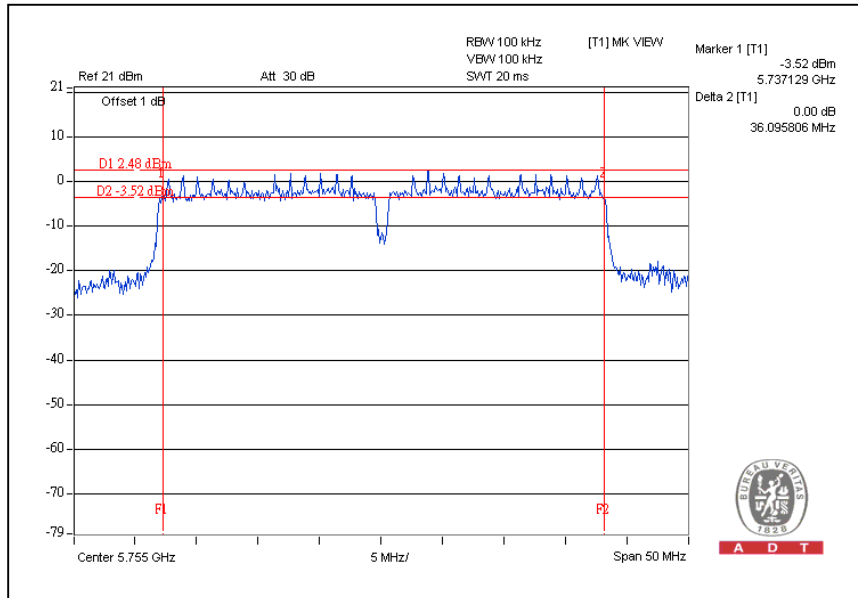

CH3

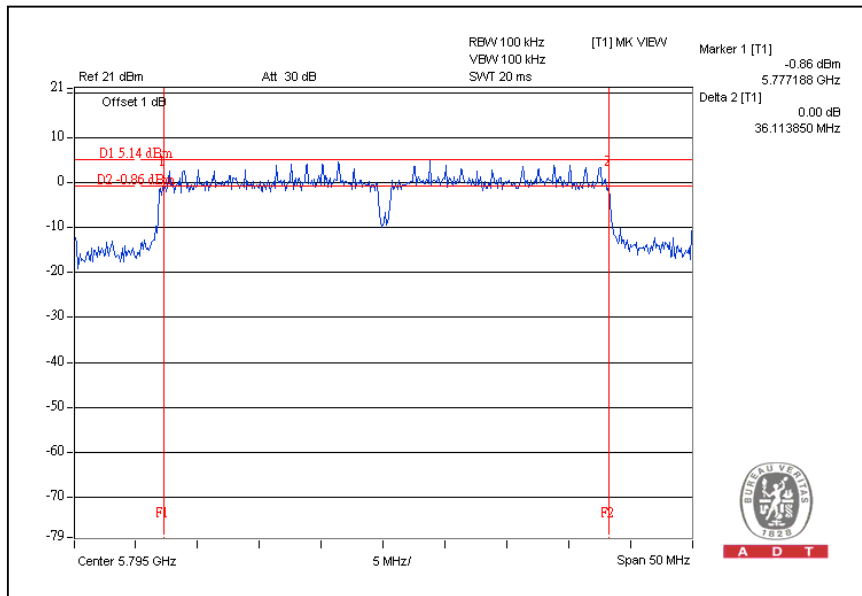

For Chain (1): CH1

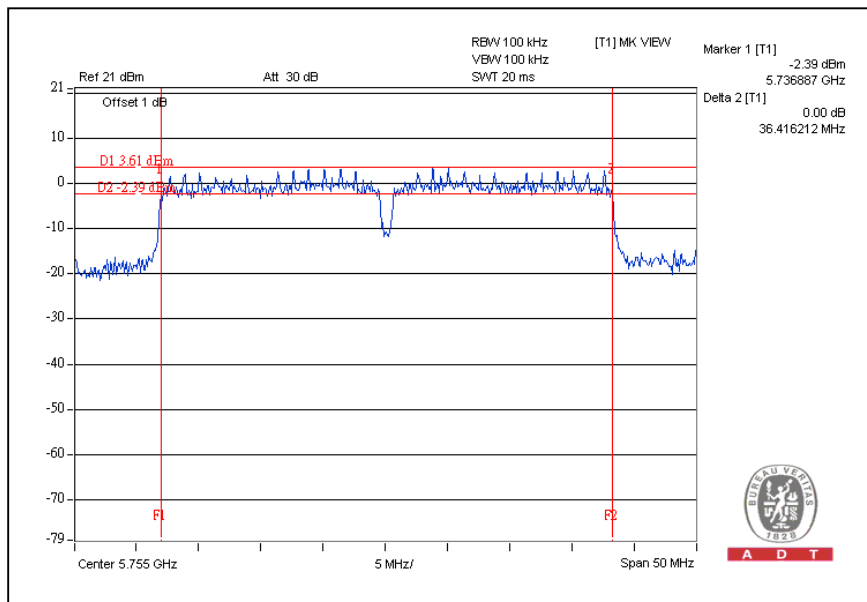

CH3

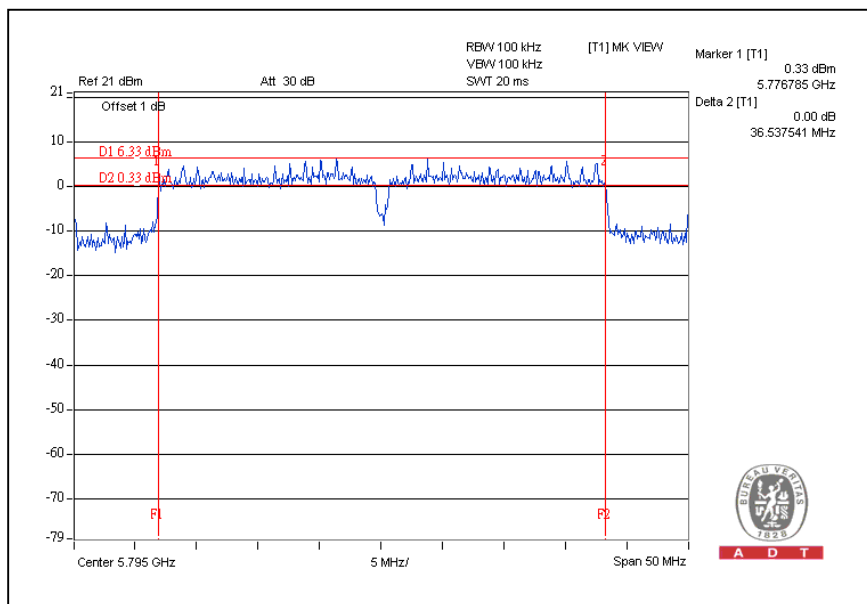

5.4 MAXIMUM PEAK OUTPUT POWER

5.4.1 LIMITS OF MAXIMUM PEAK OUTPUT POWER MEASUREMENT

The Maximum Peak Output Power Measurement is 30dBm.

5.4.2 INSTRUMENTS

Description & Manufacturer	Model No.	Serial No.	Calibrated Until
R&S SPECTRUM ANALYZER	FSP40	100037	Aug. 12, 2009
Agilent SIGNAL GENERATOR	E8257C	MY43320668	Dec. 25, 2008
TEKTRONIX OSCILLOSCOPE	TDS380	B016335	Jul. 20, 2009
NARDA DETECTOR	4503A	FSCM99899	NA

NOTE:

The calibration interval of the above test instruments is 12 months and the calibrations are traceable to NML/ROC and NIST/USA.

5.4.3 TEST PROCEDURES

1. A detector was used on the output port of the EUT. An oscilloscope was used to read the response of the detector.
2. Replaced the EUT by the signal generator. The center frequency of the S.G was adjusted to the center frequency of the measured channel.
3. Adjusted the power to have the same reading on oscilloscope. Record the power level.

5.4.4 DEVIATION FROM TEST STANDARD

No deviation

5.4.5 TEST SETUP



5.4.6 EUT OPERATING CONDITIONS

Same as Item 4.3.6

5.4.7 TEST RESULTS

802.11a OFDM modulation

MODULATION TYPE	BPSK	TRANSFER RATE	6Mbps
INPUT POWER	120Vac, 60 Hz	ENVIRONMENTAL CONDITIONS	25deg. C, 60%RH, 955hPa
TESTED BY	Rex Huang		

CHANNEL	CHANNEL FREQUENCY (MHz)	PEAK POWER OUTPUT (mW)		PEAK POWER OUTPUT (dBm)		TOTAL PEAK POWER (mW)	TOTAL PEAK POWER (dBm)	PEAK POWER LIMIT (dBm)	PASS / FAIL
		CHAIN(0)	CHAIN(1)	CHAIN(0)	CHAIN(1)				
1	5745	131.826	190.546	21.20	22.80	322.372	25.08	30	PASS
3	5785	165.959	245.471	22.20	23.90	411.430	26.14	30	PASS
4	5805	181.970	251.189	22.60	24.00	433.159	26.37	30	PASS

DRAFT 802.11n (20MHz) OFDM MODULATION:

MODULATION TYPE	BPSK	TRANSFER RATE	13Mbps
INPUT POWER (SYSTEM)	120Vac, 60 Hz	ENVIRONMENTAL CONDITIONS	25deg. C, 60%RH, 955hPa
TESTED BY	Rex Huang		

CHANNEL	CHANNEL FREQUENCY (MHz)	PEAK POWER OUTPUT (mW)		PEAK POWER OUTPUT (dBm)		TOTAL PEAK POWER (mW)	TOTAL PEAK POWER (dBm)	PEAK POWER LIMIT (dBm)	PASS / FAIL
		CHAIN(0)	CHAIN(1)	CHAIN(0)	CHAIN(1)				
1	5745	138.038	194.984	21.40	22.90	333.022	25.22	30	PASS
3	5785	173.780	245.471	22.40	23.90	419.251	26.22	30	PASS
4	5805	186.209	251.189	22.70	24.00	437.398	26.41	30	PASS



DRAFT 802.11n (40MHz) OFDM MODULATION:

MODULATION TYPE	BPSK	TRANSFER RATE	27Mbps
INPUT POWER	120Vac, 60 Hz	ENVIRONMENTAL CONDITIONS	25deg. C, 60%RH, 955hPa
TESTED BY	Rex Huang		

CHANNEL	CHANNEL FREQUENCY (MHz)	PEAK POWER OUTPUT (mW)		PEAK POWER OUTPUT (dBm)		TOTAL PEAK POWER (mW)	TOTAL PEAK POWER (dBm)	PEAK POWER LIMIT (dBm)	PASS / FAIL
		CHAIN(0)	CHAIN(1)	CHAIN(0)	CHAIN(1)				
1	5755	97.724	151.356	19.90	21.80	249.080	23.96	30	PASS
3	5795	177.828	263.027	22.50	24.20	440.855	26.44	30	PASS



5.5 POWER SPECTRAL DENSITY MEASUREMENT

5.5.1 LIMITS OF POWER SPECTRAL DENSITY MEASUREMENT

The Maximum of Power Spectral Density Measurement is 8dBm.

5.5.2 TEST INSTRUMENTS

Description & Manufacturer	Model No.	Serial No.	Calibrated Until
R&S SPECTRUM ANALYZER	FSP40	100037	Aug. 12, 2009

NOTE:

- 1.The measurement uncertainty is less than +/- 2.6dB, which is calculated as per the NAMAS document NIS81. This uncertainty represents an expanded uncertainty expressed at approximately the 95% confidence level using a coverage factor of k=2.
- 2.The calibration interval of the above test instruments is 12 months and the calibrations are traceable to NML/ROC and NIST/USA.

5.5.3 TEST PROCEDURE

The transmitter output was connected to the spectrum analyzer through an attenuator, the bandwidth of the fundamental frequency was measured with the spectrum analyzer using 3 kHz RBW and 30 kHz VBW, set sweep time = span/3 kHz. The power spectral density was measured and recorded.

The sweep time is allowed to be longer than span/3 kHz for a full response of the mixer in the spectrum analyzer.

5.5.4 DEVIATION FROM TEST STANDARD

No deviation

5.5.5 TEST SETUP



5.5.6 EUT OPERATING CONDITION

Same as Item 4.3.6

5.5.7 TEST RESULTS

802.11a OFDM modulation

MODULATION TYPE	BPSK	TRANSFER RATE	6Mbps
INPUT POWER	120Vac, 60 Hz	ENVIRONMENTAL CONDITIONS	25deg.C, 60%RH, 955hPa
TESTED BY	Rex Huang		

CHANNEL	CHANNEL FREQUENCY (MHz)	RF POWER LEVEL IN 3kHz BW (mW)		RF POWER LEVEL IN 3kHz BW (dBm)		TOTAL POWER DENSITY (mW)	TOTAL POWER DENSITY (dBm)	MAXIMUM LIMIT (dBm)	PASS / FAIL
		CHAIN(0)	CHAIN(1)	CHAIN(0)	CHAIN(1)				
1	5745	0.160	0.175	-7.95	-7.56	0.335	-4.75	8	PASS
3	5785	0.169	0.237	-7.71	-6.25	0.406	-3.91	8	PASS
4	5805	0.205	0.255	-6.88	-5.94	0.460	-3.37	8	PASS

For Chain(0): CH1

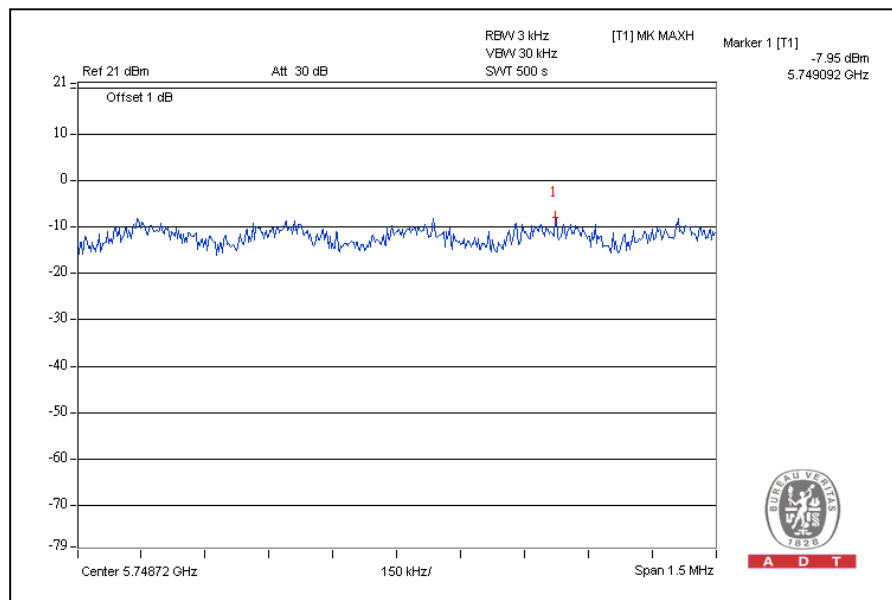

For Chain (1): CH1

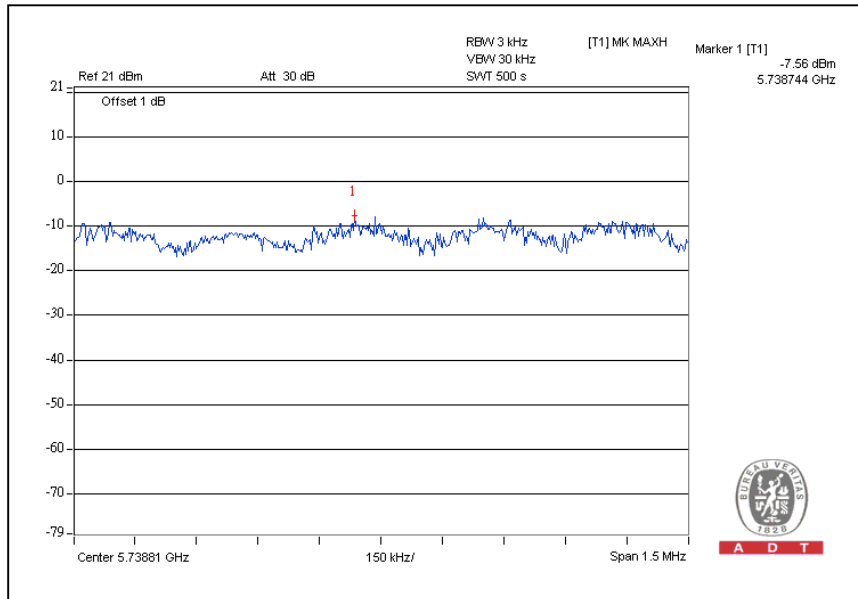

CH3

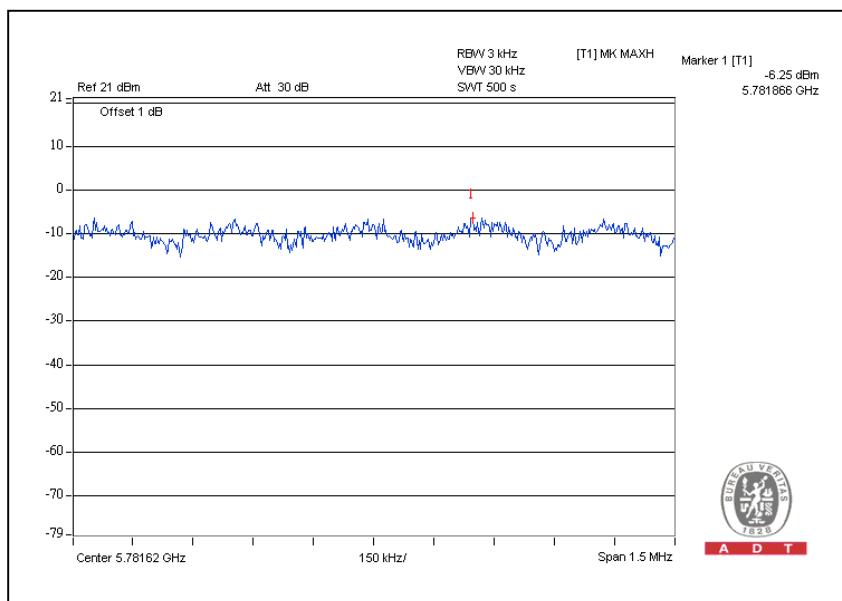

CH4

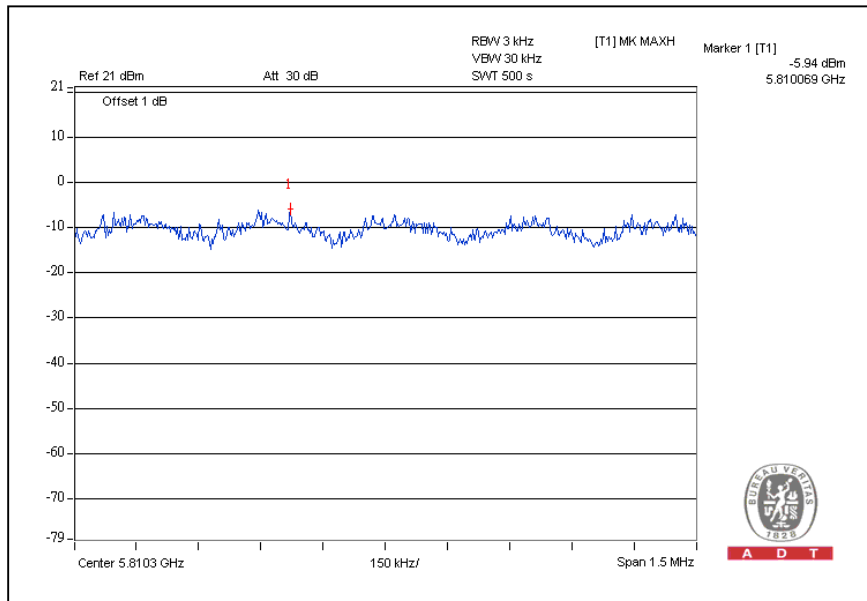

CH3

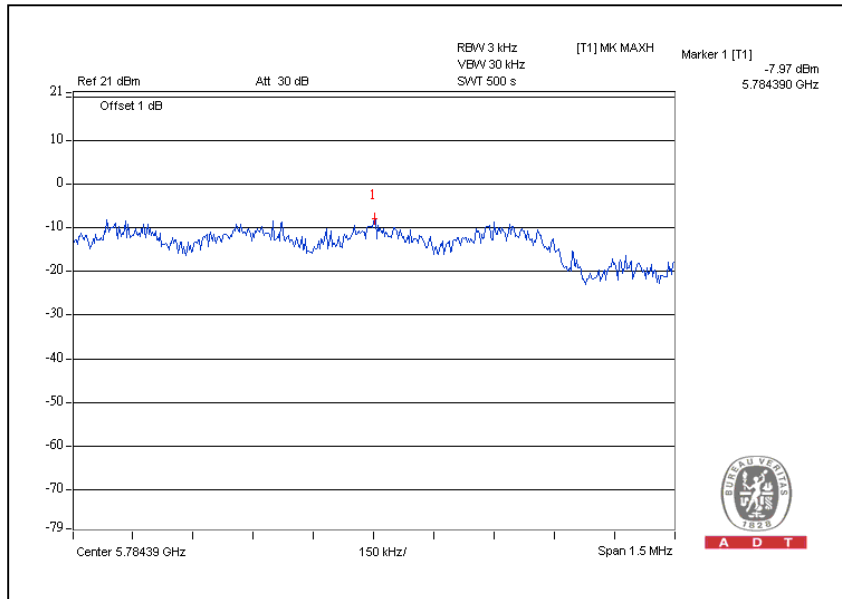

CH4

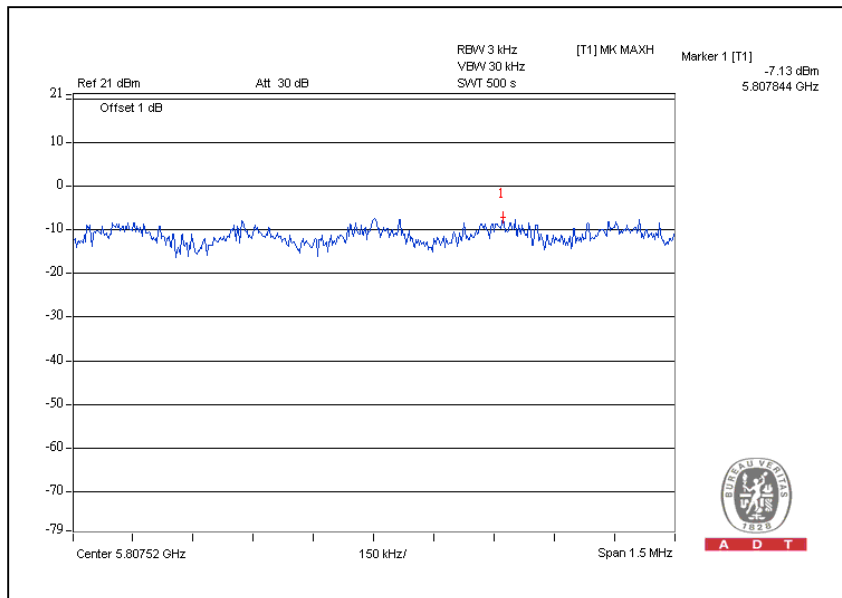

For Chain (1): CH1

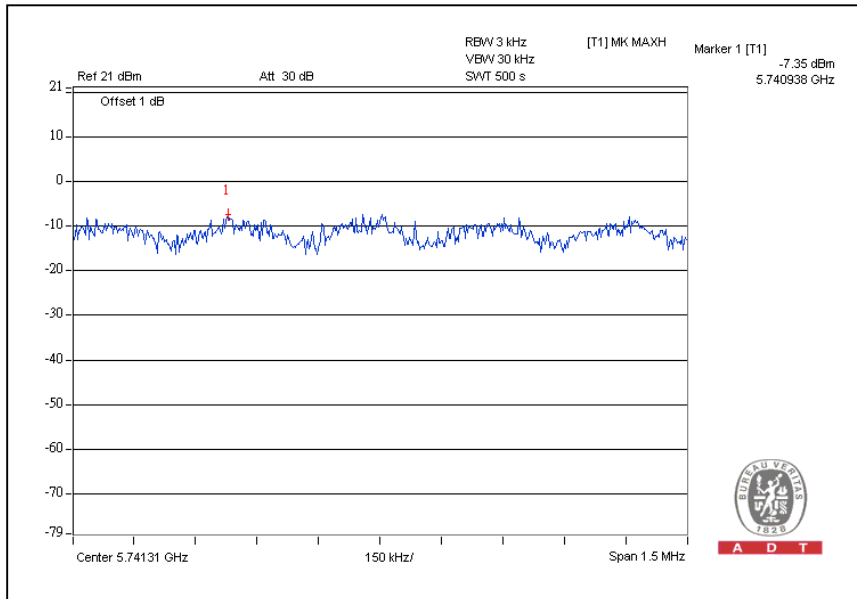

CH3

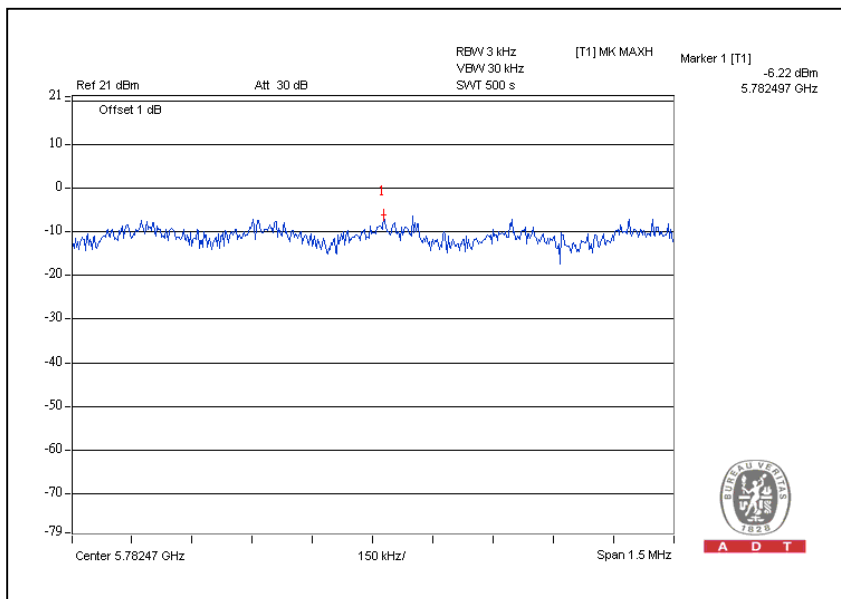

CH4

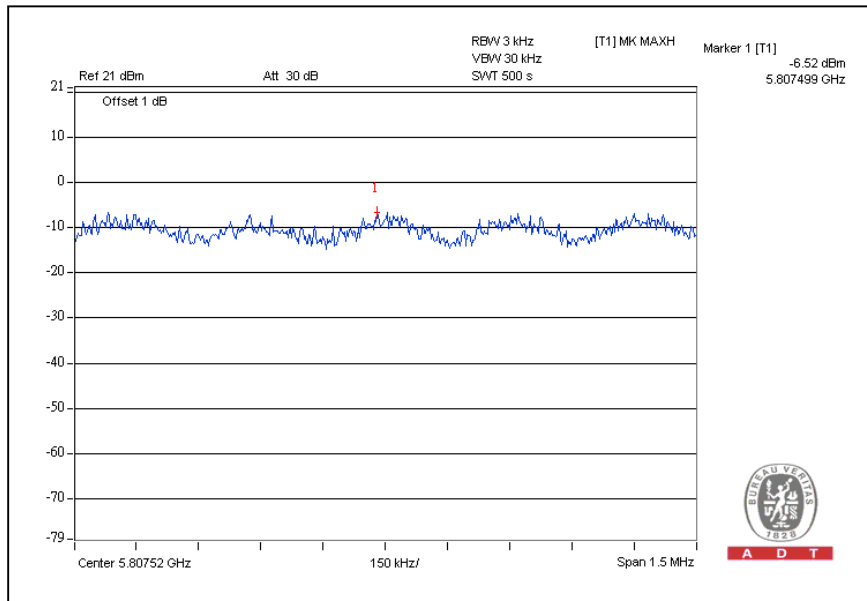



DRAFT 802.11n (40MHz) OFDM MODULATION:

MODULATION TYPE	BPSK	TRANSFER RATE	27Mbps
INPUT POWER	120Vac, 60 Hz	ENVIRONMENTAL CONDITIONS	25deg.C, 60%RH, 955hPa
TESTED BY	Rex Huang		

CHANNEL	CHANNEL FREQUENCY (MHz)	RF POWER LEVEL IN 3kHz BW (mW)		RF POWER LEVEL IN 3kHz BW (dBm)		TOTAL POWER DENSITY (mW)	TOTAL POWER DENSITY (dBm)	MAXIMUM LIMIT (dBm)	PASS / FAIL
		CHAIN(0)	CHAIN(1)	CHAIN(0)	CHAIN(1)				
1	5755	0.049	0.090	-13.10	-10.44	0.139	-8.57	8	PASS
3	5795	0.128	0.179	-8.92	-7.46	0.307	-5.13	8	PASS

For Chain(0): CH1

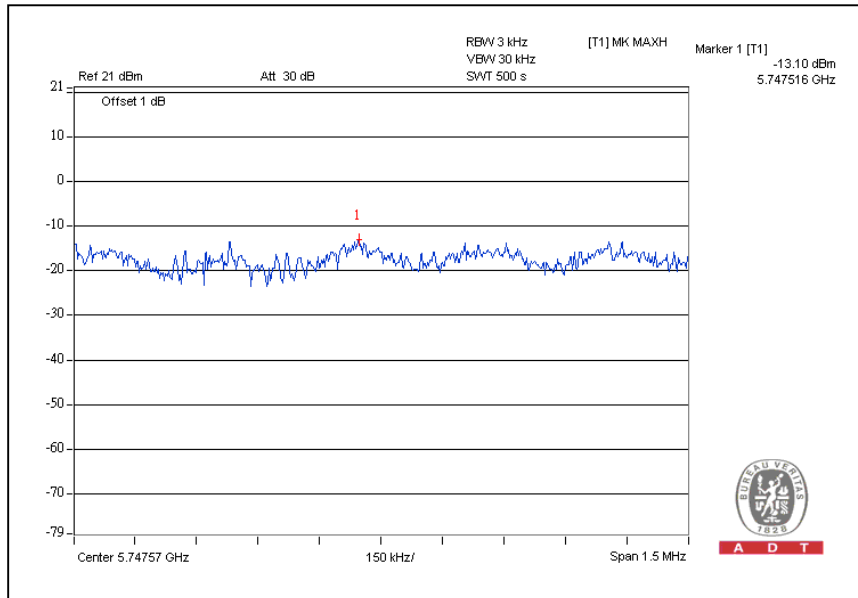

CH3

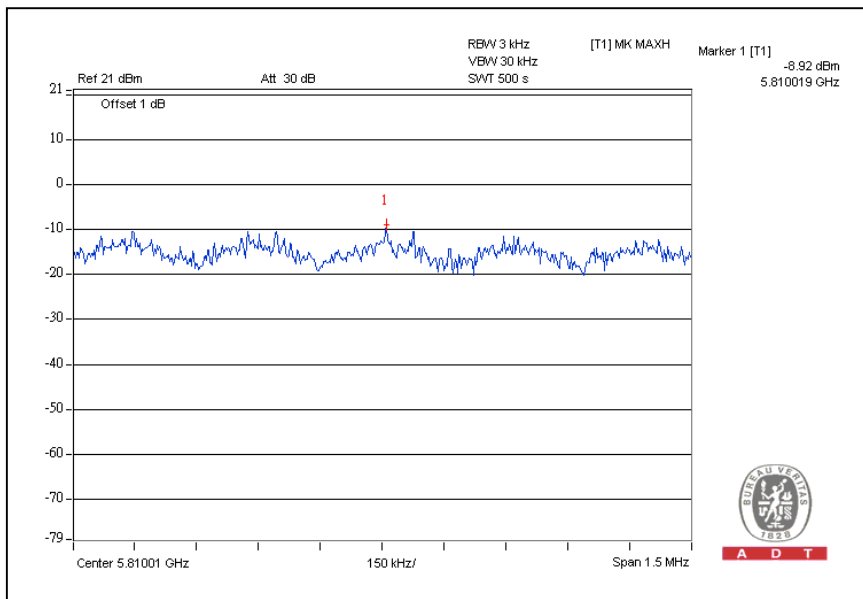

For Chain (1): CH1

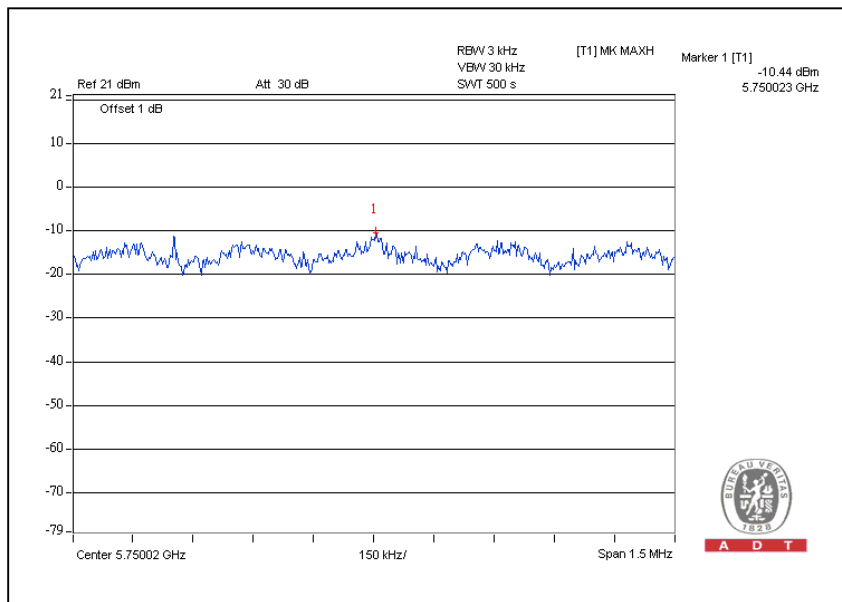

CH3

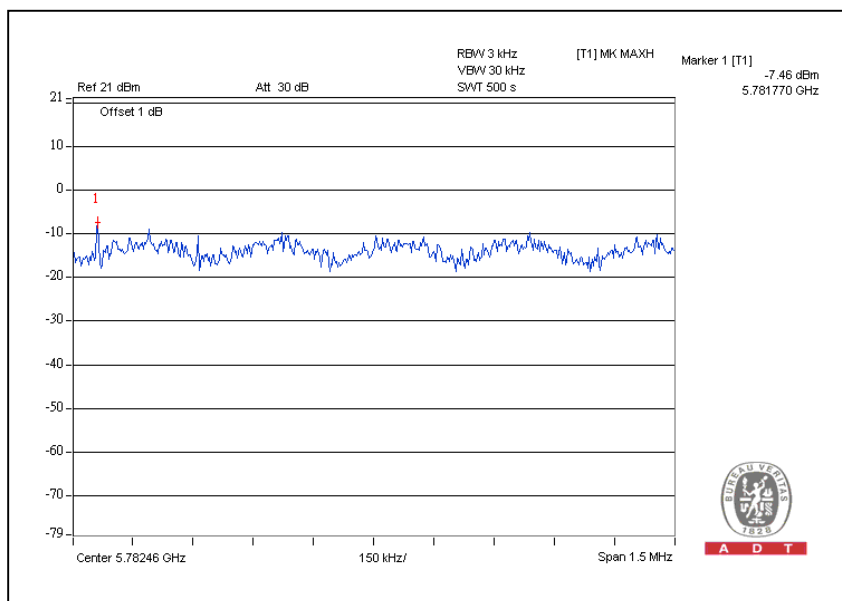

5.6 BAND EDGES MEASUREMENT

5.6.1 LIMITS OF BAND EDGES MEASUREMENT

Below -20dB of the highest emission level of operating band (in 100kHz Resolution Bandwidth).

5.6.2 TEST INSTRUMENTS

Description & Manufacturer	Model No.	Serial No.	Calibrated Until
R&S SPECTRUM ANALYZER	FSP40	100037	Aug. 12, 2009

NOTE:

- 1.The measurement uncertainty is less than +/- 2.6dB, which is calculated as per the NAMAS document NIS81.
- 2.The calibration interval of the above test instruments is 12 months and the calibrations are traceable to NML/ROC and NIST/USA.

5.6.3 TEST PROCEDURE

The transmitter output was connected to the spectrum analyzer via a low loss cable. Set RBW of spectrum analyzer to 100 kHz with suitable frequency span including 100 MHz bandwidth from band edge. The band edges was measured and recorded.

5.6.4 DEVIATION FROM TEST STANDARD

No deviation

5.6.5 EUT OPERATING CONDITION

Same as Item 4.3.6

5.6.6 TEST RESULTS

The spectrum plots are attached on the following pages. D2 line indicates the highest level, D1 line indicates the 20dB offset below D2. It shows compliance with the requirement in part 15.247(d).

802.11a OFDM modulation

For chain (0) :CH1

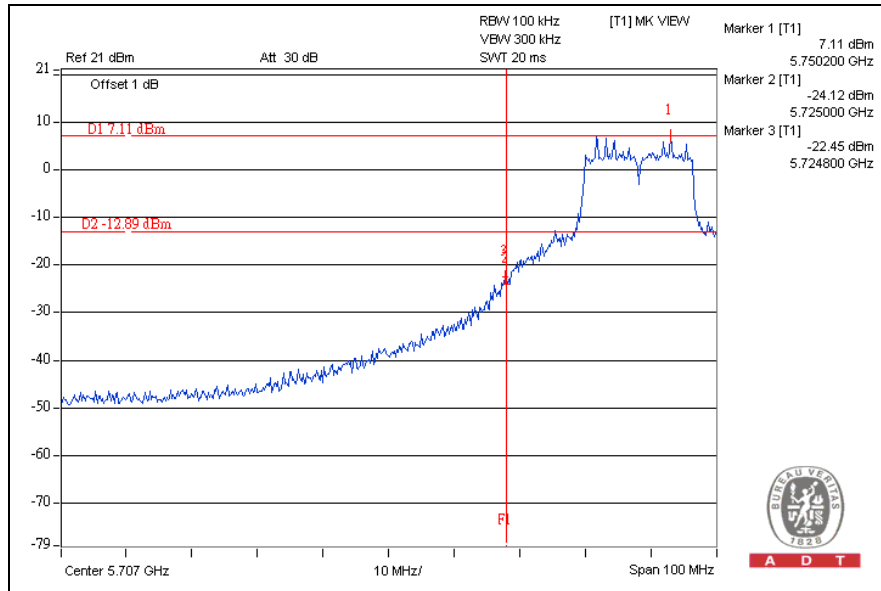

CH4

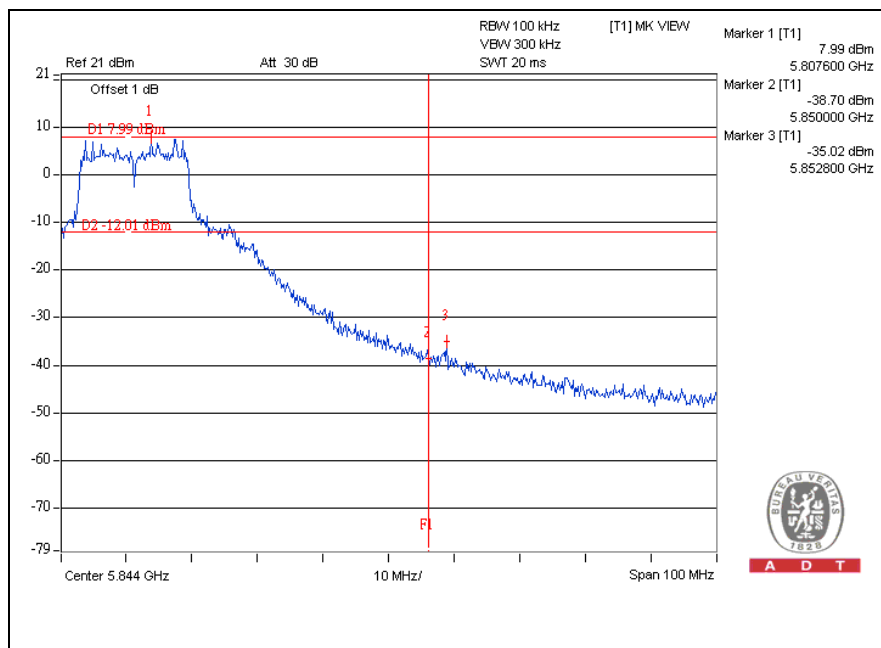

CH1

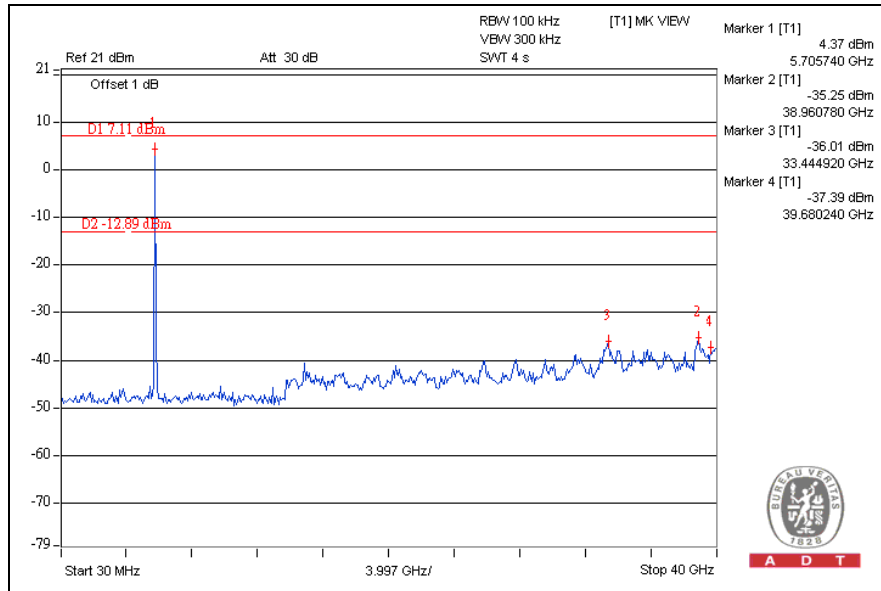

CH4

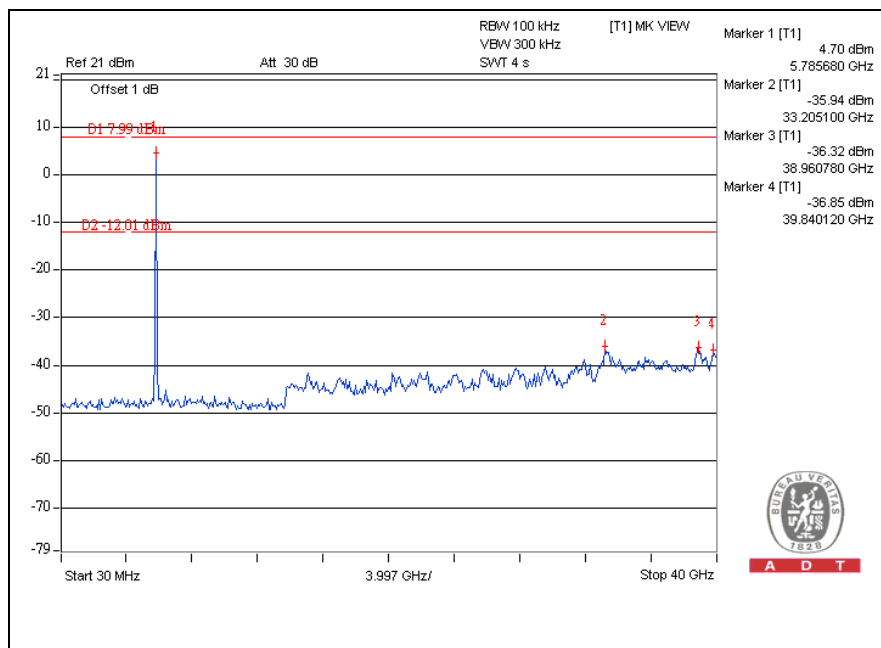

For chain (1) :CH1

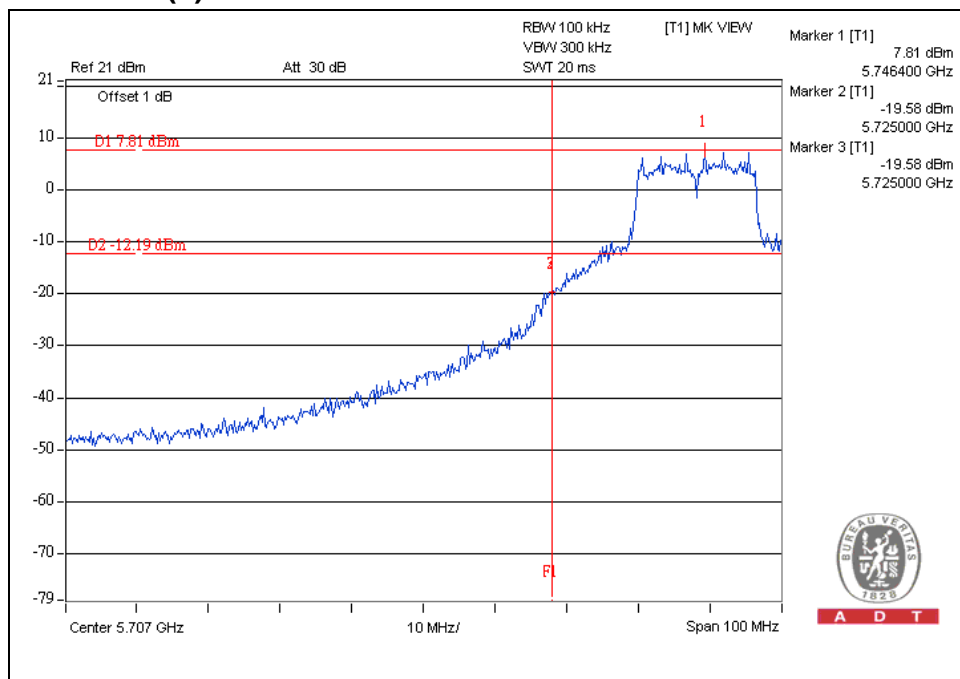

CH4

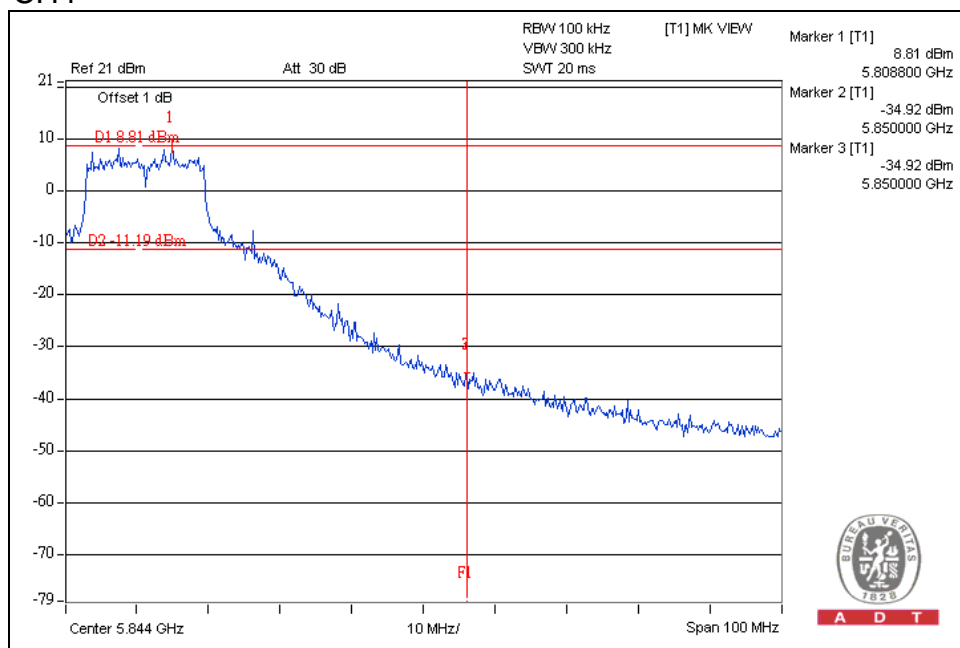

CH1

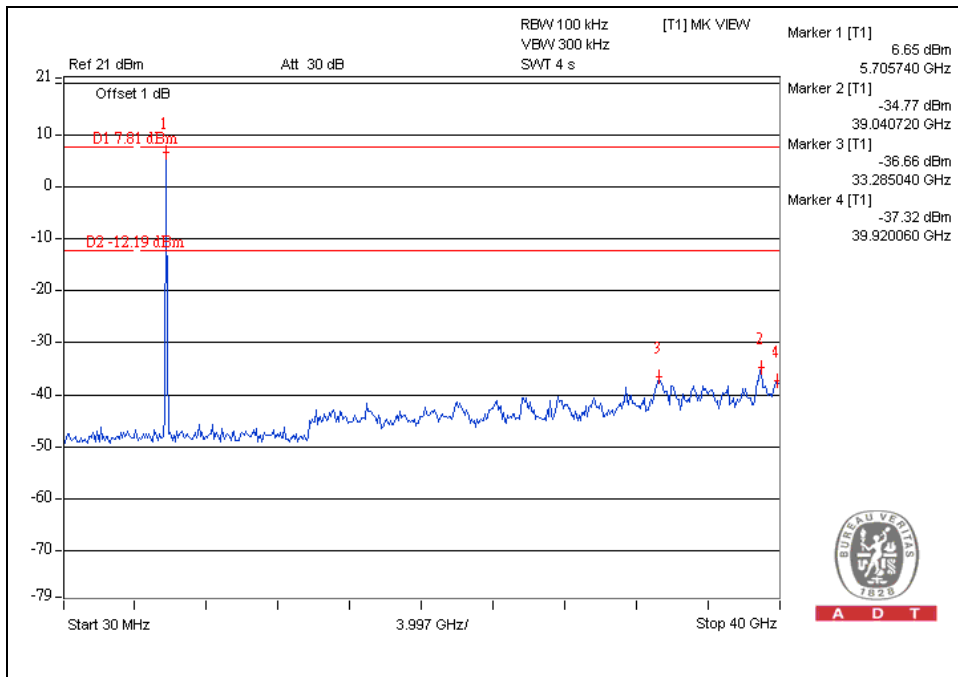

CH4

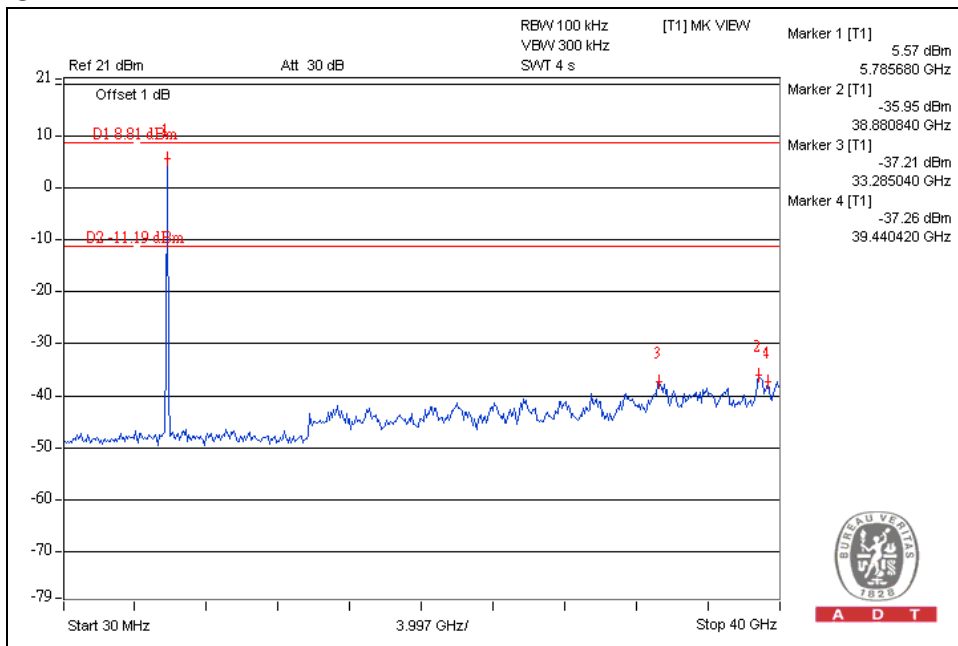

DRAFT 802.11n (20MHz) OFDM MODULATION:

For chain (0) :CH1

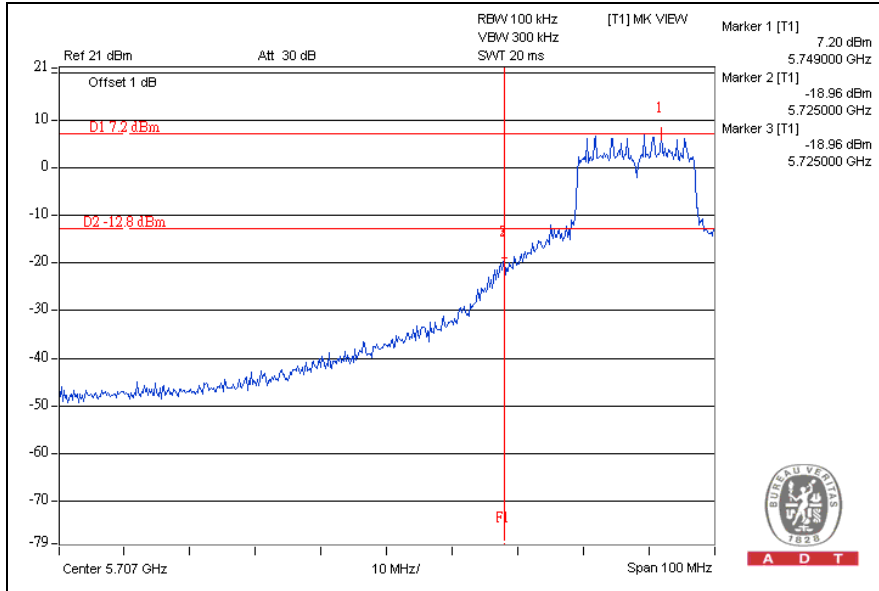

CH4

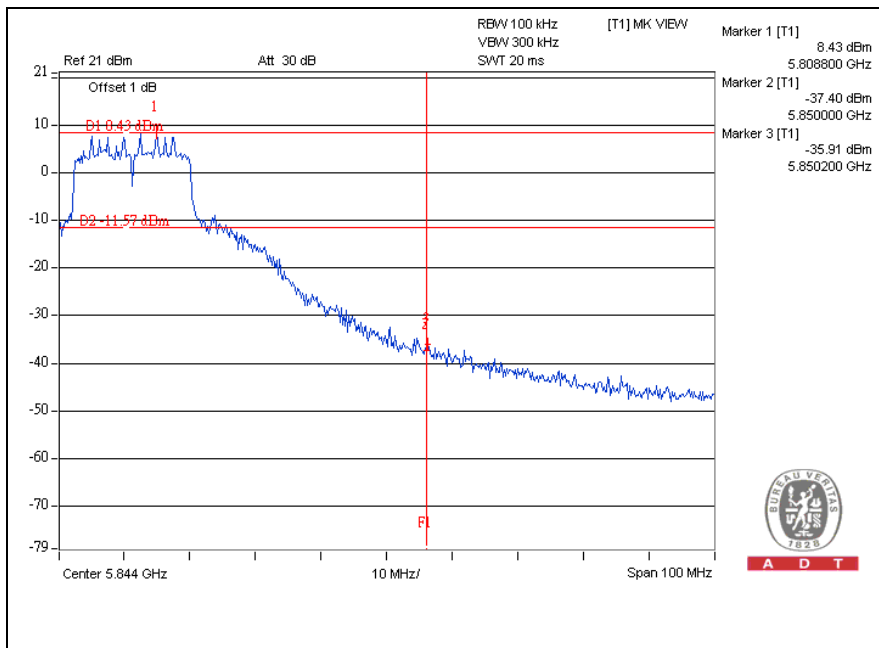

CH1

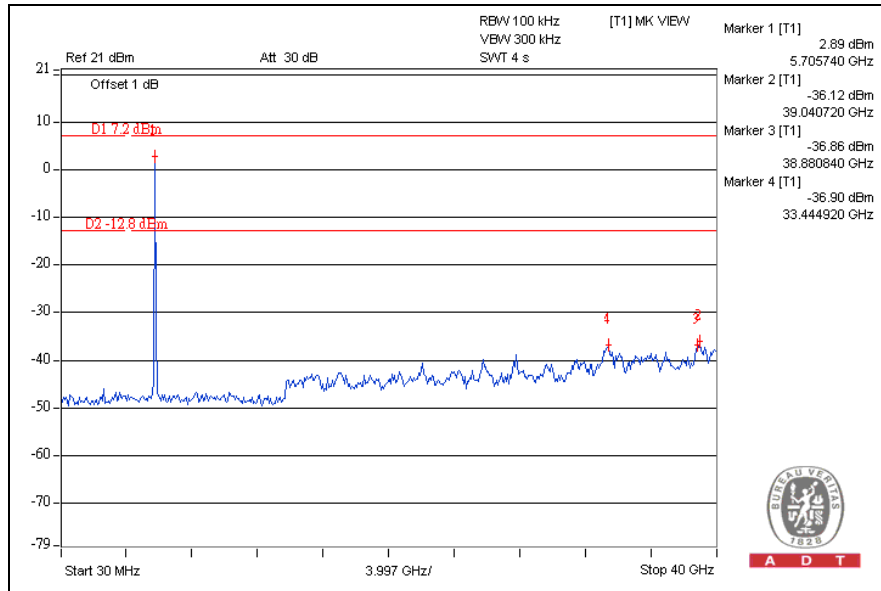

CH4

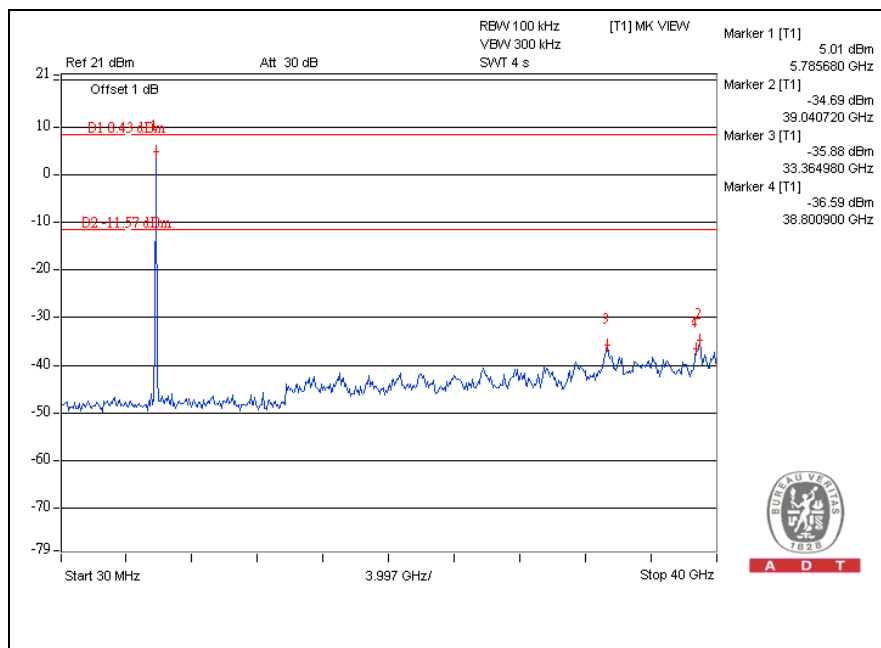

For chain (1):CH1

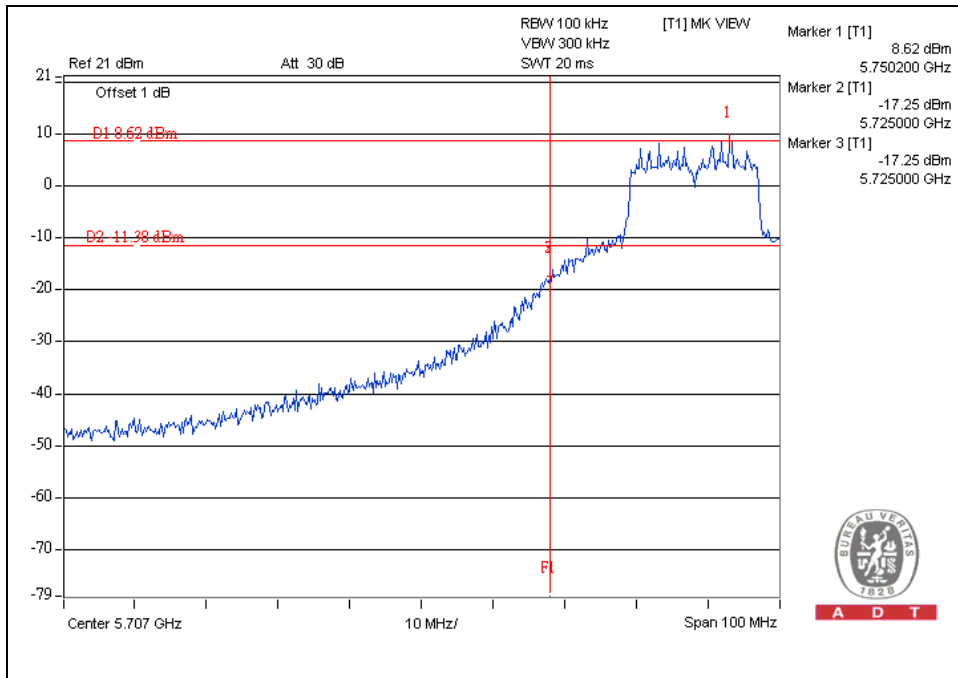

CH4

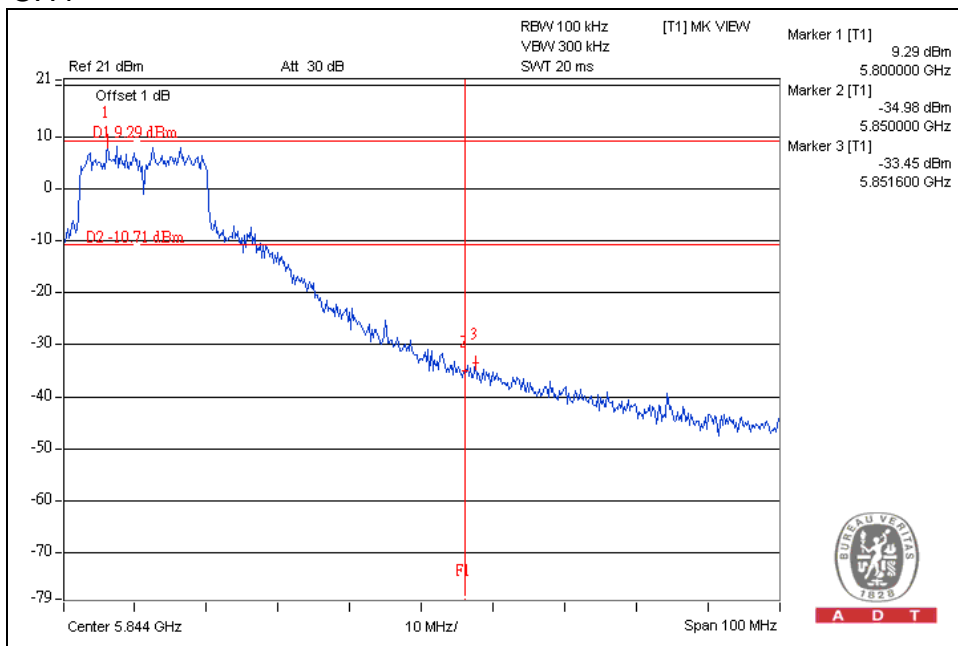

CH1

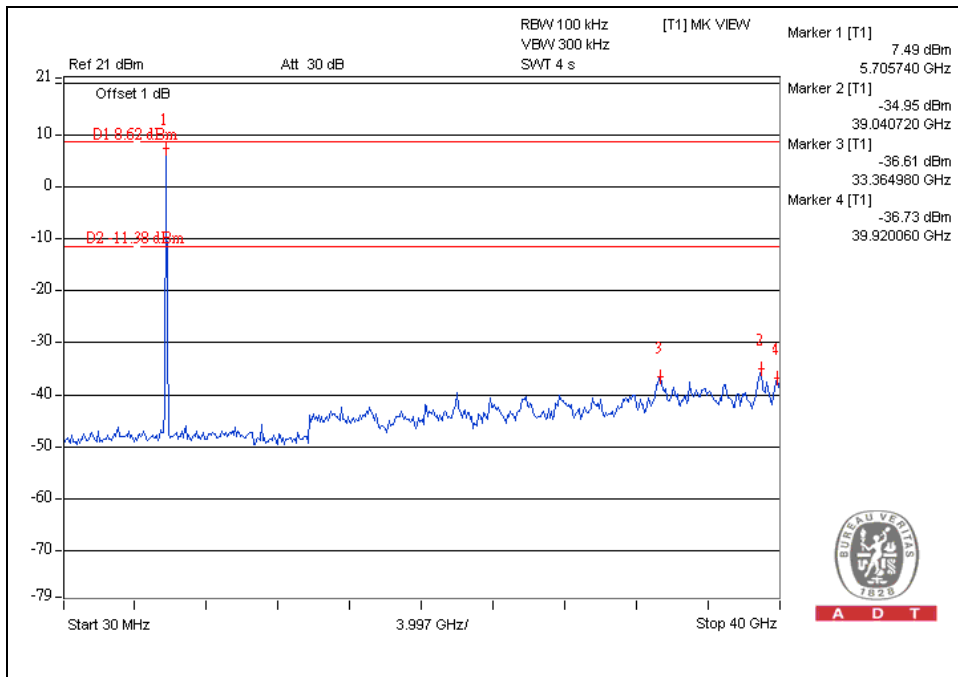

CH4

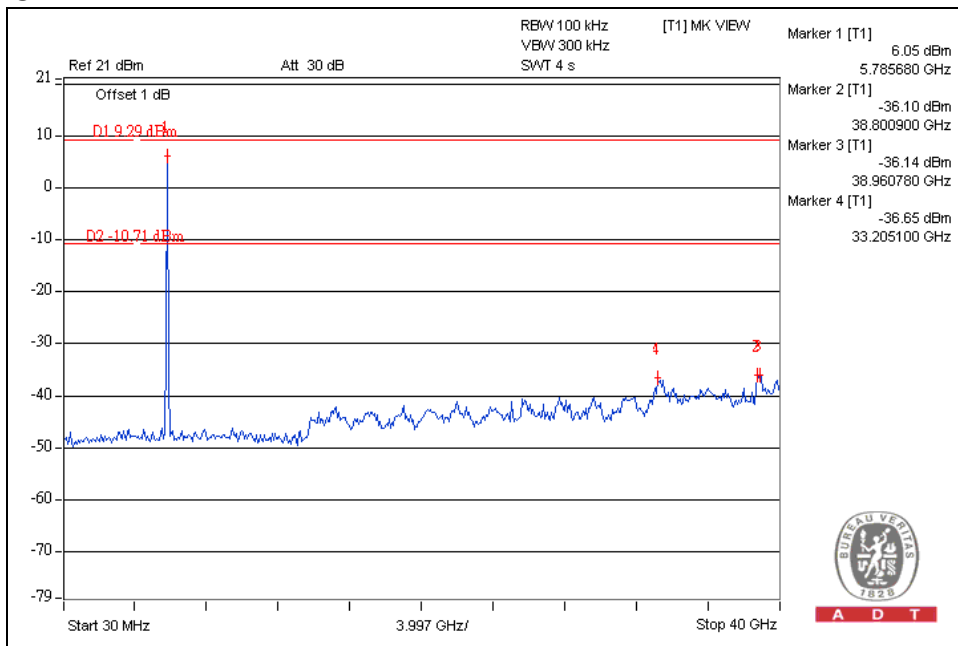

DRAFT 802.11n (40MHz) OFDM MODULATION:

For chain (0) :CH1

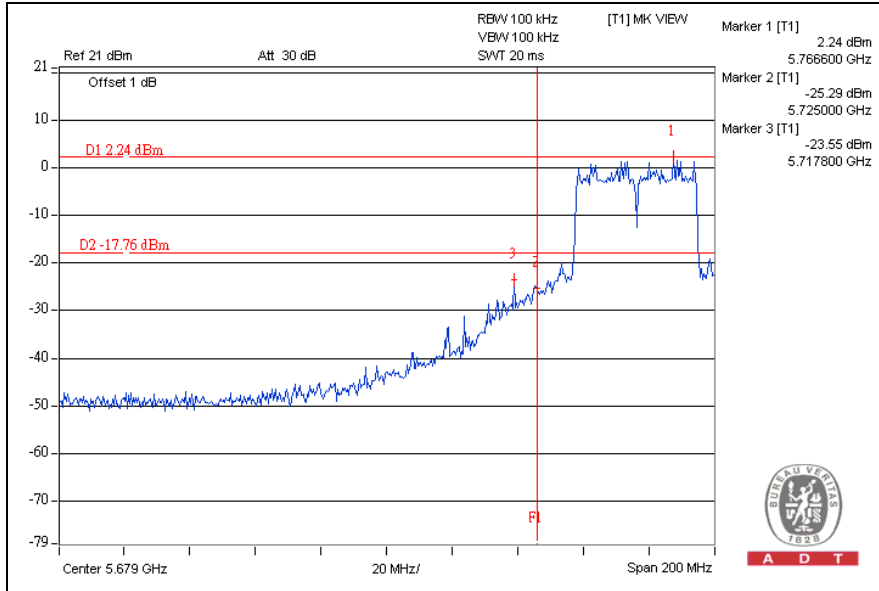

CH3

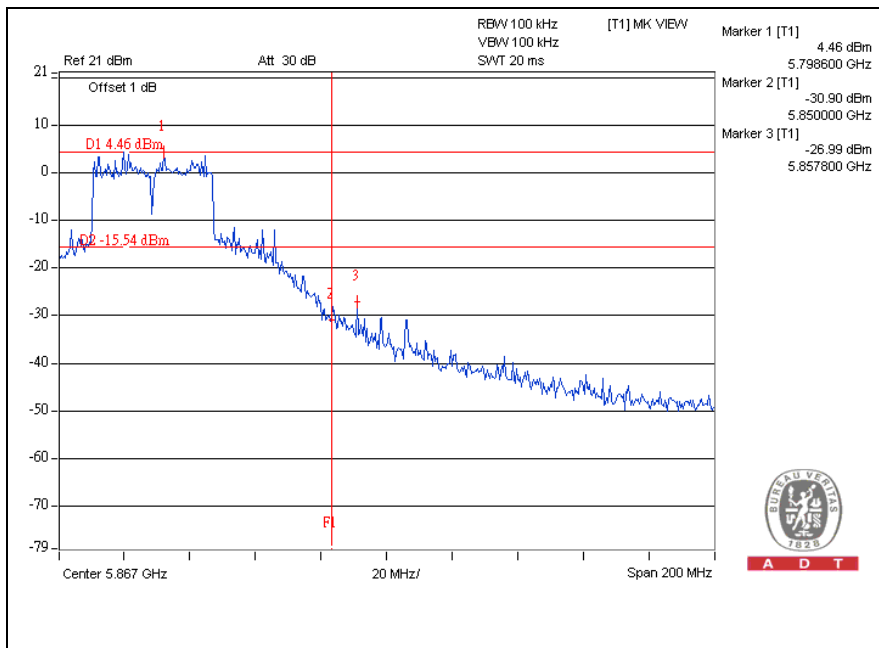

CH1

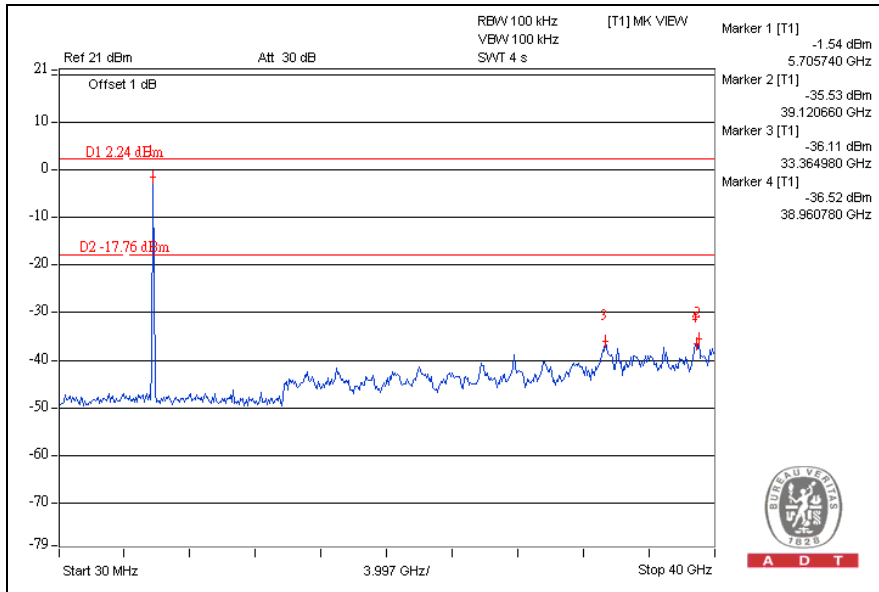

CH3

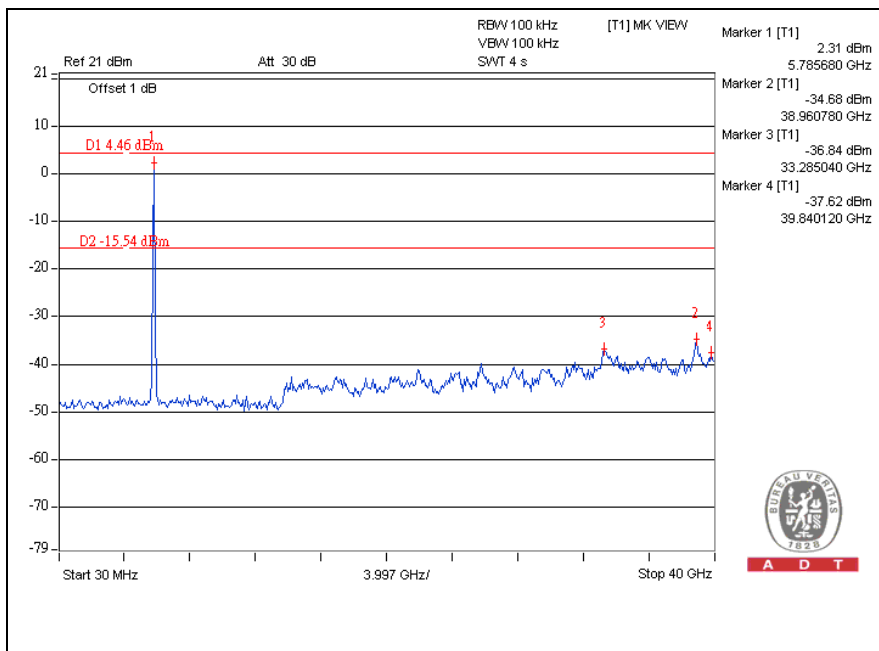

For chain (1) :CH1

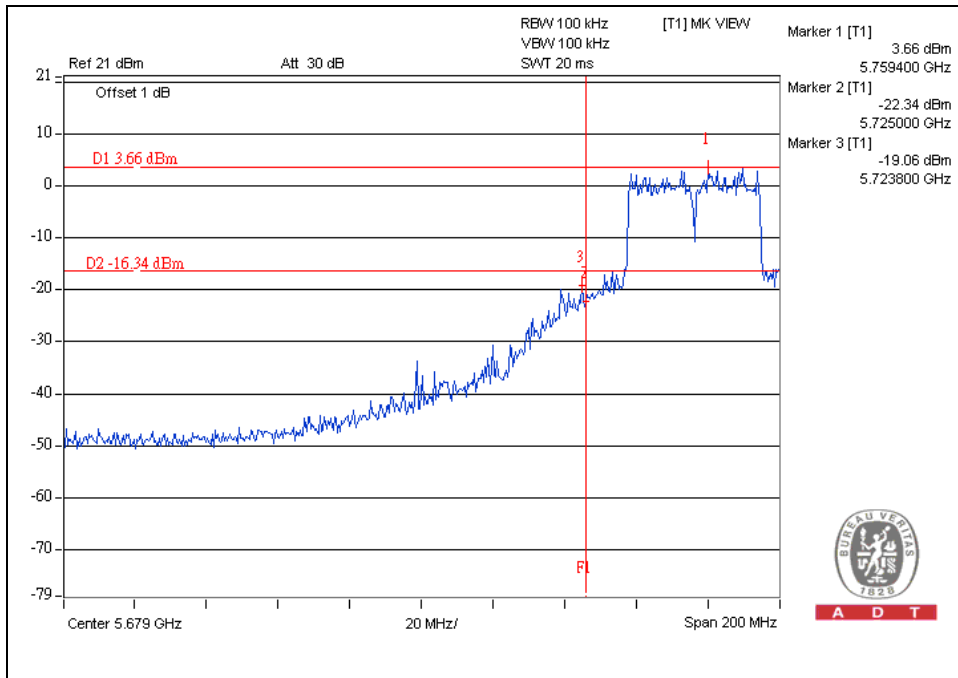

CH3

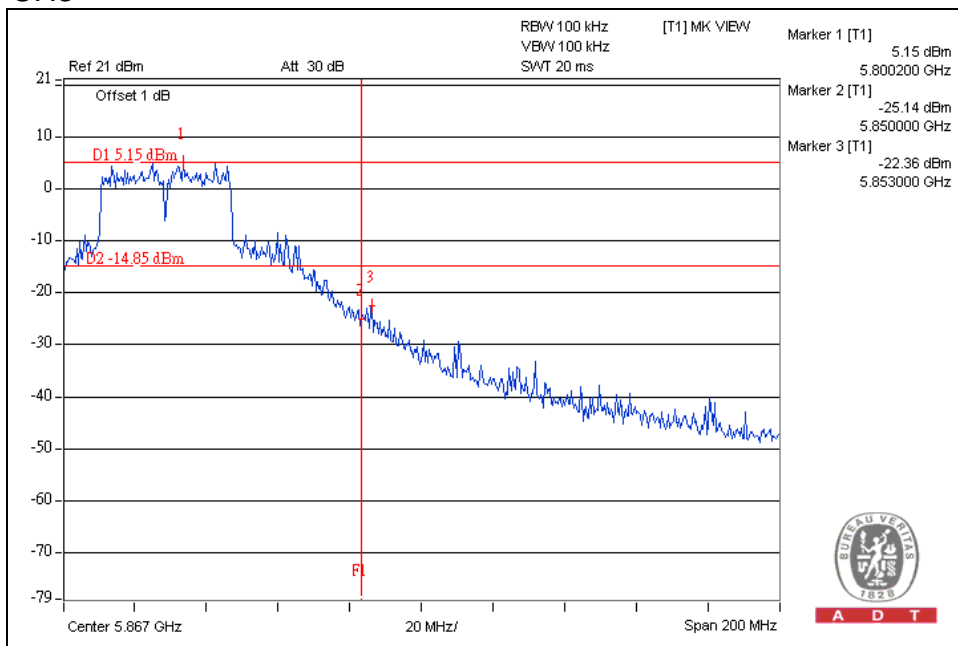

CH1

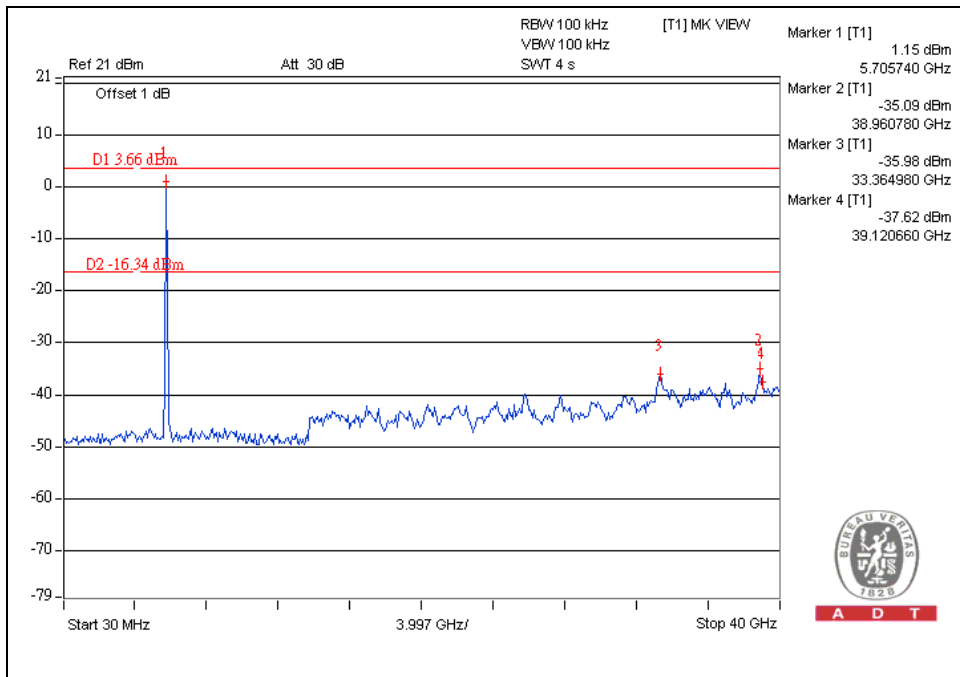

CH3

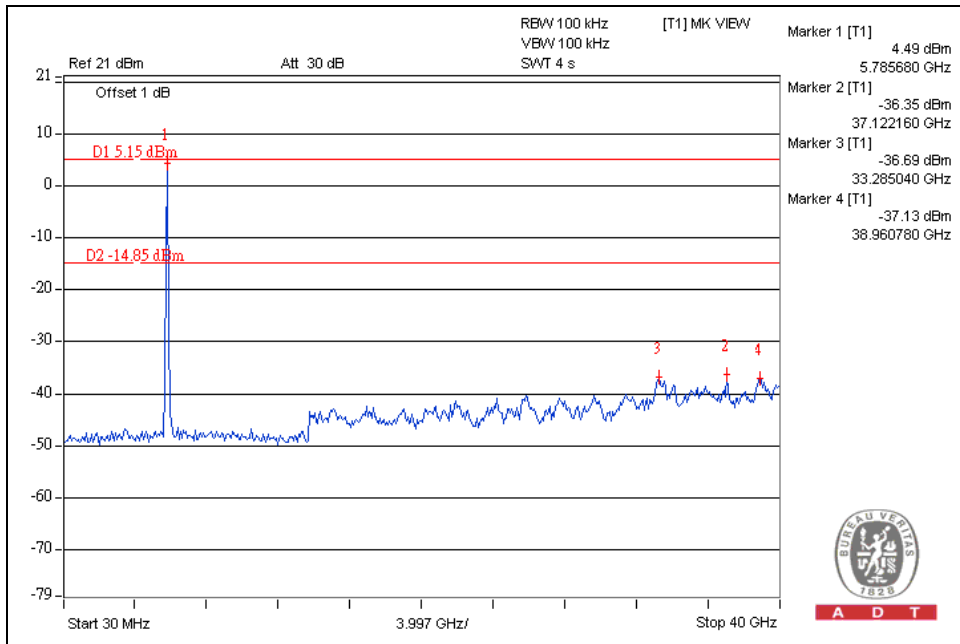

5.7 ANTENNA REQUIREMENT

5.7.1 STANDARD APPLICABLE

For intentional device, according to FCC 47 CFR Section 15.203, an intentional radiator shall be designed to ensure that no antenna other than that furnished by the responsible party shall be used with the device.

And according to FCC 47 CFR Section 15.247(a), if transmitting antennas of directional gain greater than 6dBi are used, the power shall be reduced by the amount in dB that the directional gain of the antenna exceeds 6dBi.

5.7.2 ANTENNA CONNECTED CONSTRUCTION

There three antennas provided to this EUT, please refer to the following table:

Transmitter Circuit	Antenna Type	For 2.4GHz Gain (dBi)	For 5GHz Gain (dBi)	Antenna Connector	Note
Chain(0)	PIFA	0.75	3	NA	TX & RX function
Chain(1)	PIFA	1.5	2.23	NA	TX & RX function
Chain(2)	PIFA	3.5	2.5	NA	Only RX function



6. INFORMATION ON THE TESTING LABORATORIES

We, ADT Corp., were founded in 1988 to provide our best service in EMC, Radio, Telecom and Safety consultation. Our laboratories are accredited and approved by the following approval agencies according to ISO/IEC 17025.

USA	FCC, UL
Germany	TUV Rheinland
Japan	VCCI
Norway	NEMKO
Canada	INDUSTRY CANADA , CSA
R.O.C.	TAF, BSMI, NCC
Netherlands	Telefication
Singapore	GOST-ASIA(MOU)
Russia	CERTIS(MOU)

Copies of accreditation certificates of our laboratories obtained from approval agencies can be downloaded from our web site:

www.adt.com.tw/index.5/phtml. If you have any comments, please feel free to contact us at the following:

Linko EMC/RF Lab:

Tel: 886-2-26052180

Fax: 886-2-26052943

Hsin Chu EMC/RF Lab:

Tel: 886-3-5935343

Fax: 886-3-5935342

Hwa Ya EMC/RF/Safety Telecom Lab:

Tel: 886-3-3183232

Fax: 886-3-3185050

Web Site: www.adt.com.tw

The address and road map of all our labs can be found in our web site also



7.APPENDIX-A- MODIFICATIONS RECORDERS FOR ENGINEERING CHANGES TO THE EUT BY THE LAB

No any modifications are made to the EUT by the lab during the test.

---END---