



FCC TEST REPORT

REPORT NO.: RF930519H14

MODEL NO.: WRT54GP2

RECEIVED: May 20, 2004

TESTED: Jun. 01 to 06, 2004

APPLICANT: Cisco-Linksys, LLC

ADDRESS: 121 Theory Drive Irvine, CA 92612 (USA)

ISSUED BY: Advance Data Technology Corporation

LAB LOCATION: No. 81-1, Lu Liao Keng, 9 Ling, Wu Lung Tsuen,
Chiung Lin Hsiang, Hsin Chu Hsien,
Taiwan, R.O.C.

This test report consists of 71 pages in total. It may be duplicated completely for legal use with the approval of the applicant. It should not be reproduced, except in full, without the written approval of our laboratory. The client should not use it to claim product endorsement by CNLA, or any government agencies. The test results in the report only apply to the tested sample.



0536
ILAC MRA



Table of Contents

1	CERTIFICATION.....	4
2	SUMMARY OF TEST RESULTS.....	5
3	GENERAL INFORMATION	6
3.1	GENERAL DESCRIPTION OF EUT.....	6
3.2	DESCRIPTION OF TEST MODES.....	8
3.3	GENERAL DESCRIPTION OF APPLIED STANDARDS	8
3.4	DESCRIPTION OF SUPPORT UNITS.....	9
3.5	CONFIGURATION OF SYSTEM UNDER TEST	10
4	TEST TYPES AND RESULTS.....	12
4.1	CONDUCTED EMISSION MEASUREMENT	12
4.1.1	LIMITS OF CONDUCTED EMISSION MEASUREMENT.....	12
4.1.2	TEST INSTRUMENTS	12
4.1.3	TEST SETUP.....	13
4.1.4	EUT OPERATING CONDITIONS.....	14
4.1.5	TEST RESULTS.....	15
4.2	RADIATED EMISSION MEASUREMENT	19
4.2.1	LIMITS OF RADIATED EMISSION MEASUREMENT.....	19
4.2.2	TEST INSTRUMENTS	20
4.2.3	TEST PROCEDURES.....	21
4.2.4	TEST SETUP	22
4.2.5	EUT OPERATING CONDITIONS.....	22
4.2.6	TEST RESULTS.....	23
4.2.7	TEST RESULTS - DSSS.....	25
4.2.8	TEST RESULTS -OFDM	31
4.3	6DB BANDWIDTH MEASUREMENT	37
4.3.1	LIMITS OF 6DB BANDWIDTH MEASUREMENT	37
4.3.2	TEST INSTRUMENTS	37
4.3.3	TEST PROCEDURE	38
4.3.4	TEST SETUP	38
4.3.5	EUT OPERATING CONDITIONS.....	38
4.3.6	TEST RESULTS-DSSS.....	39
4.3.7	TEST RESULTS-OFDM	43
4.4	MAXIMUM PEAK OUTPUT POWER.....	47
4.4.1	LIMITS OF MAXIMUM PEAK OUTPUT POWER MEASUREMENT.....	47
4.4.2	TEST INSTRUMENTS	47



4.4.3	TEST PROCEDURES.....	48
4.4.4	TEST SETUP.....	48
4.4.5	EUT OPERATING CONDITIONS.....	48
4.4.6	TEST RESULTS - DSSS.....	49
4.4.7	TEST RESULTS - OFDM.....	50
4.5	POWER SPECTRAL DENSITY MEASUREMENT.....	51
4.5.1	LIMITS OF POWER SPECTRAL DENSITY MEASUREMENT.....	51
4.5.2	TEST INSTRUMENTS.....	51
4.5.3	TEST PROCEDURE.....	52
4.5.4	TEST SETUP.....	52
4.5.5	EUT OPERATING CONDITIONS.....	52
4.5.6	TEST RESULTS-DSSS.....	53
4.5.7	TEST RESULTS-OFDM.....	57
4.6	BAND EDGES MEASUREMENT.....	61
4.6.1	LIMITS OF BAND EDGES MEASUREMENT.....	61
4.6.2	TEST INSTRUMENTS.....	61
4.6.3	TEST PROCEDURE.....	61
4.6.4	EUT OPERATING CONDITION.....	61
4.6.5	TEST RESULTS - DSSS.....	62
4.6.6	TEST RESULTS -OFDM.....	65
4.7	ANTENNA REQUIREMENT.....	68
4.7.1	STANDARD APPLICABLE.....	68
4.7.2	ANTENNA CONNECTED CONSTRUCTION.....	68
5	PHOTOGRAPHS OF THE TEST CONFIGURATION.....	69
6	INFORMATION ON THE TESTING LABORATORIES.....	71



1 CERTIFICATION

PRODUCT : Wireless-G Broadband Router with 2 Phone Ports
BRAND NAME : Linksys
MODEL NO. : WRT54GP2
TESTED: Jun. 01 to 06, 2004
APPLICANT : Cisco-Linksys, LLC
TEST ITEM: ENGINEERING SAMPLE
STANDARDS : 47 CFR Part 15, Subpart C (Section 15.247),
ANSI C63.4-1992

The above equipment (Model: WRT54GP2) has been tested by **Advance Data Technology Corporation**, and found compliance with the requirement of the above standards. The test record, data evaluation & Equipment Under Test (EUT) configurations represented herein are true and accurate accounts of the measurements of the sample's EMC characteristics under the conditions specified in this report.

PREPARED BY: Midoli Peng, **DATE:** Jun. 14, 2004
(Midoli Peng)

APPROVED BY: Eric Lin, **DATE:** Jun. 14, 2004
(Eric Lin, Manager)



2 SUMMARY OF TEST RESULTS

The EUT has been tested according to the following specifications:

APPLIED STANDARD: 47 CFR Part 15, Subpart C			
Standard Section	Test Type and Limit	Result	REMARK
15.207	AC Power Conducted Emission Limit: 48dBuV	PASS	Meet the requirement of limit Minimum passing margin is -9.17 dBuV at 0.220 MHz
15.247(a)(2)	Spectrum Bandwidth of a Direct Sequence Spread Spectrum System Limit: min. 500kHz	PASS	Meet the requirement of limit
15.247(b)	Maximum Peak Output Power Limit: max. 30dBm	PASS	Meet the requirement of limit
15.247(c)	Transmitter Radiated Emissions Limit: Table 15.209	PASS	Meet the requirement of limit Minimum passing margin is -1.2 dBuV at 2500.00MHz
15.247(d)	Power Spectral Density Limit: max. 8dBm	PASS	Meet the requirement of limit
15.247(c)	Band Edge Measurement Limit: 20 dB less than the peak value of fundamental frequency	PASS	Meet the requirement of limit



3 GENERAL INFORMATION

3.1 GENERAL DESCRIPTION OF EUT

PRODUCT	Wireless-G Broadband Router
MODEL NO.	WRT54GP2
POWER SUPPLY	12Vdc from Power adapter
MODULATION TYPE	CCK, OFDM
RADIO TECHNOLOGY	DSSS, OFDM
TRANSFER RATE	1/2/5.5/6/9/11/12/18/24/36/48/54Mbps
FREQUENCY RANGE	2412MHz ~ 2462MHz
NUMBER OF CHANNEL	11
OUTPUT POWER	17.31dBm
ANTENNA TYPE	Dipole Antenna
DATA CABLE	NA
I/O PORTS	LAN port x 3, WAN port x 1, Phone port x 2
ASSOCIATED DEVICES	NA

NOTE:

- The EUT must be supplied with a power adapter and following two different adapters could be chosen:

Adapter 1:	
Brand:	Linksys
Model No.:	D12-1A
Input power :	AC120V, 60Hz, 23W
Output power :	DC12V, 1A, DC Cable:1.8m, unshielded
Adapter 2:	
Brand:	Linksys
Model No.:	AM-1201000D41
Input power :	AC120V, 60Hz, 23W
Output power :	DC12V, 1A, DC Cable:1.8m, unshielded



2. The EUT operates in the 2.4GHz frequency spectrum with throughput of up to 54Mbps.
3. The EUT complies with IEEE 802.11g draft standards, and backwards compatible with IEEE 802.11b products.
4. The above EUT information was declared by the manufacturer and for more detailed features description, please refer to the manufacturer's specifications or User's Manual.



3.2 DESCRIPTION OF TEST MODES

Eleven channels are provided in this EUT.

Channel	Frequency	Channel	Frequency
1	2412 MHz	7	2442 MHz
2	2417 MHz	8	2447 MHz
3	2422 MHz	9	2452 MHz
4	2427 MHz	10	2457 MHz
5	2432 MHz	11	2462 MHz
6	2437 MHz		

NOTE:

1. Below 1 GHz, the channel 1, 6, and 11 were pre-tested in chamber. The channel 11, worst case one, was chosen for final test.
2. Above 1 GHz, the channel 1, 6, and 11 were tested individually.
3. Transfer rate, 11Mbps with CCK technique and 6Mbps with OFDM technique, the worst case, were chosen for final test.

3.3 GENERAL DESCRIPTION OF APPLIED STANDARDS

The EUT is a Wireless-G Broadband Router with 2 Phone Ports. According to the specifications of the manufacturer, it must comply with the requirements of the following standards:

47 CFR Part 15, Subpart C. (15.247)
ANSI C63.4 : 1992

All tests have been performed and recorded as per the above standards.

NOTE: The EUT is also considered as a kind of computer peripheral, because the connection to computer is necessary for typical use. It has been verified to comply with the requirements of 47 CFR Part 15, Subpart B, Class B (DoC). The test report has been issued separately.



3.4 DESCRIPTION OF SUPPORT UNITS

The EUT has been tested as an independent unit together with other necessary accessories or support units. The following support units or accessories were used to form a representative test configuration during the tests.

No.	Product	Brand	Model No.	Serial No.	FCC ID
1	PERSONAL COMPUTER	DELL	4600	00043-517-542-482	FCC DoC
2	MONITOR	ADI	CM100	026058T10200628 A	FCC DoC
3	PRINTER	HP	C2642A	MY79F1C3MZ	B94C2642X
4	MODEM	ACEEX	1414	0206026776	IFAXDM1414
5	KEYBOARD	BTC	KB-5200T	N23305028	E5XKB5122WTH0 110
6	MOUSE	BTC	M851	G00347024432	NA
7	PHONE	ROMEO	TE-812	97280903	NA
8	PHONE	ROMEO	TE-812	97280926	NA
9	NOTEBOOK COMPUTER	DELL	PP01L	TW-09C748-12800-1 A3-1999	FCC DoC
10	NOTEBOOK COMPUTER	DELL	C600	6DRV601	FCC DoC

No.	Signal cable description
1	NA
2	1.8 m braid shielded wire, terminated with VGA connector via metallic frame, w/o core.
3	1.8 m foil shielded wire, terminal by frame, PS2 Connector, w/o Core.
4	1.0 m braid shielded wire, terminated with DB25 and DB9 connector via metallic frame, w/o core
5	1.8 m foil shielded wire, terminal by frame, PS2 Connector, w/o Core.
6	1.8 m foil shielded wire, terminal by frame, PS2 Connector, w/o Core.
7	1.2 m nonshielded telephone wire, terminated with RJ11 connector, w/o core.
8	1.2 m nonshielded telephone wire, terminated with RJ11 connector, w/o core.
9	NA
10	NA

Note: 1. All power cords of the above support units are unshielded (1.8m).

3.5 CONFIGURATION OF SYSTEM UNDER TEST

For Conduction Test:

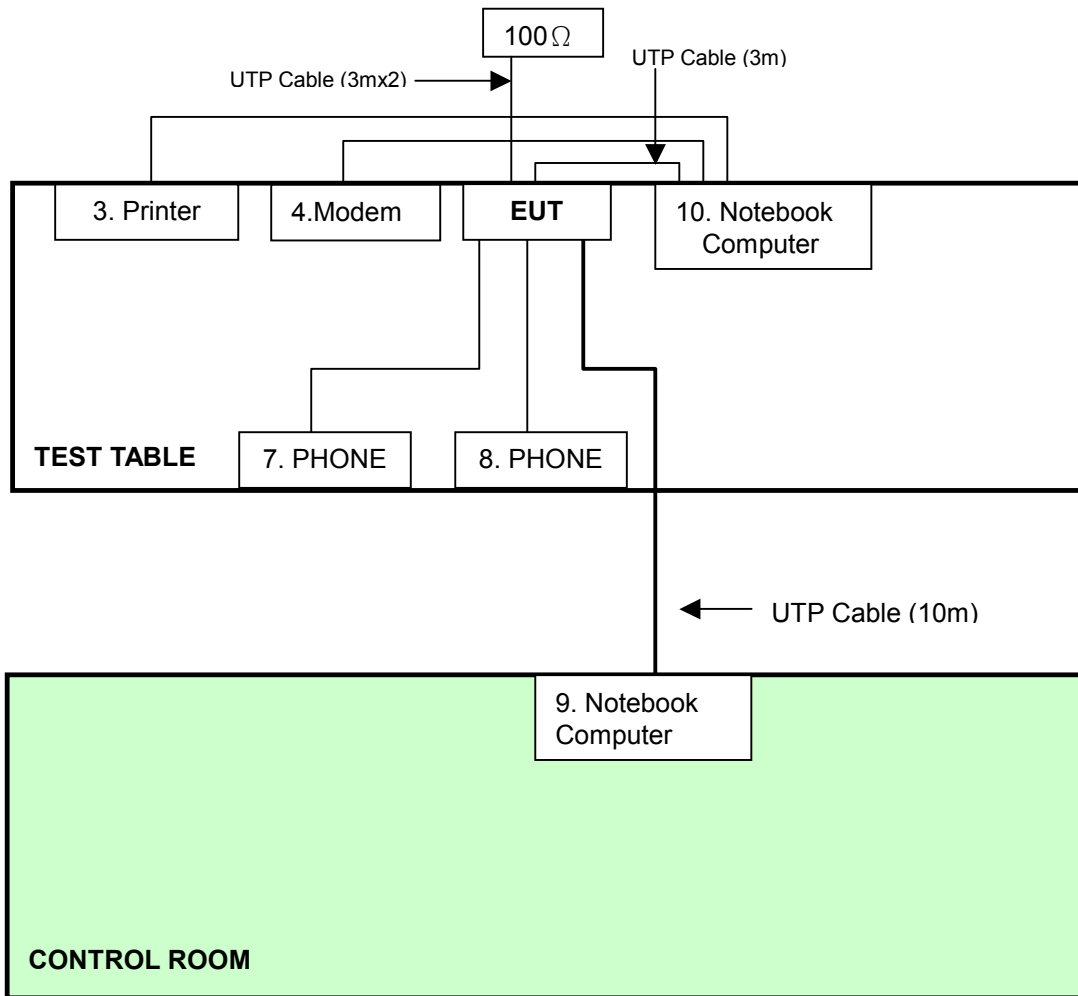

NOTE: 1. Support unit 9 was kept in the control room during the test.
 2. Please refer to the photos of test configuration in Item 5 also.

For Radiation Test:

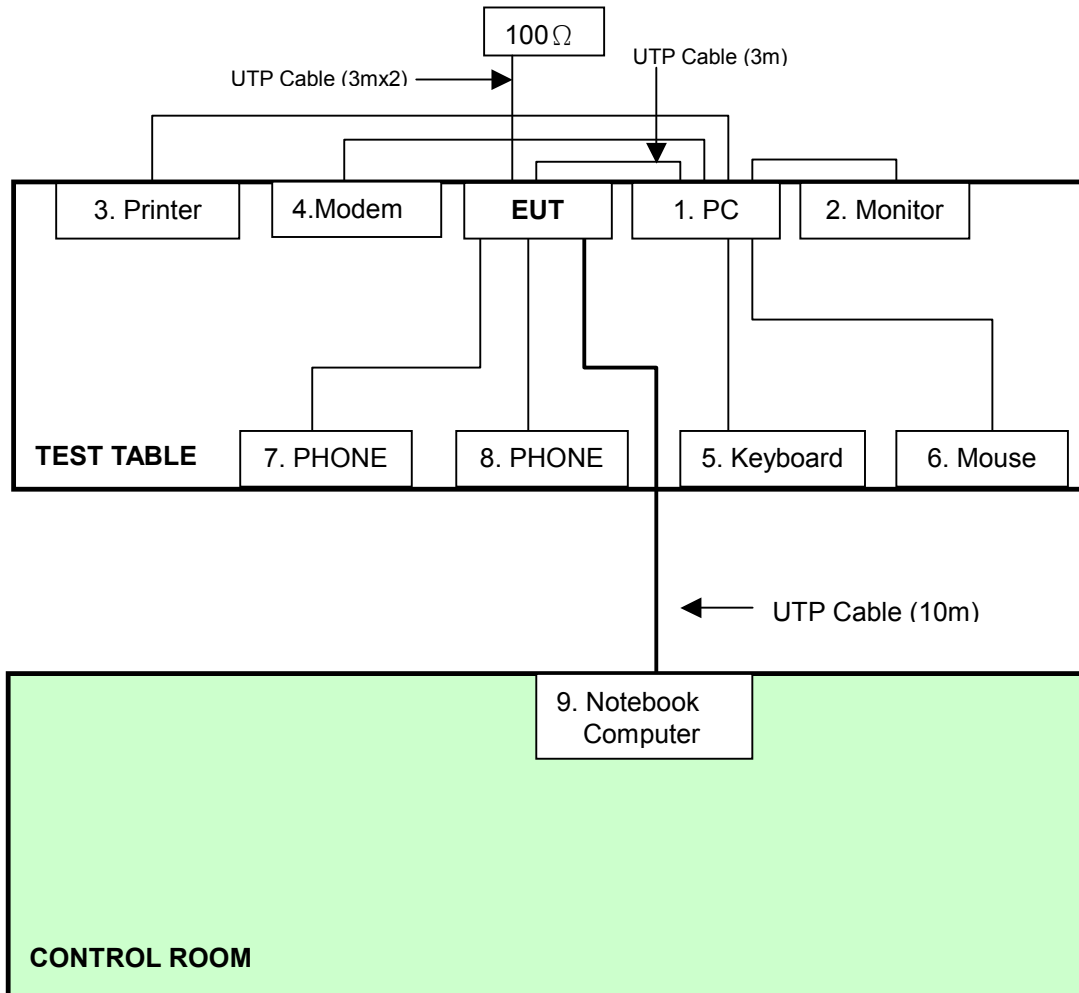

- NOTE:**
1. Support unit 9 was kept in the control room during the test.
 2. Please refer to the photos of test configuration in Item 5 also.



4 TEST TYPES AND RESULTS

4.1 CONDUCTED EMISSION MEASUREMENT

4.1.1 LIMITS OF CONDUCTED EMISSION MEASUREMENT

FREQUENCY OF EMISSION (MHz)	CONDUCTED LIMIT (dB μ V)	
	Quasi-peak	Average
0.15-0.5	66 to 56	56 to 46
0.5-5	56	46
5-30	60	50

NOTE:

1. The lower limit shall apply at the transition frequencies.
2. All emanations from a class B digital device or system, including any network of conductors and apparatus connected thereto, shall not exceed the level of field strengths specified above.

4.1.2 TEST INSTRUMENTS

DESCRIPTION & MANUFACTURER	MODEL NO.	SERIAL NO.	CALIBRATED UNTIL
ROHDE & SCHWARZ Test Receiver	ESCS 30	847124/029	Dec. 04, 2004
ROHDE & SCHWARZ LISN (for EUT)	ESHS-Z5	848773/004	Nov. 04, 2004
KYORITSU LISN (for peripheral)	KNW-407	8/1395/12	Jul. 27, 2004
RF Cable (JETBAO)	RG233/U	Cable_CA_01	Jul. 03, 2004
Terminator(for KYORITSU)	50	3	May 10, 2005
Software	Cond-V2e	NA	NA

- NOTE:**
1. The calibration interval of the above test instruments is 12 months and the calibrations are traceable to NML/ROC and NIST/USA.
 2. The test was performed in ADT Shielded Room No. A.
 3. The VCCI Con A Registration No. is C-817.

3. TEST PROCEDURES

- The EUT/HOST was placed 0.4 meters from the conducting wall of the shielded room with EUT/HOST being connected to the power mains through a line impedance stabilization network (LISN). Other support units were connected to the power mains through another LISN. The two LISNs provide 50 ohm/ 50uH of coupling impedance for the measuring instrument.
- Both lines of the power mains connected to the EUT/HOST were checked for maximum conducted interference.
- The frequency range from 150 kHz to 30 MHz was searched. Emission levels over 10dB under the prescribed limits could not be reported

4.1.3 TEST SETUP

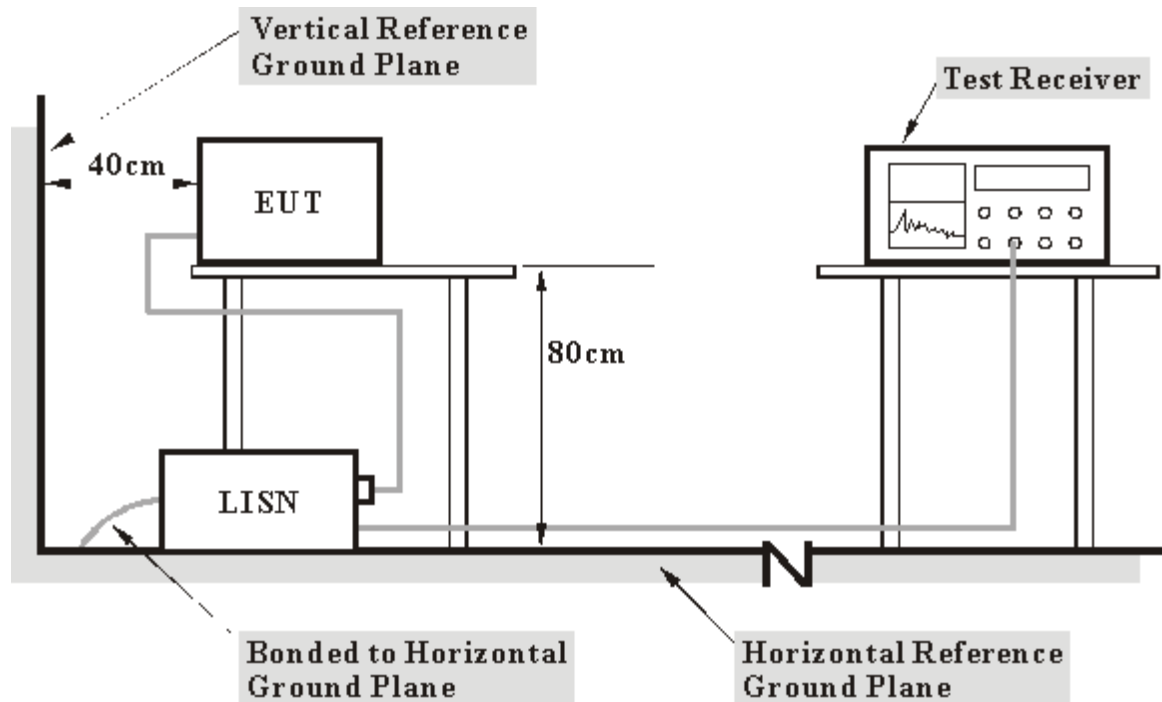

- Note:**
- Support units were connected to second LISN.
 - Both of LISNs (AMN) 80 cm from EUT and at the least 80 cm from other units and other metal planes support units.

For the actual test configuration, please refer to the related item – Photographs of the Test Configuration.



4.1.4 EUT OPERATING CONDITIONS

For Conduction Test:

- a. Placed the EUT on the testing table.
- b. The support units (3,4,7,8,10) act as a Server PC system to communicate with EUT via UTP cable.
- c. Prepared other computer systems (support unit 9) to act as a communication partner and placed them outside of testing area.
- d. The communication partner runs the test program "Ping.exe" to enable EUT under transmission/receiving condition continuously via one TEL line and wireless transmission.
- e. PC sends "H" messages to modem.
- f. PC sends "H" messages to printer, and the printer prints them on paper.

For Radiation Test:

- a. Placed the EUT on the testing table.
- b. The support units (1-8) act as a Server PC system to communicate with EUT via UTP cable.
- c. Prepared other computer systems (support unit 9) to act as a communication partner and placed them outside of testing area.
- d. The communication partner run the test program "Ping.exe" to enable EUT under transmission/receiving condition continuously via one TEL line and wireless transmission.
- e. PC sends "H" messages to modem.
- f. PC sends "H" messages to printer, and the printer prints them on paper.



4.1.5 TEST RESULTS

EUT	Wireless-G Broadband Router with 2 Phone Ports	MODEL	WRT54GP2
MODE	With Adapter 1, Channel 11	6dB BANDWIDTH	9 kHz
INPUT POWER (SYSTEM)	120Vac, 60 Hz	PHASE	Line (L)
ENVIRONMENTAL CONDITIONS	26 deg. C, 60%RH, 973 hPa	TESTED BY	Rex Huang

No	Freq. [MHz]	Corr. Factor (dB)	Reading Value [dB (uV)]		Emission Level [dB (uV)]		Limit [dB (uV)]		Margin (dB)	
			Q.P.	AV.	Q.P.	AV.	Q.P.	AV.	Q.P.	AV.
1	0.158	0.22	54.69	-	54.91	-	65.58	55.58	-10.67	-
2	0.220	0.29	52.40	-	52.69	-	62.81	52.81	-10.12	-
3	0.595	0.23	42.20	-	42.43	-	56.00	46.00	-13.57	-
4	1.068	0.30	31.09	-	31.39	-	56.00	46.00	-24.61	-
5	17.695	1.31	34.30	-	35.61	-	60.00	50.00	-24.39	-
6	23.129	1.40	33.14	-	34.54	-	60.00	50.00	-25.46	-

- NOTES:** (1) "": Undetectable
 (2) Q.P. and AV. are abbreviations of quasi-peak and average.
 (3) "-": The Quasi-peak reading value also meets an average limit, thus measurement with the average detector is unnecessary.
 (4) The emission levels of other frequencies were very low against the limit.
 (5) Correction Factor = Insertion loss + Cable loss
 (6) Margin value = Emission level - Limit value

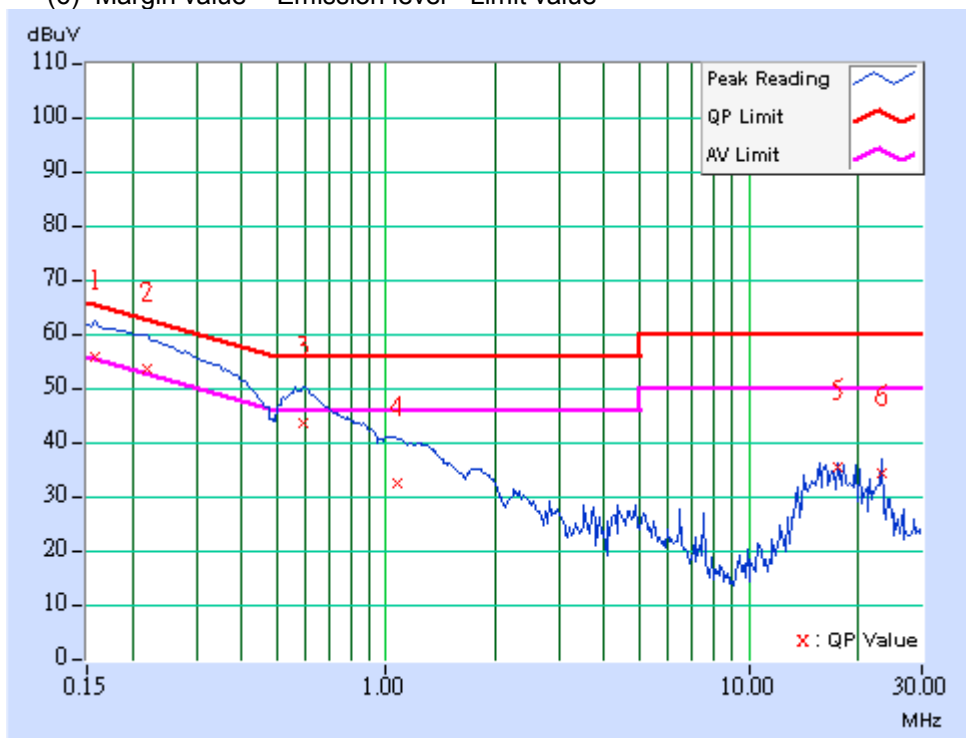



EUT	Wireless-G Broadband Router with 2 Phone Ports	MODEL	WRT54GP2
MODE	With Adapter 1, Channel 11	6dB BANDWIDTH	9 kHz
INPUT POWER (SYSTEM)	120Vac, 60 Hz	PHASE	Neutral (N)
ENVIRONMENTAL CONDITIONS	26 deg. C, 66%RH, 972 hPa	TESTED BY	Rex Huang

No	Freq. [MHz]	Corr. Factor (dB)	Reading Value [dB (uV)]		Emission Level [dB (uV)]		Limit [dB (uV)]		Margin (dB)	
			Q.P.	AV.	Q.P.	AV.	Q.P.	AV.	Q.P.	AV.
1	0.154	0.21	53.58	-	53.79	-	65.79	55.79	-12.00	-
2	0.279	0.26	47.58	-	47.84	-	60.85	50.85	-13.01	-
3	0.611	0.24	36.76	-	37.00	-	56.00	46.00	-19.00	-
4	1.072	0.30	24.15	-	24.45	-	56.00	46.00	-31.55	-
5	14.945	1.10	19.07	-	20.17	-	60.00	50.00	-39.83	-
6	23.070	1.20	23.98	-	25.18	-	60.00	50.00	-34.82	-

- NOTES:** (1) "***": Undetectable
 (2) Q.P. and AV. are abbreviations of quasi-peak and average.
 (3) "-": The Quasi-peak reading value also meets an average limit, thus measurement with the average detector is unnecessary.
 (4) The emission levels of other frequencies were very low against the limit.
 (5) Correction Factor = Insertion loss + Cable loss
 (6) Margin value = Emission level - Limit value

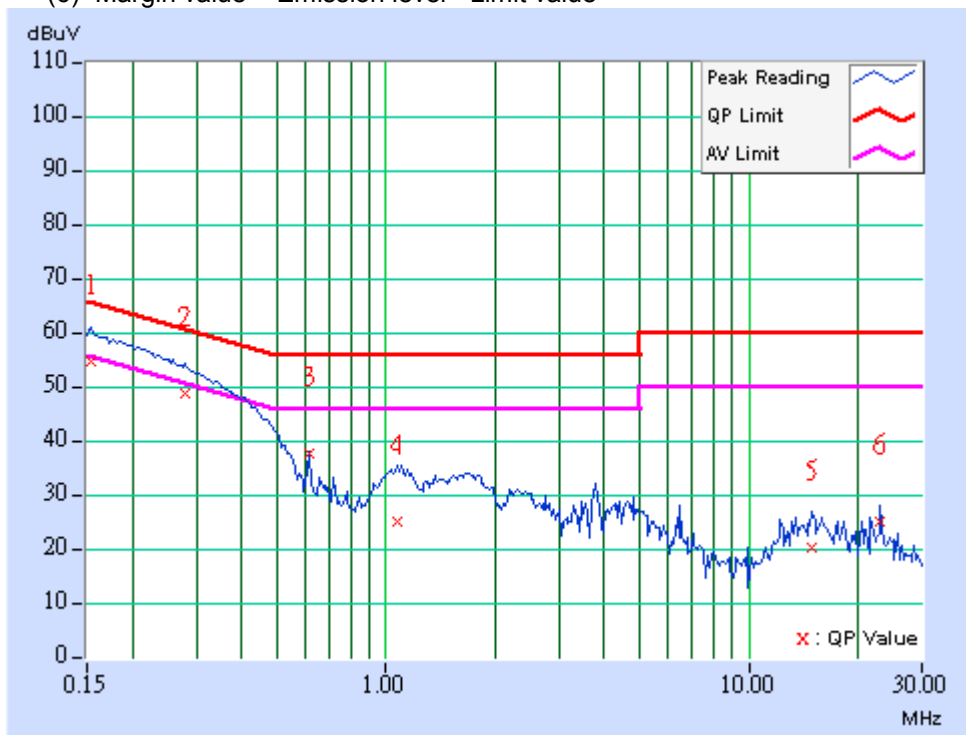



EUT	Wireless-G Broadband Router with 2 Phone Ports	MODEL	WRT54GP2
MODE	With Adapter 2, Channel 11	6dB BANDWIDTH	9 kHz
INPUT POWER (SYSTEM)	120Vac, 60 Hz	PHASE	Line (L)
ENVIRONMENTAL CONDITIONS	26 deg. C, 66%RH, 972 hPa	TESTED BY	Rex Huang

No	Freq. [MHz]	Corr. Factor (dB)	Reading Value [dB (uV)]		Emission Level [dB (uV)]		Limit [dB (uV)]		Margin (dB)	
			Q.P.	AV.	Q.P.	AV.	Q.P.	AV.	Q.P.	AV.
1	0.158	0.22	54.85	-	55.07	-	65.58	55.58	-10.51	-
2	0.281	0.26	50.39	-	50.65	-	60.78	50.78	-10.13	-
3	0.656	0.24	39.00	-	39.24	-	56.00	46.00	-16.76	-
4	0.966	0.29	32.60	-	32.89	-	56.00	46.00	-23.11	-
5	16.168	1.25	29.49	-	30.74	-	60.00	50.00	-29.26	-
6	18.242	1.33	33.11	-	34.44	-	60.00	50.00	-25.56	-

- NOTES:** (1) "***": Undetectable
 (2) Q.P. and AV. are abbreviations of quasi-peak and average.
 (3) "-": The Quasi-peak reading value also meets an average limit, thus measurement with the average detector is unnecessary.
 (4) The emission levels of other frequencies were very low against the limit.
 (5) Correction Factor = Insertion loss + Cable loss
 (6) Margin value = Emission level - Limit value

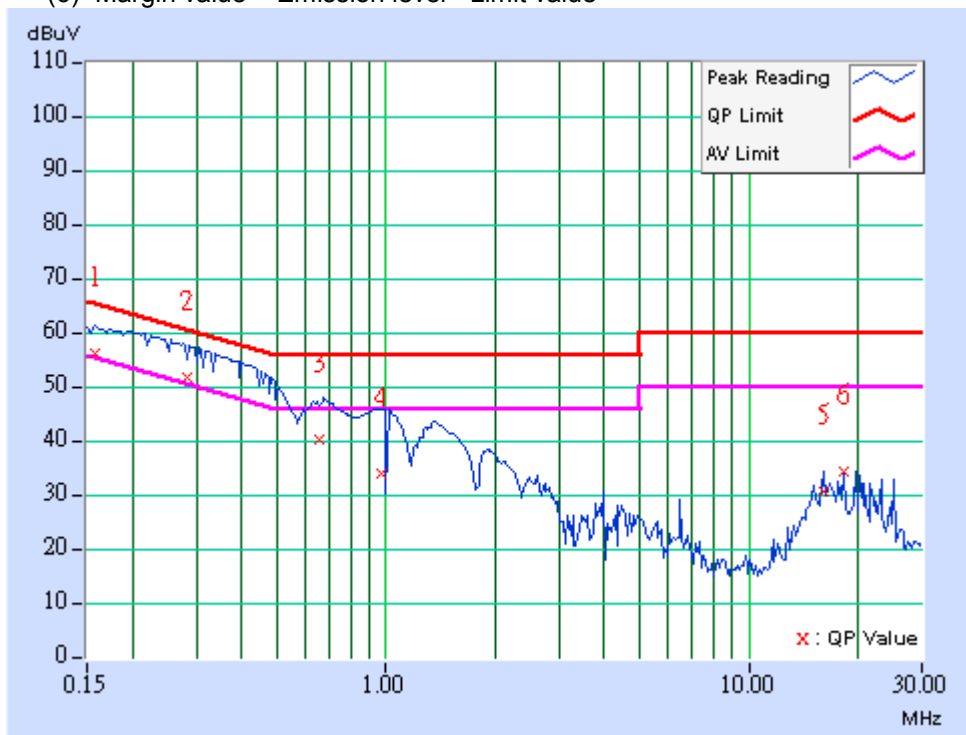



EUT	Wireless-G Broadband Router with 2 Phone Ports	MODEL	WRT54GP2
MODE	With Adapter 2, Channel 11	6dB BANDWIDTH	9 kHz
INPUT POWER (SYSTEM)	120Vac, 60 Hz	PHASE	Neutral (N)
ENVIRONMENTAL CONDITIONS	26 deg. C, 66%RH, 972 hPa	TESTED BY	Rex Huang

No	Freq. [MHz]	Corr. Factor (dB)	Reading Value [dB (uV)]		Emission Level [dB (uV)]		Limit [dB (uV)]		Margin (dB)	
			Q.P.	AV.	Q.P.	AV.	Q.P.	AV.	Q.P.	AV.
1	0.158	0.22	55.93	45.13	56.15	45.35	65.59	55.59	-9.44	-10.24
2	0.220	0.29	53.34	37.08	53.63	37.37	62.80	52.80	-9.17	-15.43
3	0.611	0.24	41.15	-	41.39	-	56.00	46.00	-14.61	-
4	1.111	0.30	35.19	-	35.49	-	56.00	46.00	-20.51	-
5	16.230	1.12	29.12	-	30.24	-	60.00	50.00	-29.76	-
6	17.695	1.15	29.62	-	30.77	-	60.00	50.00	-29.23	-

- NOTES:** (1) "": Undetectable
 (2) Q.P. and AV. are abbreviations of quasi-peak and average.
 (3) "-": The Quasi-peak reading value also meets an average limit, thus measurement with the average detector is unnecessary.
 (4) The emission levels of other frequencies were very low against the limit.
 (5) Correction Factor = Insertion loss + Cable loss
 (6) Margin value = Emission level - Limit value

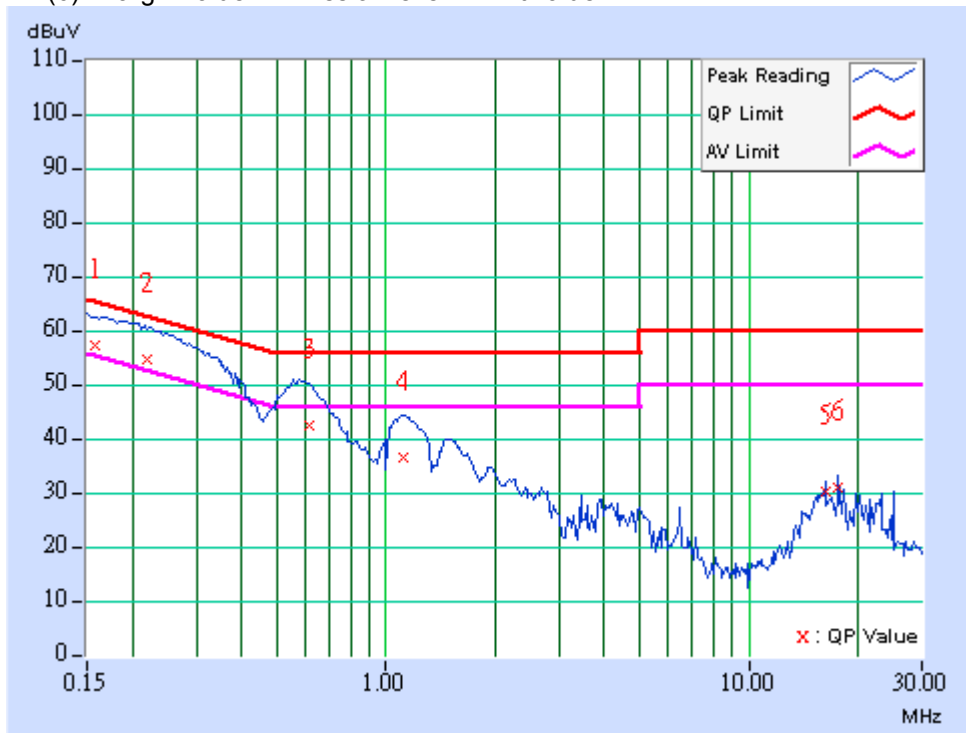



4.2 RADIATED EMISSION MEASUREMENT

4.2.1 LIMITS OF RADIATED EMISSION MEASUREMENT

Field strength limits are at the distance of 3 meters, emissions radiated outside of the specified bands, shall be according to the general radiated limits in 15.209 as following:

Frequencies (MHz)	Field strength (microvolts/meter)	Measurement distance (meters)
0.009-0.490	2400/F(kHz)	300
0.490-1.705	24000/F(kHz)	30
1.705-30.0	30	30
30-88	100	3
88-216	150	3
216-960	200	3
Above 960	500	3

NOTE:

1. The lower limit shall apply at the transition frequencies.
2. Emission level (dBuV/m) = 20 log Emission level (uV/m).
3. As shown in 15.35(b), for frequencies above 1000MHz, the field strength limits are based on average detector, however, the peak field strength of any emission shall not exceed the maximum permitted average limits, specified above by more than 20dB under any condition of modulation.



4.2.2 TEST INSTRUMENTS

DESCRIPTION & MANUFACTURER	MODEL NO.	SERIAL NO.	CALIBRATED UNTIL
HP Spectrum Analyzer	8594ER	3829U04676	Aug. 30, 2004
ADVANTEST Spectrum Analyzer	R3271A	85060311	Jun. 16, 2004
CHASE RF Pre_Amplifier	CPA9232	1057	May. 10, 2005
HP Pre_Amplifier	8449B	3008A01922	Oct. 13, 2004
ROHDE & SCHWARZ Test Receiver	ESVS 10	849231 /019	Sep. 30, 2004
CHASE Broadband Antenna	CBL6111c	2730	Jul. 30, 2004
Schwarzbeck Horn_Antenna	3115	5619	Jul. 17, 2004
Schwarzbeck Horn_Antenna	BBHA 9170	BBHA9170192	Feb. 16, 2005
SCHWARZBECK Tunable Dipole Antenna	UHAP	897	Mar. 07, 2005
SCHWARZBECK Tunable Dipole Antenna	VHAP	880	Mar. 07, 2005
RF Switches (ARNITSU)	CS-201	1565157	Dec. 01, 2004
RF CABLE (Chaintek) 1GHz-20GHz	SF102	22054-2	Feb. 10, 2005
RF Cable(RICHTEC)	9913-30M	STCCAB-30M-1GH z-021	Dec. 01, 2004
Software	AS60P8	NA	NA
CHANCE MOST Antenna Tower	AT-100	0203	NA
CHANCE MOST Turn Table	TT-100	0203	NA

Note: 1. The calibration interval of the above test instruments is 12 months (36 months for Tunable Dipole Antenna) and the calibrations are traceable to NML/ROC and NIST/USA.

2. * = These equipment are used for the final measurement.
3. The horn antenna and HP preamplifier (model: 8449B) are used only for the measurement of emission frequency above 1GHz if tested.
4. The test was performed in ADT Open Site No. C.
5. The FCC Site Registration No. is 656396.
6. The VCCI Site Registration No. is R-1626.
7. The CANADA Site Registration No. is IC 4824-3.



4.2.3 TEST PROCEDURES

- a. The EUT was placed on the top of a rotating table 0.8 meters above the ground at a 10 meter open area test site. The table was rotated 360 degrees to determine the position of the highest radiation.
- b. The EUT was set 3 meters away from the interference-receiving antenna, which was mounted on the top of a variable-height antenna tower.
- c. The antenna is a broadband antenna, and its height is varied from one meter to four meters above the ground to determine the maximum value of the field strength. Both horizontal and vertical polarizations of the antenna are set to make the measurement.
- d. For each suspected emission, the EUT was arranged to its worst case and then the antenna was tuned to heights from 1 meter to 4 meters and the rotatable table was turned from 0 degrees to 360 degrees to find the maximum reading.
- e. The test-receiver system was set to Peak Detect Function and Specified Bandwidth with Maximum Hold Mode.
- f. If the emission level of the EUT in peak mode was 10 dB lower than the limit specified, then testing could be stopped and the peak values of the EUT would be reported. Otherwise the emissions that did not have 10 dB margin would be re-tested one by one using peak, quasi-peak or average method as specified and then reported in a data sheet.

NOTE:

1. The resolution bandwidth and video bandwidth of test receiver/spectrum analyzer is 120kHz for Peak detection (PK) and Quasi-peak detection (QP) at frequency below 1GHz.
2. The resolution bandwidth and video bandwidth of test receiver/spectrum analyzer is 1 MHz for Peak detection at frequency above 1GHz.
3. The resolution bandwidth of test receiver/spectrum analyzer is 1 MHz and the video bandwidth is 300 Hz for Average detection (AV) at frequency above 1GHz.

4.2.4 TEST SETUP

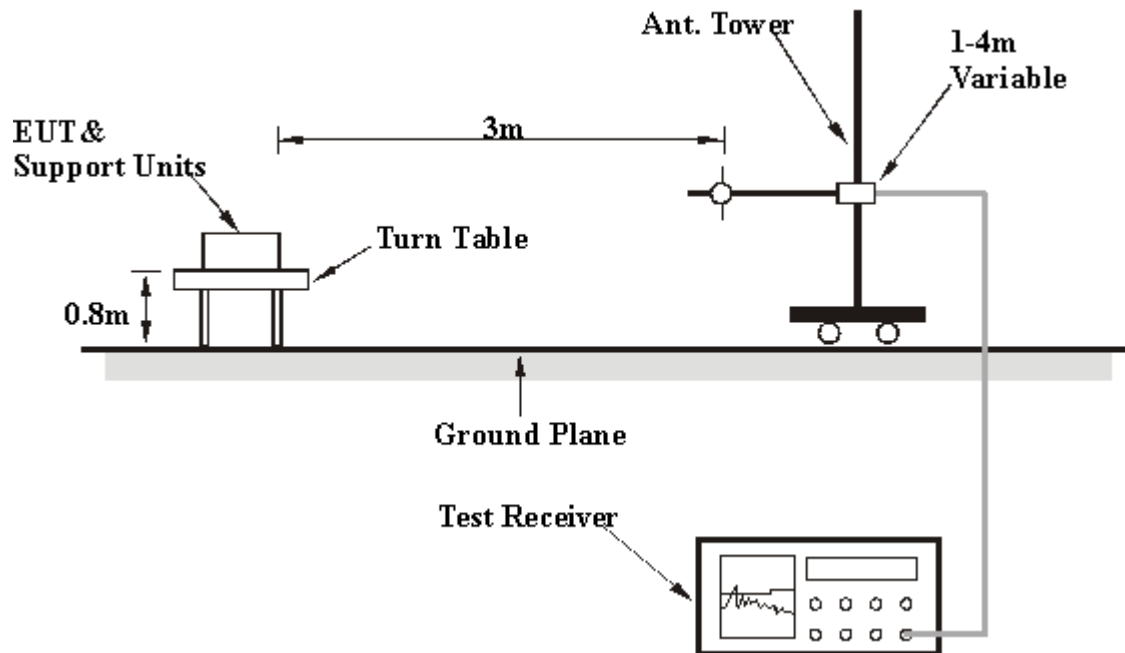

For the actual test configuration, please refer to the related item – Photographs of the Test Configuration.

4.2.5 EUT OPERATING CONDITIONS

Same as 4.1.5.



4.2.6 TEST RESULTS

EUT	Wireless-G Broadband Router with 2 Phone Ports	MODEL	WRT54GP2
MODE	Adapter 1, Channel 11	FREQUENCY RANGE	30-1000 MHz
INPUT POWER (SYSTEM)	120Vac, 60 Hz	DETECTOR FUNCTION & BANDWIDTH	Quasi-Peak, 120kHz
ENVIRONMENTAL CONDITIONS	27 deg. C, 61%RH, 972 hPa	TESTED BY	Tony Chen

ANTENNA POLARITY & TEST DISTANCE: HORIZONTAL AT 3 M

No.	Freq. (MHz)	Emission Level (dBuV/m)	Limit (dBuV/m)	Margin (dB)	Antenna Height (m)	Table Angle (Degree)	Raw Value (dBuV)	Correction Factor (dB/m)
1	125.00	29.70 QP	43.50	-13.80	2.04 H	355	16.70	13.10
2	250.00	37.50 QP	46.00	-8.50	1.34 H	33	23.10	14.40
3	350.00	30.60 QP	46.00	-15.40	1.19 H	277	13.60	17.00
4	374.99	31.30 QP	46.00	-14.70	1.20 H	13	13.50	17.80
5	399.99	30.80 QP	46.00	-15.20	1.00 H	1	12.10	18.70
6	449.99	29.50 QP	46.00	-16.50	1.00 H	21	9.40	20.10
7	480.00	36.50 QP	46.00	-9.50	2.13 H	3	15.40	21.10
8	499.99	34.20 QP	46.00	-11.80	1.08 H	118	12.60	21.60
9	625.02	34.40 QP	46.00	-11.60	1.00 H	3	10.60	23.80
10	750.00	35.80 QP	46.00	-10.20	1.03 H	207	9.70	26.10
11	800.00	38.00 QP	46.00	-8.00	1.14 H	3	12.00	26.00
12	878.30	28.50 QP	46.00	-17.50	1.03 H	223	0.70	27.80

ANTENNA POLARITY & TEST DISTANCE: VERTICAL AT 3 M

No.	Freq. (MHz)	Emission Level (dBuV/m)	Limit (dBuV/m)	Margin (dB)	Antenna Height (m)	Table Angle (Degree)	Raw Value (dBuV)	Correction Factor (dB/m)
1	56.89	27.50 QP	40.00	-12.50	1.58 V	130	20.80	6.80
2	74.27	36.70 QP	40.00	-3.30	1.28 V	139	29.30	7.40
3	125.00	38.80 QP	43.50	-4.70	1.13 V	10	25.70	13.10
4	250.00	34.00 QP	46.00	-12.00	1.04 V	180	19.60	14.40
5	374.99	28.60 QP	46.00	-17.40	1.16 V	229	10.80	17.80
6	399.99	30.00 QP	46.00	-16.00	1.34 V	344	11.30	18.70
7	480.00	36.00 QP	46.00	-10.00	1.12 V	347	14.90	21.10
8	500.01	32.10 QP	46.00	-13.90	1.09 V	3	10.40	21.60
9	625.02	32.60 QP	46.00	-13.40	1.32 V	122	8.80	23.80
10	749.98	33.70 QP	46.00	-12.30	1.00 V	282	7.60	26.10
11	800.00	37.50 QP	46.00	-8.50	1.12 V	267	11.50	26.00
12	878.38	36.30 QP	46.00	-9.70	1.18 V	194	8.50	27.80

- REMARKS:**
1. Emission level(dBuV/m)=Raw Value(dBuV) + Correction Factor(dB)
 2. Correction Factor(dB/m) = Antenna Factor (dB/m) + Cable Factor (dB)
 3. The other emission levels were very low against the limit.
 4. Margin value = Emission level – Limit value.



EUT	Wireless-G Broadband Router with 2 Phone Ports	MODEL	WRT54GP2
MODE	Adapter 2, Channel 11	FREQUENCY RANGE	30-1000 MHz
INPUT POWER (SYSTEM)	120Vac, 60 Hz	DETECTOR FUNCTION & BANDWIDTH	Quasi-Peak, 120kHz
ENVIRONMENTAL CONDITIONS	27 deg. C, 61%RH, 972 hPa	TESTED BY	Tony Chen

ANTENNA POLARITY & TEST DISTANCE: HORIZONTAL AT 3 M

No.	Freq. (MHz)	Emission Level (dBuV/m)	Limit (dBuV/m)	Margin (dB)	Antenna Height (m)	Table Angle (Degree)	Raw Value (dBuV)	Correction Factor (dB/m)
1	125.00	30.90 QP	43.50	-12.60	1.50 H	61	17.80	13.10
2	250.01	38.60 QP	46.00	-7.40	1.08 H	301	24.20	14.40
3	374.99	31.60 QP	46.00	-14.40	1.09 H	35	13.80	17.80
4	399.99	30.80 QP	46.00	-15.20	1.06 H	215	12.10	18.70
5	480.00	36.20 QP	46.00	-9.80	1.00 H	334	15.10	21.10
6	500.01	33.30 QP	46.00	-12.70	1.16 H	331	11.70	21.60
7	599.98	32.70 QP	46.00	-13.30	1.07 H	139	9.90	22.90
8	625.02	35.80 QP	46.00	-10.20	1.15 H	12	12.00	23.80
9	750.00	35.80 QP	46.00	-10.20	1.13 H	195	9.70	26.10
10	800.00	36.80 QP	46.00	-9.20	1.15 H	1	10.80	26.00

ANTENNA POLARITY & TEST DISTANCE: VERTICAL AT 3 M

No.	Freq. (MHz)	Emission Level (dBuV/m)	Limit (dBuV/m)	Margin (dB)	Antenna Height (m)	Table Angle (Degree)	Raw Value (dBuV)	Correction Factor (dB/m)
1	50.12	30.70 QP	40.00	-9.30	1.20 V	19	21.60	9.10
2	125.00	38.60 QP	43.50	-4.90	1.00 V	343	25.60	13.10
3	250.00	36.00 QP	46.00	-10.00	1.11 V	178	21.60	14.40
4	375.00	31.80 QP	46.00	-14.20	1.22 V	218	14.10	17.80
5	399.99	30.20 QP	46.00	-15.80	1.39 V	340	11.50	18.70
6	425.01	25.30 QP	46.00	-20.70	1.32 V	2	5.60	19.70
7	480.00	35.50 QP	46.00	-10.50	1.13 V	3	14.40	21.10
8	500.02	32.50 QP	46.00	-13.50	1.08 V	333	10.90	21.60
9	599.99	34.20 QP	46.00	-11.80	1.00 V	330	11.30	22.90
10	625.02	34.30 QP	46.00	-11.70	1.00 V	326	10.50	23.80
11	750.01	37.00 QP	46.00	-9.00	1.12 V	118	10.90	26.10

- REMARKS:**
1. Emission level(dBuV/m)=Raw Value(dBuV) + Correction Factor(dB)
 2. Correction Factor(dB/m) = Antenna Factor (dB/m) + Cable Factor (dB)
 3. The other emission levels were very low against the limit.
 4. Margin value = Emission level – Limit value.



4.2.7 TEST RESULTS - DSSS

EUT	Wireless-G Broadband Router with 2 Phone Ports	MODEL	WRT54GP2
MODE	Channel 1	FREQUENCY RANGE	1000~25000MHz
INPUT POWER (SYSTEM)	120Vac, 60 Hz	DETECTOR FUNCTION & BANDWIDTH	Peak (PK) Average (AV) 1 MHz
ENVIRONMENTAL CONDITIONS	30 deg. C, 60%RH, 972 hPa	TESTED BY	Wen Yu

ANTENNA POLARITY & TEST DISTANCE: HORIZONTAL AT 3 M

No.	Freq. (MHz)	Emission Level (dBuV/m)	Limit (dBuV/m)	Margin (dB)	Antenna Height (m)	Table Angle (Degree)	Raw Value (dBuV)	Correction Factor (dB/m)
1	2038.00	51.30 PK	77.60	-26.30	1.36 H	132	22.30	28.90
1	2038.00	50.50 AV	70.90	-20.40	1.36 H	132	21.60	28.90
2	2220.00	39.30 PK	74.00	-34.70	1.48 H	251	9.40	29.90
3	2310.00	40.20 PK	74.00	-33.80	1.35 H	142	9.80	30.40
4	2354.00	44.60 PK	74.00	-29.40	1.34 H	147	14.00	30.60
5	2390.00	33.50 PK	74.00	-40.50	1.06 H	2	-0.40	33.80
6	*2412.00	97.60 PK			1.06 H	2	67.70	29.90
6	*2412.00	90.90 AV			1.06 H	2	61.00	29.90
7	2500.00	48.30 PK	74.00	-25.70	1.00 H	220	17.80	30.50
8	2720.00	44.80 PK	74.00	-29.20	1.61 H	217	13.80	31.00
9	4824.00	44.30 PK	74.00	-29.70	1.22 H	5	8.10	36.20
10	7236.00	48.10 PK	74.00	-25.90	1.52 H	215	6.40	41.70
11	9648.00	51.30 PK	74.00	-22.70	1.23 H	152	6.40	44.90
11	9648.00	40.70 AV	54.00	-13.30	1.23 H	152	-4.20	44.90



ANTENNA POLARITY & TEST DISTANCE: VERTICAL AT 3 M								
No.	Freq. (MHz)	Emission Level (dBuV/m)	Limit (dBuV/m)	Margin (dB)	Antenna Height (m)	Table Angle (Degree)	Raw Value (dBuV)	Correction Factor (dB/m)
1	2038.00	57.20 PK	91.80	-34.60	1.35 V	226	28.30	28.90
1	2038.00	57.20 AV	86.00	-28.80	1.35 V	226	28.30	28.90
2	2220.00	47.00 PK	74.00	-27.00	1.00 V	25	17.10	29.90
3	2310.00	48.40 PK	74.00	-25.60	1.55 V	114	18.10	30.40
4	2354.00	51.90 PK	74.00	-22.10	1.52 V	346	21.30	30.60
4	2354.00	48.40 AV	54.00	-5.60	1.52 V	346	17.80	30.60
5	2390.00	47.70 PK	74.00	-26.30	1.13 V	359	13.90	33.80
6	*2412.00	111.80 PK			1.13 V	359	81.90	29.90
6	*2412.00	106.00 AV			1.13 V	359	76.10	29.90
7	2500.00	56.20 PK	74.00	-17.80	1.00 V	38	25.70	30.50
7	2500.00	52.60 AV	54.00	-1.40	1.00 V	38	22.10	30.50
8	2720.00	47.10 PK	74.00	-26.90	1.34 V	151	16.20	31.00
9	4824.00	45.70 PK	74.00	-28.30	1.35 V	21	9.50	36.20
10	7236.00	47.70 PK	74.00	-26.30	1.25 V	41	6.10	41.70
11	9648.00	49.30 PK	74.00	-24.70	1.35 V	52	4.40	44.90

- REMARKS:**
1. Emission level(dBuV/m)=Raw Value(dBuV) + Correction Factor(dB)
 2. Correction Factor(dB/m) = Antenna Factor (dB/m) + Cable Factor (dB)
 3. The other emission levels were very low against the limit.
 4. Margin value = Emission level – Limit value.
 5. The limit value is defined as per 15.247
 6. " * " : Fundamental frequency



EUT	Wireless-G Broadband Router with 2 Phone Ports	MODEL	WRT54GP2
MODE	Channel 6	FREQUENCY RANGE	1000~25000MHz
INPUT POWER (SYSTEM)	120Vac, 60 Hz	DETECTOR FUNCTION & BANDWIDTH	Peak (PK) Average (AV) 1 MHz
ENVIRONMENTAL CONDITIONS	30 deg. C, 60%RH, 972 hPa	TESTED BY	Wen Yu

ANTENNA POLARITY & TEST DISTANCE: HORIZONTAL AT 3 M

No.	Freq. (MHz)	Emission Level (dBuV/m)	Limit (dBuV/m)	Margin (dB)	Antenna Height (m)	Table Angle (Degree)	Raw Value (dBuV)	Correction Factor (dB/m)
1	2063.00	51.40 PK	78.40	-27.00	1.69 H	263	22.30	29.10
1	2063.00	50.60 AV	71.50	-20.90	1.69 H	263	21.50	29.10
2	2222.00	43.10 PK	74.00	-30.90	1.16 H	183	13.20	29.90
3	2310.00	41.80 PK	74.00	-32.20	1.00 H	327	11.40	30.40
4	2354.00	45.10 PK	74.00	-28.90	1.44 H	183	14.50	30.60
5	*2437.00	98.40 PK			1.16 H	26	68.40	30.00
5	*2437.00	91.50 AV			1.16 H	26	61.50	30.00
6	2500.00	48.30 PK	74.00	-25.70	1.49 H	114	17.80	30.50
7	2720.00	44.70 PK	74.00	-29.30	1.32 H	120	13.70	31.00
8	4874.00	43.60 PK	74.00	-30.40	1.29 H	4	7.10	36.50
9	7311.00	48.20 PK	74.00	-25.80	1.72 H	315	6.40	41.80
10	9748.00	51.20 PK	74.00	-22.80	1.54 H	167	6.60	44.60
10	9748.00	40.40 AV	54.00	-13.60	1.54 H	167	-4.20	44.60



ANTENNA POLARITY & TEST DISTANCE: VERTICAL AT 3 M								
No.	Freq. (MHz)	Emission Level (dBuV/m)	Limit (dBuV/m)	Margin (dB)	Antenna Height (m)	Table Angle (Degree)	Raw Value (dBuV)	Correction Factor (dB/m)
1	2063.00	59.80 PK	93.80	-34.00	1.25 V	149	30.70	29.10
1	2063.00	59.40 AV	86.50	-27.10	1.25 V	149	30.30	29.10
2	2222.00	48.10 PK	74.00	-25.90	1.00 V	27	18.20	29.90
3	2310.00	48.90 PK	74.00	-25.10	1.27 V	115	18.60	30.40
4	2354.00	52.00 PK	74.00	-22.00	1.03 V	172	21.40	30.60
4	2354.00	48.10 AV	54.00	-5.90	1.03 V	172	17.50	30.60
5	*2437.00	113.80 PK			1.14 V	345	83.80	30.00
5	*2437.00	106.50 AV			1.14 V	345	76.50	30.00
6	2500.00	52.30 PK	74.00	-21.70	1.17 V	306	21.80	30.50
6	2500.00	52.80 AV	54.00	-1.20	1.17 V	306	22.20	30.50
7	2720.00	47.10 PK	74.00	-26.90	1.06 V	121	16.20	31.00
8	4874.00	44.70 PK	74.00	-29.30	1.26 V	320	8.20	36.50
9	7311.00	48.70 PK	74.00	-25.30	1.29 V	96	7.00	41.80
10	9748.00	50.60 PK	74.00	-23.40	1.36 V	311	5.90	44.60

- REMARKS:**
1. Emission level(dBuV/m)=Raw Value(dBuV) + Correction Factor(dB)
 2. Correction Factor(dB/m) = Antenna Factor (dB/m) + Cable Factor (dB)
 3. The other emission levels were very low against the limit.
 4. Margin value = Emission level – Limit value.
 5. The limit value is defined as per 15.247
 6. " * " : Fundamental frequency



EUT	Wireless-G Broadband Router with 2 Phone Ports	MODEL	WRT54GP2
MODE	Channel 11	FREQUENCY RANGE	1000~25000MHz
INPUT POWER (SYSTEM)	120Vac, 60 Hz	DETECTOR FUNCTION & BANDWIDTH	Peak (PK) Average (AV) 1 MHz
ENVIRONMENTAL CONDITIONS	30 deg. C, 60%RH, 972 hPa	TESTED BY	Wen Yu

ANTENNA POLARITY & TEST DISTANCE: HORIZONTAL AT 3 M

No.	Freq. (MHz)	Emission Level (dBuV/m)	Limit (dBuV/m)	Margin (dB)	Antenna Height (m)	Table Angle (Degree)	Raw Value (dBuV)	Correction Factor (dB/m)
1	2087.00	55.30 PK	77.80	-22.50	1.37 H	128	26.10	29.20
1	2087.00	54.40 AV	72.00	-17.60	1.37 H	128	25.20	29.20
2	2222.00	42.40 PK	74.00	-31.60	1.57 H	250	12.50	29.90
3	2310.00	41.40 PK	74.00	-32.60	1.46 H	186	11.10	30.40
4	2354.00	44.90 PK	74.00	-29.10	1.48 H	116	14.30	30.60
5	*2462.00	97.80 PK			1.00 H	109	67.80	30.10
5	*2462.00	92.00 AV			1.00 H	109	62.00	30.10
6	2483.50	40.00 PK	74.00	-34.00	1.00 H	109	9.90	30.10
7	2500.00	48.40 PK	74.00	-25.60	1.50 H	117	17.90	30.50
8	2720.00	42.90 PK	74.00	-31.10	1.54 H	114	12.00	31.00
9	4924.00	43.40 PK	74.00	-30.60	1.22 H	23	6.70	36.70
10	7386.00	48.20 PK	74.00	-25.80	1.24 H	213	6.30	41.80
11	9848.00	50.40 PK	74.00	-23.60	1.24 H	222	6.00	44.40



ANTENNA POLARITY & TEST DISTANCE: VERTICAL AT 3 M								
No.	Freq. (MHz)	Emission Level (dBuV/m)	Limit (dBuV/m)	Margin (dB)	Antenna Height (m)	Table Angle (Degree)	Raw Value (dBuV)	Correction Factor (dB/m)
1	2087.00	61.70 PK	94.20	-32.50	1.13 V	339	32.50	29.20
1	2087.00	61.40 AV	97.10	-35.70	1.13 V	339	32.20	29.20
2	2222.00	47.80 PK	74.00	-26.20	1.34 V	25	17.90	29.90
3	2310.00	48.20 PK	74.00	-25.80	1.26 V	359	17.80	30.40
4	2354.00	53.70 PK	74.00	-20.30	1.48 V	115	23.10	30.60
4	2354.00	49.30 AV	54.00	-4.70	1.48 V	115	18.70	30.60
5	*2462.00	114.20 PK			1.12 V	345	84.10	30.10
5	*2462.00	107.10 AV			1.12 V	345	77.10	30.10
6	2483.50	56.30 PK	74.00	-17.70	1.12 V	345	26.20	30.10
6	2483.50	49.30 AV	54.00	-4.70	1.12 V	345	19.20	30.10
7	2500.00	55.70 PK	74.00	-18.30	1.33 V	112	25.20	30.50
7	2500.00	52.10 AV	54.00	-1.90	1.33 V	112	21.60	30.50
8	2720.00	48.80 PK	74.00	-25.20	1.25 V	153	17.90	31.00
9	4924.00	45.80 PK	74.00	-28.20	1.25 V	322	9.10	36.70
10	7386.00	48.80 PK	74.00	-25.20	1.52 V	256	7.00	41.80
11	9848.00	50.30 PK	74.00	-23.70	1.35 V	321	6.00	44.40

- REMARKS:**
1. Emission level(dBuV/m)=Raw Value(dBuV) + Correction Factor(dB)
 2. Correction Factor(dB/m) = Antenna Factor (dB/m) + Cable Factor (dB)
 3. The other emission levels were very low against the limit.
 4. Margin value = Emission level – Limit value.
 5. The limit value is defined as per 15.247
 6. “ * “ : Fundamental frequency



4.2.8 TEST RESULTS -OFDM

EUT	Wireless-G Broadband Router with 2 Phone Ports	MODEL	WRT54GP2
MODE	Channel 1	FREQUENCY RANGE	1000~25000MHz
INPUT POWER (SYSTEM)	120Vac, 60 Hz	DETECTOR FUNCTION & BANDWIDTH	Peak (PK) Average (AV) 1 MHz
ENVIRONMENTAL CONDITIONS	27 deg. C, 59%RH, 972 hPa	TESTED BY	Wen Yu

ANTENNA POLARITY & TEST DISTANCE: HORIZONTAL AT 3 M

No.	Freq. (MHz)	Emission Level (dBuV/m)	Limit (dBuV/m)	Margin (dB)	Antenna Height (m)	Table Angle (Degree)	Raw Value (dBuV)	Correction Factor (dB/m)
1	2038.00	51.70 PK	73.60	-21.90	1.49 H	133	22.80	28.90
1	2038.00	50.30 AV	65.90	-15.60	1.49 H	133	21.40	28.90
2	2240.00	41.00 PK	74.00	-33.00	1.44 H	251	11.00	30.00
3	2310.00	40.00 PK	74.00	-34.00	1.06 H	127	9.70	30.40
4	2354.00	42.80 PK	74.00	-31.20	1.43 H	129	12.20	30.60
5	2390.00	36.70 PK	74.00	-37.30	1.14 H	102	2.90	33.80
6	*2412.00	93.60 PK			1.14 H	102	63.70	29.90
6	*2412.00	85.90 AV			1.14 H	102	56.00	29.90
7	2500.00	50.90 PK	74.00	-23.10	1.48 H	118	20.40	30.50
8	2720.00	47.30 PK	74.00	-26.70	1.32 H	120	16.30	31.00
9	4824.00	44.10 PK	74.00	-29.90	1.25 H	111	7.90	36.20
10	7236.00	48.60 PK	74.00	-25.40	1.12 H	55	6.90	41.70
11	9648.00	52.10 PK	74.00	-21.90	1.25 H	36	7.20	44.90
11	9648.00	41.40 AV	54.00	-12.60	1.25 H	36	-3.50	44.90



ANTENNA POLARITY & TEST DISTANCE: VERTICAL AT 3 M								
No.	Freq. (MHz)	Emission Level (dBuV/m)	Limit (dBuV/m)	Margin (dB)	Antenna Height (m)	Table Angle (Degree)	Raw Value (dBuV)	Correction Factor (dB/m)
1	2038.00	59.80 PK	88.70	-28.90	1.00 V	332	30.90	28.90
1	2038.00	58.60 AV	81.00	-22.40	1.00 V	332	29.70	28.90
2	2240.00	52.60 PK	74.00	-21.40	1.20 V	5	22.60	30.00
2	2240.00	50.90 AV	54.00	-3.10	1.20 V	5	20.90	30.00
3	2310.00	51.10 PK	74.00	-22.90	1.19 V	358	20.70	30.40
3	2310.00	46.50 AV	54.00	-7.50	1.19 V	358	16.10	30.40
4	2354.00	54.30 PK	74.00	-19.70	1.14 V	360	23.70	30.60
4	2354.00	48.70 AV	54.00	-5.30	1.14 V	360	18.10	30.60
5	2390.00	51.40 PK	74.00	-22.60	1.12 V	340	17.60	33.80
5	2390.00	43.80 AV	54.00	-10.20	1.12 V	340	10.00	33.80
6	*2412.00	108.70 PK			1.12 V	340	78.80	29.90
6	*2412.00	101.00 AV			1.12 V	340	71.10	29.90
7	2500.00	55.20 PK	74.00	-18.80	1.00 V	360	24.70	30.50
7	2500.00	52.20 AV	54.00	-1.80	1.00 V	360	21.70	30.50
8	2720.00	61.90 PK	74.00	-12.10	1.00 V	6	30.90	31.00
8	2720.00	52.20 AV	54.00	-1.80	1.00 V	6	21.30	31.00
9	4824.00	41.60 PK	74.00	-32.40	1.32 V	360	5.30	36.20
10	7236.00	46.00 PK	74.00	-28.00	1.13 V	318	4.30	41.70
11	9648.00	50.40 PK	74.00	-23.60	1.22 V	3	5.50	44.90

- REMARKS:**
1. Emission level(dBuV/m)=Raw Value(dBuV) + Correction Factor(dB)
 2. Correction Factor(dB/m) = Antenna Factor (dB/m) + Cable Factor (dB)
 3. The other emission levels were very low against the limit.
 4. Margin value = Emission level – Limit value.
 5. The limit value is defined as per 15.247
 6. “ * “ : Fundamental frequency



EUT	Wireless-G Broadband Router with 2 Phone Ports	MODEL	WRT54GP2
MODE	Channel 6	FREQUENCY RANGE	1000~25000MHz
INPUT POWER (SYSTEM)	120Vac, 60 Hz	DETECTOR FUNCTION & BANDWIDTH	Peak (PK) Average (AV) 1 MHz
ENVIRONMENTAL CONDITIONS	27 deg. C, 59%RH, 972 hPa	TESTED BY	Wen Yu

ANTENNA POLARITY & TEST DISTANCE: HORIZONTAL AT 3 M

No.	Freq. (MHz)	Emission Level (dBuV/m)	Limit (dBuV/m)	Margin (dB)	Antenna Height (m)	Table Angle (Degree)	Raw Value (dBuV)	Correction Factor (dB/m)
1	2063.00	53.50 PK	74.90	-21.40	1.39 H	133	24.40	29.10
1	2063.00	52.90 AV	67.00	-14.10	1.39 H	133	23.80	29.10
2	2240.00	40.80 PK	74.00	-33.20	1.43 H	135	10.80	30.00
3	2310.00	41.70 PK	74.00	-32.30	1.36 H	136	11.40	30.40
4	2354.00	43.10 PK	74.00	-30.90	1.24 H	138	12.50	30.60
5	*2437.00	94.90 PK			1.00 H	101	64.90	30.00
5	*2437.00	87.00 AV			1.00 H	101	57.00	30.00
6	2500.00	47.10 PK	74.00	-26.90	1.46 H	214	16.60	30.50
7	2720.00	46.10 PK	74.00	-27.90	1.22 H	217	15.20	31.00
8	4874.00	45.90 PK	74.00	-28.10	1.23 H	222	9.40	36.50
9	7311.00	48.70 PK	74.00	-25.30	1.12 H	44	6.90	41.80
10	9748.00	51.80 PK	74.00	-22.20	1.32 H	154	7.10	44.60
10	9748.00	40.70 AV	54.00	-13.30	1.32 H	154	-3.90	44.60



ANTENNA POLARITY & TEST DISTANCE: VERTICAL AT 3 M								
No.	Freq. (MHz)	Emission Level (dBuV/m)	Limit (dBuV/m)	Margin (dB)	Antenna Height (m)	Table Angle (Degree)	Raw Value (dBuV)	Correction Factor (dB/m)
1	2063.00	60.20 PK	89.70	-29.50	1.64 V	13	31.10	29.10
1	2063.00	59.70 AV	81.40	-21.70	1.64 V	13	30.70	29.10
2	2240.00	47.90 PK	74.00	-26.10	1.10 V	350	18.00	30.00
3	2310.00	50.50 PK	74.00	-23.50	1.52 V	0	20.20	30.40
4	2354.00	53.70 PK	74.00	-20.30	1.45 V	233	23.10	30.60
4	2354.00	47.10 AV	54.00	-6.90	1.45 V	233	16.50	30.60
5	*2437.00	109.70 PK			1.11 V	347	79.70	30.00
5	*2437.00	101.40 AV			1.11 V	347	71.40	30.00
6	2500.00	57.90 PK	74.00	-16.10	1.30 V	235	27.40	30.50
6	2500.00	53.40 AV	54.00	-0.60	1.30 V	235	22.90	30.50
7	2720.00	51.00 PK	74.00	-23.00	1.27 V	113	20.10	31.00
7	2720.00	46.30 AV	54.00	-7.70	1.27 V	113	15.30	31.00
8	4874.00	45.90 PK	74.00	-28.10	1.23 V	235	9.40	36.50
9	7311.00	49.00 PK	74.00	-25.00	1.24 V	214	7.20	41.80
10	9748.00	51.10 PK	74.00	-22.90	1.12 V	23	6.50	44.60
10	9748.00	40.70 AV	54.00	-13.30	1.12 V	23	-3.90	44.60

- REMARKS:**
1. Emission level(dBuV/m)=Raw Value(dBuV) + Correction Factor(dB)
 2. Correction Factor(dB/m) = Antenna Factor (dB/m) + Cable Factor (dB)
 3. The other emission levels were very low against the limit.
 4. Margin value = Emission level – Limit value.
 5. The limit value is defined as per 15.247
 6. “ * “ : Fundamental frequency



EUT	Wireless-G Broadband Router with 2 Phone Ports	MODEL	WRT54GP2
MODE	Channel 11	FREQUENCY RANGE	1000~25000MHz
INPUT POWER (SYSTEM)	120Vac, 60 Hz	DETECTOR FUNCTION & BANDWIDTH	Peak (PK) Average (AV) 1 MHz
ENVIRONMENTAL CONDITIONS	27 deg. C, 59%RH, 972 hPa	TESTED BY	Wen Yu

ANTENNA POLARITY & TEST DISTANCE: HORIZONTAL AT 3 M

No.	Freq. (MHz)	Emission Level (dBuV/m)	Limit (dBuV/m)	Margin (dB)	Antenna Height (m)	Table Angle (Degree)	Raw Value (dBuV)	Correction Factor (dB/m)
1	2088.00	54.90 PK	74.80	-19.90	1.58 H	242	25.70	29.20
1	2088.00	54.00 AV	66.30	-12.30	1.58 H	242	24.80	29.20
2	2240.00	40.90 PK	74.00	-33.10	1.12 H	36	10.90	30.00
3	2310.00	41.40 PK	74.00	-32.60	1.36 H	139	11.10	30.40
4	2354.00	43.50 PK	74.00	-30.50	1.25 H	139	12.90	30.60
5	*2462.00	94.80 PK			1.59 H	108	64.80	30.10
5	*2462.00	86.30 AV			1.59 H	108	56.30	30.10
6	2483.50	41.00 PK	74.00	-33.00	1.59 H	108	10.90	30.10
7	2500.00	47.60 PK	74.00	-26.40	1.47 H	211	17.10	30.50
8	2720.00	45.90 PK	74.00	-28.10	1.21 H	220	15.00	31.00
9	4924.00	46.10 PK	74.00	-27.90	1.35 H	124	9.50	36.70
10	7386.00	48.90 PK	74.00	-25.10	1.23 H	124	7.10	41.80
11	9848.00	51.30 PK	74.00	-22.70	1.24 H	111	6.90	44.40
11	9848.00	40.20 AV	54.00	-13.80	1.24 H	111	-4.20	44.40



ANTENNA POLARITY & TEST DISTANCE: VERTICAL AT 3 M								
No.	Freq. (MHz)	Emission Level (dBuV/m)	Limit (dBuV/m)	Margin (dB)	Antenna Height (m)	Table Angle (Degree)	Raw Value (dBuV)	Correction Factor (dB/m)
1	2088.00	64.00 PK	90.10	-26.10	1.35 V	123	34.80	29.20
1	2088.00	64.00 AV	81.90	-17.9	1.35 V	123	34.80	29.20
2	2240.00	47.20 PK	74.00	-26.80	1.23 V	359	17.20	30.00
3	2310.00	47.90 PK	74.00	-26.10	1.30 V	0	17.50	30.40
4	2354.00	53.40 PK	74.00	-20.60	1.48 V	234	22.80	30.60
4	2354.00	48.10 AV	54.00	-5.90	1.48 V	234	17.50	30.60
5	*2462.00	110.10 PK			1.10 V	345	80.00	30.10
5	*2462.00	101.90 AV			1.10 V	345	71.80	30.10
6	2483.50	55.90 PK	74.00	-18.10	1.10 V	345	25.70	30.10
6	2483.50	48.00 AV	54.00	-6.00	1.10 V	345	17.80	30.10
7	2500.00	59.00 PK	74.00	-15.00	1.36 V	101	28.50	30.50
7	2500.00	53.50 AV	54.00	-0.50	1.36 V	101	23.00	30.50
8	2720.00	49.50 PK	74.00	-24.50	1.47 V	259	18.50	31.00
9	4924.00	46.50 PK	74.00	-27.50	1.23 V	214	9.80	36.70
10	7386.00	49.30 PK	74.00	-24.70	1.24 V	325	7.50	41.80
11	9848.00	51.30 PK	74.00	-22.70	1.25 V	36	6.90	44.40
11	9848.00	40.20 AV	54.00	-13.80	1.25 V	36	-4.20	44.40

- REMARKS:**
1. Emission level(dBuV/m)=Raw Value(dBuV) + Correction Factor(dB)
 2. Correction Factor(dB/m) = Antenna Factor (dB/m) + Cable Factor (dB)
 3. The other emission levels were very low against the limit.
 4. Margin value = Emission level – Limit value.
 5. The limit value is defined as per 15.247
 6. “ * “ : Fundamental frequency



4.3 6dB BANDWIDTH MEASUREMENT

4.3.1 LIMITS OF 6dB BANDWIDTH MEASUREMENT

The minimum of 6dB Bandwidth Measurement is 0.5 MHz.

4.3.2 TEST INSTRUMENTS

Description & Manufacturer	Model No.	Serial No.	Calibrated Until
R&S SPECTRUM ANALYZER	FSP40	100036	Nov. 27, 2004

NOTE:

- 1.The measurement uncertainty is less than +/- 2.6dB, which is calculated as per the NAMAS document NIS81.
- 2.The calibration interval of the above test instruments is 12 months and the calibrations are traceable to NML/ROC and NIST/USA.

4.3.3 TEST PROCEDURE

The transmitter output was connected to the spectrum analyzer through an attenuator. The bandwidth of the fundamental frequency was measured by spectrum analyzer with 100 kHz RBW and 100 kHz VBW. The 6 dB bandwidth is defined as the total spectrum the power of which is higher than peak power minus 6 dB.

4.3.4 TEST SETUP



For the actual test configuration, please refer to the related Item – Photographs of the Test Configuration.

4.3.5 EUT OPERATING CONDITIONS

The software provided by client to enable the EUT under transmission condition continuously at lowest, middle and highest channel frequencies individually.



4.3.6 TEST RESULTS-DSSS

EUT	Wireless-G Broadband Router with 2 Phone Ports		
MODEL	WRT54GP2	ENVIRONMENTAL CONDITIONS	27 deg. C, 59%RH, 972 hPa
INPUT POWER (SYSTEM)	120Vac, 60 Hz	TESTED BY	Tony Chen

CHANNEL	CHANNEL FREQUENCY (MHz)	6 dB BANDWIDTH (MHz)	MINIMUM LIMIT (MHz)	PASS/FAIL
1	2412	9.10	0.5	PASS
6	2437	9.95	0.5	PASS
11	2462	9.90	0.5	PASS



CH1

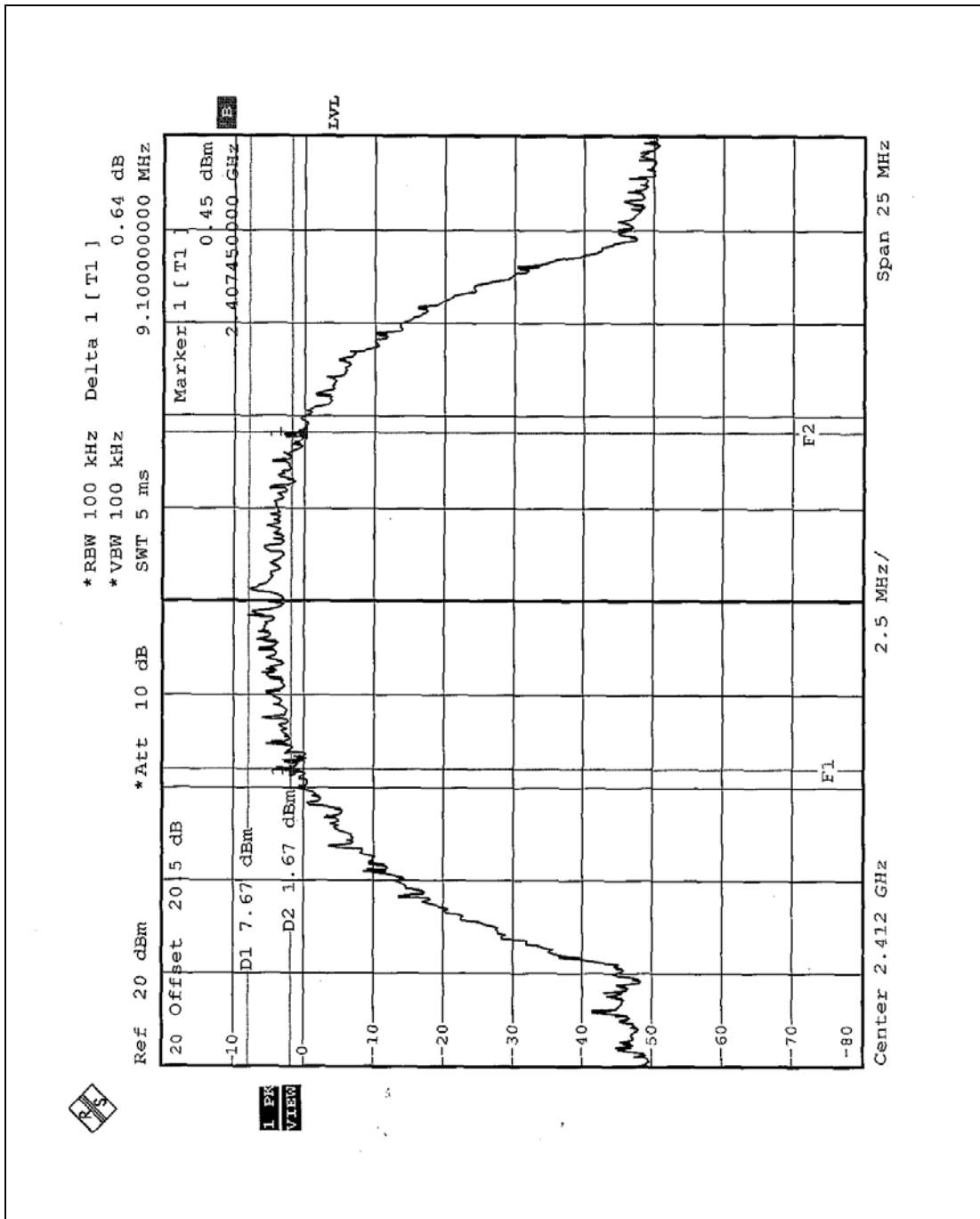



CH6

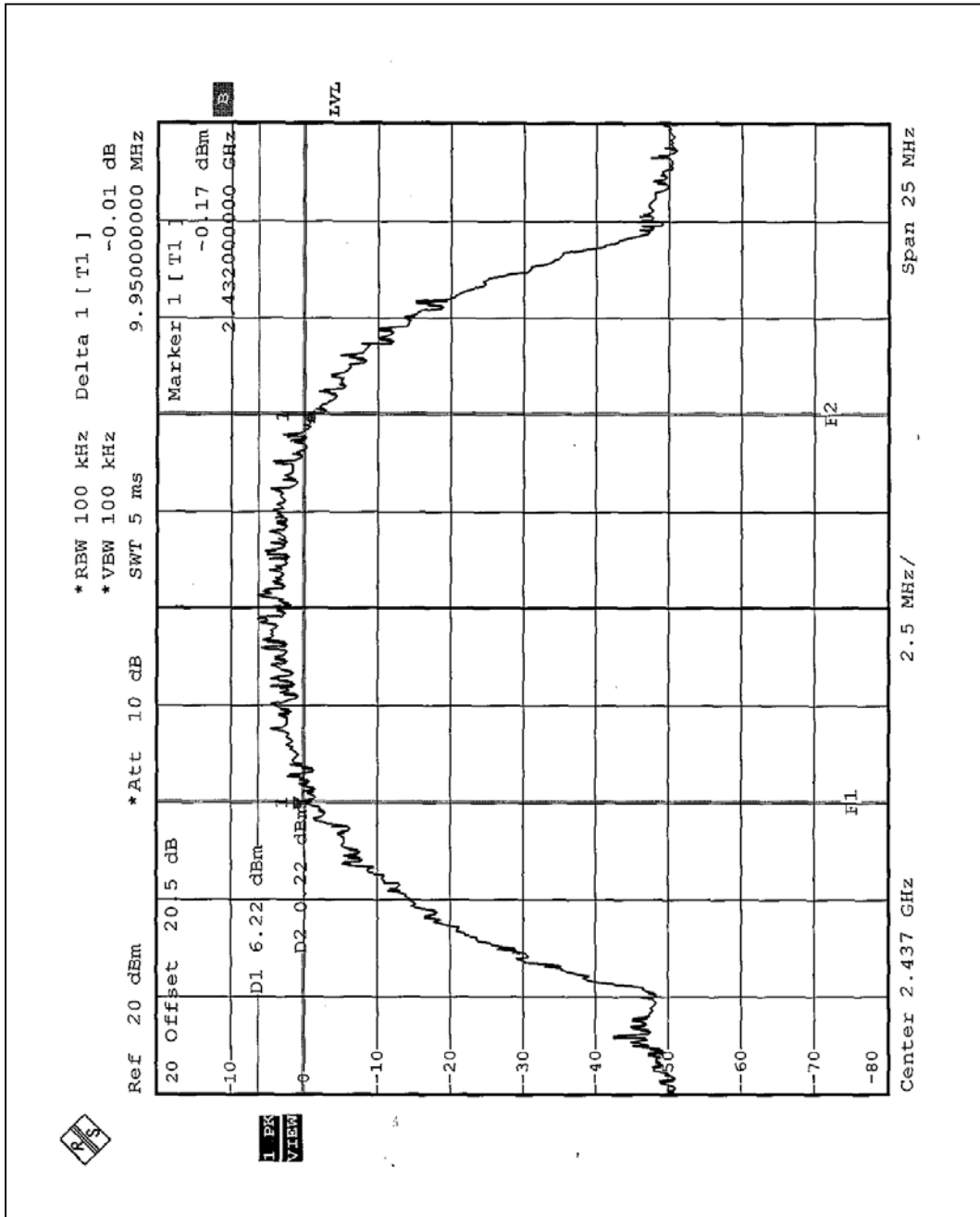



CH11

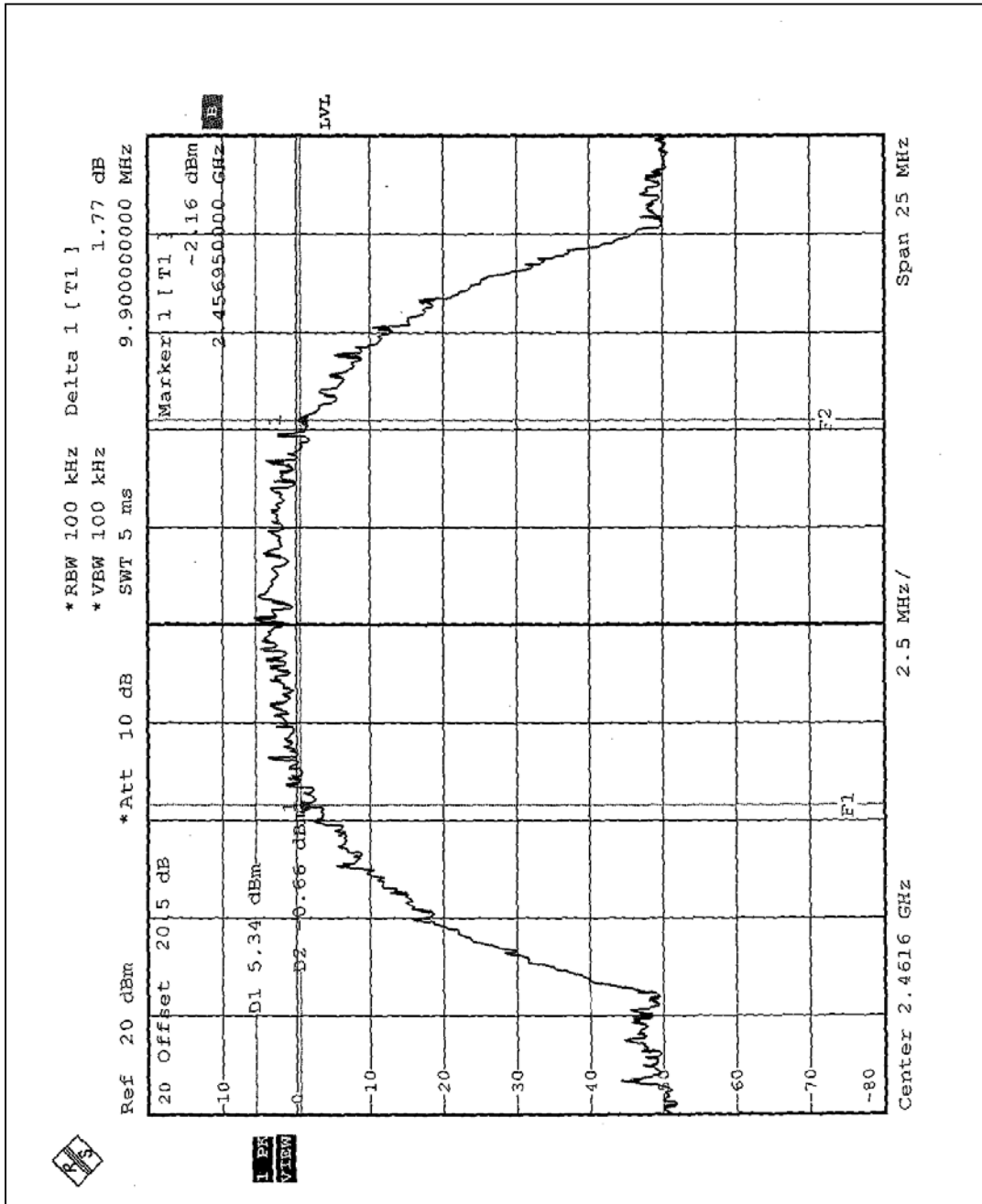



4.3.7 TEST RESULTS-OFDM

EUT	Wireless-G Broadband Router with 2 Phone Ports		
MODEL	WRT54GP2	ENVIRONMENTAL CONDITIONS	27 deg. C, 59%RH, 972 hPa
INPUT POWER (SYSTEM)	120Vac, 60 Hz	TESTED BY	Tony Chen

CHANNEL	CHANNEL FREQUENCY (MHz)	6 dB BANDWIDTH (MHz)	MINIMUM LIMIT (MHz)	PASS/FAIL
1	2412	15.15	0.5	PASS
6	2437	15.15	0.5	PASS
11	2462	15.10	0.5	PASS



CH1

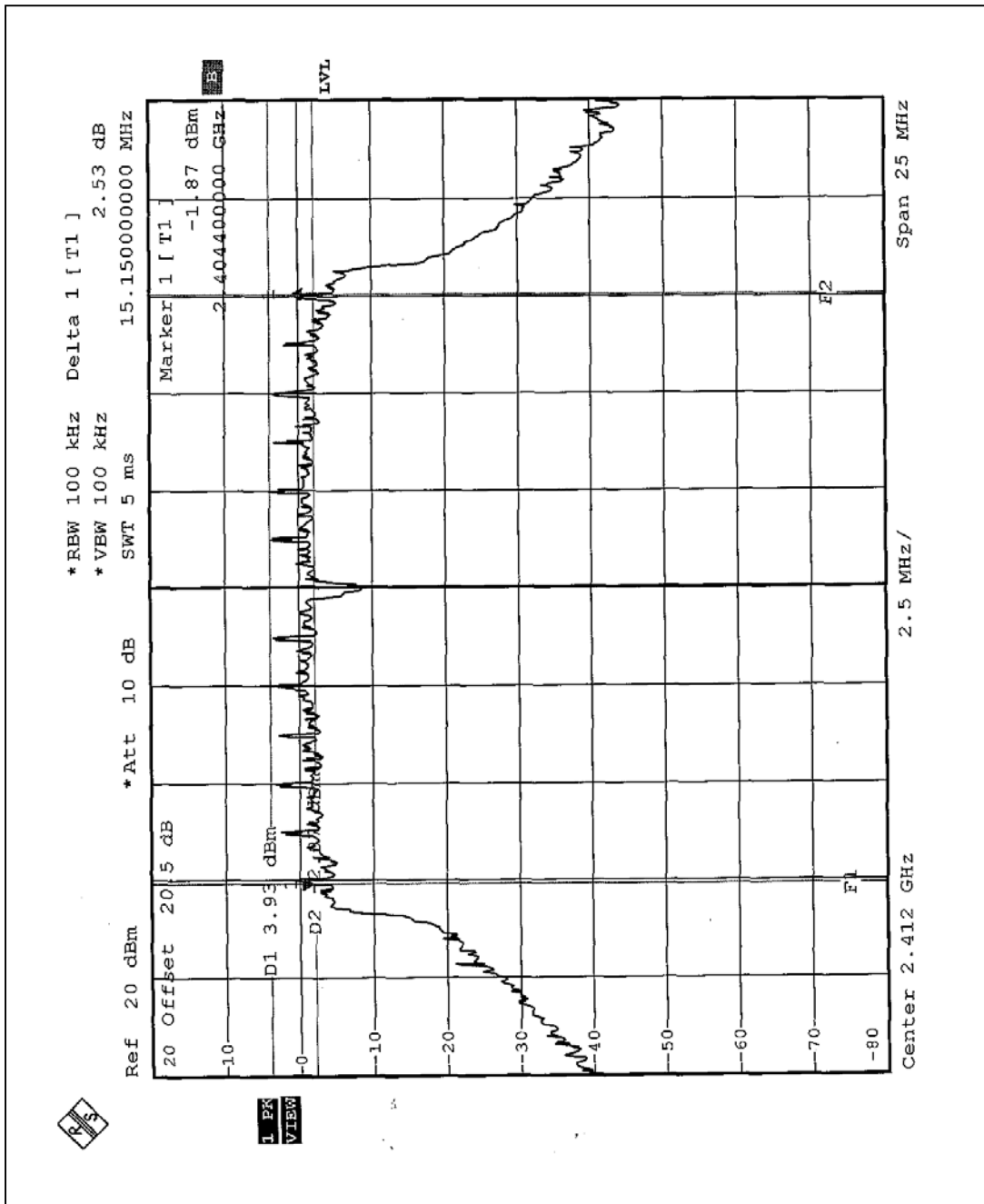



CH6

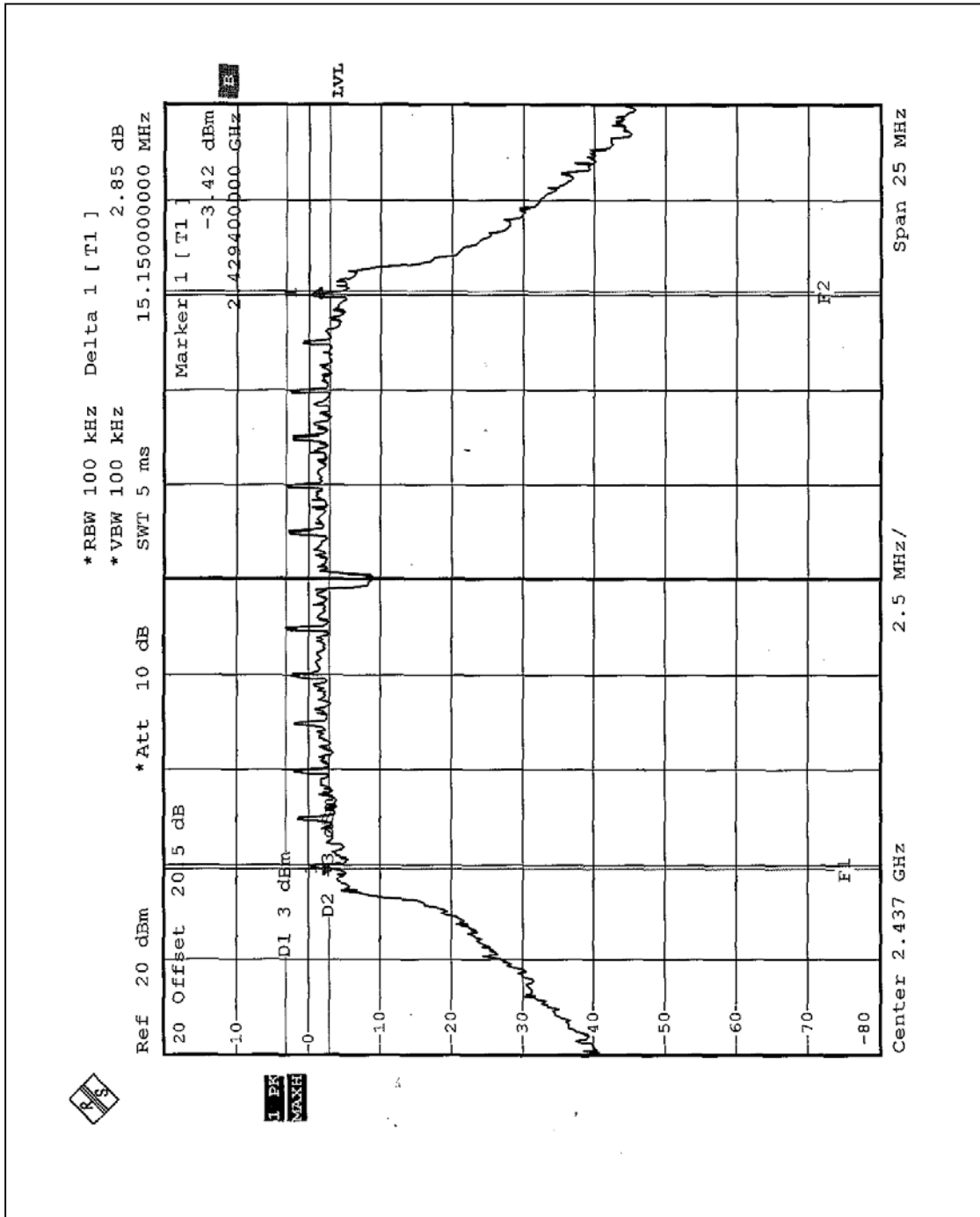



CH11

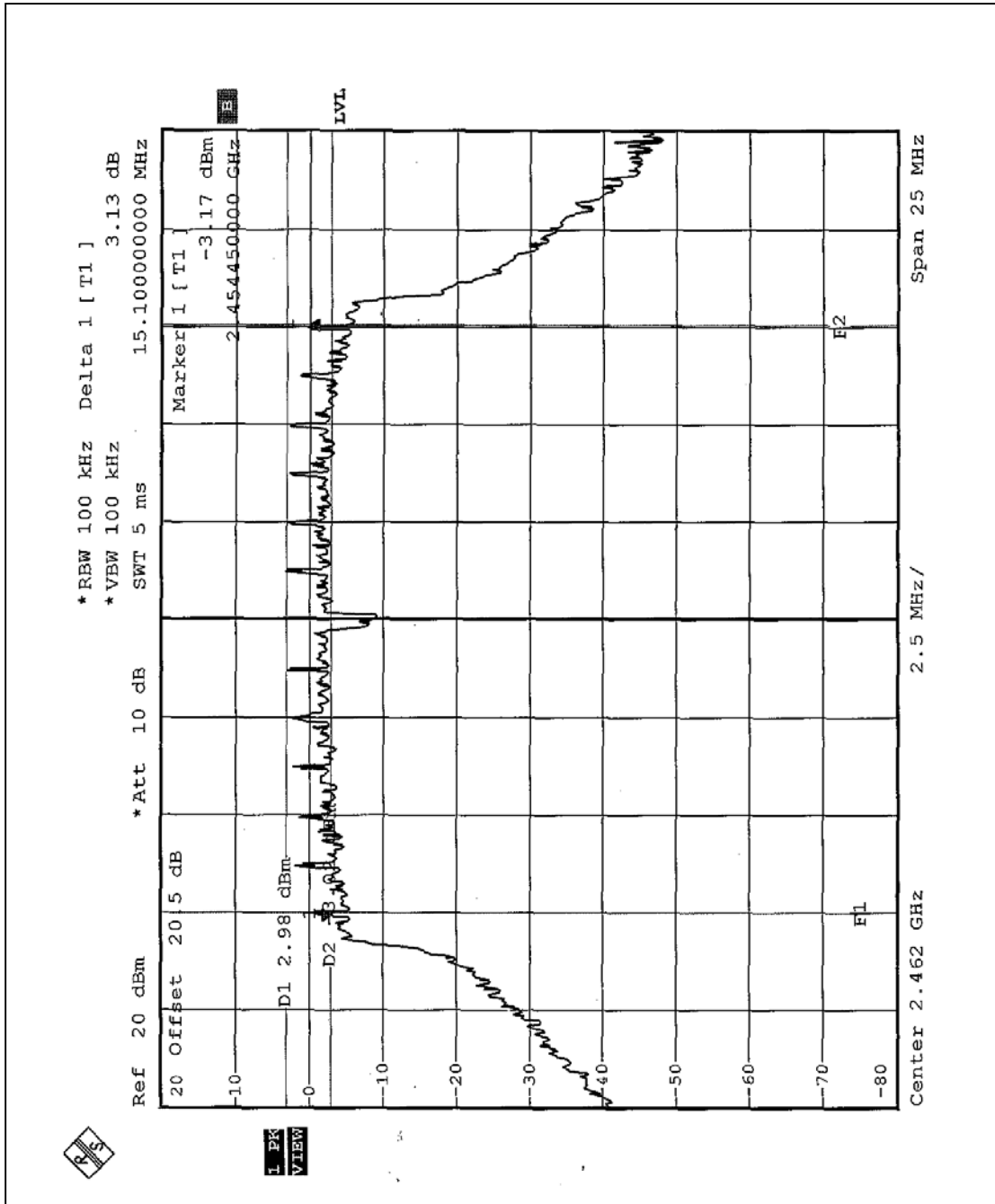



4.4 MAXIMUM PEAK OUTPUT POWER

4.4.1 LIMITS OF MAXIMUM PEAK OUTPUT POWER MEASUREMENT

The Maximum Peak Output Power Measurement is 30dBm.

4.4.2 TEST INSTRUMENTS

Description & Manufacturer	Model No.	Serial No.	Calibrated Until
R&S SPECTRUM ANALYZER	FSP40	100036	Nov. 27, 2004
Agilent SIGNAL GENERATOR	E8257C	MY43320668	Jan. 1, 2005
TEKTRONIX OSCILLOSCOPE	TDS 220	B027241	Jun. 30, 2005
NARDA DETECTOR	4503A	FSCM99899	NA

NOTE:

The calibration interval of the above test instruments is 12 months and the calibrations are traceable to NML/ROC and NIST/USA.

4.4.3 TEST PROCEDURES

1. A detector was used on the output port of the EUT. An oscilloscope was used to read the peak response of the detector.
2. Replaced the EUT by the signal generator. The center frequency of the S.G was adjusted to the center frequency of the measured channel.
3. Adjusted the power to have the same peak reading on oscilloscope. Record the power level.

4.4.4 TEST SETUP

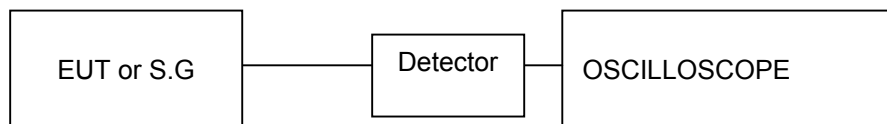

4.4.5 EUT OPERATING CONDITIONS

Same as Item 4.3.5



4.4.6 TEST RESULTS - DSSS

EUT	Wireless-G Broadband Router with 2 Phone Ports		
MODEL	WRT54GP2	ENVIRONMENTAL CONDITIONS	27 deg. C, 59%RH, 972 hPa
INPUT POWER (SYSTEM)	120Vac, 60 Hz	TESTED BY	Tony Chen

CHANNEL	CHANNEL FREQUENCY (MHz)	PEAK POWER OUTPUT (dBm)	PEAK POWER LIMIT (dBm)	PASS/FAIL
1	2412	17.21	30	PASS
6	2437	17.19	30	PASS
11	2462	17.23	30	PASS



4.4.7 TEST RESULTS - OFDM

EUT	Wireless-G Broadband Router with 2 Phone Ports		
MODEL	WRT54GP2	ENVIRONMENTAL CONDITIONS	27 deg. C, 59%RH, 972 hPa
INPUT POWER (SYSTEM)	120Vac, 60 Hz	TESTED BY	Tony Chen

CHANNEL	CHANNEL FREQUENCY (MHz)	PEAK POWER OUTPUT (dBm)	PEAK POWER LIMIT (dBm)	PASS/FAIL
1	2412	17.31	30	PASS
6	2437	17.14	30	PASS
11	2462	17.22	30	PASS



4.5 POWER SPECTRAL DENSITY MEASUREMENT

4.5.1 LIMITS OF POWER SPECTRAL DENSITY MEASUREMENT

The Maximum of Power Spectral Density Measurement is 8dBm.

4.5.2 TEST INSTRUMENTS

Description & Manufacturer	Model No.	Serial No.	Calibrated Until
R&S SPECTRUM ANALYZER	FSP40	100036	Nov. 27, 2004

NOTE:

- 1.The measurement uncertainty is less than +/- 2.6dB, which is calculated as per the NAMAS document NIS81.
- 2.The calibration interval of the above test instruments is 12 months and the calibrations are traceable to NML/ROC and NIST/USA.

4.5.3 TEST PROCEDURE

The transmitter output was connected to the spectrum analyzer through an attenuator, the bandwidth of the fundamental frequency was measured with the spectrum analyzer using 3 kHz RBW and 30 kHz VBW, set sweep time=span/3kHz. The power spectral density was measured and recorded. The sweep time is allowed to be longer than span/3KHz for a full response of the mixer in the spectrum analyzer.

4.5.4 TEST SETUP

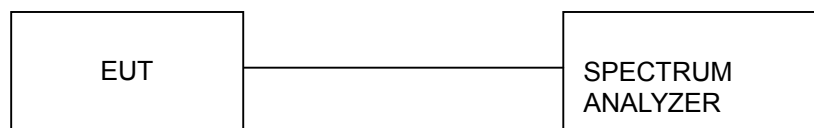

4.5.5 EUT OPERATING CONDITIONS

Same as 4.3.5



4.5.6 TEST RESULTS-DSSS

EUT	Wireless-G Broadband Router with 2 Phone Ports		
MODEL	WRT54GP2	ENVIRONMENTAL CONDITIONS	27 deg. C, 59%RH, 972 hPa
INPUT POWER (SYSTEM)	120Vac, 60 Hz	TESTED BY	Tony Chen

CHANNEL NUMBER	CHANNEL FREQUENCY (MHz)	RF POWER LEVEL IN 3 KHz BW (dBm)	MAXIMUM LIMIT (dBm)	PASS/FAIL
1	2412	-5.81	8	PASS
6	2437	-7.50	8	PASS
11	2462	-7.44	8	PASS



CH1

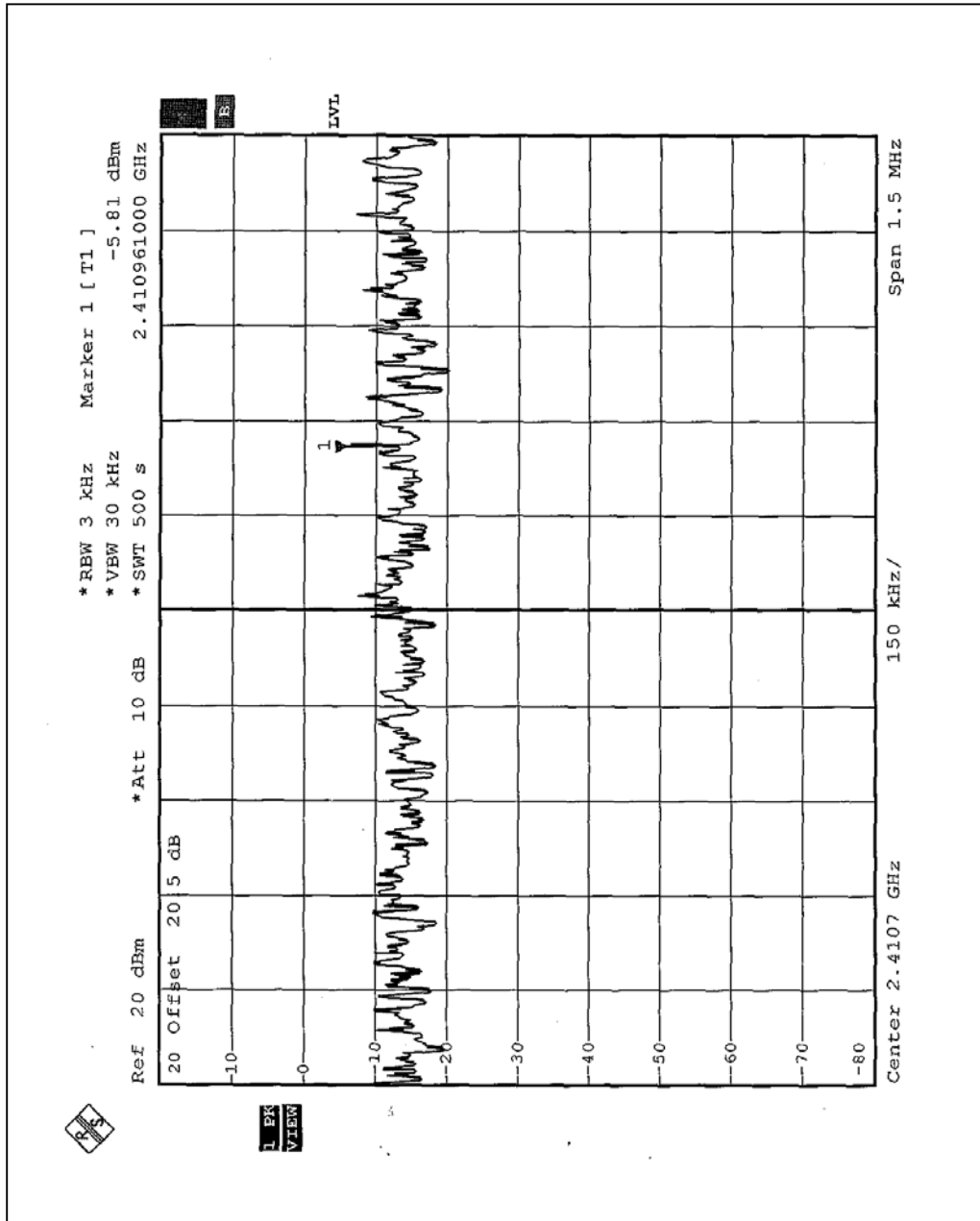



CH6

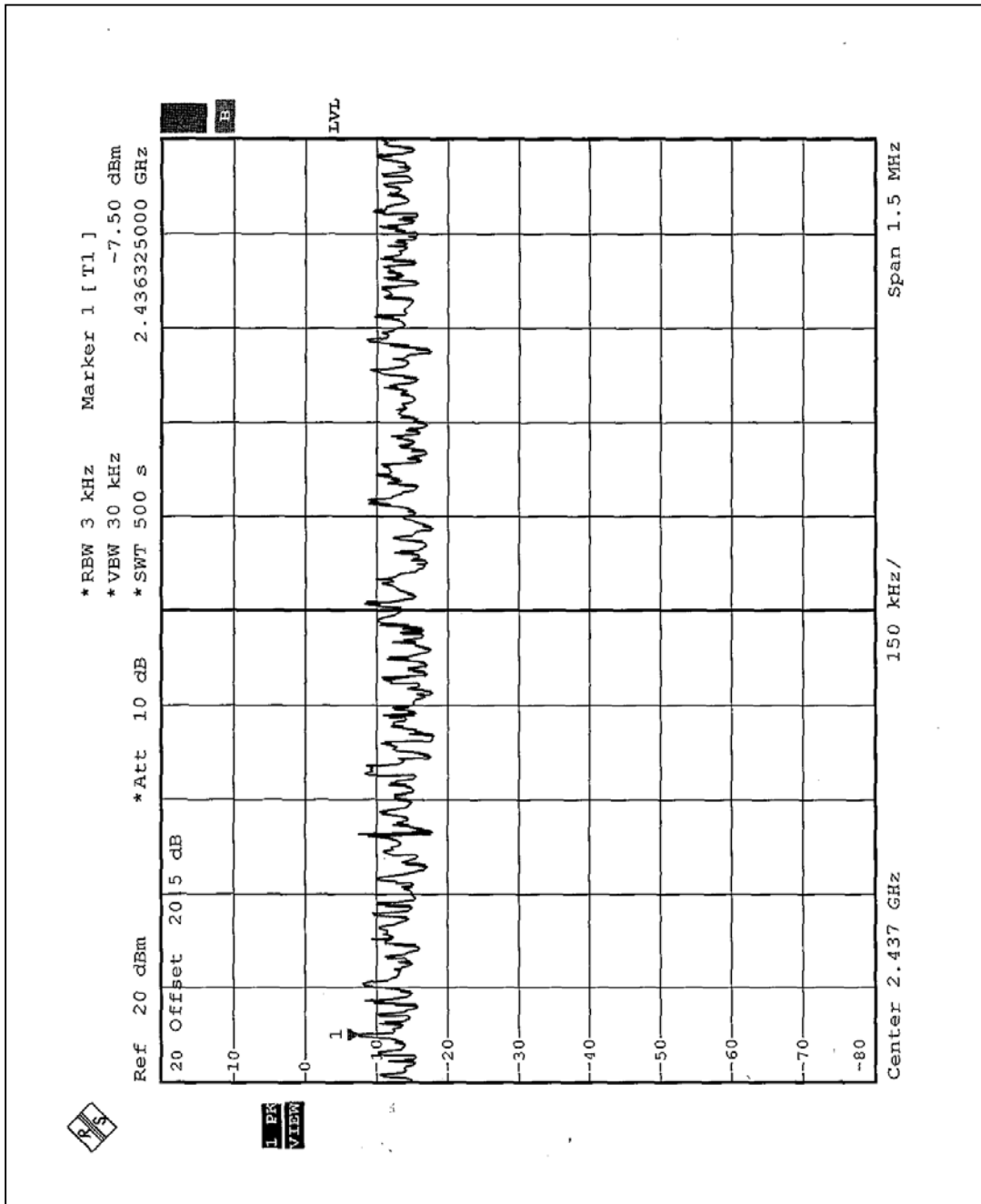



CH11

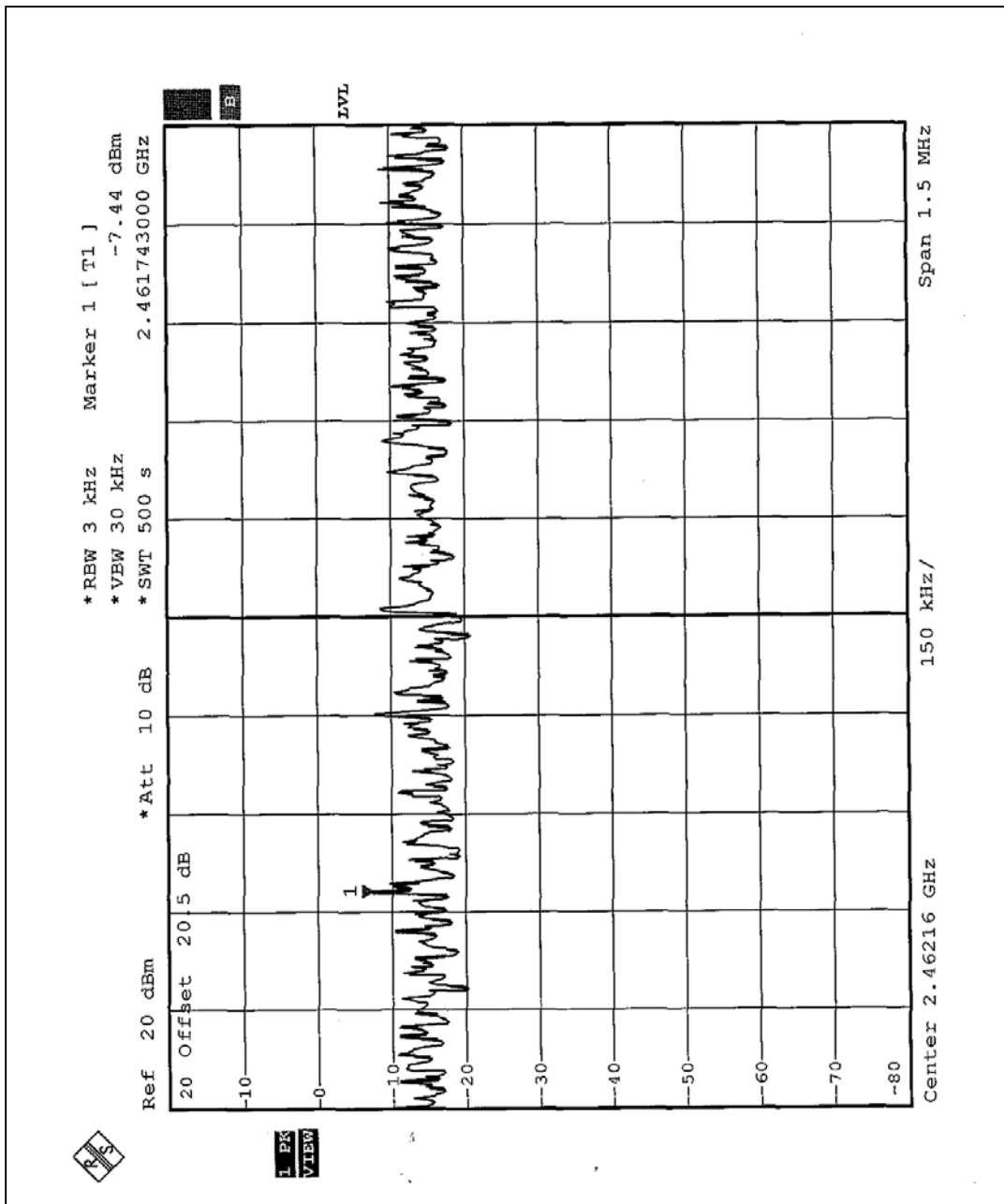



4.5.7 TEST RESULTS-OFDM

EUT	Wireless-G Broadband Router with 2 Phone Ports		
MODEL	WRT54GP2	ENVIRONMENTAL CONDITIONS	27 deg. C, 59%RH, 972 hPa
INPUT POWER (SYSTEM)	120Vac, 60 Hz	TESTED BY	Tony Chen

CHANNEL NUMBER	CHANNEL FREQUENCY (MHz)	RF POWER LEVEL IN 3 KHz BW (dBm)	MAXIMUM LIMIT (dBm)	PASS/FAIL
1	2412	-10.62	8	PASS
6	2437	-12.55	8	PASS
11	2462	-12.91	8	PASS



CH1

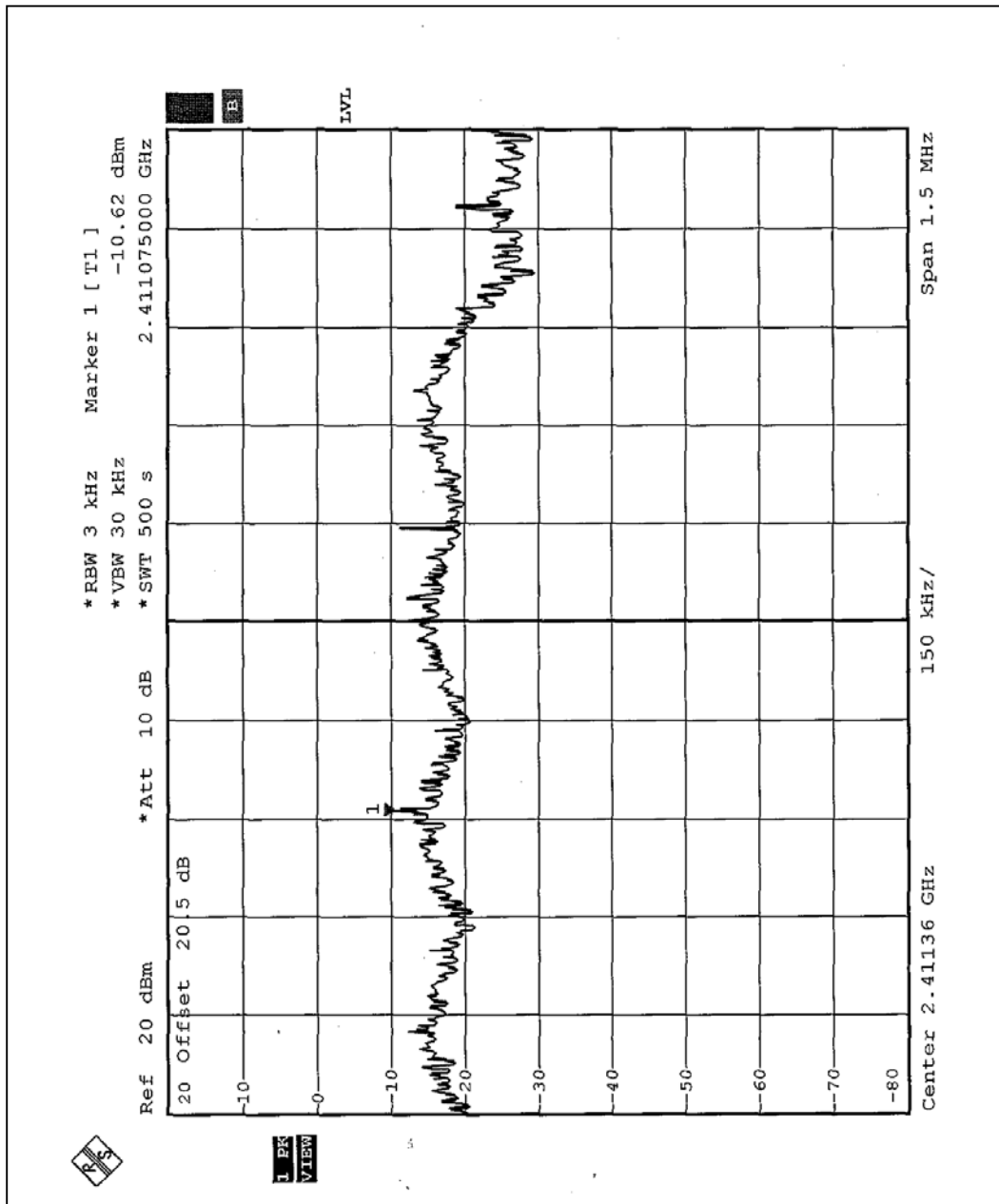



CH6

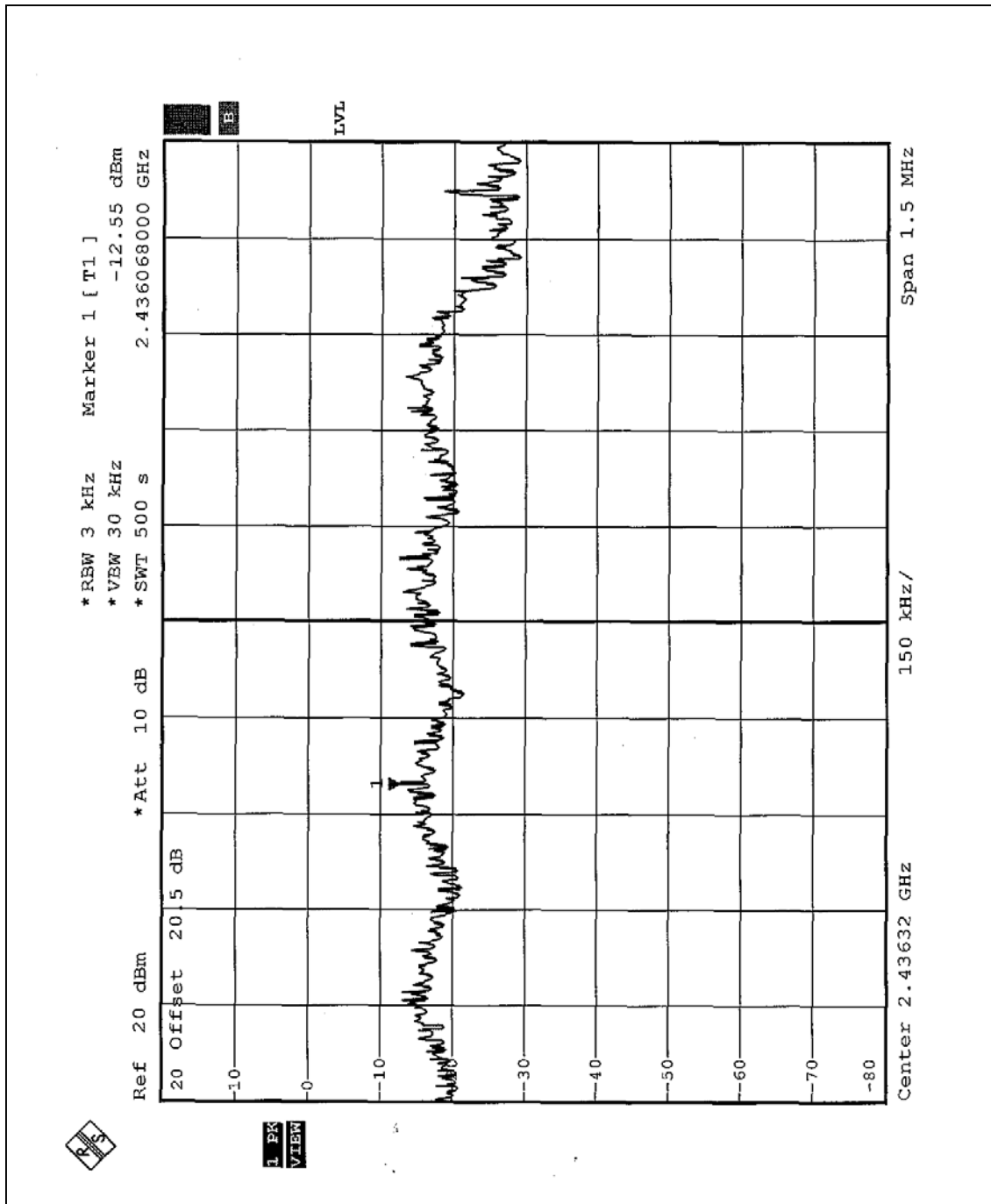



CH11

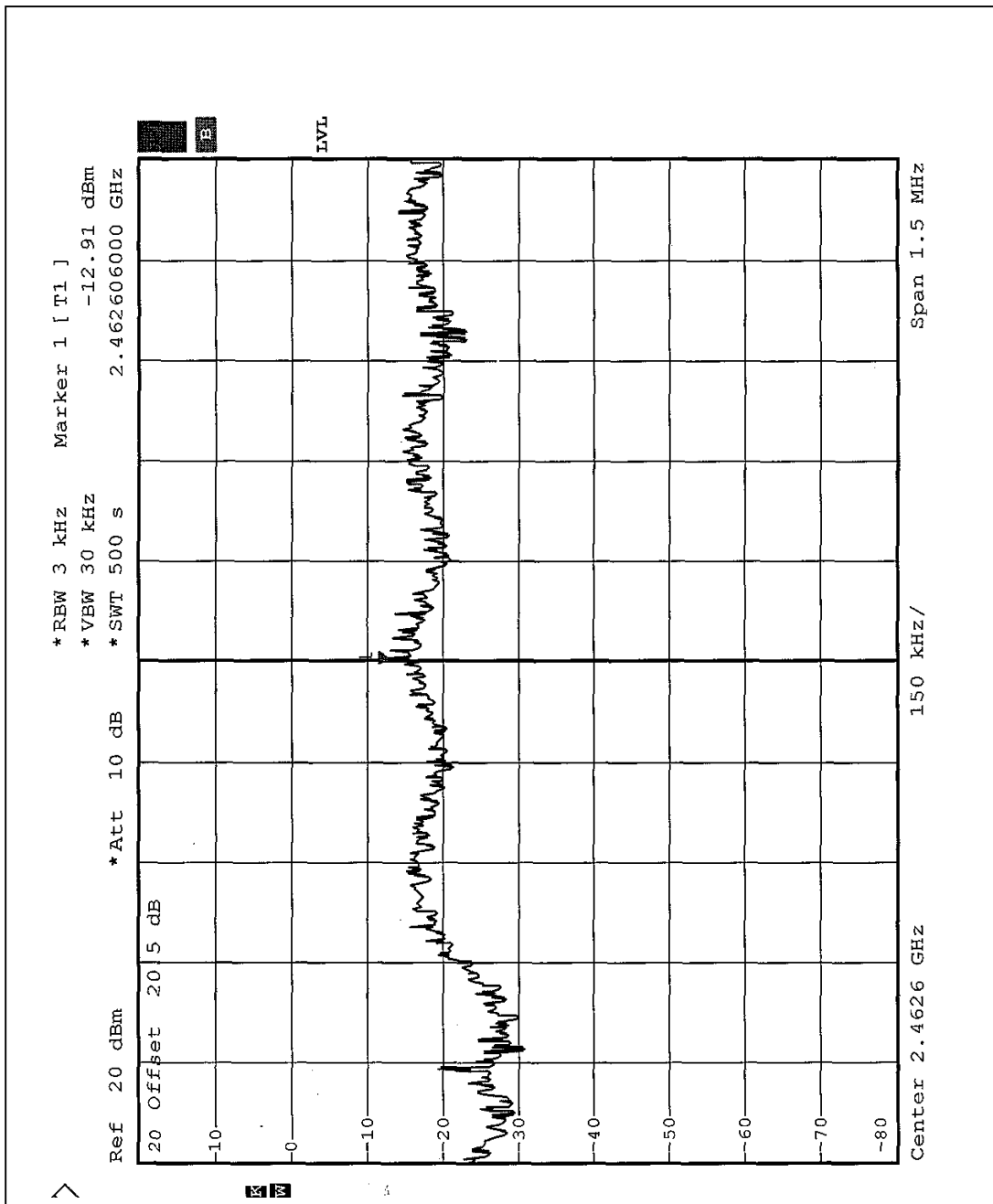



4.6 BAND EDGES MEASUREMENT

4.6.1 LIMITS OF BAND EDGES MEASUREMENT

Below -20dB of the highest emission level of operating band (in 100KHz Resolution Bandwidth).

4.6.2 TEST INSTRUMENTS

Description & Manufacturer	Model No.	Serial No.	Calibrated Until
R&S SPECTRUM ANALYZER	FSP40	100036	Nov. 27, 2004

NOTE:

- 1.The measurement uncertainty is less than $\pm 2.6\text{dB}$, which is calculated as per the NAMAS document NIS81.
- 2.The calibration interval of the above test instruments is 12 months and the calibrations are traceable to NML/ROC and NIST/USA.

4.6.3 TEST PROCEDURE

The transmitter output was connected to the spectrum analyzer via a low loss cable. Set both RBW and VBW of spectrum analyzer to 100 kHz with suitable frequency span including 100 kHz bandwidth from band edge. The band edges was measured and recorded.

4.6.4 EUT OPERATING CONDITION

Same as Item 4.3.5



4.6.5 TEST RESULTS - DSSS

The spectrum plots are attached on the following 2 pages. D1 line indicates the highest level, D2 line indicates the 20dB offset below D1. It shows compliance with the requirement in part 15.247(C).

Note - The delta method is only used up to 2 MHz away from the restricted bandage, The radiated emissions which located in other restricted frequency band, the result, please refer to 4.2.

NOTE (1): The band edge emission plot on the following first page shows 63.01dB delta between carrier maximum power and local maximum emission in restrict band (2.3900GHz). The emission of carrier strength list in the test result of channel 1 at the item 4.2 is 106.0dBuV/m, so the maximum field strength in restrict band is $106.0-63.01=42.99$ dBuV/m which is under 54 dBuV/m limit.

NOTE (2): The band edge emission plot on the following second page shows 58.4dB delta between carrier maximum power and local maximum emission in restrict band (2.4835GHz). The emission of carrier strength list in the test result of channel 11 at the item 4.2. is 107.10dBuV/m, so the maximum field strength in restrict band is $107.10-58.40=48.70$ dBuV/m which is under 54 dBuV/m limit.

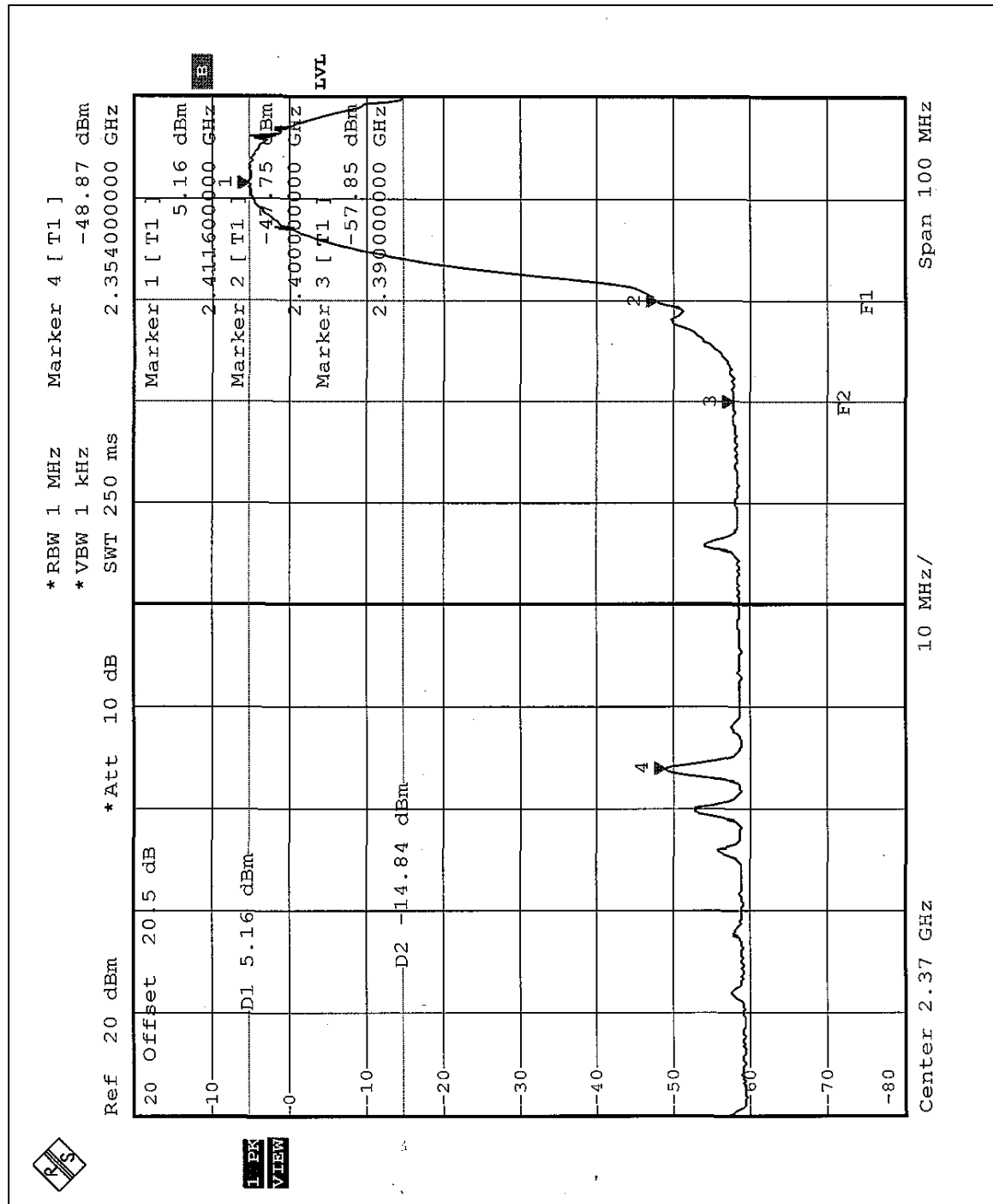

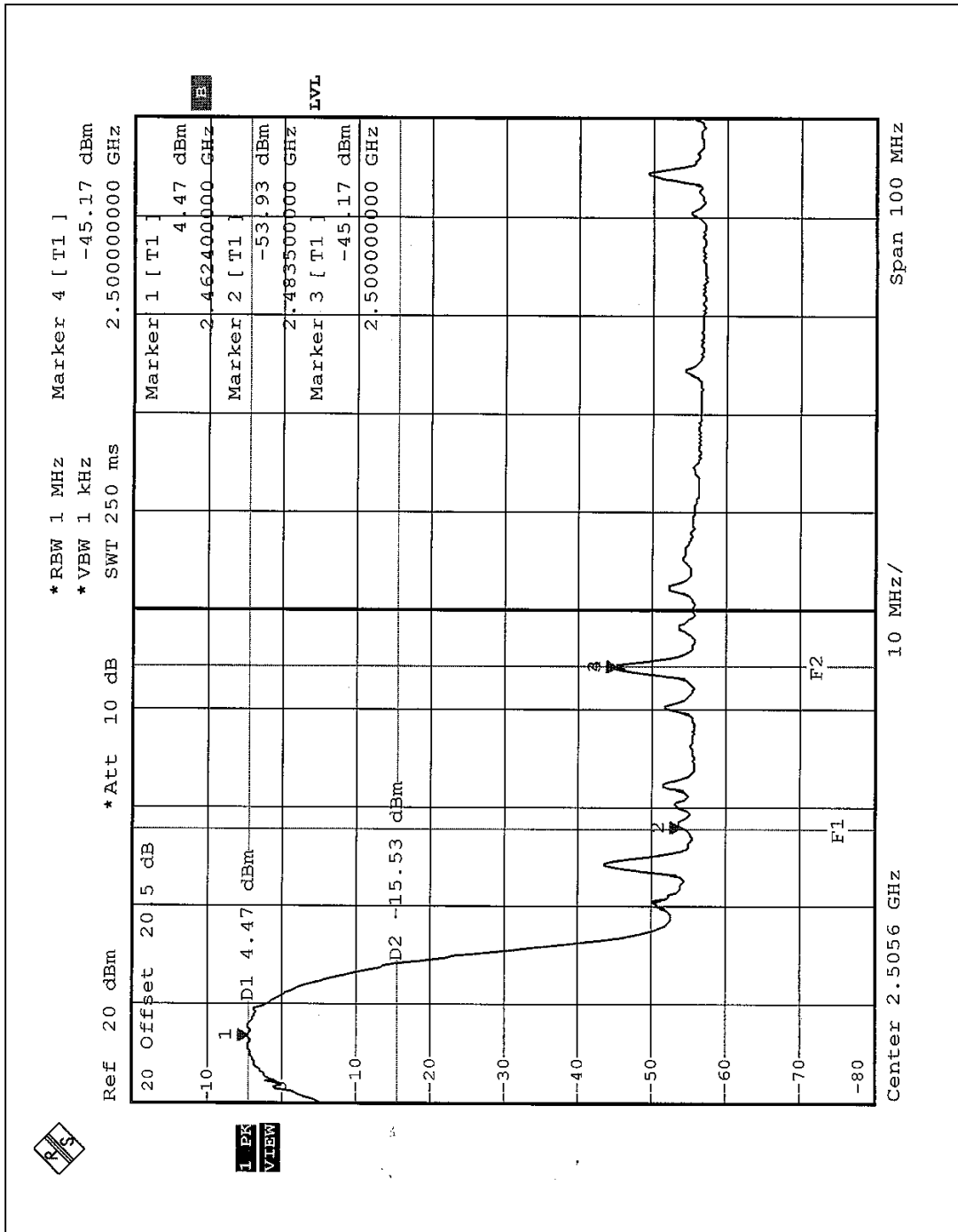



4.6.6 TEST RESULTS -OFDM

The spectrum plots are attached on the following 2 pages. D1 line indicates the highest level, D2 line indicates the 20dB offset below D1. It shows compliance with the requirement in part 15.247(C).

Note - The delta method is only used up to 2 MHz away from the restricted bandage, The radiated emissions which located in other restricted frequency band, the result, please refer to 4.2.

NOTE (1): The band edge emission plot on the following first page shows 57.53dB delta between carrier maximum power and local maximum emission in restrict band (2.3900GHz). The emission of carrier strength list in the test result of channel 1 at the item 4.2. is 101.0dBuV/m, so the maximum field strength in restrict band is $101.0-57.53=43.47$ dBuV/m which is under 54 dBuV/m limit.

NOTE (2): The band edge emission plot on the following second page shows 54.53dB delta between carrier maximum power and local maximum emission in restrict band (2.4835GHz). The emission of carrier strength list in the test result of channel 11 at the item 4.2. is 101.90dBuV/m, so the maximum field strength in restrict band is $101.90-54.53=47.37$ dBuV/m which is under 54 dBuV/m limit.

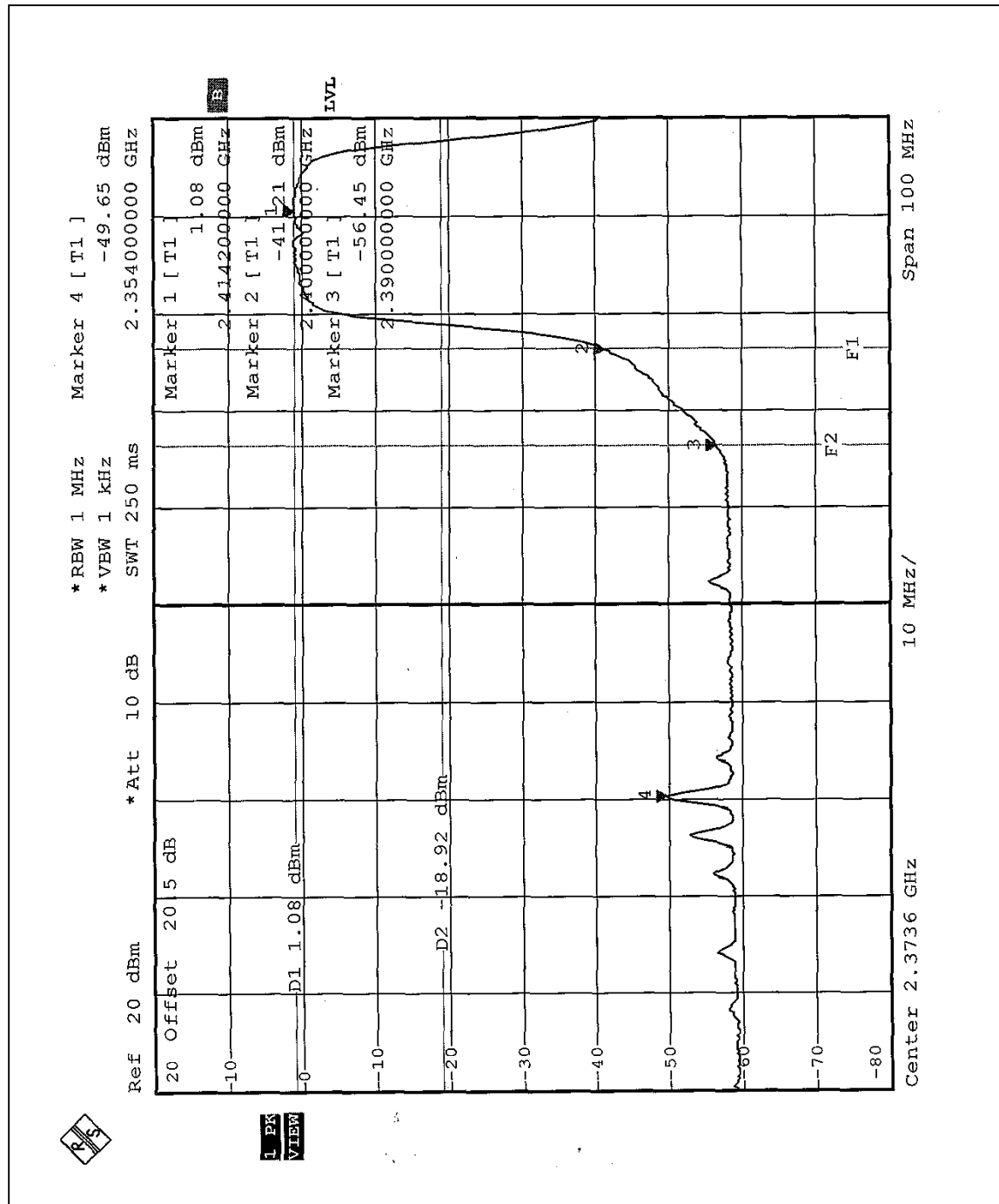

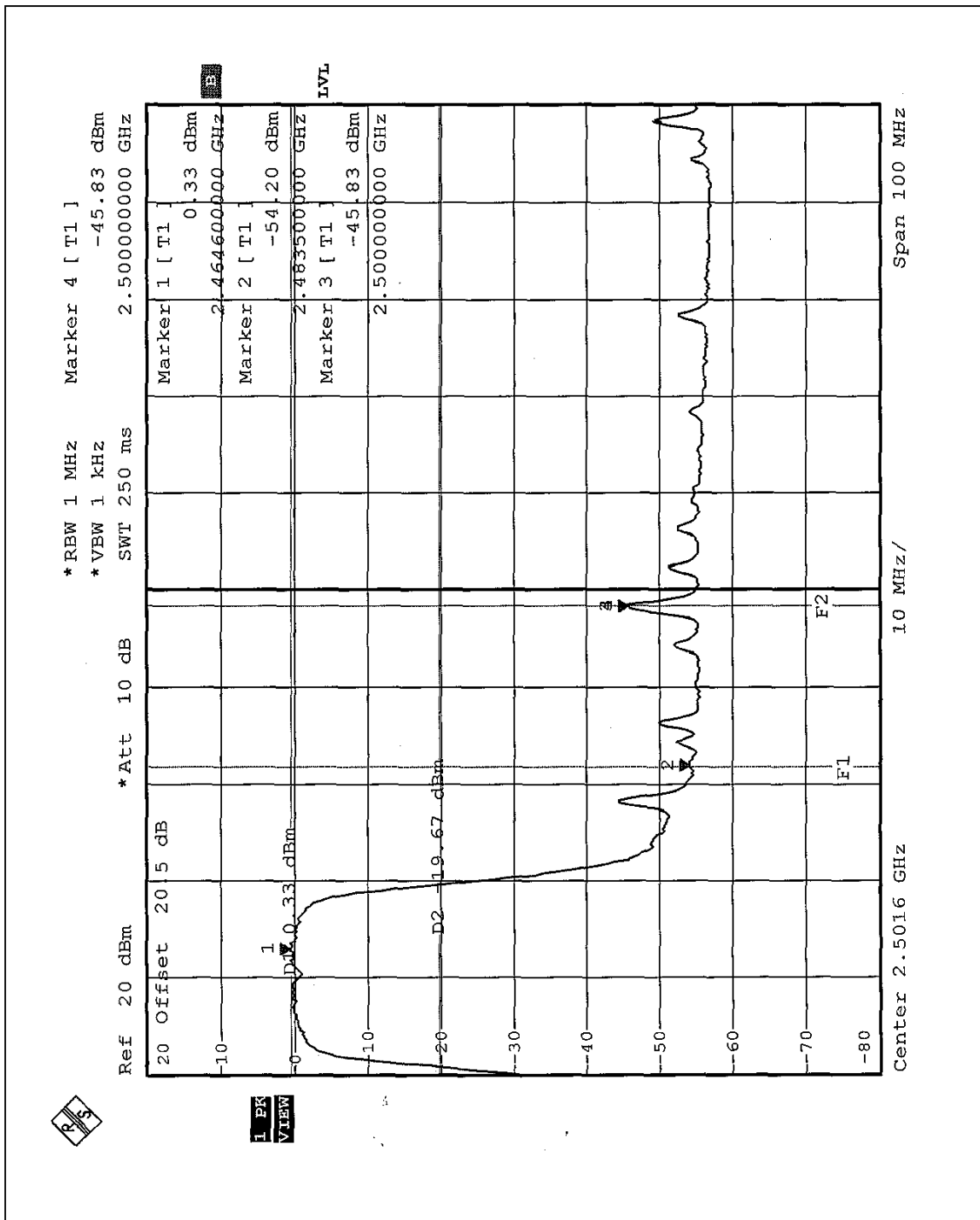



4.7 ANTENNA REQUIREMENT

4.7.1 STANDARD APPLICABLE

For intentional device, according to FCC 47 CFR Section 15.203, an intentional radiator shall be designed to ensure that no antenna other than that furnished by the responsible party shall be used with the device.

And according to FCC 47 CFR Section 15.247 (b), if transmitting antennas of directional gain greater than 6dBi are used, the power shall be reduced by the amount in dB that the directional gain of the antenna exceeds 6dBi.

4.7.2 ANTENNA CONNECTED CONSTRUCTION

The antenna used in this product is Dipole Antenna with reverse SMA connector. The maximum Gain of the antenna is 3.3dBi.

5 PHOTOGRAPHS OF THE TEST CONFIGURATION CONDUCTED EMISSION TEST



RADIATED EMISSION TEST





6 INFORMATION ON THE TESTING LABORATORIES

We, ADT Corp., were founded in 1988 to provide our best service in EMC, Radio, Telecom and Safety consultation. Our laboratories are accredited and approved by the following approval agencies according to ISO/IEC 17025, Guide 25 or EN 45001:

USA	FCC, NVLAP, UL
Germany	TUV Rheinland
Japan	VCCI
Norway	NEMKO
Canada	INDUSTRY CANADA , CSA
R.O.C.	CNLA, BSMI, DGT
Netherlands	Telefication
Singapore	PSB , GOST-ASIA(MOU)
Russia	CERTIS(MOU)

Copies of accreditation certificates of our laboratories obtained from approval agencies can be downloaded from our web site: www.adt.com.tw/index.5/phtml. If you have any comments, please feel free to contact us at the following:

Linko EMC/RF Lab:
Tel: 886-2-26052180
Fax: 886-2-26052943

Hsin Chu EMC/RF Lab:
Tel: 886-3-5935343
Fax: 886-3-5935342

Hwa Ya EMC/RF/Safety/Telecom Lab:
Tel: 886-3-3183232
Fax: 886-3-3185050

Linko RF Lab.
Tel: 886-3-3270910
Fax: 886-3-3270892

Email: service@mail.adt.com.tw
Web Site: www.adt.com.tw

The address and road map of all our labs can be found in our web site also.