



FCC TEST REPORT

REPORT NO.: RF950403H03

MODEL NO.: WRT54G3G

RECEIVED: April 03, 2006

TESTED: May 05 to 11, 2006

ISSUED: May 15, 2006

APPLICANT: Cisco-Linksys LLC

ADDRESS: 121 Theory Drive Irvine, CA 92617(USA)

ISSUED BY: Advance Data Technology Corporation

LAB LOCATION: No. 81-1, Lu Liao Keng, 9 Ling, Wu Lung Tsuen,
Chiung Lin Hsiang, Hsin Chu Hsien,
Taiwan, R.O.C.

This test report consists of 70 pages in total. It may be duplicated completely for legal use with the approval of the applicant. It should not be reproduced except in full, without the written approval of our laboratory. The client should not use it to claim product endorsement by CNLA, A2LA or any government agencies. The test results in the report only apply to the tested sample. The test results in this report are traceable to the national or international standards.





Table of Contents

1	CERTIFICATION.....	4
2	SUMMARY OF TEST RESULTS	5
3	GENERAL INFORMATION	6
3.1	GENERAL DESCRIPTION OF EUT	6
3.2	DESCRIPTION OF TEST MODES	7
3.3	TEST MODE APPLICABILITY AND TESTED CHANNEL DETAIL:	8
3.4	GENERAL DESCRIPTION OF APPLIED STANDARDS	10
3.5	DESCRIPTION OF SUPPORT UNITS.....	11
3.6	CONFIGURATION OF SYSTEM UNDER TEST	12
4	TEST TYPES AND RESULTS	13
4.1	CONDUCTED EMISSION MEASUREMENT	13
4.1.1	LIMITS OF CONDUCTED EMISSION MEASUREMENT	13
4.1.2	TEST INSTRUMENTS.....	13
4.1.3	TEST PROCEDURES	14
4.1.4	TEST SETUP	14
4.1.5	EUT OPERATING CONDITIONS.....	15
4.1.6	TEST RESULTS (ADAPTER 1)	16
4.1.7	TEST RESULTS (ADAPTER 2)	18
4.2	RADIATED EMISSION MEASUREMENT	20
4.2.1	LIMITS OF RADIATED EMISSION MEASUREMENT	20
4.2.2	TEST INSTRUMENTS.....	21
4.2.3	TEST PROCEDURES	22
4.2.4	TEST SETUP	23
4.2.5	EUT OPERATING CONDITIONS.....	23
4.2.6	TEST RESULTS	24
4.2.7	TEST RESULTS - DSSS	26
4.2.8	TEST RESULTS - OFDM.....	33
4.3	6DB BANDWIDTH MEASUREMENT.....	40
4.3.1	LIMITS OF 6DB BANDWIDTH MEASUREMENT	40
4.3.2	TEST INSTRUMENTS.....	40
4.3.3	TEST PROCEDURE.....	41
4.3.4	TEST SETUP	41
4.3.5	EUT OPERATING CONDITIONS.....	41



4.3.6	TEST RESULTS –DSSS.....	42
4.3.7	TEST RESULTS-OFDM.....	45
4.4	MAXIMUM PEAK OUTPUT POWER.....	48
4.4.1	LIMITS OF MAXIMUM PEAK OUTPUT POWER MEASUREMENT	48
4.4.2	TEST INSTRUMENTS.....	48
4.4.3	TEST PROCEDURES	49
4.4.4	TEST SETUP	49
4.4.5	EUT OPERATING CONDITIONS.....	49
4.4.6	TEST RESULTS – DSSS.....	50
4.4.7	TEST RESULTS –OFDM.....	51
4.5	POWER SPECTRAL DENSITY MEASUREMENT.....	52
4.5.1	LIMITS OF POWER SPECTRAL DENSITY MEASUREMENT.....	52
4.5.2	TEST INSTRUMENTS.....	52
4.5.3	TEST PROCEDURE.....	53
4.5.4	TEST SETUP	53
4.5.5	EUT OPERATING CONDITIONS.....	53
4.5.6	TEST RESULTS –DSSS.....	54
4.5.7	TEST RESULTS –OFDM.....	57
4.6	CONDUCTED EMISSION AND BAND EDGES MEASUREMENT	60
4.6.1	LIMITS OF CONDUCTED EMISSION AND BAND EDGES MEASUREMENT.....	60
4.6.2	TEST INSTRUMENTS.....	60
4.6.3	TEST PROCEDURE.....	60
4.6.4	DEVIATION FROM TEST STANDARD	60
4.6.5	EUT OPERATING CONDITION	60
4.6.6	TEST RESULTS	61
4.7	ANTENNA REQUIREMENT.....	66
4.7.1	STANDARD APPLICABLE.....	66
4.7.2	ANTENNA CONNECTED CONSTRUCTION.....	66
5	PHOTOGRAPHS OF THE TEST CONFIGURATION.....	67
6	INFORMATION ON THE TESTING LABORATORIES	69
	APPENDIX-A.....	A-1



1 CERTIFICATION

PRODUCT : Wireless-G Router for Mobile Broadband
BRAND NAME : Linksys
MODEL NO. : WRT54G3G
TESTED: May 05 to 11, 2006
APPLICANT : Cisco-Linksys LLC
TEST ITEM: ENGINEERING SAMPLE
STANDARDS : 47 CFR Part 15, Subpart C (Section 15.247),
ANSI C63.4-2003

The above equipment (Model: WRT54G3G) has been tested by **Advance Data Technology Corporation**, and found compliance with the requirement of the above standards. The test record, data evaluation & Equipment Under Test (EUT) configurations represented herein are true and accurate accounts of the measurements of the sample's EMC characteristics under the conditions specified in this report.

PREPARED BY : Carol Liao , **DATE:** May 15, 2006
(Carol Liao)

TECHNICAL ACCEPTANCE : Hank Chung , **DATE:** May 15, 2006
Responsible for RF (Hank Chung)

APPROVED BY : May Chen , **DATE:** May 15, 2006
(May Chen, Deputy Manager)

2 SUMMARY OF TEST RESULTS

The EUT has been tested according to the following specifications:

APPLIED STANDARD: 47 CFR Part 15, Subpart C			
Standard Section	Test Type and Limit	Result	REMARK
15.207	AC Power Conducted Emission	PASS	Meet the requirement of limit Minimum passing margin is -10.86 dB at 0.259 MHz
15.247(a)(2)	Spectrum Bandwidth of a Direct Sequence Spread Spectrum System Limit: min. 500kHz	PASS	Meet the requirement of limit
15.247(b)	Maximum Peak Output Power Limit: max. 30dBm	PASS	Meet the requirement of limit
15.247(c)	Transmitter Radiated Emissions Limit: Table 15.209	PASS	Meet the requirement of limit Minimum passing margin is -1.9 dB at 2390.00 MHz
15.247(d)	Power Spectral Density Limit: max. 8dBm	PASS	Meet the requirement of limit
15.247(c)	Band Edge Measurement Limit: 20 dB less than the peak value of fundamental frequency	PASS	Meet the requirement of limit

3 GENERAL INFORMATION

3.1 GENERAL DESCRIPTION OF EUT

PRODUCT	Wireless-G Router for Mobile Broadband
MODEL NO.	WRT54G3G
FCC ID	Q87-WRT54G3G
POWER SUPPLY	DC 12V from power adapter
MODULATION TYPE	CCK, DQPSK, DBPSK for DSSS 64QAM, 16QAM, QPSK, BPSK for OFDM
RADIO TECHNOLOGY	DSSS, OFDM
TRANSFER RATE	802.11b: 11/5.5/2/1Mbps 802.11g: 54/48/36/24/18/12/9/6Mbps
FREQUENCY RANGE	2412MHz ~ 2462MHz
NUMBER OF CHANNEL	11
CHANNEL SPACING	5MHz
OUTPUT POWER	802.11b: 109.144mW 802.11g: 178.238mW
ANTENNA TYPE	Dipole antenna, antenna gain: 2dBi
DATA CABLE	NA
I/O PORTS	One 10/100 RJ45 Internet Port Four 10/100 RJ45 Switched LAN Port
ASSOCIATED DEVICES	NA

NOTE:

- The EUT must be supplied with a power adapter and following different models could be chosen:

Adapter 1:	
Brand:	Linksys
Model No.:	AM-1201000D41
Input power :	AC120V, 50Hz, 0.15A
Output power :	DC12V, 1A Cable:1.8m/unshielded/without core
Adapter 2:	
Brand:	Linksys
Model No.:	D12-1000
Input power :	AC120V, 50Hz, 0.15A
Output power :	DC12V, 1A Cable:1.8m/unshielded/without core

2. This device provide a 3G/UMTS slot, the below cards were selected as the representative for the co-located EMC / RF exposure test.

Item	Brand name	Model name	FCC ID
1	cingular raising the bar	NRM-U730	NBZNRM-U730
2	vodafone	U630	NBZNRM-U630
3	vodafone	GT 3G Quad	NCMOGL3Q

3. The EUT operates in the 2.4GHz frequency spectrum with throughput of up to 54Mbps.
4. The EUT complies with IEEE 802.11g standards, and backwards compatible with IEEE 802.11b products.
5. The above EUT information was declared by the manufacturer and for more detailed features description, please refer to the manufacturer's specifications or User's Manual.

3.2 DESCRIPTION OF TEST MODES

Operated in 2400 ~ 2483.5MHz band:

For 802.11b/g normal mode: Eleven channels are provided to this EUT.

Channel	Frequency	Channel	Frequency
1	2412 MHz	7	2442 MHz
2	2417 MHz	8	2447 MHz
3	2422 MHz	9	2452 MHz
4	2427 MHz	10	2457 MHz
5	2432 MHz	11	2462 MHz
6	2437 MHz		

3.3 TEST MODE APPLICABILITY AND TESTED CHANNEL DETAIL:

EUT configure mode	Applicable to				Description
	PLC	RE<1G	RE≥1G	APCM	
-	√	√	√	√	NA

Where PLC: Power Line Conducted Emission RE<1G RE: Radiated Emission below 1GHz
 RE≥1G: Radiated Emission above 1GHz APCM: Antenna Port Conducted Measurement

Power Line Conducted Emission Test:

- Pre-Scan has been conducted to determine the worst-case mode from all possible combinations between available modulations, data rates and antenna ports (if EUT with antenna diversity architecture).
- Following channel(s) was (were) selected for the final test as listed below.

Mode	Available Channel	Tested Channel	Modulation Technology	Modulation Type	Data Rate (Mbps)
802.11g	1 to 11	11	OFDM	BPSK	6

- The EUT was tested with the following modes:

Test Mode	Description
Mode 1	Adapter 1
Mode 2	Adapter 2

Radiated Emission Test (Below 1 GHz):

- Pre-Scan has been conducted to determine the worst-case mode from all possible combinations between available modulations, data rates and antenna ports (if EUT with antenna diversity architecture).
- Following channel(s) was (were) selected for the final test as listed below.

Mode	Available Channel	Tested Channel	Modulation Technology	Modulation Type	Data Rate (Mbps)
802.11g	1 to 11	11	OFDM	BPSK	6

- The EUT was tested with the following modes:

Test Mode	Description
Mode 1	Adapter 1
Mode 2	Adapter 2

Radiated Emission Test (Above 1 GHz):

- Pre-Scan has been conducted to determine the worst-case mode from all possible combinations between available modulations, data rates and antenna ports (if EUT with antenna diversity architecture).
- Following channel(s) was (were) selected for the final test as listed below.

Mode	Available Channel	Tested Channel	Modulation Technology	Modulation Type	Data Rate (Mbps)
802.11b	1 to 11	1, 6, 11	DSSS	CCK	11
802.11g	1 to 11	1, 6, 11	OFDM	BPSK	6

Bandedge Measurement:

- Pre-Scan has been conducted to determine the worst-case mode from all possible combinations between available modulations, data rates and antenna ports (if EUT with antenna diversity architecture).
- Following channel(s) was (were) selected for the final test as listed below.

Mode	Available Channel	Tested Channel	Modulation Technology	Modulation Type	Data Rate (Mbps)
802.11b	1 to 11	1, 11	DSSS	CCK	11
802.11g	1 to 11	1, 11	OFDM	BPSK	6

Antenna Port Conducted Measurement:

- Pre-Scan has been conducted to determine the worst-case mode from all possible combinations between available modulations, data rates and antenna ports (if EUT with antenna diversity architecture).
- Following channel(s) was (were) selected for the final test as listed below.

Mode	Available Channel	Tested Channel	Modulation Technology	Modulation Type	Data Rate (Mbps)
802.11b	1 to 11	1, 6, 11	DSSS	CCK	11
802.11g	1 to 11	1, 6, 11	OFDM	BPSK	6



3.4 GENERAL DESCRIPTION OF APPLIED STANDARDS

The EUT is a Wireless-G Router for Mobile Broadband. According to the specifications of the manufacturer, it must comply with the requirements of the following standards:

47 CFR Part 15, Subpart C. (15.247)
ANSI C63.4 : 2003

All tests have been performed and recorded as per the above standards.

3.5 DESCRIPTION OF SUPPORT UNITS

The EUT has been tested as an independent unit together with other necessary accessories or support units. The following support units or accessories were used to form a representative test configuration during the tests.

No.	Product	Brand	Model No.	Serial No.	FCC ID
1	NOTEBOOK COMPUTER	DELL	PP01L	TW-09c748-12800-165-3171	FCC DoC
2	NOTEBOOK COMPUTER	DELL	PP01L	TW-0791UH-12800-0CK-3735	FCC DoC
3	NOTEBOOK COMPUTER	DELL	PP21L	CN-0GD366-70166-5B3-09ZX	QDS-BRCM1016
4	HUB	AVSYS	110H8	01-20E-000006	FCC DoC
5	3G Card	Option	Globe Trotter Fusion	RC31515152	NA

No.	Signal cable description
1	NA
2	NA
3	NA
4	NA
5	NA

Note: 1. All power cords of the above support units are unshielded (1.8m).

3.6 CONFIGURATION OF SYSTEM UNDER TEST

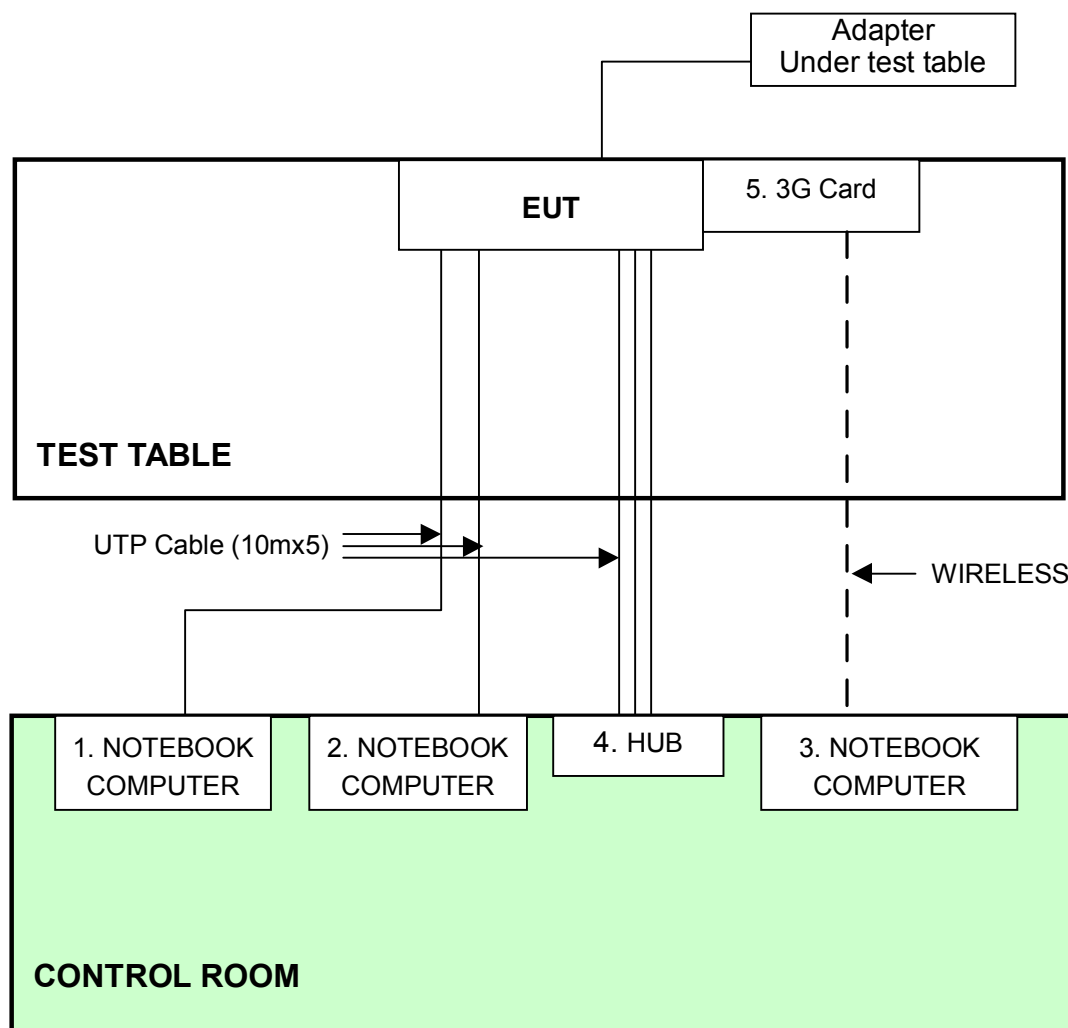

- NOTE:**
1. Support unit 1-4 were kept in the control room during the test.
 2. Please refer to the photos of test configuration in Item 5 also.

4 TEST TYPES AND RESULTS

4.1 CONDUCTED EMISSION MEASUREMENT

4.1.1 LIMITS OF CONDUCTED EMISSION MEASUREMENT

FREQUENCY OF EMISSION (MHz)	CONDUCTED LIMIT (dB μ V)	
	Quasi-peak	Average
0.15-0.5	66 to 56	56 to 46
0.5-5	56	46
5-30	60	50

NOTE:

1. The lower limit shall apply at the transition frequencies.
2. All emanations from a class B digital device or system, including any network of conductors and apparatus connected thereto, shall not exceed the level of field strengths specified above.

4.1.2 TEST INSTRUMENTS

DESCRIPTION & MANUFACTURER	MODEL NO.	SERIAL NO.	CALIBRATED UNTIL
Test Receiver	ESCS 30	847124/029	Dec. 15, 2006
Line-Impedance Stabilization Network(for EUT)	ENV-216	100071	Nov. 10, 2006
Line-Impedance Stabilization Network(for Peripheral)	KNW-407	8/1395/12	Jul. 19, 2006
RF Cable (JETBAO)	RG233/U	Cable_CB_01	Dec. 09, 2006
Terminator	50	2	Oct. 08, 2006
Software	ADT_Cond_V7.3.2	NA	NA

- NOTE: 1. The calibration interval of the above test instruments is 12 months and the calibrations are traceable to NML/ROC and NIST/USA.
 2. The test was performed in ADT Shielded Room No. B.
 3. The VCCI Con B Registration No. is C-2193.

4.1.3 TEST PROCEDURES

- a. The EUT/HOST was placed 0.4 meters from the conducting wall of the shielded room with EUT/HOST being connected to the power mains through a line impedance stabilization network (LISN). Other support units were connected to the power mains through another LISN. The two LISNs provide 50 ohm/ 50uH of coupling impedance for the measuring instrument.
- b. Both lines of the power mains connected to the EUT/HOST were checked for maximum conducted interference.
- c. The frequency range from 150 kHz to 30 MHz was searched. Emission levels over 10dB under the prescribed limits could not be reported

4.1.4 TEST SETUP

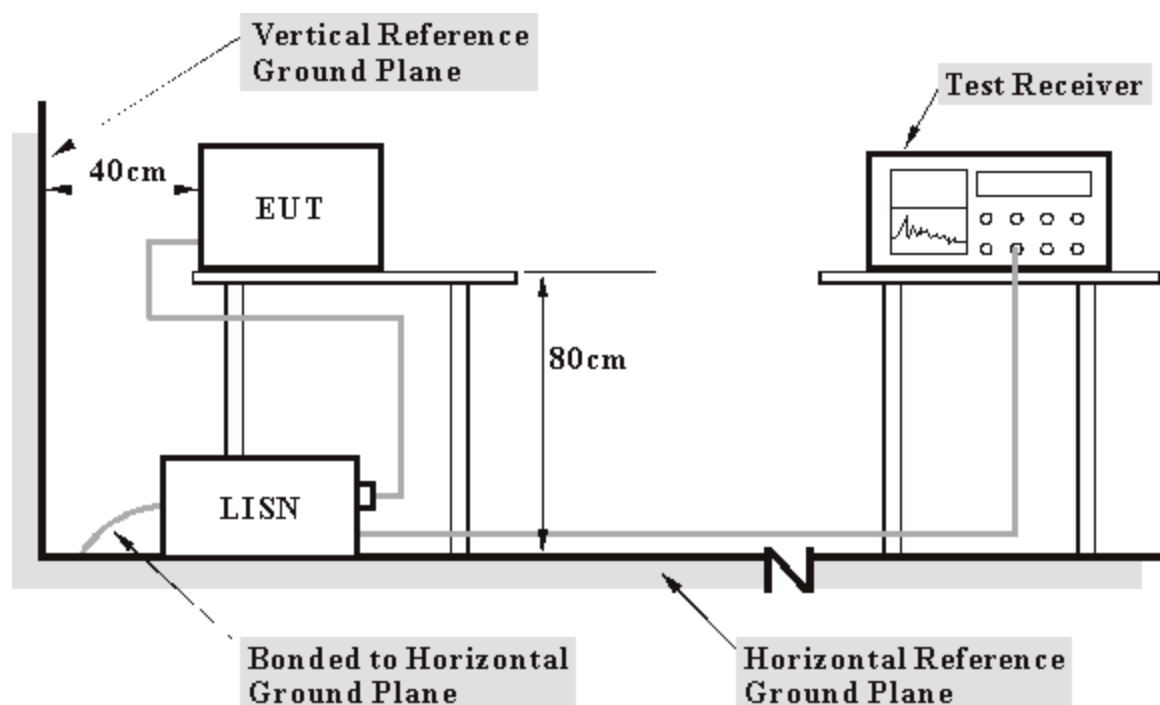

- Note:**
1. Support units were connected to second LISN.
 2. Both of LISNs (AMIN) 80 cm from EUT and at the least 80 cm from other units and other metal planes support units.

For the actual test configuration, please refer to the related item – Photographs of the Test Configuration.

4.1.5 EUT OPERATING CONDITIONS

- a. Placed the EUT on the testing table.
- b. Prepared other computer systems (support unit 1~4) to act as a communication partner and placed them outside of testing area.
- c. The communication partners run test program “IE with HTTP://192.168.1.1 ” to enable EUT under transmission/receiving condition continuously at specific channel frequency via UTP cables and wireless transmission.

4.1.6 TEST RESULTS (Adapter 1)

MODULATION TYPE	BPSK	CHANNEL	Channel 11
INPUT POWER (SYSTEM)	120Vac, 60 Hz	6dB BANDWIDTH	9 kHz
ENVIRONMENTAL CONDITIONS	25deg. C, 65%RH, 965hPa	TRANSFER RATE	6Mbps
TESTED BY	Eric Lee	PHASE	Line (L)

No	Freq. [MHz]	Corr. Factor (dB)	Reading Value		Emission Level		Limit		Margin	
			[dB (uV)]		[dB (uV)]		[dB (uV)]		(dB)	
			Q.P.	AV.	Q.P.	AV.	Q.P.	AV.	Q.P.	AV.
1	0.177	9.60	41.77	-	51.37	-	64.61	54.61	-13.24	-
2	0.259	9.60	39.46	-	49.06	-	61.45	51.45	-12.39	-
3	0.392	9.60	36.75	-	46.35	-	58.02	48.02	-11.67	-
4	0.709	9.60	31.00	-	40.60	-	56.00	46.00	-15.40	-
5	1.189	9.62	23.85	-	33.47	-	56.00	46.00	-22.53	-
6	3.465	9.70	13.56	-	23.26	-	56.00	46.00	-32.74	-

- REMARKS:**
1. Q.P. and AV. are abbreviations of quasi-peak and average individually.
 2. "-": The Quasi-peak reading value also meets average limit and measurement with the average detector is unnecessary.
 3. The emission levels of other frequencies were very low against the limit.
 4. Margin value = Emission level - Limit value
 5. Correction factor = Insertion loss + Cable loss
 6. Emission Level = Correction Factor + Reading Value.

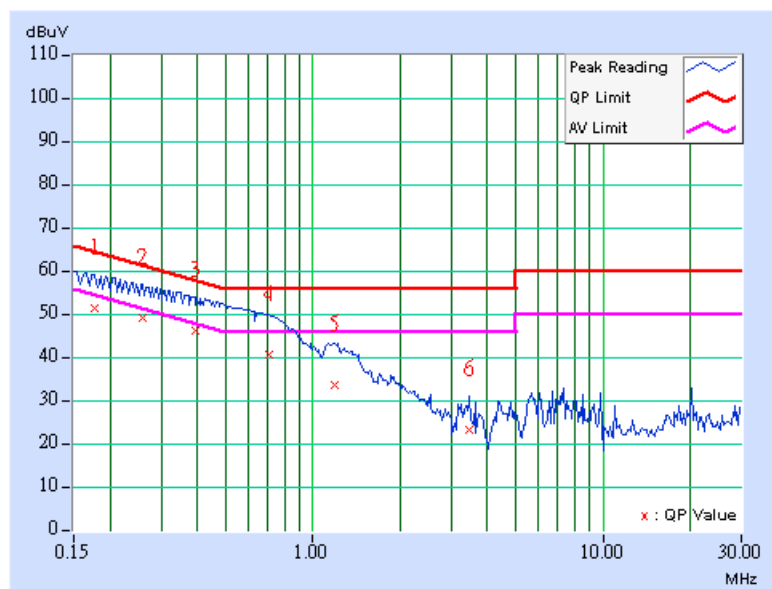

MODULATION TYPE	BPSK	CHANNEL	Channel 11
INPUT POWER (SYSTEM)	120Vac, 60 Hz	6dB BANDWIDTH	9 kHz
ENVIRONMENTAL CONDITIONS	25deg. C, 65%RH, 965hPa	TRANSFER RATE	6Mbps
TESTED BY	Eric Lee	PHASE	Neutral (N)

No	Freq. [MHz]	Corr. Factor (dB)	Reading Value [dB (uV)]		Emission Level [dB (uV)]		Limit [dB (uV)]		Margin (dB)	
			Q.P.	AV.	Q.P.	AV.	Q.P.	AV.	Q.P.	AV.
			1	0.189	9.60	41.85	-	51.45	-	64.08
2	0.259	9.60	40.99	-	50.59	-	61.45	51.45	-10.86	-
3	0.318	9.60	39.04	-	48.64	-	59.76	49.76	-11.12	-
4	0.615	9.60	32.53	-	42.13	-	56.00	46.00	-13.87	-
5	1.177	9.62	23.03	-	32.65	-	56.00	46.00	-23.35	-
6	6.902	9.80	19.12	-	28.92	-	60.00	50.00	-31.08	-

- REMARKS:**
1. Q.P. and AV. are abbreviations of quasi-peak and average individually.
 2. "-": The Quasi-peak reading value also meets average limit and measurement with the average detector is unnecessary.
 3. The emission levels of other frequencies were very low against the limit.
 4. Margin value = Emission level - Limit value
 5. Correction factor = Insertion loss + Cable loss
 6. Emission Level = Correction Factor + Reading Value.

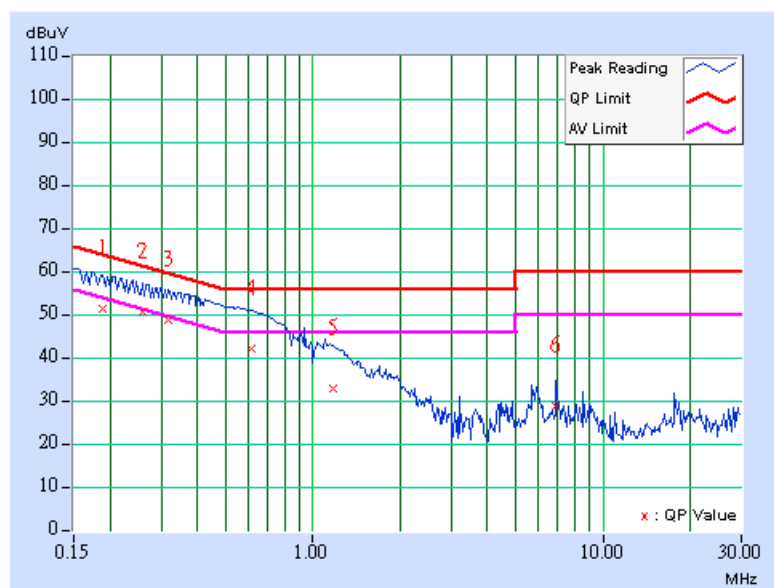

4.1.7 TEST RESULTS (Adapter 2)

MODULATION TYPE	BPSK	CHANNEL	Channel 11
INPUT POWER (SYSTEM)	120Vac, 60 Hz	6dB BANDWIDTH	9 kHz
ENVIRONMENTAL CONDITIONS	25deg. C, 65%RH, 965hPa	TRANSFER RATE	6Mbps
TESTED BY	Eric Lee	PHASE	Line (L)

No	Freq. [MHz]	Corr. Factor (dB)	Reading Value		Emission Level		Limit		Margin	
			[dB (uV)]		[dB (uV)]		[dB (uV)]		(dB)	
			Q.P.	AV.	Q.P.	AV.	Q.P.	AV.	Q.P.	AV.
1	0.193	9.60	40.81	-	50.41	-	63.91	53.91	-13.50	-
2	0.244	9.60	39.25	-	48.85	-	61.97	51.97	-13.12	-
3	0.412	9.60	36.59	-	46.19	-	57.61	47.61	-11.42	-
4	0.658	9.60	30.65	-	40.25	-	56.00	46.00	-15.75	-
5	1.084	9.61	24.59	-	34.20	-	56.00	46.00	-21.80	-
6	1.970	9.70	15.40	-	25.10	-	56.00	46.00	-30.90	-
7	5.688	9.76	20.26	-	30.02	-	60.00	50.00	-29.98	-

- REMARKS:**
1. Q.P. and AV. are abbreviations of quasi-peak and average individually.
 2. "-": The Quasi-peak reading value also meets average limit and measurement with the average detector is unnecessary.
 3. The emission levels of other frequencies were very low against the limit.
 4. Margin value = Emission level - Limit value
 5. Correction factor = Insertion loss + Cable loss
 6. Emission Level = Correction Factor + Reading Value.

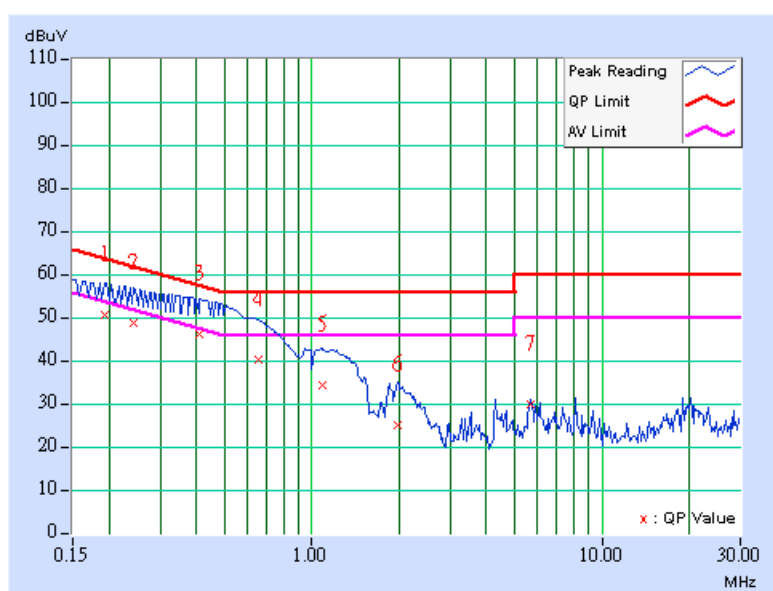

MODULATION TYPE	BPSK	CHANNEL	Channel 11
INPUT POWER (SYSTEM)	120Vac, 60 Hz	6dB BANDWIDTH	9 kHz
ENVIRONMENTAL CONDITIONS	25deg. C, 65%RH, 965hPa	TRANSFER RATE	6Mbps
TESTED BY	Eric Lee	PHASE	Neutral (N)

No	Freq. [MHz]	Corr. Factor (dB)	Reading Value [dB (uV)]		Emission Level [dB (uV)]		Limit [dB (uV)]		Margin (dB)	
			Q.P.	AV.	Q.P.	AV.	Q.P.	AV.	Q.P.	AV.
			1	0.162	9.60	41.71	-	51.31	-	65.38
2	0.205	9.60	40.58	-	50.18	-	63.42	53.42	-13.24	-
3	0.310	9.60	38.09	-	47.69	-	59.97	49.97	-12.28	-
4	0.650	9.60	31.69	-	41.29	-	56.00	46.00	-14.71	-
5	1.845	9.68	17.59	-	27.27	-	56.00	46.00	-28.73	-
6	5.875	9.76	15.72	-	25.48	-	60.00	50.00	-34.52	-

- REMARKS:**
1. Q.P. and AV. are abbreviations of quasi-peak and average individually.
 2. "-": The Quasi-peak reading value also meets average limit and measurement with the average detector is unnecessary.
 3. The emission levels of other frequencies were very low against the limit.
 4. Margin value = Emission level - Limit value
 5. Correction factor = Insertion loss + Cable loss
 6. Emission Level = Correction Factor + Reading Value.

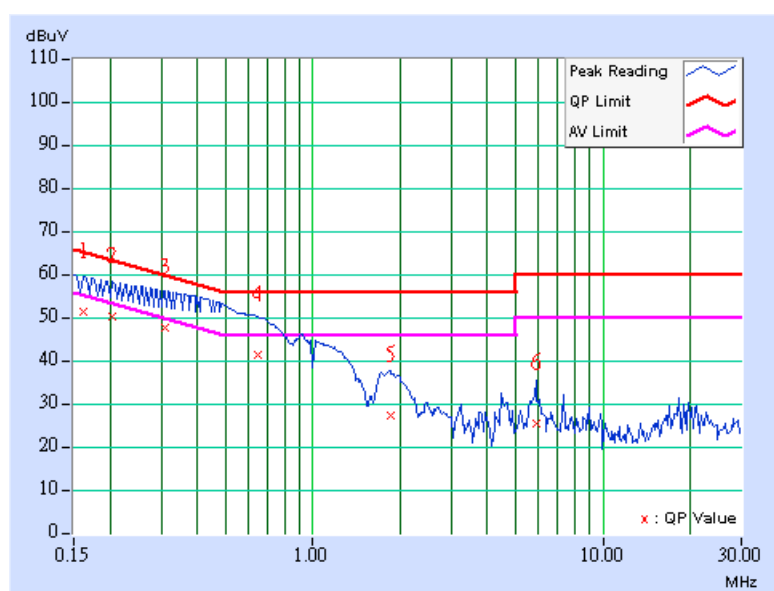

4.2 RADIATED EMISSION MEASUREMENT

4.2.1 LIMITS OF RADIATED EMISSION MEASUREMENT

Emissions radiated outside of the specified bands, shall be according to the general radiated limits in 15.209 as following:

Frequencies (MHz)	Field strength (microvolts/meter)	Measurement distance (meters)
0.009-0.490	2400/F(kHz)	300
0.490-1.705	24000/F(kHz)	30
1.705-30.0	30	30
30-88	100	3
88-216	150	3
216-960	200	3
Above 960	500	3

NOTE:

1. The lower limit shall apply at the transition frequencies.
2. Emission level (dBuV/m) = 20 log Emission level (uV/m).
3. As shown in 15.35(b), for frequencies above 1000MHz, the field strength limits are based on average detector, however, the peak field strength of any emission shall not exceed the maximum permitted average limits, specified above by more than 20dB under any condition of modulation.

4.2.2 TEST INSTRUMENTS

DESCRIPTION & MANUFACTURER	MODEL NO.	SERIAL NO.	CALIBRATED UNTIL
ADVANTEST Spectrum Analyzer	R3271A	85060311	July 07, 2006
HP Pre_Amplifier	8449B	3008A01922	Oct. 02, 2006
ROHDE & SCHWARZ Test Receiver	ESCS30	100375	Sep. 19, 2006
CHASE Broadband Antenna	VULB9168	138	Dec. 11, 2006
Schwarzbeck Horn_Antenna	BBHA9120	D124	Dec. 27, 2006
Schwarzbeck Horn_Antenna	BBHA 9170	BBHA9170153	Jan. 05, 2007
SCHWARZBECK Biconical Antenna	VHBA9123	459	Jun. 26, 2006
SCHWARZBECK Periodic Antenna	UPA6108	1148	Jun. 26, 2006
RF Switches (ARNITSU)	CS-201	1565157	NA
RF CABLE (Chaintek)	SF102	22054-2	Nov. 16. 2006
RF Cable(RICHTEC)	9913-30M N-N Cable	STCCAB-30M-1GHz	Jul. 16, 2006
Software	ADT_Radiated_V 5.14	NA	NA
CHANCE MOST Antenna Tower	AT-100	0203	NA
CHANCE MOST Turn Table	TT-100	0203	NA

Note: 1. The calibration interval of the above test instruments is 12 months (36 months for Periodic Antenna) and the calibrations are traceable to NML/ROC and NIST/USA.

2. The horn antenna and HP preamplifier (model: 8449B) are used only for the measurement of emission frequency above 1GHz if tested.
3. The test was performed in ADT Open Site No. C.
4. The FCC Site Registration No. is 656396.
5. The VCCI Site Registration No. is R-1626.
6. The CANADA Site Registration No. is IC 4824-3.
7. The following table is for the measurement uncertainty, which is calculated as per the document CISPR 16-4. This uncertainty represents an expanded uncertainty expressed at approximately the 95% confidence level using a coverage factor of k=2.

Measurement	Value
Radiated emissions (30MHz-1GHz)	2.98 dB
Radiated emissions (1GHz ~18GHz)	2.21 dB
Radiated emissions (18GHz ~40GHz)	1.88 dB

4.2.3 TEST PROCEDURES

- a. The EUT was placed on the top of a rotating table 0.8 meters above the ground at a 10 meter open area test site. The table was rotated 360 degrees to determine the position of the highest radiation.
- b. The EUT was set 3 meters away from the interference-receiving antenna, which was mounted on the top of a variable-height antenna tower.
- c. The antenna is a broadband antenna, and its height is varied from one meter to four meters above the ground to determine the maximum value of the field strength. Both horizontal and vertical polarizations of the antenna are set to make the measurement.
- d. For each suspected emission, the EUT was arranged to its worst case and then the antenna was tuned to heights from 1 meter to 4 meters and the rotatable table was turned from 0 degrees to 360 degrees to find the maximum reading.
- e. The test-receiver system was set to Peak Detect Function and Specified Bandwidth with Maximum Hold Mode.
- f. If the emission level of the EUT in peak mode was 10 dB lower than the limit specified, then testing could be stopped and the peak values of the EUT would be reported. Otherwise the emissions that did not have 10 dB margin would be re-tested one by one using peak, quasi-peak or average method as specified and then reported in a data sheet.

NOTE:

1. The resolution bandwidth and video bandwidth of test receiver/spectrum analyzer is 120kHz for Peak detection (PK) and Quasi-peak detection (QP) at frequency below 1GHz.
2. The resolution bandwidth and video bandwidth of test receiver/spectrum analyzer is 1 MHz for Peak detection at frequency above 1GHz.
3. The resolution bandwidth of test receiver/spectrum analyzer is 1 MHz and the video bandwidth is 10 Hz for Average detection (AV) at frequency above 1GHz.

4.2.4 TEST SETUP

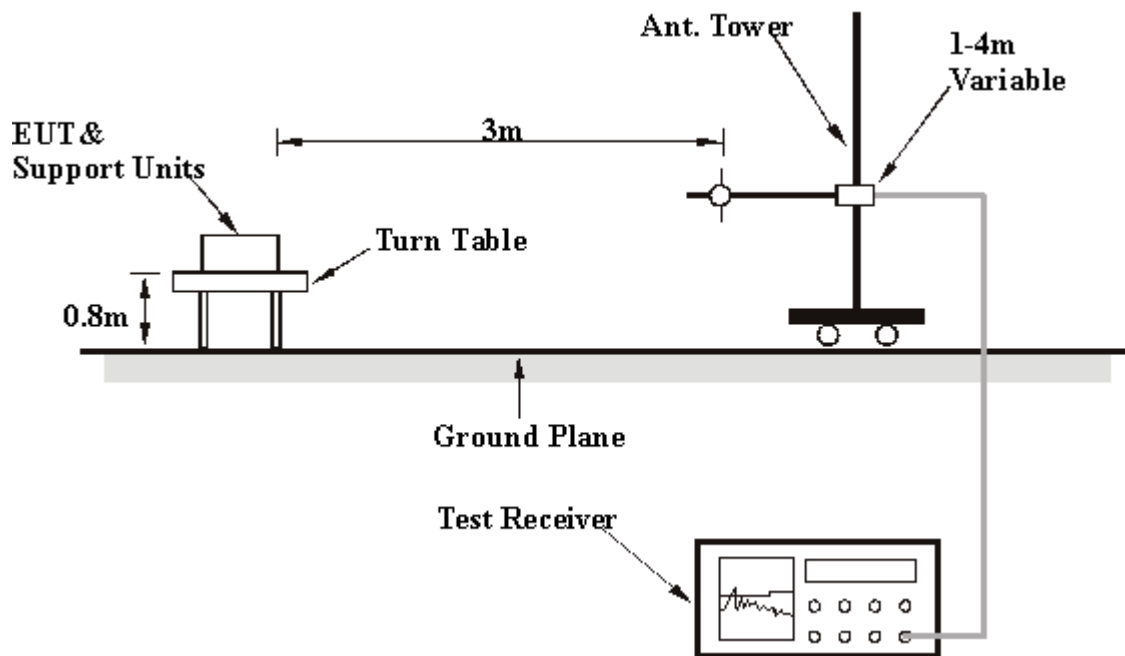

For the actual test configuration, please refer to the related item – Photographs of the Test Configuration.

4.2.5 EUT OPERATING CONDITIONS

Same as 4.1.5

4.2.6 TEST RESULTS

Below 1GHz Worst-Case Data (Adapter 1)

MODULATION TYPE	BPSK	CHANNEL	Channel 11
INPUT POWER (SYSTEM)	120Vac, 60 Hz	FREQUENCY RANGE	30-1000 MHz
ENVIRONMENTAL CONDITIONS	30deg. C, 60%RH, 965hPa	TRANSFER RATE	6Mbps
TESTED BY	Tony Chen	DETECTOR FUNCTION	Quasi-Peak, 120kHz

ANTENNA POLARITY & TEST DISTANCE: HORIZONTAL AT 3 M

No.	Freq. (MHz)	Emission Level (dBuV/m)	Limit (dBuV/m)	Margin (dB)	Antenna Height (m)	Table Angle (Degree)	Raw Value (dBuV)	Correction Factor (dB/m)
1	250.02	34.20 QP	46.00	-11.80	1.07 H	210	20.40	13.80
2	300.03	40.40 QP	46.00	-5.60	1.12 H	230	23.50	16.80
3	366.68	41.10 QP	46.00	-4.90	1.04 H	54	23.20	17.90
4	375.03	30.20 QP	46.00	-15.80	1.05 H	258	12.00	18.20
5	400.03	41.30 QP	46.00	-4.70	1.09 H	230	22.30	19.00
6	500.04	38.40 QP	46.00	-7.60	1.13 H	147	16.60	21.80
7	600.02	39.40 QP	46.00	-6.60	1.24 H	101	14.90	24.50
8	900.02	32.80 QP	46.00	-13.20	1.20 H	123	3.90	28.90

ANTENNA POLARITY & TEST DISTANCE: VERTICAL AT 3 M

No.	Freq. (MHz)	Emission Level (dBuV/m)	Limit (dBuV/m)	Margin (dB)	Antenna Height (m)	Table Angle (Degree)	Raw Value (dBuV)	Correction Factor (dB/m)
1	52.47	33.50 QP	40.00	-6.50	1.20 V	358	18.70	14.80
2	250.02	33.90 QP	46.00	-12.10	1.00 V	120	20.10	13.80
3	300.01	33.80 QP	46.00	-12.20	1.11 V	101	17.00	16.80
4	366.68	37.10 QP	46.00	-8.90	1.08 V	230	19.20	17.90
5	375.01	32.10 QP	46.00	-13.90	1.00 V	12	13.90	18.20
6	400.01	39.10 QP	46.00	-6.90	1.07 V	124	20.10	19.00
7	500.01	38.10 QP	46.00	-7.90	1.32 V	120	16.30	21.80
8	600.02	37.20 QP	46.00	-8.80	1.04 V	103	12.70	24.50
9	900.02	33.80 QP	46.00	-12.20	1.24 V	125	4.90	28.90

- REMARKS:**
1. Emission level(dBuV/m)=Raw Value(dBuV) + Correction Factor(dB/m)
 2. Correction Factor(dB/m) = Antenna Factor (dB/m) + Cable Factor (dB)
 3. The other emission levels were very low against the limit.
 4. Margin value = Emission level – Limit value.



Below 1GHz Worst-Case Data (Adapter 2)

MODULATION TYPE	BPSK	CHANNEL	Channel 11
INPUT POWER (SYSTEM)	120Vac, 60 Hz	FREQUENCY RANGE	30-1000 MHz
ENVIRONMENTAL CONDITIONS	30deg. C, 60%RH, 965hPa	TRANSFER RATE	6Mbps
TESTED BY	Tony Chen	DETECTOR FUNCTION	Quasi-Peak, 120kHz

ANTENNA POLARITY & TEST DISTANCE: HORIZONTAL AT 3 M

No.	Freq. (MHz)	Emission Level (dBuV/m)	Limit (dBuV/m)	Margin (dB)	Antenna Height (m)	Table Angle (Degree)	Raw Value (dBuV)	Correction Factor (dB/m)
1	250.03	33.80 QP	46.00	-12.20	1.22 H	6	20.00	13.80
2	300.03	41.10 QP	46.00	-4.90	1.11 H	1	24.20	16.80
3	366.68	40.50 QP	46.00	-5.50	1.00 H	1	22.60	17.90
4	375.03	31.10 QP	46.00	-14.90	1.00 H	335	12.90	18.20
5	400.03	41.60 QP	46.00	-4.40	1.08 H	35	22.50	19.00
6	500.04	37.90 QP	46.00	-8.10	1.41 H	291	16.20	21.80
7	600.02	38.70 QP	46.00	-7.30	1.65 H	72	14.20	24.50
8	900.02	30.40 QP	46.00	-15.60	1.45 H	178	1.60	28.90

ANTENNA POLARITY & TEST DISTANCE: VERTICAL AT 3 M

No.	Freq. (MHz)	Emission Level (dBuV/m)	Limit (dBuV/m)	Margin (dB)	Antenna Height (m)	Table Angle (Degree)	Raw Value (dBuV)	Correction Factor (dB/m)
1	51.13	30.50 QP	40.00	-9.50	1.00 V	305	15.50	15.00
2	250.02	33.40 QP	46.00	-12.60	1.00 V	326	19.60	13.80
3	300.01	33.10 QP	46.00	-12.90	1.31 V	203	16.30	16.80
4	366.68	36.80 QP	46.00	-9.20	1.57 V	292	18.90	17.90
5	375.01	31.40 QP	46.00	-14.60	1.27 V	8	13.20	18.20
6	400.01	40.50 QP	46.00	-5.50	1.29 V	346	21.40	19.00
7	500.01	37.40 QP	46.00	-8.60	1.29 V	223	15.70	21.80
8	600.01	38.30 QP	46.00	-7.70	1.05 V	132	13.80	24.50
9	900.03	32.80 QP	46.00	-13.20	1.27 V	150	3.90	28.90

- REMARKS:**
1. Emission level(dBuV/m)=Raw Value(dBuV) + Correction Factor(dB/m)
 2. Correction Factor(dB/m) = Antenna Factor (dB/m) + Cable Factor (dB)
 3. The other emission levels were very low against the limit.
 4. Margin value = Emission level – Limit value.

4.2.7 TEST RESULTS - DSSS

802.11b DSSS modulation

MODE	Channel 1	FREQUENCY RANGE	1000~25000MHz
INPUT POWER (SYSTEM)	120Vac, 60 Hz	DETECTOR FUNCTION & BANDWIDTH	Peak (PK) Average (AV) 1 MHz
ENVIRONMENTAL CONDITIONS	22 deg. C, 72%RH, 965hPa	TESTED BY	Sky Liao

ANTENNA POLARITY & TEST DISTANCE: HORIZONTAL AT 3 M

No.	Freq. (MHz)	Emission Level (dBuV/m)	Limit (dBuV/m)	Margin (dB)	Antenna Height (m)	Table Angle (Degree)	Raw Value (dBuV)	Correction Factor (dB/m)
1	2390.00	53.50 PK	74.00	-20.50	1.00 H	52	19.80	33.70
1	2390.00	43.50 AV	54.00	-10.50	1.00 H	52	9.80	33.70
2	*2412.00	99.70 PK			1.00 H	50	69.90	29.80
2	*2412.00	93.60 AV			1.00 H	50	63.80	29.80
3	4824.00	46.00 PK	74.00	-28.00	1.36 H	17	10.90	35.10
3	4824.00	34.90 AV	54.00	-19.10	1.36 H	17	-0.20	35.10
4	7236.00	50.00 PK	74.00	-24.00	1.52 H	320	9.50	40.50
4	7236.00	38.00 AV	54.00	-16.00	1.52 H	320	-2.50	40.50

ANTENNA POLARITY & TEST DISTANCE: VERTICAL AT 3 M

No.	Freq. (MHz)	Emission Level (dBuV/m)	Limit (dBuV/m)	Margin (dB)	Antenna Height (m)	Table Angle (Degree)	Raw Value (dBuV)	Correction Factor (dB/m)
1	2389.50	59.40 PK	74.00	-14.60	1.04 V	21	25.90	33.50
1	2389.50	50.50 AV	54.00	-3.50	1.04 V	21	17.00	33.50
2	*2412.00	110.50 PK			1.03 V	22	80.70	29.80
2	*2412.00	106.80 AV			1.03 V	22	77.00	29.80
3	4824.00	47.10 PK	74.00	-26.90	1.00 V	332	12.00	35.10
3	4824.00	39.00 AV	54.00	-15.00	1.00 V	332	3.90	35.10
4	7236.00	50.60 PK	74.00	-23.40	1.82 V	80	10.10	40.50
4	7236.00	38.20 AV	54.00	-15.80	1.82 V	80	-2.30	40.50

- REMARKS:**
1. Emission level(dBuV/m)=Raw Value(dBuV) + Correction Factor(dB/m)
 2. Correction Factor(dB/m) = Antenna Factor (dB/m) + Cable Factor (dB)
 3. The other emission levels were very low against the limit.
 4. Margin value = Emission level – Limit value.
 5. The limit value is defined as per 15.247
 6. “ * “ : Fundamental frequency



MODE	Channel 6	FREQUENCY RANGE	1000~25000MHz
INPUT POWER (SYSTEM)	120Vac, 60 Hz	DETECTOR FUNCTION & BANDWIDTH	Peak (PK) Average (AV) 1 MHz
ENVIRONMENTAL CONDITIONS	22 deg. C, 72%RH, 965hPa	TESTED BY	Sky Liao

ANTENNA POLARITY & TEST DISTANCE: HORIZONTAL AT 3 M

No.	Freq. (MHz)	Emission Level (dBuV/m)	Limit (dBuV/m)	Margin (dB)	Antenna Height (m)	Table Angle (Degree)	Raw Value (dBuV)	Correction Factor (dB/m)
1	*2437.00	99.90 PK			1.00 H	55	70.00	29.90
1	*2437.00	94.00 AV			1.00 H	55	64.10	29.90
2	4874.00	52.40 PK	74.00	-21.60	1.26 H	42	17.10	35.30
2	4874.00	42.50 AV	54.00	-11.50	1.26 H	42	7.20	35.30
3	7311.00	50.60 PK	74.00	-23.40	1.50 H	322	9.90	40.70
3	7311.00	37.40 AV	54.00	-16.60	1.50 H	322	-3.30	40.70

ANTENNA POLARITY & TEST DISTANCE: VERTICAL AT 3 M

No.	Freq. (MHz)	Emission Level (dBuV/m)	Limit (dBuV/m)	Margin (dB)	Antenna Height (m)	Table Angle (Degree)	Raw Value (dBuV)	Correction Factor (dB/m)
1	*2437.00	107.20 PK			1.15 V	16	77.30	29.90
1	*2437.00	112.10 AV			1.15 V	16	82.20	29.90
2	4874.00	46.90 PK	74.00	-27.10	1.08 V	322	11.60	35.30
2	4874.00	38.80 AV	54.00	-15.20	1.08 V	322	3.50	35.30
3	7311.00	50.90 PK	74.00	-23.10	1.80 V	78	10.20	40.70
3	7311.00	38.30 AV	54.00	-15.70	1.80 V	78	-2.40	40.70

- REMARKS:**
1. Emission level(dBuV/m)=Raw Value(dBuV) + Correction Factor(dB/m)
 2. Correction Factor(dB/m) = Antenna Factor (dB/m) + Cable Factor (dB)
 3. The other emission levels were very low against the limit.
 4. Margin value = Emission level – Limit value.
 5. The limit value is defined as per 15.247
 6. “ * “ : Fundamental frequency



MODE	Channel 11	FREQUENCY RANGE	1000~25000MHz
INPUT POWER (SYSTEM)	120Vac, 60 Hz	DETECTOR FUNCTION & BANDWIDTH	Peak (PK) Average (AV) 1 MHz
ENVIRONMENTAL CONDITIONS	22 deg. C, 72%RH, 965hPa	TESTED BY	Sky Liao

ANTENNA POLARITY & TEST DISTANCE: HORIZONTAL AT 3 M

No.	Freq. (MHz)	Emission Level (dBuV/m)	Limit (dBuV/m)	Margin (dB)	Antenna Height (m)	Table Angle (Degree)	Raw Value (dBuV)	Correction Factor (dB/m)
1	*2462.00	100.00 PK			1.03 H	60	70.00	30.00
1	*2462.00	94.30 AV			1.03 H	60	64.30	30.00
2	2483.50	53.80 PK	74.00	-20.20	1.30 H	102	23.70	30.10
2	2483.50	43.80 AV	54.00	-10.20	1.30 H	102	13.70	30.10
3	4924.00	45.10 PK	74.00	-28.90	1.48 H	32	9.50	35.50
3	4924.00	34.70 AV	54.00	-19.30	1.48 H	32	-0.90	35.50
4	7386.00	50.60 PK	74.00	-23.40	1.55 H	326	9.80	40.80
4	7386.00	37.80 AV	54.00	-16.20	1.55 H	326	-3.00	40.80

ANTENNA POLARITY & TEST DISTANCE: VERTICAL AT 3 M

No.	Freq. (MHz)	Emission Level (dBuV/m)	Limit (dBuV/m)	Margin (dB)	Antenna Height (m)	Table Angle (Degree)	Raw Value (dBuV)	Correction Factor (dB/m)
1	*2462.00	113.90 PK			1.20 V	0	83.90	30.00
1	*2462.00	108.40 AV			1.20 V	0	78.40	30.00
2	2483.50	58.70 PK	74.00	-15.30	1.23 V	21	28.60	30.10
2	2483.50	49.40 AV	54.00	-4.60	1.23 V	21	19.30	30.10
3	4924.00	47.00 PK	74.00	-27.00	1.21 V	336	11.40	35.50
3	4924.00	37.70 AV	54.00	-16.30	1.21 V	336	2.10	35.50
4	7386.00	51.00 PK	74.00	-23.00	1.62 V	92	10.20	40.80
4	7386.00	38.60 AV	54.00	-15.40	1.62 V	92	-2.20	40.80

- REMARKS:**
1. Emission level(dBuV/m)=Raw Value(dBuV) + Correction Factor(dB/m)
 2. Correction Factor(dB/m) = Antenna Factor (dB/m) + Cable Factor (dB)
 3. The other emission levels were very low against the limit.
 4. Margin value = Emission level – Limit value.
 5. The limit value is defined as per 15.247
 6. “ * ” : Fundamental frequency

RESTRICTED BANDEDGE (802.11b MODE, CH1, HORIZONTAL)

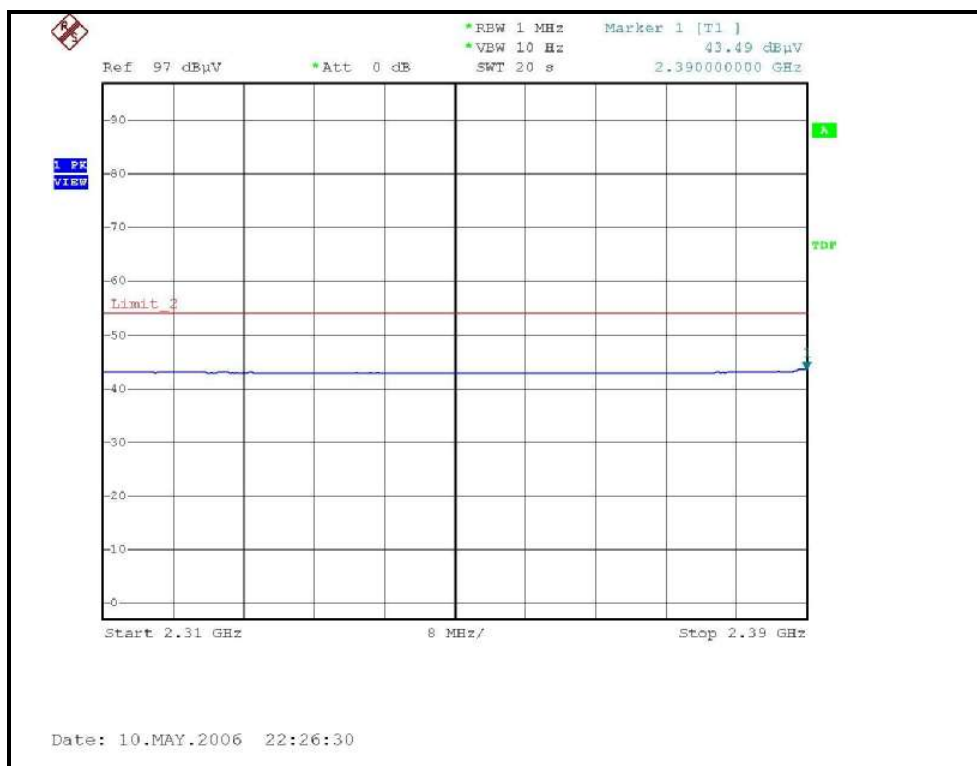
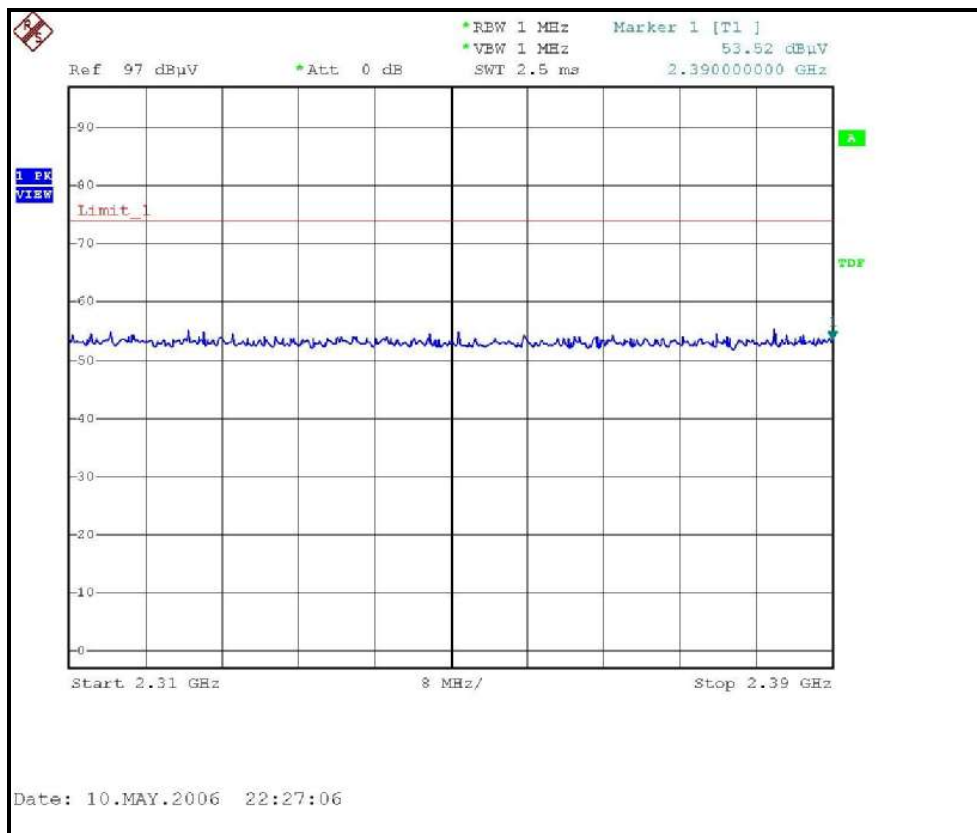

RESTRICTED BANDEDGE (802.11b MODE,CH1, VERTICAL)

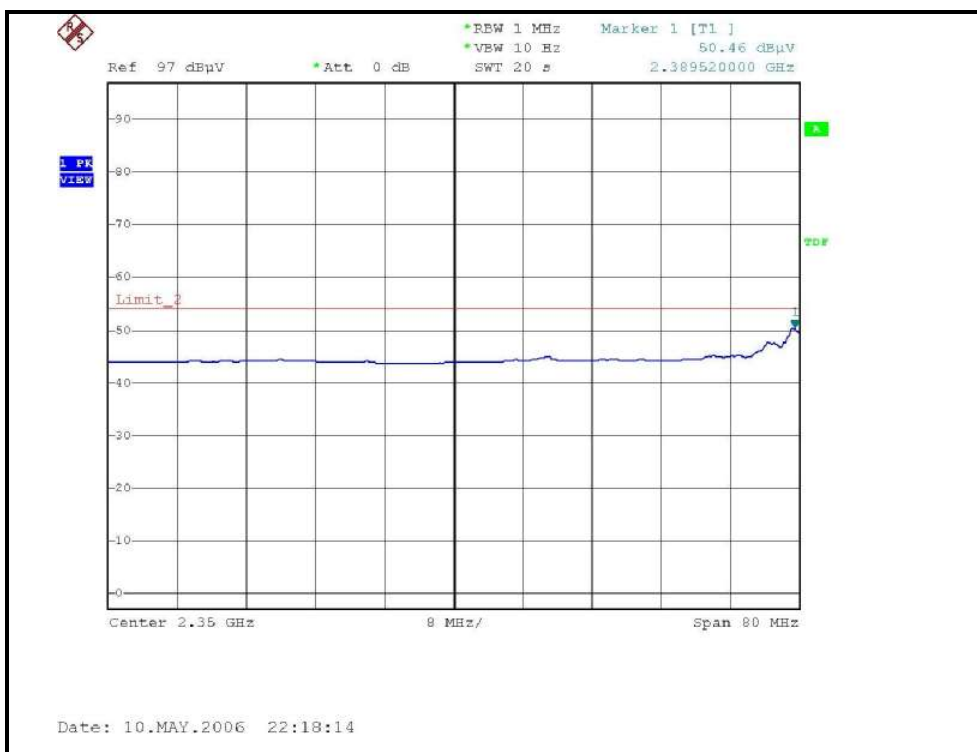
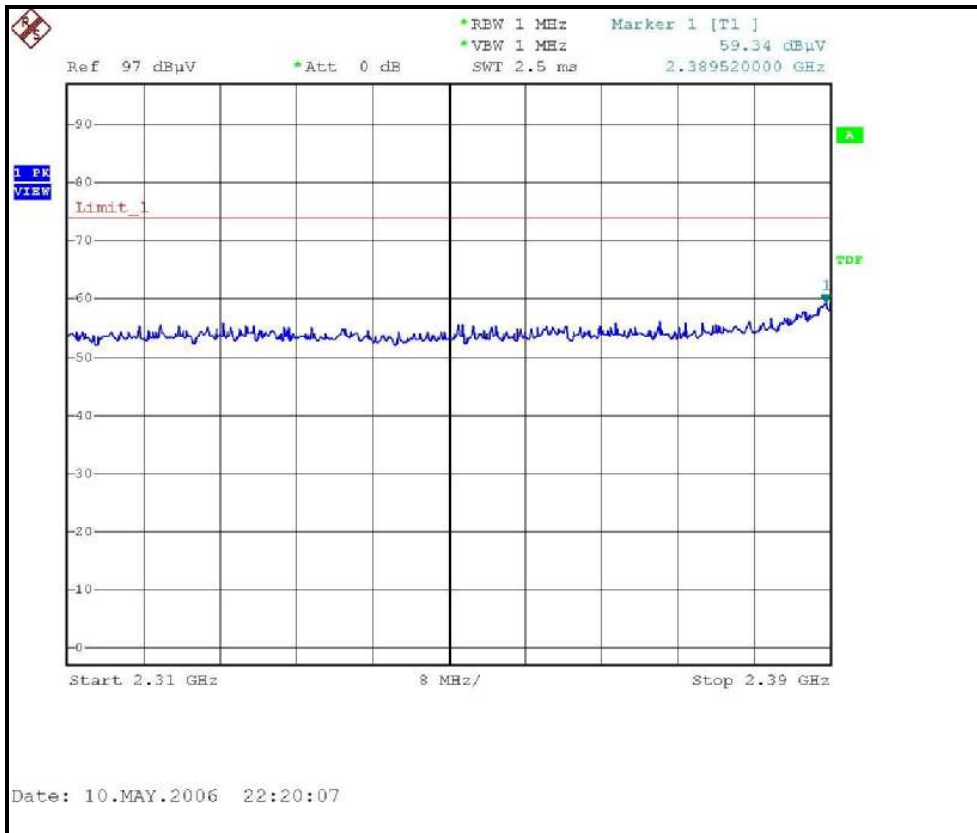

RESTRICTED BANDEDGE (802.11b MODE, CH11, HORIZONTAL)

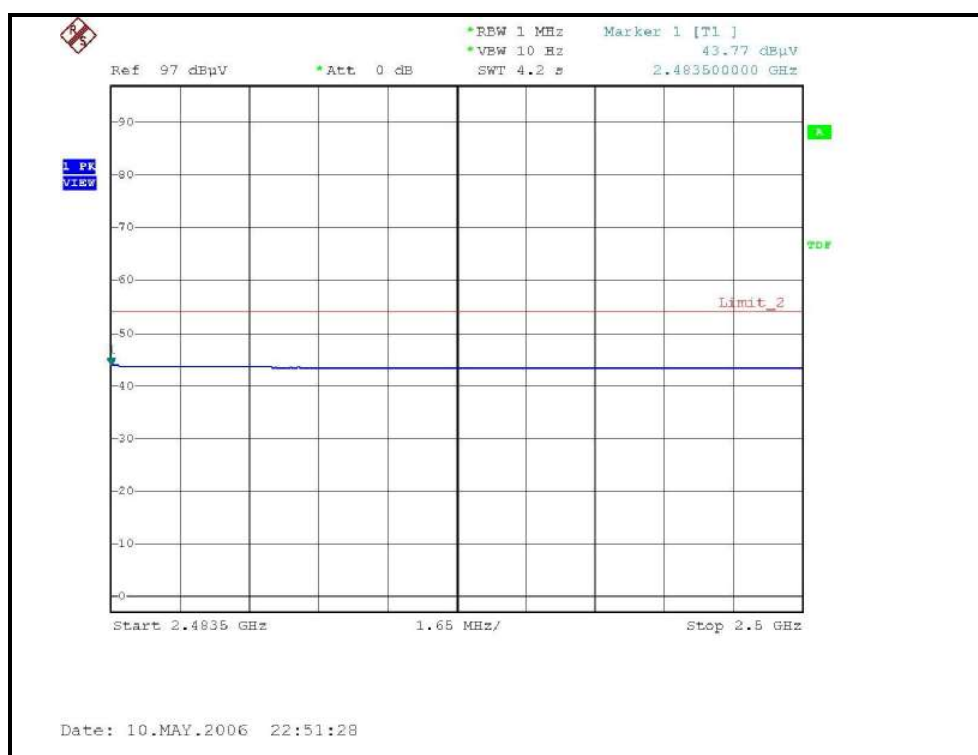
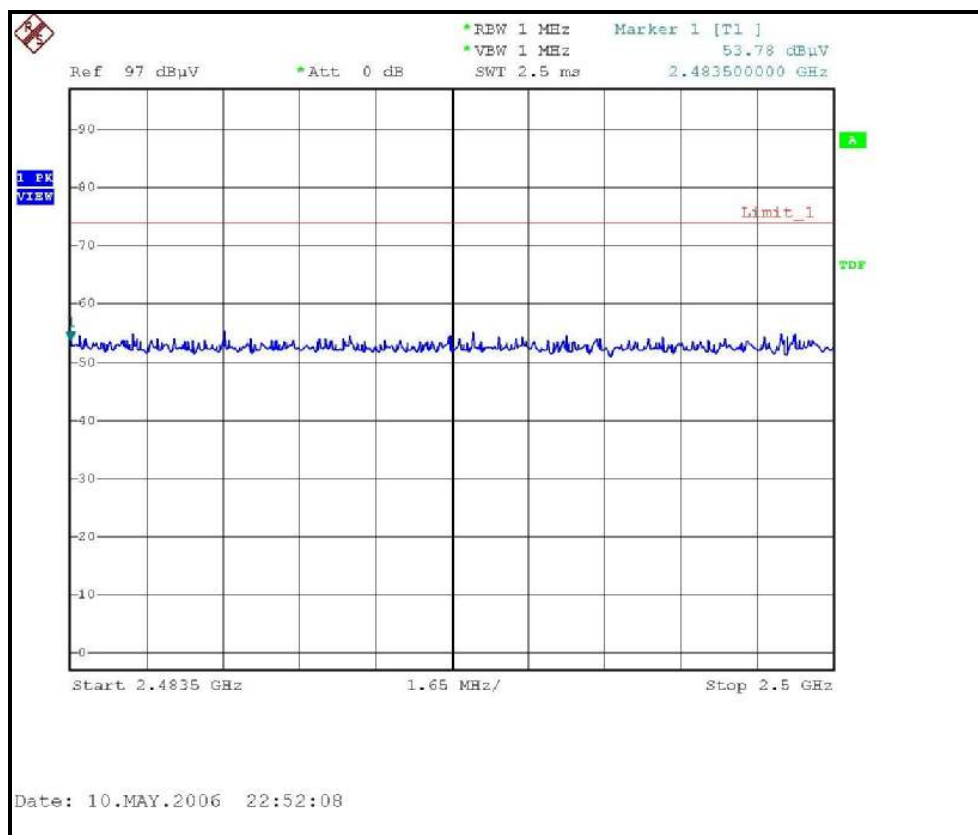

RESTRICTED BANDEDGE (802.11b MODE, CH11, VERTICAL)

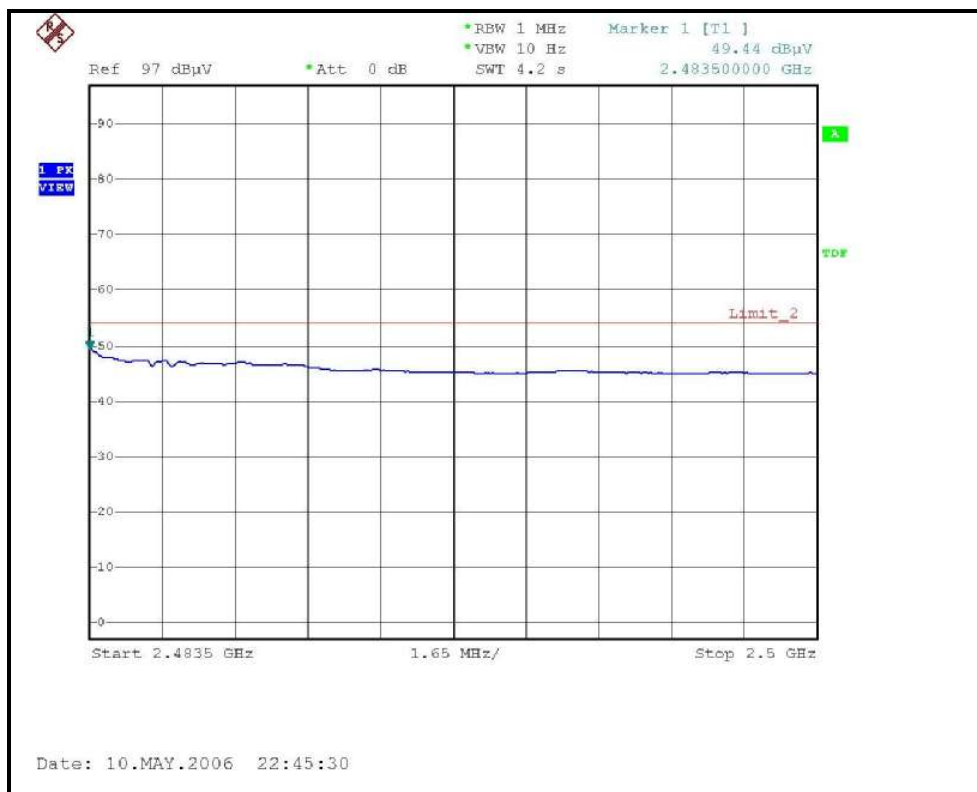
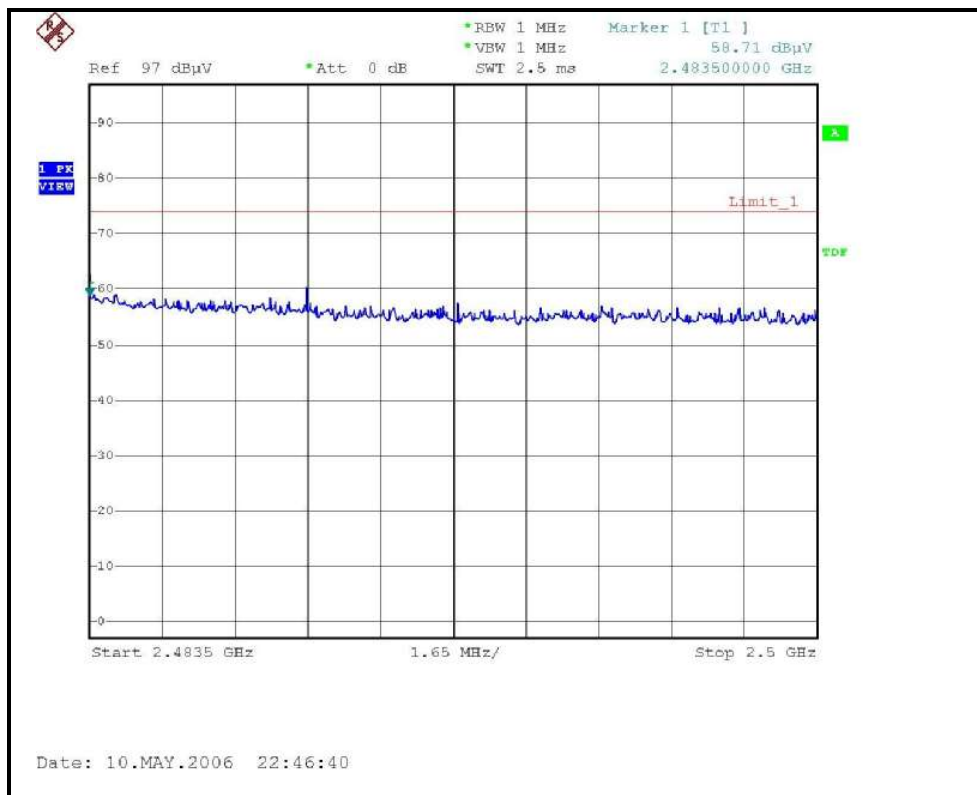

4.2.8 TEST RESULTS - OFDM

802.11g Normal OFDM modulation

MODE	Channel 1	FREQUENCY RANGE	1000~25000MHz
INPUT POWER (SYSTEM)	120Vac, 60 Hz	DETECTOR FUNCTION & BANDWIDTH	Peak (PK) Average (AV) 1 MHz
ENVIRONMENTAL CONDITIONS	22 deg. C, 72%RH, 965hPa	TESTED BY	Sky Liao

ANTENNA POLARITY & TEST DISTANCE: HORIZONTAL AT 3 M

No.	Freq. (MHz)	Emission Level (dBuV/m)	Limit (dBuV/m)	Margin (dB)	Antenna Height (m)	Table Angle (Degree)	Raw Value (dBuV)	Correction Factor (dB/m)
1	2390.00	58.30 PK	74.00	-15.70	1.00 H	52	24.60	33.70
1	2390.00	44.40 AV	54.00	-9.60	1.00 H	52	10.70	33.70
2	*2412.00	99.20 PK			1.00 H	50	69.40	29.80
2	*2412.00	91.30 AV			1.00 H	50	61.50	29.80
3	4824.00	44.40 PK	74.00	-29.60	1.00 H	240	9.30	35.10
3	4824.00	33.10 AV	54.00	-20.90	1.00 H	240	-2.00	35.10
4	7236.00	50.30 PK	74.00	-23.70	1.45 H	108	9.80	40.50
4	7236.00	37.20 AV	54.00	-16.80	1.45 H	108	-3.30	40.50

ANTENNA POLARITY & TEST DISTANCE: VERTICAL AT 3 M

No.	Freq. (MHz)	Emission Level (dBuV/m)	Limit (dBuV/m)	Margin (dB)	Antenna Height (m)	Table Angle (Degree)	Raw Value (dBuV)	Correction Factor (dB/m)
1	2390.00	67.00 PK	74.00	-7.00	1.25 V	332	33.30	33.70
1	2390.00	52.10 AV	54.00	-1.90	1.25 V	332	18.40	33.70
2	*2412.00	114.20 PK			1.24 V	321	84.40	29.80
2	*2412.00	105.90 AV			1.24 V	321	76.10	29.80
3	4824.00	45.70 PK	74.00	-28.30	1.00 V	286	10.60	35.10
3	4824.00	36.10 AV	54.00	-17.90	1.00 V	286	1.00	35.10
4	7236.00	50.60 PK	74.00	-23.40	1.70 V	244	10.10	40.50
4	7236.00	37.40 AV	54.00	-16.60	1.70 V	244	-3.10	40.50

- REMARKS:**
1. Emission level(dBuV/m)=Raw Value(dBuV) + Correction Factor(dB/m)
 2. Correction Factor(dB/m) = Antenna Factor (dB/m) + Cable Factor (dB)
 3. The other emission levels were very low against the limit.
 4. Margin value = Emission level – Limit value.
 5. The limit value is defined as per 15.247
 6. “ * “ : Fundamental frequency



MODE	Channel 6	FREQUENCY RANGE	1000~25000MHz
INPUT POWER (SYSTEM)	120Vac, 60 Hz	DETECTOR FUNCTION & BANDWIDTH	Peak (PK) Average (AV) 1 MHz
ENVIRONMENTAL CONDITIONS	22 deg. C, 72%RH, 965hPa	TESTED BY	Sky Liao

ANTENNA POLARITY & TEST DISTANCE: HORIZONTAL AT 3 M								
No.	Freq. (MHz)	Emission Level (dBuV/m)	Limit (dBuV/m)	Margin (dB)	Antenna Height (m)	Table Angle (Degree)	Raw Value (dBuV)	Correction Factor (dB/m)
1	*2437.00	99.80 PK			1.00 H	52	69.90	29.90
1	*2437.00	91.50 AV			1.00 H	52	61.60	29.90
2	4874.00	44.90 PK	74.00	-29.10	1.02 H	205	9.60	35.30
2	4874.00	33.50 AV	54.00	-20.50	1.02 H	205	-1.80	35.30
3	7311.00	50.40 PK	74.00	-23.60	1.42 H	108	9.70	40.70
3	7311.00	37.50 AV	54.00	-16.50	1.42 H	108	-3.20	40.70

ANTENNA POLARITY & TEST DISTANCE: VERTICAL AT 3 M								
No.	Freq. (MHz)	Emission Level (dBuV/m)	Limit (dBuV/m)	Margin (dB)	Antenna Height (m)	Table Angle (Degree)	Raw Value (dBuV)	Correction Factor (dB/m)
1	*2437.00	114.80 PK			1.20 V	326	84.90	29.90
1	*2437.00	106.10 AV			1.20 V	326	76.20	29.90
2	4874.00	47.70 PK	74.00	-26.30	1.05 V	262	12.40	35.30
2	4874.00	36.90 AV	54.00	-17.10	1.05 V	262	1.60	35.30
3	7311.00	50.80 PK	74.00	-23.20	1.66 V	242	10.10	40.70
3	7311.00	37.60 AV	54.00	-16.40	1.66 V	242	-3.10	40.70

- REMARKS:**
1. Emission level(dBuV/m)=Raw Value(dBuV) + Correction Factor(dB/m)
 2. Correction Factor(dB/m) = Antenna Factor (dB/m) + Cable Factor (dB)
 3. The other emission levels were very low against the limit.
 4. Margin value = Emission level – Limit value.
 5. The limit value is defined as per 15.247
 6. “ * “ : Fundamental frequency

MODE	Channel 11	FREQUENCY RANGE	1000~25000MHz
INPUT POWER (SYSTEM)	120Vac, 60 Hz	DETECTOR FUNCTION & BANDWIDTH	Peak (PK) Average (AV) 1 MHz
ENVIRONMENTAL CONDITIONS	22 deg. C, 72%RH, 965hPa	TESTED BY	Sky Liao

ANTENNA POLARITY & TEST DISTANCE: HORIZONTAL AT 3 M

No.	Freq. (MHz)	Emission Level (dBuV/m)	Limit (dBuV/m)	Margin (dB)	Antenna Height (m)	Table Angle (Degree)	Raw Value (dBuV)	Correction Factor (dB/m)
1	*2462.00	100.40 PK			1.00 H	60	70.40	30.00
1	*2462.00	91.30 AV			1.00 H	60	61.30	30.00
2	2483.50	54.80 PK	74.00	-19.20	1.23 H	105	24.70	30.10
2	2483.50	43.70 AV	54.00	-10.30	1.23 H	105	13.60	30.10
3	4924.00	45.40 PK	74.00	-28.60	1.00 H	243	9.80	35.50
3	4924.00	34.10 AV	54.00	-19.90	1.00 H	243	-1.50	35.50
4	7386.00	50.80 PK	74.00	-23.20	1.45 H	185	10.00	40.80
4	7386.00	37.90 AV	54.00	-16.10	1.45 H	185	-2.90	40.80

ANTENNA POLARITY & TEST DISTANCE: VERTICAL AT 3 M

No.	Freq. (MHz)	Emission Level (dBuV/m)	Limit (dBuV/m)	Margin (dB)	Antenna Height (m)	Table Angle (Degree)	Raw Value (dBuV)	Correction Factor (dB/m)
1	*2462.00	115.00 PK			1.22 V	333	85.00	30.00
1	*2462.00	106.30 AV			1.22 V	333	76.30	30.00
2	2483.50	60.70 PK	74.00	-13.30	1.22 V	21	30.60	30.10
2	2483.50	46.40 AV	54.00	-7.60	1.22 V	21	16.30	30.10
3	4924.00	48.50 PK	74.00	-25.50	1.31 V	242	12.90	35.50
3	4924.00	37.80 AV	54.00	-16.20	1.31 V	242	2.20	35.50
4	7386.00	50.60 PK	74.00	-23.40	1.72 V	250	9.80	40.80
4	7386.00	37.80 AV	54.00	-16.20	1.72 V	250	-3.00	40.80

- REMARKS:**
1. Emission level(dBuV/m)=Raw Value(dBuV) + Correction Factor(dB/m)
 2. Correction Factor(dB/m) = Antenna Factor (dB/m) + Cable Factor (dB)
 3. The other emission levels were very low against the limit.
 4. Margin value = Emission level – Limit value.
 5. The limit value is defined as per 15.247
 6. “ * “ : Fundamental frequency

RESTRICTED BANDEDGE (802.11g MODE, CH1, HORIZONTAL)

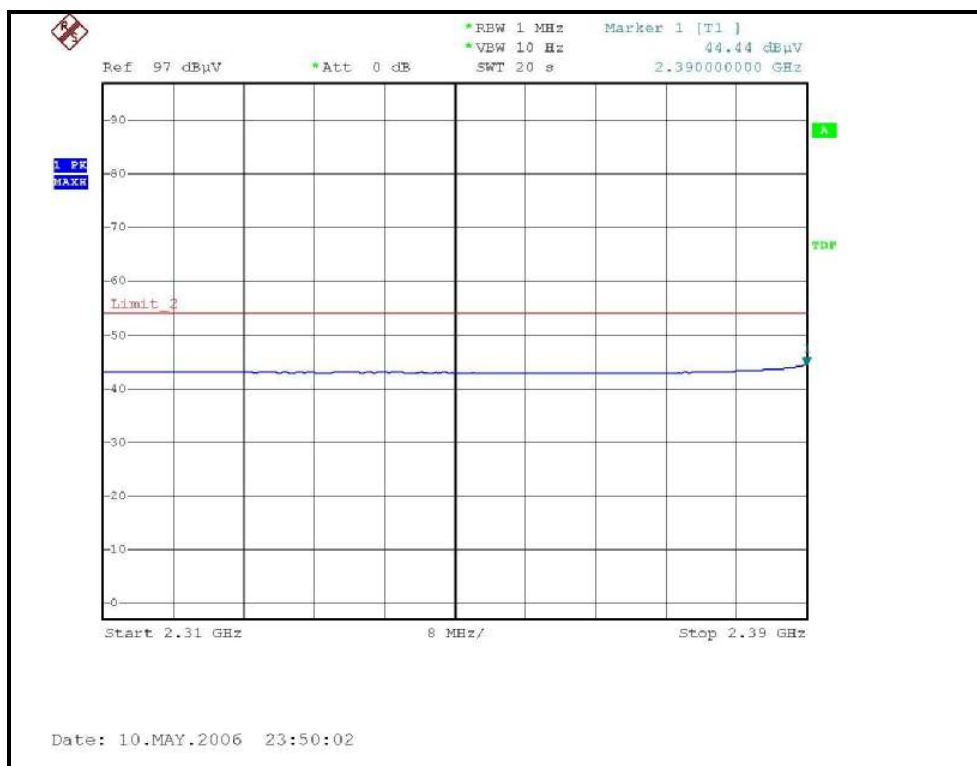
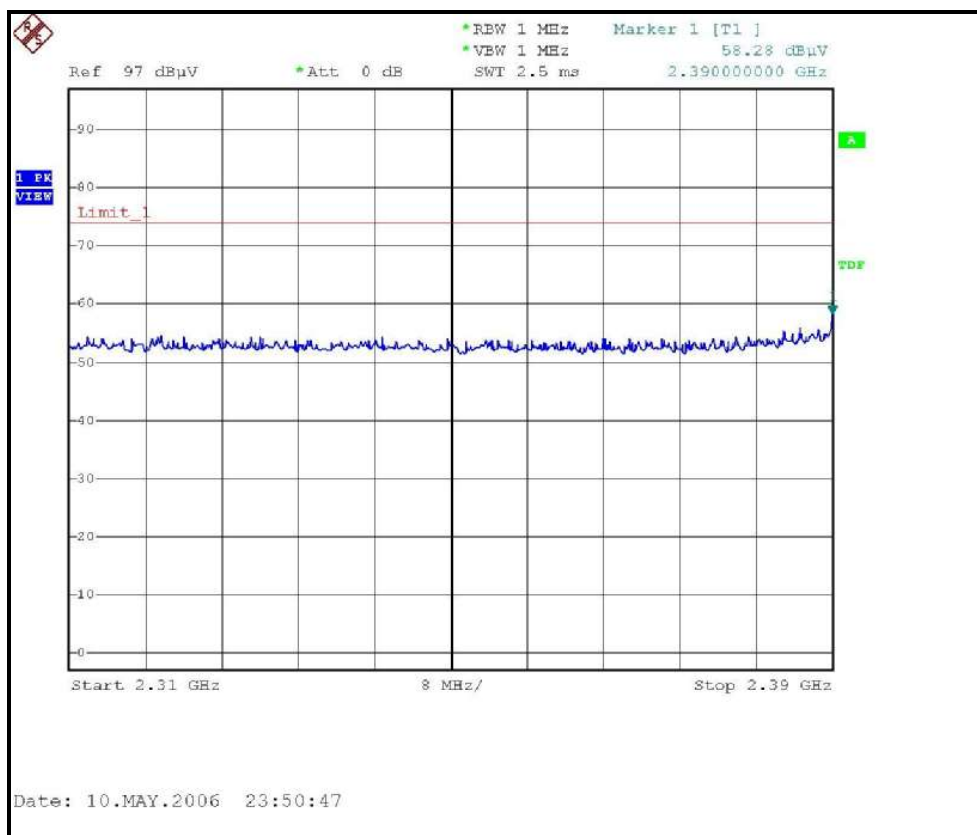

RESTRICTED BANDEDGE (802.11g MODE, CH1, VERTICAL)

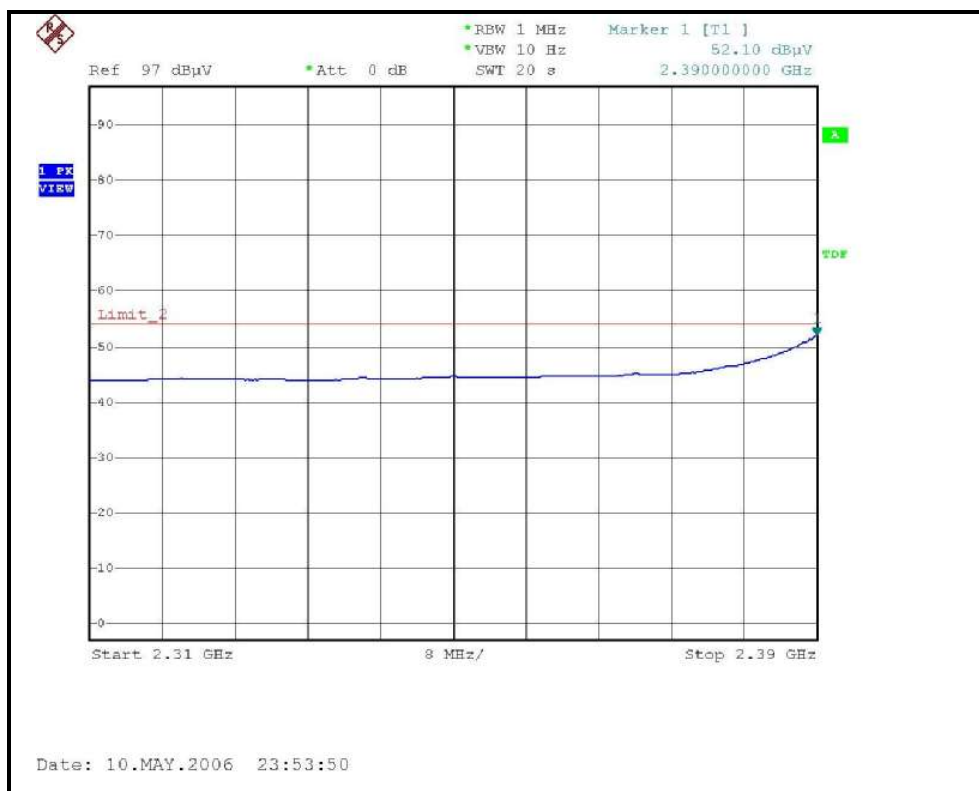
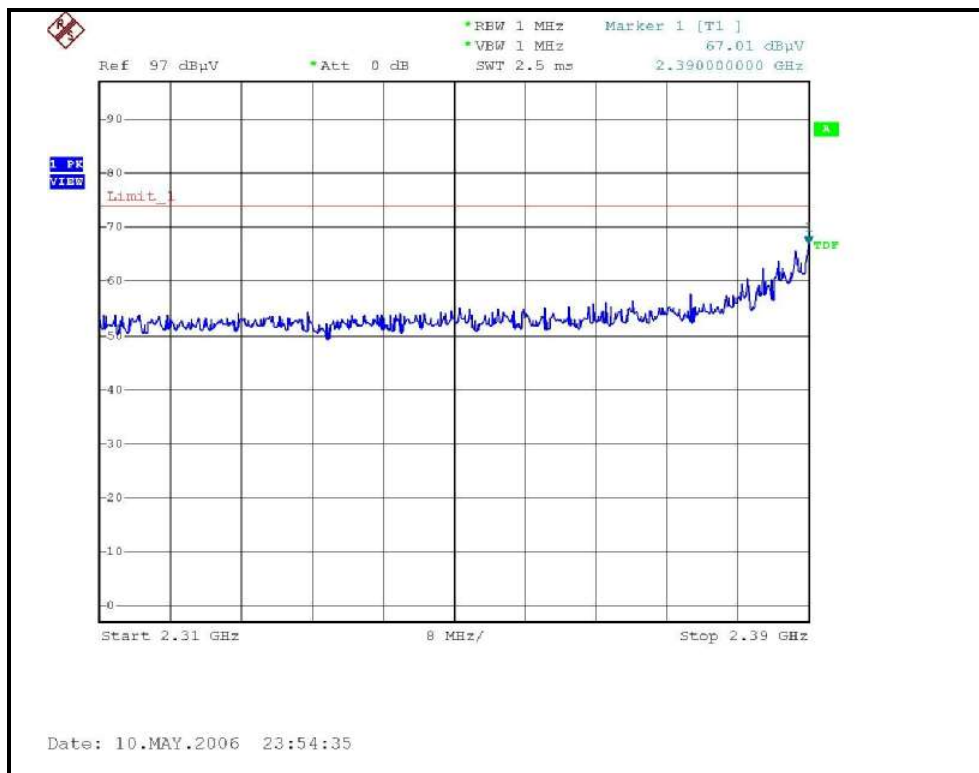

RESTRICTED BANDEDGE (802.11g MODE, CH11, HORIZONTAL)

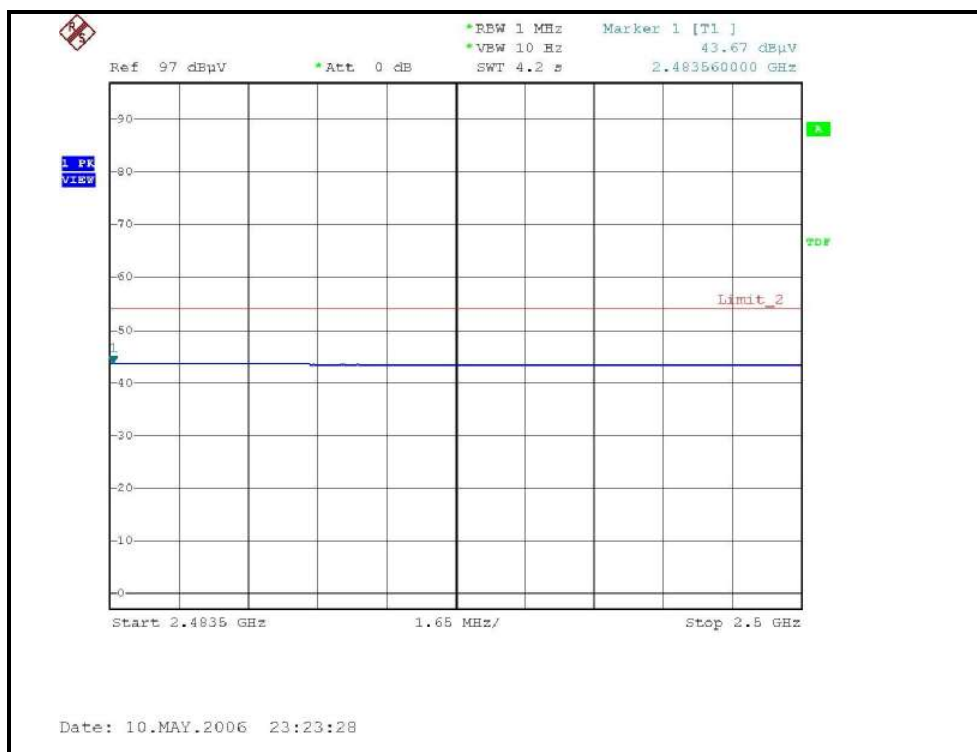
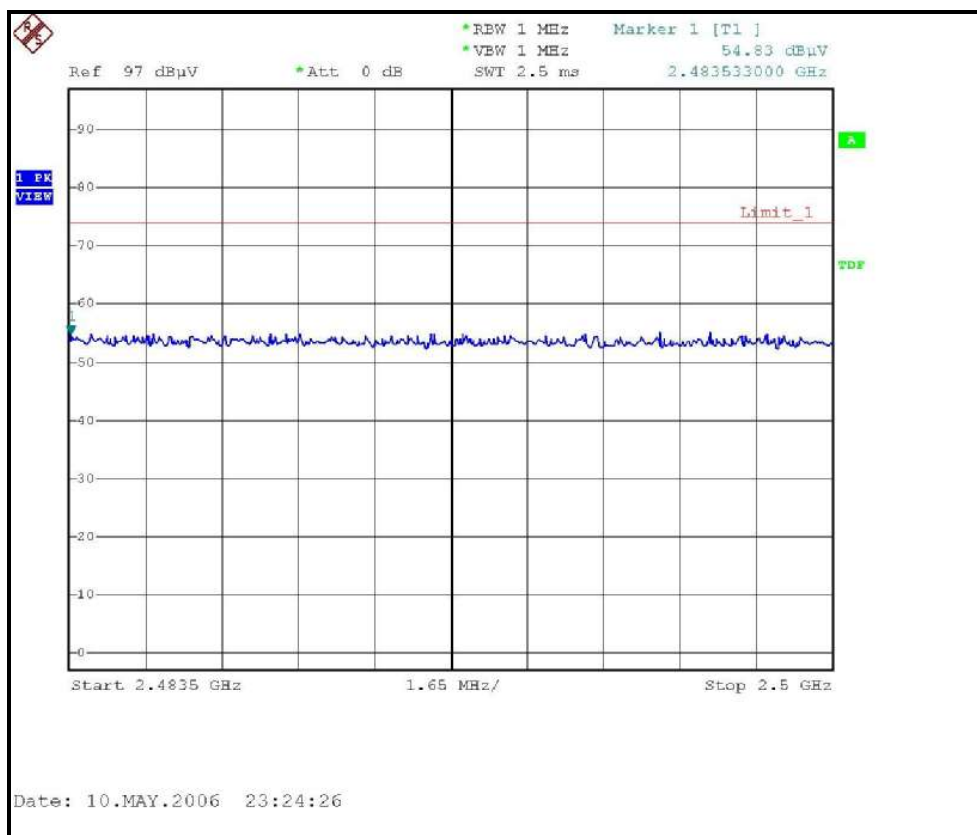

RESTRICTED BANDEDGE (802.11g MODE,CH11, VERTICAL)

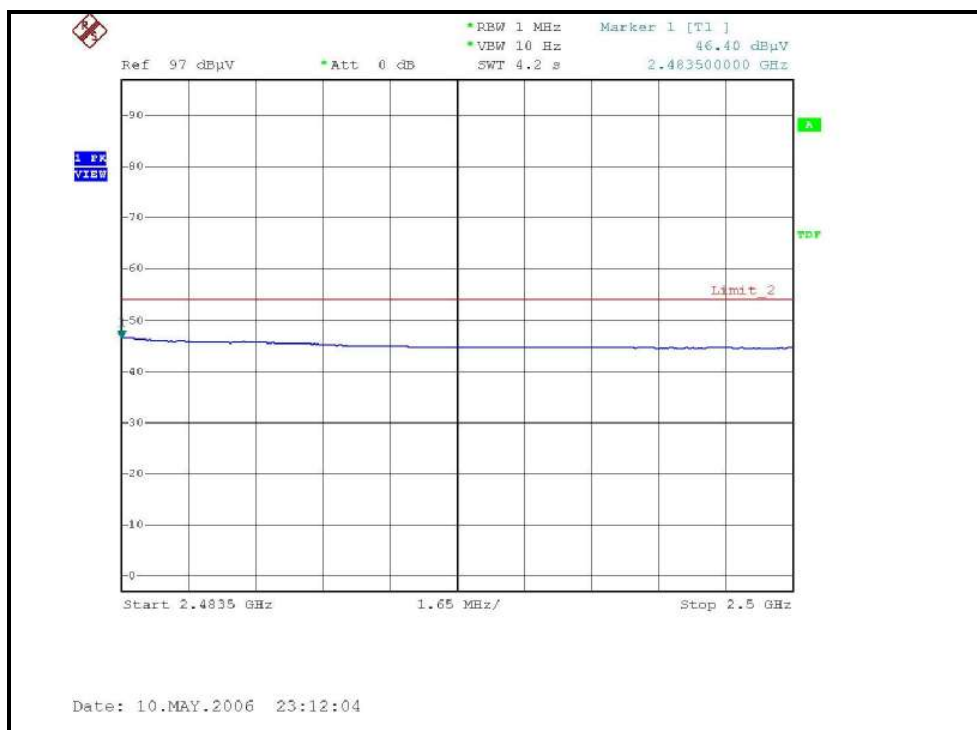
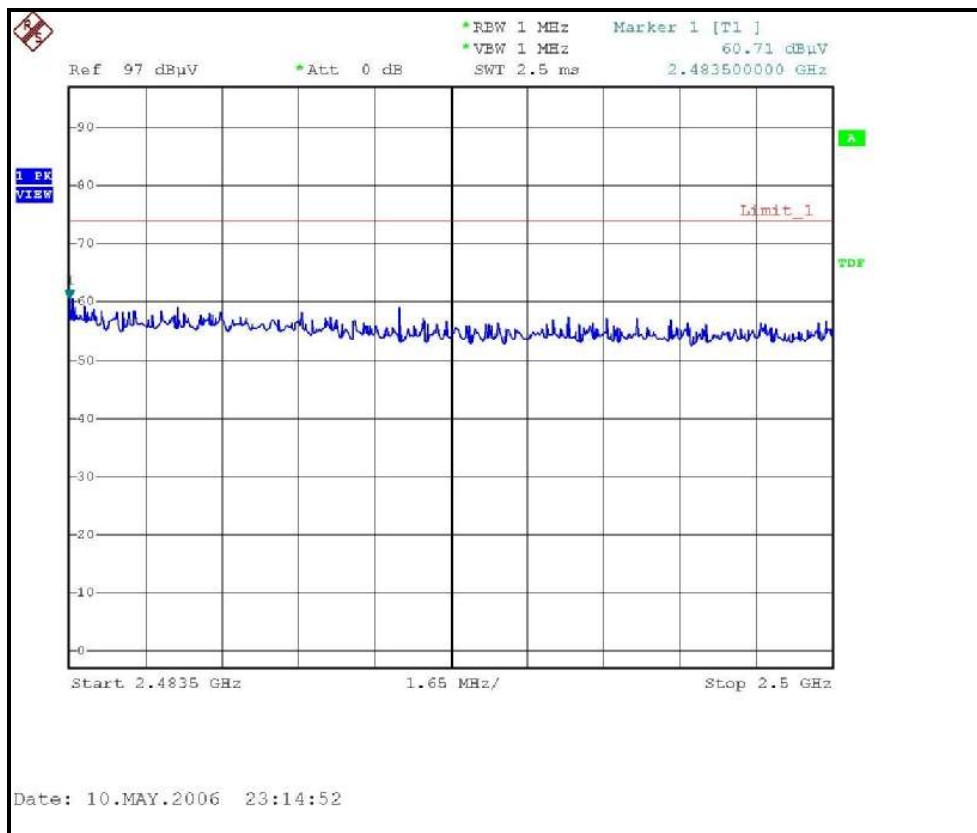

4.3 6dB BANDWIDTH MEASUREMENT

4.3.1 LIMITS OF 6dB BANDWIDTH MEASUREMENT

The minimum of 6dB Bandwidth Measurement is 0.5 MHz.

4.3.2 TEST INSTRUMENTS

Description & Manufacturer	Model No.	Serial No.	Calibrated Until
R&S SPECTRUM ANALYZER	FSP40	100036	Nov. 23, 2006

NOTE:

- 1.The measurement uncertainty is less than +/- 2.6dB, which is calculated as per the NAMAS document NIS81.
- 2.The calibration interval of the above test instruments is 12 months and the calibrations are traceable to NML/ROC and NIST/USA.

4.3.3 TEST PROCEDURE

The transmitter output was connected to the spectrum analyzer through an attenuator. The bandwidth of the fundamental frequency was measured by spectrum analyzer with 100 kHz RBW and 100 kHz VBW. The 6 dB bandwidth is defined as the total spectrum the power of which is higher than peak power minus 6 dB.

4.3.4 TEST SETUP

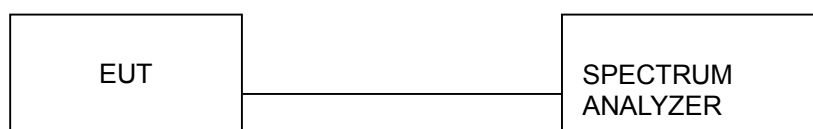

For the actual test configuration, please refer to the related Item – Photographs of the Test Configuration.

4.3.5 EUT OPERATING CONDITIONS

The software provided by client to enable the EUT under transmission condition continuously at lowest, middle and highest channel frequencies individually.

4.3.6 TEST RESULTS –DSSS

802.11b DSSS modulation

MODULATION TYPE	CCK	TRANSFER RATE	11Mbps
INPUT POWER (SYSTEM)	120Vac, 60 Hz	ENVIRONMENTAL CONDITIONS	22deg. C, 72%RH, 965hPa
TESTED BY	Sky Liao		

CHANNEL	CHANNEL FREQUENCY (MHz)	6 dB BANDWIDTH (MHz)	MINIMUM LIMIT (MHz)	PASS/FAIL
1	2412	10.15	0.5	PASS
6	2437	10.15	0.5	PASS
11	2462	10.10	0.5	PASS

CH1

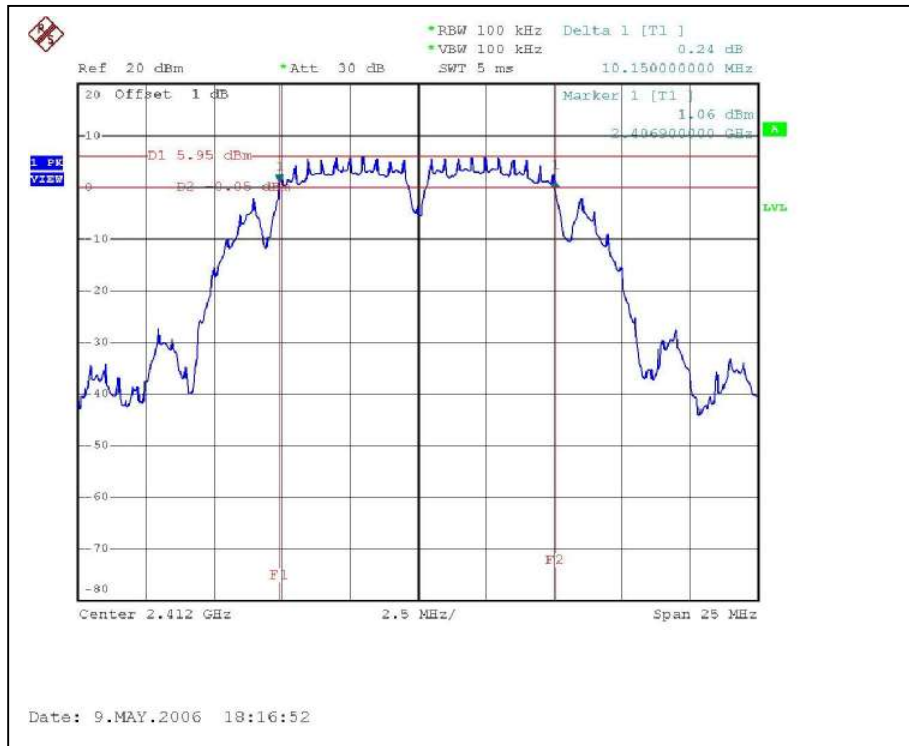

CH6

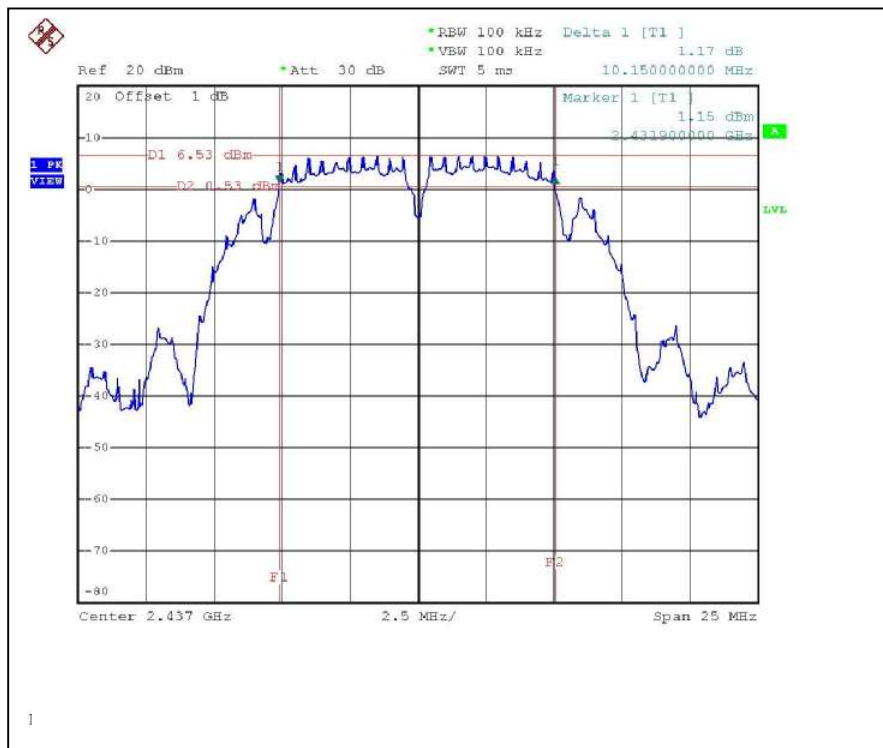

CH11



4.3.7 TEST RESULTS-OFDM

802.11g OFDM modulation

MODULATION TYPE	BPSK	TRANSFER RATE	6Mbps
INPUT POWER (SYSTEM)	120Vac, 60 Hz	ENVIRONMENTAL CONDITIONS	22deg. C, 72%RH, 965hPa
TESTED BY	Sky Liao		

CHANNEL	CHANNEL FREQUENCY (MHz)	6 dB BANDWIDTH (MHz)	MINIMUM LIMIT (MHz)	PASS/FAIL
1	2412	16.35	0.5	PASS
6	2437	16.35	0.5	PASS
11	2462	16.35	0.5	PASS

CH1

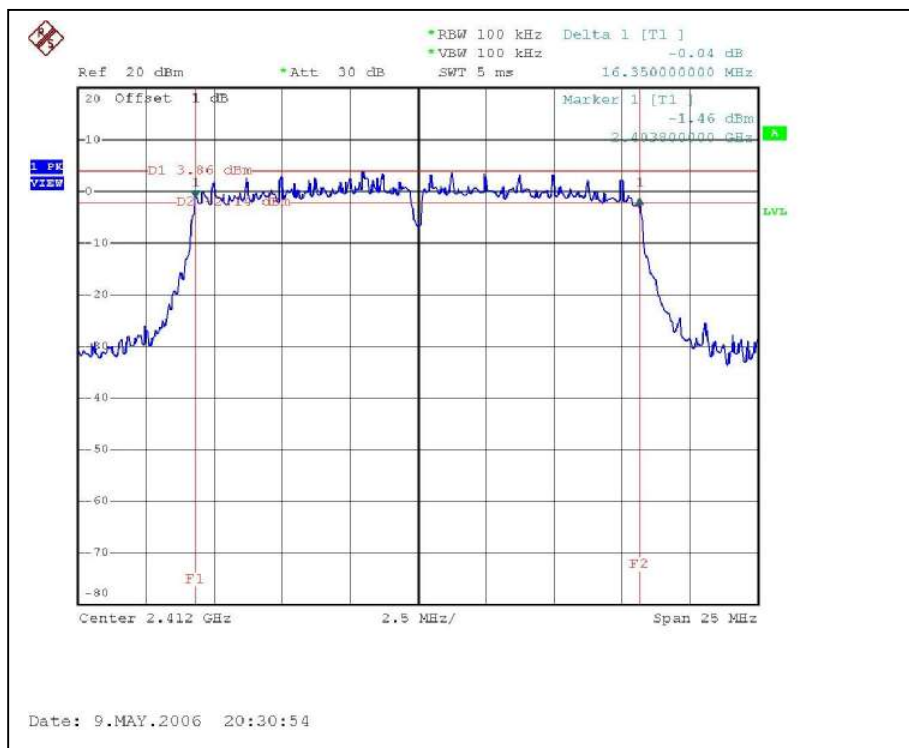

CH6

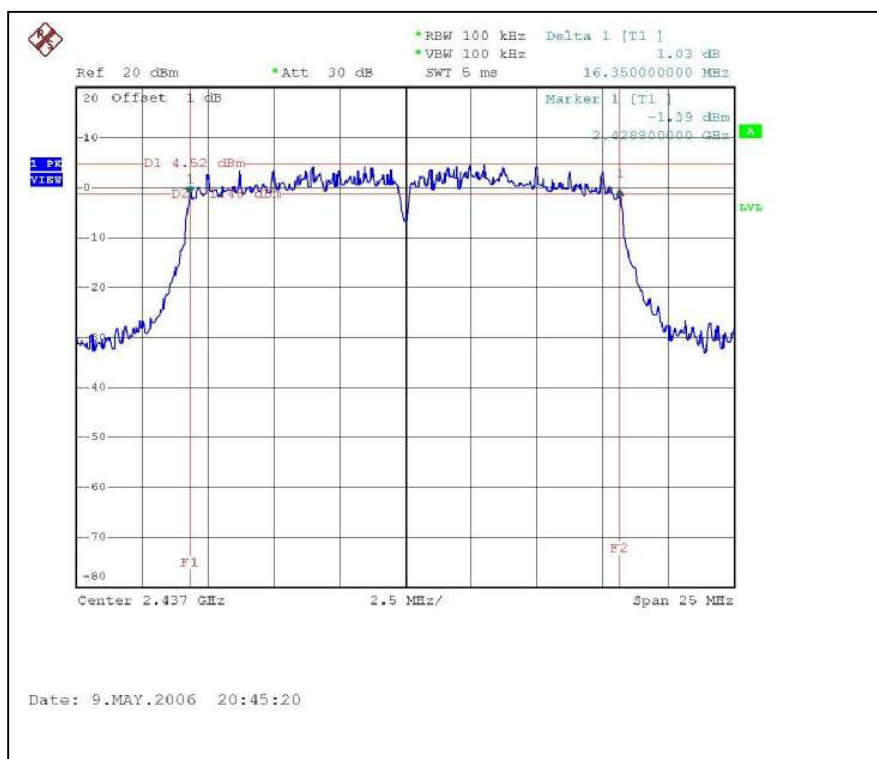

CH11

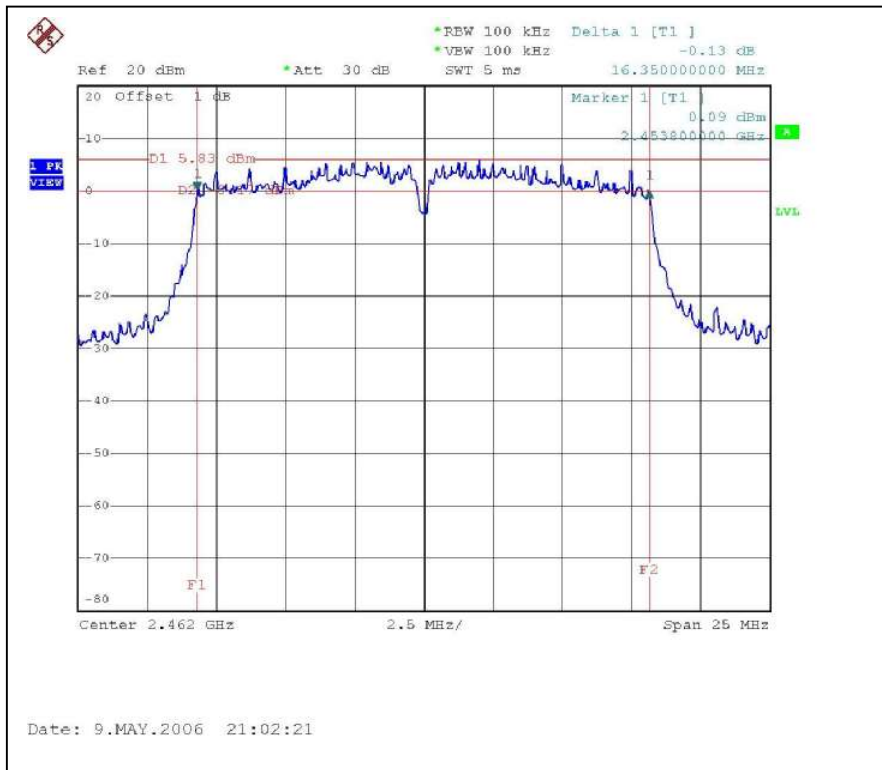

4.4 MAXIMUM PEAK OUTPUT POWER

4.4.1 LIMITS OF MAXIMUM PEAK OUTPUT POWER MEASUREMENT

The Maximum Peak Output Power Measurement is 30dBm.

4.4.2 TEST INSTRUMENTS

Description & Manufacturer	Model No.	Serial No.	Calibrated Until
R&S SPECTRUM ANALYZER	FSP40	100036	Nov. 23, 2006
Agilent SIGNAL GENERATOR	E8257C	MY43320668	Dec. 07, 2006
TEKTRONIX OSCILLOSCOPE	TDS380	B016335	Jun. 22, 2006
NARDA DETECTOR	4503A	FSCM99899	NA

NOTE:

The calibration interval of the above test instruments is 12 months and the calibrations are traceable to NML/ROC and NIST/USA.

4.4.3 TEST PROCEDURES

1. A detector was used on the output port of the EUT. An oscilloscope was used to read the peak response of the detector.
2. Replaced the EUT by the signal generator. The center frequency of the S.G was adjusted to the center frequency of the measured channel.
3. Adjusted the power to have the same peak reading on oscilloscope. Record the power level.

4.4.4 TEST SETUP

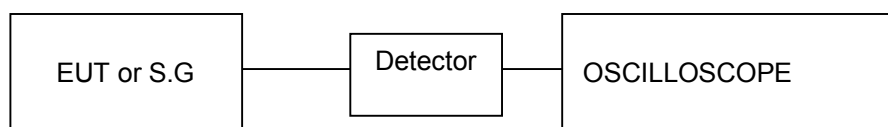

4.4.5 EUT OPERATING CONDITIONS

Same as Item 4.3.5



4.4.6 TEST RESULTS – DSSS

802.11b DSSS modulation

MODULATION TYPE	CCK	TRANSFER RATE	11Mbps
INPUT POWER (SYSTEM)	120Vac, 60Hz	ENVIRONMENTAL CONDITIONS	22deg. C, 72%RH, 965hPa
TESTED BY	Sky Liao		

CHANNEL	CHANNEL FREQUENCY (MHz)	PEAK POWER OUTPUT (mW)	PEAK POWER OUTPUT (dBm)	PEAK POWER LIMIT (dBm)	PASS/FAIL
1	2412	78.886	18.97	30	PASS
6	2437	88.105	19.45	30	PASS
11	2462	109.144	20.38	30	PASS



4.4.7 TEST RESULTS –OFDM

802.11g OFDM modulation

MODULATION TYPE	BPSK	TRANSFER RATE	6Mbps
INPUT POWER (SYSTEM)	120Vac, 60Hz	ENVIRONMENTAL CONDITIONS	22deg. C, 72%RH, 965hPa
TESTED BY	Sky Liao		

CHANNEL	CHANNEL FREQUENCY (MHz)	PEAK POWER OUTPUT (mW)	PEAK POWER OUTPUT (dBm)	PEAK POWER LIMIT (dBm)	PASS/FAIL
1	2412	136.773	21.36	30	PASS
6	2437	174.582	22.42	30	PASS
11	2462	178.238	22.51	30	PASS

4.5 POWER SPECTRAL DENSITY MEASUREMENT

4.5.1 LIMITS OF POWER SPECTRAL DENSITY MEASUREMENT

The Maximum of Power Spectral Density Measurement is 8dBm.

4.5.2 TEST INSTRUMENTS

Description & Manufacturer	Model No.	Serial No.	Calibrated Until
R&S SPECTRUM ANALYZER	FSP40	100036	Nov. 23, 2006

NOTE:

- 1.The measurement uncertainty is less than +/- 2.6dB, which is calculated as per the NAMAS document NIS81.
- 2.The calibration interval of the above test instruments is 12 months and the calibrations are traceable to NML/ROC and NIST/USA.

4.5.3 TEST PROCEDURE

The transmitter output was connected to the spectrum analyzer through an attenuator, the bandwidth of the fundamental frequency was measured with the spectrum analyzer using 3 kHz RBW and 30 kHz VBW, set sweep time=span/3kHz. The power spectral density was measured and recorded. The sweep time is allowed to be longer than span/3KHz for a full response of the mixer in the spectrum analyzer.

4.5.4 TEST SETUP

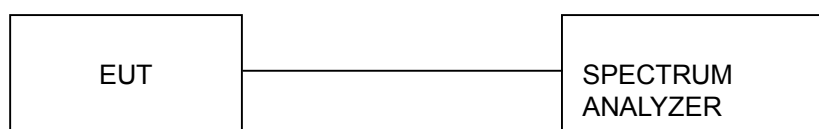

4.5.5 EUT OPERATING CONDITIONS

Same as 4.3.5



4.5.6 TEST RESULTS –DSSS

802.11b DSSS modulation

MODULATION TYPE	CCK	TRANSFER RATE	11Mbps
INPUT POWER (SYSTEM)	120Vac, 60Hz	ENVIRONMENTAL CONDITIONS	22deg. C, 72%RH, 965hPa
TESTED BY	Sky Liao		

CHANNEL NUMBER	CHANNEL FREQUENCY (MHz)	RF POWER LEVEL IN 3 KHz BW (dBm)	MAXIMUM LIMIT (dBm)	PASS/FAIL
1	2412	-6.95	8	PASS
6	2437	-6.68	8	PASS
11	2462	-6.05	8	PASS

CH1

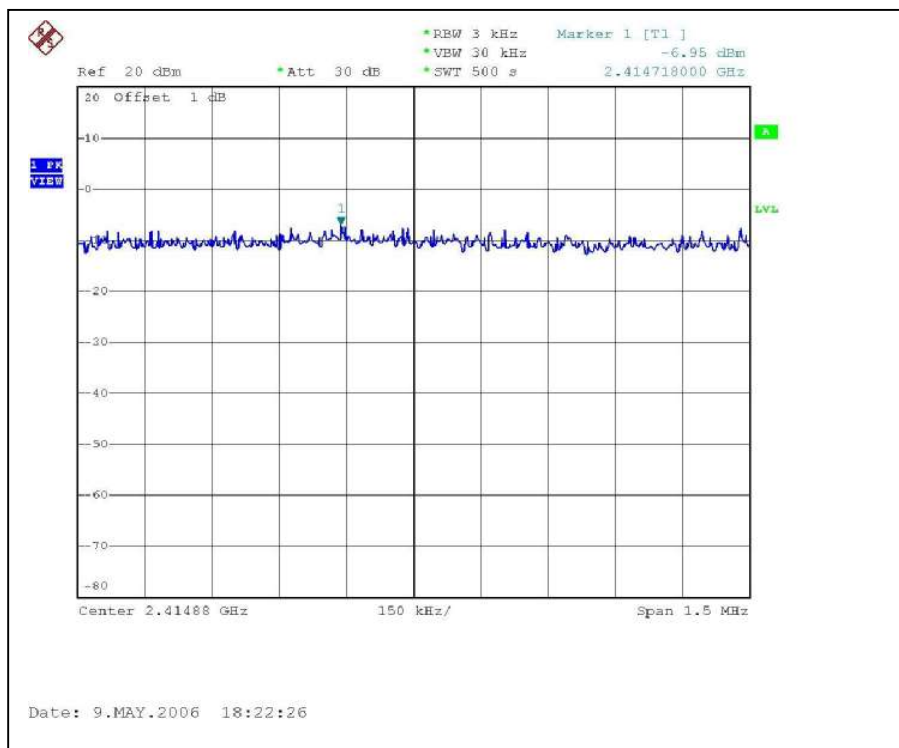

CH6

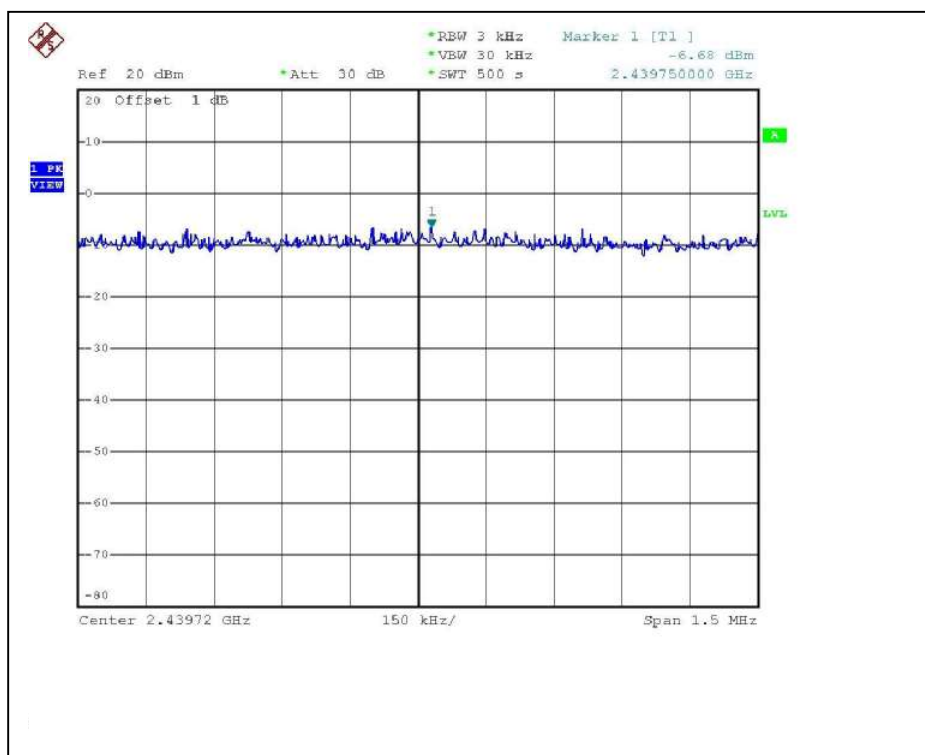

CH11

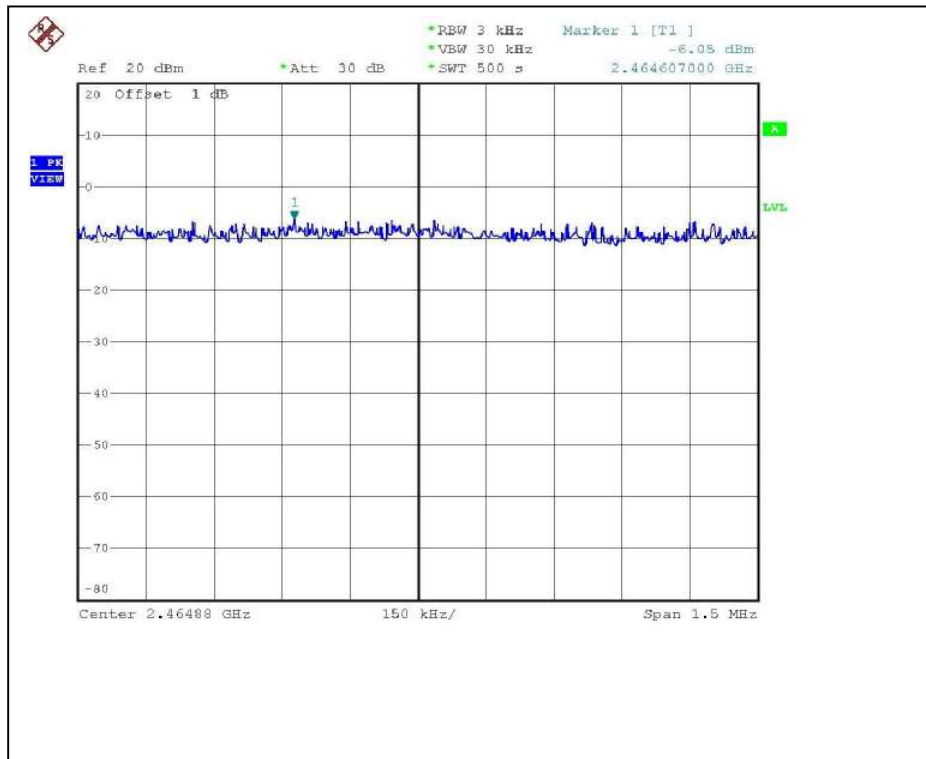



4.5.7 TEST RESULTS –OFDM

802.11g OFDM modulation

MODULATION TYPE	BPSK	TRANSFER RATE	6Mbps
INPUT POWER (SYSTEM)	120Vac, 60Hz	ENVIRONMENTAL CONDITIONS	22deg. C, 72%RH, 965hPa
TESTED BY	Sky Liao		

CHANNEL NUMBER	CHANNEL FREQUENCY (MHz)	RF POWER LEVEL IN 3 KHz BW (dBm)	MAXIMUM LIMIT (dBm)	PASS/FAIL
1	2412	-9.14	8	PASS
6	2437	-8.37	8	PASS
11	2462	-8.55	8	PASS

CH1

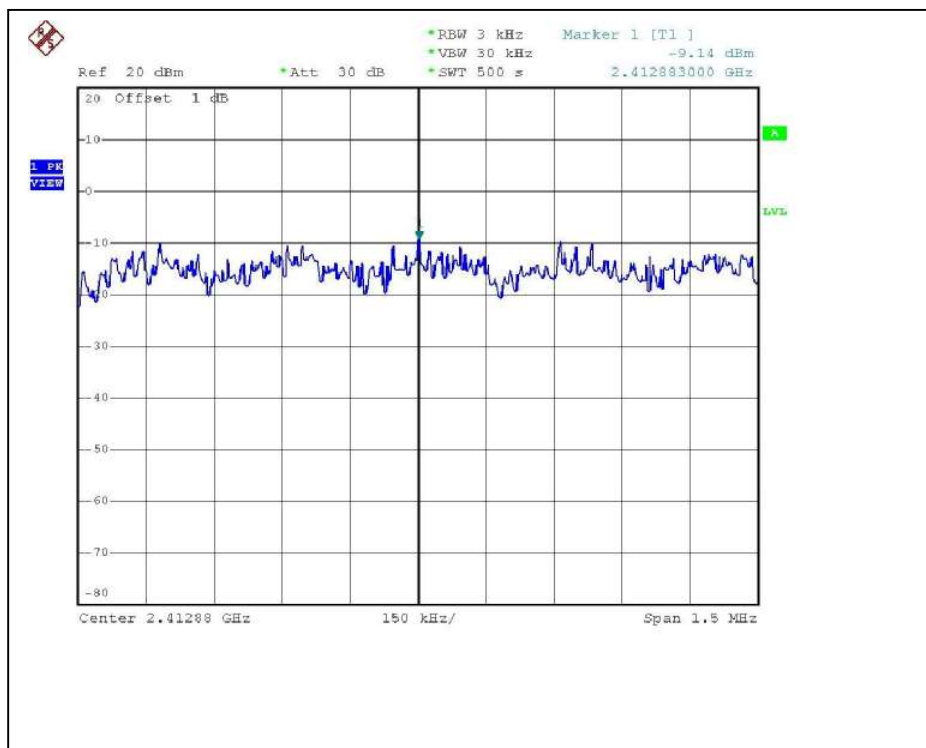

CH6

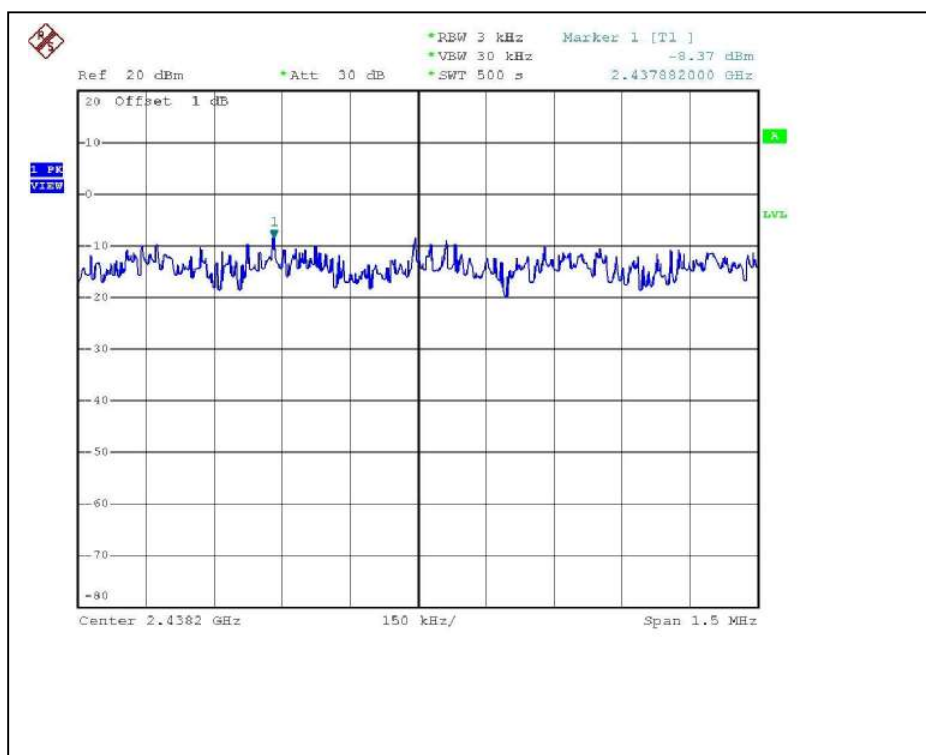

CH11

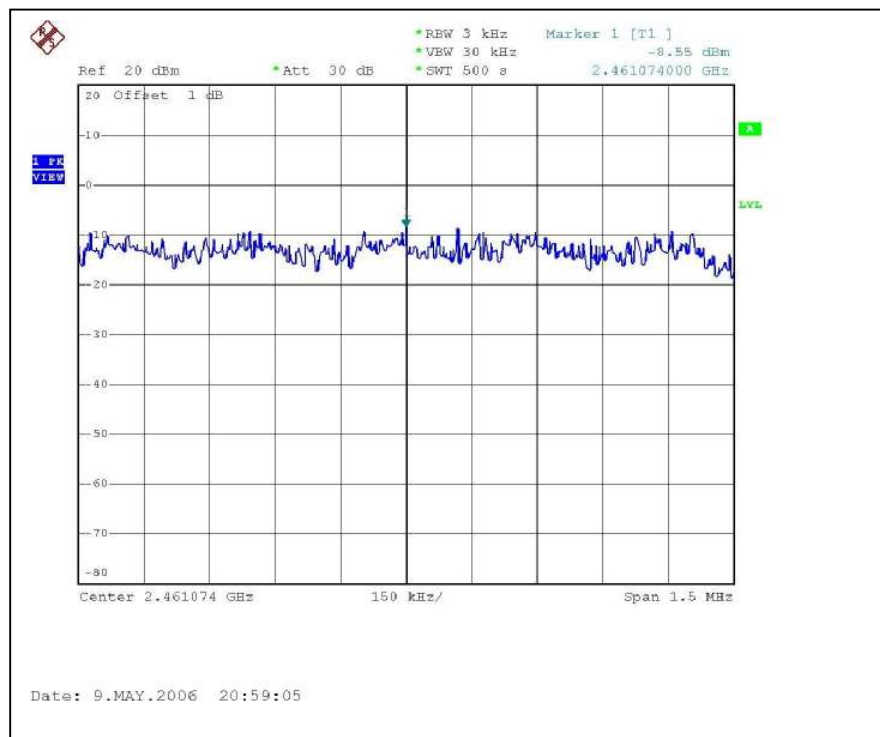

4.6 CONDUCTED EMISSION AND BAND EDGES MEASUREMENT

4.6.1 LIMITS OF CONDUCTED EMISSION AND BAND EDGES MEASUREMENT

Below -20dB of the highest emission level of operating band (in 100KHz Resolution Bandwidth).

4.6.2 TEST INSTRUMENTS

Description & Manufacturer	Model No.	Serial No.	Calibrated Until
R&S SPECTRUM ANALYZER	FSP40	100036	Nov. 23, 2006

NOTE:

1. The measurement uncertainty is less than +/- 2.6dB, which is calculated as per the NAMAS document NIS81.
2. The calibration interval of the above test instruments is 12 months and the calibrations are traceable to NML/ROC and NIST/USA.

4.6.3 TEST PROCEDURE

The transmitter output was connected to the spectrum analyzer via a low loss cable. Set both RBW and VBW of spectrum analyzer to 100kHz with suitable frequency span including 100 MHz bandwidth from band edge. The band edges were measured and recorded.

The spectrum plots (RBW = VBW = 100kHz) are attached on the following pages.

4.6.4 DEVIATION FROM TEST STANDARD

No deviation

4.6.5 EUT OPERATING CONDITION

Same as Item 4.3.6



4.6.6 TEST RESULTS

The spectrum plots are attached on the following 12 images. D1 line indicates the highest level, and D2 line indicates the 20dB offset below D1. It shows compliance with the requirement in part 15.247(d).

802.11b DSSS MODULATION:

CH1

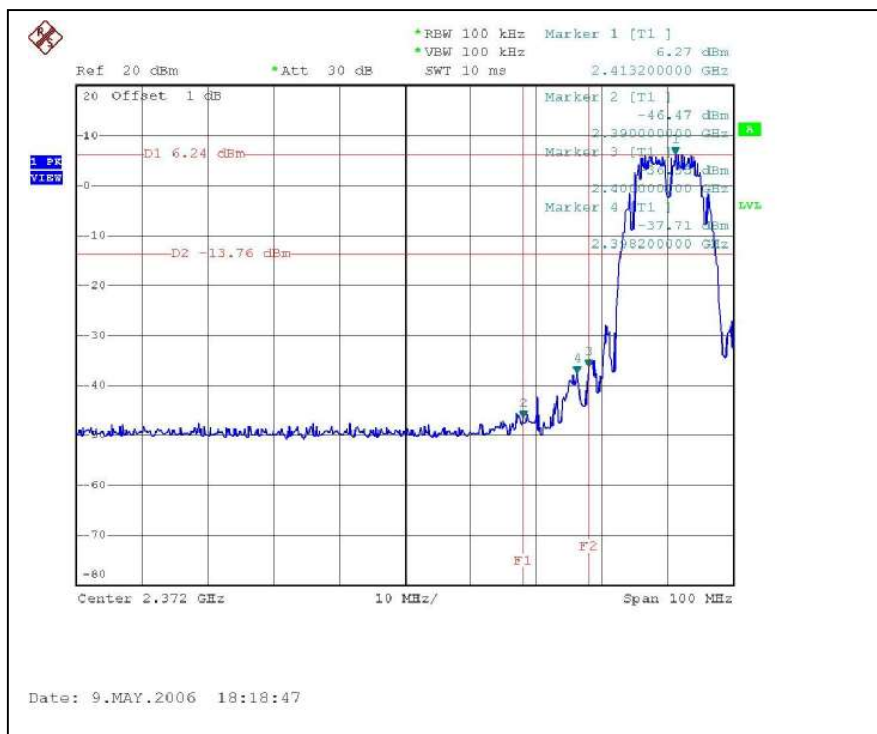

CH11

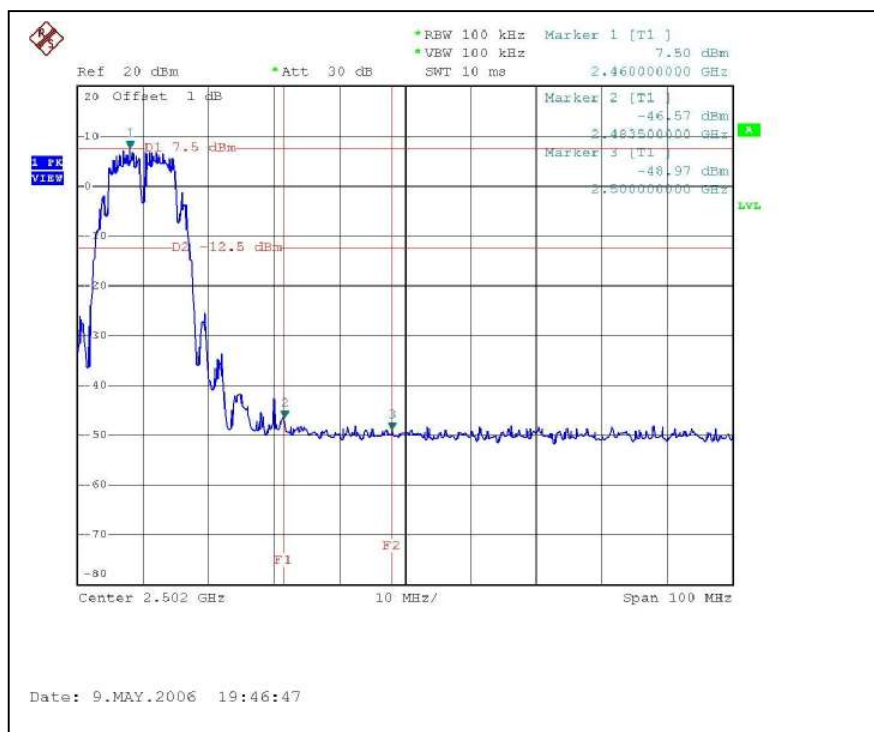

CH1

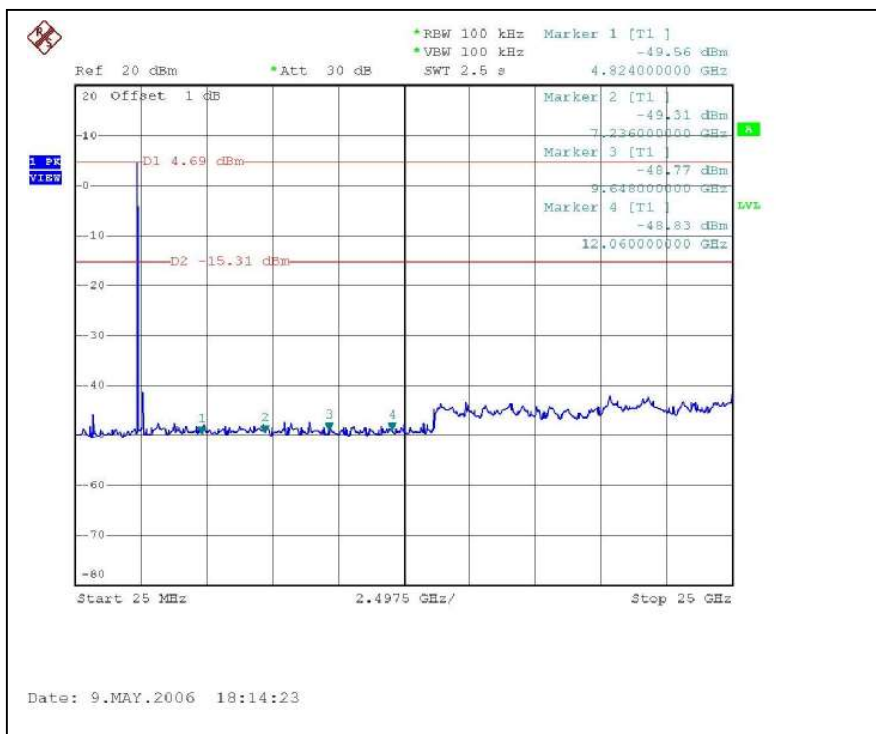

CH11

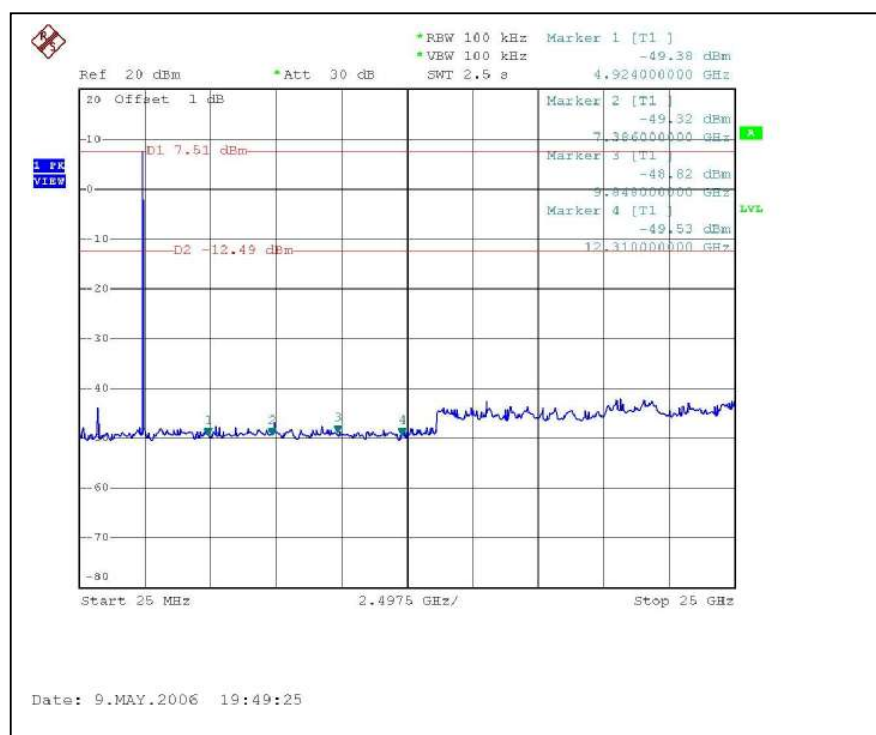

802.11g OFDM MODULATION: CH1

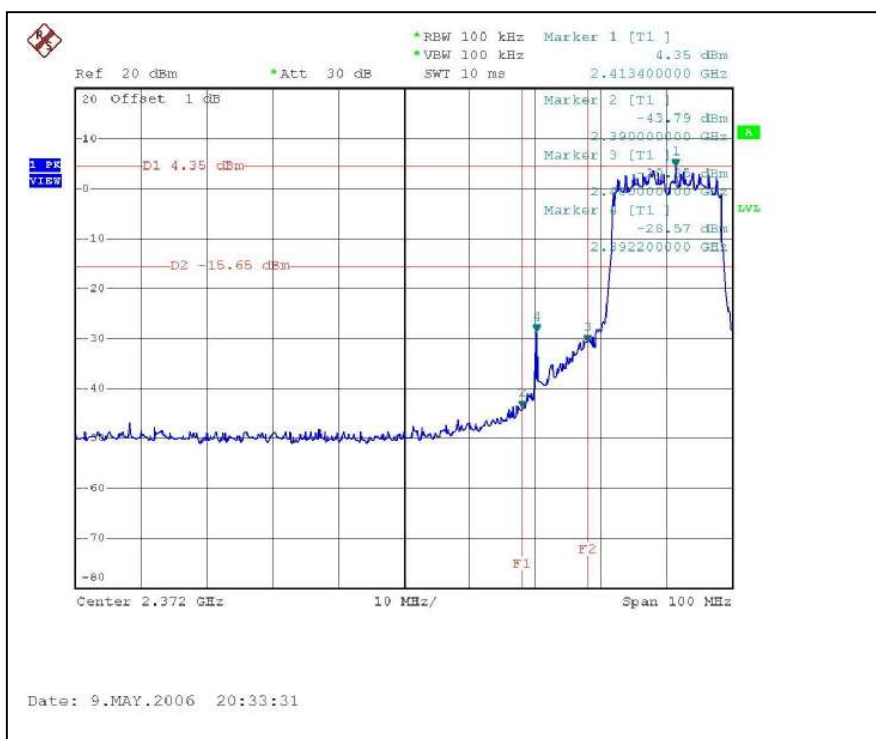

CH11

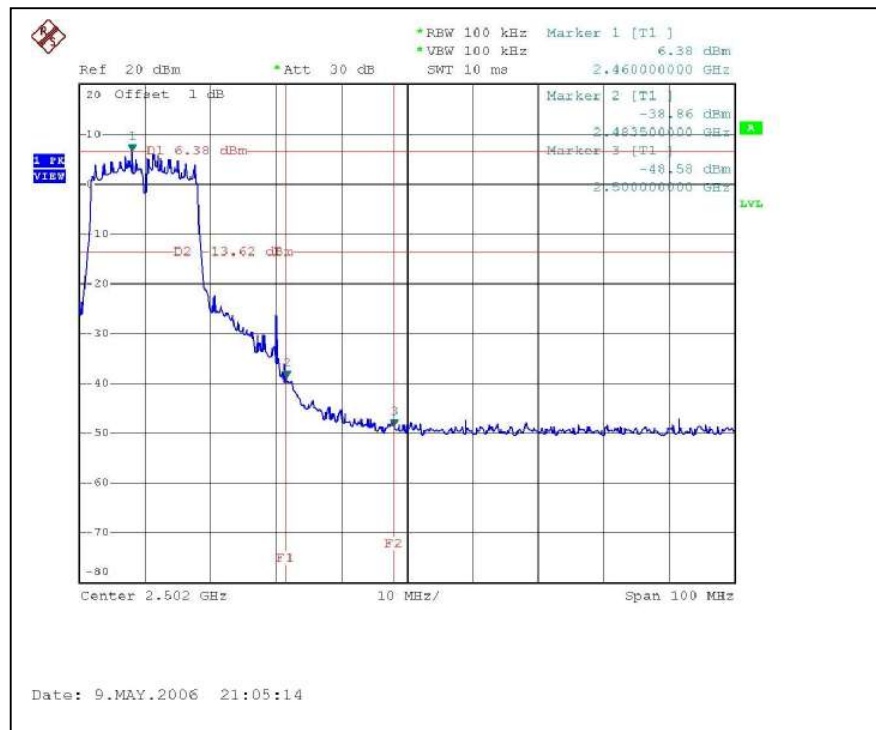

CH1

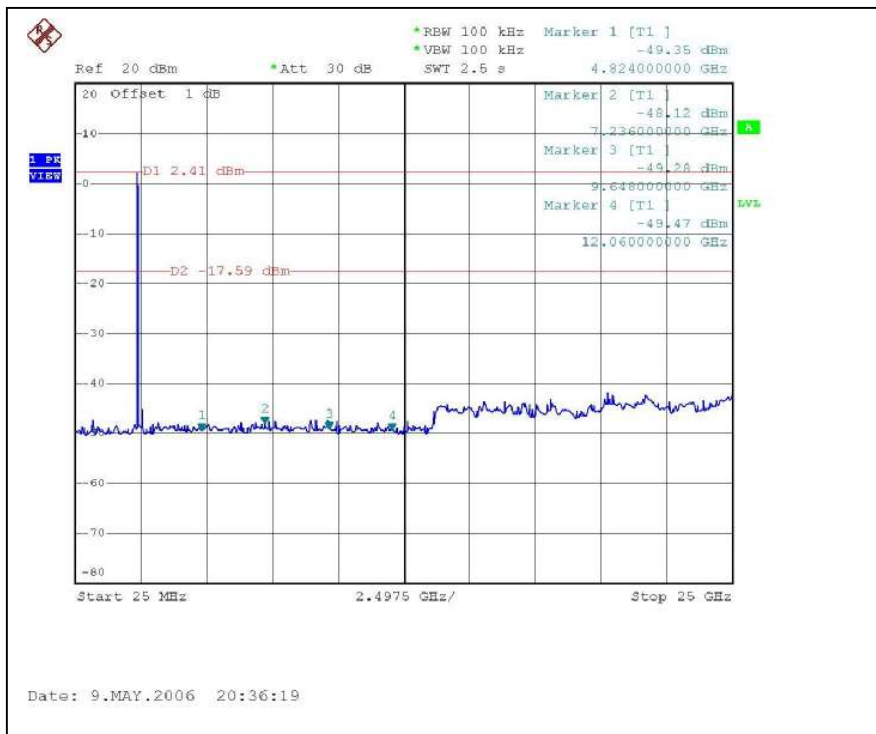

CH11

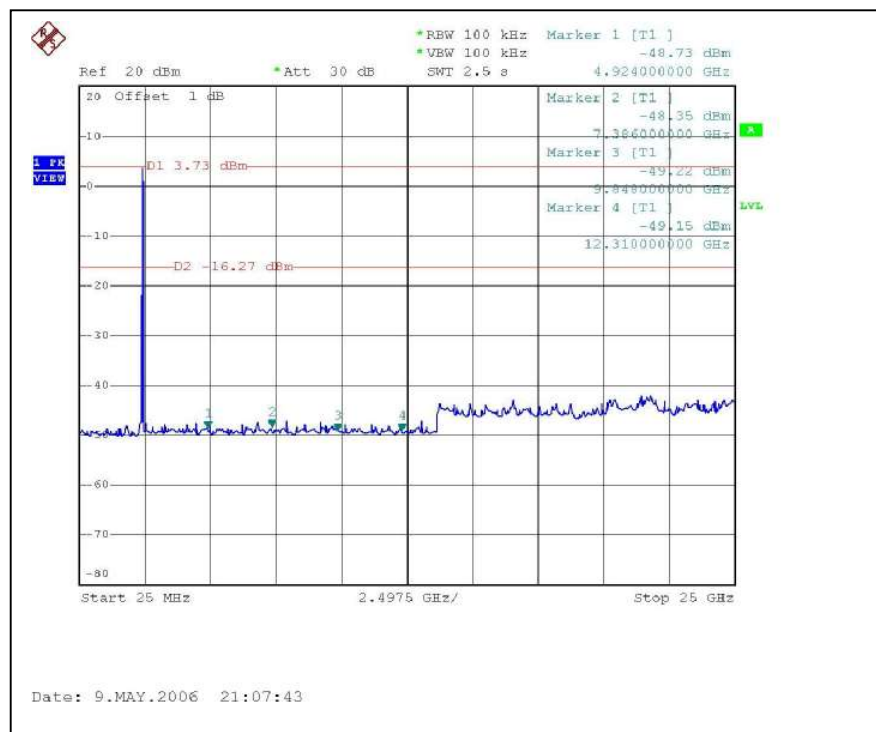

4.7 ANTENNA REQUIREMENT

4.7.1 STANDARD APPLICABLE

For intentional device, according to FCC 47 CFR Section 15.203, an intentional radiator shall be designed to ensure that no antenna other than that furnished by the responsible party shall be used with the device.

And according to FCC 47 CFR Section 15.247 (b), if transmitting antennas of directional gain greater than 6dBi are used, the power shall be reduced by the amount in dB that the directional gain of the antenna exceeds 6dBi.

4.7.2 ANTENNA CONNECTED CONSTRUCTION

The antenna used in this product is Dipole antenna with Reverse SMA connector. The maximum Gain of the antenna is 2dBi.

5 PHOTOGRAPHS OF THE TEST CONFIGURATION CONDUCTED EMISSION TEST



RADIATED EMISSION TEST





6 INFORMATION ON THE TESTING LABORATORIES

We, ADT Corp., were founded in 1988 to provide our best service in EMC, Radio, Telecom and Safety consultation. Our laboratories are accredited and approved by the following approval agencies according to ISO/IEC 17025:

USA	FCC, UL, A2LA
Germany	TUV Rheinland
Japan	VCCI
Norway	NEMKO
Canada	INDUSTRY CANADA, CSA
R.O.C.	CNLA, BSMI, DGT
Netherlands	Telefication
Singapore	PSB, GOST-ASIA (MOU)
Russia	CERTIS (MOU)

Copies of accreditation certificates of our laboratories obtained from approval agencies can be downloaded from our web site: www.adt.com.tw/index.5/phtml.

If you have any comments, please feel free to contact us at the following:

Linko EMC/RF Lab:

Tel: 886-2-26052180

Fax: 886-2-26052943

Hsin Chu EMC/RF Lab:

Tel: 886-3-5935343

Fax: 886-3-5935342

Hwa Ya EMC/RF/Safety/Telecom Lab:

Tel: 886-3-3183232

Fax: 886-3-3185050

Email: service@adt.com.tw

Web Site: www.adt.com.tw

The address and road map of all our labs can be found in our web site also.



APPENDIX-A

MODIFICATIONS RECORDERS FOR ENGINEERING CHANGES TO THE EUT BY THE LAB

No any modifications are made to the EUT by the lab during the test.