

FCC Test Report

Report No.: RF141229E04

FCC ID: Q87-WRT1200AC

Test Model: WRT1200AC

Received Date: Dec. 29, 2014

Test Date: Jan. 20 to Feb. 26, 2015

Issued Date: Mar. 13, 2015

Applicant: Linksys LLC

Address: 121 Theory Drive Irvine California 92617 United States

Issued By: Bureau Veritas Consumer Products Services (H.K.) Ltd., Taoyuan Branch
Hsin Chu Laboratory

Lab Address: No. 81-1, Lu Liao Keng, 9th Ling, Wu Lung Tsuen, Chiung Lin Hsiang, Hsin
Chu Hsien 307, Taiwan R.O.C.

Test Location (1): No. 81-1, Lu Liao Keng, 9th Ling, Wu Lung Tsuen, Chiung Lin Hsiang, Hsin
Chu Hsien 307, Taiwan R.O.C.

Test Location (2): No. 49, Ln. 206, Wende Rd., Shangshan Tsuen, Chiung Lin Hsiang, Hsin
Chu Hsien 307, Taiwan R.O.C.



This report is for your exclusive use. Any copying or replication of this report to or for any other person or entity, or use of our name or trademark, is permitted only with our prior written permission. This report sets forth our findings solely with respect to the test samples identified herein. The results set forth in this report are not indicative or representative of the quality or characteristics of the lot from which a test sample was taken or any similar or identical product unless specifically and expressly noted. Our report includes all of the tests requested by you and the results thereof based upon the information that you provided to us. You have 60 days from date of issuance of this report to notify us of any material error or omission caused by our negligence, provided, however, that such notice shall be in writing and shall specifically address the issue you wish to raise. A failure to raise such issue within the prescribed time shall constitute your unqualified acceptance of the completeness of this report, the tests conducted and the correctness of the report contents. Unless specific mention, the uncertainty of measurement has been explicitly taken into account to declare the compliance or non-compliance to the specification. The report must not be used by the client to claim product certification, approval, or endorsement by TAF or any government agencies.

Table of Contents

Release Control Record	5
1 Certificate of Conformity	6
2 Summary of Test Results	7
2.1 Measurement Uncertainty	7
2.2 Modification Record	7
3 General Information	8
3.1 General Description of EUT	8
3.2 Description of Test Modes	12
3.2.1 Test Mode Applicability and Tested Channel Detail.....	13
3.3 Duty Cycle of Test Signal	17
3.4 Description of Support Units	19
3.4.1 Configuration of System under Test	20
3.5 General Description of Applied Standards	21
4 Test Types and Results (for 2.4GHz Band)	22
4.1 Radiated Emission and Bandedge Measurement.....	22
4.1.1 Limits of Radiated Emission and Bandedge Measurement	22
4.1.2 Test Instruments	23
4.1.3 Test Procedures.....	25
4.1.4 Deviation from Test Standard	25
4.1.5 Test Setup.....	26
4.1.6 EUT Operating Conditions.....	27
4.1.7 Test Results	28
4.2 Conducted Emission Measurement	41
4.2.1 Limits of Conducted Emission Measurement	41
4.2.2 Test Instruments	41
4.2.3 Test Procedures.....	42
4.2.4 Deviation from Test Standard	42
4.2.5 Test Setup.....	42
4.2.6 EUT Operating Conditions.....	42
4.2.7 Test Results (Mode 1).....	43
4.2.8 Test Results (Mode 2).....	45
4.2.9 Test Results (Mode 3).....	47
4.2.10 Test Results (Mode 4).....	49
4.2.11 Test Results (Mode 5).....	51
4.2.12 Test Results (Mode 6).....	53
4.3 6dB Bandwidth Measurement	55
4.3.1 Limits of 6dB Bandwidth Measurement.....	55
4.3.2 Test Setup.....	55
4.3.3 Test Instruments	55
4.3.4 Test Procedures.....	55
4.3.5 Deviation from Test Standard	55
4.3.6 EUT Operating Conditions.....	55
4.3.7 Test Results	56
4.4 Conducted Output Power Measurement.....	58
4.4.1 Limits of Conducted Output Power Measurement	58
4.4.2 Test Setup.....	58
4.4.3 Test Instruments	58
4.4.4 Test Procedures.....	58
4.4.5 Deviation from Test Standard	58
4.4.6 EUT Operating Conditions.....	58
4.4.7 Test Results	59
4.5 Power Spectral Density Measurement.....	60
4.5.1 Limits of Power Spectral Density Measurement	60

4.5.2	Test Setup.....	60
4.5.3	Test Instruments	60
4.5.4	Test Procedures.....	60
4.5.5	Deviation from Test Standard	60
4.5.6	EUT Operating Conditions.....	60
4.5.7	Test Results	61
4.6	Conducted Out of Band Emission Measurement.....	63
4.6.1	Limits of Conducted Out of Band Emission Measurement	63
4.6.2	Test Setup.....	63
4.6.3	Test Instruments	63
4.6.4	Test Procedures.....	63
4.6.5	Deviation from Test Standard	63
4.6.6	EUT Operating Conditions.....	63
4.6.7	Test Results	63
5	Test Types and Results (for 5GHz Band).....	72
5.1	Radiated Emission and Bandedge Measurement.....	72
5.1.1	Limits of Radiated Emission and Bandedge Measurement	72
5.1.2	Test Instruments	72
5.1.3	Test Procedures.....	72
5.1.4	Deviation from Test Standard	72
5.1.5	Test Setup.....	72
5.1.6	EUT Operating Conditions.....	72
5.1.7	Test Results	73
5.2	Conducted Emission Measurement	83
5.2.1	Limits of Conducted Emission Measurement	83
5.2.2	Test Instruments	83
5.2.3	Test Procedures.....	83
5.2.4	Deviation from Test Standard	83
5.2.5	Test Setup.....	83
5.2.6	EUT Operating Conditions.....	83
5.2.7	Test Results (Mode 1).....	84
5.2.8	Test Results (Mode 2).....	86
5.2.9	Test Results (Mode 3).....	88
5.2.10	Test Results (Mode 4).....	90
5.2.11	Test Results (Mode 5).....	92
5.2.12	Test Results (Mode 6).....	94
5.3	6dB Bandwidth Measurement.....	96
5.3.1	Limits of 6dB Bandwidth Measurement	96
5.3.2	Test Setup.....	96
5.3.3	Test Instruments	96
5.3.4	Test Procedures.....	96
5.3.5	Deviation from Test Standard	96
5.3.6	EUT Operating Conditions.....	96
5.3.7	Test Results	97
5.4	Conducted Output Power Measurement.....	99
5.4.1	Limits of Conducted Output Power Measurement	99
5.4.2	Test Setup.....	99
5.4.3	Test Instruments	99
5.4.4	Test Procedures.....	99
5.4.5	Deviation from Test Standard	99
5.4.6	EUT Operating Conditions.....	99
5.4.7	Test Results	100
5.5	Power Spectral Density Measurement.....	101
5.5.1	Limits of Power Spectral Density Measurement	101
5.5.2	Test Setup.....	101
5.5.3	Test Instruments	101
5.5.4	Test Procedures.....	101

5.5.5	Deviation from Test Standard	101
5.5.6	EUT Operating Conditions.....	101
5.5.7	Test Results	102
5.6	Conducted Out of Band Emission Measurement.....	104
5.6.1	Limits of Conducted Out of Band Emission Measurement	104
5.6.2	Test Setup.....	104
5.6.3	Test Instruments	104
5.6.4	Test Procedures.....	104
5.6.5	Deviation from Test Standard	104
5.6.6	EUT Operating Conditions.....	104
5.6.7	Test Results	104
6	Pictures of Test Arrangements.....	113
	Appendix – Information on the Testing Laboratories	114



A D T

Release Control Record

Issue No.	Description	Date Issued
RF141229E04	Original release.	Mar. 13, 2015

1 Certificate of Conformity

Product: 802.11ac Router

Brand: Linksys

Test Model: WRT1200AC

Sample Status: ENGINEERING SAMPLE

Applicant: Linksys LLC

Test Date: Jan. 20 to Feb. 26, 2015

Standards: 47 CFR FCC Part 15, Subpart C (Section 15.247)
ANSI C63.10:2009

The above equipment has been tested by **Bureau Veritas Consumer Products Services (H.K.) Ltd., Taoyuan Branch**, and found compliance with the requirement of the above standards. The test record, data evaluation & Equipment Under Test (EUT) configurations represented herein are true and accurate accounts of the measurements of the sample's EMC characteristics under the conditions specified in this report.

Prepared by :  , **Date:** Mar. 13, 2015
(Elsie Hsu, Specialist)

Approved by :  , **Date:** Mar. 13, 2015
(May Chen, Manager)

2 Summary of Test Results

47 CFR FCC Part 15, Subpart C (SECTION 15.247)			
FCC Clause	Test Item	Result	Remarks
15.207	AC Power Conducted Emission	PASS	Meet the requirement of limit. Minimum passing margin is -6.65dB at 0.16953MHz.
15.205 / 15.209	Radiated Emissions	PASS	Meet the requirement of limit. Minimum passing margin is -3.1dB at 62.35MHz.
15.247(d)	Band Edge Measurement	PASS	Meet the requirement of limit. Minimum passing margin is -0.1dB at 2390.00MHz.
15.247(d)	Antenna Port Emission	PASS	Meet the requirement of limit.
15.247(a)(2)	6dB bandwidth	PASS	Meet the requirement of limit.
15.247(b)	Conducted power	PASS	Meet the requirement of limit.
15.247(e)	Power Spectral Density	PASS	Meet the requirement of limit.
15.203	Antenna Requirement	PASS	Antenna connector is R-SMA not a standard connector.

2.1 Measurement Uncertainty

Where relevant, the following measurement uncertainty levels have been estimated for tests performed on the EUT as specified in CISPR 16-4-2:

Measurement	Frequency	Expanded Uncertainty (k=2) (\pm)
Conducted Emissions at mains ports	150kHz ~ 30MHz	2.86 dB
Radiated Emissions up to 1 GHz	30MHz ~ 1GHz	5.37 dB
Radiated Emissions above 1 GHz	1GHz ~ 6GHz	3.72 dB
	6GHz ~ 18GHz	4.00 dB
	18GHz ~ 40GHz	4.11 dB

2.2 Modification Record

There were no modifications required for compliance.

3 General Information

3.1 General Description of EUT

Product	802.11ac Router
Brand	Linksys
Test Model	WRT1200AC
Status of EUT	ENGINEERING SAMPLE
Drive version	1.0.2.165474
Power Supply Rating	DC 12V from power adapter
Modulation Type	CCK, DQPSK, DBPSK for DSSS 64QAM, 16QAM, QPSK, BPSK for OFDM 256QAM for OFDM in 11ac mode and VHT20 and VHT40 mode of 2.4GHz Band.
Modulation Technology	DSSS, OFDM
Transfer Rate	802.11b: up to 11Mbps 802.11a/g: up to 54Mbps 802.11n: up to 300Mbps 802.11ac: up to 866.7Mbps
Operating Frequency	For 15.407 5GHz: 5.18 ~ 5.24GHz
	For 15.247 2.4GHz: 2.412 ~ 2.462GHz 5GHz: 5.745 ~ 5.825GHz
Number of Channel	For 15.407 4 for 802.11a, 802.11n (HT20), 802.11ac (VHT20) 2 for 802.11n (HT40), 802.11ac (VHT40) 1 for 802.11ac (VHT80)
	For 15.247 (2.4GHz) 11 for 802.11b, 802.11g, 802.11n (HT20), VHT20 7 for 802.11n (HT40), VHT40 For 15.247 (5GHz) 5 for 802.11a, 802.11n (HT20), 802.11ac (VHT20) 2 for 802.11n (HT40), 802.11ac (VHT40) 1 for 802.11ac (VHT80)

Output Power	For 15.407 802.11a: 928.803mW 802.11ac (VHT20): 914.962mW 802.11ac (VHT40): 431.559mW 802.11ac (VHT80): 79.822mW	
	For 15.247(2.4GHz) 802.11b: 938.114mW 802.11g: 669.703mW 802.11n (HT20): 595.132mW 802.11n (HT40): 187.976mW	
	For 15.247(5GHz) 802.11a: 974.638mW 802.11ac (VHT20): 959.49mW 802.11ac (VHT40): 930.55mW 802.11ac (VHT80): 322.057mW	
	Antenna Type	Please see NOTE
	Antenna Connector	Please see NOTE
Accessory Device	Adapter x1	
Data Cable Supplied	NA	

Note:

- 2.4GHz and 5GHz technology can transmit at same time.
- The EUT must be supplied with a power adapter and following three different models could be chosen as following table:

No	Brand	Model No.	Spec.
1	CWT	2ABL030F US	Input: 100-240V, 1.0A, 50/60Hz Output: 12V, 2.5A DC output cable: 1.8m, unshielded
2	LEI	MU30-5120250-A1	Input: 100-240V, 0.8A, 50/60Hz Output: 12V, 2.5A DC output cable: 1.8m, unshielded
3	LEI	MU30-P120250-A1	Input: 100-240V, 0.8A, 50/60Hz Output: 12V, 2.5A DC output cable: 1.8m, unshielded

Note: For radiated emissions test, the EUT was pre-tested with above adapters, the worst case was found in adapter 3. Therefore only the test data of the adapter was recorded in this report.

- The antennas provided to the EUT, please refer to the following table:

Transmitter Circuit	Brand	Gain (dBi)	Cable Loss (dB)	Net Gain (dBi)	Frequency Range (GHz to GHz)	Antenna Type	Connector Type
Chain (0)	LINKSYS	2.5	1	1.5	2.4 ~ 2.4835	DIPOLE	R-SMA
		2.6	1.6	1	5.15 ~ 5.25		
		3.8	1.9	1.9	5.725 ~ 5.85		
Chain (1)	LINKSYS	2.5	1	1.5	2.4 ~ 2.4835	DIPOLE	R-SMA
		2.6	1.5	1.1	5.15 ~ 5.25		
		3.8	2.1	1.7	5.725 ~ 5.85		

4. The EUT has two different Transformer types could be chosen and please refer the below table:

Type 1 (Vendor: MINGTEK)		
Vendor P/N	Vendor	Location
HN1878CG	MINGTEK	T1
HN3678CG	MINGTEK	T2, T3
Type 2 (Vendor: BOTHHAND)		
Vendor P/N	Vendor	Location
LG1P109N LF	BOTHHAND	T1
LG2P109N LF	BOTHHAND	T2, T3

From the above types, the worst radiated emissions was found in **Type 2 (Vendor: BOTHHAND)**. Therefore only the test data of the type were recorded in this report.

5. The EUT incorporates a MIMO function with beamforming.

2.4GHz Band			
MODULATION MODE	DATA RATE (MCS)	TX & RX CONFIGURATION	
802.11b	1 ~ 11Mbps	2TX*	2RX
802.11g	6 ~ 54Mbps	2TX	2RX
802.11n (HT20)	MCS 0~7	2TX	2RX
	MCS 8~15	2TX	2RX
802.11n (HT40)	MCS 0~7	2TX	2RX
	MCS 8~15	2TX	2RX
VHT20	MCS0~8 Nss=1	2TX	2RX
	MCS0~8 Nss=2	2TX	2RX
VHT40	MCS0~9 Nss=1	2TX	2RX
	MCS0~9 Nss=2	2TX	2RX
5GHz Band			
MODULATION MODE	DATA RATE (MCS)	TX & RX CONFIGURATION	
802.11a	6 ~ 54Mbps	2TX	2RX
802.11n (HT20)	MCS 0~7	2TX	2RX
	MCS 8~15	2TX	2RX
802.11n (HT40)	MCS 0~7	2TX	2RX
	MCS 8~15	2TX	2RX
802.11ac (VHT20)	MCS0~8 Nss= 1	2TX	2RX
	MCS0~8 Nss= 2	2TX	2RX
802.11ac (VHT40)	MCS0~9 Nss= 1	2TX	2RX
	MCS0~9 Nss= 2	2TX	2RX
802.11ac (VHT80)	MCS0~9 Nss= 1	2TX	2RX
	MCS0~9 Nss= 2	2TX	2RX

NOTE: 1. The modulation and bandwidth are similar for 802.11n mode for 20MHz / 40MHz and 802.11ac mode for 20MHz / 40MHz, therefore investigated worst case to representative mode in test report. (Final test mode refer section 3.2.1)

2. * From the above modulation modes, the 802.11b without beamforming.

6. The above EUT information is declared by manufacturer and for more detailed features description, please refer to the manufacturer's specifications or user's manual.

3.2 Description of Test Modes

FOR 2.4GHz:

11 channels are provided for 802.11b, 802.11g and 802.11n (HT20), VHT20:

Channel	Frequency	Channel	Frequency
1	2412MHz	7	2442MHz
2	2417MHz	8	2447MHz
3	2422MHz	9	2452MHz
4	2427MHz	10	2457MHz
5	2432MHz	11	2462MHz
6	2437MHz		

7 channels are provided for 802.11n (HT40), VHT40:

Channel	Frequency	Channel	Frequency
3	2422MHz	7	2442MHz
4	2427MHz	8	2447MHz
5	2432MHz	9	2452MHz
6	2437MHz		

FOR 5GHz (5745 ~ 5825MHz):

5 channels are provided for 802.11a, 802.11n (HT20), 802.11ac (VHT20):

Channel	Frequency	Channel	Frequency
149	5745MHz	161	5805MHz
153	5765MHz	165	5825MHz
157	5785MHz		

2 channels are provided for 802.11n (HT40), 802.11ac (VHT40):

Channel	Frequency	Channel	Frequency
151	5755MHz	159	5795MHz

1 channel is provided for 802.11ac (VHT80):

Channel	Frequency
155	5775MHz

3.2.1 Test Mode Applicability and Tested Channel Detail

FOR 2.4GHz:

EUT CONFIGURE MODE	APPLICABLE TO				DESCRIPTION
	RE≥1G	RE<1G	PLC	APCM	
1	√	√	√	√	Adapter 3 + Type 2
2	-	-	√	-	Adapter 3 + Type 1
3	-	-	√	-	Adapter 2 + Type 2
4	-	-	√	-	Adapter 2 + Type 1
5	-	-	√	-	Adapter 1 + Type 2
6	-	-	√	-	Adapter 1 + Type 1

Where **RE≥1G**: Radiated Emission above 1GHz **RE<1G**: Radiated Emission below 1GHz
PLC: Power Line Conducted Emission **APCM**: Antenna Port Conducted Measurement

NOTE: The EUT had been pre-tested on the positioned of each 2 axis. The worst case was found when positioned on **Y-plane** (for below 1GHz) and **X-plane** (for above 1GHz).

NOTE: "-" means no effect.

Radiated Emission Test (Above 1GHz):

- Pre-Scan has been conducted to determine the worst-case mode from all possible combinations between available modulations, data rates and antenna ports (if EUT with antenna diversity architecture).
- Following channel(s) was (were) selected for the final test as listed below.

MODE	AVAILABLE CHANNEL	TESTED CHANNEL	MODULATION TECHNOLOGY	MODULATION TYPE	DATA RATE (Mbps)
802.11b	1 to 11	1, 6, 11	DSSS	DBPSK	1
802.11g	1 to 11	1, 6, 11	OFDM	BPSK	6
802.11n (HT20)	1 to 11	1, 6, 11	OFDM	BPSK	6.5
802.11n (HT40)	3 to 9	3, 6, 9	OFDM	BPSK	13.5

Radiated Emission Test (Below 1GHz):

- Pre-Scan has been conducted to determine the worst-case mode from all possible combinations between available modulations, data rates and antenna ports (if EUT with antenna diversity architecture).
- Following channel(s) was (were) selected for the final test as listed below.

MODE	AVAILABLE CHANNEL	TESTED CHANNEL	MODULATION TECHNOLOGY	MODULATION TYPE	DATA RATE (Mbps)
802.11b	1 to 11	6	DSSS	DBPSK	1

Power Line Conducted Emission Test:

- Pre-Scan has been conducted to determine the worst-case mode from all possible combinations between available modulations, data rates and antenna ports (if EUT with antenna diversity architecture).
- Following channel(s) was (were) selected for the final test as listed below.

MODE	AVAILABLE CHANNEL	TESTED CHANNEL	MODULATION TECHNOLOGY	MODULATION TYPE	DATA RATE (Mbps)
802.11b	1 to 11	6	DSSS	DBPSK	1

Antenna Port Conducted Measurement:

- This item includes all test value of each mode, but only includes spectrum plot of worst value of each mode.
- Pre-Scan has been conducted to determine the worst-case mode from all possible combinations between available modulations, data rates and antenna ports (if EUT with antenna diversity architecture).
- Following channel(s) was (were) selected for the final test as listed below.

MODE	AVAILABLE CHANNEL	TESTED CHANNEL	MODULATION TECHNOLOGY	MODULATION TYPE	DATA RATE (Mbps)
802.11b	1 to 11	1, 6, 11	DSSS	DBPSK	1
802.11g	1 to 11	1, 6, 11	OFDM	BPSK	6
802.11n (HT20)	1 to 11	1, 6, 11	OFDM	BPSK	6.5
802.11n (HT40)	3 to 9	3, 6, 9	OFDM	BPSK	13.5

Test Condition:

APPLICABLE TO	ENVIRONMENTAL CONDITIONS	INPUT POWER	TESTED BY
RE≥1G	22deg. C, 70%RH	120Vac, 60Hz	Robert Cheng
RE<1G	22deg. C, 69%RH	120Vac, 60Hz	Tim Ho
PLC	20deg. C, 60%RH	120Vac, 60Hz	Barry Lee
APCM	25deg. C, 60%RH	120Vac, 60Hz	Anderson Chen

FOR 5GHz (5745 ~ 5825MHz):

EUT CONFIGURE MODE	APPLICABLE TO				DESCRIPTION
	RE≥1G	RE<1G	PLC	APCM	
1	√	√	√	√	Adapter 3 + Type 2
2	-	-	√	-	Adapter 3 + Type 1
3	-	-	√	-	Adapter 2 + Type 2
4	-	-	√	-	Adapter 2 + Type 1
5	-	-	√	-	Adapter 1 + Type 2
6	-	-	√	-	Adapter 1 + Type 1

Where **RE≥1G**: Radiated Emission above 1GHz **RE<1G**: Radiated Emission below 1GHz
PLC: Power Line Conducted Emission **APCM**: Antenna Port Conducted Measurement

NOTE: The EUT had been pre-tested on the positioned of each 2 axis. The worst case was found when positioned on **Y-plane** (for below 1GHz) and **X-plane** (for above 1GHz).

NOTE: "-" means no effect.

Radiated Emission Test (Above 1GHz):

- Pre-Scan has been conducted to determine the worst-case mode from all possible combinations between available modulations, data rates and antenna ports (if EUT with antenna diversity architecture).
- Following channel(s) was (were) selected for the final test as listed below.

MODE	AVAILABLE CHANNEL	TESTED CHANNEL	MODULATION TECHNOLOGY	MODULATION TYPE	DATA RATE (Mbps)
802.11a	149 to 165	149, 157, 165	OFDM	BPSK	6
802.11ac (VHT20)	149 to 165	149, 157, 165	OFDM	BPSK	6.5
802.11ac (VHT40)	151 to 159	151, 159	OFDM	BPSK	13.5
802.11ac (VHT80)	155	155	OFDM	BPSK	29.3

Radiated Emission Test (Below 1GHz):

- Pre-Scan has been conducted to determine the worst-case mode from all possible combinations between available modulations, data rates and antenna ports (if EUT with antenna diversity architecture).
- Following channel(s) was (were) selected for the final test as listed below.

MODE	AVAILABLE CHANNEL	TESTED CHANNEL	MODULATION TECHNOLOGY	MODULATION TYPE	DATA RATE (Mbps)
802.11a	149 to 165	157	OFDM	BPSK	6

Power Line Conducted Emission Test:

- Pre-Scan has been conducted to determine the worst-case mode from all possible combinations between available modulations, data rates and antenna ports (if EUT with antenna diversity architecture).
- Following channel(s) was (were) selected for the final test as listed below.

MODE	AVAILABLE CHANNEL	TESTED CHANNEL	MODULATION TECHNOLOGY	MODULATION TYPE	DATA RATE (Mbps)
802.11a	149 to 165	157	OFDM	BPSK	6

Antenna Port Conducted Measurement:

- This item includes all test value of each mode, but only includes spectrum plot of worst value of each mode.
- Pre-Scan has been conducted to determine the worst-case mode from all possible combinations between available modulations, data rates and antenna ports (if EUT with antenna diversity architecture).
- Following channel(s) was (were) selected for the final test as listed below.

MODE	AVAILABLE CHANNEL	TESTED CHANNEL	MODULATION TECHNOLOGY	MODULATION TYPE	DATA RATE (Mbps)
802.11a	149 to 165	149, 165	OFDM	BPSK	6
802.11ac (VHT20)	149 to 165	149, 165	OFDM	BPSK	6.5
802.11ac (VHT40)	151 to 159	151, 159	OFDM	BPSK	13.5
802.11ac (VHT80)	155	155	OFDM	BPSK	29.3

Test Condition:

APPLICABLE TO	ENVIRONMENTAL CONDITIONS	INPUT POWER	TESTED BY
RE≥1G	22deg. C, 68%RH	120Vac, 60Hz	Robert Cheng
RE<1G	22deg. C, 69%RH	120Vac, 60Hz	Tim Ho
PLC	20deg. C, 60%RH	120Vac, 60Hz	Barry Lee
APCM	25deg. C, 60%RH	120Vac, 60Hz	Anderson Chen

3.3 Duty Cycle of Test Signal

2.4GHz Band:

Duty cycle of test signal is 100 %, duty factor is not required.

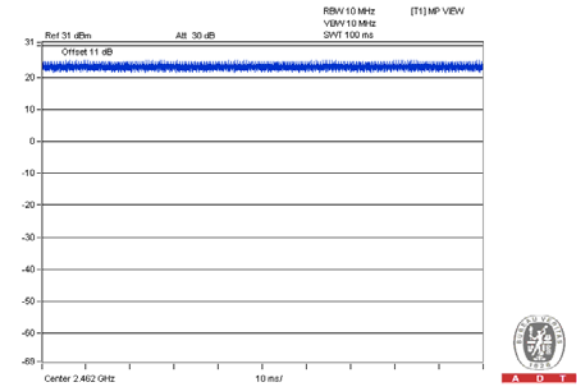
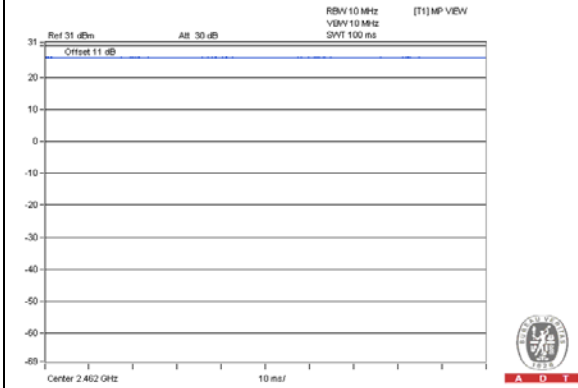
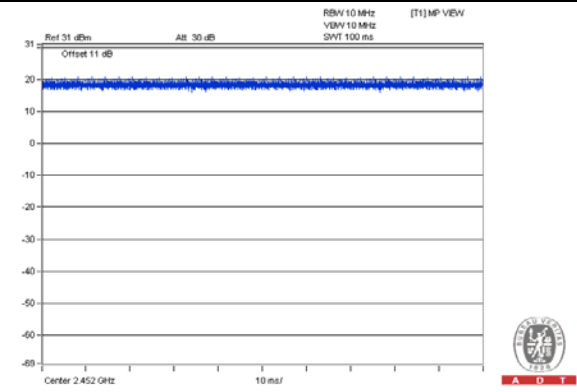
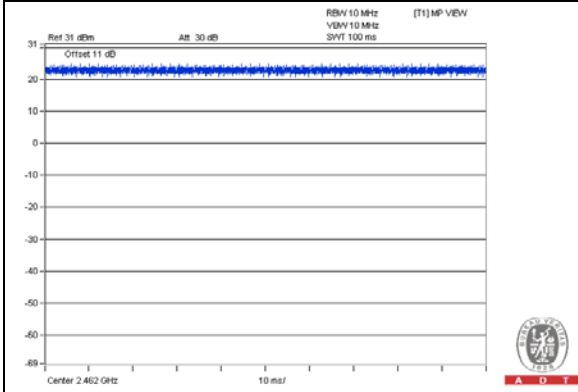
802.11b**802.11g****802.11n (HT20)****802.11n (HT40)**

5GHz Band:

Duty cycle of test signal is 100 %, duty factor is not required.

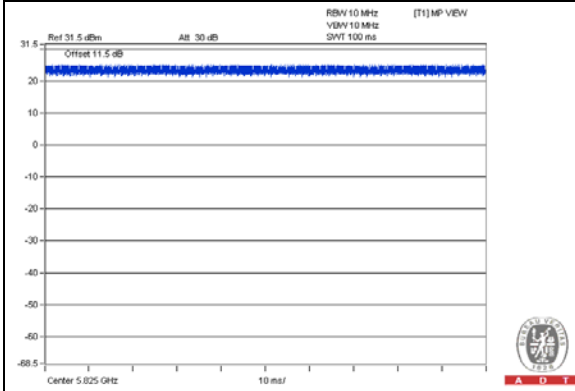
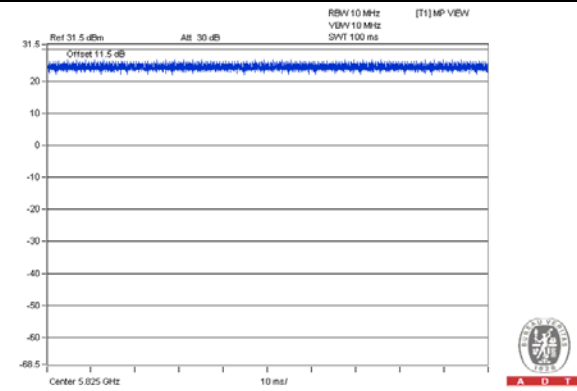
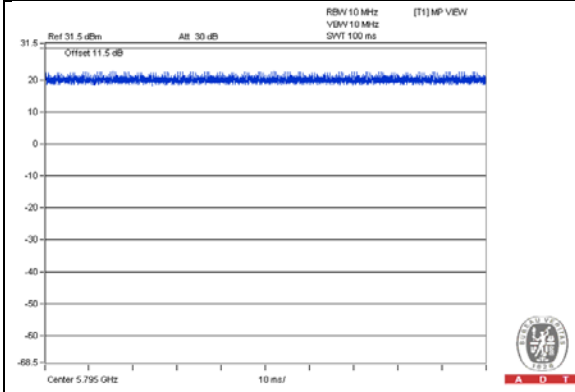
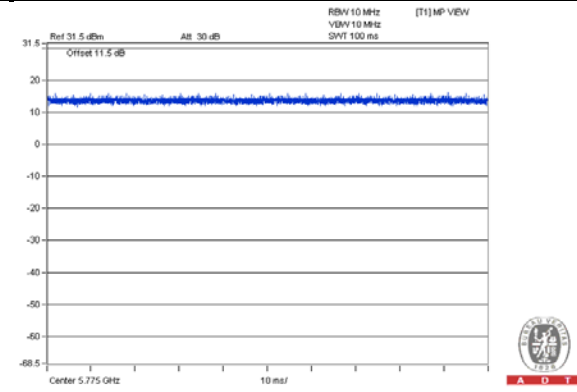
802.11a**802.11ac (VHT20)****802.11ac (VHT40)****802.11ac (VHT80)**

3.4 Description of Support Units

The EUT has been tested as an independent unit together with other necessary accessories or support units. The following support units or accessories were used to form a representative test configuration during the tests.

ID	Product	Brand	Model No.	Serial No.	FCC ID	Remarks
A.	iPod shuffle	Apple	MC749TA/A	CC4DMFKUDFDM	NA	Provided by Lab
B.	USB Dongle	Transcend	TS16GJF750K	NA	NA	Provided by Lab
C.	HUB	ZyXEL	ES-116P	S060H02000215	FCC DoC	Provided by Lab
D.	NOTEBOOK COMPUTER	DELL	PP32LA	GSLB32S	FCC DoC	Provided by Lab
E.	NOTEBOOK COMPUTER	DELL	D531	CN-0XM006-48643-86 L-4472	QDS-BRCM1019	Provided by Lab

Note:

1. All power cords of the above support units are non-shielded (1.8m).

ID	Descriptions	Qty.	Length (m)	Shielding (Yes/No)	Cores (Qty.)	Remarks
1.	DC power	1	1.8	No	0	Supplied by Client
2.	RJ-45	1	10	No	0	Provided by Lab
3.	RJ-45	3	10	No	0	Provided by Lab
4.	RJ-45	1	10	No	0	Provided by Lab
5.	USB	1	0.1	No	0	Provided by Lab

3.4.1 Configuration of System under Test

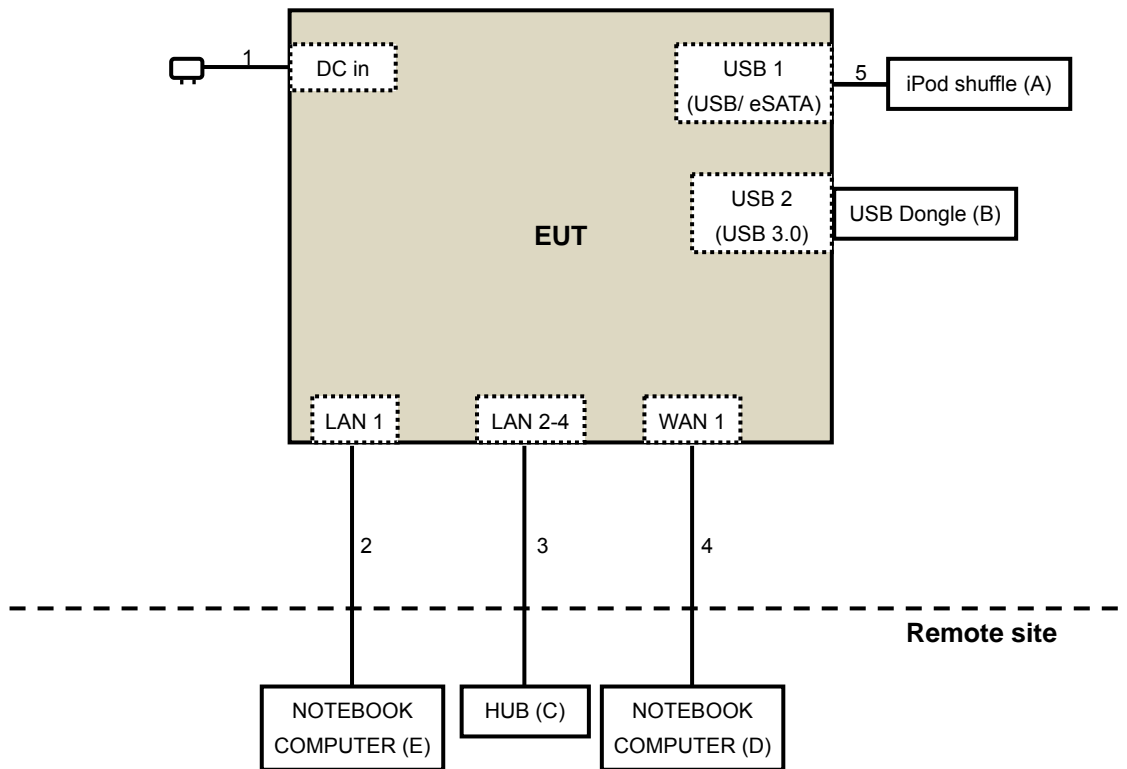

3.5 General Description of Applied Standards

The EUT is a RF Product. According to the specifications of the manufacturer, it must comply with the requirements of the following standards:

FCC Part 15, Subpart C (15.247)

558074 D01 DTS Meas Guidance v03r02

662911 D01 Multiple Transmitter Output v02r01

ANSI C63.10-2009

All test items have been performed and recorded as per the above standards.

NOTE: The EUT has been verified to comply with the requirements of FCC Part 15, Subpart B, Class B (DoC). The test report has been issued separately.

4 Test Types and Results (for 2.4GHz Band)

4.1 Radiated Emission and Bandedge Measurement

4.1.1 Limits of Radiated Emission and Bandedge Measurement

Radiated emissions which fall in the restricted bands must comply with the radiated emission limits specified as below table. Other emissions shall be at least 30dB below the highest level of the desired power:

Frequencies (MHz)	Field Strength (microvolts/meter)	Measurement Distance (meters)
0.009 ~ 0.490	2400/F(kHz)	300
0.490 ~ 1.705	24000/F(kHz)	30
1.705 ~ 30.0	30	30
30 ~ 88	100	3
88 ~ 216	150	3
216 ~ 960	200	3
Above 960	500	3

NOTE:

1. The lower limit shall apply at the transition frequencies.
2. Emission level (dBuV/m) = 20 log Emission level (uV/m).
3. For frequencies above 1000MHz, the field strength limits are based on average detector, however, the peak field strength of any emission shall not exceed the maximum permitted average limits, specified above by more than 20dB under any condition of modulation.

**4.1.2 Test Instruments
Below 1GHz**

DESCRIPTION & MANUFACTURER	MODEL NO.	SERIAL NO.	CALIBRATED DATE	CALIBRATED UNTIL
MXE EMI Receiver Agilent	N9038A	MY51210105	July 21, 2014	July 20, 2015
Pre-Amplifier Mini-Circuits	ZFL-1000VH2 B	AMP-ZFL-03	Nov. 12, 2014	Nov. 11, 2015
Trilog Broadband Antenna SCHWARZBECK	VULB 9168	9168-360	Feb. 06, 2015	Feb. 05, 2016
RF Cable	NA	CHGCAB_001	Oct. 04, 2014	Oct. 03, 2015
Horn_Antenna AISI	AIH.8018	0000320091110	Aug. 27, 2014	Aug. 26, 2015
Pre-Amplifier Agilent	8449B	3008A02578	June 24, 2014	June 23, 2015
RF Cable	NA	131205 131214 SNMY23684/4	Jan. 16, 2015	Jan. 15, 2016
Spectrum Analyzer R&S	FSV40	100964	July 05, 2014	July 04, 2015
Pre-Amplifier EMCI	EMC184045	980143	Jan. 16, 2015	Jan. 15, 2016
Horn_Antenna SCHWARZBECK	BBHA 9170	9170-424	Aug. 26, 2014	Aug. 25, 2015
RF Cable	NA	RF104-121 RF104-204	Dec. 11, 2014	Dec. 10, 2015
Antenna Tower & Turn Table CT	NA	NA	NA	NA

Note:

1. The calibration interval of the above test instruments is 12 months and the calibrations are traceable to NML/ROC and NIST/USA.
2. The horn antenna, preamplifier (model: 8449B) are used only for the measurement of emission frequency above 1GHz if tested.
- 3 The test was performed in 966 Chamber No. G.
4. The FCC Site Registration No. is 966073.
- 5 The VCCI Site Registration No. is G-137.
- 6 The CANADA Site Registration No. is IC 7450H-2.
- 7 Tested Date: Feb. 26, 2015

Above 1GHz test

DESCRIPTION & MANUFACTURER	MODEL NO.	SERIAL NO.	CALIBRATED DATE	CALIBRATED UNTIL
MXE EMI Receiver Agilent	N9038A	MY51210105	July 21, 2014	July 20, 2015
Pre-Amplifier Mini-Circuits	ZFL-1000VH2 B	AMP-ZFL-03	Nov. 12, 2014	Nov. 11, 2015
Trilog Broadband Antenna SCHWARZBECK	VULB 9168	9168-360	Feb. 26, 2014	Feb. 25, 2015
RF Cable	NA	CHGCAB_001	Oct. 04, 2014	Oct. 03, 2015
Horn_Antenna AISI	AIH.8018	0000320091110	Aug. 27, 2014	Aug. 26, 2015
Pre-Amplifier Agilent	8449B	3008A02578	June 24, 2014	June 23, 2015
RF Cable	NA	131205 131214 SNMY23684/4	Jan. 16, 2015	Jan. 15, 2016
Spectrum Analyzer R&S	FSV40	100964	July 05, 2014	July 04, 2015
Pre-Amplifier EMCI	EMC184045	980143	Jan. 15, 2015	Jan. 14, 2016
Horn_Antenna SCHWARZBECK	BBHA 9170	9170-424	Aug. 26, 2014	Aug. 25, 2015
RF Cable	NA	RF104-121 RF104-204	Dec. 11, 2014	Dec. 10, 2015
Antenna Tower & Turn Table CT	NA	NA	NA	NA
SPECTRUM ANALYZER R&S	FSP 40	100060	May 08, 2014	May 07, 2015
Power meter Anritsu	ML2495A	1014008	Apr. 30, 2014	Apr. 29, 2015
Power sensor Anritsu	MA2411B	0917122	Apr. 30, 2014	Apr. 29, 2015
Temperature & Humidity Chamber GIANTFORCE	GTH-150-40-S P-AR	MAA0812-008	Jan. 12, 2015	Jan. 11, 2016

Note:

1. The calibration interval of the above test instruments is 12 months and the calibrations are traceable to NML/ROC and NIST/USA.
2. The horn antenna, preamplifier (model: 8449B) are used only for the measurement of emission frequency above 1GHz if tested.
3. The test was performed in 966 Chamber No. G.
4. The FCC Site Registration No. is 966073.
5. The VCCI Site Registration No. is G-137.
6. The CANADA Site Registration No. is IC 7450H-2.
7. Tested Date: Jan. 20 to 26, 2015

4.1.3 Test Procedures

- a. The EUT was placed on the top of a rotating table 0.8 meters above the ground at 3 meter chamber room for test. The table was rotated 360 degrees to determine the position of the highest radiation.
- b. The EUT was set 3 meters away from the interference-receiving antenna, which was mounted on the top of a variable-height antenna tower.
- c. The height of antenna is varied from one meter to four meters above the ground to determine the maximum value of the field strength. Both horizontal and vertical polarizations of the antenna are set to make the measurement.
- d. For each suspected emission, the EUT was arranged to its worst case and then the antenna was tuned to heights from 1 meter to 4 meters and the rotatable table was turned from 0 degrees to 360 degrees to find the maximum reading.
- e. The test-receiver system was set to quasi-peak detect function and specified bandwidth with maximum hold mode when the test frequency is below 1 GHz.
- f. The test-receiver system was set to peak and average detect function and specified bandwidth with maximum hold mode when the test frequency is above 1 GHz. If the peak reading value also meets average limit, measurement with the average detector is unnecessary.

Note:

1. The resolution bandwidth and video bandwidth of test receiver/spectrum analyzer is 120kHz for Quasi-peak detection (QP) at frequency below 1GHz.
2. The resolution bandwidth of test receiver/spectrum analyzer is 1 MHz and the video bandwidth is 3 MHz for Peak detection (PK) at frequency above 1GHz.
3. The resolution bandwidth of test receiver/spectrum analyzer is 1MHz and the video bandwidth is 3MHz for RMS Average (Duty cycle < 98%) for Average detection (AV) at frequency above 1GHz, then the measurement results was added to a correction factor ($10 \log(1/\text{duty cycle})$).
4. The resolution bandwidth of test receiver/spectrum analyzer is 1MHz and the video bandwidth is 10Hz (Duty cycle \geq 98%) for Average detection (AV) at frequency above 1GHz.
5. All modes of operation were investigated and the worst-case emissions are reported.

4.1.4 Deviation from Test Standard

No deviation.

4.1.5 Test Setup

<Frequency Range below 1GHz>

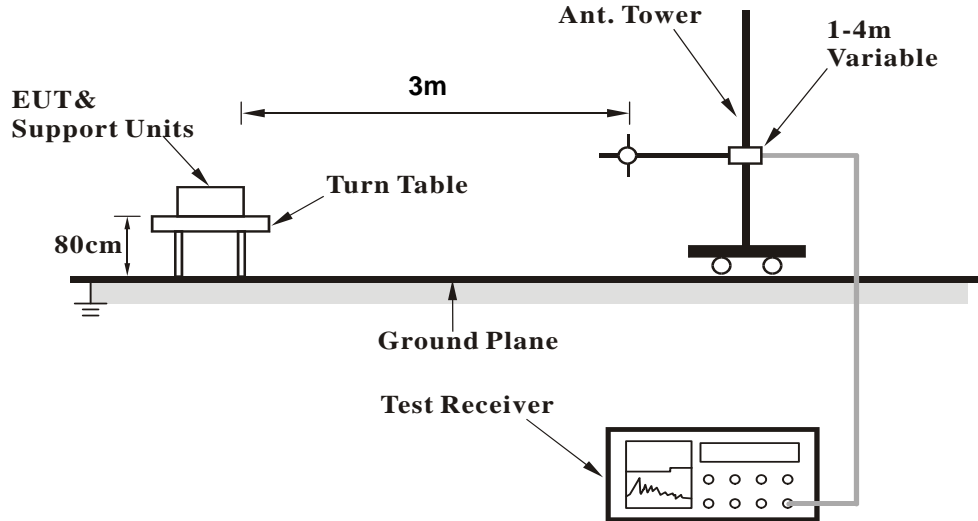

<Frequency Range above 1GHz>

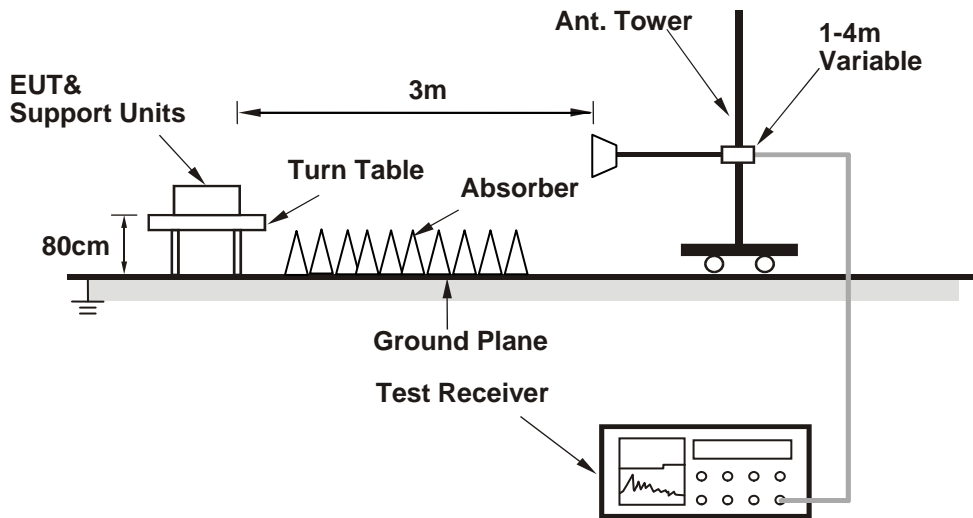

For the actual test configuration, please refer to the attached file (Test Setup Photo).

4.1.6 EUT Operating Conditions

1. Connect the EUT with the support units D-E (Notebook Computer) which is placed in remote site.
2. The communication partner run test program "DutApiMimoApApp.exe" to enable EUT under transmission/receiving condition continuously at specific channel frequency.

4.1.7 Test Results

Above 1GHz Data

802.11b

CHANNEL	TX Channel 1	DETECTOR FUNCTION	Peak (PK)
FREQUENCY RANGE	1GHz ~ 25GHz		Average (AV)

ANTENNA POLARITY & TEST DISTANCE: HORIZONTAL AT 3 M

NO.	FREQ. (MHz)	EMISSION LEVEL (dBuV/m)	LIMIT (dBuV/m)	MARGIN (dB)	ANTENNA HEIGHT (m)	TABLE ANGLE (Degree)	RAW VALUE (dBuV)	CORRECTION FACTOR (dB/m)
1	2390.00	51.8 PK	74.0	-22.2	1.31 H	96	57.40	-5.60
2	2390.00	41.5 AV	54.0	-12.5	1.31 H	96	47.10	-5.60
3	*2412.00	111.1 PK			1.31 H	96	116.63	-5.53
4	*2412.00	108.5 AV			1.31 H	96	114.03	-5.53
5	4824.00	48.3 PK	74.0	-25.7	1.46 H	77	44.44	3.86
6	4824.00	40.6 AV	54.0	-13.4	1.46 H	77	36.74	3.86

ANTENNA POLARITY & TEST DISTANCE: VERTICAL AT 3 M

NO.	FREQ. (MHz)	EMISSION LEVEL (dBuV/m)	LIMIT (dBuV/m)	MARGIN (dB)	ANTENNA HEIGHT (m)	TABLE ANGLE (Degree)	RAW VALUE (dBuV)	CORRECTION FACTOR (dB/m)
1	2390.00	59.7 PK	74.0	-14.3	1.41 V	333	65.30	-5.60
2	2390.00	53.1 AV	54.0	-0.9	1.41 V	333	58.70	-5.60
3	*2412.00	118.3 PK			1.42 V	333	123.83	-5.53
4	*2412.00	115.9 AV			1.42 V	333	121.43	-5.53
5	4824.00	50.2 PK	74.0	-23.8	1.39 V	113	46.34	3.86
6	4824.00	44.6 AV	54.0	-9.4	1.39 V	113	40.74	3.86

REMARKS:

1. Emission Level(dBuV/m) = Raw Value(dBuV) + Correction Factor(dB/m)
2. Correction Factor(dB/m) = Antenna Factor(dB/m) + Cable Factor(dB) – Pre-Amplifier Factor(dB)
3. The other emission levels were very low against the limit.
4. Margin value = Emission Level – Limit value
5. " * ": Fundamental frequency.

CHANNEL	TX Channel 6	DETECTOR FUNCTION	Peak (PK)
FREQUENCY RANGE	1GHz ~ 25GHz		Average (AV)

ANTENNA POLARITY & TEST DISTANCE: HORIZONTAL AT 3 M

NO.	FREQ. (MHz)	EMISSION LEVEL (dBuV/m)	LIMIT (dBuV/m)	MARGIN (dB)	ANTENNA HEIGHT (m)	TABLE ANGLE (Degree)	RAW VALUE (dBuV)	CORRECTION FACTOR (dB/m)
1	2390.00	51.8 PK	74.0	-22.2	1.25 H	84	57.40	-5.60
2	2390.00	41.6 AV	54.0	-12.4	1.25 H	84	47.20	-5.60
3	*2437.00	112.4 PK			1.30 H	89	117.82	-5.42
4	*2437.00	109.8 AV			1.30 H	89	115.22	-5.42
5	2491.00	52.3 PK	74.0	-21.7	1.41 H	81	57.48	-5.18
6	2491.00	41.8 AV	54.0	-12.2	1.41 H	81	46.98	-5.18
7	4874.00	51.8 PK	74.0	-22.2	1.47 H	62	47.99	3.81
8	4874.00	43.8 AV	54.0	-10.2	1.47 H	62	39.99	3.81
9	7311.00	54.3 PK	74.0	-19.7	1.00 H	50	46.07	8.23
10	7311.00	42.2 AV	54.0	-11.8	1.00 H	50	33.97	8.23

ANTENNA POLARITY & TEST DISTANCE: VERTICAL AT 3 M

NO.	FREQ. (MHz)	EMISSION LEVEL (dBuV/m)	LIMIT (dBuV/m)	MARGIN (dB)	ANTENNA HEIGHT (m)	TABLE ANGLE (Degree)	RAW VALUE (dBuV)	CORRECTION FACTOR (dB/m)
1	2390.00	59.8 PK	74.0	-14.2	1.19 V	333	65.40	-5.60
2	2390.00	53.2 AV	54.0	-0.8	1.19 V	333	58.80	-5.60
3	*2437.00	119.6 PK			1.41 V	336	125.02	-5.42
4	*2437.00	117.2 AV			1.41 V	336	122.62	-5.42
5	2491.00	58.9 PK	74.0	-15.1	1.13 V	330	64.08	-5.18
6	2491.00	46.5 AV	54.0	-7.5	1.13 V	330	51.68	-5.18
7	4874.00	53.1 PK	74.0	-20.9	1.46 V	106	49.29	3.81
8	4874.00	47.5 AV	54.0	-6.5	1.46 V	106	43.69	3.81
9	7311.00	52.4 PK	74.0	-21.6	1.45 V	12	44.17	8.23
10	7311.00	46.2 AV	54.0	-7.8	1.45 V	12	37.97	8.23

REMARKS:

1. Emission Level(dBuV/m) = Raw Value(dBuV) + Correction Factor(dB/m)
2. Correction Factor(dB/m) = Antenna Factor(dB/m) + Cable Factor(dB) – Pre-Amplifier Factor(dB)
3. The other emission levels were very low against the limit.
4. Margin value = Emission Level – Limit value
5. " * ": Fundamental frequency.

CHANNEL	TX Channel 11	DETECTOR FUNCTION	Peak (PK)
FREQUENCY RANGE	1GHz ~ 25GHz		Average (AV)

ANTENNA POLARITY & TEST DISTANCE: HORIZONTAL AT 3 M

NO.	FREQ. (MHz)	EMISSION LEVEL (dBuV/m)	LIMIT (dBuV/m)	MARGIN (dB)	ANTENNA HEIGHT (m)	TABLE ANGLE (Degree)	RAW VALUE (dBuV)	CORRECTION FACTOR (dB/m)
1	*2462.00	110.9 PK			1.32 H	91	116.21	-5.31
2	*2462.00	108.2 AV			1.32 H	91	113.51	-5.31
3	2483.50	51.5 PK	74.0	-22.5	1.32 H	91	56.70	-5.20
4	2483.50	41.5 AV	54.0	-12.5	1.32 H	91	46.70	-5.20
5	4924.00	48.3 PK	74.0	-25.7	1.47 H	66	44.50	3.80
6	4924.00	40.2 AV	54.0	-13.8	1.47 H	66	36.40	3.80
7	7386.00	51.2 PK	74.0	-22.8	1.03 H	47	42.65	8.55
8	7386.00	39.4 AV	54.0	-14.6	1.03 H	47	30.85	8.55

ANTENNA POLARITY & TEST DISTANCE: VERTICAL AT 3 M

NO.	FREQ. (MHz)	EMISSION LEVEL (dBuV/m)	LIMIT (dBuV/m)	MARGIN (dB)	ANTENNA HEIGHT (m)	TABLE ANGLE (Degree)	RAW VALUE (dBuV)	CORRECTION FACTOR (dB/m)
1	*2462.00	117.8 PK			1.15 V	330	123.11	-5.31
2	*2462.00	115.4 AV			1.15 V	330	120.71	-5.31
3	2483.50	58.7 PK	74.0	-15.3	1.15 V	330	63.90	-5.20
4	2483.50	53.1 AV	54.0	-0.9	1.15 V	330	58.30	-5.20
5	4924.00	50.6 PK	74.0	-23.4	1.36 V	115	46.80	3.80
6	4924.00	44.2 AV	54.0	-9.8	1.36 V	115	40.40	3.80
7	7386.00	49.7 PK	74.0	-24.3	1.49 V	9	41.15	8.55
8	7386.00	43.5 AV	54.0	-10.5	1.49 V	9	34.95	8.55

REMARKS:

1. Emission Level(dBuV/m) = Raw Value(dBuV) + Correction Factor(dB/m)
2. Correction Factor(dB/m) = Antenna Factor(dB/m) + Cable Factor(dB) – Pre-Amplifier Factor(dB)
3. The other emission levels were very low against the limit.
4. Margin value = Emission Level – Limit value
5. " * ": Fundamental frequency.

802.11g

CHANNEL	TX Channel 1	DETECTOR FUNCTION	Peak (PK)
FREQUENCY RANGE	1GHz ~ 25GHz		Average (AV)

ANTENNA POLARITY & TEST DISTANCE: HORIZONTAL AT 3 M								
NO.	FREQ. (MHz)	EMISSION LEVEL (dBuV/m)	LIMIT (dBuV/m)	MARGIN (dB)	ANTENNA HEIGHT (m)	TABLE ANGLE (Degree)	RAW VALUE (dBuV)	CORRECTION FACTOR (dB/m)
1	2390.00	64.4 PK	74.0	-9.6	1.30 H	93	70.00	-5.60
2	2390.00	45.5 AV	54.0	-8.5	1.30 H	93	51.10	-5.60
3	*2412.00	109.3 PK			1.30 H	93	114.83	-5.53
4	*2412.00	99.6 AV			1.30 H	93	105.13	-5.53
5	4824.00	46.7 PK	74.0	-27.3	1.47 H	77	42.84	3.86
6	4824.00	38.8 AV	54.0	-15.2	1.47 H	77	34.94	3.86
ANTENNA POLARITY & TEST DISTANCE: VERTICAL AT 3 M								
NO.	FREQ. (MHz)	EMISSION LEVEL (dBuV/m)	LIMIT (dBuV/m)	MARGIN (dB)	ANTENNA HEIGHT (m)	TABLE ANGLE (Degree)	RAW VALUE (dBuV)	CORRECTION FACTOR (dB/m)
1	2390.00	71.0 PK	74.0	-3.0	1.00 V	31	76.60	-5.60
2	2390.00	52.0 AV	54.0	-2.0	1.00 V	31	57.60	-5.60
3	*2412.00	116.7 PK			1.00 V	31	122.23	-5.53
4	*2412.00	107.1 AV			1.00 V	31	112.63	-5.53
5	4824.00	48.6 PK	74.0	-25.4	1.42 V	115	44.74	3.86
6	4824.00	42.8 AV	54.0	-11.2	1.42 V	115	38.94	3.86

REMARKS:

1. Emission Level(dBuV/m) = Raw Value(dBuV) + Correction Factor(dB/m)
2. Correction Factor(dB/m) = Antenna Factor(dB/m) + Cable Factor(dB) – Pre-Amplifier Factor(dB)
3. The other emission levels were very low against the limit.
4. Margin value = Emission Level – Limit value
5. " * ": Fundamental frequency.

CHANNEL	TX Channel 6	DETECTOR FUNCTION	Peak (PK)
FREQUENCY RANGE	1GHz ~ 25GHz		Average (AV)

ANTENNA POLARITY & TEST DISTANCE: HORIZONTAL AT 3 M

NO.	FREQ. (MHz)	EMISSION LEVEL (dBuV/m)	LIMIT (dBuV/m)	MARGIN (dB)	ANTENNA HEIGHT (m)	TABLE ANGLE (Degree)	RAW VALUE (dBuV)	CORRECTION FACTOR (dB/m)
1	2390.00	64.1 PK	74.0	-9.9	1.29 H	97	69.70	-5.60
2	2390.00	45.8 AV	54.0	-8.2	1.29 H	97	51.40	-5.60
3	*2437.00	114.2 PK			1.33 H	94	119.62	-5.42
4	*2437.00	104.8 AV			1.33 H	94	110.22	-5.42
5	4874.00	48.7 PK	74.0	-25.3	1.52 H	75	44.89	3.81
6	4874.00	40.4 AV	54.0	-13.6	1.52 H	75	36.59	3.81
7	7311.00	51.4 PK	74.0	-22.6	1.01 H	50	43.17	8.23
8	7311.00	39.9 AV	54.0	-14.1	1.01 H	50	31.67	8.23

ANTENNA POLARITY & TEST DISTANCE: VERTICAL AT 3 M

NO.	FREQ. (MHz)	EMISSION LEVEL (dBuV/m)	LIMIT (dBuV/m)	MARGIN (dB)	ANTENNA HEIGHT (m)	TABLE ANGLE (Degree)	RAW VALUE (dBuV)	CORRECTION FACTOR (dB/m)
1	2390.00	71.3 PK	74.0	-2.7	1.00 V	31	76.90	-5.60
2	2390.00	52.9 AV	54.0	-1.1	1.00 V	31	58.50	-5.60
3	*2437.00	121.8 PK			1.00 V	31	127.22	-5.42
4	*2437.00	112.1 AV			1.00 V	31	117.52	-5.42
5	4874.00	49.6 PK	74.0	-24.4	1.46 V	102	45.79	3.81
6	4874.00	44.2 AV	54.0	-9.8	1.46 V	102	40.39	3.81
7	7311.00	50.4 PK	74.0	-23.6	1.40 V	3	42.17	8.23
8	7311.00	43.5 AV	54.0	-10.5	1.40 V	3	35.27	8.23

REMARKS:

1. Emission Level(dBuV/m) = Raw Value(dBuV) + Correction Factor(dB/m)
2. Correction Factor(dB/m) = Antenna Factor(dB/m) + Cable Factor(dB) – Pre-Amplifier Factor(dB)
3. The other emission levels were very low against the limit.
4. Margin value = Emission Level – Limit value
5. " * ": Fundamental frequency.

CHANNEL	TX Channel 11	DETECTOR FUNCTION	Peak (PK)
FREQUENCY RANGE	1GHz ~ 25GHz		Average (AV)

ANTENNA POLARITY & TEST DISTANCE: HORIZONTAL AT 3 M

NO.	FREQ. (MHz)	EMISSION LEVEL (dBuV/m)	LIMIT (dBuV/m)	MARGIN (dB)	ANTENNA HEIGHT (m)	TABLE ANGLE (Degree)	RAW VALUE (dBuV)	CORRECTION FACTOR (dB/m)
1	*2462.00	110.4 PK			1.25 H	81	115.71	-5.31
2	*2462.00	101.1 AV			1.25 H	81	106.41	-5.31
3	2483.50	66.7 PK	74.0	-7.3	1.35 H	76	71.90	-5.20
4	2483.50	45.6 AV	54.0	-8.4	1.35 H	76	50.80	-5.20
5	4924.00	46.9 PK	74.0	-27.1	1.44 H	68	43.10	3.80
6	4924.00	38.9 AV	54.0	-15.1	1.44 H	68	35.10	3.80
7	7386.00	50.3 PK	74.0	-23.7	1.00 H	64	41.75	8.55
8	7386.00	38.6 AV	54.0	-15.4	1.00 H	64	30.05	8.55

ANTENNA POLARITY & TEST DISTANCE: VERTICAL AT 3 M

NO.	FREQ. (MHz)	EMISSION LEVEL (dBuV/m)	LIMIT (dBuV/m)	MARGIN (dB)	ANTENNA HEIGHT (m)	TABLE ANGLE (Degree)	RAW VALUE (dBuV)	CORRECTION FACTOR (dB/m)
1	*2462.00	117.7 PK			1.11 V	35	123.01	-5.31
2	*2462.00	108.4 AV			1.11 V	35	113.71	-5.31
3	2483.50	73.6 PK	74.0	-0.4	1.11 V	35	78.80	-5.20
4	2483.50	52.5 AV	54.0	-1.5	1.11 V	35	57.70	-5.20
5	4924.00	48.0 PK	74.0	-26.0	1.37 V	106	44.20	3.80
6	4924.00	42.5 AV	54.0	-11.5	1.37 V	106	38.70	3.80
7	7386.00	49.9 PK	74.0	-24.1	1.41 V	4	41.35	8.55
8	7386.00	42.1 AV	54.0	-11.9	1.41 V	4	33.55	8.55

REMARKS:

1. Emission Level(dBuV/m) = Raw Value(dBuV) + Correction Factor(dB/m)
2. Correction Factor(dB/m) = Antenna Factor(dB/m) + Cable Factor(dB) – Pre-Amplifier Factor(dB)
3. The other emission levels were very low against the limit.
4. Margin value = Emission Level – Limit value
5. " * ": Fundamental frequency.

802.11n (HT20)

CHANNEL	TX Channel 1	DETECTOR FUNCTION	Peak (PK)
FREQUENCY RANGE	1GHz ~ 25GHz		Average (AV)

ANTENNA POLARITY & TEST DISTANCE: HORIZONTAL AT 3 M								
NO.	FREQ. (MHz)	EMISSION LEVEL (dBuV/m)	LIMIT (dBuV/m)	MARGIN (dB)	ANTENNA HEIGHT (m)	TABLE ANGLE (Degree)	RAW VALUE (dBuV)	CORRECTION FACTOR (dB/m)
1	2390.00	66.3 PK	74.0	-7.7	1.33 H	84	71.90	-5.60
2	2390.00	46.0 AV	54.0	-8.0	1.33 H	84	51.60	-5.60
3	*2412.00	108.8 PK			1.29 H	87	114.33	-5.53
4	*2412.00	98.6 AV			1.29 H	87	104.13	-5.53
5	4824.00	46.1 PK	74.0	-27.9	1.44 H	75	42.24	3.86
6	4824.00	38.4 AV	54.0	-15.6	1.44 H	75	34.54	3.86
ANTENNA POLARITY & TEST DISTANCE: VERTICAL AT 3 M								
NO.	FREQ. (MHz)	EMISSION LEVEL (dBuV/m)	LIMIT (dBuV/m)	MARGIN (dB)	ANTENNA HEIGHT (m)	TABLE ANGLE (Degree)	RAW VALUE (dBuV)	CORRECTION FACTOR (dB/m)
1	2390.00	73.5 PK	74.0	-0.5	1.00 V	32	79.10	-5.60
2	2390.00	53.4 AV	54.0	-0.6	1.00 V	32	59.00	-5.60
3	*2412.00	115.9 PK			1.00 V	31	121.43	-5.53
4	*2412.00	106.0 AV			1.00 V	31	111.53	-5.53
5	4824.00	49.3 PK	74.0	-24.7	1.46 V	108	45.44	3.86
6	4824.00	43.3 AV	54.0	-10.7	1.46 V	108	39.44	3.86

REMARKS:

1. Emission Level(dBuV/m) = Raw Value(dBuV) + Correction Factor(dB/m)
2. Correction Factor(dB/m) = Antenna Factor(dB/m) + Cable Factor(dB) – Pre-Amplifier Factor(dB)
3. The other emission levels were very low against the limit.
4. Margin value = Emission Level – Limit value
5. " * ": Fundamental frequency.

CHANNEL	TX Channel 6	DETECTOR FUNCTION	Peak (PK)
FREQUENCY RANGE	1GHz ~ 25GHz		Average (AV)

ANTENNA POLARITY & TEST DISTANCE: HORIZONTAL AT 3 M

NO.	FREQ. (MHz)	EMISSION LEVEL (dBuV/m)	LIMIT (dBuV/m)	MARGIN (dB)	ANTENNA HEIGHT (m)	TABLE ANGLE (Degree)	RAW VALUE (dBuV)	CORRECTION FACTOR (dB/m)
1	2390.00	67.0 PK	74.0	-7.0	1.34 H	82	72.60	-5.60
2	2390.00	44.6 AV	54.0	-9.4	1.34 H	82	50.20	-5.60
3	*2437.00	113.2 PK			1.28 H	85	118.62	-5.42
4	*2437.00	103.4 AV			1.28 H	85	108.82	-5.42
5	2483.50	62.0 PK	74.0	-12.0	1.35 H	86	67.20	-5.20
6	2483.50	41.8 AV	54.0	-12.2	1.35 H	86	47.00	-5.20
7	4874.00	48.4 PK	74.0	-25.6	1.56 H	80	44.59	3.81
8	4874.00	40.3 AV	54.0	-13.7	1.56 H	80	36.49	3.81
9	7311.00	51.4 PK	74.0	-22.6	1.04 H	65	43.17	8.23
10	7311.00	40.0 AV	54.0	-14.0	1.04 H	65	31.77	8.23

ANTENNA POLARITY & TEST DISTANCE: VERTICAL AT 3 M

NO.	FREQ. (MHz)	EMISSION LEVEL (dBuV/m)	LIMIT (dBuV/m)	MARGIN (dB)	ANTENNA HEIGHT (m)	TABLE ANGLE (Degree)	RAW VALUE (dBuV)	CORRECTION FACTOR (dB/m)
1	2390.00	73.9 PK	74.0	-0.1	1.00 V	31	79.50	-5.60
2	2390.00	51.6 AV	54.0	-2.4	1.00 V	31	57.20	-5.60
3	*2437.00	120.3 PK			1.34 V	99	125.72	-5.42
4	*2437.00	110.8 AV			1.34 V	99	116.22	-5.42
5	2483.50	68.9 PK	74.0	-5.1	1.00 V	30	74.10	-5.20
6	2483.50	48.8 AV	54.0	-5.2	1.00 V	30	54.00	-5.20
7	4874.00	49.4 PK	74.0	-24.6	1.49 V	105	45.59	3.81
8	4874.00	44.2 AV	54.0	-9.8	1.49 V	105	40.39	3.81
9	7311.00	50.2 PK	74.0	-23.8	1.41 V	4	41.97	8.23
10	7311.00	43.2 AV	54.0	-10.8	1.41 V	4	34.97	8.23

REMARKS:

1. Emission Level(dBuV/m) = Raw Value(dBuV) + Correction Factor(dB/m)
2. Correction Factor(dB/m) = Antenna Factor(dB/m) + Cable Factor(dB) – Pre-Amplifier Factor(dB)
3. The other emission levels were very low against the limit.
4. Margin value = Emission Level – Limit value
5. " * ": Fundamental frequency.

CHANNEL	TX Channel 11	DETECTOR FUNCTION	Peak (PK)
FREQUENCY RANGE	1GHz ~ 25GHz		Average (AV)

ANTENNA POLARITY & TEST DISTANCE: HORIZONTAL AT 3 M

NO.	FREQ. (MHz)	EMISSION LEVEL (dBuV/m)	LIMIT (dBuV/m)	MARGIN (dB)	ANTENNA HEIGHT (m)	TABLE ANGLE (Degree)	RAW VALUE (dBuV)	CORRECTION FACTOR (dB/m)
1	*2462.00	108.9 PK			1.34 H	98	114.21	-5.31
2	*2462.00	99.8 AV			1.34 H	98	105.11	-5.31
3	2483.50	64.6 PK	74.0	-9.4	1.30 H	86	69.80	-5.20
4	2483.50	43.0 AV	54.0	-11.0	1.30 H	86	48.20	-5.20
5	4924.00	47.3 PK	74.0	-26.7	1.48 H	55	43.50	3.80
6	4924.00	39.2 AV	54.0	-14.8	1.48 H	55	35.40	3.80
7	7386.00	50.2 PK	74.0	-23.8	1.05 H	58	41.65	8.55
8	7386.00	38.7 AV	54.0	-15.3	1.05 H	58	30.15	8.55

ANTENNA POLARITY & TEST DISTANCE: VERTICAL AT 3 M

NO.	FREQ. (MHz)	EMISSION LEVEL (dBuV/m)	LIMIT (dBuV/m)	MARGIN (dB)	ANTENNA HEIGHT (m)	TABLE ANGLE (Degree)	RAW VALUE (dBuV)	CORRECTION FACTOR (dB/m)
1	*2462.00	116.4 PK			1.12 V	37	121.71	-5.31
2	*2462.00	107.2 AV			1.12 V	37	112.51	-5.31
3	2483.50	71.6 PK	74.0	-2.4	1.11 V	40	76.80	-5.20
4	2483.50	50.2 AV	54.0	-3.8	1.11 V	40	55.40	-5.20
5	4924.00	48.6 PK	74.0	-25.4	1.49 V	116	44.80	3.80
6	4924.00	42.8 AV	54.0	-11.2	1.49 V	116	39.00	3.80
7	7386.00	50.4 PK	74.0	-23.6	1.39 V	8	41.85	8.55
8	7386.00	42.5 AV	54.0	-11.5	1.39 V	8	33.95	8.55

REMARKS:

1. Emission Level(dBuV/m) = Raw Value(dBuV) + Correction Factor(dB/m)
2. Correction Factor(dB/m) = Antenna Factor(dB/m) + Cable Factor(dB) – Pre-Amplifier Factor(dB)
3. The other emission levels were very low against the limit.
4. Margin value = Emission Level – Limit value
5. " * ": Fundamental frequency.

802.11n (HT40)

CHANNEL	TX Channel 3	DETECTOR FUNCTION	Peak (PK)
FREQUENCY RANGE	1GHz ~ 25GHz		Average (AV)

ANTENNA POLARITY & TEST DISTANCE: HORIZONTAL AT 3 M

NO.	FREQ. (MHz)	EMISSION LEVEL (dBuV/m)	LIMIT (dBuV/m)	MARGIN (dB)	ANTENNA HEIGHT (m)	TABLE ANGLE (Degree)	RAW VALUE (dBuV)	CORRECTION FACTOR (dB/m)
1	2390.00	63.1 PK	74.0	-10.9	1.33 H	77	68.70	-5.60
2	2390.00	45.9 AV	54.0	-8.1	1.33 H	77	51.50	-5.60
3	*2422.00	102.6 PK			1.33 H	91	108.09	-5.49
4	*2422.00	93.0 AV			1.33 H	91	98.49	-5.49
5	4844.00	47.2 PK	74.0	-26.8	1.42 H	62	43.36	3.84
6	4844.00	39.2 AV	54.0	-14.8	1.42 H	62	35.36	3.84
7	7266.00	48.3 PK	74.0	-25.7	1.34 H	104	40.24	8.06
8	7266.00	40.2 AV	54.0	-13.8	1.34 H	104	32.14	8.06

ANTENNA POLARITY & TEST DISTANCE: VERTICAL AT 3 M

NO.	FREQ. (MHz)	EMISSION LEVEL (dBuV/m)	LIMIT (dBuV/m)	MARGIN (dB)	ANTENNA HEIGHT (m)	TABLE ANGLE (Degree)	RAW VALUE (dBuV)	CORRECTION FACTOR (dB/m)
1	2390.00	70.6 PK	74.0	-3.4	1.00 V	32	76.20	-5.60
2	2390.00	53.2 AV	54.0	-0.8	1.00 V	32	58.80	-5.60
3	*2422.00	109.8 PK			1.11 V	45	115.29	-5.49
4	*2422.00	100.4 AV			1.11 V	45	105.89	-5.49
5	4844.00	48.6 PK	74.0	-25.4	1.44 V	105	44.76	3.84
6	4844.00	40.6 AV	54.0	-13.4	1.44 V	105	36.76	3.84
7	7266.00	49.9 PK	74.0	-24.1	1.44 V	8	41.84	8.06
8	7266.00	41.5 AV	54.0	-12.5	1.44 V	8	33.44	8.06

REMARKS:

1. Emission Level(dBuV/m) = Raw Value(dBuV) + Correction Factor(dB/m)
2. Correction Factor(dB/m) = Antenna Factor(dB/m) + Cable Factor(dB) – Pre-Amplifier Factor(dB)
3. The other emission levels were very low against the limit.
4. Margin value = Emission Level – Limit value
5. " * ": Fundamental frequency.

CHANNEL	TX Channel 6	DETECTOR FUNCTION	Peak (PK)
FREQUENCY RANGE	1GHz ~ 25GHz		Average (AV)

ANTENNA POLARITY & TEST DISTANCE: HORIZONTAL AT 3 M

NO.	FREQ. (MHz)	EMISSION LEVEL (dBuV/m)	LIMIT (dBuV/m)	MARGIN (dB)	ANTENNA HEIGHT (m)	TABLE ANGLE (Degree)	RAW VALUE (dBuV)	CORRECTION FACTOR (dB/m)
1	2390.00	62.3 PK	74.0	-11.7	1.33 H	79	67.90	-5.60
2	2390.00	45.1 AV	54.0	-8.9	1.33 H	79	50.70	-5.60
3	*2437.00	106.6 PK			1.33 H	102	112.02	-5.42
4	*2437.00	97.4 AV			1.33 H	102	102.82	-5.42
5	2483.50	59.9 PK	74.0	-14.1	1.30 H	97	65.10	-5.20
6	2483.50	40.3 AV	54.0	-13.7	1.30 H	97	45.50	-5.20
7	4874.00	46.9 PK	74.0	-27.1	1.41 H	63	43.09	3.81
8	4874.00	38.9 AV	54.0	-15.1	1.41 H	63	35.09	3.81
9	7311.00	48.4 PK	74.0	-25.6	1.01 H	51	40.17	8.23
10	7311.00	40.4 AV	54.0	-13.6	1.01 H	51	32.17	8.23

ANTENNA POLARITY & TEST DISTANCE: VERTICAL AT 3 M

NO.	FREQ. (MHz)	EMISSION LEVEL (dBuV/m)	LIMIT (dBuV/m)	MARGIN (dB)	ANTENNA HEIGHT (m)	TABLE ANGLE (Degree)	RAW VALUE (dBuV)	CORRECTION FACTOR (dB/m)
1	2390.00	70.6 PK	74.0	-3.4	1.15 V	42	76.20	-5.60
2	2390.00	52.9 AV	54.0	-1.1	1.15 V	42	58.50	-5.60
3	*2437.00	113.8 PK			1.10 V	43	119.22	-5.42
4	*2437.00	104.3 AV			1.10 V	43	109.72	-5.42
5	2483.50	67.1 PK	74.0	-6.9	1.15 V	42	72.30	-5.20
6	2483.50	47.6 AV	54.0	-6.4	1.15 V	42	52.80	-5.20
7	4874.00	48.2 PK	74.0	-25.8	1.51 V	103	44.39	3.81
8	4874.00	40.5 AV	54.0	-13.5	1.51 V	103	36.69	3.81
9	7311.00	49.4 PK	74.0	-24.6	1.39 V	16	41.17	8.23
10	7311.00	41.1 AV	54.0	-12.9	1.39 V	16	32.87	8.23

REMARKS:

1. Emission Level(dBuV/m) = Raw Value(dBuV) + Correction Factor(dB/m)
2. Correction Factor(dB/m) = Antenna Factor(dB/m) + Cable Factor(dB) – Pre-Amplifier Factor(dB)
3. The other emission levels were very low against the limit.
4. Margin value = Emission Level – Limit value
5. " * ": Fundamental frequency.

CHANNEL	TX Channel 9	DETECTOR FUNCTION	Peak (PK)
FREQUENCY RANGE	1GHz ~ 25GHz		Average (AV)

ANTENNA POLARITY & TEST DISTANCE: HORIZONTAL AT 3 M

NO.	FREQ. (MHz)	EMISSION LEVEL (dBuV/m)	LIMIT (dBuV/m)	MARGIN (dB)	ANTENNA HEIGHT (m)	TABLE ANGLE (Degree)	RAW VALUE (dBuV)	CORRECTION FACTOR (dB/m)
1	*2452.00	106.5 PK			1.33 H	77	111.86	-5.36
2	*2452.00	96.7 AV			1.33 H	77	102.06	-5.36
3	2483.50	62.9 PK	74.0	-11.1	1.30 H	80	68.10	-5.20
4	2483.50	44.6 AV	54.0	-9.4	1.30 H	80	49.80	-5.20
5	4904.00	47.2 PK	74.0	-26.8	1.36 H	90	43.41	3.79
6	4904.00	39.3 AV	54.0	-14.7	1.36 H	90	35.51	3.79
7	7356.00	48.1 PK	74.0	-25.9	1.28 H	102	39.67	8.43
8	7356.00	40.2 AV	54.0	-13.8	1.28 H	102	31.77	8.43

ANTENNA POLARITY & TEST DISTANCE: VERTICAL AT 3 M

NO.	FREQ. (MHz)	EMISSION LEVEL (dBuV/m)	LIMIT (dBuV/m)	MARGIN (dB)	ANTENNA HEIGHT (m)	TABLE ANGLE (Degree)	RAW VALUE (dBuV)	CORRECTION FACTOR (dB/m)
1	*2452.00	112.7 PK			1.14 V	36	118.06	-5.36
2	*2452.00	103.2 AV			1.14 V	36	108.56	-5.36
3	2483.50	70.2 PK	74.0	-3.8	1.13 V	40	75.40	-5.20
4	2483.50	51.9 AV	54.0	-2.1	1.13 V	40	57.10	-5.20
5	4904.00	48.6 PK	74.0	-25.4	1.43 V	94	44.81	3.79
6	4904.00	40.8 AV	54.0	-13.2	1.43 V	94	37.01	3.79
7	7356.00	49.5 PK	74.0	-24.5	1.33 V	88	41.07	8.43
8	7356.00	41.4 AV	54.0	-12.6	1.33 V	88	32.97	8.43

REMARKS:

1. Emission Level(dBuV/m) = Raw Value(dBuV) + Correction Factor(dB/m)
2. Correction Factor(dB/m) = Antenna Factor(dB/m) + Cable Factor(dB) – Pre-Amplifier Factor(dB)
3. The other emission levels were very low against the limit.
4. Margin value = Emission Level – Limit value
5. " * ": Fundamental frequency.

BELOW 1GHz WORST-CASE DATA

802.11b

CHANNEL	TX Channel 6	DETECTOR FUNCTION	Quasi-Peak (QP)
FREQUENCY RANGE	Below 1GHz		

ANTENNA POLARITY & TEST DISTANCE: HORIZONTAL AT 3 M

NO.	FREQ. (MHz)	EMISSION LEVEL (dBuV/m)	LIMIT (dBuV/m)	MARGIN (dB)	ANTENNA HEIGHT (m)	TABLE ANGLE (Degree)	RAW VALUE (dBuV)	CORRECTION FACTOR (dB/m)
1	61.57	34.6 QP	40.0	-5.4	1.50 H	52	48.55	-13.96
2	223.90	38.3 QP	46.0	-7.7	1.50 H	348	54.03	-15.73
3	374.98	32.0 QP	46.0	-14.0	1.00 H	125	41.76	-9.78
4	562.48	37.6 QP	46.0	-8.4	1.50 H	0	43.00	-5.43
5	625.00	39.2 QP	46.0	-6.8	1.00 H	253	42.90	-3.68
6	687.51	32.6 QP	46.0	-13.4	1.00 H	325	35.49	-2.85

ANTENNA POLARITY & TEST DISTANCE: VERTICAL AT 3 M

NO.	FREQ. (MHz)	EMISSION LEVEL (dBuV/m)	LIMIT (dBuV/m)	MARGIN (dB)	ANTENNA HEIGHT (m)	TABLE ANGLE (Degree)	RAW VALUE (dBuV)	CORRECTION FACTOR (dB/m)
1	38.29	35.1 QP	40.0	-4.9	2.00 V	360	48.76	-13.64
2	62.35	36.9 QP	40.0	-3.1	1.00 V	341	50.94	-14.06
3	222.45	39.9 QP	46.0	-6.1	1.50 V	265	55.60	-15.73
4	562.48	37.9 QP	46.0	-8.1	1.00 V	188	43.35	-5.43
5	625.00	36.4 QP	46.0	-9.6	1.00 V	271	40.12	-3.68
6	895.24	40.8 QP	46.0	-5.2	1.00 V	302	40.12	0.65

REMARKS:

1. Emission Level(dBuV/m) = Raw Value(dBuV) + Correction Factor(dB/m)
2. Correction Factor(dB/m) = Antenna Factor(dB/m) + Cable Factor(dB) – Pre-Amplifier Factor(dB)
3. The other emission levels were very low against the limit.
4. Margin value = Emission Level – Limit value

4.2 Conducted Emission Measurement

4.2.1 Limits of Conducted Emission Measurement

Frequency (MHz)	Conducted Limit (dBuV)	
	Quasi-peak	Average
0.15 - 0.5	66 - 56	56 - 46
0.50 - 5.0	56	46
5.0 - 30.0	60	50

Note: 1. The lower limit shall apply at the transition frequencies.

2. The limit decreases in line with the logarithm of the frequency in the range of 0.15 to 0.50MHz.

4.2.2 Test Instruments

DESCRIPTION & MANUFACTURER	MODEL NO.	SERIAL NO.	CALIBRATED DATE	CALIBRATED UNTIL
Test Receiver ROHDE & SCHWARZ	ESCS 30	100375	Apr. 29, 2014	Apr. 28, 2015
Line-Impedance Stabilization Network (for EUT) SCHWARZBECK	NSLK-8127	8127-522	Sep. 15, 2014	Sep. 14, 2015
Line-Impedance Stabilization Network (for Peripheral) ROHDE & SCHWARZ	ENV216	100071	Nov. 10, 2014	Nov. 09, 2015
RF Cable (JYEBAO)	5DFB	COCCAB-001	Mar. 10, 2014	Mar. 09, 2015
50 ohms Terminator	N/A	EMC-03	Sep. 22, 2014	Sep. 21, 2015
50 ohms Terminator	N/A	EMC-02	Sep. 30, 2014	Sep. 29, 2015
Software ADT	BV ADT_Cond_V7.3.7. 3	NA	NA	NA

Note:

1. The calibration interval of the above test instruments is 12 months and the calibrations are traceable to NML/ROC and NIST/USA.
2. The test was performed in Shielded Room No. C.
3. The VCCI Con C Registration No. is C-3611.
4. Tested Date: Feb. 26, 2015

4.2.3 Test Procedures

- The EUT was placed 0.4 meters from the conducting wall of the shielded room with EUT being connected to the power mains through a line impedance stabilization network (LISN). Other support units were connected to the power mains through another LISN. The two LISNs provide 50 ohm/ 50uH of coupling impedance for the measuring instrument.
- Both lines of the power mains connected to the EUT were checked for maximum conducted interference.
- The frequency range from 150kHz to 30MHz was searched. Emission levels under (Limit - 20dB) was not recorded.

NOTE: The resolution bandwidth and video bandwidth of test receiver is 9kHz for quasi-peak detection (QP) and average detection (AV) at frequency 0.15MHz-30MHz.

4.2.4 Deviation from Test Standard

No deviation.

4.2.5 Test Setup

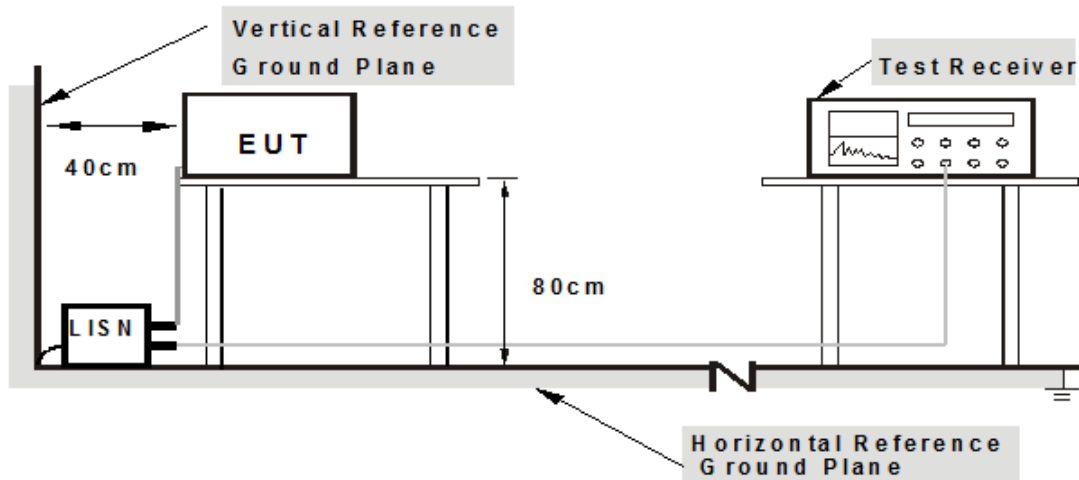

Note: 1. Support units were connected to second LISN.

For the actual test configuration, please refer to the attached file (Test Setup Photo).

4.2.6 EUT Operating Conditions

Same as 4.1.6.

4.2.7 Test Results (Mode 1)

Phase	Line (L)	Detector Function	Quasi-Peak (QP) / Average (AV)
-------	----------	-------------------	--------------------------------

No	Freq. [MHz]	Corr.	Reading Value		Emission Level		Limit		Margin	
		Factor	[dB (uV)]		[dB (uV)]		[dB (uV)]		(dB)	
	(dB)	Q.P.	AV.	Q.P.	AV.	Q.P.	AV.	Q.P.	AV.	
1	0.18516	0.07	54.33	40.00	54.40	40.07	64.25	54.25	-9.85	-14.18
2	0.23312	0.07	48.31	35.46	48.38	35.53	62.34	52.34	-13.95	-16.80
3	0.30234	0.08	38.81	26.48	38.89	26.56	60.18	50.18	-21.29	-23.62
4	0.53281	0.10	40.31	31.33	40.41	31.43	56.00	46.00	-15.59	-14.57
5	3.92578	0.25	31.07	19.48	31.32	19.73	56.00	46.00	-24.68	-26.27
6	14.31250	0.57	35.40	29.60	35.97	30.17	60.00	50.00	-24.03	-19.83

REMARKS:

1. Q.P. and AV. are abbreviations of quasi-peak and average individually.
2. The emission levels of other frequencies were very low against the limit.
3. Margin value = Emission level - Limit value
4. Correction factor = Insertion loss + Cable loss
5. Emission Level = Correction Factor + Reading Value.

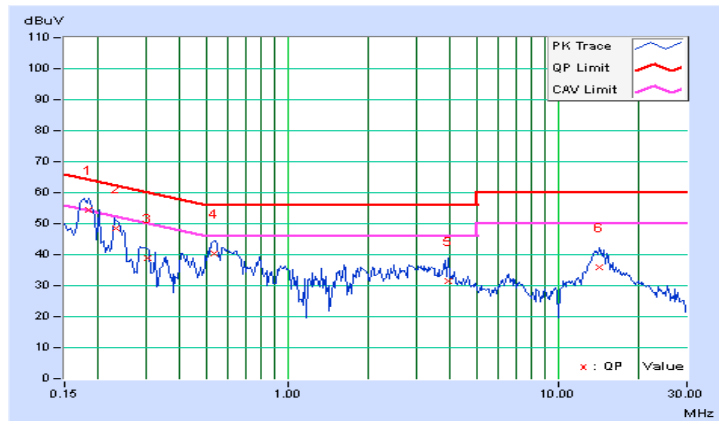

Phase	Neutral (N)	Detector Function	Quasi-Peak (QP) / Average (AV)
-------	-------------	-------------------	--------------------------------

No	Freq. [MHz]	Corr.	Reading Value		Emission Level		Limit		Margin	
		Factor	[dB (uV)]		[dB (uV)]		[dB (uV)]		(dB)	
		(dB)	Q.P.	AV.	Q.P.	AV.	Q.P.	AV.	Q.P.	AV.
1	0.17344	0.06	54.04	40.97	54.10	41.03	64.79	54.79	-10.69	-13.76
2	0.23203	0.06	47.45	35.37	47.51	35.43	62.38	52.38	-14.86	-16.94
3	0.52891	0.10	42.18	32.60	42.28	32.70	56.00	46.00	-13.72	-13.30
4	1.78125	0.17	33.80	20.62	33.97	20.79	56.00	46.00	-22.03	-25.21
5	3.99609	0.26	32.26	19.95	32.52	20.21	56.00	46.00	-23.48	-25.79
6	14.24609	0.59	34.34	28.47	34.93	29.06	60.00	50.00	-25.07	-20.94

REMARKS:

1. Q.P. and AV. are abbreviations of quasi-peak and average individually.
2. The emission levels of other frequencies were very low against the limit.
3. Margin value = Emission level - Limit value
4. Correction factor = Insertion loss + Cable loss
5. Emission Level = Correction Factor + Reading Value.

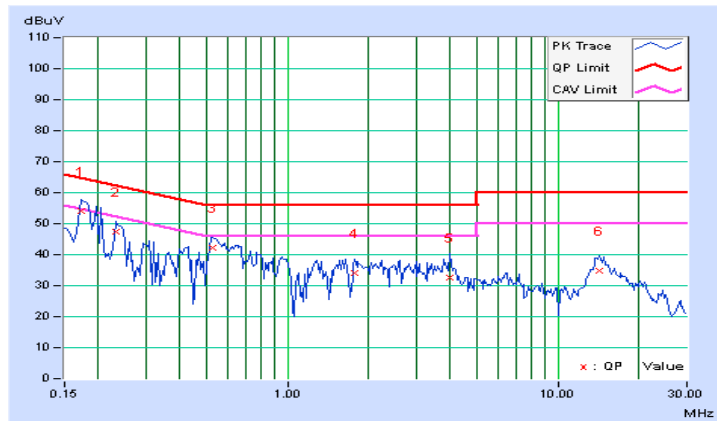

4.2.8 Test Results (Mode 2)

Phase	Line (L)	Detector Function	Quasi-Peak (QP) / Average (AV)
-------	----------	-------------------	--------------------------------

No	Freq. [MHz]	Corr.	Reading Value		Emission Level		Limit		Margin	
		Factor (dB)	[dB (uV)]		[dB (uV)]		[dB (uV)]		(dB)	
			Q.P.	AV.	Q.P.	AV.	Q.P.	AV.	Q.P.	AV.
1	0.16953	0.07	58.27	47.06	58.34	47.13	64.98	54.98	-6.65	-7.86
2	0.20078	0.07	48.41	19.81	48.48	19.88	63.58	53.58	-15.10	-33.70
3	0.23203	0.07	50.17	37.57	50.24	37.64	62.38	52.38	-12.13	-14.73
4	0.53672	0.10	40.06	27.44	40.16	27.54	56.00	46.00	-15.84	-18.46
5	2.75000	0.21	29.29	20.02	29.50	20.23	56.00	46.00	-26.50	-25.77
6	14.32422	0.57	34.87	29.51	35.44	30.08	60.00	50.00	-24.56	-19.92

REMARKS:

1. Q.P. and AV. are abbreviations of quasi-peak and average individually.
2. The emission levels of other frequencies were very low against the limit.
3. Margin value = Emission level - Limit value
4. Correction factor = Insertion loss + Cable loss
5. Emission Level = Correction Factor + Reading Value.

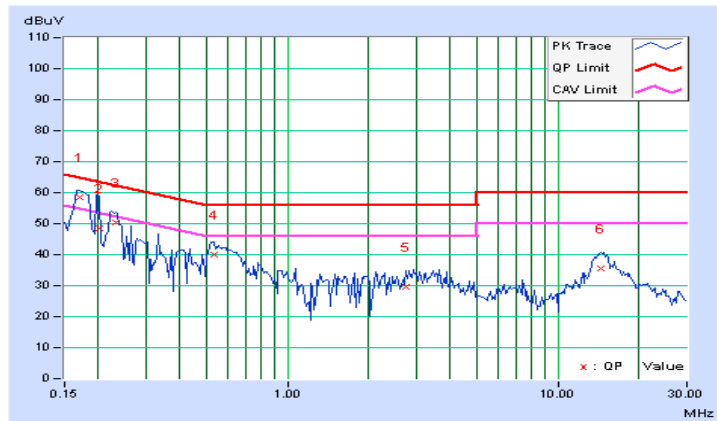

Phase	Neutral (N)	Detector Function	Quasi-Peak (QP) / Average (AV)
-------	-------------	-------------------	--------------------------------

No	Freq. [MHz]	Corr.	Reading Value		Emission Level		Limit		Margin	
		Factor	[dB (uV)]		[dB (uV)]		[dB (uV)]		(dB)	
		(dB)	Q.P.	AV.	Q.P.	AV.	Q.P.	AV.	Q.P.	AV.
1	0.16953	0.06	57.58	46.24	57.64	46.30	64.98	54.98	-7.34	-8.68
2	0.19687	0.06	47.82	19.83	47.88	19.89	63.74	53.74	-15.86	-33.85
3	0.23203	0.06	49.48	38.28	49.54	38.34	62.38	52.38	-12.83	-14.03
4	0.54453	0.10	40.40	22.59	40.50	22.69	56.00	46.00	-15.50	-23.31
5	3.84766	0.25	31.85	20.95	32.10	21.20	56.00	46.00	-23.90	-24.80
6	15.03906	0.61	32.82	26.59	33.43	27.20	60.00	50.00	-26.57	-22.80

REMARKS:

1. Q.P. and AV. are abbreviations of quasi-peak and average individually.
2. The emission levels of other frequencies were very low against the limit.
3. Margin value = Emission level - Limit value
4. Correction factor = Insertion loss + Cable loss
5. Emission Level = Correction Factor + Reading Value.

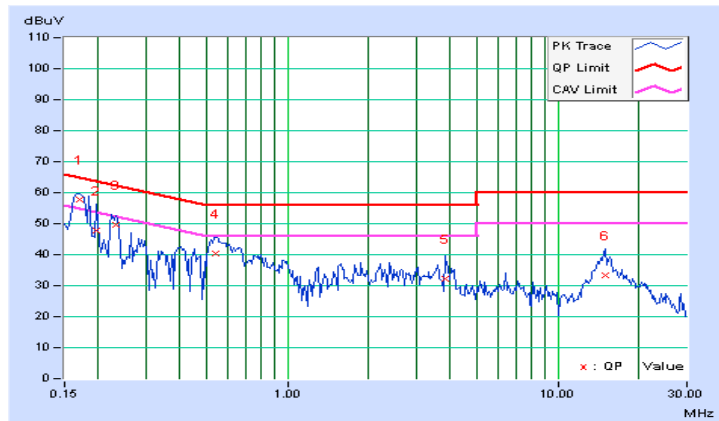

4.2.9 Test Results (Mode 3)

Phase	Line (L)	Detector Function	Quasi-Peak (QP) / Average (AV)
-------	----------	-------------------	--------------------------------

No	Freq. [MHz]	Corr.	Reading Value		Emission Level		Limit		Margin	
		Factor	[dB (uV)]		[dB (uV)]		[dB (uV)]		(dB)	
	(dB)	Q.P.	AV.	Q.P.	AV.	Q.P.	AV.	Q.P.	AV.	
1	0.15000	0.07	47.69	35.12	47.76	35.19	66.00	56.00	-18.24	-20.81
2	0.18906	0.07	42.68	28.21	42.75	28.28	64.08	54.08	-21.33	-25.80
3	0.31797	0.08	33.35	17.71	33.43	17.79	59.76	49.76	-26.33	-31.97
4	0.91563	0.12	11.06	3.11	11.18	3.23	56.00	46.00	-44.82	-42.77
5	7.14844	0.35	19.32	14.42	19.67	14.77	60.00	50.00	-40.33	-35.23
6	13.43750	0.54	21.03	16.73	21.57	17.27	60.00	50.00	-38.43	-32.73

REMARKS:

1. Q.P. and AV. are abbreviations of quasi-peak and average individually.
2. The emission levels of other frequencies were very low against the limit.
3. Margin value = Emission level - Limit value
4. Correction factor = Insertion loss + Cable loss
5. Emission Level = Correction Factor + Reading Value.

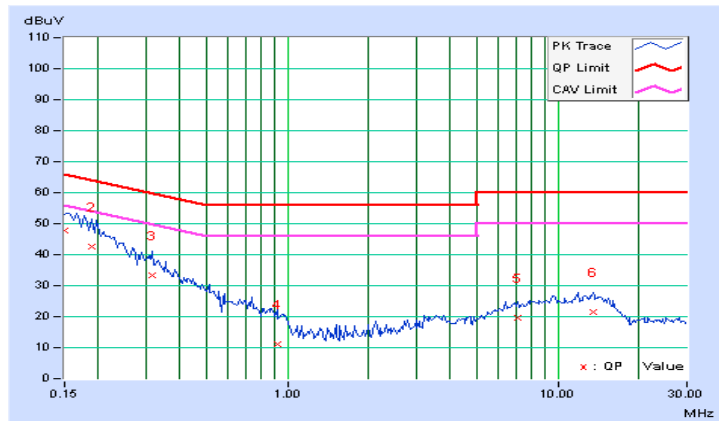

Phase	Neutral (N)	Detector Function	Quasi-Peak (QP) / Average (AV)
-------	-------------	-------------------	--------------------------------

No	Freq. [MHz]	Corr.	Reading Value		Emission Level		Limit		Margin	
		Factor	[dB (uV)]		[dB (uV)]		[dB (uV)]		(dB)	
		(dB)	Q.P.	AV.	Q.P.	AV.	Q.P.	AV.	Q.P.	AV.
1	0.18906	0.06	43.21	28.93	43.27	28.99	64.08	54.08	-20.81	-25.09
2	0.22812	0.06	40.57	29.68	40.63	29.74	62.52	52.52	-21.88	-22.77
3	0.31797	0.08	38.22	28.91	38.30	28.99	59.76	49.76	-21.46	-20.77
4	0.48203	0.10	20.51	9.01	20.61	9.11	56.30	46.30	-35.70	-37.20
5	3.70313	0.25	15.92	10.43	16.17	10.68	56.00	46.00	-39.83	-35.32
6	9.96094	0.46	19.45	14.91	19.91	15.37	60.00	50.00	-40.09	-34.63

REMARKS:

1. Q.P. and AV. are abbreviations of quasi-peak and average individually.
2. The emission levels of other frequencies were very low against the limit.
3. Margin value = Emission level - Limit value
4. Correction factor = Insertion loss + Cable loss
5. Emission Level = Correction Factor + Reading Value.

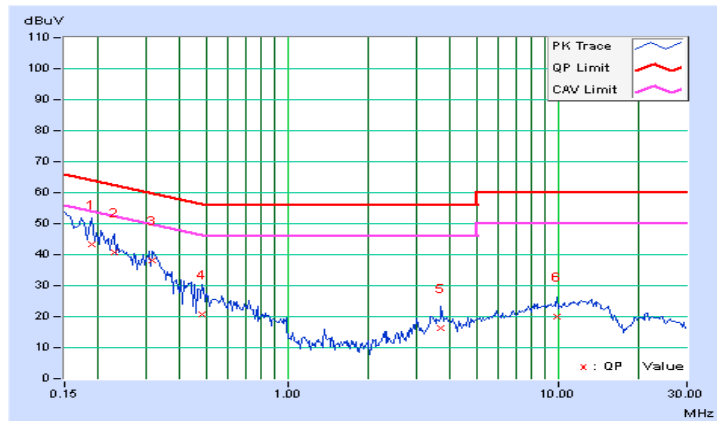

4.2.10 Test Results (Mode 4)

Phase	Line (L)	Detector Function	Quasi-Peak (QP) / Average (AV)
-------	----------	-------------------	--------------------------------

No	Freq. [MHz]	Corr.	Reading Value		Emission Level		Limit		Margin	
		Factor	[dB (uV)]		[dB (uV)]		[dB (uV)]		(dB)	
	(dB)	Q.P.	AV.	Q.P.	AV.	Q.P.	AV.	Q.P.	AV.	
1	0.15781	0.07	49.08	35.65	49.15	35.72	65.58	55.58	-16.43	-19.86
2	0.20859	0.07	42.91	30.08	42.98	30.15	63.26	53.26	-20.28	-23.11
3	0.32188	0.08	33.34	16.54	33.42	16.62	59.66	49.66	-26.24	-33.04
4	0.73594	0.11	30.71	22.73	30.82	22.84	56.00	46.00	-25.18	-23.16
5	3.91406	0.25	15.02	9.06	15.27	9.31	56.00	46.00	-40.73	-36.69
6	12.18750	0.51	21.62	17.31	22.13	17.82	60.00	50.00	-37.87	-32.18

REMARKS:

1. Q.P. and AV. are abbreviations of quasi-peak and average individually.
2. The emission levels of other frequencies were very low against the limit.
3. Margin value = Emission level - Limit value
4. Correction factor = Insertion loss + Cable loss
5. Emission Level = Correction Factor + Reading Value.

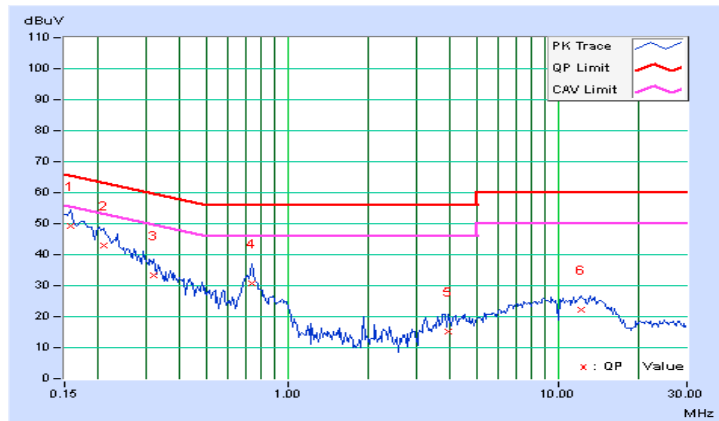

Phase	Neutral (N)	Detector Function	Quasi-Peak (QP) / Average (AV)
-------	-------------	-------------------	--------------------------------

No	Freq. [MHz]	Corr.	Reading Value		Emission Level		Limit		Margin	
		Factor	[dB (uV)]		[dB (uV)]		[dB (uV)]		(dB)	
	(dB)	Q.P.	AV.	Q.P.	AV.	Q.P.	AV.	Q.P.	AV.	
1	0.16562	0.06	46.79	32.39	46.85	32.45	65.18	55.18	-18.32	-22.72
2	0.31406	0.08	39.54	33.29	39.62	33.37	59.86	49.86	-20.25	-16.50
3	0.44688	0.09	23.73	13.59	23.82	13.68	56.93	46.93	-33.11	-33.25
4	0.73984	0.11	19.59	11.31	19.70	11.42	56.00	46.00	-36.30	-34.58
5	3.52344	0.24	16.70	10.53	16.94	10.77	56.00	46.00	-39.06	-35.23
6	12.46484	0.53	20.89	16.45	21.42	16.98	60.00	50.00	-38.58	-33.02

REMARKS:

1. Q.P. and AV. are abbreviations of quasi-peak and average individually.
2. The emission levels of other frequencies were very low against the limit.
3. Margin value = Emission level - Limit value
4. Correction factor = Insertion loss + Cable loss
5. Emission Level = Correction Factor + Reading Value.

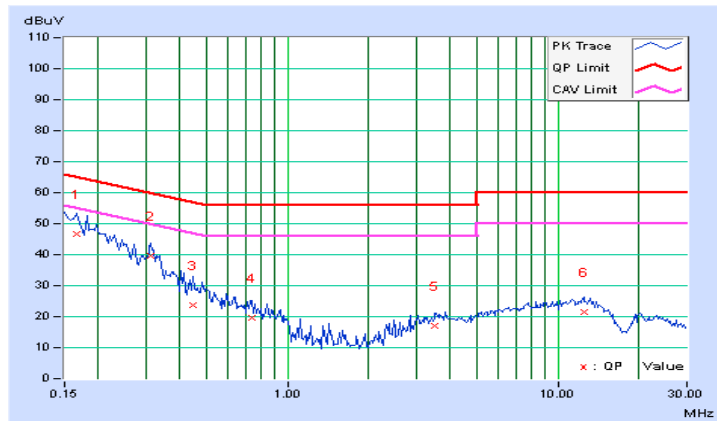

4.2.11 Test Results (Mode 5)

Phase	Line (L)	Detector Function	Quasi-Peak (QP) / Average (AV)
-------	----------	-------------------	--------------------------------

No	Freq. [MHz]	Corr.	Reading Value		Emission Level		Limit		Margin	
		Factor	[dB (uV)]		[dB (uV)]		[dB (uV)]		(dB)	
	(dB)	Q.P.	AV.	Q.P.	AV.	Q.P.	AV.	Q.P.	AV.	
1	0.16953	0.07	49.52	31.53	49.59	31.60	64.98	54.98	-15.40	-23.39
2	0.23203	0.07	41.95	26.39	42.02	26.46	62.38	52.38	-20.35	-25.91
3	0.32188	0.08	36.47	25.52	36.55	25.60	59.66	49.66	-23.11	-24.06
4	0.51328	0.10	27.80	15.02	27.90	15.12	56.00	46.00	-28.10	-30.88
5	4.71484	0.27	24.38	12.57	24.65	12.84	56.00	46.00	-31.35	-33.16
6	9.41016	0.43	26.22	15.47	26.65	15.90	60.00	50.00	-33.35	-34.10

REMARKS:

1. Q.P. and AV. are abbreviations of quasi-peak and average individually.
2. The emission levels of other frequencies were very low against the limit.
3. Margin value = Emission level - Limit value
4. Correction factor = Insertion loss + Cable loss
5. Emission Level = Correction Factor + Reading Value.

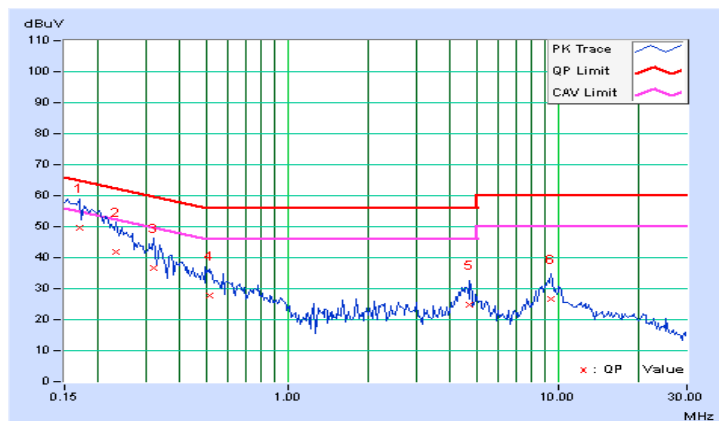

Phase	Neutral (N)	Detector Function	Quasi-Peak (QP) / Average (AV)
-------	-------------	-------------------	--------------------------------

No	Freq. [MHz]	Corr.	Reading Value		Emission Level		Limit		Margin	
		Factor	[dB (uV)]		[dB (uV)]		[dB (uV)]		(dB)	
		(dB)	Q.P.	AV.	Q.P.	AV.	Q.P.	AV.	Q.P.	AV.
1	0.16562	0.06	50.03	32.15	50.09	32.21	65.18	55.18	-15.08	-22.96
2	0.24766	0.07	41.47	26.49	41.54	26.56	61.84	51.84	-20.30	-25.28
3	0.36484	0.08	30.89	17.55	30.97	17.63	58.62	48.62	-27.64	-30.98
4	0.52891	0.10	22.26	8.92	22.36	9.02	56.00	46.00	-33.64	-36.98
5	4.57813	0.28	22.46	10.31	22.74	10.59	56.00	46.00	-33.26	-35.41
6	9.64453	0.45	25.46	14.58	25.91	15.03	60.00	50.00	-34.09	-34.97

REMARKS:

1. Q.P. and AV. are abbreviations of quasi-peak and average individually.
2. The emission levels of other frequencies were very low against the limit.
3. Margin value = Emission level - Limit value
4. Correction factor = Insertion loss + Cable loss
5. Emission Level = Correction Factor + Reading Value.

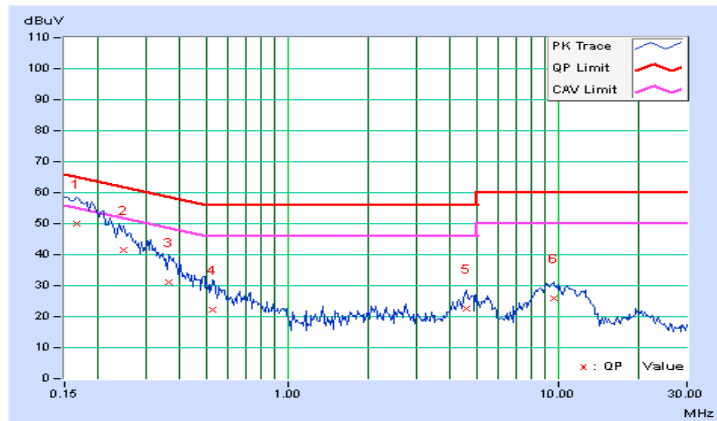

4.2.12 Test Results (Mode 6)

Phase	Line (L)	Detector Function	Quasi-Peak (QP) / Average (AV)
-------	----------	-------------------	--------------------------------

No	Freq. [MHz]	Corr.	Reading Value		Emission Level		Limit		Margin	
		Factor	[dB (uV)]		[dB (uV)]		[dB (uV)]		(dB)	
	(dB)	Q.P.	AV.	Q.P.	AV.	Q.P.	AV.	Q.P.	AV.	
1	0.16172	0.07	54.74	35.24	54.81	35.31	65.38	55.38	-10.57	-20.07
2	0.20859	0.07	49.07	31.50	49.14	31.57	63.26	53.26	-14.12	-21.69
3	0.23984	0.07	44.96	28.37	45.03	28.44	62.10	52.10	-17.07	-23.66
4	0.32578	0.08	37.97	25.06	38.05	25.14	59.56	49.56	-21.51	-24.42
5	4.70313	0.27	24.82	12.51	25.09	12.78	56.00	46.00	-30.91	-33.22
6	9.80469	0.44	25.48	14.32	25.92	14.76	60.00	50.00	-34.08	-35.24

REMARKS:

1. Q.P. and AV. are abbreviations of quasi-peak and average individually.
2. The emission levels of other frequencies were very low against the limit.
3. Margin value = Emission level - Limit value
4. Correction factor = Insertion loss + Cable loss
5. Emission Level = Correction Factor + Reading Value.

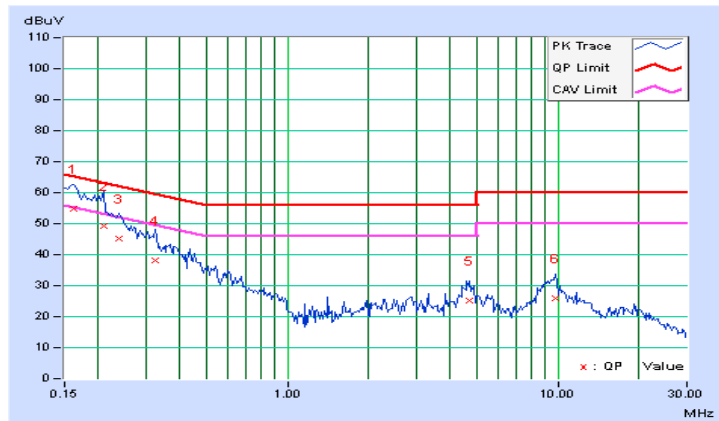

Phase	Neutral (N)	Detector Function	Quasi-Peak (QP) / Average (AV)
-------	-------------	-------------------	--------------------------------

No	Freq. [MHz]	Corr.	Reading Value		Emission Level		Limit		Margin	
		Factor	[dB (uV)]		[dB (uV)]		[dB (uV)]		(dB)	
		(dB)	Q.P.	AV.	Q.P.	AV.	Q.P.	AV.	Q.P.	AV.
1	0.16172	0.06	53.75	34.82	53.81	34.88	65.38	55.38	-11.56	-20.49
2	0.26719	0.07	40.95	25.66	41.02	25.73	61.20	51.20	-20.18	-25.47
3	0.37656	0.09	31.91	16.91	32.00	17.00	58.35	48.35	-26.36	-31.36
4	0.54453	0.10	22.76	7.60	22.86	7.70	56.00	46.00	-33.14	-38.30
5	5.18359	0.30	20.76	7.49	21.06	7.79	60.00	50.00	-38.94	-42.21
6	9.00000	0.43	25.71	14.41	26.14	14.84	60.00	50.00	-33.86	-35.16

REMARKS:

1. Q.P. and AV. are abbreviations of quasi-peak and average individually.
2. The emission levels of other frequencies were very low against the limit.
3. Margin value = Emission level - Limit value
4. Correction factor = Insertion loss + Cable loss
5. Emission Level = Correction Factor + Reading Value.

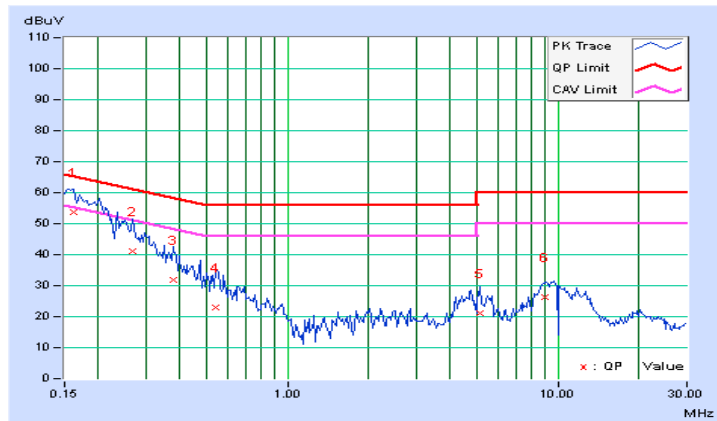

4.3 6dB Bandwidth Measurement

4.3.1 Limits of 6dB Bandwidth Measurement

The minimum of 6dB Bandwidth Measurement is 0.5 MHz.

4.3.2 Test Setup

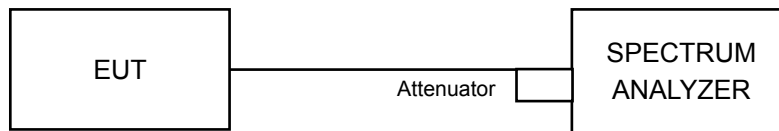

4.3.3 Test Instruments

Refer to section 4.1.2 to get information of above instrument.

4.3.4 Test Procedures

- a. Set resolution bandwidth (RBW) = 100kHz
- b. Set the video bandwidth (VBW) $\geq 3 \times$ RBW, Detector = Peak.
- c. Trace mode = max hold.
- d. Sweep = auto couple.
- e. Measure the maximum width of the emission that is constrained by the frequencies associated with the two amplitude points (upper and lower) that are attenuated by 6 dB relative to the maximum level measured in the fundamental emission

4.3.5 Deviation from Test Standard

No deviation.

4.3.6 EUT Operating Conditions

The software provided by client to enable the EUT under transmission condition continuously at lowest, middle and highest channel frequencies individually.

4.3.7 Test Results
802.11b

CHANNEL	FREQUENCY (MHz)	6dB BANDWIDTH (MHz)		MINIMUM LIMIT (MHz)	PASS / FAIL
		CHAIN 0	CHAIN 1		
1	2412	9.73	9.73	0.5	PASS
6	2437	10.07	10.07	0.5	PASS
11	2462	9.74	9.73	0.5	PASS

802.11g

CHANNEL	FREQUENCY (MHz)	6dB BANDWIDTH (MHz)		MINIMUM LIMIT (MHz)	PASS / FAIL
		CHAIN 0	CHAIN 1		
1	2412	16.60	16.58	0.5	PASS
6	2437	16.59	16.61	0.5	PASS
11	2462	16.61	16.61	0.5	PASS

802.11n (HT20)

CHANNEL	FREQUENCY (MHz)	6dB BANDWIDTH (MHz)		MINIMUM LIMIT (MHz)	PASS / FAIL
		CHAIN 0	CHAIN 1		
1	2412	17.71	17.70	0.5	PASS
6	2437	17.72	17.74	0.5	PASS
11	2462	17.72	17.73	0.5	PASS

802.11n (HT40)

CHANNEL	FREQUENCY (MHz)	6dB BANDWIDTH (MHz)		MINIMUM LIMIT (MHz)	PASS / FAIL
		CHAIN 0	CHAIN 1		
3	2422	36.54	36.56	0.5	PASS
6	2437	36.54	36.56	0.5	PASS
9	2452	36.55	36.54	0.5	PASS

SPECTRUM PLOT OF WORST VALUE

802.11b / Chain 0 : CH1

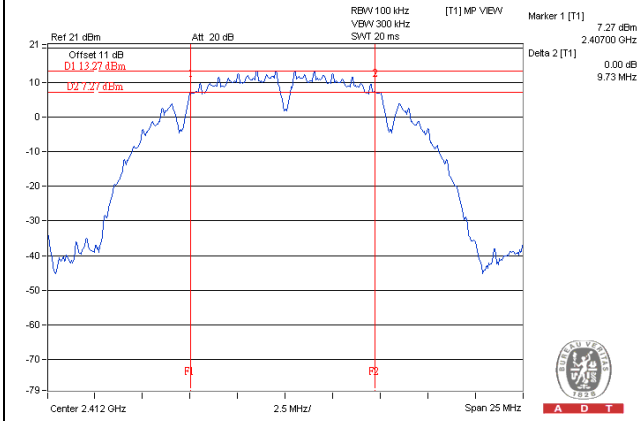

802.11g / Chain 1 : CH1

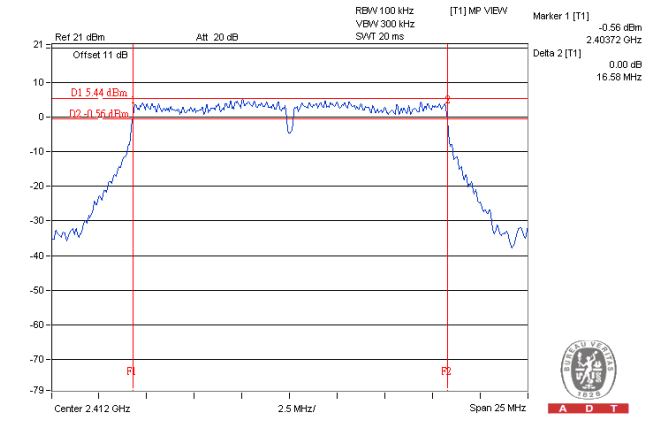

802.11n (HT20) / Chain 1 : CH1

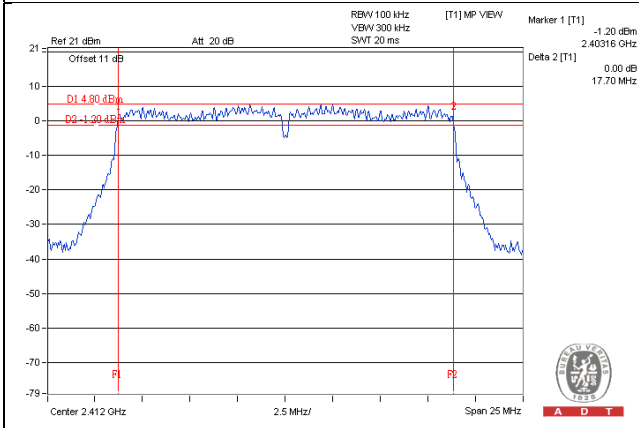

802.11n (HT40) / Chain 0 : CH3

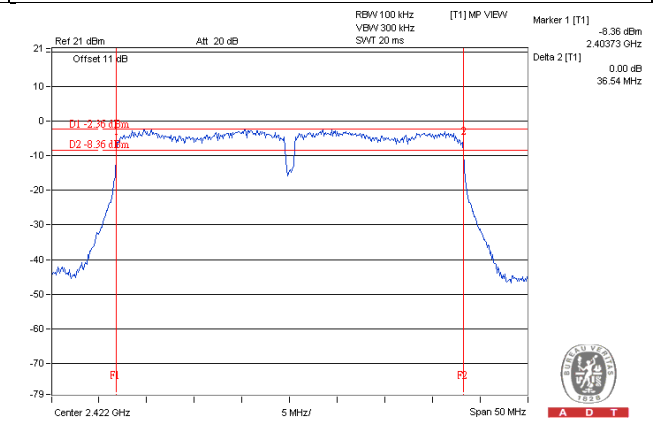

4.4 Conducted Output Power Measurement

4.4.1 Limits of Conducted Output Power Measurement

For systems using digital modulation in the 2400–2483.5 MHz bands: 1 Watt (30dBm)

Per KDB 662911 D01 Multiple Transmitter Output Method of conducted output power measurement on IEEE 802.11 devices,

Array Gain = 0 dB (i.e., no array gain) for $NANT \leq 4$;

Array Gain = 0 dB (i.e., no array gain) for channel widths ≥ 40 MHz for any NANT;

Array Gain = $5 \log(NANT/NSS)$ dB or 3 dB, whichever is less for 20-MHz channel widths with $NANT \geq 5$.

For power measurements on all other devices: Array Gain = $10 \log(NANT/NSS)$ dB.

4.4.2 Test Setup

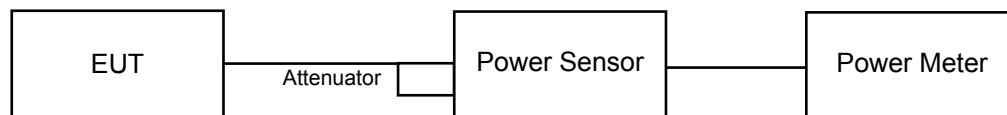

4.4.3 Test Instruments

Refer to section 4.1.2 to get information of above instrument.

4.4.4 Test Procedures

The average power sensor was used on the output port of the EUT. A power meter was used to read the response of the average power sensor. Record the average power level.

4.4.5 Deviation from Test Standard

No deviation.

4.4.6 EUT Operating Conditions

Same as Item 4.3.6.

4.4.7 Test Results

802.11b

CHANNEL	FREQUENCY (MHz)	AVERAGE POWER (dBm)		TOTAL POWER (mW)	TOTAL POWER (dBm)	LIMIT (dBm)	PASS / FAIL
		CHAIN 0	CHAIN 1				
1	2412	25.01	24.64	608.029	27.84	30	PASS
6	2437	26.85	26.57	938.114	29.72	30	PASS
11	2462	24.91	24.65	601.485	27.79	30	PASS

802.11g

CHANNEL	FREQUENCY (MHz)	AVERAGE POWER (dBm)		TOTAL POWER (mW)	TOTAL POWER (dBm)	LIMIT (dBm)	PASS / FAIL
		CHAIN 0	CHAIN 1				
1	2412	20.01	19.64	192.276	22.84	30	PASS
6	2437	25.42	25.07	669.703	28.26	30	PASS
11	2462	20.67	20.59	231.232	23.64	30	PASS

NOTE: Directional gain = $10 \log[(10^{G1/20} + 10^{G2/20})^2 / 2] = 4.51\text{dBi} < 6\text{dBi}$, so the power limit shall not be reduced.

802.11n (HT20)

CHANNEL	FREQUENCY (MHz)	AVERAGE POWER (dBm)		TOTAL POWER (mW)	TOTAL POWER (dBm)	LIMIT (dBm)	PASS / FAIL
		CHAIN 0	CHAIN 1				
1	2412	19.36	19.21	169.666	22.30	30	PASS
6	2437	24.82	24.65	595.132	27.75	30	PASS
11	2462	19.69	19.62	184.733	22.67	30	PASS

NOTE: Directional gain = $10 \log[(10^{G1/20} + 10^{G2/20})^2 / 2] = 4.51\text{dBi} < 6\text{dBi}$, so the power limit shall not be reduced.

802.11n (HT40)

CHANNEL	FREQUENCY (MHz)	AVERAGE POWER (dBm)		TOTAL POWER (mW)	TOTAL POWER (dBm)	LIMIT (dBm)	PASS / FAIL
		CHAIN 0	CHAIN 1				
3	2422	16.02	15.96	79.440	19.00	30	PASS
6	2437	19.81	19.65	187.976	22.74	30	PASS
9	2452	19.04	18.93	158.331	22.00	30	PASS

NOTE: Directional gain = $10 \log[(10^{G1/20} + 10^{G2/20})^2 / 2] = 4.51\text{dBi} < 6\text{dBi}$, so the power limit shall not be reduced.

4.5 Power Spectral Density Measurement

4.5.1 Limits of Power Spectral Density Measurement

The Maximum of Power Spectral Density Measurement is 8dBm.

4.5.2 Test Setup

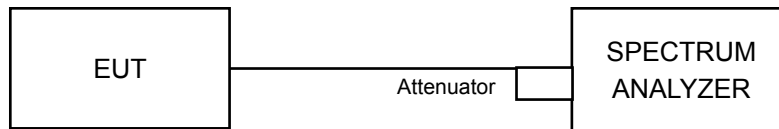

4.5.3 Test Instruments

Refer to section 4.1.2 to get information of above instrument.

4.5.4 Test Procedures

- Set the RBW = 10 kHz, VBW =30 kHz, Detector = power averaging (RMS).
- Ensure that the number of measurement points in the sweep $\geq 2 \times \text{span/RBW}$
- Sweep time = auto couple,
- Employ trace averaging (RMS) mode over a minimum of 100 traces.
- Use the peak marker function to determine the maximum amplitude level.

4.5.5 Deviation from Test Standard

No deviation.

4.5.6 EUT Operating Conditions

Same as Item 4.3.6

4.5.7 Test Results

802.11b

TX chain	Channel	Freq. (MHz)	PSD (dBm)	10 log (N=2) dB	Total PSD (dBm)	Limit (dBm)	PASS /FAIL
0	1	2412	-3.88	3.01	-0.87	8.00	PASS
	6	2437	-2.35	3.01	0.66	8.00	PASS
	11	2462	-3.55	3.01	-0.54	8.00	PASS
1	1	2412	-4.53	3.01	-1.52	8.00	PASS
	6	2437	-2.35	3.01	0.66	8.00	PASS
	11	2462	-4.09	3.01	-1.08	8.00	PASS

NOTE: Directional gain = $10 \log[(10^{G1/20} + 10^{G2/20})^2 / 2] = 4.51 \text{dBi} < 6 \text{dBi}$, so the power limit shall not be reduced.

802.11g

TX chain	Channel	Freq. (MHz)	PSD (dBm)	10 log (N=2) dB	Total PSD (dBm)	Limit (dBm)	PASS /FAIL
0	1	2412	-10.24	3.01	-7.23	8.00	PASS
	6	2437	-5.55	3.01	-2.54	8.00	PASS
	11	2462	-9.60	3.01	-6.59	8.00	PASS
1	1	2412	-10.40	3.01	-7.39	8.00	PASS
	6	2437	-4.84	3.01	-1.83	8.00	PASS
	11	2462	-9.17	3.01	-6.16	8.00	PASS

NOTE: Directional gain = $10 \log[(10^{G1/20} + 10^{G2/20})^2 / 2] = 4.51 \text{dBi} < 6 \text{dBi}$, so the power limit shall not be reduced.

802.11n (HT20)

TX chain	Channel	Freq. (MHz)	PSD (dBm)	10 log (N=2) dB	Total PSD (dBm)	Limit (dBm)	PASS /FAIL
0	1	2412	-11.16	3.01	-8.15	8.00	PASS
	6	2437	-5.50	3.01	-2.49	8.00	PASS
	11	2462	-10.46	3.01	-7.45	8.00	PASS
1	1	2412	-10.61	3.01	-7.60	8.00	PASS
	6	2437	-5.47	3.01	-2.46	8.00	PASS
	11	2462	-10.43	3.01	-7.42	8.00	PASS

NOTE: Directional gain = $10 \log[(10^{G1/20} + 10^{G2/20})^2 / 2] = 4.51 \text{dBi} < 6 \text{dBi}$, so the power limit shall not be reduced.

802.11n (HT40)

TX chain	Channel	Freq. (MHz)	PSD (dBm)	10 log (N=2) dB	Total PSD (dBm)	Limit (dBm)	PASS /FAIL
0	3	2422	-17.37	3.01	-14.36	8.00	PASS
	6	2437	-12.45	3.01	-9.44	8.00	PASS
	9	2452	-14.21	3.01	-11.20	8.00	PASS
1	3	2422	-17.73	3.01	-14.72	8.00	PASS
	6	2437	-13.24	3.01	-10.23	8.00	PASS
	9	2452	-14.13	3.01	-11.12	8.00	PASS

NOTE: Directional gain = $10 \log[(10^{G1/20} + 10^{G2/20})^2 / 2] = 4.51 \text{dBi} < 6 \text{dBi}$, so the power limit shall not be reduced.

SPECTRUM PLOT OF WORST VALUE

802.11b / Chain 0 : CH6

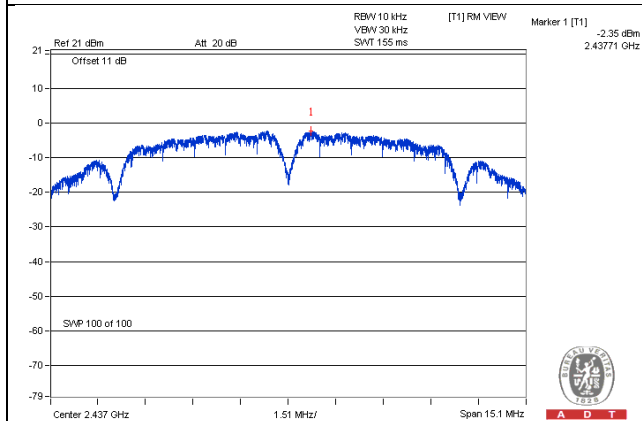

802.11g / Chain 1 : CH6

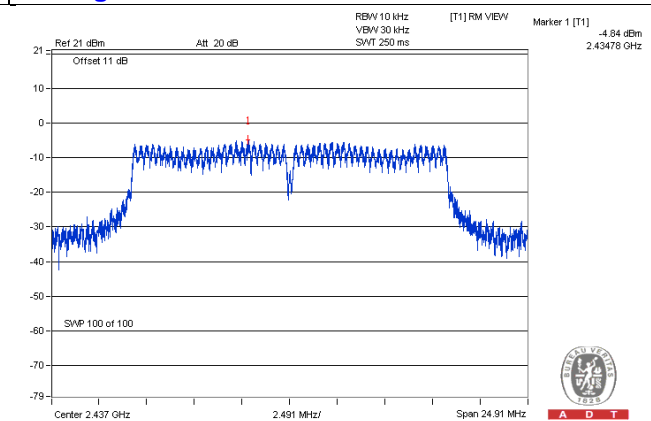

802.11n (HT20) / Chain 1 : CH6

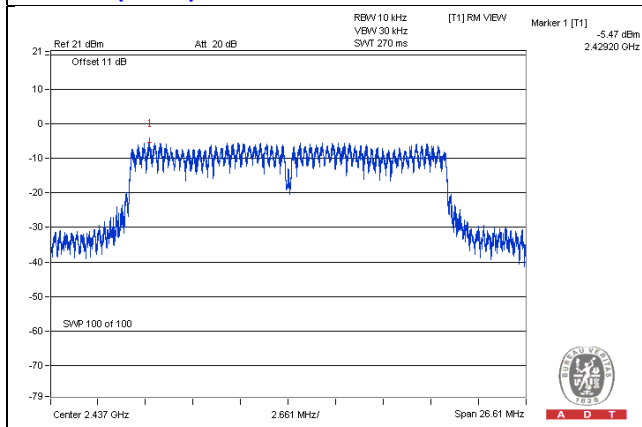

802.11n (HT40) / Chain 0 : CH6

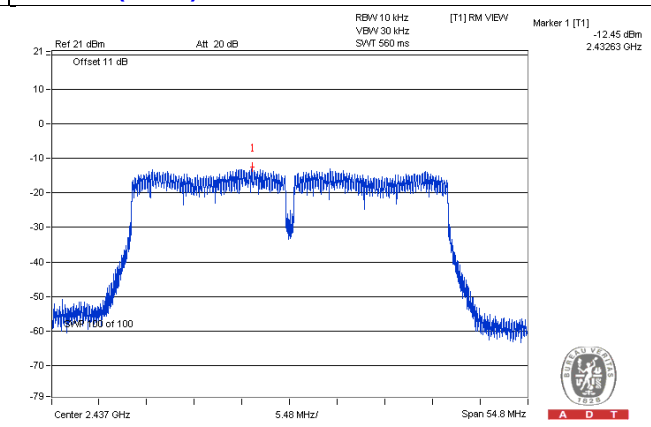

4.6 Conducted Out of Band Emission Measurement

4.6.1 Limits of Conducted Out of Band Emission Measurement

Below 30dB of the highest emission level of operating band (in 100kHz Resolution Bandwidth).

4.6.2 Test Setup

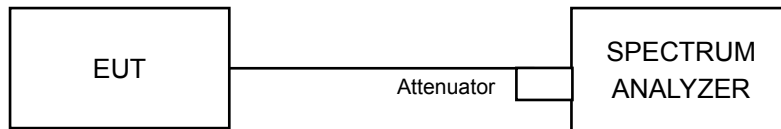

4.6.3 Test Instruments

Refer to section 4.1.2 to get information of above instrument.

4.6.4 Test Procedures

MEASUREMENT PROCEDURE REF

1. Set the RBW = 100 kHz.
2. Set the VBW \geq 300 kHz.
3. Detector = peak.
4. Sweep time = auto couple.
5. Trace mode = max hold.
6. Allow trace to fully stabilize.
7. Use the peak marker function to determine the maximum power level in any 100 kHz band segment within the fundamental EBW.

MEASUREMENT PROCEDURE OOBE

1. Set RBW = 100 kHz.
2. Set VBW \geq 300 kHz.
3. Detector = peak.
4. Sweep = auto couple.
5. Trace Mode = max hold.
6. Allow trace to fully stabilize.
7. Use the peak marker function to determine the maximum amplitude level.

4.6.5 Deviation from Test Standard

No deviation.

4.6.6 EUT Operating Conditions

Same as Item 4.3.6

4.6.7 Test Results

The spectrum plots are attached on the following pages. D1 line indicates the highest level, and D2 line indicates the 30dB offset below D1. It shows compliance with the requirement.

802.11b

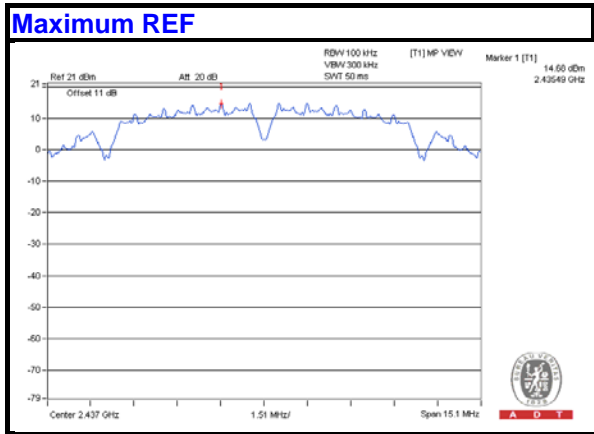

CHAIN 0

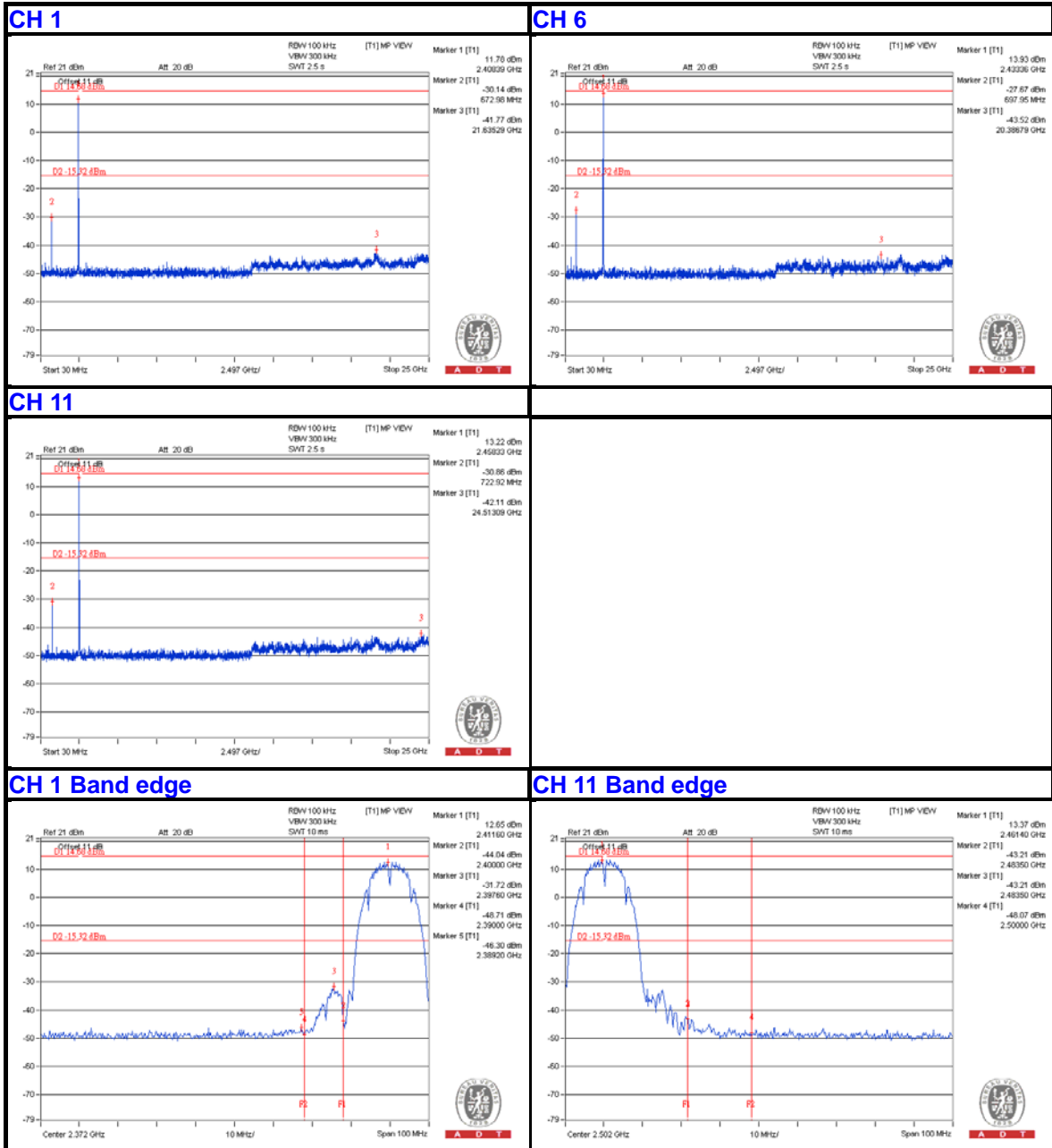

CHAIN 1

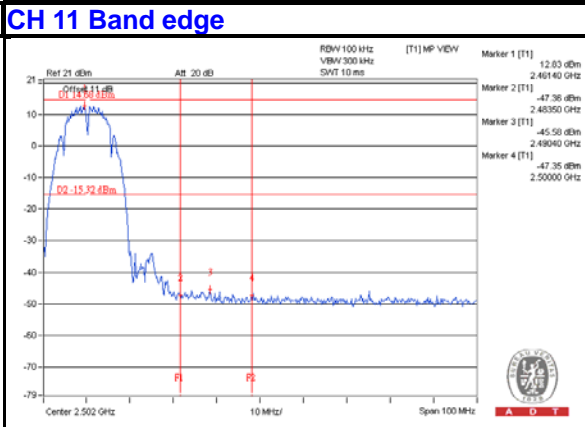
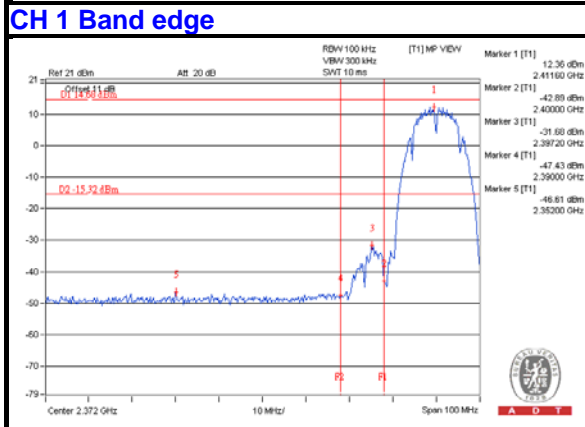
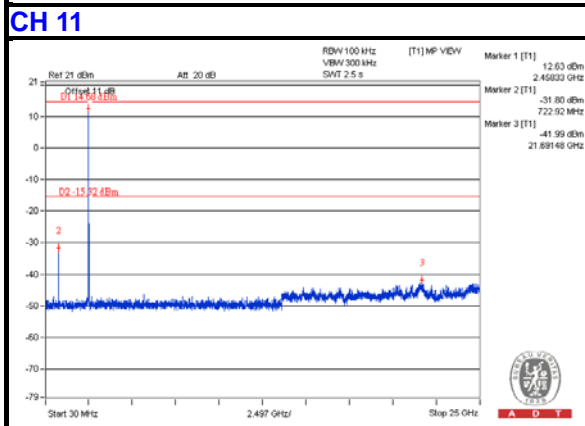
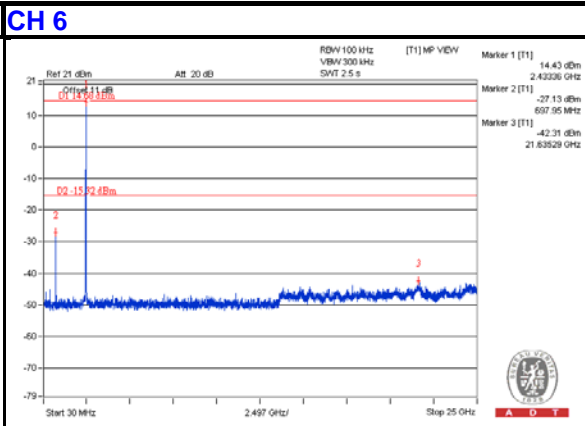
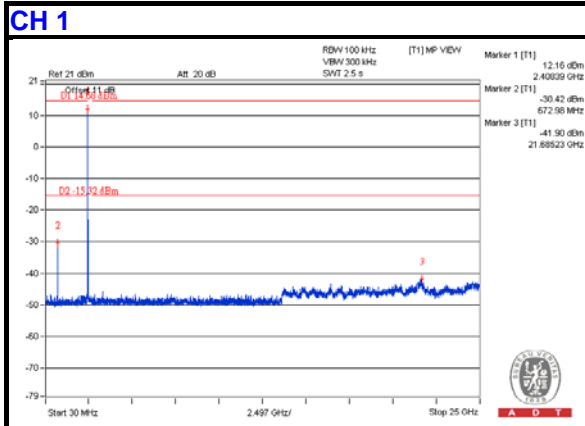

802.11g

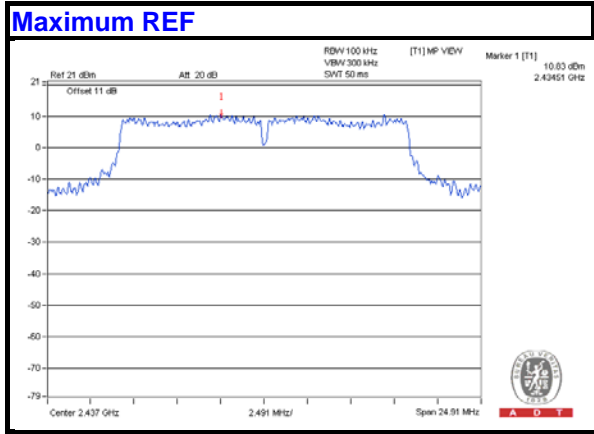

CHAIN 0

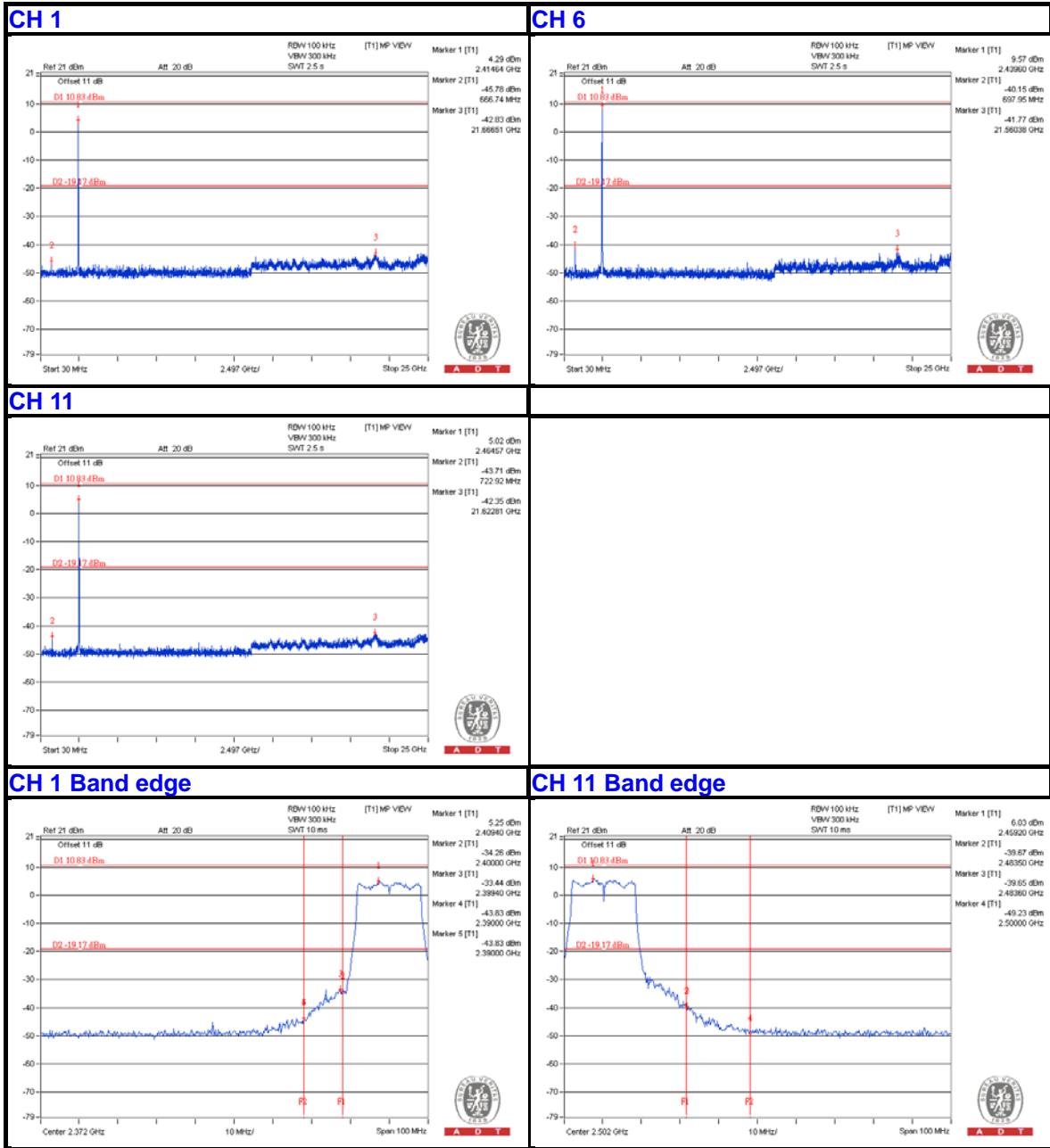

CHAIN 1

CH 1

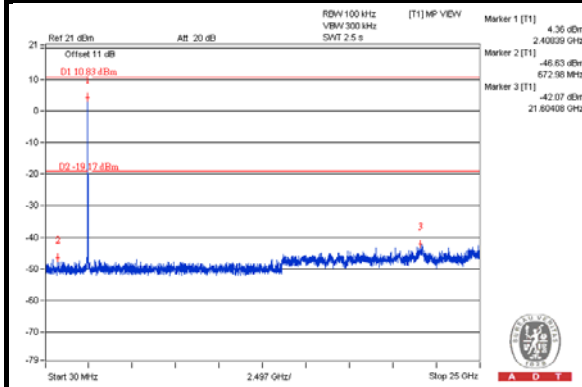

CH 6

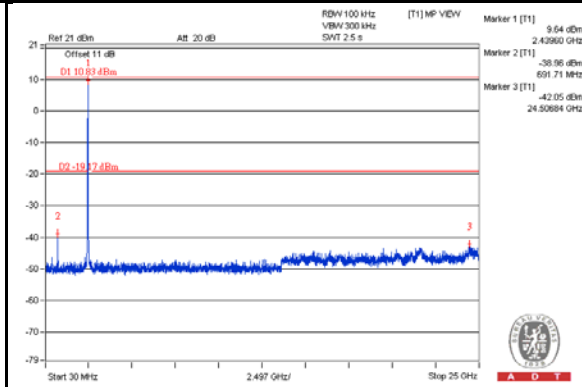

CH 11

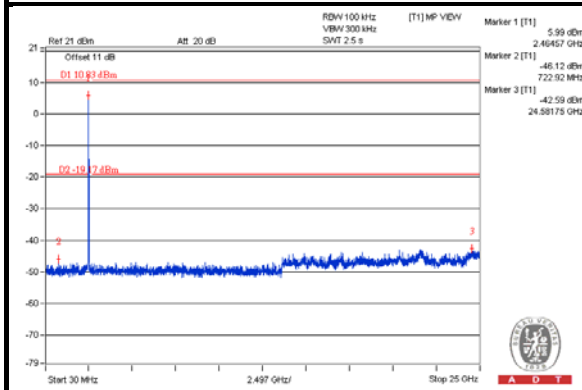

CH 1 Band edge

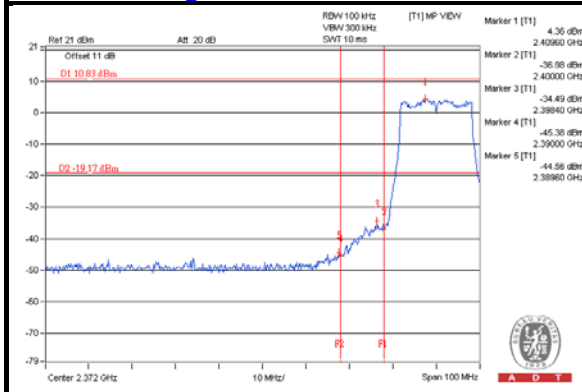

CH 11 Band edge

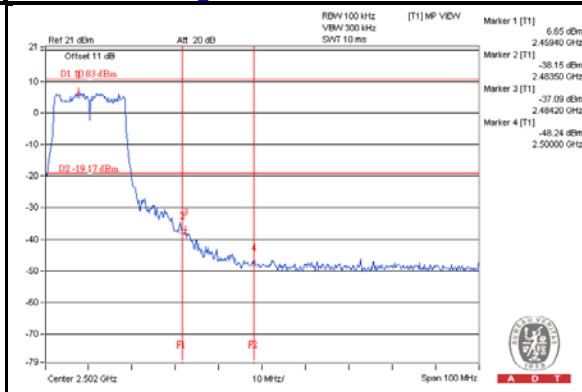

802.11n (HT20)

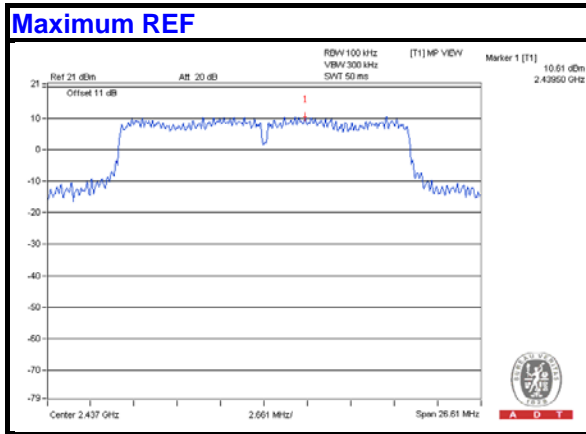

CHAIN 0

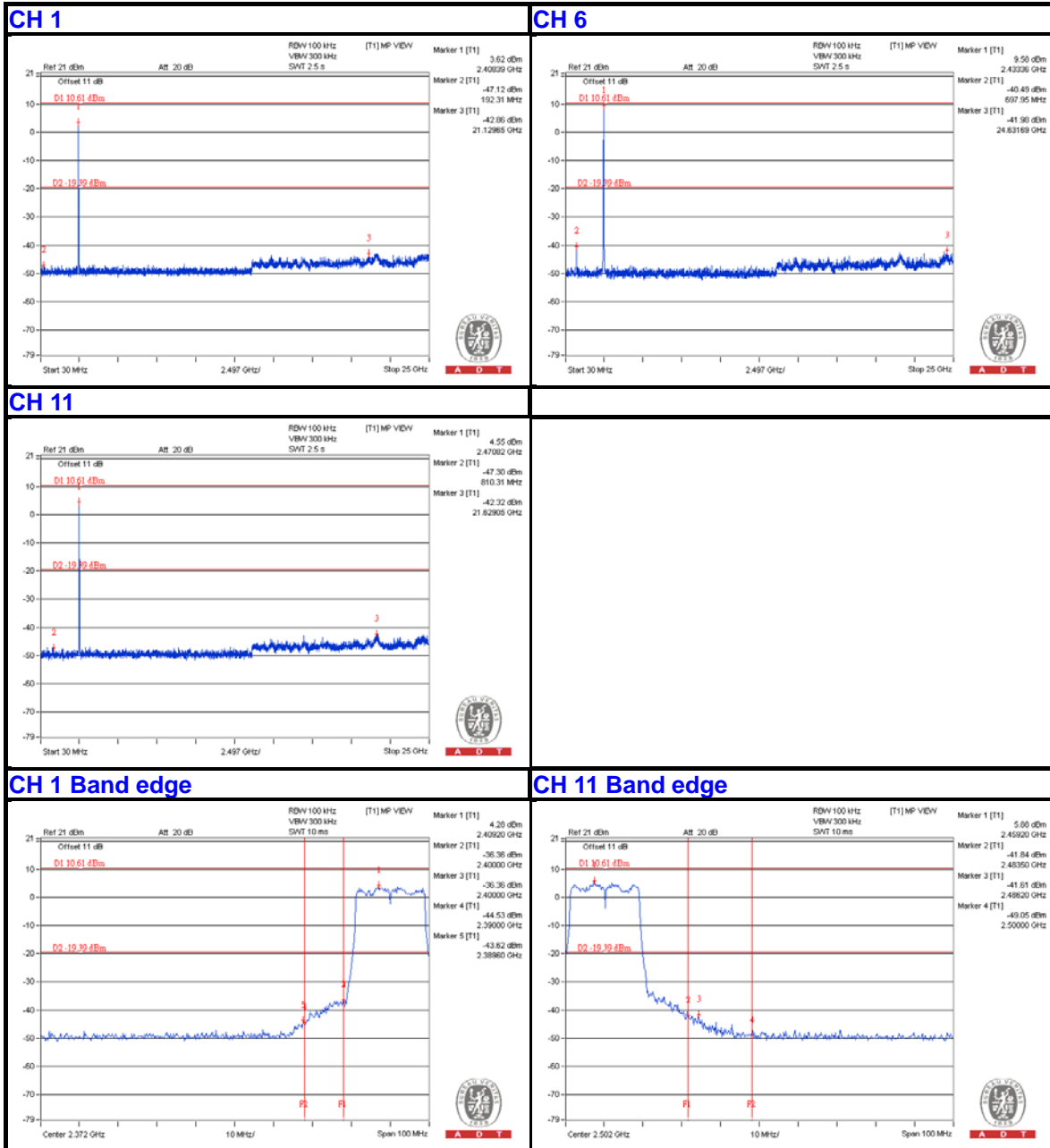

CHAIN 1

CH 1

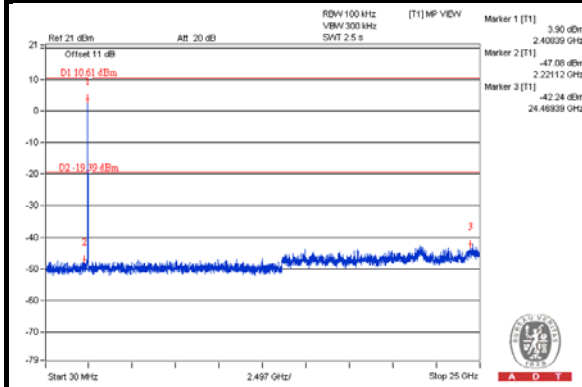

CH 6

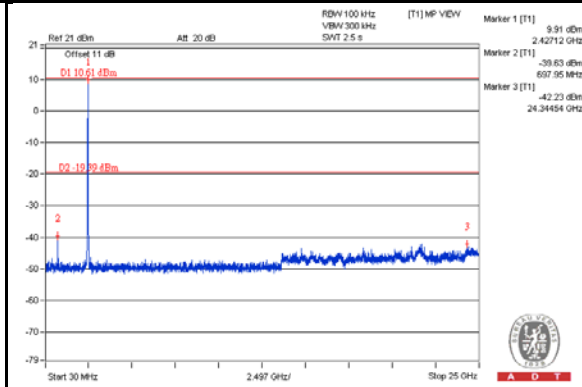

CH 11

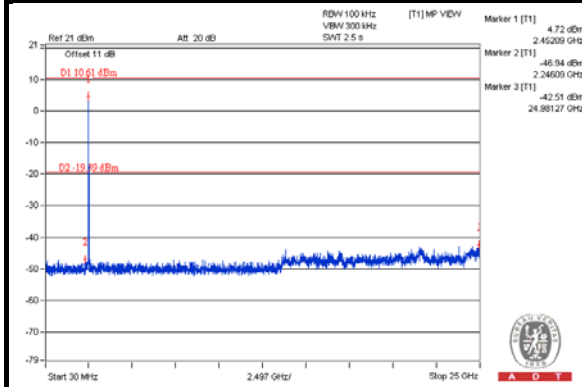

CH 1 Band edge

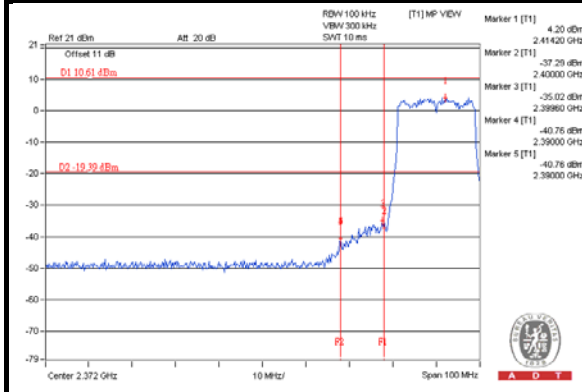

CH 11 Band edge

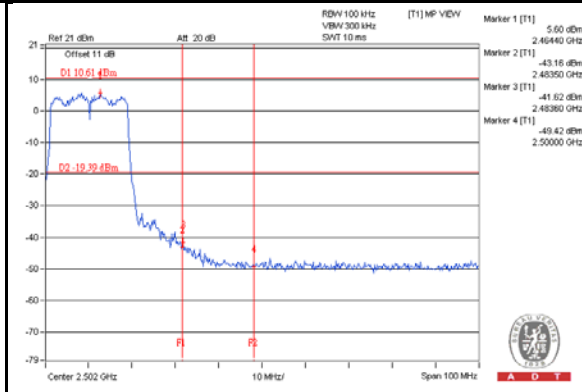

802.11n (HT40)

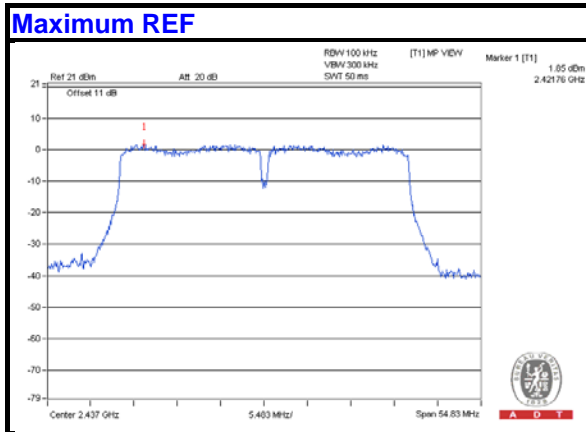

CHAIN 0

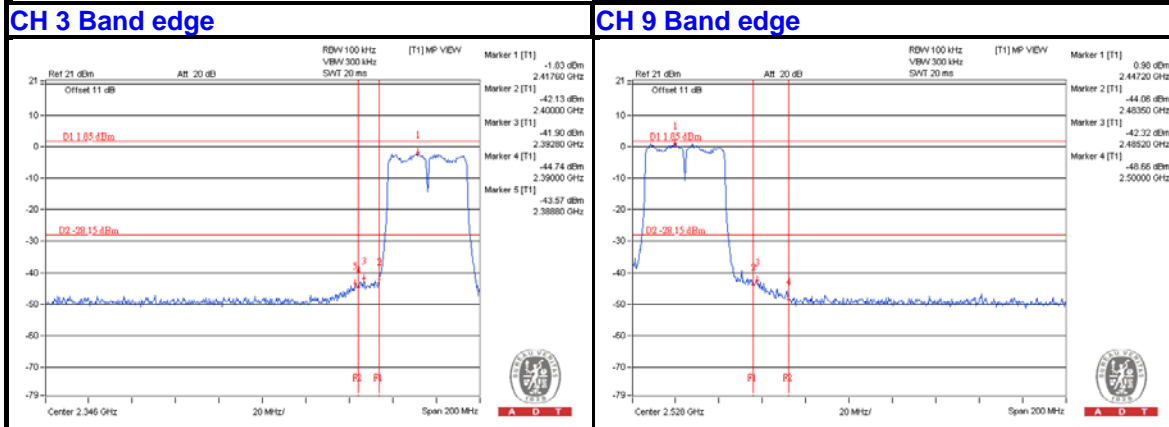
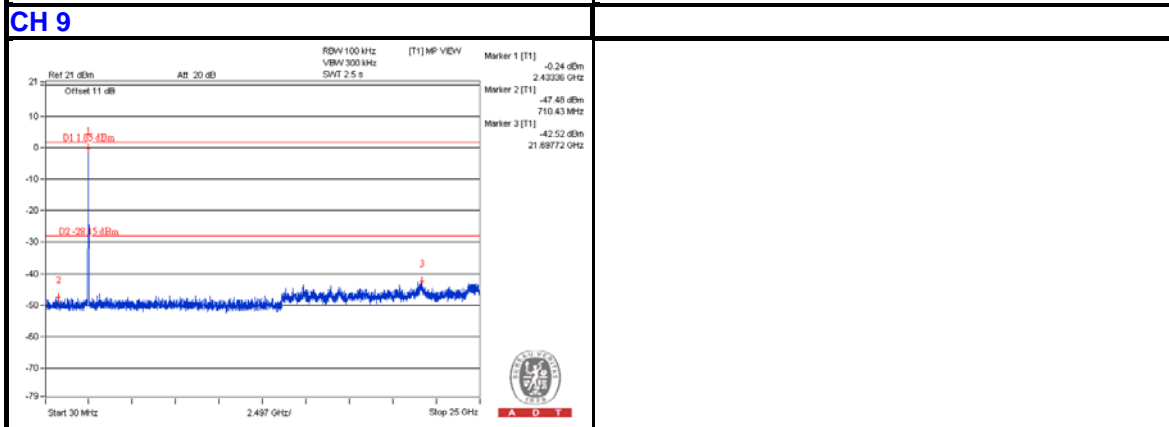
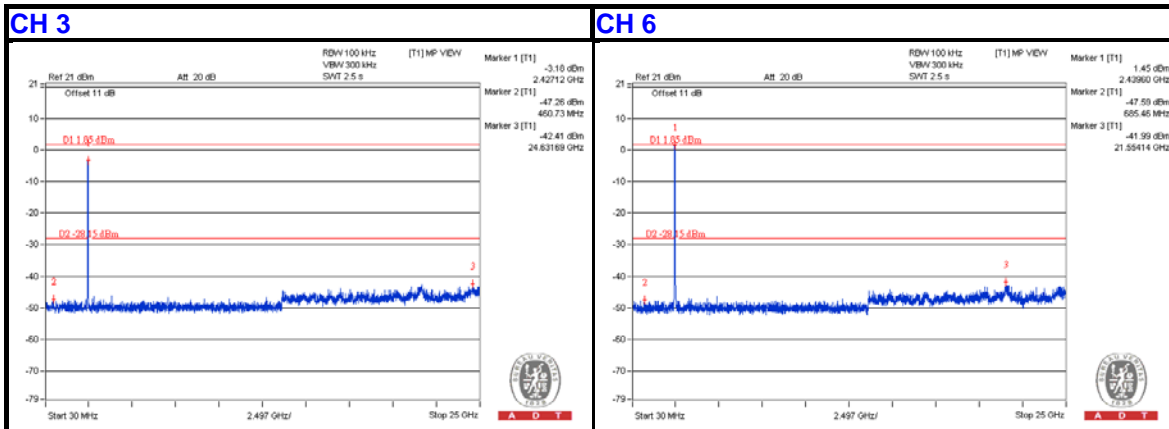

CHAIN 1

CH 3

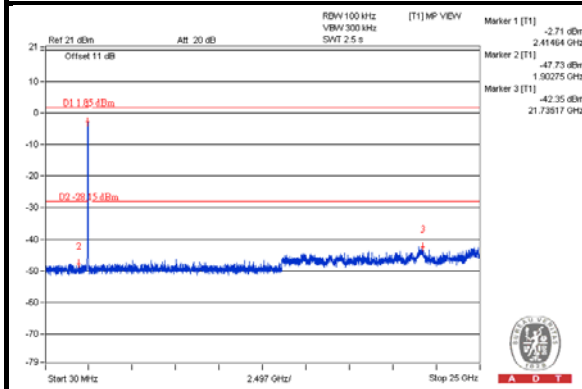

CH 6

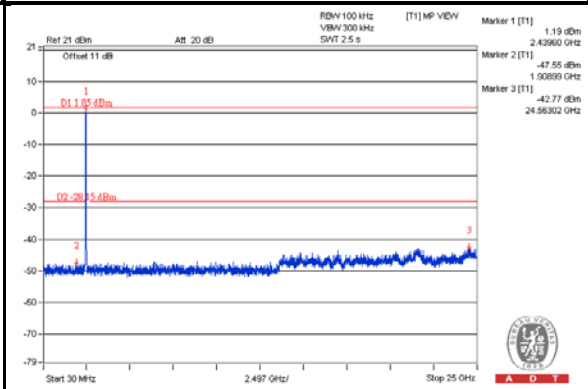

CH 9

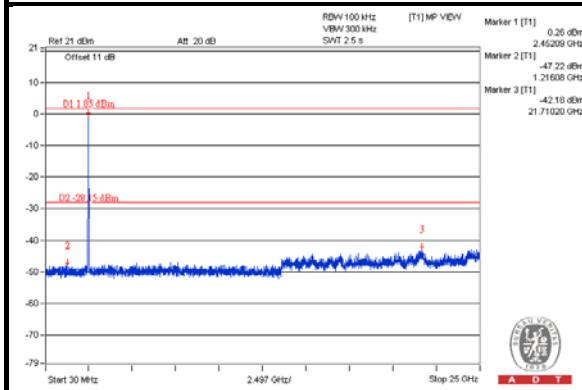

CH 3 Band edge

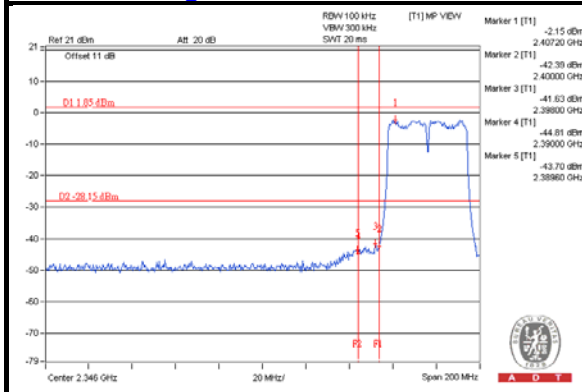

CH 9 Band edge

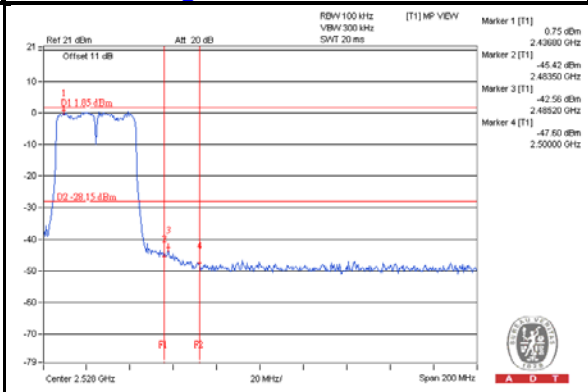

5 Test Types and Results (for 5GHz Band)

5.1 Radiated Emission and Bandedge Measurement

5.1.1 Limits of Radiated Emission and Bandedge Measurement

Radiated emissions which fall in the restricted bands must comply with the radiated emission limits specified as below table. Other emissions shall be at least 30dB below the highest level of the desired power:

Frequencies (MHz)	Field Strength (microvolts/meter)	Measurement Distance (meters)
0.009 ~ 0.490	2400/F(kHz)	300
0.490 ~ 1.705	24000/F(kHz)	30
1.705 ~ 30.0	30	30
30 ~ 88	100	3
88 ~ 216	150	3
216 ~ 960	200	3
Above 960	500	3

NOTE:

1. The lower limit shall apply at the transition frequencies.
2. Emission level (dBuV/m) = 20 log Emission level (uV/m).
3. For frequencies above 1000MHz, the field strength limits are based on average detector, however, the peak field strength of any emission shall not exceed the maximum permitted average limits, specified above by more than 20dB under any condition of modulation.

5.1.2 Test Instruments

Same as item 4.1.2.

5.1.3 Test Procedures

Same as item 4.1.3.

5.1.4 Deviation from Test Standard

No deviation.

5.1.5 Test Setup

Same as item 4.1.5.

5.1.6 EUT Operating Conditions

Same as item 4.1.6.

5.1.7 Test Results

Above 1GHz Data

802.11a

CHANNEL	TX Channel 149	DETECTOR FUNCTION	Peak (PK)
FREQUENCY RANGE	1GHz ~ 40GHz		Average (AV)

ANTENNA POLARITY & TEST DISTANCE: HORIZONTAL AT 3 M

NO.	FREQ. (MHz)	EMISSION LEVEL (dBuV/m)	LIMIT (dBuV/m)	MARGIN (dB)	ANTENNA HEIGHT (m)	TABLE ANGLE (Degree)	RAW VALUE (dBuV)	CORRECTION FACTOR (dB/m)
1	*5745.00	116.9 PK			1.16 H	314	108.48	8.42
2	*5745.00	107.1 AV			1.16 H	314	98.68	8.42
3	11490.00	55.7 PK	74.0	-18.3	1.00 H	298	41.35	14.35
4	11490.00	44.1 AV	54.0	-9.9	1.00 H	298	29.75	14.35

ANTENNA POLARITY & TEST DISTANCE: VERTICAL AT 3 M

NO.	FREQ. (MHz)	EMISSION LEVEL (dBuV/m)	LIMIT (dBuV/m)	MARGIN (dB)	ANTENNA HEIGHT (m)	TABLE ANGLE (Degree)	RAW VALUE (dBuV)	CORRECTION FACTOR (dB/m)
1	*5745.00	123.7 PK			1.18 V	308	115.28	8.42
2	*5745.00	113.8 AV			1.18 V	308	105.38	8.42
3	11490.00	58.8 PK	74.0	-15.2	1.02 V	313	44.45	14.35
4	11490.00	46.3 AV	54.0	-7.7	1.02 V	313	31.95	14.35

REMARKS:

1. Emission Level(dBuV/m) = Raw Value(dBuV) + Correction Factor(dB/m)
2. Correction Factor(dB/m) = Antenna Factor(dB/m) + Cable Factor(dB) – Pre-Amplifier Factor(dB)
3. The other emission levels were very low against the limit.
4. Margin value = Emission Level – Limit value
5. " * ": Fundamental frequency.
6. The limit value is defined as per 15.247.

CHANNEL	TX Channel 157	DETECTOR FUNCTION	Peak (PK)
FREQUENCY RANGE	1GHz ~ 40GHz		Average (AV)

ANTENNA POLARITY & TEST DISTANCE: HORIZONTAL AT 3 M

NO.	FREQ. (MHz)	EMISSION LEVEL (dBuV/m)	LIMIT (dBuV/m)	MARGIN (dB)	ANTENNA HEIGHT (m)	TABLE ANGLE (Degree)	RAW VALUE (dBuV)	CORRECTION FACTOR (dB/m)
1	*5785.00	118.3 PK			1.17 H	300	109.81	8.49
2	*5785.00	108.0 AV			1.17 H	300	99.51	8.49
3	11570.00	55.8 PK	74.0	-18.2	1.00 H	125	41.49	14.31
4	11570.00	44.2 AV	54.0	-9.8	1.00 H	125	29.89	14.31

ANTENNA POLARITY & TEST DISTANCE: VERTICAL AT 3 M

NO.	FREQ. (MHz)	EMISSION LEVEL (dBuV/m)	LIMIT (dBuV/m)	MARGIN (dB)	ANTENNA HEIGHT (m)	TABLE ANGLE (Degree)	RAW VALUE (dBuV)	CORRECTION FACTOR (dB/m)
1	*5785.00	125.1 PK			1.27 V	308	116.61	8.49
2	*5785.00	115.1 AV			1.27 V	308	106.61	8.49
3	11570.00	58.1 PK	74.0	-15.9	1.05 V	316	43.79	14.31
4	11570.00	45.9 AV	54.0	-8.1	1.05 V	316	31.59	14.31

REMARKS:

1. Emission Level(dBuV/m) = Raw Value(dBuV) + Correction Factor(dB/m)
2. Correction Factor(dB/m) = Antenna Factor(dB/m) + Cable Factor(dB) – Pre-Amplifier Factor(dB)
3. The other emission levels were very low against the limit.
4. Margin value = Emission Level – Limit value
5. " * ": Fundamental frequency.
6. The limit value is defined as per 15.247.

CHANNEL	TX Channel 165	DETECTOR FUNCTION	Peak (PK)
FREQUENCY RANGE	1GHz ~ 40GHz		Average (AV)

ANTENNA POLARITY & TEST DISTANCE: HORIZONTAL AT 3 M

NO.	FREQ. (MHz)	EMISSION LEVEL (dBuV/m)	LIMIT (dBuV/m)	MARGIN (dB)	ANTENNA HEIGHT (m)	TABLE ANGLE (Degree)	RAW VALUE (dBuV)	CORRECTION FACTOR (dB/m)
1	*5825.00	116.8 PK			1.17 H	319	108.21	8.59
2	*5825.00	107.8 AV			1.17 H	319	99.21	8.59
3	11650.00	55.4 PK	74.0	-18.6	1.00 H	309	41.02	14.38
4	11650.00	43.8 AV	54.0	-10.2	1.00 H	309	29.42	14.38

ANTENNA POLARITY & TEST DISTANCE: VERTICAL AT 3 M

NO.	FREQ. (MHz)	EMISSION LEVEL (dBuV/m)	LIMIT (dBuV/m)	MARGIN (dB)	ANTENNA HEIGHT (m)	TABLE ANGLE (Degree)	RAW VALUE (dBuV)	CORRECTION FACTOR (dB/m)
1	*5825.00	123.8 PK			1.32 V	324	115.21	8.59
2	*5825.00	114.9 AV			1.32 V	324	106.31	8.59
3	11650.00	59.2 PK	74.0	-14.8	1.01 V	322	44.82	14.38
4	11650.00	46.5 AV	54.0	-7.5	1.01 V	322	32.12	14.38

REMARKS:

1. Emission Level(dBuV/m) = Raw Value(dBuV) + Correction Factor(dB/m)
2. Correction Factor(dB/m) = Antenna Factor(dB/m) + Cable Factor(dB) – Pre-Amplifier Factor(dB)
3. The other emission levels were very low against the limit.
4. Margin value = Emission Level – Limit value
5. " * ": Fundamental frequency.
6. The limit value is defined as per 15.247.

802.11ac (VHT20)

CHANNEL	TX Channel 149	DETECTOR FUNCTION	Peak (PK)
FREQUENCY RANGE	1GHz ~ 40GHz		Average (AV)

ANTENNA POLARITY & TEST DISTANCE: HORIZONTAL AT 3 M

NO.	FREQ. (MHz)	EMISSION LEVEL (dBuV/m)	LIMIT (dBuV/m)	MARGIN (dB)	ANTENNA HEIGHT (m)	TABLE ANGLE (Degree)	RAW VALUE (dBuV)	CORRECTION FACTOR (dB/m)
1	*5745.00	114.9 PK			1.17 H	296	106.48	8.42
2	*5745.00	105.3 AV			1.17 H	296	96.88	8.42
3	11490.00	55.7 PK	74.0	-18.3	1.00 H	312	41.35	14.35
4	11490.00	44.1 AV	54.0	-9.9	1.00 H	312	29.75	14.35

ANTENNA POLARITY & TEST DISTANCE: VERTICAL AT 3 M

NO.	FREQ. (MHz)	EMISSION LEVEL (dBuV/m)	LIMIT (dBuV/m)	MARGIN (dB)	ANTENNA HEIGHT (m)	TABLE ANGLE (Degree)	RAW VALUE (dBuV)	CORRECTION FACTOR (dB/m)
1	*5745.00	121.6 PK			1.17 V	307	113.18	8.42
2	*5745.00	112.0 AV			1.17 V	307	103.58	8.42
3	11490.00	58.5 PK	74.0	-15.5	1.34 V	300	44.15	14.35
4	11490.00	46.1 AV	54.0	-7.9	1.34 V	300	31.75	14.35

REMARKS:

1. Emission Level(dBuV/m) = Raw Value(dBuV) + Correction Factor(dB/m)
2. Correction Factor(dB/m) = Antenna Factor(dB/m) + Cable Factor(dB) – Pre-Amplifier Factor(dB)
3. The other emission levels were very low against the limit.
4. Margin value = Emission Level – Limit value
5. " * ": Fundamental frequency.
6. The limit value is defined as per 15.247.

CHANNEL	TX Channel 157	DETECTOR FUNCTION	Peak (PK)
FREQUENCY RANGE	1GHz ~ 40GHz		Average (AV)

ANTENNA POLARITY & TEST DISTANCE: HORIZONTAL AT 3 M

NO.	FREQ. (MHz)	EMISSION LEVEL (dBuV/m)	LIMIT (dBuV/m)	MARGIN (dB)	ANTENNA HEIGHT (m)	TABLE ANGLE (Degree)	RAW VALUE (dBuV)	CORRECTION FACTOR (dB/m)
1	*5785.00	117.8 PK			1.20 H	307	109.31	8.49
2	*5785.00	108.2 AV			1.20 H	307	99.71	8.49
3	11570.00	56.5 PK	74.0	-17.5	1.05 H	300	42.19	14.31
4	11570.00	44.0 AV	54.0	-10.0	1.05 H	300	29.69	14.31

ANTENNA POLARITY & TEST DISTANCE: VERTICAL AT 3 M

NO.	FREQ. (MHz)	EMISSION LEVEL (dBuV/m)	LIMIT (dBuV/m)	MARGIN (dB)	ANTENNA HEIGHT (m)	TABLE ANGLE (Degree)	RAW VALUE (dBuV)	CORRECTION FACTOR (dB/m)
1	*5785.00	125.1 PK			1.30 V	300	116.61	8.49
2	*5785.00	115.2 AV			1.30 V	300	106.71	8.49
3	11570.00	59.0 PK	74.0	-15.0	1.22 V	316	44.69	14.31
4	11570.00	46.6 AV	54.0	-7.4	1.22 V	316	32.29	14.31

REMARKS:

1. Emission Level(dBuV/m) = Raw Value(dBuV) + Correction Factor(dB/m)
2. Correction Factor(dB/m) = Antenna Factor(dB/m) + Cable Factor(dB) – Pre-Amplifier Factor(dB)
3. The other emission levels were very low against the limit.
4. Margin value = Emission Level – Limit value
5. " * ": Fundamental frequency.
6. The limit value is defined as per 15.247.

CHANNEL	TX Channel 165	DETECTOR FUNCTION	Peak (PK)
FREQUENCY RANGE	1GHz ~ 40GHz		Average (AV)

ANTENNA POLARITY & TEST DISTANCE: HORIZONTAL AT 3 M

NO.	FREQ. (MHz)	EMISSION LEVEL (dBuV/m)	LIMIT (dBuV/m)	MARGIN (dB)	ANTENNA HEIGHT (m)	TABLE ANGLE (Degree)	RAW VALUE (dBuV)	CORRECTION FACTOR (dB/m)
1	*5825.00	118.2 PK			1.22 H	317	109.61	8.59
2	*5825.00	108.0 AV			1.22 H	317	99.41	8.59
3	11650.00	56.0 PK	74.0	-18.0	1.05 H	309	41.62	14.38
4	11650.00	44.1 AV	54.0	-9.9	1.05 H	309	29.72	14.38

ANTENNA POLARITY & TEST DISTANCE: VERTICAL AT 3 M

NO.	FREQ. (MHz)	EMISSION LEVEL (dBuV/m)	LIMIT (dBuV/m)	MARGIN (dB)	ANTENNA HEIGHT (m)	TABLE ANGLE (Degree)	RAW VALUE (dBuV)	CORRECTION FACTOR (dB/m)
1	*5825.00	124.8 PK			1.24 V	309	116.21	8.59
2	*5825.00	114.7 AV			1.24 V	309	106.11	8.59
3	11650.00	58.6 PK	74.0	-15.4	1.26 V	314	44.22	14.38
4	11650.00	46.1 AV	54.0	-7.9	1.26 V	314	31.72	14.38

REMARKS:

1. Emission Level(dBuV/m) = Raw Value(dBuV) + Correction Factor(dB/m)
2. Correction Factor(dB/m) = Antenna Factor(dB/m) + Cable Factor(dB) – Pre-Amplifier Factor(dB)
3. The other emission levels were very low against the limit.
4. Margin value = Emission Level – Limit value
5. " * ": Fundamental frequency.
6. The limit value is defined as per 15.247.

802.11ac (VHT40)

CHANNEL	TX Channel 151	DETECTOR FUNCTION	Peak (PK)
FREQUENCY RANGE	1GHz ~ 40GHz		Average (AV)

ANTENNA POLARITY & TEST DISTANCE: HORIZONTAL AT 3 M

NO.	FREQ. (MHz)	EMISSION LEVEL (dBuV/m)	LIMIT (dBuV/m)	MARGIN (dB)	ANTENNA HEIGHT (m)	TABLE ANGLE (Degree)	RAW VALUE (dBuV)	CORRECTION FACTOR (dB/m)
1	*5755.00	109.6 PK			1.14 H	300	101.16	8.44
2	*5755.00	100.0 AV			1.14 H	300	91.56	8.44
3	11510.00	57.2 PK	74.0	-16.8	1.08 H	302	42.86	14.34
4	11510.00	44.3 AV	54.0	-9.7	1.08 H	302	29.96	14.34

ANTENNA POLARITY & TEST DISTANCE: VERTICAL AT 3 M

NO.	FREQ. (MHz)	EMISSION LEVEL (dBuV/m)	LIMIT (dBuV/m)	MARGIN (dB)	ANTENNA HEIGHT (m)	TABLE ANGLE (Degree)	RAW VALUE (dBuV)	CORRECTION FACTOR (dB/m)
1	*5755.00	116.8 PK			1.15 V	301	108.36	8.44
2	*5755.00	107.4 AV			1.15 V	301	98.96	8.44
3	11510.00	59.4 PK	74.0	-14.6	1.31 V	330	45.06	14.34
4	11510.00	46.7 AV	54.0	-7.3	1.31 V	330	32.36	14.34

REMARKS:

1. Emission Level(dBuV/m) = Raw Value(dBuV) + Correction Factor(dB/m)
2. Correction Factor(dB/m) = Antenna Factor(dB/m) + Cable Factor(dB) – Pre-Amplifier Factor(dB)
3. The other emission levels were very low against the limit.
4. Margin value = Emission Level – Limit value
5. " * ": Fundamental frequency.
6. The limit value is defined as per 15.247.

CHANNEL	TX Channel 159	DETECTOR FUNCTION	Peak (PK)
FREQUENCY RANGE	1GHz ~ 40GHz		Average (AV)

ANTENNA POLARITY & TEST DISTANCE: HORIZONTAL AT 3 M

NO.	FREQ. (MHz)	EMISSION LEVEL (dBuV/m)	LIMIT (dBuV/m)	MARGIN (dB)	ANTENNA HEIGHT (m)	TABLE ANGLE (Degree)	RAW VALUE (dBuV)	CORRECTION FACTOR (dB/m)
1	*5795.00	113.5 PK			1.14 H	297	105.00	8.50
2	*5795.00	104.2 AV			1.14 H	297	95.70	8.50
3	11590.00	55.9 PK	74.0	-18.1	1.22 H	318	41.60	14.30
4	11590.00	44.4 AV	54.0	-9.6	1.22 H	318	30.10	14.30

ANTENNA POLARITY & TEST DISTANCE: VERTICAL AT 3 M

NO.	FREQ. (MHz)	EMISSION LEVEL (dBuV/m)	LIMIT (dBuV/m)	MARGIN (dB)	ANTENNA HEIGHT (m)	TABLE ANGLE (Degree)	RAW VALUE (dBuV)	CORRECTION FACTOR (dB/m)
1	*5795.00	120.5 PK			1.16 V	304	112.00	8.50
2	*5795.00	111.2 AV			1.16 V	304	102.70	8.50
3	11590.00	58.9 PK	74.0	-15.1	1.22 V	317	44.60	14.30
4	11590.00	46.4 AV	54.0	-7.6	1.22 V	317	32.10	14.30

REMARKS:

1. Emission Level(dBuV/m) = Raw Value(dBuV) + Correction Factor(dB/m)
2. Correction Factor(dB/m) = Antenna Factor(dB/m) + Cable Factor(dB) – Pre-Amplifier Factor(dB)
3. The other emission levels were very low against the limit.
4. Margin value = Emission Level – Limit value
5. " * ": Fundamental frequency.
6. The limit value is defined as per 15.247.

802.11ac (VHT80)

CHANNEL	TX Channel 155	DETECTOR FUNCTION	Peak (PK)
FREQUENCY RANGE	1GHz ~ 40GHz		Average (AV)

ANTENNA POLARITY & TEST DISTANCE: HORIZONTAL AT 3 M

NO.	FREQ. (MHz)	EMISSION LEVEL (dBuV/m)	LIMIT (dBuV/m)	MARGIN (dB)	ANTENNA HEIGHT (m)	TABLE ANGLE (Degree)	RAW VALUE (dBuV)	CORRECTION FACTOR (dB/m)
1	*5775.00	103.9 PK			1.12 H	320	95.43	8.47
2	*5775.00	95.2 AV			1.12 H	320	86.73	8.47
3	11550.00	56.3 PK	74.0	-17.7	1.04 H	316	41.98	14.32
4	11550.00	44.7 AV	54.0	-9.3	1.04 H	316	30.38	14.32

ANTENNA POLARITY & TEST DISTANCE: VERTICAL AT 3 M

NO.	FREQ. (MHz)	EMISSION LEVEL (dBuV/m)	LIMIT (dBuV/m)	MARGIN (dB)	ANTENNA HEIGHT (m)	TABLE ANGLE (Degree)	RAW VALUE (dBuV)	CORRECTION FACTOR (dB/m)
1	*5775.00	110.5 PK			1.15 V	301	102.03	8.47
2	*5775.00	101.3 AV			1.15 V	301	92.83	8.47
3	11550.00	59.2 PK	74.0	-14.8	1.24 V	304	44.88	14.32
4	11550.00	46.5 AV	54.0	-7.5	1.24 V	304	32.18	14.32

REMARKS:

1. Emission Level(dBuV/m) = Raw Value(dBuV) + Correction Factor(dB/m)
2. Correction Factor(dB/m) = Antenna Factor(dB/m) + Cable Factor(dB) – Pre-Amplifier Factor(dB)
3. The other emission levels were very low against the limit.
4. Margin value = Emission Level – Limit value
5. " * ": Fundamental frequency.
6. The limit value is defined as per 15.247.

Below 1GHz Data
802.11a

CHANNEL	TX Channel 157	DETECTOR FUNCTION	Quasi-Peak (QP)
FREQUENCY RANGE	Below 1GHz		

ANTENNA POLARITY & TEST DISTANCE: HORIZONTAL AT 3 M

NO.	FREQ. (MHz)	EMISSION LEVEL (dBuV/m)	LIMIT (dBuV/m)	MARGIN (dB)	ANTENNA HEIGHT (m)	TABLE ANGLE (Degree)	RAW VALUE (dBuV)	CORRECTION FACTOR (dB/m)
1	61.86	35.2 QP	40.0	-4.8	2.00 H	42	49.15	-13.99
2	222.55	40.0 QP	46.0	-6.0	1.50 H	360	55.77	-15.73
3	562.48	34.9 QP	46.0	-11.1	2.00 H	0	40.30	-5.43
4	625.00	39.1 QP	46.0	-6.9	1.00 H	258	42.80	-3.68
5	687.51	32.2 QP	46.0	-13.8	1.00 H	320	35.03	-2.85
6	875.02	35.1 QP	46.0	-10.9	1.00 H	175	34.79	0.31

ANTENNA POLARITY & TEST DISTANCE: VERTICAL AT 3 M

NO.	FREQ. (MHz)	EMISSION LEVEL (dBuV/m)	LIMIT (dBuV/m)	MARGIN (dB)	ANTENNA HEIGHT (m)	TABLE ANGLE (Degree)	RAW VALUE (dBuV)	CORRECTION FACTOR (dB/m)
1	38.28	36.6 QP	40.0	-3.4	1.00 V	13	50.24	-13.64
2	62.59	36.6 QP	40.0	-3.4	1.00 V	10	50.68	-14.08
3	220.90	41.6 QP	46.0	-4.4	1.00 V	116	57.30	-15.74
4	375.03	34.0 QP	46.0	-12.0	1.50 V	225	43.74	-9.78
5	562.48	36.9 QP	46.0	-9.1	1.00 V	186	42.37	-5.43
6	625.00	34.9 QP	46.0	-11.1	1.50 V	332	38.55	-3.68

REMARKS:

1. Emission Level(dBuV/m) = Raw Value(dBuV) + Correction Factor(dB/m)
2. Correction Factor(dB/m) = Antenna Factor(dB/m) + Cable Factor(dB) – Pre-Amplifier Factor(dB)
3. The other emission levels were very low against the limit.
4. Margin value = Emission Level – Limit value

5.2 Conducted Emission Measurement

5.2.1 Limits of Conducted Emission Measurement

Frequency (MHz)	Conducted Limit (dBuV)	
	Quasi-peak	Average
0.15 - 0.5	66 - 56	56 - 46
0.50 - 5.0	56	46
5.0 - 30.0	60	50

Note: 1. The lower limit shall apply at the transition frequencies.

2. The limit decreases in line with the logarithm of the frequency in the range of 0.15 to 0.50MHz.

5.2.2 Test Instruments

Same as item 4.2.2.

5.2.3 Test Procedures

Same as item 4.2.3.

5.2.4 Deviation from Test Standard

No deviation.

5.2.5 Test Setup

Same as item 4.2.5.

5.2.6 EUT Operating Conditions

Same as item 4.1.6.

5.2.7 Test Results (Mode 1)

Phase	Line (L)	Detector Function	Quasi-Peak (QP) / Average (AV)
-------	----------	-------------------	--------------------------------

No	Freq. [MHz]	Corr.	Reading Value		Emission Level		Limit		Margin	
		Factor	[dB (uV)]		[dB (uV)]		[dB (uV)]		(dB)	
	(dB)	Q.P.	AV.	Q.P.	AV.	Q.P.	AV.	Q.P.	AV.	
1	0.17734	0.07	55.48	45.16	55.55	45.23	64.61	54.61	-9.06	-9.38
2	0.23203	0.07	48.04	34.06	48.11	34.13	62.38	52.38	-14.26	-18.24
3	0.52891	0.10	40.47	30.89	40.57	30.99	56.00	46.00	-15.43	-15.01
4	0.99375	0.13	32.11	19.29	32.24	19.42	56.00	46.00	-23.76	-26.58
5	3.85156	0.24	31.27	20.43	31.51	20.67	56.00	46.00	-24.49	-25.33
6	14.78125	0.58	34.00	27.49	34.58	28.07	60.00	50.00	-25.42	-21.93

REMARKS:

1. Q.P. and AV. are abbreviations of quasi-peak and average individually.
2. The emission levels of other frequencies were very low against the limit.
3. Margin value = Emission level - Limit value
4. Correction factor = Insertion loss + Cable loss
5. Emission Level = Correction Factor + Reading Value.

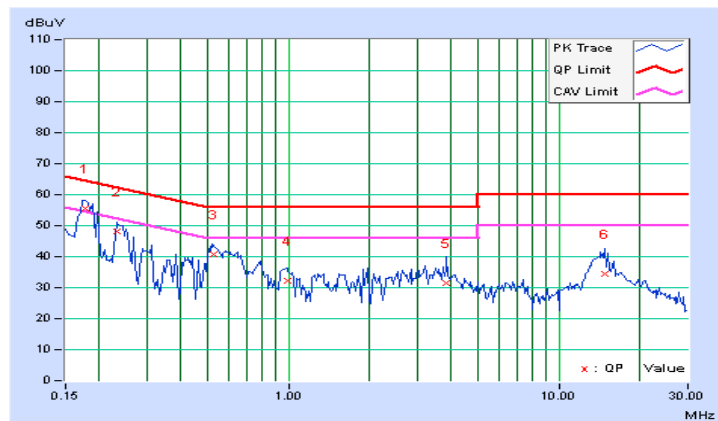

Phase	Neutral (N)	Detector Function	Quasi-Peak (QP) / Average (AV)
-------	-------------	-------------------	--------------------------------

No	Freq. [MHz]	Corr.	Reading Value		Emission Level		Limit		Margin	
		Factor	[dB (uV)]		[dB (uV)]		[dB (uV)]		(dB)	
		(dB)	Q.P.	AV.	Q.P.	AV.	Q.P.	AV.	Q.P.	AV.
1	0.18125	0.06	54.49	44.63	54.55	44.69	64.43	54.43	-9.88	-9.74
2	0.23203	0.06	47.19	35.11	47.25	35.17	62.38	52.38	-15.12	-17.20
3	0.54063	0.10	42.77	33.88	42.87	33.98	56.00	46.00	-13.13	-12.02
4	0.96250	0.13	35.50	23.64	35.63	23.77	56.00	46.00	-20.37	-22.23
5	2.07813	0.18	34.22	22.09	34.40	22.27	56.00	46.00	-21.60	-23.73
6	14.50000	0.60	34.08	28.17	34.68	28.77	60.00	50.00	-25.32	-21.23

REMARKS:

1. Q.P. and AV. are abbreviations of quasi-peak and average individually.
2. The emission levels of other frequencies were very low against the limit.
3. Margin value = Emission level - Limit value
4. Correction factor = Insertion loss + Cable loss
5. Emission Level = Correction Factor + Reading Value.

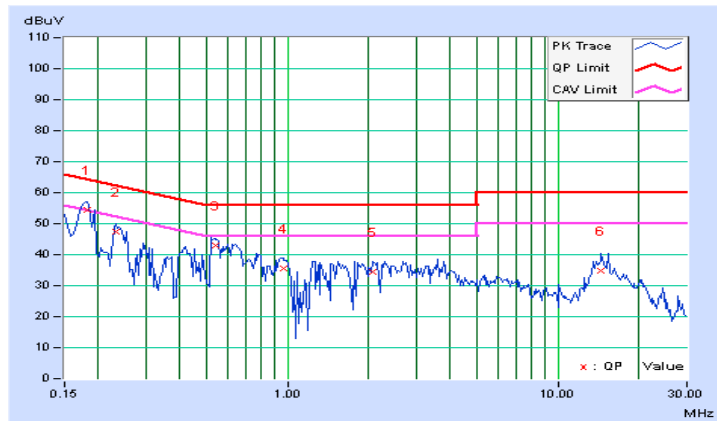

5.2.8 Test Results (Mode 2)

Phase	Line (L)	Detector Function	Quasi-Peak (QP) / Average (AV)
-------	----------	-------------------	--------------------------------

No	Freq. [MHz]	Corr.	Reading Value		Emission Level		Limit		Margin	
		Factor	[dB (uV)]		[dB (uV)]		[dB (uV)]		(dB)	
	(dB)	Q.P.	AV.	Q.P.	AV.	Q.P.	AV.	Q.P.	AV.	
1	0.16953	0.07	57.60	46.02	57.67	46.09	64.98	54.98	-7.32	-8.90
2	0.22812	0.07	50.41	38.42	50.48	38.49	62.52	52.52	-12.04	-14.03
3	0.53281	0.10	40.61	29.98	40.71	30.08	56.00	46.00	-15.29	-15.92
4	1.98828	0.18	28.95	18.59	29.13	18.77	56.00	46.00	-26.87	-27.23
5	3.67578	0.24	29.48	20.66	29.72	20.90	56.00	46.00	-26.28	-25.10
6	14.53906	0.57	34.71	29.29	35.28	29.86	60.00	50.00	-24.72	-20.14

REMARKS:

1. Q.P. and AV. are abbreviations of quasi-peak and average individually.
2. The emission levels of other frequencies were very low against the limit.
3. Margin value = Emission level - Limit value
4. Correction factor = Insertion loss + Cable loss
5. Emission Level = Correction Factor + Reading Value.

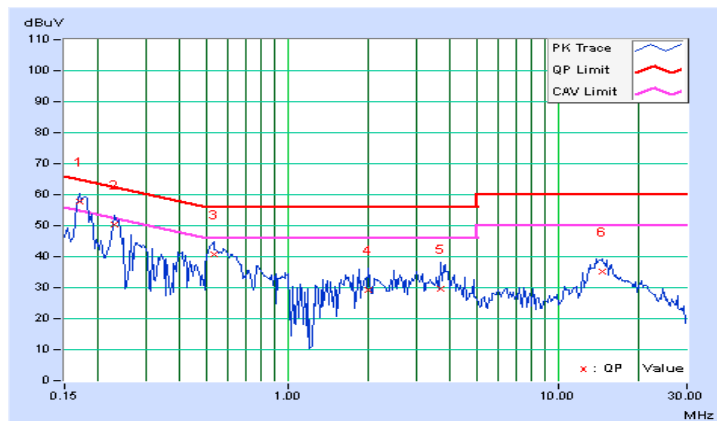

Phase	Neutral (N)	Detector Function	Quasi-Peak (QP) / Average (AV)
-------	-------------	-------------------	--------------------------------

No	Freq. [MHz]	Corr.	Reading Value		Emission Level		Limit		Margin	
		Factor	[dB (uV)]		[dB (uV)]		[dB (uV)]		(dB)	
		(dB)	Q.P.	AV.	Q.P.	AV.	Q.P.	AV.	Q.P.	AV.
1	0.17344	0.06	56.54	45.75	56.60	45.81	64.79	54.79	-8.19	-8.98
2	0.22422	0.06	49.90	37.01	49.96	37.07	62.66	52.66	-12.70	-15.59
3	0.29063	0.07	41.08	28.27	41.15	28.34	60.51	50.51	-19.35	-22.16
4	0.53672	0.10	42.30	30.50	42.40	30.60	56.00	46.00	-13.60	-15.40
5	3.84375	0.25	32.36	21.01	32.61	21.26	56.00	46.00	-23.39	-24.74
6	15.12891	0.61	32.40	25.65	33.01	26.26	60.00	50.00	-26.99	-23.74

REMARKS:

1. Q.P. and AV. are abbreviations of quasi-peak and average individually.
2. The emission levels of other frequencies were very low against the limit.
3. Margin value = Emission level - Limit value
4. Correction factor = Insertion loss + Cable loss
5. Emission Level = Correction Factor + Reading Value.

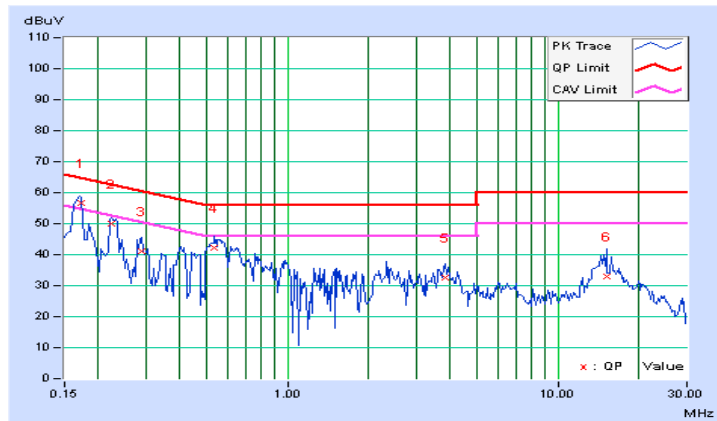

5.2.9 Test Results (Mode 3)

Phase	Line (L)	Detector Function	Quasi-Peak (QP) / Average (AV)
-------	----------	-------------------	--------------------------------

No	Freq. [MHz]	Corr.	Reading Value		Emission Level		Limit		Margin	
		Factor	[dB (uV)]		[dB (uV)]		[dB (uV)]		(dB)	
	(dB)	Q.P.	AV.	Q.P.	AV.	Q.P.	AV.	Q.P.	AV.	
1	0.16172	0.07	45.56	33.45	45.63	33.52	65.38	55.38	-19.75	-21.86
2	0.22422	0.07	40.72	29.17	40.79	29.24	62.66	52.66	-21.87	-23.42
3	0.33750	0.08	30.84	18.22	30.92	18.30	59.26	49.26	-28.34	-30.96
4	0.58750	0.10	16.16	4.03	16.26	4.13	56.00	46.00	-39.74	-41.87
5	5.80859	0.31	17.39	12.34	17.70	12.65	60.00	50.00	-42.30	-37.35
6	12.26953	0.51	21.21	16.71	21.72	17.22	60.00	50.00	-38.28	-32.78

REMARKS:

1. Q.P. and AV. are abbreviations of quasi-peak and average individually.
2. The emission levels of other frequencies were very low against the limit.
3. Margin value = Emission level - Limit value
4. Correction factor = Insertion loss + Cable loss
5. Emission Level = Correction Factor + Reading Value.

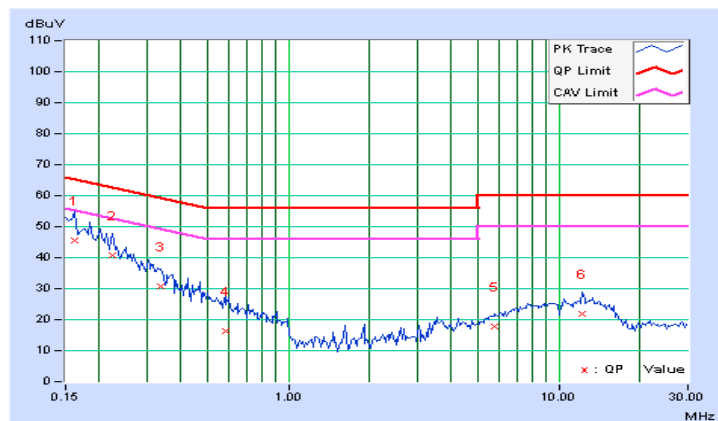

Phase	Neutral (N)	Detector Function	Quasi-Peak (QP) / Average (AV)
-------	-------------	-------------------	--------------------------------

No	Freq. [MHz]	Corr.	Reading Value		Emission Level		Limit		Margin	
		Factor	[dB (uV)]		[dB (uV)]		[dB (uV)]		(dB)	
		(dB)	Q.P.	AV.	Q.P.	AV.	Q.P.	AV.	Q.P.	AV.
1	0.15781	0.06	47.26	34.05	47.32	34.11	65.58	55.58	-18.25	-21.46
2	0.20859	0.06	40.90	28.53	40.96	28.59	63.26	53.26	-22.30	-24.67
3	0.31016	0.08	38.32	32.91	38.40	32.99	59.97	49.97	-21.57	-16.98
4	0.53281	0.10	19.22	8.73	19.32	8.83	56.00	46.00	-36.68	-37.17
5	8.44922	0.41	19.13	14.27	19.54	14.68	60.00	50.00	-40.46	-35.32
6	12.32422	0.53	20.34	15.77	20.87	16.30	60.00	50.00	-39.13	-33.70

REMARKS:

1. Q.P. and AV. are abbreviations of quasi-peak and average individually.
2. The emission levels of other frequencies were very low against the limit.
3. Margin value = Emission level - Limit value
4. Correction factor = Insertion loss + Cable loss
5. Emission Level = Correction Factor + Reading Value.

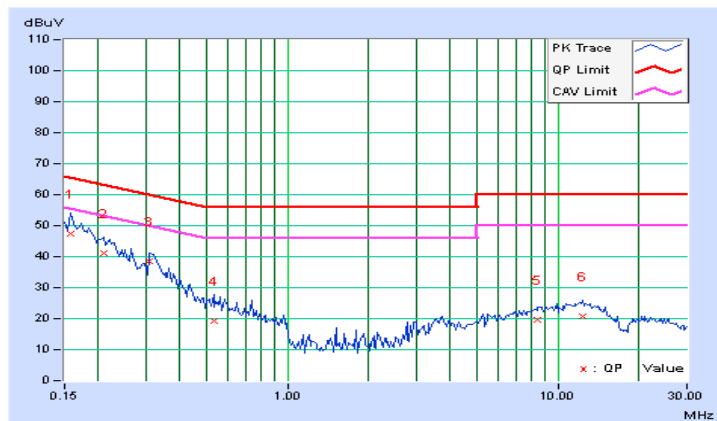

5.2.10 Test Results (Mode 4)

Phase	Line (L)	Detector Function	Quasi-Peak (QP) / Average (AV)
-------	----------	-------------------	--------------------------------

No	Freq. [MHz]	Corr.	Reading Value		Emission Level		Limit		Margin	
		Factor (dB)	[dB (uV)]		[dB (uV)]		[dB (uV)]		(dB)	
			Q.P.	AV.	Q.P.	AV.	Q.P.	AV.	Q.P.	AV.
1	0.16562	0.07	46.35	31.91	46.42	31.98	65.18	55.18	-18.76	-23.20
2	0.20469	0.07	43.05	30.91	43.12	30.98	63.42	53.42	-20.30	-22.44
3	0.31797	0.08	33.79	18.43	33.87	18.51	59.76	49.76	-25.89	-31.25
4	0.73594	0.11	20.71	11.27	20.82	11.38	56.00	46.00	-35.18	-34.62
5	7.00000	0.35	19.99	15.44	20.34	15.79	60.00	50.00	-39.66	-34.21
6	12.75781	0.52	21.82	17.42	22.34	17.94	60.00	50.00	-37.66	-32.06

REMARKS:

1. Q.P. and AV. are abbreviations of quasi-peak and average individually.
2. The emission levels of other frequencies were very low against the limit.
3. Margin value = Emission level - Limit value
4. Correction factor = Insertion loss + Cable loss
5. Emission Level = Correction Factor + Reading Value.

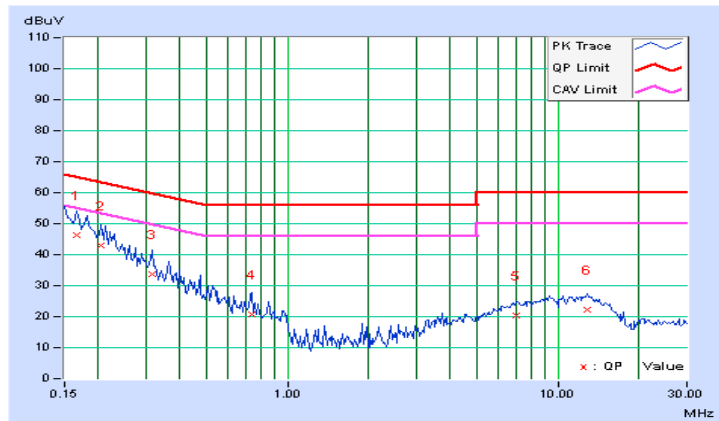

Phase	Neutral (N)	Detector Function	Quasi-Peak (QP) / Average (AV)
-------	-------------	-------------------	--------------------------------

No	Freq. [MHz]	Corr.	Reading Value		Emission Level		Limit		Margin	
		Factor	[dB (uV)]		[dB (uV)]		[dB (uV)]		(dB)	
		(dB)	Q.P.	AV.	Q.P.	AV.	Q.P.	AV.	Q.P.	AV.
1	0.15391	0.06	48.44	35.53	48.50	35.59	65.79	55.79	-17.28	-20.19
2	0.18906	0.06	43.17	29.07	43.23	29.13	64.08	54.08	-20.85	-24.95
3	0.31406	0.08	39.19	32.91	39.27	32.99	59.86	49.86	-20.60	-16.88
4	0.73594	0.11	26.16	16.70	26.27	16.81	56.00	46.00	-29.73	-29.19
5	5.85547	0.32	17.79	12.90	18.11	13.22	60.00	50.00	-41.89	-36.78
6	11.69141	0.51	20.86	16.34	21.37	16.85	60.00	50.00	-38.63	-33.15

REMARKS:

1. Q.P. and AV. are abbreviations of quasi-peak and average individually.
2. The emission levels of other frequencies were very low against the limit.
3. Margin value = Emission level - Limit value
4. Correction factor = Insertion loss + Cable loss
5. Emission Level = Correction Factor + Reading Value.

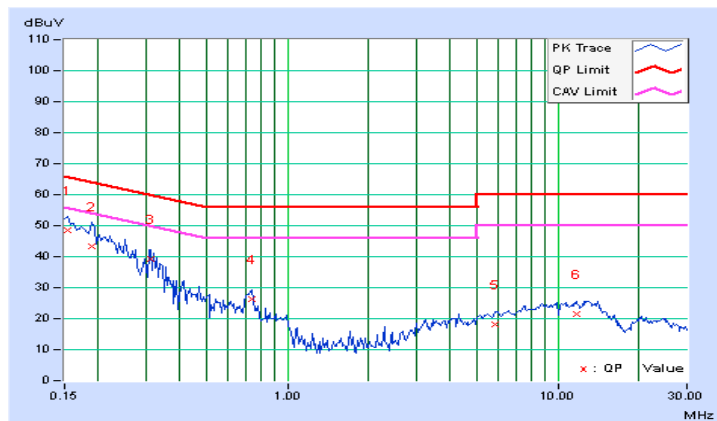

5.2.11 Test Results (Mode 5)

Phase	Line (L)	Detector Function	Quasi-Peak (QP) / Average (AV)
-------	----------	-------------------	--------------------------------

No	Freq. [MHz]	Corr.	Reading Value		Emission Level		Limit		Margin	
		Factor	[dB (uV)]		[dB (uV)]		[dB (uV)]		(dB)	
	(dB)	Q.P.	AV.	Q.P.	AV.	Q.P.	AV.	Q.P.	AV.	
1	0.16172	0.07	50.54	32.45	50.61	32.52	65.38	55.38	-14.77	-22.86
2	0.23984	0.07	41.65	26.79	41.72	26.86	62.10	52.10	-20.38	-25.24
3	0.31406	0.08	38.10	29.90	38.18	29.98	59.86	49.86	-21.68	-19.88
4	0.52891	0.10	26.68	14.70	26.78	14.80	56.00	46.00	-29.22	-31.20
5	4.55859	0.27	24.50	12.77	24.77	13.04	56.00	46.00	-31.23	-32.96
6	9.58594	0.44	25.84	15.04	26.28	15.48	60.00	50.00	-33.72	-34.52

REMARKS:

1. Q.P. and AV. are abbreviations of quasi-peak and average individually.
2. The emission levels of other frequencies were very low against the limit.
3. Margin value = Emission level - Limit value
4. Correction factor = Insertion loss + Cable loss
5. Emission Level = Correction Factor + Reading Value.

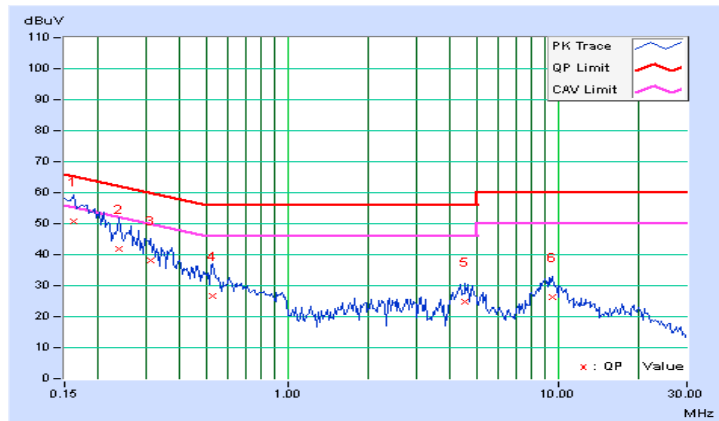

Phase	Neutral (N)	Detector Function	Quasi-Peak (QP) / Average (AV)
-------	-------------	-------------------	--------------------------------

No	Freq. [MHz]	Corr.	Reading Value		Emission Level		Limit		Margin	
		Factor	[dB (uV)]		[dB (uV)]		[dB (uV)]		(dB)	
		(dB)	Q.P.	AV.	Q.P.	AV.	Q.P.	AV.	Q.P.	AV.
1	0.16562	0.06	49.28	31.85	49.34	31.91	65.18	55.18	-15.83	-23.26
2	0.26719	0.07	38.84	24.80	38.91	24.87	61.20	51.20	-22.29	-26.33
3	0.43516	0.09	26.43	13.26	26.52	13.35	57.15	47.15	-30.63	-33.80
4	0.72813	0.11	26.63	19.09	26.74	19.20	56.00	46.00	-29.26	-26.80
5	4.79297	0.29	22.24	9.69	22.53	9.98	56.00	46.00	-33.47	-36.02
6	9.05469	0.43	25.71	14.83	26.14	15.26	60.00	50.00	-33.86	-34.74

REMARKS:

1. Q.P. and AV. are abbreviations of quasi-peak and average individually.
2. The emission levels of other frequencies were very low against the limit.
3. Margin value = Emission level - Limit value
4. Correction factor = Insertion loss + Cable loss
5. Emission Level = Correction Factor + Reading Value.

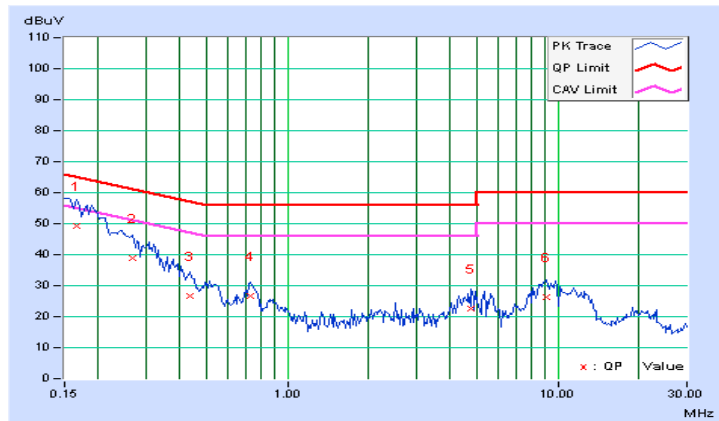

5.2.12 Test Results (Mode 6)

Phase	Line (L)	Detector Function	Quasi-Peak (QP) / Average (AV)
-------	----------	-------------------	--------------------------------

No	Freq. [MHz]	Corr.	Reading Value		Emission Level		Limit		Margin	
		Factor	[dB (uV)]		[dB (uV)]		[dB (uV)]		(dB)	
	(dB)	Q.P.	AV.	Q.P.	AV.	Q.P.	AV.	Q.P.	AV.	
1	0.16562	0.07	52.83	33.99	52.90	34.06	65.18	55.18	-12.28	-21.12
2	0.20469	0.07	48.77	31.76	48.84	31.83	63.42	53.42	-14.58	-21.59
3	0.30234	0.08	39.21	29.33	39.29	29.41	60.18	50.18	-20.89	-20.77
4	0.50547	0.10	27.45	14.63	27.55	14.73	56.00	46.00	-28.45	-31.27
5	4.77734	0.28	24.23	11.86	24.51	12.14	56.00	46.00	-31.49	-33.86
6	9.28906	0.43	26.42	15.25	26.85	15.68	60.00	50.00	-33.15	-34.32

REMARKS:

1. Q.P. and AV. are abbreviations of quasi-peak and average individually.
2. The emission levels of other frequencies were very low against the limit.
3. Margin value = Emission level - Limit value
4. Correction factor = Insertion loss + Cable loss
5. Emission Level = Correction Factor + Reading Value.

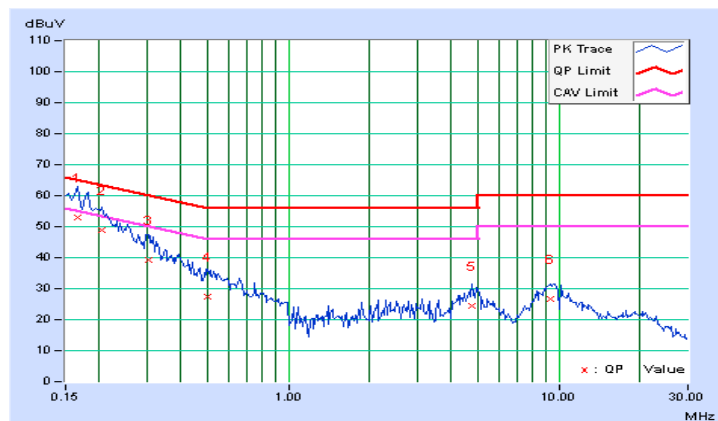

Phase	Neutral (N)	Detector Function	Quasi-Peak (QP) / Average (AV)
-------	-------------	-------------------	--------------------------------

No	Freq. [MHz]	Corr.	Reading Value		Emission Level		Limit		Margin	
		Factor	[dB (uV)]		[dB (uV)]		[dB (uV)]		(dB)	
	(dB)	Q.P.	AV.	Q.P.	AV.	Q.P.	AV.	Q.P.	AV.	
1	0.18906	0.06	50.57	32.52	50.63	32.58	64.08	54.08	-13.45	-21.50
2	0.25547	0.07	41.89	26.53	41.96	26.60	61.58	51.58	-19.62	-24.98
3	0.37656	0.09	31.89	17.14	31.98	17.23	58.35	48.35	-26.38	-31.13
4	0.73594	0.11	18.87	10.17	18.98	10.28	56.00	46.00	-37.02	-35.72
5	5.35156	0.31	20.84	7.07	21.15	7.38	60.00	50.00	-38.85	-42.62
6	9.64063	0.45	25.72	14.70	26.17	15.15	60.00	50.00	-33.83	-34.85

REMARKS:

1. Q.P. and AV. are abbreviations of quasi-peak and average individually.
2. The emission levels of other frequencies were very low against the limit.
3. Margin value = Emission level - Limit value
4. Correction factor = Insertion loss + Cable loss
5. Emission Level = Correction Factor + Reading Value.

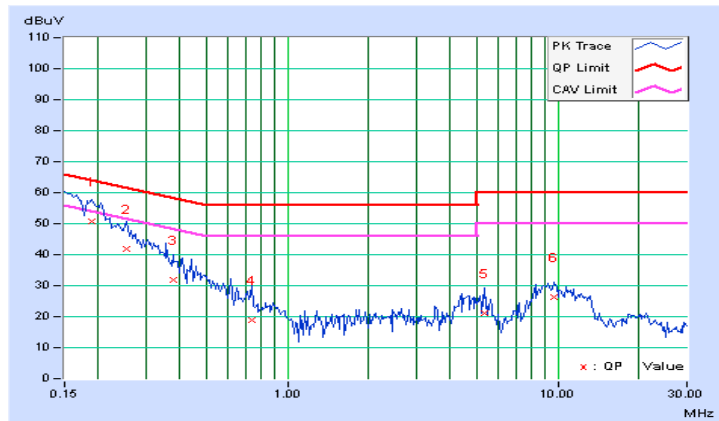

5.3 6dB Bandwidth Measurement

5.3.1 Limits of 6dB Bandwidth Measurement

The minimum of 6dB Bandwidth Measurement is 0.5 MHz.

5.3.2 Test Setup

Same as item 4.3.2.

5.3.3 Test Instruments

Refer to section 4.1.2 to get information of above instrument.

5.3.4 Test Procedures

Same as item 4.3.4.

5.3.5 Deviation from Test Standard

No deviation.

5.3.6 EUT Operating Conditions

Same as item 4.3.6.

5.3.7 Test Results
802.11a

CHANNEL	FREQUENCY (MHz)	6dB BANDWIDTH (MHz)		MINIMUM LIMIT (MHz)	PASS / FAIL
		CHAIN 0	CHAIN 1		
149	5745	16.61	16.61	0.5	PASS
157	5785	16.61	16.61	0.5	PASS
165	5825	16.60	16.62	0.5	PASS

802.11ac (VHT20)

CHANNEL	FREQUENCY (MHz)	6dB BANDWIDTH (MHz)		MINIMUM LIMIT (MHz)	PASS / FAIL
		CHAIN 0	CHAIN 1		
149	5745	17.77	17.79	0.5	PASS
157	5785	17.81	17.75	0.5	PASS
165	5825	17.80	17.70	0.5	PASS

802.11ac (VHT40)

CHANNEL	FREQUENCY (MHz)	6dB BANDWIDTH (MHz)		MINIMUM LIMIT (MHz)	PASS / FAIL
		CHAIN 0	CHAIN 1		
151	5755	36.58	36.57	0.5	PASS
159	5795	36.57	36.56	0.5	PASS

802.11ac (VHT80)

CHANNEL	FREQUENCY (MHz)	6dB BANDWIDTH (MHz)		MINIMUM LIMIT (MHz)	PASS / FAIL
		CHAIN 0	CHAIN 1		
155	5775	76.79	76.77	0.5	PASS

SPECTRUM PLOT OF WORST VALUE

802.11a / Chain 0 : CH165

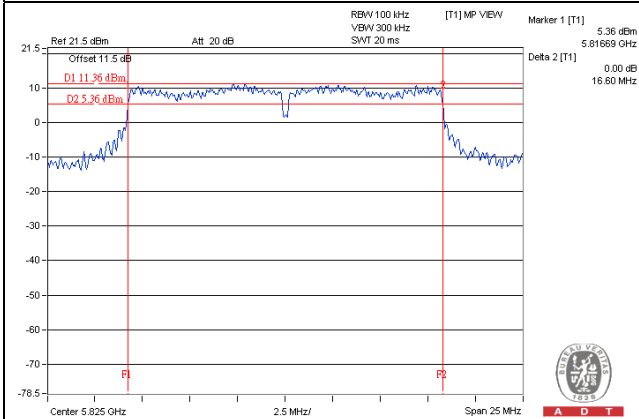

802.11ac (VHT20) / Chain 1 : CH165

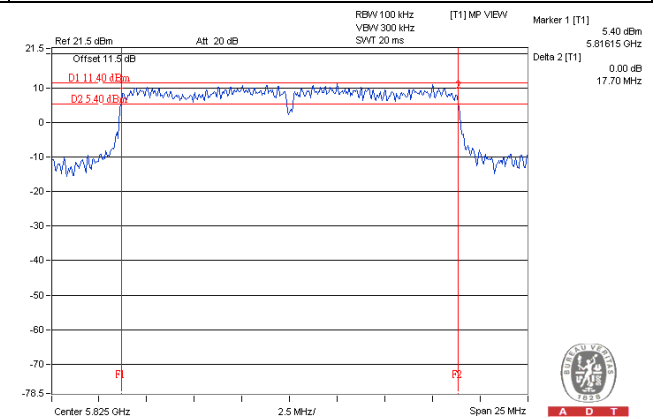

802.11ac (VHT40) / Chain 1 : CH159

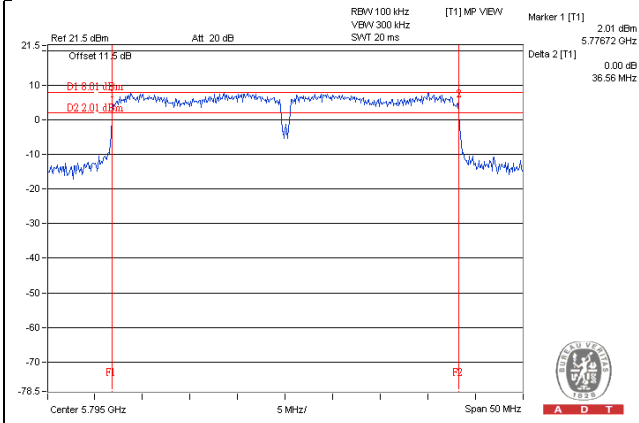

802.11ac (VHT80) / Chain 1 : CH155

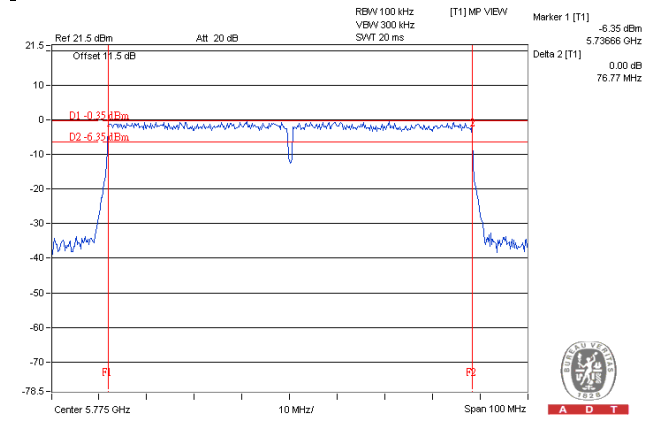

5.4 Conducted Output Power Measurement

5.4.1 Limits of Conducted Output Power Measurement

For systems using digital modulation in the 5725 –5850 MHz bands: 1 Watt (30dBm)

Per KDB 662911 D01 Multiple Transmitter Output Method of conducted output power measurement on IEEE 802.11 devices,

Array Gain = 0 dB (i.e., no array gain) for $NANT \leq 4$;

Array Gain = 0 dB (i.e., no array gain) for channel widths ≥ 40 MHz for any NANT;

Array Gain = $5 \log(NANT/NSS)$ dB or 3 dB, whichever is less for 20-MHz channel widths with $NANT \geq 5$.

For power measurements on all other devices: Array Gain = $10 \log(NANT/NSS)$ dB.

5.4.2 Test Setup

Same as Item 4.4.2.

5.4.3 Test Instruments

Refer to section 4.1.2 to get information of above instrument.

5.4.4 Test Procedures

Same as Item 4.4.4.

5.4.5 Deviation from Test Standard

No deviation.

5.4.6 EUT Operating Conditions

Same as Item 4.4.6.

5.4.7 Test Results

802.11a

CHANNEL	FREQUENCY (MHz)	AVERAGE POWER (dBm)		TOTAL POWER (mW)	TOTAL POWER (dBm)	LIMIT (dBm)	PASS / FAIL
		CHAIN 0	CHAIN 1				
149	5745	26.54	26.63	911.074	29.60	30	PASS
157	5785	26.71	27.04	974.638	29.89	30	PASS
165	5825	26.48	26.92	936.671	29.72	30	PASS

NOTE: Directional gain = $10 \log[(10^{G1/20} + 10^{G2/20})^2 / 2] = 4.81\text{dBi} < 6\text{dBi}$, so the power limit shall not be reduced.

802.11ac (VHT20)

CHANNEL	FREQUENCY (MHz)	AVERAGE POWER (dBm)		TOTAL POWER (mW)	TOTAL POWER (dBm)	LIMIT (dBm)	PASS / FAIL
		CHAIN 0	CHAIN 1				
149	5745	25.41	25.27	684.048	28.35	30	PASS
157	5785	26.84	26.78	959.490	29.82	30	PASS
165	5825	26.74	26.58	927.051	29.67	30	PASS

NOTE: Directional gain = $10 \log[(10^{G1/20} + 10^{G2/20})^2 / 2] = 4.81\text{dBi} < 6\text{dBi}$, so the power limit shall not be reduced.

802.11ac (VHT40)

CHANNEL	FREQUENCY (MHz)	AVERAGE POWER (dBm)		TOTAL POWER (mW)	TOTAL POWER (dBm)	LIMIT (dBm)	PASS / FAIL
		CHAIN 0	CHAIN 1				
151	5755	23.96	24.11	506.518	27.05	30	PASS
159	5795	26.81	26.54	930.550	29.69	30	PASS

NOTE: Directional gain = $10 \log[(10^{G1/20} + 10^{G2/20})^2 / 2] = 4.81\text{dBi} < 6\text{dBi}$, so the power limit shall not be reduced.

802.11ac (VHT80)

CHANNEL	FREQUENCY (MHz)	AVERAGE POWER (dBm)		TOTAL POWER (mW)	TOTAL POWER (dBm)	LIMIT (dBm)	PASS / FAIL
		CHAIN 0	CHAIN 1				
155	5775	21.78	22.34	322.057	25.08	30	PASS

NOTE: Directional gain = $10 \log[(10^{G1/20} + 10^{G2/20})^2 / 2] = 4.81\text{dBi} < 6\text{dBi}$, so the power limit shall not be reduced.

5.5 Power Spectral Density Measurement

5.5.1 Limits of Power Spectral Density Measurement

Same as item 4.5.1.

5.5.2 Test Setup

Same as item 4.5.2.

5.5.3 Test Instruments

Refer to section 4.1.2 to get information of above instrument.

5.5.4 Test Procedures

Same as item 4.5.4.

5.5.5 Deviation from Test Standard

No deviation.

5.5.6 EUT Operating Conditions

Same as Item 4.3.6

5.5.7 Test Results

802.11a

TX chain	Channel	Freq. (MHz)	PSD (dBm)	10 log (N=2) dB	Total PSD (dBm)	Limit (dBm)	PASS /FAIL
0	149	5745	-5.31	3.01	-2.30	8.00	PASS
	157	5785	-4.70	3.01	-1.69	8.00	PASS
	165	5825	-4.50	3.01	-1.49	8.00	PASS
1	149	5745	-4.52	3.01	-1.51	8.00	PASS
	157	5785	-3.42	3.01	-0.41	8.00	PASS
	165	5825	-4.36	3.01	-1.35	8.00	PASS

NOTE: Directional gain = $10 \log[(10^{G1/20} + 10^{G2/20})^2 / 2]$ = 4.81dBi < 6dBi , so the power limit shall not be reduced.

802.11ac (VHT20)

TX chain	Channel	Freq. (MHz)	PSD (dBm)	10 log (N=2) dB	Total PSD (dBm)	Limit (dBm)	PASS /FAIL
0	149	5745	-6.04	3.01	-3.03	8.00	PASS
	157	5785	-4.41	3.01	-1.40	8.00	PASS
	165	5825	-4.72	3.01	-1.71	8.00	PASS
1	149	5745	-6.54	3.01	-3.53	8.00	PASS
	157	5785	-4.47	3.01	-1.46	8.00	PASS
	165	5825	-4.99	3.01	-1.98	8.00	PASS

NOTE: Directional gain = $10 \log[(10^{G1/20} + 10^{G2/20})^2 / 2]$ = 4.81dBi < 6dBi , so the power limit shall not be reduced.

802.11ac (VHT40)

TX chain	Channel	Freq. (MHz)	PSD (dBm)	10 log (N=2) dB	Total PSD (dBm)	Limit (dBm)	PASS /FAIL
0	151	5755	-9.72	3.01	-6.71	8.00	PASS
	159	5795	-7.62	3.01	-4.61	8.00	PASS
1	151	5755	-9.98	3.01	-6.97	8.00	PASS
	159	5795	-7.42	3.01	-4.41	8.00	PASS

NOTE: Directional gain = $10 \log[(10^{G1/20} + 10^{G2/20})^2 / 2]$ = 4.81dBi < 6dBi , so the power limit shall not be reduced.

802.11ac (VHT80)

TX chain	Channel	Freq. (MHz)	PSD (dBm)	10 log (N=2) dB	Total PSD (dBm)	Limit (dBm)	PASS /FAIL
0	155	5775	-15.89	3.01	-12.88	8.00	PASS
1	155	5775	-15.73	3.01	-12.72	8.00	PASS

NOTE: Directional gain = $10 \log[(10^{G1/20} + 10^{G2/20})^2 / 2]$ = 4.81dBi < 6dBi , so the power limit shall not be reduced.

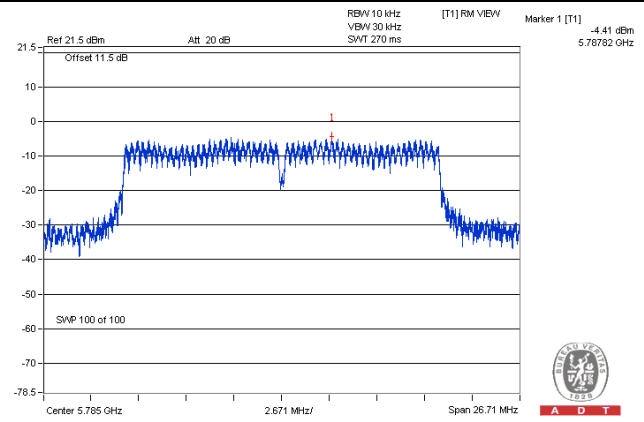
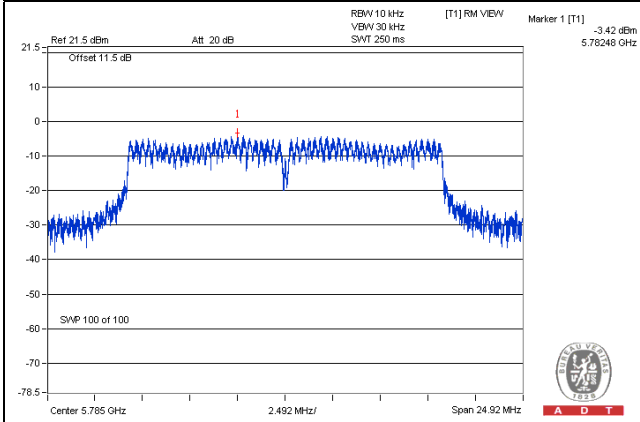
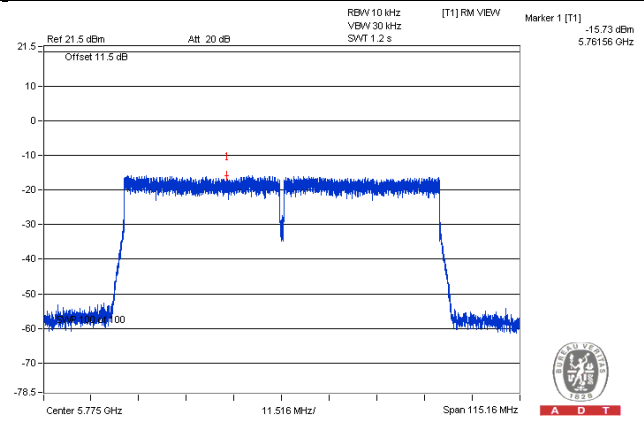
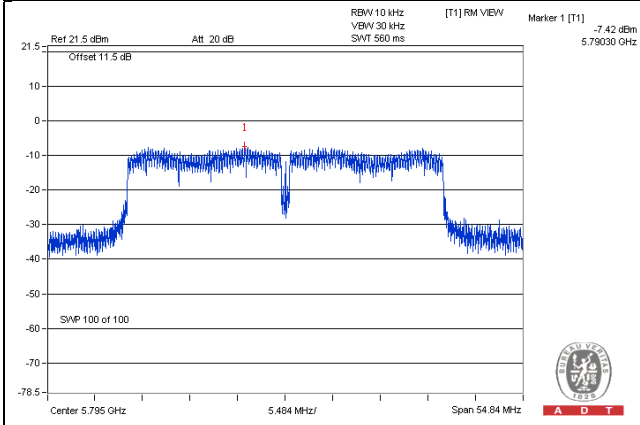
SPECTRUM PLOT OF WORST VALUE**802.11a / Chain 1 : CH157****802.11ac (VHT20) / Chain 0 : CH157****802.11ac (VHT40) / Chain 1 : CH159****802.11ac (VHT80) / Chain 1 : CH155**

5.6 Conducted Out of Band Emission Measurement

5.6.1 Limits of Conducted Out of Band Emission Measurement

Below 30dB of the highest emission level of operating band (in 100kHz Resolution Bandwidth).

5.6.2 Test Setup

Same as Item 4.6.2

5.6.3 Test Instruments

Refer to section 4.1.2 to get information of above instrument.

5.6.4 Test Procedures

Same as Item 4.6.4

5.6.5 Deviation from Test Standard

No deviation.

5.6.6 EUT Operating Conditions

Same as Item 4.3.6

5.6.7 Test Results

The spectrum plots are attached on the following pages. D1 line indicates the highest level, and D2 line indicates the 30dB offset below D1. It shows compliance with the requirement.

802.11a

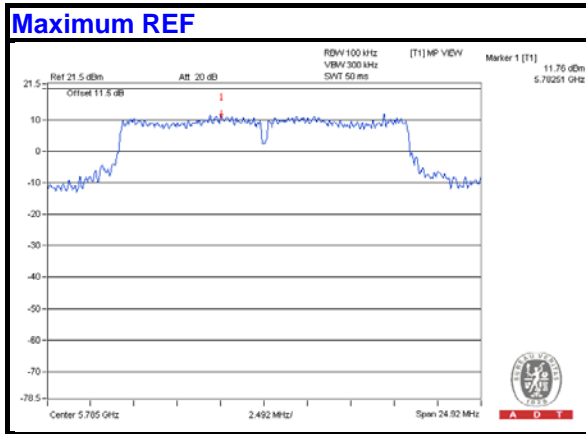

CHAIN 0

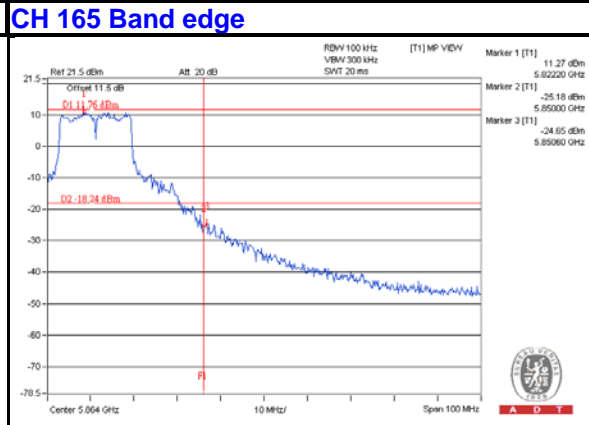
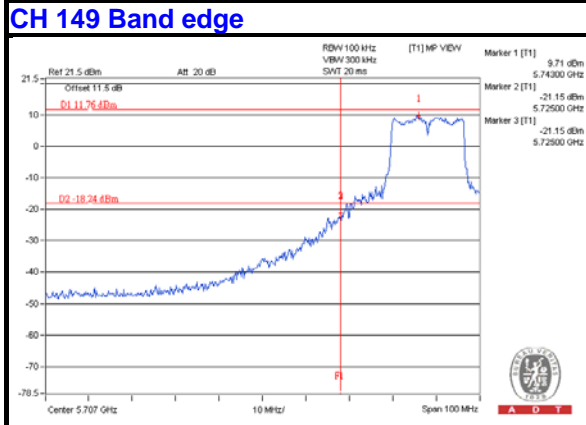
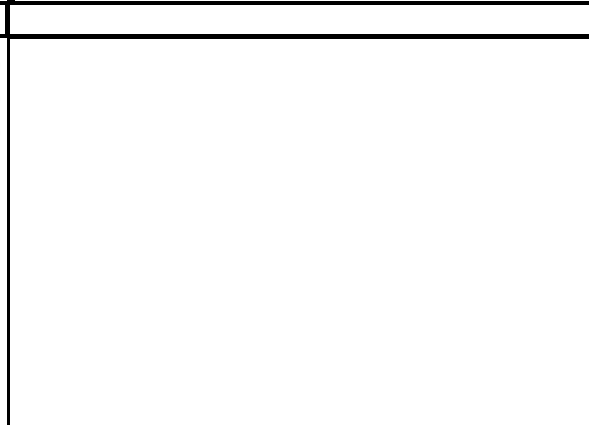
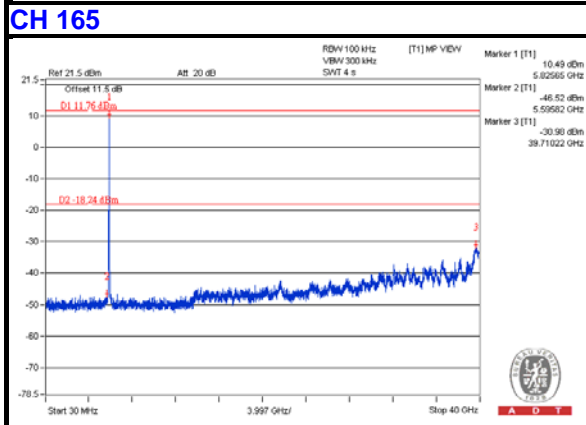
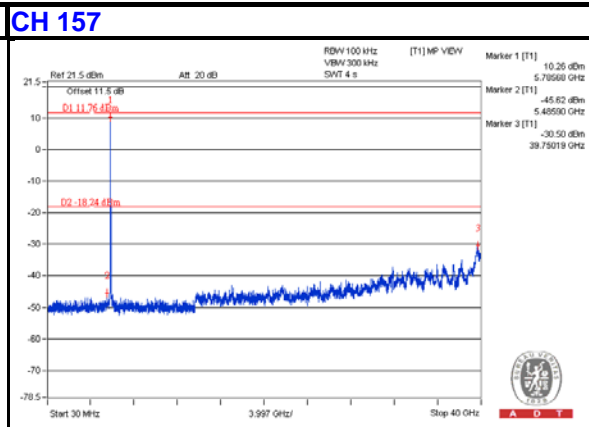
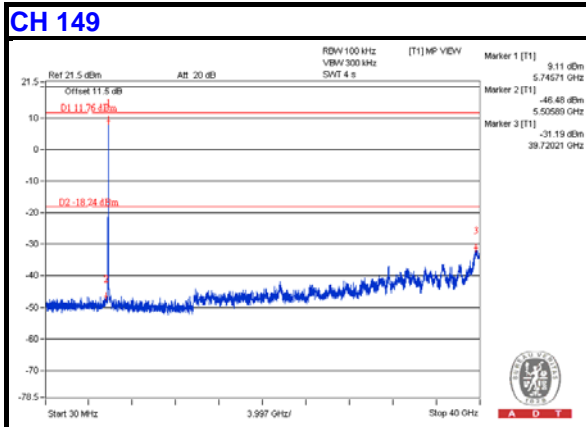

CHAIN 1

CH 149

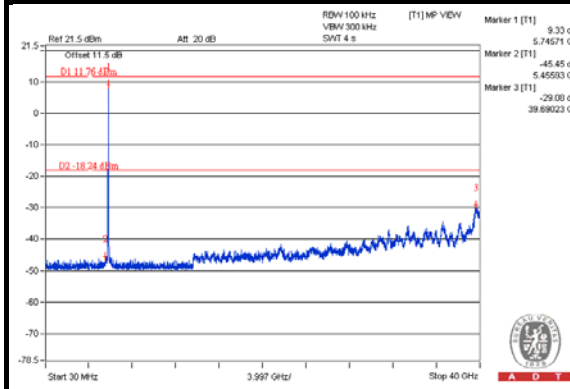

CH 157

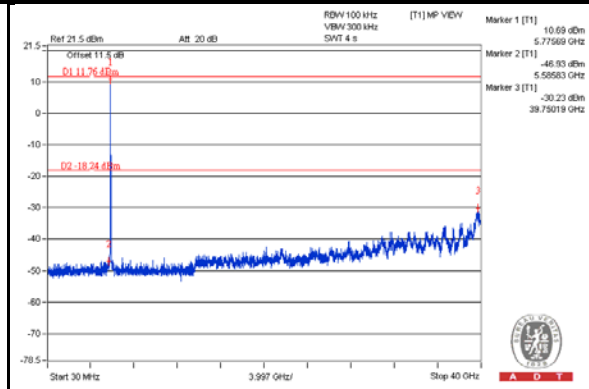

CH 165

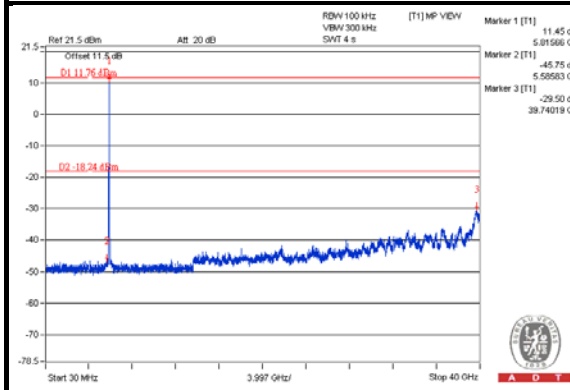

CH 149 Band edge

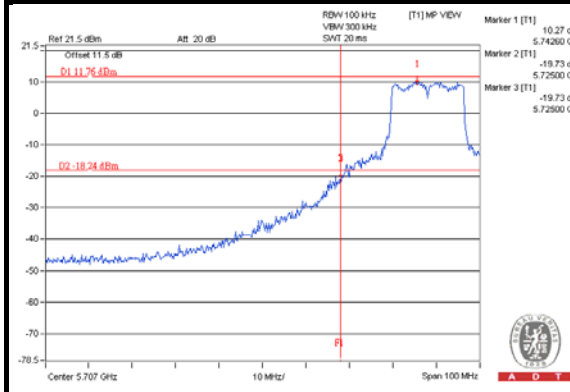

CH 165 Band edge

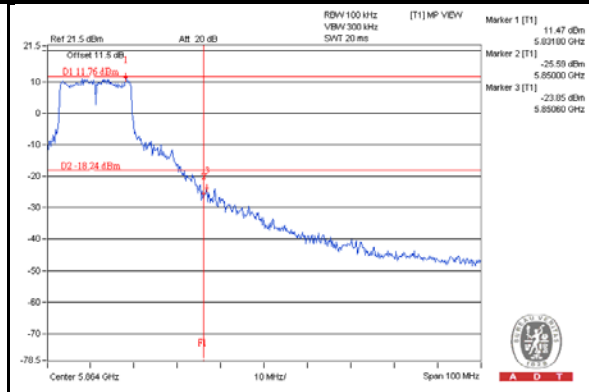

802.11n (HT20)

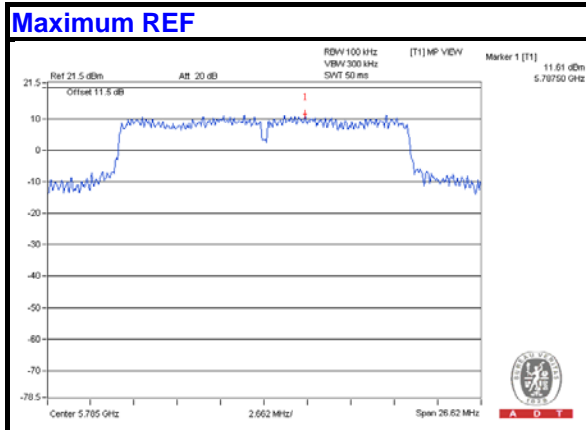

CHAIN 0

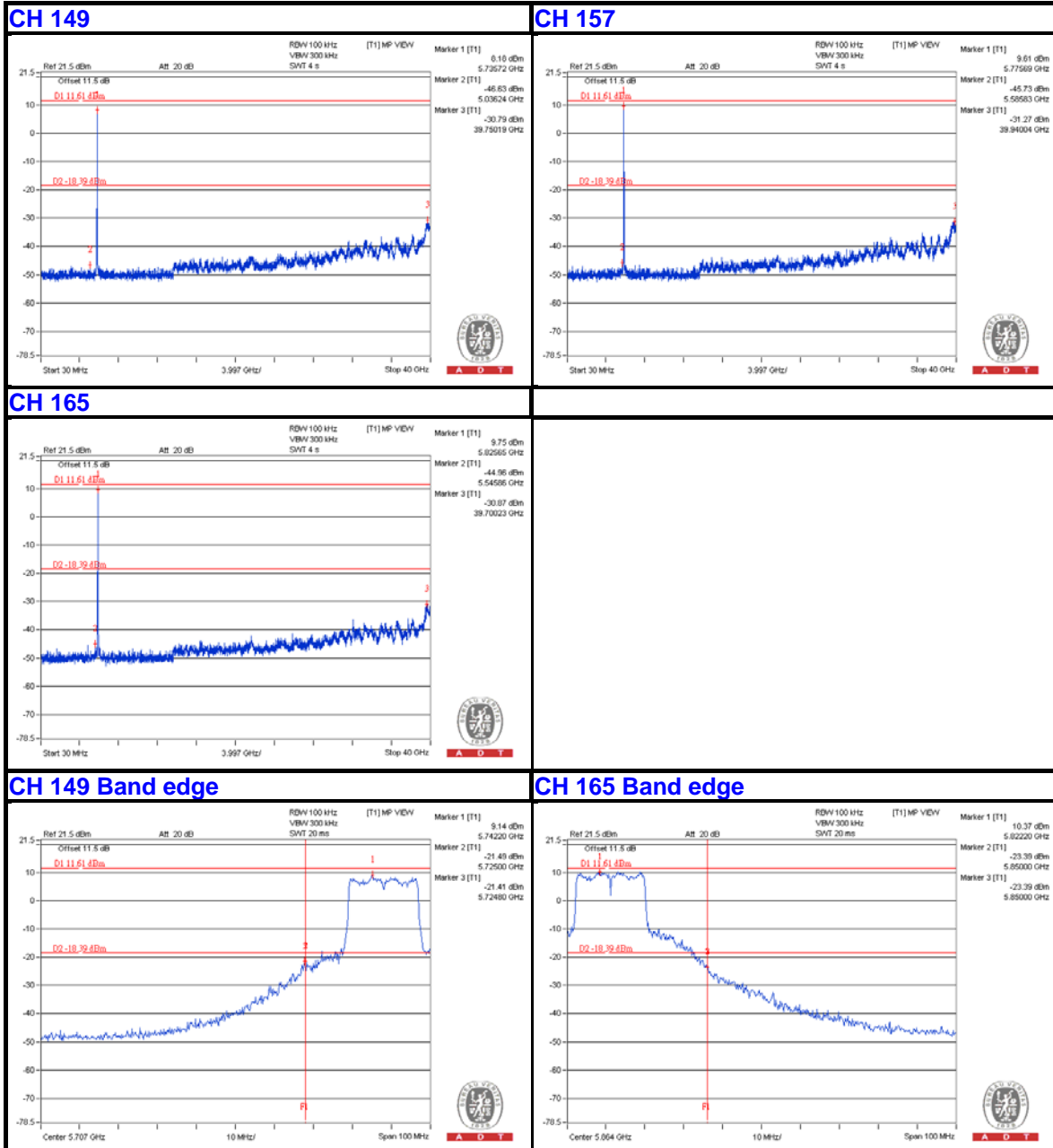

CHAIN 1

CH 149

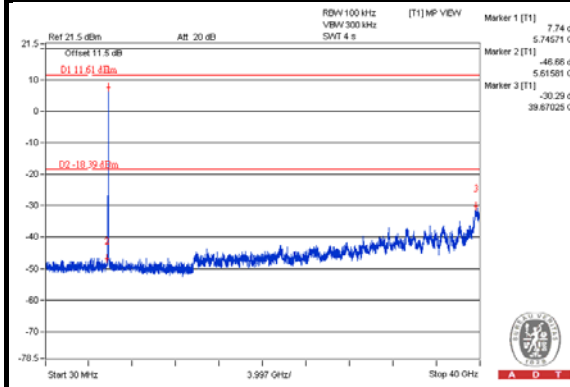

CH 157

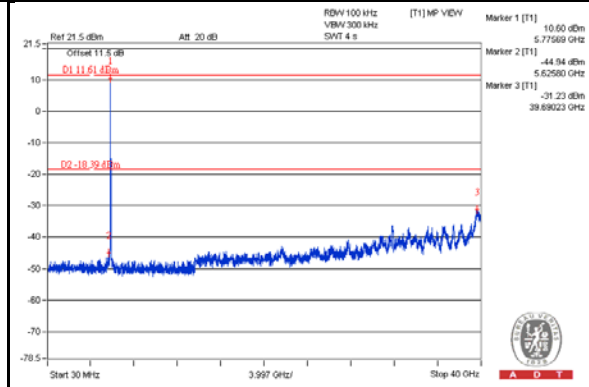

CH 165

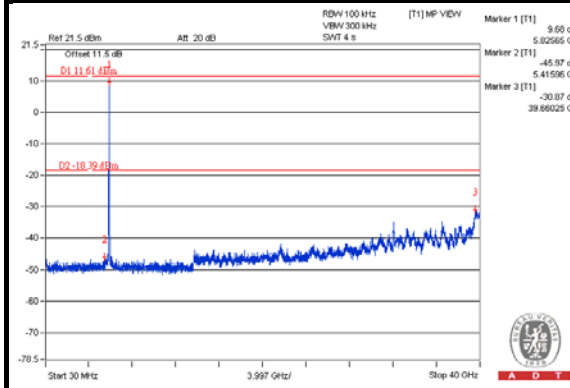

CH 149 Band edge

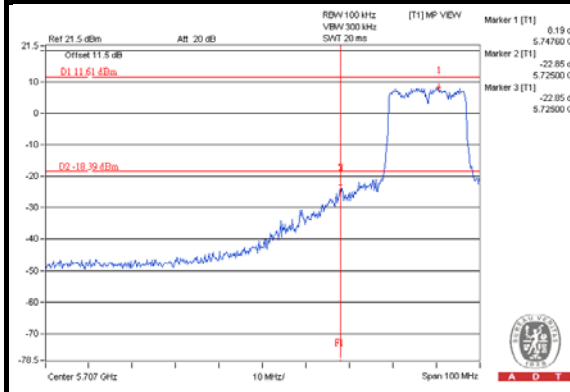

CH 165 Band edge

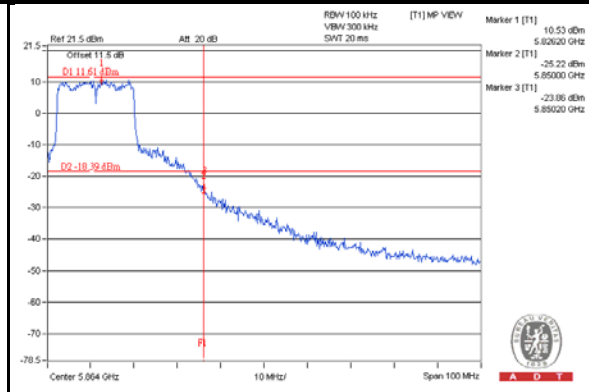

802.11n (HT40)

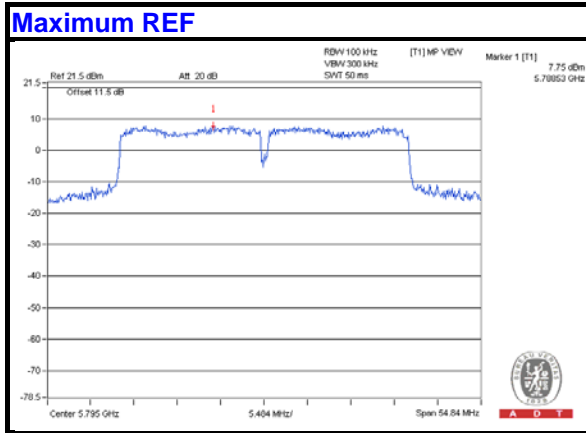

CHAIN 0

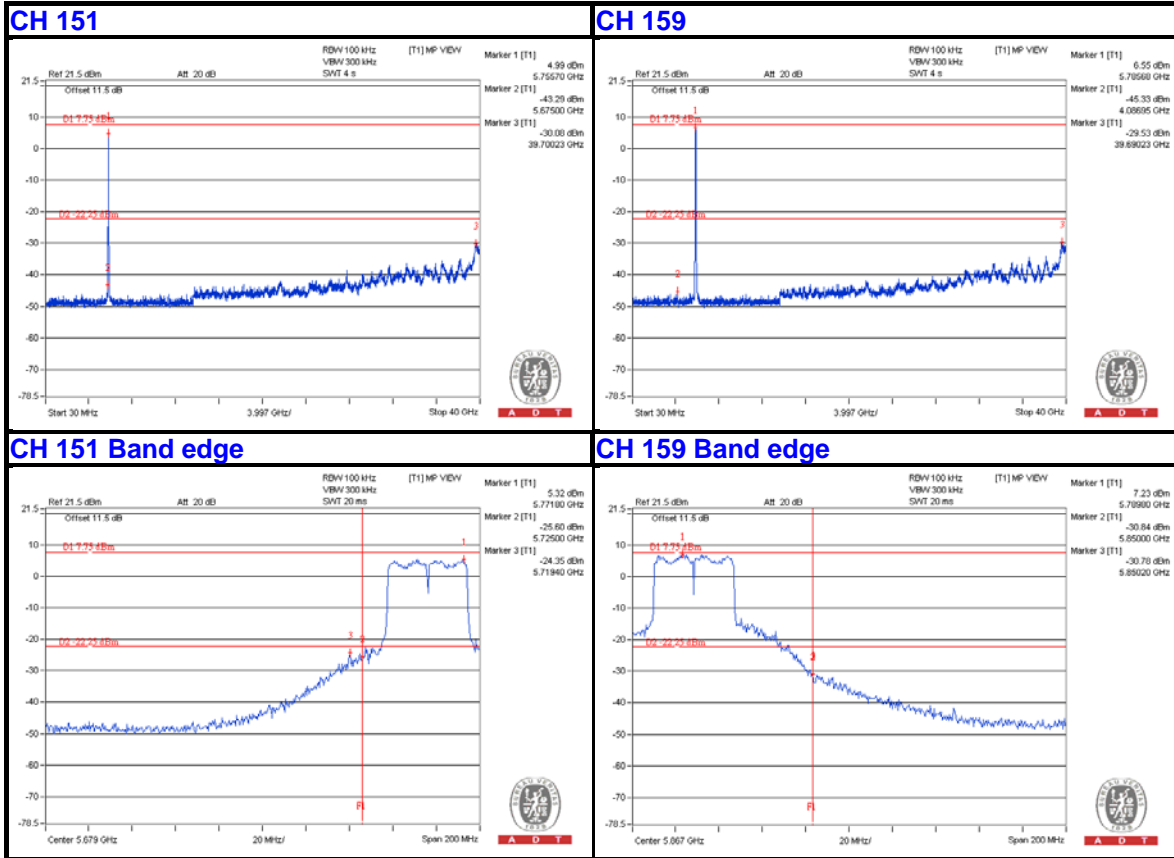

CHAIN 1

CH 151

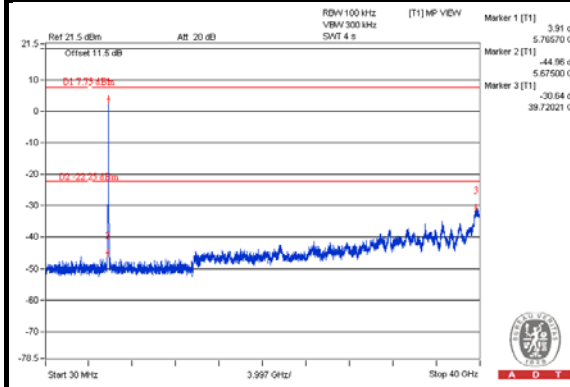

CH 159

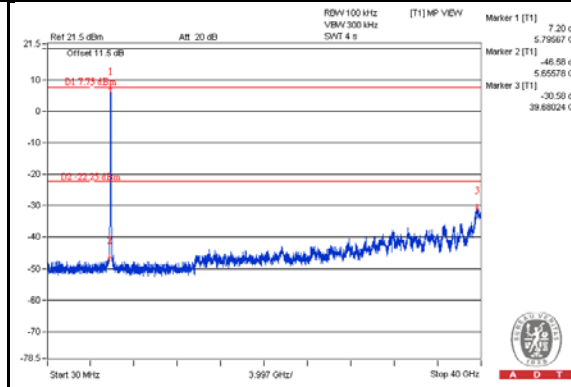

CH 151 Band edge

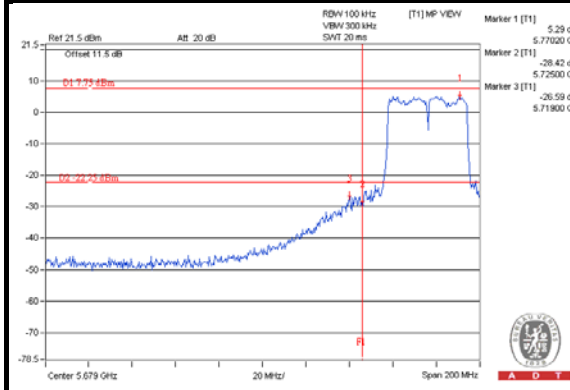

CH 159 Band edge

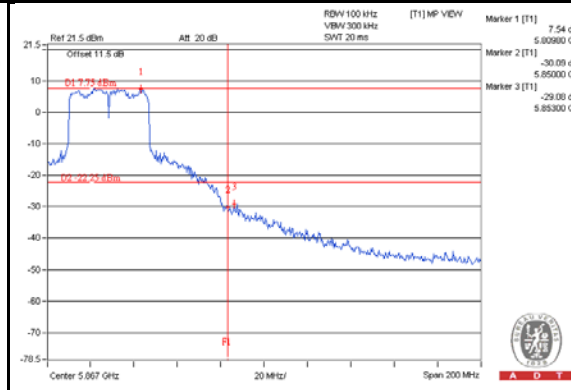

802.11n (80MHz)

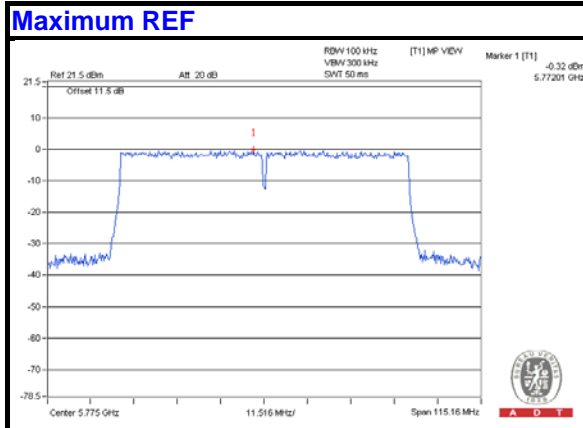

CHAIN 0

CH 155

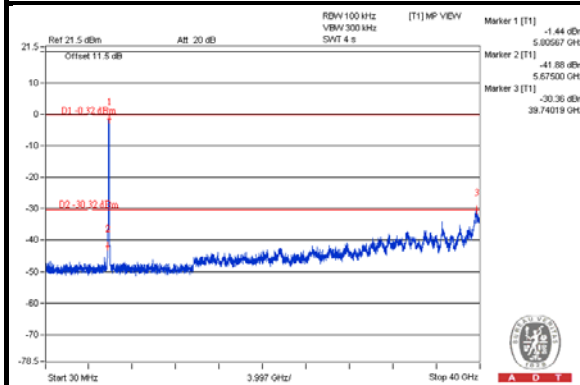

CH 155 Band edge

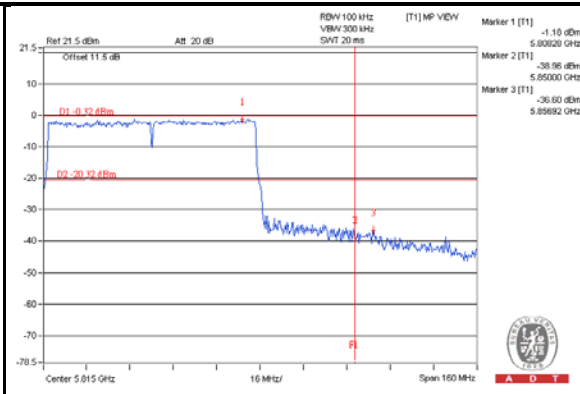
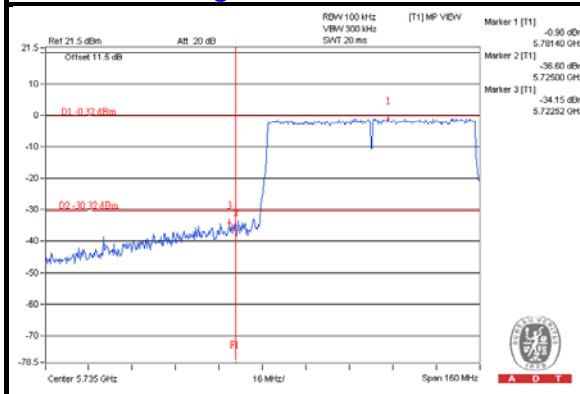

CHAIN 1

CH 155

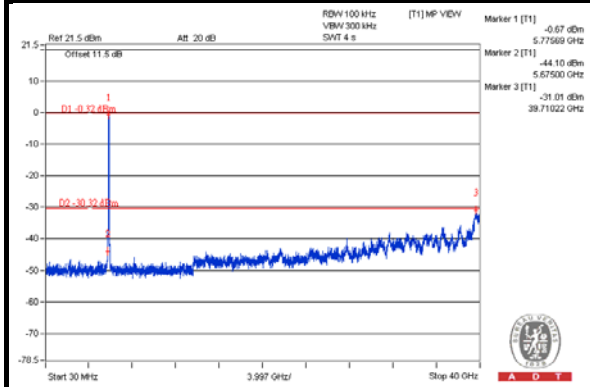

CH 155 Band edge

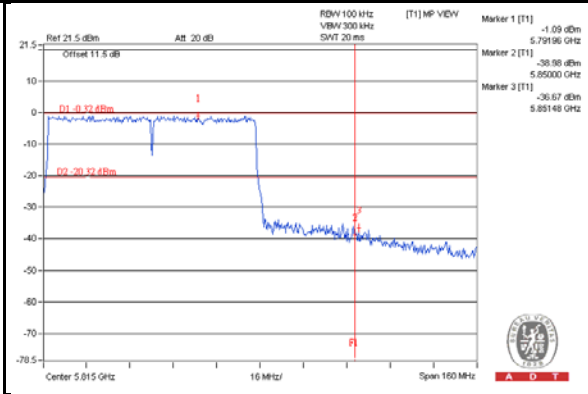
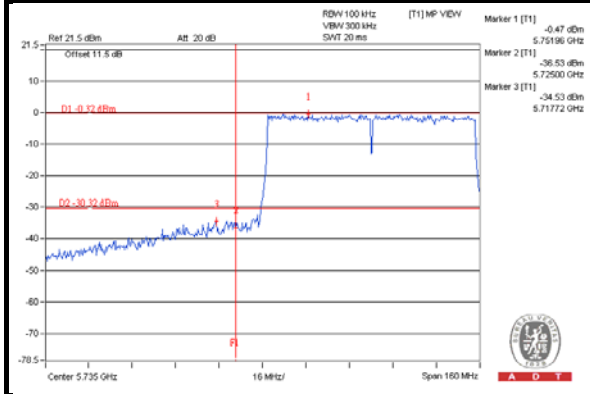

6 Pictures of Test Arrangements

Please refer to the attached file (Test Setup Photo).



Appendix – Information on the Testing Laboratories

We, Bureau Veritas Consumer Products Services (H.K.) Ltd., Taoyuan Branch, were founded in 1988 to provide our best service in EMC, Radio, Telecom and Safety consultation. Our laboratories are accredited and approved according to ISO/IEC 17025.

If you have any comments, please feel free to contact us at the following:

Linko EMC/RF Lab

Tel: 886-2-26052180

Fax: 886-2-26051924

Hsin Chu EMC/RF/Telecom Lab

Tel: 886-3-5935343

Fax: 886-3-5935342

Hwa Ya EMC/RF/Safety Lab

Tel: 886-3-3183232

Fax: 886-3-3270892

Email: service.adt@tw.bureauveritas.com

Web Site: www.bureauveritas-adt.com

The address and road map of all our labs can be found in our web site also.

--- END ---