



FCC TEST REPORT

REPORT NO.: RF931017L01

MODEL NO.: WRE54G ver. 2

RECEIVED: Oct. 08, 2004

TESTED: Oct. 08 ~ Nov. 01, 2004

APPLICANT: Cisco-Linksys, LLC

ADDRESS: 121 Theory Drive Irvine, CA 92612, U.S.A

ISSUED BY: Advance Data Technology Corporation

LAB ADDRESS: No. 47, 14th Ling, Chia Pau Tsuen, Lin Kou
Hsiang 244, Taipei Hsien, Taiwan, R.O.C.

TEST LOCATION: No. 19, Hwa Ya 2nd Rd., Wen Hwa Tsuen, Kwei
Shan Hsiang, Taoyuan Hsien 333, Taiwan,
R.O.C.

This test report consists of 66 pages in total. It may be duplicated completely for legal use with the approval of the applicant. It should not be reproduced except in full, without the written approval of our laboratory. The client should not use it to claim product endorsement by CNLA, A2LA or any government agencies. The test results in the report only apply to the tested sample.



No. 2177-01



0528
ILAC MRA



Table of Contents

1	CERTIFICATION	4
2	SUMMARY OF TEST RESULTS	5
2.1	MEASUREMENT UNCERTAINTY	5
3	GENERAL INFORMATION	6
3.1	GENERAL DESCRIPTION OF EUT	6
3.2	DESCRIPTION OF TEST MODES.....	7
3.3	GENERAL DESCRIPTION OF APPLIED STANDARDS.....	7
3.4	DESCRIPTION OF SUPPORT UNITS	8
3.5	CONFIGURATION OF SYSTEM UNDER TEST.....	8
4	TEST TYPES AND RESULTS	9
4.1	CONDUCTED EMISSION MEASUREMENT	9
4.1.1	LIMITS OF CONDUCTED EMISSION MEASUREMENT	9
4.1.2	TEST INSTRUMENTS	9
4.1.3	TEST PROCEDURES	10
4.1.4	DEVIATION FROM TEST STANDARD	10
4.1.5	TEST SETUP	11
4.1.6	EUT OPERATING CONDITIONS	11
4.1.7	TEST RESULTS.....	12
4.2	RADIATED EMISSION MEASUREMENT	18
4.2.1	LIMITS OF RADIATED EMISSION MEASUREMENT	18
4.2.2	TEST INSTRUMENTS	19
4.2.3	TEST PROCEDURES	20
4.2.4	DEVIATION FROM TEST STANDARD	20
4.2.5	TEST SETUP	21
4.2.6	EUT OPERATING CONDITIONS	21
4.2.7	TEST RESULTS.....	22
4.2.8	TEST RESULTS (A)	24
4.2.9	TEST RESULTS (B).....	27
4.3	6dB BANDWIDTH MEASUREMENT	30
4.3.1	LIMITS OF 6dB BANDWIDTH MEASUREMENT	30
4.3.2	TEST INSTRUMENTS	30
4.3.3	TEST PROCEDURE	31
4.3.4	DEVIATION FROM TEST STANDARD	31
4.3.5	TEST SETUP	31
4.3.6	EUT OPERATING CONDITIONS	31



4.3.7	TEST RESULTS (A)	32
4.3.8	TEST RESULTS (B).....	36
4.4	MAXIMUM PEAK OUTPUT POWER	40
4.4.1	LIMITS OF MAXIMUM PEAK OUTPUT POWER MEASUREMENT	40
4.4.2	TEST INSTRUMENTS	40
4.4.3	TEST PROCEDURES	41
4.4.4	DEVIATION FROM TEST STANDARD	41
4.4.5	TEST SETUP	41
4.4.6	EUT OPERATING CONDITIONS	41
4.4.7	TEST RESULTS (A)	42
4.4.8	TEST RESULTS (B).....	42
4.5	POWER SPECTRAL DENSITY MEASUREMENT	43
4.5.1	LIMITS OF POWER SPECTRAL DENSITY MEASUREMENT.....	43
4.5.2	TEST INSTRUMENTS.....	43
4.5.3	TEST PROCEDURE.....	44
4.5.4	DEVIATION FROM TEST STANDARD	44
4.5.5	TEST SETUP	44
4.5.6	EUT OPERATING CONDITIONS	44
4.5.7	TEST RESULTS (A)	45
4.5.8	TEST RESULTS (B).....	49
4.6	BAND EDGES MEASUREMENT.....	53
4.6.1	LIMITS OF BAND EDGES MEASUREMENT.....	53
4.6.2	TEST INSTRUMENTS.....	53
4.6.3	TEST PROCEDURE.....	53
4.6.4	DEVIATION FROM TEST STANDARD	53
4.6.5	EUT OPERATING CONDITION.....	53
4.6.6	TEST RESULTS.....	54
4.6.7	TEST RESULTS(A)	54
4.6.8	TEST RESULTS(B).....	54
4.7	ANTENNA REQUIREMENT	63
4.7.1	STANDARD APPLICABLE.....	63
4.7.2	ANTENNA CONNECTED CONSTRUCTION.....	63
5	PHOTOGRAPHS OF THE TEST CONFIGURATION	64
6	INFORMATION ON THE TESTING LABORATORIES.....	66



1 CERTIFICATION

PRODUCT : Wireless-G Range Expander
BRAND NAME : Linksys
MODEL NO. : WRE54G ver. 2
APPLICANT : Cisco-Linksys, LLC
TESTED : Oct. 08 ~ Nov. 01, 2004
TEST SAMPLE : ENGINEERING SAMPLE
STANDARDS : FCC Part 15, Subpart C (Section 15.247),
ANSI C63.4-2003

The above equipment has been tested by **Advance Data Technology Corporation**, and found compliance with the requirement of the above standards. The test record, data evaluation & Equipment Under Test (EUT) configurations represented herein are true and accurate accounts of the measurements of the sample's EMC characteristics under the conditions specified in this report.

PREPARED BY : Windy Chou , **DATE:** Nov. 04, 2004
(Windy Chou)

TECHNICAL ACCEPTANCE : Gary Chang , **DATE:** Nov. 04, 2004
Responsible for RF (Gary Chang)

APPROVED BY : Cody Chang , **DATE:** Nov. 04, 2004
(Cody Chang, Deputy Manager)

2 SUMMARY OF TEST RESULTS

The EUT has been tested according to the following specifications:

APPLIED STANDARD: FCC Part 15, Subpart C			
Standard Section	Test Type and Limit	Result	REMARK
15.207	AC Power Conducted Emission	PASS	Meet the requirement of limit. Minimum passing margin is -10.89dB at 3.586MHz
15.247(a)(2)	Spectrum Bandwidth of a Direct Sequence Spread Spectrum System Limit: min. 500kHz	PASS	Meet the requirement of limit.
15.247(b)	Maximum Peak Output Power Limit: max. 30dBm	PASS	Meet the requirement of limit.
15.247(d)	Transmitter Radiated Emissions Limit: Table 15.209	PASS	Meet the requirement of limit. Minimum passing margin is -1.09dB at 480.00MHz
15.247(e)	Power Spectral Density Limit: max. 8dBm	PASS	Meet the requirement of limit.
15.247(d)	Band Edge Measurement Limit: 20 dB less than the peak value of fundamental frequency	PASS	Meet the requirement of limit.

2.1 MEASUREMENT UNCERTAINTY

Where relevant, the following measurement uncertainty levels have been estimated for tests performed on the EUT as specified in CISPR 16-4:

Measurement	Frequency	Uncertainty
Conducted emissions	9k~30MHz	2.44 dB
Radiated emissions	30MHz ~ 200MHz	3.55 dB
	200MHz ~ 1000MHz	3.58 dB
	1GHz ~ 18GHz	2.20 dB
	18GHz ~ 40GHz	1.88 dB



3 GENERAL INFORMATION

3.1 GENERAL DESCRIPTION OF EUT

PRODUCT	Wireless-G Range Expander
MODEL NO.	WRE54G ver. 2
POWER SUPPLY	3.3Vdc from power adapter
MODULATION TYPE	BPSK, QPSK, CCK, 16QAM, 64QAM
RADIO TECHNOLOGY	DSSS, OFDM
TRANSFER RATE	802.11b: 11/5.5/2/1Mbps 802.11g: 54/48/36/24/18/12/9/6Mbps
FREQUENCY RANGE	2412MHz ~ 2462MHz
NUMBER OF CHANNEL	11
MAXIMUM OUTPUT POWER	40.551mW
ANTENNA TYPE	Dipole antenna with 2dBi gain
DATA CABLE	NA
I/O PORTS	RJ45
ASSOCIATED DEVICES	NA

NOTE:

1. The EUT operates in the 2.4GHz frequency spectrum with throughput of up to 54Mbps.
2. The EUT complies with IEEE 802.11g standards and backwards compatible with IEEE 802.11b products.
3. The EUT was powered by the following adapter:

Brand	UMEC
Model	UP0051A-03
Input	100-240Vac, 47-63Hz, 0.2A MAX.
Output	3.3Vdc, 1.5A

4. The above EUT information was declared by manufacturer and for more detailed features description, please refer to the manufacturer's specifications or User's Manual.



3.2 DESCRIPTION OF TEST MODES

Eleven channels are provided to this EUT.

Channel	Frequency	Channel	Frequency
1	2412 MHz	7	2442 MHz
2	2417 MHz	8	2447 MHz
3	2422 MHz	9	2452 MHz
4	2427 MHz	10	2457 MHz
5	2432 MHz	11	2462 MHz
6	2437 MHz		

NOTE:

1. Below 1GHz, the channel 1, 6, and 11 were pre-tested in chamber. The channel 11, the worst case, was chosen for final test.
2. Above 1GHz, the channel 1, 6, and 11 were tested individually.
3. From our experience and technical viewpoint, we have chosen data rates 11Mbps for CCK technique and 6Mbps for OFDM technique, as the worst cases for the test among other data rates.
4. Two test results were presented in the following sections. The test result A was for CCK technique and the test result B was for OFDM technique.

3.3 GENERAL DESCRIPTION OF APPLIED STANDARDS

The EUT is a Wireless-G Range Expander. According to the specifications of the manufacturer, it must comply with the requirements of the following standards:

FCC Part 15, Subpart C. (15.247)
ANSI C63.4-2003

All test items have been performed and recorded as per the above standards.

NOTE: The EUT is also considered as a kind of computer peripheral, because the connection to computer is necessary for typical use. It has been verified to comply with the requirements of FCC Part 15, Subpart B, Class B (DoC). The test report has been issued separately.



3.4 DESCRIPTION OF SUPPORT UNITS

The EUT has been tested as an independent unit together with other necessary accessories or support units. The following support units or accessories were used to form a representative test configuration during the tests.

NO.	PRODUCT	BRAND	MODEL NO.	SERIAL NO.	FCC ID
1	NOTEBOOK COMPUTER	DELL	PP05L	16484462992	E2K24CLNS

NO.	SIGNAL CABLE DESCRIPTION OF THE ABOVE SUPPORT UNITS
1	NA

- NOTE:**
1. All power cords of the above support units are non shielded (1.8m).
 2. Item 1 act as a communication partner to transfer data.

3.5 CONFIGURATION OF SYSTEM UNDER TEST

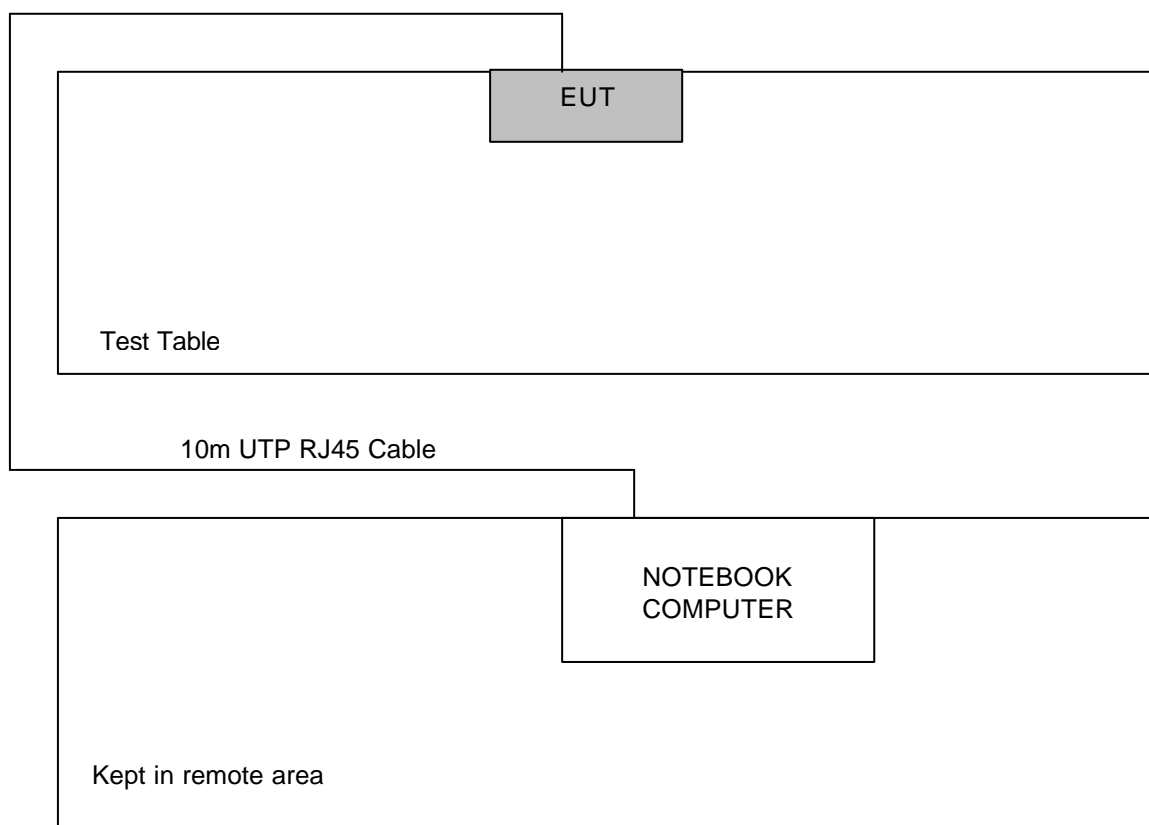



4 TEST TYPES AND RESULTS

4.1 CONDUCTED EMISSION MEASUREMENT

4.1.1 LIMITS OF CONDUCTED EMISSION MEASUREMENT

FREQUENCY OF EMISSION (MHz)	CONDUCTED LIMIT (dB μ V)	
	Quasi-peak	Average
0.15-0.5	66 to 56	56 to 46
0.5-5	56	46
5-30	60	50

- NOTE:**
1. The lower limit shall apply at the transition frequencies.
 2. The limit decreases in line with the logarithm of the frequency in the range of 0.15 to 0.50 MHz.
 3. All emanations from a class A/B digital device or system, including any network of conductors and apparatus connected thereto, shall not exceed the level of field strengths specified above.

4.1.2 TEST INSTRUMENTS

DESCRIPTION & MANUFACTURER	MODEL NO.	SERIAL NO.	CALIBRATED UNTIL
Test Receiver ROHDE & SCHWARZ	ESCS30	100288	Dec. 11, 2004
RF signal cable Woken	5D-FB	Cable-HyC02-01	Mar. 07, 2005
LISN ROHDE & SCHWARZ	ESH2-Z5	100100	Mar. 10, 2005
LISN ROHDE & SCHWARZ	ESH3-Z5	100311	Mar. 04, 2005
Software ADT	ADT_Cond_V3	NA	NA

- NOTE:**
1. The calibration interval of the above test instruments is 12 months and the calibrations are traceable to NML/ROC and NIST/USA.
 2. The test was performed in HwaYa Shielded Room 2.
 3. The VCCI Site Registration No. is C-2047.



4.1.3 TEST PROCEDURES

- a. The EUT was placed 0.4 meters from the conducting wall of the shielded room with EUT being connected to the power mains through a line impedance stabilization network (LISN). Other support units were connected to the power mains through another LISN. The two LISNs provide 50 ohm/ 50uH of coupling impedance for the measuring instrument.
- b. Both lines of the power mains connected to the EUT were checked for maximum conducted interference.
- c. The frequency range from 150kHz to 30MHz was searched. Emission levels under Limit - 20dB was not recorded.

4.1.4 DEVIATION FROM TEST STANDARD

No deviation

4.1.5 TEST SETUP

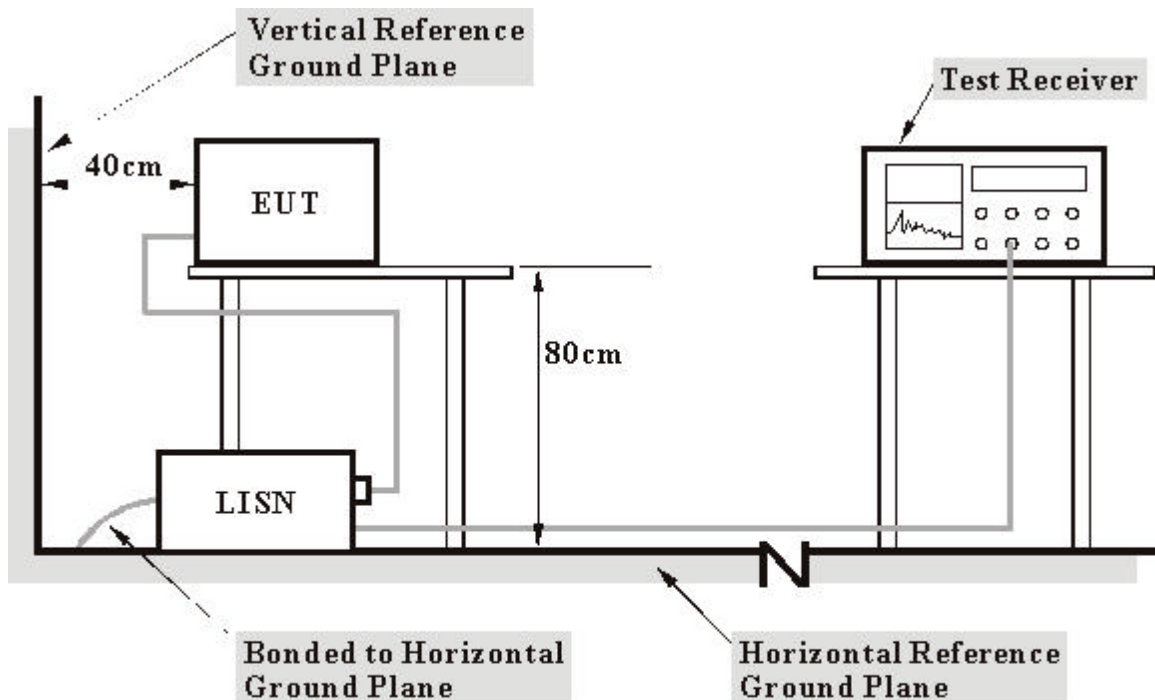

- Note:**
1. Support units were connected to second LISN.
 2. Both of LISNs (AMN) 80 cm from EUT and at the least 80 cm from other units and other metal planes support units.

For the actual test configuration, please refer to the related item – Photographs of the Test Configuration.

4.1.6 EUT OPERATING CONDITIONS

- a. Placed the EUT on the testing table.
- b. Prepared another Notebook system to act as a communication partner and placed it outside of testing area. The Notebook system ran a test program (provided by manufacturer) to enable EUT under transmission/receiving condition continuously at specific channel frequency.



4.1.7 TEST RESULTS

EUT	Wireless-G Range Expander	MODEL	WRE54G ver. 2
CHANNEL	1	6dB BANDWIDTH	9 kHz
INPUT POWER (SYSTEM)	120 Vac, 60 Hz	PHASE	Line (L)
ENVIRONMENTAL CONDITIONS	24deg. C, 64% RH, 991 hPa	TESTED BY	Leo Hung

No	Freq. [MHz]	Corr. Factor (dB)	Reading Value [dB (uV)]		Emission Level [dB (uV)]		Limit [dB (uV)]		Margin (dB)	
			Q.P.	AV.	Q.P.	AV.	Q.P.	AV.	Q.P.	AV.
	1	0.173	0.10	48.76	-	48.86	-	64.79	54.79	-15.93
2	0.287	0.11	44.77	-	44.88	-	60.62	50.62	-15.74	-
3	0.510	0.14	40.64	-	40.78	-	56.00	46.00	-15.22	-
4	0.970	0.24	38.23	-	38.47	-	56.00	46.00	-17.53	-
5	3.586	0.30	44.81	-	45.11	-	56.00	46.00	-10.89	-
6	18.246	0.84	43.08	-	43.92	-	60.00	50.00	-16.08	-

- REMARKS:**
1. Q.P. and AV. are abbreviations of quasi-peak and average individually.
 2. "-": The Quasi-peak reading value also meets average limit and measurement with the average detector is unnecessary.
 3. The emission levels of other frequencies were very low against the limit.
 4. Margin value = Emission level - Limit value
 5. Correction factor = Insertion loss + Cable loss
 6. Emission Level = Correction Factor + Reading Value.

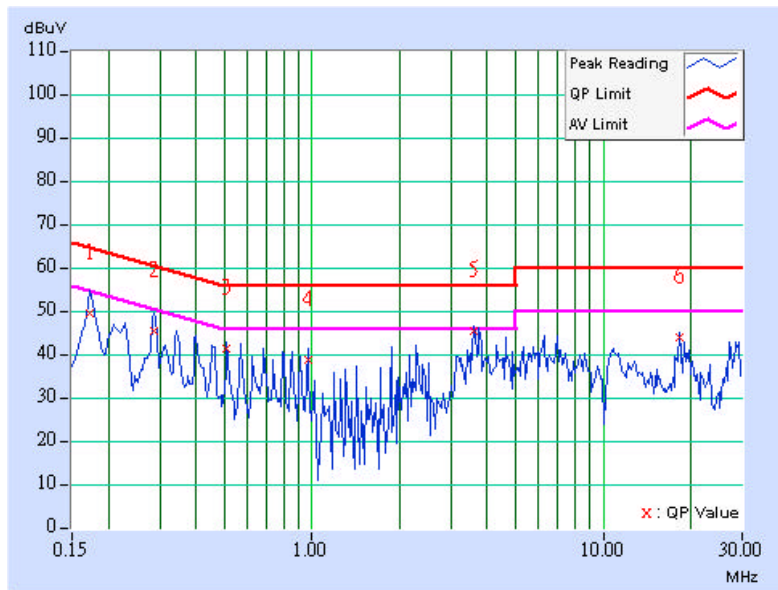



EUT	Wireless-G Range Expander	MODEL	WRE54G ver. 2
CHANNEL	1	6dB BANDWIDTH	9 kHz
INPUT POWER (SYSTEM)	120 Vac, 60 Hz	PHASE	Neutral (N)
ENVIRONMENTAL CONDITIONS	24deg. C, 64% RH, 991 hPa	TESTED BY	Leo Hung

No	Freq. [MHz]	Corr. Factor (dB)	Reading Value [dB (uV)]		Emission Level [dB (uV)]		Limit [dB (uV)]		Margin (dB)	
			Q.P.	AV.	Q.P.	AV.	Q.P.	AV.	Q.P.	AV.
			1	0.173	0.10	48.76	-	48.86	-	64.79
2	0.291	0.11	42.74	-	42.85	-	60.51	50.51	-17.66	-
3	0.740	0.18	37.68	-	37.86	-	56.00	46.00	-18.14	-
4	2.051	0.25	36.91	-	37.16	-	56.00	46.00	-18.84	-
5	3.523	0.29	37.18	-	37.47	-	56.00	46.00	-18.53	-
6	18.914	0.63	43.10	-	43.73	-	60.00	50.00	-16.27	-

- REMARKS:**
1. Q.P. and AV. are abbreviations of quasi-peak and average individually.
 2. "-": The Quasi-peak reading value also meets average limit and measurement with the average detector is unnecessary.
 3. The emission levels of other frequencies were very low against the limit.
 4. Margin value = Emission level - Limit value
 5. Correction factor = Insertion loss + Cable loss
 6. Emission Level = Correction Factor + Reading Value.

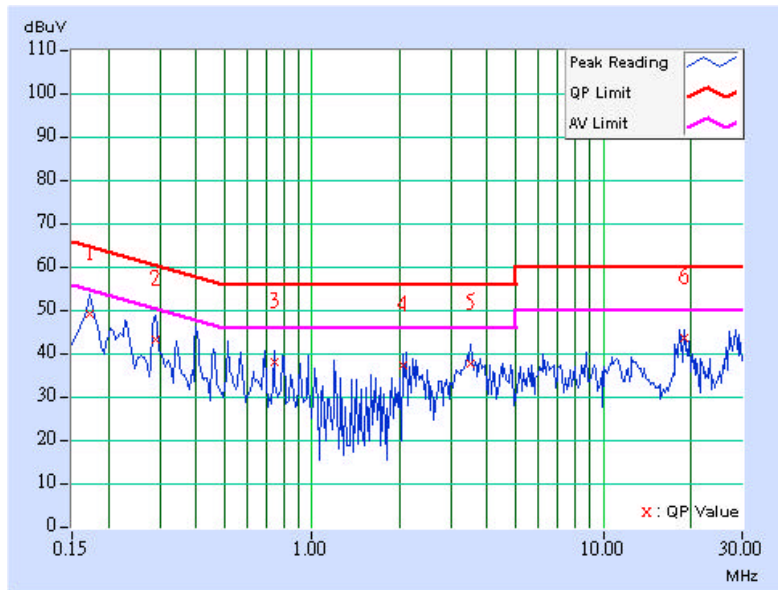



EUT	Wireless-G Range Expander	MODEL	WRE54G ver. 2
CHANNEL	6	6dB BANDWIDTH	9 kHz
INPUT POWER (SYSTEM)	120 Vac, 60 Hz	PHASE	Line (L)
ENVIRONMENTAL CONDITIONS	24deg. C, 64% RH, 991 hPa	TESTED BY	Leo Hung

No	Freq. [MHz]	Corr. Factor (dB)	Reading Value [dB (uV)]		Emission Level [dB (uV)]		Limit [dB (uV)]		Margin (dB)	
			Q.P.	AV.	Q.P.	AV.	Q.P.	AV.	Q.P.	AV.
1	0.177	0.10	45.63	-	45.73	-	64.61	54.61	-18.88	-
2	0.287	0.11	44.67	-	44.78	-	60.62	50.62	-15.84	-
3	0.970	0.24	38.21	-	38.45	-	56.00	46.00	-17.55	-
4	2.277	0.27	41.85	-	42.12	-	56.00	46.00	-13.88	-
5	3.523	0.30	42.51	-	42.81	-	56.00	46.00	-13.19	-
6	6.492	0.42	38.96	-	39.38	-	60.00	50.00	-20.62	-

- REMARKS:**
1. Q.P. and AV. are abbreviations of quasi-peak and average individually.
 2. "-": The Quasi-peak reading value also meets average limit and measurement with the average detector is unnecessary.
 3. The emission levels of other frequencies were very low against the limit.
 4. Margin value = Emission level - Limit value
 5. Correction factor = Insertion loss + Cable loss
 6. Emission Level = Correction Factor + Reading Value.

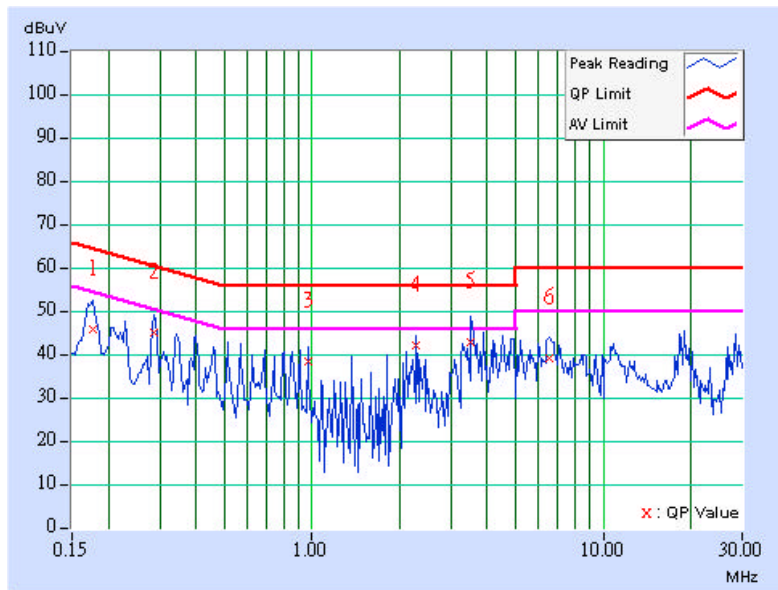



EUT	Wireless-G Range Expander	MODEL	WRE54G ver. 2
CHANNEL	6	6dB BANDWIDTH	9 kHz
INPUT POWER (SYSTEM)	120 Vac, 60 Hz	PHASE	Neutral (N)
ENVIRONMENTAL CONDITIONS	24deg. C, 64% RH, 991 hPa	TESTED BY	Leo Hung

No	Freq. [MHz]	Corr. Factor (dB)	Reading Value [dB (uV)]		Emission Level [dB (uV)]		Limit [dB (uV)]		Margin (dB)	
			Q.P.	AV.	Q.P.	AV.	Q.P.	AV.	Q.P.	AV.
			1	0.173	0.10	48.45	-	48.55	-	64.79
2	0.291	0.11	42.40	-	42.51	-	60.51	50.51	-18.00	-
3	0.517	0.14	33.61	-	33.75	-	56.00	46.00	-22.25	-
4	2.219	0.26	37.28	-	37.54	-	56.00	46.00	-18.46	-
5	3.477	0.29	34.45	-	34.74	-	56.00	46.00	-21.26	-
6	18.242	0.62	43.83	-	44.45	-	60.00	50.00	-15.55	-

- REMARKS:**
1. Q.P. and AV. are abbreviations of quasi-peak and average individually.
 2. "-": The Quasi-peak reading value also meets average limit and measurement with the average detector is unnecessary.
 3. The emission levels of other frequencies were very low against the limit.
 4. Margin value = Emission level - Limit value
 5. Correction factor = Insertion loss + Cable loss
 6. Emission Level = Correction Factor + Reading Value.

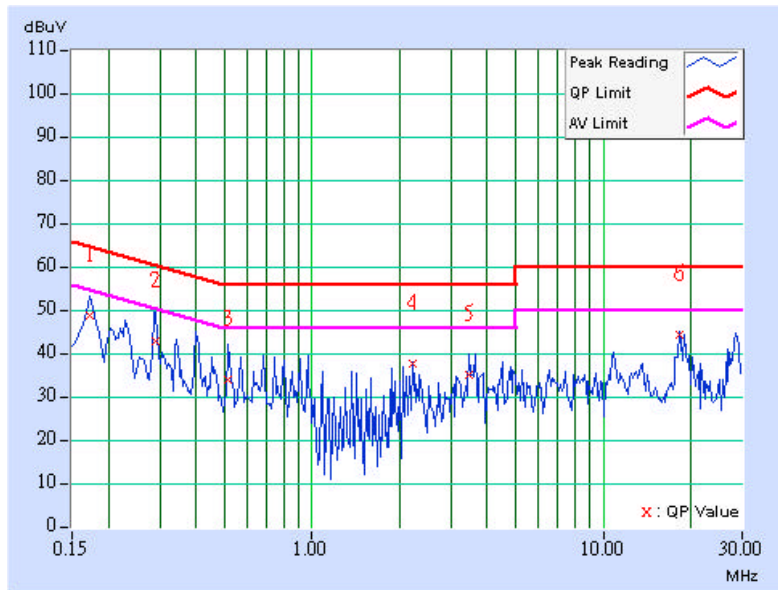



EUT	Wireless-G Range Expander	MODEL	WRE54G ver. 2
CHANNEL	11	6dB BANDWIDTH	9 kHz
INPUT POWER (SYSTEM)	120 Vac, 60 Hz	PHASE	Line (L)
ENVIRONMENTAL CONDITIONS	24deg. C, 64% RH, 991 hPa	TESTED BY	Leo Hung

No	Freq. [MHz]	Corr. Factor (dB)	Reading Value [dB (uV)]		Emission Level [dB (uV)]		Limit [dB (uV)]		Margin (dB)	
			Q.P.	AV.	Q.P.	AV.	Q.P.	AV.	Q.P.	AV.
			1	0.173	0.10	48.96	-	49.06	-	64.79
2	0.287	0.11	44.83	-	44.94	-	60.62	50.62	-15.68	-
3	0.966	0.24	39.67	-	39.91	-	56.00	46.00	-16.09	-
4	2.332	0.27	40.16	-	40.43	-	56.00	46.00	-15.57	-
5	3.465	0.30	42.68	-	42.98	-	56.00	46.00	-13.02	-
6	6.316	0.41	39.59	-	40.00	-	60.00	50.00	-20.00	-

- REMARKS:**
1. Q.P. and AV. are abbreviations of quasi-peak and average individually.
 2. "-": The Quasi-peak reading value also meets average limit and measurement with the average detector is unnecessary.
 3. The emission levels of other frequencies were very low against the limit.
 4. Margin value = Emission level - Limit value
 5. Correction factor = Insertion loss + Cable loss
 6. Emission Level = Correction Factor + Reading Value.

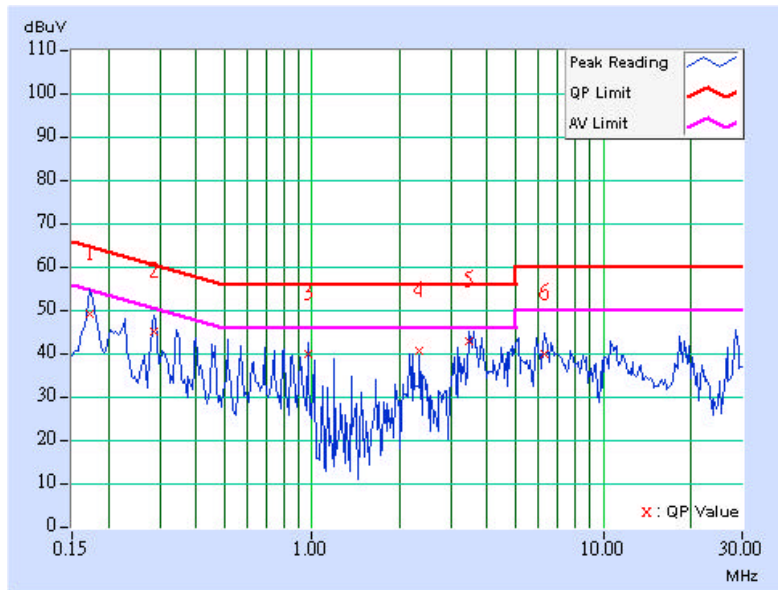



EUT	Wireless-G Range Expander	MODEL	WRE54G ver. 2
CHANNEL	11	6dB BANDWIDTH	9 kHz
INPUT POWER (SYSTEM)	120 Vac, 60 Hz	PHASE	Netural (N)
ENVIRONMENTAL CONDITIONS	24deg. C, 64% RH, 991 hPa	TESTED BY	Leo Hung

No	Freq. [MHz]	Corr. Factor (dB)	Reading Value [dB (uV)]		Emission Level [dB (uV)]		Limit [dB (uV)]		Margin (dB)	
			Q.P.	AV.	Q.P.	AV.	Q.P.	AV.	Q.P.	AV.
1	0.173	0.10	48.39	-	48.49	-	64.79	54.79	-16.31	-
2	0.287	0.11	42.74	-	42.85	-	60.62	50.62	-17.77	-
3	0.798	0.19	36.78	-	36.97	-	56.00	46.00	-19.03	-
4	3.813	0.30	35.04	-	35.34	-	56.00	46.00	-20.66	-
5	6.539	0.40	33.91	-	34.31	-	60.00	50.00	-25.69	-
6	18.242	0.62	43.75	-	44.37	-	60.00	50.00	-15.63	-

- REMARKS:**
1. Q.P. and AV. are abbreviations of quasi-peak and average individually.
 2. "-": The Quasi-peak reading value also meets average limit and measurement with the average detector is unnecessary.
 3. The emission levels of other frequencies were very low against the limit.
 4. Margin value = Emission level - Limit value
 5. Correction factor = Insertion loss + Cable loss
 6. Emission Level = Correction Factor + Reading Value.

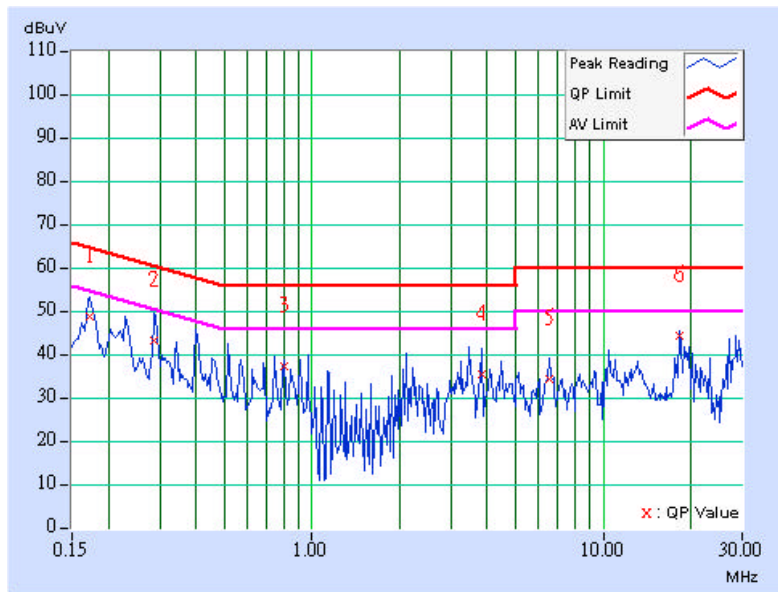



4.2 RADIATED EMISSION MEASUREMENT

4.2.1 LIMITS OF RADIATED EMISSION MEASUREMENT

Emissions radiated outside of the specified bands, shall be according to the general radiated limits in 15.209 as following:

Frequencies (MHz)	Field strength (microvolts/meter)	Measurement distance (meters)
0.009-0.490	2400/F(kHz)	300
0.490-1.705	24000/F(kHz)	30
1.705-30.0	30	30
30-88	100	3
88-216	150	3
216-960	200	3
Above 960	500	3

NOTE:

1. The lower limit shall apply at the transition frequencies.
2. Emission level (dBuV/m) = 20 log Emission level (uV/m).
3. As shown in 15.35(b), for frequencies above 1000MHz, the field strength limits are based on average detector, however, the peak field strength of any emission shall not exceed the maximum permitted average limits, specified above by more than 20dB under any condition of modulation.



4.2.2 TEST INSTRUMENTS

DESCRIPTION & MANUFACTURER	MODEL NO.	SERIAL NO.	CALIBRATED UNTIL
Test Receiver ROHDE & SCHWARZ	ESI7	100033	Jun, 08, 2005
Spectrum Analyzer ROHDE & SCHWARZ	FSP40	100040	Dec. 15, 2004
BILOG Antenna SCHWARZBECK	VULB9168	9168-153	Feb. 03, 2005
HORN Antenna SCHWARZBECK	9120D	9120D-408	Feb. 03, 2005
HORN Antenna SCHWARZBECK	BBHA 9170	BBHA 9170243	Feb. 23, 2005
Preamplifier Agilent	8447D	2944A10633	Jan. 15, 2005
Preamplifier Agilent	8449B	3008A01964	Jan. 27, 2005
RF signal cable HUBER+SUHNNER	SUCOFLEX 104	218183/4	Mar. 05, 2005
RF signal cable HUBER+SUHNNER	SUCOFLEX 104	218195/4	Mar. 05, 2005
Software ADT.	ADT_Radiated_V5.14	NA	NA
Antenna Tower inn-co GmbH	MA 4000	013303	NA
Antenna Tower Controller inn-co GmbH	CO2000	017303	NA
Turn Table ADT.	TT100.	TT93021703	NA
Turn Table Controller ADT.	SC100.	SC93021703	NA

- NOTE:**
1. The calibration interval of the above test instruments is 12 months and the calibrations are traceable to NML/ROC and NIST/USA.
 2. The test was performed in HwaYa Chamber 2.
 3. The horn antenna and HP preamplifier (model: 8449B) are used only for the measurement of emission frequency above 1GHz if tested.
 4. The IC Site Registration No. is IC4924-3.

4.2.3 TEST PROCEDURES

- a. The EUT was placed on the top of a rotating table 0.8 meters above the ground at a 3 meter semi-anechoic chamber. The table was rotated 360 degrees to determine the position of the highest radiation.
- b. The EUT was set 3 meters away from the interference-receiving antenna, which was mounted on the top of a variable-height antenna tower.
- c. The antenna is a broadband antenna, and its height is varied from one meter to four meters above the ground to determine the maximum value of the field strength. Both horizontal and vertical polarizations of the antenna are set to make the measurement.
- d. For each suspected emission, the EUT was arranged to its worst case and then the antenna was tuned to heights from 1 meter to 4 meters and the rotatable table was turned from 0 degrees to 360 degrees to find the maximum reading.
- e. The test-receiver system was set to Peak Detect Function and Specified Bandwidth with Maximum Hold Mode.
- f. If the emission level of the EUT in peak mode was 10 dB lower than the limit specified, then testing could be stopped and the peak values of the EUT would be reported. Otherwise the emissions that did not have 10 dB margin would be re-tested one by one using peak, quasi-peak or average method as specified and then reported in a data sheet.

NOTE:

1. The resolution bandwidth and video bandwidth of test receiver/spectrum analyzer is 120kHz for Peak detection (PK) and Quasi-peak detection (QP) at frequency below 1GHz.
2. The resolution bandwidth and video bandwidth of test receiver/spectrum analyzer is 1 MHz for Peak detection at frequency above 1GHz.
3. The resolution bandwidth of test receiver/spectrum analyzer is 1 MHz and the video bandwidth is 10 Hz for Average detection (AV) at frequency above 1GHz.

4.2.4 DEVIATION FROM TEST STANDARD

No deviation

4.2.5 TEST SETUP

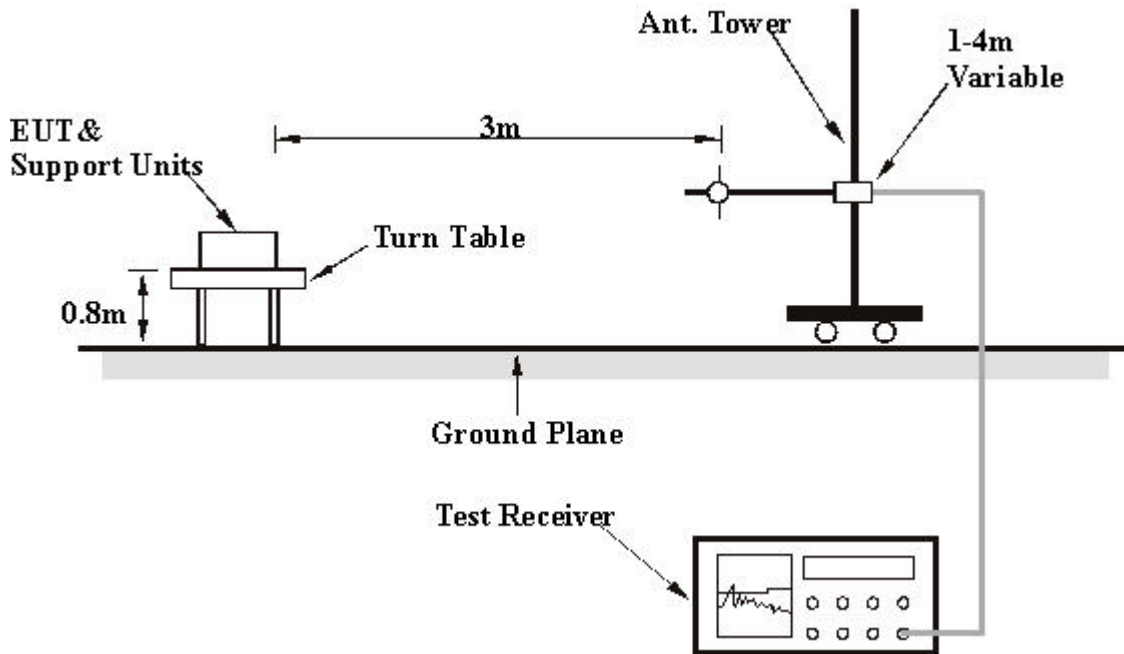

For the actual test configuration, please refer to the related item – Photographs of the Test Configuration.

4.2.6 EUT OPERATING CONDITIONS

Same as 4.1.6



4.2.7 TEST RESULTS

EUT	Wireless-G Range Expander	MODEL	WRE54G ver. 2
CHANNEL	11	FREQUENCY RANGE	Below 1000 MHz
INPUT POWER (SYSTEM)	120 Vac, 60Hz	DETECTOR FUNCTION	Quasi-Peak
ENVIRONMENTAL CONDITIONS	25 deg. C, 65% RH, 991 hPa	TESTED BY	Rush Kao

ANTENNA POLARITY & TEST DISTANCE: HORIZONTAL AT 3 M

No.	Freq. (MHz)	Emission Level (dBuV/m)	Limit (dBuV/m)	Margin (dB)	Antenna Height (m)	Table Angle (Degree)	Raw Value (dBuV)	Correction Factor (dB/m)
1	160.24	30.31 QP	43.50	-13.19	2.00 H	280	15.39	14.92
2	249.66	31.42 QP	46.00	-14.58	1.00 H	31	18.32	13.11
3	319.64	36.14 QP	46.00	-9.86	1.00 H	244	21.29	14.85
4	479.04	44.50 QP	46.00	-1.50	1.75 H	265	26.17	18.33
5	640.38	31.71 QP	46.00	-14.29	1.50 H	229	10.37	21.35
6	799.78	37.94 QP	46.00	-8.06	1.75 H	217	14.48	23.46

- REMARKS:**
1. Emission level(dBuV/m)=Raw Value(dBuV) + Correction Factor(dB/m)
 2. Correction Factor(dB/m) = Antenna Factor (dB/m) + Cable Factor (dB)
 3. The other emission levels were very low against the limit.
 4. Margin value = Emission level – Limit value.



EUT	Wireless-G Range Expander	MODEL	WRE54G ver. 2
CHANNEL	11	FREQUENCY RANGE	Below 1000 MHz
INPUT POWER (SYSTEM)	120 Vac, 60Hz	DETECTOR FUNCTION	Quasi-Peak
ENVIRONMENTAL CONDITIONS	25 deg. C, 65% RH, 991 hPa	TESTED BY	Rush Kao

ANTENNA POLARITY & TEST DISTANCE: VERTICAL AT 3 M

No.	Freq. (MHz)	Emission Level (dBuV/m)	Limit (dBuV/m)	Margin (dB)	Antenna Height (m)	Table Angle (Degree)	Raw Value (dBuV)	Correction Factor (dB/m)
1	43.61	33.43 QP	40.00	-6.57	1.00 V	313	18.04	15.39
2	109.70	37.06 QP	43.50	-6.44	1.00 V	271	25.21	11.86
3	160.24	40.24 QP	43.50	-3.26	1.00 V	319	25.32	14.92
4	232.16	36.76 QP	46.00	-9.24	1.00 V	259	24.28	12.48
5	249.66	39.16 QP	46.00	-6.84	1.00 V	265	26.05	13.11
6	319.64	37.10 QP	46.00	-8.90	1.25 V	313	22.25	14.85
7	480.00	44.91 QP	46.00	-1.09	1.10 V	98	26.57	18.34
8	799.78	36.31 QP	46.00	-9.69	1.25 V	238	12.86	23.46

- REMARKS:**
1. Emission level(dBuV/m)=Raw Value(dBuV) + Correction Factor(dB/m)
 2. Correction Factor(dB/m) = Antenna Factor (dB/m) + Cable Factor (dB)
 3. The other emission levels were very low against the limit.
 4. Margin value = Emission level – Limit value.



4.2.8 TEST RESULTS (A)

EUT	Wireless-G Range Expander	MODEL	WRE54G ver. 2
CHANNEL	1	FREQUENCY RANGE	1~25 GHz
INPUT POWER (SYSTEM)	120 Vac, 60 Hz	DETECTOR FUNCTION	Peak (PK) Average (AV)
ENVIRONMENTAL CONDITIONS	24deg. C, 64% RH, 991 hPa	TESTED BY	Leo Hung

ANTENNA POLARITY & TEST DISTANCE: HORIZONTAL AT 3 M								
No.	Freq. (MHz)	Emission Level (dBuV/m)	Limit (dBuV/m)	Margin (dB)	Antenna Height (m)	Table Angle (Degree)	Raw Value (dBuV)	Correction Factor (dB/m)
1	1700.00	43.76 PK	74.00	-30.24	1.08 H	195	15.13	28.63
1	1700.00	38.08 AV	54.00	-15.92	1.08 H	195	9.45	28.63
2	2038.00	53.94 PK	74.00	-20.06	1.42 H	324	23.90	30.04
2	2038.00	52.72 AV	54.00	-1.28	1.42 H	324	22.68	30.04
3	2390.00	37.92 PK	74.00	-36.08	1.14 H	82	6.31	31.61
3	2390.00	29.85 AV	54.00	-24.15	1.14 H	82	-1.76	31.61
4	*2412.00	97.50 PK			1.14 H	82	65.80	31.70
4	*2412.00	89.43 AV			1.14 H	82	57.73	31.70
5	4874.00	47.21 PK	74.00	-26.79	1.10 H	336	9.55	37.66
5	4874.00	34.52 AV	54.00	-19.48	1.10 H	336	-3.14	37.66

ANTENNA POLARITY & TEST DISTANCE: VERTICAL AT 3 M								
No.	Freq. (MHz)	Emission Level (dBuV/m)	Limit (dBuV/m)	Margin (dB)	Antenna Height (m)	Table Angle (Degree)	Raw Value (dBuV)	Correction Factor (dB/m)
1	1700.00	42.83 PK	74.00	-31.17	1.23 V	112	14.20	28.63
1	1700.00	38.07 AV	54.00	-15.93	1.23 V	112	9.44	28.63
2	2038.00	57.40 PK	74.00	-16.60	1.00 V	18	27.36	30.04
3	2390.00	49.23 PK	74.00	-24.77	1.46 V	196	17.62	31.61
3	2390.00	41.26 AV	54.00	-12.74	1.46 V	196	9.65	31.61
4	*2412.00	108.81 PK			1.46 V	196	77.11	31.70
4	*2412.00	100.84 AV			1.46 V	196	69.14	31.70
5	4824.00	63.70 PK	74.00	-10.30	1.00 V	192	26.12	37.58
5	4824.00	51.42 AV	54.00	-2.58	1.00 V	192	13.84	37.58

- REMARKS:**
1. Emission level(dBuV/m)=Raw Value(dBuV) + Correction Factor(dB)
 2. Correction Factor(dB/m) = Antenna Factor (dB/m) + Cable Factor (dB)
 3. The other emission levels were very low against the limit.
 4. Margin value = Emission level – Limit value.
 5. “ * “ : Fundamental frequency.



EUT	Wireless-G Range Expander	MODEL	WRE54G ver. 2
CHANNEL	6	FREQUENCY RANGE	1~25 GHz
INPUT POWER (SYSTEM)	120 Vac, 60 Hz	DETECTOR FUNCTION	Peak(PK) Average (AV)
ENVIRONMENTAL CONDITIONS	24deg. C, 64% RH, 991 hPa	TESTED BY	Leo Hung

ANTENNA POLARITY & TEST DISTANCE: HORIZONTAL AT 3 M

No.	Freq. (MHz)	Emission Level (dBuV/m)	Limit (dBuV/m)	Margin (dB)	Antenna Height (m)	Table Angle (Degree)	Raw Value (dBuV)	Correction Factor (dB/m)
1	1700.00	44.61 PK	74.00	-29.39	1.12 H	192	15.98	28.63
1	1700.00	39.40 AV	54.00	-14.60	1.12 H	192	10.77	28.63
2	2063.00	55.93 PK	74.00	-18.07	1.05 H	130	25.76	30.17
3	*2437.00	99.50 PK			1.24 H	149	67.65	31.85
3	*2437.00	91.44 AV			1.24 H	149	59.59	31.85
4	4874.00	47.85 PK	74.00	-26.15	1.15 H	332	10.19	37.66
4	4874.00	35.67 AV	54.00	-18.33	1.15 H	332	-1.99	37.66

ANTENNA POLARITY & TEST DISTANCE: VERTICAL AT 3 M

No.	Freq. (MHz)	Emission Level (dBuV/m)	Limit (dBuV/m)	Margin (dB)	Antenna Height (m)	Table Angle (Degree)	Raw Value (dBuV)	Correction Factor (dB/m)
1	1700.00	38.79 PK	74.00	-35.21	1.16 V	113	10.16	28.63
1	1700.00	44.25 AV	54.00	-9.75	1.16 V	113	15.62	28.63
2	2063.00	60.73 PK	74.00	-13.27	1.00 V	19	30.56	30.17
3	*2437.00	109.82 PK			1.00 V	229	77.97	31.85
3	*2437.00	101.84 AV			1.00 V	229	69.99	31.85
4	4874.00	55.60 PK	74.00	-18.40	1.15 V	222	17.94	37.66
4	4874.00	42.84 AV	54.00	-11.16	1.15 V	222	5.18	37.66

- REMARKS:**
1. Emission level(dBuV/m)=Raw Value(dBuV) + Correction Factor(dB)
 2. Correction Factor(dB/m) = Antenna Factor (dB/m) + Cable Factor (dB)
 3. The other emission levels were very low against the limit.
 4. Margin value = Emission level – Limit value.
 5. “ * ” : Fundamental frequency.



EUT	Wireless-G Range Expander	MODEL	WRE54G ver. 2
CHANNEL	11	FREQUENCY RANGE	1~25 GHz
INPUT POWER (SYSTEM)	120 Vac, 60 Hz	DETECTOR FUNCTION	Peak(PK) Average (AV)
ENVIRONMENTAL CONDITIONS	24deg. C, 64% RH, 991 hPa	TESTED BY	Leo Hung

ANTENNA POLARITY & TEST DISTANCE: HORIZONTAL AT 3 M

No.	Freq. (MHz)	Emission Level (dBuV/m)	Limit (dBuV/m)	Margin (dB)	Antenna Height (m)	Table Angle (Degree)	Raw Value (dBuV)	Correction Factor (dB/m)
1	1700.00	44.65 PK	74.00	-29.35	1.11 H	192	16.02	28.63
1	1700.00	39.76 AV	54.00	-14.24	1.11 H	192	11.13	28.63
2	2088.00	60.38 PK	74.00	-13.62	1.00 H	130	30.08	30.30
3	*2462.00	98.43 PK			1.00 H	142	66.43	32.00
3	*2462.00	90.87 AV			1.00 H	142	58.87	32.00
4	2483.50	42.16 PK	74.00	-31.84	1.00 H	142	10.03	32.13
4	2483.50	34.50 AV	54.00	-19.50	1.00 H	142	2.37	32.13
5	4924.00	47.21 PK	74.00	-26.79	1.01 H	221	9.46	37.74
5	4924.00	34.52 AV	54.00	-19.48	1.01 H	221	-3.23	37.74

ANTENNA POLARITY & TEST DISTANCE: VERTICAL AT 3 M

No.	Freq. (MHz)	Emission Level (dBuV/m)	Limit (dBuV/m)	Margin (dB)	Antenna Height (m)	Table Angle (Degree)	Raw Value (dBuV)	Correction Factor (dB/m)
1	1700.00	45.44 PK	74.00	-28.56	1.00 V	351	16.81	28.63
1	1700.00	40.68 AV	54.00	-13.32	1.00 V	351	12.05	28.63
2	2088.00	62.79 PK	74.00	-11.21	1.09 V	19	32.49	30.30
3	*2462.00	109.40 PK			1.22 V	129	77.40	32.00
3	*2462.00	101.20 AV			1.22 V	129	69.20	32.00
4	2483.50	53.03 PK	74.00	-20.97	1.22 V	129	20.90	32.13
4	2483.50	44.83 AV	54.00	-9.17	1.22 V	129	12.70	32.13
5	4924.00	47.92 PK	74.00	-26.08	1.00 V	121	10.18	37.74
5	4924.00	35.42 AV	54.00	-18.58	1.00 V	121	-2.32	37.74

- REMARKS:**
1. Emission level(dBuV/m)=Raw Value(dBuV) + Correction Factor(dB)
 2. Correction Factor(dB/m) = Antenna Factor (dB/m) + Cable Factor (dB)
 3. The other emission levels were very low against the limit.
 4. Margin value = Emission level – Limit value.
 5. “ * ” : Fundamental frequency.



4.2.9 TEST RESULTS (B)

EUT	Wireless-G Range Expander	MODEL	WRE54G ver. 2
CHANNEL	1	FREQUENCY RANGE	1~25 GHz
INPUT POWER (SYSTEM)	120 Vac, 60 Hz	DETECTOR FUNCTION	Peak(PK) Average (AV)
ENVIRONMENTAL CONDITIONS	24deg. C, 64% RH, 991 hPa	TESTED BY	Leo Hung

ANTENNA POLARITY & TEST DISTANCE: HORIZONTAL AT 3 M

No.	Freq. (MHz)	Emission Level (dBuV/m)	Limit (dBuV/m)	Margin (dB)	Antenna Height (m)	Table Angle (Degree)	Raw Value (dBuV)	Correction Factor (dB/m)
1	1700.00	44.31 PK	74.00	-29.69	1.07 H	192	15.68	28.63
1	1700.00	39.65 AV	54.00	-14.35	1.07 H	192	11.02	28.63
2	2038.00	55.47 PK	74.00	-18.53	1.06 H	127	25.43	30.04
3	2390.00	40.95 PK	74.00	-33.05	1.19 H	360	9.34	31.61
3	2390.00	32.94 AV	54.00	-21.06	1.19 H	360	1.33	31.61
4	*2412.00	91.97 PK			1.19 H	360	60.27	31.70
4	*2412.00	83.96 AV			1.19 H	360	52.26	31.70
5	4824.00	48.03 PK	74.00	-25.97	1.00 H	100	10.45	37.58
5	4824.00	35.51 AV	54.00	-18.49	1.00 H	100	-2.07	37.58

ANTENNA POLARITY & TEST DISTANCE: VERTICAL AT 3 M

No.	Freq. (MHz)	Emission Level (dBuV/m)	Limit (dBuV/m)	Margin (dB)	Antenna Height (m)	Table Angle (Degree)	Raw Value (dBuV)	Correction Factor (dB/m)
1	1700.00	45.71 PK	74.00	-28.29	1.02 V	353	17.08	28.63
1	1700.00	41.37 AV	54.00	-12.63	1.02 V	353	12.74	28.63
2	2038.00	58.39 PK	74.00	-15.61	1.06 V	21	28.35	30.04
3	2390.00	54.49 PK	74.00	-19.51	1.11 V	64	22.88	31.61
3	2390.00	45.26 AV	54.00	-8.74	1.11 V	64	13.65	31.61
4	*2412.00	105.51 PK			1.11 V	64	73.81	31.70
4	*2412.00	96.28 AV			1.11 V	64	64.58	31.70
5	4824.00	58.73 PK	74.00	-15.27	1.00 V	221	21.15	37.58
5	4824.00	47.08 AV	54.00	-6.92	1.00 V	221	9.50	37.58

- REMARKS:**
1. Emission level(dBuV/m)=Raw Value(dBuV) + Correction Factor(dB)
 2. Correction Factor(dB/m) = Antenna Factor (dB/m) + Cable Factor (dB)
 3. The other emission levels were very low against the limit.
 4. Margin value = Emission level – Limit value.
 5. “ * “ : Fundamental frequency.



EUT	Wireless-G Range Expander	MODEL	WRE54G ver. 2
CHANNEL	6	FREQUENCY RANGE	1~25 GHz
INPUT POWER (SYSTEM)	120 Vac, 60 Hz	DETECTOR FUNCTION	Peak(PK) Average (AV)
ENVIRONMENTAL CONDITIONS	24deg. C, 64% RH, 991 hPa	TESTED BY	Leo Hung

ANTENNA POLARITY & TEST DISTANCE: HORIZONTAL AT 3 M

No.	Freq. (MHz)	Emission Level (dBuV/m)	Limit (dBuV/m)	Margin (dB)	Antenna Height (m)	Table Angle (Degree)	Raw Value (dBuV)	Correction Factor (dB/m)
1	1700.00	40.20 PK	74.00	-33.80	1.28 H	332	11.57	28.63
1	1700.00	31.24 AV	54.00	-22.76	1.28 H	332	2.61	28.63
2	2063.00	56.53 PK	74.00	-17.47	1.21 H	11	26.36	30.17
3	*2437.00	93.56 PK			1.00 H	210	61.71	31.85
3	*2437.00	84.54 AV			1.00 H	210	52.69	31.85
4	4874.00	48.19 PK	74.00	-25.81	1.00 H	210	10.53	37.66
4	4874.00	34.56 AV	54.00	-19.44	1.00 H	210	-3.10	37.66

ANTENNA POLARITY & TEST DISTANCE: VERTICAL AT 3 M

No.	Freq. (MHz)	Emission Level (dBuV/m)	Limit (dBuV/m)	Margin (dB)	Antenna Height (m)	Table Angle (Degree)	Raw Value (dBuV)	Correction Factor (dB/m)
1	1700.00	43.24 PK	74.00	-30.76	1.04 V	221	14.61	28.63
1	1700.00	38.72 AV	54.00	-15.28	1.04 V	221	10.09	28.63
2	2063.00	61.48 PK	74.00	-12.52	1.37 V	360	31.31	30.17
3	*2437.00	104.26 PK			1.03 V	230	72.41	31.85
3	*2437.00	95.10 AV			1.03 V	230	63.25	31.85
4	4874.00	48.76 PK	74.00	-25.24	1.04 V	287	11.10	37.66
4	4874.00	36.76 AV	54.00	-17.24	1.04 V	287	-0.90	37.66

- REMARKS:**
1. Emission level(dBuV/m)=Raw Value(dBuV) + Correction Factor(dB)
 2. Correction Factor(dB/m) = Antenna Factor (dB/m) + Cable Factor (dB)
 3. The other emission levels were very low against the limit.
 4. Margin value = Emission level – Limit value.
 5. " * " : Fundamental frequency.



EUT	Wireless-G Range Expander	MODEL	WRE54G ver. 2
CHANNEL	11	FREQUENCY RANGE	1~25 GHz
INPUT POWER (SYSTEM)	120 Vac, 60 Hz	DETECTOR FUNCTION	Peak(PK) Average (AV)
ENVIRONMENTAL CONDITIONS	24deg. C, 64% RH, 991 hPa	TESTED BY	Leo Hung

ANTENNA POLARITY & TEST DISTANCE: HORIZONTAL AT 3 M

No.	Freq. (MHz)	Emission Level (dBuV/m)	Limit (dBuV/m)	Margin (dB)	Antenna Height (m)	Table Angle (Degree)	Raw Value (dBuV)	Correction Factor (dB/m)
1	1700.00	40.93 PK	74.00	-33.07	1.20 H	23	12.30	28.63
1	1700.00	33.31 AV	54.00	-20.69	1.20 H	23	4.68	28.63
2	2088.00	60.81 PK	74.00	-13.19	1.32 H	128	30.51	30.30
3	2462.00	*94.50 PK			1.00 H	143	62.50	32.00
3	2462.00	*85.52 AV			1.00 H	143	53.52	32.00
4	2483.50	44.78 PK	74.00	-29.22	1.00 H	143	12.65	32.13
4	2483.50	35.80 AV	54.00	-18.20	1.00 H	143	3.67	32.13
5	4924.00	47.25 PK	74.00	-26.75	1.08 H	221	9.51	37.74
5	4924.00	34.62 AV	54.00	-19.38	1.08 H	221	-3.12	37.74

ANTENNA POLARITY & TEST DISTANCE: VERTICAL AT 3 M

No.	Freq. (MHz)	Emission Level (dBuV/m)	Limit (dBuV/m)	Margin (dB)	Antenna Height (m)	Table Angle (Degree)	Raw Value (dBuV)	Correction Factor (dB/m)
1	1700.00	44.83 PK	74.00	-29.17	1.00 V	320	16.20	28.63
1	1700.00	40.90 AV	54.00	-13.10	1.00 V	320	12.27	28.63
2	2088.00	64.96 PK	74.00	-9.04	1.00 V	4	34.66	30.30
3	*2462.00	105.94 PK			1.22 V	127	73.94	32.00
3	*2462.00	95.16 AV			1.22 V	127	63.16	32.00
4	2483.50	56.02 PK	74.00	-17.98	1.22 V	127	23.89	32.13
4	2483.50	45.24 AV	54.00	-8.76	1.22 V	127	13.11	32.13
5	4924.00	47.95 PK	74.00	-26.05	1.08 V	221	10.21	37.74
5	4924.00	35.66 AV	54.00	-18.34	1.08 V	221	-2.08	37.74

- REMARKS:**
1. Emission level(dBuV/m)=Raw Value(dBuV) + Correction Factor(dB)
 2. Correction Factor(dB/m) = Antenna Factor (dB/m) + Cable Factor (dB)
 3. The other emission levels were very low against the limit.
 4. Margin value = Emission level – Limit value.
 5. " * " : Fundamental frequency.



4.3 6dB BANDWIDTH MEASUREMENT

4.3.1 LIMITS OF 6dB BANDWIDTH MEASUREMENT

The minimum of 6dB Bandwidth Measurement is 0.5 MHz.

4.3.2 TEST INSTRUMENTS

Description & Manufacturer	Model No.	Serial No.	Calibrated Until
SPECTRUM ANALYZER	FSEK30	100049	Aug. 12, 2005

NOTE: The calibration interval of the above test instruments is 12 months and the calibrations are traceable to NML/ROC and NIST/USA.

4.3.3 TEST PROCEDURE

The transmitter output was connected to the spectrum analyzer through an attenuator. The bandwidth of the fundamental frequency was measured by spectrum analyzer with 100 kHz RBW and 100kHz VBW. The 6dB bandwidth is defined as the total spectrum the power of which is higher than peak power minus 6dB.

4.3.4 DEVIATION FROM TEST STANDARD

No deviation

4.3.5 TEST SETUP

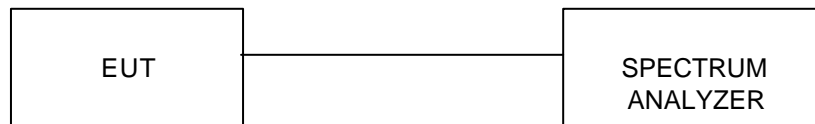

For the actual test configuration, please refer to the related Item – Photographs of the Test Configuration.

4.3.6 EUT OPERATING CONDITIONS

The software provided by client to enable the EUT under transmission condition continuously at lowest, middle and highest channel frequencies individually.



4.3.7 TEST RESULTS (A)

EUT	Wireless-G Range Expander	MODEL	WRE54G ver. 2
INPUT POWER (SYSTEM)	120 Vac, 60 Hz	ENVIRONMENTAL CONDITIONS	23 deg. C, 67% RH, 991 hPa
TESTED BY	Leo Hung		

CHANNEL	CHANNEL FREQUENCY (MHz)	6dB BANDWIDTH (MHz)	MINIMUM LIMIT (MHz)	PASS/FAIL
1	2412	8.81	0.5	PASS
6	2437	8.93	0.5	PASS
11	2462	8.89	0.5	PASS



CH 1

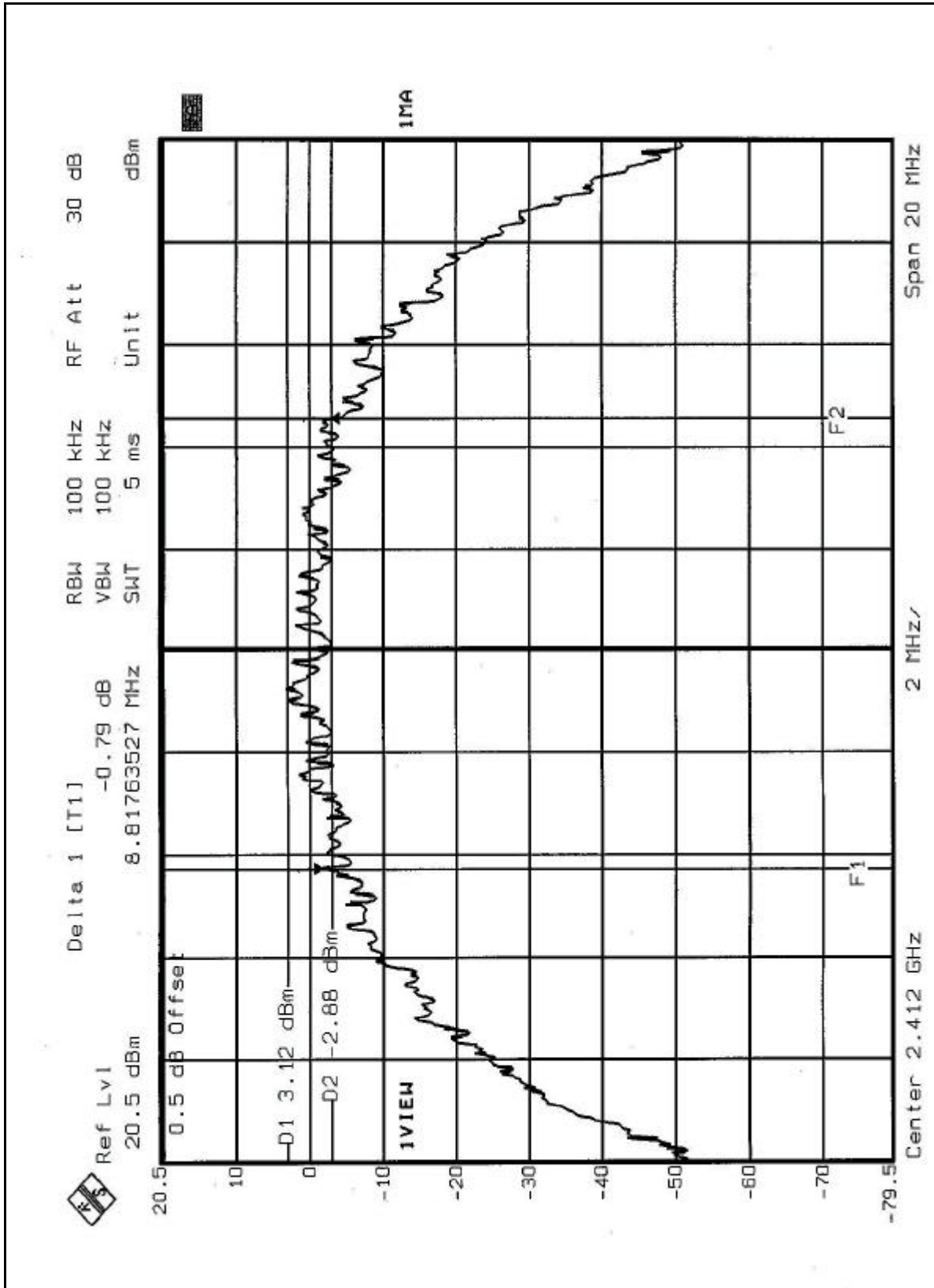



CH 6

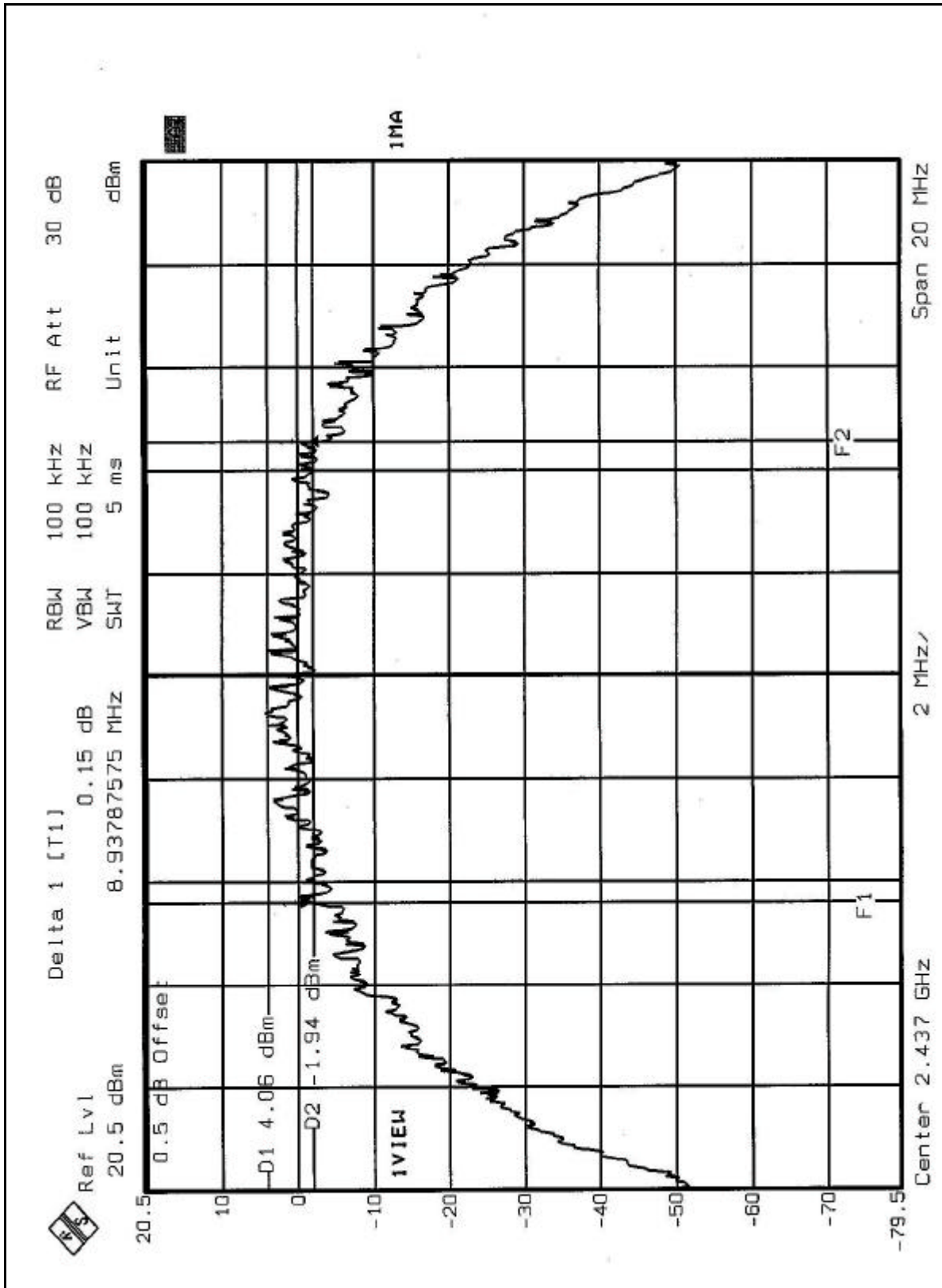



CH 11

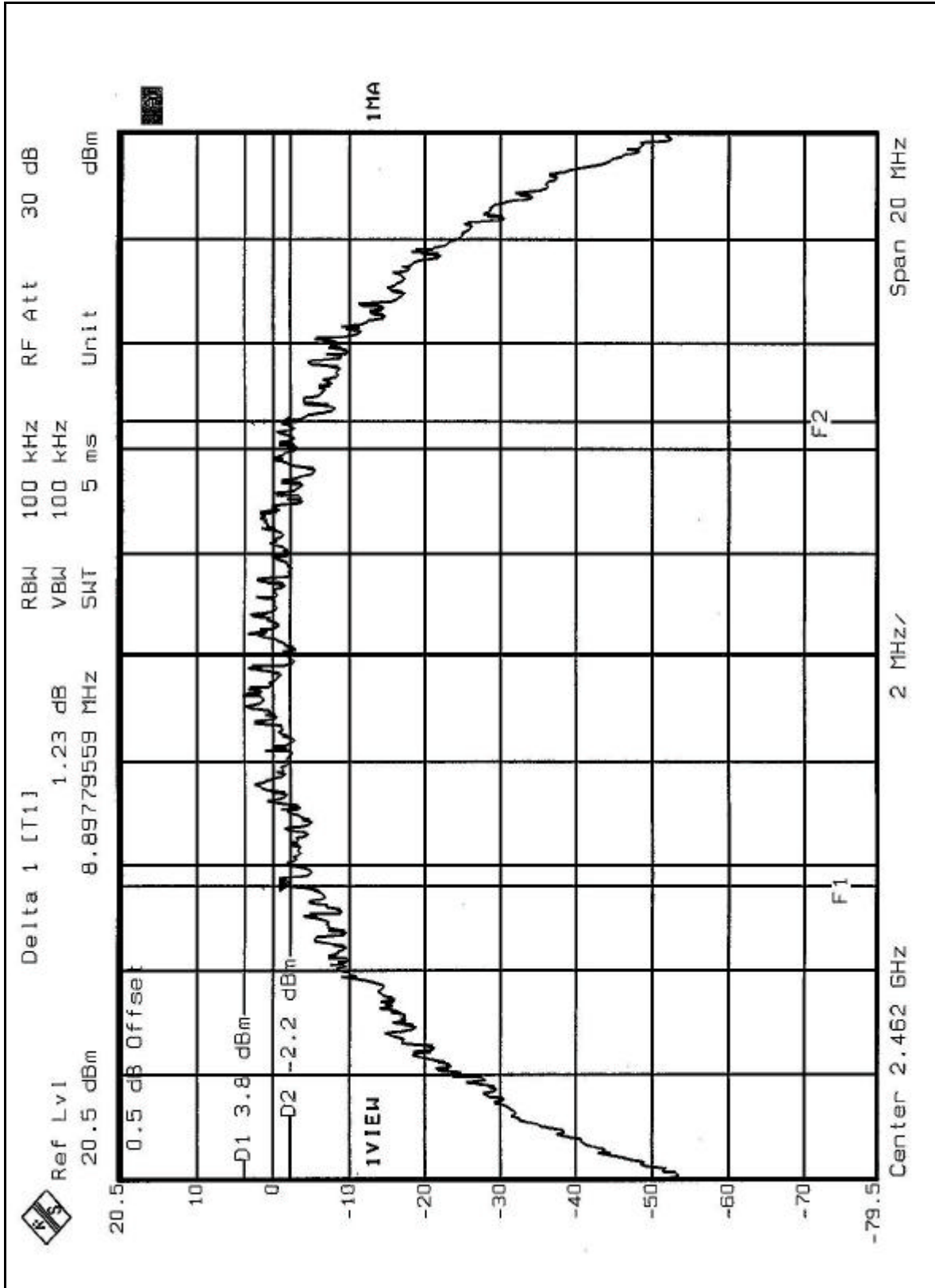



4.3.8 TEST RESULTS (B)

EUT	Wireless-G Range Expander	MODEL	WRE54G ver. 2
INPUT POWER (SYSTEM)	120 Vac, 60 Hz	ENVIRONMENTAL CONDITIONS	23 deg. C, 67% RH, 991 hPa
TESTED BY	Leo Hung		

CHANNEL	CHANNEL FREQUENCY (MHz)	6 dB BANDWIDTH (MHz)	MINIMUM LIMIT (MHz)	PASS/FAIL
1	2412	15.75	0.5	PASS
6	2437	15.67	0.5	PASS
11	2462	15.63	0.5	PASS



CH 1

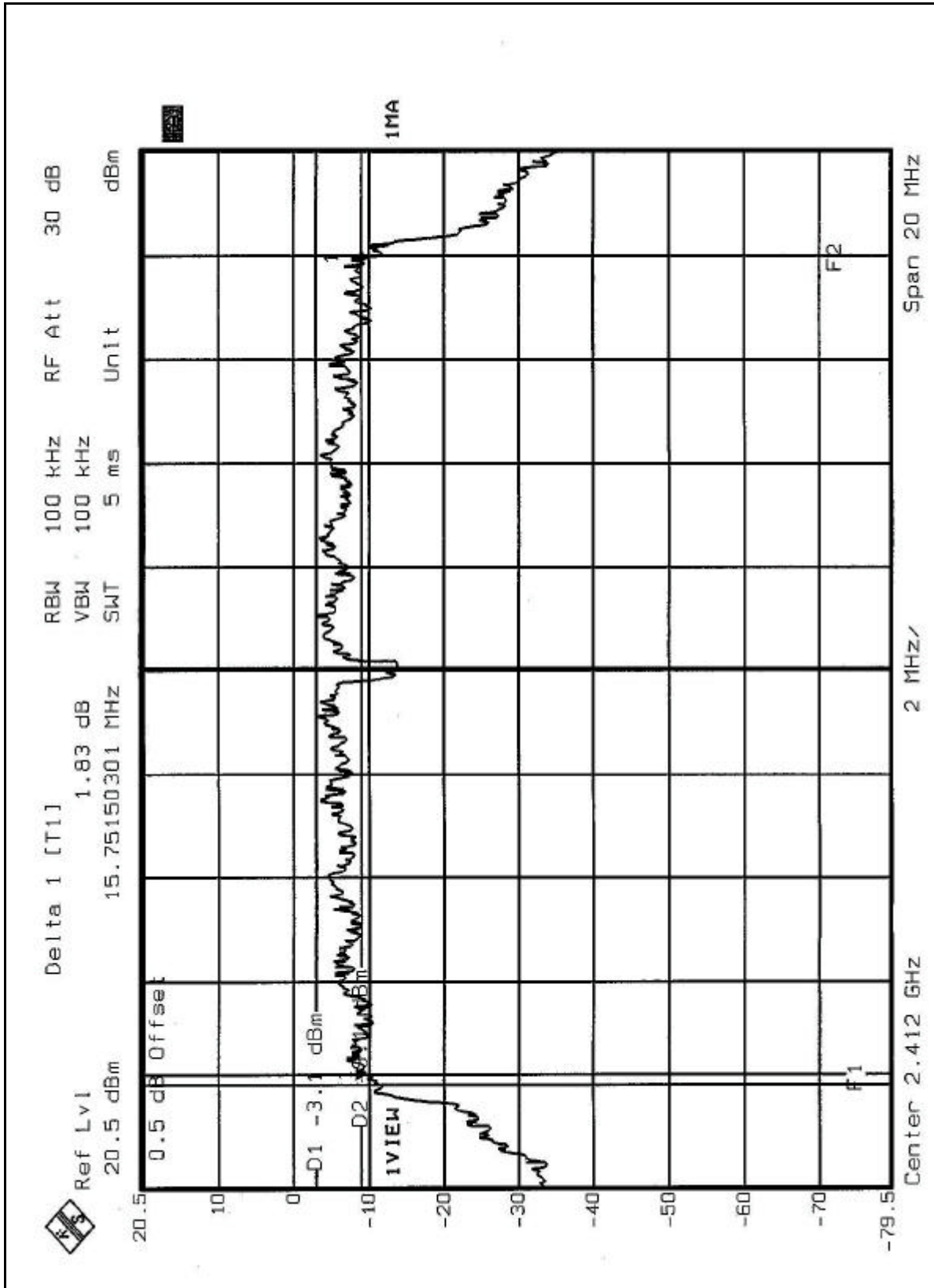



CH 6

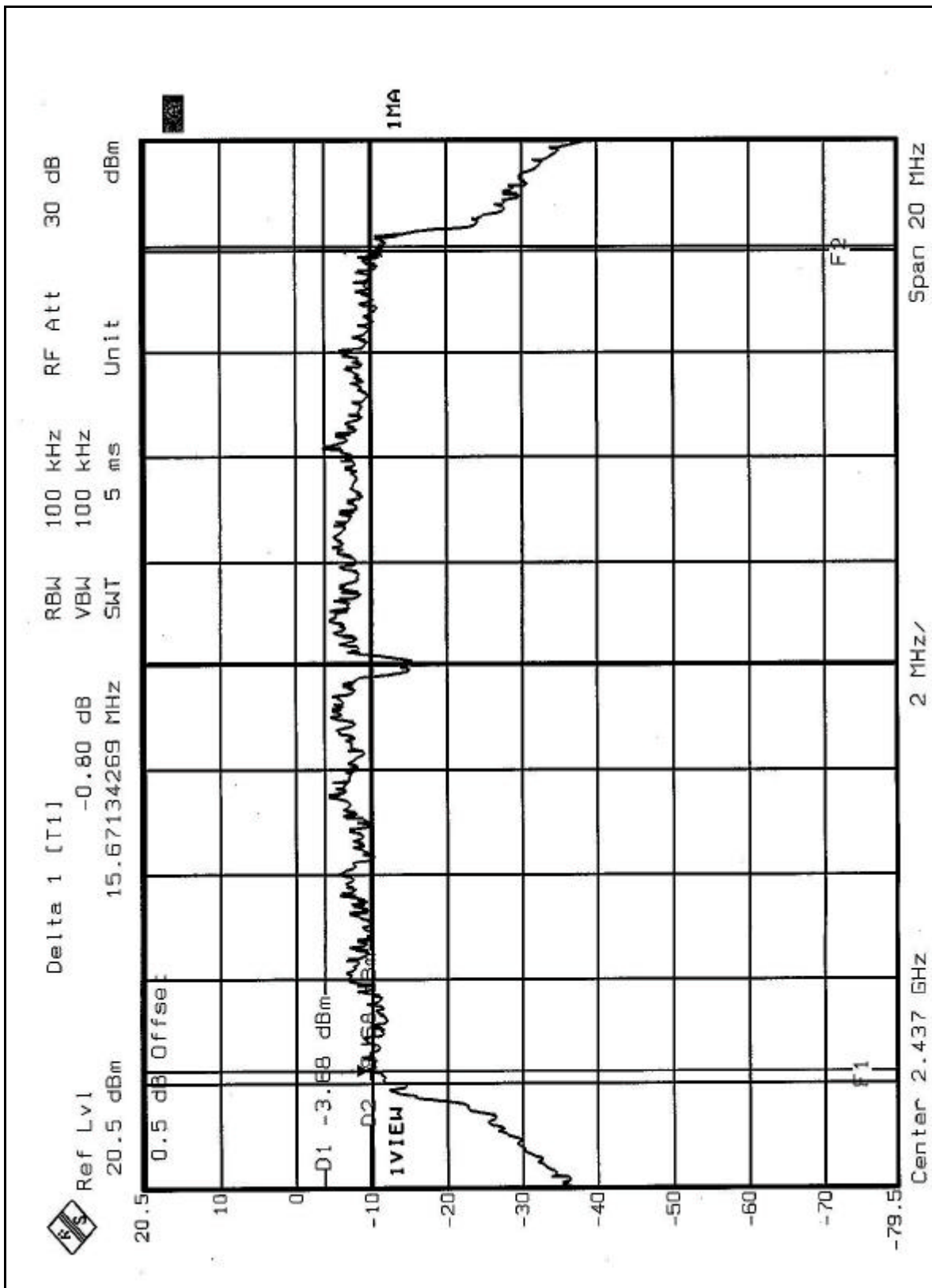



CH 11

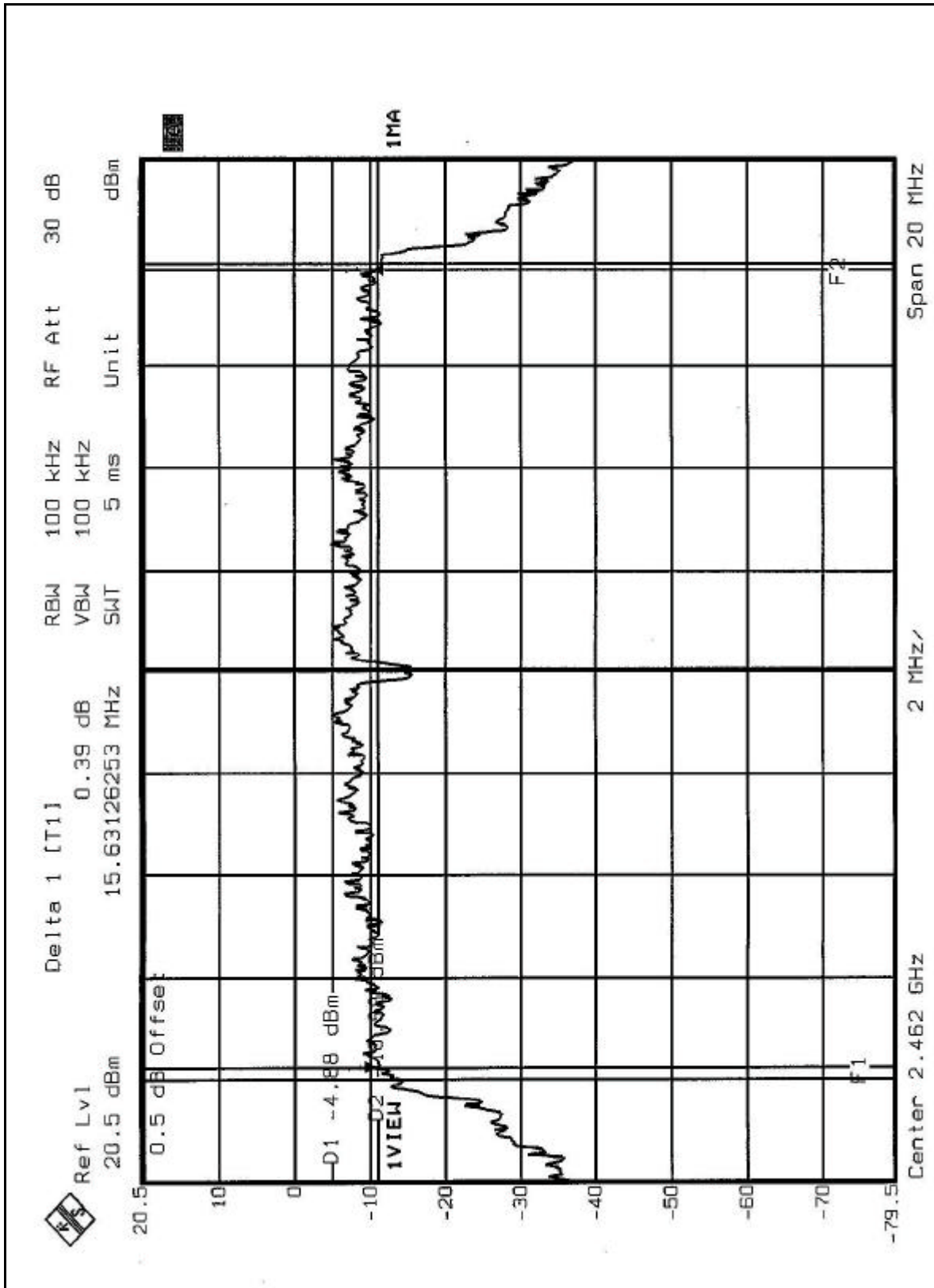



4.4 MAXIMUM PEAK OUTPUT POWER

4.4.1 LIMITS OF MAXIMUM PEAK OUTPUT POWER MEASUREMENT

The Maximum Peak Output Power Measurement is 30dBm.

4.4.2 TEST INSTRUMENTS

Description & Manufacturer	Model No.	Serial No.	Calibrated Until
R&S SPECTRUM ANALYZER	FSEK30	100049	Aug. 12, 2005
AGILENT SIGNAL GENERATOR	E8257C	MY43320668	Dec. 31, 2004
TEKTRONIX OSCILLOSCOPE	TDS 220	C019167	Feb. 1, 2005
NARDA DETECTOR	4503A	FSCM99899	NA

NOTE:

The calibration interval of the above test instruments is 12 months and the calibrations are traceable to NML/ROC and NIST/USA.



4.4.3 TEST PROCEDURES

1. A detector was used on the output port of the EUT. An oscilloscope was used to peak the response of the detector.
2. Replaced the EUT by the signal generator. The center frequency of the S.G was adjusted to the center frequency of the measured channel.
3. Adjusted the power to have the same peak reading on oscilloscope. Record the power level.

4.4.4 DEVIATION FROM TEST STANDARD

No deviation

4.4.5 TEST SETUP



4.4.6 EUT OPERATING CONDITIONS

Same as Item 4.3.6



4.4.7 TEST RESULTS (A)

EUT	Wireless-G Range Expander	MODEL	WRE54G ver. 2
INPUT POWER (SYSTEM)	120 Vac, 60 Hz	ENVIRONMENTAL CONDITIONS	23 deg. C, 67% RH, 991 hPa
TESTED BY	Leo Hung		

CHANNEL	CHANNEL FREQUENCY (MHz)	PEAK POWER OUTPUT (mW)	PEAK POWER OUTPUT (dBm)	PEAK POWER LIMIT (dBm)	PASS/FAIL
1	2412	39.811	16.00	30	PASS
6	2437	40.365	16.06	30	PASS
11	2462	40.551	16.08	30	PASS

4.4.8 TEST RESULTS (B)

EUT	Wireless-G Range Expander	MODEL	WRE54G ver. 2
INPUT POWER (SYSTEM)	120 Vac, 60 Hz	ENVIRONMENTAL CONDITIONS	23 deg. C, 67% RH, 991 hPa
TESTED BY	Leo Hung		

CHANNEL	CHANNEL FREQUENCY (MHz)	PEAK POWER OUTPUT (mW)	PEAK POWER OUTPUT (dBm)	PEAK POWER LIMIT (dBm)	PASS/FAIL
1	2412	25.119	14.00	30	PASS
6	2437	25.351	14.04	30	PASS
11	2462	25.293	14.03	30	PASS