



FCC TEST REPORT

REPORT NO.: RF930308R01

MODEL NO.: WMP54Gv4

RECEIVED: Mar. 26, 2004

TESTED: Mar. 26, 2004 ~ Apr. 5, 2004

APPLICANT: Cisco Linksys, LLC

ADDRESS: 121 Theory Drive, Irvine, CA 92612 (USA)

ISSUED BY: Advance Data Technology Corporation

LAB LOCATION: 47 14th Lin, Chiapau Tsun, Linko, Taipei,
Taiwan, R.O.C.

This test report consists of 67 pages in total. It may be duplicated completely for legal use with the approval of the applicant. It should not be reproduced except in full, without the written approval of our laboratory. The client should not use it to claim product endorsement by CNLA or any government agencies. The test results in the report only apply to the tested sample.



0528
ILAC MRA



Table of Contents

1	CERTIFICATION.....	4
2	SUMMARY OF TEST RESULTS	5
3	GENERAL INFORMATION	6
3.1	GENERAL DESCRIPTION OF EUT	6
3.2	DESCRIPTION OF TEST MODES	7
3.3	GENERAL DESCRIPTION OF APPLIED STANDARDS	7
3.4	DESCRIPTION OF SUPPORT UNITS	8
3.5	CONFIGURATION OF SYSTEM UNDER TEST.....	9
4	TEST TYPES AND RESULTS	10
4.1	CONDUCTED EMISSION MEASUREMENT.....	10
4.1.1	LIMITS OF CONDUCTED EMISSION MEASUREMENT	10
4.1.2	TEST INSTRUMENTS.....	10
4.1.3	TEST PROCEDURES	11
4.1.4	DEVIATION FROM TEST STANDARD.....	11
4.1.5	TEST SETUP.....	12
4.1.6	EUT OPERATING CONDITIONS	12
4.1.7	TEST RESULTS	13
4.2	RADIATED EMISSION MEASUREMENT	19
4.2.1	LIMITS OF RADIATED EMISSION MEASUREMENT	19
4.2.2	TEST INSTRUMENTS.....	20
4.2.3	TEST PROCEDURES	21
4.2.4	DEVIATION FROM TEST STANDARD.....	21
4.2.5	TEST SETUP.....	22
4.2.6	EUT OPERATING CONDITIONS	22
4.2.7	TEST RESULTS	23
4.2.8	TEST RESULTS (A).....	24
4.2.9	TEST RESULTS (B).....	27
4.3	6dB BANDWIDTH MEASUREMENT	30
4.3.1	LIMITS OF 6dB BANDWIDTH MEASUREMENT.....	30
4.3.2	TEST INSTRUMENTS.....	30
4.3.3	TEST PROCEDURE.....	31
4.3.4	DEVIATION FROM TEST STANDARD.....	31
4.3.5	TEST SETUP.....	31
4.3.6	EUT OPERATING CONDITIONS	31
4.3.7	TEST RESULTS (A).....	32



4.3.8	TEST RESULTS (B).....	36
4.4	MAXIMUM PEAK OUTPUT POWER.....	40
4.4.1	LIMITS OF MAXIMUM PEAK OUTPUT POWER MEASUREMENT.....	40
4.4.2	TEST INSTRUMENTS.....	40
4.4.3	TEST PROCEDURES.....	41
4.4.4	DEVIATION FROM TEST STANDARD.....	41
4.4.5	TEST SETUP.....	41
4.4.6	EUT OPERATING CONDITIONS.....	41
4.4.7	TEST RESULTS (A).....	42
4.4.8	TEST RESULTS (B).....	42
4.5	POWER SPECTRAL DENSITY MEASUREMENT.....	43
4.5.1	LIMITS OF POWER SPECTRAL DENSITY MEASUREMENT.....	43
4.5.2	TEST INSTRUMENTS.....	43
4.5.3	TEST PROCEDURE.....	44
4.5.4	DEVIATION FROM TEST STANDARD.....	44
4.5.5	TEST SETUP.....	44
4.5.6	EUT OPERATING CONDITIONS.....	44
4.5.7	TEST RESULTS (A).....	45
4.5.8	TEST RESULTS (B).....	49
4.6	BAND EDGES MEASUREMENT.....	53
4.6.1	LIMITS OF BAND EDGES MEASUREMENT.....	53
4.6.2	TEST INSTRUMENTS.....	53
4.6.3	TEST PROCEDURE.....	53
4.6.4	DEVIATION FROM TEST STANDARD.....	53
4.6.5	EUT OPERATING CONDITION.....	54
4.6.6	TEST RESULTS (A).....	54
4.6.7	TEST RESULTS (B).....	59
4.7	ANTENNA REQUIREMENT.....	64
4.7.1	STANDARD APPLICABLE.....	64
4.7.2	ANTENNA CONNECTED CONSTRUCTION.....	64
5	PHOTOGRAPHS OF THE TEST CONFIGURATION.....	65
6	INFORMATION ON THE TESTING LABORATORIES.....	67



1 CERTIFICATION

PRODUCT : Wireless-G PCI Adapter
MODEL NO.: WMP54Gv4
BRAND: Linksys
APPLICANT : Cisco Linksys, LLC
TEST ITEM: ENGINEERING SAMPLE
STANDARDS : FCC Part 15, Subpart C (Section 15.247),
ANSI C63.4-1992

We, **Advance Data Technology Corporation**, hereby certify that one sample of the designation has been tested in our facility from Mar. 26, 2004 to Apr. 5, 2004. The test record, data evaluation and Equipment Under Test (EUT) configurations represented herein are true and accurate accounts of the measurements of the sample's EMC characteristics under the conditions herein specified.

PREPARED BY: Wendy Liao , **DATE:** Apr. 6, 2004
Wendy Liao
APPROVED BY: Ellis Wu , **DATE:** Apr. 6, 2004
Ellis Wu / Manager



2 SUMMARY OF TEST RESULTS

The EUT has been tested according to the following specifications:

APPLIED STANDARD: FCC Part 15, Subpart C			
Standard Section	Test Type and Limit	Result	REMARK
15.207	AC Power Conducted Emission	PASS	Meet the requirement of limit. Minimum passing margin is -15.24dB at 3.051MHz.
15.247(a)(2)	Spectrum Bandwidth of a Direct Sequence Spread Spectrum System Limit : min. 500kHz	PASS	Meet the requirement of limit.
15.247(b)	Maximum Peak Output Power Limit: max. 30dBm	PASS	Meet the requirement of limit.
15.247(c)	Transmitter Radiated Emissions Limit: Table 15.209	PASS	Meet the requirement of limit. Minimum passing margin is -1.16dB at 2450.00MHz.
15.247(d)	Power Spectral Density Limit: max. 8dBm	PASS	Meet the requirement of limit.
15.247(c)	Band Edge Measurement Limit: 20 dB less than the peak value of fundamental frequency	PASS	Meet the requirement of limit.

NOTE: The information of measurement uncertainty is available upon the customer's request.

3 GENERAL INFORMATION

3.1 GENERAL DESCRIPTION OF EUT

PRODUCT	Wireless-G PCI Adapter
MODEL NO.	WMP54Gv4
POWER SUPPLY	5Vdc from host equipment
MODULATION TYPE	BPSK, QPSK, CCK, 16QAM, 64QAM
MODULATION TECHNOLOGY	DSSS, OFDM
TRANSFER RATE	54/48/36/24/18/12/11/9/6/5.5/2/1Mbps
FREQUENCY RANGE	2412MHz ~ 2462MHz
NUMBER OF CHANNEL	11
MAXIMUM OUTPUT POWER (FOF CCK)	13.03dBm
MAXIMUM OUTPUT POWER (FOF OFDM)	12.89dBm
ANTENNA TYPE	Dipole antenna with 5dBi gain
DATA CABLE	NA
I/O PORTS	NA
ASSOCIATED DEVICES	NA

NOTE:

- 1.The EUT operates in the 2.4GHz frequency spectrum with throughput of up to 54Mbps.
- 2.The EUT complies with IEEE 802.11g draft standards, and backwards compatible with IEEE 802.11b products.
- 3.For a more detailed features description, please refer to the manufacturer's specifications or User's Manual.



3.2 DESCRIPTION OF TEST MODES

Eleven channels are provided to this EUT.

Channel	Frequency	Channel	Frequency
1	2412 MHz	7	2442 MHz
2	2417 MHz	8	2447 MHz
3	2422 MHz	9	2452 MHz
4	2427 MHz	10	2457 MHz
5	2432 MHz	11	2462 MHz
6	2437 MHz		

NOTE:

1. For Radiated Emission Measurement test: Below 1GHz, the channel 1, 6, and 11 were pre-tested in chamber. The channel 11, worst case one, was chosen for final test. Above 1GHz, the channel 1, 6, and 11 were tested individually.
2. Transfer rate, 11Mbps with CCK technique and 6Mbps with OFDM technique, worst cases, were chosen for final test.
3. Two test results were presented in the following sections, the test result A was for CCK technique, the test result B was for OFDM technique.

3.3 GENERAL DESCRIPTION OF APPLIED STANDARDS

The EUT is a Wireless-G PCI Adapter. According to the specifications of the manufacturer, it must comply with the requirements of the following standards:

FCC Part 15, Subpart C. (15.247)
ANSI C63.4-1992

All test items have been performed and recorded as per the above standards.

NOTE: The EUT is also considered as a kind of computer peripheral, because the connection to computer is necessary for typical use. It has been verified to comply with the requirements of FCC Part 15, Subpart B, Class B (DoC). The test report has been issued separately.



3.4 DESCRIPTION OF SUPPORT UNITS

The EUT has been tested as an independent unit together with other necessary accessories or support units. The following support units or accessories were used to form a representative test configuration during the tests.

NO.	PRODUCT	BRAND	MODEL NO.	SERIAL NO.	FCC ID
1	PERSONAL COMPUTER	HP	Brio BA410	SG12902751	FCC DoC Approved
2	MONITOR	HP	D2846A	JP90512318	FCC DoC Approved
3	PS/2 KEYBOARD	BTC	5200T	F24800258	E5XKB5122WTH 0110
4	PS/2 MOUSE	BTC	M851	N/A	E5XMSM860
5	PRINTER	EPSON	LQ-300+	DCGY038835	FCC DoC Approved
6	MODEM	ACEEX	1414	0206026755	IFAXDM1414

NO.	SIGNAL CABLE DESCRIPTION OF THE ABOVE SUPPORT UNITS
1	NA
2	1.8 m braid shielded wire, terminated with VGA connector via metallic frame, w/o core.
3	1.6 m foil shielded wire, terminated with PS/2 connector via metallic frame, w/o core.
4	1.5 m Non shielded wire, terminated with PS/2 connector via drain wire, w/o core.
5	1.2m braid shielded wire, terminated with DB25 and Centronics connector via metallic frame, w/o core
6	1.2 m braid shielded wire, terminated with DB25 and DB9 connector via metallic frame, w/o core.

NOTE: All power cords of the above support units are non shielded (1.8m).



3.5 CONFIGURATION OF SYSTEM UNDER TEST

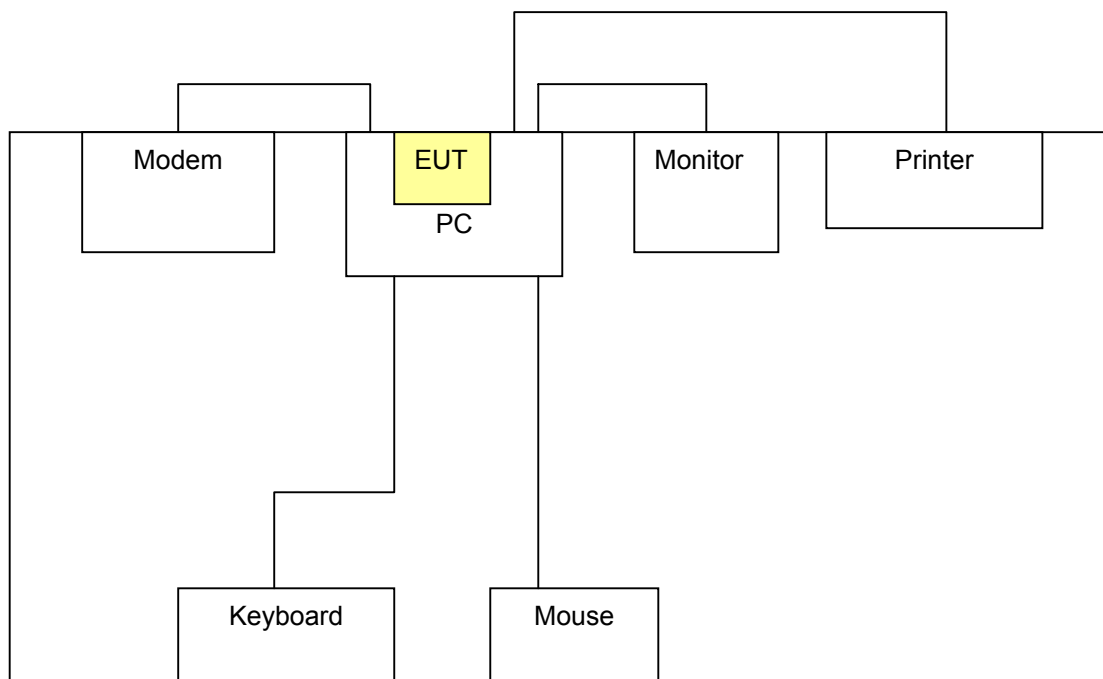



4 TEST TYPES AND RESULTS

4.1 CONDUCTED EMISSION MEASUREMENT

4.1.1 LIMITS OF CONDUCTED EMISSION MEASUREMENT

FREQUENCY OF EMISSION (MHz)	CONDUCTED LIMIT (dB μ V)	
	Quasi-peak	Average
0.15-0.5	66 to 56	56 to 46
0.5-5	56	46
5-30	60	50

- NOTE:**
1. The lower limit shall apply at the transition frequencies.
 2. The limit decreases in line with the logarithm of the frequency in the range of 0.15 to 0.50 MHz.
 3. All emanations from a class A/B digital device or system, including any network of conductors and apparatus connected thereto, shall not exceed the level of field strengths specified above.

4.1.2 TEST INSTRUMENTS

DESCRIPTION & MANUFACTURER	MODEL NO.	SERIAL NO.	CALIBRATED UNTIL
ROHDE & SCHWARZ Test Receiver	ESCS 30	838251/021	Jan. 04, 2005
ROHDE & SCHWARZ Artificial Mains Network (for EUT)	ESH3-Z5	100218	Dec. 09, 2004
ROHDE & SCHWARZ Artificial Mains Network (for peripherals)	ESH3-Z5	100219	Dec. 09, 2004
ROHDE & SCHWARZ Artificial Mains Network (for peripherals)	ESH3-Z5	100220	Dec. 09, 2004
*ROHDE & SCHWARZ 4-wire ISN	ENY41	837032/016	Nov. 19, 2004
*ROHDE & SCHWARZ 2-wire ISN	ENY22	837497/016	Nov. 19, 2004
Software	Cond-V2M3	NA	NA
RF cable (JYEBAO)	5D-FB	Cable-C10.01	May 01, 2004
SUHNTER Terminator (For ROHDE & SCHWARZ LISN)	65BNC-5001	E1-010770	Feb. 28, 2005
SUHNTER Terminator (For ROHDE & SCHWARZ LISN)	65BNC-5001	E1-010773	Feb. 28, 2005

- NOTE:**
1. The calibration interval of the above test instruments is 12 months and the calibrations are traceable to NML/ROC and NIST/USA.
 2. "*": These equipment are used for conducted telecom port test only (if tested).
 3. The test was performed in ADT Shielded Room No. 10.
 4. The VCCI Site Registration No. is C-1312.



4.1.3 TEST PROCEDURES

- a. The EUT was placed 0.4 meters from the conducting wall of the shielded room with EUT being connected to the power mains through a line impedance stabilization network (LISN). Other support units were connected to the power mains through another LISN. The two LISNs provide 50 ohm/ 50uH of coupling impedance for the measuring instrument.
- b. Both lines of the power mains connected to the EUT were checked for maximum conducted interference.
- c. The frequency range from 150kHz to 30MHz was searched. Emission levels under Limit - 20dB was not recorded.

4.1.4 DEVIATION FROM TEST STANDARD

No deviation

4.1.5 TEST SETUP

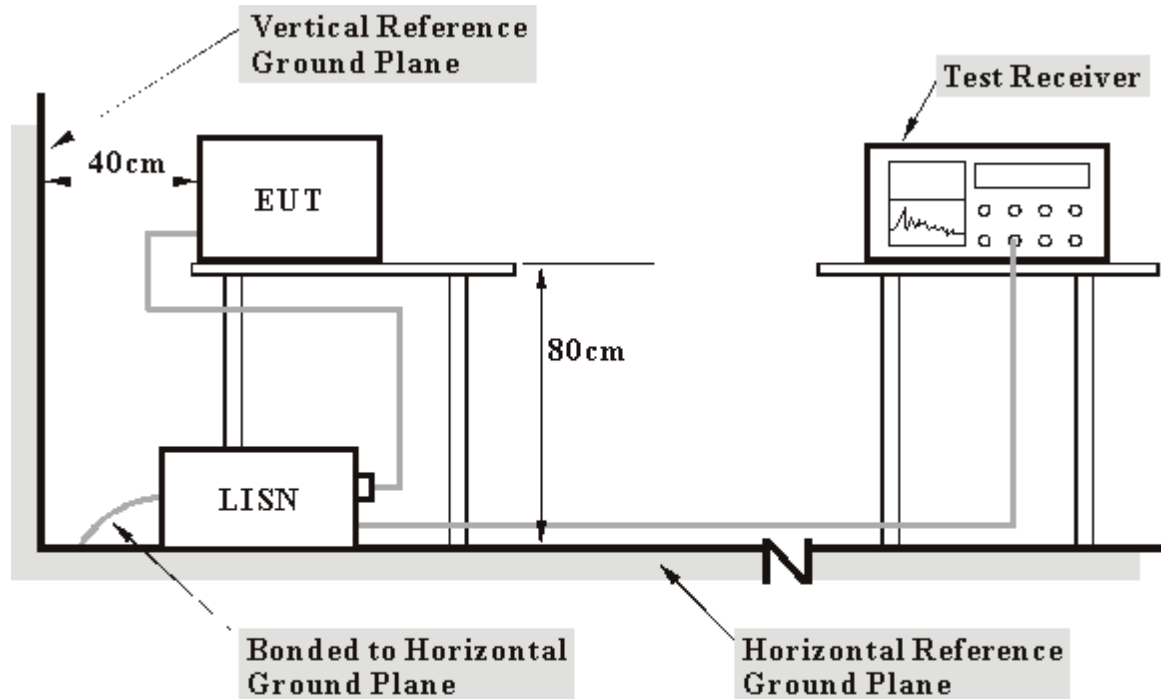

- Note:**
1. Support units were connected to second LISN.
 2. Both of LISNs (AMN) 80 cm from EUT and at the least 80 cm from other units and other metal planes support units.

For the actual test configuration, please refer to the related item – Photographs of the Test Configuration.

4.1.6 EUT OPERATING CONDITIONS

- a. Plug the EUT a personal computer system placed on a testing table.
- b. The personal computer system ran a test program (provided by manufacturer) to enable EUT under transmission/receiving condition continuously at specific channel frequency.
- c. The personal computer system show "H" messages on its screen.
- d. The personal computer sent "H" messages to modem.
- e. The personal computer sent "H" messages to printer, and the printer prints them on paper.
- f. Repeated c ~e.



4.1.7 TEST RESULTS

EUT	Wireless-G PCI Adapter	MODEL	WMP54Gv4
MODE	Channel 1	6dB BANDWIDTH	9kHz
INPUT POWER (SYSTEM)	120Vac, 60 Hz	PHASE	Line (L)
ENVIRONMENTAL CONDITIONS	20deg. C, 60%RH, 991hPa	TESTED BY: Steven Lu	

No	Freq. [MHz]	Corr. Factor (dB)	Reading Value		Emission Level		Limit		Margin	
			[dB (uV)]		[dB (uV)]		[dB (uV)]		(dB)	
			Q.P.	AV.	Q.P.	AV.	Q.P.	AV.	Q.P.	AV.
1	0.228	0.10	42.08	-	42.18	-	62.52	52.52	-20.34	-
2	0.666	0.14	39.42	-	39.56	-	56.00	46.00	-16.44	-
3	1.810	0.20	39.39	-	39.59	-	56.00	46.00	-16.41	-
4	3.051	0.25	38.74	-	38.99	-	56.00	46.00	-17.01	-
5	4.191	0.31	39.73	-	40.04	-	56.00	46.00	-15.96	-
6	9.557	0.58	36.06	-	36.64	-	60.00	50.00	-23.36	-

- REMARKS:**
1. Q.P. and AV. are abbreviations of quasi-peak and average individually.
 2. "-": The Quasi-peak reading value also meets average limit and measurement with the average detector is unnecessary.
 3. The emission levels of other frequencies were very low against the limit.
 4. Margin value = Emission level - Limit value
 5. Correction factor = Insertion loss + Cable loss
 6. Emission Level = Correction Factor + Reading Value.

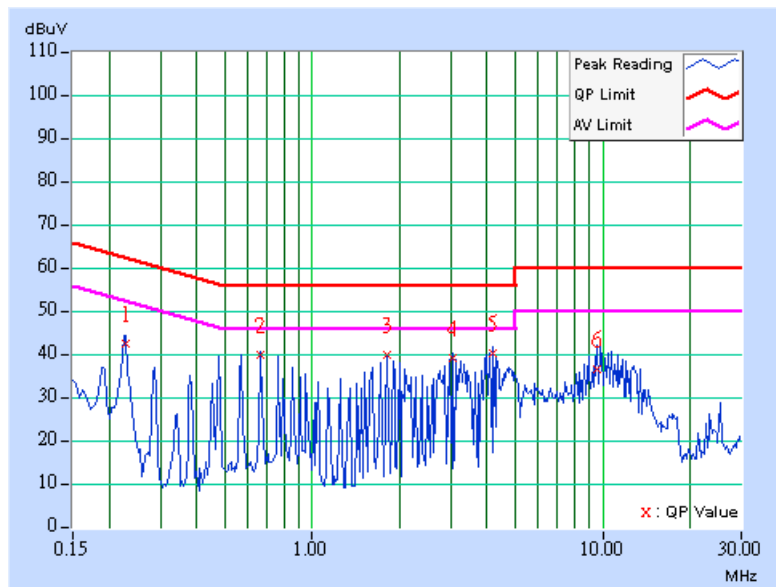



EUT	Wireless-G PCI Adapter	MODEL	WMP54Gv4
MODE	Channel 1	6dB BANDWIDTH	9kHz
INPUT POWER (SYSTEM)	120Vac, 60 Hz	PHASE	Neutral (N)
ENVIRONMENTAL CONDITIONS	20deg. C, 60%RH, 991hPa	TESTED BY: Steven Lu	

No	Freq. [MHz]	Corr. Factor (dB)	Reading Value [dB (uV)]		Emission Level [dB (uV)]		Limit [dB (uV)]		Margin (dB)	
			Q.P.	AV.	Q.P.	AV.	Q.P.	AV.	Q.P.	AV.
			1	0.228	0.10	43.49	-	43.59	-	62.52
2	0.570	0.13	38.78	-	38.91	-	56.00	46.00	-17.09	-
3	1.809	0.20	38.52	-	38.72	-	56.00	46.00	-17.28	-
4	2.952	0.25	37.39	-	37.64	-	56.00	46.00	-18.36	-
5	4.095	0.30	39.23	-	39.53	-	56.00	46.00	-16.47	-
6	9.563	0.49	36.93	-	37.42	-	60.00	50.00	-22.58	-

- REMARKS:**
1. Q.P. and AV. are abbreviations of quasi-peak and average individually.
 2. "-": The Quasi-peak reading value also meets average limit and measurement with the average detector is unnecessary.
 3. The emission levels of other frequencies were very low against the limit.
 4. Margin value = Emission level - Limit value
 5. Correction factor = Insertion loss + Cable loss
 6. Emission Level = Correction Factor + Reading Value.

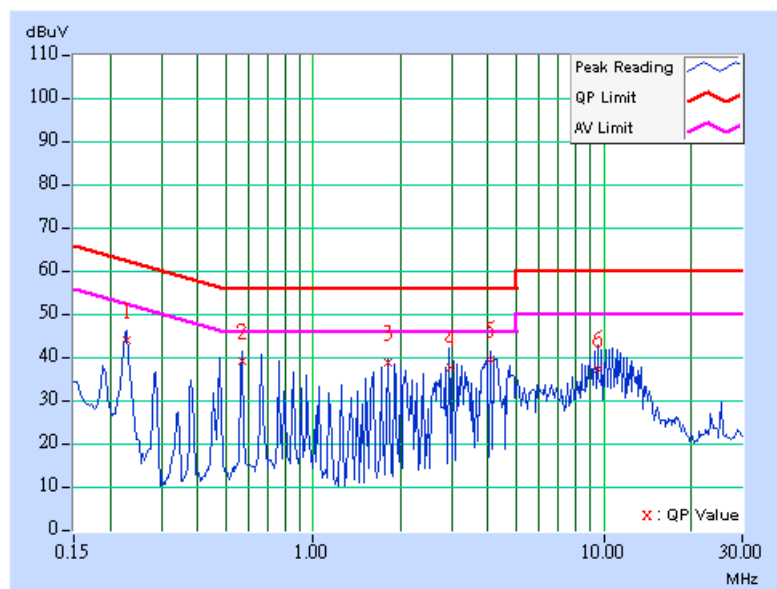



EUT	Wireless-G PCI Adapter	MODEL	WMP54Gv4
MODE	Channel 6	6dB BANDWIDTH	9kHz
INPUT POWER (SYSTEM)	120Vac, 60 Hz	PHASE	Line (L)
ENVIRONMENTAL CONDITIONS	20deg. C, 60%RH, 991hPa	TESTED BY: Steven Lu	

No	Freq. [MHz]	Corr. Factor (dB)	Reading Value		Emission Level		Limit		Margin	
			[dB (uV)]		[dB (uV)]		[dB (uV)]		(dB)	
			Q.P.	AV.	Q.P.	AV.	Q.P.	AV.	Q.P.	AV.
1	0.226	0.10	42.72	-	42.82	-	62.59	52.59	-19.77	-
2	0.666	0.14	39.32	-	39.46	-	56.00	46.00	-16.54	-
3	1.812	0.20	38.98	-	39.18	-	56.00	46.00	-16.82	-
4	3.051	0.25	39.51	-	39.76	-	56.00	46.00	-16.24	-
5	4.191	0.31	39.30	-	39.61	-	56.00	46.00	-16.39	-
6	9.254	0.56	36.75	-	37.31	-	60.00	50.00	-22.69	-

- REMARKS:**
1. Q.P. and AV. are abbreviations of quasi-peak and average individually.
 2. "-": The Quasi-peak reading value also meets average limit and measurement with the average detector is unnecessary.
 3. The emission levels of other frequencies were very low against the limit.
 4. Margin value = Emission level - Limit value
 5. Correction factor = Insertion loss + Cable loss
 6. Emission Level = Correction Factor + Reading Value.

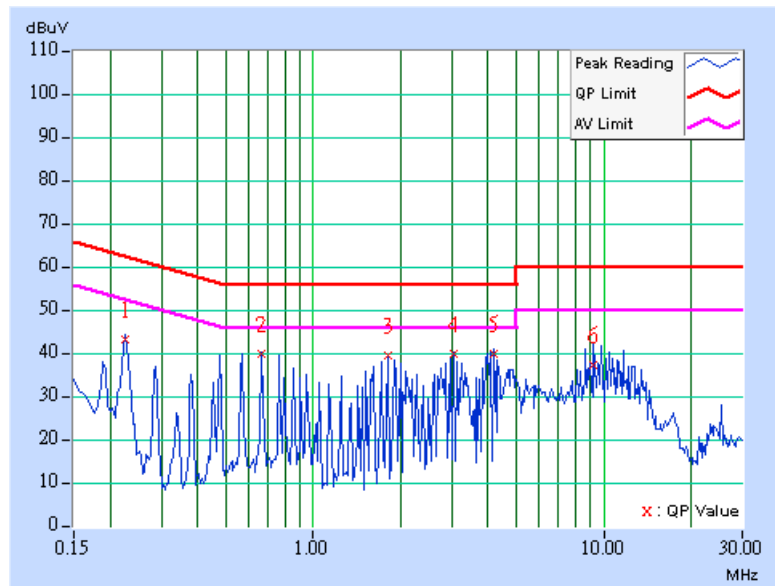



EUT	Wireless-G PCI Adapter	MODEL	WMP54Gv4
MODE	Channel 6	6dB BANDWIDTH	9kHz
INPUT POWER (SYSTEM)	120Vac, 60 Hz	PHASE	Neutral (N)
ENVIRONMENTAL CONDITIONS	20deg. C, 60%RH, 991hPa	TESTED BY: Steven Lu	

No	Freq. [MHz]	Corr. Factor (dB)	Reading Value [dB (uV)]		Emission Level [dB (uV)]		Limit [dB (uV)]		Margin (dB)	
			Q.P.	AV.	Q.P.	AV.	Q.P.	AV.	Q.P.	AV.
			1	0.224	0.10	43.05	-	43.15	-	62.66
2	0.666	0.14	39.04	-	39.18	-	56.00	46.00	-16.82	-
3	1.812	0.20	38.56	-	38.76	-	56.00	46.00	-17.24	-
4	3.051	0.25	39.78	-	40.03	-	56.00	46.00	-15.97	-
5	4.191	0.31	39.01	-	39.32	-	56.00	46.00	-16.68	-
6	10.742	0.53	37.56	-	38.09	-	60.00	50.00	-21.91	-

- REMARKS:**
1. Q.P. and AV. are abbreviations of quasi-peak and average individually.
 2. "-": The Quasi-peak reading value also meets average limit and measurement with the average detector is unnecessary.
 3. The emission levels of other frequencies were very low against the limit.
 4. Margin value = Emission level - Limit value
 5. Correction factor = Insertion loss + Cable loss
 6. Emission Level = Correction Factor + Reading Value.

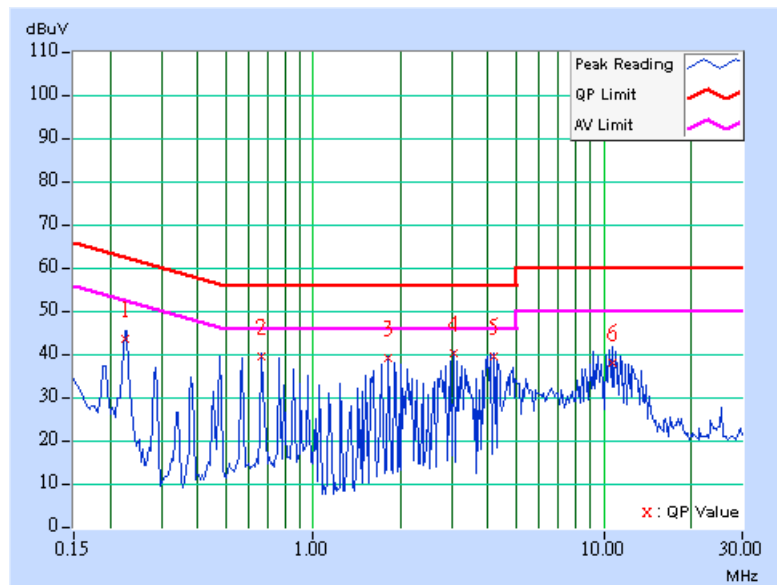



EUT	Wireless-G PCI Adapter	MODEL	WMP54Gv4
MODE	Channel 11	6dB BANDWIDTH	9kHz
INPUT POWER (SYSTEM)	120Vac, 60 Hz	PHASE	Line (L)
ENVIRONMENTAL CONDITIONS	20deg. C, 60%RH, 991hPa	TESTED BY: Steven Lu	

No	Freq. [MHz]	Corr. Factor (dB)	Reading Value [dB (uV)]		Emission Level [dB (uV)]		Limit [dB (uV)]		Margin (dB)	
			Q.P.	AV.	Q.P.	AV.	Q.P.	AV.	Q.P.	AV.
			1	0.224	0.10	42.04	-	42.14	-	62.66
2	0.666	0.14	39.16	-	39.30	-	56.00	46.00	-16.70	-
3	1.810	0.20	39.03	-	39.23	-	56.00	46.00	-16.77	-
4	3.051	0.25	40.51	-	40.76	-	56.00	46.00	-15.24	-
5	4.098	0.30	39.41	-	39.71	-	56.00	46.00	-16.29	-
6	9.844	0.59	37.05	-	37.64	-	60.00	50.00	-22.36	-

- REMARKS:**
1. Q.P. and AV. are abbreviations of quasi-peak and average individually.
 2. "-": The Quasi-peak reading value also meets average limit and measurement with the average detector is unnecessary.
 3. The emission levels of other frequencies were very low against the limit.
 4. Margin value = Emission level - Limit value
 5. Correction factor = Insertion loss + Cable loss
 6. Emission Level = Correction Factor + Reading Value.

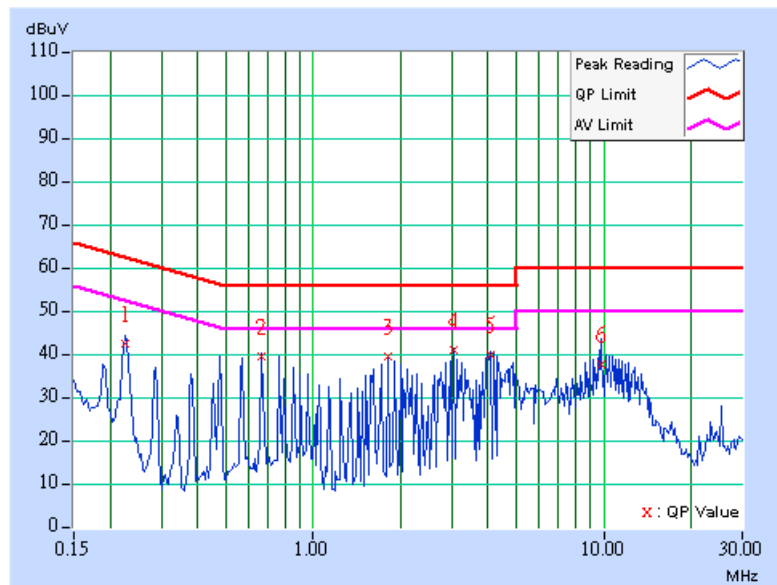



EUT	Wireless-G PCI Adapter	MODEL	WMP54Gv4
MODE	Channel 11	6dB BANDWIDTH	9kHz
INPUT POWER (SYSTEM)	120Vac, 60 Hz	PHASE	Neutral (N)
ENVIRONMENTAL CONDITIONS	20deg. C, 60%RH, 991hPa	TESTED BY: Steven Lu	

No	Freq. [MHz]	Corr. Factor (dB)	Reading Value		Emission Level		Limit		Margin	
			[dB (uV)]		[dB (uV)]		[dB (uV)]		(dB)	
			Q.P.	AV.	Q.P.	AV.	Q.P.	AV.	Q.P.	AV.
1	0.228	0.10	42.76	-	42.86	-	62.52	52.52	-19.66	-
2	0.666	0.14	38.99	-	39.13	-	56.00	46.00	-16.87	-
3	1.810	0.20	38.88	-	39.08	-	56.00	46.00	-16.92	-
4	3.051	0.25	39.96	-	40.21	-	56.00	46.00	-15.79	-
5	4.098	0.30	39.21	-	39.51	-	56.00	46.00	-16.49	-
6	10.141	0.51	38.39	-	38.90	-	60.00	50.00	-21.10	-

- REMARKS:**
1. Q.P. and AV. are abbreviations of quasi-peak and average individually.
 2. "-": The Quasi-peak reading value also meets average limit and measurement with the average detector is unnecessary.
 3. The emission levels of other frequencies were very low against the limit.
 4. Margin value = Emission level - Limit value
 5. Correction factor = Insertion loss + Cable loss
 6. Emission Level = Correction Factor + Reading Value.

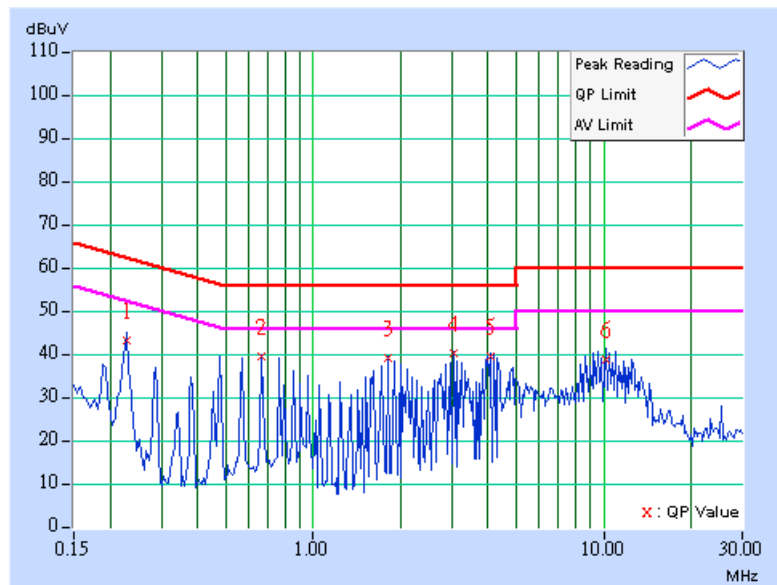



4.2 RADIATED EMISSION MEASUREMENT

4.2.1 LIMITS OF RADIATED EMISSION MEASUREMENT

Emissions radiated outside of the specified bands, shall be according to the general radiated limits in 15.209 as following:

Frequencies (MHz)	Field strength (microvolts/meter)	Measurement distance (meters)
0.009-0.490	2400/F(kHz)	300
0.490-1.705	24000/F(kHz)	30
1.705-30.0	30	30
30-88	100	3
88-216	150	3
216-960	200	3
Above 960	500	3

NOTE:

1. The lower limit shall apply at the transition frequencies.
2. Emission level (dBuV/m) = 20 log Emission level (uV/m).
3. As shown in 15.35(b), for frequencies above 1000MHz, the field strength limits are based on average detector, however, the peak field strength of any emission shall not exceed the maximum permitted average limits, specified above by more than 20dB under any condition of modulation.



4.2.2 TEST INSTRUMENTS

DESCRIPTION & MANUFACTURER	MODEL NO.	SERIAL NO.	CALIBRATED UNTIL
* HP Spectrum Analyzer	8590L	3544A01176	Jun. 10, 2004
* HP Preamplifier	8447D	2944A08485	May 01, 2004
* HP Spectrum Analyzer	8593E	3926A04191	Mar. 23, 2005
* HP Preamplifier	8449B	3008A01292	Aug. 13, 2004
ROHDE & SCHWARZ TEST RECEIVER	ESI7	838496/016	Feb. 8, 2005
* ROHDE & SCHWARZ TEST RECEIVER	ESMI	839013/007 839379/002	Feb. 12, 2005
SCHAFFNER Tunable Dipole Antenna	VHBA 9123	459	Jun. 26, 2004
SCHWARZBECK Tunable Dipole Antenna	UHA 9105	977	
* CHASE BILOG Antenna	CBL6112A	2221	Jul. 26, 2004
* SCHWARZBECK Horn Antenna	BBHA9120-D1	D130	Jun. 30, 2004
* EMCO Turn Table	1060	1115	NA
* CHANCE Tower	CM-AT40	CM-A010	NA
* Software	ADT_Radiated_V5.14	NA	NA
* ANRITSU RF Switches	MP59B	M35046	Oct. 9, 2004
* TIMES RF cable	LMR-600	CABLE-ST5-01	Oct. 9, 2004

- NOTE:** 1. The calibration interval of the above test instruments is 12 months. And the calibrations are traceable to NML/ROC and NIST/USA.
2. "*" = These equipment are used for the final measurement.
 3. The horn antenna and HP preamplifier (model: 8449B) are used only for the measurement of emission frequency above 1GHz if tested.
 4. The test was performed in ADT Open Site No. 5.
 5. The VCCI Site Registration No. is R-1039.



4.2.3 TEST PROCEDURES

- a. The EUT was placed on the top of a rotating table 0.8 meters above the ground at a 10 meter open area test site. The table was rotated 360 degrees to determine the position of the highest radiation.
- b. The EUT was set 3 meters away from the interference-receiving antenna, which was mounted on the top of a variable-height antenna tower.
- c. The antenna is a broadband antenna, and its height is varied from one meter to four meters above the ground to determine the maximum value of the field strength. Both horizontal and vertical polarizations of the antenna are set to make the measurement.
- d. For each suspected emission, the EUT was arranged to its worst case and then the antenna was tuned to heights from 1 meter to 4 meters and the rotatable table was turned from 0 degrees to 360 degrees to find the maximum reading.
- e. The test-receiver system was set to Peak Detect Function and Specified Bandwidth with Maximum Hold Mode.
- f. If the emission level of the EUT in peak mode was 10 dB lower than the limit specified, then testing could be stopped and the peak values of the EUT would be reported. Otherwise the emissions that did not have 10 dB margin would be re-tested one by one using peak, quasi-peak or average method as specified and then reported in a data sheet.

NOTE:

1. The resolution bandwidth and video bandwidth of test receiver/spectrum analyzer is 120kHz for Peak detection (PK) and Quasi-peak detection (QP) at frequency below 1GHz.
2. The resolution bandwidth and video bandwidth of test receiver/spectrum analyzer is 1 MHz for Peak detection at frequency above 1GHz.
3. The resolution bandwidth of test receiver/spectrum analyzer is 1 MHz and the video bandwidth is 10 Hz for Average detection (AV) at frequency above 1GHz.

4.2.4 DEVIATION FROM TEST STANDARD

No deviation

4.2.5 TEST SETUP

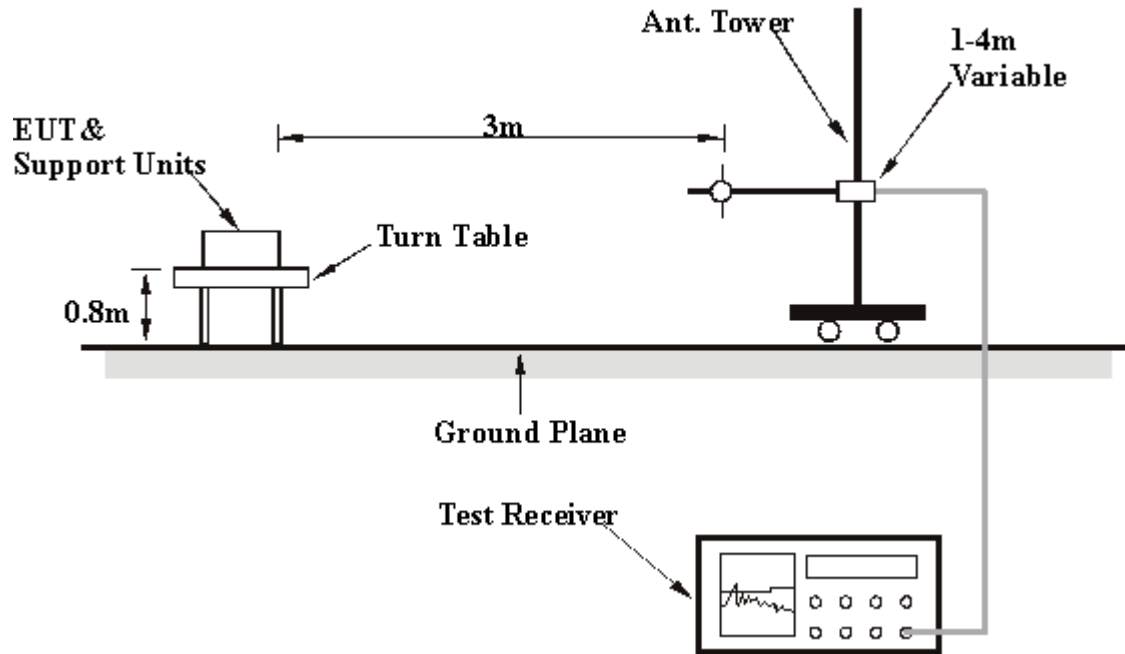

For the actual test configuration, please refer to the related item – Photographs of the Test Configuration.

4.2.6 EUT OPERATING CONDITIONS

Same as 4.1.6

4.2.7 TEST RESULTS

EUT	Wireless-G PCI Adapter	MODEL	WMP54Gv4
MODE	Channel 11	FREQUENCY RANGE	Below 1000MHz
INPUT POWER (SYSTEM)	120Vac, 60 Hz	DETECTOR FUNCTION	Quasi-Peak
ENVIRONMENTAL CONDITIONS	19 deg. C, 81 % RH, 991hPa	TESTED BY: Vincent Lin	

ANTENNA POLARITY & TEST DISTANCE: HORIZONTAL AT 3 M

No.	Freq. (MHz)	Emission Level (dBuV/m)	Limit (dBuV/m)	Margin (dB)	Antenna Height (m)	Table Angle (Degree)	Raw Value (dBuV)	Correction Factor (dB/m)
1	49.03	34.28 QP	40.00	-5.72	2.63 H	177	25.04	9.24
2	275.02	39.63 QP	46.00	-6.37	1.58 H	112	24.77	14.86
3	300.00	40.11 QP	46.00	-5.89	1.77 H	251	24.69	15.42
4	500.12	38.17 QP	46.00	-7.83	2.01 H	199	18.25	19.92
5	575.00	37.03 QP	46.00	-8.97	1.63 H	90	15.88	21.15
6	625.00	38.81 QP	46.00	-7.19	1.41 H	118	16.93	21.89
7	850.00	37.55 QP	46.00	-8.45	1.33 H	360	13.51	24.04

ANTENNA POLARITY & TEST DISTANCE: VERTICAL AT 3 M

No.	Freq. (MHz)	Emission Level (dBuV/m)	Limit (dBuV/m)	Margin (dB)	Antenna Height (m)	Table Angle (Degree)	Raw Value (dBuV)	Correction Factor (dB/m)
1	49.05	35.81 QP	40.00	-4.19	1.52 V	281	26.59	9.22
2	125.00	34.81 QP	43.50	-8.69	1.00 V	180	22.25	12.56
3	175.00	36.89 QP	43.50	-6.61	1.00 V	263	26.77	10.12
4	275.00	38.26 QP	46.00	-7.74	1.14 V	309	23.40	14.86
5	400.06	40.33 QP	46.00	-5.67	2.02 V	63	22.25	18.08
6	600.39	40.06 QP	46.00	-5.94	1.00 V	178	18.30	21.76
7	733.52	38.19 QP	46.00	-7.81	1.58 V	52	15.21	22.98
8	899.97	38.37 QP	46.00	-7.63	1.22 V	360	14.19	24.18

- REMARKS:**
1. Emission level(dBuV/m)=Raw Value(dBuV) + Correction Factor(dB)
 2. Correction Factor(dB/m) = Antenna Factor (dB/m) + Cable Factor (dB)
 3. The other emission levels were very low against the limit.
 4. Margin value = Emission level – Limit value.



4.2.8 TEST RESULTS (A)

EUT	Wireless-G PCI Adapter	MODEL	WMP54Gv4
CHANNEL	Channel 1	FREQUENCY RANGE	1 ~25GHz
INPUT POWER (SYSTEM)	120Vac, 60 Hz	DETECTOR FUNCTION	Peak(PK) Average (AV)
ENVIRONMENTAL CONDITIONS	20 deg. C, 70 % RH, 991hPa	TESTED BY	Vincent Lin

ANTENNA POLARITY & TEST DISTANCE: HORIZONTAL AT 3 M								
No.	Freq. (MHz)	Emission Level (dBuV/m)	Limit (dBuV/m)	Margin (dB)	Antenna Height (m)	Table Angle (Degree)	Raw Value (dBuV)	Correction Factor (dB/m)
1	2038.00	50.63 PK	74.00	-23.37	1.00 H	198	21.83	28.80
1	2038.00	40.24 AV	54.00	-13.76	1.00 H	198	11.44	28.80
2	2390.00	40.87 PK	74.00	-33.13	1.22 H	168	10.55	30.32
2	2390.00	32.80 AV	54.00	-21.20	1.22 H	168	2.48	30.32
3	*2412.00	99.28 PK			1.22 H	168	68.87	30.41
3	*2412.00	91.21 AV			1.22 H	168	60.80	30.41
4	2444.00	55.98 PK	74.00	-18.02	1.00 H	173	25.45	30.53
4	2444.00	47.22 AV	54.00	-6.78	1.00 H	173	16.69	30.53
5	2450.00	54.27 PK	74.00	-19.73	1.00 H	168	23.72	30.55
5	2450.00	46.38 AV	54.00	-7.62	1.00 H	168	15.83	30.55
6	4824.00	45.16 PK	74.00	-28.84	1.00 H	109	9.66	35.50

NTENNA POLARITY & TEST DISTANCE: VERTICAL AT 3 M								
No.	Freq. (MHz)	Emission Level (dBuV/m)	Limit (dBuV/m)	Margin (dB)	Antenna Height (m)	Table Angle (Degree)	Raw Value (dBuV)	Correction Factor (dB/m)
1	2038.00	54.59 PK	74.00	-19.41	1.26 V	178	25.79	28.80
1	2038.00	44.17 AV	54.00	-9.83	1.26 V	178	15.37	28.80
2	2390.00	52.36 PK	74.00	-21.64	2.10 V	197	22.04	30.32
2	2390.00	44.88 AV	54.00	-9.12	2.10 V	197	14.56	30.32
3	*2412.00	110.77 PK			2.10 V	197	80.36	30.41
3	*2412.00	103.29 AV			2.10 V	197	72.88	30.41
4	2444.00	60.40 PK	74.00	-13.60	1.14 V	167	29.87	30.53
4	2444.00	51.12 AV	54.00	-2.88	1.14 V	167	20.59	30.53
5	2450.00	59.92 PK	74.00	-14.08	1.37 V	168	29.37	30.55
5	2450.00	50.56 AV	54.00	-3.44	1.37 V	168	20.01	30.55
6	4824.00	47.25 PK	74.00	-26.75	1.11 V	163	11.75	35.50

- REMARKS:**
1. Emission level(dBuV/m)=Raw Value(dBuV) + Correction Factor(dB)
 2. Correction Factor(dB/m) = Antenna Factor (dB/m) + Cable Factor (dB)
 3. The other emission levels were very low against the limit.
 4. Margin value = Emission level – Limit value.
 5. " * " : Fundamental frequency.



EUT	Wireless-G PCI Adapter	MODEL	WMP54Gv4
CHANNEL	Channel 6	FREQUENCY RANGE	1 ~25GHz
INPUT POWER (SYSTEM)	120Vac, 60 Hz	DETECTOR FUNCTION	Peak(PK) Average (AV)
ENVIRONMENTAL CONDITIONS	20 deg. C, 70 % RH, 991hPa	TESTED BY	Vincent Lin

ANTENNA POLARITY & TEST DISTANCE: HORIZONTAL AT 3M

No.	Freq. (MHz)	Emission Level (dBuV/m)	Limit (dBuV/m)	Margin (dB)	Antenna Height (m)	Table Angle (Degree)	Raw Value (dBuV)	Correction Factor (dB/m)
1	2063.00	51.24 PK	74.00	-22.76	1.26 H	177	22.31	28.93
1	2063.00	40.28 AV	54.00	-13.72	1.26 H	177	11.35	28.93
2	*2437.00	98.72 PK			1.18 H	172	68.22	30.50
2	*2437.00	91.19 AV			1.18 H	172	60.69	30.50
3	2494.00	55.87 PK	74.00	-18.13	1.10 H	174	25.16	30.71
3	2494.00	47.87 AV	54.00	-6.13	1.10 H	174	17.16	30.71
4	4874.00	46.09 PK	74.00	-27.91	1.00 H	112	10.33	35.76

ANTENNA POLARITY & TEST DISTANCE: VERTICAL AT 3M

No.	Freq. (MHz)	Emission Level (dBuV/m)	Limit (dBuV/m)	Margin (dB)	Antenna Height (m)	Table Angle (Degree)	Raw Value (dBuV)	Correction Factor (dB/m)
1	2063.00	55.66 PK	74.00	-18.34	1.25 V	177	26.73	28.93
1	2063.00	44.45 AV	54.00	-9.55	1.25 V	177	15.52	28.93
2	*2437.00	111.54 PK	74.00			195	81.04	30.50
2	*2437.00	103.90 AV	54.00			195	73.40	30.50
3	2494.00	60.86 PK	74.00	-13.14	1.12 V	171	30.15	30.71
3	2494.00	51.24 AV	54.00	-2.76	1.12 V	171	20.53	30.71
4	4874.00	48.66 PK	74.00	-25.34	1.08 V	166	12.90	35.76

- REMARKS:**
1. Emission level(dBuV/m)=Raw Value(dBuV) + Correction Factor(dB)
 2. Correction Factor(dB/m) = Antenna Factor (dB/m) + Cable Factor (dB)
 3. The other emission levels were very low against the limit.
 4. Margin value = Emission level – Limit value.
 5. “ * “ : Fundamental frequency.



EUT	Wireless-G PCI Adapter	MODEL	WMP54Gv4
CHANNEL	Channel 11	FREQUENCY RANGE	1 ~25GHz
INPUT POWER (SYSTEM)	120Vac, 60 Hz	DETECTOR FUNCTION	Peak(PK) Average (AV)
ENVIRONMENTAL CONDITIONS	20 deg. C, 70 % RH, 991hPa	TESTED BY	Vincent Lin

ANTENNA POLARITY & TEST DISTANCE: HORIZONTAL AT 3M								
No.	Freq. (MHz)	Emission Level (dBuV/m)	Limit (dBuV/m)	Margin (dB)	Antenna Height (m)	Table Angle (Degree)	Raw Value (dBuV)	Correction Factor (dB/m)
1	2088.00	51.22 PK	74.00	-22.78	1.10 H	177	22.16	29.06
1	2088.00	42.60 AV	54.00	-11.40	1.10 H	177	13.54	29.06
2	2400.00	55.00 PK	74.00	-19.00	1.16 H	177	24.63	30.37
2	2400.00	42.58 AV	54.00	-11.42	1.16 H	177	12.21	30.37
3	*2462.00	98.56 PK			1.20 H	167	67.97	30.59
3	*2462.00	90.83 AV			1.20 H	167	60.24	30.59
4	2483.50	39.49 PK	74.00	-34.51	1.20 H	167	8.82	30.67
4	2483.50	31.76 AV	54.00	-22.24	1.20 H	167	1.09	30.67
5	2488.10	40.53 PK	74.00	-33.47	1.20 H	167	9.84	30.69
5	2488.10	32.80 AV	54.00	-21.20	1.20 H	167	2.11	30.69
6	2544.00	56.87 PK	74.00	-17.13	1.13 H	154	26.15	30.72
6	2544.00	48.32 AV	54.00	-5.68	1.13 H	154	17.60	30.72
7	4924.00	46.22 PK	74.00	-27.78	1.00 H	221	10.23	35.99

ANTENNA POLARITY & TEST DISTANCE: VERTICAL AT 3M								
No.	Freq. (MHz)	Emission Level (dBuV/m)	Limit (dBuV/m)	Margin (dB)	Antenna Height (m)	Table Angle (Degree)	Raw Value (dBuV)	Correction Factor (dB/m)
1	2088.00	56.57 PK	74.00	-17.43	1.25 V	177	27.51	29.06
1	2088.00	46.80 AV	54.00	-7.20	1.25 V	177	17.74	29.06
2	2400.00	59.06 PK	74.00	-14.94	1.31 V	167	28.69	30.37
2	2400.00	47.07 AV	54.00	-6.93	1.31 V	167	16.70	30.37
3	*2462.00	112.42 PK			1.20 V	198	81.83	30.59
3	*2462.00	104.84 AV			1.20 V	198	74.25	30.59
4	2483.50	53.55 PK	74.00	-20.45	1.20 V	198	22.88	30.67
4	2483.50	45.77 AV	54.00	-8.23	1.20 V	198	15.10	30.67
5	2488.10	54.39 PK	74.00	-19.61	1.20 V	198	23.70	30.69
5	2488.10	46.81 AV	54.00	-7.19	1.20 V	198	16.12	30.69
6	2544.00	60.24 PK	74.00	-13.76	1.11 V	165	29.52	30.72
6	2544.00	51.08 AV	54.00	-2.92	1.11 V	165	20.36	30.72
7	4924.00	48.01 PK	74.00	-25.99	1.06 V	166	12.02	35.99

- REMARKS:**
1. Emission level(dBuV/m)=Raw Value(dBuV) + Correction Factor(dB)
 2. Correction Factor(dB/m) = Antenna Factor (dB/m) + Cable Factor (dB)
 3. The other emission levels were very low against the limit.
 4. Margin value = Emission level – Limit value.
 5. “ * “ : Fundamental frequency.



4.2.9 TEST RESULTS (B)

EUT	Wireless-G PCI Adapter	MODEL	WMP54Gv4
CHANNEL	Channel 1	FREQUENCY RANGE	1 ~25GHz
INPUT POWER (SYSTEM)	120Vac, 60 Hz	DETECTOR FUNCTION	Peak(PK) Average (AV)
ENVIRONMENTAL CONDITIONS	20 deg. C, 70 % RH, 991hPa	TESTED BY	Vincent Lin

ANTENNA POLARITY & TEST DISTANCE: HORIZONTAL AT 3M								
No.	Freq. (MHz)	Emission Level (dBuV/m)	Limit (dBuV/m)	Margin (dB)	Antenna Height (m)	Table Angle (Degree)	Raw Value (dBuV)	Correction Factor (dB/m)
1	2038.00	42.55 PK	74.00	-31.45	1.42 H	233	12.89	29.66
1	2038.00	34.88 AV	54.00	-19.12	1.42 H	233	5.22	29.66
2	2390.00	41.83 PK	74.00	-32.17	1.75 H	114	11.00	30.83
2	2390.00	32.48 AV	54.00	-21.52	1.75 H	114	1.65	30.83
3	*2412.00	96.38 PK			1.75 H	114	65.48	30.90
3	*2412.00	87.03 AV			1.75 H	114	56.13	30.90
4	2444.00	50.44 PK	74.00	-23.56	1.75 H	114	19.46	30.98
4	2444.00	41.09 AV	54.00	-12.91	1.75 H	114	10.11	30.98
5	2450.00	50.67 PK	74.00	-23.33	1.75 H	114	19.67	31.00
5	2450.00	41.32 AV	54.00	-12.68	1.75 H	114	10.32	31.00
6	4824.00	47.53 PK	74.00	-26.47	1.29 H	211	10.46	37.07

ANTENNA POLARITY & TEST DISTANCE: VERTICAL AT 3M								
No.	Freq. (MHz)	Emission Level (dBuV/m)	Limit (dBuV/m)	Margin (dB)	Antenna Height (m)	Table Angle (Degree)	Raw Value (dBuV)	Correction Factor (dB/m)
1	2038.00	44.81 PK	74.00	-29.19	1.30 V	212	16.01	28.80
1	2038.00	40.24 AV	54.00	-13.76	1.30 V	212	11.44	28.80
2	2390.00	53.03 PK	74.00	-20.97	1.19 V	124	22.71	30.32
2	2390.00	44.00 AV	54.00	-10.00	1.19 V	124	13.68	30.32
3	*2412.00	107.58 PK			1.19 V	124	77.17	30.41
3	*2412.00	98.55 AV			1.19 V	124	68.14	30.41
4	2444.00	61.64 PK	74.00	-12.36	1.19 V	124	31.11	30.53
4	2444.00	52.61 AV	54.00	-1.39	1.19 V	124	22.08	30.53
5	2450.00	61.87 PK	74.00	-12.13	1.19 V	124	31.32	30.55
5	2450.00	52.84 AV	54.00	-1.16	1.19 V	124	22.29	30.55
6	4824.00	48.11 PK	74.00	-25.89	1.10 V	166	12.61	35.50

- REMARKS:**
1. Emission level(dBuV/m)=Raw Value(dBuV) + Correction Factor(dB)
 2. Correction Factor(dB/m) = Antenna Factor (dB/m) + Cable Factor (dB)
 3. The other emission levels were very low against the limit.
 4. Margin value = Emission level – Limit value.
 5. “ * “ : Fundamental frequency.



EUT	Wireless-G PCI Adapter	MODEL	WMP54Gv4
CHANNEL	Channel 6	FREQUENCY RANGE	1 ~25GHz
INPUT POWER (SYSTEM)	120Vac, 60 Hz	DETECTOR FUNCTION	Peak(PK) Average (AV)
ENVIRONMENTAL CONDITIONS	20 deg. C, 70 % RH, 991hPa	TESTED BY	Vincent Lin

ANTENNA POLARITY & TEST DISTANCE: HORIZONTAL AT 3M								
No.	Freq. (MHz)	Emission Level (dBuV/m)	Limit (dBuV/m)	Margin (dB)	Antenna Height (m)	Table Angle (Degree)	Raw Value (dBuV)	Correction Factor (dB/m)
1	2063.00	41.35 PK	74.00	-32.65	1.03 H	63	11.58	29.76
1	2063.00	33.16 AV	54.00	-20.84	1.03 H	63	3.39	29.76
2	*2437.00	95.41 PK			1.00 H	123	64.44	30.97
2	*2437.00	86.12 AV			1.00 H	123	55.15	30.97
3	2494.00	47.70 PK	74.00	-26.30	1.00 H	123	16.59	31.11
3	2494.00	38.41 AV	54.00	-15.59	1.00 H	123	7.30	31.11
4	4874.00	47.36 PK	74.00	-26.64	1.54 H	285	10.05	37.31

ANTENNA POLARITY & TEST DISTANCE: VERTICAL AT 3M								
No.	Freq. (MHz)	Emission Level (dBuV/m)	Limit (dBuV/m)	Margin (dB)	Antenna Height (m)	Table Angle (Degree)	Raw Value (dBuV)	Correction Factor (dB/m)
1	2063.00	44.32 PK	74.00	-29.68	1.32 V	210	15.39	28.93
1	2063.00	40.01 AV	54.00	-13.99	1.32 V	210	11.08	28.93
2	*2437.00	105.78 PK			1.20 V	120	75.28	30.50
2	*2437.00	96.04 AV			1.20 V	120	65.54	30.50
3	2494.00	58.07 PK	74.00	-15.93	1.20 V	120	27.36	30.71
3	2494.00	48.33 AV	54.00	-5.67	1.20 V	120	17.62	30.71
4	4874.00	47.10 PK	74.00	-26.90	1.00 V	277	11.34	35.76

- REMARKS:**
1. Emission level(dBuV/m)=Raw Value(dBuV) + Correction Factor(dB)
 2. Correction Factor(dB/m) = Antenna Factor (dB/m) + Cable Factor (dB)
 3. The other emission levels were very low against the limit.
 4. Margin value = Emission level – Limit value.
 5. “ * “ : Fundamental frequency.



EUT	Wireless-G PCI Adapter	MODEL	WMP54Gv4
CHANNEL	Channel 11	FREQUENCY RANGE	1 ~25GHz
INPUT POWER (SYSTEM)	120Vac, 60 Hz	DETECTOR FUNCTION	Peak(PK) Average (AV)
ENVIRONMENTAL CONDITIONS	20 deg. C, 70 % RH, 991hPa	TESTED BY	Vincent Lin

ANTENNA POLARITY & TEST DISTANCE: HORIZONTAL AT 3M								
No.	Freq. (MHz)	Emission Level (dBuV/m)	Limit (dBuV/m)	Margin (dB)	Antenna Height (m)	Table Angle (Degree)	Raw Value (dBuV)	Correction Factor (dB/m)
1	2088.00	43.56 PK	74.00	-30.44	1.30 H	22	13.69	29.87
1	2088.00	36.77 AV	54.00	-17.23	1.30 H	22	6.90	29.87
2	2400.00	46.91 PK	74.00	-27.09	1.69 H	116	16.04	30.87
2	2400.00	37.40 AV	54.00	-16.60	1.69 H	116	6.53	30.87
3	*2462.00	96.11 PK			1.69 H	116	65.08	31.03
3	*2462.00	86.64 AV			1.69 H	116	55.61	31.03
4	2483.50	46.93 PK	74.00	-27.07	1.69 H	116	15.84	31.09
4	2483.50	37.46 AV	54.00	-16.54	1.69 H	116	6.37	31.09
5	2544.00	47.17 PK	74.00	-26.83	1.69 H	116	15.89	31.28
5	2544.00	37.70 AV	54.00	-16.30	1.69 H	116	6.42	31.28
6	4924.00	47.09 PK	74.00	-26.91	1.17 H	271	9.57	37.52

ANTENNA POLARITY & TEST DISTANCE: VERTICAL AT 3M								
No.	Freq. (MHz)	Emission Level (dBuV/m)	Limit (dBuV/m)	Margin (dB)	Antenna Height (m)	Table Angle (Degree)	Raw Value (dBuV)	Correction Factor (dB/m)
1	2088.00	45.22 PK	74.00	-28.78	1.32 V	213	16.16	29.06
1	2088.00	41.34 AV	54.00	-12.66	1.32 V	213	12.28	29.06
2	2400.00	56.99 PK	74.00	-17.01	1.24 V	117	26.62	30.37
2	2400.00	47.60 AV	54.00	-6.40	1.24 V	117	17.23	30.37
3	*2462.00	106.19 PK			1.24 V	117	75.60	30.59
3	*2462.00	96.80 AV			1.24 V	117	66.21	30.59
4	2483.50	57.01 PK	74.00	-16.99	1.24 V	117	26.34	30.67
4	2483.50	47.62 AV	54.00	-6.38	1.24 V	117	16.95	30.67
5	2544.00	57.25 PK	74.00	-16.75	1.24 V	117	26.53	30.72
5	2544.00	47.86 AV	54.00	-6.14	1.24 V	117	17.14	30.72
6	4924.00	47.25 PK	74.00	-26.75	1.06 V	170	11.26	35.99

- REMARKS:**
1. Emission level(dBuV/m)=Raw Value(dBuV) + Correction Factor(dB)
 2. Correction Factor(dB/m) = Antenna Factor (dB/m) + Cable Factor (dB)
 3. The other emission levels were very low against the limit.
 4. Margin value = Emission level – Limit value.
 5. “ * “ : Fundamental frequency.



4.3 6dB BANDWIDTH MEASUREMENT

4.3.1 LIMITS OF 6dB BANDWIDTH MEASUREMENT

The minimum of 6dB Bandwidth Measurement is 0.5 MHz.

4.3.2 TEST INSTRUMENTS

Description & Manufacturer	Model No.	Serial No.	Calibrated Until
SPECTRUM ANALYZER	FSEK30	100049	Aug. 12, 2004

NOTE: The calibration interval of the above test instruments is 12 months and the calibrations are traceable to NML/ROC and NIST/USA.

4.3.3 TEST PROCEDURE

The transmitter output was connected to the spectrum analyzer through an attenuator. The bandwidth of the fundamental frequency was measured by spectrum analyzer with 100 kHz RBW and 100kHz VBW. The 6dB bandwidth is defined as the total spectrum the power of which is higher than peak power minus 6dB.

4.3.4 DEVIATION FROM TEST STANDARD

No deviation

4.3.5 TEST SETUP

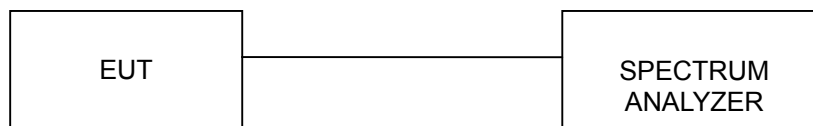

For the actual test configuration, please refer to the related Item – Photographs of the Test Configuration.

4.3.6 EUT OPERATING CONDITIONS

The software provided by client to enable the EUT under transmission condition continuously at lowest, middle and highest channel frequencies individually.



4.3.7 TEST RESULTS (A)

EUT	Wireless-G PCI Adapter	MODEL	WMP54Gv4
INPUT POWER (SYSTEM)	120Vac, 60 Hz	ENVIRONMENTAL CONDITIONS	22deg. C, 62%RH, 991hPa
TESTED BY:	Steven Lu		

CHANNEL	CHANNEL FREQUENCY (MHz)	6dB BANDWIDTH (MHz)	MINIMUM LIMIT (MHz)	PASS/FAIL
1	2412	11.76	0.5	PASS
6	2437	11.96	0.5	PASS
11	2462	11.80	0.5	PASS



CH1

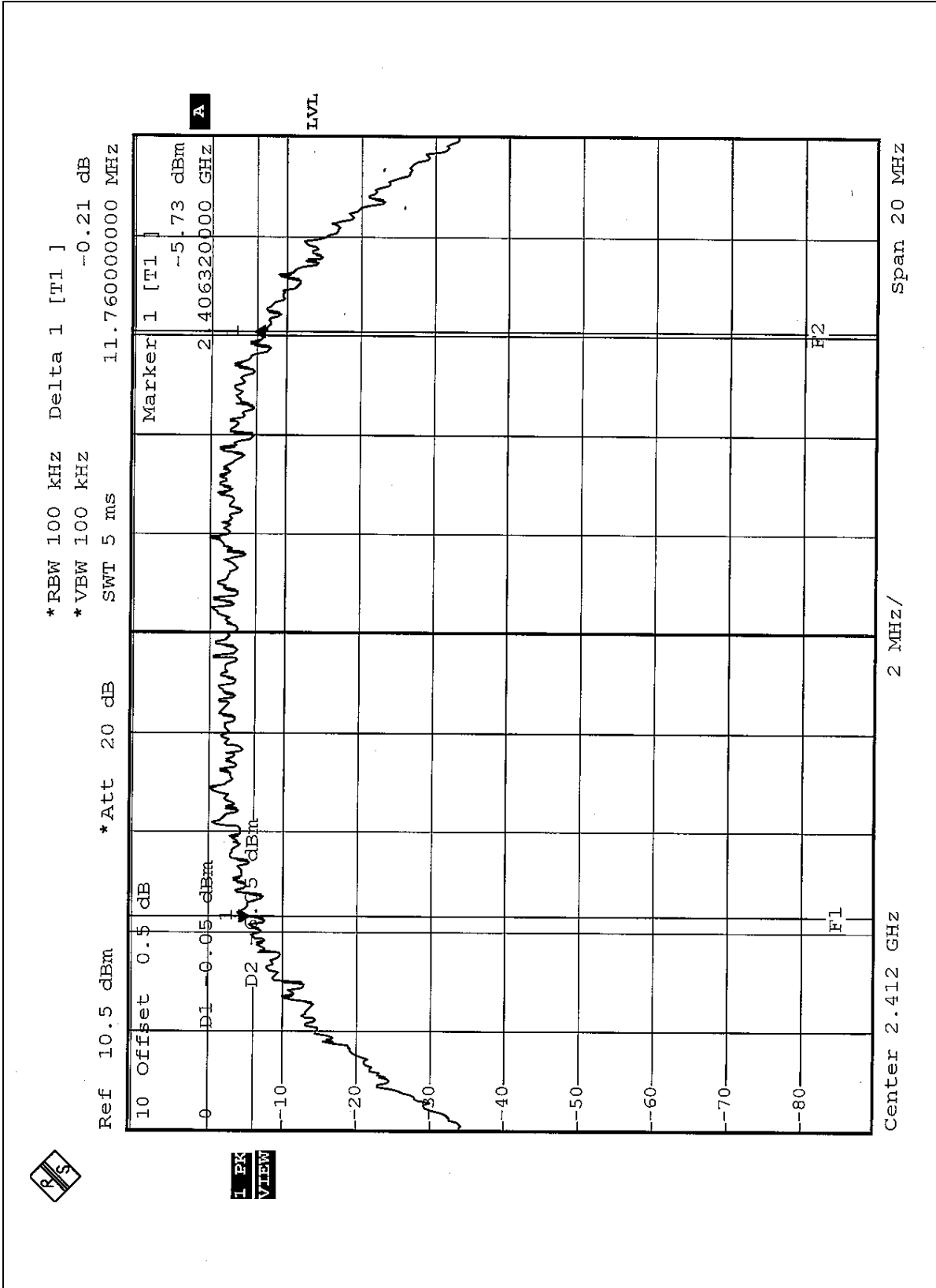



CH6

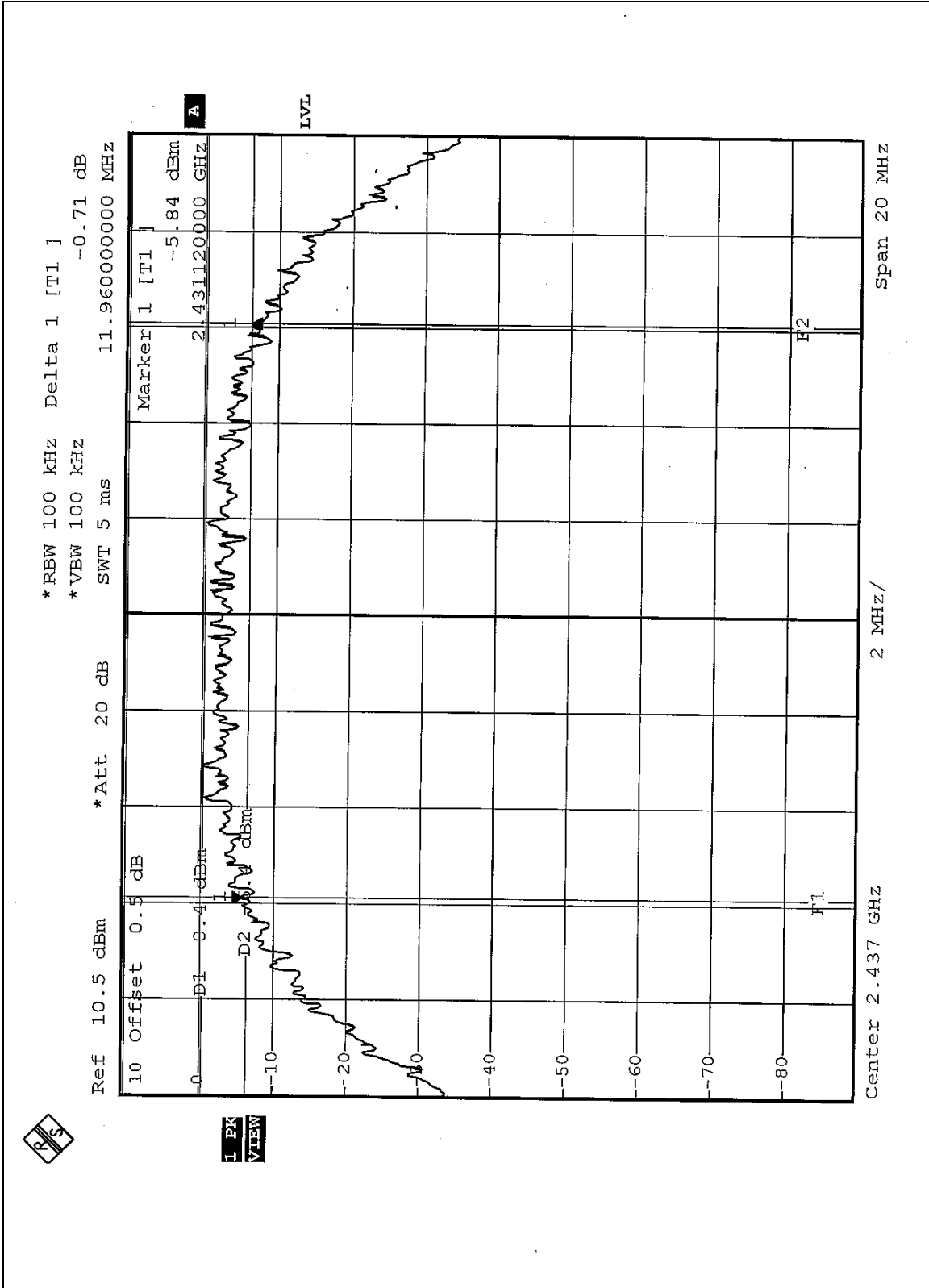



CH11

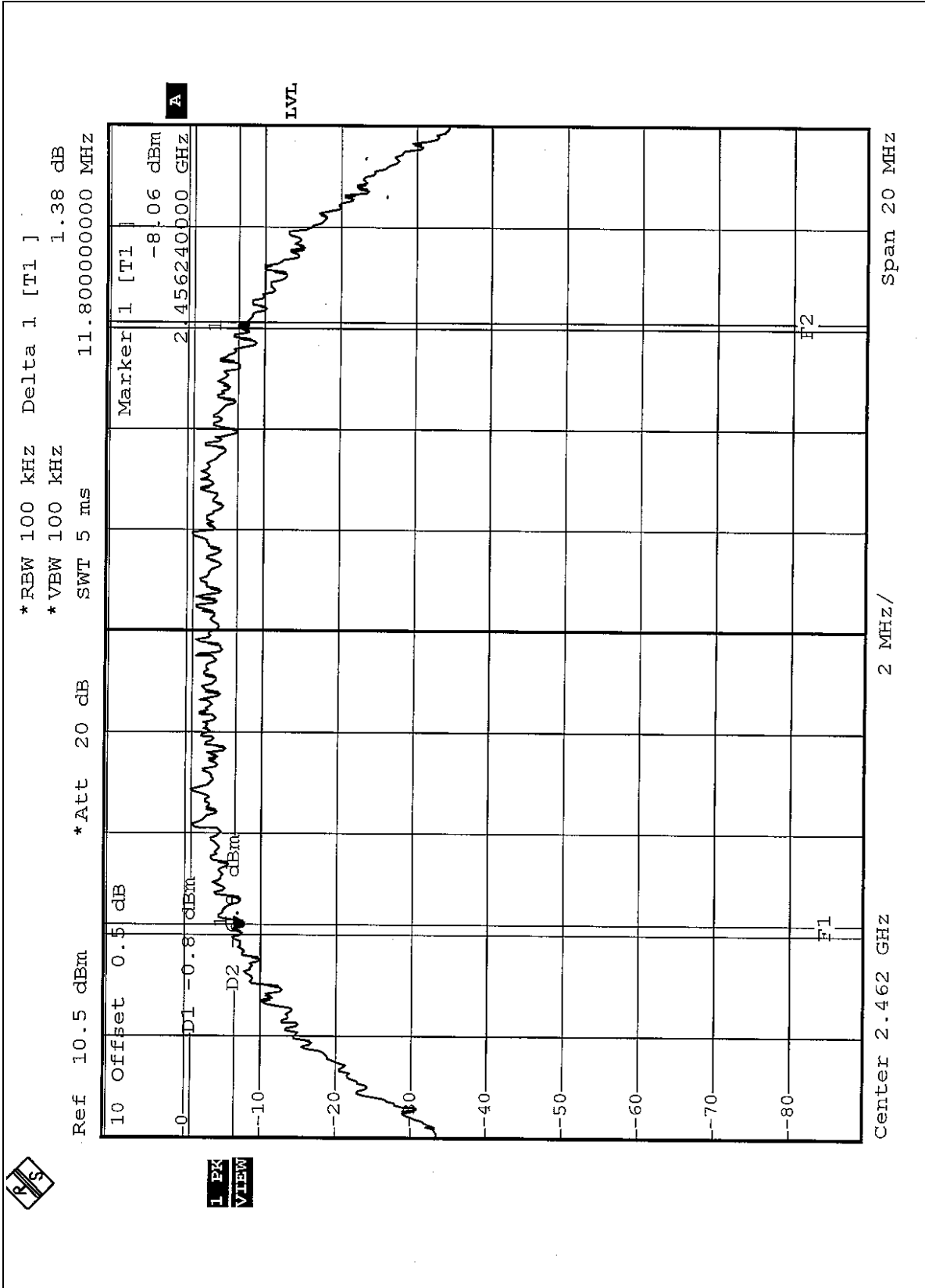



4.3.8 TEST RESULTS (B)

EUT	Wireless-G PCI Adapter	MODEL	WMP54Gv4
INPUT POWER (SYSTEM)	120Vac, 60 Hz	ENVIRONMENTAL CONDITIONS	22deg. C, 62%RH, 991hPa
TESTED BY:	Steven Lu		

CHANNEL	CHANNEL FREQUENCY (MHz)	6dB BANDWIDTH (MHz)	MINIMUM LIMIT (MHz)	PASS/FAIL
1	2412	16.60	0.5	PASS
6	2437	16.60	0.5	PASS
11	2462	16.64	0.5	PASS



CH1

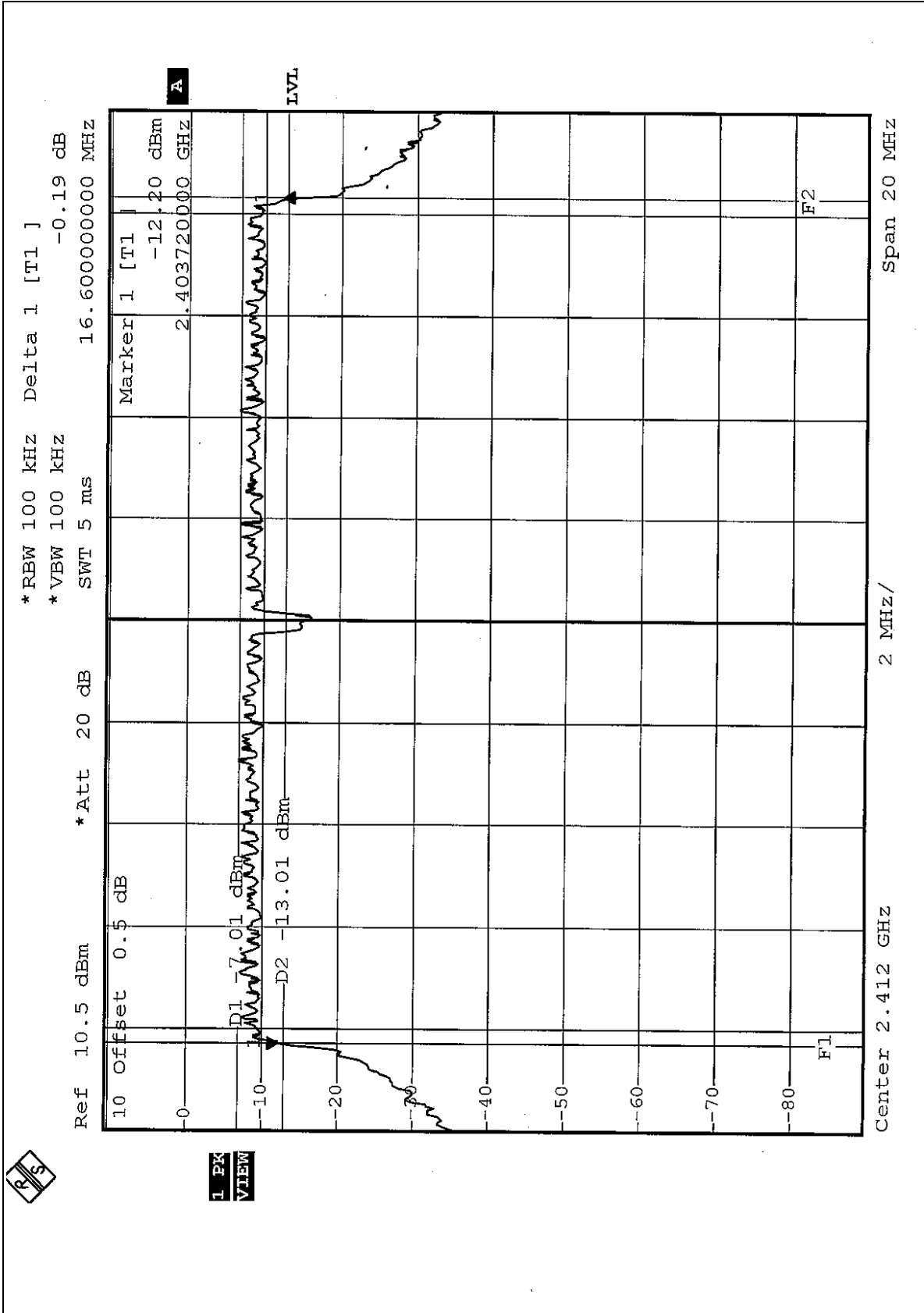



CH6

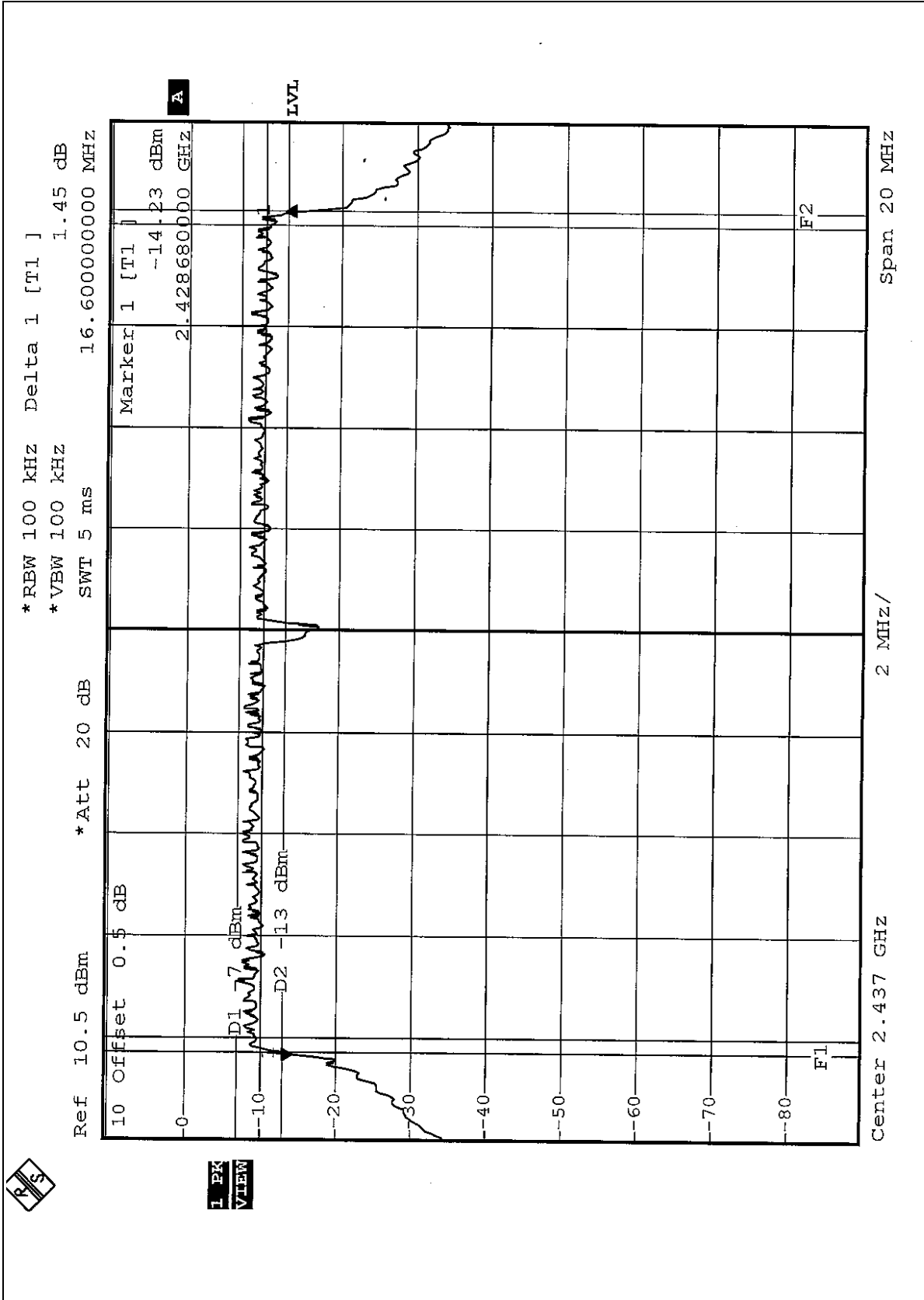



CH11

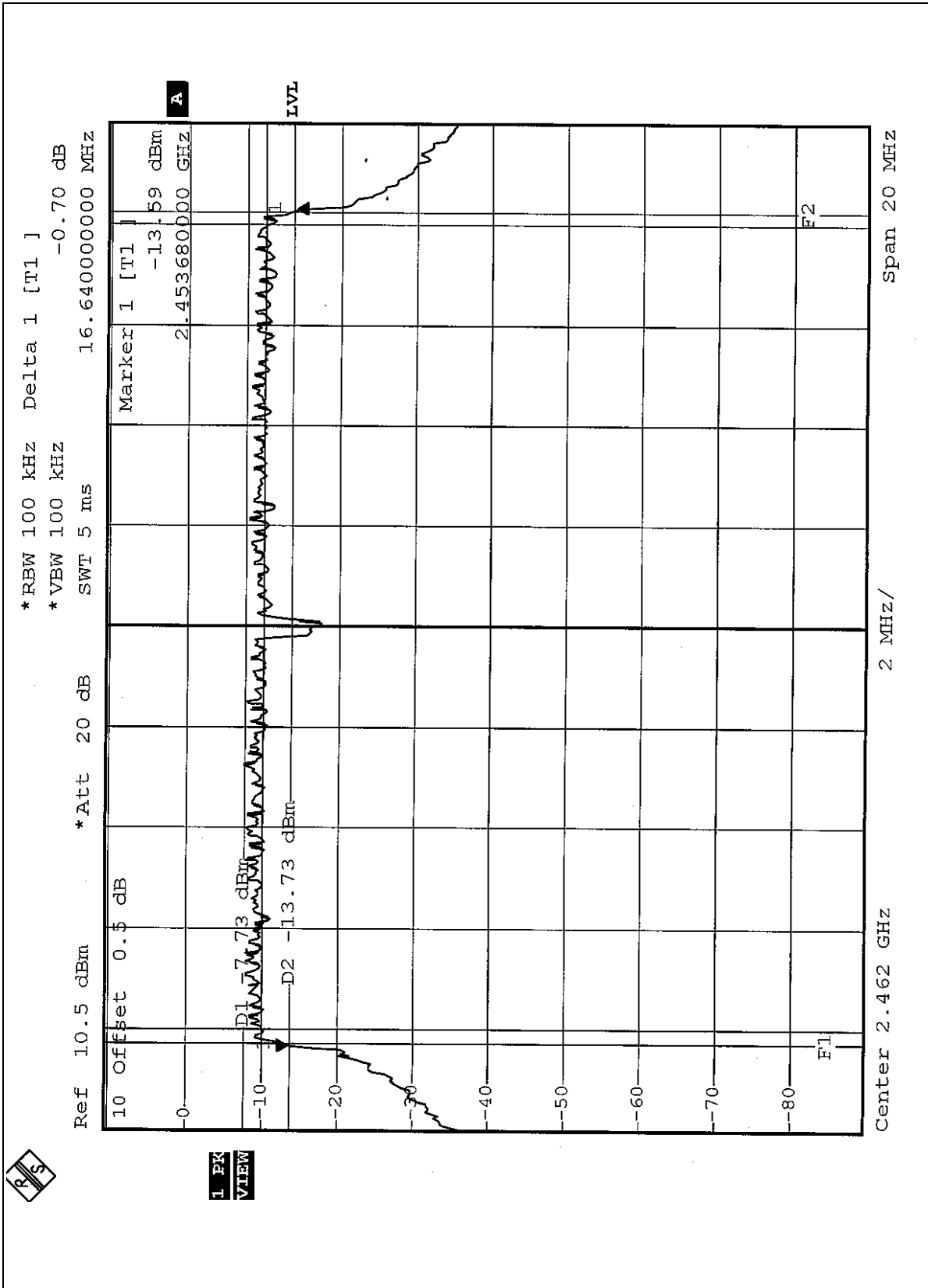



4.4 MAXIMUM PEAK OUTPUT POWER

4.4.1 LIMITS OF MAXIMUM PEAK OUTPUT POWER MEASUREMENT

The Maximum Peak Output Power Measurement is 30dBm.

4.4.2 TEST INSTRUMENTS

Description & Manufacturer	Model No.	Serial No.	Calibrated Until
R&S SPECTRUM ANALYZER	FSEK30	100049	Aug. 12, 2004
R&S SIGNAL GENERATOR	SMP04	100011	May 28, 2004
TEKTRONIX OSCILLOSCOPE	TDS 220	C019167	Feb. 01, 2005
NARDA DETECTOR	4503A	FSCM99899	NA

NOTE:

The calibration interval of the above test instruments is 12 months and the calibrations are traceable to NML/ROC and NIST/USA.

4.4.3 TEST PROCEDURES

1. A detector was used on the output port of the EUT. An oscilloscope was used to peak the response of the detector.
2. Replaced the EUT by the signal generator . The center frequency of the S.G was adjusted to the center frequency of the measured channel.
3. Adjusted the power to have the same peak reading on oscilloscope. Record the power level.

4.4.4 DEVIATION FROM TEST STANDARD

No deviation

4.4.5 TEST SETUP



4.4.6 EUT OPERATING CONDITIONS

Same as Item 4.3.6



4.4.7 TEST RESULTS (A)

EUT	Wireless-G PCI Adapter	MODEL	WMP54Gv4
INPUT POWER (SYSTEM)	120Vac, 60 Hz	ENVIRONMENTAL CONDITIONS	23deg. C, 67%RH, 991hPa
TESTED BY:	Steven Lu		

CHANNEL	CHANNEL FREQUENCY (MHz)	PEAK POWER OUTPUT (dBm)	PEAK POWER LIMIT (dBm)	PASS/FAIL
1	2412	12.99	30	PASS
6	2437	13.03	30	PASS
11	2462	12.88	30	PASS

4.4.8 TEST RESULTS (B)

EUT	Wireless-G PCI Adapter	MODEL	WMP54Gv4
INPUT POWER (SYSTEM)	120Vac, 60 Hz	ENVIRONMENTAL CONDITIONS	23deg. C, 67%RH, 991hPa
TESTED BY:	Steven Lu		

CHANNEL	CHANNEL FREQUENCY (MHz)	PEAK POWER OUTPUT (dBm)	PEAK POWER LIMIT (dBm)	PASS/FAIL
1	2412	12.81	30	PASS
6	2437	12.89	30	PASS
11	2462	12.89	30	PASS



4.5 POWER SPECTRAL DENSITY MEASUREMENT

4.5.1 LIMITS OF POWER SPECTRAL DENSITY MEASUREMENT

The Maximum of Power Spectral Density Measurement is 8dBm.

4.5.2 TEST INSTRUMENTS

Description & Manufacturer	Model No.	Serial No.	Calibrated Until
SPECTRUM ANALYZER	FSEK30	100049	Aug. 12, 2004

NOTE: The calibration interval of the above test instruments is 12 months and the calibrations are traceable to NML/ROC and NIST/USA.

4.5.3 TEST PROCEDURE

The transmitter output was connected to the spectrum analyzer through an attenuator, the bandwidth of the fundamental frequency was measured with the spectrum analyzer using 3kHz RBW and 30kHz VBW, set sweep time=span/3kHz. The power spectral density was measured and recorded. The sweep time is allowed to be longer than span/3kHz for a full response of the mixer in the spectrum analyzer.

4.5.4 DEVIATION FROM TEST STANDARD

No deviation

4.5.5 TEST SETUP

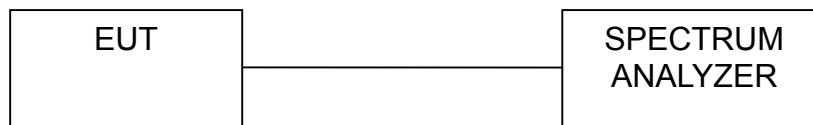

4.5.6 EUT OPERATING CONDITIONS

Same as 4.3.6



4.5.7 TEST RESULTS (A)

EUT	Wireless-G PCI Adapter	MODEL	WMP54Gv4
INPUT POWER (SYSTEM)	120Vac, 60 Hz	ENVIRONMENTAL CONDITIONS	22deg. C, 62%RH, 991hPa
TESTED BY:	Steven Lu		

CHANNEL	CHANNEL FREQUENCY (MHz)	RF POWER LEVEL IN 3 kHz BW (dBm)	MAXIMUM LIMIT (dBm)	PASS/FAIL
1	2412	-14.39	8	PASS
6	2437	-13.93	8	PASS
11	2462	-14.37	8	PASS



CH1

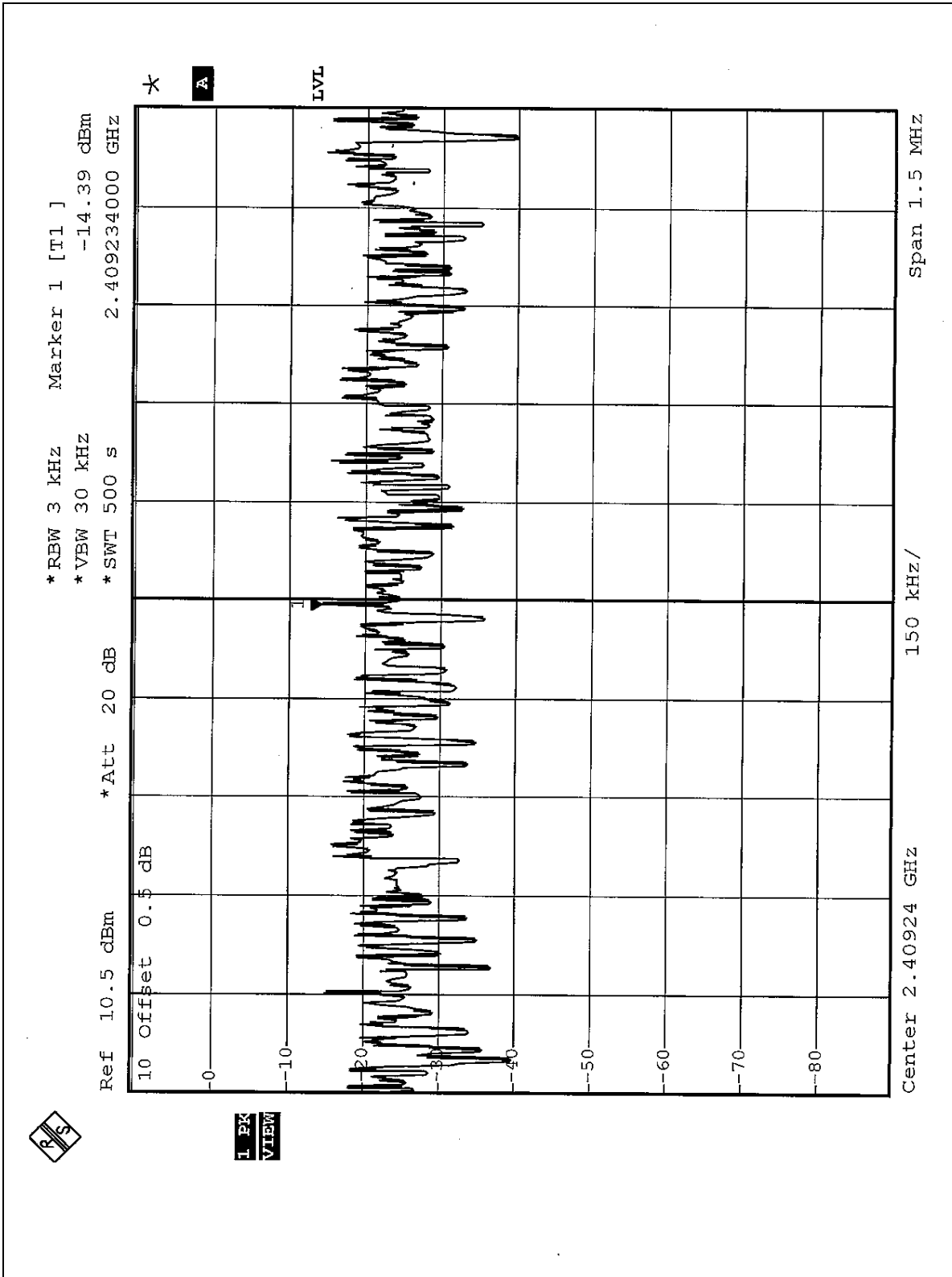



CH6

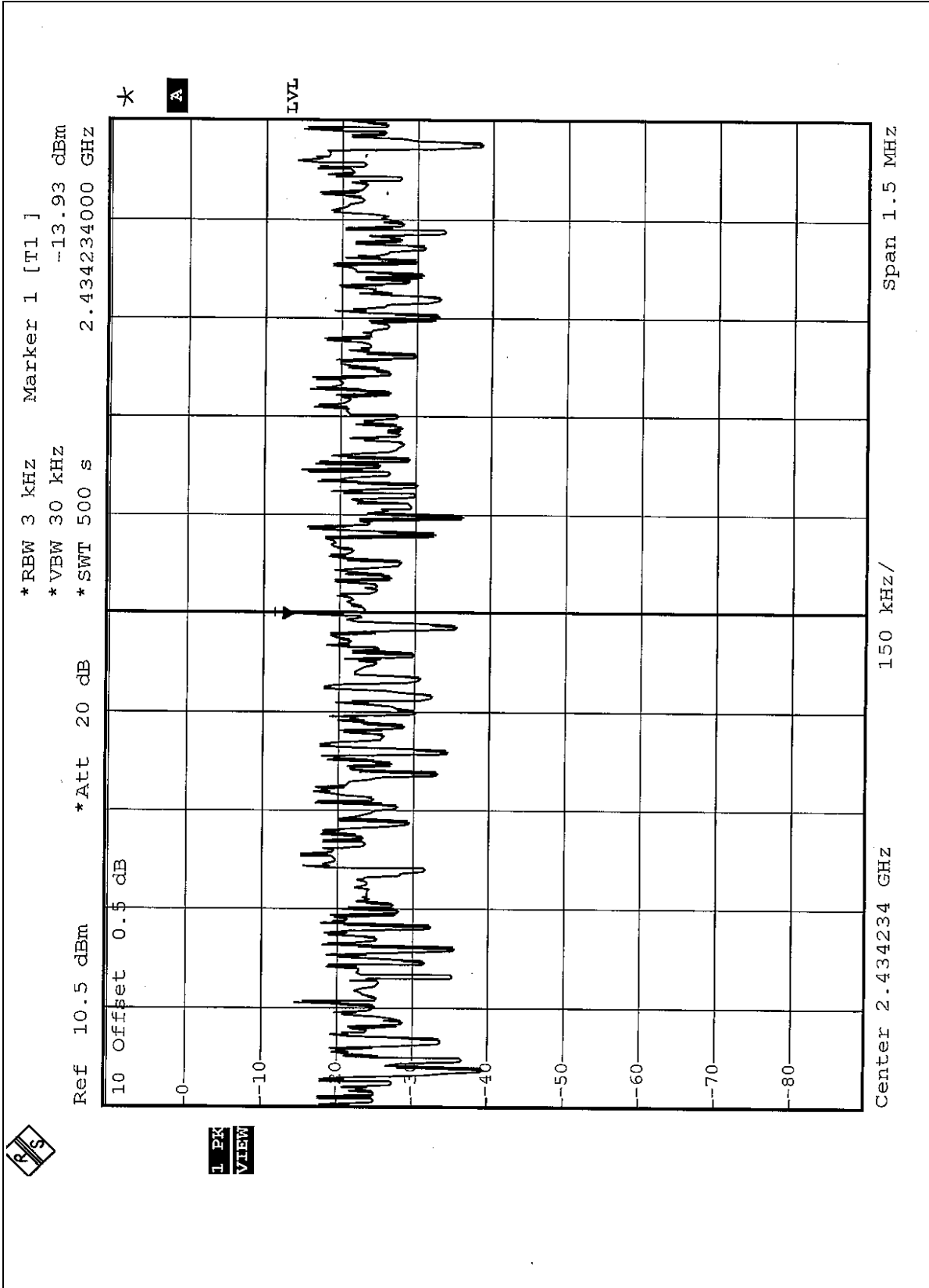



CH11

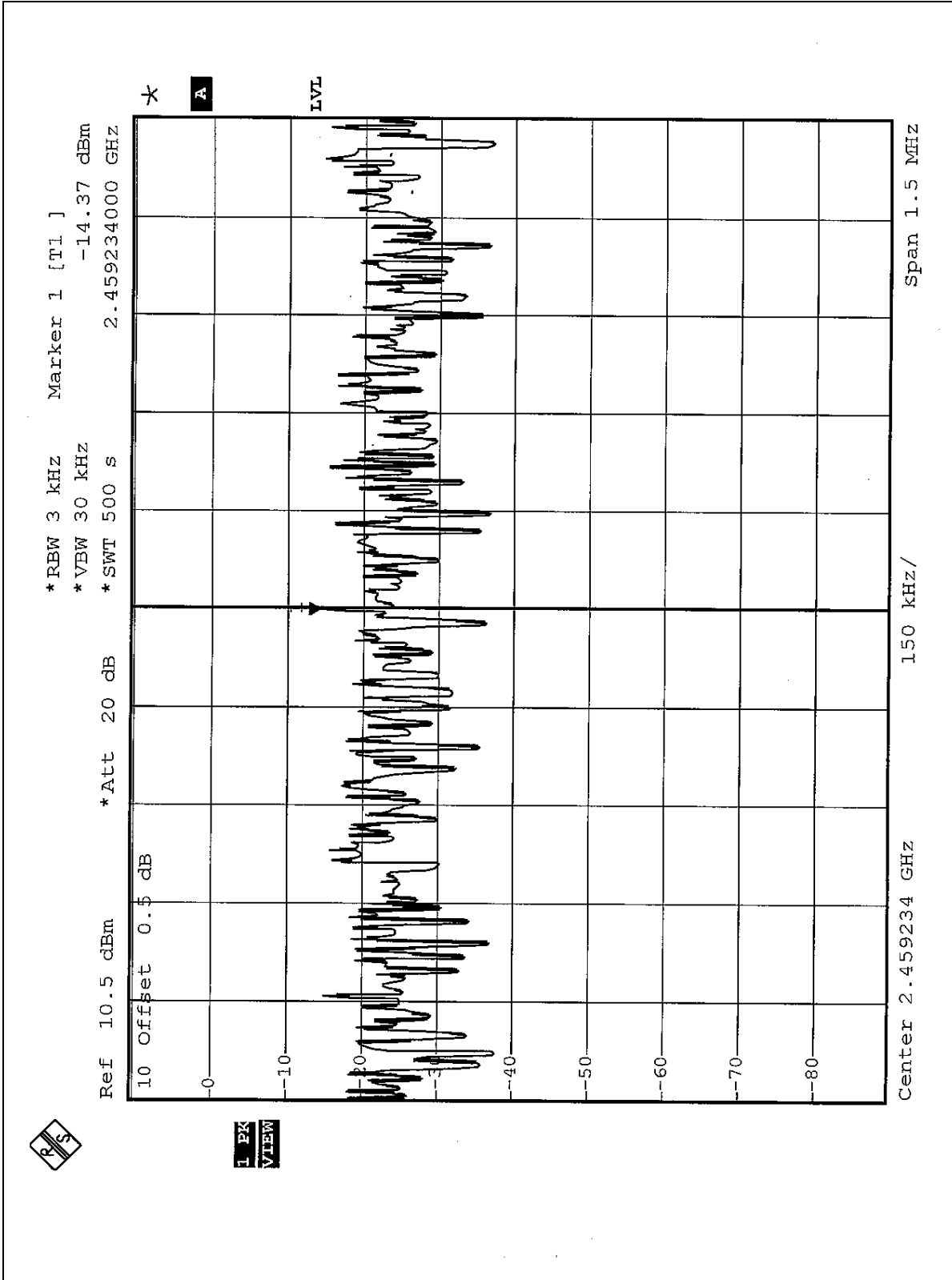



4.5.8 TEST RESULTS (B)

EUT	Wireless-G PCI Adapter	MODEL	WMP54Gv4
INPUT POWER (SYSTEM)	120Vac, 60 Hz	ENVIRONMENTAL CONDITIONS	22deg. C, 62%RH, 991hPa
TESTED BY:	Steven Lu		

CHANNEL	CHANNEL FREQUENCY (MHz)	RF POWER LEVEL IN 3 kHz BW (dBm)	MAXIMUM LIMIT (dBm)	PASS/FAIL
1	2412	-21.07	8	PASS
6	2437	-21.71	8	PASS
11	2462	-21.97	8	PASS



CH1

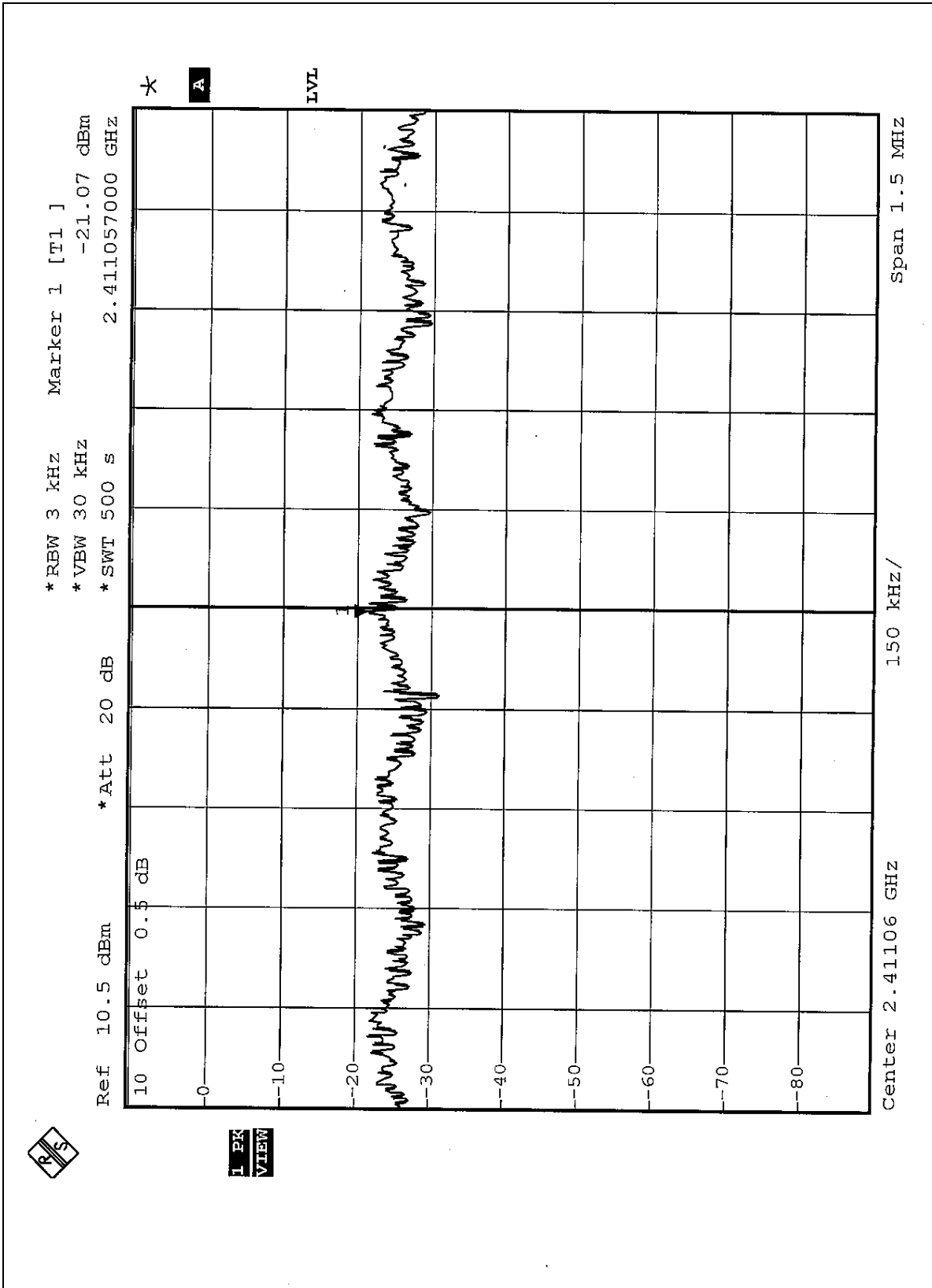



CH6

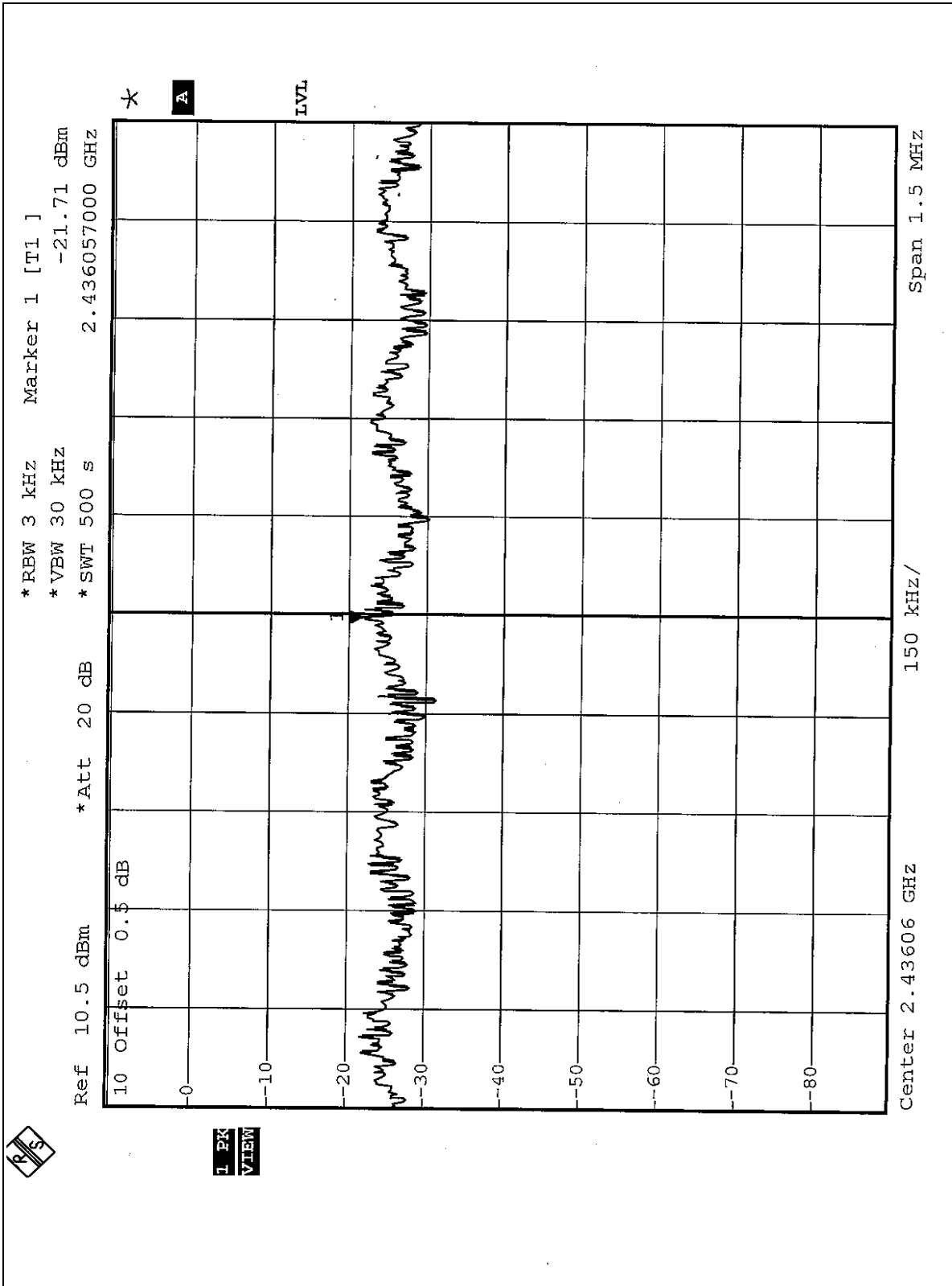



CH11

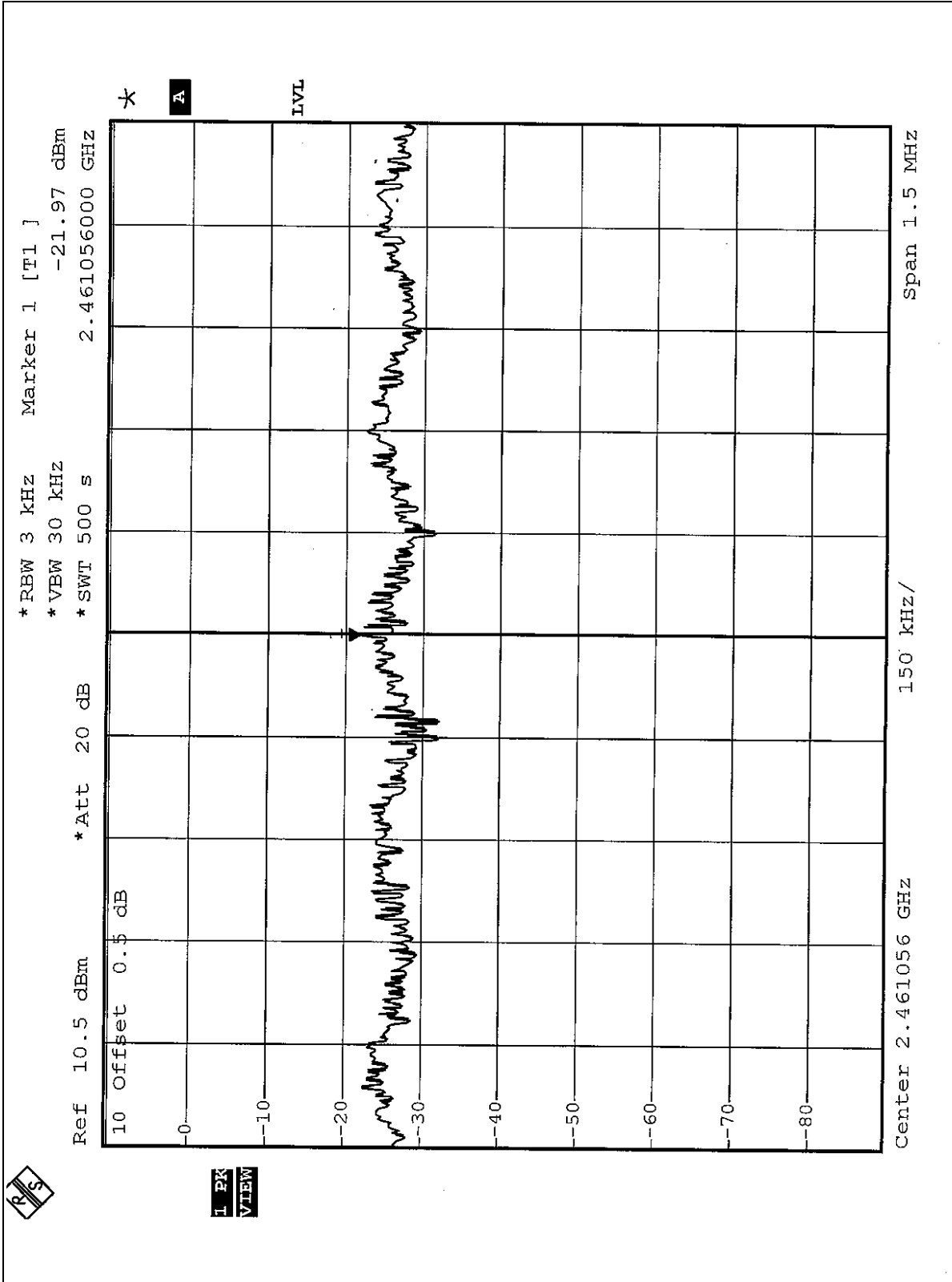



4.6 BAND EDGES MEASUREMENT

4.6.1 LIMITS OF BAND EDGES MEASUREMENT

Below -20dB of the highest emission level of operating band (in 100kHz Resolution Bandwidth).

4.6.2 TEST INSTRUMENTS

Description & Manufacturer	Model No.	Serial No.	Calibrated Until
SPECTRUM ANALYZER	FSEK30	100049	Aug. 12, 2004

NOTE: The calibration interval of the above test instruments is 12 months and the calibrations are traceable to NML/ROC and NIST/USA.

4.6.3 TEST PROCEDURE

The transmitter output was connected to the spectrum analyzer via a low lose cable. Set both RBW and VBW of spectrum analyzer to 100kHz with suitable frequency span including 100MHz bandwidth from band edge. The band edges was measured and recorded.

4.6.4 DEVIATION FROM TEST STANDARD

No deviation



4.6.5 EUT OPERATING CONDITION

Same as Item 4.3.6

4.6.6 TEST RESULTS (A)

The spectrum plots are attached on the following 4 pages. D2 line indicates the highest level, D1 line indicates the 20dB offset below D2. It shows compliance with the requirement in part 15.247(C).

NOTE 1:

The band edge emission plot of CCK technique on the following 1-2 pages shows 55.60lta between carrier maximum power and local maximum emission in restrict band (2.3706GHz). The emission of carrier strength list in the test result of channel 1 at the item 4.2.8 is 103.29dBuV/m, so the maximum field strength in restrict band is $103.29-55.60=47.69$ dBuV/m which is under 54dBuV/m limit.

NOTE 2:

The band edge emission plot of CCK technique on the following 3-4 pages shows 55.37dB delta between carrier maximum power and local maximum emission in restrict band (2.4835GHz). The emission of carrier strength list in the test result of channel 11 at the item 4.2.8 is 104.84dBuV/m, so the maximum field strength in restrict band is $104.84-55.37=49.47$ dBuV/m which is under 54dBuV/m limit.

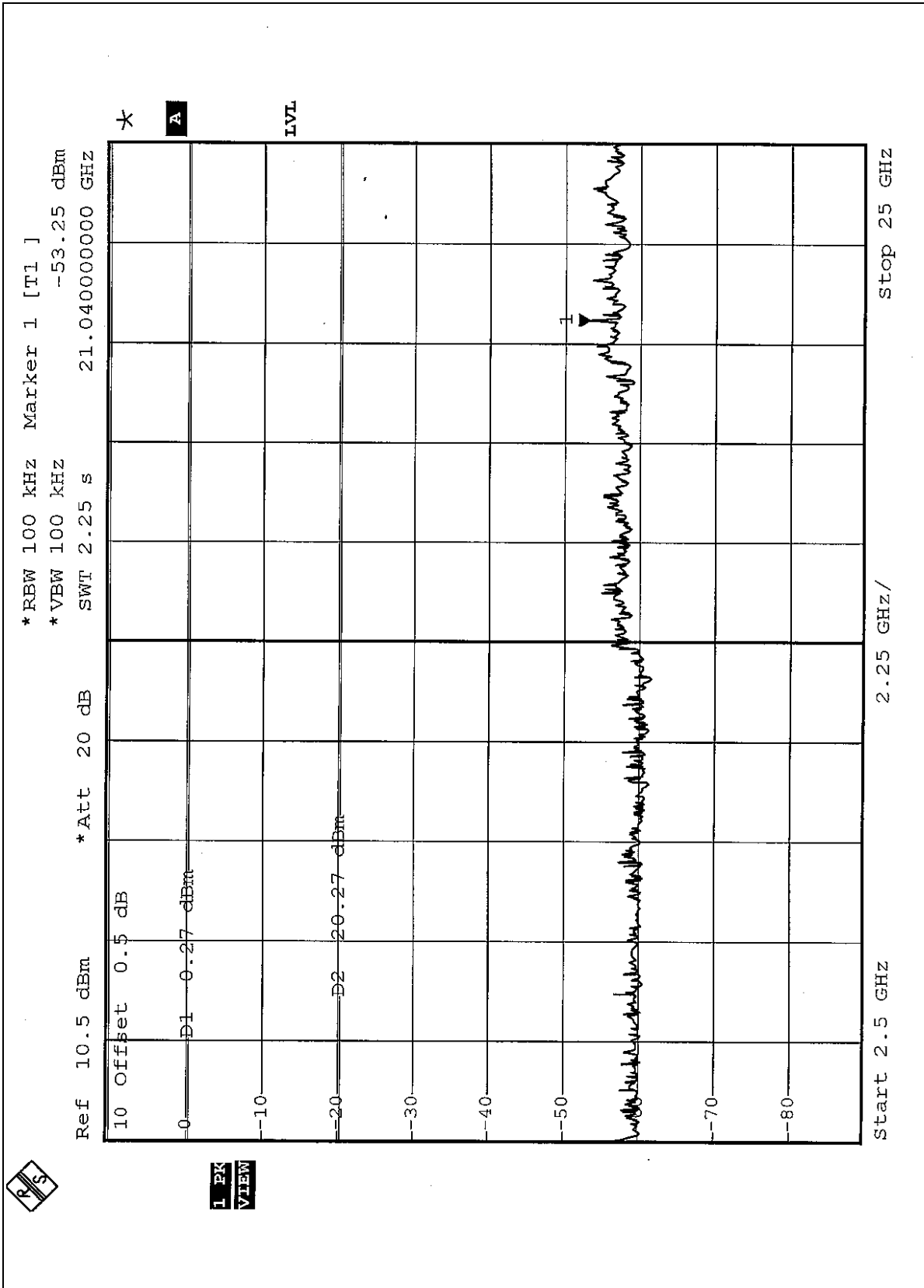

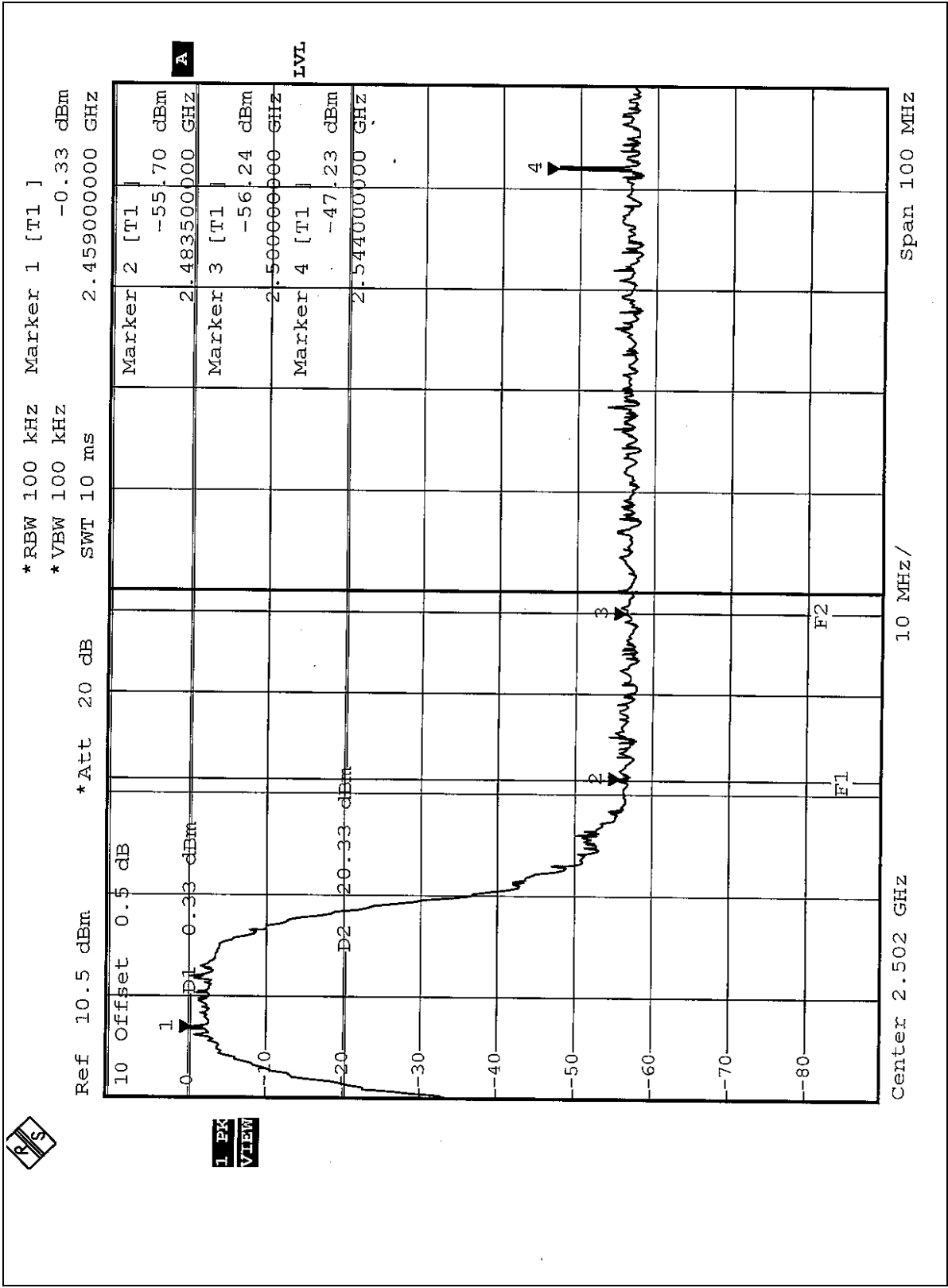

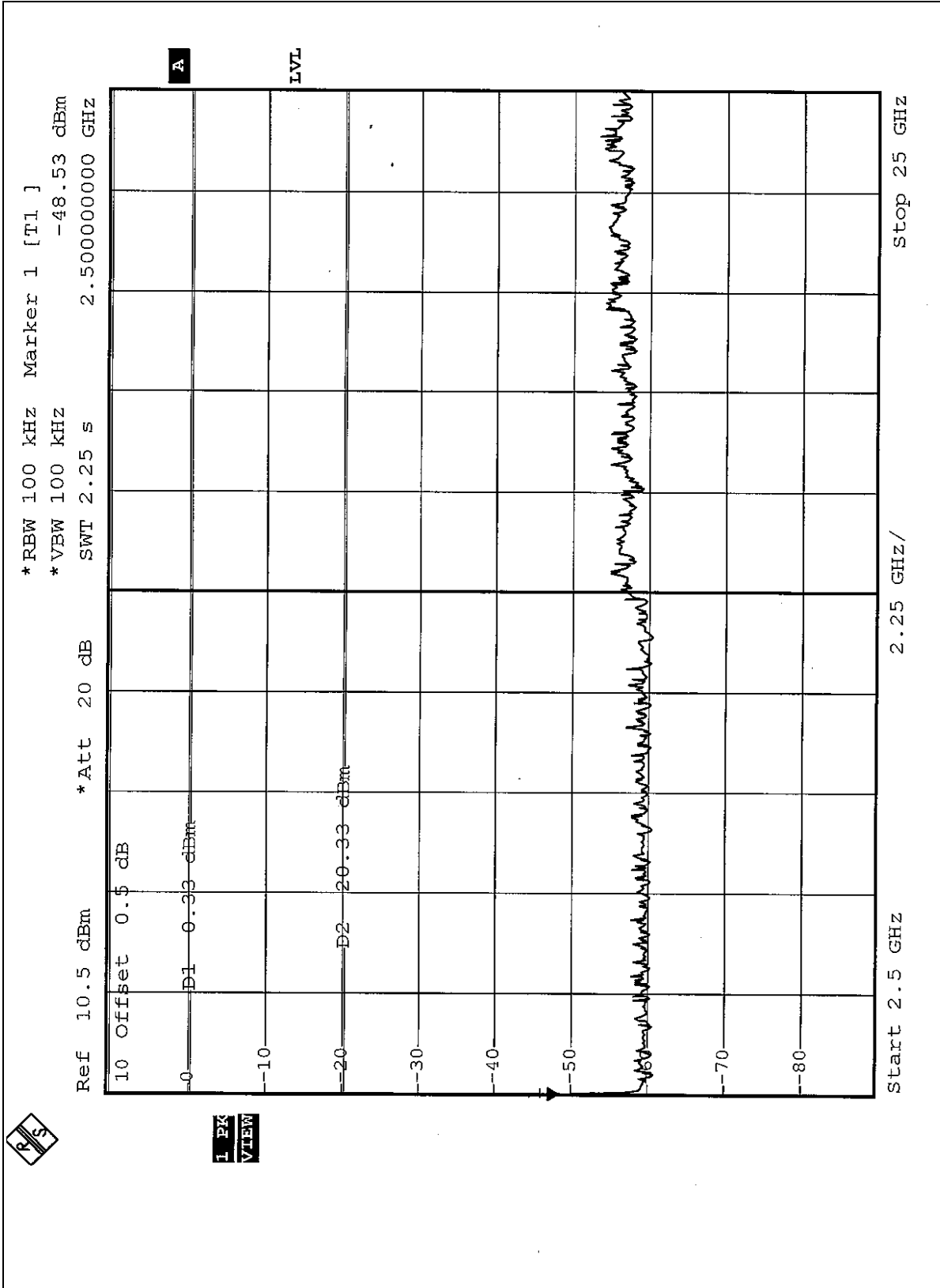



4.6.7 TEST RESULTS (B)

The spectrum plots are attached on the following 4 pages. D2 line indicates the highest level, D1 line indicates the 20dB offset below D2. It shows compliance with the requirement in part 15.247(C).

NOTE 1:

The band edge emission plot of OFDM technique on the following 1-2 pages shows 49.68dB delta between carrier maximum power and local maximum emission in restrict band (2.3884GHz). The emission of carrier strength list in the test result of channel 1 at the item 4.2.9 is 98.55dBuV/m, so the maximum field strength in restrict band is $98.55 - 49.68 = 48.87$ dBuV/m which is under 54dBuV/m limit.

NOTE 2:

The band edge emission plot of OFDM technique on the following 3-4 pages shows 47.33dB delta between carrier maximum power and local maximum emission in restrict band (2.4881GHz). The emission of carrier strength list in the test result of channel 11 at the item 4.2.9 is 96.80dBuV/m, so the maximum field strength in restrict band is $96.80 - 47.33 = 49.47$ dBuV/m which is under 54dBuV/m limit.

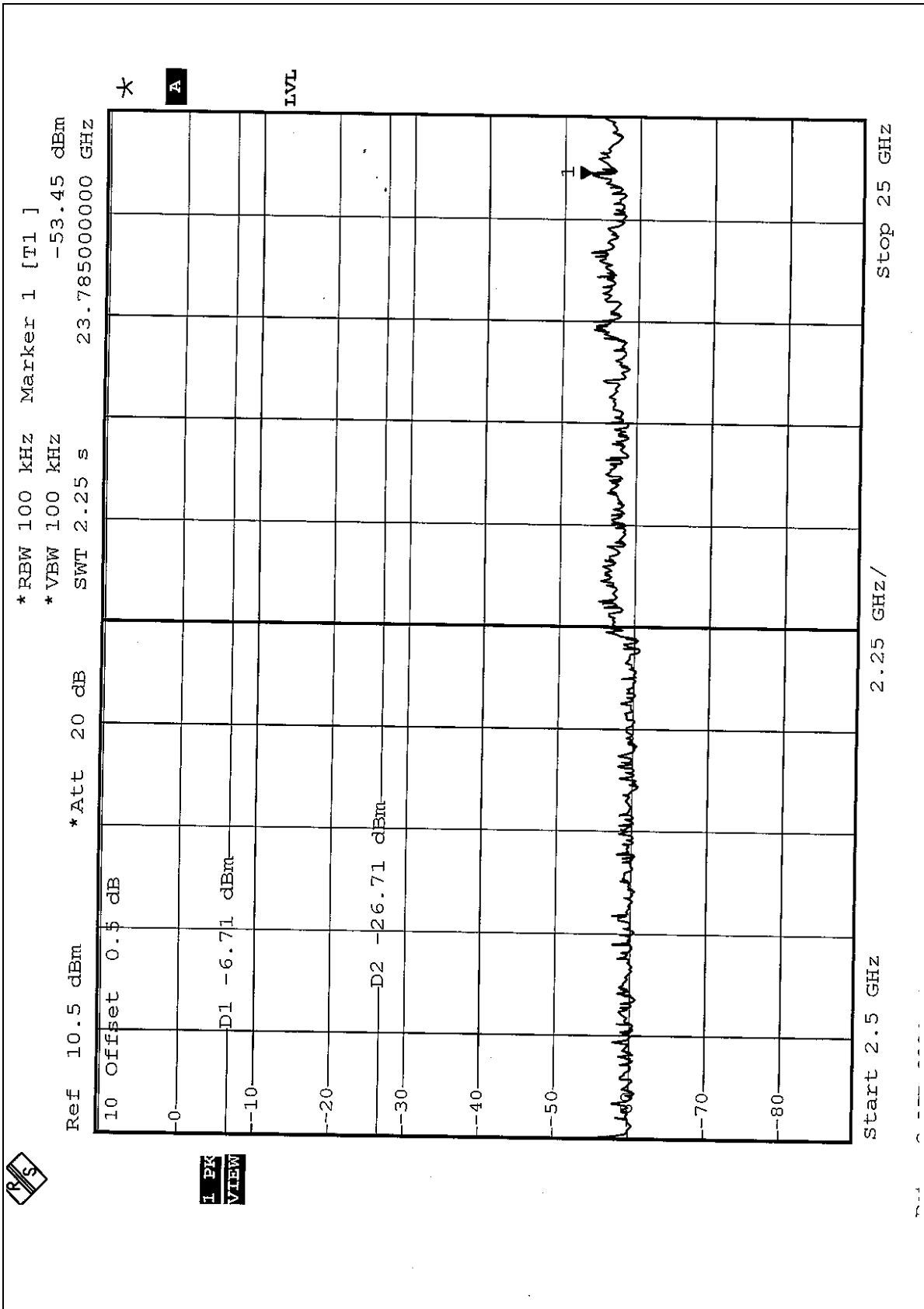

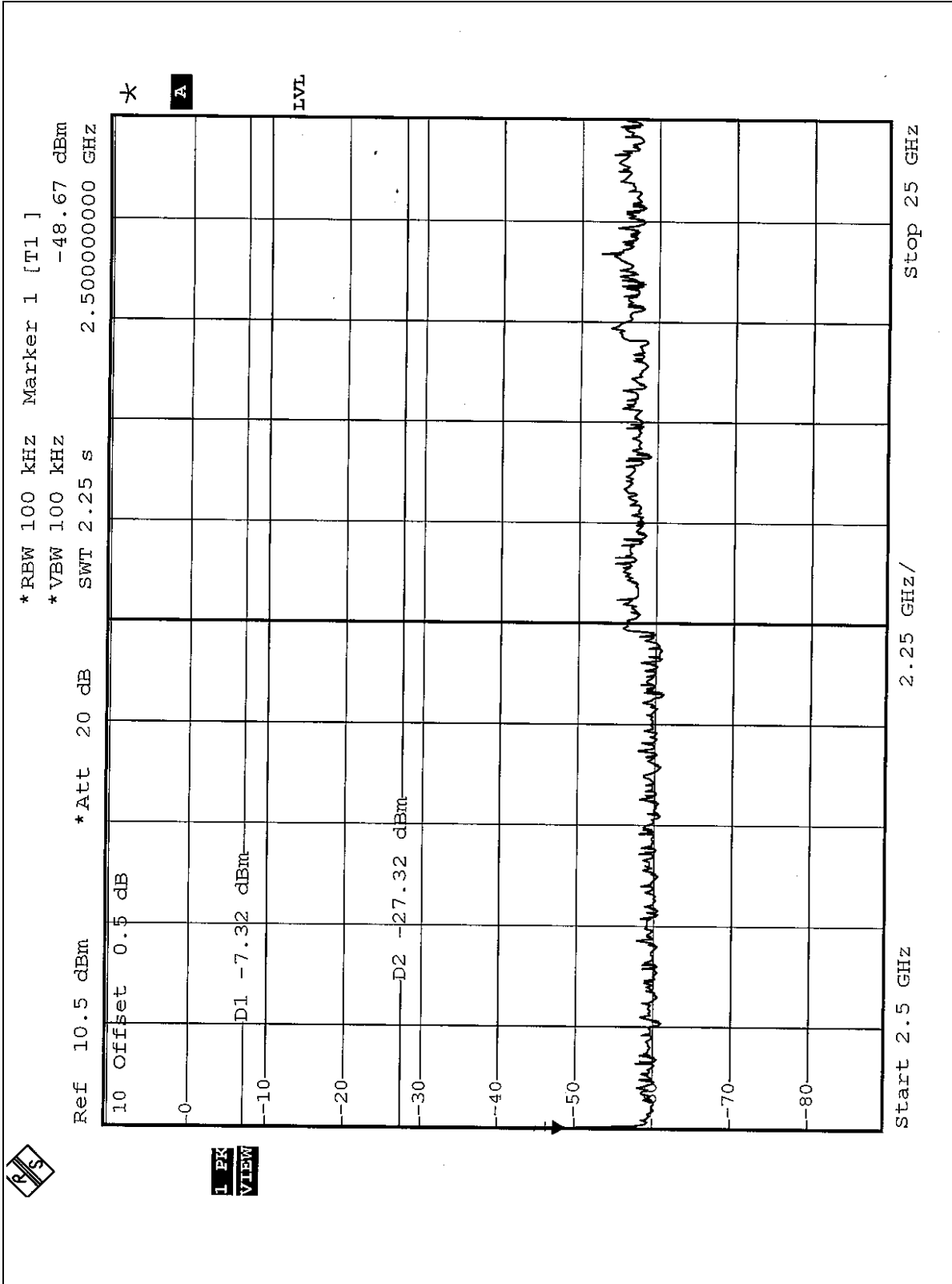



4.7 ANTENNA REQUIREMENT

4.7.1 STANDARD APPLICABLE

For intentional device, according to FCC 47 CFR Section 15.203, an intentional radiator shall be designed to ensure that no antenna other than that furnished by the responsible party shall be used with the device.

And according to FCC 47 CFR Section 15.247 (b), if transmitting antennas of directional gain greater than 6dBi are used, the power shall be reduced by the amount in dB that the directional gain of the antenna exceeds 6dBi.

4.7.2 ANTENNA CONNECTED CONSTRUCTION

The antenna type used in this product is Dipole antenna with reversed SMA antenna connector. The maximum Gain of this antenna is only 5.0dBi.

5 PHOTOGRAPHS OF THE TEST CONFIGURATION

CONDUCTED EMISSION TEST



RADIATED EMISSION TEST





6 INFORMATION ON THE TESTING LABORATORIES

We, ADT Corp., were founded in 1988 to provide our best service in EMC, Radio, Telecom and Safety consultation. Our laboratories are accredited and approved by the following approval agencies according to ISO/IEC 17025, Guide 25 or EN 45001:

USA	FCC, NVLAP, UL
Germany	TUV Rheinland
Japan	VCCI
Norway	NEMKO
Canada	INDUSTRY CANADA , CSA
R.O.C.	CNLA, BSMI, DGT
Netherlands	Telefication
Singapore	PSB , GOST-ASIA(MOU)
Russia	CERTIS(MOU)

Copies of accreditation certificates of our laboratories obtained from approval agencies can be downloaded from our web site:

www.adt.com.tw/index.5/phtml. If you have any comments, please feel free to contact us at the following:

Linko EMC/RF Lab:

Tel: 886-2-26052180

Fax: 886-2-26052943

Hsin Chu EMC/RF Lab:

Tel: 886-3-5935343

Fax: 886-3-5935342

Hwa Ya EMC/RF/Safety Lab:

Tel: 886-3-3183232

Fax: 886-3-3185050

Linko RF & Telecom Lab.

Tel: 886-3-3270910

Fax: 886-3-3270892

Email: service@mail.adt.com.tw

Web Site: www.adt.com.tw

The address and road map of all our labs can be found in our web site also.