



FCC TEST REPORT

REPORT NO.: RF930901L11
MODEL NO.: WMCE54AG
RECEIVED: Sep. 01, 2004
TESTED: Sep. 02 ~ Sep 15, 2004

APPLICANT: Cisco-Linksys, LLC
ADDRESS: 121 Theory Drive Irvine, CA 92612, USA

ISSUED BY: Advance Data Technology Corporation
LAB ADDRESS: No. 47, 14th Lin, Chiapau Tsun, Linko Hsiang, Taipei Hsien, Taiwan, R.O.C.
LAB LOCATION: No. 19, Hwa Ya 2nd Rd., Wen Hwa Tsuen, Kwei Shan Hsiang, Taoyuan Hsien 333, Taiwan, R.O.C.

This test report consists of 192 pages in total. It may be duplicated completely for legal use with the approval of the applicant. It should not be reproduced except in full, without the written approval of our laboratory. The client should not use it to claim product endorsement by CNLA, A2LA or any government agencies. The test results in the report only apply to the tested sample.



No. 2177-01



0528
ILAC MRA



Table of Contents

1.	CERTIFICATION	6
2.	SUMMARY OF TEST RESULTS	7
2.1	MEASUREMENT UNCERTAINTY	9
3.	GENERAL INFORMATION.....	10
3.1	GENERAL DESCRIPTION OF EUT	10
3.2	DESCRIPTION OF TEST MODES	11
3.3	GENERAL DESCRIPTION OF APPLIED STANDARDS	12
3.4	DESCRIPTION OF SUPPORT UNITS	13
3.5	CONFIGURATION OF SYSTEM UNDER TEST	13
4.	TEST TYPES AND RESULTS (FOR PART 802.11b & 802.11g)	14
4.1	CONDUCTED EMISSION MEASUREMENT	14
4.1.1	LIMITS OF CONDUCTED EMISSION MEASUREMENT.....	14
4.1.2	TEST INSTRUMENTS.....	14
4.1.3	TEST PROCEDURES	15
4.1.4	DEVIATION FROM TEST STANDARD	15
4.1.5	TEST SETUP	16
4.1.6	EUT OPERATING CONDITIONS	16
4.1.7	TEST RESULTS	17
4.2	RADIATED EMISSION MEASUREMENT	23
4.2.1	LIMITS OF RADIATED EMISSION MEASUREMENT.....	23
4.2.2	TEST INSTRUMENTS.....	24
4.2.3	TEST PROCEDURES	25
4.2.4	DEVIATION FROM TEST STANDARD	25
4.2.5	TEST SETUP	26
4.2.6	EUT OPERATING CONDITIONS	26
4.2.7	TEST RESULTS	27
4.3	6dB BANDWIDTH MEASUREMENT	36
4.3.1	LIMITS OF 6dB BANDWIDTH MEASUREMENT	36
4.3.2	TEST INSTRUMENTS.....	36
4.3.3	TEST PROCEDURE.....	37
4.3.4	DEVIATION FROM TEST STANDARD	37
4.3.5	TEST SETUP	37
4.3.6	EUT OPERATING CONDITIONS	37
4.3.7	TEST RESULTS	38
4.4	MAXIMUM PEAK OUTPUT POWER	48
4.4.1	LIMITS OF MAXIMUM PEAK OUTPUT POWER MEASUREMENT	48
4.4.2	INSTRUMENTS.....	48
4.4.1	TEST PROCEDURES	49
4.4.2	DEVIATION FROM TEST STANDARD	49
4.4.3	TEST SETUP	49
4.4.4	EUT OPERATING CONDITIONS	49
4.4.3	TEST RESULTS	50



4.5	POWER SPECTRAL DENSITY MEASUREMENT	51
4.5.1	LIMITS OF POWER SPECTRAL DENSITY MEASUREMENT	51
4.5.2	TEST INSTRUMENTS.....	51
4.5.3	TEST PROCEDURE.....	52
4.5.4	DEVIATION FROM TEST STANDARD	52
4.5.5	TEST SETUP	52
4.5.6	EUT OPERATING CONDITION	52
4.5.7	TEST RESULTS	53
4.6	BAND EDGES MEASUREMENT	63
4.6.1	LIMITS OF BAND EDGES MEASUREMENT	63
4.6.2	TEST INSTRUMENTS.....	63
4.6.3	TEST PROCEDURE.....	63
4.6.4	DEVIATION FROM TEST STANDARD	63
4.6.5	EUT OPERATING CONDITION	63
4.6.6	TEST RESULTS	64
4.7	ANTENNA REQUIREMENT	77
4.7.1	STANDARD APPLICABLE	77
4.7.2	ANTENNA CONNECTED CONSTRUCTION.....	77
5.	TEST TYPES AND RESULTS (FOR PART 802.11a)	78
5.1	CONDUCTED EMISSION MEASUREMENT	78
5.1.1	LIMITS OF CONDUCTED EMISSION MEASUREMENT.....	78
5.1.2	TEST INSTRUMENTS.....	78
5.1.3	TEST PROCEDURES	79
5.1.4	DEVIATION FROM TEST STANDARD	79
5.1.5	TEST SETUP	80
5.1.6	EUT OPERATING CONDITIONS	80
5.1.7	TEST RESULTS	81
5.2	RADIATED EMISSION MEASUREMENT	83
5.2.1	LIMITS OF RADIATED EMISSION MEASUREMENT.....	83
5.2.2	LIMITS OF UNWANTED EMISSION OUT OF THE RESTRICTED BANDS.....	84
5.2.3	TEST INSTRUMENTS.....	85
5.2.4	TEST PROCEDURES	86
5.2.5	DEVIATION FROM TEST STANDARD	86
5.2.6	TEST SETUP	87
5.2.7	EUT OPERATING CONDITIONS	87
5.2.8	TEST RESULTS	88
	FOR FREQUENCY 5.15~5.35GHz	101
5.3	PEAK TRANSMIT POWER MEASUREMENT	101
5.3.1	LIMITS OF PEAK TRANSMIT POWER MEASUREMENT.....	101
5.3.2	TEST INSTRUMENTS.....	101
5.3.3	TEST PROCEDURE.....	102
5.3.4	DEVIATION FROM TEST STANDARD	102
5.3.5	TEST SETUP	102
5.3.6	EUT OPERATING CONDITIONS	102
5.3.7	TEST RESULTS	103



5.4 PEAK POWER EXCURSION MEASUREMENT 119

5.4.1 LIMITS OF PEAK POWER EXCURSION MEASUREMENT..... 119

5.4.2 TEST INSTRUMENTS..... 119

5.4.3 TEST PROCEDURE..... 120

5.4.4 DEVIATION FROM TEST STANDARD 120

5.4.5 TEST SETUP 120

5.4.6 EUT OPERATING CONDITIONS 120

5.4.7 TEST RESULTS 121

5.5 PEAK POWER SPECTRAL DENSITY MEASUREMENT 130

5.5.1 LIMITS OF PEAK POWER SPECTRAL DENSITY MEASUREMENT..... 130

5.5.2 TEST INSTRUMENTS..... 130

5.5.3 TEST PROCEDURES 131

5.5.4 DEVIATION FROM TEST STANDARD 131

5.5.5 TEST SETUP 131

5.5.6 EUT OPERATING CONDITIONS 131

5.5.7 TEST RESULTS 132

5.6 FREQUENCY STABILITY 141

5.6.1 LIMITS OF FREQUENCY STABILITY MEASUREMENT 141

5.6.2 TEST INSTRUMENTS..... 141

5.6.3 TEST PROCEDURE..... 141

5.6.4 DEVIATION FROM TEST STANDARD 141

5.6.5 TEST SETUP 142

5.6.6 EUT OPERATING CONDITION 142

5.6.7 TEST RESULTS 143

5.7 BAND EDGES MEASUREMENT 144

5.7.1 TEST INSTRUMENTS..... 144

5.7.2 TEST PROCEDURE..... 144

5.7.3 EUT OPERATING CONDITION 144

5.7.4 TEST RESULTS 144

5.8 ANTENNA REQUIREMENT 154

5.8.1 STANDARD APPLICABLE 154

5.8.2 ANTENNA CONNECTED CONSTRUCTION 154

FOR FREQUENCY 5.725~5.850GHz 155

5.9 6dB BANDWIDTH MEASUREMENT 155

5.9.1 LIMITS OF 6dB BANDWIDTH MEASUREMENT 155

5.9.2 TEST INSTRUMENTS..... 155

5.9.3 TEST PROCEDURE..... 156

5.9.4 DEVIATION FROM TEST STANDARD 156

5.9.5 TEST SETUP 156

5.9.6 EUT OPERATING CONDITIONS 156

5.9.7 TEST RESULTS 157

5.10 MAXIMUM PEAK OUTPUT POWER 164

5.10.1 LIMITS OF MAXIMUM PEAK OUTPUT POWER MEASUREMENT..... 164

5.10.2 INSTRUMENTS..... 164

5.10.3 TEST PROCEDURES 165



5.10.4 DEVIATION FROM TEST STANDARD 165

5.10.5 TEST SETUP 165

5.10.6 EUT OPERATING CONDITIONS 165

5.10.7 TEST RESULTS 166

5.11 POWER SPECTRAL DENSITY MEASUREMENT 167

5.11.1 LIMITS OF POWER SPECTRAL DENSITY MEASUREMENT 167

5.11.2 TEST INSTRUMENTS..... 167

5.11.3 TEST PROCEDURE..... 168

5.11.4 DEVIATION FROM TEST STANDARD 168

5.11.5 TEST SETUP 168

5.11.6 EUT OPERATING CONDITION 168

5.11.7 TEST RESULTS 169

5.12 BAND EDGES MEASUREMENT 176

5.12.1 LIMITS OF BAND EDGES MEASUREMENT 176

5.12.2 TEST INSTRUMENTS..... 176

5.12.3 TEST PROCEDURE..... 176

5.12.4 DEVIATION FROM TEST STANDARD 176

5.12.5 EUT OPERATING CONDITION 177

5.12.6 TEST RESULTS 177

5.13 ANTENNA REQUIREMENT 188

5.13.1 STANDARD APPLICABLE 188

5.13.2 ANTENNA CONNECTED CONSTRUCTION 188

6. PHOTOGRAPHS OF THE TEST CONFIGURATION..... 189

7. INFORMATION ON THE TESTING LABORATORIES 192



1. CERTIFICATION

PRODUCT: Wireless A+G Mini PCI Card
BRAND NAME: Linksys
MODEL NO.: WMCE54AG
APPLICANT: Cisco-Linksys, LLC
TEST SAMPLE: Engineering Sample
TESTED: Sep. 02 ~ Sep 15, 2004
STANDARDS: FCC Part 15, Subpart C (Section 15.247),
Subpart E (Section 15.407), ANSI C63.4-2001

The above equipment have been tested by **Advance Data Technology Corporation**, and found compliance with the requirement of the above standards. The test record, data evaluation & Equipment Under Test (EUT) configurations represented herein are true and accurate accounts of the measurements of the sample's EMC characteristics under the conditions specified in this report.

PREPARED BY : Andrea Hsia , **DATE:** Sep. 21, 2004
(Andrea Hsia)

TECHNICAL
ACCEPTANCE : Gary Chang , **DATE:** Sep. 21, 2004
Responsible for RF (Gary Chang)

APPROVED BY : Cody Chang , **DATE:** Sep. 21, 2004
(Cody Chang, Deputy Manager)



2. SUMMARY OF TEST RESULTS

The EUT has been tested according to the following specifications:

APPLIED STANDARD: FCC Part 15, Subpart C (Section 15.247)			
Standard Section	Test Type and Limit	Result	Remark
15.207	AC Power Conducted Emission	PASS	Meet the requirement of limit. Minimum passing margin is -17.79dB at 0.220MHz
15.247(a)(2)	Spectrum Bandwidth of a Direct Sequence Spread Spectrum System Limit: min. 500kHz	PASS	Meet the requirement of limit.
15.247(b)	Maximum Peak Output Power Limit: max. 30dBm	PASS	Meet the requirement of limit.
15.247(c)	Radiated Emissions Limit: Table 15.209	PASS	Meet the requirement of limit. Minimum passing margin is -0.54dB at 2016.00MHz
15.247(d)	Power Spectral Density Limit: max. 8dBm	PASS	Meet the requirement of limit.
15.247(c)	Band Edge Measurement Limit: 20dB less than the peak value of fundamental frequency	PASS	Meet the requirement of limit.



For Freq. 5.15 ~ 5.35GHz:

APPLIED STANDARD: FCC Part 15, Subpart E (Section 15.407)			
Standard Section	Test Type	Result	Remark
15.407(b)(5)	AC Power Conducted Emission	PASS	Meet the requirement of limit. Minimum passing margin is -19.10dB at 0.220MHz
15.407(b/1/2/3) (b)(5)	Electric Field Strength Spurious Emissions, 30MHz ~ 40000MHz	PASS	Meet the requirement of limit. Minimum passing margin is -1.49dB at 166.07MHz
15.407(a/1/2/3)	Peak Transmit Power	PASS	Meet the requirement of limit.
15.407(a)(6)	Peak Power Excursion	PASS	Meet the requirement of limit.
15.407(a/1/2/3)	Peak Power Spectral Density	PASS	Meet the requirement of limit.
15.407(g)	Frequency Stability	PASS	Meet the requirement of limit.

For Freq. 5.725 ~ 5.850GHz :

APPLIED STANDARD: FCC Part 15, Subpart C (Section 15.247)			
Standard Section	Test Type and Limit	Result	Remark
15.207	AC Power Conducted Emission	PASS	Meet the requirement of limit. Minimum passing margin is -19.10dB at 0.220MHz
15.247(a)(2)	Spectrum Bandwidth of a Direct Sequence Spread Spectrum System Limit: min. 500kHz	PASS	Meet the requirement of limit.
15.247(b)	Maximum Peak Output Power Limit: max. 30dBm	PASS	Meet the requirement of limit.
15.247(c)	Radiated Emissions Limit: Table 15.209	PASS	Meet the requirement of limit. Minimum passing margin is -4.73dB at 11570.00MHz
15.247(d)	Power Spectral Density Limit: max. 8dBm	PASS	Meet the requirement of limit.
15.247(c)	Band Edge Measurement Limit: 20dB less than the peak value of fundamental frequency	PASS	Meet the requirement of limit.

2.1 MEASUREMENT UNCERTAINTY

Where relevant, the following measurement uncertainty levels have been estimated for tests performed on the EUT as specified in CISPR 16-4:

Measurement	Frequency	Uncertainty
Conducted emissions	9k~30MHz	2.44 dB
Radiated emissions	30MHz ~ 200MHz	3.63 dB
	200MHz ~1000MHz	3.65 dB
	1GHz ~ 18GHz	2.20 dB
	18GHz ~ 40GHz	1.88 dB



3. GENERAL INFORMATION

3.1 GENERAL DESCRIPTION OF EUT

EUT	Wireless A+G Mini PCI Card
MODEL NO.	WMCE54AG
POWER SUPPLY	3.3Vdc from host equipment
MODULATION TYPE	DBPSK, DQPSK, CCK, 16QAM, 64QAM
MODULATION TECHNOLOGY	DSSS, OFDM
TRANSFER RATE	802.11b: 11/5.5/2/1Mbps 802.11g: 54/48/36/24/18/12/9/6Mbps 802.11a: 54/48/36/24/18/12/9/6Mbps (Turbo mode: up to 108Mbps *see Note 2)
FREQUENCY RANGE	802.11b & 802.11g: 2412 ~ 2462MHz 802.11a: 5.15 ~ 5.35GHz and 5.725 ~ 5.850GHz
NUMBER OF CHANNEL	802.11b & 802.11g: 11 for Normal mode / 1 for Turbo mode 802.11a: 13 for Normal mode / 5 for Turbo mode
CHANNEL SPACING	802.11b & 802.11g: 5MHz 802.11a: 20MHz for Normal mode / 40MHz for Turbo mode
OUTPUT POWER	802.11b: 35.645 mW 802.11g: 22.491 mW 802.11a: 20.749 mW
DATA CABLE	NA
ANTENNA TYPE	External antenna: Dipole antenna with 4.0dBi gain for 5GHz band Dipole antenna with 2.0dBi gain for 2.4GHz band Internal antenna Dipole antenna with 0.76dBi gain for 5.80GHz band Dipole antenna with 1.65dBi gain for 5.20GHz band Dipole antenna with 2.44dBi gain for 2.45GHz band
I/O PORTS	NA
ASSOCIATED DEVICES	NA

NOTE:

1. The EUT operates in both the 5.0GHz and 2.4GHz Bands and compatibility with 802.11a and 802.11b, 802.11g technology.
2. This EUT is capable of providing data rates of up to 108Mbps in Turbo Mode depending upon reception quality.
3. The above EUT information was declared by the manufacturer and for more detailed features description, please refer to the manufacturer's specifications or User's Manual.



3.2 DESCRIPTION OF TEST MODES

802.11b and 802.11g: Eleven channels are provided to this EUT.

Channel	Frequency	Channel	Frequency
1	2412 MHz	7	2442 MHz
2	2417 MHz	8	2447 MHz
3	2422 MHz	9	2452 MHz
4	2427 MHz	10	2457 MHz
5	2432 MHz	11	2462 MHz
6	2437 MHz		

NOTE:

1. Below 1GHz, the channel 1, 6, and 11 were pre-tested in chamber. The channel 11, worst case one, was chosen for final test.
2. Above 1GHz, the channel 1, 6, and 11 were tested individually.
3. From our experience and technical viewpoint, we have chosen data rates, 11Mbps with CCK technique and 6Mbps with OFDM technique, as the worst cases for the test among other data rates.

One channel is provided to this EUT for Turbo Mode.

Channel	Frequency
6	2437 MHz

NOTE: One turbo mode at frequency 2437MHz.

For 802.11a: Thirteen channels are provided to this EUT for Normal mode.

Channel	Frequency	Channel	Frequency
1	5180 MHz	8	5320 MHz
2	5200 MHz	9	5745 MHz
3	5220 MHz	10	5765 MHz
4	5240 MHz	11	5785 MHz
5	5260 MHz	12	5805 MHz
6	5280 MHz	13	5825 MHz
7	5300 MHz		

Five channels are provided to this EUT for Turbo Mode.

Channel	Frequency	Channel	Frequency
1	5210 MHz	4	5760 MHz
2	5250 MHz	5	5800 MHz
3	5290 MHz		

NOTE:

1. The EUT was tested in both normal mode (channel bandwidth of approximately 30MHz) and turbo mode (channel bandwidth of approximately 60MHz).
2. "Normal Mode" allows data rates of up to 54Mbps. The device was, therefore, tested in Normal mode at the data rate that produced the highest output power for normal mode (6Mbps).
3. "Turbo Mode" allows data rates of up to 108Mbps. At data rates higher than 12Mbps the PA gain is reduced to improve signal fidelity. The device was, therefore, tested in turbo mode at the data rate that produced the highest output power for turbo mode (12Mbps).
4. Channel 1, 4, 5, 8, 9, 11, 12 and 13 are the closest frequencies to the band edge, were chosen for final test of Normal Mode.
5. Channel 1~5 were chosen for final test of Turbo mode.



3.3 GENERAL DESCRIPTION OF APPLIED STANDARDS

The EUT is a Wireless A+G Mini PCI Card. According to the specifications of the manufacturer, it must comply with the requirements of the following standards:

**FCC Part 15, Subpart C. (15.247),
Subpart E (15.407). ANSI C63.4 : 2001**

All test items have been performed and recorded as per the above standards.

NOTE: The EUT is also considered as a kind of computer peripheral, because the connection to computer is necessary for typical use. It has been verified to comply with the requirements of FCC Part 15, Subpart B, Class B (DoC). The test report has been issued separately.

3.4 DESCRIPTION OF SUPPORT UNITS

The EUT has been tested as an independent unit together with other necessary accessories or support units. The following support units or accessories were used to form a representative test configuration during the tests.

NO.	PRODUCT	BRAND	MODEL NO.	SERIAL NO.	FCC ID
1	NOTEBOOK COMPUTER	DELL	PP05L	12130898320	E2K24CLNS
2	PRINTER	EPSON	LQ-300+	DCGY054147	FCC DoC Approved
3	MODEM	ACEEX	1414V/3	0401008269	IFAXDM1414

NO.	SIGNAL CABLE DESCRIPTION OF THE ABOVE SUPPORT UNITS
1	NA
2	1.2m shielded without core
3	1.2m shielded without core

NOTE: 1. All power cords of the above support units are non shielded (1.8m).

3.5 CONFIGURATION OF SYSTEM UNDER TEST

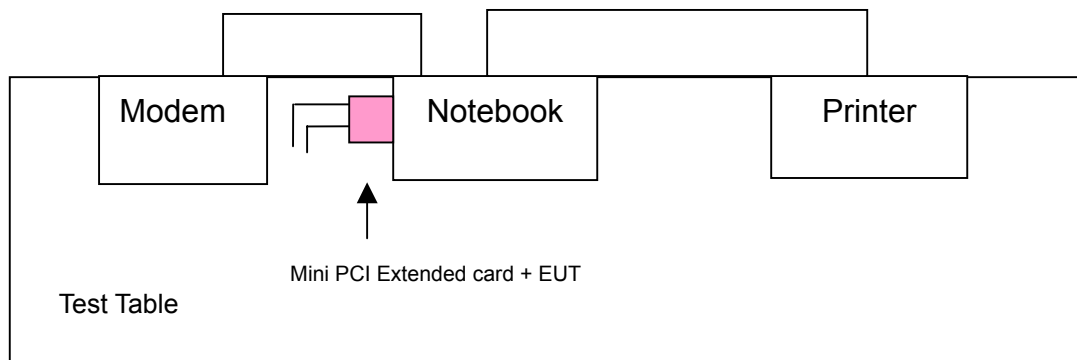



4. TEST TYPES AND RESULTS (FOR PART 802.11b & 802.11g)

4.1 CONDUCTED EMISSION MEASUREMENT

4.1.1 LIMITS OF CONDUCTED EMISSION MEASUREMENT

FREQUENCY OF EMISSION (MHz)	CONDUCTED LIMIT (dB μ V)	
	Quasi-peak	Average
0.15-0.5	66 to 56	56 to 46
0.5-5	56	46
5-30	60	50

- NOTE:**
1. The lower limit shall apply at the transition frequencies.
 2. The limit decreases in line with the logarithm of the frequency in the range of 0.15 to 0.50 MHz.
 3. All emanations from a class A/B digital device or system, including any network of conductors and apparatus connected thereto, shall not exceed the level of field strengths specified above.

4.1.2 TEST INSTRUMENTS

DESCRIPTION & MANUFACTURER	MODEL NO.	SERIAL NO.	CALIBRATED UNTIL
Test Receiver ROHDE & SCHWARZ	ESCS30	100291	Dec. 12, 2004
RF signal cable Woken	5D-FB	Cable-HYC01-01	Mar. 02, 2005
LISN ROHDE & SCHWARZ	ESH3-Z5	100312	Mar. 03, 2005
LISN ROHDE & SCHWARZ	ESH2-Z5	100104	Mar. 02, 2005
Software ADT	ADT_Cond_V3	NA	NA

- NOTE:**
1. The calibration interval of the above test instruments is 12 months and the calibrations are traceable to NML/ROC and NIST/USA.
 2. The test was performed in HwaYa Shielded Room 1.
 3. The VCCI Site Registration No. is C-2040.



4.1.3 TEST PROCEDURES

- a. The EUT was placed 0.4 meters from the conducting wall of the shielded room with EUT being connected to the power mains through a line impedance stabilization network (LISN). Other support units were connected to the power mains through another LISN. The two LISNs provide 50 ohm/ 50uH of coupling impedance for the measuring instrument.
- b. Both lines of the power mains connected to the EUT were checked for maximum conducted interference.
- c. The frequency range from 150kHz to 30MHz was searched. Emission levels under (Limit - 20dB) was not recorded.

4.1.4 DEVIATION FROM TEST STANDARD

No deviation

4.1.5 TEST SETUP

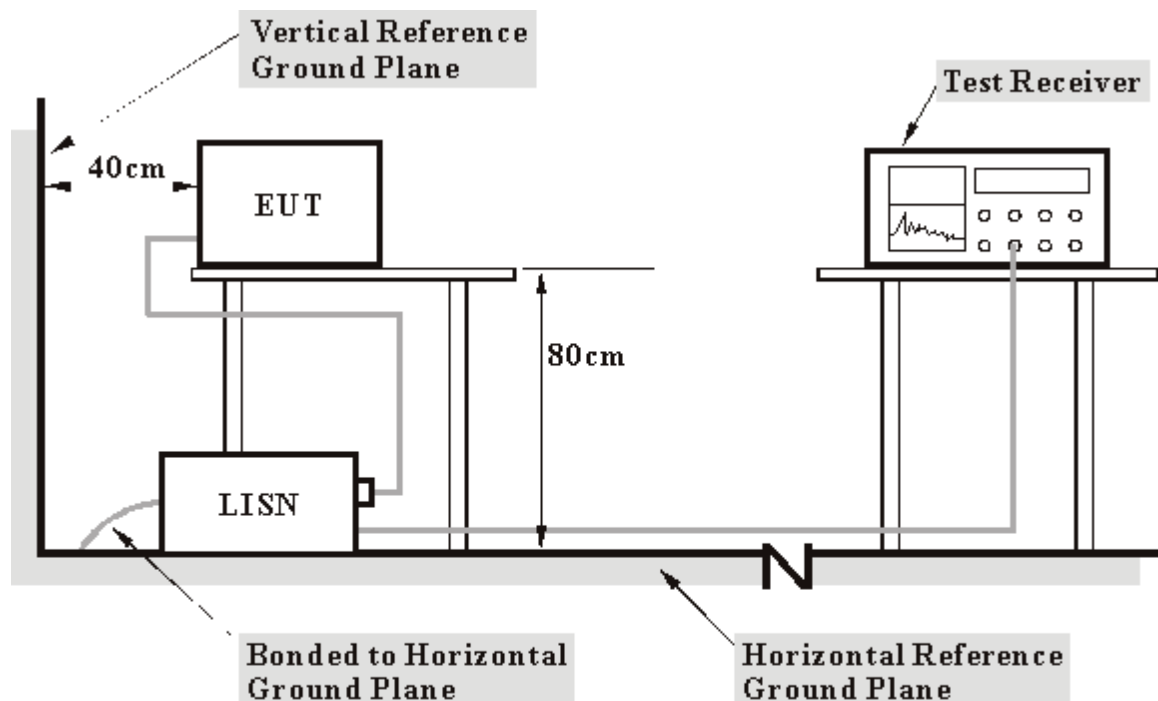

- Note:**
1. Support units were connected to second LISN.
 2. Both of LISNs (AMN) 80 cm from EUT and at the least 80 cm from other units and other metal planes support units.

For the actual test configuration, please refer to the related item – Photographs of the Test Configuration.

4.1.6 EUT OPERATING CONDITIONS

- a. Connected the EUT to a notebook system placed on a testing table.
- b. The notebook system ran a test program (provided by manufacturer) to enable EUT under transmission/receiving condition continuously at specific channel frequency.
- c. The notebook system sent "H" messages to its screen.
- d. The notebook system sent "H" messages to modem.
- e. The notebook system sent "H" messages to printer, and the printer prints them on paper.
- f. Steps c-e are repeated.



4.1.7 TEST RESULTS

EUT	Wireless A+G Mini PCI Card	MODEL	WMCE54AG
MODE	Channel 1	6dB BANDWIDTH	9 kHz
INPUT POWER (SYSTEM)	120Vac, 60Hz	PHASE	Line (L)
ENVIRONMENTAL CONDITIONS	25deg. C, 77%RH, 991hPa	TESTED BY	Leo Hung

No	Freq. [MHz]	Corr. Factor (dB)	Reading Value [dB (uV)]		Emission Level [dB (uV)]		Limit [dB (uV)]		Margin (dB)	
			Q.P.	AV.	Q.P.	AV.	Q.P.	AV.	Q.P.	AV.
	1	0.198	0.12	36.75	-	36.87	-	63.69	53.69	-26.82
2	0.220	0.12	44.90	-	45.02	-	62.81	52.81	-17.79	-
3	1.539	0.16	30.45	-	30.61	-	56.00	46.00	-25.39	-
4	4.367	0.22	19.40	-	19.62	-	56.00	46.00	-36.38	-
5	9.902	0.30	30.47	-	30.77	-	60.00	50.00	-29.23	-
6	17.410	0.90	24.54	-	25.44	-	60.00	50.00	-34.56	-

- REMARKS:**
1. Q.P. and AV. are abbreviations of quasi-peak and average individually.
 2. "-": The Quasi-peak reading value also meets average limit and measurement with the average detector is unnecessary.
 3. The emission levels of other frequencies were very low against the limit.
 4. Margin value = Emission level - Limit value
 5. Correction factor = Insertion loss + Cable loss
 6. Emission Level = Correction Factor + Reading Value.

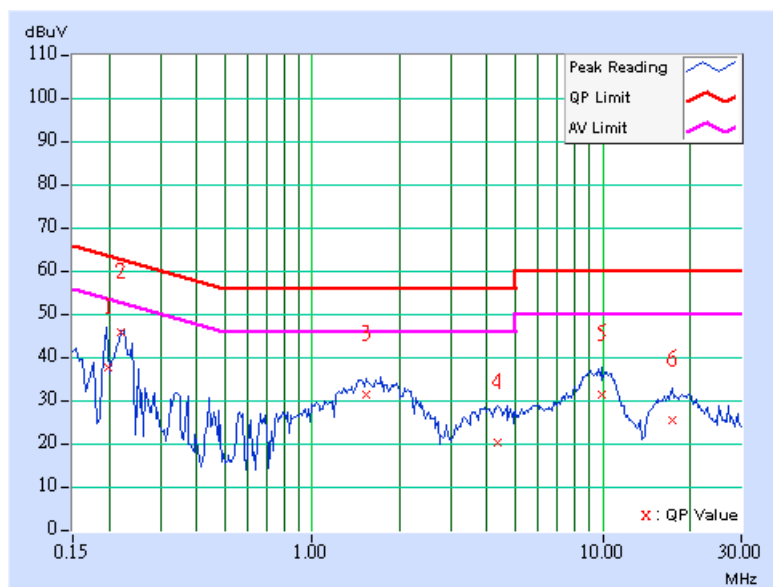



EUT	Wireless A+G Mini PCI Card	MODEL	WMCE54AG
MODE	Channel 1	6dB BANDWIDTH	9 kHz
INPUT POWER (SYSTEM)	120Vac, 60Hz	PHASE	Neutral (N)
ENVIRONMENTAL CONDITIONS	25deg. C, 77%RH, 991hPa	TESTED BY	Leo Hung

No	Freq. [MHz]	Corr. Factor (dB)	Reading Value [dB (uV)]		Emission Level [dB (uV)]		Limit [dB (uV)]		Margin (dB)	
			Q.P.	AV.	Q.P.	AV.	Q.P.	AV.	Q.P.	AV.
			1	0.185	0.11	36.42	-	36.53	-	64.25
2	0.220	0.11	44.76	-	44.87	-	62.81	52.81	-17.94	-
3	1.711	0.16	31.41	-	31.57	-	56.00	46.00	-24.43	-
4	3.445	0.19	24.69	-	24.88	-	56.00	46.00	-31.12	-
5	10.520	0.32	30.35	-	30.67	-	60.00	50.00	-29.33	-
6	18.328	0.69	24.82	-	25.51	-	60.00	50.00	-34.49	-

- REMARKS:**
1. Q.P. and AV. are abbreviations of quasi-peak and average individually.
 2. "-": The Quasi-peak reading value also meets average limit and measurement with the average detector is unnecessary.
 3. The emission levels of other frequencies were very low against the limit.
 4. Margin value = Emission level - Limit value
 5. Correction factor = Insertion loss + Cable loss
 6. Emission Level = Correction Factor + Reading Value.

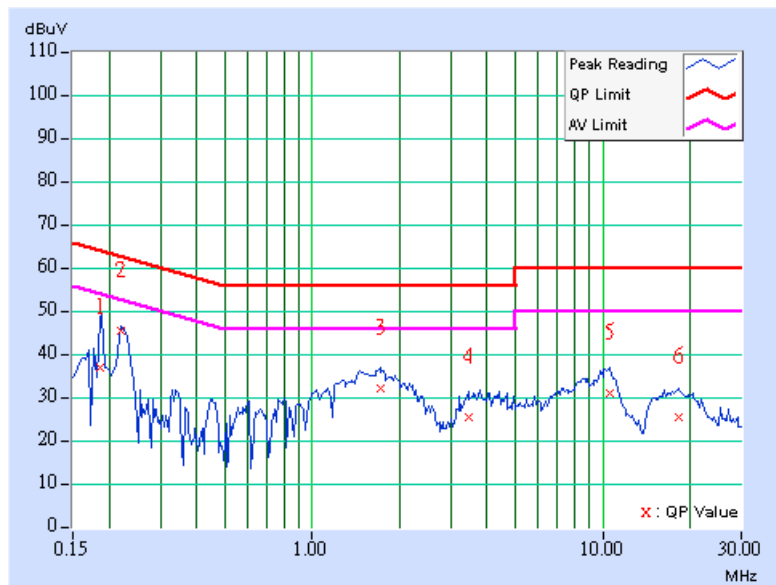



EUT	Wireless A+G Mini PCI Card	MODEL	WMCE54AG
MODE	Channel 6	6dB BANDWIDTH	9 kHz
INPUT POWER (SYSTEM)	120Vac, 60Hz	PHASE	Line (L)
ENVIRONMENTAL CONDITIONS	25deg. C, 77%RH, 991hPa	TESTED BY	Leo Hung

No	Freq. [MHz]	Corr. Factor (dB)	Reading Value [dB (uV)]		Emission Level [dB (uV)]		Limit [dB (uV)]		Margin (dB)	
			Q.P.	AV.	Q.P.	AV.	Q.P.	AV.	Q.P.	AV.
			1	0.189	0.12	38.81	-	38.93	-	64.08
2	0.224	0.12	43.67	-	43.79	-	62.66	52.66	-18.87	-
3	0.447	0.13	25.37	-	25.50	-	56.93	46.93	-31.44	-
4	1.648	0.16	30.32	-	30.48	-	56.00	46.00	-25.52	-
5	9.816	0.30	30.53	-	30.83	-	60.00	50.00	-29.17	-
6	17.855	0.92	24.72	-	25.64	-	60.00	50.00	-34.36	-

- REMARKS:**
1. Q.P. and AV. are abbreviations of quasi-peak and average individually.
 2. "-": The Quasi-peak reading value also meets average limit and measurement with the average detector is unnecessary.
 3. The emission levels of other frequencies were very low against the limit.
 4. Margin value = Emission level - Limit value
 5. Correction factor = Insertion loss + Cable loss
 6. Emission Level = Correction Factor + Reading Value.

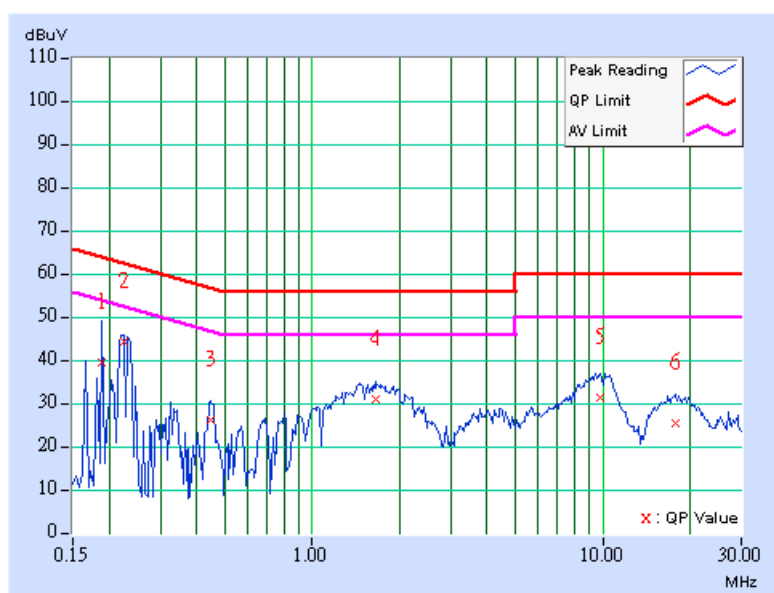



EUT	Wireless A+G Mini PCI Card	MODEL	WMCE54AG
MODE	Channel 6	6dB BANDWIDTH	9 kHz
INPUT POWER (SYSTEM)	120Vac, 60Hz	PHASE	Neutral (N)
ENVIRONMENTAL CONDITIONS	25deg. C, 77%RH, 991hPa	TESTED BY	Leo Hung

No	Freq. [MHz]	Corr. Factor (dB)	Reading Value [dB (uV)]		Emission Level [dB (uV)]		Limit [dB (uV)]		Margin (dB)	
			Q.P.	AV.	Q.P.	AV.	Q.P.	AV.	Q.P.	AV.
			1	0.193	0.11	36.33	-	36.44	-	63.91
2	0.220	0.11	44.76	-	44.87	-	62.81	52.81	-17.94	-
3	1.539	0.16	31.29	-	31.45	-	56.00	46.00	-24.55	-
4	3.453	0.19	24.72	-	24.91	-	56.00	46.00	-31.09	-
5	10.477	0.31	30.30	-	30.61	-	60.00	50.00	-29.39	-
6	17.770	0.68	24.88	-	25.56	-	60.00	50.00	-34.44	-

- REMARKS:**
1. Q.P. and AV. are abbreviations of quasi-peak and average individually.
 2. "-": The Quasi-peak reading value also meets average limit and measurement with the average detector is unnecessary.
 3. The emission levels of other frequencies were very low against the limit.
 4. Margin value = Emission level - Limit value
 5. Correction factor = Insertion loss + Cable loss
 6. Emission Level = Correction Factor + Reading Value.

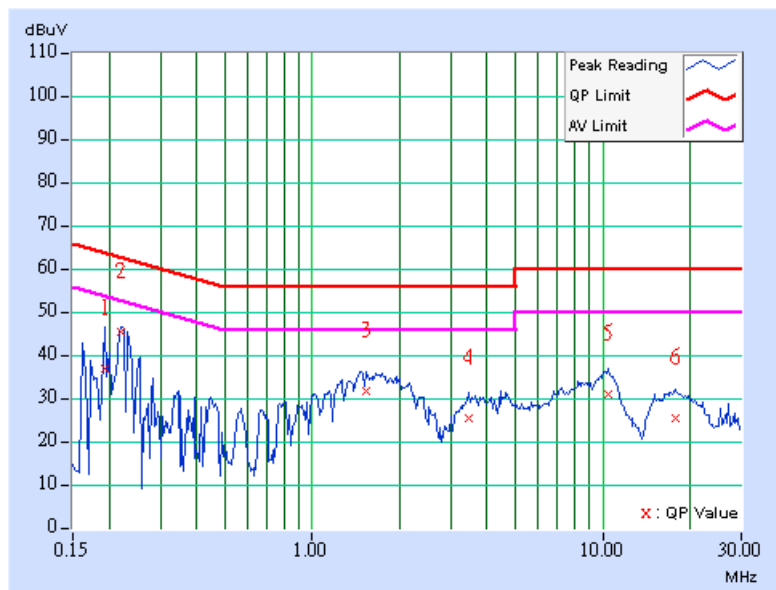



EUT	Wireless A+G Mini PCI Card	MODEL	WMCE54AG
MODE	Channel 11	6dB BANDWIDTH	9 kHz
INPUT POWER (SYSTEM)	120Vac, 60Hz	PHASE	Line (L)
ENVIRONMENTAL CONDITIONS	25deg. C, 77%RH, 991hPa	TESTED BY	Leo Hung

No	Freq. [MHz]	Corr. Factor (dB)	Reading Value [dB (uV)]		Emission Level [dB (uV)]		Limit [dB (uV)]		Margin (dB)	
			Q.P.	AV.	Q.P.	AV.	Q.P.	AV.	Q.P.	AV.
			1	0.189	0.12	34.88	-	35.00	-	64.08
2	0.219	0.12	44.14	-	44.26	-	62.86	52.86	-18.60	-
3	1.715	0.16	30.31	-	30.47	-	56.00	46.00	-25.53	-
4	3.844	0.20	22.02	-	22.22	-	56.00	46.00	-33.78	-
5	10.359	0.33	30.63	-	30.96	-	60.00	50.00	-29.04	-
6	17.309	0.89	24.64	-	25.53	-	60.00	50.00	-34.47	-

- REMARKS:**
1. Q.P. and AV. are abbreviations of quasi-peak and average individually.
 2. "-": The Quasi-peak reading value also meets average limit and measurement with the average detector is unnecessary.
 3. The emission levels of other frequencies were very low against the limit.
 4. Margin value = Emission level - Limit value
 5. Correction factor = Insertion loss + Cable loss
 6. Emission Level = Correction Factor + Reading Value.

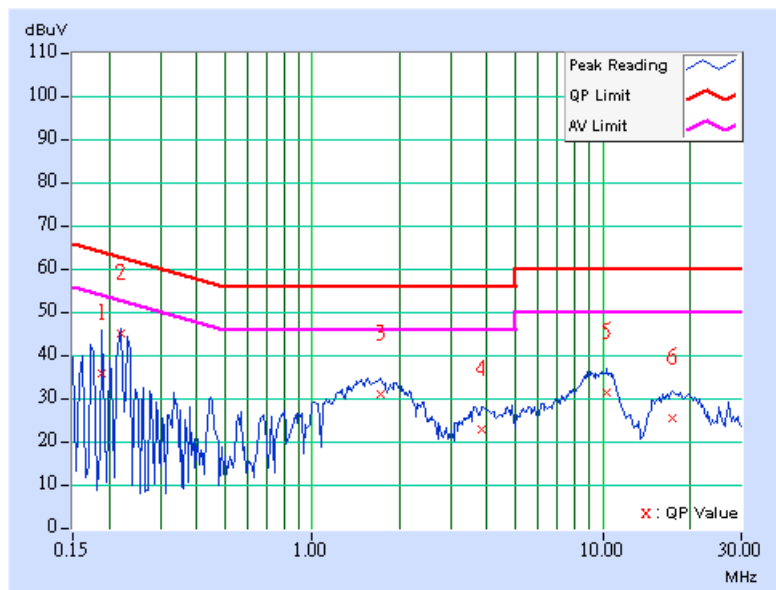



EUT	Wireless A+G Mini PCI Card	MODEL	WMCE54AG
MODE	Channel 11	6dB BANDWIDTH	9 kHz
INPUT POWER (SYSTEM)	120Vac, 60Hz	PHASE	Neutral (N)
ENVIRONMENTAL CONDITIONS	23deg. C, 65%RH, 991hPa	TESTED BY	Leo Hung

No	Freq. [MHz]	Corr. Factor (dB)	Reading Value [dB (uV)]		Emission Level [dB (uV)]		Limit [dB (uV)]		Margin (dB)	
			Q.P.	AV.	Q.P.	AV.	Q.P.	AV.	Q.P.	AV.
			1	0.173	0.10	36.33	-	36.43	-	64.79
2	0.224	0.11	44.29	-	44.40	-	62.66	52.66	-18.26	-
3	0.445	0.12	25.96	-	26.08	-	56.96	46.96	-30.88	-
4	1.496	0.15	32.13	-	32.28	-	56.00	46.00	-23.72	-
5	9.992	0.28	29.92	-	30.20	-	60.00	50.00	-29.80	-
6	18.621	0.69	24.45	-	25.14	-	60.00	50.00	-34.86	-

- REMARKS:**
1. Q.P. and AV. are abbreviations of quasi-peak and average individually.
 2. "-": The Quasi-peak reading value also meets average limit and measurement with the average detector is unnecessary.
 3. The emission levels of other frequencies were very low against the limit.
 4. Margin value = Emission level - Limit value
 5. Correction factor = Insertion loss + Cable loss
 6. Emission Level = Correction Factor + Reading Value.

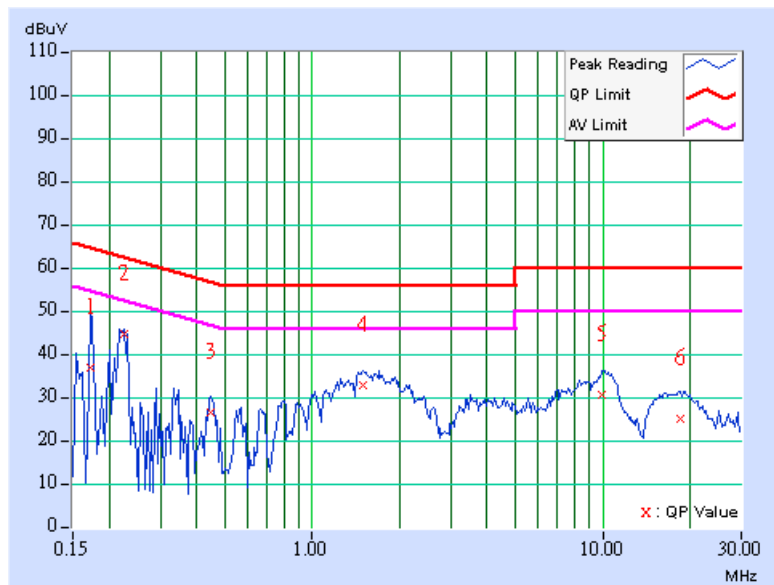



4.2 RADIATED EMISSION MEASUREMENT

4.2.1 LIMITS OF RADIATED EMISSION MEASUREMENT

Emissions radiated outside of the specified bands, shall be according to the general radiated limits in 15.209 as following:

Frequencies (MHz)	Field strength (microvolts/meter)	Measurement distance (meters)
0.009-0.490	2400/F(kHz)	300
0.490-1.705	24000/F(kHz)	30
1.705-30.0	30	30
30-88	100	3
88-216	150	3
216-960	200	3
Above 960	500	3

NOTE:

1. The lower limit shall apply at the transition frequencies.
2. Emission level (dBuV/m) = 20 log Emission level (uV/m).
3. As shown in 15.35(b), for frequencies above 1000MHz, the field strength limits are based on average detector, however, the peak field strength of any emission shall not exceed the maximum permitted average limits, specified above by more than 20dB under any condition of modulation.



4.2.2 TEST INSTRUMENTS

DESCRIPTION & MANUFACTURER	MODEL NO.	SERIAL NO.	CALIBRATED UNTIL
Test Receiver ROHDE & SCHWARZ	ESI7	838496/016	Feb. 09, 2005
Spectrum Analyzer ROHDE & SCHWARZ	FSP40	100041	Dec. 15, 2004
BILOG Antenna SCHWARZBECK	VULB9168	9168-155	Feb. 03, 2005
HORN Antenna SCHWARZBECK	BBHA 9120D	9120D-404	Feb. 03, 2005
HORN Antenna SCHWARZBECK	BBHA 9170	BBHA 9170242	Feb. 23, 2005
Preamplifier Agilent	8447D	2944A10631	Jan. 15, 2005
Preamplifier Agilent	8449B	3008A01960	Jan. 22, 2005
RF signal cable HUBER+SUHNNER	SUCOFLEX 104	219272/4	Mar. 04, 2005
RF signal cable HUBER+SUHNNER	SUCOFLEX 104	219275/4	Mar. 04, 2005
Software ADT.	ADT_Radiated_V5.14	NA	NA
Antenna Tower inn-co GmbH	MA 4000	010303	NA
Antenna Tower Controller inn-co GmbH	CO2000	019303	NA
Turn Table ADT.	TT100.	TT93021704	NA
Turn Table Controller ADT.	SC100.	SC93021704	NA

- NOTE:**
1. The calibration interval of the above test instruments is 12 months and the calibrations are traceable to NML/ROC and NIST/USA.
 2. The test was performed in HwaYa Chamber 3.
 3. The horn antenna and HP preamplifier (model: 8449B) are used only for the measurement of emission frequency above 1GHz if tested.
 4. The IC Site Registration No. is IC4924-4.



4.2.3 TEST PROCEDURES

- a. The EUT was placed on the top of a rotating table 0.8 meters above the ground at a 3 meter semi- anechoic. The table was rotated 360 degrees to determine the position of the highest radiation.
- b. The EUT was set 3 meters away from the interference-receiving antenna, which was mounted on the top of a variable-height antenna tower.
- c. The antenna is a broadband antenna, and its height is varied from one meter to four meters above the ground to determine the maximum value of the field strength. Both horizontal and vertical polarizations of the antenna are set to make the measurement.
- d. For each suspected emission, the EUT was arranged to its worst case and then the antenna was tuned to heights from 1 meter to 4 meters and the rotatable table was turned from 0 degrees to 360 degrees to find the maximum reading.
- e. The test-receiver system was set to Peak Detect Function and Specified Bandwidth with Maximum Hold Mode.
- f. If the emission level of the EUT in peak mode was 10 dB lower than the limit specified, then testing could be stopped and the peak values of the EUT would be reported. Otherwise the emissions that did not have 10 dB margin would be re-tested one by one using the quasi-peak method or average method as specified and then reported in Data sheet peak mode and QP mode.

NOTE:

1. The resolution bandwidth and video bandwidth of test receiver/spectrum analyzer is 120kHz for Quasi-peak detection at frequency below 1GHz.
2. The resolution bandwidth and video bandwidth of test receiver/spectrum analyzer is 1 MHz for Peak detection (PK) at frequency above 1GHz.
3. The resolution bandwidth of test receiver/spectrum analyzer is 1 MHz and the video bandwidth is 10 Hz for Average detection (AV) at frequency above 1GHz.

4.2.4 DEVIATION FROM TEST STANDARD

No deviation

4.2.5 TEST SETUP

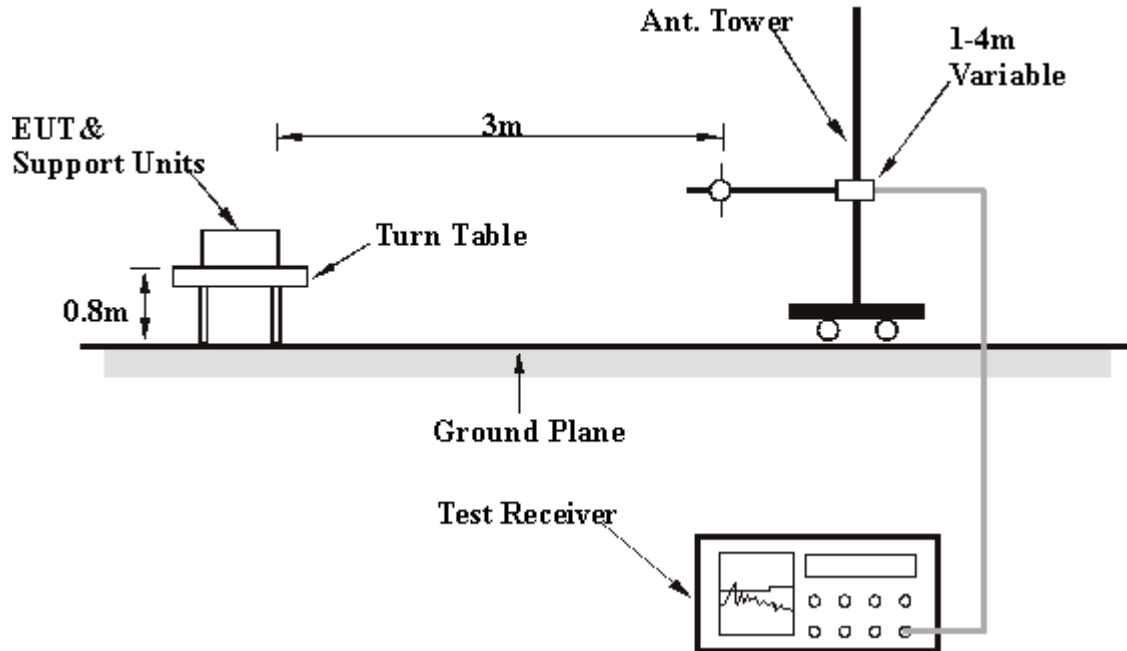

For the actual test configuration, please refer to the related item – Photographs of the Test Configuration.

4.2.6 EUT OPERATING CONDITIONS

Same as 4.1.6



4.2.7 TEST RESULTS

EUT	Wireless A+G Mini PCI Card	MODEL	WMCE54AG
CHANNEL	Channel 11	FREQUENCY RANGE	Below 1000MHz
INPUT POWER (SYSTEM)	120Vac, 60 Hz	DETECTOR FUNCTION	Quasi-Peak
ENVIRONMENTAL CONDITIONS	25deg. C, 60%RH, 991hPa	TESTED BY	Leo Hung

ANTENNA POLARITY & TEST DISTANCE: HORIZONTAL AT 3 M

No.	Freq. (MHz)	Emission Level (dBuV/m)	Limit (dBuV/m)	Margin (dB)	Antenna Height (m)	Table Angle (Degree)	Raw Value (dBuV)	Correction Factor (dB/m)
1	133.03	39.95 QP	43.50	-3.55	1.25 H	154	26.06	13.89
2	158.30	41.23 QP	43.50	-2.27	1.00 H	313	26.33	14.90
3	166.07	42.01 QP	43.50	-1.49	1.50 H	169	27.69	14.32
4	183.57	41.81 QP	43.50	-1.69	1.50 H	187	29.20	12.61
5	199.12	41.78 QP	43.50	-1.72	1.50 H	166	30.44	11.34
6	265.21	42.98 QP	46.00	-3.02	1.00 H	37	29.51	13.47
7	298.26	37.97 QP	46.00	-8.03	1.00 H	49	23.58	14.38
8	333.25	42.42 QP	46.00	-3.58	1.00 H	154	27.27	15.15
9	440.16	39.12 QP	46.00	-6.88	1.75 H	46	21.37	17.75
10	465.43	36.08 QP	46.00	-9.92	2.00 H	22	17.90	18.18
11	640.38	34.52 QP	46.00	-11.48	1.25 H	295	13.18	21.35
12	735.63	31.52 QP	46.00	-14.48	1.00 H	307	8.63	22.89

ANTENNA POLARITY & TEST DISTANCE: VERTICAL AT 3 M

No.	Freq. (MHz)	Emission Level (dBuV/m)	Limit (dBuV/m)	Margin (dB)	Antenna Height (m)	Table Angle (Degree)	Raw Value (dBuV)	Correction Factor (dB/m)
1	98.04	33.20 QP	43.50	-10.30	1.25 V	337	22.45	10.75
2	133.03	35.64 QP	43.50	-7.86	2.50 V	280	21.75	13.89
3	166.07	40.71 QP	43.50	-2.79	2.50 V	271	26.39	14.32
4	197.17	35.50 QP	43.50	-8.00	2.00 V	118	23.99	11.50
5	265.21	36.09 QP	46.00	-9.91	1.75 V	328	22.62	13.47
6	333.25	36.16 QP	46.00	-9.84	1.25 V	76	21.01	15.15
7	370.18	34.32 QP	46.00	-11.68	1.25 V	118	18.31	16.01
8	401.28	34.40 QP	46.00	-11.60	1.00 V	106	17.63	16.76
9	440.16	35.91 QP	46.00	-10.09	1.25 V	115	18.16	17.75
10	597.62	32.12 QP	46.00	-13.88	1.00 V	238	11.35	20.76
11	733.69	30.15 QP	46.00	-15.85	1.50 V	280	7.31	22.84
12	811.44	28.62 QP	46.00	-17.38	2.00 V	4	5.05	23.56

- REMARKS:**
1. Emission level(dBuV/m)=Raw Value(dBuV) + Correction Factor(dB)
 2. Correction Factor(dB/m) = Antenna Factor (dB/m) + Cable Factor (dB)
 3. The other emission levels were very low against the limit.
 4. Margin value = Emission level – Limit value



EUT	Wireless A+G Mini PCI Card	MODEL	WMCE54AG
CHANNEL	Channel 1	MODE	CCK
INPUT POWER (SYSTEM)	120Vac, 60 Hz	FREQUENCY RANGE	1 ~ 25GHz
ENVIRONMENTAL CONDITIONS	24deg. C, 64%RH, 991hPa	DETECTOR FUNCTION	Peak(PK) Average (AV)
TESTED BY	Leo Hung		

ANTENNA POLARITY & TEST DISTANCE: HORIZONTAL AT 3 M

No.	Freq. (MHz)	Emission Level (dBuV/m)	Limit (dBuV/m)	Margin (dB)	Antenna Height (m)	Table Angle (Degree)	Raw Value (dBuV)	Correction Factor (dB/m)
1	2016.00	61.92 PK	77.52	-15.60	1.08 H	54	29.95	31.96
1	2016.00	58.36 AV	70.61	-12.25	1.08 H	54	26.39	31.96
2	2360.00	57.18 PK	74.00	-16.82	1.20 H	204	23.50	33.68
2	2360.00	46.27 AV	54.00	-7.73	1.20 H	204	12.59	33.68
3	2390.00	44.96 PK	74.00	-29.04	1.59 H	31	11.13	33.83
4	*2412.00	97.52 PK			1.59 H	31	63.59	33.93
4	*2412.00	90.61 AV			1.59 H	31	56.68	33.93
5	2688.00	54.63 PK	74.00	-19.37	1.15 H	225	19.76	34.86
5	2688.00	42.67 AV	54.00	-11.33	1.15 H	225	7.80	34.86
6	4824.00	60.29 PK	74.00	-13.71	1.19 H	228	19.63	40.66
6	4824.00	48.69 AV	54.00	-5.31	1.19 H	228	8.03	40.66

ANTENNA POLARITY & TEST DISTANCE: VERTICAL AT 3 M

No.	Freq. (MHz)	Emission Level (dBuV/m)	Limit (dBuV/m)	Margin (dB)	Antenna Height (m)	Table Angle (Degree)	Raw Value (dBuV)	Correction Factor (dB/m)
1	2016.00	53.42 PK	74.00	-20.58	1.08 V	360	21.46	31.96
1	2016.00	50.84 AV	54.00	-3.16	1.08 V	360	18.88	31.96
2	2360.00	56.45 PK	74.00	-17.55	1.25 V	55	22.77	33.68
2	2360.00	46.43 AV	54.00	-7.57	1.25 V	55	12.75	33.68
3	2390.00	57.26 PK	74.00	-16.74	1.16 V	55	23.43	33.83
3	2390.00	49.86 AV	54.00	-4.14	1.16 V	55	16.03	33.83
4	*2412.00	110.95 PK			1.16 V	55	77.02	33.93
4	*2412.00	103.55 AV			1.16 V	55	69.62	33.93
5	2688.00	45.17 PK	74.00	-28.83	1.03 V	265	10.31	34.86
6	4824.00	52.54 PK	74.00	-21.46	1.08 V	360	11.88	40.66
6	4824.00	43.66 AV	54.00	-10.34	1.08 V	360	3.00	40.66

- REMARKS:**
1. Emission level(dBuV/m)=Raw Value(dBuV) + Correction Factor(dB)
 2. Correction Factor(dB/m) = Antenna Factor (dB/m) + Cable Factor (dB)
 3. The other emission levels were very low against the limit.
 4. Margin value = Emission level – Limit value.
 5. The limit value is defined as per 15.247
 6. “ * “ : Fundamental frequency



EUT	Wireless A+G Mini PCI Card	MODEL	WMCE54AG
CHANNEL	Channel 6	FREQUENCY RANGE	1 ~ 25GHz
ENVIRONMENTAL CONDITIONS	25deg. C, 60%RH, 991hPa	DETECTOR FUNCTION	Peak(PK) Average (AV)
INPUT POWER (SYSTEM)	120Vac, 60 Hz	MODE	CCK
TESTED BY	Leo Hung		

ANTENNA POLARITY & TEST DISTANCE: HORIZONTAL AT 3M

No.	Freq. (MHz)	Emission Level (dBuV/m)	Limit (dBuV/m)	Margin (dB)	Antenna Height (m)	Table Angle (Degree)	Raw Value (dBuV)	Correction Factor (dB/m)
1	2016.00	49.96 PK	74.00	-24.04	1.09 H	226	18.00	31.96
1	2016.00	46.08 AV	54.00	-7.92	1.09 H	226	14.12	31.96
2	2360.00	43.89 PK	74.00	-30.11	1.00 H	112	10.21	33.68
2	2360.00	34.94 AV	54.00	-19.06	1.00 H	112	1.26	33.68
3	*2437.00	99.96 PK			1.37 H	46	65.91	34.05
3	*2437.00	92.77 AV			1.37 H	46	58.72	34.05
4	2688.00	44.48 PK	74.00	-29.52	1.00 H	275	9.62	34.86
4	2688.00	32.84 AV	54.00	-21.16	1.00 H	275	-2.02	34.86
5	4874.00	39.53 PK	74.00	-34.47	1.10 H	268	-1.16	40.69
5	4874.00	51.15 AV	54.00	-2.85	1.10 H	268	10.16	40.89

ANTENNA POLARITY & TEST DISTANCE: VERTICAL AT 3M

No.	Freq. (MHz)	Emission Level (dBuV/m)	Limit (dBuV/m)	Margin (dB)	Antenna Height (m)	Table Angle (Degree)	Raw Value (dBuV)	Correction Factor (dB/m)
1	2016.00	54.20 PK	74.00	-19.80	1.05 V	181	22.24	31.96
1	2016.00	52.09 AV	54.00	-1.91	1.05 V	181	20.13	31.96
2	2360.00	58.20 PK	74.00	-15.80	1.18 V	237	24.52	33.68
2	2360.00	46.53 AV	54.00	-7.47	1.18 V	237	12.85	33.68
3	*2437.00	109.76 PK			1.08 V	72	75.71	34.05
3	*2437.00	102.32 AV			1.08 V	72	68.27	34.05
4	2688.00	46.94 PK	74.00	-27.06	1.00 V	23	12.08	34.86
4	2688.00	38.02 AV	54.00	-15.98	1.00 V	23	3.16	34.86
5	4874.00	50.47 PK	74.00	-23.53	1.11 V	245	9.78	40.69
5	4874.00	42.13 AV	54.00	-11.87	1.11 V	245	1.44	40.69

- REMARKS:**
1. Emission level(dBuV/m)=Raw Value(dBuV) + Correction Factor(dB)
 2. Correction Factor(dB/m) = Antenna Factor (dB/m) + Cable Factor (dB)
 3. The other emission levels were very low against the limit.
 4. Margin value = Emission level – Limit value.
 5. The limit value is defined as per 15.247
 6. " * " : Fundamental frequency



EUT	Wireless A+G Mini PCI Card	MODEL	WMCE54AG
CHANNEL	Channel 11	FREQUENCY RANGE	1 ~ 25GHz
ENVIRONMENTAL CONDITIONS	25deg. C, 60%RH, 991hPa	MODE	CCK
INPUT POWER (SYSTEM)	120Vac, 60 Hz	DETECTOR FUNCTION	Peak(PK) Average (AV)
TESTED BY	Leo Hung		

ANTENNA POLARITY & TEST DISTANCE: HORIZONTAL AT 3M

No.	Freq. (MHz)	Emission Level (dBuV/m)	Limit (dBuV/m)	Margin (dB)	Antenna Height (m)	Table Angle (Degree)	Raw Value (dBuV)	Correction Factor (dB/m)
1	2016.00	55.60 PK	74.00	-18.40	1.00 H	297	23.64	31.96
1	2016.00	53.46 AV	54.00	-0.54	1.00 H	297	21.50	31.96
2	2360.00	45.24 PK	74.00	-28.76	1.00 H	54	11.56	33.68
2	2360.00	37.15 AV	54.00	-16.85	1.00 H	54	3.47	33.68
3	2390.00	43.20 PK	74.00	-30.80	1.59 H	31	9.37	33.83
3	2390.00	35.44 AV	54.00	-18.56	1.59 H	31	1.61	33.83
4	*2462.00	96.89 PK			1.59 H	31	62.73	34.16
4	*2462.00	89.13 AV			1.59 H	31	54.97	34.16
5	2688.00	44.30 PK	74.00	-29.70	1.11 H	360	9.44	34.86
5	2688.00	32.42 AV	54.00	-21.58	1.11 H	360	-2.44	34.86
6	4924.00	50.73 PK	74.00	-23.27	1.01 H	208	9.87	40.86
6	4924.00	38.31 AV	54.00	-15.69	1.01 H	208	-2.55	40.86

ANTENNA POLARITY & TEST DISTANCE: VERTICAL AT 3M

No.	Freq. (MHz)	Emission Level (dBuV/m)	Limit (dBuV/m)	Margin (dB)	Antenna Height (m)	Table Angle (Degree)	Raw Value (dBuV)	Correction Factor (dB/m)
1	2016.00	55.77 PK	74.00	-18.23	1.09 V	182	23.81	31.96
1	2016.00	52.95 AV	54.00	-1.05	1.09 V	182	20.99	31.96
2	2360.00	54.04 PK	74.00	-19.96	1.22 V	353	20.36	33.68
2	2360.00	44.52 AV	54.00	-9.48	1.22 V	353	10.84	33.68
3	*2462.00	110.49 PK			1.13 V	301	76.33	34.16
3	*2462.00	102.51 AV			1.13 V	301	68.35	34.16
4	2483.50	56.80 PK	74.00	-17.20	1.13 V	301	22.54	34.26
4	2483.50	48.82 AV	54.00	-5.18	1.13 V	301	14.56	34.26
5	2688.00	47.46 PK	74.00	-26.54	1.06 V	360	12.60	34.86
5	2688.00	40.90 AV	54.00	-13.10	1.06 V	360	6.04	34.86
6	4924.00	53.76 PK	74.00	-20.24	1.05 V	264	12.90	40.86
6	4924.00	45.51 AV	54.00	-8.49	1.05 V	264	4.65	40.86

- REMARKS:**
1. Emission level(dBuV/m)=Raw Value(dBuV) + Correction Factor(dB)
 2. Correction Factor(dB/m) = Antenna Factor (dB/m) + Cable Factor (dB)
 3. The other emission levels were very low against the limit.
 4. Margin value = Emission level – Limit value.
 5. The limit value is defined as per 15.247
 6. “ * “ : Fundamental frequency

**Normal mode**

EUT	Wireless A+G Mini PCI Card	MODEL	WMCE54AG
CHANNEL	Channel 1	FREQUENCY RANGE	1 ~ 25GHz
INPUT POWER (SYSTEM)	120Vac, 60 Hz	DETECTOR FUNCTION	Peak(PK) Average (AV)
ENVIRONMENTAL CONDITIONS	25deg. C, 60%RH, 991hPa	MODE	OFDM
TESTED BY	Leo Hung		

ANTENNA POLARITY & TEST DISTANCE: HORIZONTAL AT 3 M

No.	Freq. (MHz)	Emission Level (dBuV/m)	Limit (dBuV/m)	Margin (dB)	Antenna Height (m)	Table Angle (Degree)	Raw Value (dBuV)	Correction Factor (dB/m)
1	1600.00	40.80 PK	74.00	-33.20	1.05 H	155	10.68	30.12
1	1600.00	29.66 AV	54.00	-24.34	1.05 H	155	-0.46	30.12
2	2016.00	49.94 PK	74.00	-24.06	1.00 H	93	17.98	31.96
2	2016.00	45.49 AV	54.00	-8.51	1.00 H	93	13.53	31.96
3	2360.00	48.04 PK	74.00	-25.96	1.35 H	93	14.36	33.68
3	2360.00	38.45 AV	54.00	-15.55	1.35 H	93	4.77	33.68
4	2390.00	54.84 PK	74.00	-19.16	1.36 H	114	21.01	33.83
4	2390.00	45.33 AV	54.00	-8.67	1.36 H	114	11.50	33.83
5	*2412.00	102.18 PK			1.36 H	114	68.25	33.93
5	*2412.00	92.67 AV			1.36 H	114	58.74	33.93
6	2688.00	45.64 PK	74.00	-28.36	1.16 H	333	10.78	34.86
6	2688.00	33.41 AV	54.00	-20.59	1.16 H	333	-1.45	34.86
7	4824.00	50.95 PK	74.00	-23.05	1.10 H	255	10.29	40.66
7	4824.00	38.87 AV	54.00	-15.13	1.10 H	255	-1.79	40.66

- REMARKS:**
1. Emission level(dBuV/m)=Raw Value(dBuV) + Correction Factor(dB)
 2. Correction Factor(dB/m) = Antenna Factor (dB/m) + Cable Factor (dB)
 3. The other emission levels were very low against the limit.
 4. Margin value = Emission level – Limit value.
 5. The limit value is defined as per 15.247
 6. “ * “ : Fundamental frequency



EUT	Wireless A+G Mini PCI Card	MODEL	WMCE54AG
CHANNEL	Channel 1	FREQUENCY RANGE	1 ~ 25GHz
INPUT POWER (SYSTEM)	120Vac, 60 Hz	DETECTOR FUNCTION	Peak(PK) Average (AV)
ENVIRONMENTAL CONDITIONS	25deg. C, 60%RH, 991hPa	MODE	OFDM
TESTED BY	Leo Hung		

ANTENNA POLARITY & TEST DISTANCE: VERTICAL AT 3 M

No.	Freq. (MHz)	Emission Level (dBuV/m)	Limit (dBuV/m)	Margin (dB)	Antenna Height (m)	Table Angle (Degree)	Raw Value (dBuV)	Correction Factor (dB/m)
1	1600.00	42.80 PK	74.00	-31.20	1.05 V	78	12.68	30.12
1	1600.00	33.54 AV	54.00	-20.46	1.05 V	78	3.42	30.12
2	2016.00	49.87 PK	74.00	-24.13	1.02 V	219	17.91	31.96
2	2016.00	46.56 AV	54.00	-7.44	1.02 V	219	14.60	31.96
3	2360.00	52.29 PK	74.00	-21.71	1.46 V	51	18.61	33.68
3	2360.00	43.23 AV	54.00	-10.77	1.46 V	51	9.55	33.68
4	2390.00	59.37 PK	74.00	-14.63	1.15 V	360	25.54	33.83
4	2390.00	48.71 AV	54.00	-5.29	1.15 V	360	14.88	33.83
5	*2412.00	106.71 PK			1.15 V	360	72.78	33.93
5	*2412.00	96.05 AV			1.15 V	360	62.12	33.93
6	2688.00	46.48 PK	74.00	-27.52	1.28 V	125	11.62	34.86
6	2688.00	38.38 AV	54.00	-15.62	1.28 V	125	3.52	34.86
7	4824.00	50.86 PK	74.00	-23.14	1.00 V	22	10.20	40.66
7	4824.00	38.79 AV	54.00	-15.21	1.00 V	22	-1.87	40.66

- REMARKS:**
1. Emission level(dBuV/m)=Raw Value(dBuV) + Correction Factor(dB)
 2. Correction Factor(dB/m) = Antenna Factor (dB/m) + Cable Factor (dB)
 3. The other emission levels were very low against the limit.
 4. Margin value = Emission level – Limit value.
 5. The limit value is defined as per 15.247
 6. “ * “ : Fundamental frequency



EUT	Wireless A+G Mini PCI Card	MODEL	WMCE54AG
CHANNEL	Channel 6	FREQUENCY RANGE	1 ~ 25GHz
INPUT POWER (SYSTEM)	120Vac, 60 Hz	DETECTOR FUNCTION	Peak(PK) Average (AV)
ENVIRONMENTAL CONDITIONS	25deg. C, 60%RH, 991hPa	MODE	OFDM
TESTED BY	Leo Hung		

ANTENNA POLARITY & TEST DISTANCE: HORIZONTAL AT 3M

No.	Freq. (MHz)	Emission Level (dBuV/m)	Limit (dBuV/m)	Margin (dB)	Antenna Height (m)	Table Angle (Degree)	Raw Value (dBuV)	Correction Factor (dB/m)
1	2016.00	50.28 PK	74.00	-23.72	1.31 H	112	18.32	31.96
1	2016.00	49.07 AV	54.00	-4.93	1.31 H	112	17.11	31.96
2	2360.00	46.18 PK	74.00	-27.82	1.21 H	145	12.50	33.68
2	2360.00	33.88 AV	54.00	-20.12	1.21 H	145	0.20	33.68
3	*2437.00	99.41 PK			1.33 H	115	65.36	34.05
3	*2437.00	90.29 AV			1.33 H	115	56.24	34.05
4	2688.00	44.33 PK	74.00	-29.67	1.00 H	360	9.47	34.86
4	2688.00	32.72 AV	54.00	-21.28	1.00 H	360	-2.14	34.86
5	4874.00	50.62 PK	74.00	-23.38	1.04 H	334	9.93	40.69
5	4874.00	38.99 AV	54.00	-15.01	1.04 H	334	9.93	40.69

ANTENNA POLARITY & TEST DISTANCE: VERTICAL AT 3M

No.	Freq. (MHz)	Emission Level (dBuV/m)	Limit (dBuV/m)	Margin (dB)	Antenna Height (m)	Table Angle (Degree)	Raw Value (dBuV)	Correction Factor (dB/m)
1	2016.00	47.71 PK	74.00	-26.29	1.12 V	152	15.75	31.96
1	2016.00	45.51 AV	54.00	-8.49	1.12 V	152	13.55	31.96
2	2360.00	49.83 PK	74.00	-24.17	1.20 V	360	16.15	33.68
2	2360.00	41.74 AV	54.00	-12.26	1.20 V	360	8.06	33.68
3	*2437.00	106.60 PK			1.17 V	14	72.55	34.05
3	*2437.00	95.43 AV			1.17 V	14	61.38	34.05
4	2688.00	47.18 PK	74.00	-26.82	1.04 V	16	12.32	34.86
4	2688.00	40.82 AV	54.00	-13.18	1.04 V	16	5.96	34.86
5	4874.00	50.07 PK	74.00	-23.93	1.12 V	231	9.38	40.69
5	4874.00	38.48 AV	54.00	-15.52	1.12 V	231	-2.21	40.69

- REMARKS:**
1. Emission level(dBuV/m)=Raw Value(dBuV) + Correction Factor(dB)
 2. Correction Factor(dB/m) = Antenna Factor (dB/m) + Cable Factor (dB)
 3. The other emission levels were very low against the limit.
 4. Margin value = Emission level – Limit value.
 5. The limit value is defined as per 15.247
 6. “ * “ : Fundamental frequency



EUT	Wireless A+G Mini PCI Card	MODEL	WMCE54AG
CHANNEL	Channel 11	FREQUENCY RANGE	1 ~ 25GHz
INPUT POWER (SYSTEM)	120Vac, 60 Hz	DETECTOR FUNCTION	Peak(PK) Average (AV)
ENVIRONMENTAL CONDITIONS	25deg. C, 60%RH, 991hPa	MODE	OFDM
TESTED BY	Leo Hung		

ANTENNA POLARITY & TEST DISTANCE: HORIZONTAL AT 3M

No.	Freq. (MHz)	Emission Level (dBuV/m)	Limit (dBuV/m)	Margin (dB)	Antenna Height (m)	Table Angle (Degree)	Raw Value (dBuV)	Correction Factor (dB/m)
1	2016.00	50.40 PK	74.00	-23.60	1.04 H	120	18.44	31.96
1	2016.00	49.06 AV	54.00	-4.94	1.04 H	120	17.10	31.96
2	2360.00	48.10 PK	74.00	-25.90	1.41 H	130	14.42	33.68
2	2360.00	38.37 AV	54.00	-15.63	1.41 H	130	4.69	33.68
3	*2462.00	95.71 PK			1.49 H	20	61.55	34.16
3	*2462.00	85.38 AV			1.49 H	20	51.22	34.16
4	2483.50	46.85 PK	74.00	-27.15	1.49 H	20	12.59	34.26
4	2483.50	36.52 AV	54.00	-17.48	1.49 H	20	2.26	34.26
5	2688.00	44.04 PK	74.00	-29.96	1.00 H	251	9.18	34.86
5	2688.00	32.64 AV	54.00	-21.36	1.00 H	251	-2.22	34.86
6	4924.00	50.51 PK	74.00	-23.49	1.10 H	125	9.65	40.86
6	4924.00	39.09 AV	54.00	-14.91	1.10 H	125	-1.77	40.86

ANTENNA POLARITY & TEST DISTANCE: VERTICAL AT 3M

No.	Freq. (MHz)	Emission Level (dBuV/m)	Limit (dBuV/m)	Margin (dB)	Antenna Height (m)	Table Angle (Degree)	Raw Value (dBuV)	Correction Factor (dB/m)
1	2016.00	55.66 PK	87.30	-31.64	1.07 V	189	23.70	31.96
1	2016.00	54.23 AV	77.40	-23.17	1.07 V	189	22.27	31.96
2	2360.00	50.66 PK	74.00	-23.34	1.37 V	265	16.98	33.68
2	2360.00	43.58 AV	54.00	-10.42	1.37 V	265	9.90	33.68
3	*2462.00	107.30 PK			1.13 V	355	73.14	34.16
3	*2462.00	97.40 AV			1.13 V	355	63.24	34.16
4	2483.50	58.44 PK	74.00	-15.56	1.13 V	355	24.18	34.26
4	2483.50	48.54 AV	54.00	-5.46	1.13 V	355	14.28	34.26
5	2688.00	46.46 PK	74.00	-27.54	1.20 V	220	11.60	34.86
5	2688.00	39.49 AV	54.00	-14.51	1.20 V	220	4.63	34.86
6	4924.00	43.07 PK	74.00	-30.93	1.12 V	221	2.21	40.86
6	4924.00	32.35 AV	54.00	-21.65	1.12 V	221	-8.51	40.86

- REMARKS:**
1. Emission level(dBuV/m)=Raw Value(dBuV) + Correction Factor(dB)
 2. Correction Factor(dB/m) = Antenna Factor (dB/m) + Cable Factor (dB)
 3. The other emission levels were very low against the limit.
 4. Margin value = Emission level – Limit value.
 5. The limit value is defined as per 15.247
 6. “ * “ : Fundamental frequency

**Turbo mode**

EUT	Wireless A+G Mini PCI Card	MODEL	WMCE54AG
CHANNEL	Channel 6	FREQUENCY RANGE	1 ~ 25GHz
INPUT POWER (SYSTEM)	120Vac, 60 Hz	DETECTOR FUNCTION	Peak(PK) Average (AV)
ENVIRONMENTAL CONDITIONS	25deg. C, 55%RH, 991hPa	MODE	OFDM
TESTED BY	Leo Hung		

ANTENNA POLARITY & TEST DISTANCE: HORIZONTAL AT 3M

No.	Freq. (MHz)	Emission Level (dBuV/m)	Limit (dBuV/m)	Margin (dB)	Antenna Height (m)	Table Angle (Degree)	Raw Value (dBuV)	Correction Factor (dB/m)
1	2016.00	51.26 PK	74.00	-22.74	1.17 H	115	19.30	31.96
1	2016.00	48.93 AV	54.00	-5.07	1.17 H	115	16.97	31.96
2	2360.00	47.07 PK	74.00	-26.93	1.35 H	48	13.39	33.68
2	2360.00	37.85 AV	54.00	-16.15	1.35 H	48	4.17	33.68
3	*2437.00	93.60 PK			1.35 H	48	59.55	34.05
3	*2437.00	84.38 AV			1.35 H	48	50.33	34.05
4	2483.50	44.19 PK	74.00	-29.81	1.35 H	48	9.93	34.26
4	2483.50	34.97 AV	54.00	-19.03	1.35 H	48	0.71	34.26
5	2688.00	44.84 PK	74.00	-29.16	1.17 H	115	9.98	34.86
5	2688.00	32.75 AV	54.00	-21.25	1.17 H	115	-2.11	34.86
6	4874.00	51.32 PK	74.00	-22.68	1.00 H	180	10.63	40.69
6	4874.00	38.83 AV	54.00	-15.17	1.00 H	180	-1.86	40.69

ANTENNA POLARITY & TEST DISTANCE: VERTICAL AT 3M

No.	Freq. (MHz)	Emission Level (dBuV/m)	Limit (dBuV/m)	Margin (dB)	Antenna Height (m)	Table Angle (Degree)	Raw Value (dBuV)	Correction Factor (dB/m)
1	2016.00	56.82 PK	85.47	-28.65	1.35 V	232	24.86	31.96
1	2016.00	54.18 AV	75.55	-21.37	1.35 V	232	22.22	31.96
2	2360.00	58.94 PK	74.00	-15.06	1.08 V	76	25.26	33.68
2	2360.00	49.02 AV	54.00	-4.98	1.08 V	76	15.34	33.68
3	*2437.00	105.47 PK			1.08 V	76	71.42	34.05
3	*2437.00	95.55 AV			1.08 V	76	61.50	34.05
4	2483.50	56.06 PK	74.00	-17.94	1.08 V	76	21.80	34.26
4	2483.50	46.14 AV	54.00	-7.86	1.08 V	76	11.88	34.26
5	2688.00	48.34 PK	74.00	-25.66	1.00 V	243	13.48	34.86
5	2688.00	41.76 AV	54.00	-12.24	1.00 V	243	6.90	34.86
6	4874.00	51.50 PK	74.00	-22.50	1.00 V	360	10.81	40.69
6	4874.00	39.20 AV	54.00	-14.80	1.00 V	360	-1.49	40.69

REMARKS:

1. Emission level(dBuV/m)=Raw Value(dBuV) + Correction Factor(dB)
2. Correction Factor(dB/m) = Antenna Factor (dB/m) + Cable Factor (dB)
3. The other emission levels were very low against the limit.
4. Margin value = Emission level – Limit value.
5. The limit value is defined as per 15.247
6. " * " : Fundamental frequency



4.3 6dB BANDWIDTH MEASUREMENT

4.3.1 LIMITS OF 6dB BANDWIDTH MEASUREMENT

The minimum of 6dB Bandwidth Measurement is 0.5 MHz.

4.3.2 TEST INSTRUMENTS

Description & Manufacturer	Model No.	Serial No.	Calibrated Until
SPECTRUM ANALYZER	FSEK 30	100049	Aug. 12, 2005

NOTE: The calibration interval of the above test instruments is 12 months and the calibrations are traceable to NML/ROC and NIST/USA.

4.3.3 TEST PROCEDURE

The transmitter output was connected to the spectrum analyzer through an attenuator. The bandwidth of the fundamental frequency was measured by spectrum analyzer with 100kHz RBW and 100kHz VBW. The 6dB bandwidth is defined as the total spectrum the power of which is higher than peak power minus 6dB.

4.3.4 DEVIATION FROM TEST STANDARD

No deviation

4.3.5 TEST SETUP



4.3.6 EUT OPERATING CONDITIONS

The software provided by client to enable the EUT under transmission condition continuously at lowest, middle and highest channel frequencies individually.



4.3.7 TEST RESULTS

EUT	Wireless A+G Mini PCI Card	MODEL	WMCE54AG
MODE	CCK	INPUT POWER (SYSTEM)	120Vac, 60 Hz
ENVIRONMENTAL CONDITIONS	25deg. C, 64%RH, 991hPa	TESTED BY	Steven Lu

CHANNEL	CHANNEL FREQUENCY (MHz)	6dB BANDWIDTH (MHz)	MINIMUM LIMIT (MHz)	PASS/FAIL
1	2412	11.58	0.5	PASS
6	2437	11.78	0.5	PASS
11	2462	11.98	0.5	PASS



CH1

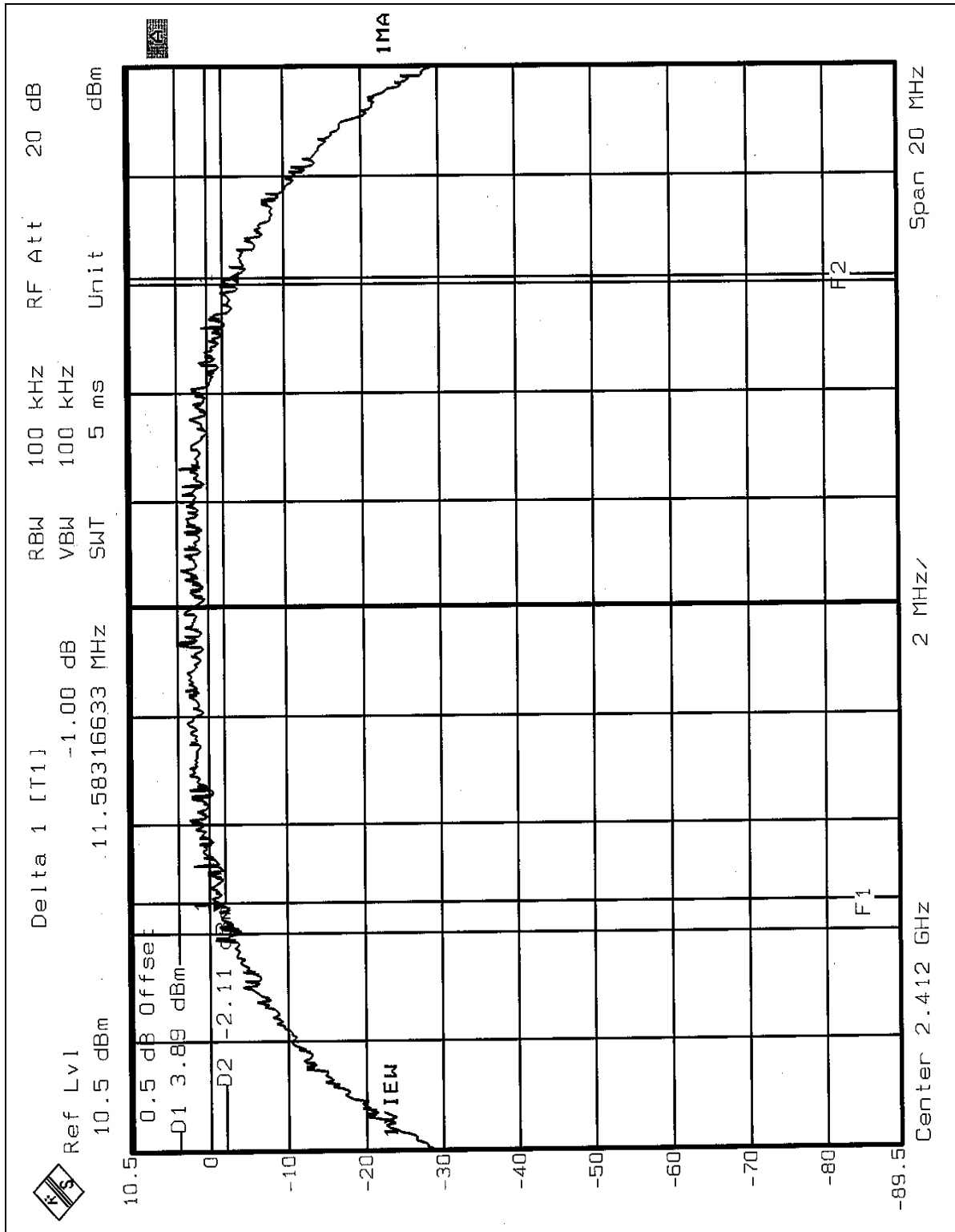



CH6

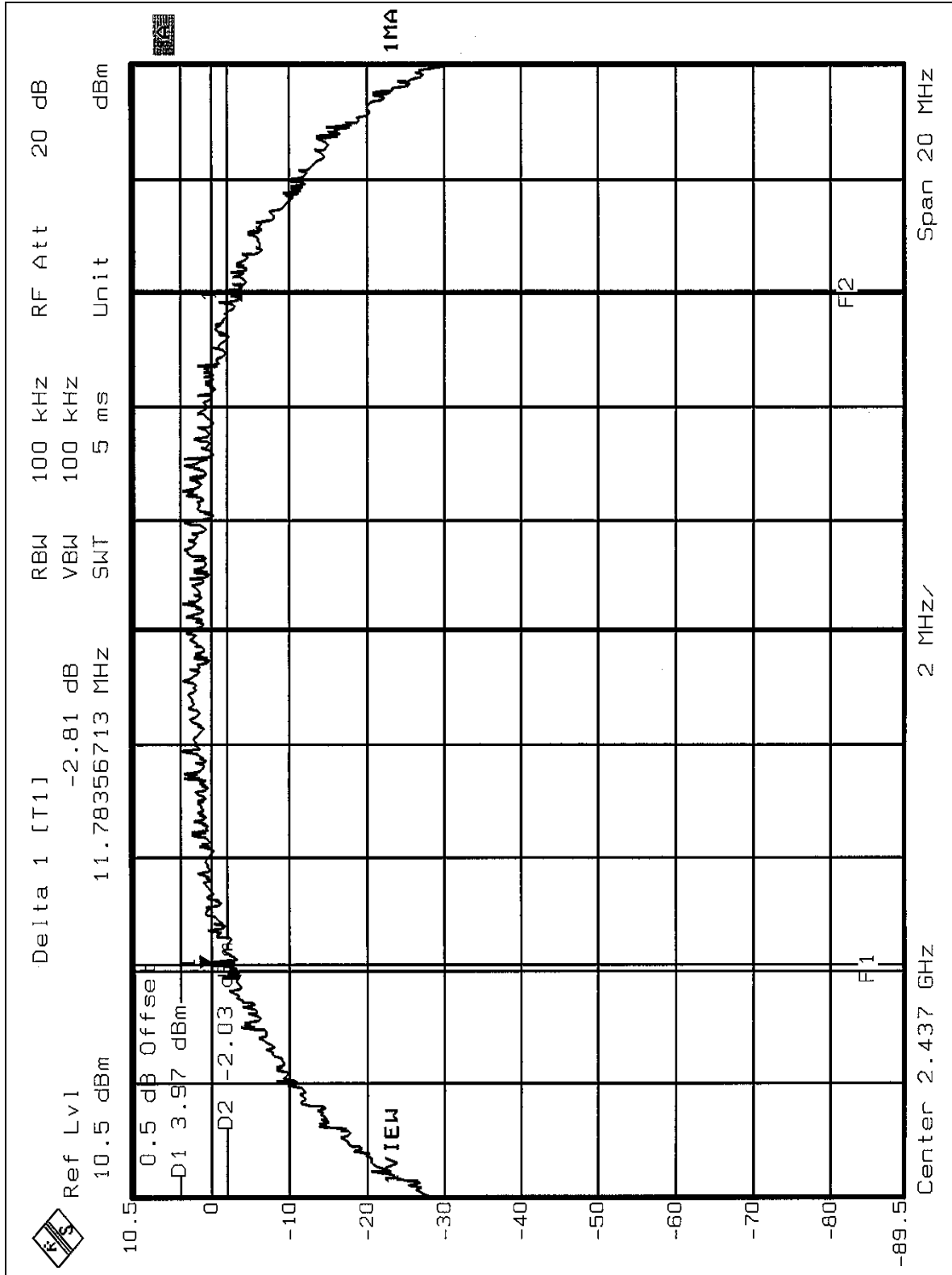



CH11

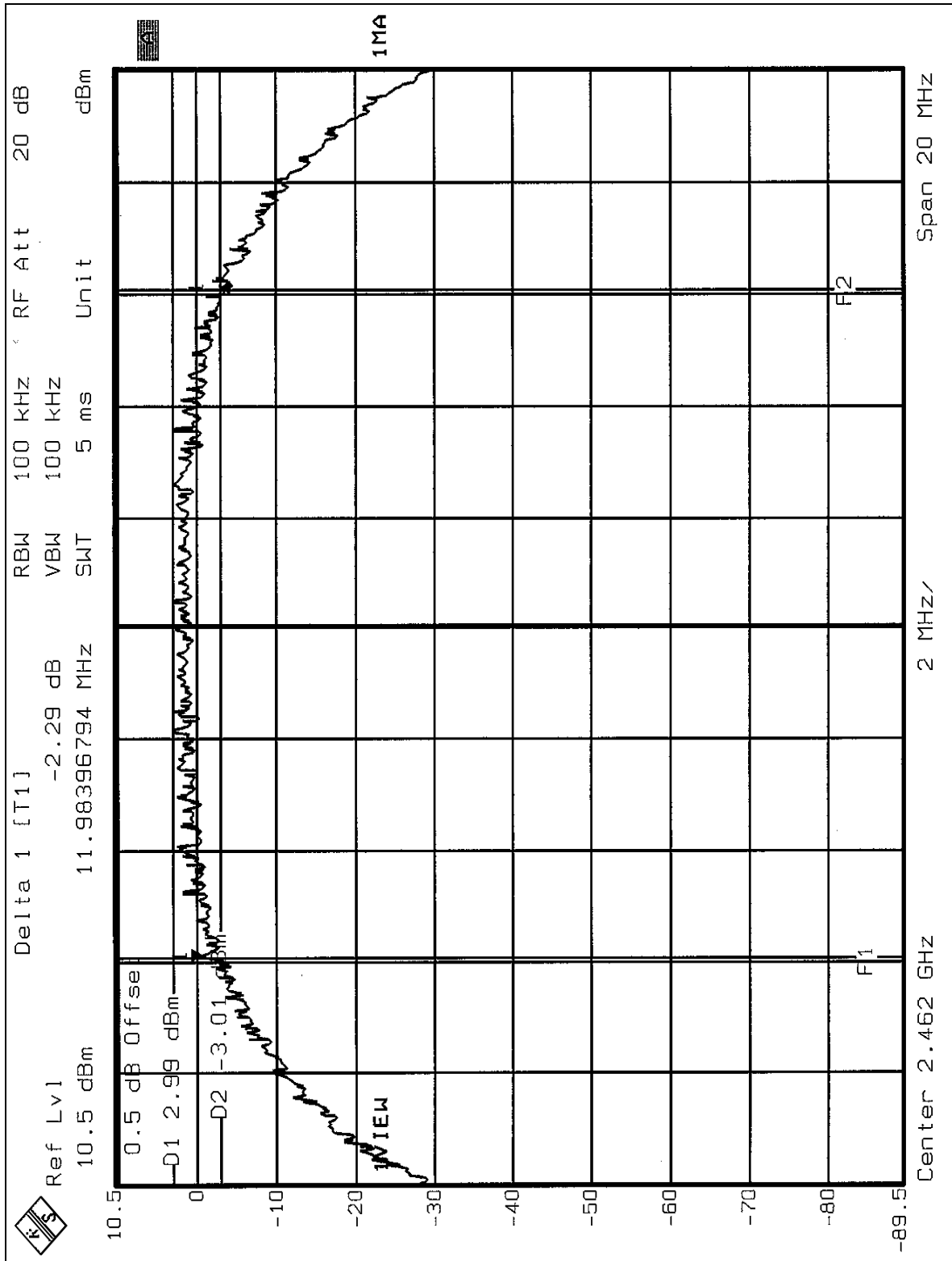

**Normal mode**

EUT	Wireless A+G Mini PCI Card	MODEL	WMCE54AG
MODE	OFDM	INPUT POWER (SYSTEM)	120Vac, 60 Hz
ENVIRONMENTAL CONDITIONS	25deg. C, 64%RH, 991hPa	TESTED BY	Steven Lu

CHANNEL	CHANNEL FREQUENCY (MHz)	6dB BANDWIDTH (MHz)	MINIMUM LIMIT (MHz)	PASS/FAIL
1	2412	16.47	0.5	PASS
6	2437	16.43	0.5	PASS
11	2462	16.39	0.5	PASS



CH1

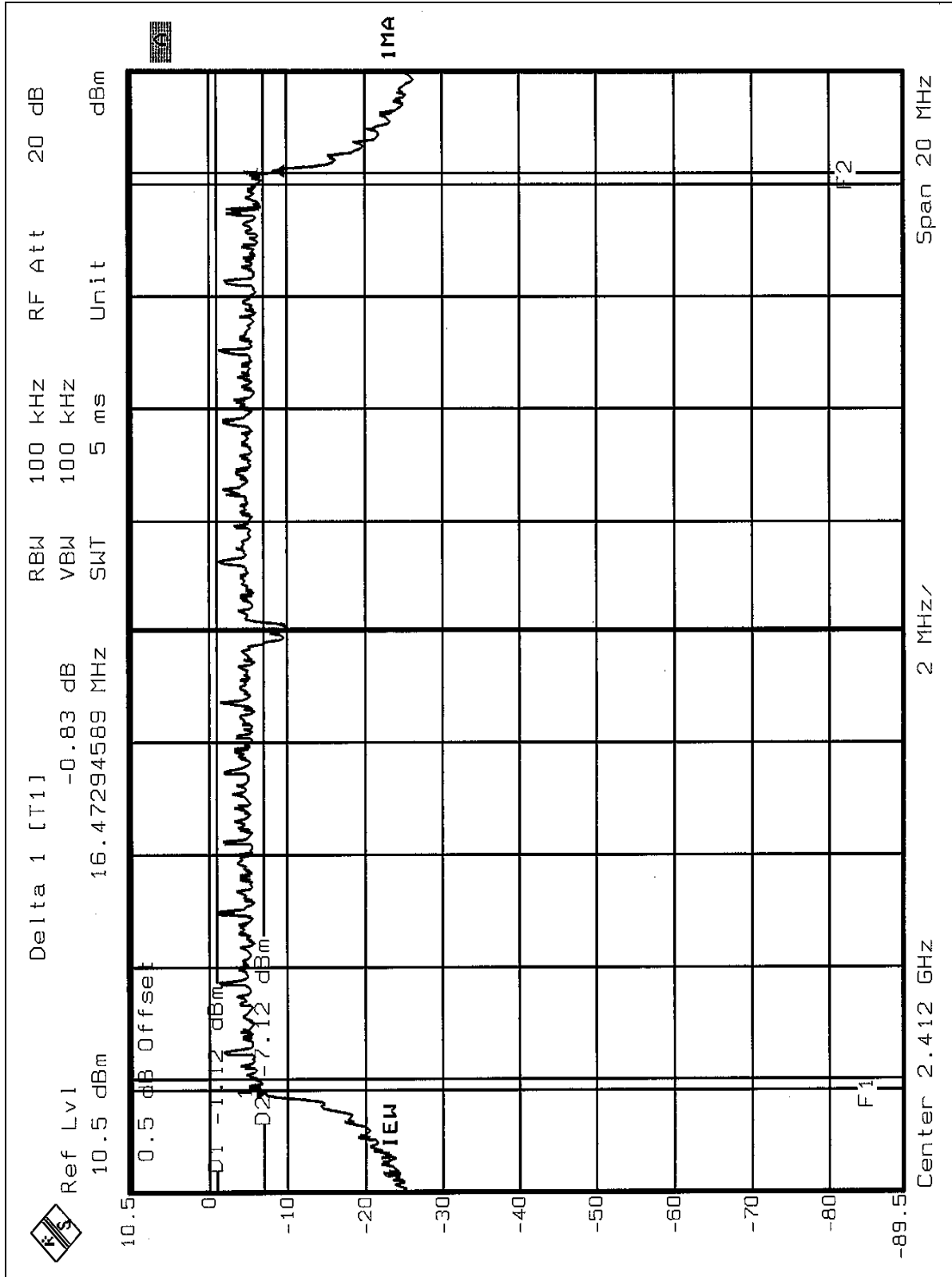



CH6

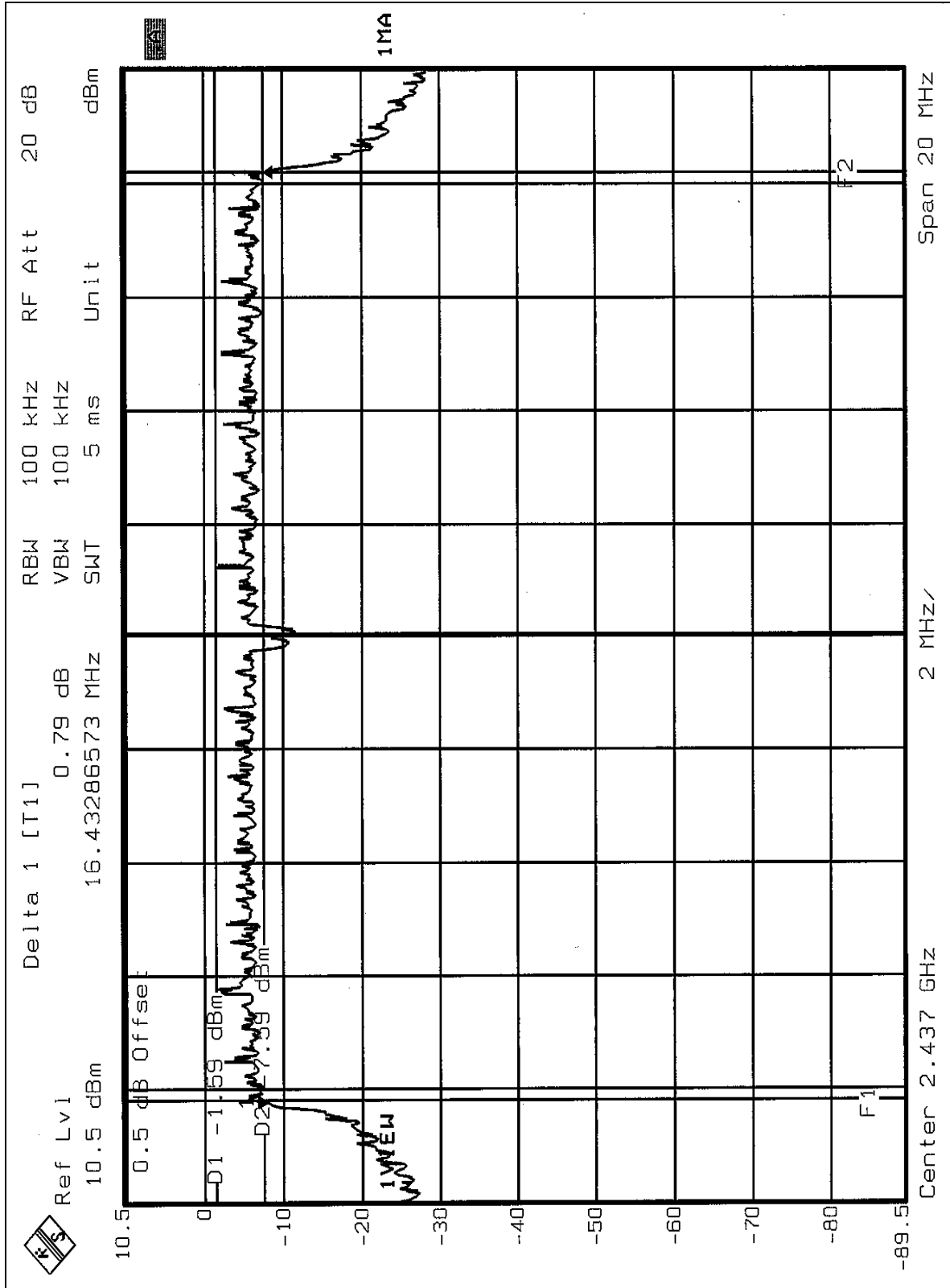



CH11

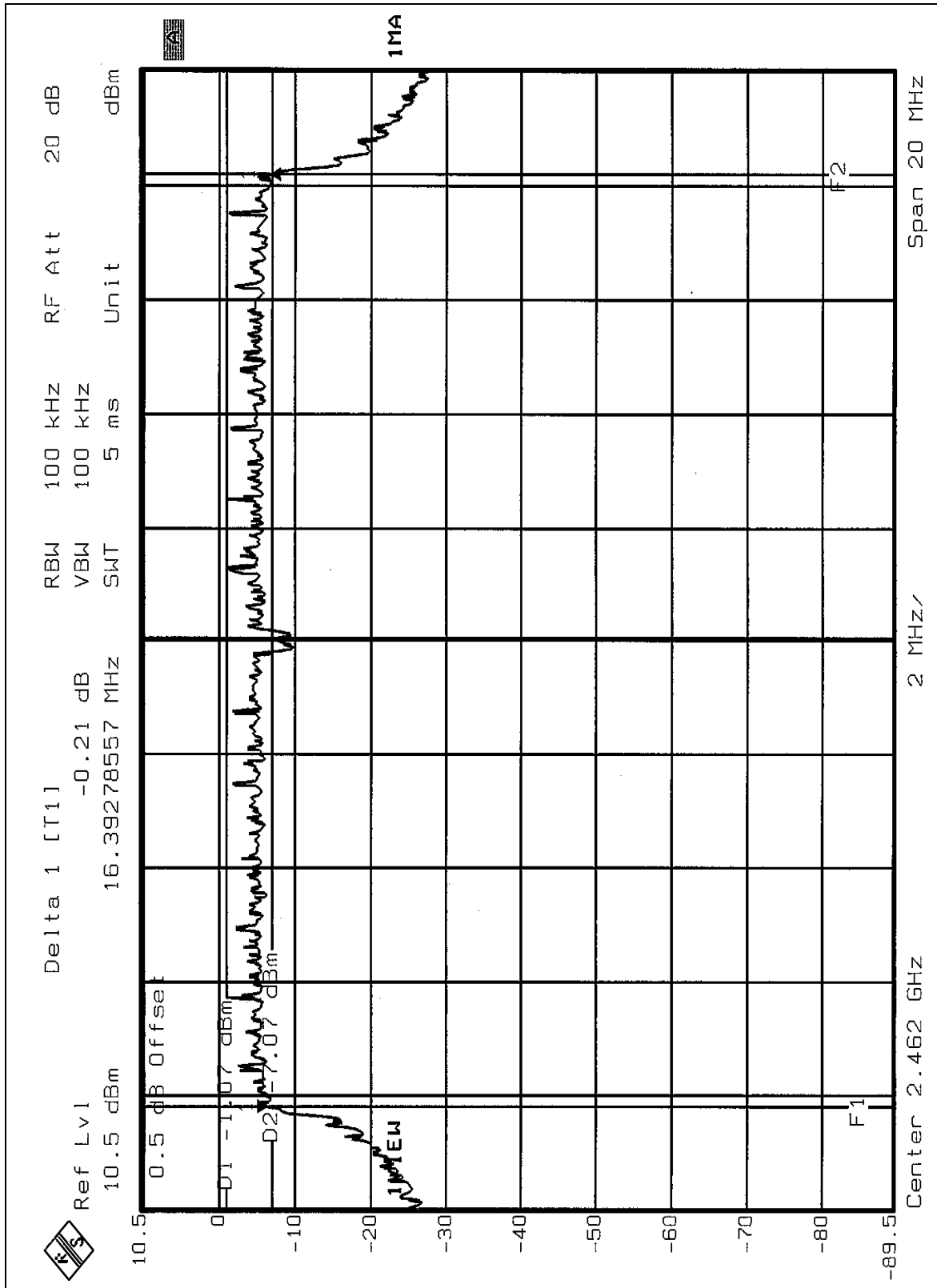



Turbo mode

EUT	Wireless A+G Mini PCI Card	MODEL	WMCE54AG
MODE	OFDM	INPUT POWER (SYSTEM)	120Vac, 60 Hz
ENVIRONMENTAL CONDITIONS	25deg. C, 64%RH, 991hPa	TESTED BY	Steven Lu

CHANNEL	CHANNEL FREQUENCY (MHz)	6dB BANDWIDTH (MHz)	MINIMUM LIMIT (MHz)	PASS/FAIL
6	2437	32.55	0.5	PASS



CH6

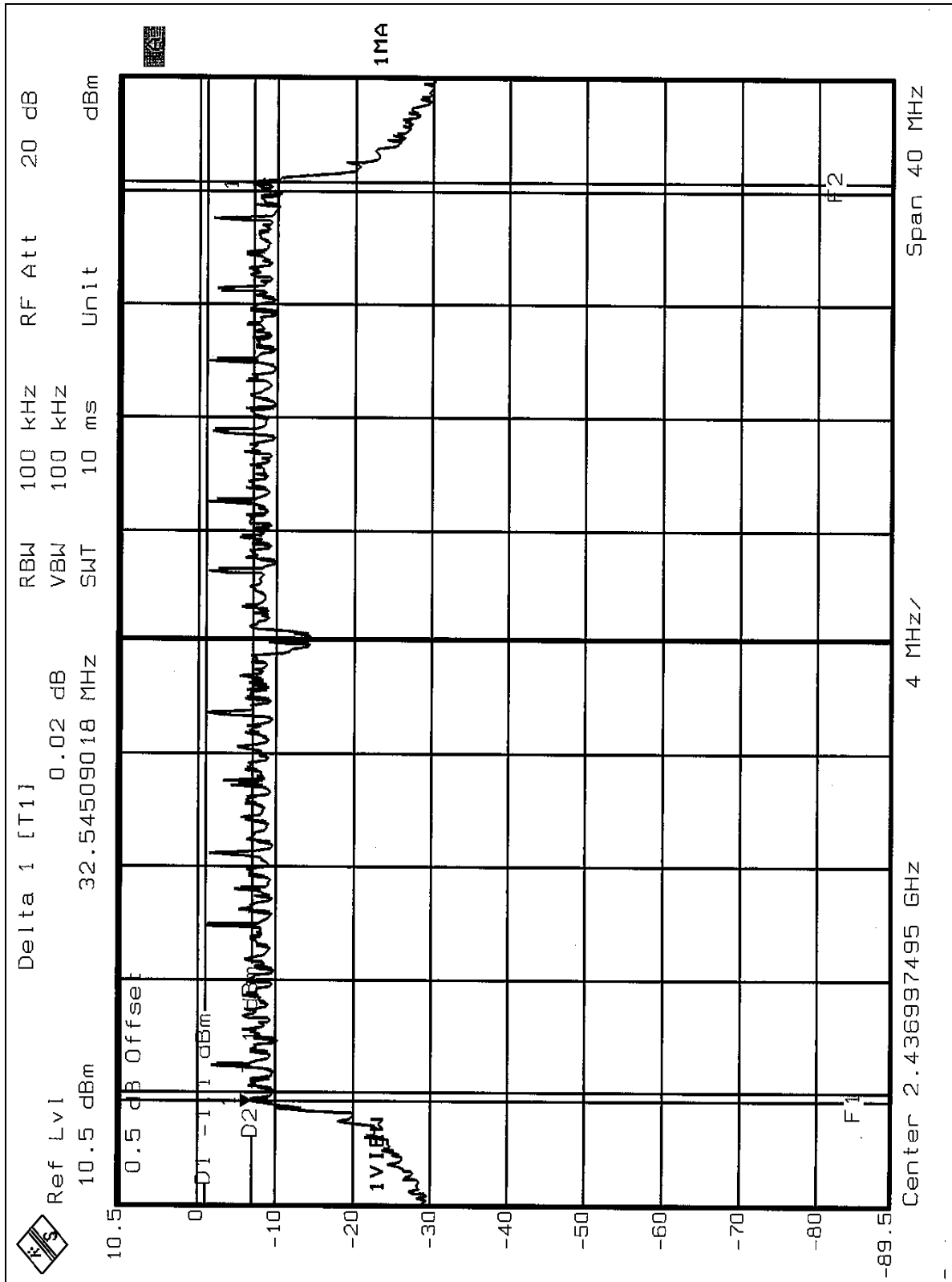



4.4 MAXIMUM PEAK OUTPUT POWER

4.4.1 LIMITS OF MAXIMUM PEAK OUTPUT POWER MEASUREMENT

The Maximum Peak Output Power Measurement is 30dBm.

4.4.2 INSTRUMENTS

Description & Manufacturer	Model No.	Serial No.	Calibrated Until
R&S SPECTRUM ANALYZER	FSEK30	100049	Aug. 12, 2005
AGILENT SIGNAL GENERATOR	E8257C	MY43320668	Dec. 31, 2004
TEKTRONIX OSCILLOSCOPE	TDS 1012	C019167	Feb. 01, 2005
NARDA DETECTOR	4503A	FSCM99899	NA

NOTE:

The calibration interval of the above test instruments is 12 months and the calibrations are traceable to NML/ROC and NIST/USA..



4.4.1 TEST PROCEDURES

1. A detector was used on the output port of the EUT. An oscilloscope was used to read the response of the detector.
2. Replaced the EUT by the signal generator . The center frequency of the S.G was adjusted to the center frequency of the measured channel.
3. Adjusted the power to have the same reading on oscilloscope. Record the power level.

4.4.2 DEVIATION FROM TEST STANDARD

No deviation

4.4.3 TEST SETUP



4.4.4 EUT OPERATING CONDITIONS

Same as Item 4.3.6



4.4.3 TEST RESULTS

EUT	Wireless A+G Mini PCI Card	MODEL	WMCE54AG
INPUT POWER (SYSTEM)	120Vac, 60Hz	ENVIRONMENTAL CONDITIONS	25deg. C, 64%RH, 991hPa
MODE	CCK	TESTED BY	Steven Lu

CHANNEL	CHANNEL FREQUENCY (MHz)	PEAK POWER OUTPUT (mW)	PEAK POWER OUTPUT (dBm)	PEAK POWER LIMIT (dBm)	PASS/FAIL
1	2412	35.65	15.52	30	PASS
6	2437	35.56	15.51	30	PASS
11	2462	35.48	15.50	30	PASS

Normal mode

EUT	Wireless A+G Mini PCI Card	MODEL	WMCE54AG
INPUT POWER (SYSTEM)	120Vac, 60Hz	ENVIRONMENTAL CONDITIONS	25deg. C, 64%RH, 991hPa
MODE	OFDM	TESTED BY	Steven Lu

CHANNEL	CHANNEL FREQUENCY (MHz)	PEAK POWER OUTPUT (mW)	PEAK POWER OUTPUT (dBm)	PEAK POWER LIMIT (dBm)	PASS/FAIL
1	2412	22.44	13.51	30	PASS
6	2437	22.39	13.50	30	PASS
11	2462	22.49	13.52	30	PASS

Turbo mode

EUT	Wireless A+G Mini PCI Card	MODEL	WMCE54AG
INPUT POWER (SYSTEM)	120Vac, 60Hz	ENVIRONMENTAL CONDITIONS	25deg. C, 64%RH, 991hPa
MODE	OFDM	TESTED BY	Steven Lu

CHANNEL	CHANNEL FREQUENCY (MHz)	PEAK POWER OUTPUT (mW)	PEAK POWER OUTPUT (dBm)	PEAK POWER LIMIT (dBm)	PASS/FAIL
6	2437	22.39	13.50	30	PASS



4.5 POWER SPECTRAL DENSITY MEASUREMENT

4.5.1 LIMITS OF POWER SPECTRAL DENSITY MEASUREMENT

The Maximum of Power Spectral Density Measurement is 8dBm.

4.5.2 TEST INSTRUMENTS

Description & Manufacturer	Model No.	Serial No.	Calibrated Until
R&S SPECTRUM ANALYZER	FSEK30	100049	Aug. 12, 2005

NOTE:

The calibration interval of the above test instruments is 12 months and the calibrations are traceable to NML/ROC and NIST/USA.

4.5.3 TEST PROCEDURE

The transmitter output was connected to the spectrum analyzer through an attenuator, the bandwidth of the fundamental frequency was measured with the spectrum analyzer using 3kHz RBW and 30kHz VBW, set sweep time = span/3kHz. The power spectral density was measured and recorded. The sweep time is allowed to be longer than span/3kHz for a full response of the mixer in the spectrum analyzer.

4.5.4 DEVIATION FROM TEST STANDARD

No deviation

4.5.5 TEST SETUP

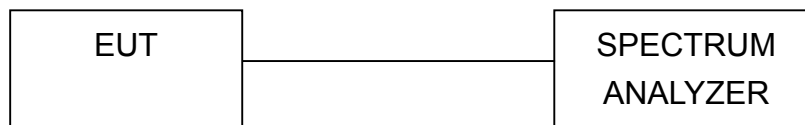

4.5.6 EUT OPERATING CONDITION

Same as Item 4.3.6



4.5.7 TEST RESULTS

EUT	Wireless A+G Mini PCI Card	MODEL	WMCE54AG
INPUT POWER (SYSTEM)	120Vac, 60Hz	ENVIRONMENTAL CONDITIONS	25deg. C, 64%RH, 991hPa
MODE	CCK	TESTED BY	Steven Lu

CHANNEL	CHANNEL FREQUENCY (MHz)	RF POWER LEVEL IN 3kHz BW (dBm)	MAXIMUM LIMIT (dBm)	PASS/FAIL
1	2412	-8.56	8	PASS
6	2437	-8.43	8	PASS
11	2462	-8.84	8	PASS



CH1

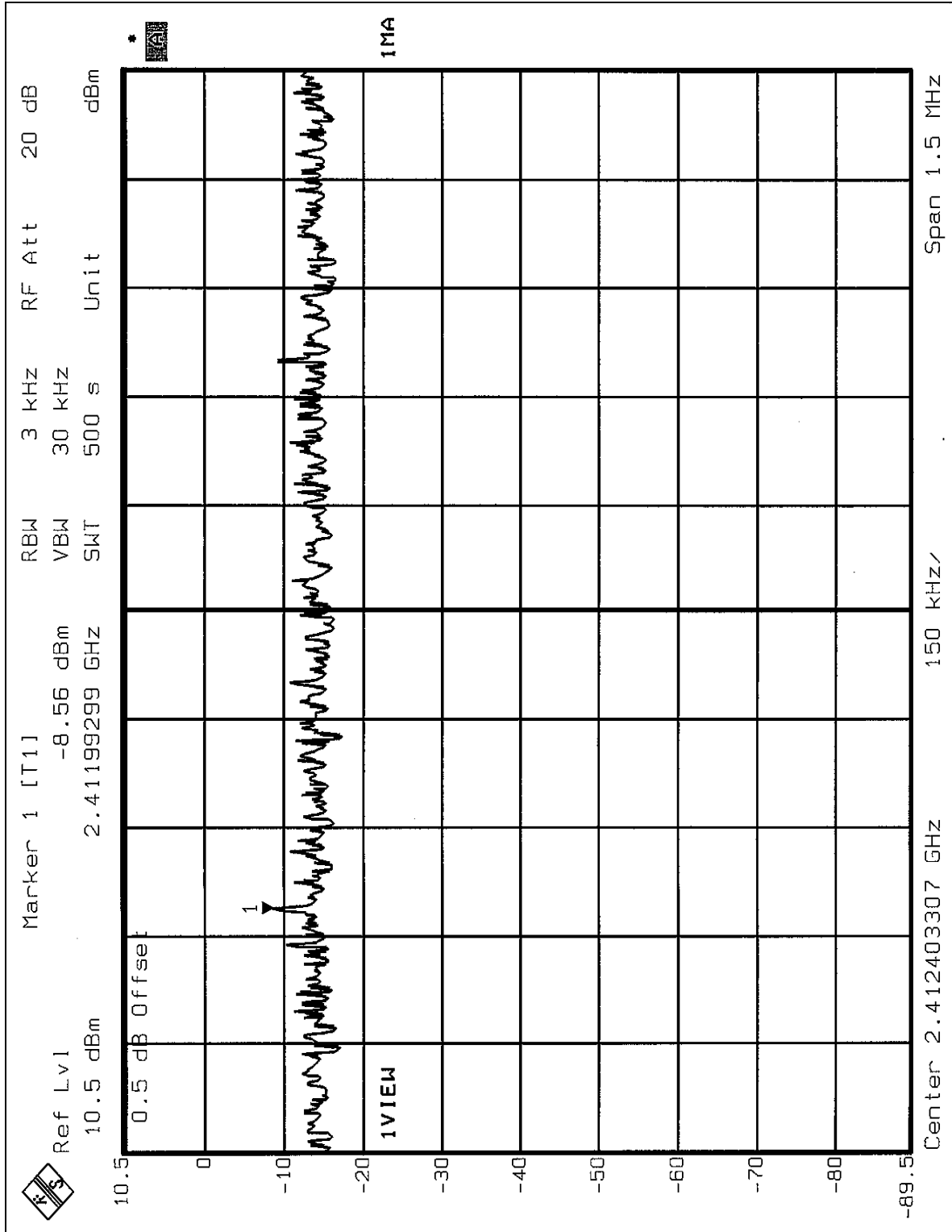



CH6

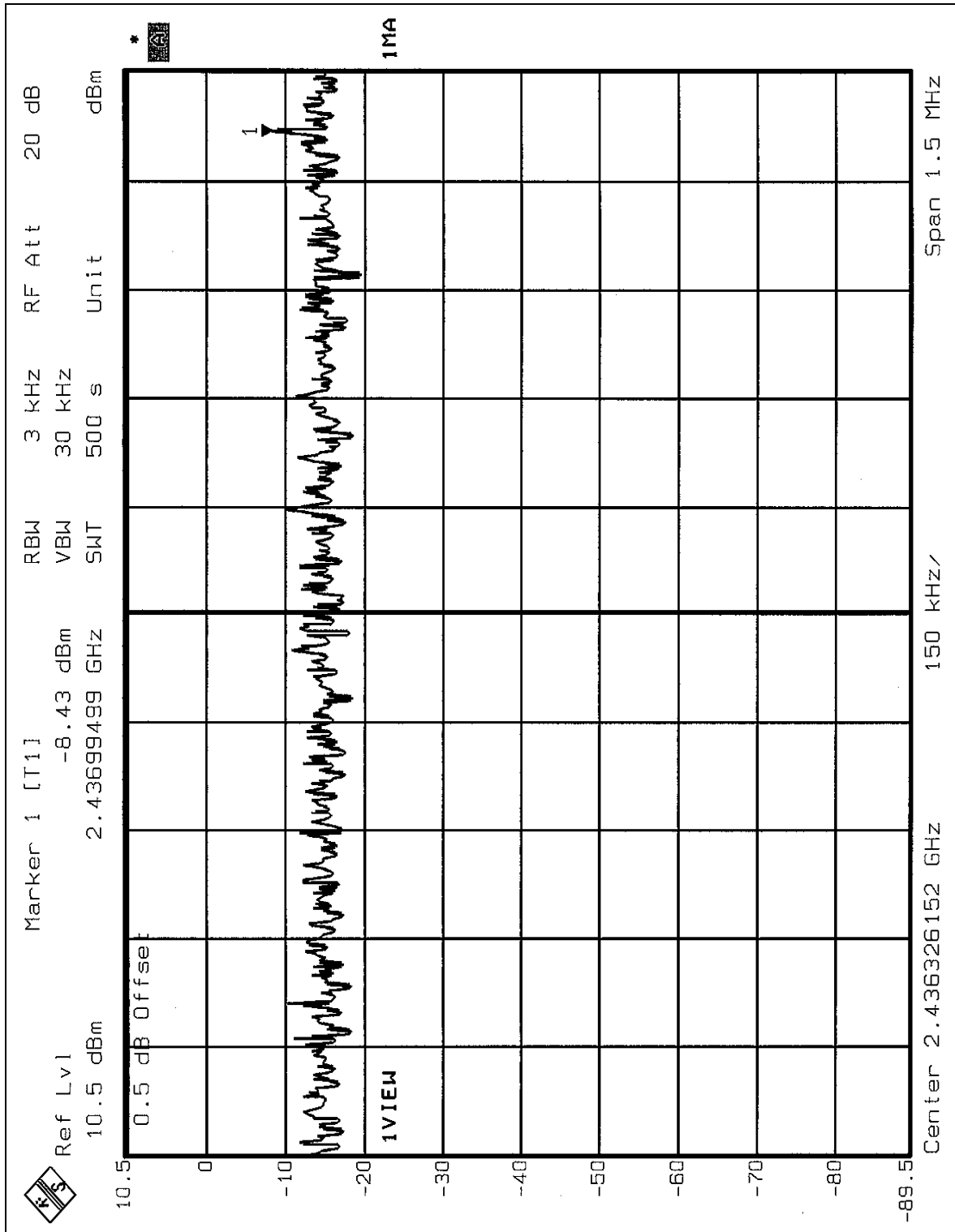



CH11

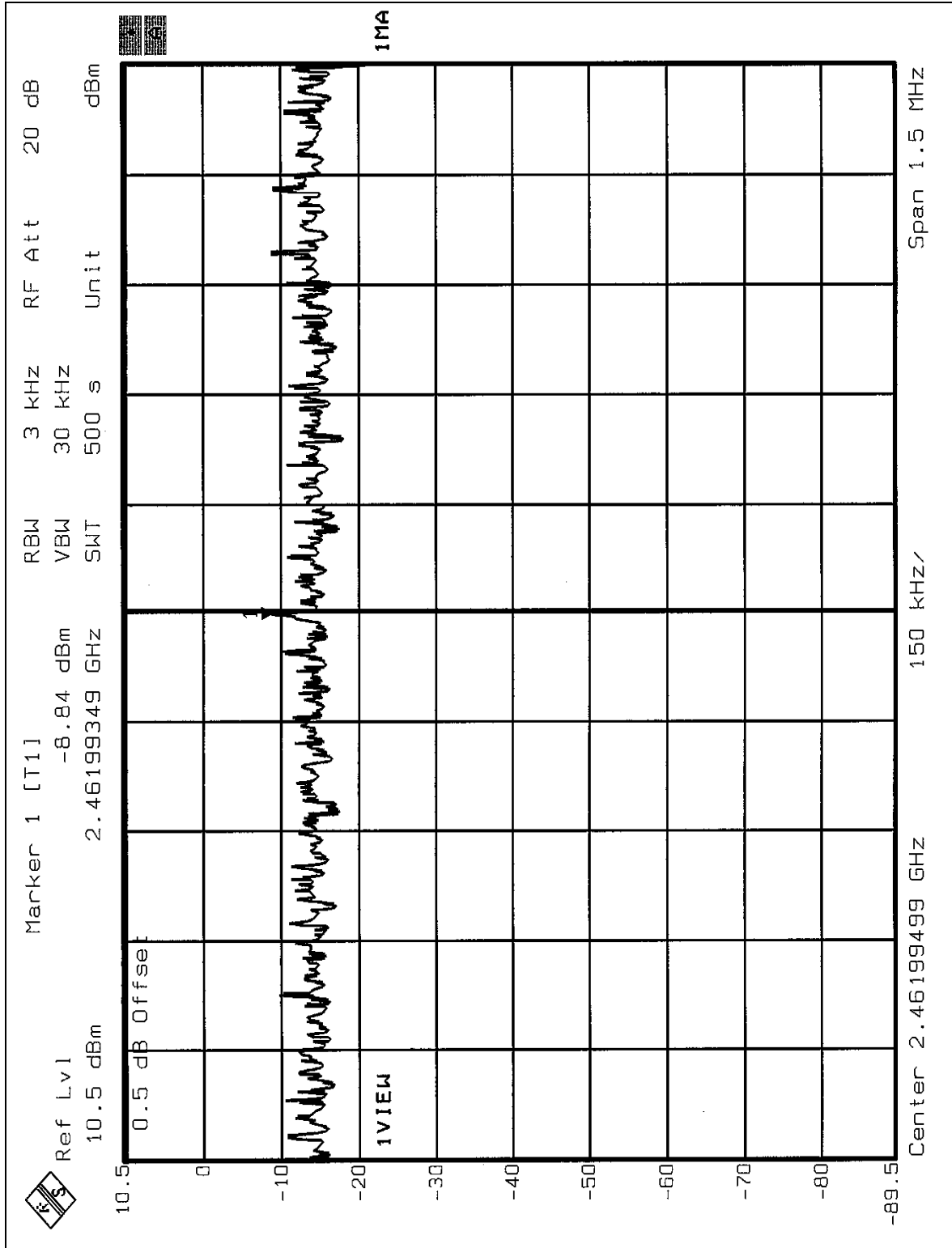

**Normal mode**

EUT	Wireless A+G Mini PCI Card	MODEL	WMCE54AG
INPUT POWER (SYSTEM)	120Vac, 60Hz	ENVIRONMENTAL CONDITIONS	25deg. C, 64%RH, 991hPa
MODE	OFDM	TESTED BY	Steven Lu

CHANNEL	CHANNEL FREQUENCY (MHz)	RF POWER LEVEL IN 3kHz BW (dBm)	MAXIMUM LIMIT (dBm)	PASS/FAIL
1	2412	-16.02	8	PASS
6	2437	-16.40	8	PASS
11	2462	-16.08	8	PASS



CH1

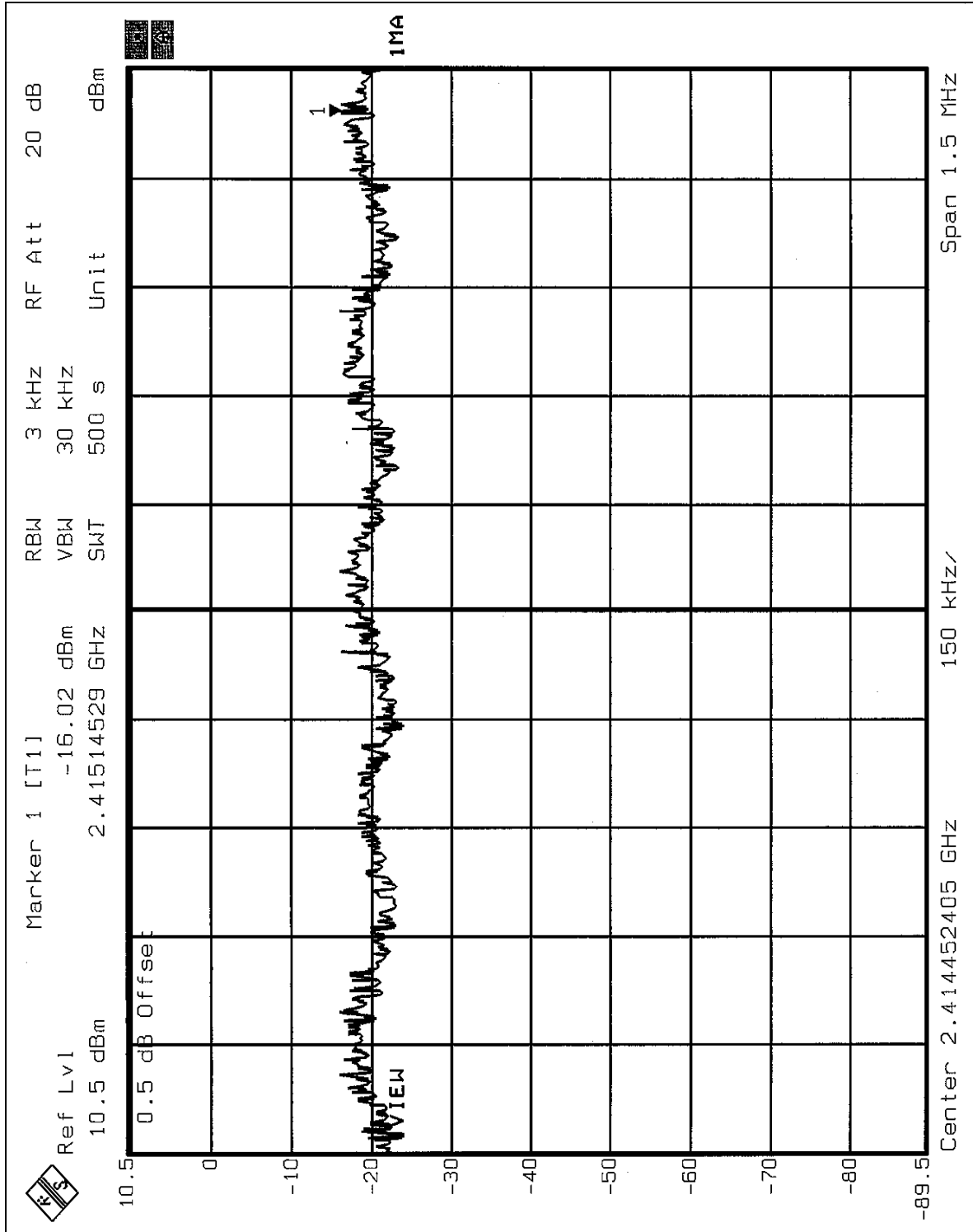



CH6

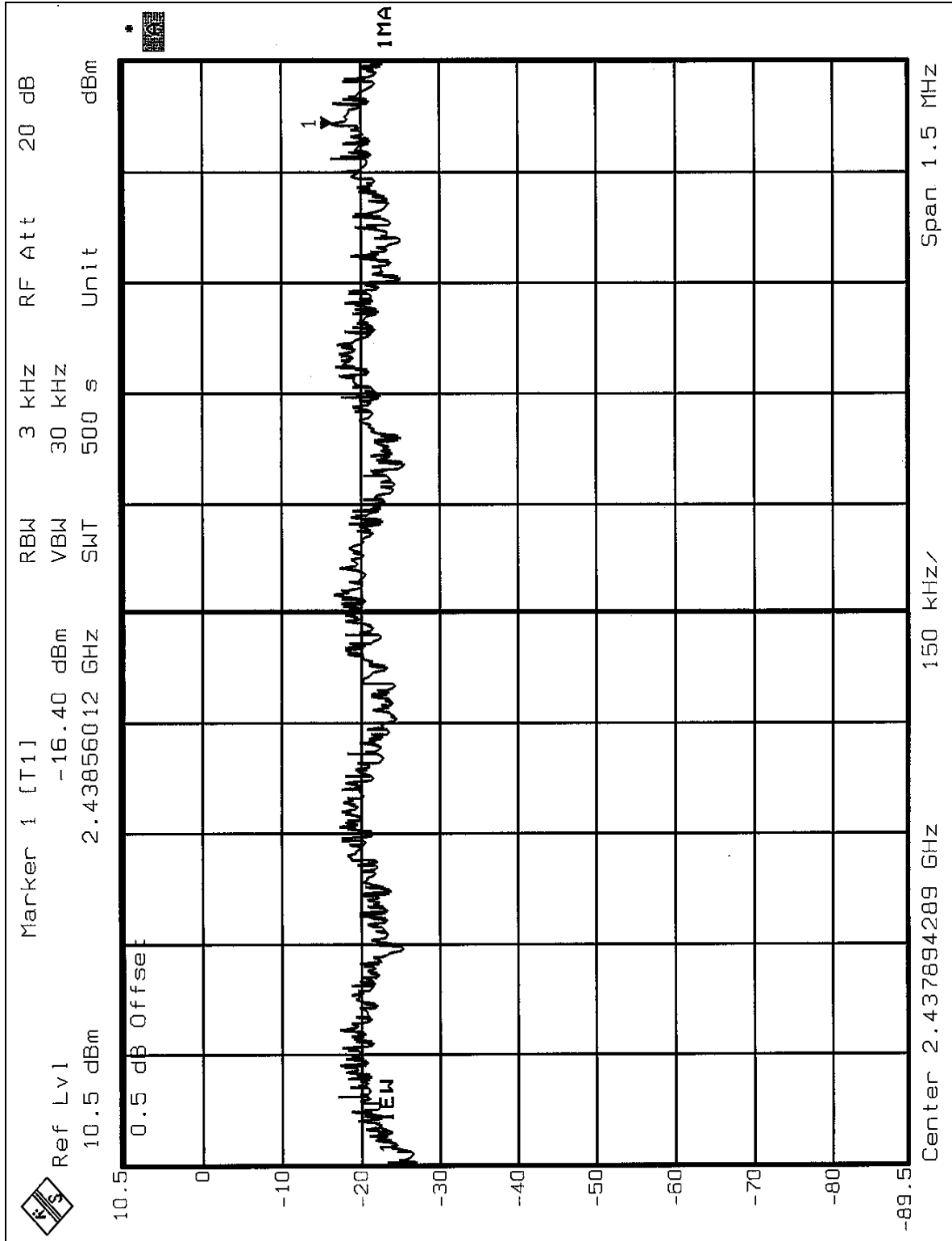



CH11

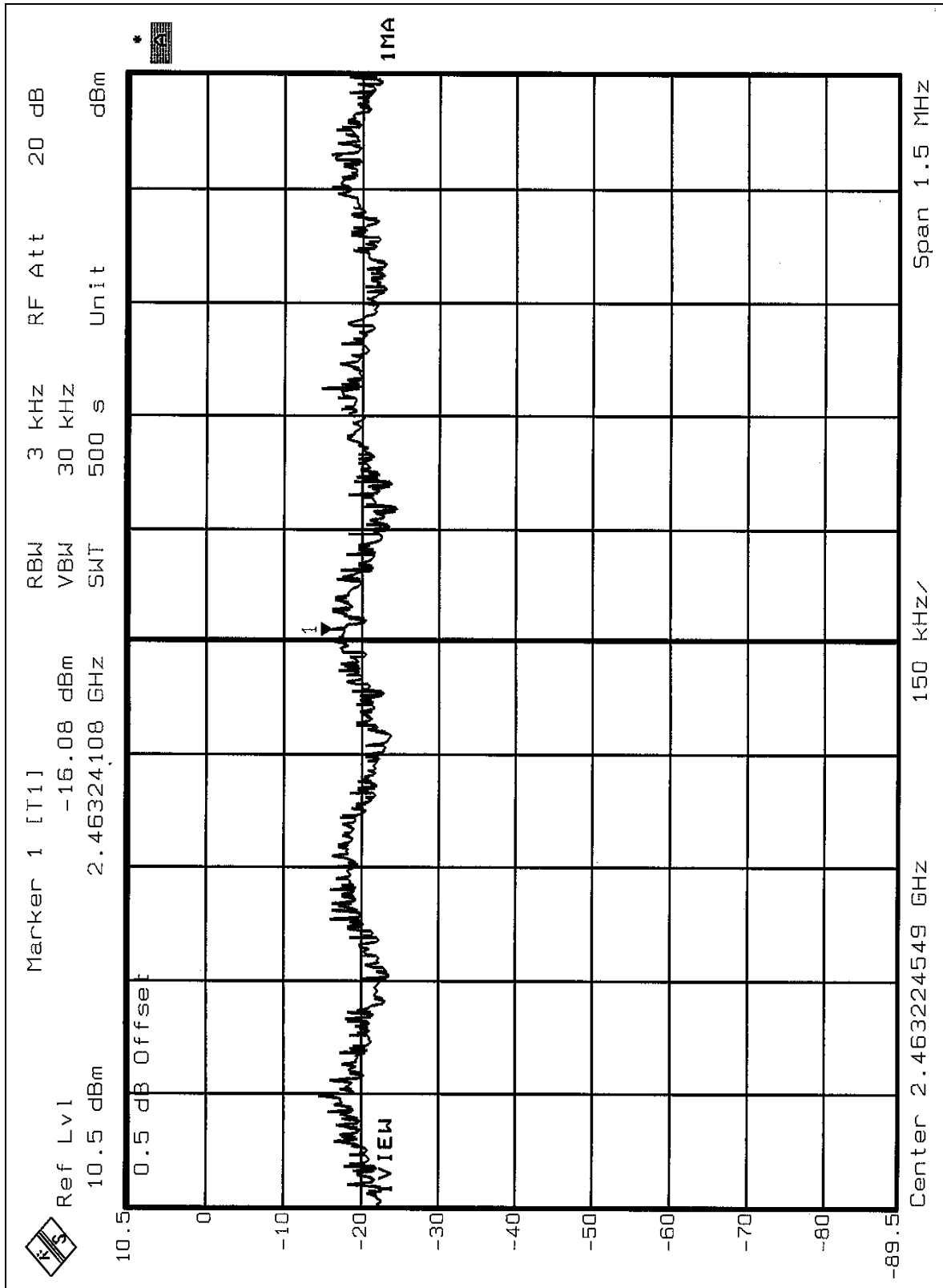



Turbo mode

EUT	Wireless A+G Mini PCI Card	MODEL	WMCE54AG
INPUT POWER (SYSTEM)	120Vac, 60Hz	ENVIRONMENTAL CONDITIONS	25deg. C, 64%RH, 991hPa
MODE	OFDM	TESTED BY	Steven Lu

CHANNEL	CHANNEL FREQUENCY (MHz)	RF POWER LEVEL IN 3kHz BW (dBm)	MAXIMUM LIMIT (dBm)	PASS/FAIL
6	2437	-12.95	8	PASS



CH6

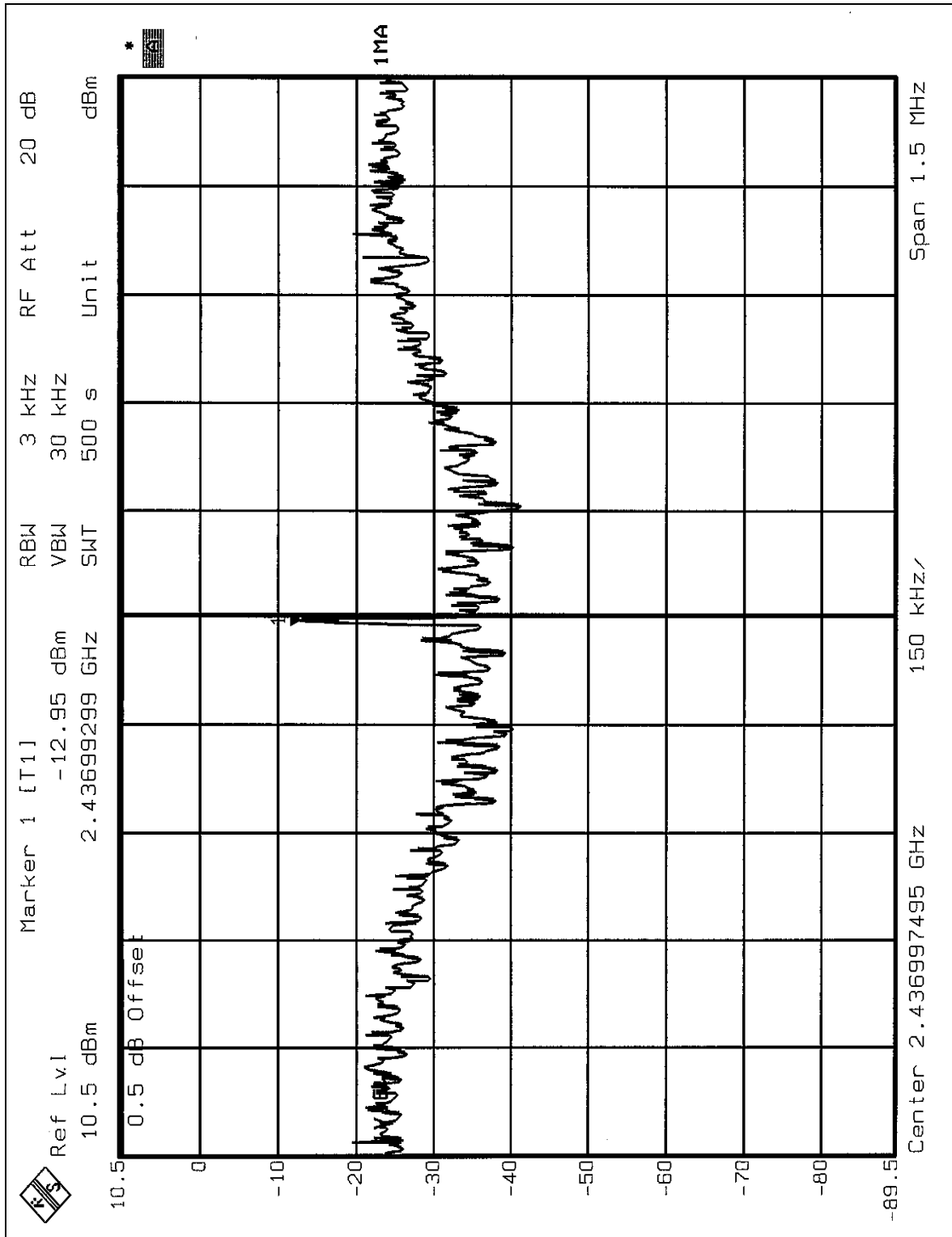



4.6 BAND EDGES MEASUREMENT

4.6.1 LIMITS OF BAND EDGES MEASUREMENT

Below -20dB of the highest emission level of operating band (in 100kHz Resolution Bandwidth).

4.6.2 TEST INSTRUMENTS

Description & Manufacturer	Model No.	Serial No.	Calibrated Until
R&S SPECTRUM ANALYZER	FSEK30	100049	Aug. 12, 2005

NOTE: The calibration interval of the above test instruments is 12 months and the calibrations are traceable to NML/ROC and NIST/USA.

4.6.3 TEST PROCEDURE

The transmitter output was connected to the spectrum analyzer via a low lose cable. Set both RBW and VBW of spectrum analyzer to 100KHz with suitable frequency span including 100 MHz bandwidth from band edge. The band edges was measured and recorded.

4.6.4 DEVIATION FROM TEST STANDARD

No deviation

4.6.5 EUT OPERATING CONDITION

Same as Item 4.3.6



4.6.6 TEST RESULTS

The spectrum plots are attached on the following 12 pages. D2 line indicates the highest level, and D1 line indicates the 20dB offset below D2. It shows compliance with the requirement in part 15.247(C).

NOTE 1: The band edge emission plot of CCK technique on page 65 show 52.40dB delta between carrier maximum power and local maximum emission in restrict band (2.3599GHz). The emission of carrier strength list in the test result of channel 1 at the item 4.2.7 is 103.55dBuV/m, so the maximum field strength in restrict band is $103.55 - 52.40 = 51.15$ dBuV/m which is under 54dBuV/m limit.

NOTE 2: The band edge emission plot of CCK technique on page 67 show 51.69dB delta between carrier maximum power and local maximum emission in restrict band (2.4835GHz). The emission of carrier strength list in the test result of channel 11 at the item 4.2.7 is 102.51dBuV/m, so the maximum field strength in restrict band is $102.51 - 51.69 = 50.82$ dBuV/m which is under 54dBuV/m limit.

NOTE 3: The band edge emission plot of OFDM technique with Normal mode on page 69 show 47.27dB delta between carrier maximum power and local maximum emission in restrict band (2.3900GHz). The emission of carrier strength list in the test result of channel 11 at the item 4.2.7 is 96.05dBuV/m, so the maximum field strength in restrict band is $96.05 - 47.27 = 48.78$ dBuV/m which is under 54dBuV/m limit.

NOTE 4: The band edge emission plot of OFDM technique with Normal mode on page 71 show 49.25dB delta between carrier maximum power and local maximum emission in restrict band (2.4835GHz). The emission of carrier strength list in the test result of channel 11 at the item 4.2.7 is 97.40dBuV/m, so the maximum field strength in restrict band is $97.40 - 49.25 = 48.15$ dBuV/m which is under 54dBuV/m limit.

NOTE 5: The band edge emission plot of OFDM technique with Turbo mode on page 73 shows 48.35dB delta between carrier maximum power and local maximum emission in restrict band (2.3599GHz). The emission of carrier strength list in the test result of channel 6 at the item 4.2.7 is 101.67dBuV/m, so the maximum field strength in restrict band is $101.67 - 48.35 = 53.32$ dBuV/m which is under 54dBuV/m limit.

NOTE 6: The band edge emission plot of OFDM technique with Turbo mode on page 75 shows 53.21dB delta between carrier maximum power and local maximum emission in restrict band (2.4835GHz). The emission of carrier strength list in the test result of channel 6 at the item 4.2.7 is 95.55dBuV/m, so the maximum field strength in restrict band is $95.55 - 53.21 = 42.34$ dBuV/m which is under 54dBuV/m limit.



CCK mode:

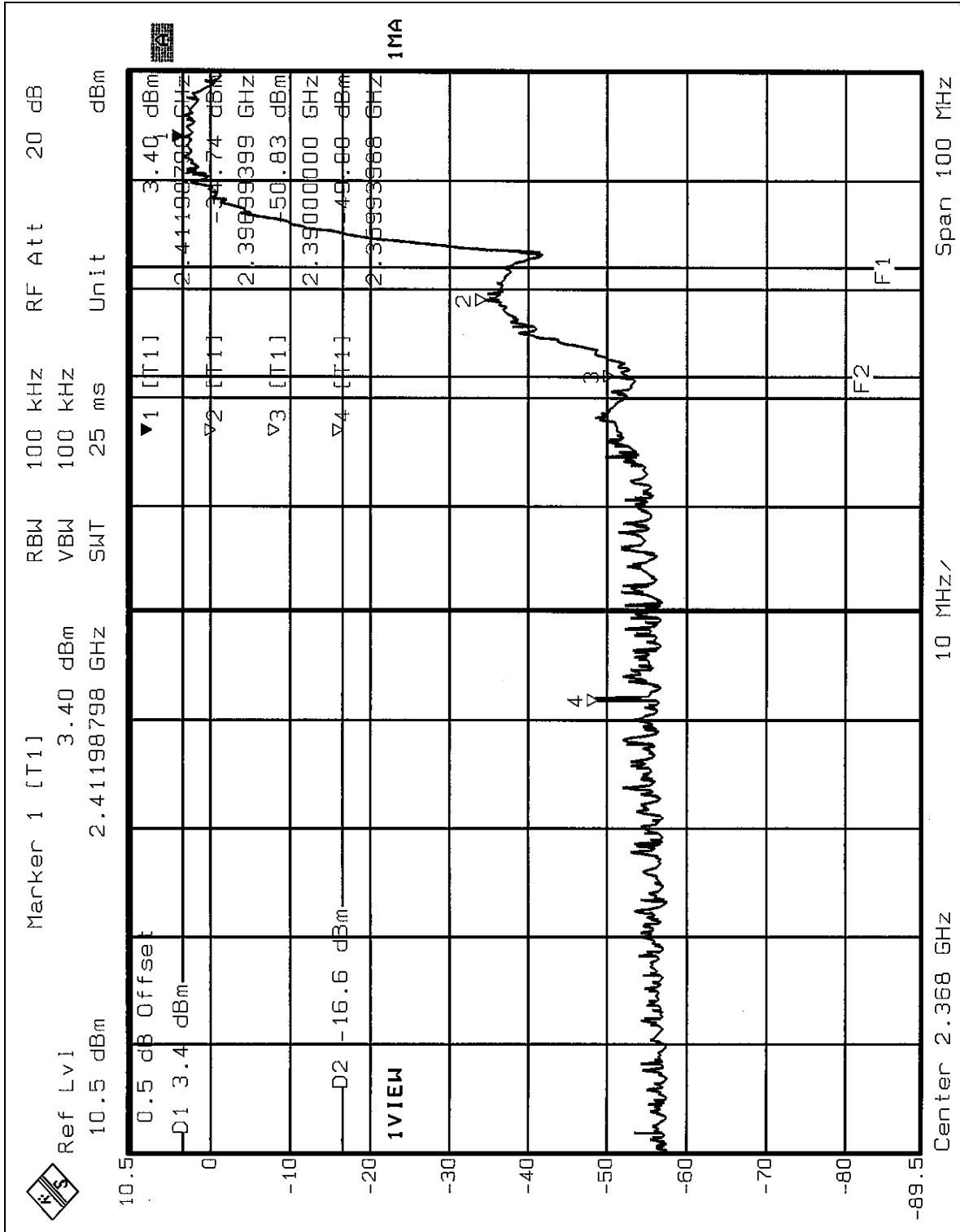

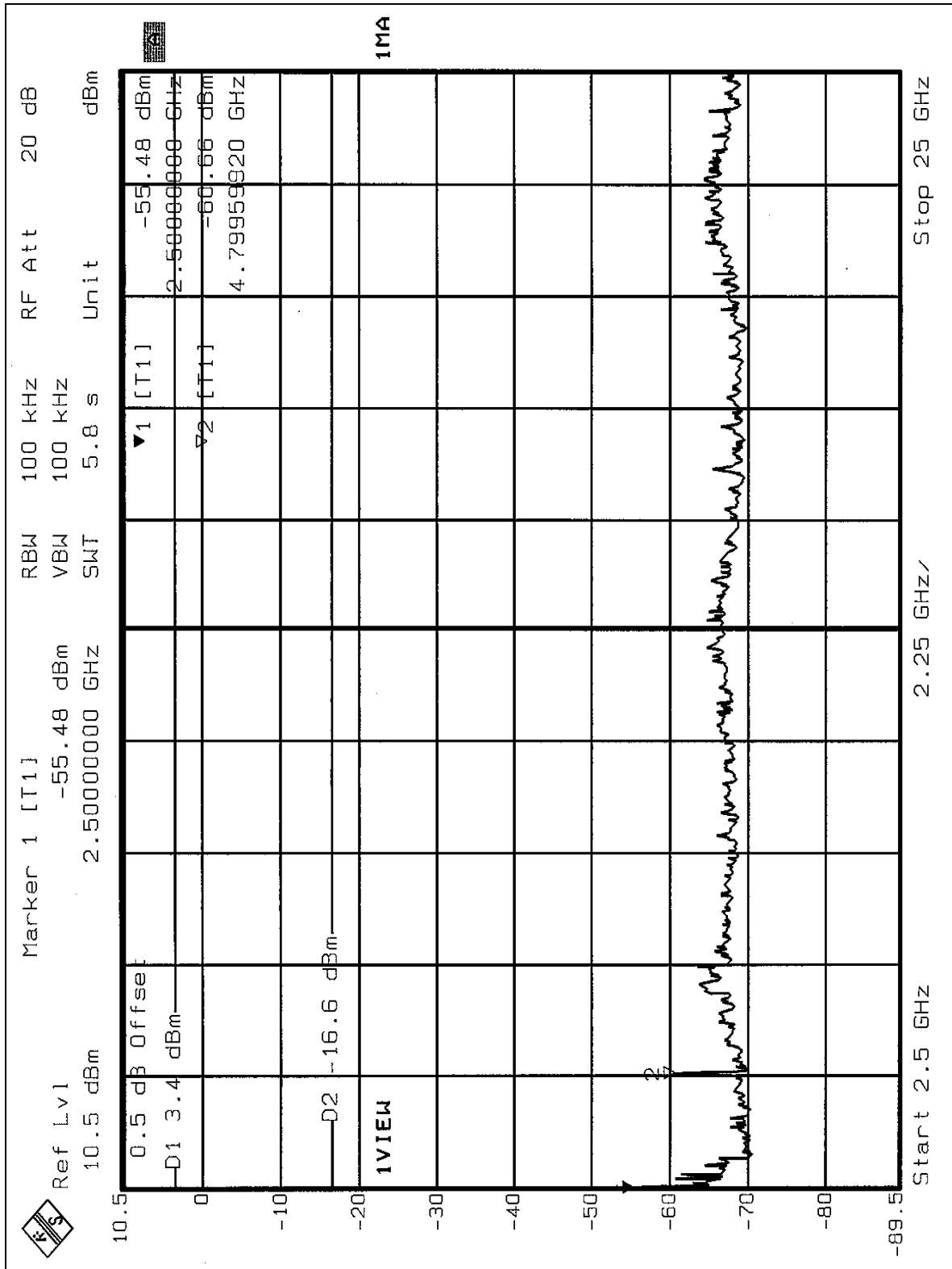

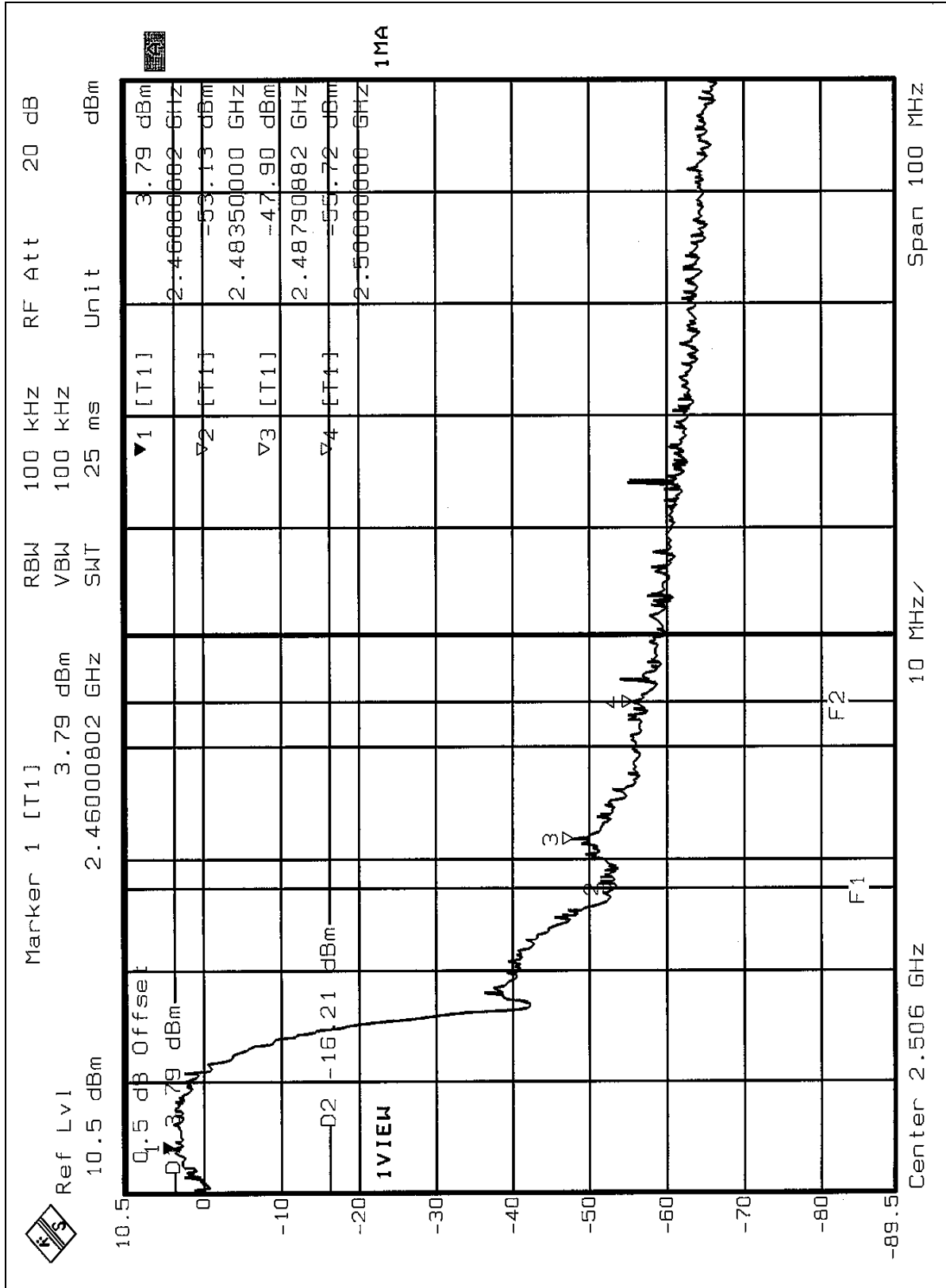

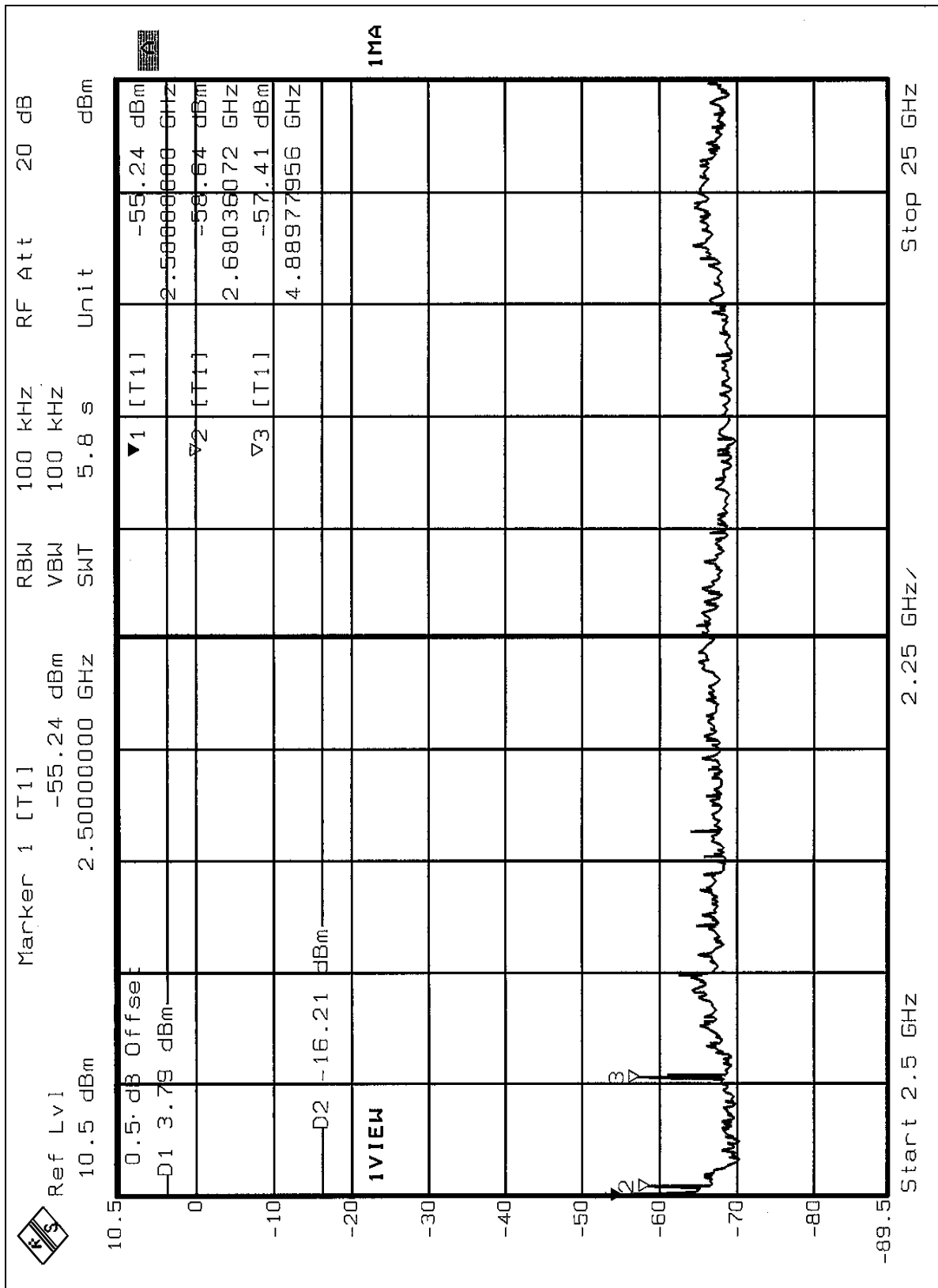



OFDM mode:

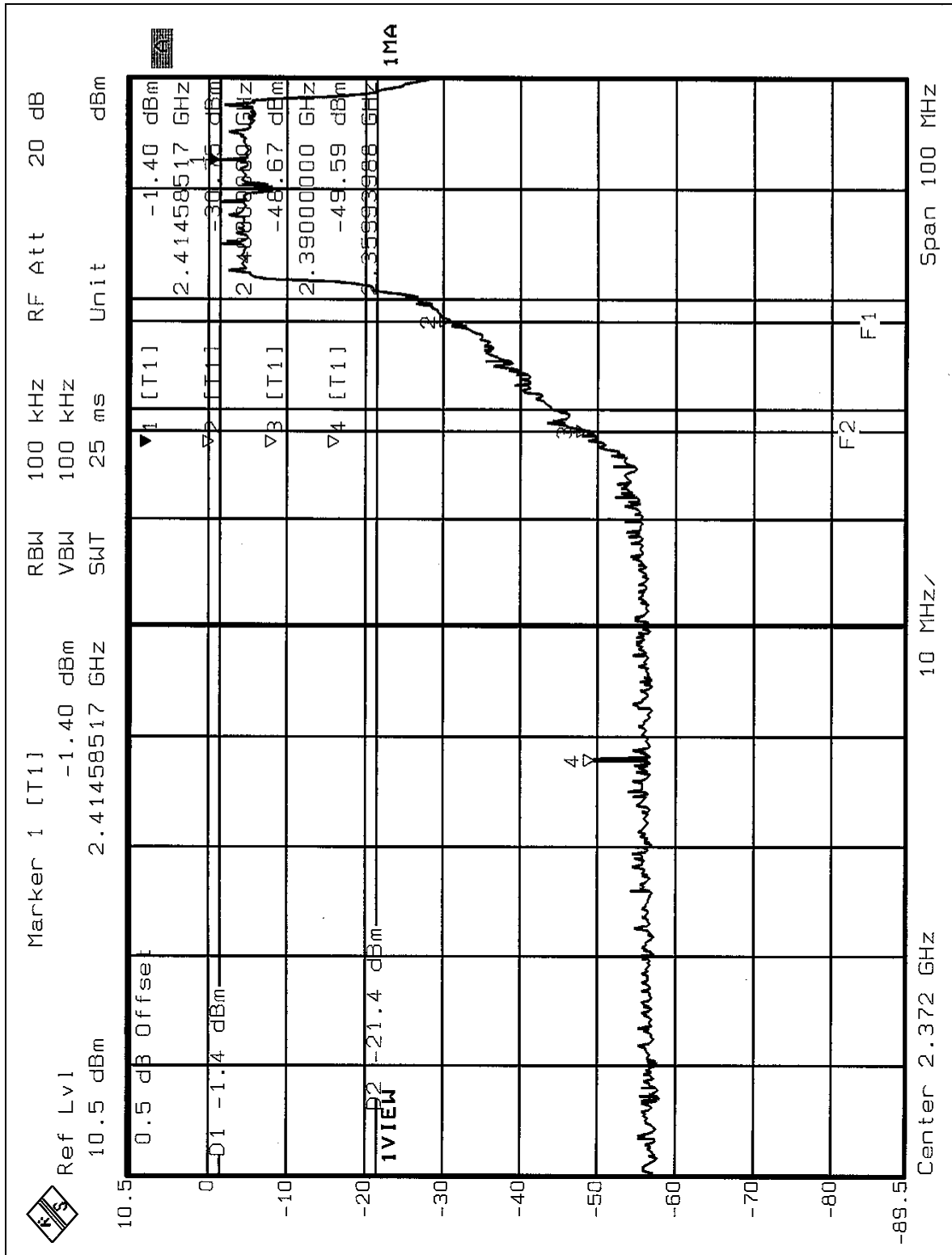

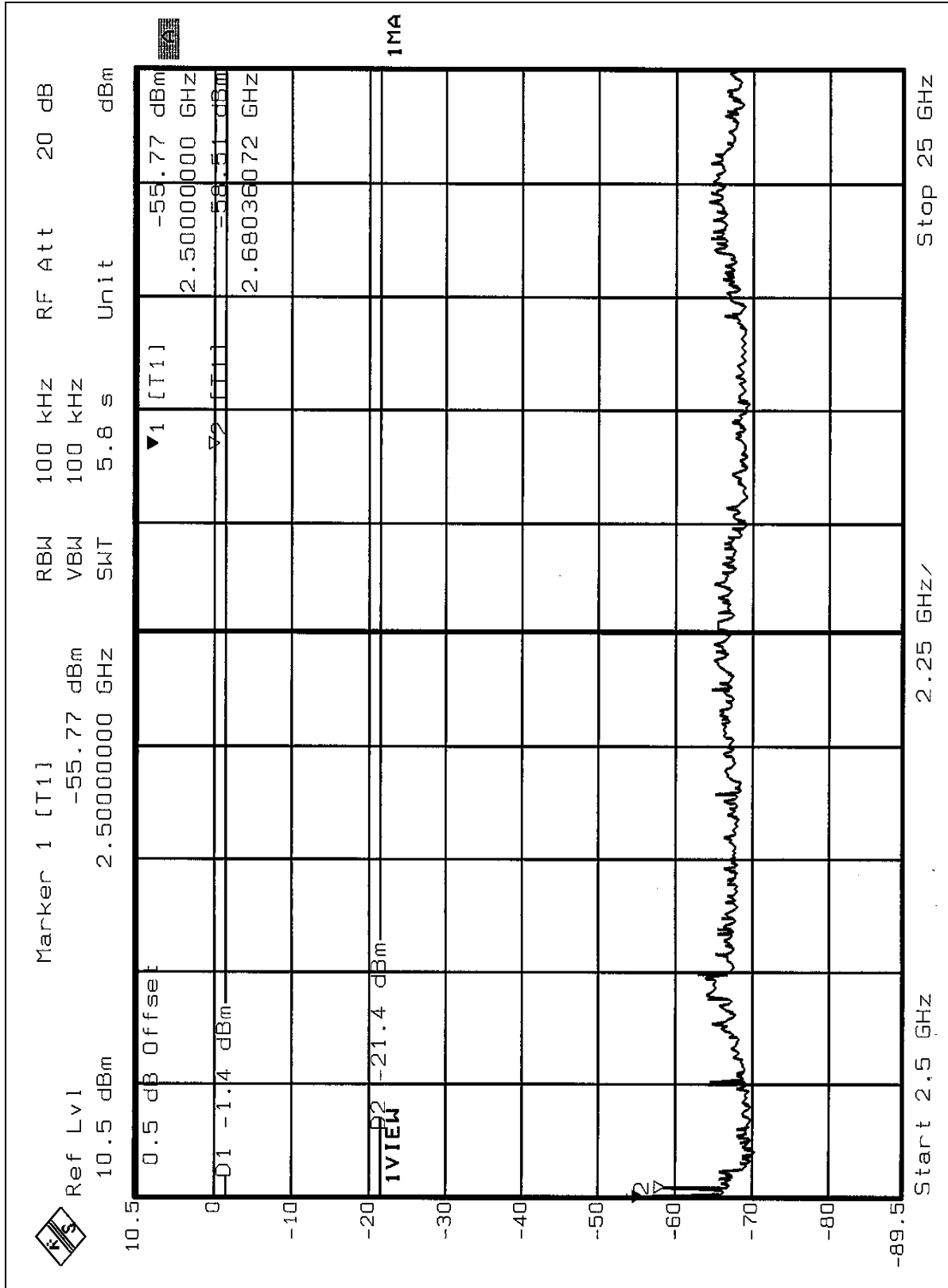

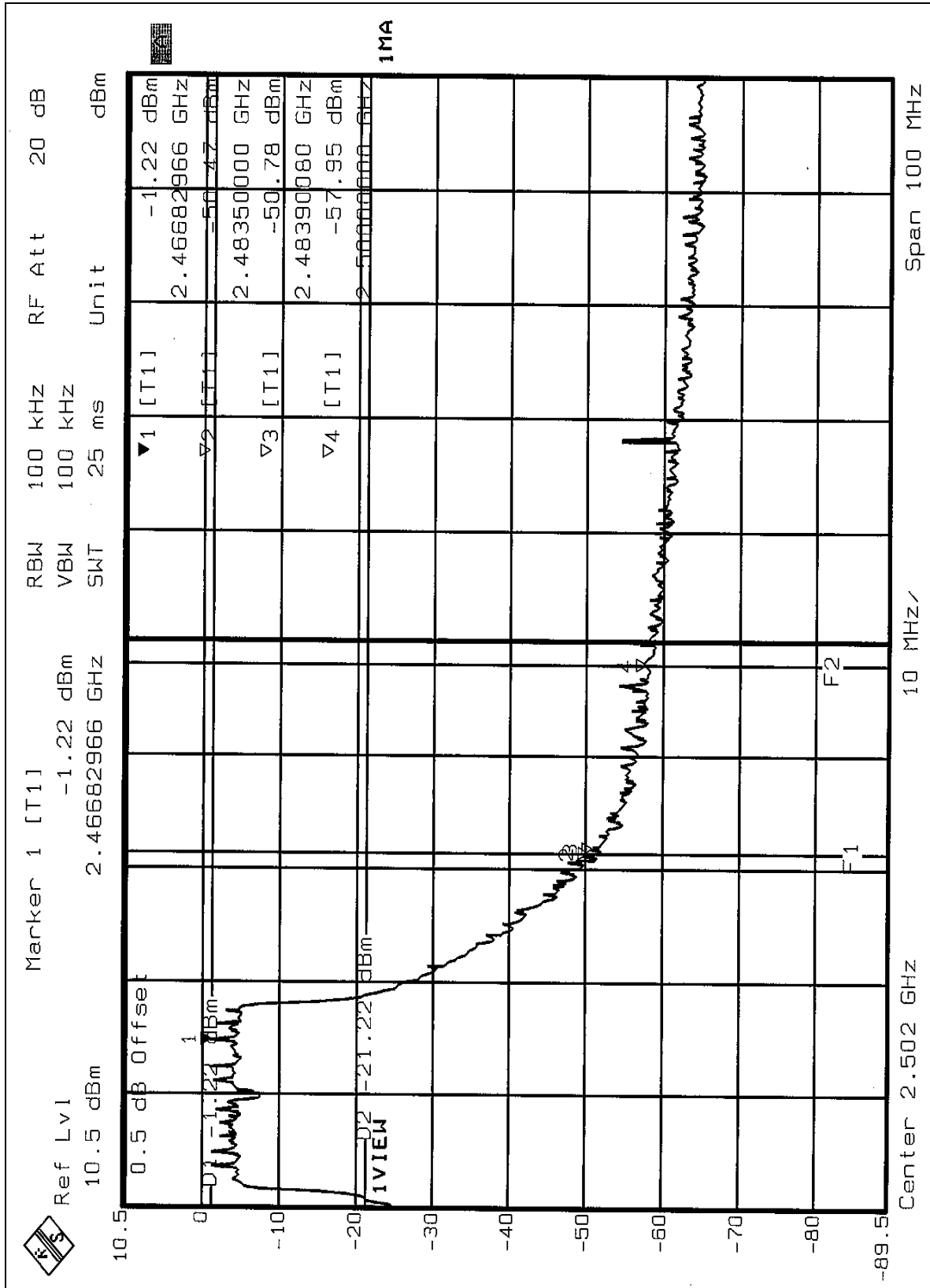

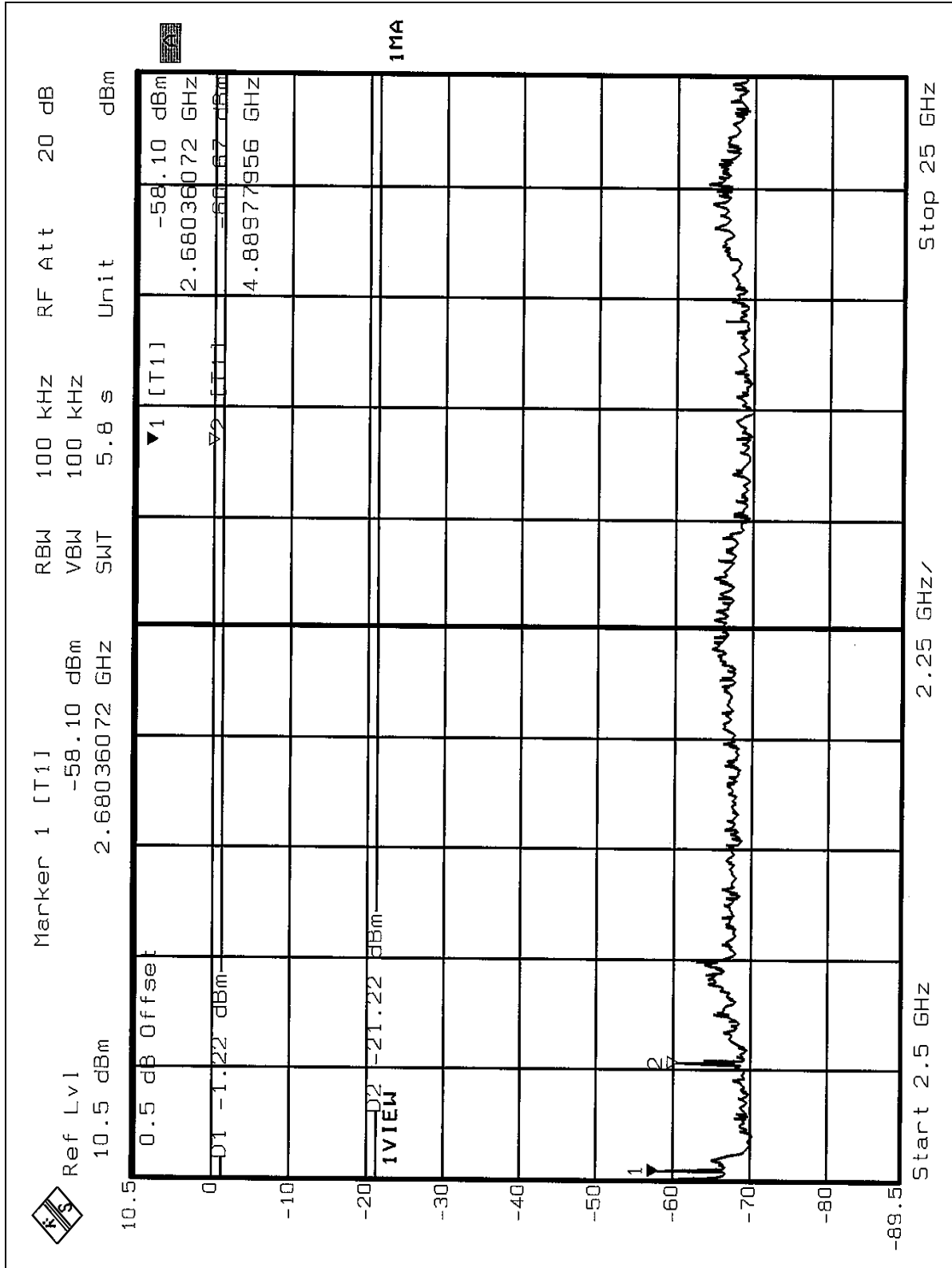

OFDM Turbo mode:

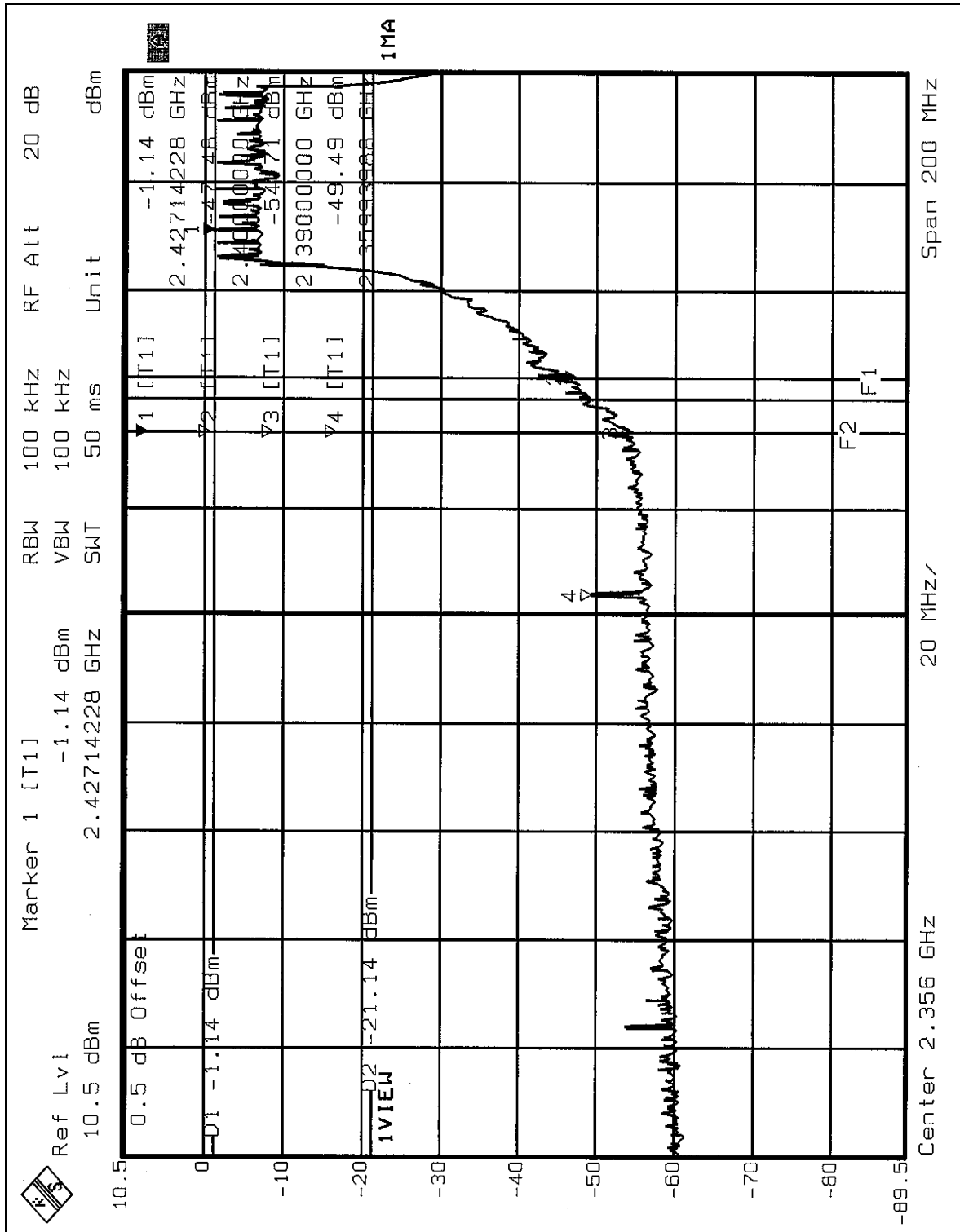

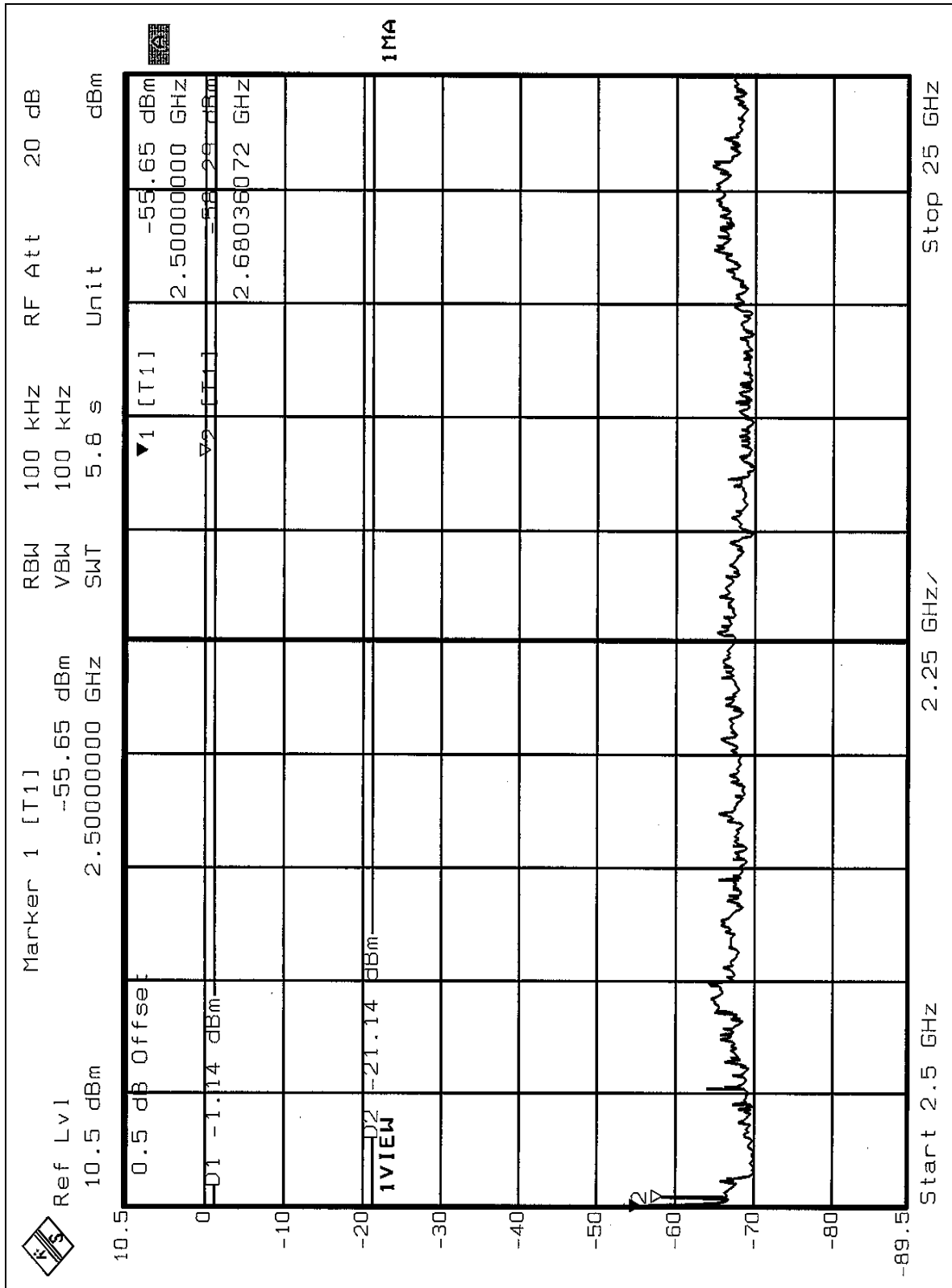

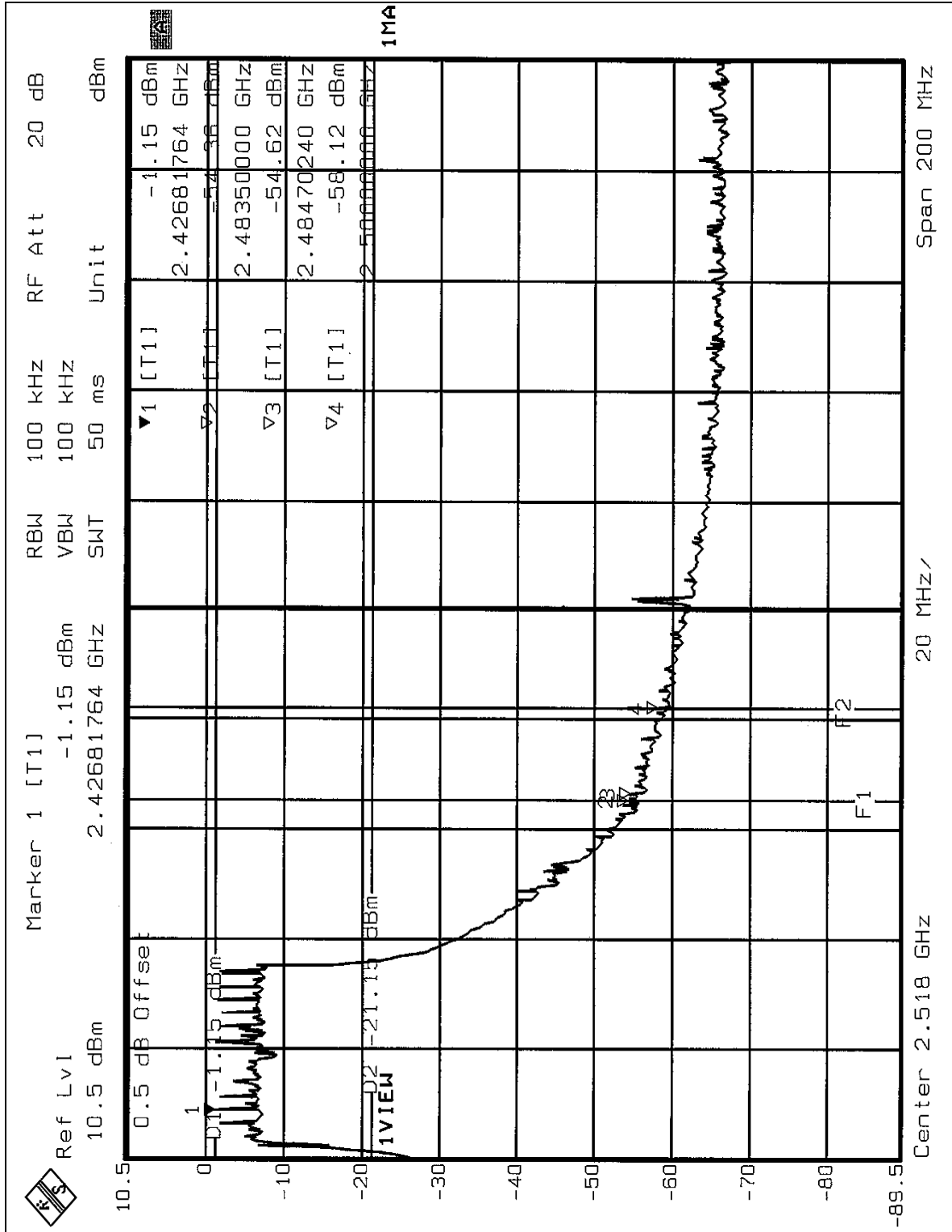

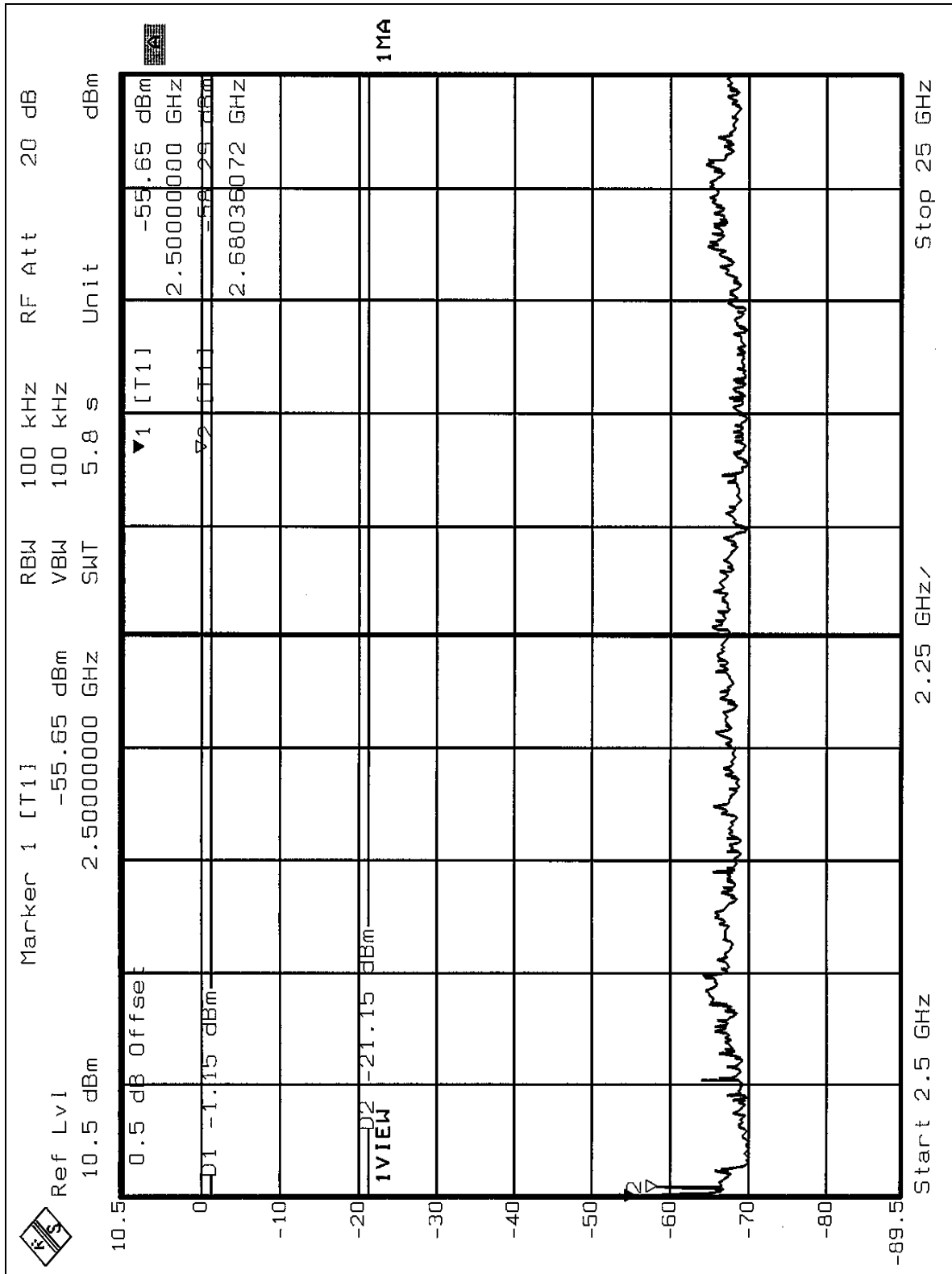



4.7 ANTENNA REQUIREMENT

4.7.1 STANDARD APPLICABLE

For intentional device, according to FCC 47 CFR Section 15.203, an intentional radiator shall be designed to ensure that no antenna other than that furnished by the responsible party shall be used with the device. And according to FCC 47 CFR Section 15.247 (b), if transmitting antennas of directional gain greater than 6dBi are used, the power shall be reduced by the amount in dB that the directional gain of the antenna exceeds 6dBi.

4.7.2 ANTENNA CONNECTED CONSTRUCTION

The antenna used in this product is Dipole antenna with UFL connector. The maximum Gain of the antenna is 2.44dBi.



5. TEST TYPES AND RESULTS (FOR PART 802.11a)

5.1 CONDUCTED EMISSION MEASUREMENT

5.1.1 LIMITS OF CONDUCTED EMISSION MEASUREMENT

FREQUENCY OF EMISSION (MHz)	CONDUCTED LIMIT (dB μ V)	
	Quasi-peak	Average
0.15-0.5	66 to 56	56 to 46
0.5-5	56	46
5-30	60	50

- NOTE:**
1. The lower limit shall apply at the transition frequencies.
 2. The limit decreases in line with the logarithm of the frequency in the range of 0.15 to 0.50 MHz.
 3. All emanations from a class A/B digital device or system, including any network of conductors and apparatus connected thereto, shall not exceed the level of field strengths specified above.

5.1.2 TEST INSTRUMENTS

DESCRIPTION & MANUFACTURER	MODEL NO.	SERIAL NO.	CALIBRATED UNTIL
Test Receiver ROHDE & SCHWARZ	ESCS30	100291	Dec. 12, 2004
RF signal cable Woken	5D-FB	Cable-HYC01-01	Mar. 02, 2005
LISN ROHDE & SCHWARZ	ESH3-Z5	100312	Mar. 03, 2005
LISN ROHDE & SCHWARZ	ESH2-Z5	100104	Mar. 02, 2005
Software ADT	ADT_Cond_V3	NA	NA

- NOTE:**
1. The calibration interval of the above test instruments is 12 months and the calibrations are traceable to NML/ROC and NIST/USA.
 2. The test was performed in HwaYa Shielded Room 1.
 3. The VCCI Site Registration No. is C-2040.



5.1.3 TEST PROCEDURES

- a. The EUT was placed 0.4 meters from the conducting wall of the shielded room with EUT being connected to the power mains through a line impedance stabilization network (LISN). Other support units were connected to the power mains through another LISN. The two LISNs provide 50 ohm/ 50uH of coupling impedance for the measuring instrument.
- b. Both lines of the power mains connected to the EUT were checked for maximum conducted interference.
- c. The frequency range from 150kHz to 30MHz was searched. Emission levels under (Limit - 20dB) was not recorded.

5.1.4 DEVIATION FROM TEST STANDARD

No deviation

5.1.5 TEST SETUP

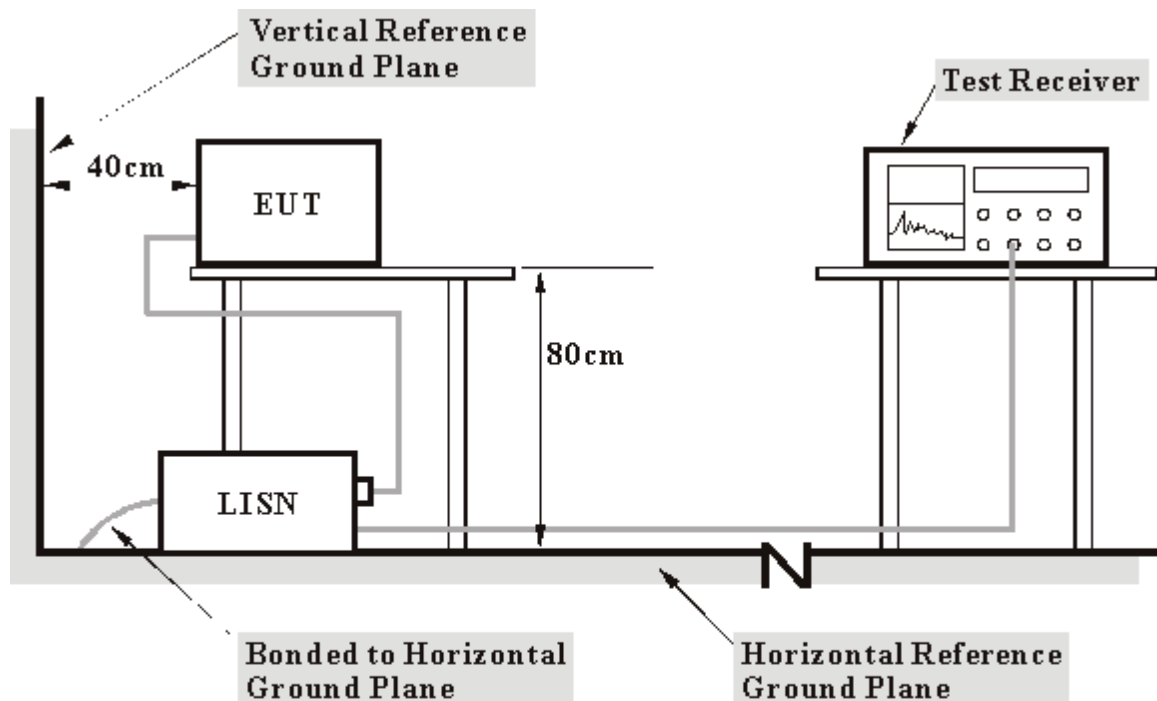

- Note:**
1. Support units were connected to second LISN.
 2. Both of LISNs (AMN) 80 cm from EUT and at the least 80 cm from other units and other metal planes support units.

For the actual test configuration, please refer to the related item – Photographs of the Test Configuration.

5.1.6 EUT OPERATING CONDITIONS

Same as 4.1.6



5.1.7 TEST RESULTS

EUT	Wireless A+G Mini PCI Card	MODEL	WMCE54AG
INPUT POWER (SYSTEM)	120Vac, 60 Hz	6dB BANDWIDTH	9 kHz
ENVIRONMENTAL CONDITIONS	25deg. C, 77%RH, 991hPa	PHASE	Line (L)
TESTED BY	Leo Hung		

No	Freq. [MHz]	Corr. Factor (dB)	Reading Value [dB (uV)]		Emission Level [dB (uV)]		Limit [dB (uV)]		Margin (dB)	
			Q.P.	AV.	Q.P.	AV.	Q.P.	AV.	Q.P.	AV.
			1	0.232	0.12	42.80	-	42.92	-	62.38
2	0.341	0.12	27.67	-	27.79	-	59.17	49.17	-31.37	-
3	1.973	0.16	29.28	-	29.44	-	56.00	46.00	-26.56	-
4	3.668	0.20	22.65	-	22.85	-	56.00	46.00	-33.15	-
5	9.895	0.30	30.34	-	30.64	-	60.00	50.00	-29.36	-
6	17.539	0.90	24.55	-	25.45	-	60.00	50.00	-34.55	-

- REMARKS:**
1. Q.P. and AV. are abbreviations of quasi-peak and average individually.
 2. "-": The Quasi-peak reading value also meets average limit and measurement with the average detector is unnecessary.
 3. The emission levels of other frequencies were very low against the limit.
 4. Margin value = Emission level - Limit value
 5. Correction factor = Insertion loss + Cable loss
 6. Emission Level = Correction Factor + Reading Value.

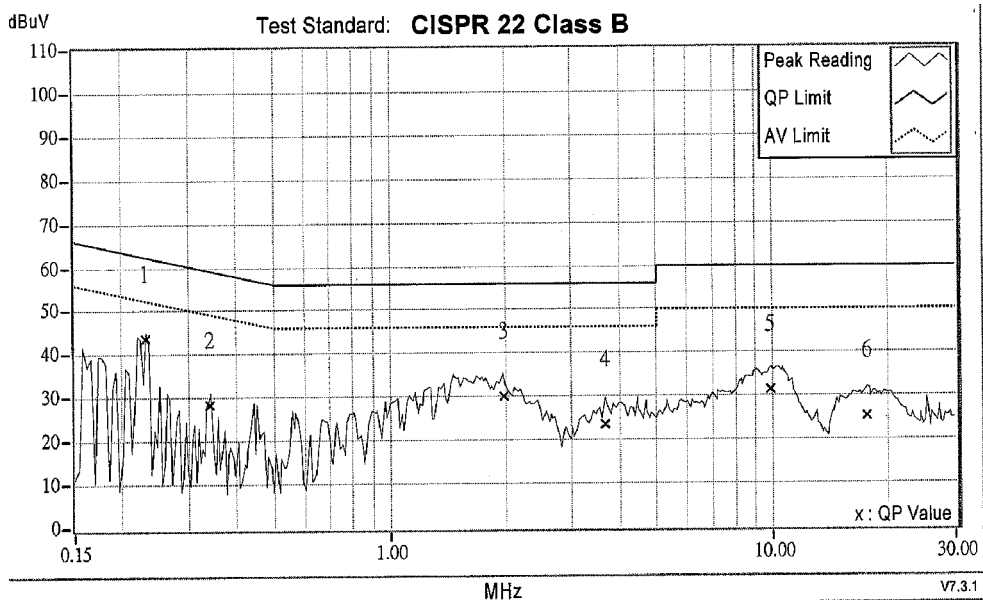



EUT	Wireless A+G Mini PCI Card	MODEL	WMCE54AG
INPUT POWER (SYSTEM)	120Vac, 60 Hz	PHASE	Neutral (N)
ENVIRONMENTAL CONDITIONS	25deg. C, 60%RH, 991hPa	6dB BANDWIDTH	9 kHz
TESTED BY	Leo Hung		

No	Freq. [MHz]	Corr. Factor (dB)	Reading Value [dB (uV)]		Emission Level [dB (uV)]		Limit [dB (uV)]		Margin (dB)	
			Q.P.	AV.	Q.P.	AV.	Q.P.	AV.	Q.P.	AV.
			1	0.189	0.11	42.46	-	42.57	-	64.08
2	0.220	0.11	43.60	-	43.71	-	62.81	52.81	-19.10	-
3	1.855	0.16	31.71	-	31.87	-	56.00	46.00	-24.13	-
4	3.754	0.20	24.25	-	24.45	-	56.00	46.00	-31.55	-
5	10.285	0.30	31.18	-	31.48	-	60.00	50.00	-28.52	-
6	18.508	0.69	26.04	-	26.73	-	60.00	50.00	-33.27	-

- REMARKS:**
1. Q.P. and AV. are abbreviations of quasi-peak and average individually.
 2. "-": The Quasi-peak reading value also meets average limit and measurement with the average detector is unnecessary.
 3. The emission levels of other frequencies were very low against the limit.
 4. Margin value = Emission level - Limit value
 5. Correction factor = Insertion loss + Cable loss
 6. Emission Level = Correction Factor + Reading Value.

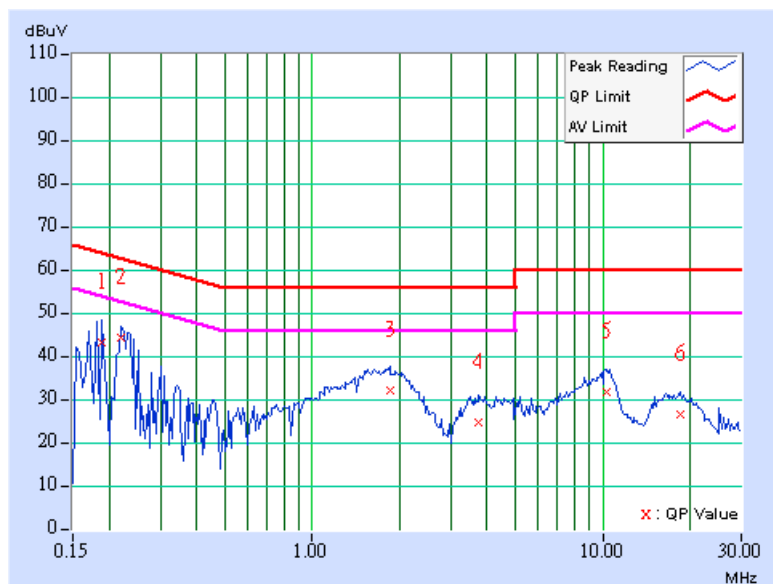



5.2 RADIATED EMISSION MEASUREMENT

5.2.1 LIMITS OF RADIATED EMISSION MEASUREMENT

Emissions radiated outside of the specified bands, shall be according to the general radiated limits in 15.209 as following:

Frequencies (MHz)	Field strength (microvolts/meter)	Measurement distance (meters)
0.009-0.490	2400/F(kHz)	300
0.490-1.705	24000/F(kHz)	30
1.705-30.0	30	30
30-88	100	3
88-216	150	3
216-960	200	3
Above 960	500	3

NOTE:

1. The lower limit shall apply at the transition frequencies.
2. Emission level (dBuV/m) = 20 log Emission level (uV/m).
3. As shown in 15.35(b), for frequencies above 1000MHz, the field strength limits are based on average detector, however, the peak field strength of any emission shall not exceed the maximum permitted average limits, specified above by more than 20dB under any condition of modulation.



5.2.2 LIMITS OF UNWANTED EMISSION OUT OF THE RESTRICTED BANDS

Frequencies (MHz)	EIRP Limit (dBm)	Equivalent Field Strength at 3m (dB μ V/m) *note 3
5150~5250	-27	68.3
5250~5350	-27	68.3
5725~5825	-27 *note 1	68.3
	-17 *note 2	78.3

NOTE:

1. For frequencies 10MHz or greater above or below the band edge.
2. All emissions within the frequency range from the band edge to 10MHz above or below the band edge.
3. The following formula is used to convert the equipment isotropic radiated power (eirp) to field strength

$$E = \frac{1000000\sqrt{30P}}{3} \mu\text{V/m, where P is the eirp (Watts)}$$



5.2.3 TEST INSTRUMENTS

DESCRIPTION & MANUFACTURER	MODEL NO.	SERIAL NO.	CALIBRATED UNTIL
Test Receiver ROHDE & SCHWARZ	ESI7	838496/016	Feb. 09, 2005
Spectrum Analyzer ROHDE & SCHWARZ	FSP40	100041	Dec. 15, 2004
BILOG Antenna SCHWARZBECK	VULB9168	9168-155	Feb. 03, 2005
HORN Antenna SCHWARZBECK	BBHA 9120D	9120D-404	Feb. 03, 2005
HORN Antenna SCHWARZBECK	BBHA 9170	BBHA 9170242	Feb. 23, 2005
Preamplifier Agilent	8447D	2944A10631	Jan. 15, 2005
Preamplifier Agilent	8449B	3008A01960	Jan. 22, 2005
RF signal cable HUBER+SUHNNER	SUCOFLEX 104	219272/4	Mar. 04, 2005
RF signal cable HUBER+SUHNNER	SUCOFLEX 104	219275/4	Mar. 04, 2005
Software ADT.	ADT_Radiated_V5.14	NA	NA
Antenna Tower inn-co GmbH	MA 4000	010303	NA
Antenna Tower Controller inn-co GmbH	CO2000	019303	NA
Turn Table ADT.	TT100.	TT93021704	NA
Turn Table Controller ADT.	SC100.	SC93021704	NA

- NOTE:**
1. The calibration interval of the above test instruments is 12 months and the calibrations are traceable to NML/ROC and NIST/USA.
 2. The test was performed in HwaYa Chamber 3.
 3. The horn antenna and HP preamplifier (model: 8449B) are used only for the measurement of emission frequency above 1GHz if tested.
 4. The IC Site Registration No. is IC4924-4.



5.2.4 TEST PROCEDURES

- a. The EUT was placed on the top of a rotating table 0.8 meters above the ground at a 3 meter semi-anechoic chamber. The table was rotated 360 degrees to determine the position of the highest radiation.
- b. The EUT was set 3 meters away from the interference-receiving antenna, which was mounted on the top of a variable-height antenna tower.
- c. The antenna is a broadband antenna, and its height is varied from one meter to four meters above the ground to determine the maximum value of the field strength. Both horizontal and vertical polarizations of the antenna are set to make the measurement.
- d. For each suspected emission, the EUT was arranged to its worst case and then the antenna was tuned to heights from 1 meter to 4 meters and the rotatable table was turned from 0 degrees to 360 degrees to find the maximum reading.
- e. The test-receiver system was set to Peak Detect Function and Specified Bandwidth with Maximum Hold Mode.
- f. If the emission level of the EUT in peak mode was 10dB lower than the limit specified, then testing could be stopped and the peak values of the EUT would be reported. Otherwise the emissions that did not have 10dB margin would be re-tested one by one using peak, quasi-peak or average method as specified and then reported in a data sheet.

NOTE:

1. The resolution bandwidth and video bandwidth of test receiver/spectrum analyzer is 120kHz for Peak detection (PK) and Quasi-peak detection (QP) at frequency below 1GHz.
2. The resolution bandwidth and video bandwidth of test receiver/spectrum analyzer is 1 MHz for Peak detection at frequency above 1GHz.
3. The resolution bandwidth of test receiver/spectrum analyzer is 1 MHz and the video bandwidth is 10 Hz for Average detection (AV) at frequency above 1GHz.

5.2.5 DEVIATION FROM TEST STANDARD

No deviation

5.2.6 TEST SETUP

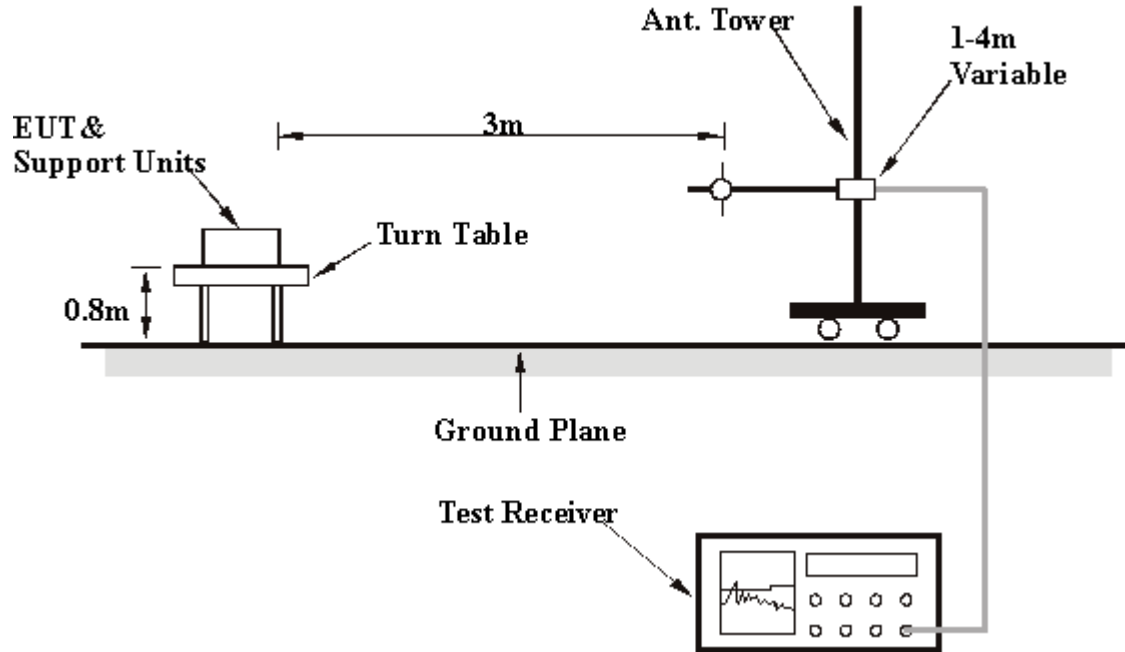

For the actual test configuration, please refer to the related item – Photographs of the Test Configuration.

5.2.7 EUT OPERATING CONDITIONS

Same as 4.1.6



5.2.8 TEST RESULTS

EUT	Wireless A+G Mini PCI Card	MODEL	WMCE54AG
CHANNEL	Channel 11	FREQUENCY RANGE	Below 1000MHz
INPUT POWER (SYSTEM)	120Vac, 60 Hz	DETECTOR FUNCTION	Quasi-Peak
ENVIRONMENTAL CONDITIONS	25deg. C, 60%RH, 991hPa	TESTED BY	Leo Hung

ANTENNA POLARITY & TEST DISTANCE: HORIZONTAL AT 3 M

No.	Freq. (MHz)	Emission Level (dBuV/m)	Limit (dBuV/m)	Margin (dB)	Antenna Height (m)	Table Angle (Degree)	Raw Value (dBuV)	Correction Factor (dB/m)
1	133.03	39.95 QP	43.50	-3.55	1.25 H	154	26.06	13.89
2	158.30	41.23 QP	43.50	-2.27	1.00 H	313	26.33	14.90
3	166.07	42.01 QP	43.50	-1.49	1.50 H	169	27.69	14.32
4	183.57	41.81 QP	43.50	-1.69	1.50 H	187	29.20	12.61
5	199.12	41.78 QP	43.50	-1.72	1.50 H	166	30.44	11.34
6	265.21	42.98 QP	46.00	-3.02	1.00 H	37	29.51	13.47
7	298.26	37.97 QP	46.00	-8.03	1.00 H	49	23.58	14.38
8	333.25	42.42 QP	46.00	-3.58	1.00 H	154	27.27	15.15
9	440.16	39.12 QP	46.00	-6.88	1.75 H	46	21.37	17.75
10	465.43	36.08 QP	46.00	-9.92	2.00 H	22	17.90	18.18
11	640.38	34.52 QP	46.00	-11.48	1.25 H	295	13.18	21.35
12	735.63	31.52 QP	46.00	-14.48	1.00 H	307	8.63	22.89

ANTENNA POLARITY & TEST DISTANCE: VERTICAL AT 3 M

No.	Freq. (MHz)	Emission Level (dBuV/m)	Limit (dBuV/m)	Margin (dB)	Antenna Height (m)	Table Angle (Degree)	Raw Value (dBuV)	Correction Factor (dB/m)
1	98.04	33.20 QP	43.50	-10.30	1.25 V	337	22.45	10.75
2	133.03	35.64 QP	43.50	-7.86	2.50 V	280	21.75	13.89
3	166.07	40.71 QP	43.50	-2.79	2.50 V	271	26.39	14.32
4	197.17	35.50 QP	43.50	-8.00	2.00 V	118	23.99	11.50
5	265.21	36.09 QP	46.00	-9.91	1.75 V	328	22.62	13.47
6	333.25	36.16 QP	46.00	-9.84	1.25 V	76	21.01	15.15
7	370.18	34.32 QP	46.00	-11.68	1.25 V	118	18.31	16.01
8	401.28	34.40 QP	46.00	-11.60	1.00 V	106	17.63	16.76
9	440.16	35.91 QP	46.00	-10.09	1.25 V	115	18.16	17.75
10	597.62	32.12 QP	46.00	-13.88	1.00 V	238	11.35	20.76
11	733.69	30.15 QP	46.00	-15.85	1.50 V	280	7.31	22.84
12	811.44	28.62 QP	46.00	-17.38	2.00 V	4	5.05	23.56

- REMARKS:**
1. Emission level(dBuV/m)=Raw Value(dBuV) + Correction Factor(dB)
 2. Correction Factor(dB/m) = Antenna Factor (dB/m) + Cable Factor (dB)
 3. The other emission levels were very low against the limit.
 4. Margin value = Emission level – Limit value



EUT	Wireless A+G Mini PCI Card	MODEL	WMCE54AG
MODE	Normal Mode	CHANNEL	1
FREQUENCY RANGE	1 ~ 40 GHz	DETECTOR FUNCTION	Peak(PK) Average (AV)
ENVIRONMENTAL CONDITIONS	25deg. C, 60%RH, 991hPa	INPUT POWER (SYSTEM)	120Vac, 60Hz
TESTED BY	Match Tsui		

ANTENNA POLARITY & TEST DISTANCE: HORIZONTAL AT 3 M

No.	Freq. (MHz)	Emission Level (dBuV/m)	Limit (dBuV/m)	Margin (dB)	Antenna Height (m)	Table Angle (Degree)	Raw Value (dBuV)	Correction Factor (dB)
1	3453.00	48.30 PK	68.30	-20.00	1.14 H	73	12.72	35.58
1	3453.00	35.91 AV	54.00	-18.09	1.14 H	73	0.33	35.58
2	#5150.00	46.68 PK	74.00	-27.32	1.00 H	330	7.58	39.10
2	#5150.00	37.35 AV	54.00	-16.65	1.00 H	330	-1.75	39.10
3	*5180.00	98.98 PK			1.00 H	330	59.81	39.17
3	*5180.00	89.65 AV			1.00 H	330	50.48	39.17
4	10360.00	56.12 PK	68.30	-12.18	1.19 H	10	10.83	45.29
4	10360.00	44.13 AV	54.00	-9.87	1.19 H	10	-1.16	45.29

ANTENNA POLARITY & TEST DISTANCE: VERTICAL AT 3 M

No.	Freq. (MHz)	Emission Level (dBuV/m)	Limit (dBuV/m)	Margin (dB)	Antenna Height (m)	Table Angle (Degree)	Raw Value (dBuV)	Correction Factor (dB)
1	1600.00	44.41 PK	74.00	-29.59	1.01 V	281	15.78	28.63
1	1600.00	35.71 AV	54.00	-18.29	1.01 V	281	7.08	28.63
2	3453.00	52.70 PK	68.30	-15.60	1.17 V	258	17.12	35.58
2	3453.00	43.58 AV	54.00	-10.42	1.17 V	258	8.00	35.58
3	#5150.00	58.54 PK	74.00	-15.46	1.22 V	352	19.44	39.10
3	#5150.00	47.23 AV	54.00	-6.77	1.22 V	352	8.13	39.10
4	*5180.00	110.84 PK			1.22 V	352	71.67	39.17
4	*5180.00	99.53 AV			1.22 V	352	60.36	39.17
5	10360.00	61.11 PK	68.30	-7.19	1.01 V	36	15.82	45.29
5	10360.00	46.98 AV	54.00	-7.02	1.01 V	36	1.69	45.29

NOTE:

1. Emission level = Raw value + Correction Factor
2. Correction Factor = Ant. Factor + Cable loss
3. Margin value = Emission level - Limit value
4. The other emission levels were very low against the limit.
5. "*" : Fundamental frequency
6. "#" The radiated frequency falling in the restricted band.



EUT	Wireless A+G Mini PCI Card	MODEL	WMCE54AG
MODE	Normal Mode	CHANNEL	4
FREQUENCY RANGE	1 ~ 40 GHz	DETECTOR FUNCTION	Peak(PK) Average (AV)
ENVIRONMENTAL CONDITIONS	25deg. C, 60%RH, 991hPa	INPUT POWER (SYSTEM)	120Vac, 60Hz
TESTED BY	Match Tsui		

ANTENNA POLARITY & TEST DISTANCE: HORIZONTAL AT 3 M

No.	Freq. (MHz)	Emission Level (dBuV/m)	Limit (dBuV/m)	Margin (dB)	Antenna Height (m)	Table Angle (Degree)	Raw Value (dBuV)	Correction Factor (dB)
1	3494.00	39.21 PK	68.30	-29.09	1.00 H	91	3.51	35.70
1	3494.00	33.28 AV	54.00	-20.72	1.00 H	91	-2.42	35.70
2	*5240.00	100.96 PK			1.08 H	329	61.78	39.18
2	*5240.00	91.05 AV			1.08 H	329	51.87	39.18
3	10480.00	56.97 PK	68.30	-11.33	1.07 H	207	10.88	46.08
3	10480.00	43.73 AV	54.00	-10.27	1.07 H	207	-2.36	46.08

ANTENNA POLARITY & TEST DISTANCE: VERTICAL AT 3 M

No.	Freq. (MHz)	Emission Level (dBuV/m)	Limit (dBuV/m)	Margin (dB)	Antenna Height (m)	Table Angle (Degree)	Raw Value (dBuV)	Correction Factor (dB)
1	3494.00	49.01 PK	68.30	-19.29	1.16 V	255	13.31	35.70
1	3494.00	37.07 AV	54.00	-16.93	1.16 V	255	1.37	35.70
2	*5240.00	109.45 PK			1.00 V	327	70.27	39.18
2	*5240.00	98.28 AV			1.00 V	327	59.10	39.18
3	10480.00	57.52 PK	68.30	-10.78	1.00 V	35	11.43	46.08
3	10480.00	45.49 AV	54.00	-8.51	1.00 V	35	-0.60	46.08

NOTE:

1. Emission level = Raw value + Correction Factor
2. Correction Factor = Ant. Factor + Cable loss
3. Margin value = Emission level - Limit value
4. The other emission levels were very low against the limit.
5. "*" : Fundamental frequency
6. "#" The radiated frequency falling in the restricted band.



EUT	Wireless A+G Mini PCI Card	MODEL	WMCE54AG
MODE	Normal Mode	CHANNEL	5
FREQUENCY RANGE	1 ~ 40 GHz	DETECTOR FUNCTION	Peak(PK) Average (AV)
ENVIRONMENTAL CONDITIONS	25deg. C, 60%RH, 991hPa	INPUT POWER (SYSTEM)	120Vac, 60Hz
TESTED BY	Match Tsui		

ANTENNA POLARITY & TEST DISTANCE: HORIZONTAL AT 3 M

No.	Freq. (MHz)	Emission Level (dBuV/m)	Limit (dBuV/m)	Margin (dB)	Antenna Height (m)	Table Angle (Degree)	Raw Value (dBuV)	Correction Factor (dB/m)
1	3506.00	39.85 PK	68.30	-28.45	1.00 H	167	4.11	35.73
1	3506.00	33.11 AV	54.00	-20.89	1.00 H	167	-2.63	35.73
2	*5260.00	99.91 PK			1.08 H	239	60.75	39.16
2	*5260.00	89.87 AV			1.08 H	239	50.71	39.16
3	10520.00	57.38 PK	68.30	-10.92	1.00 H	239	11.23	46.16
3	10520.00	44.24 AV	54.00	-9.76	1.00 H	239	-1.91	46.16

ANTENNA POLARITY & TEST DISTANCE: VERTICAL AT 3 M

No.	Freq. (MHz)	Emission Level (dBuV/m)	Limit (dBuV/m)	Margin (dB)	Antenna Height (m)	Table Angle (Degree)	Raw Value (dBuV)	Correction Factor (dB/m)
1	3506.00	48.56 PK	68.30	-19.74	1.00 V	255	12.82	35.73
1	3506.00	37.94 AV	54.00	-16.06	1.00 V	255	2.20	35.73
2	*5260.00	109.80 PK			1.07 V	339	70.64	39.16
2	*5260.00	100.50 AV			1.07 V	339	61.34	39.16
3	10520.00	58.09 PK	68.30	-10.21	1.33 V	39	11.94	46.16
3	10520.00	46.67 AV	54.00	-7.33	1.33 V	39	0.52	46.16

NOTE:

1. Emission level = Raw value + Correction Factor
2. Correction Factor = Ant. Factor + Cable loss
3. Margin value = Emission level - Limit value
4. The other emission levels were very low against the limit.
5. "*" : Fundamental frequency
6. "#"The radiated frequency falling in the restricted band.



EUT	Wireless A+G Mini PCI Card	MODEL	WMCE54AG
MODE	Normal Mode	CHANNEL	8
FREQUENCY RANGE	1 ~ 40 GHz	DETECTOR FUNCTION	Peak(PK) Average (AV)
ENVIRONMENTAL CONDITIONS	25deg. C, 60%RH, 991hPa	INPUT POWER (SYSTEM)	120Vac, 60Hz
TESTED BY	Match Tsui		

ANTENNA POLARITY & TEST DISTANCE: HORIZONTAL AT 3 M

No.	Freq. (MHz)	Emission Level (dBuV/m)	Limit (dBuV/m)	Margin (dB)	Antenna Height (m)	Table Angle (Degree)	Raw Value (dBuV)	Antenna Factor (dB)
1	3546.00	47.89 PK	68.30	-20.41	1.05 H	16	12.04	35.85
1	3546.00	35.37 AV	54.00	-18.63	1.05 H	16	-0.48	35.85
2	*5320.00	100.43 PK			1.06 H	329	61.28	39.15
2	*5320.00	89.63 AV			1.06 H	329	50.48	39.15
3	#5350.00	45.44 PK	74.00	-28.56	1.06 H	329	6.24	39.20
3	#5350.00	34.64 AV	54.00	-19.36	1.06 H	329	-4.56	39.20
4	#10640.00	57.27 PK	74.00	-16.73	1.05 H	16	11.03	46.23
4	#10640.00	43.98 AV	54.00	-10.02	1.05 H	16	-2.25	46.23

ANTENNA POLARITY & TEST DISTANCE: VERTICAL AT 3 M

No.	Freq. (MHz)	Emission Level (dBuV/m)	Limit (dBuV/m)	Margin (dB)	Antenna Height (m)	Table Angle (Degree)	Raw Value (dBuV)	Antenna Factor (dB)
1	3546.00	48.58 PK	68.30	-19.72	1.02 V	193	12.73	35.85
1	3546.00	35.62 AV	54.00	-18.38	1.02 V	193	-0.23	35.85
2	*5320.00	110.81 PK			1.18 V	340	71.66	39.15
2	*5320.00	100.16 AV			1.18 V	340	61.01	39.15
3	#5350.00	55.82 PK	74.00	-18.18	1.18 V	340	16.62	39.20
3	#5350.00	45.17 AV	54.00	-8.83	1.18 V	340	5.97	39.20
4	#10640.00	58.74 PK	74.00	-15.26	1.06 V	37	12.51	46.23
4	#10640.00	45.96 AV	54.00	-8.04	1.06 V	37	-0.27	46.23

NOTE:

1. Emission level = Raw value + Correction Factor
2. Correction Factor = Ant. Factor + Cable loss
3. Margin value = Emission level - Limit value
4. The other emission levels were very low against the limit.
5. "*" : Fundamental frequency
6. "#": The radiated frequency falling in the restricted band.



EUT	Wireless A+G Mini PCI Card	MODEL	WMCE54AG
MODE	Normal Mode	CHANNEL	9
FREQUENCY RANGE	1 ~ 40 GHz	DETECTOR FUNCTION	Peak(PK) Average (AV)
ENVIRONMENTAL CONDITIONS	25deg. C, 60%RH, 991hPa	INPUT POWER (SYSTEM)	120Vac, 60Hz
TESTED BY	Match Tsui		

ANTENNA POLARITY & TEST DISTANCE: HORIZONTAL AT 3 M

No.	Freq. (MHz)	Emission Level (dBuV/m)	Limit (dBuV/m)	Margin (dB)	Antenna Height (m)	Table Angle (Degree)	Raw Value (dBuV)	Correction Factor (dB)
1	*5745.00	99.68 PK			1.17 H	334	58.78	40.90
1	*5745.00	89.74 AV			1.17 H	334	48.84	40.90
2	#11490.00	58.24 PK	74.00	-15.76	1.16 H	329	10.86	47.38
2	#11490.00	45.96 AV	54.00	-8.04	1.16 H	329	-1.42	47.38

ANTENNA POLARITY & TEST DISTANCE: VERTICAL AT 3 M

No.	Freq. (MHz)	Emission Level (dBuV/m)	Limit (dBuV/m)	Margin (dB)	Antenna Height (m)	Table Angle (Degree)	Raw Value (dBuV)	Correction Factor (dB)
1	*5745.00	111.34 PK			1.05 V	287	70.44	40.90
1	*5745.00	100.72 AV			1.05 V	287	59.82	40.90
2	#11490.00	60.13 PK	74.00	-13.87	1.34 V	2	12.75	47.38
2	#11490.00	46.77 AV	54.00	-7.23	1.34 V	2	-0.61	47.38

NOTE:

1. Emission level = Raw value + Correction Factor
2. Correction Factor = Ant. Factor + Cable loss
3. Margin value = Emission level - Limit value
4. The other emission levels were very low against the limit.
5. "*" : Fundamental frequency
6. "#" The radiated frequency falling in the restricted band.



EUT	Wireless A+G Mini PCI Card	MODEL	WMCE54AG
MODE	Normal Mode	CHANNEL	11
FREQUENCY RANGE	1 ~ 40 GHz	DETECTOR FUNCTION	Peak(PK) Average (AV)
ENVIRONMENTAL CONDITIONS	25deg. C, 60%RH, 991hPa	INPUT POWER (SYSTEM)	120Vac, 60Hz
TESTED BY	Match Tsui		

ANTENNA POLARITY & TEST DISTANCE: HORIZONTAL AT 3 M

No.	Freq. (MHz)	Emission Level (dBuV/m)	Limit (dBuV/m)	Margin (dB)	Antenna Height (m)	Table Angle (Degree)	Raw Value (dBuV)	Correction Factor (dB/m)
1	*5785.00	99.97 PK			1.08 H	325	58.92	41.05
1	*5785.00	89.48 AV			1.08 H	325	48.43	41.05
2	#11570.00	58.24 PK	74.00	-15.76	1.09 H	145	10.77	47.47
2	#11570.00	46.45 AV	54.00	-7.55	1.09 H	145	-1.02	47.47

ANTENNA POLARITY & TEST DISTANCE: VERTICAL AT 3 M

No.	Freq. (MHz)	Emission Level (dBuV/m)	Limit (dBuV/m)	Margin (dB)	Antenna Height (m)	Table Angle (Degree)	Raw Value (dBuV)	Correction Factor (dB/m)
1	*5785.00	111.67 PK			1.16 V	282	70.62	41.05
1	*5785.00	101.16 AV			1.16 V	282	60.11	41.05
2	#11570.00	62.54 PK	74.00	-11.46	1.26 V	102	15.07	47.47
2	#11570.00	49.27 AV	54.00	-4.73	1.26 V	102	1.80	47.47

NOTE:

1. Emission level = Raw value + Correction Factor
2. Correction Factor = Ant. Factor + Cable loss
3. Margin value = Emission level - Limit value
4. The other emission levels were very low against the limit.
5. "*" : Fundamental frequency
6. "#" The radiated frequency falling in the restricted band.



EUT	Wireless A+G Mini PCI Card	MODEL	WMCE54AG
MODE	Normal Mode	CHANNEL	13
FREQUENCY RANGE	1 ~ 40 GHz	DETECTOR FUNCTION	Peak(PK) Average (AV)
ENVIRONMENTAL CONDITIONS	25deg. C, 60%RH, 991hPa	INPUT POWER (SYSTEM)	120Vac, 60Hz
TESTED BY	Match Tsui		

ANTENNA POLARITY & TEST DISTANCE: HORIZONTAL AT 3 M

No.	Freq. (MHz)	Emission Level (dBuV/m)	Limit (dBuV/m)	Margin (dB)	Antenna Height (m)	Table Angle (Degree)	Raw Value (dBuV)	Antenna Factor (dB)
1	*5825.00	100.97 PK			1.40 H	250	60.02	40.95
1	*5825.00	90.46 AV			1.40 H	250	49.51	40.95
2	#11650.00	59.54 PK	74.00	-14.46	1.20 H	360	11.82	47.72
2	#11650.00	47.11 AV	54.00	-6.89	1.20 H	360	-0.61	47.72

ANTENNA POLARITY & TEST DISTANCE: VERTICAL AT 3 M

No.	Freq. (MHz)	Emission Level (dBuV/m)	Limit (dBuV/m)	Margin (dB)	Antenna Height (m)	Table Angle (Degree)	Raw Value (dBuV)	Antenna Factor (dB)
1	*5825.00	109.97 PK			1.17 V	326	69.02	40.95
1	*5825.00	99.15 AV			1.17 V	326	58.20	40.95
2	#11650.00	62.79 PK	74.00	-11.21	1.23 V	101	15.07	47.72
2	#11650.00	49.12 AV	54.00	-4.88	1.23 V	101	1.40	47.72

NOTE:

1. Emission level = Raw value + Correction Factor
2. Correction Factor = Ant. Factor + Cable loss
3. Margin value = Emission level - Limit value
4. The other emission levels were very low against the limit.
5. "*" : Fundamental frequency
6. "#"The radiated frequency falling in the restricted band.



EUT	Wireless A+G Mini PCI Card	MODEL	WMCE54AG
MODE	Turbo Mode	CHANNEL	1
FREQUENCY RANGE	1 ~ 40 GHz	DETECTOR FUNCTION	Peak(PK) Average (AV)
ENVIRONMENTAL CONDITIONS	25deg. C, 60%RH, 991hPa	INPUT POWER (SYSTEM)	120Vac, 60Hz
TESTED BY	Match Tsui		

ANTENNA POLARITY & TEST DISTANCE: HORIZONTAL AT 3 M

No.	Freq. (MHz)	Emission Level (dBuV/m)	Limit (dBuV/m)	Margin (dB)	Antenna Height (m)	Table Angle (Degree)	Raw Value (dBuV)	Correction Factor (dB/m)
1	3473.00	48.35 PK	68.30	-19.95	1.06 H	68	12.71	35.64
1	3473.00	37.09 AV	54.00	-16.91	1.06 H	68	1.45	35.64
2	#5150.00	44.99 PK	74.00	-29.01	1.00 H	339	5.89	39.10
2	#5150.00	34.19 AV	54.00	-19.81	1.00 H	339	-4.91	39.10
3	*5210.00	95.68 PK			1.00 H	339	56.47	39.21
3	*5210.00	84.88 AV			1.00 H	339	45.67	39.21
4	10420.00	56.34 PK	68.30	-11.96	1.06 H	324	10.57	45.77
4	10420.00	43.73 AV	54.00	-10.27	1.06 H	324	-2.04	45.77

ANTENNA POLARITY & TEST DISTANCE: VERTICAL AT 3 M

No.	Freq. (MHz)	Emission Level (dBuV/m)	Limit (dBuV/m)	Margin (dB)	Antenna Height (m)	Table Angle (Degree)	Raw Value (dBuV)	Correction Factor (dB/m)
1	3473.00	49.51 PK	68.30	-18.79	1.17 V	258	13.87	35.64
1	3473.00	39.54 AV	54.00	-14.46	1.17 V	258	3.90	35.64
2	#5150.00	56.61 PK	74.00	-17.39	1.14 V	307	17.51	39.10
2	#5150.00	45.31 AV	54.00	-8.69	1.14 V	307	6.21	39.10
3	*5210.00	107.30 PK			1.14 V	307	68.09	39.21
3	*5210.00	96.84 AV			1.14 V	307	57.63	39.21
4	10420.00	57.39 PK	68.30	-10.91	1.13 V	1	11.62	45.77
4	10420.00	45.34 AV	54.00	-8.66	1.13 V	1	-0.43	45.77

NOTE:

1. Emission level(dBuV/m)=Raw Value(dBuV) + Correction Factor(dB).
2. Correction Factor(dB/m) = Antenna Factor (dB/m) + Cable Factor (dB).
3. The other emission levels were very low against the limit.
4. Margin value = Emission level – Limit value.
5. “ * “ : Fundamental frequency.
6. “#” The radiated frequency falling in the restricted band.



EUT	Wireless A+G Mini PCI Card	MODEL	WMCE54AG
MODE	Turbo Mode	CHANNEL	2
FREQUENCY RANGE	1 ~ 40 GHz	DETECTOR FUNCTION	Peak(PK) Average (AV)
ENVIRONMENTAL CONDITIONS	25deg. C, 60%RH, 991hPa	INPUT POWER (SYSTEM)	120Vac, 60Hz
TESTED BY	Match Tsui		

ANTENNA POLARITY & TEST DISTANCE: HORIZONTAL AT 3 M

No.	Freq. (MHz)	Emission Level (dBuV/m)	Limit (dBuV/m)	Margin (dB)	Antenna Height (m)	Table Angle (Degree)	Raw Value (dBuV)	Correction Factor (dB/m)
1	3500.00	47.57 PK	68.30	-20.73	1.19 H	75	11.85	35.72
1	3500.00	35.22 AV	54.00	-18.78	1.19 H	75	-0.50	35.72
2	*5250.00	95.78 PK			1.00 H	276	56.61	39.17
2	*5250.00	85.09 AV			1.00 H	276	45.92	39.17
3	10500.00	56.94 PK	68.30	-11.36	1.00 H	154	10.75	46.19
3	10500.00	43.06 AV	54.00	-10.94	1.00 H	154	-3.13	46.19

ANTENNA POLARITY & TEST DISTANCE: VERTICAL AT 3 M

No.	Freq. (MHz)	Emission Level (dBuV/m)	Limit (dBuV/m)	Margin (dB)	Antenna Height (m)	Table Angle (Degree)	Raw Value (dBuV)	Correction Factor (dB/m)
1	3500.00	49.28 PK	68.30	-19.02	1.17 V	256	13.56	35.72
1	3500.00	38.41 AV	54.00	-15.59	1.17 V	256	2.69	35.72
2	*5250.00	106.00 PK			1.00 V	22	66.83	39.17
2	*5250.00	96.09 AV			1.00 V	22	56.92	39.17
3	10500.00	58.91 PK	68.30	-9.39	1.44 V	358	12.72	46.19
3	10500.00	45.93 AV	54.00	-8.07	1.44 V	358	-0.26	46.19

NOTE:

1. Emission level(dBuV/m)=Raw Value(dBuV) + Correction Factor(dB).
2. Correction Factor(dB/m) = Antenna Factor (dB/m) + Cable Factor (dB).
3. The other emission levels were very low against the limit.
4. Margin value = Emission level – Limit value.
5. “ * “ : Fundamental frequency.
6. “#” The radiated frequency falling in the restricted band.



EUT	Wireless A+G Mini PCI Card	MODEL	WMCE54AG
MODE	Turbo Mode	CHANNEL	3
FREQUENCY RANGE	1 ~ 40 GHz	DETECTOR FUNCTION	Peak(PK) Average (AV)
ENVIRONMENTAL CONDITIONS	25deg. C, 60%RH, 991hPa	INPUT POWER (SYSTEM)	120Vac, 60Hz
TESTED BY	Match Tsui		

ANTENNA POLARITY & TEST DISTANCE: HORIZONTAL AT 3 M

No.	Freq. (MHz)	Emission Level (dBuV/m)	Limit (dBuV/m)	Margin (dB)	Antenna Height (m)	Table Angle (Degree)	Raw Value (dBuV)	Correction Factor (dB/m)
1	3526.00	47.77 PK	68.30	-20.53	1.05 H	26	11.98	35.79
1	3526.00	35.70 AV	54.00	-18.30	1.05 H	26	-0.09	35.79
2	*5290.00	95.75 PK			1.04 H	295	56.62	39.13
2	*5290.00	86.06 AV			1.04 H	295	46.93	39.13
3	#5350.00	40.98 PK	74.00	-33.02	1.04 H	295	1.78	39.20
3	#5350.00	31.29 AV	54.00	-22.71	1.04 H	295	-7.91	39.20
4	10580.00	56.51 PK	68.30	-11.79	1.05 H	176	10.44	46.07
4	10580.00	43.92 AV	54.00	-10.08	1.05 H	176	-2.15	46.07

ANTENNA POLARITY & TEST DISTANCE: VERTICAL AT 3 M

No.	Freq. (MHz)	Emission Level (dBuV/m)	Limit (dBuV/m)	Margin (dB)	Antenna Height (m)	Table Angle (Degree)	Raw Value (dBuV)	Correction Factor (dB/m)
1	3526.00	48.60 PK	68.30	-19.70	1.00 V	255	12.81	35.79
1	3526.00	38.27 AV	54.00	-15.73	1.00 V	255	2.48	35.79
2	*5290.00	107.52 PK			1.11 V	307	68.39	39.13
2	*5290.00	96.92 AV			1.11 V	307	57.79	39.13
3	#5350.00	52.75 PK	74.00	-21.25	1.11 V	307	13.55	39.20
3	#5350.00	42.15 AV	54.00	-11.85	1.11 V	307	2.95	39.20
4	10580.00	58.24 PK	68.30	-10.06	1.00 V	36	12.17	46.07
4	10580.00	45.28 AV	54.00	-8.72	1.00 V	36	-0.79	46.07

NOTE:

1. Emission level(dBuV/m)=Raw Value(dBuV) + Correction Factor(dB).
2. Correction Factor(dB/m) = Antenna Factor (dB/m) + Cable Factor (dB).
3. The other emission levels were very low against the limit.
4. Margin value = Emission level – Limit value.
5. “ * ” : Fundamental frequency.
6. “#”The radiated frequency falling in the restricted band.



EUT	Wireless A+G Mini PCI Card	MODEL	WMCE54AG
MODE	Turbo Mode	CHANNEL	4
FREQUENCY RANGE	1 ~ 40 GHz	DETECTOR FUNCTION	Peak(PK) Average (AV)
ENVIRONMENTAL CONDITIONS	25deg. C, 60%RH, 991hPa	INPUT POWER (SYSTEM)	120Vac, 60Hz
TESTED BY	Match Tsui		

ANTENNA POLARITY & TEST DISTANCE: HORIZONTAL AT 3 M

No.	Freq. (MHz)	Emission Level (dBuV/m)	Limit (dBuV/m)	Margin (dB)	Antenna Height (m)	Table Angle (Degree)	Raw Value (dBuV)	Correction Factor (dB/m)
1	*5760.00	97.72 PK			1.00 H	294	56.76	40.96
1	*5760.00	87.77 AV			1.00 H	294	46.81	40.96
2	#11520.00	57.79 PK	74.00	-16.21	1.06 H	192	10.37	47.41
2	#11520.00	45.25 AV	54.00	-8.75	1.06 H	192	-2.17	47.41

ANTENNA POLARITY & TEST DISTANCE: VERTICAL AT 3 M

No.	Freq. (MHz)	Emission Level (dBuV/m)	Limit (dBuV/m)	Margin (dB)	Antenna Height (m)	Table Angle (Degree)	Raw Value (dBuV)	Correction Factor (dB/m)
1	*5760.00	109.08 PK			1.16 V	288	68.12	40.96
1	*5760.00	98.81 AV			1.16 V	288	57.85	40.96
2	#11520.00	58.38 PK	74.00	-15.62	1.20 V	37	10.96	47.41
2	#11520.00	45.89 AV	54.00	-8.11	1.20 V	37	-1.53	47.41

NOTE:

1. Emission level(dBuV/m)=Raw Value(dBuV) + Correction Factor(dB).
2. Correction Factor(dB/m) = Antenna Factor (dB/m) + Cable Factor (dB).
3. The other emission levels were very low against the limit.
4. Margin value = Emission level – Limit value.
5. “ * “ : Fundamental frequency.
6. “#”The radiated frequency falling in the restricted band.
7. The limit value is defined as per 15.247



EUT	Wireless A+G Mini PCI Card	MODEL	WMCE54AG
MODE	Turbo Mode	CHANNEL	5
FREQUENCY RANGE	1 ~ 40 GHz	DETECTOR FUNCTION	Peak(PK) Average (AV)
ENVIRONMENTAL CONDITIONS	25deg. C, 60%RH, 991hPa	INPUT POWER (SYSTEM)	120Vac, 60Hz
TESTED BY	Match Tsui		

ANTENNA POLARITY & TEST DISTANCE: HORIZONTAL AT 3 M

No.	Freq. (MHz)	Emission Level (dBuV/m)	Limit (dBuV/m)	Margin (dB)	Antenna Height (m)	Table Angle (Degree)	Raw Value (dBuV)	Correction Factor (dB/m)
1	*5800.00	95.66 PK			1.01 H	274	54.55	41.11
1	*5800.00	86.54 AV			1.01 H	274	45.43	41.11
2	#11600.00	58.54 PK	74.00	-15.46	1.03 H	59	11.04	47.50
2	#11600.00	45.84 AV	54.00	-8.16	1.03 H	59	-1.66	47.50

ANTENNA POLARITY & TEST DISTANCE: VERTICAL AT 3 M

No.	Freq. (MHz)	Emission Level (dBuV/m)	Limit (dBuV/m)	Margin (dB)	Antenna Height (m)	Table Angle (Degree)	Raw Value (dBuV)	Correction Factor (dB/m)
1	*5800.00	107.18 PK			1.00 V	305	66.07	41.11
1	*5800.00	97.72 AV			1.00 V	305	56.61	41.11
2	#11600.00	59.62 PK	74.00	-14.38	1.19 V	37	12.12	47.50
2	#11600.00	46.70 AV	54.00	-7.30	1.19 V	37	-0.80	47.50

NOTE:

1. Emission level(dBuV/m)=Raw Value(dBuV) + Correction Factor(dB).
2. Correction Factor(dB/m) = Antenna Factor (dB/m) + Cable Factor (dB).
3. The other emission levels were very low against the limit.
4. Margin value = Emission level – Limit value.
5. “ * “ : Fundamental frequency.
6. “#” The radiated frequency falling in the restricted band.
7. The limit value is defined as per 15.247



FOR FREQUENCY 5.15~5.35GHz

5.3 PEAK TRANSMIT POWER MEASUREMENT

5.3.1 LIMITS OF PEAK TRANSMIT POWER MEASUREMENT

Frequency Band	Limit
5.15 – 5.25GHz	The lesser of 50mW (17dBm) or 4dBm + 10logB
5.25 – 5.35GHz	The lesser of 250mW (24dBm) or 11dBm + 10logB
5.725 – 5.825GHz	The lesser of 1W (30dBm) or 17dBm + 10logB

NOTE: Where B is the 26dB emission bandwidth in MHz.

5.3.2 TEST INSTRUMENTS

Description & Manufacturer	Model No.	Serial No.	Calibrated Until
R&S SPECTRUM ANALYZER	FSEK30	100049	Aug. 12, 2005

NOTE: The calibration interval of the above test instruments is 12 months and the calibrations are traceable to NML/ROC and NIST/USA.



5.3.3 TEST PROCEDURE

1. The transmitter output was connected to the spectrum analyzer.
2. Set span to encompass the entire emission bandwidth of the signal.
3. Set RBW to 1MHz, VBW to 300kHz.
4. Using the spectrum analyzer's channel power measurement function to measure the output power.

5.3.4 DEVIATION FROM TEST STANDARD

No deviation

5.3.5 TEST SETUP

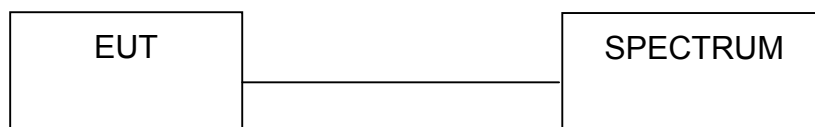

5.3.6 EUT OPERATING CONDITIONS

The software provided by client to enable the EUT under transmission condition continuously at specific channel frequencies individually.



5.3.7 TEST RESULTS

EUT	Wireless A+G Mini PCI Card	MODEL	WMCE54AG
MODE	Normal	INPUT POWER (SYSTEM)	120Vac, 60 Hz
ENVIRONMENTAL CONDITIONS	24deg. C, 65%RH, 991hPa	TESTED BY	Steven Lu

CHANNEL	CHANNEL FREQUENCY (MHz)	PEAK POWER OUTPUT (dBm)	PEAK POWER OUTPUT (mW)	PEAK POWER LIMIT (dBm)	26dBc Occupied Bandwidth (MHz)	PASS/FAIL
1	5180	13.02	20.05	17.00	25.74	PASS
4	5240	13.09	20.37	17.00	25.46	PASS
5	5260	13.09	20.37	24.00	24.76	PASS
8	5320	13.04	20.14	24.00	24.90	PASS

NOTE: The 26dBc Occupied Bandwidth plot, please refer to the following pages.



Peak Power Output:
CH1

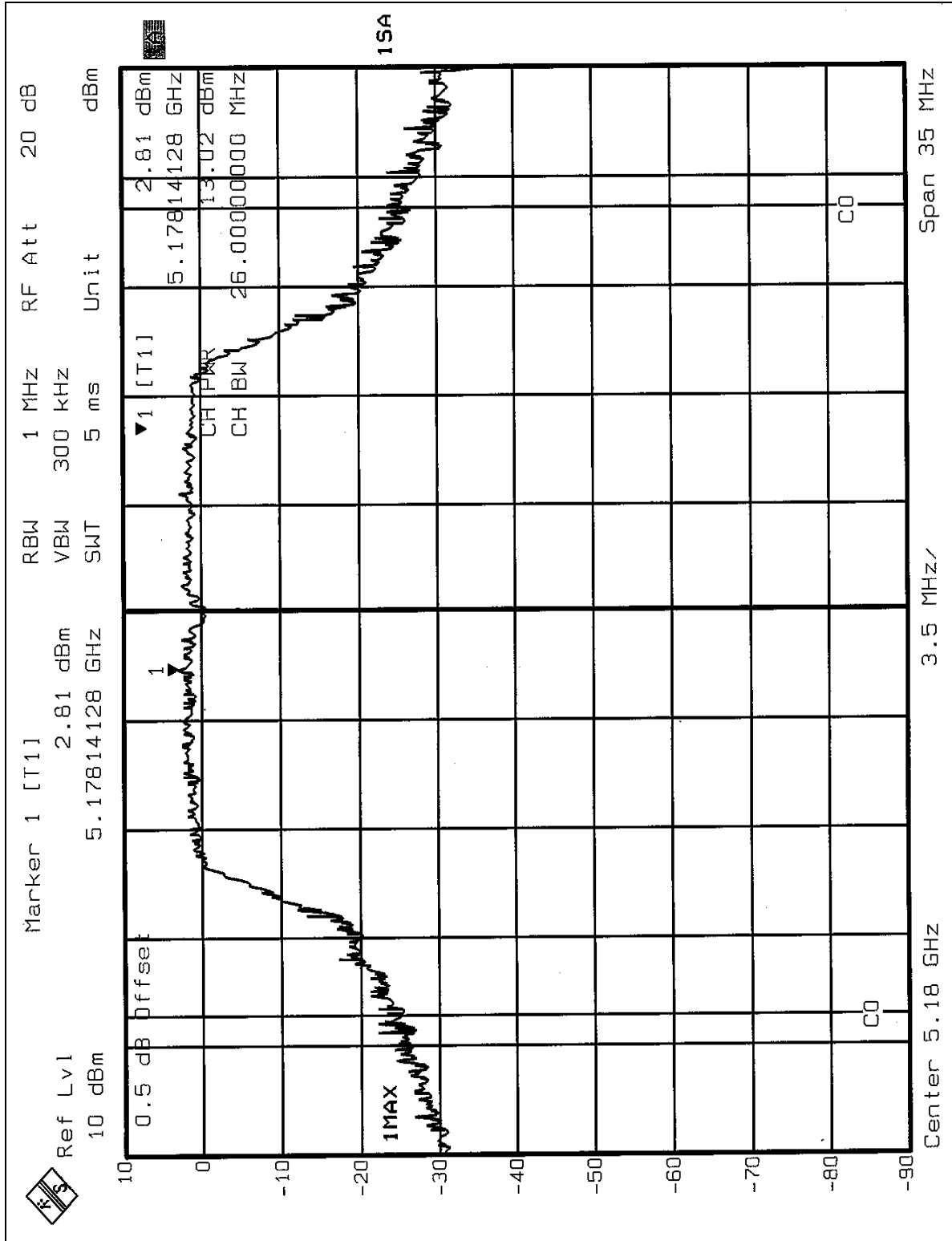



CH4

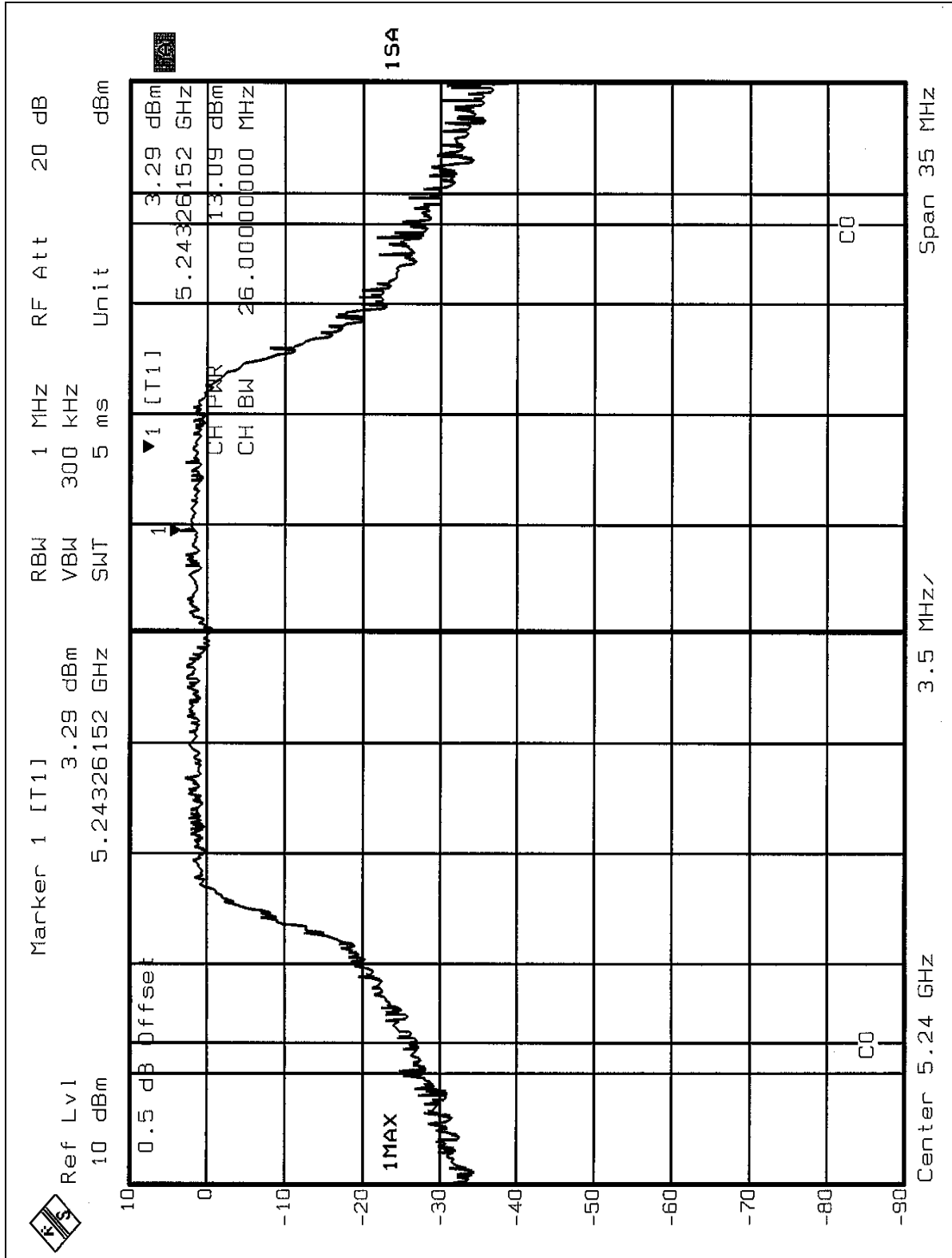



CH5

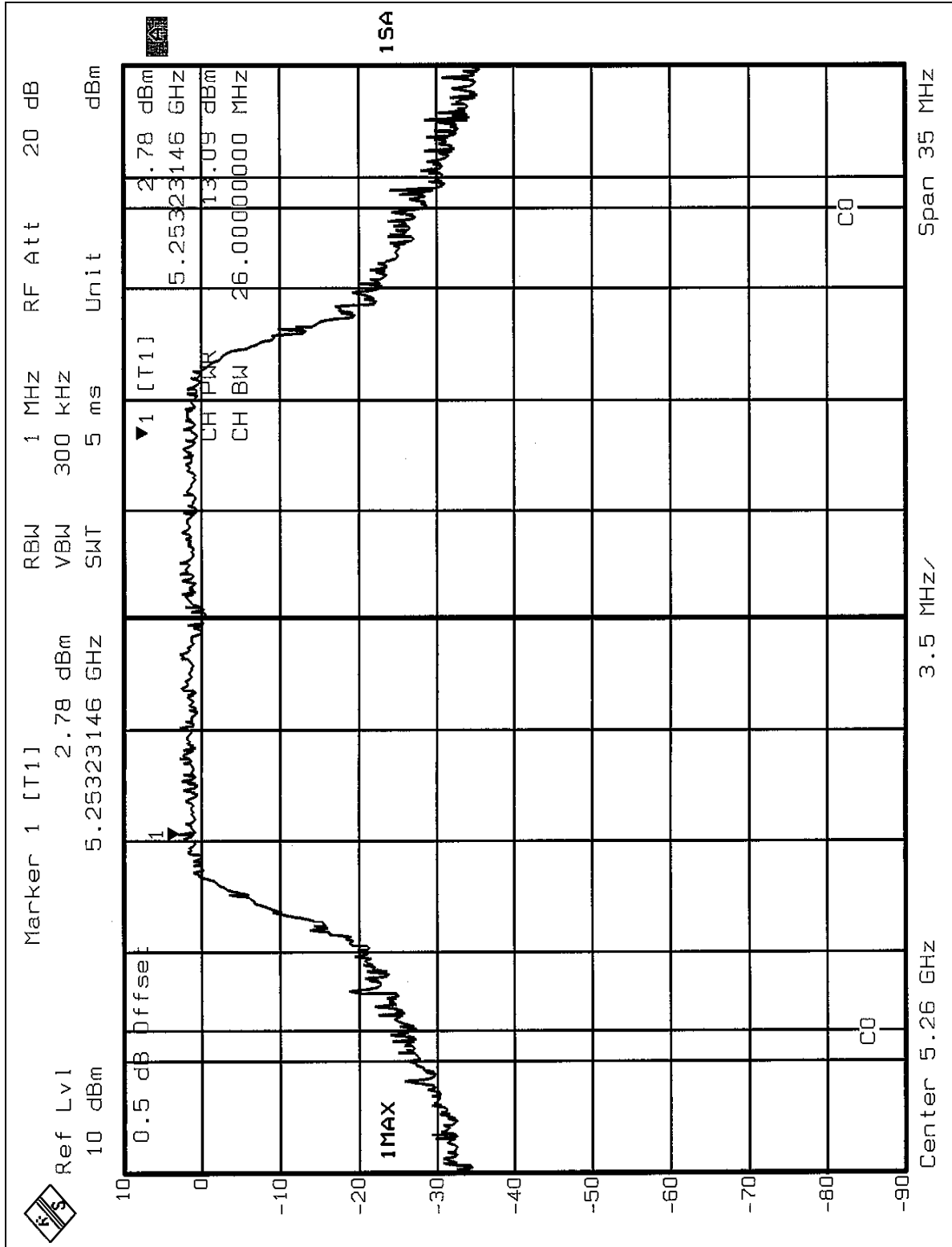



CH8

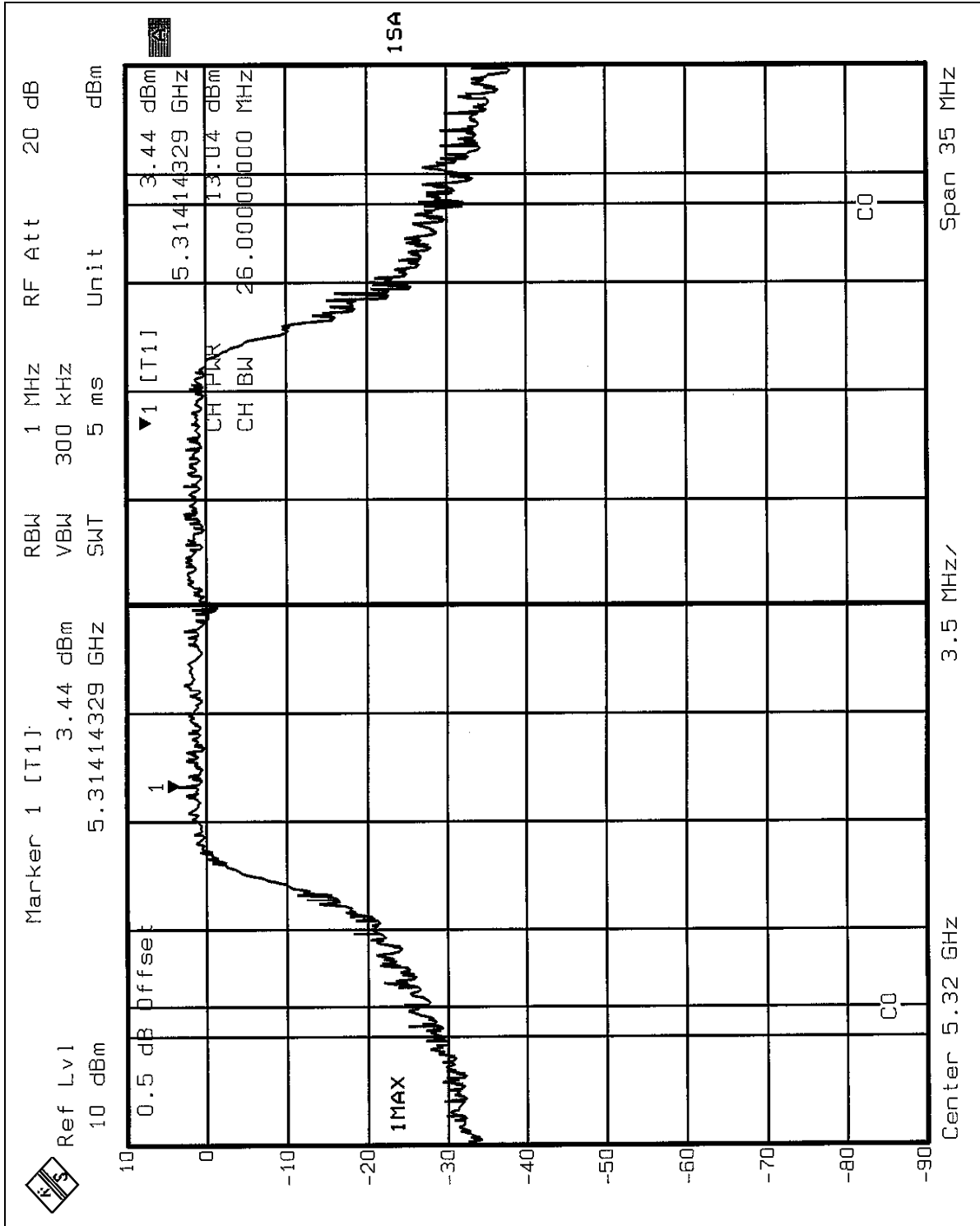



26dB Occupied Bandwidth:
CH1

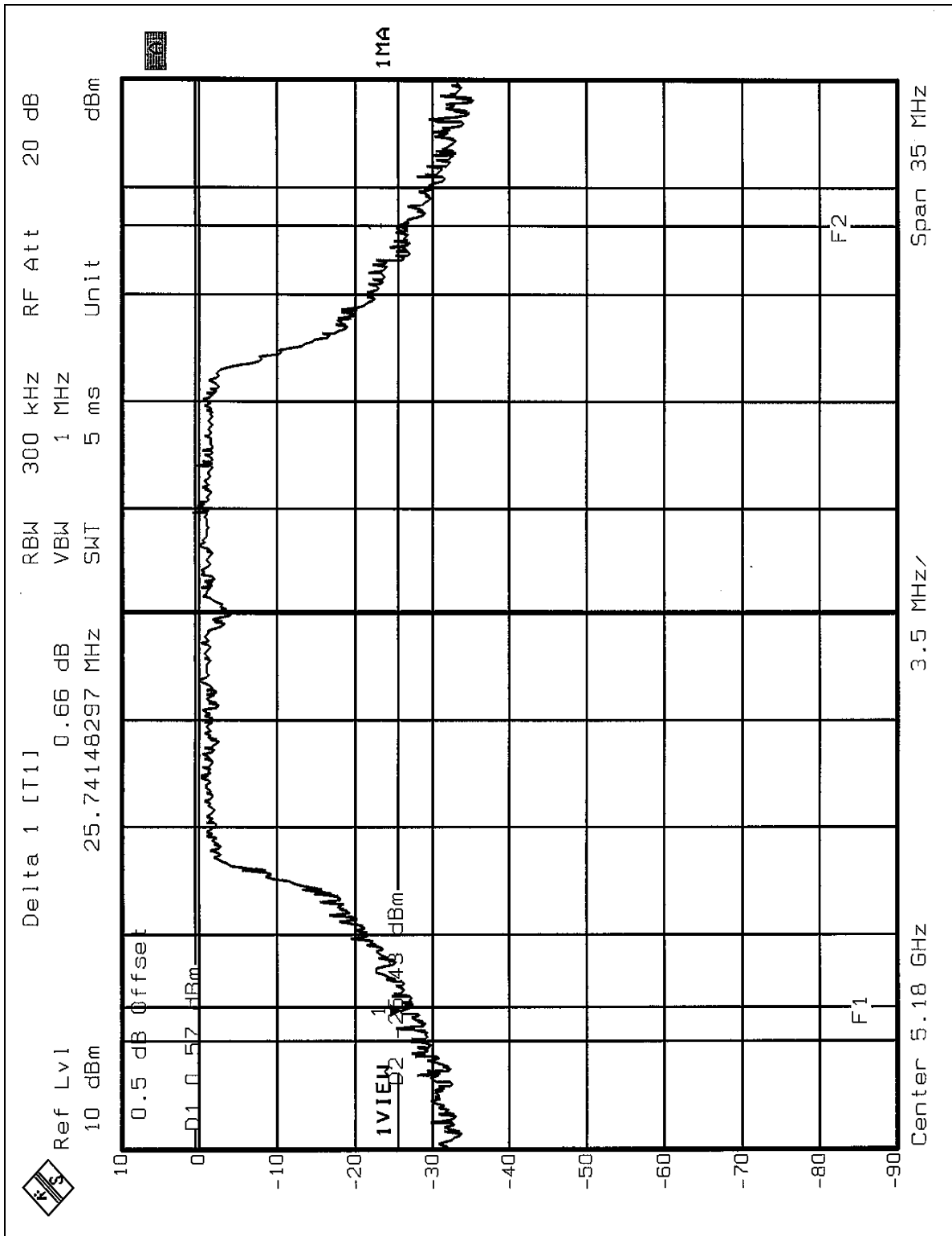



CH4

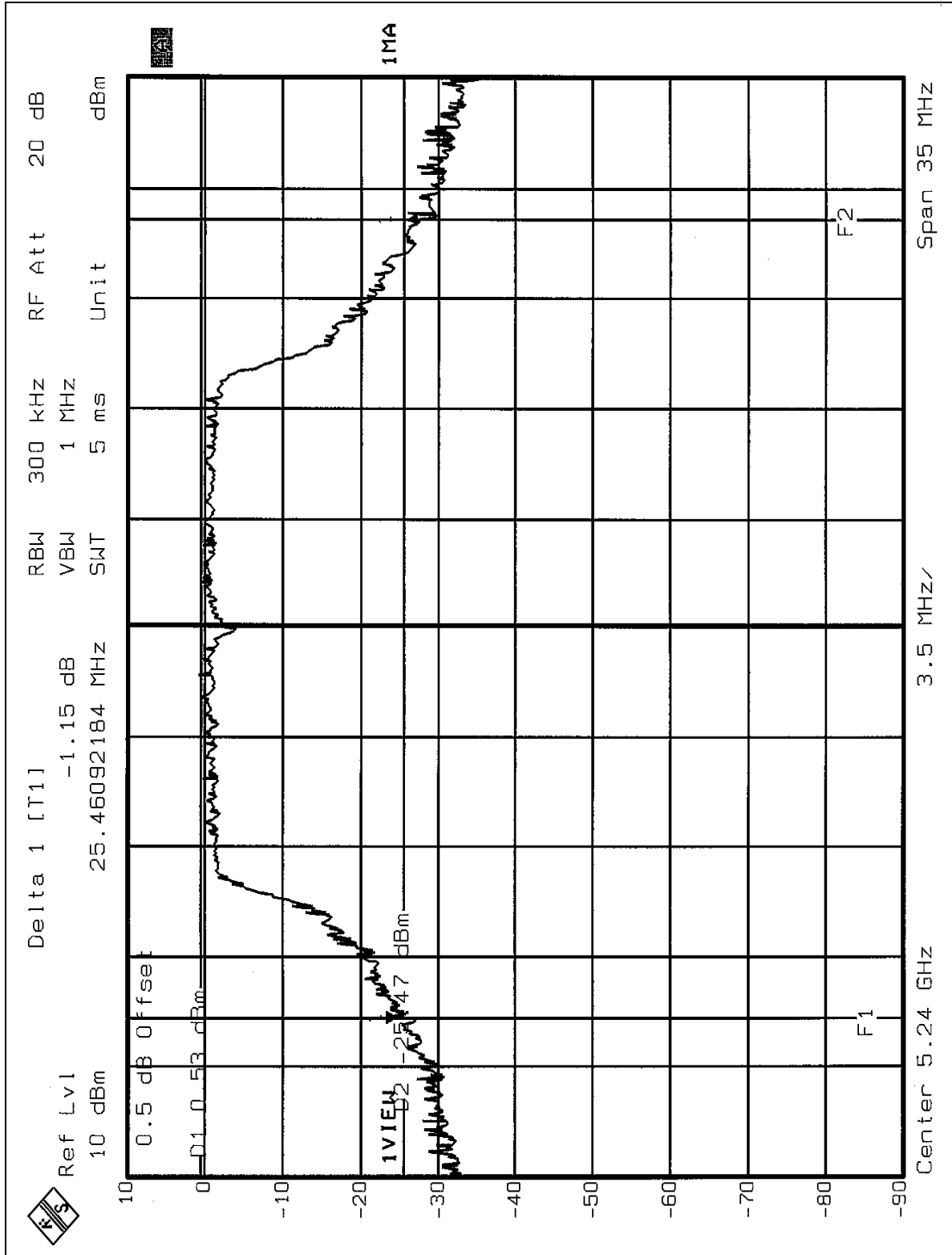



CH5

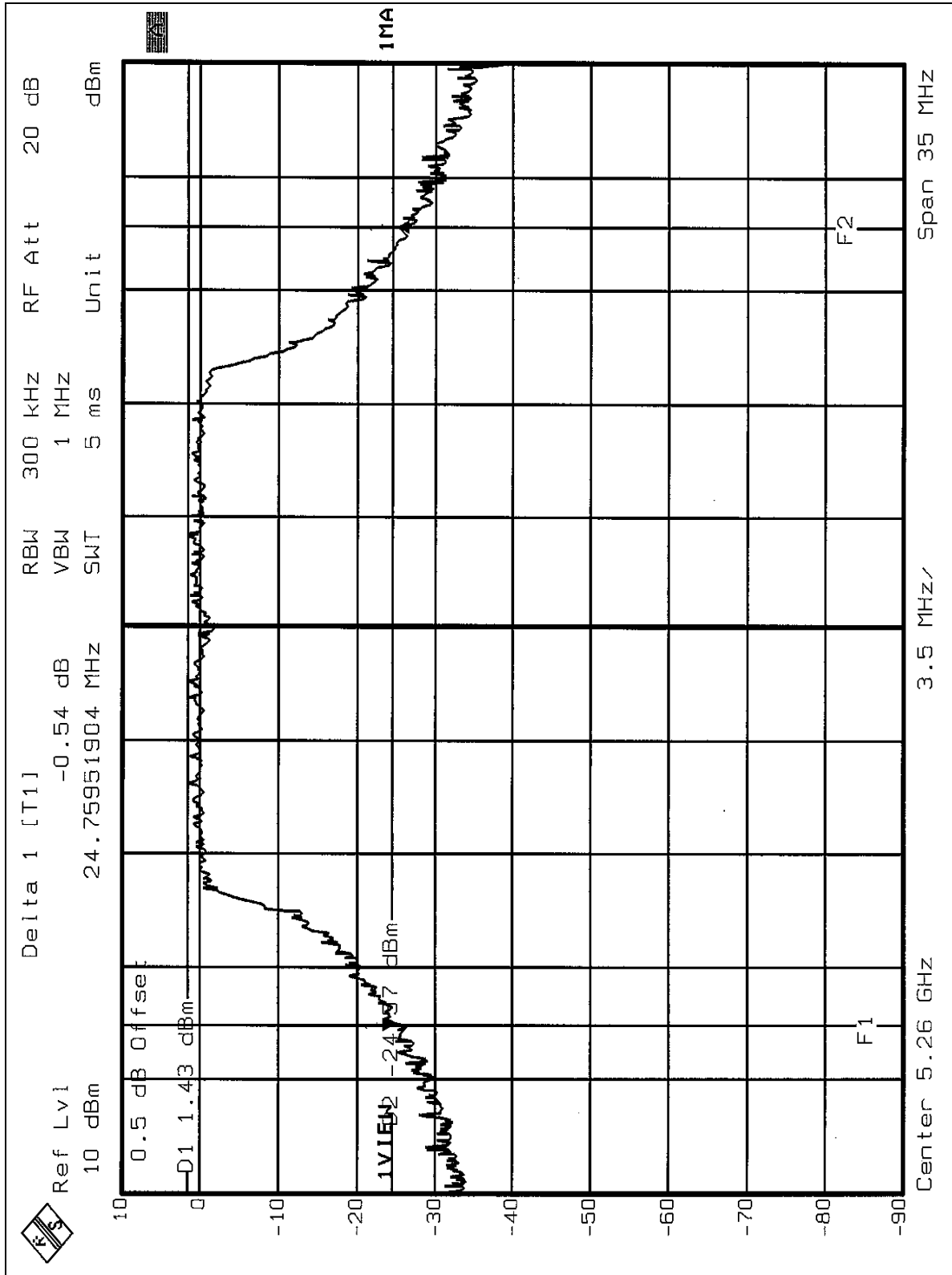



CH8

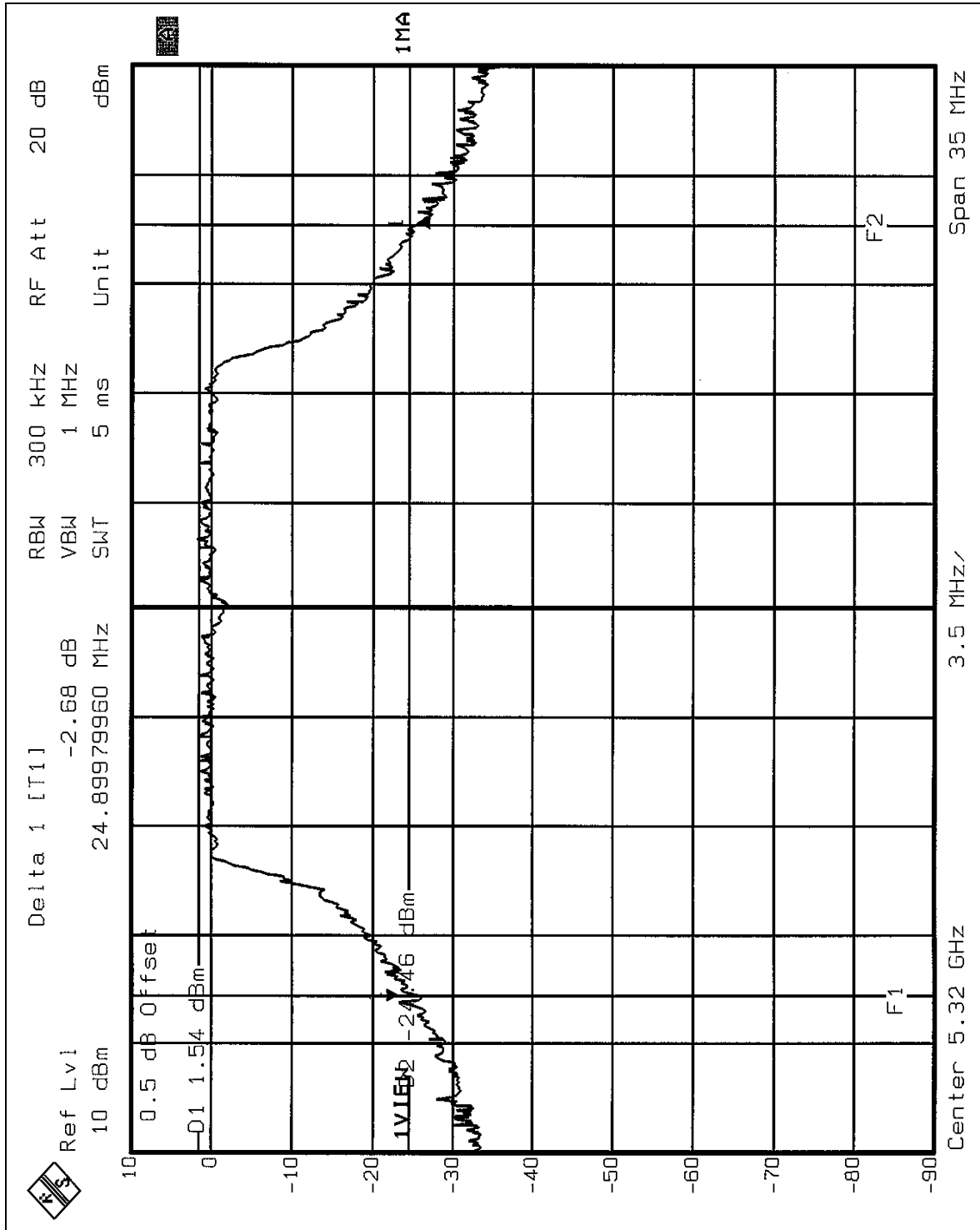



EUT	Wireless A+G Mini PCI Card	MODEL	WMCE54AG
MODE	Turbo	INPUT POWER (SYSTEM)	120Vac, 60 Hz
ENVIRONMENTAL CONDITIONS	24deg. C, 65%RH, 991hPa	TESTED BY	Steven Lu

CHANNEL	CHANNEL FREQUENCY (MHz)	PEAK POWER OUTPUT (dBm)	PEAK POWER OUTPUT (mW)	PEAK POWER LIMIT (dBm)	26dBc Occupied Bandwidth (MHz)	PASS/FAIL
1	5210	13.17	20.75	17.00	44.96	PASS
2	5250	13.03	20.09	17.00	45.45	PASS
3	5290	13.09	20.37	24.00	46.29	PASS

NOTE: The 26dBc Occupied Bandwidth plot, please refer to the following pages.



Peak Power Output:
CH1

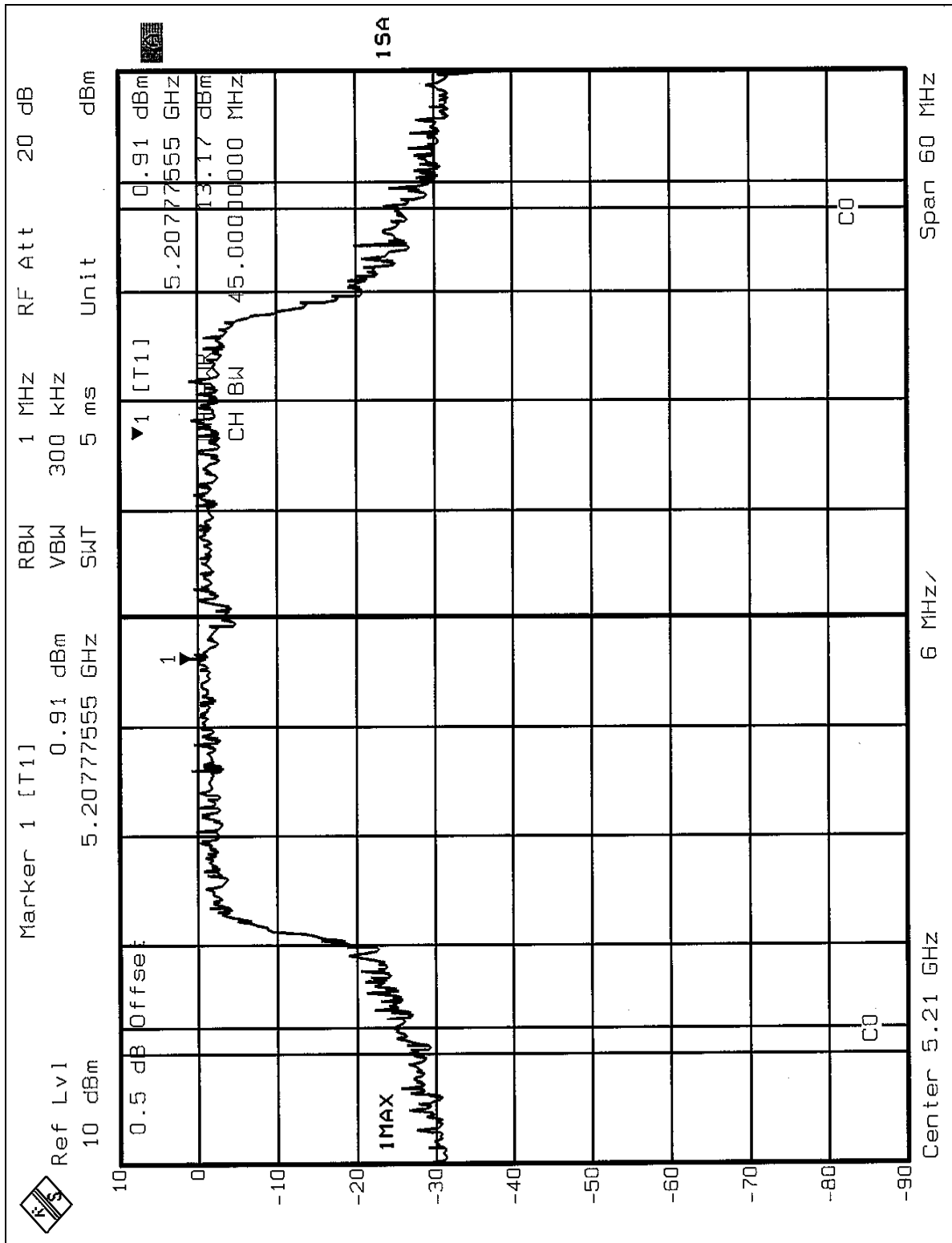



CH2

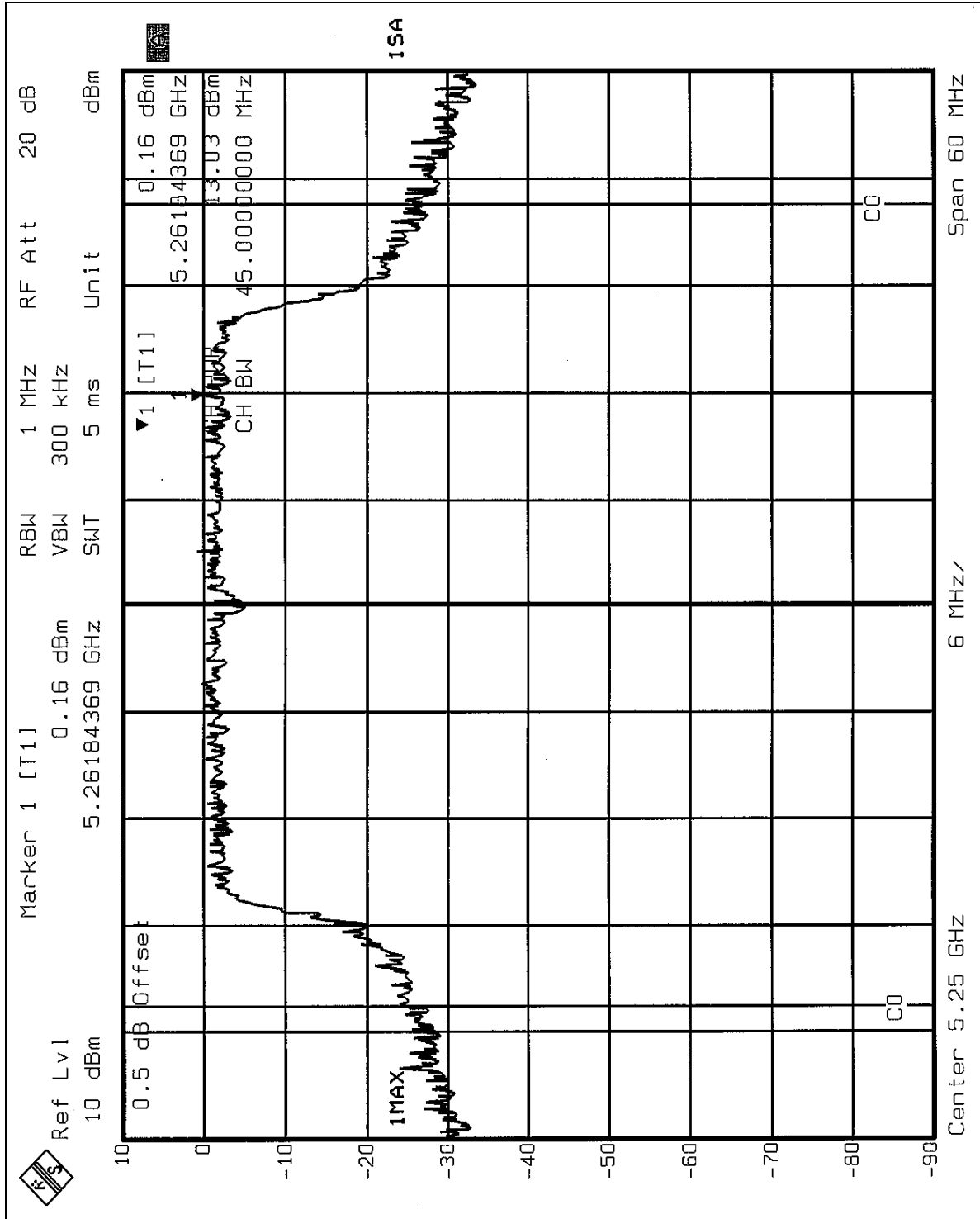



CH3

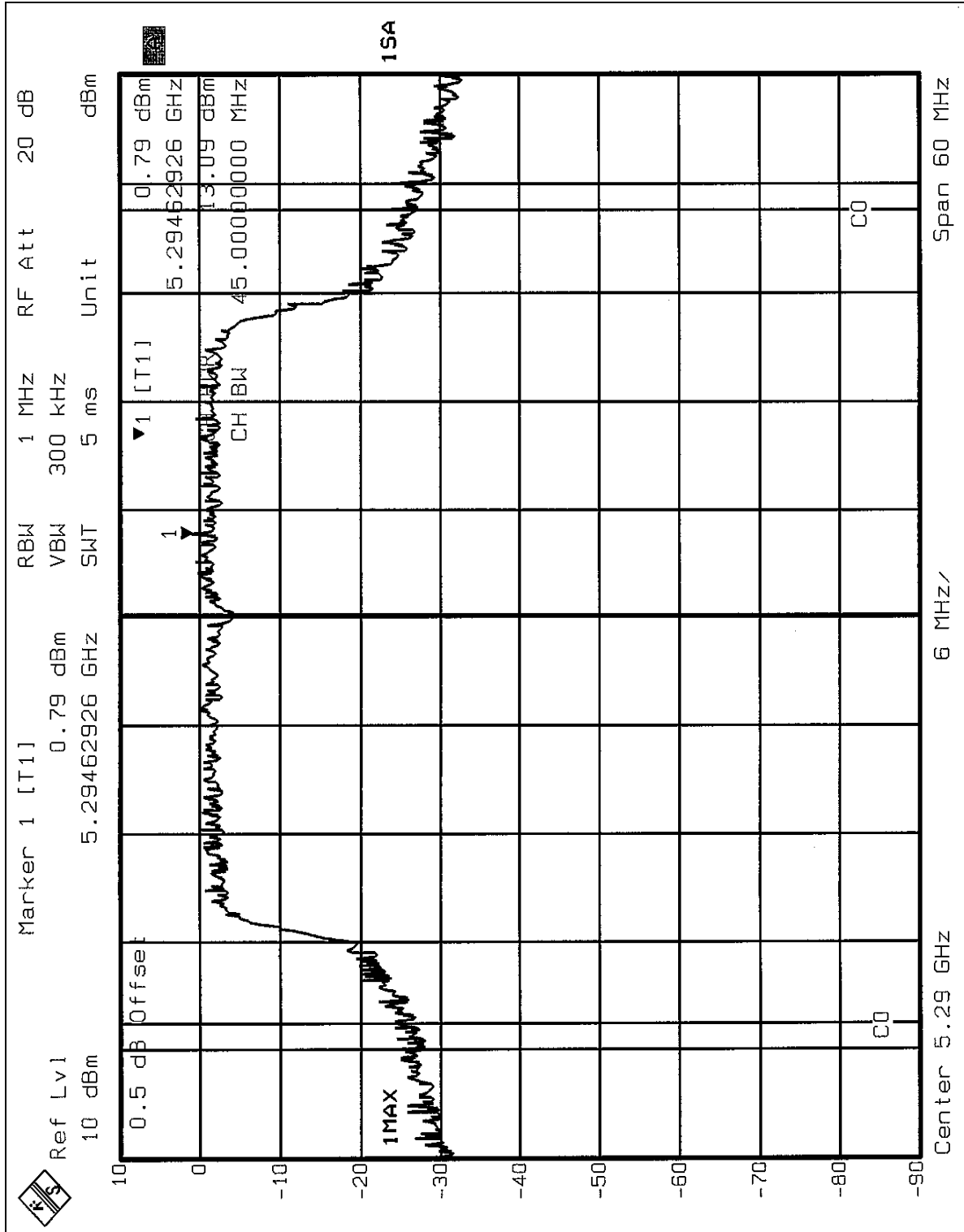



26dB Occupied Bandwidth:
CH1

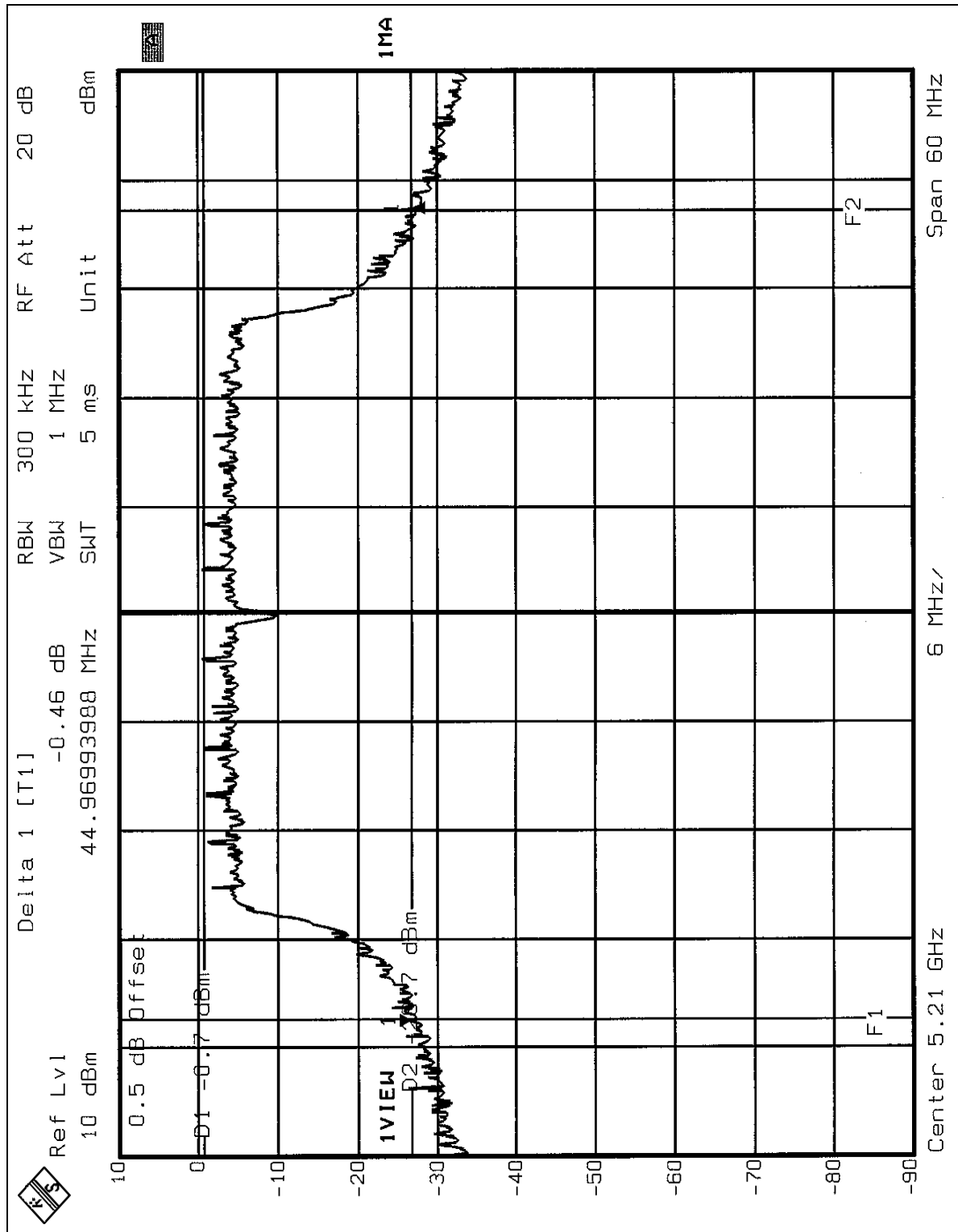



CH2

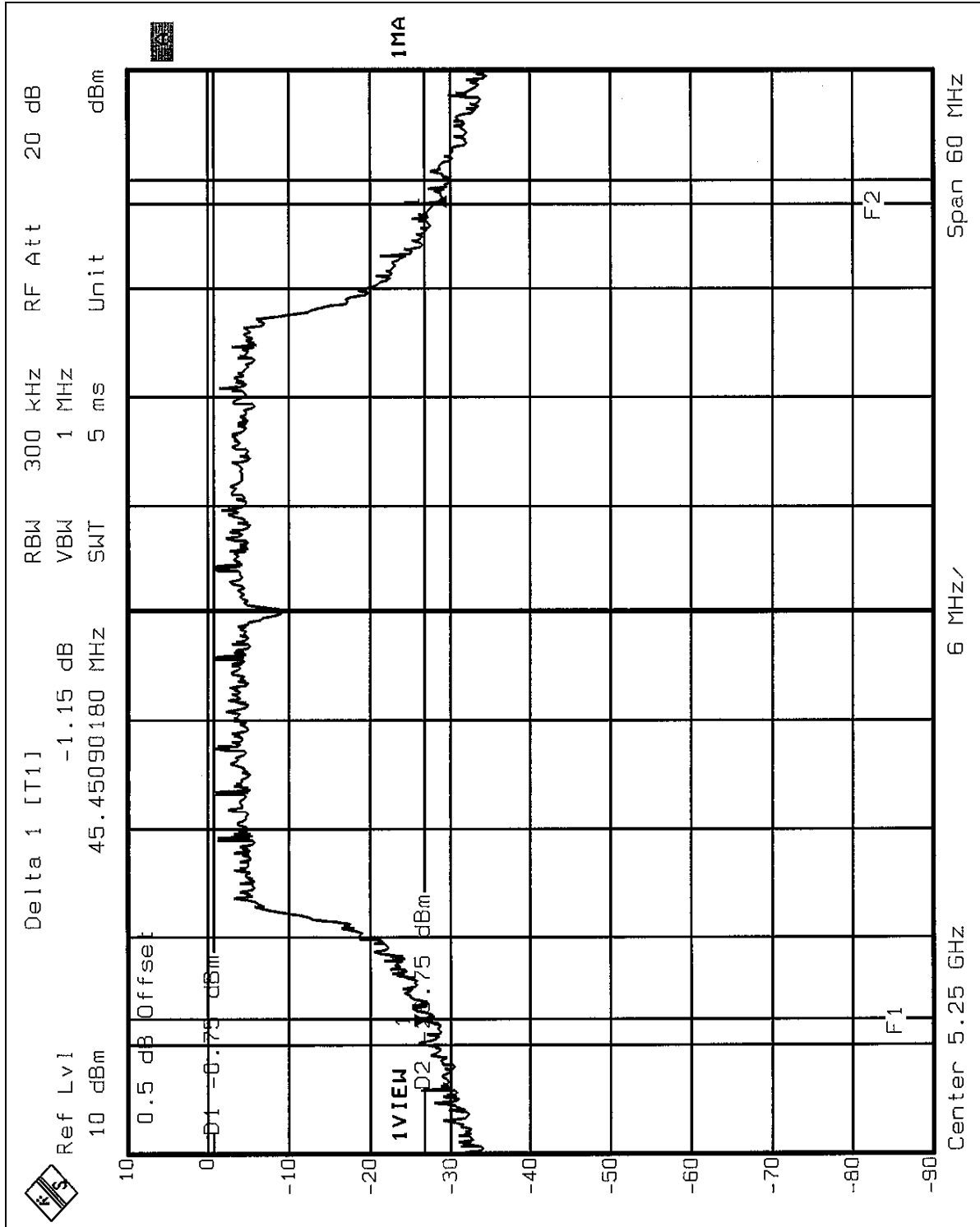



CH3

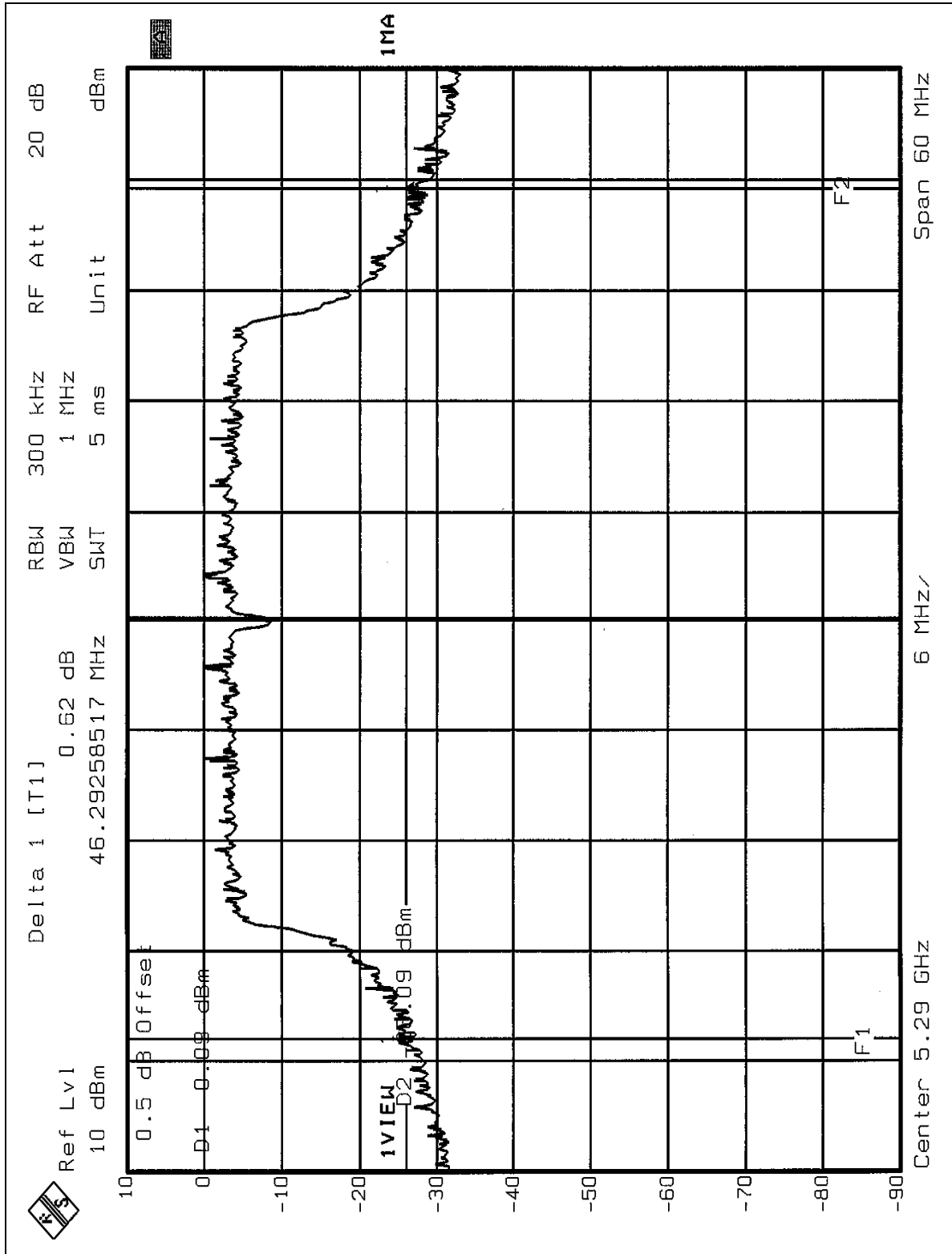



5.4 PEAK POWER EXCURSION MEASUREMENT

5.4.1 LIMITS OF PEAK POWER EXCURSION MEASUREMENT

Frequency Band	Limit
5.15 – 5.25 GHz	13dB
5.25 – 5.35 GHz	13dB
5.725 – 5.825 GHz	13dB

5.4.2 TEST INSTRUMENTS

Description & Manufacturer	Model No.	Serial No.	Calibrated Until
SPECTRUM ANALYZER	FSEK30	100049	Aug. 12, 2005

NOTE: The calibration interval of the above test instruments is 12 months and the calibrations are traceable to NML/ROC and NIST/USA.



5.4.3 TEST PROCEDURE

1. The transmitter output was connected to the spectrum analyzer.
2. Set the spectrum bandwidth span to view the entire spectrum.
3. Using peak detector and Max-hold function for Trace 1 (RB=1MHz, VB=3MHz) and 2 (RB=1MHz, VB=300KHz).
4. The largest difference between Trace 1 and Trace 2 in any 1MHz band on any frequency was recorded.

5.4.4 DEVIATION FROM TEST STANDARD

No deviation

5.4.5 TEST SETUP

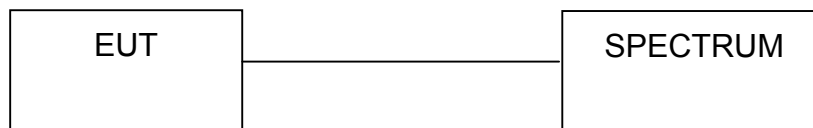

5.4.6 EUT OPERATING CONDITIONS

The software provided by client to enable the EUT under transmission condition continuously at specific channel frequencies individually.



5.4.7 TEST RESULTS

EUT	Wireless A+G Mini PCI Card	MODEL	WMCE54AG
MODE	Normal	INPUT POWER (SYSTEM)	120Vac, 60 Hz
ENVIRONMENTAL CONDITIONS	24deg. C, 65%RH, 991hPa	TESTED BY	Steven Lu

CHANNEL	CHANNEL FREQUENCY (MHz)	PEAK POWER EXCURSION (dB)	PEAK to AVERAGE EXCURSION LIMIT (dB)	PASS/FAIL
1	5180	6.70	13	PASS
4	5240	6.44	13	PASS
5	5260	6.19	13	PASS
8	5320	6.27	13	PASS



CH1

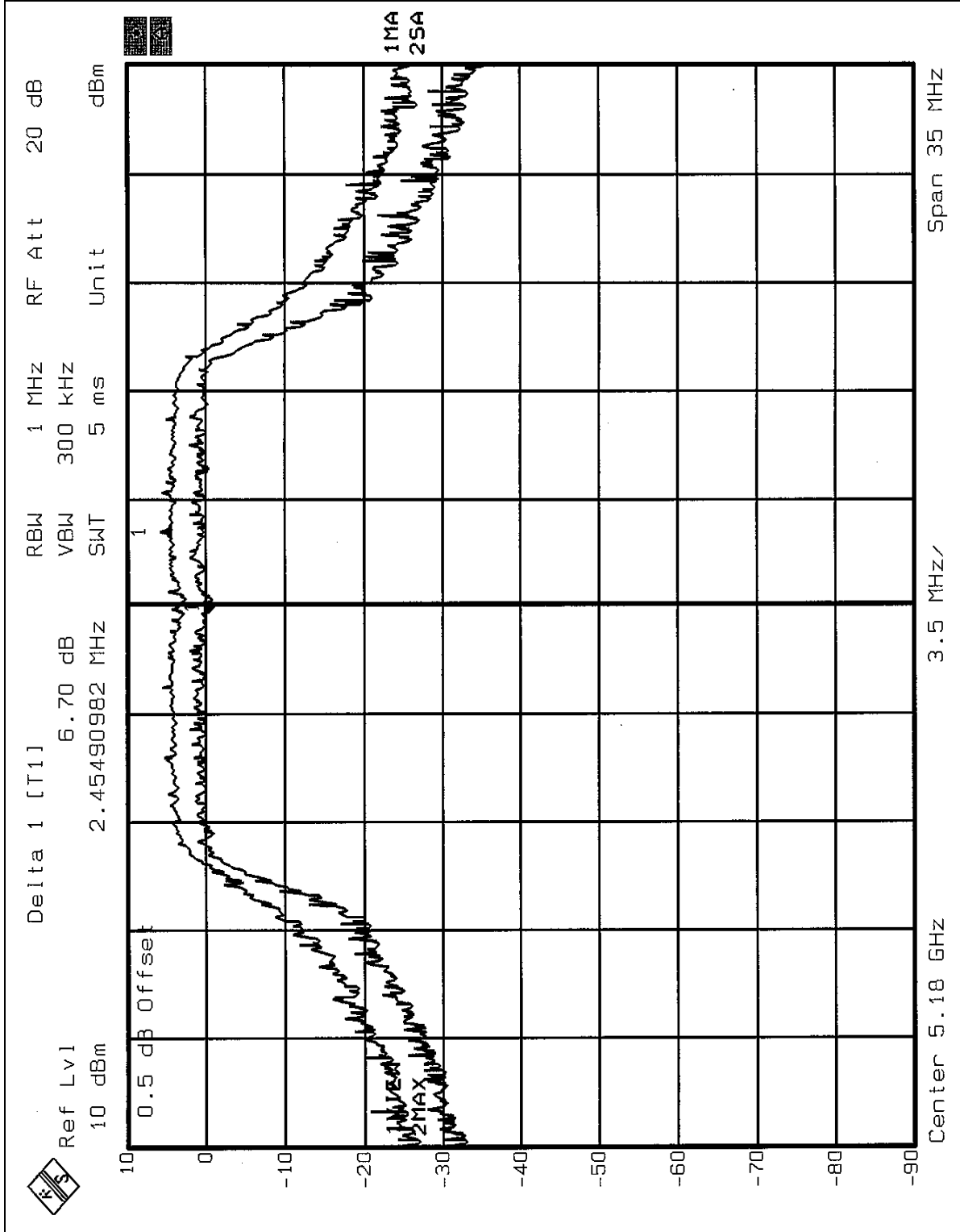



CH4

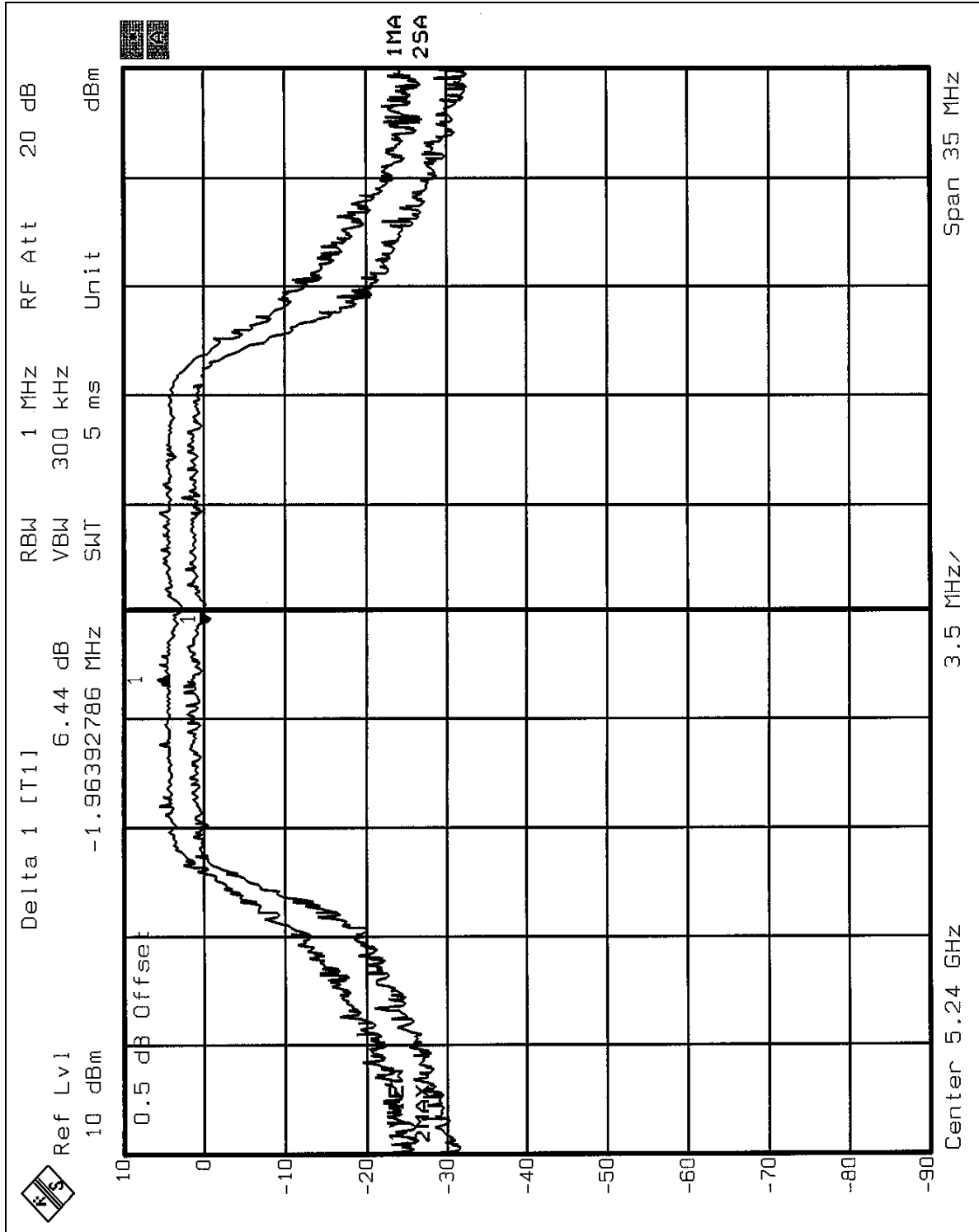



CH5

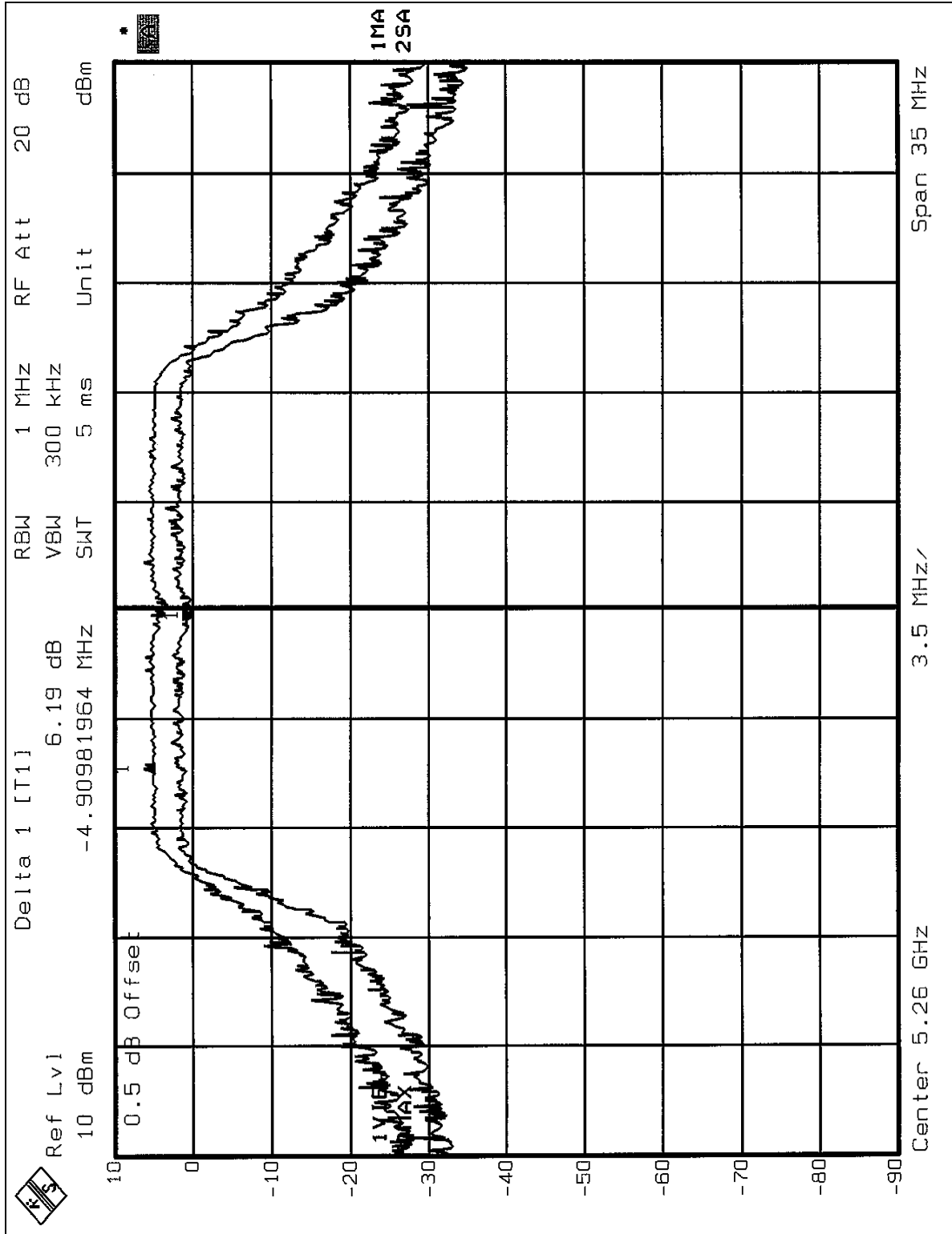



CH8

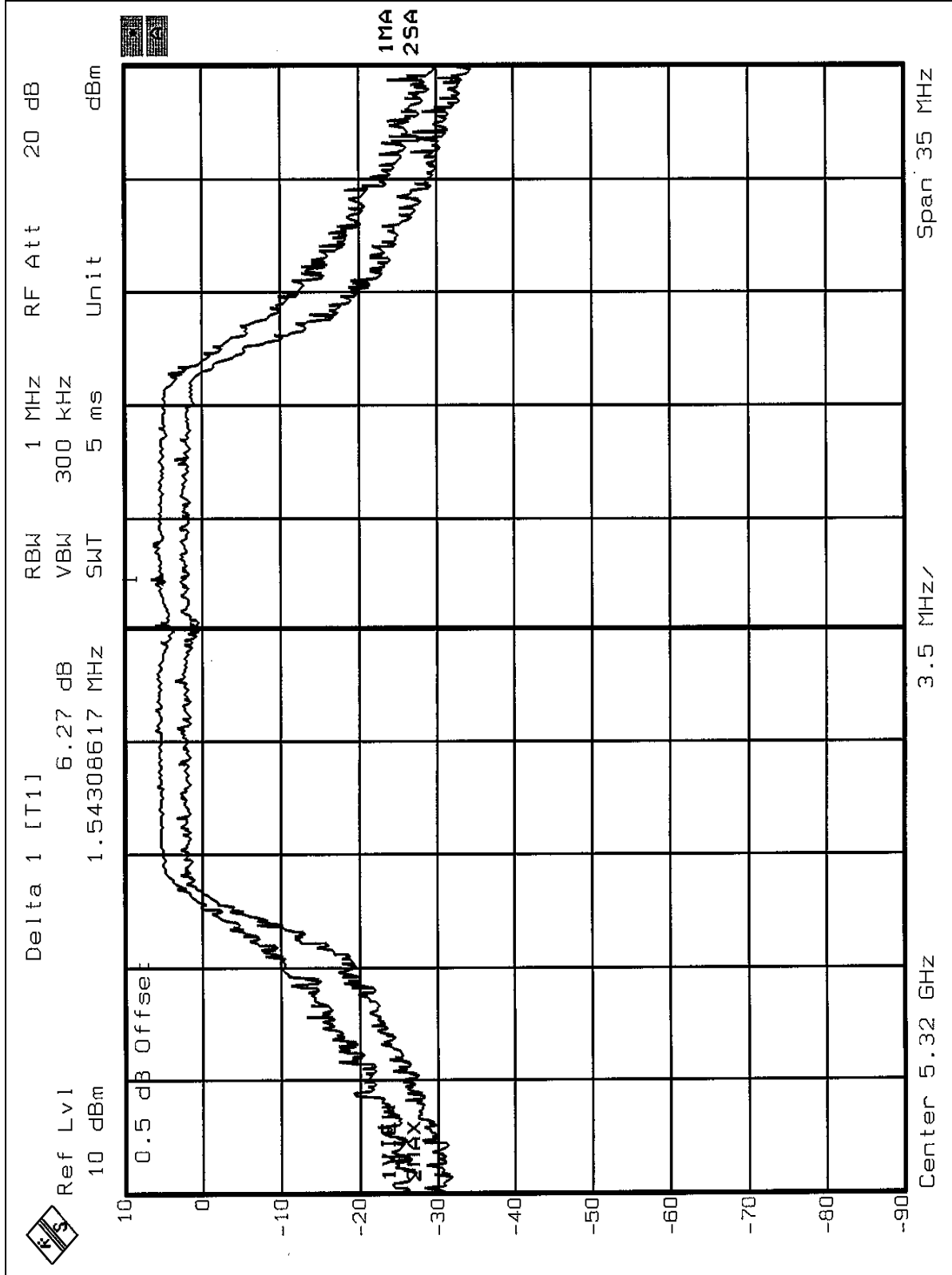



EUT	Wireless A+G Mini PCI Card	MODEL	WMCE54AG
MODE	Turbo	INPUT POWER (SYSTEM)	120Vac, 60 Hz
ENVIRONMENTAL CONDITIONS	24deg. C, 65%RH, 991hPa	TESTED BY	Steven Lu

CHANNEL	CHANNEL FREQUENCY (MHz)	PEAK POWER EXCURSION (dB)	PEAK to AVERAGE EXCURSION LIMIT (dB)	PASS/FAIL
1	5210	7.92	13	PASS
2	5250	7.23	13	PASS
3	5290	7.27	13	PASS



CH1

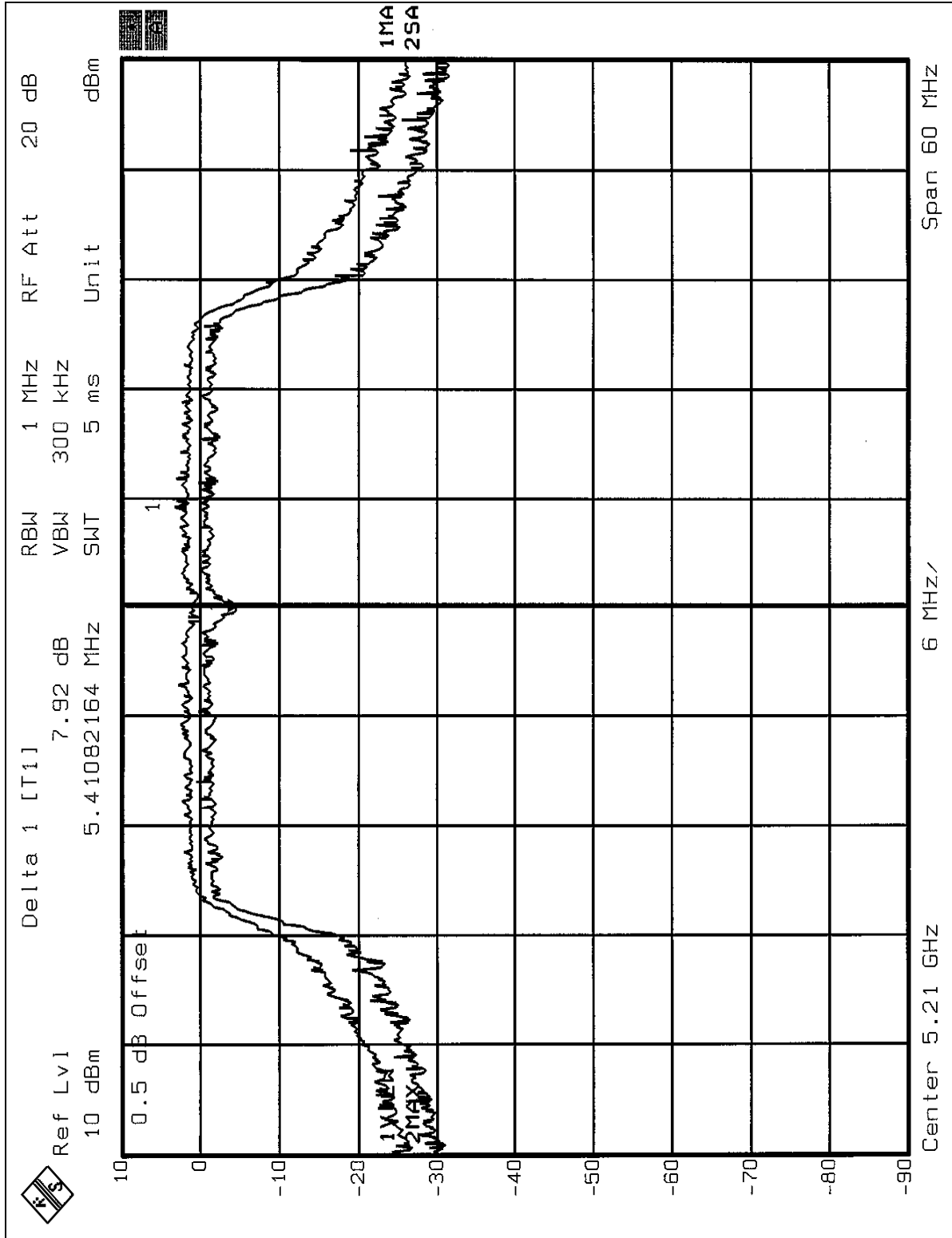



CH2

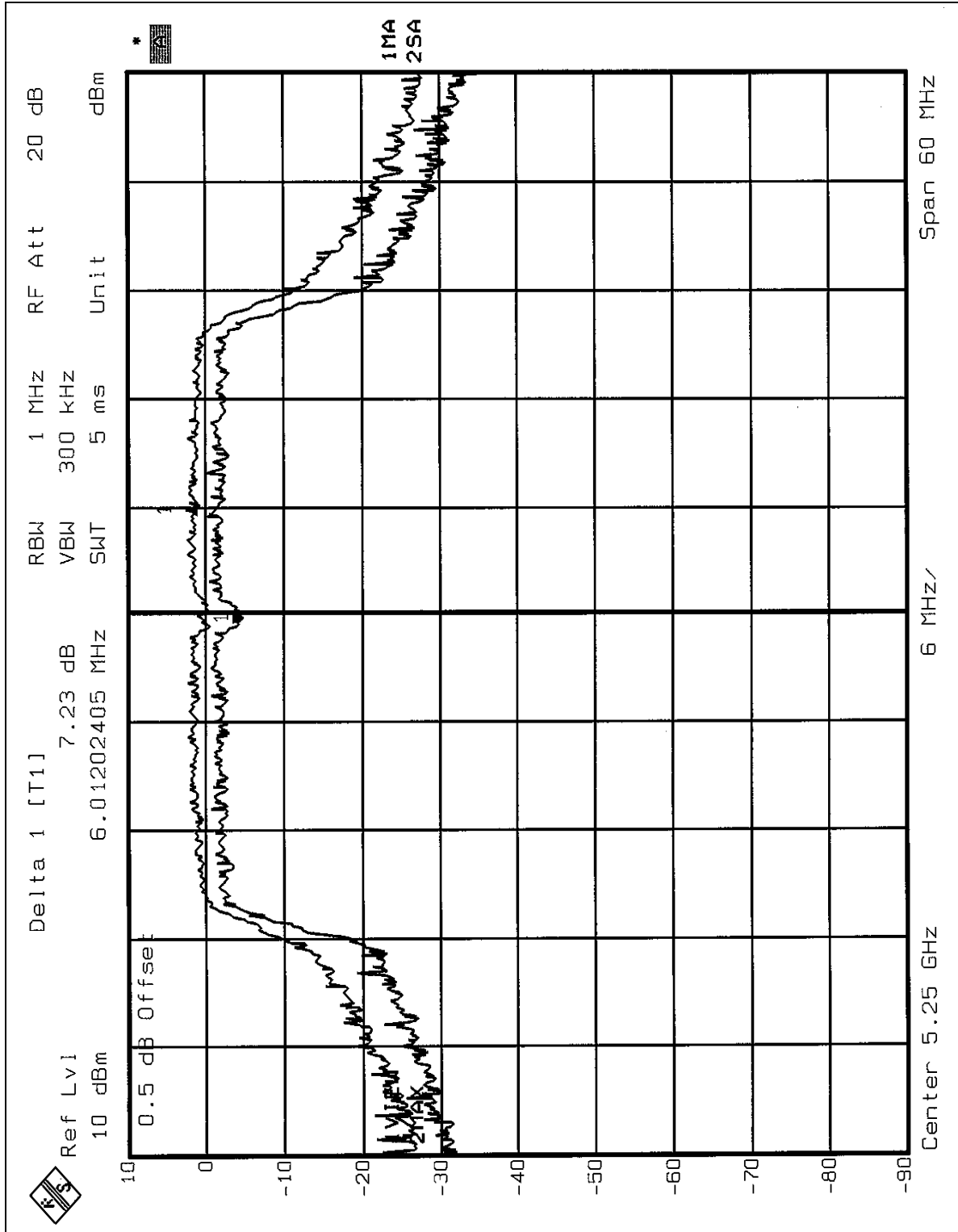



CH3

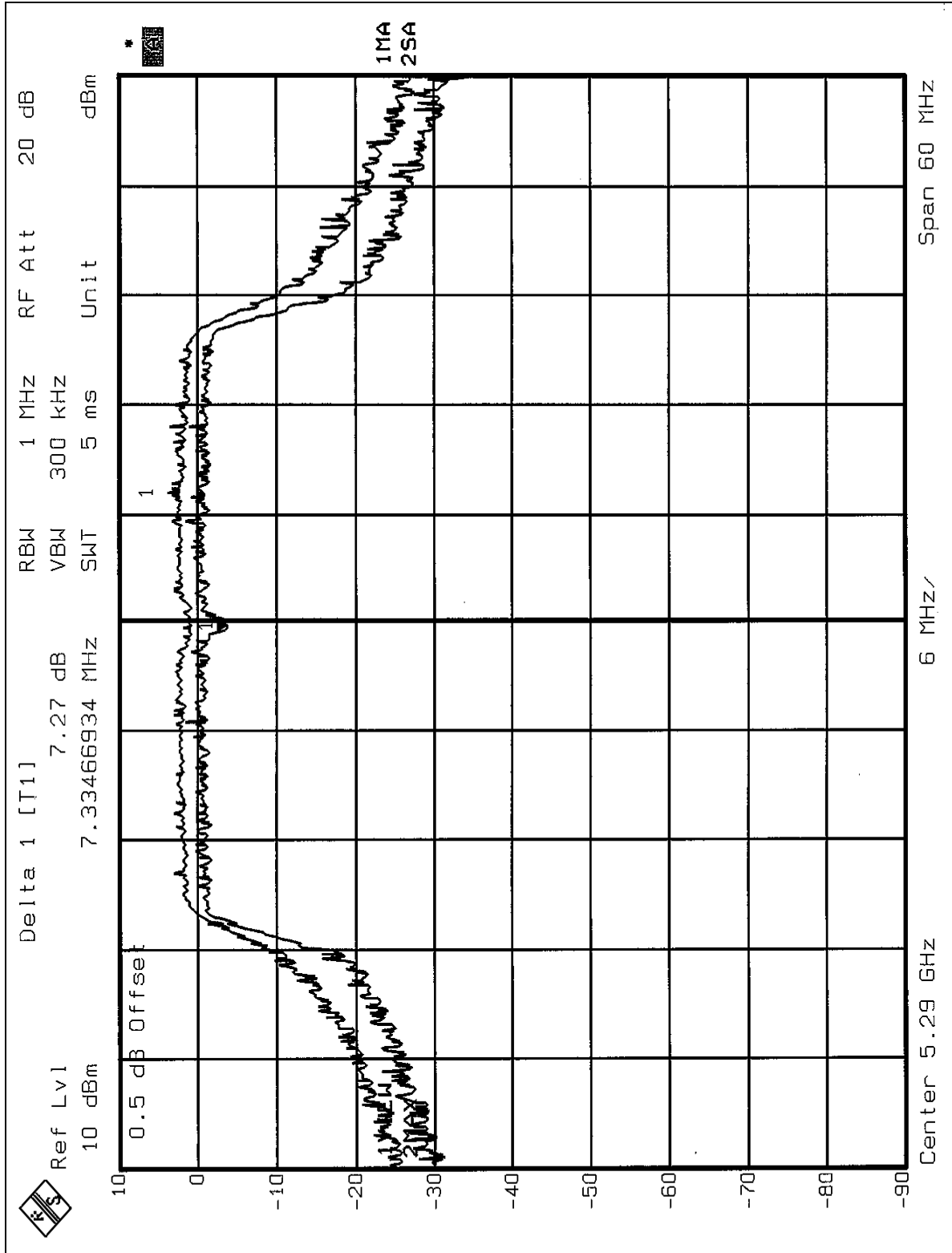



5.5 PEAK POWER SPECTRAL DENSITY MEASUREMENT

5.5.1 LIMITS OF PEAK POWER SPECTRAL DENSITY MEASUREMENT

Frequency Band	Limit
5.15 – 5.25GHz	4dBm
5.25 – 5.35GHz	11dBm
5.725 – 5.825GHz	17dBm

5.5.2 TEST INSTRUMENTS

Description & Manufacturer	Model No.	Serial No.	Calibrated Until
SPECTRUM ANALYZER	FSEK30	100049	Aug. 12, 2005

NOTE: The calibration interval of the above test instruments is 12 months and the calibrations are traceable to NML/ROC and NIST/USA.



5.5.3 TEST PROCEDURES

1. The transmitter output was connected to the spectrum analyzer.
2. Set RBW=1MHz, VBW=3MHz. The PPSD is the highest level found across the emission in any 1MHz band.

5.5.4 DEVIATION FROM TEST STANDARD

No deviation

5.5.5 TEST SETUP



5.5.6 EUT OPERATING CONDITIONS

Same as 5.3.6



5.5.7 TEST RESULTS

EUT	Wireless A+G Mini PCI Card	MODEL	WMCE54AG
MODE	Normal	INPUT POWER (SYSTEM)	120Vac, 60 Hz
ENVIRONMENTAL CONDITIONS	24deg. C, 65%RH, 991hPa	TESTED BY	Steven Lu

CHANNEL	CHANNEL FREQUENCY (MHz)	RF POWER LEVEL IN 1MHz BW (dBm)	MAXIMUM LIMIT (dBm)	PASS/FAIL
1	5180	-3.70	4	PASS
4	5240	-3.62	4	PASS
5	5260	-3.65	11	PASS
8	5320	-3.59	11	PASS



CH1

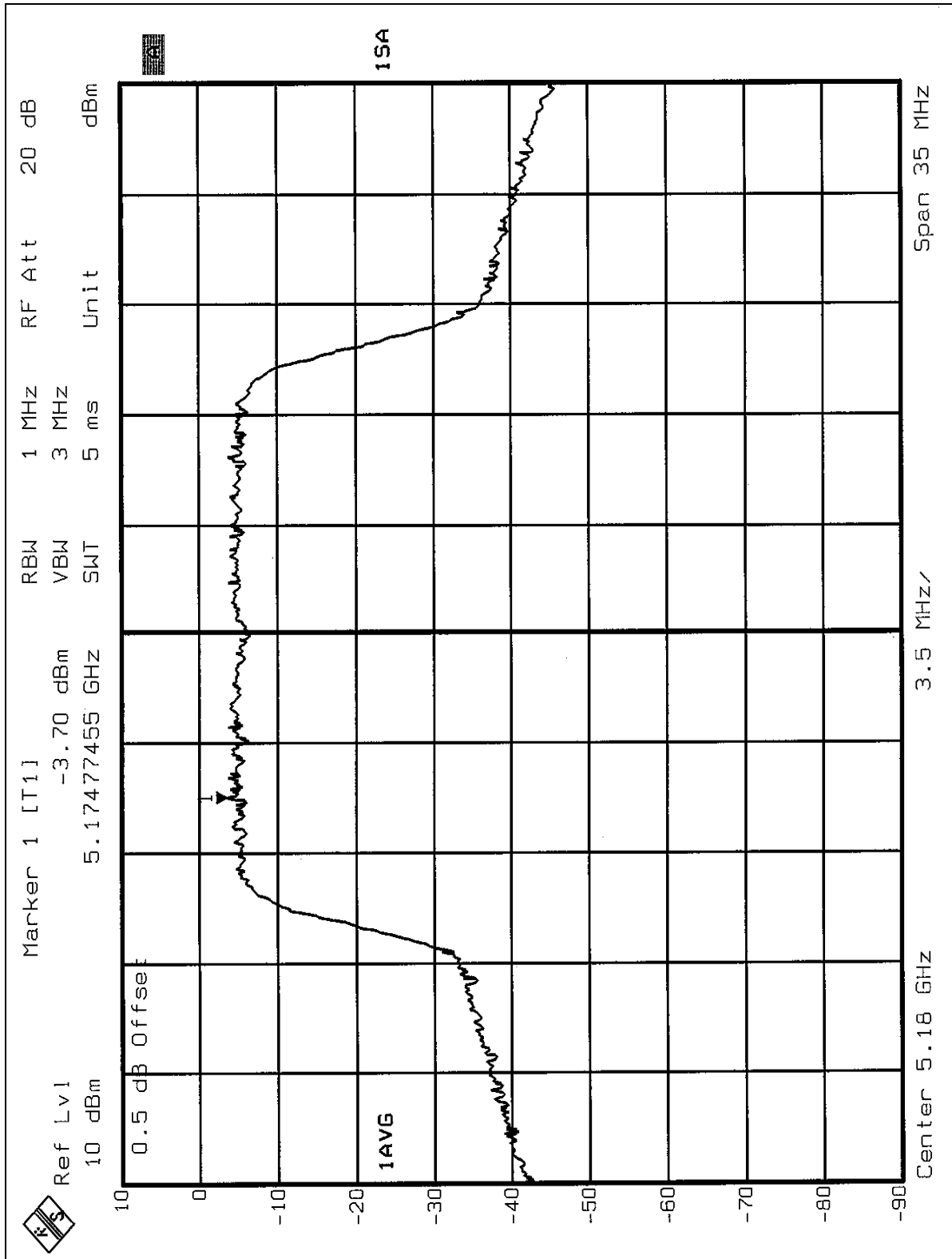



CH4

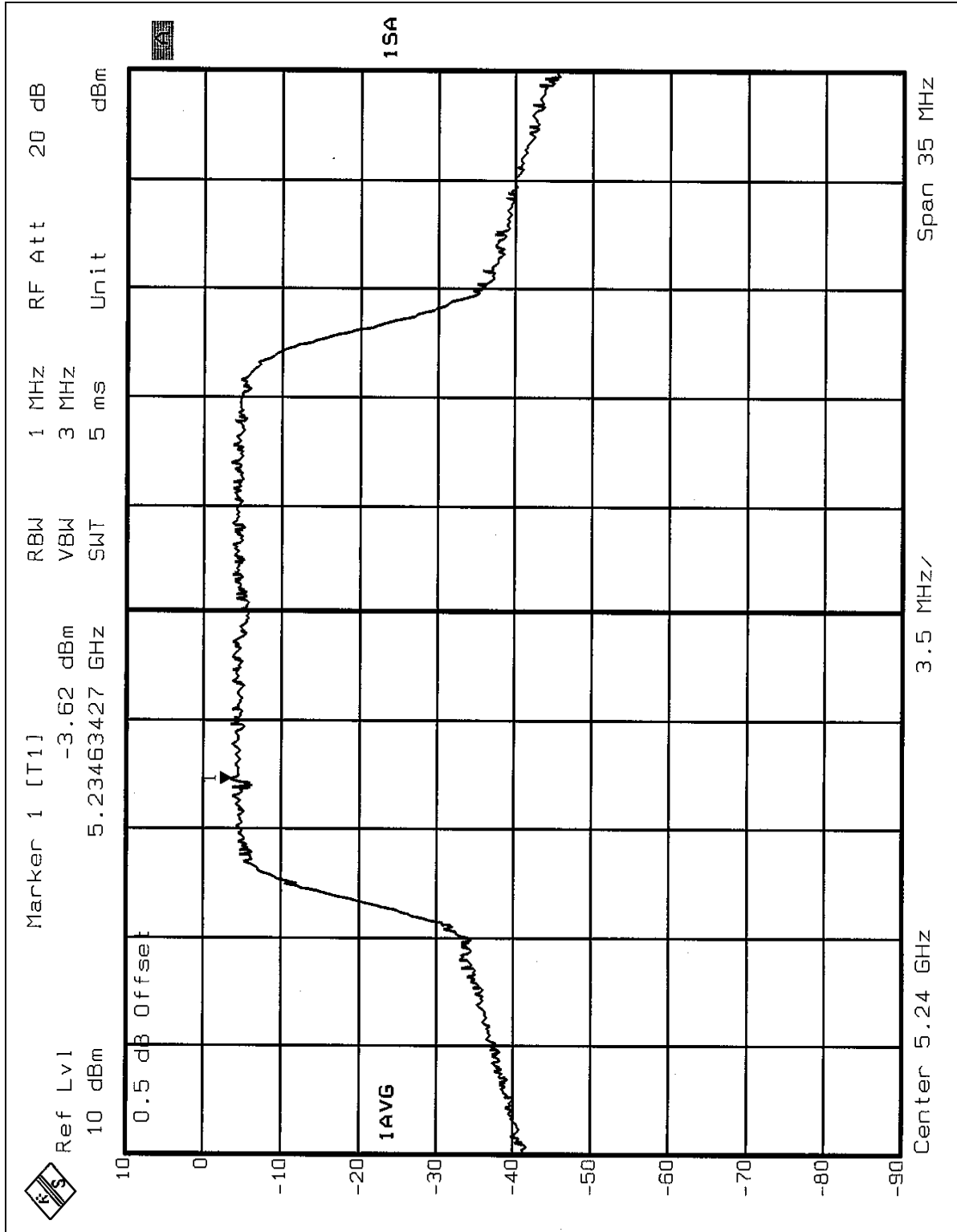



CH5

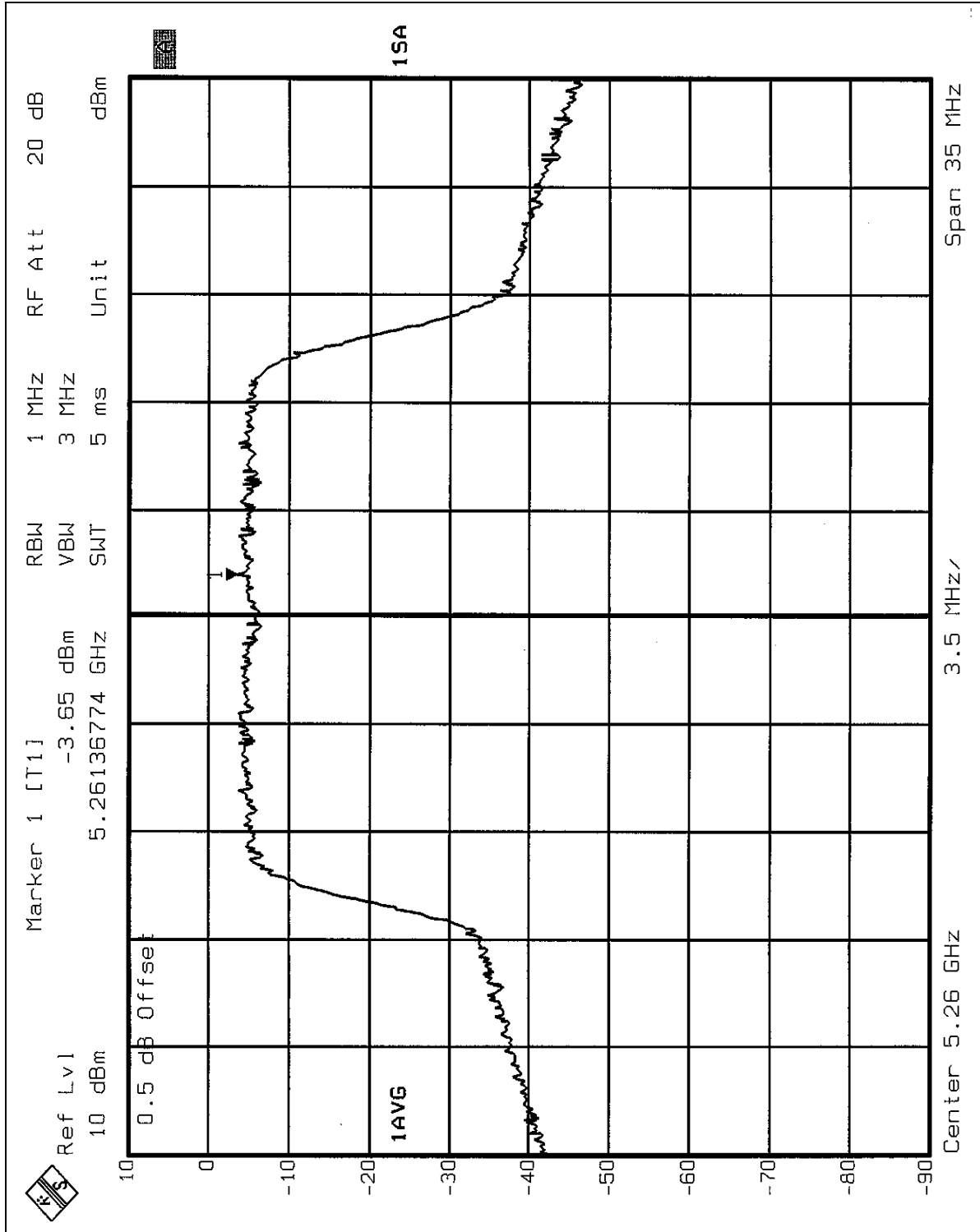



CH8

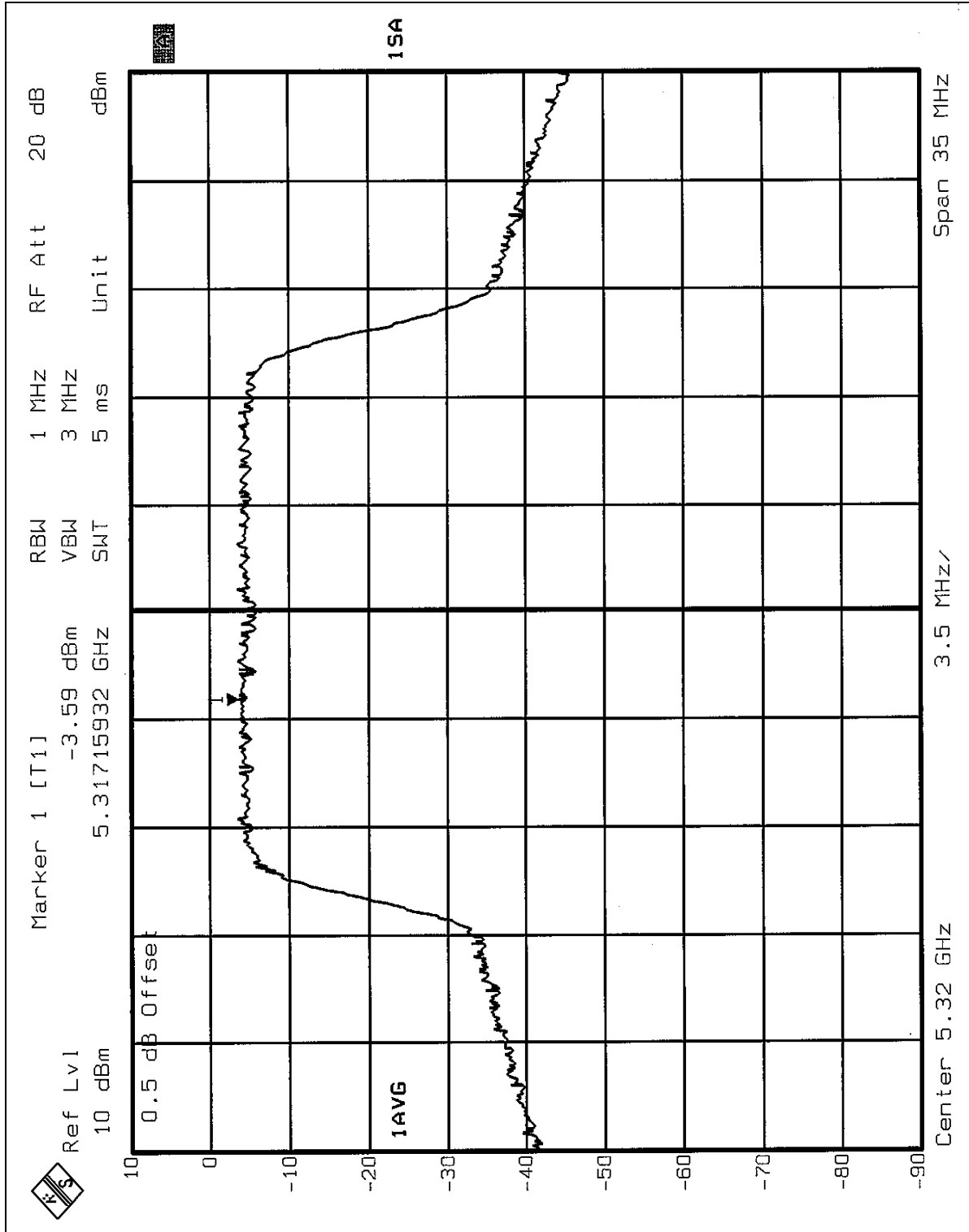



EUT	Wireless A+G Mini PCI Card	MODEL	WMCE54AG
MODE	Turbo	INPUT POWER (SYSTEM)	120Vac, 60 Hz
ENVIRONMENTAL CONDITIONS	24deg. C, 65%RH, 991hPa	TESTED BY	Steven Lu

CHANNEL	CHANNEL FREQUENCY (MHz)	RF POWER LEVEL IN 1 MHz BW (dBm)	MAXIMUM LIMIT (dBm)	PASS/FAIL
1	5210	-5.27	4	PASS
2	5250	-5.66	4	PASS
3	5290	-5.48	11	PASS



CH1

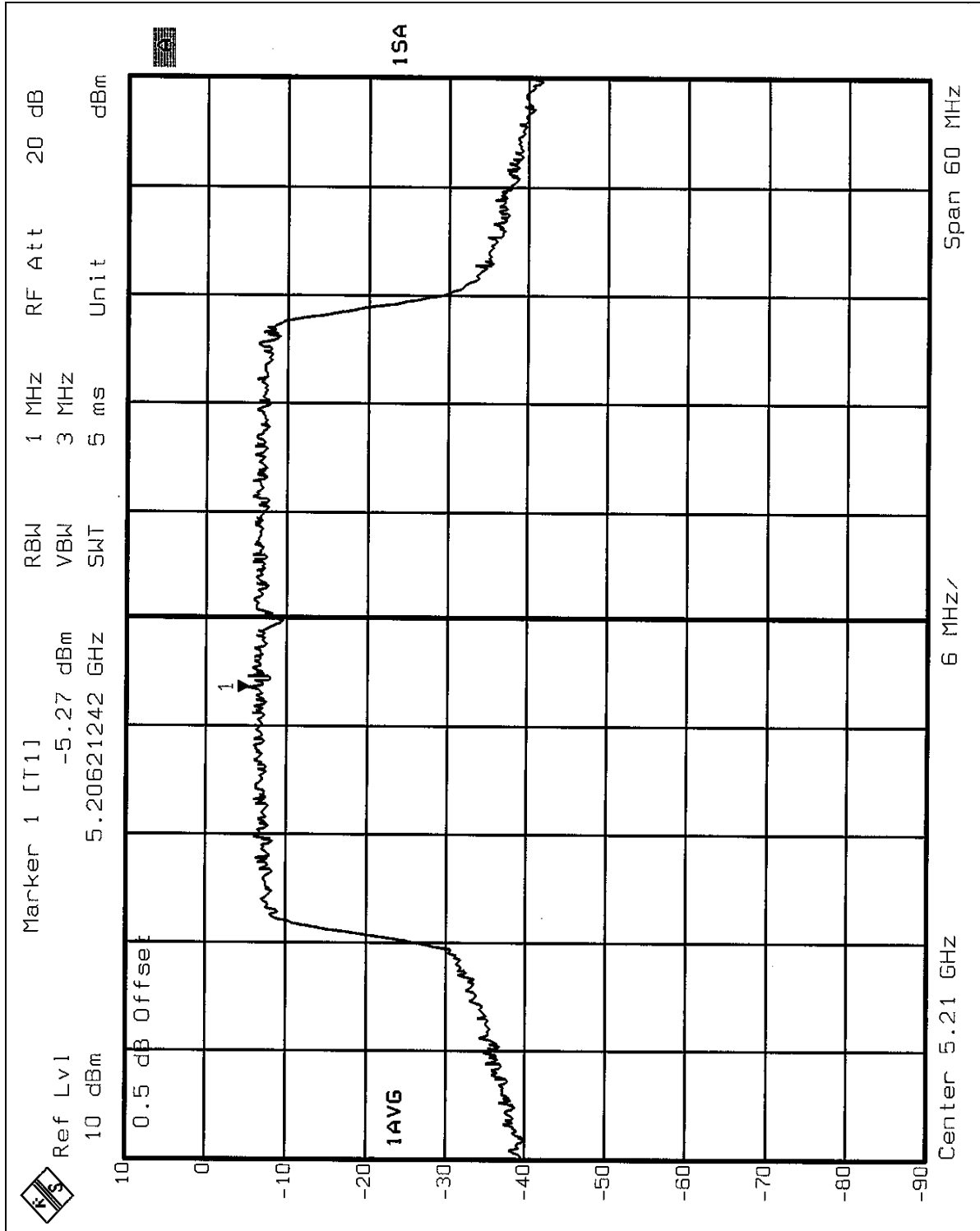



CH2

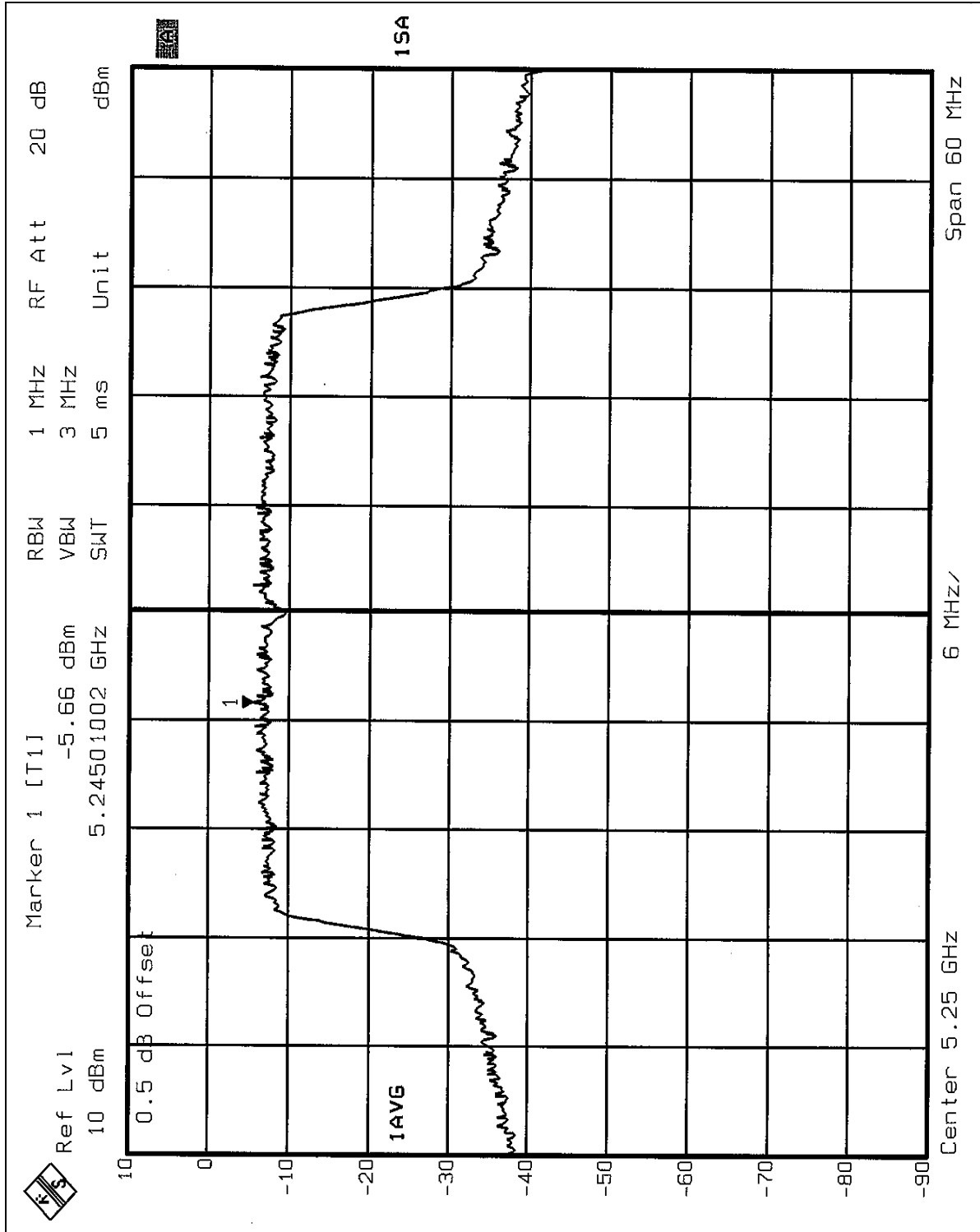



CH3

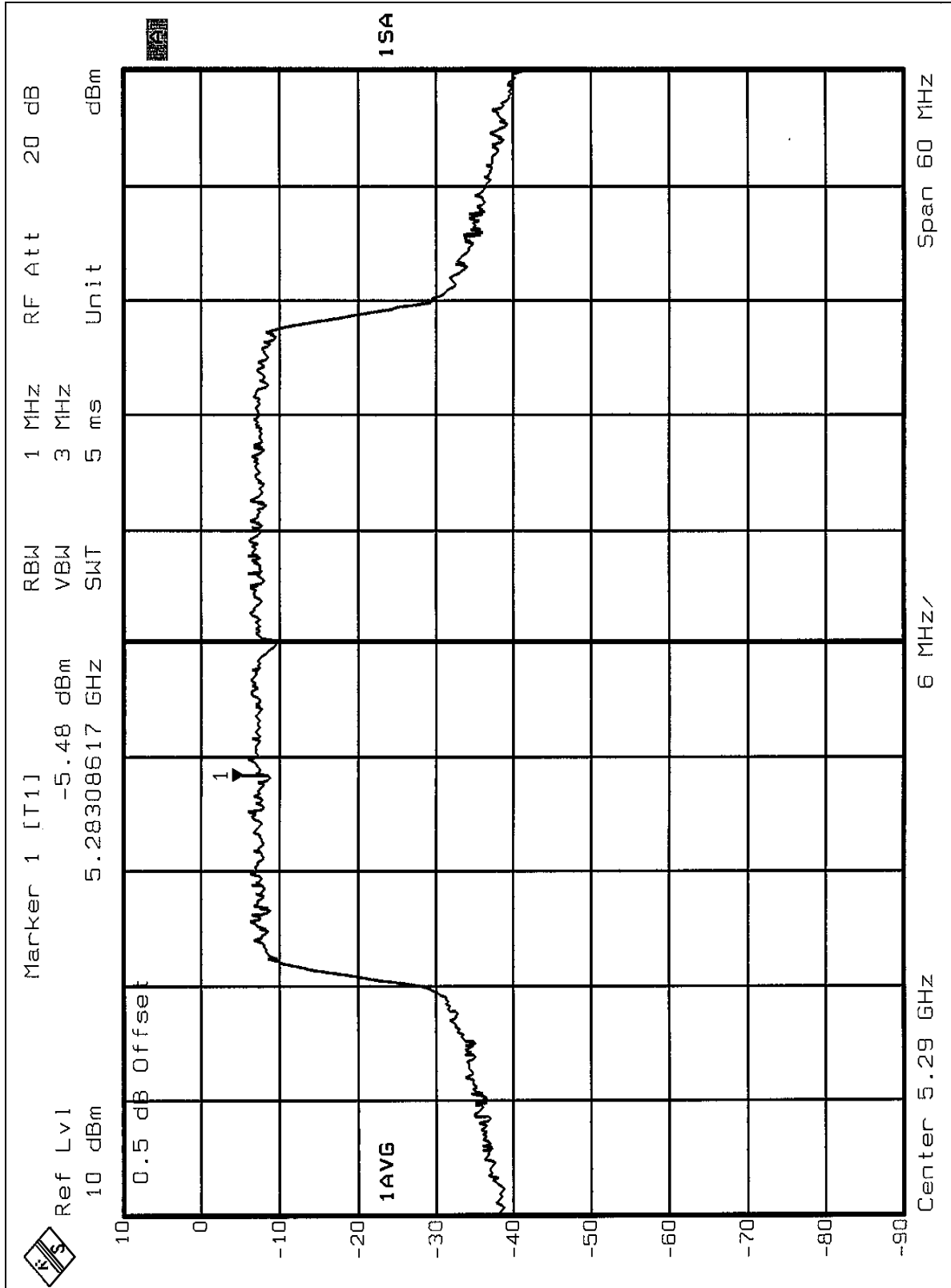



5.6 FREQUENCY STABILITY

5.6.1 LIMITS OF FREQUENCY STABILITY MEASUREMENT

The frequency tolerance of the carrier signal shall be maintained within +/- 0.02% of the operating frequency over a temperature variation of -30 degrees to 50 degrees C at normal supply voltage, and for a variation in the primary supply voltage from 85% to 115% of the rated supply voltage at a temperature of 20 degrees C.

5.6.2 TEST INSTRUMENTS

Description & Manufacturer	Model No.	Serial No.	Calibrated Until
ANRITSU SPECTRUM ANALYZER	MS2667C	M10281	Feb. 09, 2005
WIT STANDARD TEMPERATURE AND HUMIDITY CHAMBER	TH-4S-C	W981030	July 18, 2005

NOTE: The calibration interval of the above test instruments is 12 months and the calibrations are traceable to NML/ROC and NIST/USA.

5.6.3 TEST PROCEDURE

1. The EUT was placed inside the environmental test chamber and powered by nominal DC voltage.
2. Turn the EUT on and couple its output to a spectrum analyzer.
3. Turn the EUT off and set the chamber to the highest temperature specified.
4. Allow sufficient time (approximately 30 min) for the temperature of the chamber to stabilize, turn the EUT on and measure the operating frequency after 2, 5, and 10 minutes.
5. Repeat step 2 and 3 with the temperature chamber set to the lowest temperature.
6. The test chamber was allowed to stabilize at +20 degree C for a minimum of 30 minutes. The supply voltage was then adjusted on the EUT from 85% to 115% and the frequency record.

5.6.4 DEVIATION FROM TEST STANDARD

No deviation

5.6.5 TEST SETUP

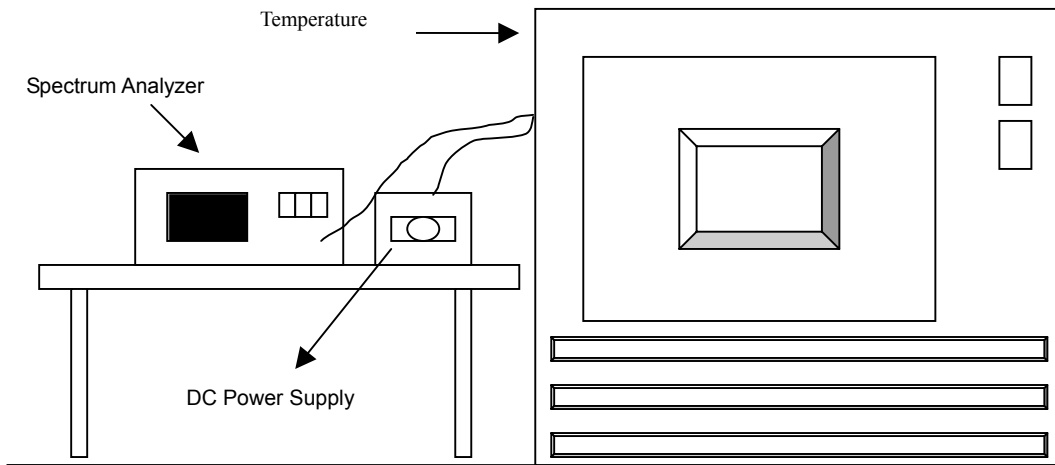

5.6.6 EUT OPERATING CONDITION

Same as Item 4.1.6



5.6.7 TEST RESULTS

		Operating frequency: 5320MHz				Limit : $\pm 0.01\%$	
Temp. (°C)	Power supply (VDC)	2 minute		5 minute		10 minute	
		(MHz)	(%)	(MHz)	(%)	(MHz)	(%)
50	93.5	5319.9856	-0.0002707	5319.9861	-0.0002613	5319.9864	-0.0002556
	110.0	5319.9858	-0.0002669	5319.9862	-0.0002594	5319.9868	-0.0002481
	126.5	5319.9859	-0.0002650	5319.9863	-0.0002575	5319.9867	-0.0002500
40	93.5	5319.9847	-0.0002876	5319.9849	-0.0002838	5319.9850	-0.0002820
	110.0	5319.9848	-0.0002857	5319.9848	-0.0002857	5319.9850	-0.0002820
	126.5	5319.9849	-0.0002838	5319.9870	-0.0002444	5319.9850	-0.0002820
30	93.5	5319.9872	-0.0002406	5319.9870	-0.0002444	5319.9870	-0.0002444
	110.0	5319.9871	-0.0002425	5319.9870	-0.0002444	5319.9869	-0.0002462
	126.5	5319.9870	-0.0002444	5319.9942	-0.0001090	5319.9869	-0.0002462
20	93.5	5319.9942	-0.0001090	5319.9941	-0.0001109	5319.9941	-0.0001109
	110.0	5319.9942	-0.0001090	5319.9941	-0.0001109	5319.9942	-0.0001090
	126.5	5319.9941	-0.0001109	5319.9941	0.0000771	5319.9942	-0.0001090
10	93.5	5320.0027	0.0000508	5320.0041	0.0000789	5320.0043	0.0000808
	110.0	5320.0036	0.0000677	5320.0042	0.0000789	5320.0042	0.0000789
	126.5	5320.0039	0.0000733	5320.0042	0.0001898	5320.0043	0.0000808
0	93.5	5320.0097	0.0001823	5320.0101	0.0001917	5320.0102	0.0001917
	110.0	5320.0100	0.0001880	5320.0102	0.0001917	5320.0102	0.0001917
	126.5	5320.0101	0.0001898	5320.0102	0.0002613	5320.0102	0.0001917
-10	93.5	5320.0139	0.0002613	5320.0139	0.0002632	5320.0140	0.0002632
	110.0	5320.0139	0.0002613	5320.0140	0.0002594	5320.0139	0.0002613
	126.5	5320.0139	0.0002613	5320.0138	0.0001880	5320.0138	0.0002594
-20	93.5	5320.0104	0.0001955	5320.0100	0.0001880	5320.0102	0.0001917
	110.0	5320.0102	0.0001917	5320.0100	0.0001898	5320.0102	0.0001917
	126.5	5320.0101	0.0001898	5320.0101	0.0001203	5320.0101	0.0001898
-30	93.5	5320.0069	0.0001297	5320.0064	0.0001184	5320.0061	0.0001147
	110.0	5320.0068	0.0001278	5320.0063	0.0001147	5320.0061	0.0001147
	126.5	5320.0065	0.0001222	5320.0061	0.0001147	5320.0060	0.0001128



5.7 BAND EDGES MEASUREMENT

5.7.1 TEST INSTRUMENTS

Description & Manufacturer	Model No.	Serial No.	Calibrated Until
SPECTRUM ANALYZER	FSEK30	100049	Aug. 12, 2005

NOTE: The calibration interval of the above test instruments is 12 months and the calibrations are traceable to NML/ROC and NIST/USA.

5.7.2 TEST PROCEDURE

The transmitter output was connected to the spectrum analyzer via a low loss cable. Set both RBW and VBW of spectrum analyzer to 1MHz with suitable frequency span including 100 MHz bandwidth from band edge. The band edges was measured and recorded.

5.7.3 EUT OPERATING CONDITION

The software provided by client to enable the EUT under transmission condition continuously at specific channel frequencies individually.

5.7.4 TEST RESULTS

For signals in the restricted bands above and below the 5.15 to 5.35GHz allocated band a measurement was made of the amplitude of the spurious emissions with respect to the intentional signals. The relative amplitude, in dBc, was applied to the average and peak field strength of the intentional signal made on the OATS to calculate the field strength of the unintentional signals.

The spectrum plots (Peak RBW=VBW=1MHz; Average RBW=1MHz, VBW=10Hz) are attached on the following pages.

**Normal Mode:**

Channel 1 (5180MHz)

The band edge emission plot on the pages 146 ~ 147 shows 42.52dBc (Peak) / 52.69Bc (Average) between carrier maximum power and local maximum emission in restrict band. The emission of carrier strength list in the test result of channel 1 is 99.53dBuV/m, so the maximum field strength in restrict band is $99.53-52.69=46.84$ dBuV/m which is under 54dBuV/m limit.

Channel 8 (5320MHz)

The band edge emission plot on the pages 148~ 149 shows 52.33dBc (Peak) / 55.63dBc (Average) between carrier maximum power and local maximum emission in restrict band. The emission of carrier strength list in the test result of channel 8 is 100.16dBuV/m, so the maximum field strength in restrict band is $100.16-52.33=47.83$ dBuV/m which is under 54dBuV/m limit.

Turbo Mode:

Channel 1 (5210MHz)

The band edge emission plot on the pages 150 ~151 shows 44.33dBc (Peak) / 51.01dBc (Average) between carrier maximum power and local maximum emission in restrict band. The emission of carrier strength list in the test result of channel 1 is 96.84dBuV/m, so the maximum field strength in restrict band is $96.84-51.01=45.83$ dBuV/m which is under 54dBuV/m limit.

Channel 3 (5290MHz)

The band edge emission plot on the pages 152~153 shows 55.23dBc (Peak) / 51.21dBc (Average) between carrier maximum power and local maximum emission in restrict band. The emission of carrier strength list in the test result of channel 3 is 96.92dBuV/m, so the maximum field strength in restrict band is $96.92-51.21=45.71$ dBuV/m which is under 54dBuV/m limit.



Normal Mode (CH1)

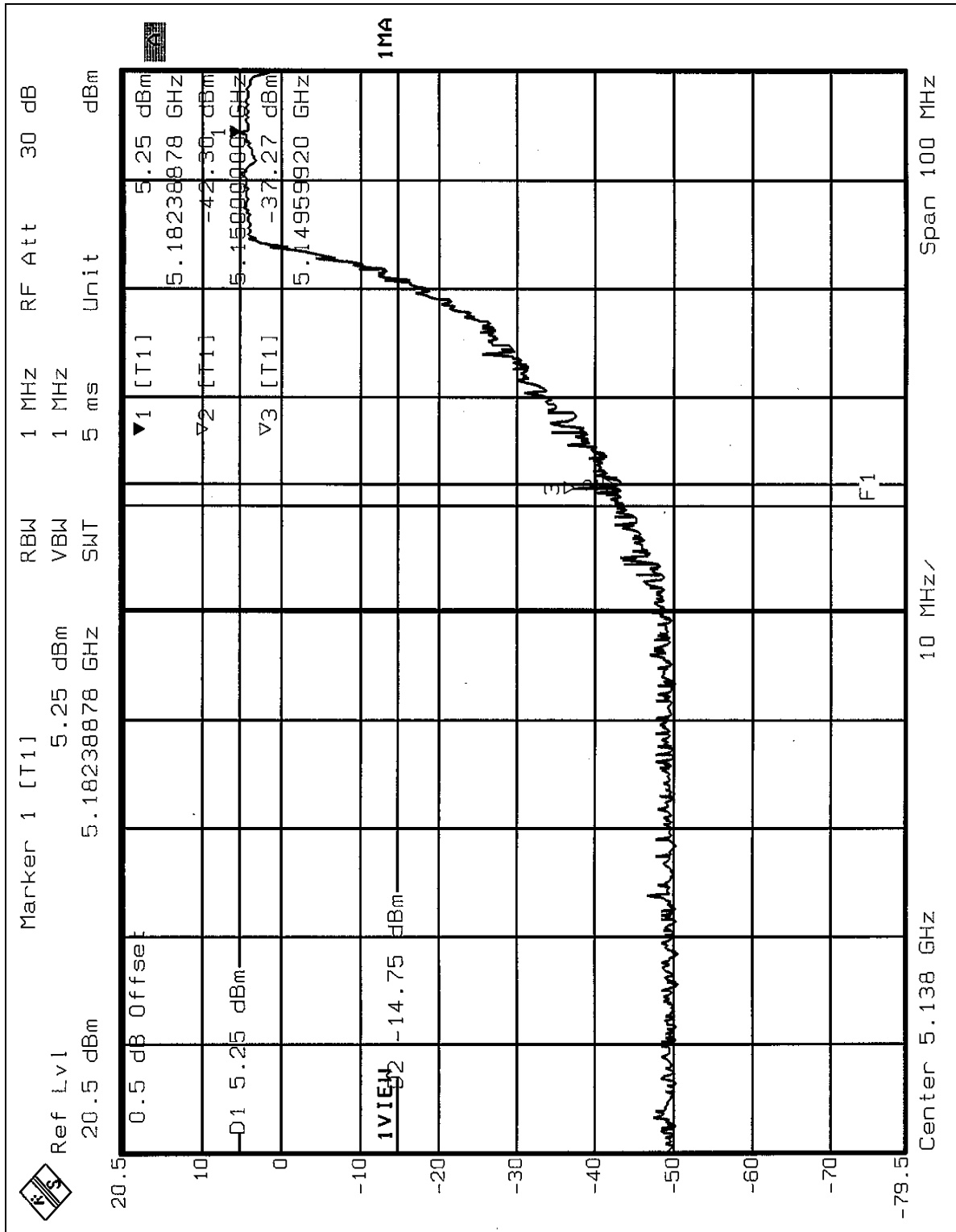

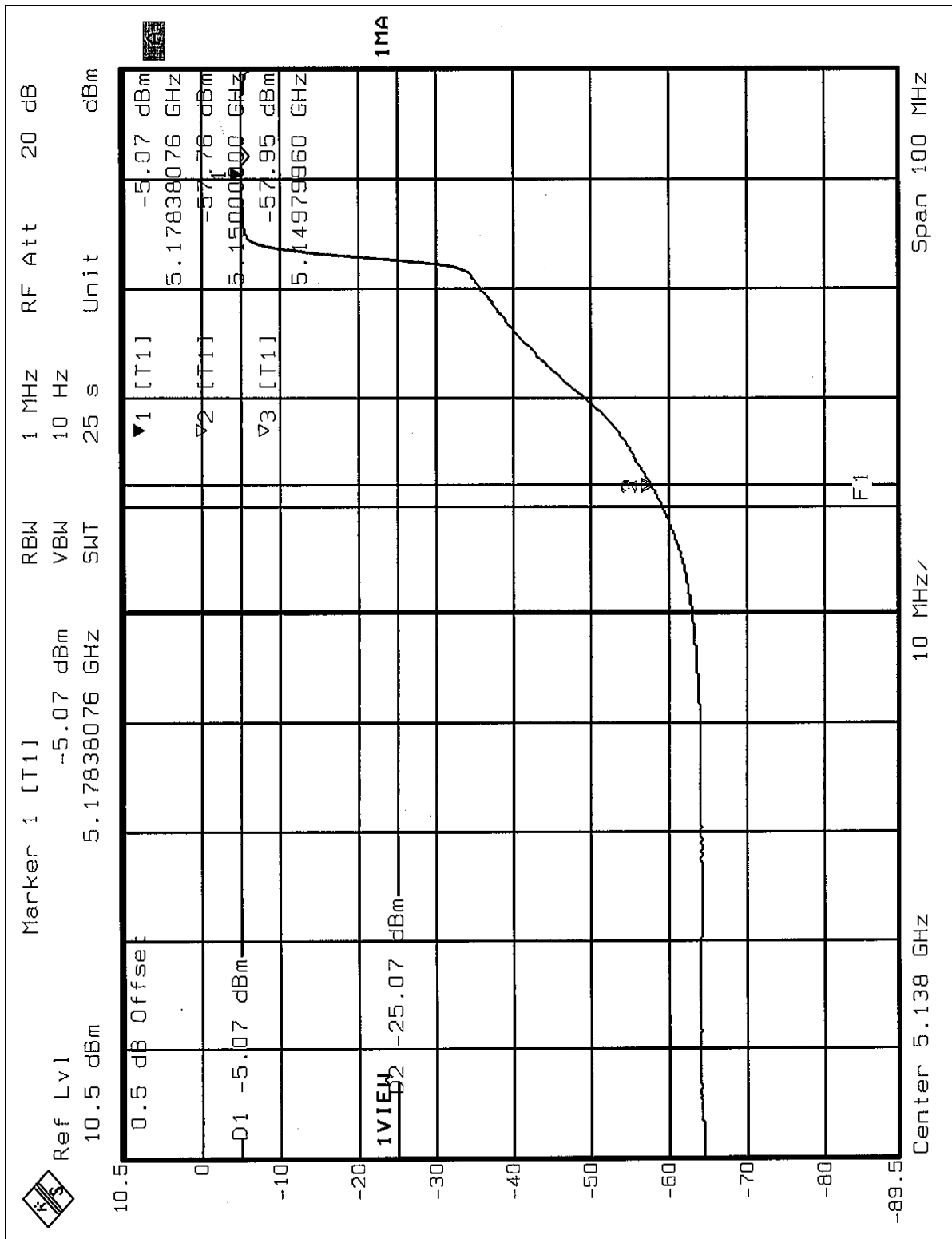



Normal Mode (CH8)

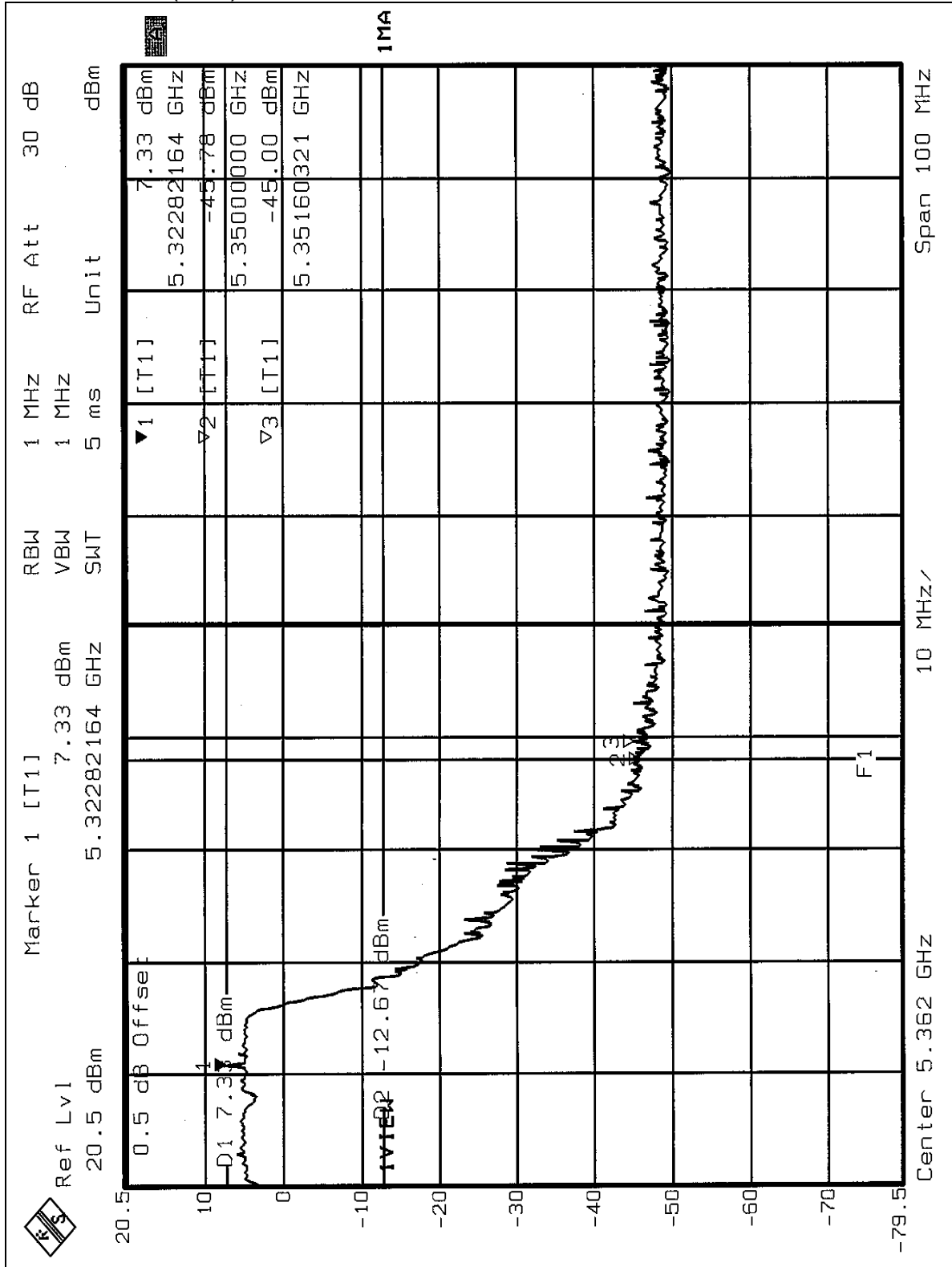

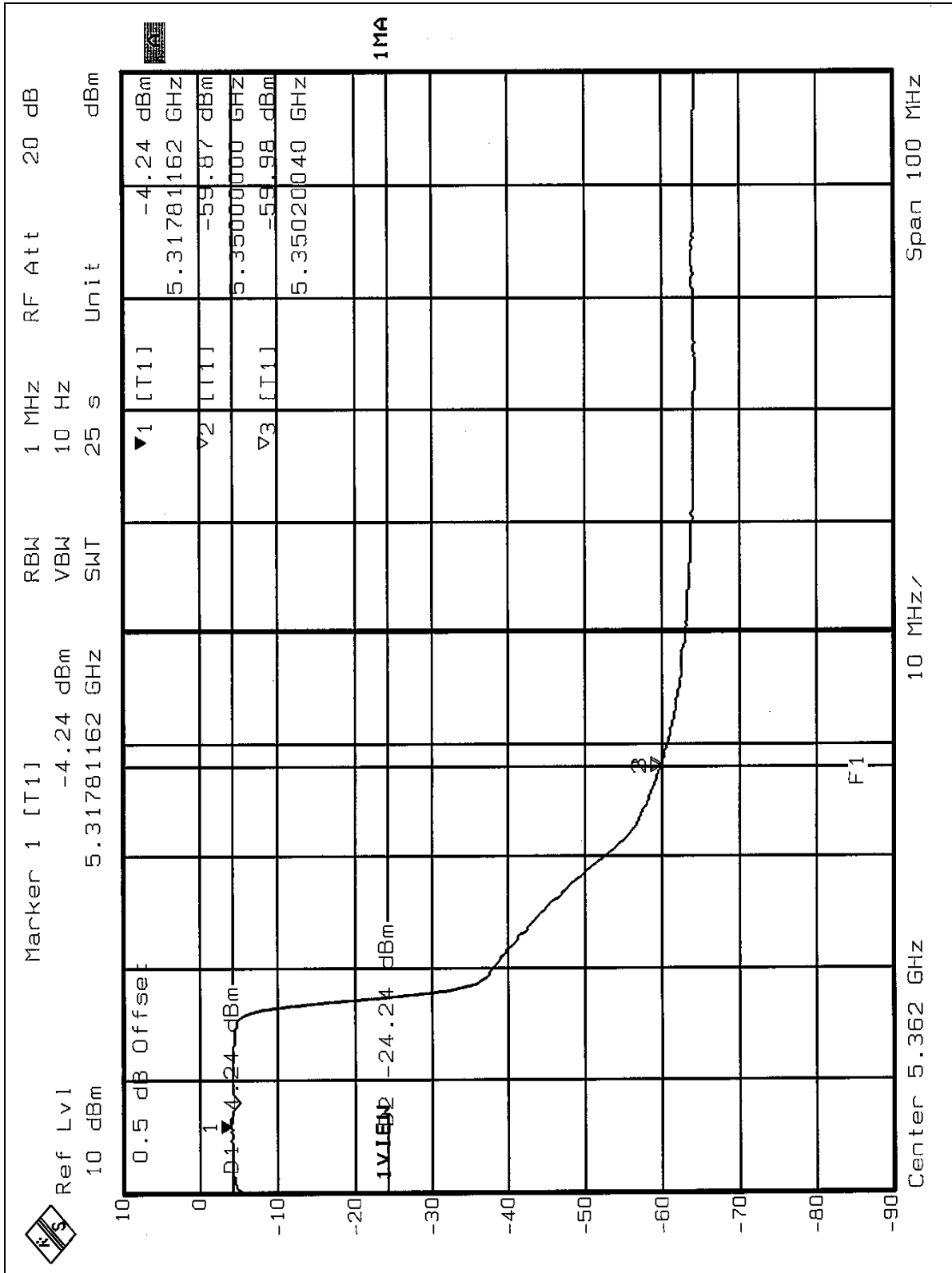



Turbo Mode (CH1)

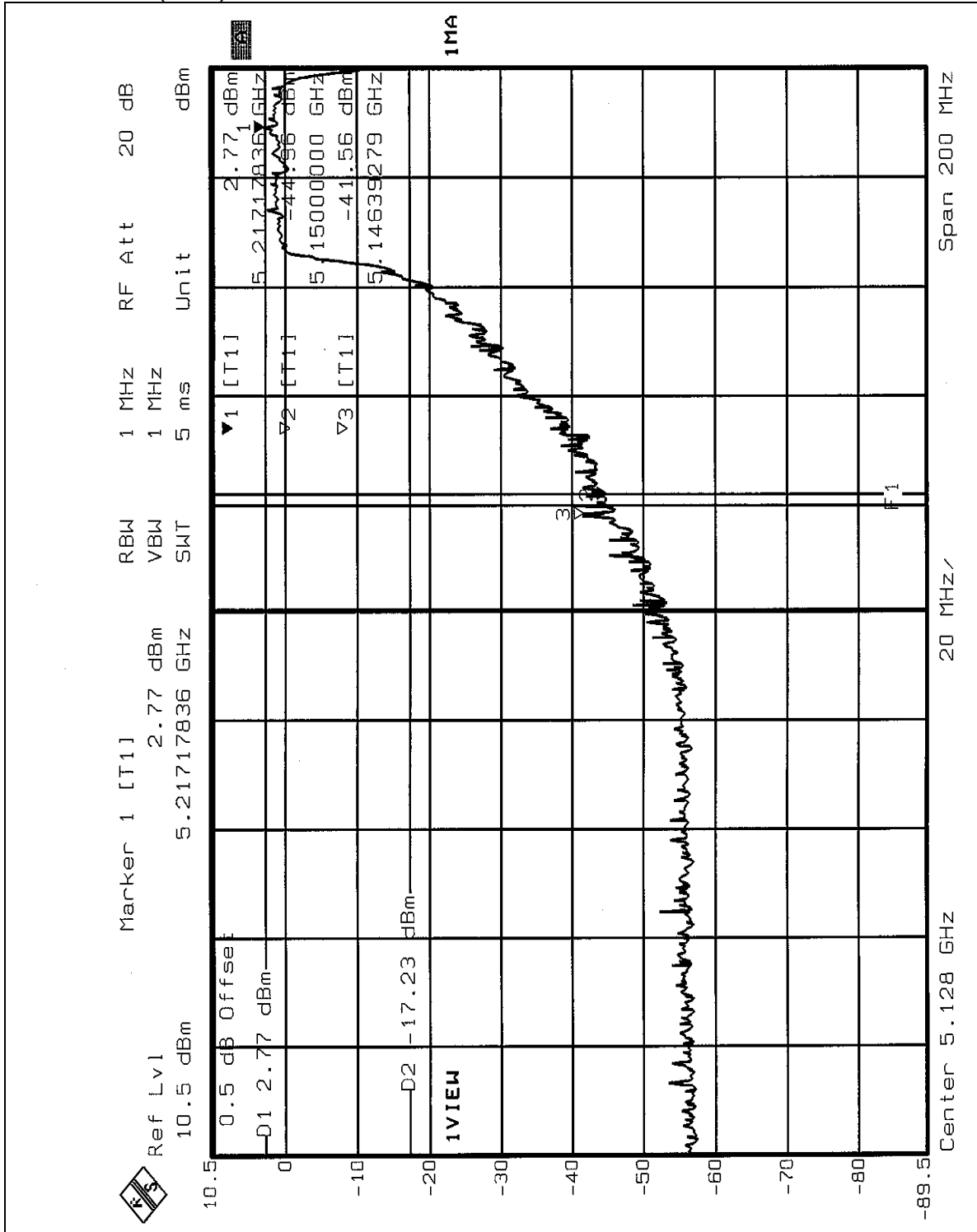

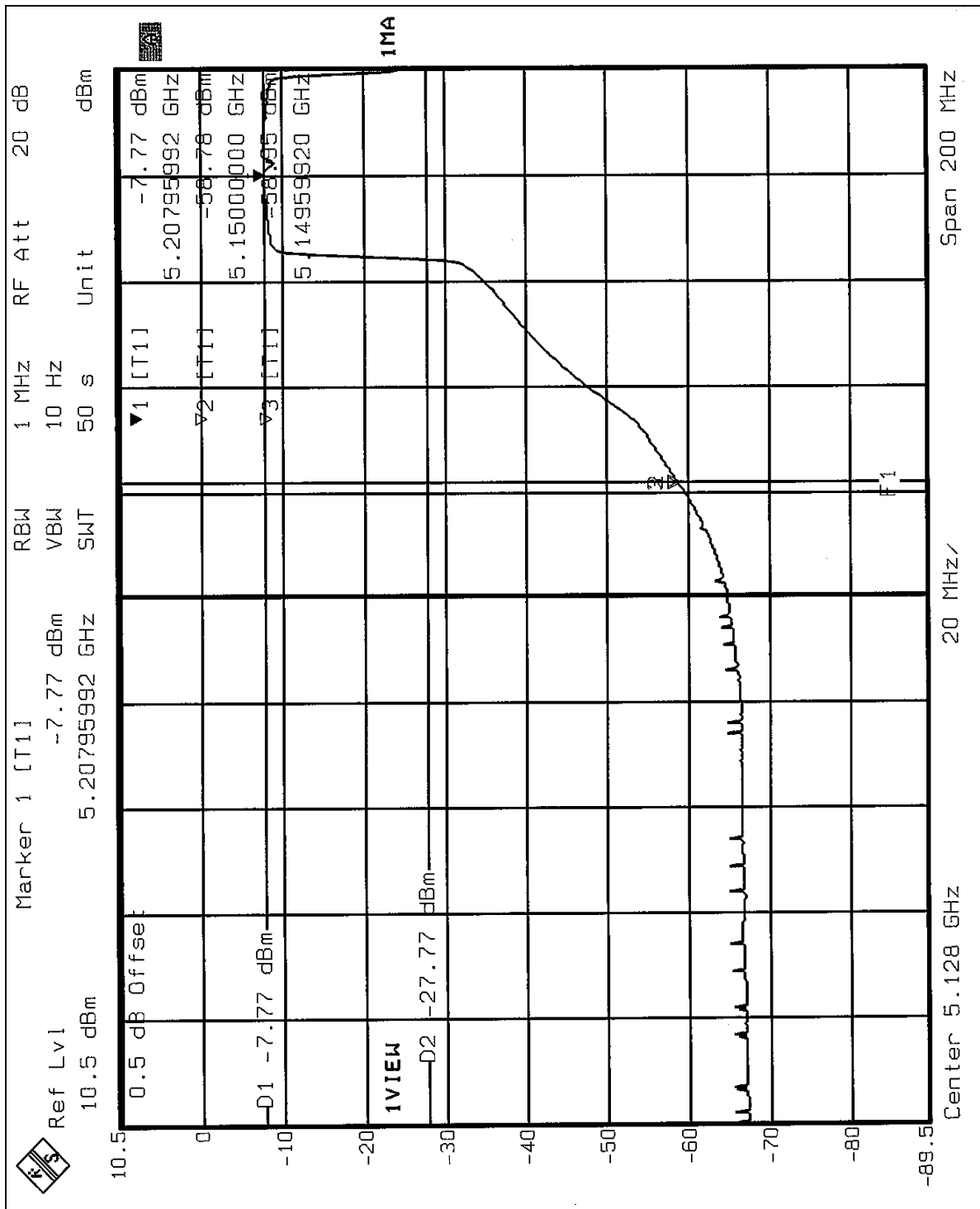



Turbo Mode (CH3)

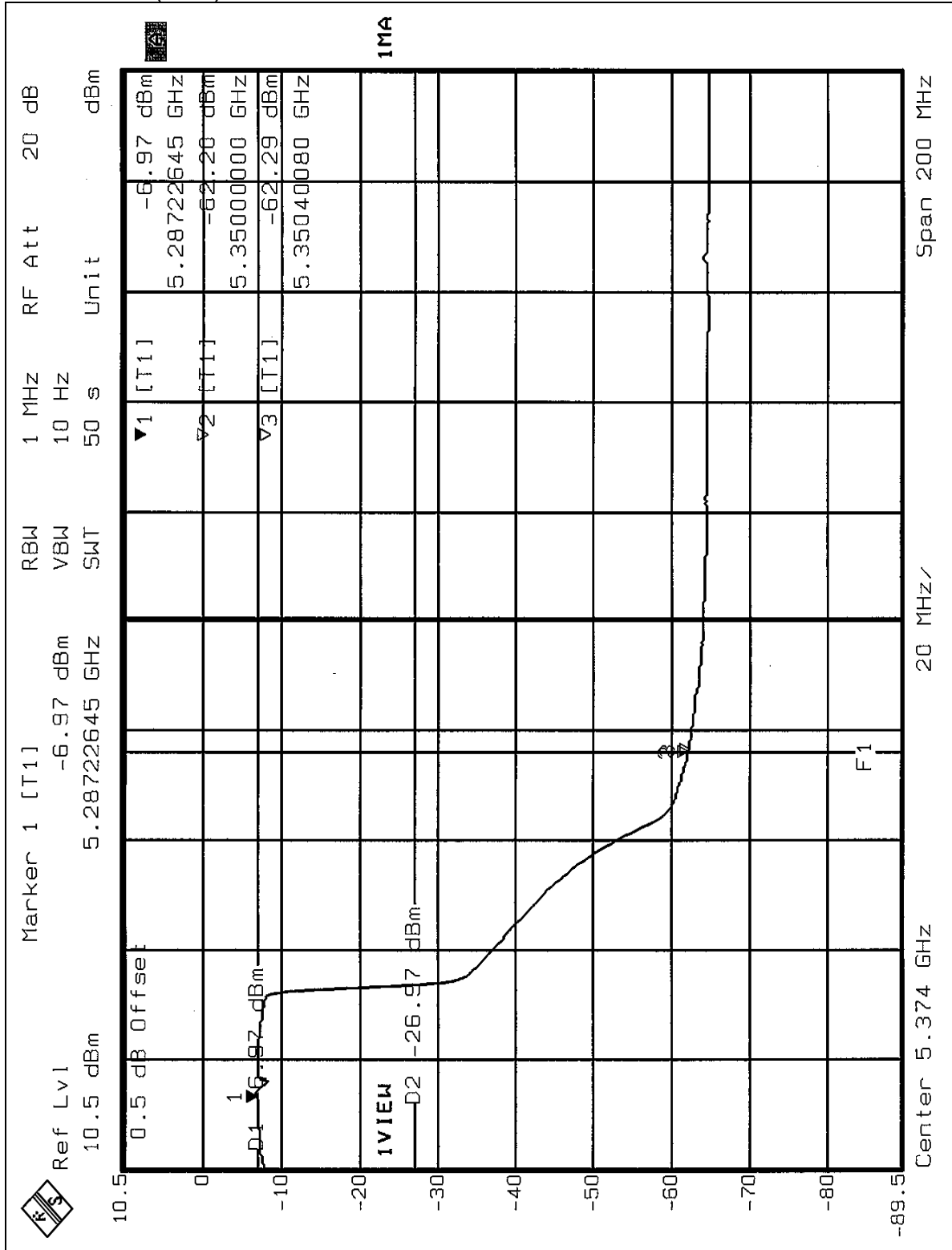

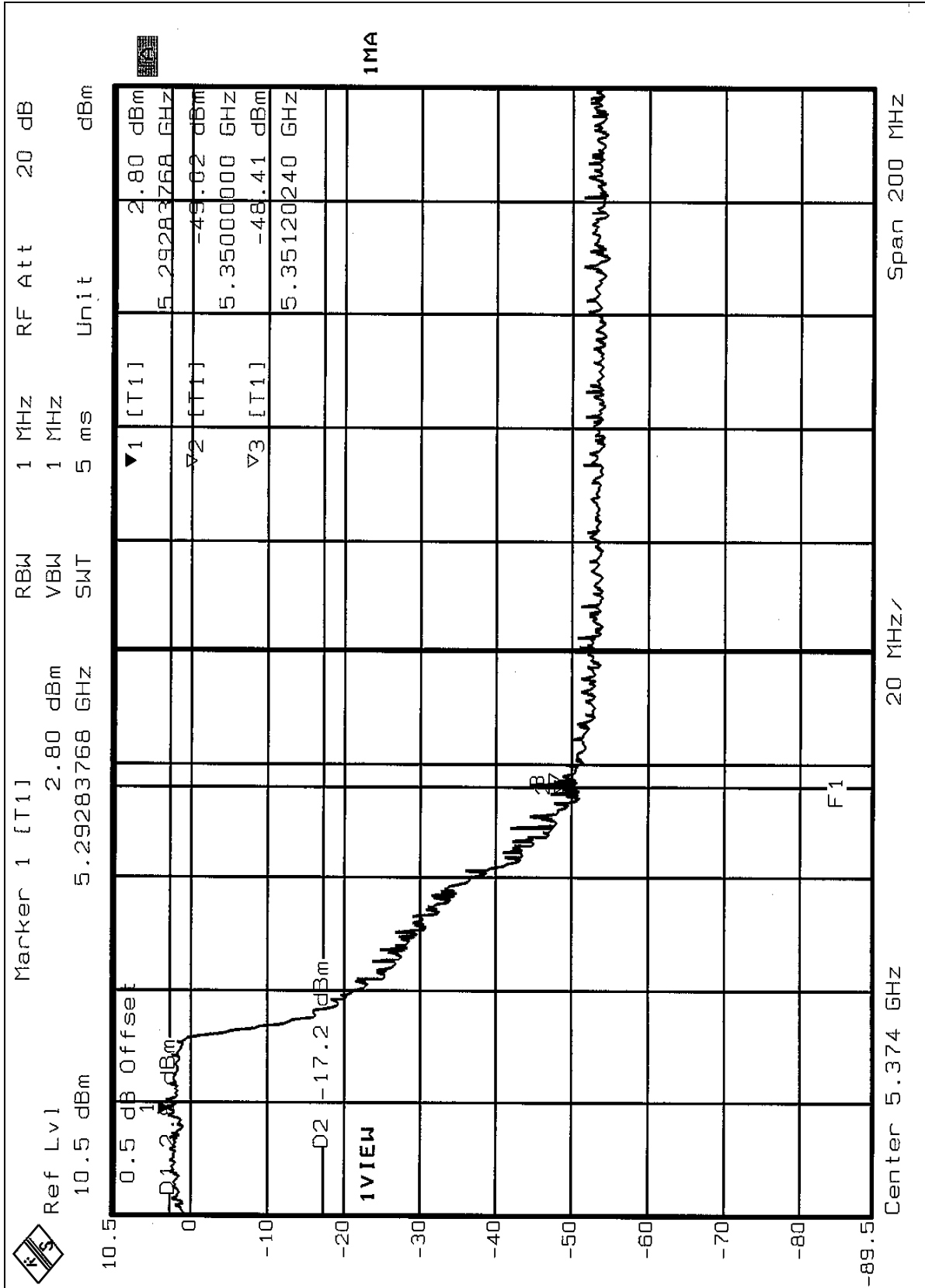



5.8 ANTENNA REQUIREMENT

5.8.1 STANDARD APPLICABLE

For intentional device, according to FCC 47 CFR Section 15.203, an intentional radiator shall be designed to ensure that no antenna other than that furnished by the responsible party shall be used with the device.

And according to FCC 47 CFR Section 15.407(a), if transmitting antennas of directional gain greater than 6dBi are used, the power shall be reduced by the amount in dB that the directional gain of the antenna exceeds 6dBi.

5.8.2 ANTENNA CONNECTED CONSTRUCTION

The antenna used in this product is Dipole antenna with UFL antenna connector. The maximum Gain of the antenna is 4.0dBi.



FOR FREQUENCY 5.725~5.850GHz

5.9 6dB BANDWIDTH MEASUREMENT

5.9.1 LIMITS OF 6dB BANDWIDTH MEASUREMENT

The minimum of 6dB Bandwidth Measurement is 0.5 MHz.

5.9.2 TEST INSTRUMENTS

Description & Manufacturer	Model No.	Serial No.	Calibrated Until
R&S SPECTRUM ANALYZER	FSEK30	100049	Aug. 12, 2005

NOTES: The calibration interval of the above test instruments is 12 months and the calibrations are traceable to NML/ROC and NIST/USA.

5.9.3 TEST PROCEDURE

The transmitter output was connected to the spectrum analyzer through an attenuator. The bandwidth of the fundamental frequency was measured by spectrum analyzer with 100kHz RBW and 100kHz VBW. The 6dB bandwidth is defined as the total spectrum the power of which is higher than peak power minus 6dB.

5.9.4 DEVIATION FROM TEST STANDARD

No deviation

5.9.5 TEST SETUP

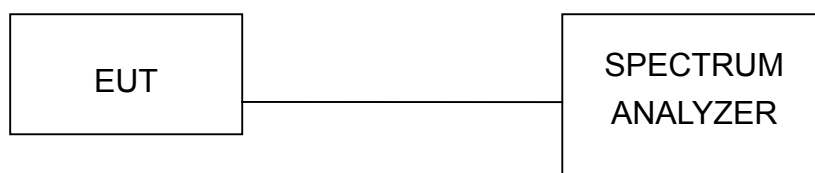

5.9.6 EUT OPERATING CONDITIONS

The software provided by client to enable the EUT under transmission condition continuously at lowest, middle and highest channel frequencies individually.



5.9.7 TEST RESULTS

EUT	Wireless A+G Mini PCI Card	MODEL	WMCE54AG
MODE	Normal	INPUT POWER (SYSTEM)	120Vac, 60 Hz
ENVIRONMENTAL CONDITIONS	24deg. C, 65%RH, 991 hPa	TESTED BY	Steven Lu

CHANNEL	CHANNEL FREQUENCY (MHz)	6dB BANDWIDTH (MHz)	MINIMUM LIMIT (MHz)	PASS/FAIL
9	5745	16.47	0.5	PASS
11	5785	16.43	0.5	PASS
13	5825	16.51	0.5	PASS



CH9

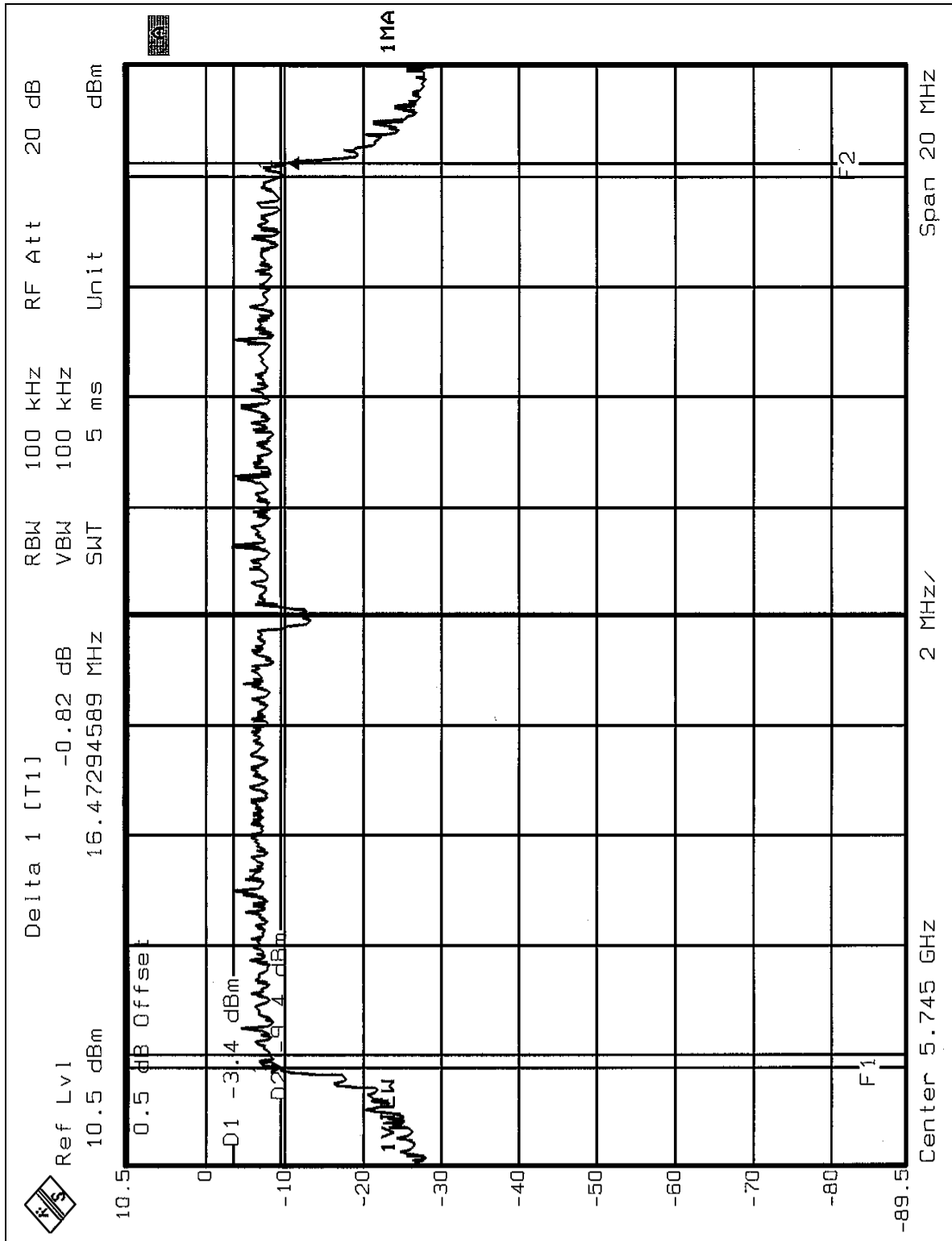



CH11

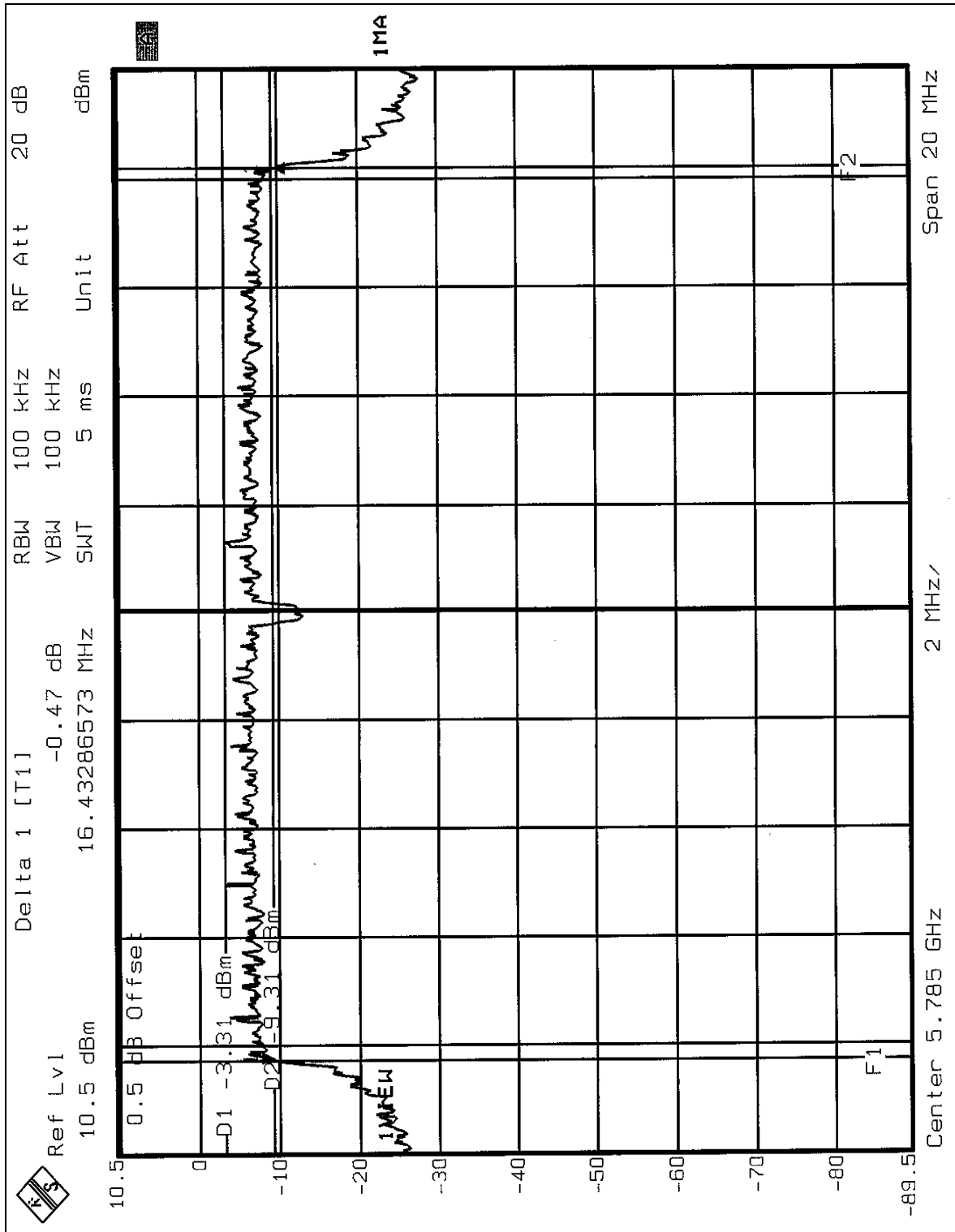



CH13

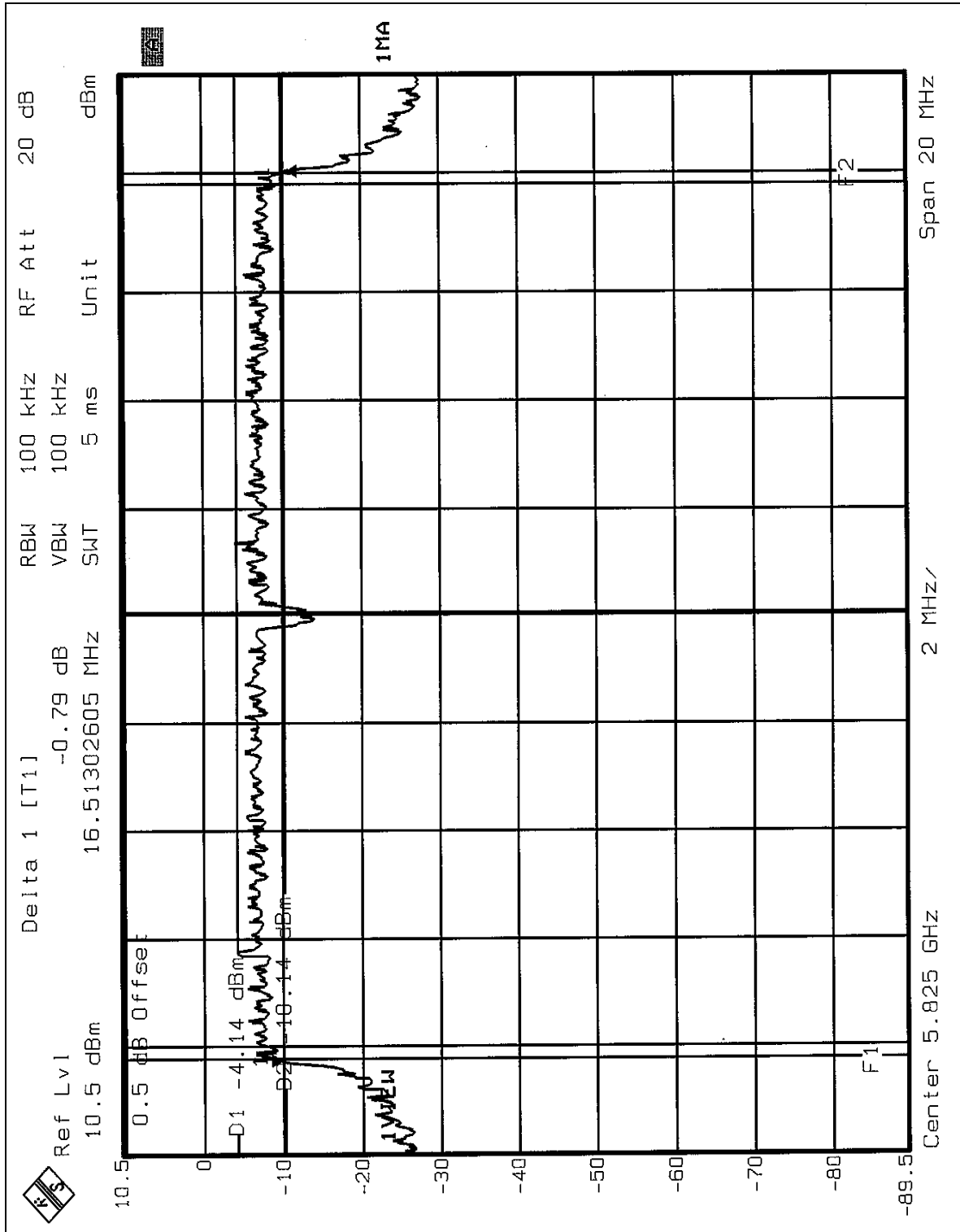



EUT	Wireless A+G Mini PCI Card	MODEL	WMCE54AG
MODE	Turbo	INPUT POWER (SYSTEM)	120Vac, 60 Hz
ENVIRONMENTAL CONDITIONS	24deg. C, 65%RH, 991 hPa	TESTED BY	Steven Lu

CHANNEL	CHANNEL FREQUENCY (MHz)	6dB BANDWIDTH (MHz)	MINIMUM LIMIT (MHz)	PASS/FAIL
4	5760	32.62	0.5	PASS
5	5800	32.54	0.5	PASS



CH4

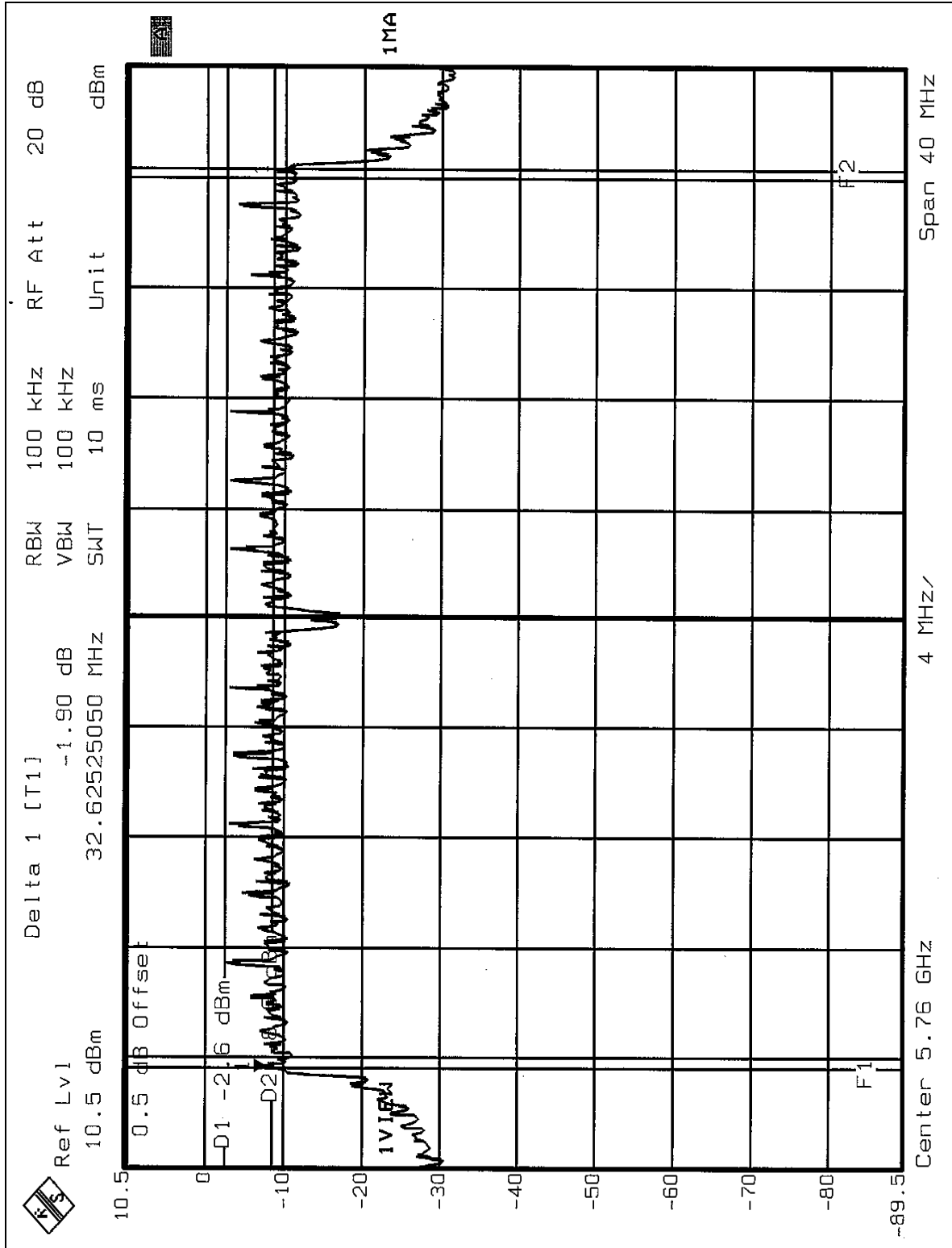



CH5

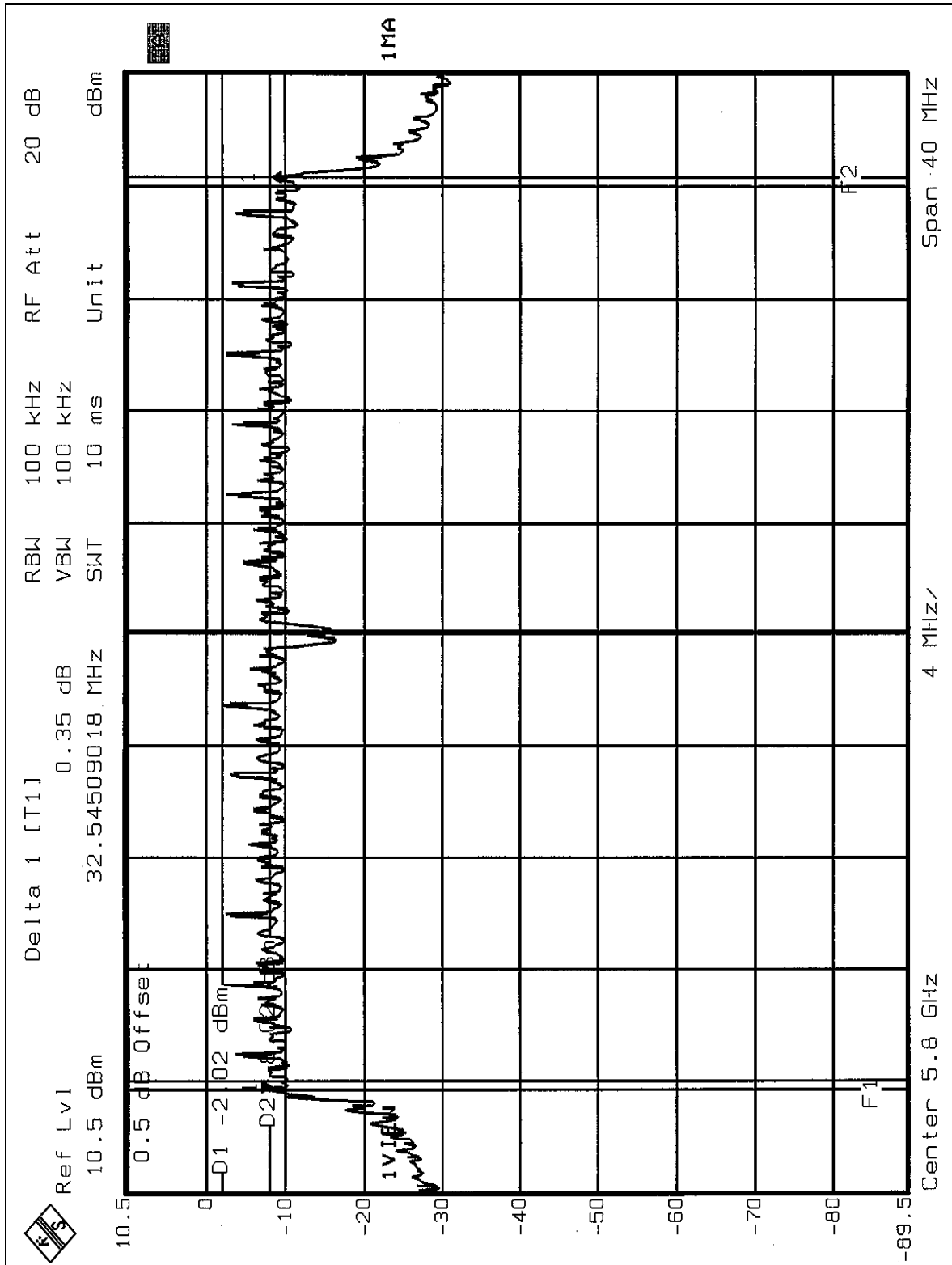



5.10 MAXIMUM PEAK OUTPUT POWER

5.10.1 LIMITS OF MAXIMUM PEAK OUTPUT POWER MEASUREMENT

The Maximum Peak Output Power Measurement is 30dBm.

5.10.2 INSTRUMENTS

Description & Manufacturer	Model No.	Serial No.	Calibrated Until
R&S SPECTRUM ANALYZER	FSEK30	100049	Aug. 12, 2005
AGILENT SIGNAL GENERATOR	E8257C	MY43320668	Dec. 31, 2004
TEKTRONIX OSCILLOSCOPE	TDS 1012	C019167	Feb. 01, 2005
NARDA DETECTOR	4503A	FSCM99899	NA

NOTE:

The calibration interval of the above test instruments is 12 months and the calibrations are traceable to NML/ROC and NIST/USA..



5.10.3 TEST PROCEDURES

1. A detector was used on the output port of the EUT. An oscilloscope was used to read the response of the detector.
2. Replaced the EUT by the signal generator . The center frequency of the S.G was adjusted to the center frequency of the measured channel.
3. Adjusted the power to have the same reading on oscilloscope. Record the power level.

5.10.4 DEVIATION FROM TEST STANDARD

No deviation

5.10.5 TEST SETUP



5.10.6 EUT OPERATING CONDITIONS

Same as Item 5.9.6



5.10.7 TEST RESULTS

EUT	Wireless A+G Mini PCI Card	MODEL	WMCE54AG
MODE	Normal	INPUT POWER (SYSTEM)	120Vac, 60 Hz
ENVIRONMENTAL CONDITIONS	24deg. C, 65%RH, 991 hPa	TESTED BY	Steven Lu

CHANNEL	CHANNEL FREQUENCY (MHz)	PEAK POWER OUTPUT (dBm)	PEAK POWER OUTPUT (mW)	PEAK POWER LIMIT (dBm)	PASS/FAIL
9	5745	13.03	20.091	30	PASS
11	5785	13.02	20.045	30	PASS
13	5825	13.00	19.953	30	PASS

EUT	Wireless A+G Mini PCI Card	MODEL	WMCE54AG
MODE	Turbo	INPUT POWER (SYSTEM)	120Vac, 60 Hz
ENVIRONMENTAL CONDITIONS	24deg. C, 65%RH, 991 hPa	TESTED BY	Steven Lu

CHANNEL	CHANNEL FREQUENCY (MHz)	PEAK POWER OUTPUT (dBm)	PEAK POWER OUTPUT (dBm)	PEAK POWER LIMIT (dBm)	PASS/FAIL
4	5760	13.05	20.184	30	PASS
5	5800	13.06	20.230	30	PASS



5.11 POWER SPECTRAL DENSITY MEASUREMENT

5.11.1 LIMITS OF POWER SPECTRAL DENSITY MEASUREMENT

The Maximum of Power Spectral Density Measurement is 8dBm.

5.11.2 TEST INSTRUMENTS

Description & Manufacturer	Model No.	Serial No.	Calibrated Until
R&S SPECTRUM ANALYZER	FSEK30	100049	Aug. 12, 2005

NOTES:

The calibration interval of the above test instruments is 12 months and the calibrations are traceable to NML/ROC and NIST/USA.

5.11.3 TEST PROCEDURE

The transmitter output was connected to the spectrum analyzer through an attenuator, the bandwidth of the fundamental frequency was measured with the spectrum analyzer using 3 kHz RBW and 30 kHz VBW, set sweep time = span/3 kHz. The power spectral density was measured and recorded.

The sweep time is allowed to be longer than span/3 kHz for a full response of the mixer in the spectrum analyzer.

5.11.4 DEVIATION FROM TEST STANDARD

No deviation

5.11.5 TEST SETUP

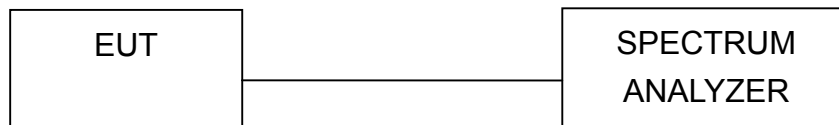

5.11.6 EUT OPERATING CONDITION

Same as Item 5.9.6



5.11.7 TEST RESULTS

EUT	Wireless A+G Mini PCI Card	MODEL	WMCE54AG
MODE	Normal	INPUT POWER (SYSTEM)	120Vac, 60 Hz
ENVIRONMENTAL CONDITIONS	24deg. C, 65%RH, 991 hPa	TESTED BY	Steven Lu

CHANNEL	CHANNEL FREQUENCY (MHz)	RF POWER LEVEL IN 3 kHz BW (dBm)	MAXIMUM LIMIT (dBm)	PASS/FAIL
9	5745	-16.56	8	PASS
11	5785	-16.88	8	PASS
13	5825	-16.78	8	PASS



CH9

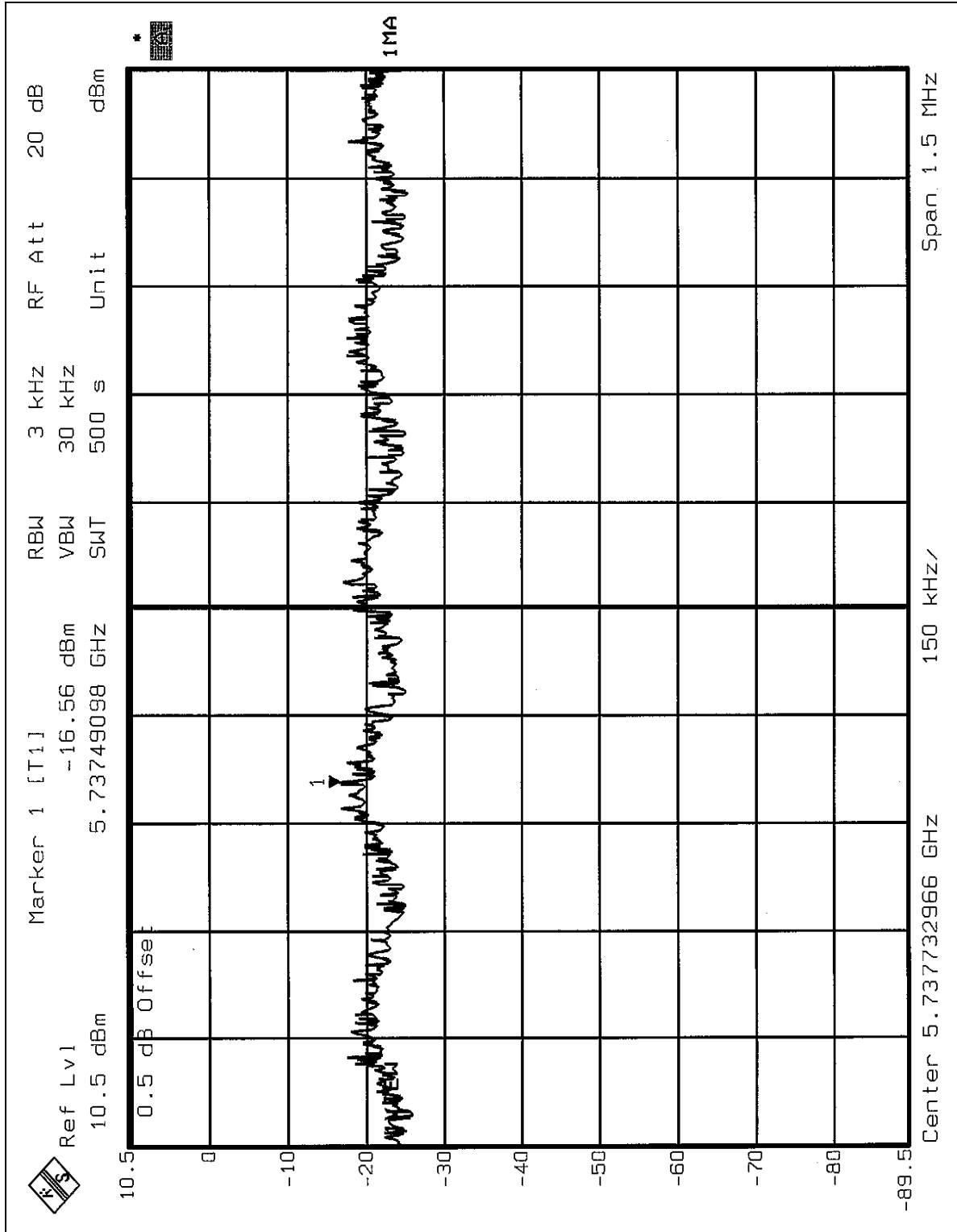



CH11

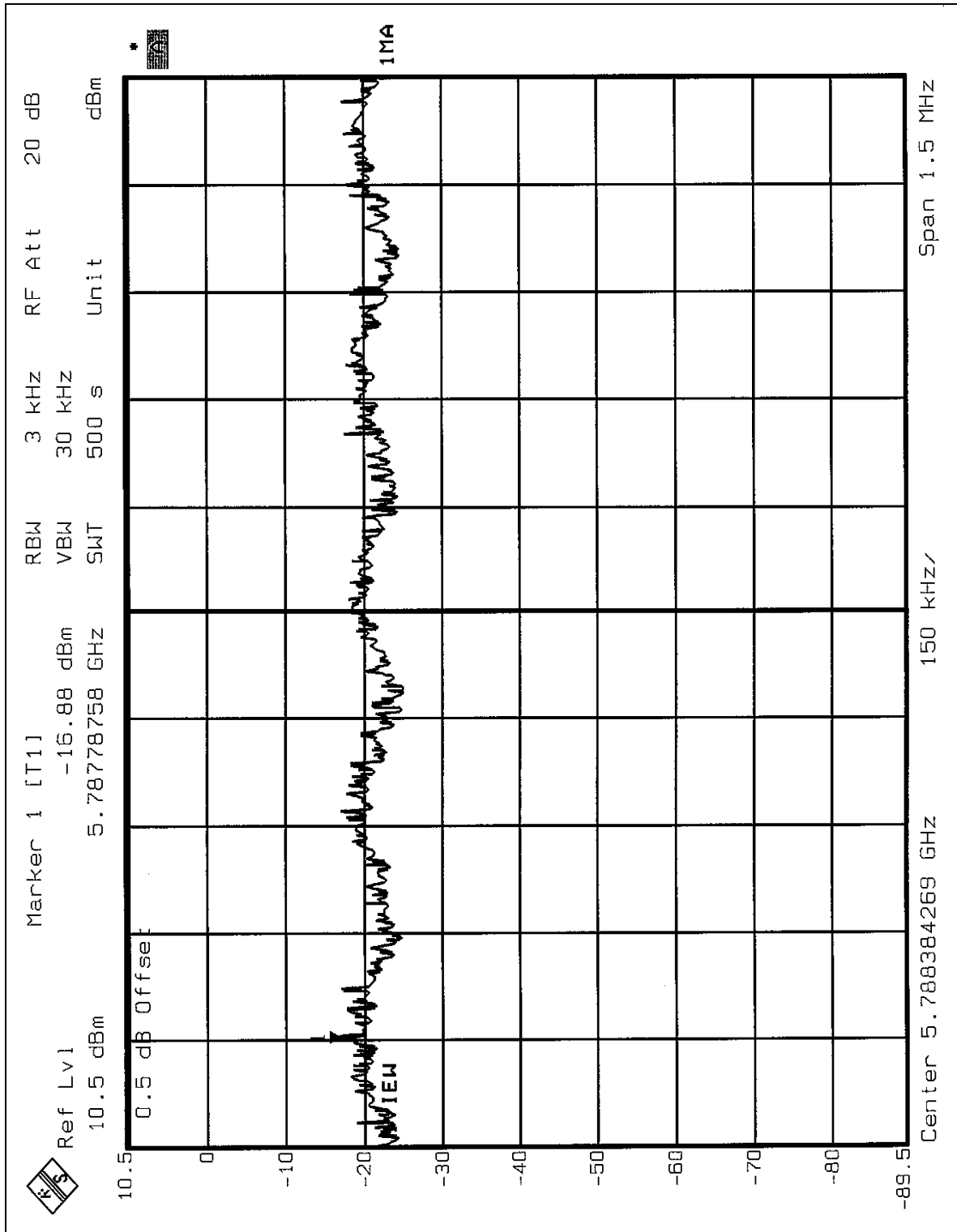



CH13

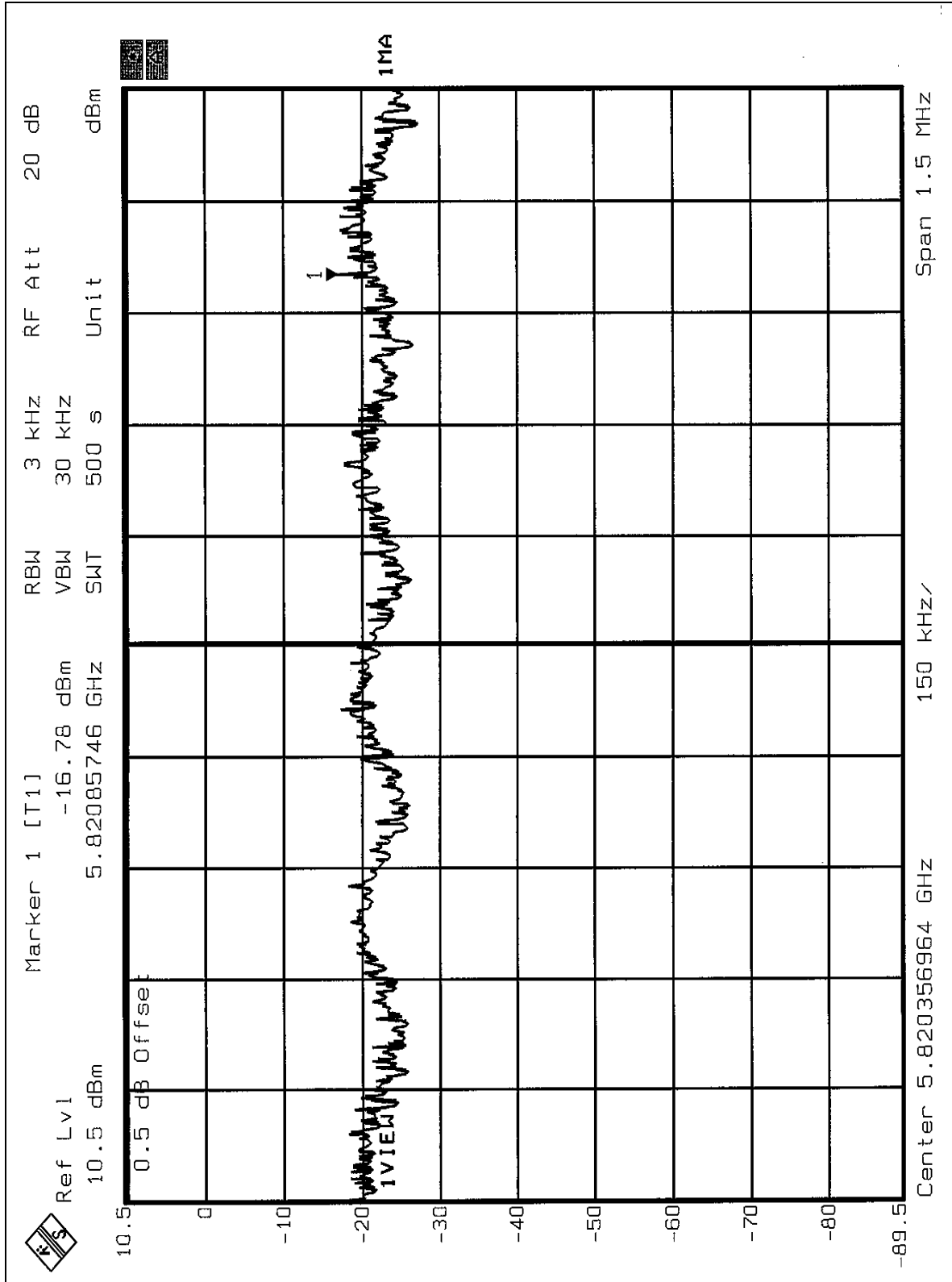



EUT	Wireless A+G Mini PCI Card	MODEL	WMCE54AG
MODE	Turbo	INPUT POWER (SYSTEM)	120Vac, 60 Hz
ENVIRONMENTAL CONDITIONS	24deg. C, 65%RH, 991 hPa	TESTED BY	Steven Lu

CHANNEL	CHANNEL FREQUENCY (MHz)	RF POWER LEVEL IN 3 kHz BW (dBm)	MAXIMUM LIMIT (dBm)	PASS/FAIL
4	5760	-18.88	8	PASS
5	5800	-18.49	8	PASS



CH4

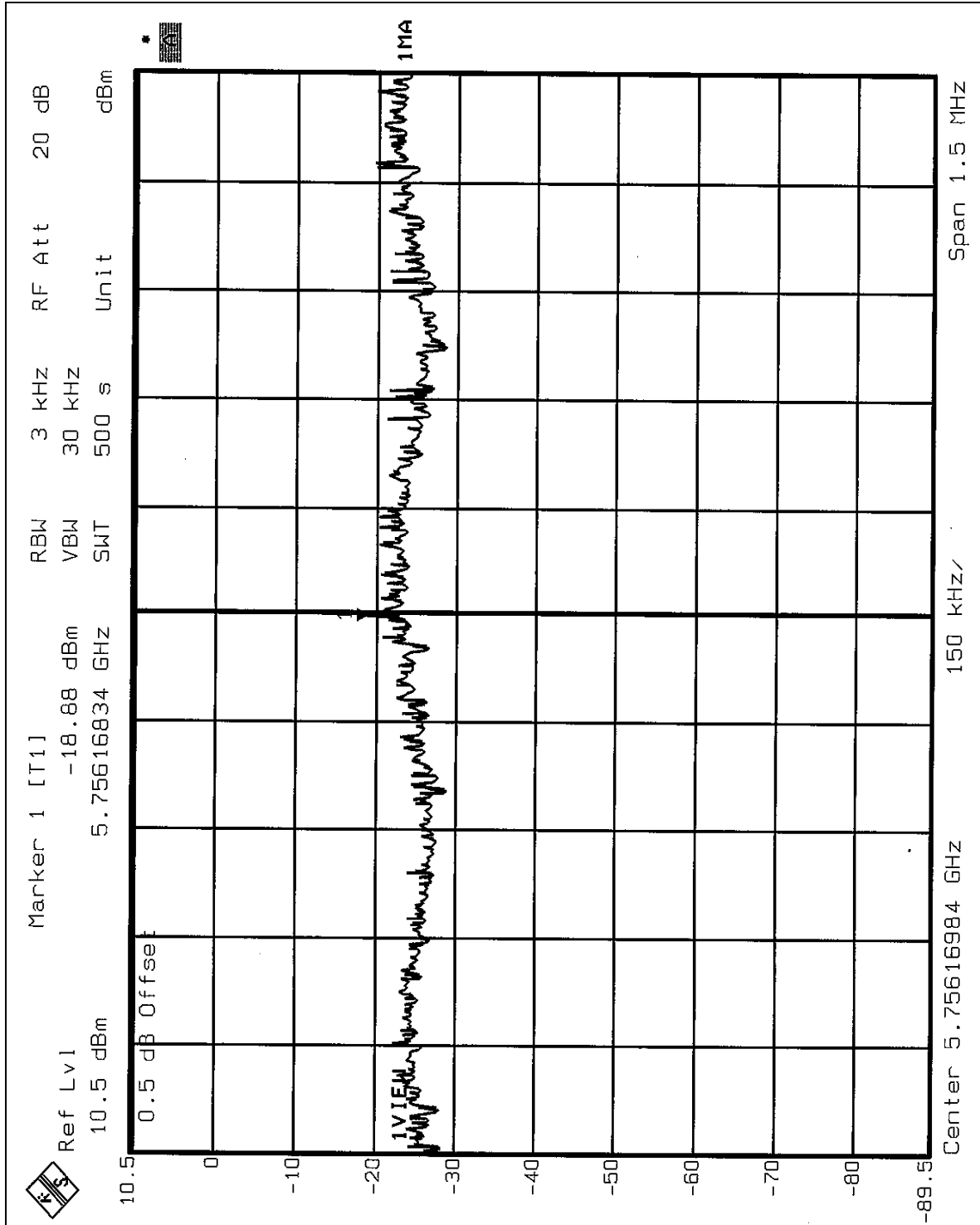



CH5

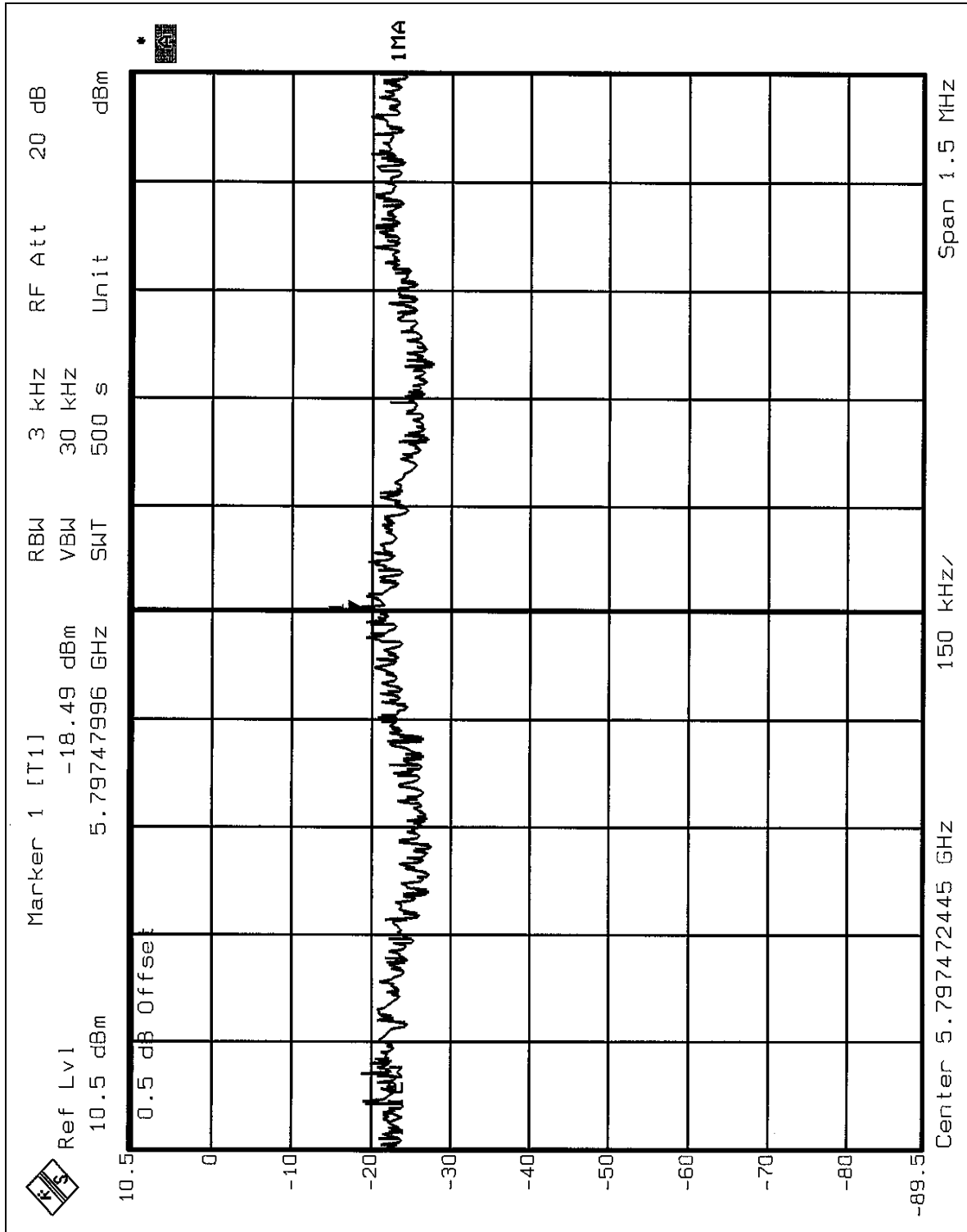



5.12 BAND EDGES MEASUREMENT

5.12.1 LIMITS OF BAND EDGES MEASUREMENT

Below -20dB of the highest emission level of operating band (in 100kHz Resolution Bandwidth).

5.12.2 TEST INSTRUMENTS

Description & Manufacturer	Model No.	Serial No.	Calibrated Until
R&S SPECTRUM ANALYZER	FSEK30	100049	Aug. 12, 2005

NOTES:

The calibration interval of the above test instruments is 12 months and the calibrations are traceable to NML/ROC and NIST/USA.

5.12.3 TEST PROCEDURE

The transmitter output was connected to the spectrum analyzer via a low lose cable. Set both RBW and VBW of spectrum analyzer to 100 kHz with suitable frequency span including 100 MHz bandwidth from band edge. The band edges was measured and recorded.

5.12.4 DEVIATION FROM TEST STANDARD

No deviation



5.12.5 EUT OPERATING CONDITION

Same as Item 5.9.6

5.12.6 TEST RESULTS

The spectrum plots are attached on the following pages. D2 line indicates the highest level, D1 line indicates the 20dB offset below D2. It shows compliance with the requirement in part 15.247(C).



Normal Mode

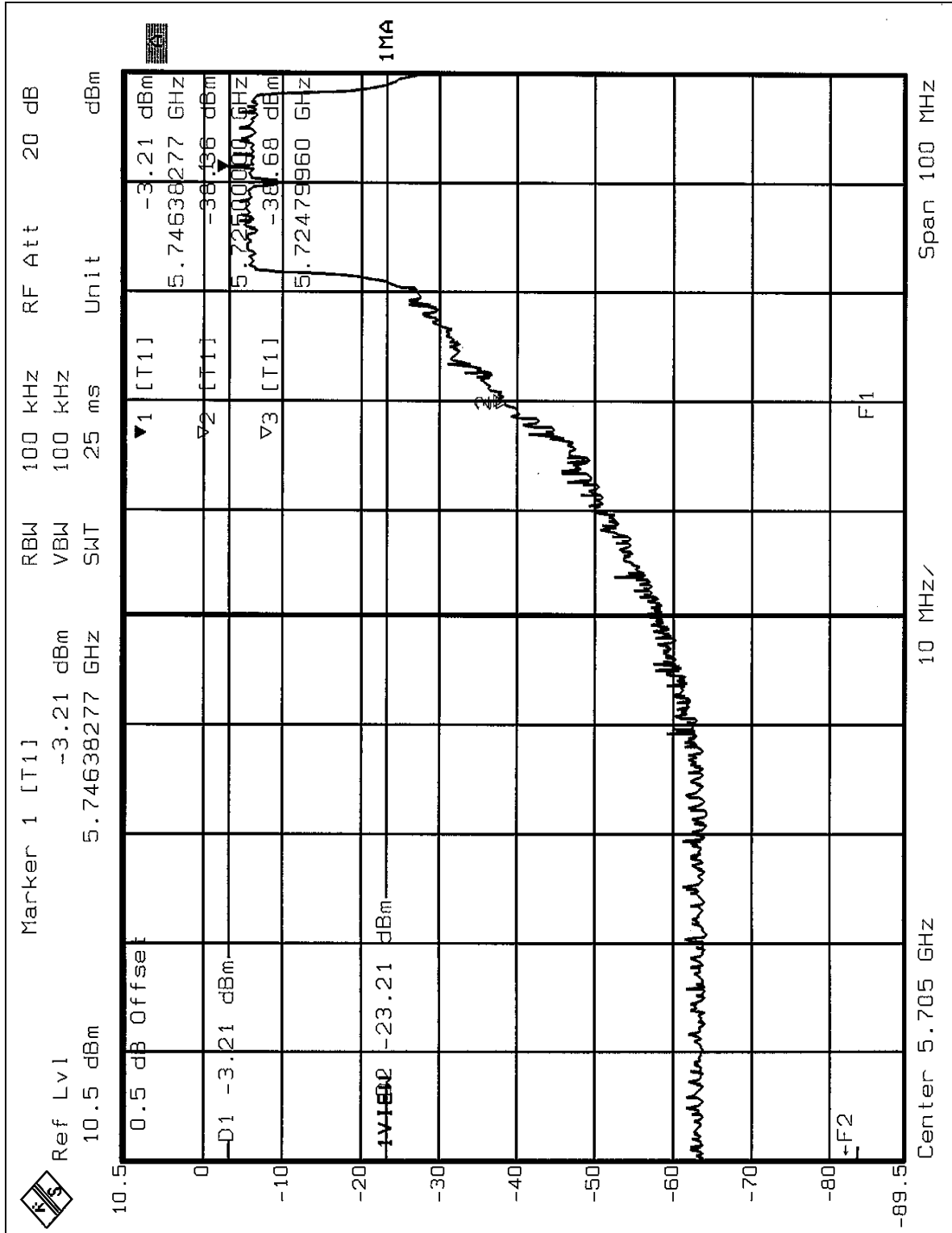

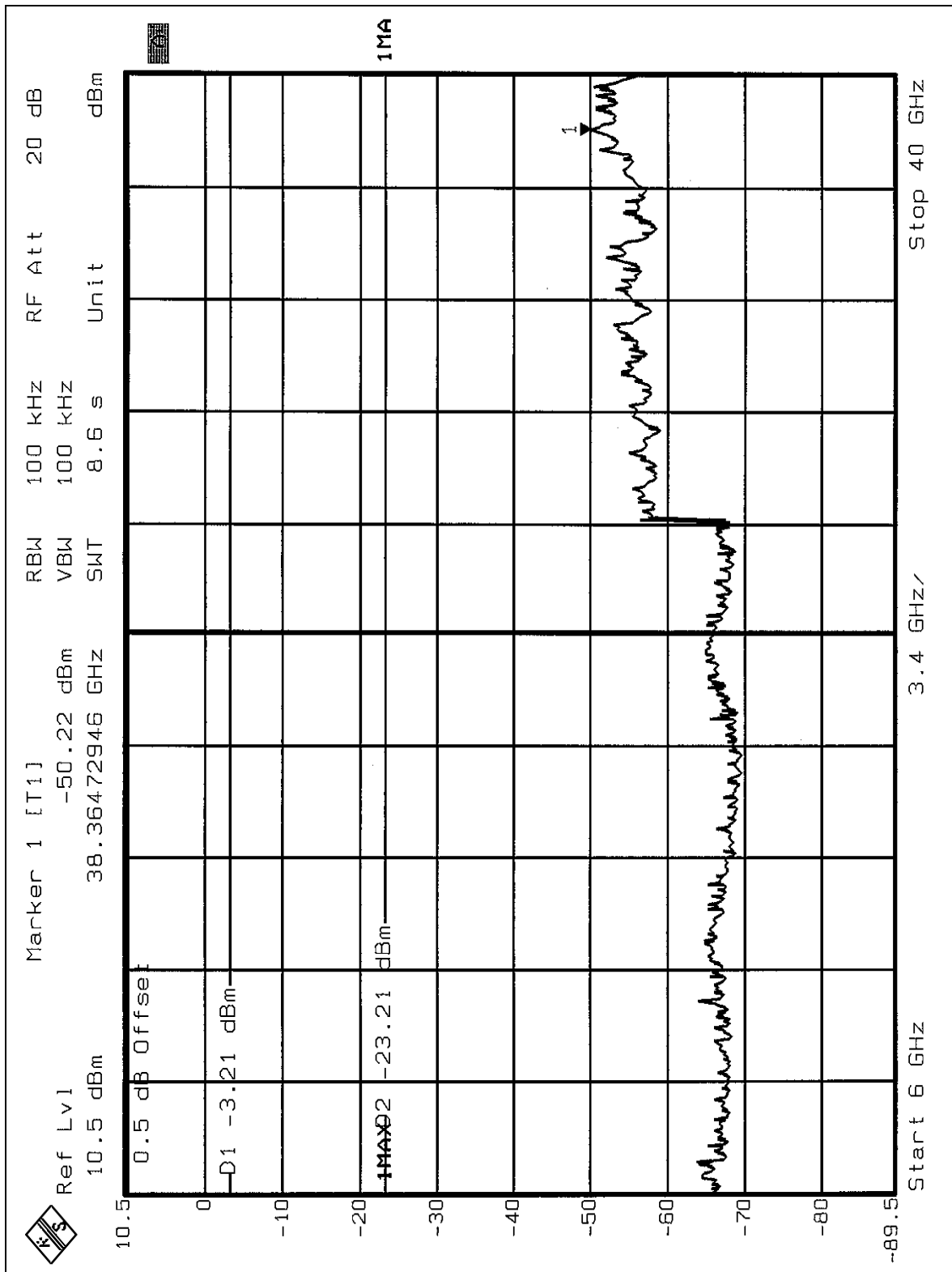

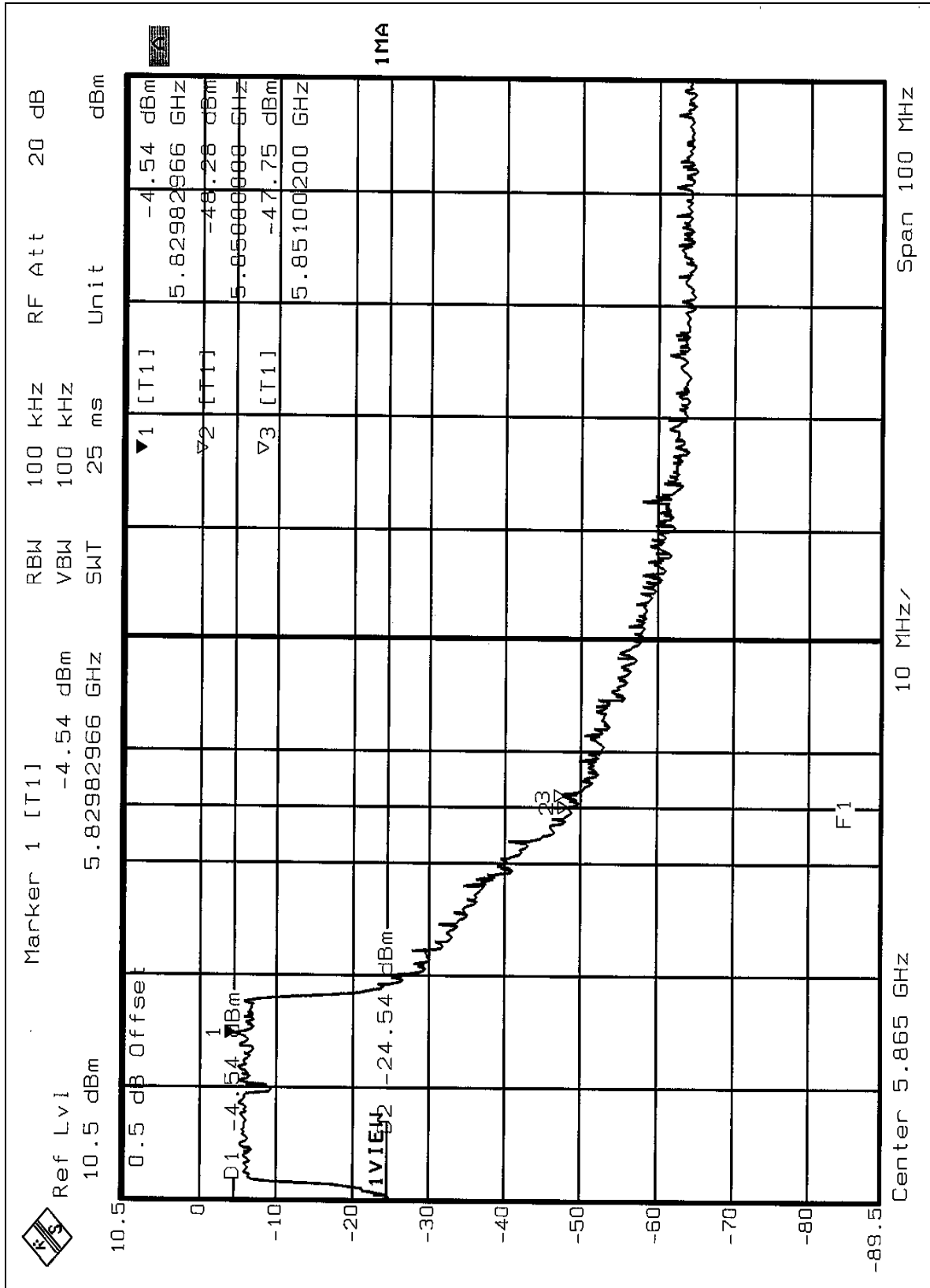

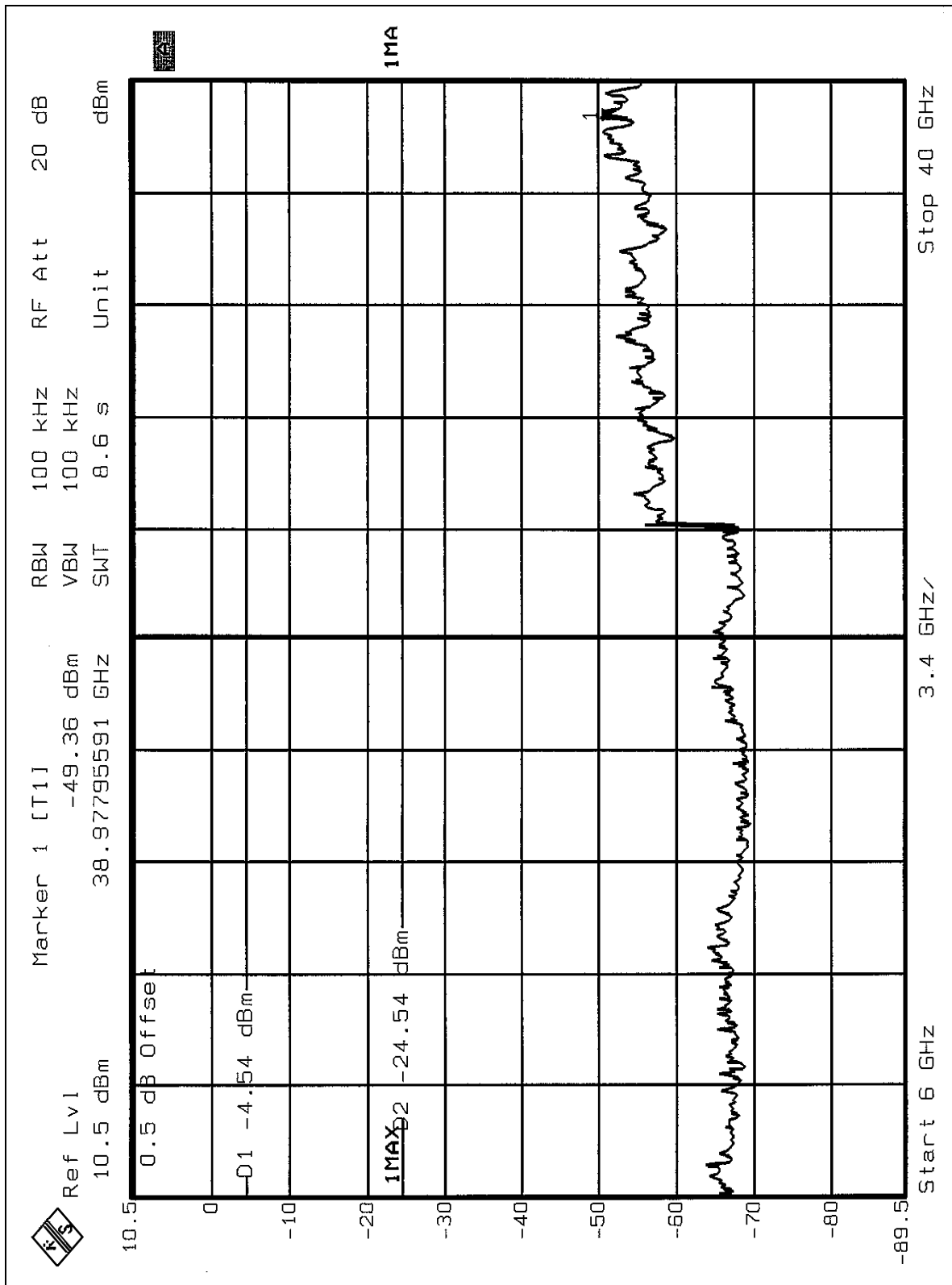



Turbo Mode

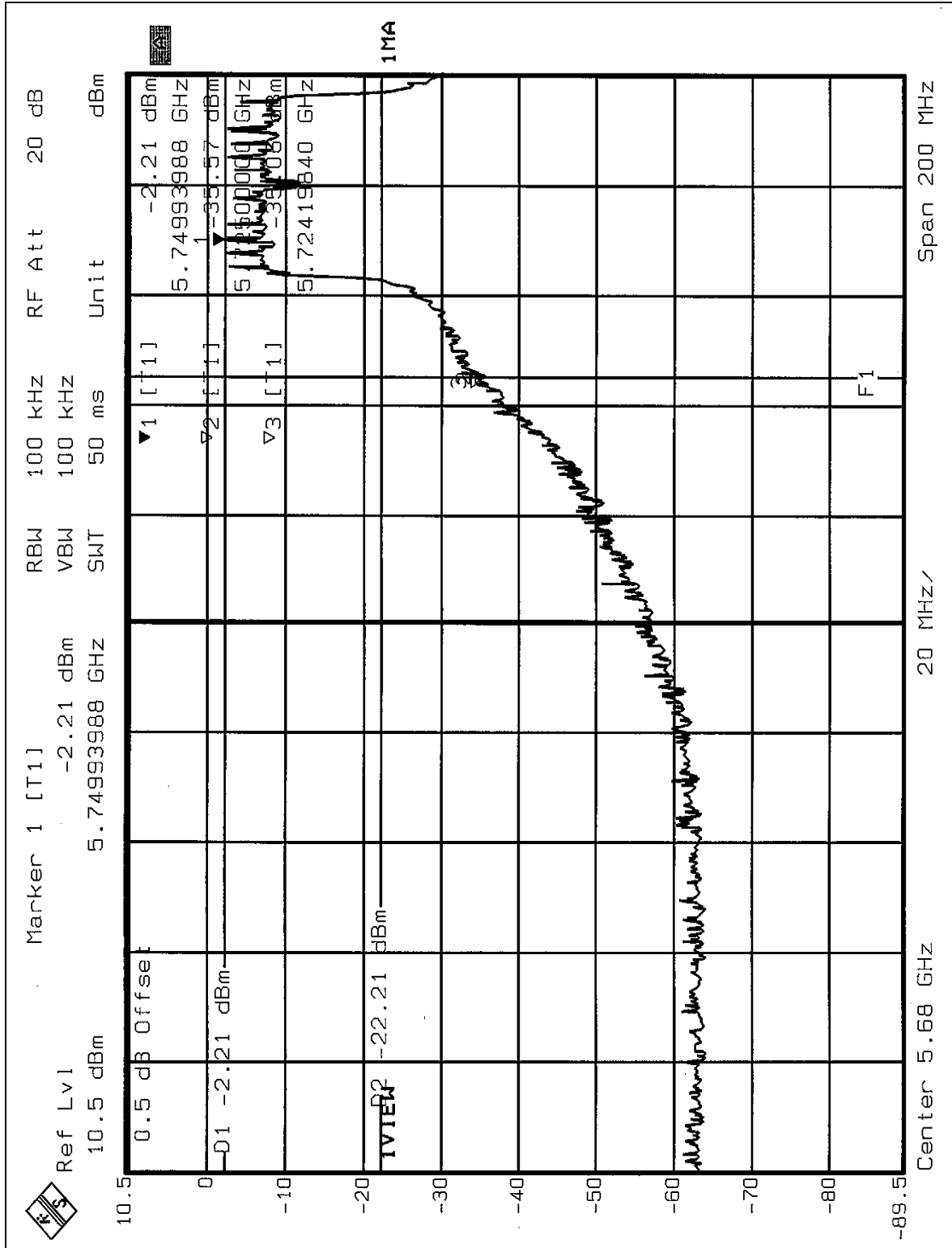

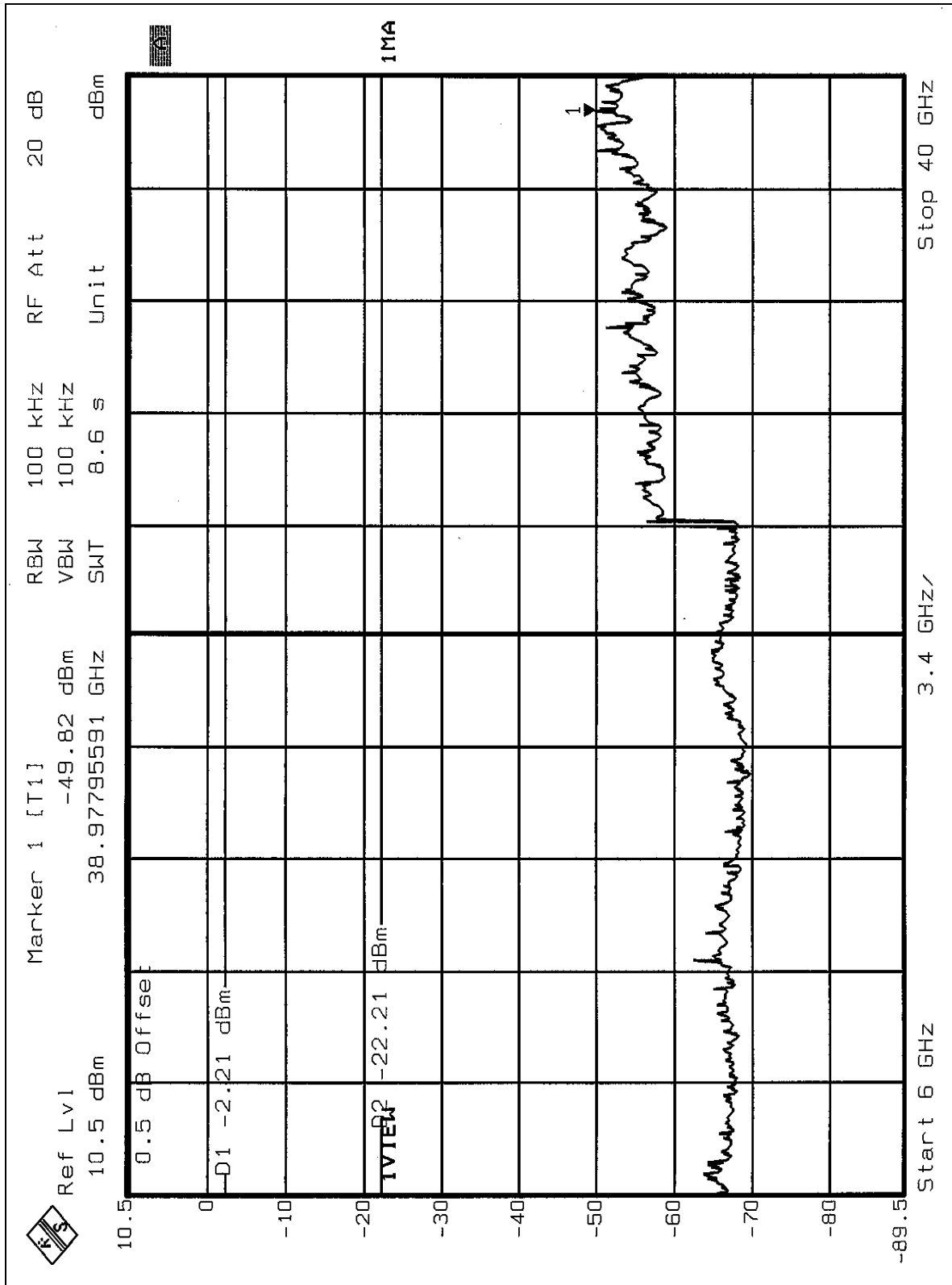

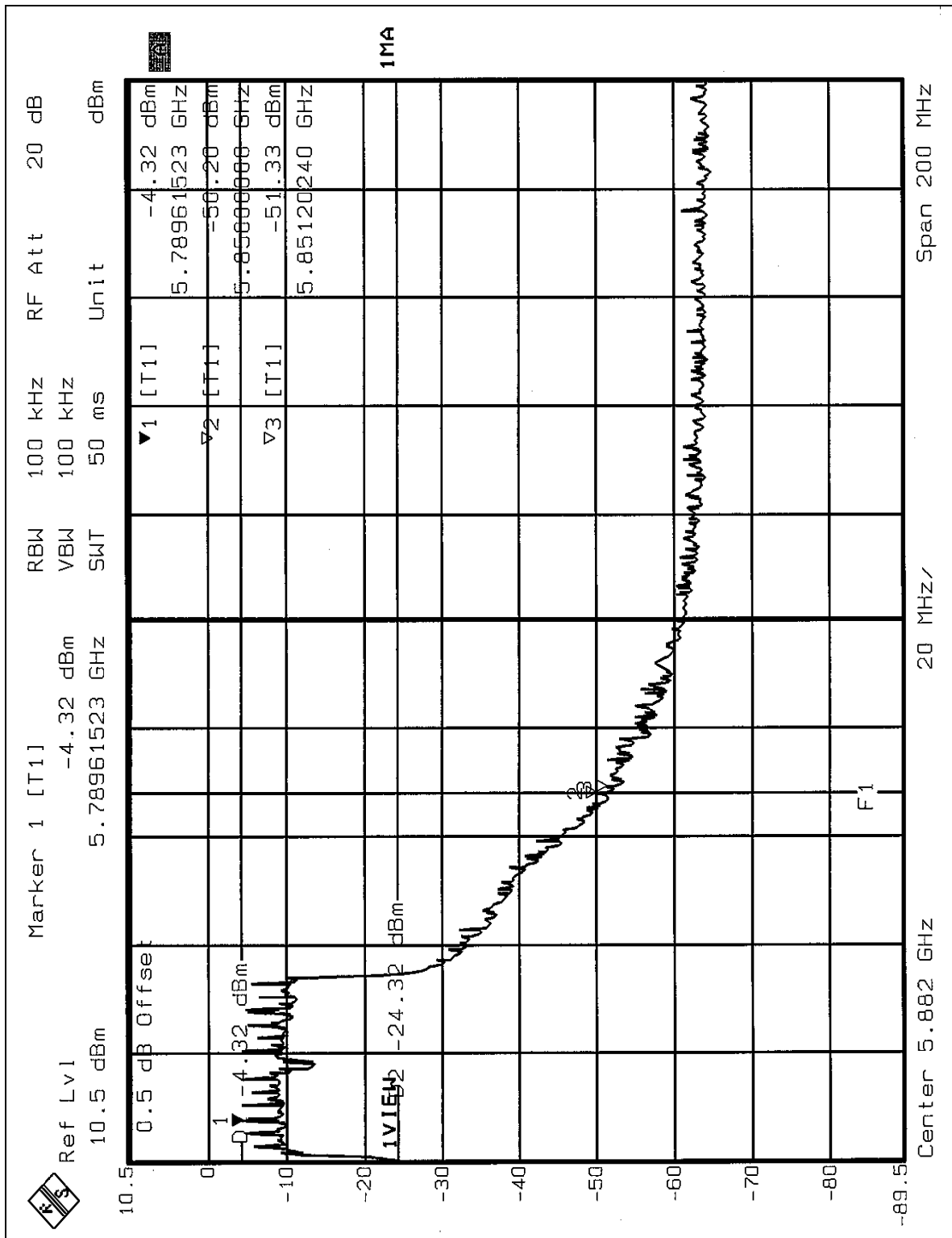

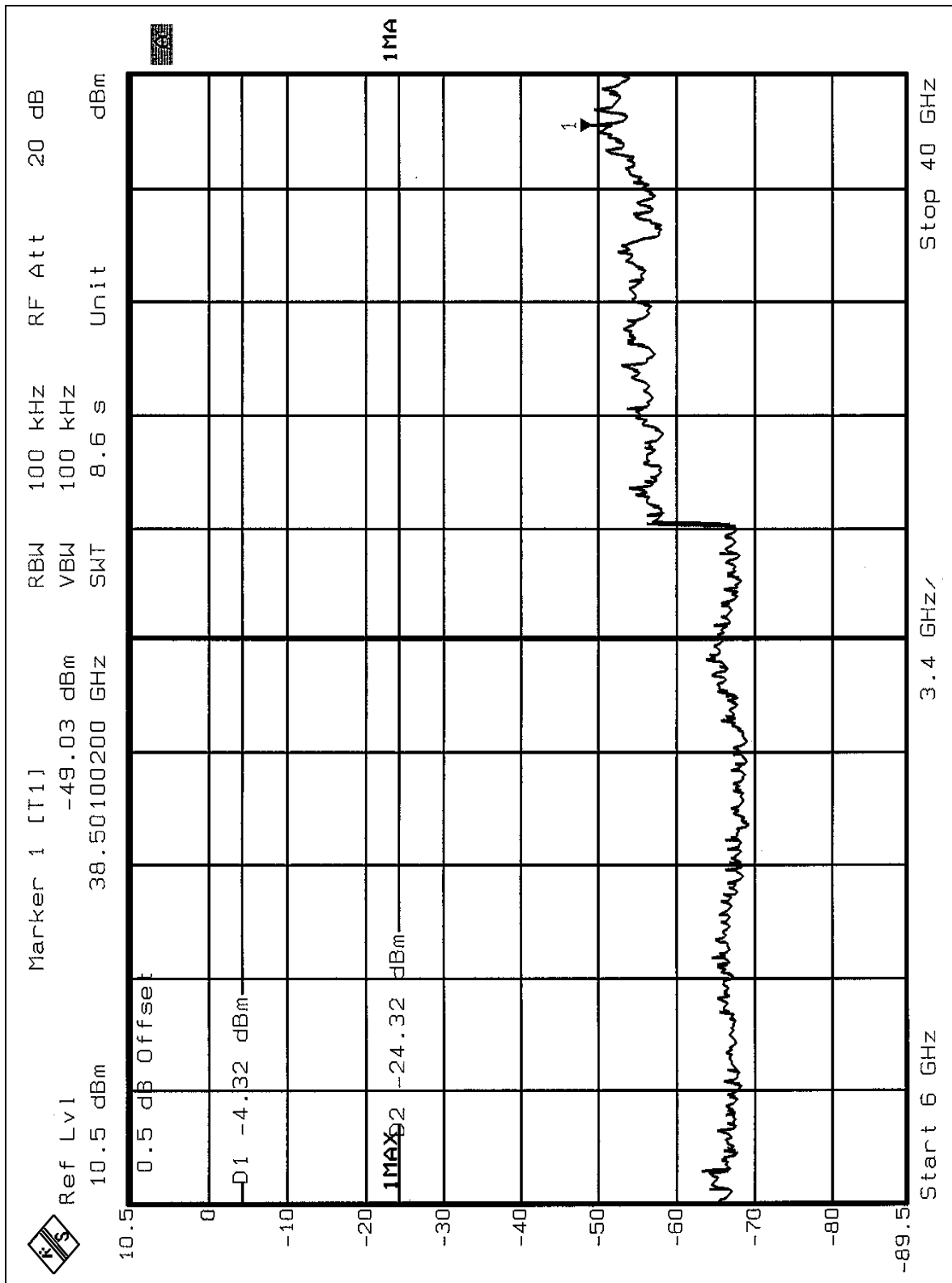

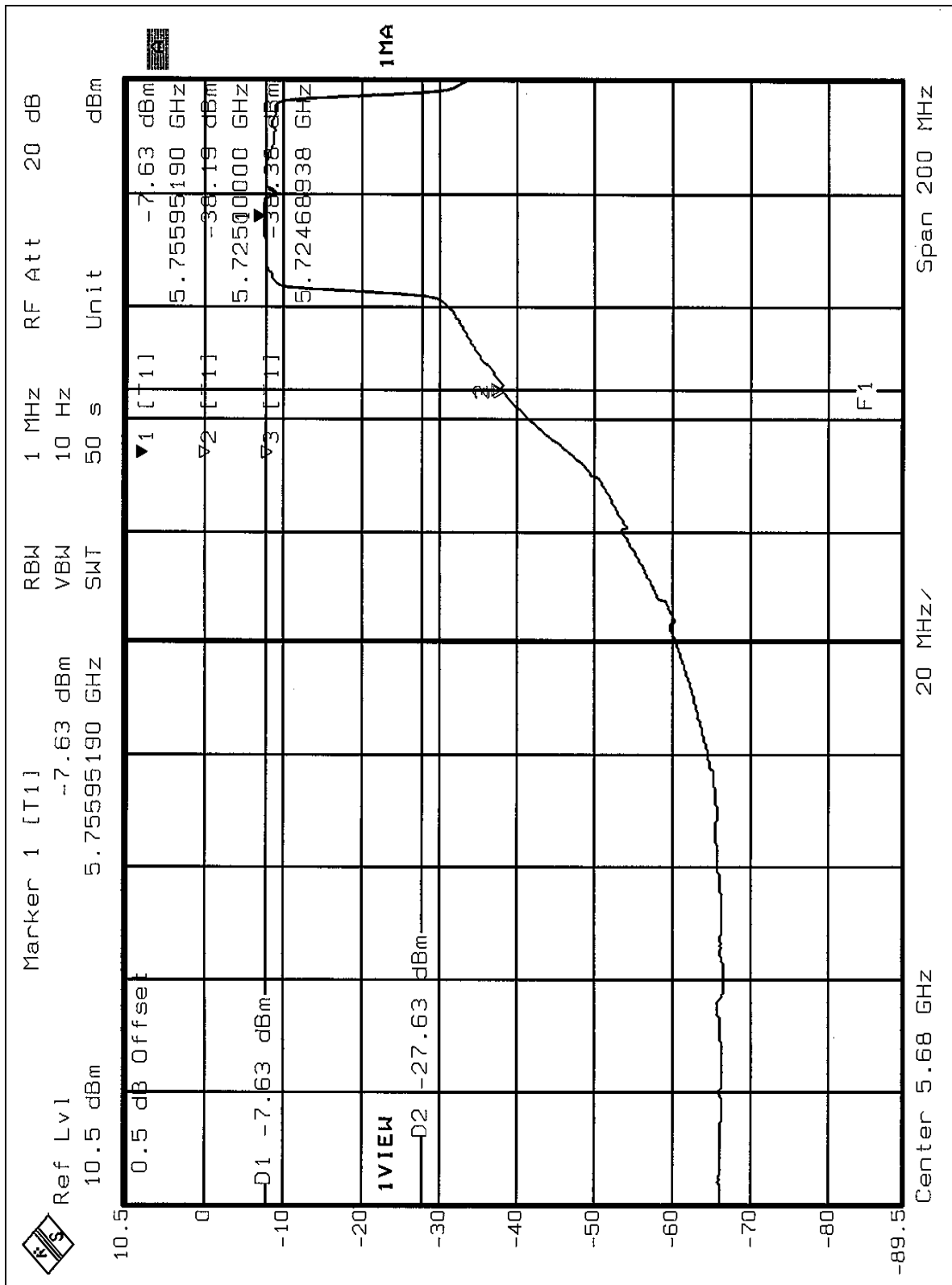

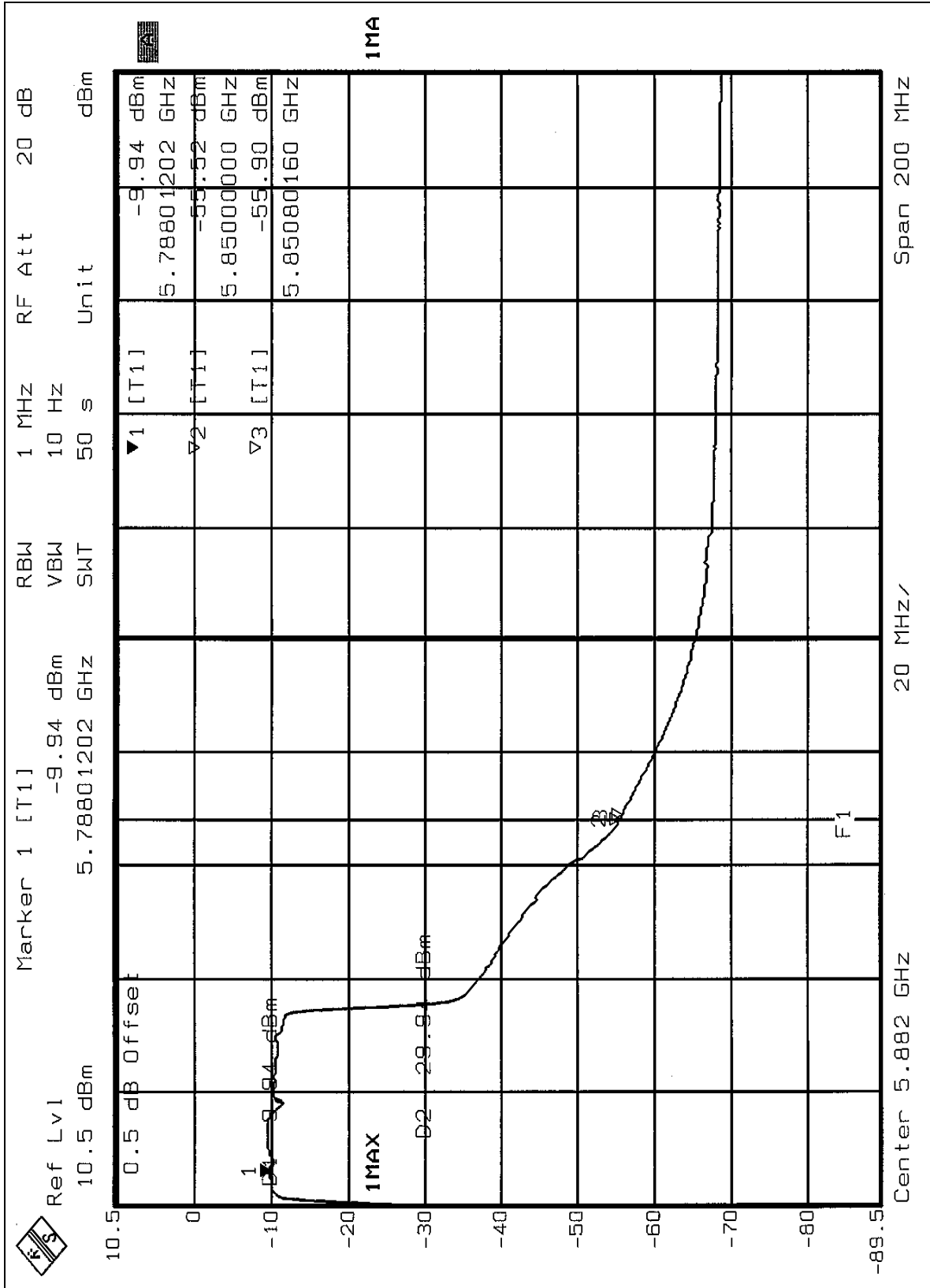



5.13 ANTENNA REQUIREMENT

5.13.1 STANDARD APPLICABLE

For intentional device, according to FCC 47 CFR Section 15.203, an intentional radiator shall be designed to ensure that no antenna other than that furnished by the responsible party shall be used with the device.

And according to FCC 47 CFR Section 15.247(a), if transmitting antennas of directional gain greater than 6dBi are used, the power shall be reduced by the amount in dB that the directional gain of the antenna exceeds 6dBi.

5.13.2 ANTENNA CONNECTED CONSTRUCTION

The antenna used in this product is Dipole antenna with ULF antenna connector. The maximum Gain of the antenna is 4.0dBi.

6. PHOTOGRAPHS OF THE TEST CONFIGURATION CONDUCTED EMISSION TEST





RADIATED EMISSION TEST



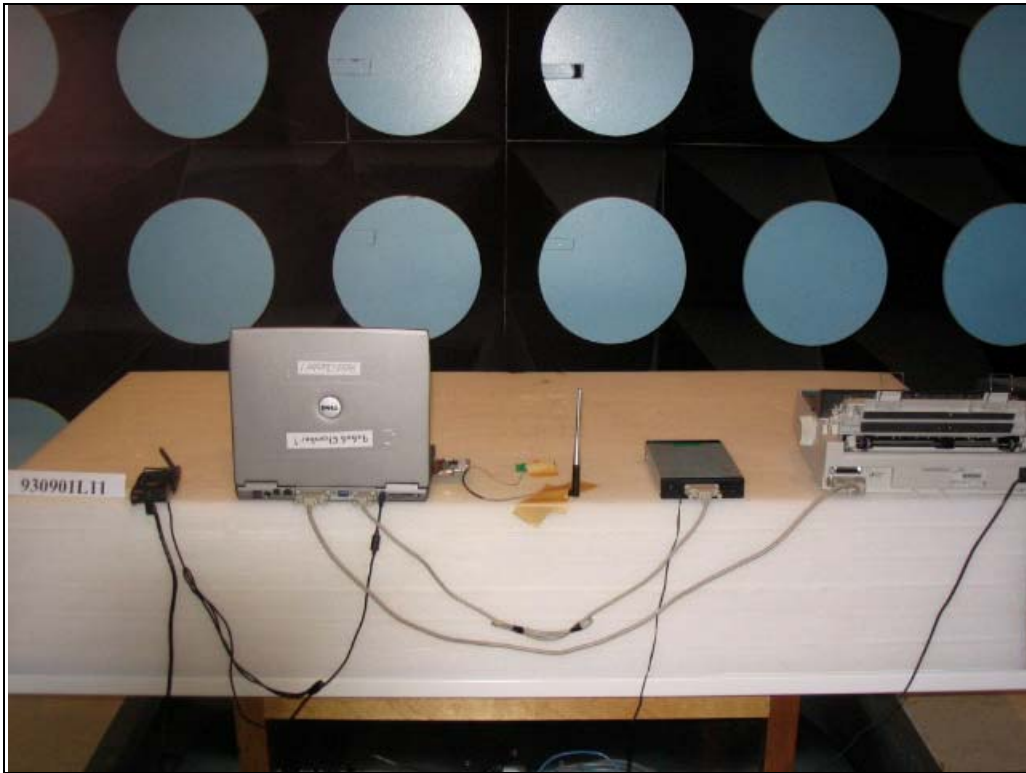



7. INFORMATION ON THE TESTING LABORATORIES

We, ADT Corp., were founded in 1988 to provide our best service in EMC, Radio, Telecom and Safety consultation. Our laboratories are accredited and approved by the following approval agencies according to ISO/IEC 17025, Guide 25 or EN 45001:

USA	FCC, NVLAP, UL , A2LA
Germany	TUV Rheinland
Japan	VCCI
Norway	NEMKO
Canada	INDUSTRY CANADA , CSA
R.O.C.	CNLA, BSMI, DGT
Netherlands	Telefication
Singapore	PSB , GOST-ASIA(MOU)
Russia	CERTIS(MOU)

Copies of accreditation certificates of our laboratories obtained from approval agencies can be downloaded from our web site:

www.adt.com.tw/index.5/phtml. If you have any comments, please feel free to contact us at the following:

Linko EMC/RF Lab:

Tel: 886-2-26052180

Fax: 886-2-26052943

Hsin Chu EMC/RF Lab:

Tel: 886-3-5935343

Fax: 886-3-5935342

Hwa Ya EMC/RF/Safety Telecom Lab:

Tel: 886-3-3183232

Fax: 886-3-3185050

Linko RF Lab.

Tel: 886-3-3270910

Fax: 886-3-3270892

Email: service@mail.adt.com.tw

Web Site: www.adt.com.tw

The address and road map of all our labs can be found in our web site also

Report Format Version 1.5