

DFS Test Report

Report No.: RF160810E03D-2

FCC ID: Q87-WHW03

Test Model: WHW03

Received Date: Jan. 25, 2017

Test Date: Apr. 18 to 25, 2017

Issued Date: June 08, 2017

Applicant: Linksys LLC

Address: 121 Theory Drive Irvine California 92617 United States

Issued By: Bureau Veritas Consumer Products Services (H.K.) Ltd., Taoyuan Branch
Hsin Chu Laboratory

Lab Address: E-2, No.1, Li Hsin 1st Road, Hsinchu Science Park, Hsinchu City 300,
Taiwan R.O.C.



This report is for your exclusive use. Any copying or replication of this report to or for any other person or entity, or use of our name or trademark, is permitted only with our prior written permission. This report sets forth our findings solely with respect to the test samples identified herein. The results set forth in this report are not indicative or representative of the quality or characteristics of the lot from which a test sample was taken or any similar or identical product unless specifically and expressly noted. Our report includes all of the tests requested by you and the results thereof based upon the information that you provided to us. You have 60 days from date of issuance of this report to notify us of any material error or omission caused by our negligence, provided, however, that such notice shall be in writing and shall specifically address the issue you wish to raise. A failure to raise such issue within the prescribed time shall constitute your unqualified acceptance of the completeness of this report, the tests conducted and the correctness of the report contents. Unless specific mention, the uncertainty of measurement has been explicitly taken into account to declare the compliance or non-compliance to the specification. The report must not be used by the client to claim product certification, approval, or endorsement by TAF or any government agencies.

Table of Contents

Release Control Record	3
1 Certificate of Conformity	4
2 EUT Information	5
2.1 Operating Frequency Bands and Mode of EUT	5
2.2 EUT Software and Firmware Version	5
2.3 Description of Available Antennas to the EUT	6
2.4 EUT Maximum and Minimum Conducted Power	7
2.5 EUT Maximum and Minimum EIRP Power	8
2.6 Transmit Power Control (TPC)	9
2.7 Statement of Manufacturer	9
3. U-NII DFS Rule Requirements	10
3.1 Working Modes and Required Test Items	10
3.2 Test Limits And Radar Signal Parameters	11
4. Test & Support Equipment List	14
4.1 Test Instruments	14
4.2 Description of Support Units	14
5. Test Procedure	15
5.1 DFS Measurement System	15
5.2 Calibration of DFS Detection Threshold Level	15
5.3 Deviation From Test Standard	16
5.4 Radiated Test Setup Configuration	17
6. Test Results	18
6.1 Summary of Test Results	18
6.2 Test Results	19
6.2.1 Test Mode: Device Operating In Master Mode	19
6.2.2 U-NII Detection Bandwidth	24
6.2.3 Channel Availability Check Time	35
6.2.4 Channel Closing Transmission and Channel Move Time	38
6.2.5 Non- Occupancy Period	103
7. Information on The Testing Laboratories	105
8. APPENDIX-A	106

Release Control Record

Issue No.	Description	Date Issued
RF160810E03D-2	Original release.	June 08, 2017

1 Certificate of Conformity

Product: Access Point
Brand: LINKSYS
Test Model: WHW03
Sample Status: ENGINEERING SAMPLE
Applicant: Linksys LLC
Test Date: Apr. 18 to 25, 2017
Standards: FCC Part 15, Subpart E (Section 15.407)
KDB 905462 D02 UNII DFS Compliance Procedures New Rules v02

The above equipment has been tested by **Bureau Veritas Consumer Products Services (H.K.) Ltd., Taoyuan Branch**, and found compliance with the requirement of the above standards. The test record, data evaluation & Equipment Under Test (EUT) configurations represented herein are true and accurate accounts of the measurements of the sample's EMC characteristics under the conditions specified in this report.

Prepared by : Wendy Wu , **Date:** June 08, 2017
Wendy Wu / Specialist

Approved by : May Chen , **Date:** June 08, 2017
May Chen / Manager

2 EUT Information

2.1 Operating Frequency Bands and Mode of EUT

Table 1: Operating Frequency Bands and Mode of EUT

Operational Mode	Operating Frequency Range	
	5250~5350MHz	5470~5725MHz
Master	✓	✓

2.2 EUT Software and Firmware Version

Table 2: The EUT Software/Firmware Version

No.	Product	Model No.	Software Version
1	Access Point	WHW03	1.1.1.180217

2.3 Description of Available Antennas to the EUT

Table 3: Antenna List

BT Antenna Spec.							
Antenna No	Brand	Model	Antenna Net Gain(dBi)	Frequency range (GHz)	Antenna Type	Connector Type	
1	galtronics	60-2703-03	3.13	2.4~2.4835	Dipole	i-pex(MHF)	
Zigbee Antenna Spec.							
Antenna No	Brand	Model	Antenna Net Gain(dBi)	Frequency range (GHz)	Antenna Type	Connector Type	
2	galtronics	60-2699-03	2.52	2.4~2.4835	Dipole	i-pex(MHF)	
WLAN (Radio 2) Antenna Spec.							
Antenna No	Transmitter Circuit	Brand	Model	Antenna Net Gain(dBi)	Frequency range (GHz)	Antenna Type	Connector Type
3	5GHz-Chain (1) (UNII-2C, UNII-3)	galtronics	60-2704-03	3.86	5.5~5.825	Dipole	i-pex(MHF)
4	5GHz-Chain (0) (UNII-2C, UNII-3)	galtronics	60-2708-03	2.36	5.5~5.825	Dipole	i-pex(MHF)
WLAN (Radio 1) Antenna Spec.							
Antenna No	Transmitter Circuit	Brand	Model	Antenna Net Gain(dBi)	Frequency range (GHz)	Antenna Type	Connector Type
5	2.4GHz-Chain (0)	galtronics	60-2698-03	3.43	2.4~2.4835	Dipole	i-pex(MHF)
	5GHz-Chain (1) (UNII-1, UNII-2A)			3.62	5.18~5.320		
6	2.4GHz-Chain (1)	galtronics	60-2697-03	1.49	2.4~2.4835	Dipole	i-pex(MHF)
	5GHz-Chain (0) (UNII-1, UNII-2A)			4.35	5.18~5.320		

2.4 EUT Maximum and Minimum Conducted Power

Table 4: The Measured Conducted Output Power

802.11a

Frequency Band (MHz)	MAX. Power		MIN. Power	
	Output Power(dBm)	Output Power(mW)	Output Power(dBm)	Output Power(mW)
5250~5350	22.96	197.879	16.96	49.659
5470~5725	23.76	237.952	17.76	59.704

802.11ac (VHT20)

Frequency Band (MHz)	MAX. Power		MIN. Power	
	Output Power(dBm)	Output Power(mW)	Output Power(dBm)	Output Power(mW)
5250~5350	22.98	198.398	16.98	49.888
5470~5725	23.75	236.882	17.75	59.566

802.11ac (VHT40)

Frequency Band (MHz)	MAX. Power		MIN. Power	
	Output Power(dBm)	Output Power(mW)	Output Power(dBm)	Output Power(mW)
5250~5350	22.92	195.914	16.92	49.204
5470~5725	23.82	241.222	17.82	60.534

802.11ac (VHT80)

Frequency Band (MHz)	MAX. Power		MIN. Power	
	Output Power(dBm)	Output Power(mW)	Output Power(dBm)	Output Power(mW)
5250~5350	22.72	187.076	16.72	46.989
5470~5725	23.84	242.048	17.84	60.814

2.5 EUT Maximum and Minimum EIRP Power

Table 5: The EIRP Output Power List

802.11a

Frequency Band (MHz)	MAX. EIRP Power		MIN. EIRP Power	
	Output Power(dBm)	Output Power(mW)	Output Power(dBm)	Output Power(mW)
5250~5350	29.96	991.744	23.96	248.886
5470~5725	29.91	980.594	23.91	246.037

802.11ac (VHT20)

Frequency Band (MHz)	MAX. EIRP Power		MIN. EIRP Power	
	Output Power(dBm)	Output Power(mW)	Output Power(dBm)	Output Power(mW)
5250~5350	29.98	994.345	23.98	250.035
5470~5725	29.9	976.185	23.9	245.471

802.11ac (VHT40)

Frequency Band (MHz)	MAX. EIRP Power		MIN. EIRP Power	
	Output Power(dBm)	Output Power(mW)	Output Power(dBm)	Output Power(mW)
5250~5350	29.92	981.896	23.92	246.604
5470~5725	29.97	994.07	23.97	249.459

802.11ac (VHT80)

Frequency Band (MHz)	MAX. EIRP Power		MIN. EIRP Power	
	Output Power(dBm)	Output Power(mW)	Output Power(dBm)	Output Power(mW)
5250~5350	29.72	937.601	23.72	235.505
5470~5725	29.99	997.474	23.99	250.611

2.6 Transmit Power Control (TPC)

U-NII devices operating in the 5.25-5.35 GHz band and the 5.47-5.725 GHz band shall employ a TPC mechanism. The U-NII device is required to have the capability to operate at least 6 dB below the mean EIRP value of 30 dBm. A TPC mechanism is not required for systems with an e.i.r.p. of less than 500 mW.

Applicable	EIRP	FCC 15.407 (h)(1)
√	>500mW	The TPC mechanism is required for system with an EIRP of above 500mW
	<500mW	The TPC mechanism is not required for system with an EIRP of less 500mW

The TPC mechanism of the UUT can adjust a transmitter's output power at least reduce 6dB by WEB GUI configure.

2.7 Statement of Manufacturer

Manufacturer statement confirming that information regarding the parameters of the detected Radar Waveforms is not available to the end user.

3. U-NII DFS Rule Requirements

3.1 Working Modes and Required Test Items

The manufacturer shall state whether the UUT is capable of operating as a Master and/or a Client. If the UUT is capable of operating in more than one operating mode then each operating mode shall be tested separately. See tables 6 and 7 for the applicability of DFS requirements for each of the operational modes.

Table 6: Applicability of DFS Requirements Prior To Use a Channel

Requirement	Operational Mode		
	Master	Client without radar detection	Client with radar detection
Non-Occupancy Period	✓	✓ note	✓
DFS Detection Threshold	✓	Not required	✓
Channel Availability Check Time	✓	Not required	Not required
U-NII Detection Bandwidth	✓	Not required	✓

Note: Regarding KDB 905462 D03 Client Without DFS New Rules v01r01 section (b)(5/6), If the client moves with the master, the device is considered compliant if nothing appears in the client non-occupancy period test. For devices that shut down (rather than moving channels), no beacons should appear. An analyzer plot that contains a single 30-minute sweep on the original channel.

Table 7: Applicability of DFS Requirements During Normal Operation.

Requirement	Operational Mode	
	Master or Client with radar detection	Client without radar detection
DFS Detection Threshold	✓	Not required
Channel Closing Transmission Time	✓	✓
Channel Move Time	✓	✓
U-NII Detection Bandwidth	✓	Not required

Additional requirements for devices with multiple bandwidth modes	Master or Client with radar detection	Client without radar detection
U-NII Detection Bandwidth and Statistical Performance Check	All BW modes must be tested	Not required
Channel Move Time and Channel Closing Transmission Time	Test using widest BW mode available	Test using the widest BW mode available for the link
All other tests	Any single BW mode	Not required

Note: Frequencies selected for statistical performance check (Section 7.8.4) should include several frequencies within the radar detection bandwidth and frequencies near the edge of the radar detection bandwidth. For 802.11 devices it is suggested to select frequencies in each of the bonded 20 MHz channels and the channel center frequency.

3.2 Test Limits And Radar Signal Parameters

Detection Threshold Values

Table 8: DFS Detection Thresholds For Master Devices And Client Devices With Radar Detection

Maximum Transmit Power	Value (See Notes 1, 2, and 3)
EIRP \geq 200 milliwatt	-64 dBm
EIRP < 200 milliwatt and power spectral density < 10 dBm/MHz	-62 dBm
EIRP < 200 milliwatt that do not meet the power spectral density requirement	-64 dBm

Note 1: This is the level at the input of the receiver assuming a 0 dBi receive antenna.

Note 2: Throughout these test procedures an additional 1 dB has been added to the amplitude of the test transmission waveforms to account for variations in measurement equipment. This will ensure that the test signal is at or above the detection threshold level to trigger a DFS response.

Note3: EIRP is based on the highest antenna gain. For MIMO devices refer to KDB Publication 662911 D01.

Table 9: DFS Response Requirement Values

Parameter	Value
Non-occupancy period	Minimum 30 minutes
Channel Availability Check Time	60 seconds
Channel Move Time	10 seconds See Note 1.
Channel Closing Transmission Time	200 milliseconds + an aggregate of 60 milliseconds over remaining 10 second period. See Notes 1 and 2.
U-NII Detection Bandwidth	Minimum 100% of the U-NII 99% transmission power bandwidth. See Note 3

Note 1: Channel Move Time and the Channel Closing Transmission Time should be performed with Radar Type 0. The measurement timing begins at the end of the Radar Type 0 burst.

Note 2: The Channel Closing Transmission Time is comprised of 200 milliseconds starting at the beginning of the Channel Move Time plus any additional intermittent control signals required to facilitate a Channel move (an aggregate of 60 milliseconds) during the remainder of the 10 second period. The aggregate duration of control signals will not count quiet periods in between transmissions.

Note 3: During the U-NII Detection Bandwidth detection test, radar type 0 should be used. For each frequency step the minimum percentage of detection is 90 percent. Measurements are performed with no data traffic.

Parameters of DFS Test Signals

Step intervals of 0.1 microsecond for Pulse Width, 1 microsecond for PRI, 1 MHz for chirp width and 1 for the number of pulses will be utilized for the random determination of specific test waveforms.

Table 10: Short Pulse Radar Test Waveforms

Radar Type	Pulse Width (μsec)	PRI (μsec)	Number of Pulses	Minimum Percentage of Successful Detection	Minimum Number of Trials
0	1	1428	18	See Note 1	See Note 1
1	1	Test A: 15 unique PRI values randomly selected from the list of 23 PRI values in Table 5a	$\text{Roundup} \left\{ \left(\frac{1}{360} \right) \cdot \left(\frac{19 \cdot 10^6}{\text{PRI}_{\text{min}}} \right) \right\}$	60%	30
		Test B: 15 unique PRI values randomly selected within the range of 518-3066μ sec, with a minimum increment of 1μ sec, excluding PRI values selected in Test A			
2	1-5	150-230	23-29	60%	30
3	6-10	200-500	16-18	60%	30
4	11-20	200-500	12-16	60%	30
Aggregate (Radar Types 1-4)				80%	120
Note 1: Short Pulse Radar Type 0 should be used for the detection bandwidth test, channel move time, and channel closing time tests.					

Table 11: Long Pulse Radar Test Waveform

Radar Type	Pulse Width (µsec)	Chirp Width (MHz)	PRI (µsec)	Number of Pulses Per Burst	Number of Bursts	Minimum Percentage of Successful Detection	Minimum Number of Trials
5	50-100	5-20	1000-2000	1-3	8-20	80%	30

Three subsets of trials will be performed with a minimum of ten trials per subset. The subset of trials differ in where the Long Pulse Type 5 Signal is tuned in frequency.

- a) the Channel center frequency
- b) tuned frequencies such that 90% of the Long Pulse Type 5 frequency modulation is within the low edge of the UUT Occupied Bandwidth
- c) tuned frequencies such that 90% of the Long Pulse Type 5 frequency modulation is within the high edge of the UUT Occupied Bandwidth

It include 10 trails for every subset, the formula as below,

For subset case 1: the center frequency of the signal generator will remain fixed at the center of the UUT Channel.

For subset case 2: to retain 90% frequency overlap between the radar signal and the UUT Occupied Bandwidth, the center frequency of the signal generator will vary for each of the ten trials in subset case 2. The center frequency of the signal generator for each trial is calculated by:

$$FL+(0.4*Chirp\ Width\ [in\ MHz])$$

For subset case 3: to retain 90% frequency overlap between the radar signal and the UUT Occupied Bandwidth, the center frequency of the signal generator will vary for each of the ten trials in subset case 3. The center frequency of the signal generator for each trial is calculated by:

$$FH-(0.4*Chirp\ Width\ [in\ MHz])$$

Table 12: Frequency Hopping Radar Test Waveform

Radar Type	Pulse Width (µsec)	PRI (µsec)	Pulses per Hop	Hopping Rate (kHz)	Hopping Sequence Length (msec)	Minimum Percentage of Successful Detection	Minimum Number of Trials
6	1	333	9	0.333	300	70%	30

4. Test & Support Equipment List

4.1 Test Instruments

Table 13: Test Instruments List

Description & Manufacturer	Model No.	Serial No	Date of Calibration	Due Date of Calibration
Spectrum Analyzer Agilent	N9030A	MY54490679	Jul. 23, 2016	Jul. 22, 2017
Vector Signal Generator Agilent	E4438CK-403	ESG E4_010001	Aug. 10, 2016	Aug. 09, 2017
Horn_Antenna EMCO	1018G	0001	Dec 15, 2016	Dec. 14, 2017
DFS Control Box	BV-DFS-CB	001	Sep. 18, 2016	Sep. 17, 2017

4.2 Description of Support Units

Table 14: Support Unit Information.

No.	Product	Brand	Model No.	FCC ID	Spec
1	Wireless LAN Unit	NEC	NP05LM	RRK-NECNP05LM	

NOTE: This device was functioned as a Master Slave device during the DFS test.

Table 15: Software/Firmware Information.

No.	Product	Model No.	Software/Firmware Version
1	Wireless LAN Unit	NP05LM	Driver Version: 06/18/2014, 1026.12.606.2014

5. Test Procedure

5.1 DFS Measurement System

A complete DFS Measurement System consists of two subsystems: (1) the Radar Signal Generating system and (2) the Traffic Monitoring system. The control PC is necessary for generating the Radar waveforms in Table 10, 11 and 12. The traffic monitoring subsystem is specified to the type of unit under test (UUT).

Radiated Setup Configuration of DFS Measurement System

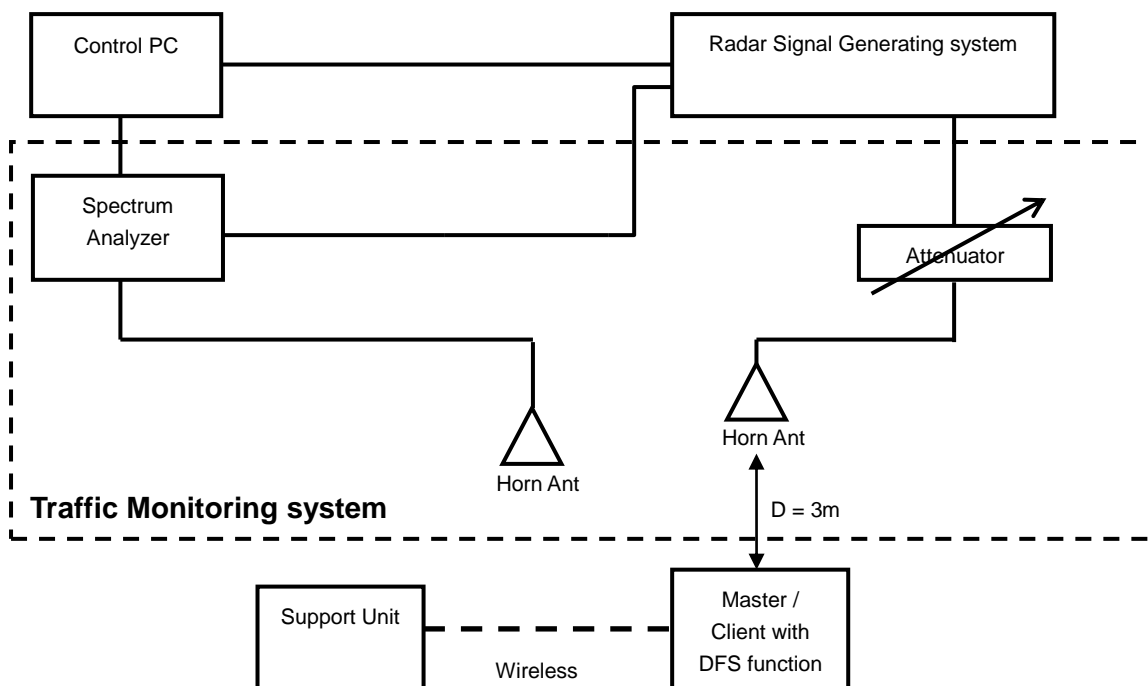

Channel Loading

System testing will be performed with channel-loading using means appropriate to the data types that are used by the unlicensed device. The following requirements apply:

a)	The data file must be of a type that is typical for the device (i.e., MPEG-2, MPEG-4, WAV, MP3, MP4, AVI, etc.) and must generally be transmitting in a streaming mode.	
b)	Software to ping the client is permitted to simulate data transfer but must have random ping intervals.	
c)	Timing plots are required with calculations demonstrating a minimum channel loading of approximately 17% or greater.	✓
d)	Unicast or Multicast protocols are preferable but other protocols may be used. The appropriate protocol used must be described in the test procedures.	

5.2 Calibration of DFS Detection Threshold Level

The measured channel is 5300MHz and 5310MHz and 5290MHz and 5500MHz and 5510MHz and 5530MHz. The radar signal was the same as transmitted channels, and injected into the antenna of AP (master) or Client Device with Radar Detection, measured the channel closing transmission time and channel move time.

Radiated setup configuration of Calibration of DFS Detection Threshold Level

The calibrated conducted detection threshold level is set to -64dBm. The tested level is lower than required level hence it provides margin to the limit.

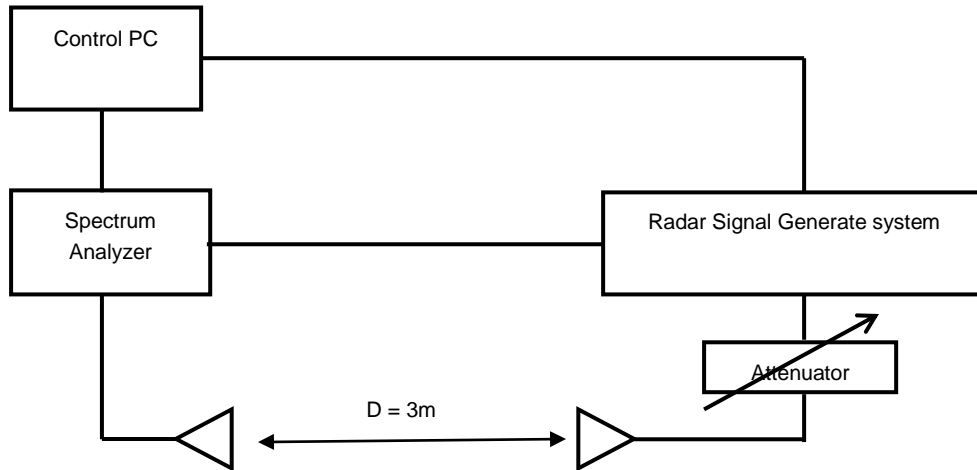

5.3 Deviation From Test Standard

No deviation.

5.4 Radiated Test Setup Configuration

Master mode

The EUT is a U-NII Device operating in Master mode. The radar test signals are injected into the Master Device.

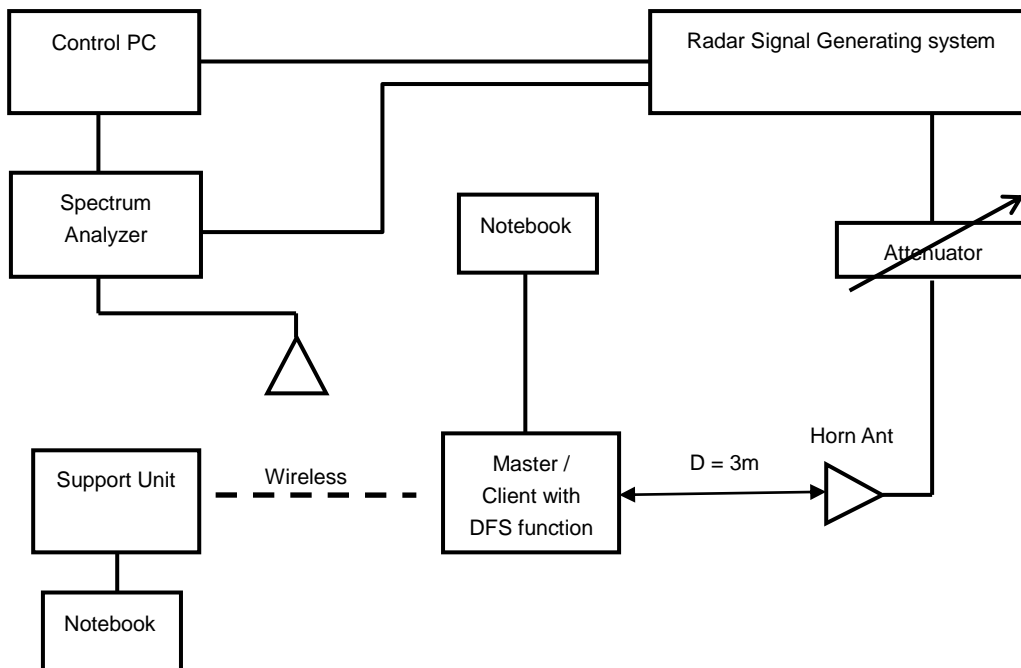

Note: The UUT main beam of the antenna is directly toward the radar emitter during testing.

6. Test Results

6.1 Summary of Test Results

Clause	Test Parameter	Remarks	Pass/Fail
15.407	DFS Detection Threshold	Applicable	Pass
15.407	Channel Availability Check Time	Applicable	Pass
15.407	Channel Move Time	Applicable	Pass
15.407	Channel Closing Transmission Time	Applicable	Pass
15.407	Non- Occupancy Period	Applicable	Pass
15.407	U-NII Detection Bandwidth	Applicable	Pass

6.2 Test Results

6.2.1 Test Mode: Device Operating In Master Mode.

The radar test waveforms are injected into the Master.
 This test was investigated for different bandwidth (20MHz · 40MHz and 80MHz).
 The following plots was done on 80MHz as a representative

DFS Detection Threshold

For detection threshold level of -64dBm, the tested level is lower than required level for 1dB, hence it provides margin to the limit.

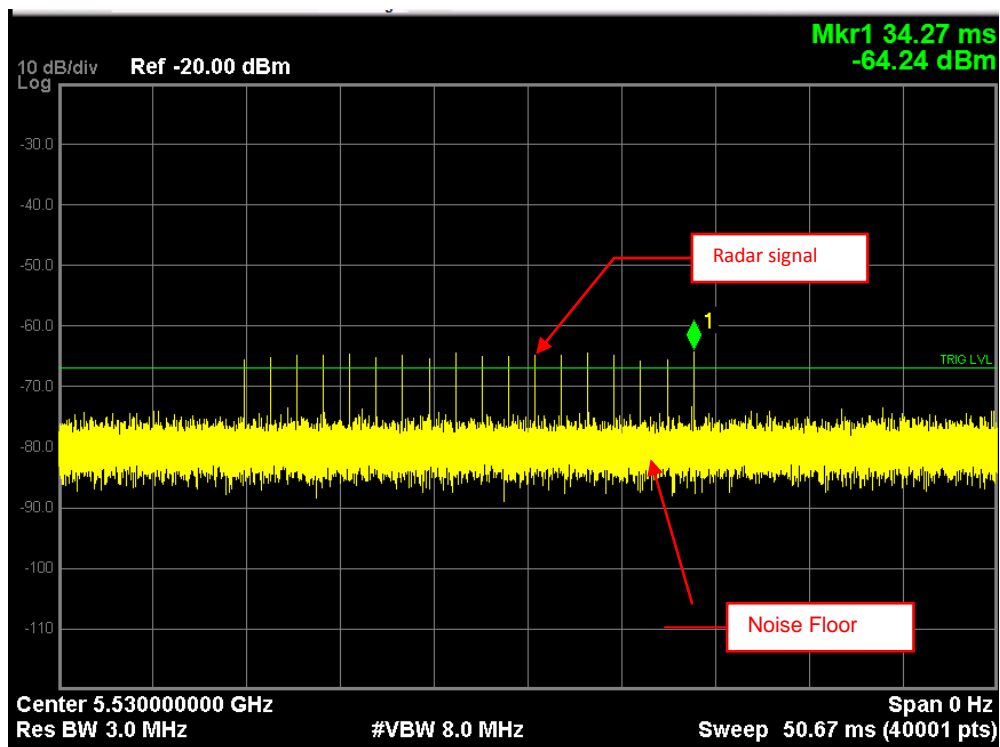

Radar Signal 0

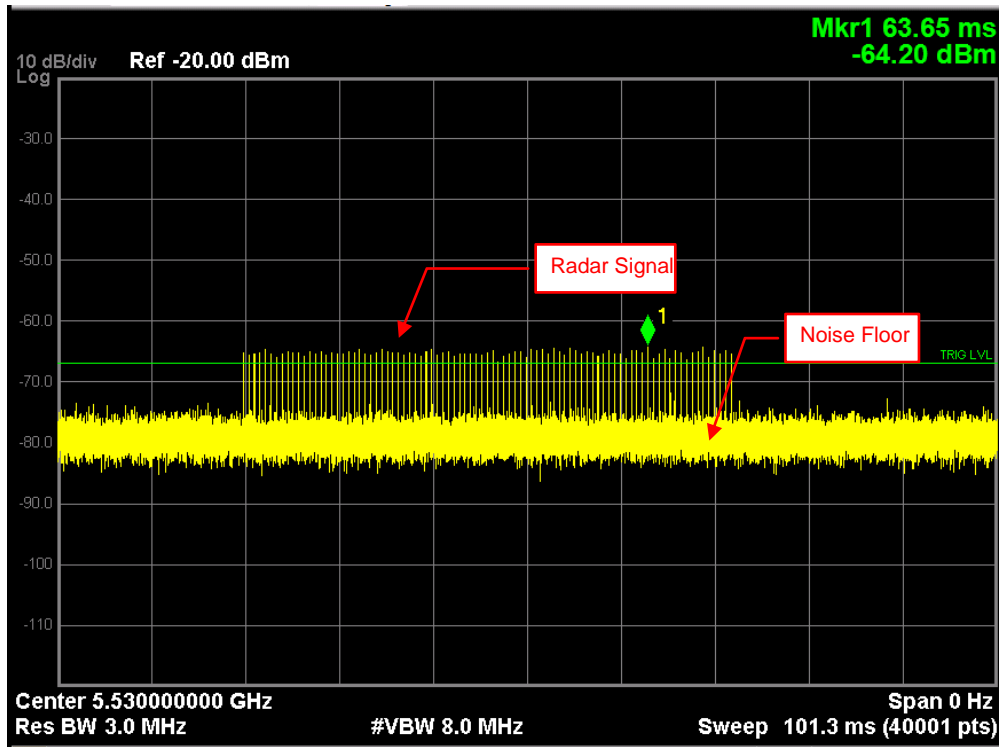

Radar Signal 1 (Test A)

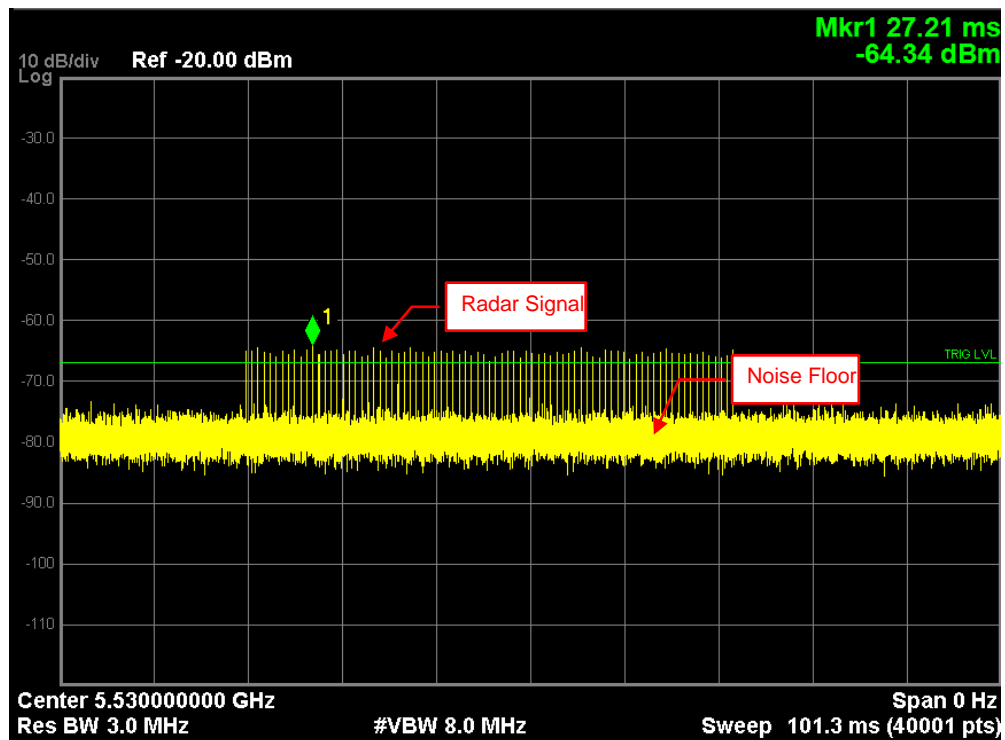

Radar Signal 1 (Test B)

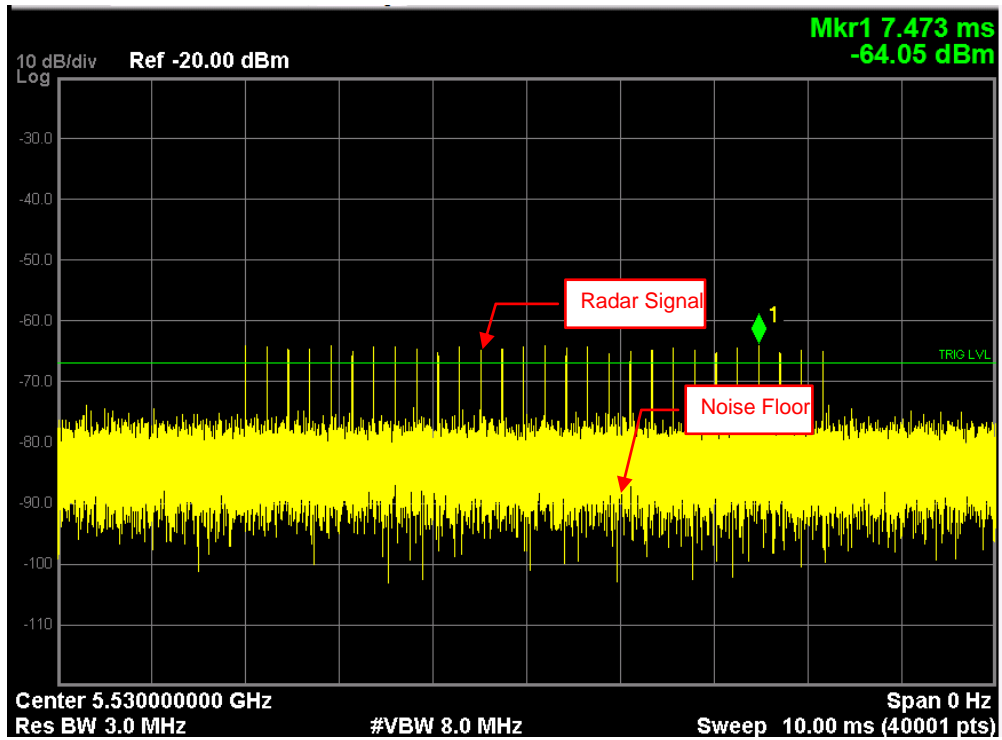

Radar Signal 2

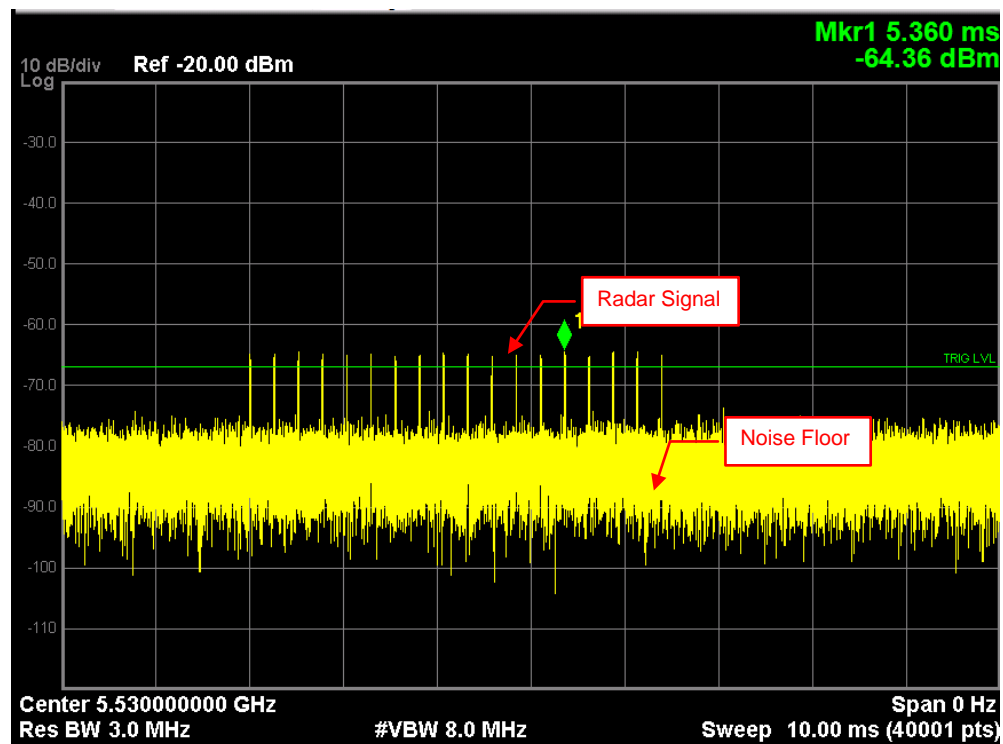

Radar Signal 3

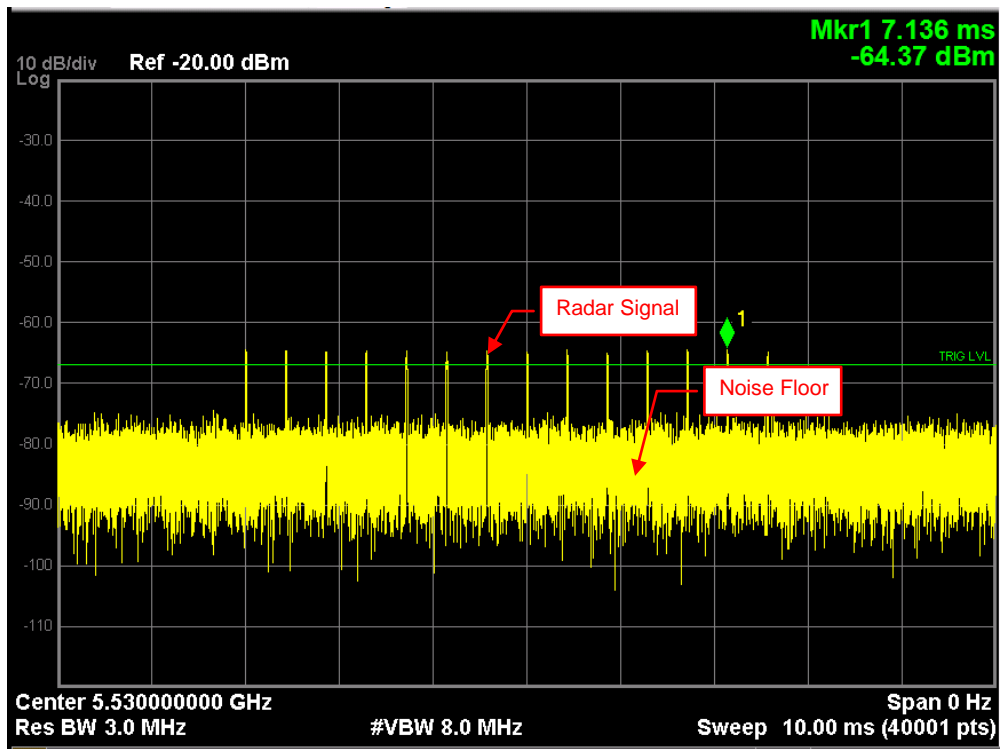

Single Burst of Radar Signal 4

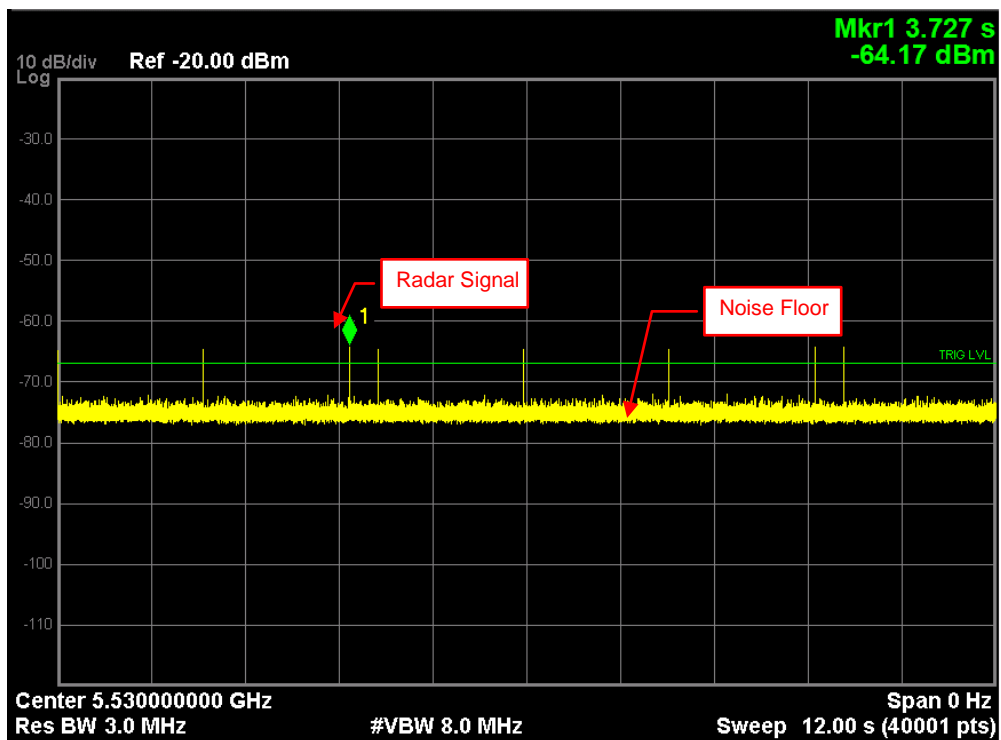

Radar Signal 5

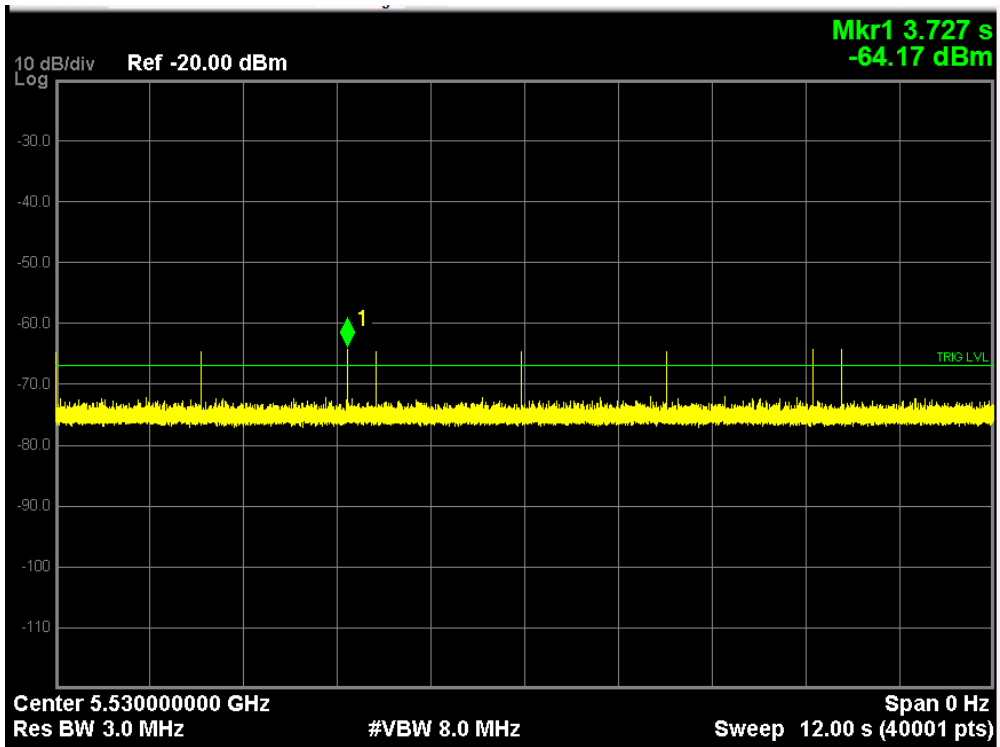

Single Burst of Radar Signal 5

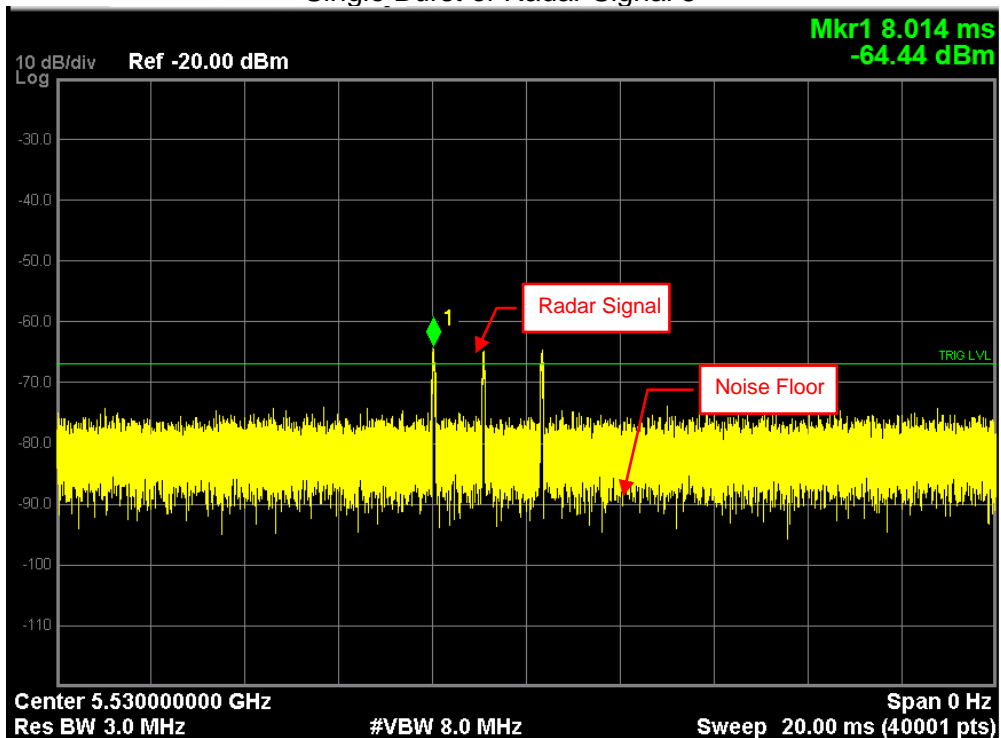

Radar Signal 6

6.2.2 U-NII Detection Bandwidth

802.11ac (VHT20)

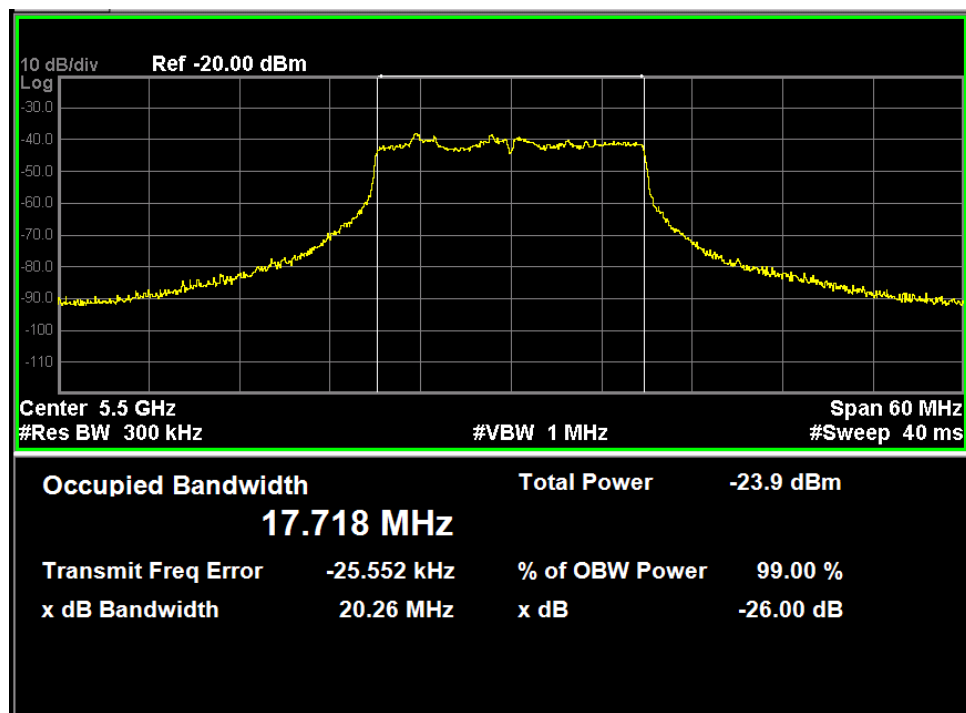
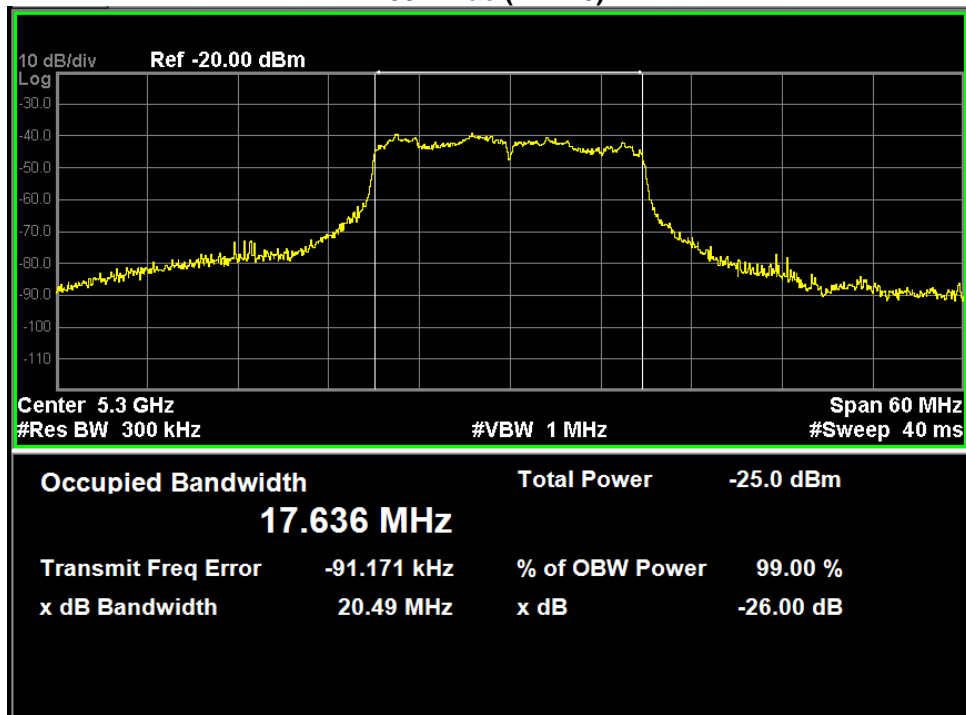

U-NII 99% Channel bandwidth

802.11ac (VHT40)

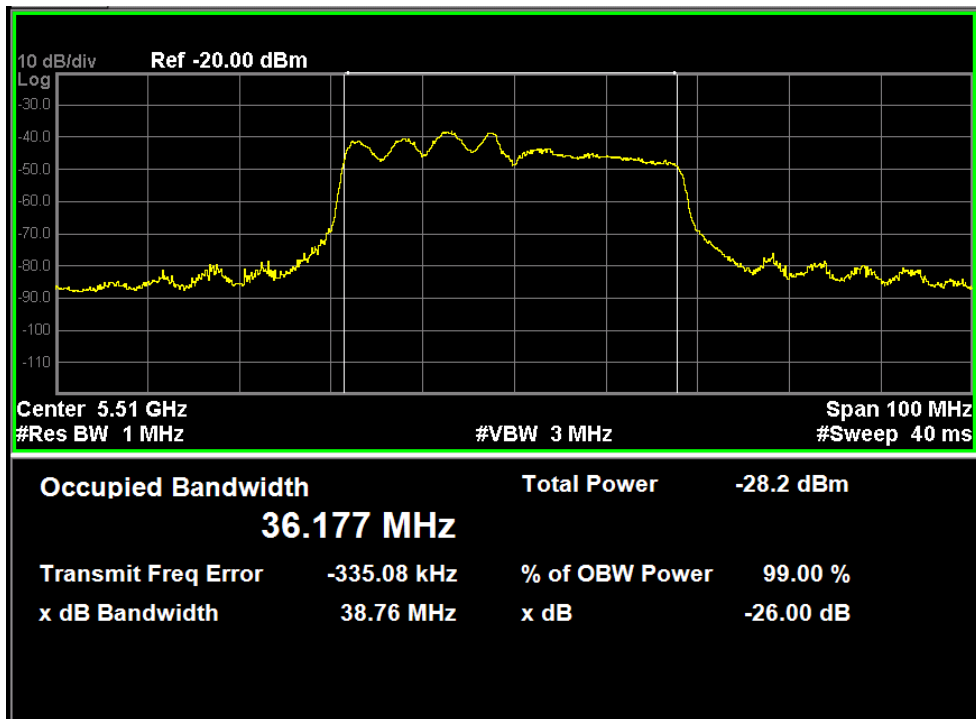
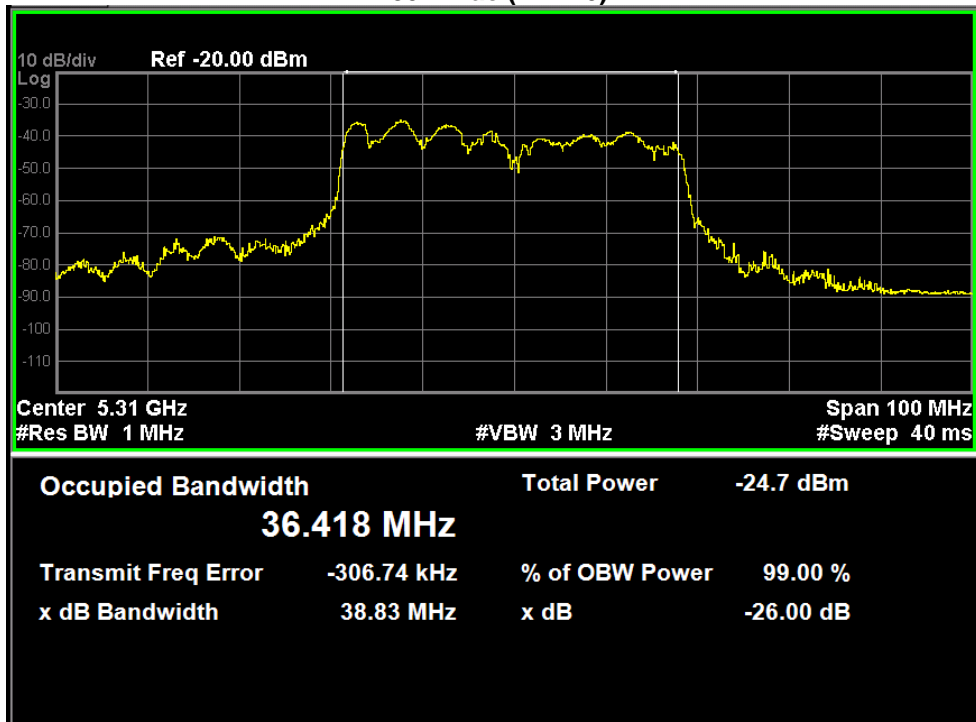

U-NII 99% Channel bandwidth

802.11ac (VHT80)

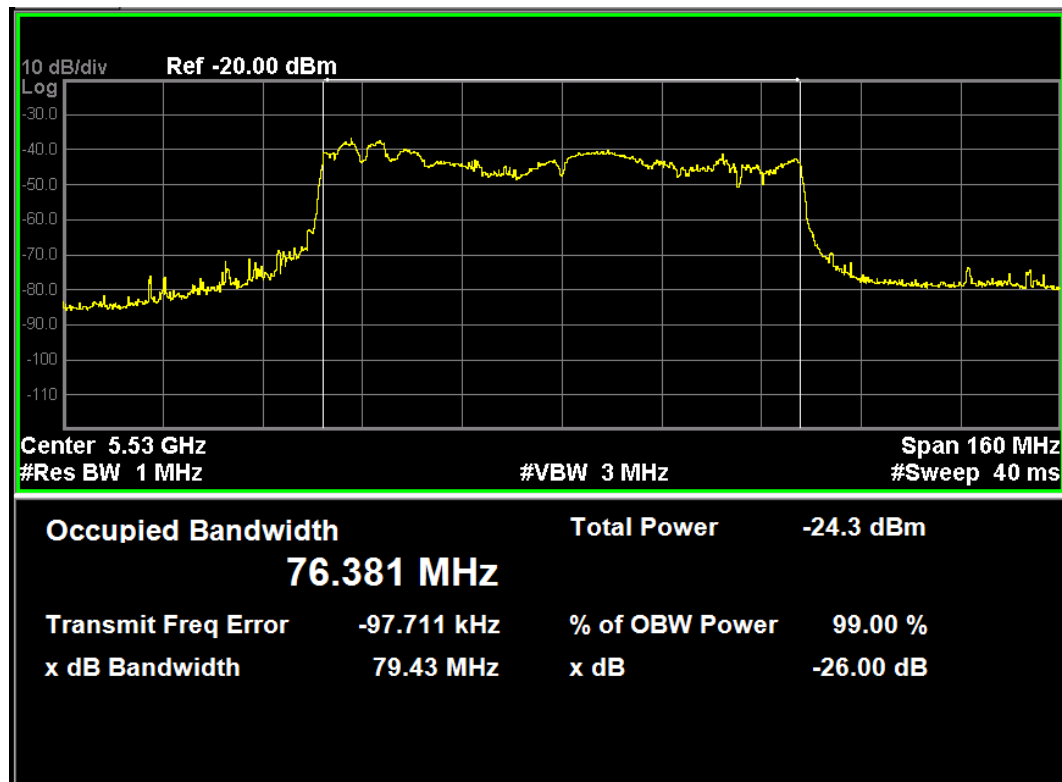
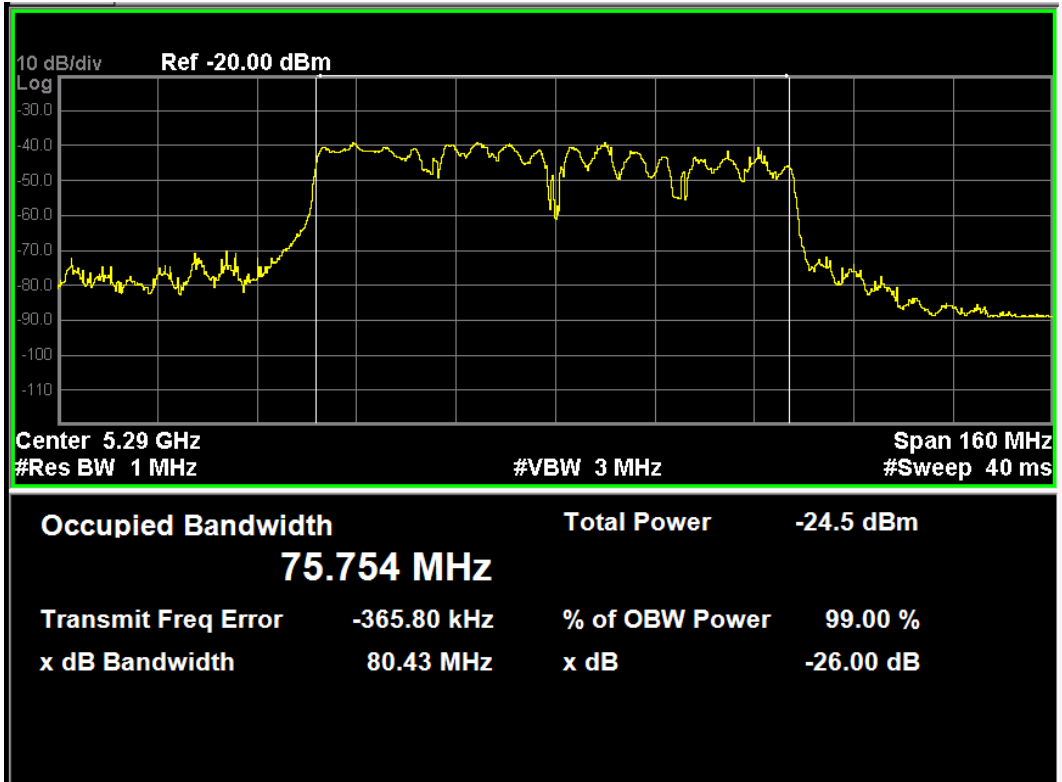

U-NII 99% Channel bandwidth

Detection Bandwidth Test - 802.11ac (VHT20)

Radar Type 0

EUT Frequency: 5300MHz

EUT 99% Power bandwidth: 17.636MHz

Detection bandwidth limit (100% of EUT 99% Power bandwidth): 17.636MHz

Detection bandwidth (5309(FH) – 5291(FL)) : 18MHz

Test Result : PASS

Radar Frequency (MHz)	Trial Number / Detection										Detection Rate (%)
	1	2	3	4	5	6	7	8	9	10	
5.291G(FL)	Yes	Yes	Yes	No	Yes	Yes	Yes	Yes	Yes	Yes	90
5.292G	Yes	Yes	Yes	Yes	Yes	Yes	Yes	Yes	Yes	Yes	100
5.293G	Yes	Yes	Yes	Yes	Yes	Yes	Yes	Yes	Yes	Yes	100
5.294G	Yes	Yes	Yes	Yes	Yes	Yes	Yes	Yes	Yes	Yes	100
5.295G	Yes	Yes	Yes	Yes	Yes	Yes	Yes	Yes	Yes	Yes	100
5.296G	Yes	Yes	Yes	Yes	Yes	Yes	Yes	Yes	Yes	Yes	100
5.297G	Yes	Yes	Yes	Yes	Yes	Yes	Yes	Yes	Yes	Yes	100
5.298G	Yes	Yes	Yes	Yes	Yes	Yes	Yes	Yes	Yes	Yes	100
5.299G	Yes	Yes	Yes	Yes	Yes	Yes	Yes	Yes	Yes	Yes	100
5.300G	Yes	Yes	Yes	Yes	Yes	Yes	Yes	Yes	Yes	Yes	100
5.301G	Yes	Yes	Yes	Yes	Yes	Yes	Yes	Yes	Yes	Yes	100
5.302G	Yes	Yes	Yes	Yes	Yes	Yes	Yes	Yes	Yes	Yes	100
5.303G	Yes	Yes	Yes	Yes	Yes	Yes	Yes	Yes	Yes	Yes	100
5.304G	Yes	Yes	Yes	Yes	Yes	Yes	Yes	Yes	Yes	Yes	100
5.305G	Yes	Yes	Yes	Yes	Yes	Yes	Yes	Yes	Yes	Yes	100
5.306G	Yes	Yes	Yes	Yes	Yes	Yes	Yes	Yes	Yes	Yes	100
5.307G	Yes	Yes	Yes	Yes	Yes	Yes	Yes	Yes	Yes	Yes	100
5.308G	Yes	Yes	Yes	Yes	Yes	Yes	Yes	Yes	Yes	Yes	100
5.309G(FH)	Yes	Yes	Yes	Yes	Yes	Yes	Yes	Yes	Yes	Yes	100

Detection Bandwidth Test - 802.11ac (VHT20)											
Radar Type 0											
EUT Frequency: 5500MHz											
EUT 99% Power bandwidth: 17.718MHz											
Detection bandwidth limit (100% of EUT 99% Power bandwidth): 17.718MHz											
Detection bandwidth (5509(FH) – 5491(FL)) : 18MHz											
Test Result : PASS											
Radar Frequency (MHz)	Trial Number / Detection										Detection Rate (%)
	1	2	3	4	5	6	7	8	9	10	
5.491G(FL)	Yes	Yes	Yes	Yes	Yes	Yes	Yes	Yes	Yes	Yes	100
5.492G	Yes	Yes	Yes	Yes	Yes	Yes	Yes	Yes	Yes	Yes	100
5.493G	Yes	Yes	Yes	Yes	Yes	Yes	Yes	Yes	Yes	Yes	100
5.494G	Yes	Yes	Yes	Yes	Yes	Yes	Yes	Yes	Yes	Yes	100
5.495G	Yes	Yes	Yes	Yes	Yes	Yes	Yes	Yes	Yes	Yes	100
5.496G	Yes	Yes	Yes	Yes	Yes	Yes	Yes	Yes	Yes	Yes	100
5.497G	Yes	Yes	Yes	Yes	Yes	Yes	Yes	Yes	Yes	Yes	100
5.498G	Yes	Yes	Yes	Yes	Yes	Yes	Yes	Yes	Yes	Yes	100
5.499G	Yes	Yes	Yes	Yes	Yes	Yes	Yes	Yes	Yes	Yes	100
5.500G	Yes	Yes	Yes	Yes	Yes	Yes	Yes	Yes	Yes	Yes	100
5.501G	Yes	Yes	Yes	Yes	Yes	Yes	Yes	Yes	Yes	Yes	100
5.502G	Yes	Yes	Yes	Yes	Yes	Yes	Yes	Yes	Yes	Yes	100
5.503G	Yes	Yes	Yes	Yes	Yes	Yes	Yes	Yes	Yes	Yes	100
5.504G	Yes	Yes	Yes	Yes	Yes	Yes	Yes	Yes	Yes	Yes	100
5.505G	Yes	Yes	Yes	Yes	Yes	Yes	Yes	Yes	Yes	Yes	100
5.506G	Yes	Yes	Yes	Yes	Yes	Yes	Yes	Yes	Yes	Yes	100
5.507G	Yes	Yes	Yes	Yes	Yes	Yes	Yes	Yes	Yes	Yes	100
5.508G	Yes	Yes	Yes	Yes	Yes	Yes	Yes	Yes	Yes	Yes	100
5.509G(FH)	Yes	Yes	Yes	Yes	Yes	Yes	Yes	Yes	Yes	Yes	100

Detection Bandwidth Test - 802.11ac (VHT40)											
Radar Type 0											
EUT Frequency: 5310MHz											
EUT 99% Power bandwidth: 36.418MHz											
Detection bandwidth limit (100% of EUT 99% Power bandwidth): 36.418MHz											
Detection bandwidth (5329(FH) – 5291(FL)) : 38MHz											
Test Result : PASS											
Radar Frequency (MHz)	Trial Number / Detection										Detection Rate (%)
	1	2	3	4	5	6	7	8	9	10	
5.291G(FL)	Yes	No	Yes	Yes	Yes	Yes	Yes	Yes	Yes	Yes	90
5.292G	Yes	Yes	Yes	Yes	Yes	Yes	Yes	Yes	Yes	Yes	100
5.293G	Yes	Yes	Yes	Yes	Yes	Yes	Yes	Yes	Yes	Yes	100
5.294G	Yes	Yes	Yes	Yes	Yes	Yes	Yes	Yes	Yes	Yes	100
5.295G	Yes	Yes	Yes	Yes	Yes	Yes	Yes	Yes	Yes	Yes	100
5.296G	Yes	Yes	Yes	Yes	Yes	Yes	Yes	Yes	Yes	Yes	100
5.297G	Yes	Yes	Yes	Yes	Yes	Yes	Yes	Yes	Yes	Yes	100
5.298G	Yes	Yes	Yes	Yes	Yes	Yes	Yes	Yes	Yes	Yes	100
5.299G	Yes	Yes	Yes	Yes	Yes	Yes	Yes	Yes	Yes	Yes	100
5.300G	Yes	Yes	Yes	Yes	Yes	Yes	Yes	Yes	Yes	Yes	100
5.301G	Yes	Yes	Yes	Yes	Yes	Yes	Yes	Yes	Yes	Yes	100
5.302G	Yes	Yes	Yes	Yes	Yes	Yes	Yes	Yes	Yes	Yes	100
5.303G	Yes	Yes	Yes	Yes	Yes	Yes	Yes	Yes	Yes	Yes	100
5.304G	Yes	Yes	Yes	Yes	Yes	Yes	Yes	Yes	Yes	Yes	100
5.305G	Yes	Yes	Yes	Yes	Yes	Yes	Yes	Yes	Yes	Yes	100
5.306G	Yes	Yes	Yes	Yes	Yes	Yes	Yes	Yes	Yes	Yes	100
5.307G	Yes	Yes	Yes	Yes	Yes	Yes	Yes	Yes	Yes	Yes	100
5.308G	Yes	Yes	Yes	Yes	Yes	Yes	Yes	Yes	Yes	Yes	100
5.309G	Yes	Yes	Yes	Yes	Yes	Yes	Yes	Yes	Yes	Yes	100
5.310G	Yes	Yes	Yes	Yes	Yes	Yes	Yes	Yes	Yes	Yes	100
5.311G	Yes	Yes	Yes	Yes	Yes	Yes	Yes	Yes	Yes	Yes	100
5.312G	Yes	Yes	Yes	Yes	Yes	Yes	Yes	Yes	Yes	Yes	100
5.313G	Yes	Yes	Yes	Yes	Yes	Yes	Yes	Yes	Yes	Yes	100
5.314G	Yes	Yes	Yes	Yes	Yes	Yes	Yes	Yes	Yes	Yes	100
5.315G	Yes	Yes	Yes	Yes	Yes	Yes	Yes	Yes	Yes	Yes	100
5.316G	Yes	Yes	Yes	Yes	Yes	Yes	Yes	Yes	Yes	Yes	100
5.317G	Yes	Yes	Yes	Yes	Yes	Yes	Yes	Yes	Yes	Yes	100
5.318G	Yes	Yes	Yes	Yes	Yes	Yes	Yes	Yes	Yes	Yes	100
5.319G	Yes	Yes	Yes	Yes	Yes	Yes	Yes	Yes	Yes	Yes	100
5.320G	Yes	Yes	Yes	Yes	Yes	Yes	Yes	Yes	Yes	Yes	100
5.321G	Yes	Yes	Yes	Yes	Yes	Yes	Yes	Yes	Yes	Yes	100
5.322G	Yes	Yes	Yes	Yes	Yes	Yes	Yes	Yes	Yes	Yes	100
5.323G	Yes	Yes	Yes	Yes	Yes	Yes	Yes	Yes	Yes	Yes	100
5.324G	Yes	Yes	Yes	Yes	Yes	Yes	Yes	Yes	Yes	Yes	100
5.325G	Yes	Yes	Yes	Yes	Yes	Yes	Yes	Yes	Yes	Yes	100
5.326G	Yes	Yes	Yes	Yes	Yes	Yes	Yes	Yes	Yes	Yes	100
5.327G	Yes	Yes	Yes	Yes	Yes	Yes	Yes	Yes	Yes	Yes	100
5.328G	Yes	Yes	Yes	Yes	Yes	Yes	Yes	Yes	Yes	Yes	100
5.329G(FH)	Yes	Yes	Yes	Yes	Yes	Yes	Yes	Yes	Yes	Yes	100

Detection Bandwidth Test - 802.11ac (VHT40)											
Radar Type 0											
EUT Frequency: 5510MHz											
EUT 99% Power bandwidth: 36.177MHz											
Detection bandwidth limit (100% of EUT 99% Power bandwidth): 36.177MHz											
Detection bandwidth (5529(FH) – 5491(FL)) : 38MHz											
Test Result : PASS											
Radar Frequency (MHz)	Trial Number / Detection										Detection Rate (%)
	1	2	3	4	5	6	7	8	9	10	
5.491G(FL)	Yes	Yes	Yes	Yes	Yes	Yes	Yes	Yes	Yes	Yes	100
5.492G	Yes	Yes	Yes	Yes	Yes	Yes	Yes	Yes	Yes	Yes	100
5.493G	Yes	Yes	Yes	Yes	Yes	Yes	Yes	Yes	Yes	Yes	100
5.494G	Yes	Yes	Yes	Yes	Yes	Yes	Yes	Yes	Yes	Yes	100
5.495G	Yes	Yes	Yes	Yes	Yes	Yes	Yes	Yes	Yes	Yes	100
5.496G	Yes	Yes	Yes	Yes	Yes	Yes	Yes	Yes	Yes	Yes	100
5.497G	Yes	Yes	Yes	Yes	Yes	Yes	Yes	Yes	Yes	Yes	100
5.498G	Yes	Yes	Yes	Yes	Yes	Yes	Yes	Yes	Yes	Yes	100
5.499G	Yes	Yes	Yes	Yes	Yes	Yes	Yes	Yes	Yes	Yes	100
5.500G	Yes	Yes	Yes	Yes	Yes	Yes	Yes	Yes	Yes	Yes	100
5.501G	Yes	Yes	Yes	Yes	Yes	Yes	Yes	Yes	Yes	Yes	100
5.502G	Yes	Yes	Yes	Yes	Yes	Yes	Yes	Yes	Yes	Yes	100
5.503G	Yes	Yes	Yes	Yes	Yes	Yes	Yes	Yes	Yes	Yes	100
5.504G	Yes	Yes	Yes	Yes	Yes	Yes	Yes	Yes	Yes	Yes	100
5.505G	Yes	Yes	Yes	Yes	Yes	Yes	Yes	Yes	Yes	Yes	100
5.506G	Yes	Yes	Yes	Yes	Yes	Yes	Yes	Yes	Yes	Yes	100
5.507G	Yes	Yes	Yes	Yes	Yes	Yes	Yes	Yes	Yes	Yes	100
5.508G	Yes	Yes	Yes	Yes	Yes	Yes	Yes	Yes	Yes	Yes	100
5.509G	Yes	Yes	Yes	Yes	Yes	Yes	Yes	Yes	Yes	Yes	100
5.510G	Yes	Yes	Yes	Yes	Yes	Yes	Yes	No	Yes	Yes	90
5.511G	Yes	Yes	Yes	Yes	Yes	Yes	Yes	Yes	Yes	Yes	100
5.512G	Yes	Yes	Yes	Yes	Yes	Yes	Yes	Yes	Yes	Yes	100
5.513G	Yes	Yes	Yes	Yes	Yes	Yes	Yes	Yes	Yes	Yes	100
5.514G	Yes	Yes	Yes	Yes	Yes	Yes	Yes	Yes	Yes	Yes	100
5.515G	Yes	Yes	Yes	Yes	Yes	Yes	Yes	Yes	Yes	Yes	100
5.516G	Yes	Yes	Yes	Yes	Yes	Yes	Yes	Yes	Yes	Yes	100
5.517G	Yes	Yes	Yes	Yes	Yes	Yes	Yes	Yes	Yes	Yes	100
5.518G	Yes	Yes	Yes	Yes	Yes	Yes	Yes	Yes	Yes	Yes	100
5.519G	Yes	Yes	Yes	Yes	Yes	Yes	Yes	Yes	Yes	Yes	100
5.520G	Yes	Yes	Yes	Yes	Yes	Yes	Yes	Yes	Yes	Yes	100
5.521G	Yes	Yes	Yes	Yes	Yes	Yes	Yes	Yes	Yes	Yes	100
5.522G	Yes	Yes	Yes	Yes	Yes	Yes	Yes	Yes	Yes	Yes	100
5.523G	Yes	Yes	Yes	Yes	Yes	Yes	Yes	Yes	Yes	Yes	100
5.524G	Yes	Yes	Yes	Yes	Yes	Yes	Yes	Yes	Yes	Yes	100
5.525G	Yes	Yes	Yes	Yes	Yes	Yes	Yes	Yes	Yes	Yes	100
5.526G	Yes	Yes	Yes	Yes	Yes	Yes	Yes	Yes	Yes	Yes	100
5.527G	Yes	Yes	Yes	Yes	Yes	Yes	Yes	Yes	Yes	Yes	100
5.528G	Yes	Yes	Yes	Yes	Yes	Yes	Yes	Yes	Yes	Yes	100
5.529G(FH)	Yes	Yes	Yes	Yes	No	Yes	Yes	Yes	Yes	Yes	90

Detection Bandwidth Test - 802.11ac (VHT80)											
Radar Type 0											
EUT Frequency: 5290MHz											
EUT 99% Power bandwidth: 75.754MHz											
Detection bandwidth limit (100% of EUT 99% Power bandwidth): 75.754MHz											
Detection bandwidth (5328(FH) – 5252(FL)) : 76MHz											
Test Result : PASS											
Radar Frequency (MHz)	Trial Number / Detection										Detection Rate (%)
	1	2	3	4	5	6	7	8	9	10	
5.252G(FL)	Yes	Yes	Yes	Yes	Yes	Yes	Yes	Yes	Yes	Yes	100
5.253G	Yes	Yes	Yes	Yes	Yes	Yes	Yes	Yes	Yes	Yes	100
5.254G	Yes	Yes	Yes	Yes	Yes	Yes	Yes	Yes	Yes	Yes	100
5.255G	Yes	Yes	Yes	Yes	Yes	Yes	Yes	Yes	Yes	Yes	100
5.256G	Yes	Yes	Yes	Yes	Yes	Yes	Yes	Yes	Yes	Yes	100
5.257G	Yes	Yes	Yes	Yes	Yes	Yes	Yes	Yes	Yes	Yes	100
5.258G	Yes	Yes	Yes	Yes	Yes	Yes	Yes	Yes	Yes	Yes	100
5.259G	Yes	Yes	Yes	Yes	Yes	Yes	Yes	Yes	Yes	Yes	100
5.260G	Yes	Yes	Yes	Yes	Yes	Yes	Yes	Yes	Yes	Yes	100
5.261G	Yes	Yes	Yes	Yes	Yes	Yes	Yes	Yes	Yes	Yes	100
5.262G	Yes	Yes	Yes	Yes	Yes	Yes	Yes	Yes	Yes	Yes	100
5.263G	Yes	Yes	Yes	Yes	Yes	Yes	Yes	Yes	Yes	Yes	100
5.264G	Yes	Yes	Yes	Yes	Yes	Yes	Yes	Yes	Yes	Yes	100
5.265G	Yes	Yes	Yes	Yes	Yes	Yes	Yes	Yes	Yes	Yes	100
5.266G	Yes	Yes	Yes	Yes	Yes	Yes	Yes	Yes	Yes	Yes	100
5.267G	Yes	Yes	Yes	Yes	Yes	Yes	Yes	Yes	Yes	Yes	100
5.268G	Yes	Yes	Yes	Yes	Yes	Yes	Yes	Yes	Yes	Yes	100
5.269G	Yes	Yes	Yes	Yes	Yes	Yes	Yes	Yes	Yes	Yes	100
5.270G	Yes	Yes	Yes	Yes	Yes	Yes	Yes	Yes	Yes	Yes	100
5.271G	Yes	Yes	Yes	Yes	Yes	Yes	Yes	Yes	Yes	Yes	100
5.272G	Yes	Yes	Yes	Yes	Yes	Yes	Yes	Yes	Yes	Yes	100
5.273G	Yes	Yes	Yes	Yes	Yes	Yes	Yes	Yes	Yes	Yes	100
5.274G	Yes	Yes	Yes	Yes	Yes	Yes	Yes	Yes	Yes	Yes	100
5.275G	Yes	Yes	Yes	Yes	Yes	Yes	Yes	Yes	Yes	Yes	100
5.276G	Yes	Yes	Yes	Yes	Yes	Yes	Yes	Yes	Yes	Yes	100
5.277G	Yes	Yes	Yes	Yes	Yes	Yes	Yes	Yes	Yes	Yes	100
5.278G	Yes	Yes	Yes	Yes	Yes	Yes	Yes	Yes	Yes	Yes	100
5.279G	Yes	Yes	Yes	Yes	Yes	Yes	Yes	Yes	Yes	Yes	100
5.280G	Yes	Yes	Yes	Yes	Yes	Yes	Yes	Yes	Yes	Yes	100
5.281G	Yes	Yes	Yes	Yes	Yes	Yes	Yes	Yes	Yes	Yes	100
5.282G	Yes	Yes	Yes	Yes	Yes	Yes	Yes	Yes	Yes	Yes	100
5.283G	Yes	Yes	Yes	Yes	Yes	Yes	Yes	Yes	Yes	Yes	100
5.284G	Yes	Yes	Yes	Yes	Yes	Yes	Yes	Yes	Yes	Yes	100
5.285G	Yes	Yes	Yes	Yes	Yes	Yes	Yes	Yes	Yes	Yes	100
5.286G	Yes	Yes	Yes	Yes	Yes	Yes	Yes	Yes	Yes	Yes	100
5.287G	Yes	Yes	Yes	Yes	Yes	Yes	Yes	Yes	Yes	Yes	100
5.288G	Yes	Yes	Yes	Yes	Yes	Yes	Yes	Yes	Yes	Yes	100
5.289G	Yes	Yes	Yes	Yes	Yes	Yes	Yes	Yes	Yes	Yes	100
5.290G	Yes	Yes	Yes	Yes	Yes	Yes	Yes	Yes	Yes	Yes	100
5.291G	Yes	Yes	Yes	Yes	Yes	Yes	Yes	Yes	Yes	Yes	100
5.292G	Yes	Yes	Yes	Yes	Yes	Yes	Yes	Yes	Yes	Yes	100
5.293G	Yes	Yes	Yes	Yes	Yes	Yes	Yes	Yes	Yes	Yes	100
5.294G	Yes	Yes	Yes	Yes	Yes	Yes	Yes	Yes	Yes	Yes	100
5.295G	Yes	Yes	Yes	Yes	Yes	Yes	Yes	Yes	Yes	Yes	100
5.296G	Yes	Yes	Yes	Yes	Yes	Yes	Yes	Yes	Yes	Yes	100

5.297G	Yes	Yes	Yes	Yes	Yes	Yes	Yes	Yes	Yes	Yes	100
5.298G	Yes	Yes	Yes	Yes	Yes	Yes	Yes	Yes	Yes	Yes	100
5.299G	Yes	Yes	Yes	Yes	Yes	Yes	Yes	Yes	Yes	Yes	100
5.300G	Yes	Yes	Yes	Yes	Yes	Yes	Yes	Yes	Yes	Yes	100
5.301G	Yes	Yes	Yes	Yes	Yes	Yes	Yes	Yes	Yes	Yes	100
5.302G	Yes	Yes	Yes	Yes	Yes	Yes	Yes	Yes	Yes	Yes	100
5.303G	Yes	Yes	Yes	Yes	Yes	Yes	Yes	Yes	Yes	Yes	100
5.304G	Yes	Yes	Yes	Yes	Yes	Yes	Yes	Yes	Yes	Yes	100
5.305G	Yes	Yes	Yes	Yes	Yes	Yes	Yes	Yes	Yes	Yes	100
5.306G	Yes	Yes	Yes	Yes	Yes	Yes	Yes	Yes	Yes	Yes	100
5.307G	Yes	Yes	Yes	Yes	Yes	Yes	Yes	Yes	Yes	Yes	100
5.308G	Yes	Yes	Yes	Yes	Yes	Yes	Yes	Yes	Yes	Yes	100
5.309G	Yes	Yes	Yes	Yes	Yes	Yes	Yes	Yes	Yes	Yes	100
5.310G	Yes	Yes	Yes	Yes	Yes	Yes	Yes	Yes	Yes	Yes	100
5.311G	Yes	Yes	Yes	Yes	Yes	Yes	Yes	Yes	Yes	Yes	100
5.312G	Yes	Yes	Yes	Yes	Yes	Yes	Yes	Yes	Yes	Yes	100
5.313G	Yes	Yes	Yes	Yes	Yes	Yes	Yes	Yes	Yes	Yes	100
5.314G	Yes	Yes	Yes	Yes	Yes	Yes	Yes	Yes	Yes	Yes	100
5.315G	Yes	Yes	Yes	Yes	Yes	Yes	Yes	Yes	Yes	Yes	100
5.316G	Yes	Yes	Yes	Yes	Yes	Yes	Yes	Yes	Yes	Yes	100
5.317G	Yes	Yes	Yes	Yes	Yes	Yes	Yes	Yes	Yes	Yes	100
5.318G	Yes	Yes	Yes	Yes	Yes	Yes	Yes	Yes	Yes	Yes	100
5.319G	Yes	Yes	Yes	Yes	Yes	Yes	Yes	Yes	Yes	Yes	100
5.320G	Yes	Yes	Yes	Yes	Yes	Yes	Yes	Yes	Yes	Yes	100
5.321G	Yes	Yes	Yes	Yes	Yes	Yes	Yes	Yes	Yes	Yes	100
5.322G	Yes	Yes	Yes	Yes	Yes	Yes	Yes	Yes	Yes	Yes	100
5.323G	Yes	Yes	Yes	Yes	Yes	Yes	Yes	Yes	Yes	Yes	100
5.324G	Yes	Yes	Yes	Yes	Yes	Yes	Yes	Yes	Yes	Yes	100
5.325G	Yes	Yes	Yes	Yes	Yes	Yes	Yes	Yes	Yes	Yes	100
5.326G	Yes	Yes	Yes	Yes	Yes	Yes	Yes	Yes	Yes	Yes	100
5.327G	Yes	Yes	Yes	Yes	Yes	Yes	Yes	Yes	Yes	Yes	100
5.328G(FH)	Yes	Yes	Yes	Yes	Yes	Yes	Yes	Yes	Yes	Yes	100

Detection Bandwidth Test - 802.11ac (VHT80)											
Radar Type 0											
EUT Frequency: 5530MHz											
EUT 99% Power bandwidth: 76.318MHz											
Detection bandwidth limit (100% of EUT 99% Power bandwidth): 76.318MHz											
Detection bandwidth (5569(FH) – 5491(FL)) : 78MHz											
Test Result : PASS											
Radar Frequency (MHz)	Trial Number / Detection										Detection Rate (%)
	1	2	3	4	5	6	7	8	9	10	
5.491G(FL)	Yes	Yes	Yes	Yes	Yes	Yes	Yes	Yes	No	Yes	90
5.492G	Yes	Yes	Yes	Yes	Yes	Yes	Yes	Yes	Yes	Yes	100
5.493G	Yes	Yes	Yes	Yes	Yes	Yes	Yes	Yes	Yes	Yes	100
5.494G	Yes	Yes	Yes	Yes	Yes	Yes	Yes	Yes	Yes	Yes	100
5.495G	Yes	Yes	Yes	Yes	Yes	Yes	Yes	Yes	Yes	Yes	100
5.496G	Yes	Yes	Yes	Yes	Yes	Yes	Yes	Yes	Yes	Yes	100
5.497G	Yes	Yes	Yes	Yes	Yes	Yes	Yes	Yes	Yes	Yes	100
5.498G	Yes	Yes	Yes	Yes	Yes	Yes	Yes	Yes	Yes	Yes	100
5.499G	Yes	Yes	Yes	Yes	Yes	Yes	Yes	Yes	Yes	Yes	100
5.500G	Yes	Yes	Yes	Yes	Yes	Yes	Yes	Yes	Yes	Yes	100
5.501G	Yes	Yes	Yes	Yes	Yes	Yes	Yes	Yes	Yes	Yes	100
5.502G	Yes	Yes	Yes	Yes	Yes	Yes	Yes	Yes	Yes	Yes	100
5.503G	Yes	Yes	Yes	Yes	Yes	Yes	Yes	Yes	Yes	Yes	100
5.504G	Yes	Yes	Yes	Yes	Yes	Yes	Yes	Yes	Yes	Yes	100
5.505G	Yes	Yes	Yes	Yes	Yes	Yes	Yes	Yes	Yes	Yes	100
5.506G	Yes	Yes	Yes	Yes	Yes	Yes	Yes	Yes	Yes	Yes	100
5.507G	Yes	Yes	Yes	Yes	Yes	Yes	Yes	Yes	Yes	Yes	100
5.508G	Yes	Yes	Yes	Yes	Yes	Yes	Yes	Yes	Yes	Yes	100
5.509G	Yes	Yes	Yes	Yes	Yes	Yes	Yes	Yes	Yes	Yes	100
5.510G	Yes	Yes	Yes	Yes	Yes	Yes	Yes	Yes	Yes	Yes	100
5.511G	Yes	Yes	Yes	Yes	Yes	Yes	Yes	Yes	Yes	Yes	100
5.512G	Yes	Yes	Yes	Yes	Yes	Yes	Yes	Yes	Yes	Yes	100
5.513G	Yes	Yes	Yes	Yes	Yes	Yes	Yes	Yes	Yes	Yes	100
5.514G	Yes	Yes	Yes	Yes	Yes	Yes	Yes	Yes	Yes	Yes	100
5.515G	Yes	Yes	Yes	Yes	Yes	Yes	Yes	Yes	Yes	Yes	100
5.516G	Yes	Yes	Yes	Yes	Yes	Yes	Yes	Yes	Yes	Yes	100
5.517G	Yes	Yes	Yes	Yes	Yes	Yes	Yes	Yes	Yes	Yes	100
5.518G	Yes	Yes	Yes	Yes	Yes	Yes	Yes	Yes	Yes	Yes	100
5.519G	Yes	Yes	Yes	Yes	Yes	Yes	Yes	Yes	Yes	Yes	100
5.520G	Yes	Yes	Yes	Yes	Yes	Yes	Yes	Yes	Yes	Yes	100
5.521G	Yes	Yes	Yes	Yes	Yes	Yes	Yes	Yes	Yes	Yes	100
5.522G	Yes	Yes	Yes	Yes	Yes	Yes	Yes	Yes	Yes	Yes	100
5.523G	Yes	Yes	Yes	Yes	Yes	Yes	Yes	Yes	Yes	Yes	100
5.524G	Yes	Yes	Yes	Yes	Yes	Yes	Yes	Yes	Yes	Yes	100
5.525G	Yes	Yes	Yes	Yes	Yes	Yes	Yes	Yes	Yes	Yes	100
5.526G	Yes	Yes	Yes	Yes	Yes	Yes	Yes	Yes	Yes	Yes	100
5.527G	Yes	Yes	Yes	Yes	Yes	Yes	Yes	Yes	Yes	Yes	100
5.528G	Yes	Yes	Yes	Yes	Yes	Yes	Yes	Yes	Yes	Yes	100
5.529G	Yes	Yes	Yes	Yes	Yes	Yes	Yes	Yes	Yes	Yes	100
5.530G	Yes	Yes	Yes	Yes	Yes	Yes	Yes	Yes	Yes	Yes	100
5.531G	Yes	Yes	Yes	Yes	Yes	Yes	Yes	Yes	Yes	Yes	100
5.532G	Yes	Yes	Yes	Yes	Yes	Yes	Yes	Yes	Yes	Yes	100
5.533G	Yes	Yes	Yes	Yes	Yes	Yes	Yes	Yes	Yes	Yes	100
5.534G	Yes	Yes	Yes	Yes	Yes	Yes	Yes	Yes	Yes	Yes	100
5.535G	Yes	Yes	Yes	Yes	Yes	Yes	Yes	Yes	Yes	Yes	100

5.536G	Yes	Yes	Yes	Yes	Yes	Yes	Yes	Yes	Yes	Yes	100
5.537G	Yes	Yes	Yes	Yes	Yes	Yes	Yes	Yes	Yes	Yes	100
5.538G	Yes	Yes	Yes	Yes	Yes	Yes	Yes	Yes	Yes	Yes	100
5.539G	Yes	Yes	Yes	Yes	Yes	Yes	Yes	Yes	Yes	Yes	100
5.540G	Yes	Yes	Yes	Yes	Yes	Yes	Yes	Yes	Yes	Yes	100
5.541G	Yes	Yes	Yes	Yes	Yes	Yes	Yes	Yes	Yes	Yes	100
5.542G	Yes	Yes	Yes	Yes	Yes	Yes	Yes	Yes	Yes	Yes	100
5.543G	Yes	Yes	Yes	Yes	Yes	Yes	Yes	Yes	Yes	Yes	100
5.544G	Yes	Yes	Yes	Yes	Yes	Yes	Yes	Yes	Yes	Yes	100
5.545G	Yes	Yes	Yes	Yes	Yes	Yes	Yes	Yes	Yes	Yes	100
5.546G	Yes	Yes	Yes	Yes	Yes	Yes	Yes	Yes	Yes	Yes	100
5.547G	Yes	Yes	Yes	Yes	Yes	Yes	Yes	Yes	Yes	Yes	100
5.548G	Yes	Yes	Yes	Yes	Yes	Yes	Yes	Yes	Yes	Yes	100
5.549G	Yes	Yes	Yes	Yes	Yes	Yes	Yes	Yes	Yes	Yes	100
5.550G	Yes	Yes	Yes	Yes	Yes	Yes	Yes	Yes	Yes	Yes	100
5.551G	Yes	Yes	Yes	Yes	Yes	Yes	Yes	Yes	Yes	Yes	100
5.552G	Yes	Yes	Yes	Yes	Yes	Yes	Yes	Yes	Yes	Yes	100
5.553G	Yes	Yes	Yes	Yes	Yes	Yes	Yes	Yes	Yes	Yes	100
5.554G	Yes	Yes	Yes	Yes	Yes	Yes	Yes	Yes	Yes	Yes	100
5.555G	Yes	Yes	Yes	Yes	Yes	Yes	Yes	Yes	Yes	Yes	100
5.556G	Yes	Yes	Yes	Yes	Yes	Yes	Yes	Yes	Yes	Yes	100
5.557G	Yes	Yes	Yes	Yes	Yes	Yes	Yes	Yes	Yes	Yes	100
5.558G	Yes	Yes	Yes	Yes	Yes	Yes	Yes	Yes	Yes	Yes	100
5.559G	Yes	Yes	Yes	Yes	Yes	Yes	Yes	Yes	Yes	Yes	100
5.560G	Yes	Yes	Yes	Yes	Yes	Yes	Yes	Yes	Yes	Yes	100
5.561G	Yes	Yes	Yes	Yes	Yes	Yes	Yes	Yes	Yes	Yes	100
5.562G	Yes	Yes	Yes	Yes	Yes	Yes	Yes	Yes	Yes	Yes	100
5.563G	Yes	Yes	Yes	Yes	Yes	Yes	Yes	Yes	Yes	Yes	100
5.564G	Yes	Yes	Yes	Yes	Yes	Yes	Yes	Yes	Yes	Yes	100
5.565G	Yes	Yes	Yes	Yes	Yes	Yes	Yes	Yes	Yes	Yes	100
5.566G	Yes	Yes	Yes	Yes	Yes	Yes	Yes	Yes	Yes	Yes	100
5.567G	Yes	Yes	Yes	Yes	Yes	Yes	Yes	Yes	Yes	Yes	100
5.567G	Yes	Yes	Yes	Yes	Yes	Yes	Yes	Yes	Yes	Yes	100
5.569G(FH)	Yes	Yes	Yes	Yes	Yes	Yes	Yes	Yes	Yes	Yes	100

6.2.3 Channel Availability Check Time

If the EUT successfully detected the radar burst, it should be observed as the EUT has no transmissions occurred until the EUT starts transmitting on another channel.

Timing of Radar Signal	Observation	
	EUT	Spectrum Analyzer
Within 1 to 6 second	Detected	No transmissions
Within 54 to 60 second	Detected	No transmissions

Initial Channel Availability Check Time

Channel Availability Check @ CH58 - 5290MHz



NOTE: T1 denotes the end of power-up time period is 104th second. T2 denotes the end of Channel Availability Check time is 164th second. Channel Availability Check time is equal to (T2 – T1) 60 seconds.

Radar Burst at the Beginning of the Channel Availability Check Time

Channel Availability Check @ CH58 - 5290MHz

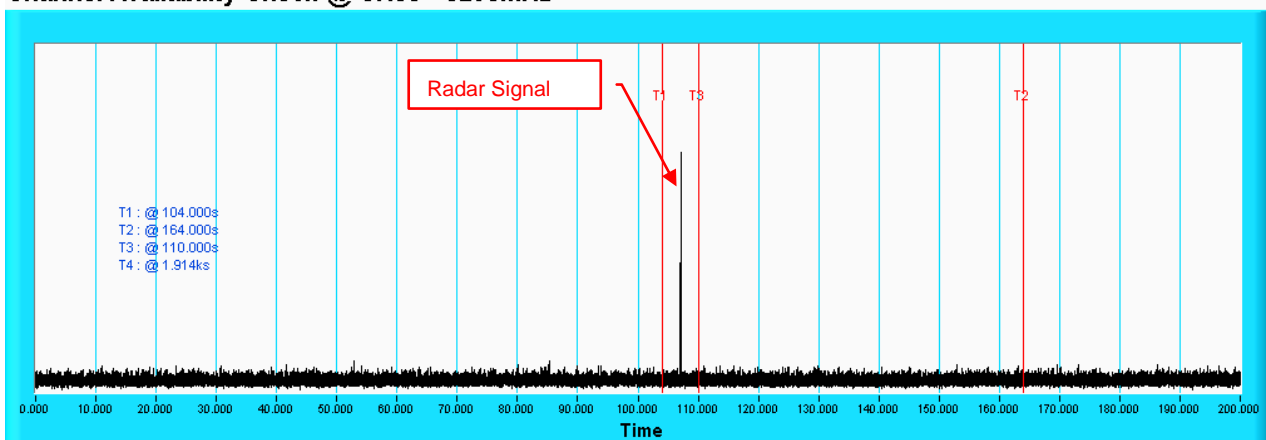

NOTE: T1 denotes the end of power up time period is 104th second. T3 denotes 110th second and the radar burst was commenced within a 6 second window starting from the end of power-up sequence. T2 denotes the 164th second.

Radar Burst at the End of the Channel Availability Check Time

Channel Availability Check @ CH58 - 5290MHz

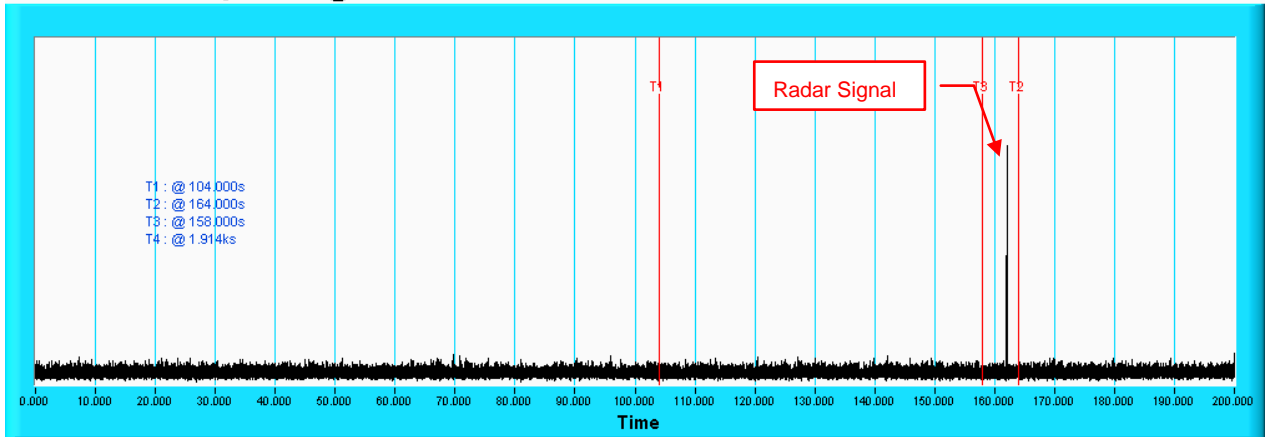

NOTE: T1 denotes the end of power up time period is 104th second. T3 denotes 158th second and the radar burst was commenced within 54th second to 60th second window starting from the end of power-up sequence. T2 denotes the 164th second.

Initial Channel Availability Check Time

Channel Availability Check @ CH106 - 5530MHz

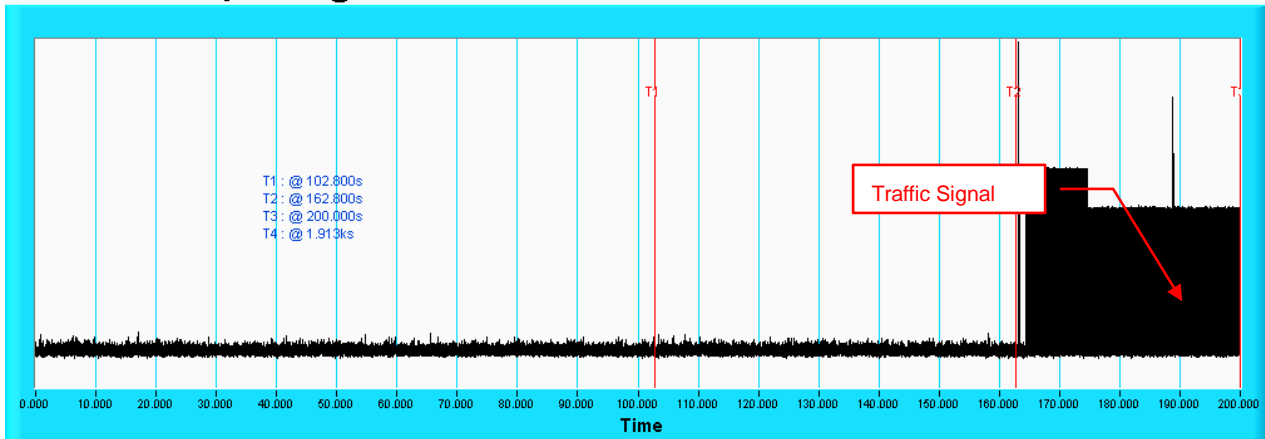

NOTE: T1 denotes the end of power-up time period is 102.8th second. T2 denotes the end of Channel Availability Check time is 162.8th second. Channel Availability Check time is equal to (T2 – T1) 60 seconds.

Radar Burst at the Beginning of the Channel Availability Check Time

Channel Availability Check @ CH106 - 5530MHz

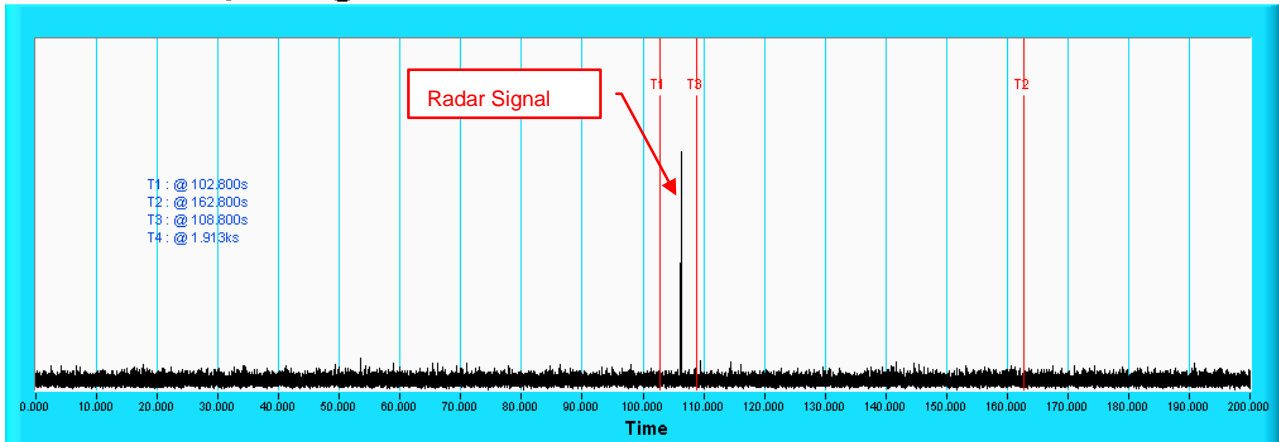

NOTE: T1 denotes the end of power up time period is 102.8th second. T3 denotes 108.8th second and the radar burst was commenced within a 6 second window starting from the end of power-up sequence. T2 denotes the 162.8th second.

Radar Burst at the End of the Channel Availability Check Time

Channel Availability Check @ CH106 - 5530MHz

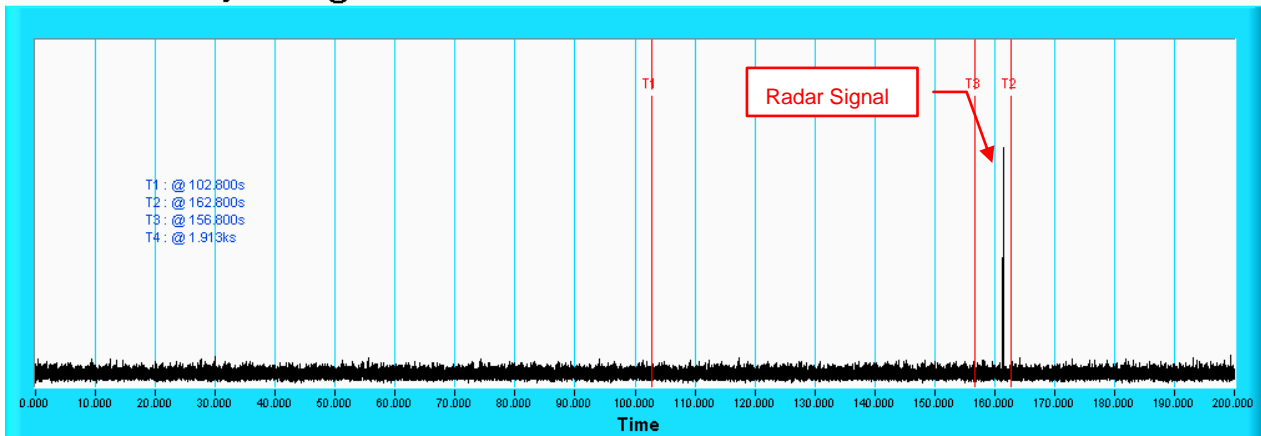

NOTE: T1 denotes the end of power up time period is 102.8th second. T3 denotes 156.8th second and the radar burst was commenced within 54th second to 60th second window starting from the end of power-up sequence. T2 denotes the 162.8th second.

6.2.4 Channel Closing Transmission and Channel Move Time

Wireless Traffic Loading

802.11ac (VHT20)

Duty Cycle

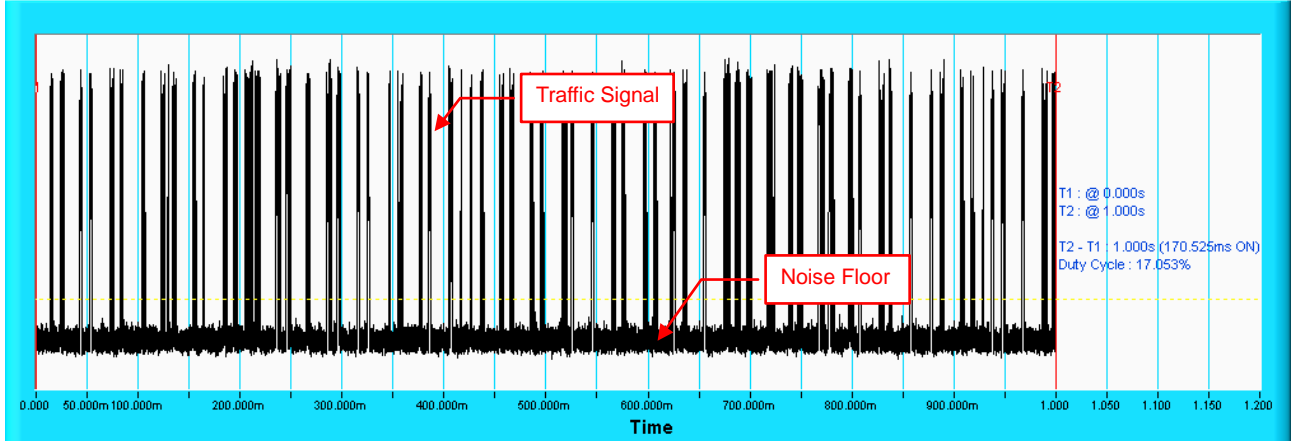

802.11ac (VHT40)

Duty Cycle

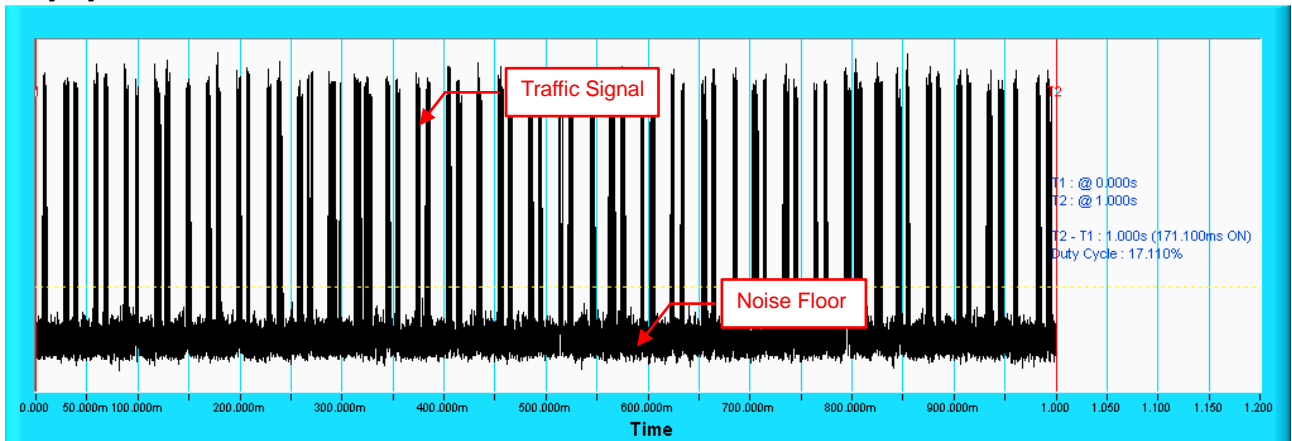

802.11ac (VHT80)

Duty Cycle

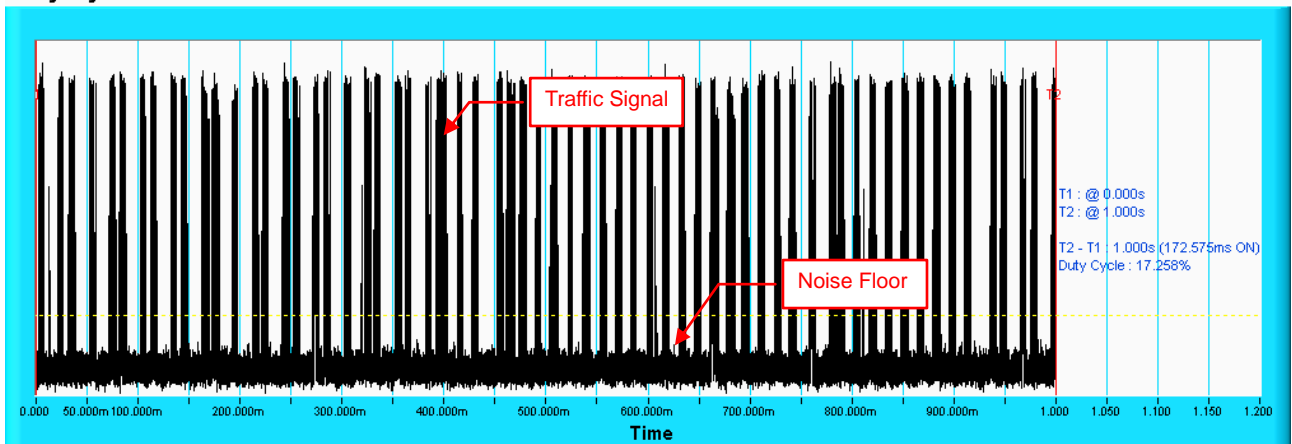

802.11ac (VHT20) CH60

Table 1: Short Pulse Radar Test Waveforms.

Radar Type	Pulse Width (µsec)	PRI (µsec)	Number of Pulses	Number of Trials(Times)	Percentage of Successful Detection (%)
1	Test A: 15 unique PRI values randomly selected from the list of 23 PRI values in Table 5a ----- Test B: 15 unique PRI values randomly selected within the range of 518-3066 µ sec, with a minimum increment of 1 µ sec, excluding PRI values selected in Test A	$\text{Roundup} \left\{ \begin{array}{l} \left(\frac{1}{360} \right) \cdot \\ \left(\frac{19 \cdot 10^6}{\text{PRI}_{\mu \text{ sec}}} \right) \end{array} \right\}$	18	30	90
2	1-5	150-230	23-29	30	86.7
3	6-10	200-500	16-18	30	90
4	11-20	200-500	12-16	30	83.3
Aggregate (Radar Types 1-4)				120	87.5

Table 2: Long Pulse Radar Test Waveform

Radar Type	Pulse Width (µsec)	Chirp Width (MHz)	PRI (µsec)	Number of Pulses per Burst	Number of Bursts	Number of Trials(Times)	Percentage of Successful Detection (%)
5	50-100	5-20	1000-2000	1-3	8-20	30	83.3

Table 3: Frequency Hopping Radar Test Waveform

Radar Type	Pulse Width (μ sec)	PRI (μ sec)	Pulses per Hop	Hopping Rate (kHz)	Hopping Sequence Length (msec)	Number of Trials(Times)	Percentage of Successful Detection (%)
6	1	333	9	0.333	300	30	90

802.11ac (VHT20) CH100

Table 1: Short Pulse Radar Test Waveforms.

Radar Type	Pulse Width (µsec)	PRI (µsec)	Number of Pulses	Number of Trials(Times)	Percentage of Successful Detection (%)
1	Test A: 15 unique PRI values randomly selected from the list of 23 PRI values in Table 5a ----- Test B: 15 unique PRI values randomly selected within the range of 518-3066 µ sec, with a minimum increment of 1 µ sec, excluding PRI values selected in Test A	$\text{Roundup} \left\{ \begin{array}{l} \left(\frac{1}{360} \right) \cdot \\ \left(\frac{19 \cdot 10^6}{\text{PRI}_{\mu \text{ sec}}} \right) \end{array} \right\}$	18	30	86.7
2	1-5	150-230	23-29	30	83.3
3	6-10	200-500	16-18	30	90
4	11-20	200-500	12-16	30	86.7
Aggregate (Radar Types 1-4)				120	86.7

Table 2: Long Pulse Radar Test Waveform

Radar Type	Pulse Width (µsec)	Chirp Width (MHz)	PRI (µsec)	Number of Pulses per Burst	Number of Bursts	Number of Trials(Times)	Percentage of Successful Detection (%)
5	50-100	5-20	1000-2000	1-3	8-20	30	90

Table 3: Frequency Hopping Radar Test Waveform

Radar Type	Pulse Width (μ sec)	PRI (μ sec)	Pulses per Hop	Hopping Rate (kHz)	Hopping Sequence Length (msec)	Number of Trials(Times)	Percentage of Successful Detection (%)
6	1	333	9	0.333	300	30	90

802.11ac (VHT40)CH62

Table 1: Short Pulse Radar Test Waveforms.

Radar Type	Pulse Width (µsec)	PRI (µsec)	Number of Pulses	Number of Trials(Times)	Percentage of Successful Detection (%)
1	Test A: 15 unique PRI values randomly selected from the list of 23 PRI values in Table 5a ----- Test B: 15 unique PRI values randomly selected within the range of 518-3066 µ sec, with a minimum increment of 1 µ sec, excluding PRI values selected in Test A	$\left\{ \begin{array}{l} \frac{1}{360} \\ \text{Roundup} \\ \frac{19 \cdot 10^6}{\text{PRI}_{\mu \text{ sec}}} \end{array} \right\}$	18	30	90
2	1-5	150-230	23-29	30	83.3
3	6-10	200-500	16-18	30	90
4	11-20	200-500	12-16	30	86.7
Aggregate (Radar Types 1-4)				120	87.5

Table 2: Long Pulse Radar Test Waveform

Radar Type	Pulse Width (µsec)	Chirp Width (MHz)	PRI (µsec)	Number of Pulses per Burst	Number of Bursts	Number of Trials(Times)	Percentage of Successful Detection (%)
5	50-100	5-20	1000-2000	1-3	8-20	30	90

Table 3: Frequency Hopping Radar Test Waveform

Radar Type	Pulse Width (μ sec)	PRI (μ sec)	Pulses per Hop	Hopping Rate (kHz)	Hopping Sequence Length (msec)	Number of Trials(Times)	Percentage of Successful Detection (%)
6	1	333	9	0.333	300	30	93.3

802.11ac (VHT40)CH102

Table 1: Short Pulse Radar Test Waveforms.

Radar Type	Pulse Width (µsec)	PRI (µsec)	Number of Pulses	Number of Trials(Times)	Percentage of Successful Detection (%)
1	Test A: 15 unique PRI values randomly selected from the list of 23 PRI values in Table 5a ----- Test B: 15 unique PRI values randomly selected within the range of 518-3066 µ sec, with a minimum increment of 1 µ sec, excluding PRI values selected in Test A	$\left\{ \begin{array}{l} \frac{1}{360} \\ \text{Roundup} \\ \frac{19 \cdot 10^6}{\text{PRI}_{\mu \text{ sec}}} \end{array} \right\}$	18	30	90
2	1-5	150-230	23-29	30	86.7
3	6-10	200-500	16-18	30	90
4	11-20	200-500	12-16	30	83.3
Aggregate (Radar Types 1-4)				120	87.5

Table 2: Long Pulse Radar Test Waveform

Radar Type	Pulse Width (µsec)	Chirp Width (MHz)	PRI (µsec)	Number of Pulses per Burst	Number of Bursts	Number of Trials(Times)	Percentage of Successful Detection (%)
5	50-100	5-20	1000-2000	1-3	8-20	30	90

Table 3: Frequency Hopping Radar Test Waveform

Radar Type	Pulse Width (μ sec)	PRI (μ sec)	Pulses per Hop	Hopping Rate (kHz)	Hopping Sequence Length (msec)	Number of Trials(Times)	Percentage of Successful Detection (%)
6	1	333	9	0.333	300	30	93.3

802.11ac (VHT80)CH58

Table 1: Short Pulse Radar Test Waveforms.

Radar Type	Pulse Width (µsec)	PRI (µsec)	Number of Pulses	Number of Trials(Times)	Percentage of Successful Detection (%)
1	Test A: 15 unique PRI values randomly selected from the list of 23 PRI values in Table 5a ----- Test B: 15 unique PRI values randomly selected within the range of 518-3066 µ sec, with a minimum increment of 1 µ sec, excluding PRI values selected in Test A	$\text{Roundup} \left\{ \begin{array}{l} \left(\frac{1}{360} \right) \cdot \\ \left(\frac{19 \cdot 10^6}{\text{PRI}_{\mu \text{ sec}}} \right) \end{array} \right\}$	18	30	86.7
2	1-5	150-230	23-29	30	90
3	6-10	200-500	16-18	30	90
4	11-20	200-500	12-16	30	83.3
Aggregate (Radar Types 1-4)				120	87.5

Table 2: Long Pulse Radar Test Waveform

Radar Type	Pulse Width (µsec)	Chirp Width (MHz)	PRI (µsec)	Number of Pulses per Burst	Number of Bursts	Number of Trials(Times)	Percentage of Successful Detection (%)
5	50-100	5-20	1000-2000	1-3	8-20	30	83.3

Table 3: Frequency Hopping Radar Test Waveform

Radar Type	Pulse Width (μsec)	PRI (μsec)	Pulses per Hop	Hopping Rate (kHz)	Hopping Sequence Length (msec)	Number of Trials(Times)	Percentage of Successful Detection (%)
6	1	333	9	0.333	300	30	90

802.11ac (VHT80)CH106

Table 1: Short Pulse Radar Test Waveforms.

Radar Type	Pulse Width (µsec)	PRI (µsec)	Number of Pulses	Number of Trials(Times)	Percentage of Successful Detection (%)
1	Test A: 15 unique PRI values randomly selected from the list of 23 PRI values in Table 5a ----- Test B: 15 unique PRI values randomly selected within the range of 518-3066 µ sec, with a minimum increment of 1 µ sec, excluding PRI values selected in Test A	$\text{Roundup} \left\{ \left(\frac{1}{360} \right) \cdot \left(\frac{19 \cdot 10^6}{\text{PRI}_{\mu \text{ sec}}} \right) \right\}$	18	30	86.7
2	1-5	150-230	23-29	30	83.3
3	6-10	200-500	16-18	30	83.3
4	11-20	200-500	12-16	30	86.7
Aggregate (Radar Types 1-4)				120	85

Table 2: Long Pulse Radar Test Waveform

Radar Type	Pulse Width (µsec)	Chirp Width (MHz)	PRI (µsec)	Number of Pulses per Burst	Number of Bursts	Number of Trials(Times)	Percentage of Successful Detection (%)
5	50-100	5-20	1000-2000	1-3	8-20	30	83.3

Table 3: Frequency Hopping Radar Test Waveform

Radar Type	Pulse Width (μsec)	PRI (μsec)	Pulses per Hop	Hopping Rate (kHz)	Hopping Sequence Length (msec)	Number of Trials(Times)	Percentage of Successful Detection (%)
6	1	333	9	0.333	300	30	90

Radar signal 0

802.11ac (VHT80)

Channel Closing Transmission Time & Channel Move Time @ CH58 - 5290MHz

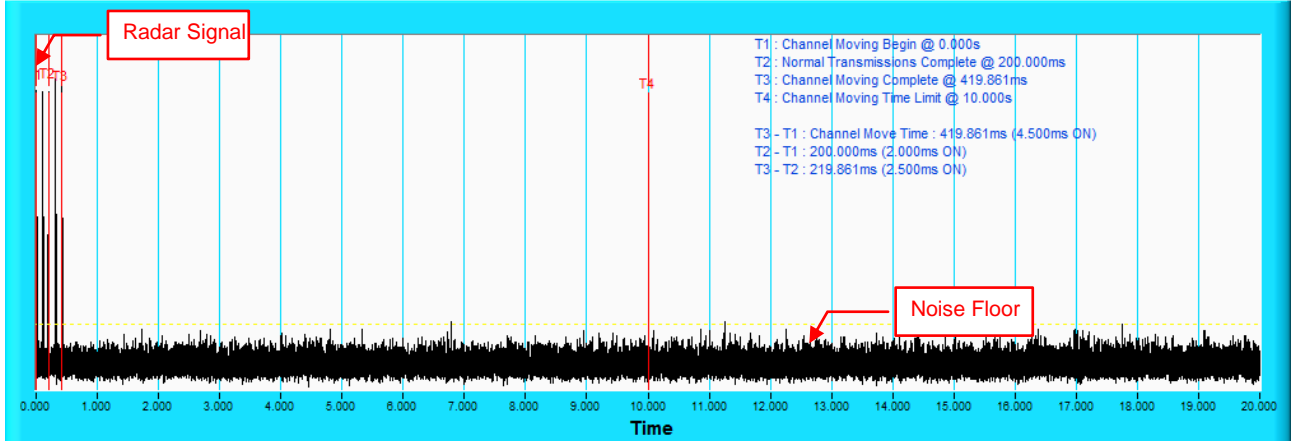

NOTE: T1 denotes the start of Channel Move Time upon the end of the last Radar burst. T2 denotes the data transmission time of 200ms from T1. T3 denotes the end of Channel Move Time. T4 denotes the 10 second from T1 to observe the aggregate duration of transmissions.

Channel Closing Transmission Time & Channel Move Time @ CH58 - 5290MHz

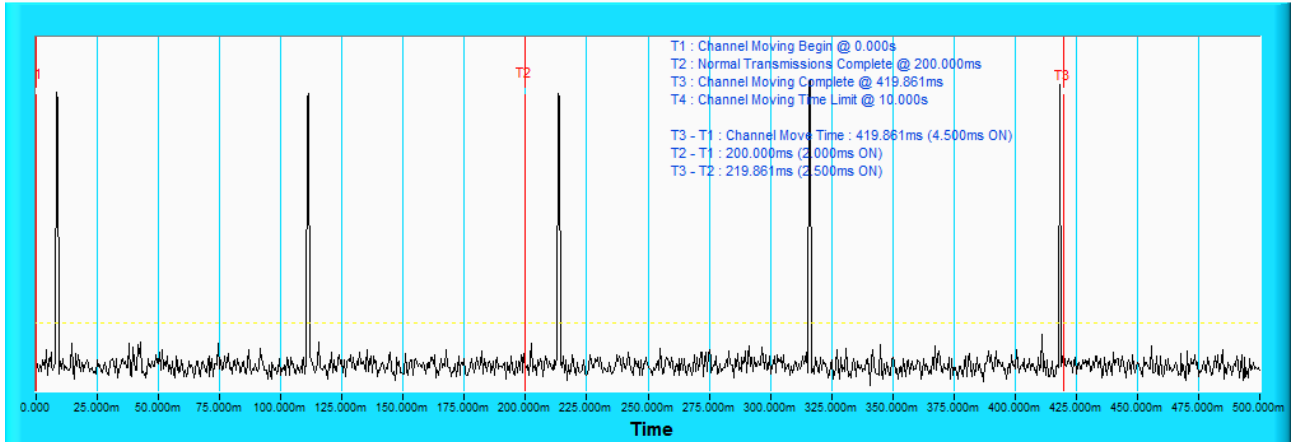

NOTE: Zoom in of the first 500ms after radar signal applied.

Radar signal 1

802.11ac (VHT80)

Channel Closing Transmission Time & Channel Move Time @ CH58 - 5290MHz

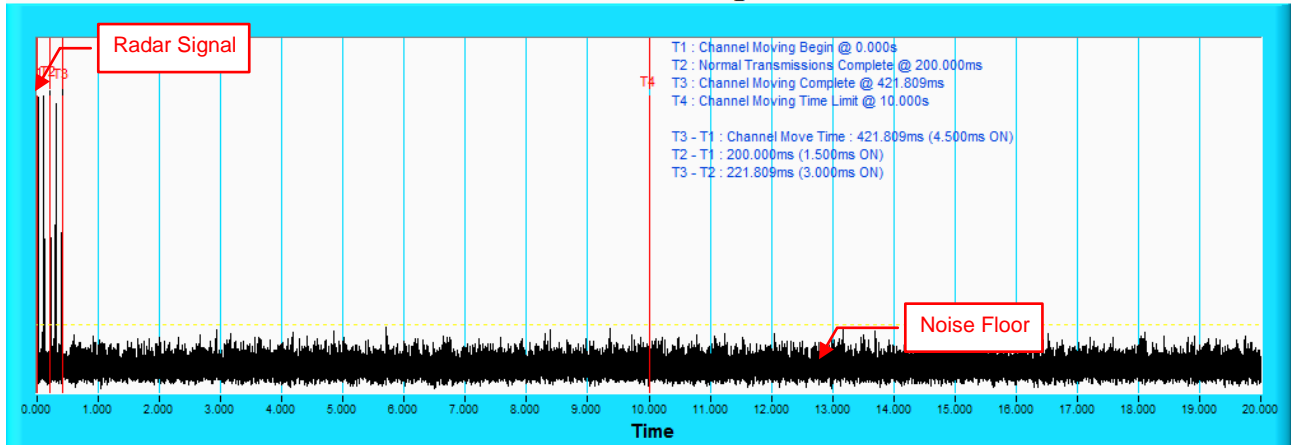

NOTE: T1 denotes the start of Channel Move Time upon the end of the last Radar burst. T2 denotes the data transmission time of 200ms from T1. T3 denotes the end of Channel Move Time. T4 denotes the 10 second from T1 to observe the aggregate duration of transmissions.

Channel Closing Transmission Time & Channel Move Time @ CH58 - 5290MHz

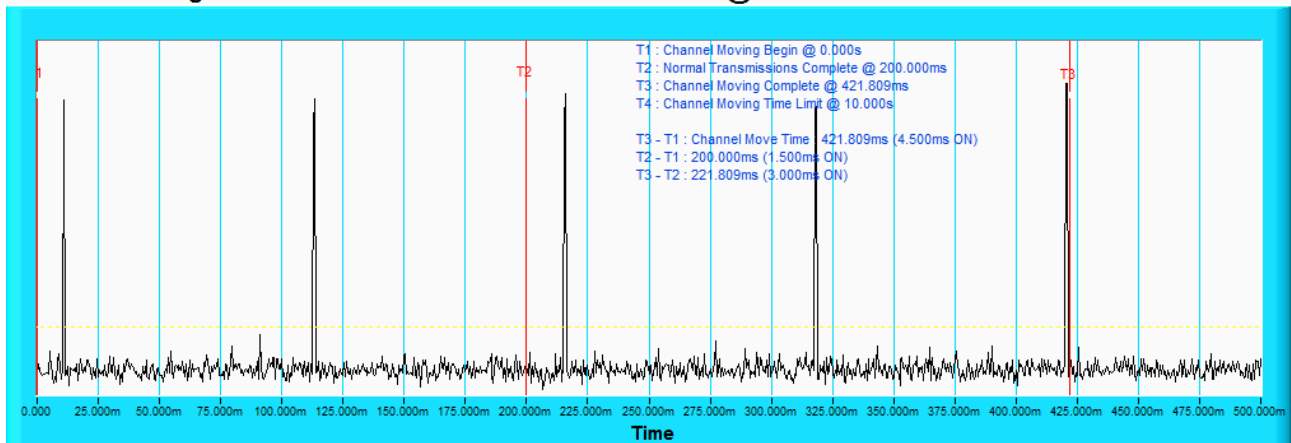

NOTE: Zoom in of the first 500ms after radar signal applied.

Radar signal 2

802.11ac (VHT80)

Channel Closing Transmission Time & Channel Move Time @ CH58 - 5290MHz

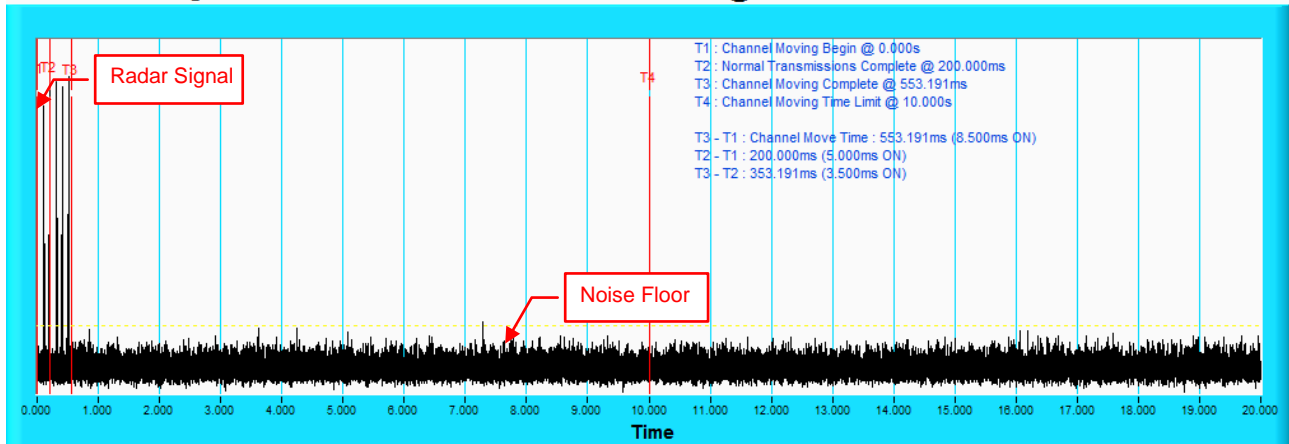

NOTE: T1 denotes the start of Channel Move Time upon the end of the last Radar burst. T2 denotes the data transmission time of 200ms from T1. T3 denotes the end of Channel Move Time. T4 denotes the 10 second from T1 to observe the aggregate duration of transmissions.

Channel Closing Transmission Time & Channel Move Time @ CH58 - 5290MHz

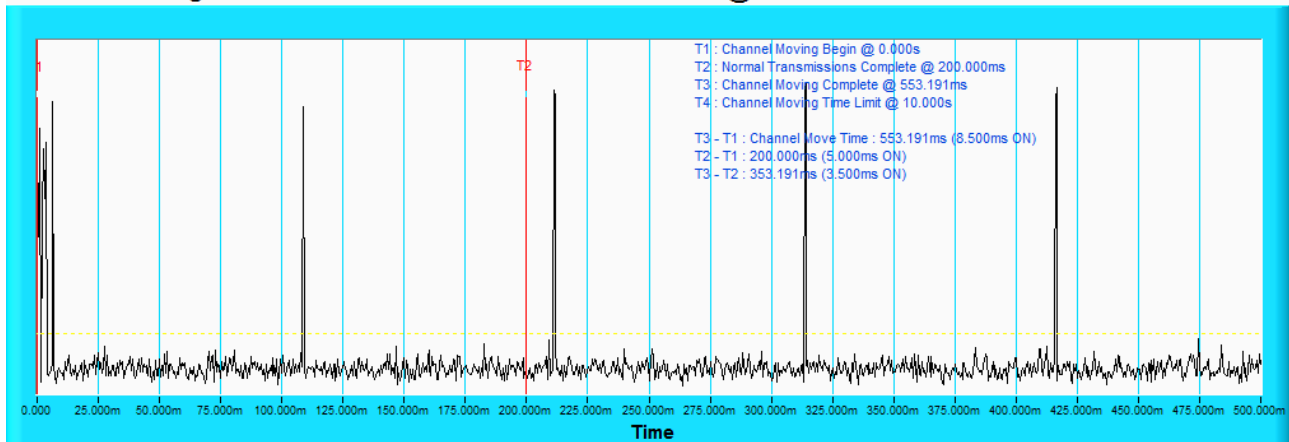

NOTE: Zoom in of the first 500ms after radar signal applied.

Radar signal 3

802.11ac (VHT80)

Channel Closing Transmission Time & Channel Move Time @ CH58 - 5290MHz

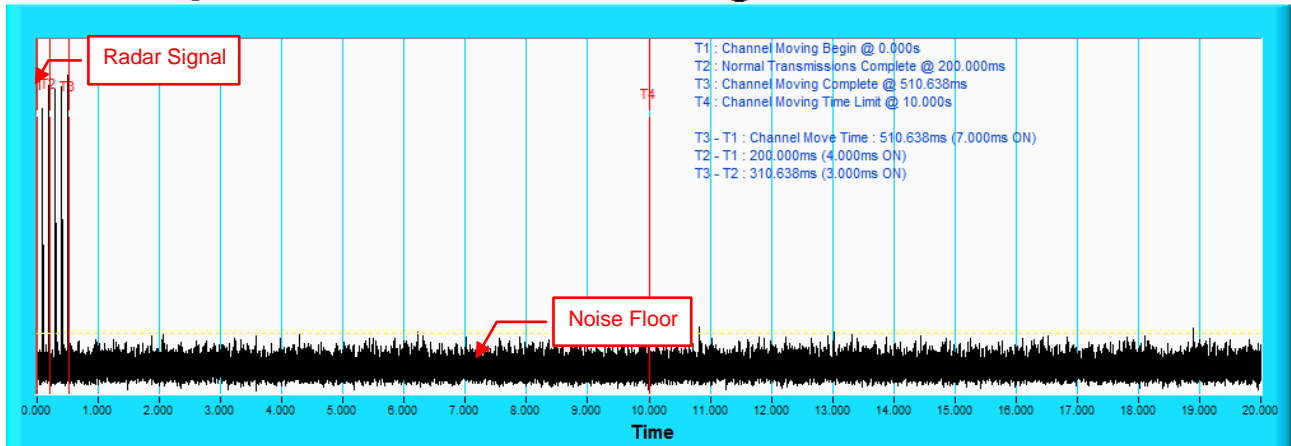

NOTE: T1 denotes the start of Channel Move Time upon the end of the last Radar burst. T2 denotes the data transmission time of 200ms from T1. T3 denotes the end of Channel Move Time. T4 denotes the 10 second from T1 to observe the aggregate duration of transmissions.

Channel Closing Transmission Time & Channel Move Time @ CH58 - 5290MHz

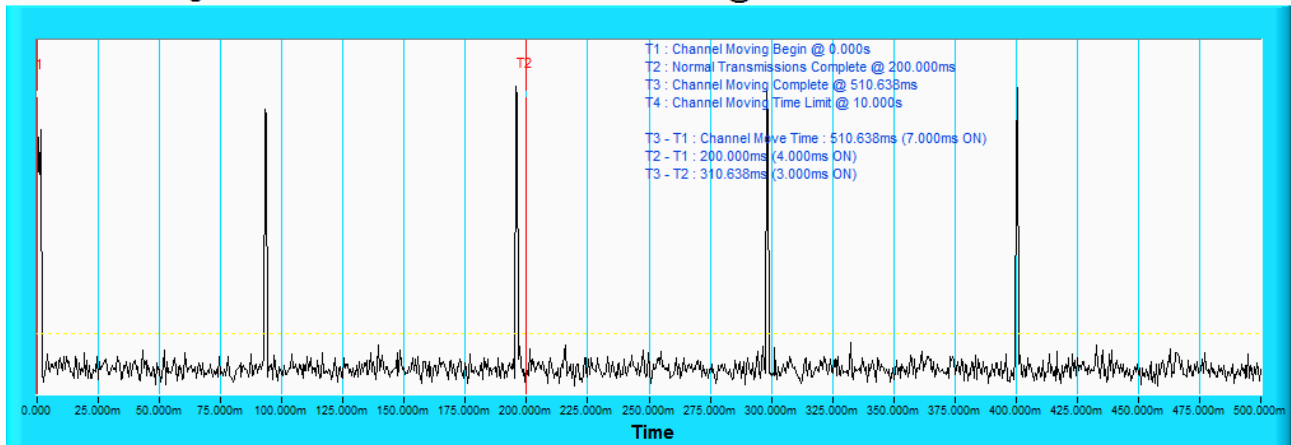

NOTE: Zoom in of the first 500ms after radar signal applied.

Radar signal 4

802.11ac (VHT80)

Channel Closing Transmission Time & Channel Move Time @ CH58 - 5290MHz

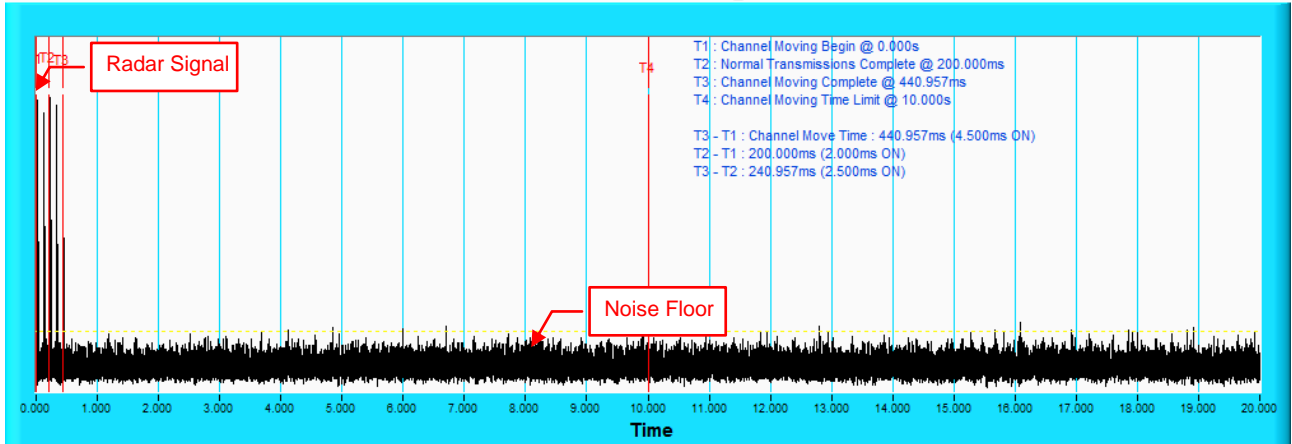

NOTE: T1 denotes the start of Channel Move Time upon the end of the last Radar burst. T2 denotes the data transmission time of 200ms from T1. T3 denotes the end of Channel Move Time. T4 denotes the 10 second from T1 to observe the aggregate duration of transmissions.

Channel Closing Transmission Time & Channel Move Time @ CH58 - 5290MHz

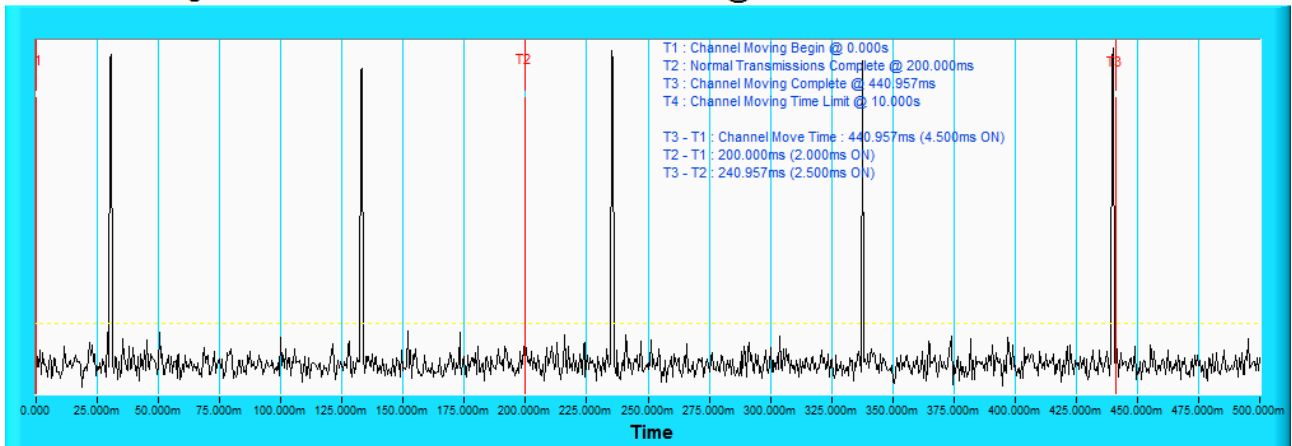

NOTE: Zoom in of the first 500ms after radar signal applied.

Radar signal 0

802.11ac (VHT80)

Channel Closing Transmission Time & Channel Move Time @ CH106 - 5530MHz

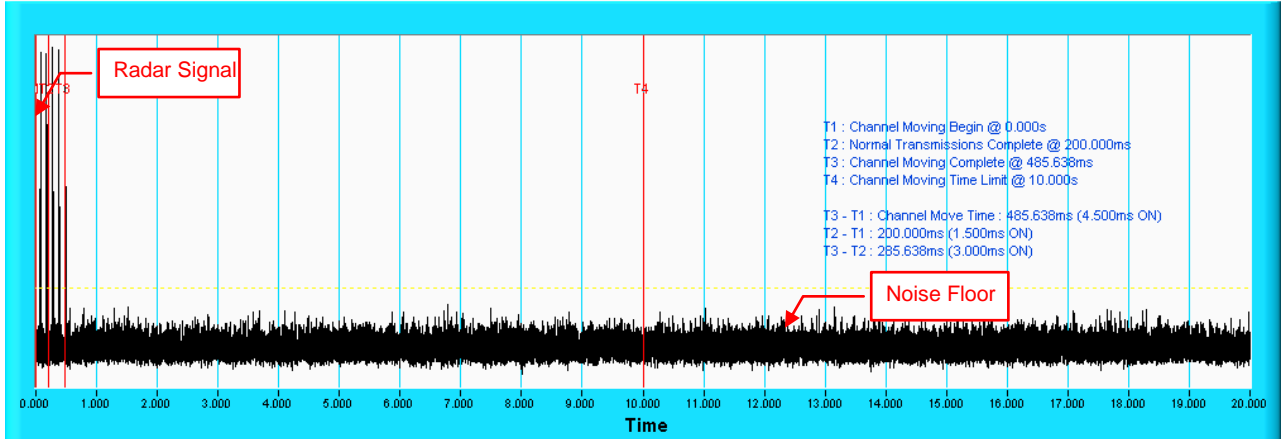

NOTE: T1 denotes the start of Channel Move Time upon the end of the last Radar burst. T2 denotes the data transmission time of 200ms from T1. T3 denotes the end of Channel Move Time. T4 denotes the 10 second from T1 to observe the aggregate duration of transmissions.

Channel Closing Transmission Time & Channel Move Time @ CH106 - 5530MHz

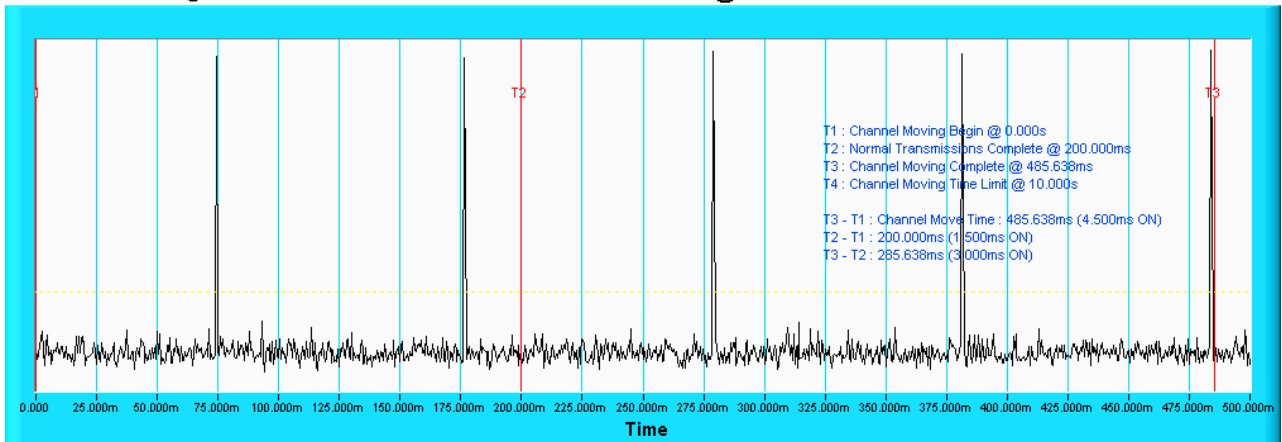

NOTE: Zoom in of the first 500ms after radar signal applied.

Radar signal 1

802.11ac (VHT80)

Channel Closing Transmission Time & Channel Move Time @ CH106 - 5530MHz

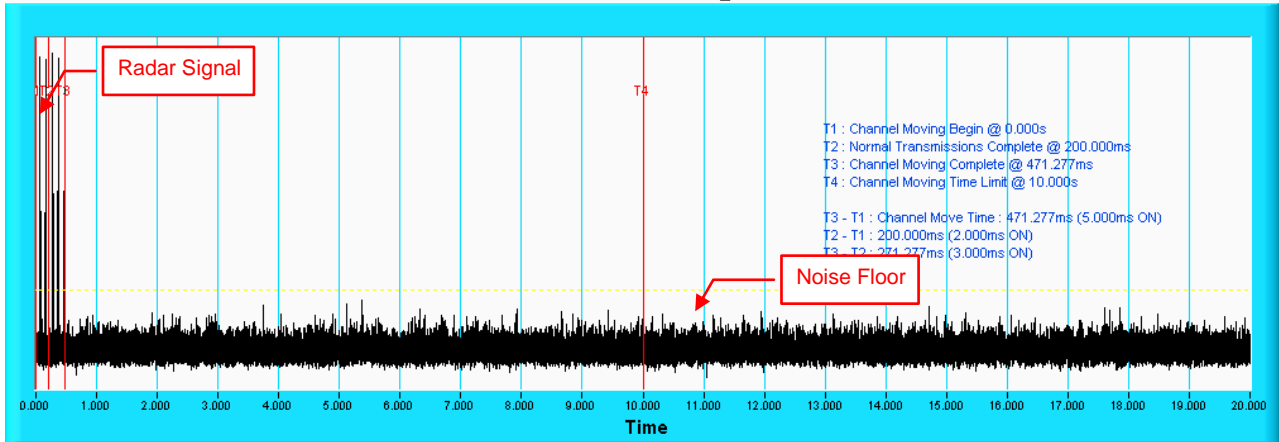

NOTE: T1 denotes the start of Channel Move Time upon the end of the last Radar burst. T2 denotes the data transmission time of 200ms from T1. T3 denotes the end of Channel Move Time. T4 denotes the 10 second from T1 to observe the aggregate duration of transmissions.

Channel Closing Transmission Time & Channel Move Time @ CH106 - 5530MHz

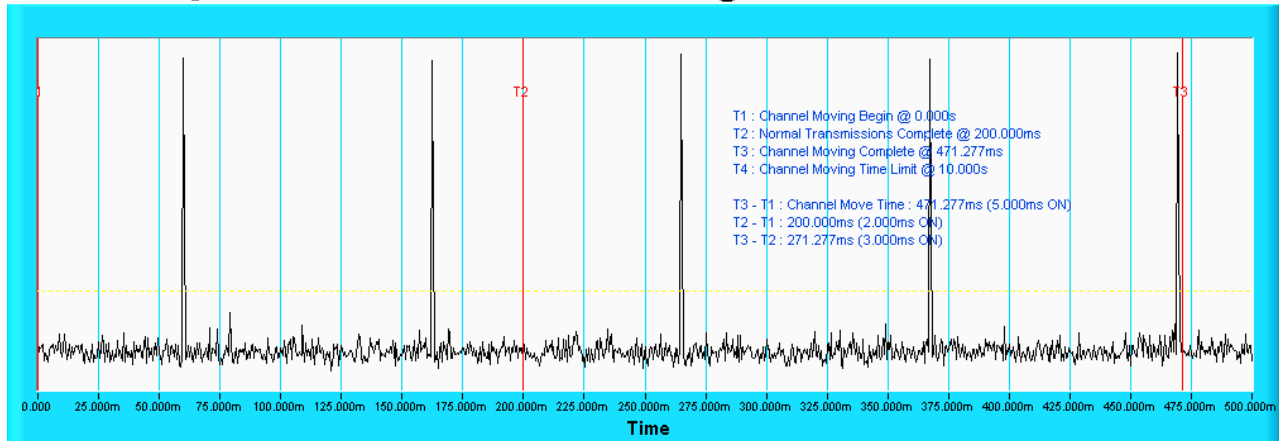

NOTE: Zoom in of the first 500ms after radar signal applied.

Radar signal 2

802.11ac (VHT80)

Channel Closing Transmission Time & Channel Move Time @ CH106 - 5530MHz

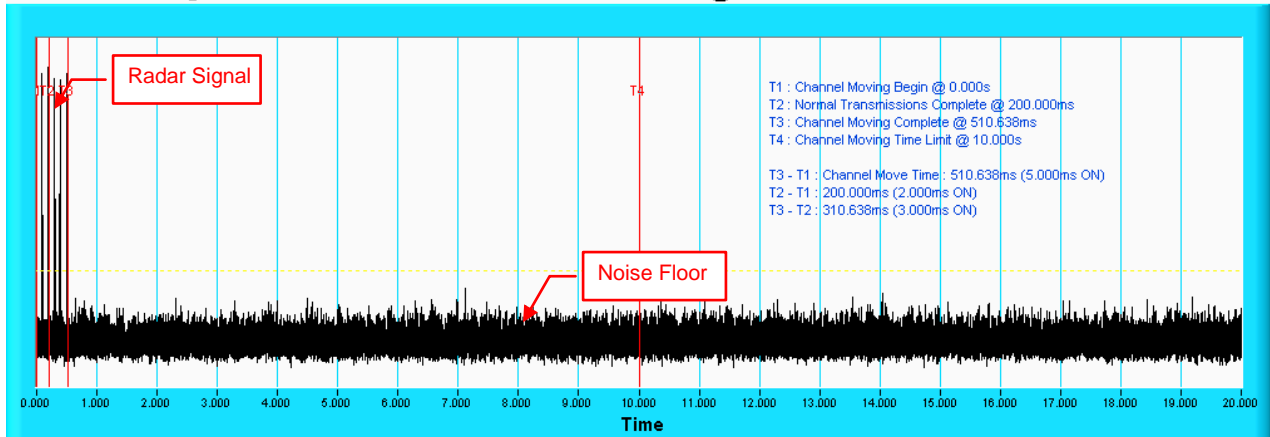

NOTE: T1 denotes the start of Channel Move Time upon the end of the last Radar burst. T2 denotes the data transmission time of 200ms from T1. T3 denotes the end of Channel Move Time. T4 denotes the 10 second from T1 to observe the aggregate duration of transmissions.

Channel Closing Transmission Time & Channel Move Time @ CH106 - 5530MHz

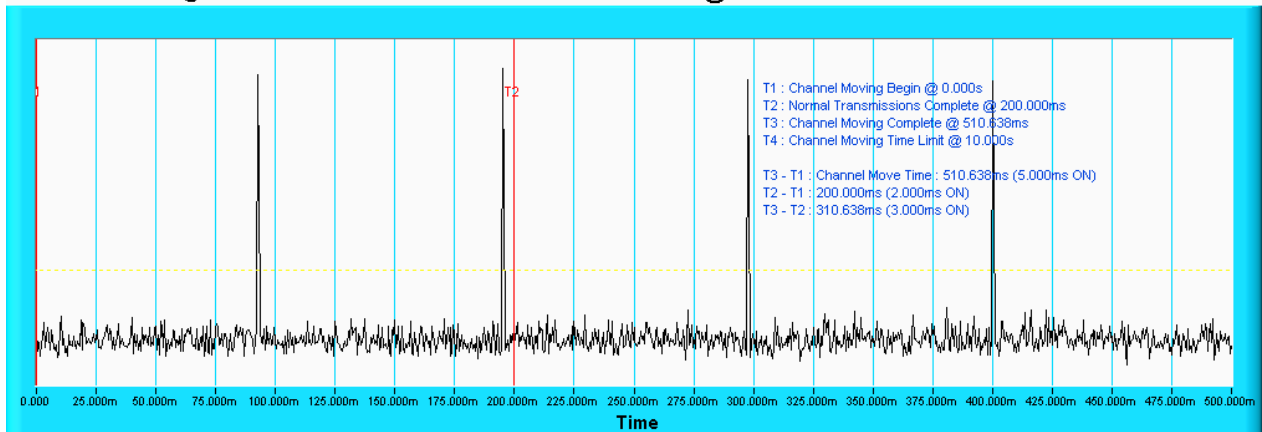

NOTE: Zoom in of the first 500ms after radar signal applied.

Radar signal 3

802.11ac (VHT80)

Channel Closing Transmission Time & Channel Move Time @ CH106 - 5530MHz

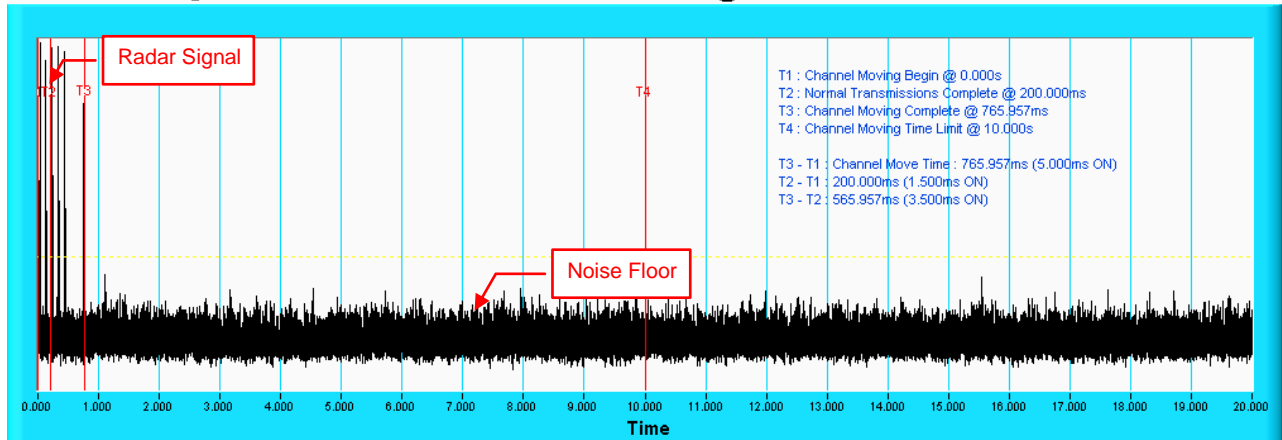

NOTE: T1 denotes the start of Channel Move Time upon the end of the last Radar burst. T2 denotes the data transmission time of 200ms from T1. T3 denotes the end of Channel Move Time. T4 denotes the 10 second from T1 to observe the aggregate duration of transmissions.

Channel Closing Transmission Time & Channel Move Time @ CH106 - 5530MHz

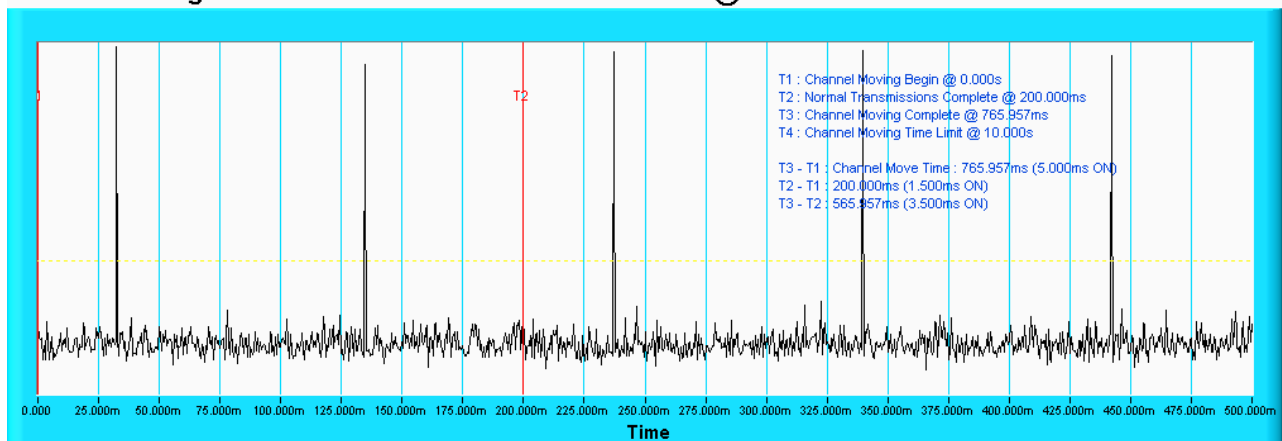

NOTE: Zoom in of the first 500ms after radar signal applied.

Radar signal 4

802.11ac (VHT80)

Channel Closing Transmission Time & Channel Move Time @ CH106 - 5530MHz

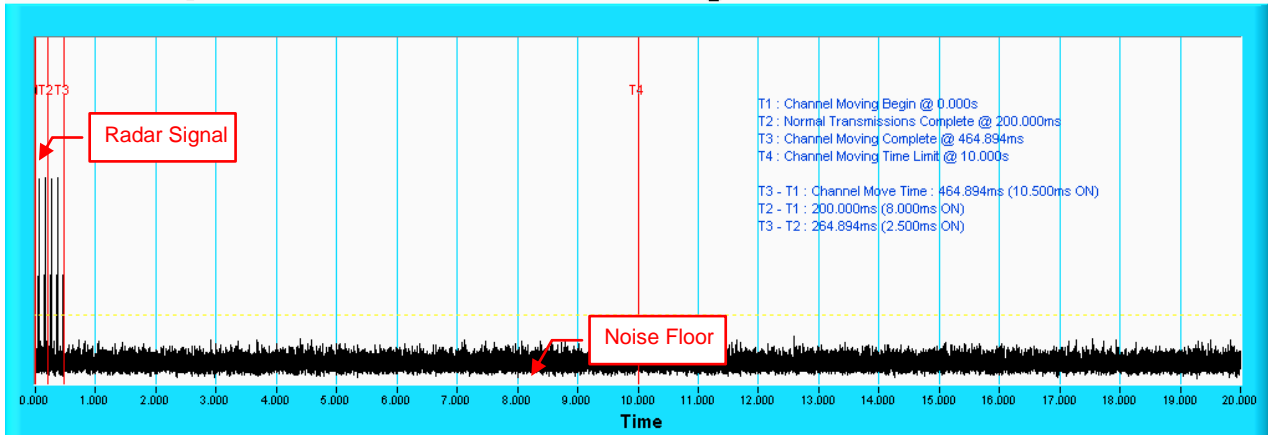

NOTE: T1 denotes the start of Channel Move Time upon the end of the last Radar burst. T2 denotes the data transmission time of 200ms from T1. T3 denotes the end of Channel Move Time. T4 denotes the 10 second from T1 to observe the aggregate duration of transmissions.

Channel Closing Transmission Time & Channel Move Time @ CH106 - 5530MHz

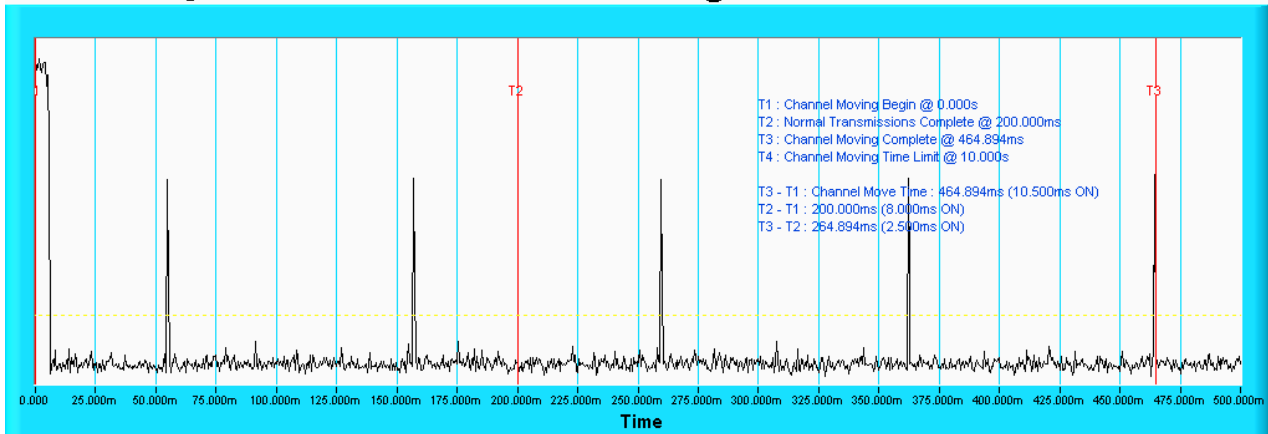

NOTE: Zoom in of the first 500ms after radar signal applied.



802.11ac (VHT20)CH60

Type 1 Radar Statistical Performances						
Trial #	Test Frequency (MHz)	Pulse Repetition Frequency Number (1 to 23)	Pulse Repetition Frequency (Pulse per seconds)	Pulses per Burst	Pulse Repetition Interval (microseconds)	Detection
1	5300	15	1253	67	798	Yes
2	5300	16	1223	65	818	No
3	5303	4	1730	92	578	Yes
4	5309	11	1393	74	718	Yes
5	5298	22	1066	57	938	Yes
6	5306	7	1567	83	638	Yes
7	5303	2	1859	99	538	Yes
8	5294	8	1520	81	658	Yes
9	5307	1	1931	102	518	Yes
10	5292	19	1139	61	878	Yes
11	5294	21	1089	58	918	Yes
12	5294	23	326.2	18	3066	Yes
13	5297	9	1475	78	678	Yes
14	5300	5	1672	89	598	Yes
15	5307	6	1618	86	618	Yes
16	5299		1111	59	900	Yes
17	5299		1024	55	977	Yes
18	5303		625.8	34	1598	Yes
19	5305		730.5	39	1369	Yes
20	5306		1181	63	847	Yes
21	5297		400.6	22	2496	No
22	5308		529.4	28	1889	Yes
23	5304		347.6	19	2877	Yes
24	5304		641.4	34	1559	Yes
25	5295		508.9	27	1965	Yes
26	5303		345.4	19	2895	Yes
27	5301		580.7	31	1722	Yes
28	5308		786.8	42	1271	Yes
29	5297		808.4	43	1237	No
30	5296		517.1	28	1934	Yes

Detection Rate: 90 %

802.11ac (VHT20)CH60
Type 2 Radar Statistical Performances

Trial #	Test Frequency (MHz)	Pulses per Burst	Pulse Width(us)	PRI(us)	Detection
1	5300	24	1.7	174	Yes
2	5308	27	3.8	176	Yes
3	5292	28	4	161	Yes
4	5301	28	4.3	226	Yes
5	5293	24	1.9	193	Yes
6	5301	23	1.1	230	Yes
7	5292	29	4.5	198	Yes
8	5302	26	2.9	227	Yes
9	5292	26	2.8	171	Yes
10	5307	27	3.6	221	Yes
11	5308	23	1.1	180	Yes
12	5302	23	1.3	189	Yes
13	5306	25	2.5	204	Yes
14	5299	29	4.5	203	Yes
15	5307	29	5	170	Yes
16	5299	26	3.1	201	Yes
17	5295	24	2.1	218	Yes
18	5296	25	2.6	208	Yes
19	5292	24	1.8	223	No
20	5302	23	1.2	220	Yes
21	5309	26	2.9	224	No
22	5304	28	4	160	Yes
23	5297	25	2.5	209	Yes
24	5292	23	1	205	Yes
25	5306	27	3.7	151	Yes
26	5294	25	2.5	186	No
27	5303	23	1.5	190	No
28	5293	23	1.3	185	Yes
29	5304	23	1.2	175	Yes
30	5295	24	1.7	216	Yes

Detection Rate: 86.7 %

802.11ac (VHT20) CH60
Type 3 Radar Statistical Performances

Trial #	Test Frequency (MHz)	Pulses per Burst	Pulse Width(us)	PRI(us)	Detection
1	5300	16	6.7	467	Yes
2	5301	18	8.8	304	No
3	5307	18	9	316	Yes
4	5293	18	9.3	439	Yes
5	5308	16	6.9	420	Yes
6	5303	16	6.1	249	Yes
7	5305	18	9.5	463	Yes
8	5298	17	7.9	258	Yes
9	5297	17	7.8	212	Yes
10	5296	17	8.6	236	Yes
11	5300	16	6.1	474	Yes
12	5300	16	6.3	461	Yes
13	5293	17	7.5	437	Yes
14	5303	18	9.5	287	Yes
15	5299	18	10	395	Yes
16	5305	17	8.1	322	Yes
17	5295	16	7.1	468	Yes
18	5295	17	7.6	255	Yes
19	5303	16	6.8	423	No
20	5308	16	6.2	456	Yes
21	5307	17	7.9	351	Yes
22	5297	18	9	411	Yes
23	5301	17	7.5	279	Yes
24	5300	16	6	431	Yes
25	5299	17	8.7	324	Yes
26	5304	17	7.5	419	Yes
27	5308	16	6.5	447	Yes
28	5291	16	6.3	481	No
29	5308	16	6.2	438	Yes
30	5309	16	6.7	270	Yes

Detection Rate: 90 %

802.11ac (VHT20) CH60

Type 4 Radar Statistical Performances					
Trial #	Test Frequency (MHz)	Pulses per Burst	Pulse Width(us)	PRI(us)	Detection
1	5300	12	12.5	467	Yes
2	5305	15	17.2	304	No
3	5292	15	17.8	316	Yes
4	5308	16	18.5	439	Yes
5	5308	13	13.1	420	Yes
6	5300	12	11.3	249	No
7	5291	16	18.8	463	Yes
8	5294	14	15.3	258	Yes
9	5298	14	15.1	212	Yes
10	5305	15	16.9	236	Yes
11	5302	12	11.2	474	No
12	5292	12	11.7	461	Yes
13	5298	13	14.4	437	Yes
14	5300	16	18.9	287	Yes
15	5295	16	19.9	395	Yes
16	5293	14	15.7	322	Yes
17	5300	13	13.4	468	Yes
18	5299	13	14.5	255	Yes
19	5291	13	12.9	423	Yes
20	5301	12	11.5	456	No
21	5305	14	15.3	351	Yes
22	5298	15	17.8	411	Yes
23	5303	13	14.3	279	Yes
24	5305	12	11.1	431	Yes
25	5299	15	17	324	Yes
26	5298	13	14.5	419	Yes
27	5292	12	12.1	447	Yes
28	5308	12	11.7	481	No
29	5297	12	11.6	438	Yes
30	5305	12	12.7	270	Yes

Detection Rate: 83.3 %

802.11ac (VHT20) CH60

Type 5 Radar Statistical Performances				
Trial #	Minimum Chirp Width(MHz)	Chirp Center Frequency(MHz)	Test Signal Name	Detection
1	17	5300	LP_Signal_01	Yes
2	7	5300	LP_Signal_02	Yes
3	8	5300	LP_Signal_03	Yes
4	19	5300	LP_Signal_04	Yes
5	12	5300	LP_Signal_05	Yes
6	11	5300	LP_Signal_06	Yes
7	6	5300	LP_Signal_07	Yes
8	20	5300	LP_Signal_08	Yes
9	6	5300	LP_Signal_09	No
10	12	5300	LP_Signal_10	Yes
11	16	5297	LP_Signal_11	No
12	20	5299	LP_Signal_12	No
13	18	5298	LP_Signal_13	Yes
14	12	5296	LP_Signal_14	No
15	12	5296	LP_Signal_15	Yes
16	15	5297	LP_Signal_16	Yes
17	10	5295	LP_Signal_17	Yes
18	12	5296	LP_Signal_18	Yes
19	10	5295	LP_Signal_19	No
20	20	5299	LP_Signal_20	Yes
21	7	5306	LP_Signal_21	Yes
22	20	5301	LP_Signal_22	Yes
23	8	5306	LP_Signal_23	Yes
24	17	5302	LP_Signal_24	Yes
25	7	5306	LP_Signal_25	Yes
26	14	5303	LP_Signal_26	Yes
27	11	5305	LP_Signal_27	Yes
28	7	5306	LP_Signal_28	Yes
29	12	5304	LP_Signal_29	Yes
30	8	5306	LP_Signal_30	Yes

Detection Rate: 83.3 %

The Long Pulse Radar pattern shown in Appendix A.1

802.11ac (VHT20) CH60

Type 6 Radar Statistical Performances				
Trial #	Pulses per Burst	Pulse Width(us)	PRI(us)	Detection
1	9	1	333.3	Yes
2	9	1	333.3	Yes
3	9	1	333.3	Yes
4	9	1	333.3	Yes
5	9	1	333.3	Yes
6	9	1	333.3	Yes
7	9	1	333.3	No
8	9	1	333.3	Yes
9	9	1	333.3	Yes
10	9	1	333.3	Yes
11	9	1	333.3	Yes
12	9	1	333.3	Yes
13	9	1	333.3	No
14	9	1	333.3	Yes
15	9	1	333.3	Yes
16	9	1	333.3	Yes
17	9	1	333.3	Yes
18	9	1	333.3	Yes
19	9	1	333.3	Yes
20	9	1	333.3	Yes
21	9	1	333.3	Yes
22	9	1	333.3	Yes
23	9	1	333.3	Yes
24	9	1	333.3	Yes
25	9	1	333.3	Yes
26	9	1	333.3	Yes
27	9	1	333.3	Yes
28	9	1	333.3	No
29	9	1	333.3	Yes
30	9	1	333.3	Yes

Detection Rate: 90 %

802.11ac (VHT20) CH60

Type 6 Radar Statistical Performances		
Trial #	Hopping Frequency Sequence Name	Detection
1	HOP_FREQ_SEQ_01	Yes
2	HOP_FREQ_SEQ_02	Yes
3	HOP_FREQ_SEQ_03	Yes
4	HOP_FREQ_SEQ_04	Yes
5	HOP_FREQ_SEQ_05	Yes
6	HOP_FREQ_SEQ_06	Yes
7	HOP_FREQ_SEQ_07	No
8	HOP_FREQ_SEQ_08	Yes
9	HOP_FREQ_SEQ_09	Yes
10	HOP_FREQ_SEQ_10	Yes
11	HOP_FREQ_SEQ_11	Yes
12	HOP_FREQ_SEQ_12	Yes
13	HOP_FREQ_SEQ_13	No
14	HOP_FREQ_SEQ_14	Yes
15	HOP_FREQ_SEQ_15	Yes
16	HOP_FREQ_SEQ_16	Yes
17	HOP_FREQ_SEQ_17	Yes
18	HOP_FREQ_SEQ_18	Yes
19	HOP_FREQ_SEQ_19	Yes
20	HOP_FREQ_SEQ_20	Yes
21	HOP_FREQ_SEQ_21	Yes
22	HOP_FREQ_SEQ_22	Yes
23	HOP_FREQ_SEQ_23	Yes
24	HOP_FREQ_SEQ_24	Yes
25	HOP_FREQ_SEQ_25	Yes
26	HOP_FREQ_SEQ_26	Yes
27	HOP_FREQ_SEQ_27	Yes
28	HOP_FREQ_SEQ_28	No
29	HOP_FREQ_SEQ_29	Yes
30	HOP_FREQ_SEQ_30	Yes

Detection Rate: 90 %

The Frequency Hopping Radar pattern shown in Appendix A.2

802.11ac (VHT20)CH100

Type 1 Radar Statistical Performances						
Trial #	Test Frequency (MHz)	Pulse Repetition Frequency Number (1 to 23)	Pulse Repetition Frequency (Pulse per seconds)	Pulses per Burst	Pulse Repetition Interval (microseconds)	Detection
1	5500	15	1253	67	798	Yes
2	5497	16	1223	65	818	Yes
3	5503	4	1730	92	578	Yes
4	5505	11	1393	74	718	Yes
5	5497	22	1066	57	938	Yes
6	5501	7	1567	83	638	Yes
7	5505	2	1859	99	538	Yes



8	5496	8	1520	81	658	Yes
9	5508	1	1931	102	518	Yes
10	5500	19	1139	61	878	Yes
11	5491	21	1089	58	918	Yes
12	5507	23	326.2	18	3066	No
13	5498	9	1475	78	678	Yes
14	5499	5	1672	89	598	Yes
15	5504	6	1618	86	618	Yes
16	5492		1111	59	900	Yes
17	5500		1024	55	977	Yes
18	5492		625.8	34	1598	Yes
19	5509		730.5	39	1369	Yes
20	5498		1181	63	847	Yes
21	5508		400.6	22	2496	Yes
22	5491		529.4	28	1889	Yes
23	5509		347.6	19	2877	Yes
24	5509		641.4	34	1559	No
25	5493		508.9	27	1965	No
26	5495		345.4	19	2895	Yes
27	5501		580.7	31	1722	Yes
28	5494		786.8	42	1271	Yes
29	5501		808.4	43	1237	No
30	5501		517.1	28	1934	Yes

Detection Rate: 86.7 %

802.11ac (VHT20)CH100
Type 2 Radar Statistical Performances

Trial #	Test Frequency (MHz)	Pulses per Burst	Pulse Width(us)	PRI(us)	Detection
1	5500	24	1.7	174	Yes
2	5499	27	3.8	176	Yes
3	5508	28	4	161	Yes
4	5508	28	4.3	226	Yes
5	5506	24	1.9	193	No
6	5506	23	1.1	230	Yes
7	5495	29	4.5	198	Yes
8	5496	26	2.9	227	Yes
9	5504	26	2.8	171	No
10	5508	27	3.6	221	Yes
11	5496	23	1.1	180	Yes
12	5508	23	1.3	189	Yes
13	5495	25	2.5	204	Yes
14	5502	29	4.5	203	No
15	5500	29	5	170	Yes
16	5493	26	3.1	201	Yes
17	5492	24	2.1	218	Yes
18	5502	25	2.6	208	No
19	5495	24	1.8	223	Yes
20	5506	23	1.2	220	Yes
21	5499	26	2.9	224	Yes
22	5495	28	4	160	No
23	5507	25	2.5	209	Yes
24	5503	23	1	205	Yes
25	5493	27	3.7	151	Yes
26	5500	25	2.5	186	Yes
27	5505	23	1.5	190	Yes
28	5506	23	1.3	185	Yes
29	5507	23	1.2	175	Yes
30	5497	24	1.7	216	Yes

Detection Rate: 83.3 %

802.11ac (VHT20) CH100
Type 3 Radar Statistical Performances

Trial #	Test Frequency (MHz)	Pulses per Burst	Pulse Width(us)	PRI(us)	Detection
1	5500	16	6.7	467	Yes
2	5504	18	8.8	304	Yes
3	5497	18	9	316	Yes
4	5495	18	9.3	439	Yes
5	5507	16	6.9	420	Yes
6	5498	16	6.1	249	Yes
7	5503	18	9.5	463	No
8	5506	17	7.9	258	Yes
9	5494	17	7.8	212	Yes
10	5506	17	8.6	236	Yes
11	5494	16	6.1	474	Yes
12	5496	16	6.3	461	Yes
13	5500	17	7.5	437	Yes
14	5491	18	9.5	287	No
15	5497	18	10	395	Yes
16	5496	17	8.1	322	No
17	5495	16	7.1	468	Yes
18	5496	17	7.6	255	Yes
19	5508	16	6.8	423	Yes
20	5506	16	6.2	456	Yes
21	5495	17	7.9	351	Yes
22	5498	18	9	411	Yes
23	5497	17	7.5	279	Yes
24	5503	16	6	431	Yes
25	5507	17	8.7	324	Yes
26	5498	17	7.5	419	Yes
27	5505	16	6.5	447	Yes
28	5494	16	6.3	481	Yes
29	5506	16	6.2	438	Yes
30	5502	16	6.7	270	Yes

Detection Rate: 90 %

802.11ac (VHT20) CH100
Type 4 Radar Statistical Performances

Trial #	Test Frequency (MHz)	Pulses per Burst	Pulse Width(us)	PRI(us)	Detection
1	5500	12	12.5	467	Yes
2	5502	15	17.2	304	Yes
3	5493	15	17.8	316	Yes
4	5494	16	18.5	439	Yes
5	5506	13	13.1	420	Yes
6	5503	12	11.3	249	Yes
7	5504	16	18.8	463	Yes
8	5492	14	15.3	258	Yes
9	5498	14	15.1	212	Yes
10	5500	15	16.9	236	Yes
11	5506	12	11.2	474	Yes
12	5493	12	11.7	461	Yes
13	5506	13	14.4	437	Yes
14	5497	16	18.9	287	Yes
15	5492	16	19.9	395	Yes
16	5498	14	15.7	322	Yes
17	5508	13	13.4	468	Yes
18	5503	13	14.5	255	Yes
19	5494	13	12.9	423	Yes
20	5498	12	11.5	456	Yes
21	5491	14	15.3	351	Yes
22	5507	15	17.8	411	Yes
23	5496	13	14.3	279	No
24	5504	12	11.1	431	No
25	5495	15	17	324	Yes
26	5500	13	14.5	419	Yes
27	5496	12	12.1	447	No
28	5504	12	11.7	481	Yes
29	5507	12	11.6	438	No
30	5498	12	12.7	270	Yes

Detection Rate: 86.7 %

802.11ac (VHT20) CH100

Type 5 Radar Statistical Performances				
Trial #	Minimum Chirp Width(MHz)	Chirp Center Frequency(MHz)	Test Signal Name	Detection
1	17	5500	LP_Signal_01	Yes
2	7	5500	LP_Signal_02	Yes
3	8	5500	LP_Signal_03	Yes
4	19	5500	LP_Signal_04	Yes
5	12	5500	LP_Signal_05	Yes
6	11	5500	LP_Signal_06	Yes
7	6	5500	LP_Signal_07	Yes
8	20	5500	LP_Signal_08	Yes
9	6	5500	LP_Signal_09	No
10	12	5500	LP_Signal_10	Yes
11	16	5497	LP_Signal_11	Yes
12	20	5499	LP_Signal_12	Yes
13	18	5498	LP_Signal_13	Yes
14	12	5496	LP_Signal_14	No
15	12	5496	LP_Signal_15	Yes
16	15	5497	LP_Signal_16	Yes
17	10	5495	LP_Signal_17	Yes
18	12	5496	LP_Signal_18	Yes
19	10	5495	LP_Signal_19	No
20	20	5499	LP_Signal_20	Yes
21	7	5506	LP_Signal_21	Yes
22	20	5501	LP_Signal_22	Yes
23	8	5506	LP_Signal_23	Yes
24	17	5502	LP_Signal_24	Yes
25	7	5506	LP_Signal_25	Yes
26	14	5503	LP_Signal_26	Yes
27	11	5505	LP_Signal_27	Yes
28	7	5506	LP_Signal_28	Yes
29	12	5504	LP_Signal_29	Yes
30	8	5506	LP_Signal_30	Yes

Detection Rate: 90 %

The Long Pulse Radar pattern shown in Appendix A.1

802.11ac (VHT20) CH100

Type 6 Radar Statistical Performances				
Trial #	Pulses per Burst	Pulse Width(us)	PRI(us)	Detection
1	9	1	333.3	Yes
2	9	1	333.3	Yes
3	9	1	333.3	Yes
4	9	1	333.3	Yes
5	9	1	333.3	Yes
6	9	1	333.3	Yes
7	9	1	333.3	Yes
8	9	1	333.3	Yes
9	9	1	333.3	Yes
10	9	1	333.3	Yes
11	9	1	333.3	Yes
12	9	1	333.3	Yes
13	9	1	333.3	Yes
14	9	1	333.3	Yes
15	9	1	333.3	Yes
16	9	1	333.3	Yes
17	9	1	333.3	Yes
18	9	1	333.3	No
19	9	1	333.3	No
20	9	1	333.3	Yes
21	9	1	333.3	Yes
22	9	1	333.3	Yes
23	9	1	333.3	Yes
24	9	1	333.3	Yes
25	9	1	333.3	Yes
26	9	1	333.3	Yes
27	9	1	333.3	Yes
28	9	1	333.3	Yes
29	9	1	333.3	Yes
30	9	1	333.3	No
				Detection Rate: 90 %

802.11ac (VHT20) CH100

Type 6 Radar Statistical Performances		
Trial #	Hopping Frequency Sequence Name	Detection
1	HOP_FREQ_SEQ_01	Yes
2	HOP_FREQ_SEQ_02	Yes
3	HOP_FREQ_SEQ_03	Yes
4	HOP_FREQ_SEQ_04	Yes
5	HOP_FREQ_SEQ_05	Yes
6	HOP_FREQ_SEQ_06	Yes
7	HOP_FREQ_SEQ_07	Yes
8	HOP_FREQ_SEQ_08	Yes
9	HOP_FREQ_SEQ_09	Yes
10	HOP_FREQ_SEQ_10	Yes
11	HOP_FREQ_SEQ_11	Yes
12	HOP_FREQ_SEQ_12	Yes
13	HOP_FREQ_SEQ_13	Yes
14	HOP_FREQ_SEQ_14	Yes
15	HOP_FREQ_SEQ_15	Yes
16	HOP_FREQ_SEQ_16	Yes
17	HOP_FREQ_SEQ_17	Yes
18	HOP_FREQ_SEQ_18	No
19	HOP_FREQ_SEQ_19	No
20	HOP_FREQ_SEQ_20	Yes
21	HOP_FREQ_SEQ_21	Yes
22	HOP_FREQ_SEQ_22	Yes
23	HOP_FREQ_SEQ_23	Yes
24	HOP_FREQ_SEQ_24	Yes
25	HOP_FREQ_SEQ_25	Yes
26	HOP_FREQ_SEQ_26	Yes
27	HOP_FREQ_SEQ_27	Yes
28	HOP_FREQ_SEQ_28	Yes
29	HOP_FREQ_SEQ_29	Yes
30	HOP_FREQ_SEQ_30	No
		Detection Rate: 90 %

The Frequency Hopping Radar pattern shown in Appendix A.2



802.11ac (VHT40)CH62

Type 1 Radar Statistical Performances

Trial #	Test Frequency (MHz)	Pulse Repetition Frequency Number (1 to 23)	Pulse Repetition Frequency (Pulse per seconds)	Pulses per Burst	Pulse Repetition Interval (microseconds)	Detection
1	5310	15	1253	67	798	Yes
2	5320	16	1223	65	818	Yes
3	5300	4	1730	92	578	Yes
4	5307	11	1393	74	718	Yes
5	5311	22	1066	57	938	Yes
6	5301	7	1567	83	638	Yes
7	5326	2	1859	99	538	Yes
8	5300	8	1520	81	658	Yes
9	5318	1	1931	102	518	Yes
10	5320	19	1139	61	878	Yes
11	5293	21	1089	58	918	Yes
12	5292	23	326.2	18	3066	No
13	5327	9	1475	78	678	Yes
14	5298	5	1672	89	598	No
15	5309	6	1618	86	618	Yes
16	5318		1111	59	900	No
17	5316		1024	55	977	Yes
18	5314		625.8	34	1598	Yes
19	5324		730.5	39	1369	Yes
20	5316		1181	63	847	Yes
21	5301		400.6	22	2496	Yes
22	5313		529.4	28	1889	Yes
23	5297		347.6	19	2877	Yes
24	5318		641.4	34	1559	Yes
25	5327		508.9	27	1965	Yes
26	5301		345.4	19	2895	Yes
27	5306		580.7	31	1722	Yes
28	5304		786.8	42	1271	Yes
29	5297		808.4	43	1237	Yes
30	5315		517.1	28	1934	Yes

Detection Rate: 90 %

802.11ac (VHT40)CH62
Type 2 Radar Statistical Performances

Trial #	Test Frequency (MHz)	Pulses per Burst	Pulse Width(us)	PRI(us)	Detection
1	5310	24	1.7	174	Yes
2	5320	27	3.8	176	Yes
3	5300	28	4	161	Yes
4	5323	28	4.3	226	Yes
5	5312	24	1.9	193	Yes
6	5304	23	1.1	230	Yes
7	5320	29	4.5	198	Yes
8	5328	26	2.9	227	Yes
9	5303	26	2.8	171	Yes
10	5306	27	3.6	221	No
11	5298	23	1.1	180	Yes
12	5311	23	1.3	189	Yes
13	5308	25	2.5	204	Yes
14	5292	29	4.5	203	Yes
15	5322	29	5	170	Yes
16	5316	26	3.1	201	Yes
17	5320	24	2.1	218	Yes
18	5294	25	2.6	208	Yes
19	5302	24	1.8	223	Yes
20	5320	23	1.2	220	Yes
21	5328	26	2.9	224	No
22	5295	28	4	160	No
23	5293	25	2.5	209	Yes
24	5326	23	1	205	Yes
25	5310	27	3.7	151	Yes
26	5303	25	2.5	186	Yes
27	5297	23	1.5	190	No
28	5316	23	1.3	185	No
29	5301	23	1.2	175	Yes
30	5327	24	1.7	216	Yes

Detection Rate: 83.3 %

802.11ac (VHT40)CH62
Type 3 Radar Statistical Performances

Trial #	Test Frequency (MHz)	Pulses per Burst	Pulse Width(us)	PRI(us)	Detection
1	5310	16	6.7	467	Yes
2	5320	18	8.8	304	Yes
3	5300	18	9	316	Yes
4	5305	18	9.3	439	Yes
5	5314	16	6.9	420	Yes
6	5304	16	6.1	249	Yes
7	5323	18	9.5	463	Yes
8	5310	17	7.9	258	Yes
9	5316	17	7.8	212	No
10	5321	17	8.6	236	Yes
11	5314	16	6.1	474	Yes
12	5313	16	6.3	461	Yes
13	5301	17	7.5	437	Yes
14	5309	18	9.5	287	Yes
15	5319	18	10	395	Yes
16	5306	17	8.1	322	Yes
17	5318	16	7.1	468	Yes
18	5300	17	7.6	255	Yes
19	5314	16	6.8	423	Yes
20	5310	16	6.2	456	Yes
21	5323	17	7.9	351	No
22	5301	18	9	411	No
23	5293	17	7.5	279	Yes
24	5298	16	6	431	Yes
25	5314	17	8.7	324	Yes
26	5313	17	7.5	419	Yes
27	5300	16	6.5	447	Yes
28	5315	16	6.3	481	Yes
29	5302	16	6.2	438	Yes
30	5296	16	6.7	270	Yes

Detection Rate: 90 %

802.11ac (VHT40)CH62
Type 4 Radar Statistical Performances

Trial #	Test Frequency (MHz)	Pulses per Burst	Pulse Width(us)	PRI(us)	Detection
1	5310	12	12.5	467	No
2	5320	15	17.2	304	Yes
3	5300	15	17.8	316	Yes
4	5305	16	18.5	439	Yes
5	5319	13	13.1	420	Yes
6	5302	12	11.3	249	Yes
7	5293	16	18.8	463	No
8	5314	14	15.3	258	Yes
9	5298	14	15.1	212	Yes
10	5322	15	16.9	236	Yes
11	5313	12	11.2	474	Yes
12	5322	12	11.7	461	Yes
13	5323	13	14.4	437	Yes
14	5326	16	18.9	287	Yes
15	5325	16	19.9	395	No
16	5313	14	15.7	322	Yes
17	5295	13	13.4	468	Yes
18	5298	13	14.5	255	Yes
19	5307	13	12.9	423	Yes
20	5309	12	11.5	456	Yes
21	5307	14	15.3	351	Yes
22	5317	15	17.8	411	Yes
23	5298	13	14.3	279	Yes
24	5328	12	11.1	431	Yes
25	5310	15	17	324	Yes
26	5323	13	14.5	419	Yes
27	5327	12	12.1	447	No
28	5305	12	11.7	481	Yes
29	5311	12	11.6	438	Yes
30	5311	12	12.7	270	Yes

Detection Rate: 86.7 %

802.11ac (VHT40)CH62

Type 5 Radar Statistical Performances

Trial #	Minimum Chirp Width(MHz)	Chirp Center Frequency(MHz)	Test Signal Name	Detection
1	17	5310	LP_Signal_01	Yes
2	7	5310	LP_Signal_02	Yes
3	8	5310	LP_Signal_03	Yes
4	19	5310	LP_Signal_04	No
5	12	5310	LP_Signal_05	Yes
6	11	5310	LP_Signal_06	Yes
7	6	5310	LP_Signal_07	Yes
8	20	5310	LP_Signal_08	Yes
9	6	5310	LP_Signal_09	Yes
10	12	5310	LP_Signal_10	Yes
11	16	5297	LP_Signal_11	Yes
12	20	5299	LP_Signal_12	No
13	18	5298	LP_Signal_13	Yes
14	12	5296	LP_Signal_14	Yes
15	12	5296	LP_Signal_15	Yes
16	15	5297	LP_Signal_16	Yes
17	10	5295	LP_Signal_17	Yes
18	12	5296	LP_Signal_18	Yes
19	10	5295	LP_Signal_19	Yes
20	20	5299	LP_Signal_20	Yes
21	7	5326	LP_Signal_21	Yes
22	20	5321	LP_Signal_22	Yes
23	8	5326	LP_Signal_23	Yes
24	17	5322	LP_Signal_24	Yes
25	7	5326	LP_Signal_25	Yes
26	14	5323	LP_Signal_26	Yes
27	11	5325	LP_Signal_27	No
28	7	5326	LP_Signal_28	Yes
29	12	5324	LP_Signal_29	Yes
30	8	5326	LP_Signal_30	Yes

Detection Rate: 90 %

The Long Pulse Radar pattern shown in Appendix A.1

802.11ac (VHT40)CH62

Type 6 Radar Statistical Performances				
Trial #	Pulses per Burst	Pulse Width(us)	PRI(us)	Detection
1	9	1	333.3	No
2	9	1	333.3	Yes
3	9	1	333.3	Yes
4	9	1	333.3	Yes
5	9	1	333.3	Yes
6	9	1	333.3	Yes
7	9	1	333.3	Yes
8	9	1	333.3	Yes
9	9	1	333.3	No
10	9	1	333.3	Yes
11	9	1	333.3	Yes
12	9	1	333.3	Yes
13	9	1	333.3	Yes
14	9	1	333.3	Yes
15	9	1	333.3	Yes
16	9	1	333.3	Yes
17	9	1	333.3	Yes
18	9	1	333.3	Yes
19	9	1	333.3	Yes
20	9	1	333.3	Yes
21	9	1	333.3	Yes
22	9	1	333.3	Yes
23	9	1	333.3	Yes
24	9	1	333.3	Yes
25	9	1	333.3	Yes
26	9	1	333.3	Yes
27	9	1	333.3	Yes
28	9	1	333.3	Yes
29	9	1	333.3	Yes
30	9	1	333.3	Yes
				Detection Rate: 93.3 %

802.11ac (VHT40)CH62

Type 6 Radar Statistical Performances		
Trial #	Hopping Frequency Sequence Name	Detection
1	HOP_FREQ_SEQ_01	No
2	HOP_FREQ_SEQ_02	Yes
3	HOP_FREQ_SEQ_03	Yes
4	HOP_FREQ_SEQ_04	Yes
5	HOP_FREQ_SEQ_05	Yes
6	HOP_FREQ_SEQ_06	Yes
7	HOP_FREQ_SEQ_07	Yes
8	HOP_FREQ_SEQ_08	Yes
9	HOP_FREQ_SEQ_09	No
10	HOP_FREQ_SEQ_10	Yes
11	HOP_FREQ_SEQ_11	Yes
12	HOP_FREQ_SEQ_12	Yes
13	HOP_FREQ_SEQ_13	Yes
14	HOP_FREQ_SEQ_14	Yes
15	HOP_FREQ_SEQ_15	Yes
16	HOP_FREQ_SEQ_16	Yes
17	HOP_FREQ_SEQ_17	Yes
18	HOP_FREQ_SEQ_18	Yes
19	HOP_FREQ_SEQ_19	Yes
20	HOP_FREQ_SEQ_20	Yes
21	HOP_FREQ_SEQ_21	Yes
22	HOP_FREQ_SEQ_22	Yes
23	HOP_FREQ_SEQ_23	Yes
24	HOP_FREQ_SEQ_24	Yes
25	HOP_FREQ_SEQ_25	Yes
26	HOP_FREQ_SEQ_26	Yes
27	HOP_FREQ_SEQ_27	Yes
28	HOP_FREQ_SEQ_28	Yes
29	HOP_FREQ_SEQ_29	Yes
30	HOP_FREQ_SEQ_30	Yes
		Detection Rate: 93.3 %

The Frequency Hopping Radar pattern shown in Appendix A.2



802.11ac (VHT40)CH102

Type 1 Radar Statistical Performances

Trial #	Test Frequency (MHz)	Pulse Repetition Frequency Number (1 to 23)	Pulse Repetition Frequency (Pulse per seconds)	Pulses per Burst	Pulse Repetition Interval (microseconds)	Detection
1	5510	15	1253	67	798	Yes
2	5520	16	1223	65	818	Yes
3	5500	4	1730	92	578	Yes
4	5513	11	1393	74	718	Yes
5	5512	22	1066	57	938	No
6	5521	7	1567	83	638	Yes
7	5527	2	1859	99	538	Yes
8	5523	8	1520	81	658	Yes
9	5516	1	1931	102	518	Yes
10	5504	19	1139	61	878	Yes
11	5504	21	1089	58	918	Yes
12	5492	23	326.2	18	3066	No
13	5504	9	1475	78	678	Yes
14	5521	5	1672	89	598	Yes
15	5524	6	1618	86	618	No
16	5526		1111	59	900	Yes
17	5518		1024	55	977	Yes
18	5501		625.8	34	1598	Yes
19	5495		730.5	39	1369	Yes
20	5514		1181	63	847	Yes
21	5516		400.6	22	2496	Yes
22	5528		529.4	28	1889	Yes
23	5498		347.6	19	2877	Yes
24	5528		641.4	34	1559	Yes
25	5524		508.9	27	1965	Yes
26	5504		345.4	19	2895	Yes
27	5524		580.7	31	1722	Yes
28	5516		786.8	42	1271	Yes
29	5505		808.4	43	1237	Yes
30	5499		517.1	28	1934	Yes

Detection Rate: 90 %

802.11ac (VHT40)CH102

Type 2 Radar Statistical Performances

Trial #	Test Frequency (MHz)	Pulses per Burst	Pulse Width(us)	PRI(us)	Detection
1	5510	24	1.7	174	Yes
2	5520	27	3.8	176	Yes
3	5500	28	4	161	Yes
4	5509	28	4.3	226	No
5	5507	24	1.9	193	Yes
6	5505	23	1.1	230	No
7	5495	29	4.5	198	Yes
8	5523	26	2.9	227	Yes
9	5507	26	2.8	171	Yes
10	5528	27	3.6	221	Yes
11	5514	23	1.1	180	Yes
12	5502	23	1.3	189	Yes
13	5495	25	2.5	204	Yes
14	5517	29	4.5	203	Yes
15	5528	29	5	170	Yes
16	5510	26	3.1	201	Yes
17	5503	24	2.1	218	Yes
18	5511	25	2.6	208	Yes
19	5506	24	1.8	223	Yes
20	5518	23	1.2	220	No
21	5514	26	2.9	224	Yes
22	5496	28	4	160	Yes
23	5503	25	2.5	209	Yes
24	5525	23	1	205	Yes
25	5497	27	3.7	151	Yes
26	5492	25	2.5	186	Yes
27	5503	23	1.5	190	Yes
28	5506	23	1.3	185	Yes
29	5496	23	1.2	175	Yes
30	5499	24	1.7	216	No

Detection Rate: 86.7 %

802.11ac (VHT40)CH102
Type 3 Radar Statistical Performances

Trial #	Test Frequency (MHz)	Pulses per Burst	Pulse Width(us)	PRI(us)	Detection
1	5510	16	6.7	467	Yes
2	5520	18	8.8	304	Yes
3	5500	18	9	316	Yes
4	5525	18	9.3	439	Yes
5	5505	16	6.9	420	Yes
6	5504	16	6.1	249	Yes
7	5499	18	9.5	463	Yes
8	5496	17	7.9	258	No
9	5511	17	7.8	212	Yes
10	5504	17	8.6	236	Yes
11	5518	16	6.1	474	Yes
12	5513	16	6.3	461	Yes
13	5516	17	7.5	437	Yes
14	5505	18	9.5	287	No
15	5511	18	10	395	Yes
16	5521	17	8.1	322	Yes
17	5501	16	7.1	468	Yes
18	5511	17	7.6	255	Yes
19	5515	16	6.8	423	Yes
20	5504	16	6.2	456	Yes
21	5499	17	7.9	351	Yes
22	5505	18	9	411	Yes
23	5493	17	7.5	279	Yes
24	5523	16	6	431	No
25	5496	17	8.7	324	Yes
26	5498	17	7.5	419	Yes
27	5498	16	6.5	447	Yes
28	5502	16	6.3	481	Yes
29	5507	16	6.2	438	Yes
30	5494	16	6.7	270	Yes

Detection Rate: 90 %

802.11ac (VHT40)CH102

Type 4 Radar Statistical Performances					
Trial #	Test Frequency (MHz)	Pulses per Burst	Pulse Width(us)	PRI(us)	Detection
1	5510	12	12.5	467	Yes
2	5520	15	17.2	304	No
3	5500	15	17.8	316	Yes
4	5512	16	18.5	439	Yes
5	5507	13	13.1	420	No
6	5515	12	11.3	249	No
7	5510	16	18.8	463	Yes
8	5510	14	15.3	258	Yes
9	5503	14	15.1	212	Yes
10	5519	15	16.9	236	Yes
11	5520	12	11.2	474	Yes
12	5518	12	11.7	461	Yes
13	5527	13	14.4	437	Yes
14	5521	16	18.9	287	Yes
15	5526	16	19.9	395	Yes
16	5527	14	15.7	322	No
17	5526	13	13.4	468	Yes
18	5499	13	14.5	255	Yes
19	5512	13	12.9	423	Yes
20	5505	12	11.5	456	Yes
21	5509	14	15.3	351	Yes
22	5517	15	17.8	411	Yes
23	5495	13	14.3	279	Yes
24	5497	12	11.1	431	Yes
25	5494	15	17	324	Yes
26	5494	13	14.5	419	No
27	5514	12	12.1	447	Yes
28	5522	12	11.7	481	Yes
29	5518	12	11.6	438	Yes
30	5511	12	12.7	270	Yes

Detection Rate: 83.3 %

802.11ac (VHT40)CH102
Type 5 Radar Statistical Performances

Trial #	Minimum Chirp Width(MHz)	Chirp Center Frequency(MHz)	Test Signal Name	Detection
1	17	5510	LP_Signal_01	Yes
2	7	5510	LP_Signal_02	Yes
3	8	5510	LP_Signal_03	Yes
4	19	5510	LP_Signal_04	Yes
5	12	5510	LP_Signal_05	Yes
6	11	5510	LP_Signal_06	Yes
7	6	5510	LP_Signal_07	Yes
8	20	5510	LP_Signal_08	Yes
9	6	5510	LP_Signal_09	Yes
10	12	5510	LP_Signal_10	Yes
11	16	5497	LP_Signal_11	Yes
12	20	5499	LP_Signal_12	Yes
13	18	5498	LP_Signal_13	Yes
14	12	5496	LP_Signal_14	Yes
15	12	5496	LP_Signal_15	No
16	15	5497	LP_Signal_16	Yes
17	10	5495	LP_Signal_17	Yes
18	12	5496	LP_Signal_18	Yes
19	10	5495	LP_Signal_19	Yes
20	20	5499	LP_Signal_20	Yes
21	7	5526	LP_Signal_21	Yes
22	20	5521	LP_Signal_22	No
23	8	5526	LP_Signal_23	Yes
24	17	5522	LP_Signal_24	Yes
25	7	5526	LP_Signal_25	No
26	14	5523	LP_Signal_26	Yes
27	11	5525	LP_Signal_27	Yes
28	7	5526	LP_Signal_28	Yes
29	12	5524	LP_Signal_29	Yes
30	8	5526	LP_Signal_30	Yes

Detection Rate: 90 %

The Long Pulse Radar pattern shown in Appendix A.1

802.11ac (VHT40)CH102

Type 6 Radar Statistical Performances				
Trial #	Pulses per Burst	Pulse Width(us)	PRI(us)	Detection
1	9	1	333.3	Yes
2	9	1	333.3	Yes
3	9	1	333.3	No
4	9	1	333.3	Yes
5	9	1	333.3	Yes
6	9	1	333.3	Yes
7	9	1	333.3	Yes
8	9	1	333.3	Yes
9	9	1	333.3	Yes
10	9	1	333.3	Yes
11	9	1	333.3	Yes
12	9	1	333.3	Yes
13	9	1	333.3	Yes
14	9	1	333.3	Yes
15	9	1	333.3	Yes
16	9	1	333.3	Yes
17	9	1	333.3	Yes
18	9	1	333.3	Yes
19	9	1	333.3	Yes
20	9	1	333.3	Yes
21	9	1	333.3	Yes
22	9	1	333.3	Yes
23	9	1	333.3	Yes
24	9	1	333.3	No
25	9	1	333.3	Yes
26	9	1	333.3	Yes
27	9	1	333.3	Yes
28	9	1	333.3	Yes
29	9	1	333.3	Yes
30	9	1	333.3	Yes
				Detection Rate: 93.3 %

802.11ac (VHT40)CH102

Type 6 Radar Statistical Performances		
Trial #	Hopping Frequency Sequence Name	Detection
1	HOP_FREQ_SEQ_01	Yes
2	HOP_FREQ_SEQ_02	Yes
3	HOP_FREQ_SEQ_03	No
4	HOP_FREQ_SEQ_04	Yes
5	HOP_FREQ_SEQ_05	Yes
6	HOP_FREQ_SEQ_06	Yes
7	HOP_FREQ_SEQ_07	Yes
8	HOP_FREQ_SEQ_08	Yes
9	HOP_FREQ_SEQ_09	Yes
10	HOP_FREQ_SEQ_10	Yes
11	HOP_FREQ_SEQ_11	Yes
12	HOP_FREQ_SEQ_12	Yes
13	HOP_FREQ_SEQ_13	Yes
14	HOP_FREQ_SEQ_14	Yes
15	HOP_FREQ_SEQ_15	Yes
16	HOP_FREQ_SEQ_16	Yes
17	HOP_FREQ_SEQ_17	Yes
18	HOP_FREQ_SEQ_18	Yes
19	HOP_FREQ_SEQ_19	Yes
20	HOP_FREQ_SEQ_20	Yes
21	HOP_FREQ_SEQ_21	Yes
22	HOP_FREQ_SEQ_22	Yes
23	HOP_FREQ_SEQ_23	Yes
24	HOP_FREQ_SEQ_24	No
25	HOP_FREQ_SEQ_25	Yes
26	HOP_FREQ_SEQ_26	Yes
27	HOP_FREQ_SEQ_27	Yes
28	HOP_FREQ_SEQ_28	Yes
29	HOP_FREQ_SEQ_29	Yes
30	HOP_FREQ_SEQ_30	Yes
		Detection Rate: 93.3 %

The Frequency Hopping Radar pattern shown in Appendix A.2

802.11ac (VHT80)CH58
Type 1 Radar Statistical Performances

Trial #	Test Frequency (MHz)	Pulse Repetition Frequency Number (1 to 23)	Pulse Repetition Frequency (Pulse per seconds)	Pulses per Burst	Pulse Repetition Interval (microseconds)	Detection
1	5290	15	1253	67	798	No
2	5300	16	1223	65	818	Yes
3	5320	4	1730	92	578	Yes
4	5280	11	1393	74	718	Yes
5	5260	22	1066	57	938	Yes
6	5287	7	1567	83	638	Yes
7	5300	2	1859	99	538	Yes
8	5278	8	1520	81	658	Yes
9	5277	1	1931	102	518	Yes
10	5289	19	1139	61	878	Yes
11	5304	21	1089	58	918	Yes
12	5289	23	326.2	18	3066	Yes
13	5277	9	1475	78	678	Yes
14	5264	5	1672	89	598	Yes
15	5296	6	1618	86	618	Yes
16	5307		1111	59	900	Yes
17	5296		1024	55	977	Yes
18	5319		625.8	34	1598	Yes
19	5263		730.5	39	1369	Yes
20	5325		1181	63	847	Yes
21	5255		400.6	22	2496	No
22	5299		529.4	28	1889	Yes
23	5309		347.6	19	2877	No
24	5277		641.4	34	1559	Yes
25	5281		508.9	27	1965	Yes
26	5253		345.4	19	2895	Yes
27	5264		580.7	31	1722	No
28	5308		786.8	42	1271	Yes
29	5289		808.4	43	1237	Yes
30	5267		517.1	28	1934	Yes

Detection Rate: 86.7 %

802.11ac (VHT80)CH58
Type 2 Radar Statistical Performances

Trial #	Test Frequency (MHz)	Pulses per Burst	Pulse Width(us)	PRI(us)	Detection
1	5290	24	1.7	174	Yes
2	5300	27	3.8	176	Yes
3	5320	28	4	161	Yes
4	5280	28	4.3	226	Yes
5	5260	24	1.9	193	Yes
6	5286	23	1.1	230	Yes
7	5267	29	4.5	198	Yes
8	5263	26	2.9	227	Yes
9	5272	26	2.8	171	Yes
10	5262	27	3.6	221	Yes
11	5261	23	1.1	180	Yes
12	5306	23	1.3	189	Yes
13	5275	25	2.5	204	Yes
14	5323	29	4.5	203	Yes
15	5293	29	5	170	Yes
16	5313	26	3.1	201	Yes
17	5277	24	2.1	218	Yes
18	5274	25	2.6	208	Yes
19	5262	24	1.8	223	Yes
20	5304	23	1.2	220	No
21	5315	26	2.9	224	Yes
22	5307	28	4	160	Yes
23	5294	25	2.5	209	Yes
24	5277	23	1	205	Yes
25	5299	27	3.7	151	Yes
26	5316	25	2.5	186	Yes
27	5290	23	1.5	190	Yes
28	5319	23	1.3	185	Yes
29	5277	23	1.2	175	No
30	5268	24	1.7	216	No

Detection Rate: 90 %

802.11ac (VHT80)CH58
Type 3 Radar Statistical Performances

Trial #	Test Frequency (MHz)	Pulses per Burst	Pulse Width(us)	PRI(us)	Detection
1	5290	16	6.7	467	No
2	5300	18	8.8	304	Yes
3	5320	18	9	316	Yes
4	5280	18	9.3	439	Yes
5	5260	16	6.9	420	Yes
6	5267	16	6.1	249	Yes
7	5300	18	9.5	463	No
8	5276	17	7.9	258	Yes
9	5301	17	7.8	212	Yes
10	5320	17	8.6	236	No
11	5279	16	6.1	474	Yes
12	5291	16	6.3	461	Yes
13	5283	17	7.5	437	Yes
14	5283	18	9.5	287	Yes
15	5312	18	10	395	Yes
16	5319	17	8.1	322	Yes
17	5301	16	7.1	468	Yes
18	5301	17	7.6	255	Yes
19	5315	16	6.8	423	Yes
20	5316	16	6.2	456	Yes
21	5314	17	7.9	351	Yes
22	5305	18	9	411	Yes
23	5283	17	7.5	279	Yes
24	5317	16	6	431	Yes
25	5286	17	8.7	324	Yes
26	5325	17	7.5	419	Yes
27	5316	16	6.5	447	Yes
28	5258	16	6.3	481	Yes
29	5300	16	6.2	438	Yes
30	5256	16	6.7	270	Yes

Detection Rate: 90 %

802.11ac (VHT80)CH58
Type 4 Radar Statistical Performances

Trial #	Test Frequency (MHz)	Pulses per Burst	Pulse Width(us)	PRI(us)	Detection
1	5290	12	12.5	467	Yes
2	5300	15	17.2	304	Yes
3	5320	15	17.8	316	Yes
4	5280	16	18.5	439	Yes
5	5260	13	13.1	420	No
6	5285	12	11.3	249	Yes
7	5309	16	18.8	463	Yes
8	5280	14	15.3	258	Yes
9	5278	14	15.1	212	No
10	5283	15	16.9	236	Yes
11	5277	12	11.2	474	Yes
12	5255	12	11.7	461	Yes
13	5277	13	14.4	437	Yes
14	5304	16	18.9	287	Yes
15	5264	16	19.9	395	Yes
16	5308	14	15.7	322	Yes
17	5269	13	13.4	468	Yes
18	5256	13	14.5	255	Yes
19	5325	13	12.9	423	Yes
20	5268	12	11.5	456	Yes
21	5322	14	15.3	351	Yes
22	5258	15	17.8	411	Yes
23	5257	13	14.3	279	No
24	5294	12	11.1	431	Yes
25	5289	15	17	324	Yes
26	5265	13	14.5	419	No
27	5293	12	12.1	447	No
28	5255	12	11.7	481	Yes
29	5290	12	11.6	438	Yes
30	5316	12	12.7	270	Yes

Detection Rate: 83.3 %

802.11ac (VHT80)CH58
Type 5 Radar Statistical Performances

Trial #	Minimum Chirp Width(MHz)	Chirp Center Frequency(MHz)	Test Signal Name	Detection
1	17	5290	LP_Signal_01	Yes
2	7	5290	LP_Signal_02	Yes
3	8	5290	LP_Signal_03	Yes
4	19	5290	LP_Signal_04	Yes
5	12	5290	LP_Signal_05	Yes
6	11	5290	LP_Signal_06	Yes
7	6	5290	LP_Signal_07	Yes
8	20	5290	LP_Signal_08	Yes
9	6	5290	LP_Signal_09	No
10	12	5290	LP_Signal_10	Yes
11	16	5258	LP_Signal_11	Yes
12	20	5260	LP_Signal_12	Yes
13	18	5259	LP_Signal_13	No
14	12	5257	LP_Signal_14	Yes
15	12	5257	LP_Signal_15	No
16	15	5258	LP_Signal_16	Yes
17	10	5256	LP_Signal_17	Yes
18	12	5257	LP_Signal_18	No
19	10	5256	LP_Signal_19	No
20	20	5260	LP_Signal_20	Yes
21	7	5325	LP_Signal_21	Yes
22	20	5320	LP_Signal_22	Yes
23	8	5325	LP_Signal_23	Yes
24	17	5321	LP_Signal_24	Yes
25	7	5325	LP_Signal_25	Yes
26	14	5322	LP_Signal_26	Yes
27	11	5324	LP_Signal_27	Yes
28	7	5325	LP_Signal_28	Yes
29	12	5323	LP_Signal_29	Yes
30	8	5325	LP_Signal_30	Yes

Detection Rate: 83.3 %

The Long Pulse Radar pattern shown in Appendix A.1

802.11ac (VHT80)CH58

Type 6 Radar Statistical Performances				
Trial #	Pulses per Burst	Pulse Width(us)	PRI(us)	Detection
1	9	1	333.3	Yes
2	9	1	333.3	Yes
3	9	1	333.3	Yes
4	9	1	333.3	Yes
5	9	1	333.3	No
6	9	1	333.3	Yes
7	9	1	333.3	Yes
8	9	1	333.3	Yes
9	9	1	333.3	Yes
10	9	1	333.3	Yes
11	9	1	333.3	Yes
12	9	1	333.3	Yes
13	9	1	333.3	Yes
14	9	1	333.3	Yes
15	9	1	333.3	Yes
16	9	1	333.3	Yes
17	9	1	333.3	Yes
18	9	1	333.3	Yes
19	9	1	333.3	Yes
20	9	1	333.3	Yes
21	9	1	333.3	Yes
22	9	1	333.3	Yes
23	9	1	333.3	Yes
24	9	1	333.3	Yes
25	9	1	333.3	Yes
26	9	1	333.3	Yes
27	9	1	333.3	Yes
28	9	1	333.3	Yes
29	9	1	333.3	No
30	9	1	333.3	No
				Detection Rate: 90%

802.11ac (VHT80)CH58

Type 6 Radar Statistical Performances		
Trial #	Hopping Frequency Sequence Name	Detection
1	HOP_FREQ_SEQ_01	Yes
2	HOP_FREQ_SEQ_02	Yes
3	HOP_FREQ_SEQ_03	Yes
4	HOP_FREQ_SEQ_04	Yes
5	HOP_FREQ_SEQ_05	No
6	HOP_FREQ_SEQ_06	Yes
7	HOP_FREQ_SEQ_07	Yes
8	HOP_FREQ_SEQ_08	Yes
9	HOP_FREQ_SEQ_09	Yes
10	HOP_FREQ_SEQ_10	Yes
11	HOP_FREQ_SEQ_11	Yes
12	HOP_FREQ_SEQ_12	Yes
13	HOP_FREQ_SEQ_13	Yes
14	HOP_FREQ_SEQ_14	Yes
15	HOP_FREQ_SEQ_15	Yes
16	HOP_FREQ_SEQ_16	Yes
17	HOP_FREQ_SEQ_17	Yes
18	HOP_FREQ_SEQ_18	Yes
19	HOP_FREQ_SEQ_19	Yes
20	HOP_FREQ_SEQ_20	Yes
21	HOP_FREQ_SEQ_21	Yes
22	HOP_FREQ_SEQ_22	Yes
23	HOP_FREQ_SEQ_23	Yes
24	HOP_FREQ_SEQ_24	Yes
25	HOP_FREQ_SEQ_25	Yes
26	HOP_FREQ_SEQ_26	Yes
27	HOP_FREQ_SEQ_27	Yes
28	HOP_FREQ_SEQ_28	Yes
29	HOP_FREQ_SEQ_29	No
30	HOP_FREQ_SEQ_30	No
		Detection Rate: 90 %

The Frequency Hopping Radar pattern shown in Appendix A.2

802.11ac (VHT80)CH106
Type 1 Radar Statistical Performances

Trial #	Test Frequency (MHz)	Pulse Repetition Frequency Number (1 to 23)	Pulse Repetition Frequency (Pulse per seconds)	Pulses per Burst	Pulse Repetition Interval (microseconds)	Detection
1	5530	15	1253	67	798	Yes
2	5540	16	1223	65	818	Yes
3	5560	4	1730	92	578	Yes
4	5520	11	1393	74	718	Yes
5	5500	22	1066	57	938	Yes
6	5495	7	1567	83	638	Yes
7	5533	2	1859	99	538	No
8	5558	8	1520	81	658	Yes
9	5518	1	1931	102	518	No
10	5553	19	1139	61	878	No
11	5508	21	1089	58	918	Yes
12	5554	23	326.2	18	3066	Yes
13	5506	9	1475	78	678	Yes
14	5552	5	1672	89	598	No
15	5537	6	1618	86	618	Yes
16	5513		1111	59	900	Yes
17	5537		1024	55	977	Yes
18	5520		625.8	34	1598	Yes
19	5566		730.5	39	1369	Yes
20	5545		1181	63	847	Yes
21	5544		400.6	22	2496	Yes
22	5537		529.4	28	1889	Yes
23	5515		347.6	19	2877	Yes
24	5495		641.4	34	1559	Yes
25	5523		508.9	27	1965	Yes
26	5561		345.4	19	2895	Yes
27	5523		580.7	31	1722	Yes
28	5516		786.8	42	1271	Yes
29	5536		808.4	43	1237	Yes
30	5556		517.1	28	1934	Yes

Detection Rate: 86.7 %

802.11ac (VHT80)CH106
Type 2 Radar Statistical Performances

Trial #	Test Frequency (MHz)	Pulses per Burst	Pulse Width(us)	PRI(us)	Detection
1	5530	24	1.7	174	Yes
2	5540	27	3.8	176	Yes
3	5560	28	4	161	Yes
4	5520	28	4.3	226	Yes
5	5500	24	1.9	193	Yes
6	5519	23	1.1	230	Yes
7	5555	29	4.5	198	Yes
8	5528	26	2.9	227	Yes
9	5553	26	2.8	171	Yes
10	5496	27	3.6	221	No
11	5542	23	1.1	180	No
12	5510	23	1.3	189	Yes
13	5548	25	2.5	204	Yes
14	5545	29	4.5	203	No
15	5529	29	5	170	Yes
16	5545	26	3.1	201	Yes
17	5523	24	2.1	218	Yes
18	5510	25	2.6	208	No
19	5532	24	1.8	223	Yes
20	5548	23	1.2	220	No
21	5518	26	2.9	224	Yes
22	5535	28	4	160	Yes
23	5557	25	2.5	209	Yes
24	5566	23	1	205	Yes
25	5501	27	3.7	151	Yes
26	5512	25	2.5	186	Yes
27	5516	23	1.5	190	Yes
28	5564	23	1.3	185	Yes
29	5530	23	1.2	175	Yes
30	5525	24	1.7	216	Yes

Detection Rate: 83.3 %

802.11ac (VHT80)CH106
Type 3 Radar Statistical Performances

Trial #	Test Frequency (MHz)	Pulses per Burst	Pulse Width(us)	PRI(us)	Detection
1	5530	16	6.7	467	Yes
2	5540	18	8.8	304	Yes
3	5560	18	9	316	Yes
4	5520	18	9.3	439	Yes
5	5500	16	6.9	420	No
6	5560	16	6.1	249	No
7	5501	18	9.5	463	Yes
8	5550	17	7.9	258	Yes
9	5558	17	7.8	212	Yes
10	5496	17	8.6	236	Yes
11	5520	16	6.1	474	No
12	5494	16	6.3	461	Yes
13	5533	17	7.5	437	Yes
14	5562	18	9.5	287	No
15	5548	18	10	395	Yes
16	5511	17	8.1	322	No
17	5531	16	7.1	468	Yes
18	5532	17	7.6	255	Yes
19	5493	16	6.8	423	Yes
20	5551	16	6.2	456	Yes
21	5532	17	7.9	351	Yes
22	5561	18	9	411	Yes
23	5550	17	7.5	279	Yes
24	5503	16	6	431	Yes
25	5507	17	8.7	324	Yes
26	5545	17	7.5	419	Yes
27	5522	16	6.5	447	Yes
28	5511	16	6.3	481	Yes
29	5505	16	6.2	438	Yes
30	5556	16	6.7	270	Yes

Detection Rate: 83.3 %

802.11ac (VHT80)CH106
Type 4 Radar Statistical Performances

Trial #	Test Frequency (MHz)	Pulses per Burst	Pulse Width(us)	PRI(us)	Detection
1	5530	12	12.5	467	Yes
2	5540	15	17.2	304	Yes
3	5560	15	17.8	316	No
4	5520	16	18.5	439	Yes
5	5500	13	13.1	420	Yes
6	5556	12	11.3	249	No
7	5541	16	18.8	463	Yes
8	5497	14	15.3	258	Yes
9	5498	14	15.1	212	Yes
10	5536	15	16.9	236	Yes
11	5541	12	11.2	474	Yes
12	5525	12	11.7	461	Yes
13	5508	13	14.4	437	Yes
14	5505	16	18.9	287	Yes
15	5513	16	19.9	395	Yes
16	5561	14	15.7	322	Yes
17	5556	13	13.4	468	Yes
18	5501	13	14.5	255	Yes
19	5493	13	12.9	423	Yes
20	5537	12	11.5	456	Yes
21	5556	14	15.3	351	Yes
22	5551	15	17.8	411	Yes
23	5504	13	14.3	279	Yes
24	5531	12	11.1	431	No
25	5493	15	17	324	Yes
26	5514	13	14.5	419	Yes
27	5515	12	12.1	447	Yes
28	5536	12	11.7	481	Yes
29	5520	12	11.6	438	No
30	5545	12	12.7	270	Yes

Detection Rate: 86.7 %

802.11ac (VHT80)CH106
Type 5 Radar Statistical Performances

Trial #	Minimum Chirp Width(MHz)	Chirp Center Frequency(MHz)	Test Signal Name	Detection
1	17	5530	LP_Signal_01	Yes
2	7	5530	LP_Signal_02	Yes
3	8	5530	LP_Signal_03	Yes
4	19	5530	LP_Signal_04	Yes
5	12	5530	LP_Signal_05	Yes
6	11	5530	LP_Signal_06	Yes
7	6	5530	LP_Signal_07	Yes
8	20	5530	LP_Signal_08	Yes
9	6	5530	LP_Signal_09	No
10	12	5530	LP_Signal_10	Yes
11	16	5497	LP_Signal_11	Yes
12	20	5499	LP_Signal_12	Yes
13	18	5498	LP_Signal_13	No
14	12	5498	LP_Signal_14	Yes
15	12	5498	LP_Signal_15	No
16	15	5497	LP_Signal_16	Yes
17	10	5495	LP_Signal_17	No
18	12	5496	LP_Signal_18	Yes
19	10	5495	LP_Signal_19	No
20	20	5499	LP_Signal_20	Yes
21	7	5566	LP_Signal_21	Yes
22	20	5561	LP_Signal_22	Yes
23	8	5566	LP_Signal_23	Yes
24	17	5562	LP_Signal_24	Yes
25	7	5566	LP_Signal_25	Yes
26	14	5563	LP_Signal_26	Yes
27	11	5565	LP_Signal_27	Yes
28	7	5566	LP_Signal_28	Yes
29	12	5564	LP_Signal_29	Yes
30	8	5566	LP_Signal_30	Yes

Detection Rate:83.3 %

The Long Pulse Radar pattern shown in Appendix A.1

802.11ac (VHT80)CH106

Type 6 Radar Statistical Performances				
Trial #	Pulses per Burst	Pulse Width(us)	PRI(us)	Detection
1	9	1	333.3	Yes
2	9	1	333.3	Yes
3	9	1	333.3	Yes
4	9	1	333.3	Yes
5	9	1	333.3	Yes
6	9	1	333.3	Yes
7	9	1	333.3	Yes
8	9	1	333.3	Yes
9	9	1	333.3	Yes
10	9	1	333.3	Yes
11	9	1	333.3	Yes
12	9	1	333.3	Yes
13	9	1	333.3	Yes
14	9	1	333.3	Yes
15	9	1	333.3	Yes
16	9	1	333.3	Yes
17	9	1	333.3	Yes
18	9	1	333.3	No
19	9	1	333.3	Yes
20	9	1	333.3	Yes
21	9	1	333.3	Yes
22	9	1	333.3	Yes
23	9	1	333.3	Yes
24	9	1	333.3	Yes
25	9	1	333.3	Yes
26	9	1	333.3	Yes
27	9	1	333.3	No
28	9	1	333.3	No
29	9	1	333.3	Yes
30	9	1	333.3	Yes
				Detection Rate: 90%

802.11ac (VHT80)CH106

Type 6 Radar Statistical Performances		
Trial #	Hopping Frequency Sequence Name	Detection
1	HOP_FREQ_SEQ_01	Yes
2	HOP_FREQ_SEQ_02	Yes
3	HOP_FREQ_SEQ_03	Yes
4	HOP_FREQ_SEQ_04	Yes
5	HOP_FREQ_SEQ_05	Yes
6	HOP_FREQ_SEQ_06	Yes
7	HOP_FREQ_SEQ_07	Yes
8	HOP_FREQ_SEQ_08	Yes
9	HOP_FREQ_SEQ_09	Yes
10	HOP_FREQ_SEQ_10	Yes
11	HOP_FREQ_SEQ_11	Yes
12	HOP_FREQ_SEQ_12	Yes
13	HOP_FREQ_SEQ_13	Yes
14	HOP_FREQ_SEQ_14	Yes
15	HOP_FREQ_SEQ_15	Yes
16	HOP_FREQ_SEQ_16	Yes
17	HOP_FREQ_SEQ_17	Yes
18	HOP_FREQ_SEQ_18	No
19	HOP_FREQ_SEQ_19	Yes
20	HOP_FREQ_SEQ_20	Yes
21	HOP_FREQ_SEQ_21	Yes
22	HOP_FREQ_SEQ_22	Yes
23	HOP_FREQ_SEQ_23	Yes
24	HOP_FREQ_SEQ_24	Yes
25	HOP_FREQ_SEQ_25	Yes
26	HOP_FREQ_SEQ_26	Yes
27	HOP_FREQ_SEQ_27	No
28	HOP_FREQ_SEQ_28	No
29	HOP_FREQ_SEQ_29	Yes
30	HOP_FREQ_SEQ_30	Yes
		Detection Rate: 90 %

The Frequency Hopping Radar pattern shown in Appendix A.2

6.2.5 Non- Occupancy Period

1) Test results demonstrating an associated client link is established with the master on a test frequency.

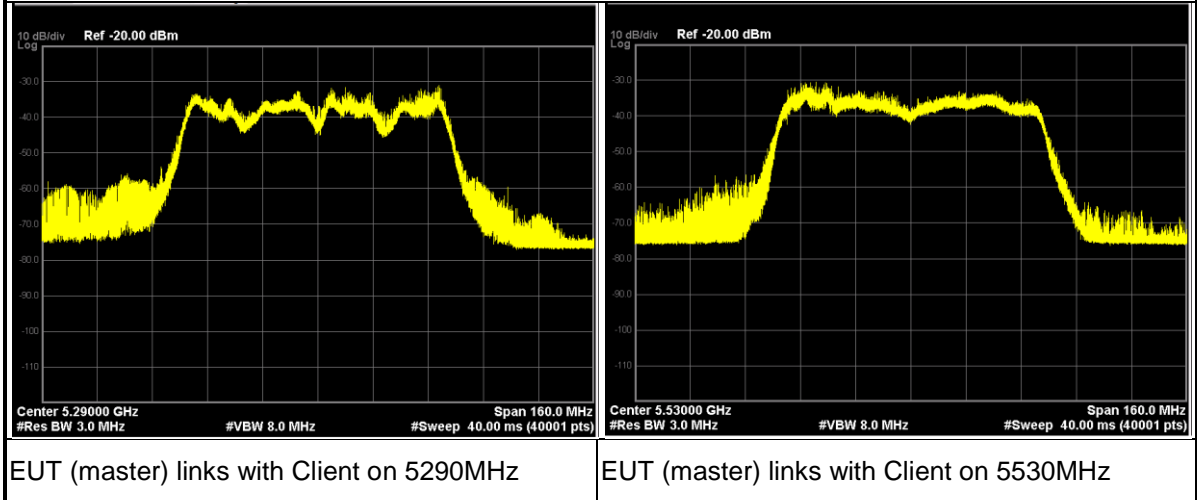

2) The master and DFS-certified client device are associated, and system testing will be performed with channel-loading for a non-occupancy period test.

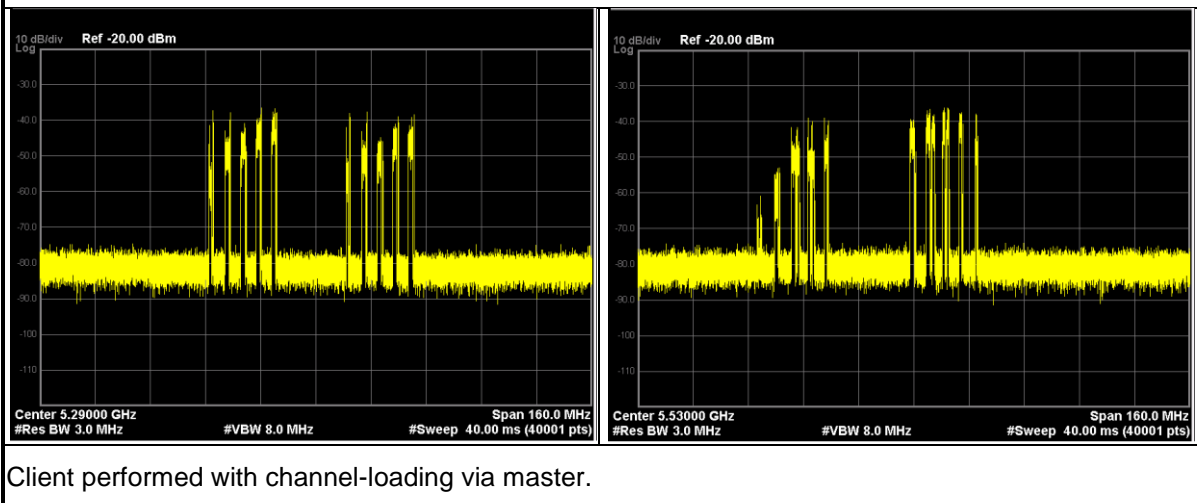

3). The device transmits one type of radar as specified in the DFS Order.

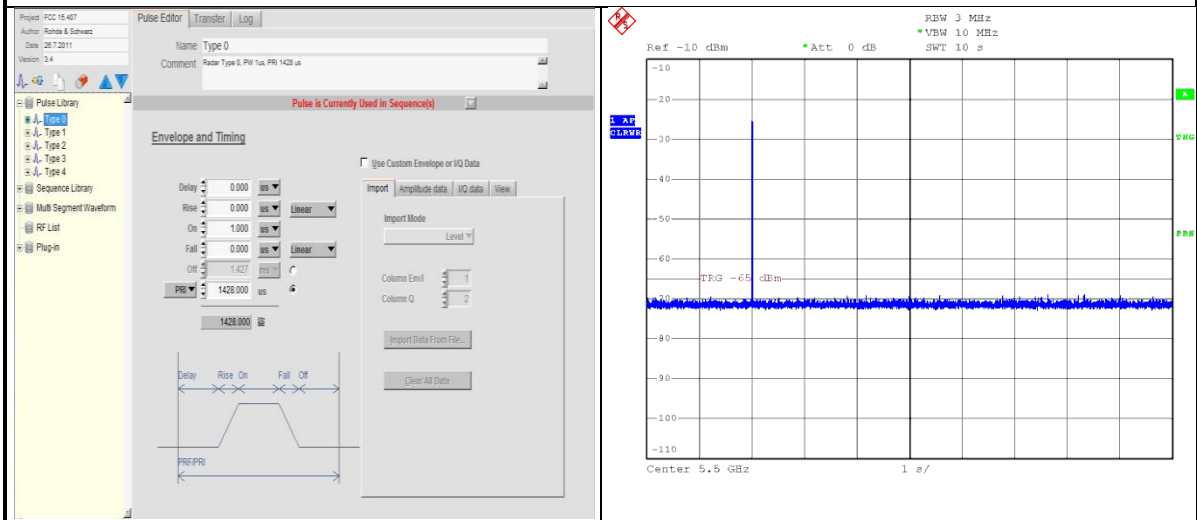

Radar 0 is used to test during DFS testing.

4) The test frequency has been monitored to ensure no transmission of any type has occurred for 30 minutes;

Note: If the client moves with the master, the device is considered compliant if nothing appears in the client non-occupancy period test. For devices that shut down (rather than moving channels), no beacons should appear;

5) An analyzer plot that contains a single 30-minute sweep on the original test frequency.

Non - Occupancy Period @ CH58 - 5290MHz

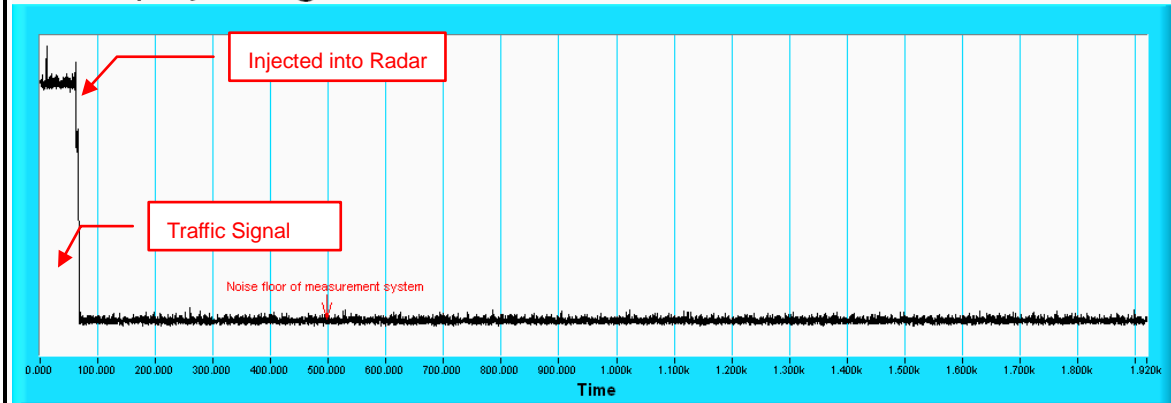

Non - Occupancy Period @ CH106 - 5530MHz

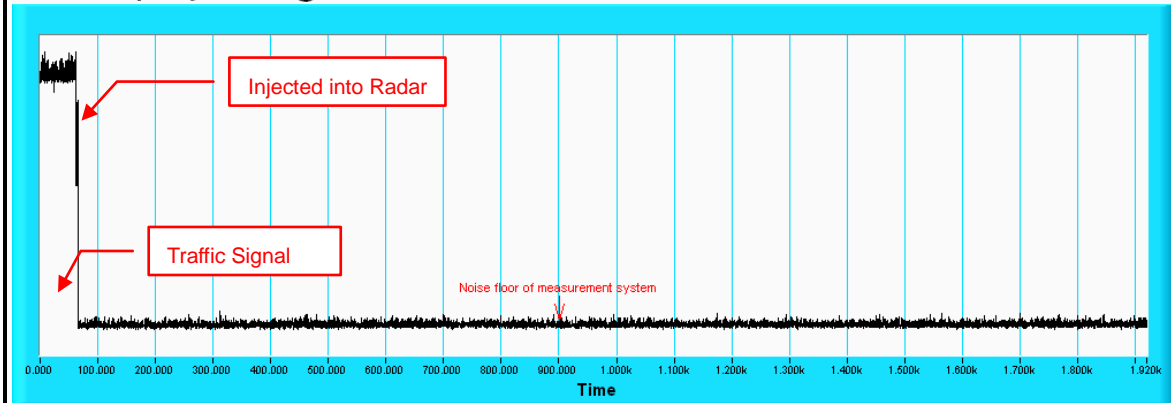

7. Information on The Testing Laboratories

We, Bureau Veritas Consumer Products Services (H.K.) Ltd., Taoyuan Branch, were founded in 1988 to provide our best service in EMC, Radio, Telecom and Safety consultation. Our laboratories are accredited and approved according to ISO/IEC 17025.

If you have any comments, please feel free to contact us at the following:

Linko EMC/RF Lab:

Tel: 886-2-26052180

Fax: 886-2-26051924

Hsin Chu EMC/RF/Telecom Lab:

Tel: 886-3-6668565

Fax: 886-3-6668323

Hwa Ya EMC/RF/Safety Lab:

Tel: 886-3-3183232

Fax: 886-3-3270892

Email: service.adt@tw.bureauveritas.com

Web Site: www.bureauveritas-adt.com

The address and road map of all our labs can be found in our web site also.

8. APPENDIX-A

RADAR TEST SIGNAL

A.1 The Long Pulse Radar Pattern

Long Pulse Radar Test Signal

Test Signal Name: LP_Signal_01

Number of Bursts in Trial: 18

Burst	Pulses per Burst	Chrip (MHz)	Pulse Width(us)	PRI-1 (us)	PRI-2 (us)	PRI-3 (us)
1	3	17	89.4	1750	1823	1091
2	1	17	57.6	1831	-	-
3	1	17	62.1	1839	-	-
4	3	17	94.8	1258	1771	1217
5	2	17	74.7	1246	1854	-
6	2	17	70.3	1286	1132	-
7	1	17	55.3	1409	-	-
8	3	17	99.3	1879	1810	1391
9	1	17	53.5	1673	-	-
10	2	17	74.6	1448	1969	-
11	3	17	85.5	1999	1087	1140
12	3	17	99.3	1602	1435	1376
13	3	17	91	1211	1374	1783
14	2	17	73.8	1924	1124	-
15	2	17	74.1	1641	1247	-
16	2	17	82.2	1904	1345	-
17	2	17	68.6	1168	1844	-
18	2	17	74.8	1444	1778	-
19						
20						

Long Pulse Radar Test Signal

Test Signal Name: LP_Signal_02

Number of Bursts in Trial: 9

Burst	Pulses per Burst	Chrip (MHz)	Pulse Width(us)	PRI-1 (us)	PRI-2 (us)	PRI-3 (us)
1	2	7	67.7	1691	1157	-
2	3	7	99.8	1097	1766	1178
3	1	7	56.9	1188	-	-
4	3	7	99.1	1208	1655	1974
5	1	7	60.8	1480	-	-
6	3	7	88.3	1272	1863	1474
7	1	7	57.5	1911	-	-
8	2	7	80.3	1455	1881	-
9	2	7	71.4	1137	1241	0
10						
11						
12						
13						
14						
15						
16						
17						
18						
19						
20						

Long Pulse Radar Test Signal

Test Signal Name: LP_Signal_03

Number of Bursts in Trial: 11

Burst	Pulses per Burst	Chrip (MHz)	Pulse Width(us)	PRI-1 (us)	PRI-2 (us)	PRI-3 (us)
1	1	8	58.9	1295	-	-
2	2	8	72.6	1375	1213	-
3	1	8	60.7	1039	-	-
4	2	8	70.8	1230	1064	-
5	1	8	51.9	1025	-	-
6	2	8	67.5	1895	1802	-
7	2	8	80.8	1550	1533	-
8	2	8	68.6	1525	1221	-
9	3	8	92.4	1651	1985	1505
10	3	8	87	1671	1451	1643
11	2	8	70.9	1439	1724	-
12						
13						
14						
15						
16						
17						
18						
19						
20						

Long Pulse Radar Test Signal

Test Signal Name: LP_Signal_04

Number of Bursts in Trial: 19

Burst	Pulses per Burst	Chrip (MHz)	Pulse Width(us)	PRI-1 (us)	PRI-2 (us)	PRI-3 (us)
1	2	19	81.2	1922	1020	-
2	1	19	57.6	1677	-	-
3	3	19	84.9	1073	1244	1949
4	2	19	83.1	1935	1174	-
5	2	19	71.1	1542	1560	-
6	1	19	55.1	1790	-	-
7	1	19	54.4	1396	-	-
8	3	19	90.6	1035	1886	1980
9	3	19	92.2	1950	1759	1163
10	3	19	92.5	1108	1661	1358
11	2	19	79.5	1441	1957	-
12	2	19	76.3	1259	1876	-
13	1	19	65.7	1880	-	-
14	3	19	99.4	1971	1493	1004
15	3	19	89.5	1238	1700	1581
16	2	19	79.1	1906	1546	-
17	1	19	60	1019	-	-
18	3	19	90.3	1808	1034	1199
19	3	19	96.8	1869	1993	1967
20						

Long Pulse Radar Test Signal

Test Signal Name: LP_Signal_05

Number of Bursts in Trial: 14

Burst	Pulses per Burst	Chrip (MHz)	Pulse Width(us)	PRI-1 (us)	PRI-2 (us)	PRI-3 (us)
1	2	12	73.8	1686	1255	-
2	3	12	87.2	1201	1621	1693
3	3	12	94.4	1503	1529	1431
4	3	12	99	1308	1366	1481
5	3	12	96.5	1318	1418	1452
6	2	12	76.6	1695	1170	-
7	3	12	92.8	1304	1113	1835
8	1	12	53.8	1068	-	-
9	3	12	83.6	1384	1593	1212
10	2	12	81.8	1395	1768	-
11	1	12	60.2	1129	-	-
12	1	12	55.1	1045	-	-
13	2	12	81.8	1984	1703	-
14	3	12	95.3	1992	1828	1932
15						
16						
17						
18						
19						
20						

Long Pulse Radar Test Signal

Test Signal Name: LP_Signal_06

Number of Bursts in Trial: 13

Burst	Pulses per Burst	Chrip (MHz)	Pulse Width(us)	PRI-1 (us)	PRI-2 (us)	PRI-3 (us)
1	3	11	97.7	1350	1354	1424
2	3	11	93.6	1779	1273	1540
3	1	11	60	1065	-	-
4	1	11	64.8	1956	-	-
5	2	11	73.9	1390	1794	-
6	2	11	77.9	1670	1206	-
7	1	11	55.7	1942	-	-
8	3	11	83.9	1105	1853	1440
9	2	11	66.9	1819	1281	-
10	3	11	88.2	1734	1361	1371
11	2	11	79	1400	1522	-
12	2	11	79.4	1516	1031	-
13	3	11	96.4	1328	1845	1833
14						
15						
16						
17						
18						
19						
20						

Long Pulse Radar Test Signal

Test Signal Name: LP_Signal_07

Number of Bursts in Trial: 9

Burst	Pulses per Burst	Chrip (MHz)	Pulse Width(us)	PRI-1 (us)	PRI-2 (us)	PRI-3 (us)
1	3	6	95.1	1436	1883	1146
2	2	6	71.5	1669	1952	-
3	1	6	62.5	1309	-	-
4	3	6	88.5	1797	1846	1528
5	2	6	70.7	1976	1714	-
6	2	6	78.3	1943	1873	-
7	3	6	95.6	1763	1887	1977
8	1	6	63.1	1434	-	-
9	3	6	83.7	1069	1236	1277
10						
11						
12						
13						
14						
15						
16						
17						
18						
19						
20						

Long Pulse Radar Test Signal

Test Signal Name: LP_Signal_08

Number of Bursts in Trial: 20

Burst	Pulses per Burst	Chrip (MHz)	Pulse Width(us)	PRI-1 (us)	PRI-2 (us)	PRI-3 (us)
1	3	20	86.9	1257	1010	1287
2	1	20	58.7	1628	-	-
3	3	20	88.4	1800	1214	1234
4	1	20	56.4	1340	-	-
5	2	20	78.4	1792	1243	-
6	1	20	51.3	1416	-	-
7	2	20	70.8	1645	1975	-
8	1	20	58.8	1755	-	-
9	2	20	82	1476	1356	-
10	3	20	87.3	1650	1941	1834
11	3	20	97.8	1898	1608	1523
12	2	20	81.1	1696	1870	-
13	2	20	68.1	1652	1323	-
14	1	20	55.7	1814	-	-
15	2	20	79.4	1078	1527	-
16	1	20	64.2	1667	-	-
17	3	20	86.2	1052	1038	1690
18	1	20	62.3	1494	-	-
19	3	20	91.1	1885	1460	1013
20	3	20	89.9	1603	1592	1239

Long Pulse Radar Test Signal

Test Signal Name: LP_Signal_09

Number of Bursts in Trial: 8

Burst	Pulses per Burst	Chrip (MHz)	Pulse Width(us)	PRI-1 (us)	PRI-2 (us)	PRI-3 (us)
1	2	6	70.2	1773	1471	-
2	1	6	56.2	1180	-	-
3	2	6	69.9	1042	1393	-
4	2	6	67	1569	1594	-
5	2	6	80.3	1292	1588	-
6	3	6	97.8	1338	1678	1114
7	2	6	82.3	1803	1185	-
8	2	6	71.1	1564	1164	-
9						
10						
11						
12						
13						
14						
15						
16						
17						
18						
19						
20						

Long Pulse Radar Test Signal

Test Signal Name: LP_Signal_10

Number of Bursts in Trial: 14

Burst	Pulses per Burst	Chrip (MHz)	Pulse Width(us)	PRI-1 (us)	PRI-2 (us)	PRI-3 (us)
1	3	12	93.3	1781	1456	1265
2	3	12	89.5	1276	1002	1998
3	2	12	76.9	1607	1538	-
4	3	12	86.2	1261	1890	1231
5	2	12	82.1	1559	1369	-
6	1	12	63.9	1752	-	-
7	1	12	56.7	1225	-	-
8	1	12	51.3	1183	-	-
9	2	12	76.5	1498	1486	-
10	2	12	67.4	1235	1381	-
11	3	12	99.6	1582	1629	1177
12	1	12	54.4	1983	-	-
13	1	12	63.1	1953	-	-
14	1	12	58.1	1075	-	-
15						
16						
17						
18						
19						
20						

Long Pulse Radar Test Signal

Test Signal Name: LP_Signal_11

Number of Bursts in Trial: 17

Burst	Pulses per Burst	Chrip (MHz)	Pulse Width(us)	PRI-1 (us)	PRI-2 (us)	PRI-3 (us)
1	1	16	56.2	1389	-	-
2	3	16	91.7	1227	1497	1722
3	2	16	81.7	1437	1561	-
4	1	16	65.2	1001	-	-
5	2	16	76.9	1649	1267	-
6	1	16	65.7	1962	-	-
7	2	16	83.1	1242	1536	-
8	2	16	74.3	1972	1030	-
9	3	16	84.6	1148	1675	1683
10	1	16	66	1398	-	-
11	1	16	54.4	1368	-	-
12	2	16	73.2	1692	1156	-
13	1	16	63.5	1508	-	-
14	2	16	80.7	1506	1426	-
15	3	16	88.8	1939	1738	1841
16	2	16	71.3	1430	1705	-
17	2	16	76.2	1182	1708	-
18						
19						
20						

Long Pulse Radar Test Signal

Test Signal Name: LP_Signal_12

Number of Bursts in Trial: 20

Burst	Pulses per Burst	Chrip (MHz)	Pulse Width(us)	PRI-1 (us)	PRI-2 (us)	PRI-3 (us)
1	2	20	80.6	1716	1419	-
2	2	20	69	1197	1349	-
3	3	20	99.8	1300	1756	1712
4	1	20	65.5	1028	-	-
5	3	20	92.5	1857	1534	1544
6	1	20	60.4	1640	-	-
7	1	20	61.5	1761	-	-
8	3	20	99	1457	1908	1599
9	1	20	54.1	1487	-	-
10	3	20	99.1	1720	1314	1945
11	2	20	78	1155	1829	-
12	3	20	87.8	1812	1617	1159
13	2	20	68.8	1458	1438	-
14	1	20	62.7	1672	-	-
15	3	20	86.7	1618	1422	1224
16	2	20	76.8	1056	1934	-
17	1	20	62	1006	-	-
18	1	20	50	1884	-	-
19	2	20	78.2	1330	1630	-
20	3	20	85.3	1464	1955	1960

Long Pulse Radar Test Signal

Test Signal Name: LP_Signal_13

Number of Bursts in Trial: 18

Burst	Pulses per Burst	Chrip (MHz)	Pulse Width(us)	PRI-1 (us)	PRI-2 (us)	PRI-3 (us)
1	1	18	65	1066	-	-
2	2	18	70.8	1929	1636	-
3	1	18	66.5	1094	-	-
4	3	18	88	1855	1252	1111
5	2	18	69	1290	1859	-
6	1	18	54.9	1551	-	-
7	1	18	60.8	2000	-	-
8	2	18	81.8	1585	1864	-
9	1	18	58.8	1130	-	-
10	1	18	50.4	1169	-	-
11	2	18	76	1325	1445	-
12	1	18	62.6	1530	-	-
13	1	18	55.1	1851	-	-
14	3	18	91.2	1181	1302	1966
15	2	18	68.9	1348	1355	-
16	3	18	85.4	1537	1758	1109
17	1	18	63.4	1011	-	-
18	3	18	92.7	1122	1333	1584
19						
20						

Long Pulse Radar Test Signal

Test Signal Name: LP_Signal_14

Number of Bursts in Trial: 14

Burst	Pulses per Burst	Chrip (MHz)	Pulse Width(us)	PRI-1 (us)	PRI-2 (us)	PRI-3 (us)
1	1	12	63.7	1830	-	-
2	2	12	81.3	1110	1746	-
3	2	12	70.2	1334	1187	-
4	1	12	66.3	1587	-	-
5	2	12	72.8	1578	1745	-
6	2	12	66.7	1694	1931	-
7	1	12	55.1	1284	-	-
8	3	12	86.5	1089	1490	1762
9	1	12	65.7	1084	-	-
10	1	12	53.2	1268	-	-
11	2	12	67.8	1625	1411	-
12	3	12	96.5	1576	1799	1233
13	1	12	51.4	1373	-	-
14	2	12	80.7	1098	1849	-
15						
16						
17						
18						
19						
20						

Long Pulse Radar Test Signal

Test Signal Name: LP_Signal_15

Number of Bursts in Trial: 14

Burst	Pulses per Burst	Chrip (MHz)	Pulse Width(us)	PRI-1 (us)	PRI-2 (us)	PRI-3 (us)
1	1	12	60.5	1668	-	-
2	3	12	86	1786	1666	1266
3	1	12	61.2	1228	-	-
4	1	12	59.8	1204	-	-
5	1	12	52.5	1021	-	-
6	1	12	61.7	1634	-	-
7	3	12	96.5	1741	1875	1296
8	3	12	87.6	1093	1250	1172
9	3	12	99.6	1215	1813	1820
10	2	12	79.7	1327	1512	-
11	3	12	90.2	1589	1145	1082
12	1	12	53.7	1136	-	-
13	2	12	73	1706	1526	-
14	1	12	65.4	1420	-	-
15						
16						
17						
18						
19						
20						

Long Pulse Radar Test Signal

Test Signal Name: LP_Signal_16

Number of Bursts in Trial: 16

Burst	Pulses per Burst	Chrip (MHz)	Pulse Width(us)	PRI-1 (us)	PRI-2 (us)	PRI-3 (us)
1	2	15	82.6	1347	1485	-
2	2	15	77.6	1312	1500	-
3	3	15	93.8	1062	1005	1749
4	1	15	51.3	1809	-	-
5	1	15	63.4	1699	-	-
6	2	15	69.4	1606	1219	-
7	3	15	86.3	1102	1878	1728
8	3	15	97	1192	1858	1772
9	1	15	65.1	1363	-	-
10	3	15	98.8	1083	1567	1961
11	3	15	98.1	1473	1271	1263
12	3	15	99.9	1780	1871	1249
13	2	15	82.9	1785	1081	-
14	2	15	82.5	1501	1921	-
15	3	15	89.2	1767	1357	1479
16	1	15	57.5	1891	-	-
17						
18						
19						
20						

Long Pulse Radar Test Signal

Test Signal Name: LP_Signal_17

Number of Bursts in Trial: 12

Burst	Pulses per Burst	Chrip (MHz)	Pulse Width(us)	PRI-1 (us)	PRI-2 (us)	PRI-3 (us)
1	1	10	63.9	1331	-	-
2	1	10	62.4	1897	-	-
3	3	10	99.1	1769	1832	1647
4	3	10	95.4	1991	1085	1937
5	1	10	52	1029	-	-
6	2	10	69.1	1637	1611	-
7	2	10	80	1447	1685	-
8	1	10	59.1	1635	-	-
9	2	10	82.8	1134	1080	-
10	1	10	51.6	1138	-	-
11	3	10	96.2	1165	1754	1269
12	2	10	76.1	1406	1818	-
13						
14						
15						
16						
17						
18						
19						
20						

Long Pulse Radar Test Signal

Test Signal Name: LP_Signal_18

Number of Bursts in Trial: 14

Burst	Pulses per Burst	Chrip (MHz)	Pulse Width(us)	PRI-1 (us)	PRI-2 (us)	PRI-3 (us)
1	2	12	81.7	1946	1868	-
2	3	12	90.5	1414	1453	1305
3	2	12	76.2	2000	1852	-
4	2	12	69.1	1351	1071	-
5	3	12	93.7	1865	1196	1782
6	3	12	89.7	1429	1948	1402
7	1	12	53.9	1070	-	-
8	3	12	88.2	1632	1940	1689
9	1	12	59.4	1733	-	-
10	1	12	66.4	1285	-	-
11	2	12	83	1321	1591	-
12	2	12	82	1912	1012	-
13	3	12	94.4	1698	1784	1303
14	1	12	63.6	1175	-	-
15						
16						
17						
18						
19						
20						

Long Pulse Radar Test Signal

Test Signal Name: LP_Signal_19

Number of Bursts in Trial: 12

Burst	Pulses per Burst	Chrip (MHz)	Pulse Width(us)	PRI-1 (us)	PRI-2 (us)	PRI-3 (us)
1	2	10	70.9	1736	1367	-
2	1	10	62.4	1193	-	-
3	1	10	61.8	1596	-	-
4	1	10	52.6	1646	-	-
5	2	10	78.9	1049	1639	-
6	1	10	63.9	1679	-	-
7	3	10	98.5	1627	1731	1442
8	3	10	92	1294	1547	1119
9	1	10	65.8	1386	-	-
10	2	10	77.7	1987	1964	-
11	1	10	54.6	1553	-	-
12	2	10	77.7	1171	1413	-
13						
14						
15						
16						
17						
18						
19						
20						

Long Pulse Radar Test Signal

Test Signal Name: LP_Signal_20

Number of Bursts in Trial: 20

Burst	Pulses per Burst	Chrip (MHz)	Pulse Width(us)	PRI-1 (us)	PRI-2 (us)	PRI-3 (us)
1	1	20	63.4	1899	-	-
2	1	20	63.5	1633	-	-
3	3	20	97.6	1815	1198	1488
4	3	20	84.7	1626	1026	1326
5	2	20	68.5	1469	1684	-
6	1	20	61.8	1408	-	-
7	2	20	73.2	1735	1125	-
8	1	20	60.2	1468	-	-
9	1	20	65.2	1519	-	-
10	2	20	74.6	1954	1654	-
11	2	20	72.6	1394	1096	-
12	2	20	78.9	1343	1843	-
13	1	20	56.2	1003	-	-
14	3	20	93.2	1433	1299	1324
15	2	20	78.6	1404	1539	-
16	1	20	50.9	1570	-	-
17	3	20	98.2	1346	1179	1510
18	3	20	97.5	1616	1360	1710
19	2	20	79.5	1822	1721	-
20	2	20	67	1554	1237	-

Long Pulse Radar Test Signal

Test Signal Name: LP_Signal_21

Number of Bursts in Trial: 9

Burst	Pulses per Burst	Chrip (MHz)	Pulse Width(us)	PRI-1 (us)	PRI-2 (us)	PRI-3 (us)
1	1	7	51	1893	-	-
2	3	7	88.5	1270	1664	1623
3	3	7	98.2	1979	1826	1128
4	2	7	67.5	1417	1586	-
5	3	7	97.4	1642	1121	1770
6	2	7	80.2	1816	1060	-
7	2	7	72.8	1619	1203	-
8	2	7	82.2	1499	1848	-
9	2	7	77.6	1562	1573	-
10						
11						
12						
13						
14						
15						
16						
17						
18						
19						
20						

Long Pulse Radar Test Signal

Test Signal Name: LP_Signal_22

Number of Bursts in Trial: 20

Burst	Pulses per Burst	Chrip (MHz)	Pulse Width(us)	PRI-1 (us)	PRI-2 (us)	PRI-3 (us)
1	3	20	89.8	1742	1968	1036
2	2	20	74.7	1850	1306	-
3	3	20	98.5	1123	1336	1791
4	1	20	64.4	1740	-	-
5	1	20	66	1000	-	-
6	2	20	76.3	1521	1928	-
7	3	20	90.4	1764	1383	1726
8	3	20	90.6	1896	1653	1697
9	2	20	74.8	1995	1938	-
10	3	20	98	1251	1520	1725
11	2	20	71.2	1775	1240	-
12	1	20	58.8	1195	-	-
13	3	20	84.1	1475	1472	1590
14	3	20	98.4	1274	1282	1918
15	3	20	96.4	1131	1739	1009
16	3	20	89.9	1484	1283	1412
17	2	20	82.9	1729	1571	-
18	3	20	96.5	1978	1478	1555
19	3	20	85.7	1872	1737	1847
20	3	20	85.4	1387	1151	1531

Long Pulse Radar Test Signal

Test Signal Name: LP_Signal_23

Number of Bursts in Trial: 10

Burst	Pulses per Burst	Chrip (MHz)	Pulse Width(us)	PRI-1 (us)	PRI-2 (us)	PRI-3 (us)
1	3	8	97.6	1568	1676	1023
2	3	8	93.9	1407	1682	1209
3	2	8	68.3	1807	1365	-
4	3	8	98.3	1107	1882	1524
5	3	8	87.6	1557	1342	1910
6	2	8	76.6	1033	1048	-
7	2	8	74.9	1101	1443	-
8	1	8	65.3	1341	-	-
9	2	8	80	1220	1015	-
10	3	8	87.4	1765	1316	1377
11						
12						
13						
14						
15						
16						
17						
18						
19						
20						

Long Pulse Radar Test Signal

Test Signal Name: LP_Signal_24

Number of Bursts in Trial: 17

Burst	Pulses per Burst	Chrip (MHz)	Pulse Width(us)	PRI-1 (us)	PRI-2 (us)	PRI-3 (us)
1	3	17	88.4	1279	1317	1150
2	3	17	89.1	1288	1660	1789
3	3	17	91	1385	1988	1461
4	2	17	82.6	1915	1059	-
5	2	17	75.5	1662	1982	-
6	3	17	99.9	1222	1796	1717
7	2	17	74.1	1877	1917	-
8	1	17	64.5	1380	-	-
9	3	17	90.3	1032	1613	1191
10	2	17	66.9	1158	1930	-
11	3	17	88.2	1753	1399	1507
12	1	17	60.4	1307	-	-
13	2	17	73.3	1152	1543	-
14	3	17	99.6	1207	1491	1297
15	1	17	58.2	1024	-	-
16	1	17	58.2	1925	-	-
17	2	17	66.9	1994	1090	-
18						
19						
20						

Long Pulse Radar Test Signal

Test Signal Name: LP_Signal_25

Number of Bursts in Trial: 9

Burst	Pulses per Burst	Chrip (MHz)	Pulse Width(us)	PRI-1 (us)	PRI-2 (us)	PRI-3 (us)
1	3	7	90.1	1465	1459	1862
2	1	7	51.8	1730	-	-
3	2	7	77.7	1874	1388	-
4	1	7	64.4	1401	-	-
5	3	7	83.7	1517	1861	1612
6	3	7	87.1	1981	1161	1541
7	3	7	96.9	1143	1757	1115
8	2	7	80.1	1232	1574	-
9	3	7	95.9	1051	1202	1344
10						
11						
12						
13						
14						
15						
16						
17						
18						
19						
20						

Long Pulse Radar Test Signal

Test Signal Name: LP_Signal_26

Number of Bursts in Trial: 15

Burst	Pulses per Burst	Chrip (MHz)	Pulse Width(us)	PRI-1 (us)	PRI-2 (us)	PRI-3 (us)
1	1	14	56.4	1379	-	-
2	1	14	50.2	1827	-	-
3	2	14	76.8	1189	1788	-
4	3	14	89.4	1713	1774	1743
5	1	14	51.3	1926	-	-
6	2	14	75	1958	1194	-
7	1	14	60.5	1631	-	-
8	3	14	87.5	1483	1825	1329
9	1	14	59.6	1495	-	-
10	2	14	82.2	1604	1421	-
11	2	14	67.8	1139	1482	-
12	1	14	51.5	1018	-	-
13	2	14	72.9	1135	1332	-
14	3	14	96.5	1116	1291	1665
15	1	14	65.7	1256	-	-
16						
17						
18						
19						
20						

Long Pulse Radar Test Signal

Test Signal Name: LP_Signal_27

Number of Bursts in Trial: 13

Burst	Pulses per Burst	Chrip (MHz)	Pulse Width(us)	PRI-1 (us)	PRI-2 (us)	PRI-3 (us)
1	2	11	68.4	1210	1254	-
2	1	11	56.2	1106	-	-
3	2	11	68.7	1989	1167	-
4	3	11	97.2	1963	1037	1860
5	3	11	87.1	1120	1335	1563
6	2	11	70.6	1298	1502	-
7	2	11	68.7	1747	1446	-
8	3	11	90	1315	1072	1226
9	2	11	79.4	1577	1311	-
10	1	11	59.6	1176	-	-
11	3	11	84.9	1027	1727	1260
12	1	11	63.5	1605	-	-
13	1	11	52.3	1702	-	-
14						
15						
16						
17						
18						
19						
20						

Long Pulse Radar Test Signal

Test Signal Name: LP_Signal_28

Number of Bursts in Trial: 10

Burst	Pulses per Burst	Chrip (MHz)	Pulse Width(us)	PRI-1 (us)	PRI-2 (us)	PRI-3 (us)
1	2	7	72.9	1622	1104	-
2	1	7	54.6	1609	-	-
3	1	7	51.9	1707	-	-
4	3	7	94.2	1173	1515	1688
5	1	7	52.5	1077	-	-
6	2	7	79.6	1054	1245	-
7	3	7	93.5	1575	1141	1046
8	2	7	73.9	1718	1638	-
9	3	7	87.7	1126	1462	1310
10	1	7	50.8	1154	-	-
11						
12						
13						
14						
15						
16						
17						
18						
19						
20						

Long Pulse Radar Test Signal

Test Signal Name: LP_Signal_29

Number of Bursts in Trial: 13

Burst	Pulses per Burst	Chrip (MHz)	Pulse Width(us)	PRI-1 (us)	PRI-2 (us)	PRI-3 (us)
1	1	12	65.6	1074	-	-
2	1	12	63.2	1477	-	-
3	3	12	99.9	1053	1805	1657
4	3	12	85.8	1293	1680	1184
5	3	12	90	1200	1511	1127
6	2	12	76.1	1017	1133	-
7	3	12	90.4	1043	1088	1362
8	1	12	65.4	1610	-	-
9	2	12	67.1	1824	1410	-
10	1	12	55.3	1278	-	-
11	1	12	61.9	1403	-	-
12	3	12	96.1	1923	1216	1744
13	2	12	77.5	1558	1253	-
14						
15						
16						
17						
18						
19						

Long Pulse Radar Test Signal

Test Signal Name: LP_Signal_30

Number of Bursts in Trial: 10

Burst	Pulses per Burst	Chrip (MHz)	Pulse Width(us)	PRI-1 (us)	PRI-2 (us)	PRI-3 (us)
1	2	8	68.4	1190	1907	-
2	3	8	99.7	1996	1806	1079
3	3	8	93	1777	1092	1337
4	2	8	75.3	1548	1583	-
5	3	8	87.7	1715	1889	1470
6	1	8	60.2	1008	-	-
7	3	8	97.5	1658	1514	1748
8	2	8	79.7	1532	1793	-
9	1	8	66.4	1014	-	-
10	1	8	61.4	1322	-	-
11						
12						
13						
14						
15						
16						
17						
18						
19						
20						

A.2 The Frequency Hopping Radar pattern

Hopping Frequency Sequence Name: HOP_FREQ_SEQ_01					
Frequency (MHz)	0	1	2	3	4
0	5385	5718	5545	5371	5537
5	5323	5519	5588	5621	5549
10	5327	5659	5489	5570	5584
15	5336	5311	5303	5647	5458
20	5612	5354	5716	5479	5348
25	5438	5337	5335	5574	5601
30	5265	5713	5577	5653	5715
35	5307	5432	5674	5562	5506
40	5306	5258	5345	5631	5632
45	5514	5320	5568	5696	5628
50	5602	5428	5708	5378	5349
55	5413	5273	5446	5333	5531
60	5264	5367	5534	5339	5332
65	5561	5580	5624	5251	5459
70	5563	5391	5402	5701	5259
75	5618	5573	5538	5271	5364
80	5328	5353	5252	5496	5670
85	5684	5305	5269	5463	5520
90	5597	5719	5325	5539	5639
95	5550	5678	5465	5552	5664

Hopping Frequency Sequence Name: HOP_FREQ_SEQ_02					
Frequency (MHz)	0	1	2	3	4
0	5543	5482	5481	5435	5282
5	5365	5541	5566	5309	5281
10	5636	5448	5530	5290	5605
15	5424	5438	5406	5692	5650
20	5620	5423	5279	5471	5321
25	5704	5664	5538	5678	5635
30	5307	5699	5534	5393	5489
35	5505	5474	5358	5695	5572
40	5428	5286	5396	5629	5346
45	5437	5626	5274	5418	5381
50	5604	5284	5467	5550	5357
55	5461	5400	5426	5253	5710
60	5399	5639	5484	5623	5350
65	5675	5398	5298	5283	5680
70	5720	5718	5422	5514	5705
75	5711	5708	5568	5277	5359
80	5272	5464	5651	5305	5580
85	5684	5312	5459	5715	5402
90	5337	5601	5370	5445	5649
95	5472	5654	5660	5672	5420

Hopping Frequency Sequence Name: HOP_FREQ_SEQ_03

Frequency (MHz)	0	1	2	3	4
0	5323	5721	5417	5596	5599
5	5504	5466	5641	5472	5585
10	5567	5712	5571	5485	5626
15	5415	5565	5509	5262	5367
20	5628	5589	5695	5560	5294
25	5592	5613	5266	5404	5669
30	5446	5588	5491	5511	5325
35	5381	5629	5434	5609	5411
40	5608	5699	5636	5275	5658
45	5520	5587	5327	5683	5257
50	5305	5335	5556	5373	5679
55	5552	5616	5547	5584	5528
60	5389	5704	5471	5310	5569
65	5648	5624	5605	5553	5483
70	5467	5706	5649	5490	5664
75	5680	5542	5689	5488	5678
80	5533	5523	5677	5281	5651
85	5719	5543	5409	5330	5657
90	5405	5690	5436	5694	5715
95	5425	5526	5644	5575	5377

Hopping Frequency Sequence Name: HOP_FREQ_SEQ_04

Frequency (MHz)	0	1	2	3	4
0	5578	5582	5353	5282	5344
5	5546	5488	5716	5635	5317
10	5498	5501	5612	5583	5647
15	5503	5692	5515	5685	5559
20	5539	5658	5636	5552	5267
25	5480	5465	5469	5508	5703
30	5574	5448	5251	5415	5523
35	5277	5569	5522	5587	5620
40	5347	5691	5637	5401	5623
45	5638	5603	5645	5380	5570
50	5608	5481	5386	5671	5265
55	5686	5331	5366	5555	5657
60	5554	5271	5400	5611	5374
65	5573	5373	5340	5445	5286
70	5314	5346	5466	5649	5591
75	5588	5670	5590	5495	5674
80	5476	5561	5601	5517	5284
85	5333	5318	5479	5419	5257
90	5510	5542	5572	5678	5672
95	5375	5621	5410	5504	5500

Hopping Frequency Sequence Name: HOP_FREQ_SEQ_05

Frequency (MHz)	0	1	2	3	4
0	5358	5346	5289	5443	5661
5	5588	5413	5316	5701	5524
10	5332	5290	5653	5303	5668
15	5591	5722	5618	5255	5276
20	5547	5349	5674	5641	5715
25	5271	5414	5672	5612	5262
30	5530	5463	5405	5466	5567
35	5343	5416	5660	5318	5362
40	5534	5299	5575	5544	5620
45	5511	5686	5703	5433	5360
50	5484	5657	5437	5356	5494
55	5470	5453	5640	5521	5563
60	5526	5311	5719	5691	5707
65	5558	5522	5409	5647	5467
70	5708	5300	5347	5345	5582
75	5711	5256	5651	5420	5326
80	5570	5279	5671	5457	5403
85	5566	5696	5385	5335	5581
90	5675	5260	5324	5407	5361
95	5431	5274	5535	5440	5551

Hopping Frequency Sequence Name: HOP_FREQ_SEQ_06

Frequency (MHz)	0	1	2	3	4
0	5613	5585	5700	5604	5406
5	5630	5435	5391	5389	5353
10	5263	5554	5694	5498	5689
15	5679	5374	5721	5300	5468
20	5555	5418	5615	5633	5688
25	5634	5266	5303	5716	5296
30	5669	5352	5362	5681	5341
35	5541	5458	5276	5589	5515
40	5448	5500	5382	5513	5309
45	5714	5440	5598	5294	5664
50	5722	5358	5488	5445	5695
55	5414	5641	5594	5711	5497
60	5409	5636	5539	5360	5504
65	5398	5471	5510	5270	5305
70	5286	5449	5671	5321	5490
75	5356	5302	5632	5672	5339
80	5351	5443	5621	5668	5457
85	5342	5626	5413	5350	5289
90	5354	5425	5330	5441	5540
95	5291	5590	5575	5338	5530

Hopping Frequency Sequence Name: HOP_FREQ_SEQ_07

Frequency (MHz)	0	1	2	3	4
0	5296	5349	5636	5290	5723
5	5294	5457	5466	5552	5560
10	5669	5440	5260	5693	5710
15	5670	5501	5345	5660	5584
20	5556	5722	5661	5425	5593
25	5506	5330	5711	5338	5319
30	5324	5493	5361	5597	5367
35	5482	5668	5459	5339	5562
40	5451	5549	5272	5578	5377
45	5442	5512	5614	5534	5539
50	5518	5261	5354	5548	5426
55	5676	5371	5569	5574	5581
60	5283	5450	5599	5420	5384
65	5689	5402	5474	5369	5452
70	5423	5297	5500	5362	5476
75	5445	5613	5449	5607	5306
80	5568	5683	5360	5659	5589
85	5508	5340	5602	5590	5336
90	5378	5503	5649	5308	5645
95	5559	5412	5413	5563	5307

Hopping Frequency Sequence Name: HOP_FREQ_SEQ_08

Frequency (MHz)	0	1	2	3	4
0	5551	5588	5572	5451	5468
5	5336	5382	5541	5715	5292
10	5503	5704	5398	5413	5256
15	5283	5628	5452	5293	5377
20	5474	5653	5497	5714	5634
25	5313	5542	5709	5546	5364
30	5278	5702	5276	5539	5267
35	5656	5261	5458	5443	5373
40	5645	5314	5708	5676	5558
45	5460	5305	5495	5399	5490
50	5710	5590	5623	5341	5680
55	5502	5616	5342	5601	5264
60	5678	5584	5396	5422	5369
65	5420	5424	5672	5351	5355
70	5455	5272	5273	5459	5331
75	5499	5491	5594	5701	5559
80	5388	5674	5565	5403	5263
85	5501	5649	5700	5658	5294
90	5375	5416	5280	5412	5385
95	5661	5543	5609	5391	5615

Hopping Frequency Sequence Name: HOP_FREQ_SEQ_09

Frequency (MHz)	0	1	2	3	4
0	5331	5352	5508	5612	5310
5	5378	5404	5616	5403	5596
10	5434	5493	5439	5511	5277
15	5371	5658	5458	5338	5666
20	5482	5344	5535	5328	5704
25	5579	5394	5437	5650	5398
30	5417	5591	5708	5279	5419
35	5379	5303	5646	5549	5287
40	5589	5253	5705	5457	5441
45	5543	5266	5548	5664	5366
50	5411	5641	5334	5639	5527
55	5255	5456	5709	5692	5313
60	5429	5568	5607	5410	5623
65	5318	5359	5256	5564	5629
70	5715	5341	5555	5724	5321
75	5678	5619	5634	5575	5478
80	5572	5644	5363	5432	5562
85	5598	5263	5440	5526	5345
90	5711	5445	5349	5645	5295
95	5280	5624	5507	5273	5718

Hopping Frequency Sequence Name: HOP_FREQ_SEQ_10

Frequency (MHz)	0	1	2	3	4
0	5586	5591	5444	5676	5530
5	5420	5329	5691	5469	5328
10	5268	5282	5480	5706	5298
15	5459	5310	5561	5383	5393
20	5413	5476	5320	5677	5467
25	5343	5640	5279	5432	5577
30	5665	5494	5668	5674	5442
35	5262	5345	5274	5428	5433
40	5643	5697	5702	5437	5421
45	5626	5324	5601	5551	5620
50	5587	5692	5423	5365	5471
55	5346	5410	5424	5511	5284
60	5384	5594	5513	5439	5333
65	5385	5446	5267	5395	5466
70	5359	5335	5312	5327	5558
75	5445	5700	5280	5647	5264
80	5302	5653	5633	5682	5425
85	5527	5495	5559	5318	5641
90	5575	5512	5491	5299	5434
95	5610	5451	5404	5456	5608

Hopping Frequency Sequence Name: HOP_FREQ_SEQ_11

Frequency (MHz)	0	1	2	3	4
0	5269	5355	5380	5362	5372
5	5559	5351	5291	5632	5535
10	5674	5546	5521	5426	5319
15	5450	5437	5664	5331	5575
20	5401	5579	5417	5409	5650
25	5670	5271	5383	5466	5501
30	5622	5612	5345	5397	5581
35	5353	5713	5524	5687	5267
40	5516	5462	5321	5366	5709
45	5382	5654	5341	5496	5288
50	5268	5512	5663	5318	5534
55	5364	5614	5330	5633	5513
60	5284	5458	5634	5647	5691
65	5431	5298	5629	5613	5481
70	5410	5658	5294	5714	5616
75	5384	5348	5317	5681	5655
80	5556	5544	5599	5635	5704
85	5359	5350	5547	5254	5300
90	5457	5320	5312	5416	5473
95	5390	5592	5400	5609	5449

Hopping Frequency Sequence Name: HOP_FREQ_SEQ_12

Frequency (MHz)	0	1	2	3	4
0	5524	5594	5316	5523	5592
5	5601	5276	5366	5320	5267
10	5605	5432	5562	5621	5340
15	5538	5564	5292	5376	5409
20	5270	5455	5401	5623	5522
25	5474	5584	5500	5543	5355
30	5579	5352	5692	5720	5444
35	5509	5677	5581	5599	5519
40	5318	5673	5381	5317	5343
45	5610	5703	5372	5464	5319
50	5486	5262	5722	5329	5527
55	5604	5642	5449	5578	5460
60	5374	5470	5640	5370	5508
65	5521	5416	5553	5396	5661
70	5555	5488	5504	5491	5615
75	5662	5330	5462	5283	5718
80	5544	5598	5324	5304	5452
85	5465	5463	5354	5669	5525
90	5587	5445	5576	5298	5588
95	5552	5550	5466	5417	5566

Hopping Frequency Sequence Name: HOP_FREQ_SEQ_13

Frequency (MHz)	0	1	2	3	4
0	5304	5358	5252	5684	5434
5	5643	5298	5441	5483	5571
10	5439	5696	5603	5341	5361
15	5626	5691	5395	5421	5484
20	5320	5339	5396	5490	5596
25	5509	5471	5677	5688	5534
30	5682	5536	5567	5271	5415
35	5287	5535	5305	5355	5612
40	5420	5457	5370	5315	5602
45	5400	5401	5663	5493	5723
50	5543	5690	5309	5584	5435
55	5272	5519	5346	5575	5674
60	5614	5445	5410	5383	5671
65	5589	5406	5340	5316	5694
70	5625	5382	5286	5531	5632
75	5527	5537	5440	5718	5447
80	5306	5453	5525	5380	5658
85	5516	5667	5258	5568	5630
90	5566	5291	5551	5634	5604
95	5500	5657	5470	5655	5273

Hopping Frequency Sequence Name: HOP_FREQ_SEQ_14

Frequency (MHz)	0	1	2	3	4
0	5559	5597	5663	5370	5654
5	5685	5698	5516	5549	5303
10	5485	5644	5439	5382	5714
15	5721	5401	5466	5676	5328
20	5505	5337	5482	5569	5300
25	5323	5405	5317	5568	5724
30	5705	5493	5307	5520	5710
35	5426	5626	5673	5605	5526
40	5356	5387	5395	5610	5312
45	5434	5341	5483	5459	5716
50	5380	5502	5719	5421	5510
55	5528	5623	5701	5709	5640
60	5546	5304	5390	5339	5684
65	5266	5494	5538	5345	5550
70	5683	5497	5319	5368	5289
75	5694	5507	5591	5329	5647
80	5680	5577	5691	5453	5499
85	5611	5450	5720	5350	5621
90	5708	5632	5309	5470	5320
95	5572	5325	5336	5646	5555

Hopping Frequency Sequence Name: HOP_FREQ_SEQ_15

Frequency (MHz)	0	1	2	3	4
0	5339	5361	5599	5531	5496
5	5349	5720	5591	5712	5510
10	5301	5274	5685	5634	5403
15	5705	5373	5504	5414	5393
20	5336	5574	5375	5571	5542
25	5663	5272	5608	5421	5602
30	5291	5691	5450	5425	5672
35	5530	5565	5469	5283	5440
40	5670	5470	5333	5309	5363
45	5699	5566	5420	5294	5645
50	5378	5472	5490	5558	5424
55	5459	5457	5432	5646	5607
60	5687	5695	5487	5381	5382
65	5478	5678	5391	5451	5389
70	5543	5483	5550	5298	5292
75	5251	5371	5563	5280	5300
80	5529	5447	5350	5636	5681
85	5328	5500	5263	5589	5290
90	5485	5578	5359	5693	5638
95	5610	5625	5467	5331	5386

Hopping Frequency Sequence Name: HOP_FREQ_SEQ_16

Frequency (MHz)	0	1	2	3	4
0	5497	5600	5535	5692	5716
5	5391	5645	5666	5400	5339
10	5610	5538	5348	5354	5424
15	5318	5500	5607	5459	5585
20	5722	5265	5316	5563	5515
25	5454	5599	5714	5622	5539
30	5430	5580	5407	5640	5446
35	5253	5704	5436	5451	5509
40	5553	5649	5518	5403	5292
45	5679	5478	5347	5532	5254
50	5596	5523	5579	5631	5319
55	5427	5512	5517	5656	5586
60	5634	5377	5433	5255	5421
65	5417	5592	5273	5481	5560
70	5437	5392	5412	5394	5623
75	5673	5536	5367	5444	5635
80	5644	5520	5465	5314	5488
85	5650	5584	5296	5277	5665
90	5706	5462	5310	5489	5274
95	5315	5350	5694	5591	5344

Hopping Frequency Sequence Name: HOP_FREQ_SEQ_17

Frequency (MHz)	0	1	2	3	4
0	5277	5364	5471	5281	5558
5	5433	5667	5266	5563	5546
10	5541	5424	5389	5549	5445
15	5406	5627	5710	5504	5399
20	5255	5334	5257	5652	5488
25	5342	5548	5442	5251	5573
30	5472	5469	5380	5598	5271
35	5521	5536	5589	5365	5348
40	5258	5587	5283	5400	5599
45	5659	5322	5508	5297	5574
50	5668	5454	5641	5615	5466
55	5707	5475	5362	5715	5324
60	5310	5259	5676	5719	5385
65	5356	5640	5284	5632	5423
70	5395	5619	5338	5468	5614
75	5435	5537	5520	5686	5317
80	5531	5655	5441	5452	5631
85	5417	5704	5333	5268	5513
90	5340	5590	5330	5360	5401
95	5294	5720	5690	5289	5592

Hopping Frequency Sequence Name: HOP_FREQ_SEQ_18

Frequency (MHz)	0	1	2	3	4
0	5532	5603	5407	5442	5303
5	5572	5592	5341	5629	5278
10	5472	5688	5430	5269	5466
15	5494	5279	5338	5549	5591
20	5263	5500	5295	5644	5461
25	5705	5400	5645	5355	5607
30	5514	5455	5321	5595	5372
35	5271	5410	5612	5429	5364
40	5284	5525	5523	5397	5528
45	5639	5340	5594	5356	5684
50	5384	5473	5625	5379	5655
55	5585	5328	5420	5422	5294
60	5333	5369	5489	5267	5714
65	5657	5622	5445	5334	5392
70	5634	5435	5562	5326	5409
75	5495	5468	5314	5427	5486
80	5555	5583	5501	5652	5573
85	5695	5647	5631	5259	5667
90	5332	5676	5319	5286	5506
95	5505	5693	5717	5510	5311

Hopping Frequency Sequence Name: HOP_FREQ_SEQ_19

Frequency (MHz)	0	1	2	3	4
0	5312	5464	5343	5603	5620
5	5614	5416	5317	5582	5306
10	5477	5471	5367	5487	5485
15	5309	5344	5497	5308	5649
20	5569	5711	5258	5434	5496
25	5252	5373	5459	5641	5653
30	5278	5713	5524	5566	5549
35	5703	5700	5517	5290	5598
40	5424	5463	5288	5394	5360
45	5619	5423	5555	5409	5474
50	5260	5676	5468	5478	5432
55	5516	5374	5612	5491	5682
60	5401	5276	5546	5483	5665
65	5268	5283	5428	5466	5327
70	5365	5398	5492	5498	5386
75	5455	5675	5251	5579	5429
80	5431	5354	5384	5403	5338
85	5534	5576	5273	5704	5670
90	5699	5301	5502	5522	5328
95	5355	5280	5631	5625	5323

Hopping Frequency Sequence Name: HOP_FREQ_SEQ_20

Frequency (MHz)	0	1	2	3	4
0	5470	5703	5279	5289	5365
5	5656	5539	5491	5480	5314
10	5712	5266	5512	5562	5508
15	5573	5436	5447	5542	5500
20	5657	5260	5652	5250	5407
25	5384	5676	5576	5660	5675
30	5695	5708	5710	5453	5298
35	5591	5416	5496	5670	5679
40	5437	5507	5401	5431	5391
45	5599	5506	5613	5462	5361
50	5611	5350	5252	5557	5301
55	5376	5704	5328	5327	5310
60	5653	5530	5441	5254	5378
65	5309	5469	5707	5367	5597
70	5546	5567	5478	5598	5641
75	5345	5424	5320	5297	5560
80	5681	5444	5610	5451	5466
85	5335	5515	5690	5619	5509
90	5324	5307	5524	5360	5705
95	5713	5631	5410	5264	5529

Hopping Frequency Sequence Name: HOP_FREQ_SEQ_21

Frequency (MHz)	0	1	2	3	4
0	5250	5467	5690	5450	5682
5	5698	5561	5566	5643	5521
10	5546	5530	5553	5282	5529
15	5661	5563	5550	5587	5692
20	5665	5329	5593	5339	5380
25	5650	5528	5289	5709	5262
30	5694	5667	5668	5584	5255
35	5507	5389	5445	5276	5687
40	5671	5485	5693	5579	5589
45	5515	5626	5390	5526	5303
50	5646	5599	5417	5517	5604
55	5624	5659	5606	5674	5685
60	5707	5557	5292	5656	5403
65	5508	5392	5349	5639	5464
70	5601	5393	5717	5304	5296
75	5440	5541	5361	5554	5391
80	5615	5332	5437	5357	5275
85	5336	5474	5278	5555	5722
90	5525	5711	5272	5644	5265
95	5459	5465	5723	5427	5486

Hopping Frequency Sequence Name: HOP_FREQ_SEQ_22

Frequency (MHz)	0	1	2	3	4
0	5505	5706	5626	5611	5427
5	5362	5486	5641	5709	5350
10	5477	5416	5594	5550	5274
15	5690	5653	5535	5409	5576
20	5495	5631	5331	5353	5538
25	5410	5393	5268	5401	5583
30	5624	5408	5699	5404	5394
35	5598	5660	5604	5590	5295
40	5277	5436	5482	5525	5462
45	5672	5632	5568	5513	5266
50	5702	5354	5357	5325	5642
55	5605	5711	5707	5423	5595
60	5313	5296	5619	5517	5533
65	5503	5493	5342	5718	5284
70	5627	5547	5701	5717	5693
75	5263	5265	5463	5522	5613
80	5664	5647	5304	5689	5329
85	5574	5340	5713	5431	5328
90	5542	5339	5684	5526	5476
95	5520	5422	5368	5446	5650

Hopping Frequency Sequence Name: HOP_FREQ_SEQ_23

Frequency (MHz)	0	1	2	3	4
0	5285	5470	5562	5297	5269
5	5404	5508	5716	5397	5557
10	5408	5680	5635	5672	5571
15	5265	5342	5281	5580	5601
20	5584	5661	5572	5420	5326
25	5329	5613	5497	5302	5443
30	5569	5581	5526	5376	5602
35	5533	5689	5456	5276	5518
40	5378	5690	5579	5479	5454
45	5442	5280	5621	5303	5617
50	5403	5405	5446	5623	5489
55	5696	5665	5325	5620	5469
60	5461	5546	5694	5554	5550
65	5430	5704	5566	5697	5612
70	5583	5629	5503	5390	5677
75	5428	5468	5277	5294	5718
80	5298	5307	5283	5380	5345
85	5386	5493	5575	5313	5320
90	5347	5638	5266	5270	5471
95	5693	5535	5384	5662	5664

Hopping Frequency Sequence Name: HOP_FREQ_SEQ_24

Frequency (MHz)	0	1	2	3	4
0	5540	5709	5498	5458	5489
5	5446	5433	5316	5560	5289
10	5717	5469	5298	5295	5592
15	5353	5372	5287	5625	5318
20	5255	5513	5412	5299	5692
25	5656	5341	5698	5336	5485
30	5538	5266	5422	5575	5305
35	5252	5526	5432	5365	5461
40	5531	5344	5476	5286	5363
45	5273	5577	5665	5493	5579
50	5456	5535	5409	5619	5515
55	5439	5440	5474	5626	5606
60	5278	5282	5492	5517	5503
65	5414	5285	5708	5477	5519
70	5329	5415	5548	5581	5703
75	5675	5484	5642	5312	5684
80	5340	5701	5718	5455	5261
85	5650	5334	5545	5351	5655
90	5668	5495	5510	5630	5297
95	5693	5704	5464	5268	5683

Hopping Frequency Sequence Name: HOP_FREQ_SEQ_25

Frequency (MHz)	0	1	2	3	4
0	5698	5473	5531	5522	5331
5	5488	5455	5391	5723	5593
10	5648	5258	5339	5490	5613
15	5441	5499	5390	5670	5607
20	5503	5421	5551	5501	5272
25	5580	5605	5544	5327	5370
30	5527	5347	5495	5481	5302
35	5620	5714	5493	5679	5443
40	5641	5469	5584	5690	5402
45	5446	5709	5630	5280	5507
50	5624	5269	5597	5573	5705
55	5411	5603	5316	5585	5583
60	5438	5718	5549	5353	5592
65	5716	5511	5646	5505	5332
70	5264	5524	5615	5453	5348
75	5343	5465	5419	5325	5699
80	5500	5684	5621	5394	5435
85	5288	5283	5710	5357	5689
90	5550	5685	5378	5591	5683
95	5369	5662	5363	5420	5502

Hopping Frequency Sequence Name: HOP_FREQ_SEQ_26

Frequency (MHz)	0	1	2	3	4
0	5478	5712	5467	5683	5551
5	5627	5380	5466	5411	5325
10	5579	5522	5685	5634	5529
15	5626	5493	5618	5324	5511
20	5490	5492	5720	5371	5457
25	5650	5431	5404	5666	5333
30	5452	5696	5440	5378	5584
35	5416	5357	5518	5724	5407
40	5349	5567	5619	5382	5292
45	5342	5623	5456	5558	5713
50	5470	5699	5310	5527	5420
55	5455	5257	5481	5496	5417
60	5506	5541	5498	5389	5327
65	5692	5718	5588	5335	5491
70	5500	5574	5422	5486	5446
75	5435	5721	5388	5563	5695
80	5501	5524	5711	5284	5483
85	5717	5273	5578	5400	5363
90	5723	5616	5641	5265	5362
95	5489	5565	5472	5482	5458

Hopping Frequency Sequence Name: HOP_FREQ_SEQ_27

Frequency (MHz)	0	1	2	3	4
0	5258	5476	5403	5369	5393
5	5669	5402	5541	5477	5532
10	5413	5408	5421	5405	5655
15	5520	5278	5596	5663	5516
20	5519	5656	5433	5582	5693
25	5259	5406	5378	5535	5438
30	5708	5697	5409	5339	5703
35	5638	5420	5675	5687	5607
40	5271	5454	5332	5345	5492
45	5564	5451	5362	5709	5350
50	5261	5499	5632	5609	5424
55	5293	5546	5498	5384	5610
60	5274	5256	5386	5646	5538
65	5724	5427	5267	5447	5328
70	5634	5495	5412	5574	5435
75	5340	5533	5294	5491	5351
80	5545	5502	5552	5626	5692
85	5696	5524	5553	5722	5344
90	5448	5521	5301	5565	5466
95	5660	5250	5658	5320	5346

Hopping Frequency Sequence Name: HOP_FREQ_SEQ_28

Frequency (MHz)	0	1	2	3	4
0	5513	5715	5339	5530	5613
5	5711	5327	5616	5640	5264
10	5344	5672	5462	5600	5676
15	5608	5405	5699	5708	5430
20	5250	5471	5574	5666	5525
25	5258	5581	5639	5472	5275
30	5586	5366	5554	5477	5458
35	5559	5291	5580	5285	5282
40	5293	5512	5283	5257	5561
45	5380	5720	5317	5311	5314
50	5494	5278	5333	5660	5591
55	5490	5686	5338	5325	5568
60	5702	5515	5336	5483	5653
65	5633	5373	5565	5396	5364
70	5369	5673	5298	5484	5560
75	5438	5664	5355	5492	5263
80	5611	5675	5505	5603	5558
85	5619	5689	5592	5416	5427
90	5307	5439	5316	5722	5294
95	5596	5255	5694	5262	5375

Hopping Frequency Sequence Name: HOP_FREQ_SEQ_29

Frequency (MHz)	0	1	2	3	4
0	5671	5479	5275	5691	5455
5	5278	5349	5328	5568	5461
10	5503	5698	5697	5696	5435
15	5705	5425	5438	5416	5412
20	5663	5639	5413	5585	5309
25	5365	5506	5414	5572	5323
30	5294	5629	5382	5376	5607
35	5595	5497	5558	5687	5700
40	5400	5369	5367	5284	5509
45	5711	5602	5337	5302	5292
50	5515	5387	5673	5644	5501
55	5428	5485	5556	5319	5291
60	5345	5676	5565	5576	5653
65	5546	5538	5513	5331	5451
70	5707	5256	5721	5486	5380
75	5668	5539	5308	5374	5589
80	5611	5330	5334	5270	5631
85	5281	5298	5542	5420	5478
90	5359	5371	5692	5430	5411
95	5280	5405	5306	5601	5646

Hopping Frequency Sequence Name: HOP_FREQ_SEQ_30

Frequency (MHz)	0	1	2	3	4
0	5451	5718	5686	5377	5675
5	5417	5274	5291	5491	5300
10	5584	5250	5544	5418	5309
15	5562	5333	5701	5617	5446
20	5485	5353	5655	5612	5679
25	5534	5512	5469	5540	5456
30	5461	5280	5509	5403	5476
35	5362	5473	5647	5688	5585
40	5678	5634	5262	5555	5616
45	5680	5483	5427	5323	5646
50	5505	5685	5287	5691	5615
55	5281	5490	5721	5608	5644
60	5676	5666	5470	5317	5382
65	5492	5294	5339	5411	5360
70	5379	5629	5541	5265	5307
75	5410	5579	5376	5389	5467
80	5632	5303	5320	5472	5437
85	5586	5331	5330	5273	5251
90	5624	5252	5315	5517	5484
95	5665	5716	5383	5395	5653

--- END ---