



# FCC TEST REPORT

**REPORT NO.:** RF931203L06  
**MODEL NO.:** WGA54G ver. 2  
**RECEIVED:** Dec. 03, 2004  
**TESTED:** Dec. 03 ~ Dec. 13, 2004  
**ISSUED:** Jan. 11, 2005

**APPLICANT:** Cisco-Linksys, LLC

**ADDRESS:** 121 Theory Drive Irvine, CA 92612 U.S.A.

**ISSUED BY:** Advance Data Technology Corporation

**LAB ADDRESS:** No. 47, 14<sup>th</sup> Ling, Chia Pau Tsuen, Lin Kou Hsiang 244, Taipei Hsien, Taiwan, R.O.C.

**TEST LOCATION:** No. 19, Hwa Ya 2<sup>nd</sup> Rd., Wen Hwa Tsuen, Kwei Shan Hsiang, Taoyuan Hsien 333, Taiwan, R.O.C.

This test report consists of 72 pages in total. It may be duplicated completely for legal use with the approval of the applicant. It should not be reproduced except in full, without the written approval of our laboratory. The client should not use it to claim product endorsement by CNLA, A2LA or any government agencies. The test results in the report only apply to the tested sample.



0528  
ILAC MRA



No. 2177-01



## Table of Contents

1.	CERTIFICATION .....	4
2.	SUMMARY OF TEST RESULTS .....	5
2.1	MEASUREMENT UNCERTAINTY .....	5
3.	GENERAL INFORMATION.....	6
3.1	GENERAL DESCRIPTION OF EUT .....	6
3.2	DESCRIPTION OF TEST MODES.....	7
3.2.1	CONFIGURATION OF SYSTEM UNDER TEST .....	7
3.2.2	TEST MODE APPLICABILITY:.....	8
3.3	GENERAL DESCRIPTION OF APPLIED STANDARDS .....	10
3.4	DESCRIPTION OF SUPPORT UNITS .....	10
4.	TEST TYPES AND RESULTS .....	11
4.1	CONDUCTED EMISSION MEASUREMENT .....	11
4.1.1	LIMITS OF CONDUCTED EMISSION MEASUREMENT.....	11
4.1.2	TEST INSTRUMENTS .....	11
4.1.3	TEST PROCEDURES .....	12
4.1.4	DEVIATION FROM TEST STANDARD .....	12
4.1.5	TEST SETUP .....	13
4.1.6	EUT OPERATING CONDITIONS .....	13
4.1.7	TEST RESULTS .....	14
4.2	RADIATED EMISSION MEASUREMENT .....	26
4.2.1	LIMITS OF RADIATED EMISSION MEASUREMENT.....	26
4.2.2	TEST INSTRUMENTS .....	27
4.2.3	TEST PROCEDURES .....	28
4.2.4	DEVIATION FROM TEST STANDARD .....	28
4.2.5	TEST SETUP .....	29
4.2.6	EUT OPERATING CONDITIONS .....	29
4.2.7	TEST RESULTS .....	30
4.3	6dB BANDWIDTH MEASUREMENT .....	39
4.3.1	LIMITS OF 6DB BANDWIDTH MEASUREMENT .....	39
4.3.2	TEST INSTRUMENTS .....	39
4.3.3	TEST PROCEDURE .....	40
4.3.4	DEVIATION FROM TEST STANDARD .....	40
4.3.5	TEST SETUP .....	40
4.3.6	EUT OPERATING CONDITIONS .....	40
4.3.7	TEST RESULTS .....	41
4.4	MAXIMUM PEAK OUTPUT POWER .....	47
4.4.1	LIMITS OF MAXIMUM PEAK OUTPUT POWER MEASUREMENT.....	47
4.4.2	INSTRUMENTS.....	47
4.4.1	TEST PROCEDURES .....	48
4.4.2	DEVIATION FROM TEST STANDARD .....	48
4.4.3	TEST SETUP .....	48
4.4.4	EUT OPERATING CONDITIONS .....	48
4.4.3	TEST RESULTS .....	49



4.5	POWER SPECTRAL DENSITY MEASUREMENT .....	50
4.5.1	LIMITS OF POWER SPECTRAL DENSITY MEASUREMENT .....	50
4.5.2	TEST INSTRUMENTS .....	50
4.5.3	TEST PROCEDURE .....	51
4.5.4	DEVIATION FROM TEST STANDARD .....	51
4.5.5	TEST SETUP .....	51
4.5.6	EUT OPERATING CONDITION .....	51
4.5.7	TEST RESULTS .....	52
4.6	BAND EDGES MEASUREMENT .....	58
4.6.1	LIMITS OF BAND EDGES MEASUREMENT .....	58
4.6.2	TEST INSTRUMENTS .....	58
4.6.3	TEST PROCEDURE .....	58
4.6.4	DEVIATION FROM TEST STANDARD .....	58
4.6.5	EUT OPERATING CONDITION .....	58
4.6.6	TEST RESULTS .....	59
4.6.7	TEST RESULTS .....	59
4.7	ANTENNA REQUIREMENT .....	67
4.7.1	STANDARD APPLICABLE .....	67
4.7.2	ANTENNA CONNECTED CONSTRUCTION .....	67
5.	PHOTOGRAPHS OF THE TEST CONFIGURATION.....	68
6.	INFORMATION ON THE TESTING LABORATORIES .....	72



## 1. CERTIFICATION

**PRODUCT:** Wireless-G Game Adapter  
**BRAND NAME:** Linksys  
**MODEL NO.:** WGA54G ver. 2  
**TEST SAMPLE:** ENGINEERING SAMPLE  
**TESTED:** Dec. 03 ~ Dec. 13, 2004  
**APPLICANT:** Cisco-Linksys, LLC  
**STANDARDS:** FCC Part 15, Subpart C (Section 15.247),  
ANSI C63.4 -2003

The above equipment have been tested by **Advance Data Technology Corporation**, and found compliance with the requirement of the above standards. The test record, data evaluation & Equipment Under Test (EUT) configurations represented herein are true and accurate accounts of the measurements of the sample's EMC characteristics under the conditions specified in this report.

**PREPARED BY** : Andrea Hsia , **DATE:** Jan. 11, 2005  
( Andrea Hsia )

**TECHNICAL**  
**ACCEPTANCE** : Gary Chang , **DATE:** Jan. 11, 2005  
Responsible for RF ( Gary Chang )

**APPROVED BY** : Cody Chang , **DATE:** Jan. 11, 2005  
( Cody Chang, Deputy Manager )

## 2. SUMMARY OF TEST RESULTS

The EUT has been tested according to the following specifications:

APPLIED STANDARD: FCC Part 15, Subpart C			
Standard Section	Test Type and Limit	Result	Remark
15.207	AC Power Conducted Emission	PASS	Meet the requirement of limit. Minimum passing margin is -11.21dB at 0.525MHz
15.247(a)(2)	Spectrum Bandwidth of a Direct Sequence Spread Spectrum System Limit: min. 500kHz	PASS	Meet the requirement of limit.
15.247(b)	Maximum Peak Output Power Limit: max. 30dBm	PASS	Meet the requirement of limit.
15.247(d)	Radiated Emissions Limit: Table 15.209	PASS	Meet the requirement of limit. Minimum passing margin is -1.79dB at 199.12MHz
15.247(e)	Power Spectral Density Limit: max. 8dBm	PASS	Meet the requirement of limit.
15.247(d)	Band Edge Measurement Limit: 20dB less than the peak value of fundamental frequency	PASS	Meet the requirement of limit.

### 2.1 MEASUREMENT UNCERTAINTY

Where relevant, the following measurement uncertainty levels have been estimated for tests performed on the EUT as specified in CISPR 16-4:

Measurement	Frequency	Uncertainty
Conducted emissions	9kHz~30MHz	2.44 dB
	30MHz ~ 200MHz	3.73 dB
Radiated emissions	200MHz ~ 1000MHz	3.74 dB
	1GHz ~ 18GHz	2.20 dB
	18GHz ~ 40GHz	1.88 dB



### 3. GENERAL INFORMATION

#### 3.1 GENERAL DESCRIPTION OF EUT

<b>EUT</b>	Wireless-G Game Adapter
<b>MODEL NO.</b>	WGA54G ver. 2
<b>POWER SUPPLY</b>	12Vdc from AC Adapter
<b>MODULATION TYPE</b>	CCK, DQPSK, DBPSK for DSSS 64QAM, 16QAM, QPSK, BPSK for OFDM
<b>RADIO TECHNOLOGY</b>	DSSS, OFDM
<b>TRANSFER RATE</b>	802.11b: 11/5.5/2/1Mbps 802.11g: 54/48/36/24/18/12/9/6Mbps
<b>FREQUENCY RANGE</b>	2412MHz ~ 2462MHz
<b>NUMBER OF CHANNEL</b>	11
<b>OUTPUT POWER</b>	25.645mW
<b>ANTENNA TYPE</b>	Dipole antenna with 2dBi gain
<b>DATA CABLE</b>	NA
<b>I/O PORTS</b>	Refer to User's Manual
<b>ASSOCIATED DEVICES</b>	NA

**NOTE:**

1. The EUT complies with IEEE 802.11g standards and backwards compatible with IEEE 802.11b products.
2. The EUT operates in the 2.4GHz frequency spectrum with throughput of up to 54Mbps.
3. The EUT were powered by the following Adapters:

<b>Brand</b>	LINKSYS
<b>Model</b>	WD411200500
<b>Input</b>	120Vac, 60Hz, 11W
<b>Output</b>	12Vdc, 500mA
<b>Power Line</b>	DC 1.8m non-shielded cable without core

<b>Brand</b>	LINKSYS
<b>Model</b>	411210003CT
<b>Input</b>	120Vac, 60Hz, 20W
<b>Output</b>	12Vdc, 1000mA
<b>Power Line</b>	DC 1.8m non-shielded cable with one core

4. The above EUT information was declared by manufacturer and for more detailed features description, please refer to the manufacturer's specifications or User's Manual.

### 3.2 DESCRIPTION OF TEST MODES

802.11b and 802.11g: Eleven channels are provided to this EUT.

Channel	Frequency	Channel	Frequency
1	2412 MHz	7	2442 MHz
2	2417 MHz	8	2447 MHz
3	2422 MHz	9	2452 MHz
4	2427 MHz	10	2457 MHz
5	2432 MHz	11	2462 MHz
6	2437 MHz		

#### 3.2.1 CONFIGURATION OF SYSTEM UNDER TEST

##### Test Mode1

(With AC Adapter: WD411200500)

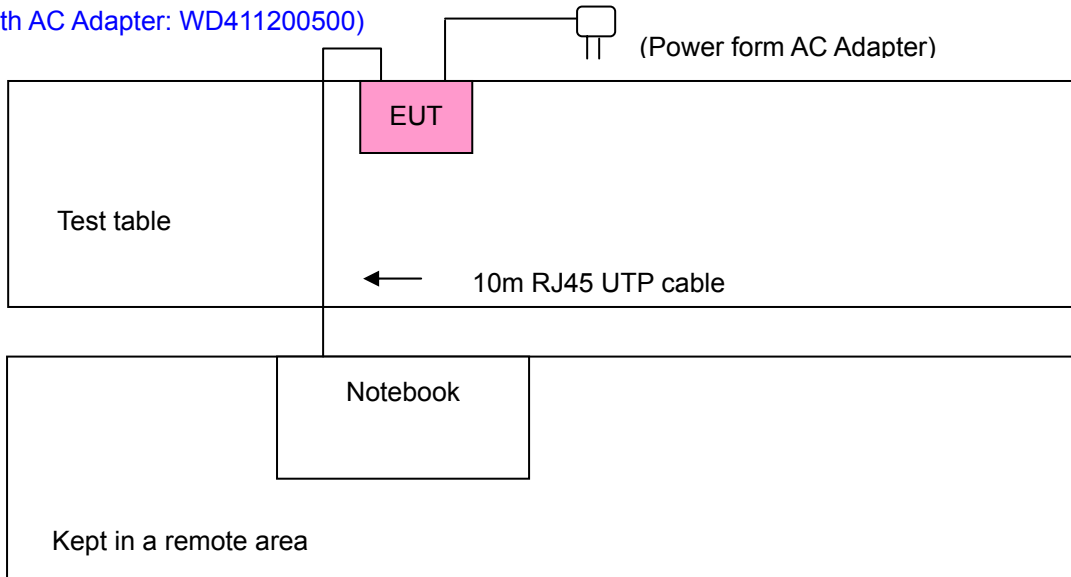

##### Test Mode 2

(With AC Adapter: 411210003CT)

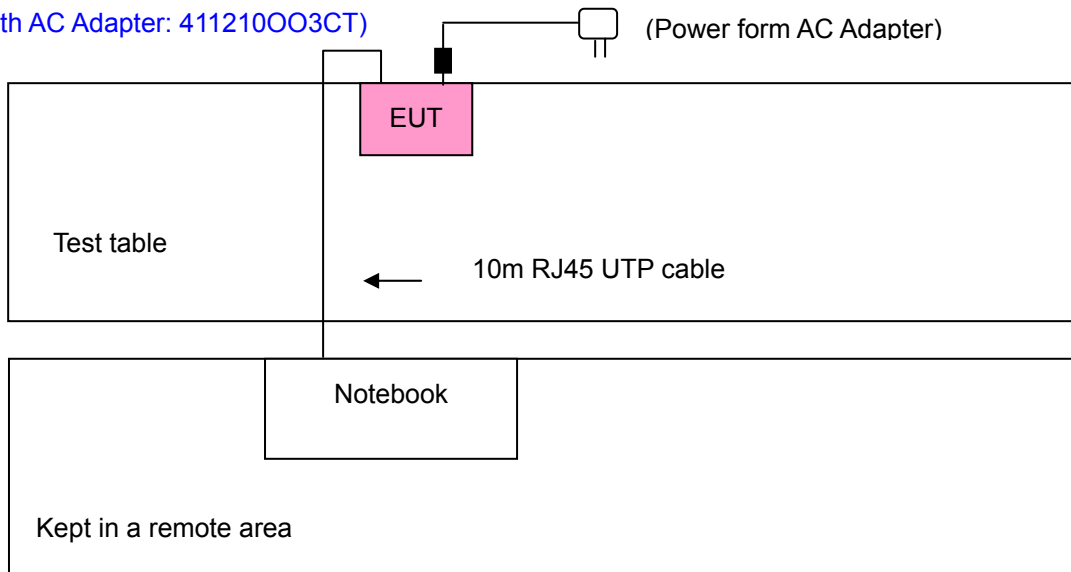



3.2.2 TEST MODE APPLICABILITY AND TESTED CHANNEL DETAIL:

EUT configure mode	Applicable to				Description
	PLC	RE<1G	RE≥1G	APCM	
1	X	X	Note 1	Note 2	With WD411200500 AC Adapter
2	X	X	Note 1	Note 2	With 411210003CT AC Adapter

Where PLC: Power Line Conducted Emission RE<1G RE: Radiated Emission below 1GHz  
 RE≥1G: Radiated Emission above 1GHz APCM: Antenna Port Conducted Measurement

Note 1: Pre-Scan show AC Adapter has no effect for Radiated Emission above 1GHz.  
 Note 2: Pre-Scan show AC Adapter has no effect for conducted RF measurement.

**Power Line Conducted Emission Test:**

- Pre-Scan has been conducted to determine the worst-case mode from all possible combinations between available modulations, data rates and antenna ports (if EUT with antenna diversity architecture).
- Following channel(s) was (were) selected for the final test as listed below.

Mode	Available Channel	Tested Channel	Modulation Technology	Modulation Type	Data Rate (Mbps)
802.11g	1 to 11	1, 6, 11	OFDM	BPSK	6

**Radiated Emission Test (Below 1 GHz):**

- Pre-Scan has been conducted to determine the worst-case mode from all possible combinations between available modulations, data rates and antenna ports (if EUT with antenna diversity architecture).
- Following channel(s) was (were) selected for the final test as listed below.

Mode	Available Channel	Tested Channel	Modulation Technology	Modulation Type	Data Rate (Mbps)
802.11g	1 to 11	11	OFDM	BPSK	6

**Radiated Emission Test (Above 1 GHz):**

- Pre-Scan has been conducted to determine the worst-case mode from all possible combinations between available modulations, data rates and antenna ports (if EUT with antenna diversity architecture).
- Following channel(s) was (were) selected for the final test as listed below.

Mode	Available Channel	Tested Channel	Modulation Technology	Modulation Type	Data Rate (Mbps)
802.11b	1 to 11	1, 6, 11	DSSS	CCK	11
802.11g	1 to 11	1, 6, 11	OFDM	BPSK	6





**Bandedge Measurement:**

- Pre-Scan has been conducted to determine the worst-case mode from all possible combinations between available modulations, data rates and antenna ports (if EUT with antenna diversity architecture).
- Following channel(s) was (were) selected for the final test as listed below.

Mode	Available Channel	Tested Channel	Modulation Technology	Modulation Type	Data Rate (Mbps)
802.11b	1 to 11	1, 11	DSSS	CCK	11
802.11g	1 to 11	1, 11	OFDM	BPSK	6

**Antenna Port Conducted Measurement:**

- Pre-Scan has been conducted to determine the worst-case mode from all possible combinations between available modulations, data rates and antenna ports (if EUT with antenna diversity architecture).
- Following channel(s) was (were) selected for the final test as listed below.

Mode	Available Channel	Tested Channel	Modulation Technology	Modulation Type	Data Rate (Mbps)
802.11b	1 to 11	1, 6, 11	DSSS	CCK	11
802.11g	1 to 11	1, 6, 11	OFDM	BPSK	6



### 3.3 GENERAL DESCRIPTION OF APPLIED STANDARDS

The EUT is a Wireless-G Game Adapter. According to the specifications of the manufacturer, it must comply with the requirements of the following standards:

#### FCC Part 15, Subpart C. (15.247)

#### ANSI C63.4- 2003

All test items have been performed and recorded as per the above standards.

**NOTE:** The EUT is also considered as a kind of computer peripheral, because the connection to computer is necessary for typical use. It has been verified to comply with the requirements of FCC Part 15, Subpart B, Class B (DoC). The test report has been issued separately.

### 3.4 DESCRIPTION OF SUPPORT UNITS

The EUT has been tested as an independent unit together with other necessary accessories or support units. The following support units or accessories were used to form a representative test configuration during the tests.

NO.	PRODUCT	BRAND	MODEL NO.	SERIAL NO.	FCC ID
1	NOTEBOOK	DELL	PP05L	12130898320	E2K24CLNS

NO.	SIGNAL CABLE DESCRIPTION OF THE ABOVE SUPPORT UNITS
1	NA

- NOTE:** 1. All power cords of the above support units are non shielded (1.8m).  
2. Item 1 act as a communication partner to transfer data.



## 4. TEST TYPES AND RESULTS

### 4.1 CONDUCTED EMISSION MEASUREMENT

#### 4.1.1 LIMITS OF CONDUCTED EMISSION MEASUREMENT

FREQUENCY OF EMISSION (MHz)	CONDUCTED LIMIT (dB $\mu$ V)	
	Quasi-peak	Average
0.15-0.5	66 to 56	56 to 46
0.5-5	56	46
5-30	60	50

- NOTE:**
1. The lower limit shall apply at the transition frequencies.
  2. The limit decreases in line with the logarithm of the frequency in the range of 0.15 to 0.50 MHz.
  3. All emanations from a class A/B digital device or system, including any network of conductors and apparatus connected thereto, shall not exceed the level of field strengths specified above.

#### 4.1.2 TEST INSTRUMENTS

DESCRIPTION & MANUFACTURER	MODEL NO.	SERIAL NO.	CALIBRATED UNTIL
Test Receiver ROHDE & SCHWARZ	ESCS30	100291	Nov. 16, 2005
RF signal cable Woken	5D-FB	Cable-HYC01-01	Mar. 02, 2005
LISN ROHDE & SCHWARZ	ESH3-Z5	100312	Mar. 03, 2005
LISN ROHDE & SCHWARZ	ESH2-Z5	100104	Mar. 02, 2005
Software ADT	ADT_Cond_V3	NA	NA

- NOTE:**
1. The calibration interval of the above test instruments is 12 months and the calibrations are traceable to NML/ROC and NIST/USA.
  2. The test was performed in HwaYa Shielded Room 1.
  3. The VCCI Site Registration No. is C-2040.



#### 4.1.3 TEST PROCEDURES

- a. The EUT was placed 0.4 meters from the conducting wall of the shielded room with EUT being connected to the power mains through a line impedance stabilization network (LISN). Other support units were connected to the power mains through another LISN. The two LISNs provide 50 ohm/ 50uH of coupling impedance for the measuring instrument.
- b. Both lines of the power mains connected to the EUT were checked for maximum conducted interference.
- c. The frequency range from 150kHz to 30MHz was searched. Emission levels under (Limit - 20dB) was not recorded.

#### 4.1.4 DEVIATION FROM TEST STANDARD

No deviation

#### 4.1.5 TEST SETUP

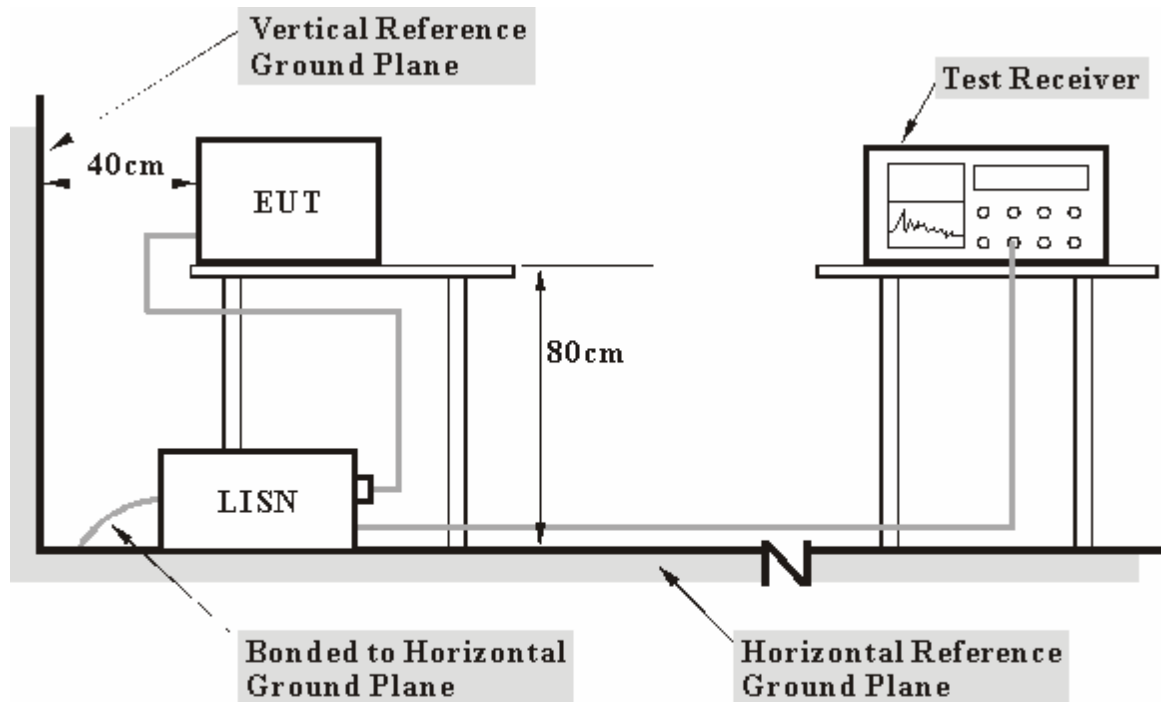

- Note:**
1. Support units were connected to second LISN.
  2. Both of LISNs (AMN) 80 cm from EUT and at the least 80 cm from other units and other metal planes support units.

For the actual test configuration, please refer to the related item – Photographs of the Test Configuration.

#### 4.1.6 EUT OPERATING CONDITIONS

- a. Placed the EUT on the testing table.
- b. Prepared another Notebook system to act as a communication partner and placed it outside of testing via an RJ45 cable area.
- c. The communication partner and run a test program (provided by manufacturer) to enable EUT under transmission/receiving condition continuously at specific channel frequency.
- d. The communication partner sent data to EUT by command "PING".



4.1.7 TEST RESULTS

**Conducted Worst-Case Data**

Test Mode1 (with WD411200500 AC adapter)

<b>EUT</b>	Wireless-G Game Adapter	<b>MODEL</b>	WGA54G ver. 2
<b>CHANNEL</b>	Channel 1	<b>6dB BANDWIDTH</b>	9 kHz
<b>MODULATION TYPE</b>	BPSK	<b>TRANSFER RATE</b>	6Mbps
<b>INPUT POWER (SYSTEM)</b>	120Vac, 60Hz	<b>PHASE</b>	Line (L)
<b>ENVIRONMENTAL CONDITIONS</b>	23deg. C, 69%RH, 991hPa	<b>TESTED BY</b>	Steven Lu

No	Freq. [MHz]	Corr. Factor (dB)	Reading Value		Emission Level		Limit		Margin	
			[dB (uV)]		[dB (uV)]		[dB (uV)]		(dB)	
			Q.P.	AV.	Q.P.	AV.	Q.P.	AV.	Q.P.	AV.
1	0.154	0.10	44.79	-	44.89	-	65.79	55.79	-20.89	-
2	0.201	0.10	45.04	-	45.14	-	63.58	53.58	-18.44	-
3	0.372	0.11	36.36	-	36.47	-	58.47	48.47	-21.99	-
4	0.623	0.16	27.58	-	27.74	-	56.00	46.00	-28.26	-
5	1.751	0.26	21.90	-	22.16	-	56.00	46.00	-33.84	-
6	25.000	1.16	25.60	-	26.76	-	60.00	50.00	-33.24	-

- REMARKS:**
1. Q.P. and AV. are abbreviations of quasi-peak and average individually.
  2. "-": The Quasi-peak reading value also meets average limit and measurement with the average detector is unnecessary.
  3. The emission levels of other frequencies were very low against the limit.
  4. Margin value = Emission level - Limit value
  5. Correction factor = Insertion loss + Cable loss
  6. Emission Level = Correction Factor + Reading Value.

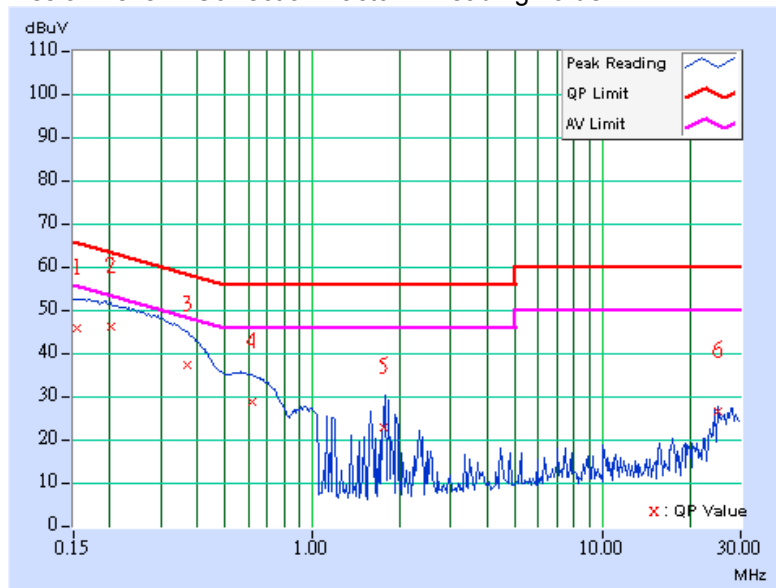



Test Mode1 (with WD411200500 AC adapter)

<b>EUT</b>	Wireless-G Game Adapter	<b>MODEL</b>	WGA54G ver. 2
<b>CHANNEL</b>	Channel 1	<b>6dB BANDWIDTH</b>	9 kHz
<b>MODULATION TYPE</b>	BPSK	<b>TRANSFER RATE</b>	6Mbps
<b>INPUT POWER (SYSTEM)</b>	120Vac, 60 Hz	<b>PHASE</b>	Neutral (N)
<b>ENVIRONMENTAL CONDITIONS</b>	23deg. C, 69%RH, 991hPa	<b>TESTED BY</b>	Steven Lu

No	Freq. [MHz]	Corr. Factor (dB)	Reading Value		Emission Level		Limit		Margin	
			[dB (uV)]		[dB (uV)]		[dB (uV)]		(dB)	
			Q.P.	AV.	Q.P.	AV.	Q.P.	AV.	Q.P.	AV.
1	0.201	0.10	46.58	-	46.68	-	63.58	53.58	-16.90	-
2	0.283	0.11	42.93	-	43.04	-	60.73	50.73	-17.70	-
3	0.372	0.11	41.22	-	41.33	-	58.45	48.45	-17.12	-
4	0.900	0.22	30.40	-	30.62	-	56.00	46.00	-25.38	-
5	1.115	0.24	24.26	-	24.50	-	56.00	46.00	-31.50	-
6	1.582	0.25	21.94	-	22.19	-	56.00	46.00	-33.81	-

- REMARKS:**
1. Q.P. and AV. are abbreviations of quasi-peak and average individually.
  2. "-": The Quasi-peak reading value also meets average limit and measurement with the average detector is unnecessary.
  3. The emission levels of other frequencies were very low against the limit.
  4. Margin value = Emission level - Limit value
  5. Correction factor = Insertion loss + Cable loss
  6. Emission Level = Correction Factor + Reading Value.

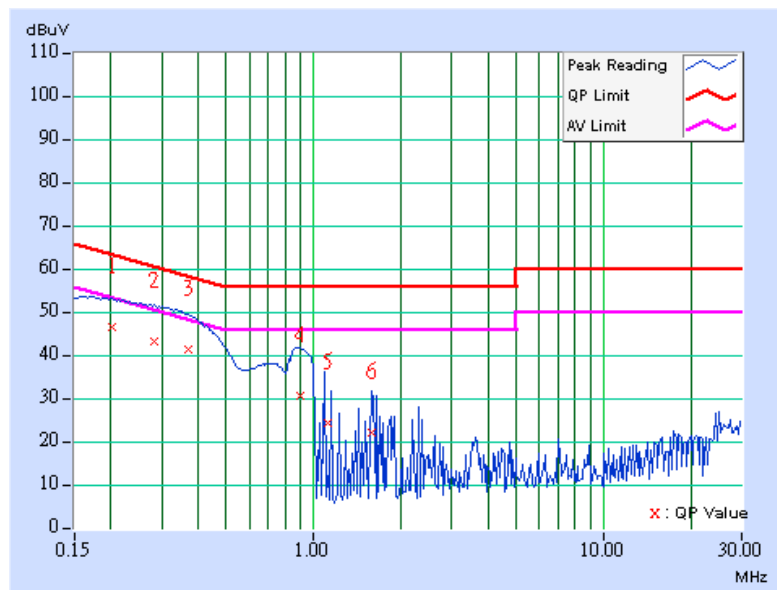



Test Mode1 (with WD411200500 AC adapter)

<b>EUT</b>	Wireless-G Game Adapter	<b>MODEL</b>	WGA54G ver. 2
<b>CHANNEL</b>	Channel 6	<b>6dB BANDWIDTH</b>	9 kHz
<b>MODULATION TYPE</b>	BPSK	<b>TRANSFER RATE</b>	6Mbps
<b>INPUT POWER (SYSTEM)</b>	120Vac, 60 Hz	<b>PHASE</b>	Line (L)
<b>ENVIRONMENTAL CONDITIONS</b>	23deg. C, 69%RH, 991hPa	<b>TESTED BY</b>	Steven Lu

No	Freq. [MHz]	Corr. Factor (dB)	Reading Value		Emission Level		Limit		Margin	
			[dB (uV)]		[dB (uV)]		[dB (uV)]		(dB)	
			Q.P.	AV.	Q.P.	AV.	Q.P.	AV.	Q.P.	AV.
1	0.162	0.10	44.91	-	45.01	-	65.38	55.38	-20.36	-
2	0.201	0.10	43.66	-	43.76	-	63.58	53.58	-19.82	-
3	0.287	0.11	40.01	-	40.12	-	60.62	50.62	-20.50	-
4	0.745	0.19	22.59	-	22.78	-	56.00	46.00	-33.22	-
5	1.490	0.25	21.75	-	22.00	-	56.00	46.00	-34.00	-
6	24.555	1.14	26.54	-	27.68	-	60.00	50.00	-32.32	-

- REMARKS:**
1. Q.P. and AV. are abbreviations of quasi-peak and average individually.
  2. "-": The Quasi-peak reading value also meets average limit and measurement with the average detector is unnecessary.
  3. The emission levels of other frequencies were very low against the limit.
  4. Margin value = Emission level - Limit value
  5. Correction factor = Insertion loss + Cable loss
  6. Emission Level = Correction Factor + Reading Value.

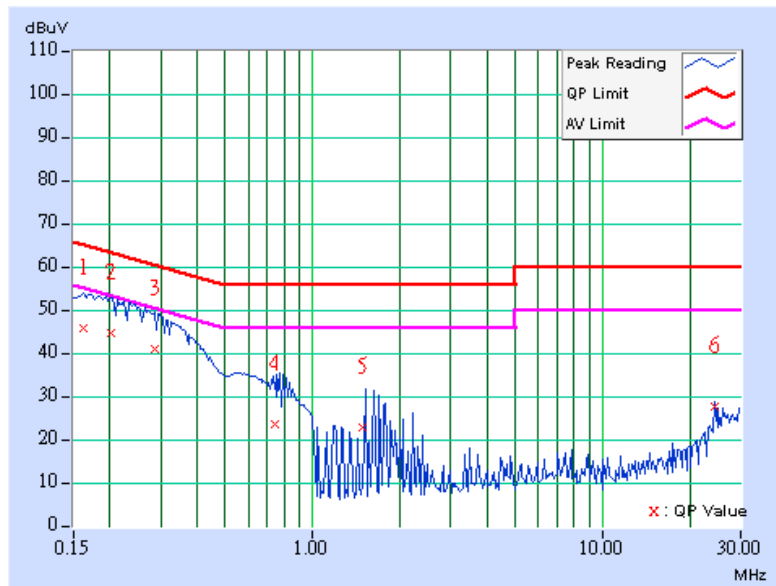





Test Mode1 (with WD411200500 AC adapter)

<b>EUT</b>	Wireless-G Game Adapter	<b>MODEL</b>	WGA54G ver. 2
<b>CHANNEL</b>	Channel 6	<b>6dB BANDWIDTH</b>	9 kHz
<b>MODULATION TYPE</b>	BPSK	<b>TRANSFER RATE</b>	6Mbps
<b>INPUT POWER (SYSTEM)</b>	120Vac, 60 Hz	<b>PHASE</b>	Neutral (N)
<b>ENVIRONMENTAL CONDITIONS</b>	23deg. C, 69%RH, 991hPa	<b>TESTED BY</b>	Steven Lu

No	Freq. [MHz]	Corr. Factor (dB)	Reading Value		Emission Level		Limit		Margin	
			[dB (uV)]		[dB (uV)]		[dB (uV)]		(dB)	
			Q.P.	AV.	Q.P.	AV.	Q.P.	AV.	Q.P.	AV.
1	0.166	0.10	45.89	-	45.99	-	65.18	55.18	-19.19	-
2	0.252	0.10	43.69	-	43.79	-	61.71	51.71	-17.91	-
3	0.326	0.11	41.93	-	42.04	-	59.56	49.56	-17.52	-
4	0.370	0.11	41.34	-	41.45	-	58.49	48.49	-17.04	-
5	0.802	0.19	30.05	-	30.24	-	56.00	46.00	-25.76	-
6	1.487	0.24	22.69	-	22.93	-	56.00	46.00	-33.07	-

- REMARKS:**
1. Q.P. and AV. are abbreviations of quasi-peak and average individually.
  2. "-": The Quasi-peak reading value also meets average limit and measurement with the average detector is unnecessary.
  3. The emission levels of other frequencies were very low against the limit.
  4. Margin value = Emission level - Limit value
  5. Correction factor = Insertion loss + Cable loss
  6. Emission Level = Correction Factor + Reading Value.

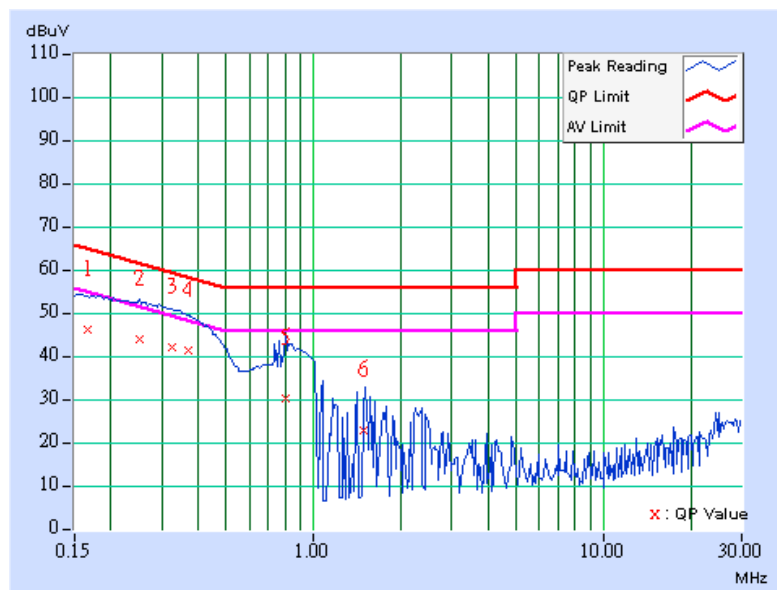



Test Mode1 (with WD411200500 AC adapter)

<b>EUT</b>	Wireless-G Game Adapter	<b>MODEL</b>	WGA54G ver. 2
<b>CHANNEL</b>	Channel 11	<b>6dB BANDWIDTH</b>	9 kHz
<b>MODULATION TYPE</b>	BPSK	<b>TRANSFER RATE</b>	6Mbps
<b>INPUT POWER (SYSTEM)</b>	120Vac, 60 Hz	<b>PHASE</b>	Line (L)
<b>ENVIRONMENTAL CONDITIONS</b>	23deg. C, 69%RH, 991hPa	<b>TESTED BY</b>	Steven Lu

No	Freq. [MHz]	Corr. Factor (dB)	Reading Value		Emission Level		Limit		Margin	
			[dB (uV)]		[dB (uV)]		[dB (uV)]		(dB)	
			Q.P.	AV.	Q.P.	AV.	Q.P.	AV.	Q.P.	AV.
1	0.177	0.10	45.21	-	45.31	-	64.61	54.61	-19.30	-
2	0.224	0.10	43.25	-	43.35	-	62.66	52.66	-19.31	-
3	0.373	0.11	36.06	-	36.17	-	58.44	48.44	-22.27	-
4	0.572	0.15	28.03	-	28.18	-	56.00	46.00	-27.82	-
5	1.484	0.25	21.98	-	22.23	-	56.00	46.00	-33.77	-
6	24.555	1.14	25.87	-	27.01	-	60.00	50.00	-32.99	-

- REMARKS:**
1. Q.P. and AV. are abbreviations of quasi-peak and average individually.
  2. "-": The Quasi-peak reading value also meets average limit and measurement with the average detector is unnecessary.
  3. The emission levels of other frequencies were very low against the limit.
  4. Margin value = Emission level - Limit value
  5. Correction factor = Insertion loss + Cable loss
  6. Emission Level = Correction Factor + Reading Value.

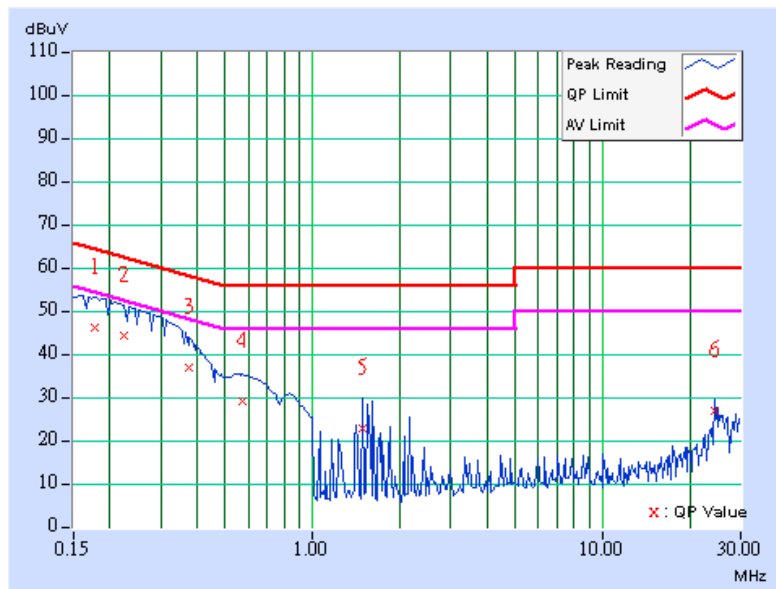



Test Mode1 (with WD411200500 AC adapter)

<b>EUT</b>	Wireless-G Game Adapter	<b>MODEL</b>	WGA54G ver. 2
<b>CHANNEL</b>	Channel 11	<b>6dB BANDWIDTH</b>	9 kHz
<b>MODULATION TYPE</b>	BPSK	<b>TRANSFER RATE</b>	6Mbps
<b>INPUT POWER (SYSTEM)</b>	120Vac, 60 Hz	<b>PHASE</b>	Neutral (N)
<b>ENVIRONMENTAL CONDITIONS</b>	23deg. C, 69%RH, 991hPa	<b>TESTED BY</b>	Steven Lu

No	Freq. [MHz]	Corr. Factor (dB)	Reading Value		Emission Level		Limit		Margin	
			[dB (uV)]		[dB (uV)]		[dB (uV)]		(dB)	
			Q.P.	AV.	Q.P.	AV.	Q.P.	AV.	Q.P.	AV.
1	0.189	0.10	47.58	-	47.68	-	64.08	54.08	-16.40	-
2	0.252	0.10	44.24	-	44.34	-	61.71	51.71	-17.36	-
3	0.370	0.11	41.30	-	41.41	-	58.51	48.51	-17.10	-
4	0.744	0.18	29.11	-	29.29	-	56.00	46.00	-26.71	-
5	1.116	0.24	22.26	-	22.50	-	56.00	46.00	-33.50	-
6	2.230	0.26	21.94	-	22.20	-	56.00	46.00	-33.80	-

- REMARKS:**
1. Q.P. and AV. are abbreviations of quasi-peak and average individually.
  2. "-": The Quasi-peak reading value also meets average limit and measurement with the average detector is unnecessary.
  3. The emission levels of other frequencies were very low against the limit.
  4. Margin value = Emission level - Limit value
  5. Correction factor = Insertion loss + Cable loss
  6. Emission Level = Correction Factor + Reading Value.

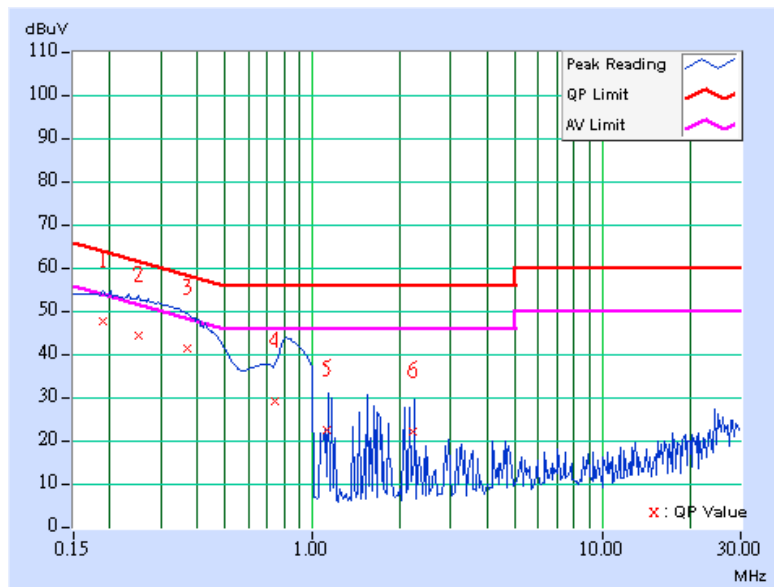



Test Mode 2 (with 411210003CT AC Adapter)

<b>EUT</b>	Wireless-G Game Adapter	<b>MODEL</b>	WGA54G ver. 2
<b>CHANNEL</b>	Channel 1	<b>6dB BANDWIDTH</b>	9 kHz
<b>MODULATION TYPE</b>	BPSK	<b>TRANSFER RATE</b>	6Mbps
<b>INPUT POWER (SYSTEM)</b>	120Vac, 60Hz	<b>PHASE</b>	Line (L)
<b>ENVIRONMENTAL CONDITIONS</b>	24deg. C, 64%RH, 991hPa	<b>TESTED BY</b>	Leo Hung

No	Freq. [MHz]	Corr. Factor (dB)	Reading Value		Emission Level		Limit		Margin	
			[dB (uV)]		[dB (uV)]		[dB (uV)]		(dB)	
			Q.P.	AV.	Q.P.	AV.	Q.P.	AV.	Q.P.	AV.
1	0.154	0.10	48.88	-	48.98	-	65.79	55.79	-16.80	-
2	0.185	0.10	48.17	-	48.27	-	64.25	54.25	-15.98	-
3	0.392	0.11	40.42	-	40.53	-	58.02	48.02	-17.48	-
4	1.773	0.26	15.14	-	15.40	-	56.00	46.00	-40.60	-
5	14.137	0.67	28.41	-	29.08	-	60.00	50.00	-30.92	-
6	26.406	1.21	34.07	-	35.28	-	60.00	50.00	-24.72	-

- REMARKS:**
1. Q.P. and AV. are abbreviations of quasi-peak and average individually.
  2. "-": The Quasi-peak reading value also meets average limit and measurement with the average detector is unnecessary.
  3. The emission levels of other frequencies were very low against the limit.
  4. Margin value = Emission level - Limit value
  5. Correction factor = Insertion loss + Cable loss
  6. Emission Level = Correction Factor + Reading Value.

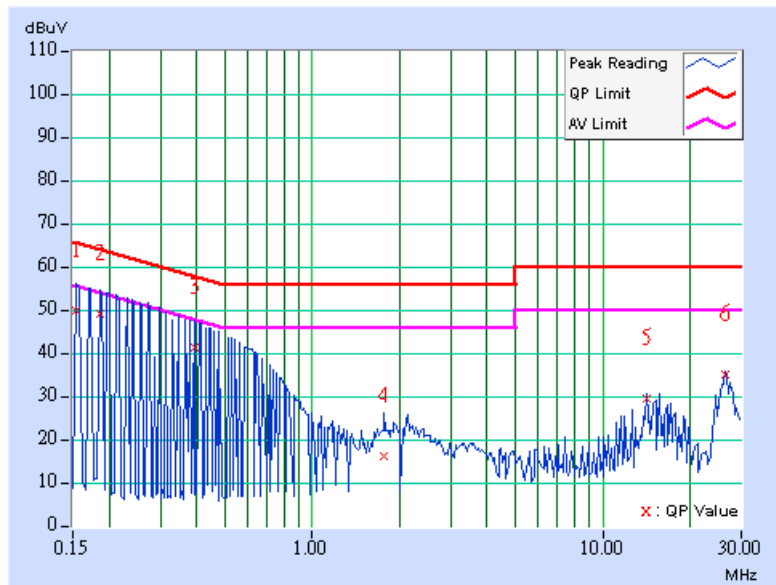



Test Mode 2 (with 411210003CT AC Adapter)

<b>EUT</b>	Wireless-G Game Adapter	<b>MODEL</b>	WGA54G ver. 2
<b>CHANNEL</b>	Channel 1	<b>6dB BANDWIDTH</b>	9 kHz
<b>MODULATION TYPE</b>	BPSK	<b>TRANSFER RATE</b>	6Mbps
<b>INPUT POWER (SYSTEM)</b>	120Vac, 60Hz	<b>PHASE</b>	Neutral (N)
<b>ENVIRONMENTAL CONDITIONS</b>	24deg. C, 64%RH, 991hPa	<b>TESTED BY</b>	Leo Hung

No	Freq. [MHz]	Corr. Factor (dB)	Reading Value [dB (uV)]		Emission Level [dB (uV)]		Limit [dB (uV)]		Margin (dB)	
			Q.P.	AV.	Q.P.	AV.	Q.P.	AV.	Q.P.	AV.
			1	0.166	0.10	49.09	-	49.19	-	65.18
2	0.216	0.10	47.91	-	48.01	-	62.96	52.96	-14.94	-
3	0.341	0.11	45.33	-	45.44	-	59.17	49.17	-13.73	-
4	0.603	0.15	43.55	-	43.70	-	56.00	46.00	-12.30	-
5	15.258	0.56	28.32	-	28.88	-	60.00	50.00	-31.12	-
6	27.168	0.67	32.52	-	33.19	-	60.00	50.00	-26.81	-

- REMARKS:**
1. Q.P. and AV. are abbreviations of quasi-peak and average individually.
  2. "-": The Quasi-peak reading value also meets average limit and measurement with the average detector is unnecessary.
  3. The emission levels of other frequencies were very low against the limit.
  4. Margin value = Emission level - Limit value
  5. Correction factor = Insertion loss + Cable loss
  6. Emission Level = Correction Factor + Reading Value.

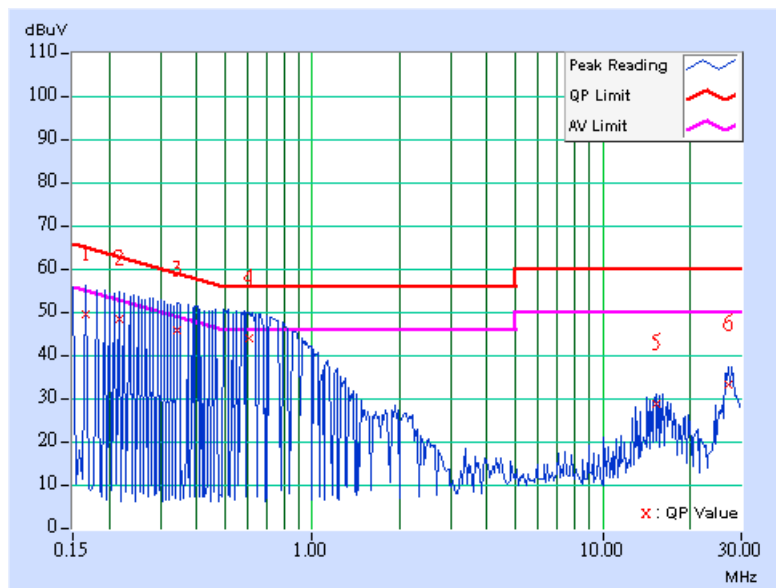



Test Mode 2 (with 411210003CT AC Adapter)

<b>EUT</b>	Wireless-G Game Adapter	<b>MODEL</b>	WGA54G ver. 2
<b>CHANNEL</b>	Channel 6	<b>6dB BANDWIDTH</b>	9 kHz
<b>MODULATION TYPE</b>	BPSK	<b>TRANSFER RATE</b>	6Mbps
<b>INPUT POWER (SYSTEM)</b>	120Vac, 60 Hz	<b>PHASE</b>	Line (L)
<b>ENVIRONMENTAL CONDITIONS</b>	24deg. C, 64%RH, 991hPa	<b>TESTED BY</b>	Leo Hung

No	Freq. [MHz]	Corr. Factor (dB)	Reading Value		Emission Level		Limit		Margin	
			[dB (uV)]		[dB (uV)]		[dB (uV)]		(dB)	
			Q.P.	AV.	Q.P.	AV.	Q.P.	AV.	Q.P.	AV.
1	0.181	0.10	47.68	-	47.78	-	64.43	54.43	-16.65	-
2	0.220	0.10	47.36	-	47.46	-	62.81	52.81	-15.35	-
3	0.357	0.11	41.36	-	41.47	-	58.80	48.80	-17.33	-
4	0.556	0.15	37.24	-	37.39	-	56.00	46.00	-18.61	-
5	15.250	0.71	28.46	-	29.17	-	60.00	50.00	-30.83	-
6	25.664	1.18	31.48	-	32.66	-	60.00	50.00	-27.34	-

- REMARKS:**
1. Q.P. and AV. are abbreviations of quasi-peak and average individually.
  2. "-": The Quasi-peak reading value also meets average limit and measurement with the average detector is unnecessary.
  3. The emission levels of other frequencies were very low against the limit.
  4. Margin value = Emission level - Limit value
  5. Correction factor = Insertion loss + Cable loss
  6. Emission Level = Correction Factor + Reading Value.

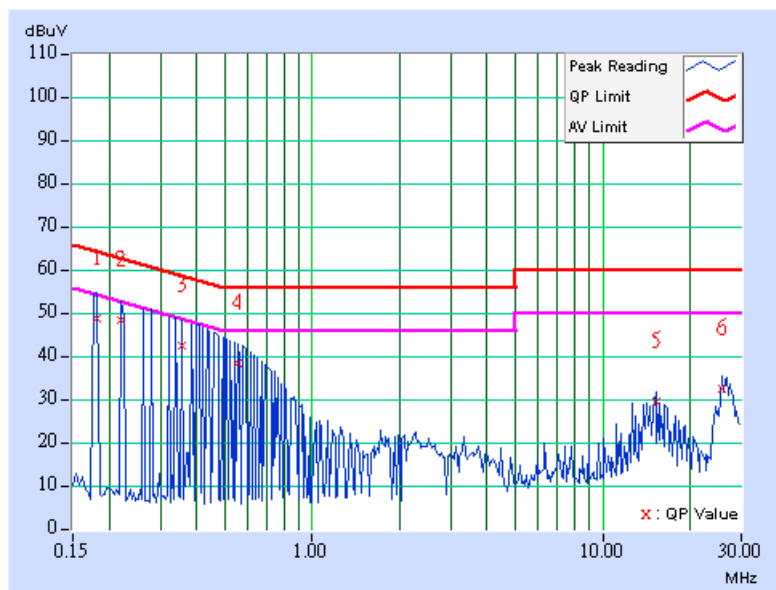



Test Mode 2 (with 411210003CT AC Adapter)

<b>EUT</b>	Wireless-G Game Adapter	<b>MODEL</b>	WGA54G ver. 2
<b>CHANNEL</b>	Channel 6	<b>6dB BANDWIDTH</b>	9 kHz
<b>MODULATION TYPE</b>	BPSK	<b>TRANSFER RATE</b>	6Mbps
<b>INPUT POWER (SYSTEM)</b>	120Vac, 60 Hz	<b>PHASE</b>	Neutral (N)
<b>ENVIRONMENTAL CONDITIONS</b>	24deg. C, 64%RH, 991hPa	<b>TESTED BY</b>	Leo Hung

No	Freq. [MHz]	Corr. Factor (dB)	Reading Value		Emission Level		Limit		Margin	
			[dB (uV)]		[dB (uV)]		[dB (uV)]		(dB)	
			Q.P.	AV.	Q.P.	AV.	Q.P.	AV.	Q.P.	AV.
1	0.162	0.10	49.26	-	49.36	-	65.38	55.38	-16.02	-
2	0.205	0.10	48.34	-	48.44	-	63.42	53.42	-14.98	-
3	0.338	0.11	45.43	-	45.54	-	59.26	49.26	-13.73	-
4	0.611	0.16	43.45	-	43.61	-	56.00	46.00	-12.39	-
5	1.676	0.25	24.57	-	24.82	-	56.00	46.00	-31.18	-
6	26.418	0.68	35.39	-	36.07	-	60.00	50.00	-23.93	-

- REMARKS:**
1. Q.P. and AV. are abbreviations of quasi-peak and average individually.
  2. "-": The Quasi-peak reading value also meets average limit and measurement with the average detector is unnecessary.
  3. The emission levels of other frequencies were very low against the limit.
  4. Margin value = Emission level - Limit value
  5. Correction factor = Insertion loss + Cable loss
  6. Emission Level = Correction Factor + Reading Value.

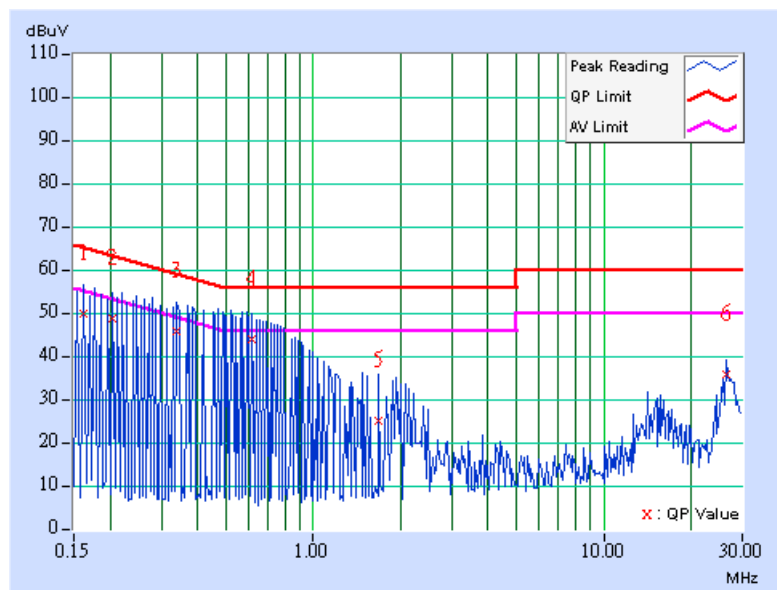



Test Mode 2 (with 41121003CT AC Adapter)

<b>EUT</b>	Wireless-G Game Adapter	<b>MODEL</b>	WGA54G ver. 2
<b>CHANNEL</b>	Channel 11	<b>6dB BANDWIDTH</b>	9 kHz
<b>MODULATION TYPE</b>	BPSK	<b>TRANSFER RATE</b>	6Mbps
<b>INPUT POWER (SYSTEM)</b>	120Vac, 60 Hz	<b>PHASE</b>	Line (L)
<b>ENVIRONMENTAL CONDITIONS</b>	24deg. C, 64%RH, 991hPa	<b>TESTED BY</b>	Leo Hung

No	Freq. [MHz]	Corr. Factor (dB)	Reading Value [dB (uV)]		Emission Level [dB (uV)]		Limit [dB (uV)]		Margin (dB)	
			Q.P.	AV.	Q.P.	AV.	Q.P.	AV.	Q.P.	AV.
			1	0.162	0.10	48.88	-	48.98	-	65.38
2	0.205	0.10	47.08	-	47.18	-	63.42	53.42	-16.24	-
3	0.334	0.11	41.91	-	42.02	-	59.36	49.36	-17.34	-
4	0.591	0.16	36.01	-	36.17	-	56.00	46.00	-19.83	-
5	15.246	0.71	29.30	-	30.01	-	60.00	50.00	-29.99	-
6	26.031	1.19	32.21	-	33.40	-	60.00	50.00	-26.60	-

- REMARKS:**
1. Q.P. and AV. are abbreviations of quasi-peak and average individually.
  2. "-": The Quasi-peak reading value also meets average limit and measurement with the average detector is unnecessary.
  3. The emission levels of other frequencies were very low against the limit.
  4. Margin value = Emission level - Limit value
  5. Correction factor = Insertion loss + Cable loss
  6. Emission Level = Correction Factor + Reading Value.

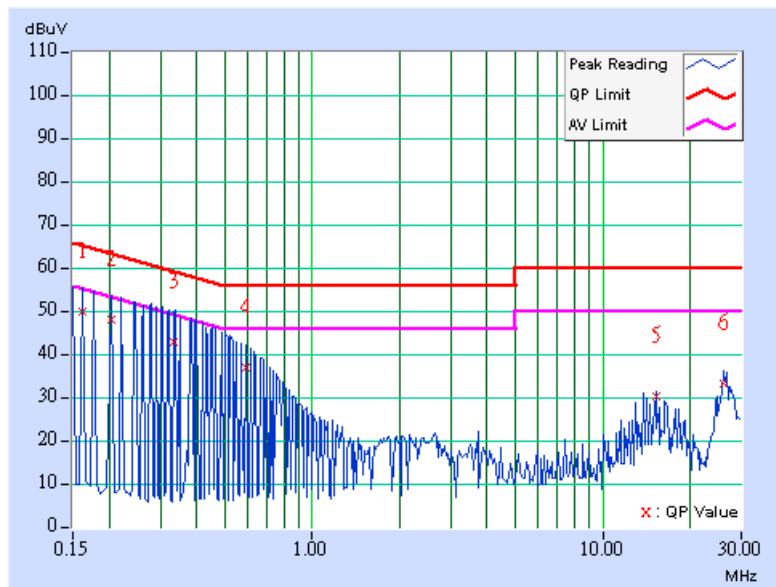





Test Mode 2 (with 411210003CT AC Adapter)

<b>EUT</b>	Wireless-G Game Adapter	<b>MODEL</b>	WGA54G ver. 2
<b>CHANNEL</b>	Channel 11	<b>6dB BANDWIDTH</b>	9 kHz
<b>MODULATION TYPE</b>	BPSK	<b>TRANSFER RATE</b>	6Mbps
<b>INPUT POWER (SYSTEM)</b>	120Vac, 60 Hz	<b>PHASE</b>	Neutral (N)
<b>ENVIRONMENTAL CONDITIONS</b>	24deg. C, 64%RH, 991hPa	<b>TESTED BY</b>	Leo Hung

No	Freq. [MHz]	Corr. Factor (dB)	Reading Value		Emission Level		Limit		Margin	
			[dB (uV)]		[dB (uV)]		[dB (uV)]		(dB)	
			Q.P.	AV.	Q.P.	AV.	Q.P.	AV.	Q.P.	AV.
1	0.181	0.10	48.79	-	48.89	-	64.43	54.43	-15.54	-
2	0.306	0.11	45.73	-	45.84	-	60.07	50.07	-14.23	-
<b>3</b>	<b>0.525</b>	<b>0.14</b>	<b>44.65</b>	-	<b>44.79</b>	-	<b>56.00</b>	<b>46.00</b>	<b>-11.21</b>	-
4	1.848	0.25	24.95	-	25.20	-	56.00	46.00	-30.80	-
5	15.254	0.56	28.28	-	28.84	-	60.00	50.00	-31.16	-
6	26.039	0.68	34.13	-	34.81	-	60.00	50.00	-25.19	-

- REMARKS:**
1. Q.P. and AV. are abbreviations of quasi-peak and average individually.
  2. "-": The Quasi-peak reading value also meets average limit and measurement with the average detector is unnecessary.
  3. The emission levels of other frequencies were very low against the limit.
  4. Margin value = Emission level - Limit value
  5. Correction factor = Insertion loss + Cable loss
  6. Emission Level = Correction Factor + Reading Value.

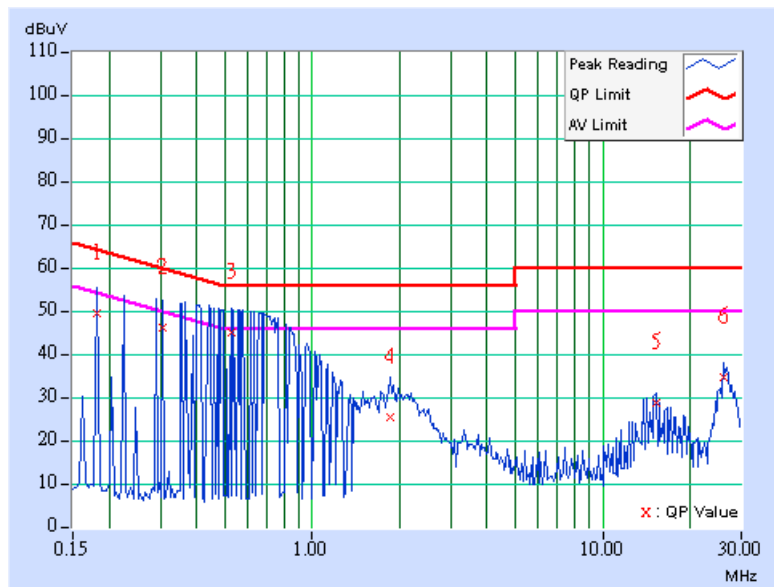



## 4.2 RADIATED EMISSION MEASUREMENT

### 4.2.1 LIMITS OF RADIATED EMISSION MEASUREMENT

Emissions radiated outside of the specified bands, shall be according to the general radiated limits in 15.209 as following:

Frequencies (MHz)	Field strength (microvolts/meter)	Measurement distance (meters)
0.009-0.490	2400/F(kHz)	300
0.490-1.705	24000/F(kHz)	30
1.705-30.0	30	30
30-88	100	3
88-216	150	3
216-960	200	3
Above 960	500	3

**NOTE:**

1. The lower limit shall apply at the transition frequencies.
2. Emission level (dBuV/m) = 20 log Emission level (uV/m).
3. As shown in 15.35(b), for frequencies above 1000MHz, the field strength limits are based on average detector, however, the peak field strength of any emission shall not exceed the maximum permitted average limits, specified above by more than 20dB under any condition of modulation.



## 4.2.2 TEST INSTRUMENTS

DESCRIPTION & MANUFACTURER	MODEL NO.	SERIAL NO.	CALIBRATED UNTIL
Test Receiver ROHDE & SCHWARZ	ESIB7	100188	Dec. 19, 2005
Spectrum Analyzer ROHDE & SCHWARZ	FSP40	100039	Nov. 21, 2005
BILOG Antenna SCHWARZBECK	VULB9168	9168-157	Feb. 03, 2005
HORN Antenna SCHWARZBECK	BBHA 9120 D	9120D-407	Feb. 03, 2005
HORN Antenna SCHWARZBECK	BBHA 9170	BBHA 9170241	Feb. 23, 2005
Preamplifier Agilent	8449B	3008A01961	Nov. 09, 2005
Preamplifier Agilent	8447D	2944A10629	Nov. 09, 2005
RF signal cable HUBER+SUHNER	SUCOFLEX 104	218182/4	Mar. 04, 2005
RF signal cable HUBER+SUHNER	SUCOFLEX 104	218194/4	Mar. 04, 2005
Software ADT.	ADT_Radiated_V5.14	NA	NA
Antenna Tower ADT.	AT100	AT93021702	NA
Turn Table ADT.	TT100.	TT93021702	NA
Controller ADT.	SC100.	SC93021702	NA

- NOTE:**
1. The calibration interval of the above test instruments is 12 months and the calibrations are traceable to NML/ROC and NIST/USA.
  2. The test was performed in HwaYa Chamber 1.
  3. The horn antenna and HP preamplifier (model: 8449B) are used only for the measurement of emission frequency above 1GHz if tested.
  4. The IC Site Registration No. is IC4924-2.

#### 4.2.3 TEST PROCEDURES

- a. The EUT was placed on the top of a rotating table 0.8 meters above the ground at a 3 meter semi-anechoic chamber. The table was rotated 360 degrees to determine the position of the highest radiation.
- b. The EUT was set 3 meters away from the interference-receiving antenna, which was mounted on the top of a variable-height antenna tower.
- c. The antenna is a broadband antenna, and its height is varied from one meter to four meters above the ground to determine the maximum value of the field strength. Both horizontal and vertical polarizations of the antenna are set to make the measurement.
- d. For each suspected emission, the EUT was arranged to its worst case and then the antenna was tuned to heights from 1 meter to 4 meters and the rotatable table was turned from 0 degrees to 360 degrees to find the maximum reading.
- e. The test-receiver system was set to Peak Detect Function and Specified Bandwidth with Maximum Hold Mode.
- f. If the emission level of the EUT in peak mode was 10 dB lower than the limit specified, then testing could be stopped and the peak values of the EUT would be reported. Otherwise the emissions that did not have 10 dB margin would be re-tested one by one using the quasi-peak method or average method as specified and then reported in Data sheet peak mode and QP mode.

**NOTE:**

1. The resolution bandwidth and video bandwidth of test receiver/spectrum analyzer is 120kHz for Quasi-peak detection at frequency below 1GHz.
2. The resolution bandwidth and video bandwidth of test receiver/spectrum analyzer is 1 MHz for Peak detection (PK) at frequency above 1GHz.
3. The resolution bandwidth of test receiver/spectrum analyzer is 1 MHz and the video bandwidth is 10 Hz for Average detection (AV) at frequency above 1GHz.

#### 4.2.4 DEVIATION FROM TEST STANDARD

No deviation

#### 4.2.5 TEST SETUP

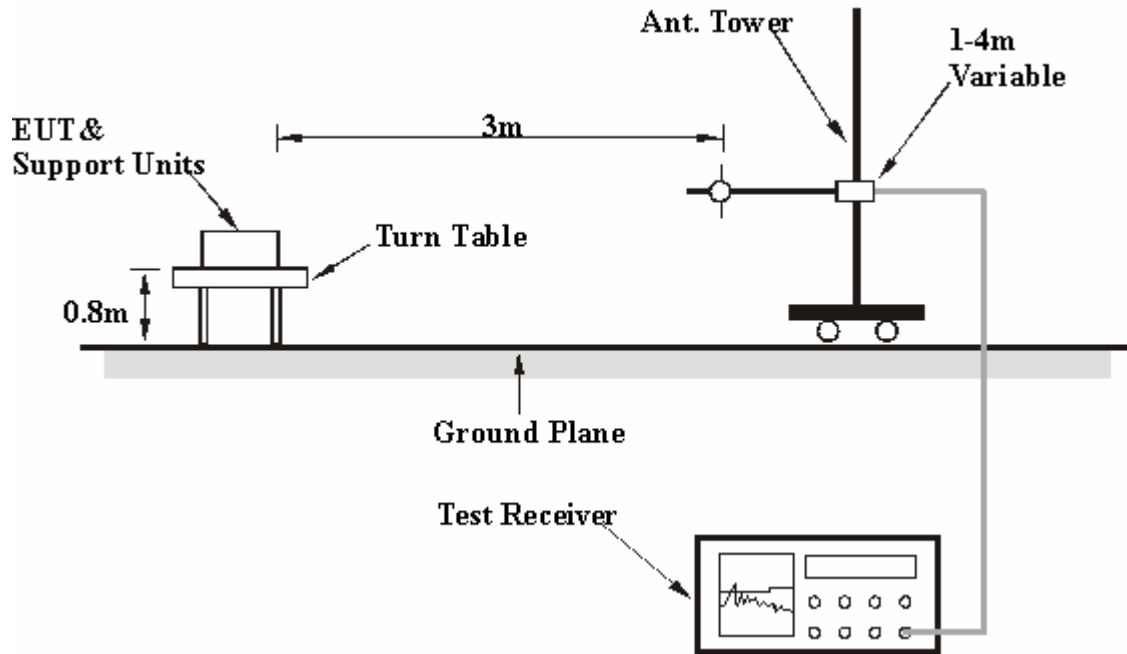

For the actual test configuration, please refer to the related item – Photographs of the Test Configuration.

#### 4.2.6 EUT OPERATING CONDITIONS

Same as 4.1.6

## 4.2.7 TEST RESULTS

**Below 1GHz Worst-Case Data**

Test Mode 1 (with WD411200500 AC Adapter)

<b>EUT</b>	Wireless-G Game Adapter	<b>MODEL</b>	WGA54G ver. 2
<b>CHANNEL</b>	Channel 11	<b>FREQUENCY RANGE</b>	Below 1000MHz
<b>MODULATION TYPE</b>	BPSK	<b>TRANSFER RATE</b>	6Mbps
<b>INPUT POWER (SYSTEM)</b>	120Vac, 60 Hz	<b>DETECTOR FUNCTION</b>	Quasi-Peak
<b>ENVIRONMENTAL CONDITIONS</b>	25deg. C, 60%RH, 991hPa	<b>TESTED BY</b>	Match Tsui

**ANTENNA POLARITY & TEST DISTANCE: HORIZONTAL AT 3 M**

No.	Freq. (MHz)	Emission Level (dBuV/m)	Limit (dBuV/m)	Margin (dB)	Antenna Height (m)	Table Angle (Degree)	Raw Value (dBuV)	Correction Factor (dB/m)
1	39.72	28.38 QP	40.00	-11.62	1.00 H	277	13.20	15.18
2	99.98	38.83 QP	43.50	-4.67	1.50 H	250	27.85	10.98
3	166.07	32.18 QP	43.50	-11.32	1.50 H	280	17.87	14.30
<b>4</b>	<b>199.12</b>	<b>41.71 QP</b>	<b>43.50</b>	<b>-1.79</b>	<b>1.50 H</b>	<b>280</b>	<b>30.25</b>	<b>11.46</b>
5	245.77	34.15 QP	46.00	-11.85	1.00 H	283	20.99	13.16
6	300.20	38.48 QP	46.00	-7.52	1.00 H	232	23.98	14.50
7	389.62	33.33 QP	46.00	-12.67	1.00 H	238	16.81	16.52
8	500.42	39.72 QP	46.00	-6.28	1.50 H	247	20.98	18.74
9	556.79	33.34 QP	46.00	-12.66	1.50 H	229	13.47	19.87
10	599.56	38.97 QP	46.00	-7.03	1.50 H	40	17.97	21.00
11	634.55	32.01 QP	46.00	-13.99	1.00 H	28	10.54	21.47
12	700.64	40.13 QP	46.00	-5.87	1.00 H	310	17.81	22.32
13	799.78	35.54 QP	46.00	-10.46	1.00 H	94	11.72	23.82
14	840.60	34.19 QP	46.00	-11.81	1.50 H	100	10.07	24.12
15	900.86	43.81 QP	46.00	-2.19	1.50 H	274	18.69	25.12
16	933.91	35.17 QP	46.00	-10.83	1.50 H	271	9.70	25.47

- REMARKS:**
1. Emission level(dBuV/m)=Raw Value(dBuV) + Correction Factor(dB/m)
  2. Correction Factor(dB/m) = Antenna Factor (dB/m) + Cable Factor (dB)
  3. The other emission levels were very low against the limit.
  4. Margin value = Emission level – Limit value.

## Test Mode 1 (with WD411200500 AC Adapter)

<b>EUT</b>	Wireless-G Game Adapter	<b>MODEL</b>	WGA54G ver. 2
<b>CHANNEL</b>	Channel 11	<b>FREQUENCY RANGE</b>	Below 1000MHz
<b>MODULATION TYPE</b>	BPSK	<b>TRANSFER RATE</b>	6Mbps
<b>INPUT POWER (SYSTEM)</b>	120Vac, 60 Hz	<b>DETECTOR FUNCTION</b>	Quasi-Peak
<b>ENVIRONMENTAL CONDITIONS</b>	25deg. C, 60%RH, 991hPa	<b>TESTED BY</b>	Match Tsui

**ANTENNA POLARITY & TEST DISTANCE: VERTICAL AT 3 M**

No.	Freq. (MHz)	Emission Level (dBuV/m)	Limit (dBuV/m)	Margin (dB)	Antenna Height (m)	Table Angle (Degree)	Raw Value (dBuV)	Correction Factor (dB/m)
1	40.12	38.14 QP	40.00	-1.86	1.00 V	150	22.92	15.22
2	99.98	39.59 QP	43.50	-3.91	1.00 V	256	28.61	10.98
3	166.07	33.84 QP	43.50	-9.66	1.00 V	70	19.54	14.30
4	199.12	41.08 QP	43.50	-2.42	1.00 V	199	29.62	11.46
5	300.20	33.11 QP	46.00	-12.89	1.50 V	160	18.60	14.50
6	387.68	35.79 QP	46.00	-10.21	1.50 V	19	19.31	16.48
7	500.42	33.42 QP	46.00	-12.58	1.00 V	25	14.68	18.74
8	611.22	38.18 QP	46.00	-7.82	1.50 V	154	17.02	21.16
9	700.64	34.87 QP	46.00	-11.13	1.00 V	322	12.56	22.32
10	733.69	32.67 QP	46.00	-13.33	1.50 V	31	9.54	23.13
11	799.78	33.42 QP	46.00	-12.58	1.50 V	172	9.60	23.82
12	840.60	36.42 QP	46.00	-9.58	1.00 V	226	12.30	24.12
13	900.86	38.04 QP	46.00	-7.96	1.00 V	55	12.92	25.12

- REMARKS:**
1. Emission level(dBuV/m)=Raw Value(dBuV) + Correction Factor(dB/m)
  2. Correction Factor(dB/m) = Antenna Factor (dB/m) + Cable Factor (dB)
  3. The other emission levels were very low against the limit.
  4. Margin value = Emission level – Limit value.



## Test Mode 2 (with 411210003CT AC Adapter)

<b>EUT</b>	Wireless-G Game Adapter	<b>MODEL</b>	WGA54G ver. 2
<b>CHANNEL</b>	Channel 11	<b>FREQUENCY RANGE</b>	Below 1000MHz
<b>MODULATION TYPE</b>	BPSK	<b>TRANSFER RATE</b>	6Mbps
<b>INPUT POWER (SYSTEM)</b>	120Vac, 60 Hz	<b>DETECTOR FUNCTION</b>	Quasi-Peak
<b>ENVIRONMENTAL CONDITIONS</b>	24deg. C, 64%RH, 991hPa	<b>TESTED BY</b>	Match Tsui

**ANTENNA POLARITY & TEST DISTANCE: HORIZONTAL AT 3 M**

No.	Freq. (MHz)	Emission Level (dBuV/m)	Limit (dBuV/m)	Margin (dB)	Antenna Height (m)	Table Angle (Degree)	Raw Value (dBuV)	Correction Factor (dB/m)
1	57.21	27.77 QP	40.00	-12.23	2.00 H	16	13.79	13.99
2	99.98	35.23 QP	43.50	-8.27	1.50 H	274	24.25	10.98
3	199.12	39.33 QP	43.50	-4.17	1.00 H	49	27.87	11.46
4	243.83	33.45 QP	46.00	-12.55	1.00 H	277	20.31	13.13
5	300.20	37.08 QP	46.00	-8.92	1.00 H	214	22.58	14.50
6	389.62	34.67 QP	46.00	-11.33	1.00 H	73	18.15	16.52
7	500.42	38.00 QP	46.00	-8.00	1.50 H	244	19.26	18.74
8	566.51	31.48 QP	46.00	-14.52	1.50 H	109	11.36	20.13
9	599.56	37.58 QP	46.00	-8.42	1.50 H	94	16.59	21.00
10	634.55	33.18 QP	46.00	-12.82	1.50 H	301	11.70	21.47
11	700.64	38.86 QP	46.00	-7.14	1.00 H	238	16.55	22.32
12	776.45	32.92 QP	46.00	-13.08	1.00 H	319	9.24	23.68
13	840.60	35.84 QP	46.00	-10.16	1.50 H	52	11.72	24.12
14	900.86	41.14 QP	46.00	-4.86	1.50 H	229	16.02	25.12

**ANTENNA POLARITY & TEST DISTANCE: VERTICAL AT 3 M**

No.	Freq. (MHz)	Emission Level (dBuV/m)	Limit (dBuV/m)	Margin (dB)	Antenna Height (m)	Table Angle (Degree)	Raw Value (dBuV)	Correction Factor (dB/m)
1	37.78	37.89 QP	40.00	-2.11	1.00 V	118	23.02	14.87
2	99.98	38.00 QP	43.50	-5.50	1.00 V	253	27.02	10.98
3	156.35	30.64 QP	43.50	-12.86	1.00 V	247	15.83	14.80
4	199.12	40.16 QP	43.50	-3.34	1.00 V	169	28.70	11.46
5	300.20	33.68 QP	46.00	-12.32	1.50 V	37	19.18	14.50
6	387.68	37.19 QP	46.00	-8.81	1.50 V	223	20.72	16.48
7	500.42	32.55 QP	46.00	-13.45	1.00 V	202	13.81	18.74
8	599.56	31.87 QP	46.00	-14.13	1.50 V	352	10.87	21.00
9	632.61	31.18 QP	46.00	-14.82	1.50 V	352	9.73	21.45
10	700.64	33.12 QP	46.00	-12.88	1.00 V	151	10.80	22.32
11	799.78	32.27 QP	46.00	-13.73	1.50 V	1	8.45	23.82
12	840.60	40.44 QP	46.00	-5.56	1.00 V	226	16.32	24.12
13	914.47	41.24 QP	46.00	-4.76	1.00 V	196	15.97	25.26

- REMARKS:**
1. Emission level(dBuV/m)=Raw Value(dBuV) + Correction Factor(dB/m)
  2. Correction Factor(dB/m) = Antenna Factor (dB/m) + Cable Factor (dB)
  3. The other emission levels were very low against the limit.
  4. Margin value = Emission level – Limit value.



**802.11b DSSS modulation**

<b>EUT</b>	Wireless-G Game Adapter	<b>MODEL</b>	WGA54G ver. 2
<b>CHANNEL</b>	Channel 1	<b>FREQUENCY RANGE</b>	1 ~ 25GHz
<b>MODULATION TYPE</b>	CCK	<b>TRANSFER RATE</b>	11Mbps
<b>INPUT POWER (SYSTEM)</b>	120Vac, 60 Hz	<b>DETECTOR FUNCTION</b>	Peak(PK) Average (AV)
<b>ENVIRONMENTAL CONDITIONS</b>	25deg. C, 60%RH, 991hPa	<b>TESTED BY</b>	Match Tsui

**ANTENNA POLARITY & TEST DISTANCE: HORIZONTAL AT 3 M**

No.	Freq. (MHz)	Emission Level (dBuV/m)	Limit (dBuV/m)	Margin (dB)	Antenna Height (m)	Table Angle (Degree)	Raw Value (dBuV)	Correction Factor (dB/m)
1	2038.00	42.59 PK	74.00	-31.41	1.00 H	72	11.94	30.65
1	2038.00	35.90 AV	54.00	-18.10	1.00 H	72	5.25	30.65
2	2390.00	53.21 PK	74.00	-20.79	1.22 H	115	21.41	31.80
2	2390.00	44.78 AV	54.00	-9.22	1.22 H	115	12.98	31.80
3	*2412.00	98.89 PK			1.22 H	115	67.02	31.87
3	*2412.00	91.30 AV			1.22 H	115	59.43	31.87
4	4824.00	49.29 PK	74.00	-24.71	1.10 H	210	11.17	38.11
4	4824.00	39.98 AV	54.00	-14.02	1.10 H	210	1.86	38.11

**ANTENNA POLARITY & TEST DISTANCE: VERTICAL AT 3 M**

No.	Freq. (MHz)	Emission Level (dBuV/m)	Limit (dBuV/m)	Margin (dB)	Antenna Height (m)	Table Angle (Degree)	Raw Value (dBuV)	Correction Factor (dB/m)
1	2038.00	45.69 PK	74.00	-28.31	1.16 V	334	15.04	30.65
1	2038.00	41.35 AV	54.00	-12.65	1.16 V	334	10.70	30.65
2	2386.00	56.52 PK	74.00	-17.48	1.02 V	258	24.73	31.79
2	2386.00	46.85 AV	54.00	-7.15	1.02 V	258	15.06	31.79
3	*2412.00	112.00 PK			1.02 V	258	80.13	31.87
3	*2412.00	104.53 AV			1.02 V	258	72.66	31.87
4	4824.00	51.86 PK	74.00	-22.14	1.09 V	88	13.74	38.11
4	4824.00	44.84 AV	54.00	-9.16	1.09 V	88	6.72	38.11

- REMARKS:**
1. Emission level(dBuV/m)=Raw Value(dBuV) + Correction Factor(dB/m)
  2. Correction Factor(dB/m) = Antenna Factor (dB/m) + Cable Factor (dB)
  3. The other emission levels were very low against the limit.
  4. Margin value = Emission level – Limit value.
  5. “ \* ” : Fundamental frequency



<b>EUT</b>	Wireless-G Game Adapter	<b>MODEL</b>	WGA54G ver. 2
<b>CHANNEL</b>	Channel 6	<b>FREQUENCY RANGE</b>	1 ~ 25GHz
<b>MODULATION TYPE</b>	CCK	<b>TRANSFER RATE</b>	11Mbps
<b>INPUT POWER (SYSTEM)</b>	120Vac, 60 Hz	<b>DETECTOR FUNCTION</b>	Peak(PK) Average (AV)
<b>ENVIRONMENTAL CONDITIONS</b>	25deg. C, 60%RH, 991hPa	<b>TESTED BY</b>	Match Tsui

#### ANTENNA POLARITY & TEST DISTANCE: HORIZONTAL AT 3 M

No.	Freq. (MHz)	Emission Level (dBuV/m)	Limit (dBuV/m)	Margin (dB)	Antenna Height (m)	Table Angle (Degree)	Raw Value (dBuV)	Correction Factor (dB/m)
1	2063.00	42.23 PK	74.00	-31.77	1.00 H	71	11.54	30.69
1	2063.00	34.57 AV	54.00	-19.43	1.00 H	71	3.88	30.69
2	*2437.00	100.29 PK			1.20 H	114	68.34	31.95
2	*2437.00	92.63 AV			1.20 H	114	60.68	31.95
3	4874.00	51.17 PK	74.00	-22.83	1.21 H	202	12.88	38.28
3	4874.00	42.58 AV	54.00	-11.42	1.21 H	202	4.29	38.28

#### ANTENNA POLARITY & TEST DISTANCE: VERTICAL AT 3 M

No.	Freq. (MHz)	Emission Level (dBuV/m)	Limit (dBuV/m)	Margin (dB)	Antenna Height (m)	Table Angle (Degree)	Raw Value (dBuV)	Correction Factor (dB/m)
1	1320.00	43.73 PK	74.00	-30.27	1.20 V	248	16.30	27.43
1	1320.00	40.82 AV	54.00	-13.18	1.20 V	248	13.39	27.43
2	*2437.00	112.79 PK			1.03 V	253	80.84	31.95
2	*2437.00	104.98 AV			1.03 V	253	73.03	31.95
3	2544.00	55.26 PK	74.00	-18.74	1.00 V	255	22.95	32.31
3	2544.00	45.33 AV	54.00	-8.67	1.00 V	255	13.02	32.31
4	4874.00	55.93 PK	74.00	-18.07	1.14 V	272	17.64	38.28
4	4874.00	47.10 AV	54.00	-6.90	1.14 V	272	8.81	38.28

- REMARKS:**
1. Emission level(dBuV/m)=Raw Value(dBuV) + Correction Factor(dB/m)
  2. Correction Factor(dB/m) = Antenna Factor (dB/m) + Cable Factor (dB)
  3. The other emission levels were very low against the limit.
  4. Margin value = Emission level – Limit value.
  5. “ \* “ : Fundamental frequency



<b>EUT</b>	Wireless-G Game Adapter	<b>MODEL</b>	WGA54G ver. 2
<b>CHANNEL</b>	Channel 11	<b>FREQUENCY RANGE</b>	1 ~ 25GHz
<b>MODULATION TYPE</b>	CCK	<b>TRANSFER RATE</b>	11Mbps
<b>INPUT POWER (SYSTEM)</b>	120Vac, 60 Hz	<b>DETECTOR FUNCTION</b>	Peak(PK) Average (AV)
<b>ENVIRONMENTAL CONDITIONS</b>	25deg. C, 60%RH, 991hPa	<b>TESTED BY</b>	Match Tsui

### ANTENNA POLARITY & TEST DISTANCE: HORIZONTAL AT 3 M

No.	Freq. (MHz)	Emission Level (dBuV/m)	Limit (dBuV/m)	Margin (dB)	Antenna Height (m)	Table Angle (Degree)	Raw Value (dBuV)	Correction Factor (dB/m)
1	2088.00	41.76 PK	74.00	-32.24	1.19 H	102	11.03	30.73
1	2088.00	33.52 AV	54.00	-20.48	1.19 H	102	2.79	30.73
2	*2462.00	97.60 PK			1.12 H	69	65.58	32.02
2	*2462.00	89.93 AV			1.12 H	69	57.91	32.02
3	2483.50	54.63 PK	74.00	-19.37	1.12 H	69	22.54	32.09
3	2483.50	45.12 AV	54.00	-8.88	1.12 H	69	13.03	32.09
4	4924.00	53.75 PK	74.00	-20.25	1.15 H	297	15.26	38.49
4	4924.00	45.46 AV	54.00	-8.54	1.15 H	297	6.97	38.49

### ANTENNA POLARITY & TEST DISTANCE: VERTICAL AT 3 M

No.	Freq. (MHz)	Emission Level (dBuV/m)	Limit (dBuV/m)	Margin (dB)	Antenna Height (m)	Table Angle (Degree)	Raw Value (dBuV)	Correction Factor (dB/m)
1	1560.00	43.74 PK	74.00	-30.26	1.04 V	283	15.35	28.39
1	1560.00	39.42 AV	54.00	-14.58	1.04 V	283	11.03	28.39
2	*2462.00	111.23 PK			1.00 V	241	79.21	32.02
2	*2462.00	103.64 AV			1.00 V	241	71.62	32.02
3	2487.00	57.62 PK	74.00	-16.38	1.00 V	241	25.52	32.10
3	2487.00	48.06 AV	54.00	-5.94	1.00 V	241	15.96	32.10
4	2544.00	56.14 PK	74.00	-17.86	1.00 V	230	23.83	32.31
4	2544.00	48.01 AV	54.00	-5.99	1.00 V	230	15.70	32.31
5	4924.00	59.37 PK	74.00	-14.63	1.14 V	43	20.88	38.49
5	4924.00	52.02 AV	54.00	-1.98	1.14 V	43	13.53	38.49

- REMARKS:**
1. Emission level(dBuV/m)=Raw Value(dBuV) + Correction Factor(dB/m)
  2. Correction Factor(dB/m) = Antenna Factor (dB/m) + Cable Factor (dB)
  3. The other emission levels were very low against the limit.
  4. Margin value = Emission level – Limit value.
  5. “ \* “ : Fundamental frequency



### 802.11g OFDM modulation

<b>EUT</b>	Wireless-G Game Adapter	<b>MODEL</b>	WGA54G ver. 2
<b>CHANNEL</b>	Channel 1	<b>FREQUENCY RANGE</b>	1 ~ 25GHz
<b>MODULATION TYPE</b>	BPSK	<b>TRANSFER RATE</b>	6Mbps
<b>INPUT POWER (SYSTEM)</b>	120Vac, 60 Hz	<b>DETECTOR FUNCTION</b>	Peak(PK) Average (AV)
<b>ENVIRONMENTAL CONDITIONS</b>	25deg. C, 60%RH, 991hPa	<b>TESTED BY</b>	Match Tsui

#### ANTENNA POLARITY & TEST DISTANCE: HORIZONTAL AT 3 M

No.	Freq. (MHz)	Emission Level (dBuV/m)	Limit (dBuV/m)	Margin (dB)	Antenna Height (m)	Table Angle (Degree)	Raw Value (dBuV)	Correction Factor (dB/m)
1	2038.00	41.98 PK	74.00	-32.02	1.00 H	202	11.33	30.65
1	2038.00	34.87 AV	54.00	-19.13	1.00 H	202	4.22	30.65
2	2390.00	52.89 PK	74.00	-21.11	1.21 H	50	21.09	31.80
2	2390.00	44.91 AV	54.00	-9.09	1.21 H	50	13.11	31.80
3	*2412.00	97.21 PK			1.21 H	50	65.34	31.87
3	*2412.00	88.31 AV			1.21 H	50	56.44	31.87
4	4824.00	46.68 PK	74.00	-27.32	1.14 H	115	8.56	38.11
4	4824.00	34.73 AV	54.00	-19.27	1.14 H	115	-3.39	38.11

#### ANTENNA POLARITY & TEST DISTANCE: VERTICAL AT 3 M

No.	Freq. (MHz)	Emission Level (dBuV/m)	Limit (dBuV/m)	Margin (dB)	Antenna Height (m)	Table Angle (Degree)	Raw Value (dBuV)	Correction Factor (dB/m)
1	1320.00	43.78 PK	74.00	-30.22	1.21 V	63	16.35	27.43
1	1320.00	40.29 AV	54.00	-13.71	1.21 V	63	12.86	27.43
2	2390.00	58.73 PK	74.00	-15.27	1.21 V	207	26.93	31.80
2	2390.00	47.16 AV	54.00	-6.84	1.21 V	207	15.36	31.80
3	*2412.00	108.56 PK			1.21 V	207	76.69	31.87
3	*2412.00	99.98 AV			1.21 V	207	68.11	31.87
4	2548.00	53.22 PK	74.00	-20.78	1.00 V	352	20.90	32.32
4	2548.00	42.50 AV	54.00	-11.50	1.00 V	352	10.18	32.32
5	4824.00	51.70 PK	74.00	-22.30	1.12 V	44	13.59	38.11
5	4824.00	37.97 AV	54.00	-16.03	1.12 V	44	-0.14	38.11

- REMARKS:**
1. Emission level(dBuV/m)=Raw Value(dBuV) + Correction Factor(dB/m)
  2. Correction Factor(dB/m) = Antenna Factor (dB/m) + Cable Factor (dB)
  3. The other emission levels were very low against the limit.
  4. Margin value = Emission level – Limit value.
  5. “ \* ” : Fundamental frequency



<b>EUT</b>	Wireless-G Game Adapter	<b>MODEL</b>	WGA54G ver. 2
<b>CHANNEL</b>	Channel 6	<b>FREQUENCY RANGE</b>	1 ~ 25GHz
<b>MODULATION TYPE</b>	BPSK	<b>TRANSFER RATE</b>	6Mbps
<b>INPUT POWER (SYSTEM)</b>	120Vac, 60 Hz	<b>DETECTOR FUNCTION</b>	Peak(PK) Average (AV)
<b>ENVIRONMENTAL CONDITIONS</b>	25deg. C, 60%RH, 991hPa	<b>TESTED BY</b>	Match Tsui

**ANTENNA POLARITY & TEST DISTANCE: HORIZONTAL AT 3 M**

No.	Freq. (MHz)	Emission Level (dBuV/m)	Limit (dBuV/m)	Margin (dB)	Antenna Height (m)	Table Angle (Degree)	Raw Value (dBuV)	Correction Factor (dB/m)
1	2063.00	43.32 PK	74.00	-30.68	1.27 H	201	12.63	30.69
1	2063.00	37.58 AV	54.00	-16.42	1.27 H	201	6.89	30.69
2	*2437.00	96.87 PK			1.15 H	54	64.92	31.95
2	*2437.00	87.74 AV			1.15 H	54	55.79	31.95
3	4874.00	47.95 PK	74.00	-26.05	1.08 H	360	9.66	38.28
3	4874.00	35.49 AV	54.00	-18.51	1.08 H	360	-2.80	38.28

**ANTENNA POLARITY & TEST DISTANCE: VERTICAL AT 3 M**

No.	Freq. (MHz)	Emission Level (dBuV/m)	Limit (dBuV/m)	Margin (dB)	Antenna Height (m)	Table Angle (Degree)	Raw Value (dBuV)	Correction Factor (dB/m)
1	1320.00	43.39 PK	74.00	-30.61	1.21 V	63	15.96	27.43
1	1320.00	40.07 AV	54.00	-13.93	1.21 V	63	12.64	27.43
2	1320.00	43.41 PK	74.00	-30.59	1.19 V	63	15.98	27.43
2	1320.00	39.91 AV	54.00	-14.09	1.19 V	63	12.48	27.43
3	*2437.00	110.43 PK			1.00 V	97	78.48	31.95
3	*2437.00	101.56 AV			1.00 V	97	69.61	31.95
4	2548.00	53.65 PK	74.00	-20.35	1.18 V	93	21.33	32.32
4	2548.00	44.93 AV	54.00	-9.07	1.18 V	93	12.61	32.32
5	4874.00	51.86 PK	74.00	-22.14	1.16 V	220	13.57	38.28
5	4874.00	38.68 AV	54.00	-15.32	1.16 V	220	0.39	38.28

- REMARKS:**
1. Emission level(dBuV/m)=Raw Value(dBuV) + Correction Factor(dB/m)
  2. Correction Factor(dB/m) = Antenna Factor (dB/m) + Cable Factor (dB)
  3. The other emission levels were very low against the limit.
  4. Margin value = Emission level – Limit value.
  5. “ \* “ : Fundamental frequency



<b>EUT</b>	Wireless-G Game Adapter	<b>MODEL</b>	WGA54G ver. 2
<b>CHANNEL</b>	Channel 11	<b>FREQUENCY RANGE</b>	1 ~ 25GHz
<b>MODULATION TYPE</b>	BPSK	<b>TRANSFER RATE</b>	6Mbps
<b>INPUT POWER (SYSTEM)</b>	120Vac, 60 Hz	<b>DETECTOR FUNCTION</b>	Peak(PK) Average (AV)
<b>ENVIRONMENTAL CONDITIONS</b>	25deg. C, 60%RH, 991hPa	<b>TESTED BY</b>	Match Tsui

#### ANTENNA POLARITY & TEST DISTANCE: HORIZONTAL AT 3 M

No.	Freq. (MHz)	Emission Level (dBuV/m)	Limit (dBuV/m)	Margin (dB)	Antenna Height (m)	Table Angle (Degree)	Raw Value (dBuV)	Correction Factor (dB/m)
1	2087.00	41.78 PK	74.00	-32.22	1.00 H	360	11.05	30.73
1	2087.00	36.88 AV	54.00	-17.12	1.00 H	360	6.15	30.73
2	*2462.00	98.19 PK			1.00 H	206	66.17	32.02
2	*2462.00	89.15 AV			1.00 H	206	57.13	32.02
3	2483.50	53.96 PK	74.00	-20.04	1.00 H	206	21.87	32.09
3	2483.50	45.42 AV	54.00	-8.58	1.00 H	206	13.33	32.09
4	4924.00	51.27 PK	74.00	-22.73	1.08 H	15	12.78	38.49
4	4924.00	38.70 AV	54.00	-15.30	1.08 H	15	0.21	38.49

#### ANTENNA POLARITY & TEST DISTANCE: VERTICAL AT 3 M

No.	Freq. (MHz)	Emission Level (dBuV/m)	Limit (dBuV/m)	Margin (dB)	Antenna Height (m)	Table Angle (Degree)	Raw Value (dBuV)	Correction Factor (dB/m)
1	1320.00	41.87 PK	74.00	-32.13	1.30 V	248	14.44	27.43
1	1320.00	37.33 AV	54.00	-16.67	1.30 V	248	9.90	27.43
2	2088.00	46.57 PK	74.00	-27.43	1.14 V	77	15.84	30.73
2	2088.00	42.75 AV	54.00	-11.25	1.14 V	77	12.02	30.73
3	*2462.00	109.81 PK			1.00 V	102	77.79	32.02
3	*2462.00	100.77 AV			1.00 V	102	68.75	32.02
4	2483.50	62.23 PK	74.00	-11.77	1.00 V	102	30.14	32.09
4	2483.50	51.03 AV	54.00	-2.97	1.00 V	102	18.94	32.09
5	4924.00	57.49 PK	74.00	-16.51	1.28 V	62	19.00	38.49
5	4924.00	44.83 AV	54.00	-9.17	1.28 V	62	6.34	38.49

- REMARKS:**
1. Emission level(dBuV/m)=Raw Value(dBuV) + Correction Factor(dB/m)
  2. Correction Factor(dB/m) = Antenna Factor (dB/m) + Cable Factor (dB)
  3. The other emission levels were very low against the limit.
  4. Margin value = Emission level – Limit value.
  5. “ \* “ : Fundamental frequency



### 4.3 6dB BANDWIDTH MEASUREMENT

#### 4.3.1 LIMITS OF 6dB BANDWIDTH MEASUREMENT

The minimum of 6dB Bandwidth Measurement is 0.5 MHz.

#### 4.3.2 TEST INSTRUMENTS

Description & Manufacturer	Model No.	Serial No.	Calibrated Until
SPECTRUM ANALYZER	FSEK 30	100049	Aug. 12, 2005

**NOTE:** The calibration interval of the above test instruments is 12 months and the calibrations are traceable to NML/ROC and NIST/USA.

#### 4.3.3 TEST PROCEDURE

The transmitter output was connected to the spectrum analyzer through an attenuator. The bandwidth of the fundamental frequency was measured by spectrum analyzer with 100kHz RBW and 100kHz VBW. The 6dB bandwidth is defined as the total spectrum the power of which is higher than peak power minus 6dB.

#### 4.3.4 DEVIATION FROM TEST STANDARD

No deviation

#### 4.3.5 TEST SETUP



#### 4.3.6 EUT OPERATING CONDITIONS

The software provided by client to enable the EUT under transmission condition continuously at lowest, middle and highest channel frequencies individually.





## 4.3.7 TEST RESULTS

**802.11b DSSS modulation**

<b>EUT</b>	Wireless-G Game Adapter	<b>MODEL</b>	WGA54G ver. 2
<b>MODULATION TYPE</b>	CCK	<b>TRANSFER RATE</b>	11Mbps
<b>INPUT POWER (SYSTEM)</b>	120Vac, 60 Hz	<b>ENVIRONMENTAL CONDITIONS</b>	24deg. C, 53%RH, 991hPa
<b>TESTED BY</b>	Leo Hung		

<b>CHANNEL</b>	<b>CHANNEL FREQUENCY (MHz)</b>	<b>6dB BANDWIDTH (MHz)</b>	<b>MINIMUM LIMIT (MHz)</b>	<b>PASS/FAIL</b>
1	2412	12.12	0.5	PASS
6	2437	12.48	0.5	PASS
11	2462	12.08	0.5	PASS



CH1

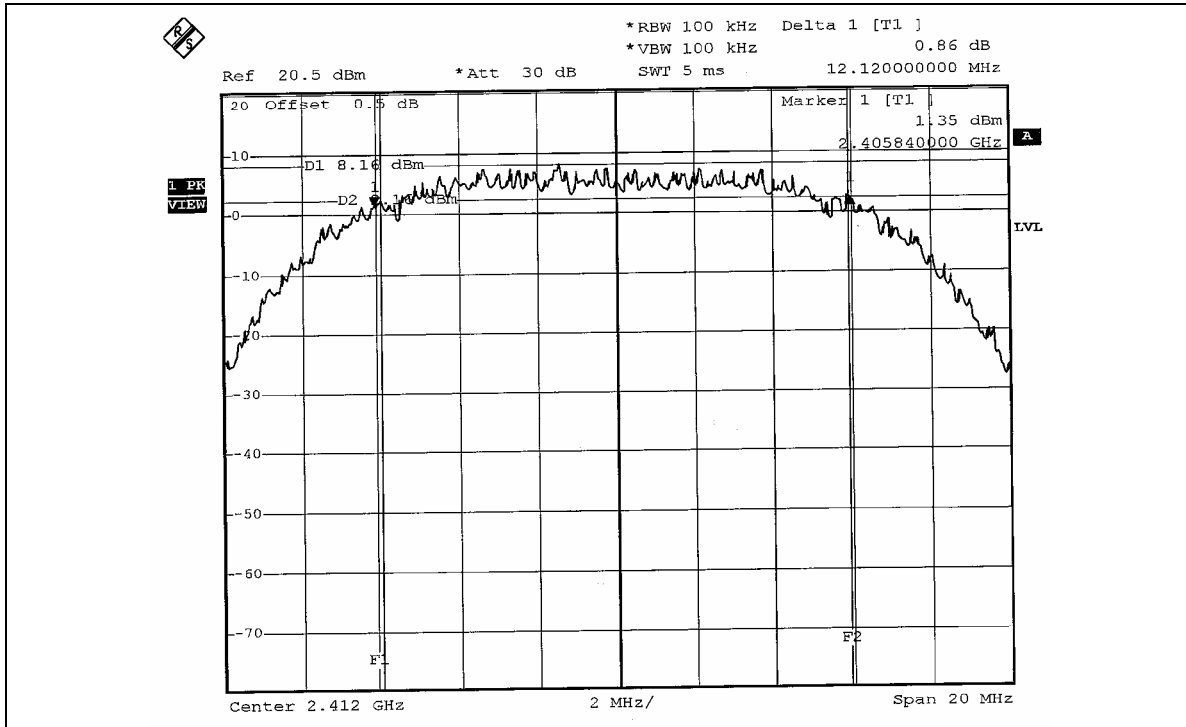

CH6

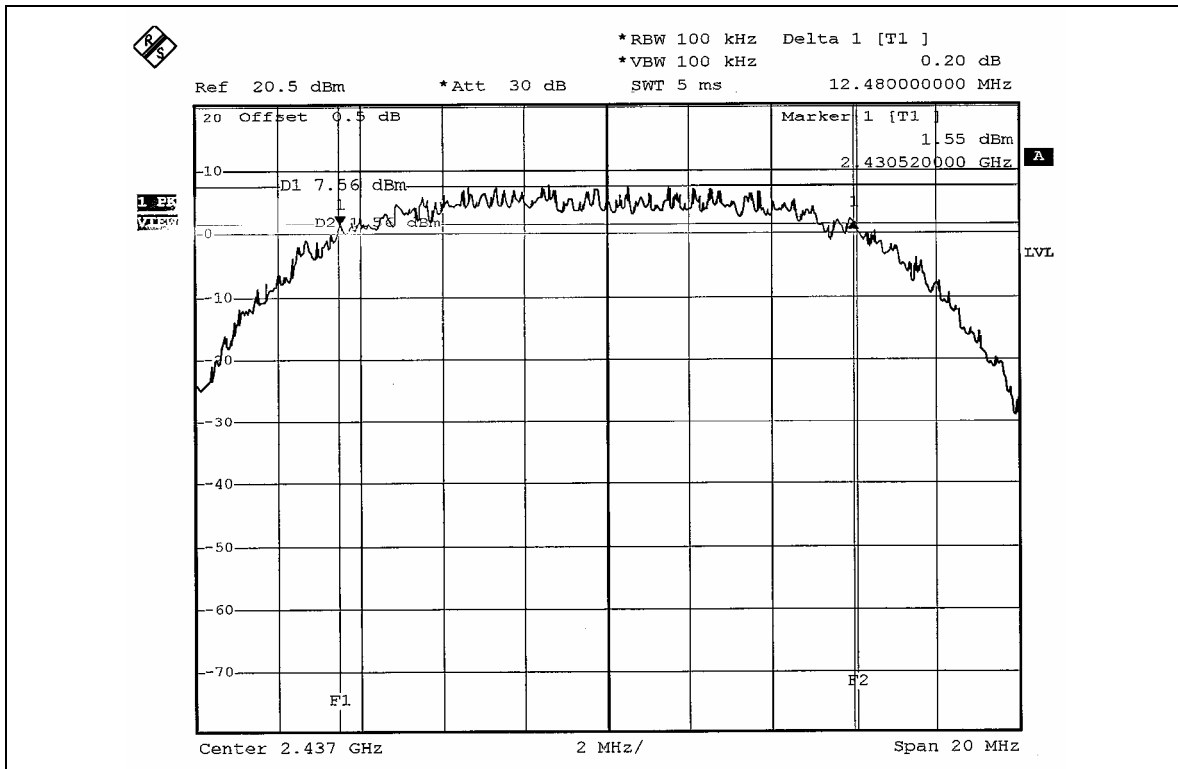



CH11

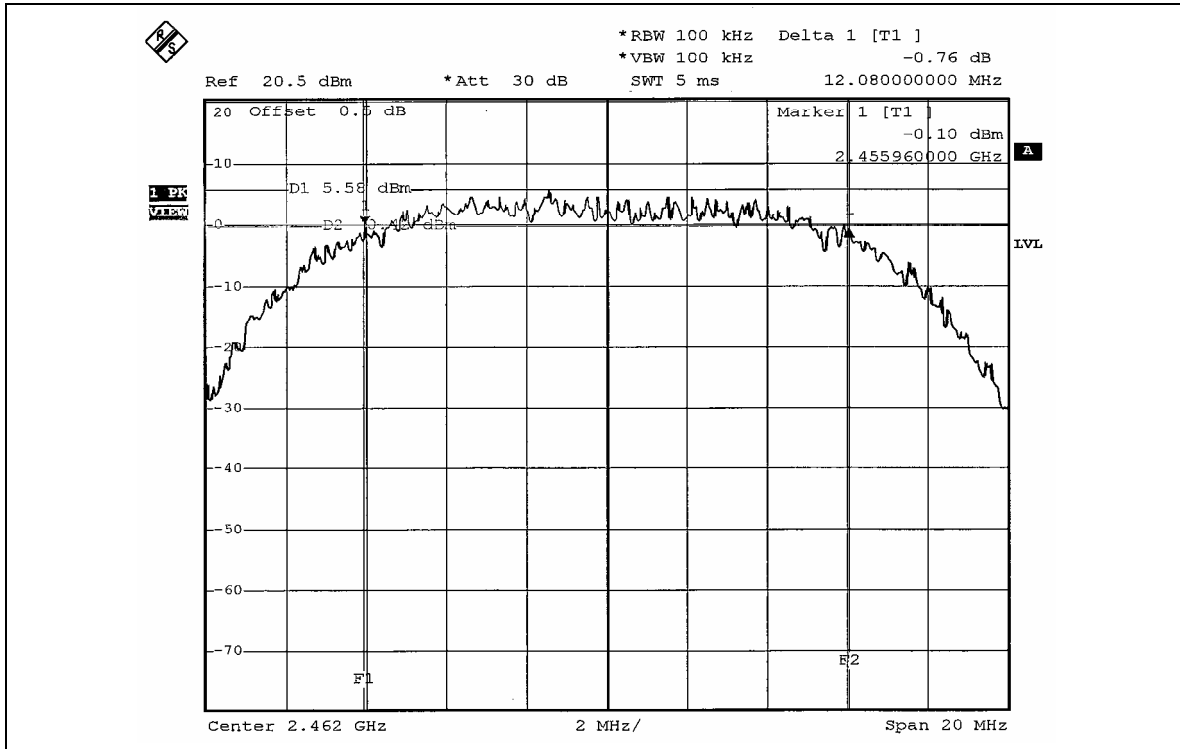

**802.11g OFDM modulation**

<b>EUT</b>	Wireless-G Game Adapter	<b>MODEL</b>	WGA54G ver. 2
<b>MODULATION TYPE</b>	BPSK	<b>TRANSFER RATE</b>	6Mbps
<b>INPUT POWER (SYSTEM)</b>	120Vac, 60 Hz	<b>ENVIRONMENTAL CONDITIONS</b>	24deg. C, 53%RH, 991hPa
<b>TESTED BY</b>	Leo Hung		

<b>CHANNEL</b>	<b>CHANNEL FREQUENCY (MHz)</b>	<b>6dB BANDWIDTH (MHz)</b>	<b>MINIMUM LIMIT (MHz)</b>	<b>PASS/FAIL</b>
1	2412	16.52	0.5	PASS
6	2437	16.56	0.5	PASS
11	2462	16.56	0.5	PASS



CH1

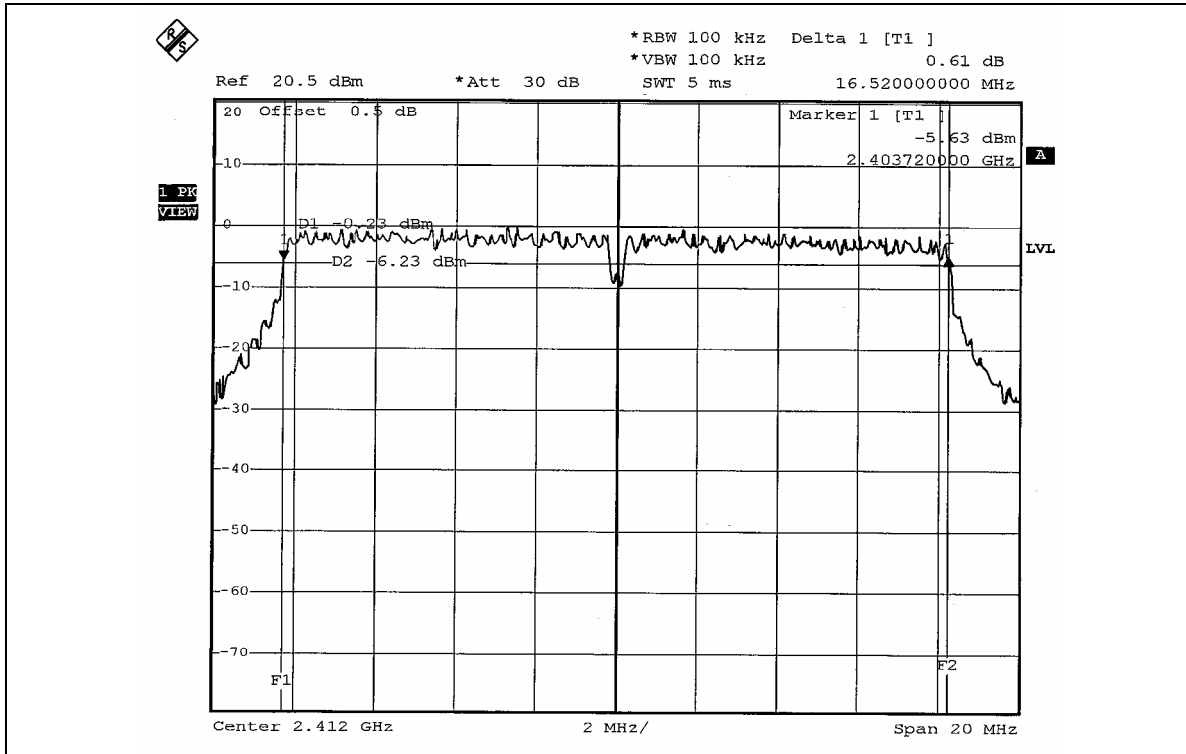

CH6

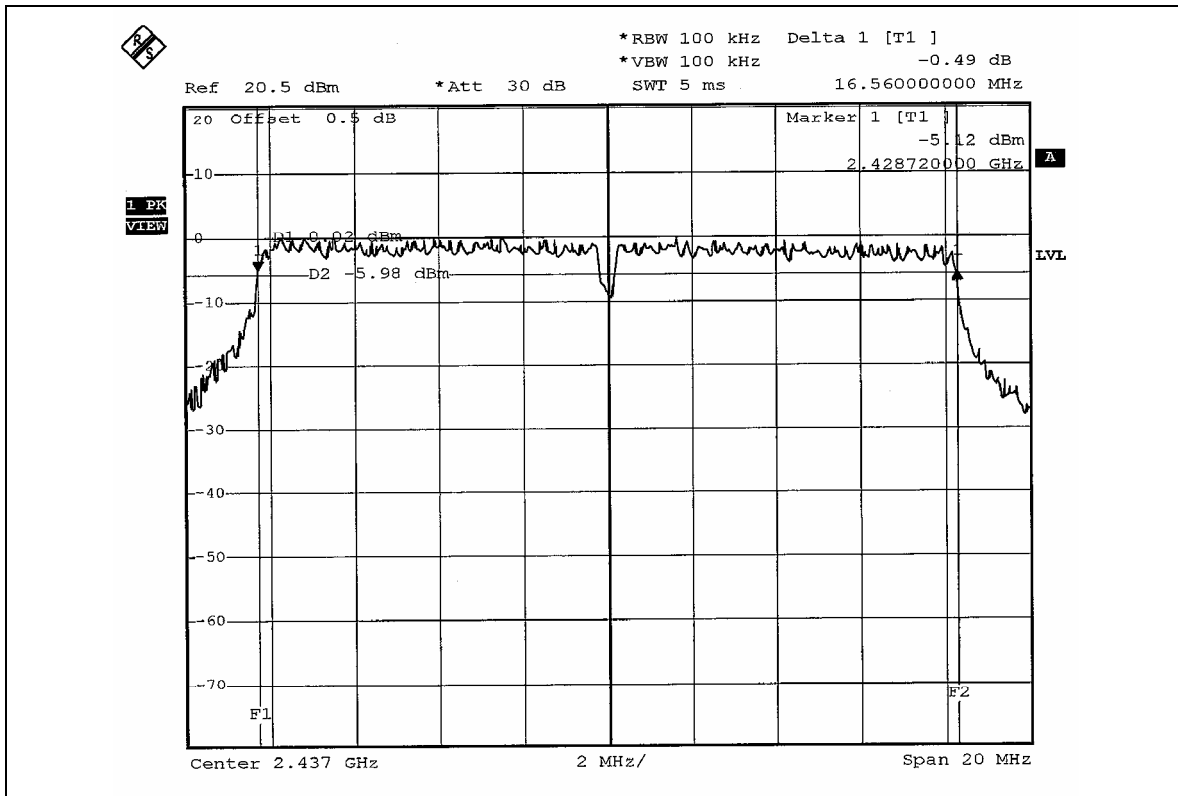



CH11

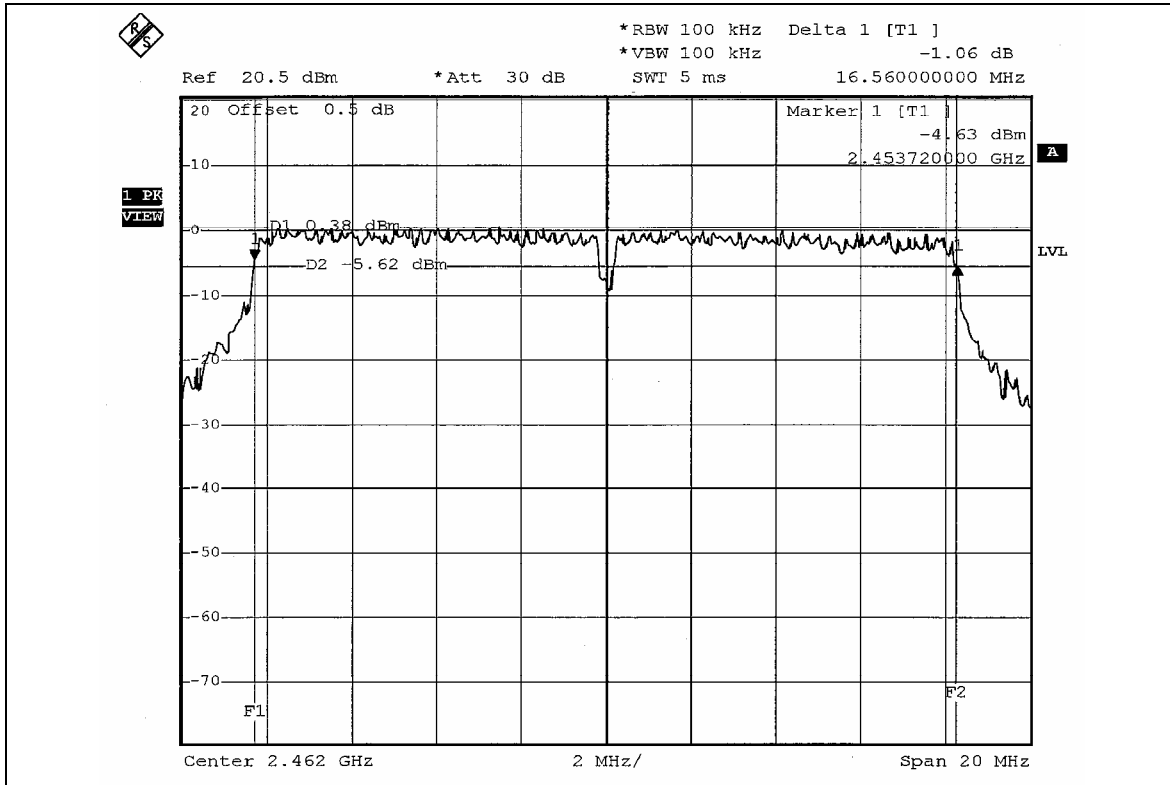



#### 4.4 MAXIMUM PEAK OUTPUT POWER

##### 4.4.1 LIMITS OF MAXIMUM PEAK OUTPUT POWER MEASUREMENT

The Maximum Peak Output Power Measurement is 30dBm.

##### 4.4.2 INSTRUMENTS

Description & Manufacturer	Model No.	Serial No.	Calibrated Until
R&S SPECTRUM ANALYZER	FSEK30	100049	Aug. 12, 2005
AGILENT SIGNAL GENERATOR	E8257C	MY43320668	Dec. 06, 2005
TEKTRONIX OSCILLOSCOPE	TDS 1012	C019167	Feb. 01, 2005
NARDA DETECTOR	4503A	FSCM99899	NA

**NOTE:**

The calibration interval of the above test instruments is 12 months and the calibrations are traceable to NML/ROC and NIST/USA..



#### 4.4.1 TEST PROCEDURES

1. A detector was used on the output port of the EUT. An oscilloscope was used to read the response of the detector.
2. Replaced the EUT by the signal generator. The center frequency of the S.G was adjusted to the center frequency of the measured channel.
3. Adjusted the power to have the same reading on oscilloscope. Record the power level.

#### 4.4.2 DEVIATION FROM TEST STANDARD

No deviation

#### 4.4.3 TEST SETUP



#### 4.4.4 EUT OPERATING CONDITIONS

Same as Item 4.3.6



## 4.4.3 TEST RESULTS

**802.11b DSSS modulation**

<b>EUT</b>	Wireless-G Game Adapter	<b>MODEL</b>	WGA54G ver. 2
<b>MODULATION TYPE</b>	CCK	<b>TRANSFER RATE</b>	11Mbps
<b>INPUT POWER (SYSTEM)</b>	120Vac, 60 Hz	<b>ENVIRONMENTAL CONDITIONS</b>	24deg. C, 53%RH, 991hPa
<b>TESTED BY</b>	Leo Hung		

CHANNEL	CHANNEL FREQUENCY (MHz)	PEAK POWER OUTPUT (mW)	PEAK POWER OUTPUT (dBm)	PEAK POWER LIMIT (dBm)	PASS/FAIL
1	2412	25.351	14.04	30	PASS
6	2437	25.410	14.05	30	PASS
11	2462	16.069	12.06	30	PASS

**802.11g OFDM modulation**

<b>EUT</b>	Wireless-G Game Adapter	<b>MODEL</b>	WGA54G ver. 2
<b>MODULATION TYPE</b>	BPSK	<b>TRANSFER RATE</b>	6Mbps
<b>INPUT POWER (SYSTEM)</b>	120Vac, 60 Hz	<b>ENVIRONMENTAL CONDITIONS</b>	24deg. C, 53%RH, 991hPa
<b>TESTED BY</b>	Leo Hung		

CHANNEL	CHANNEL FREQUENCY (MHz)	PEAK POWER OUTPUT (mW)	PEAK POWER OUTPUT (dBm)	PEAK POWER LIMIT (dBm)	PASS/FAIL
1	2412	25.645	14.09	30	PASS
6	2437	25.293	14.03	30	PASS
11	2462	25.410	14.05	30	PASS



## 4.5 POWER SPECTRAL DENSITY MEASUREMENT

### 4.5.1 LIMITS OF POWER SPECTRAL DENSITY MEASUREMENT

The Maximum of Power Spectral Density Measurement is 8dBm.

### 4.5.2 TEST INSTRUMENTS

Description & Manufacturer	Model No.	Serial No.	Calibrated Until
R&S SPECTRUM ANALYZER	FSEK30	100049	Aug. 12, 2005

**NOTE:**

The calibration interval of the above test instruments is 12 months and the calibrations are traceable to NML/ROC and NIST/USA.

#### 4.5.3 TEST PROCEDURE

The transmitter output was connected to the spectrum analyzer through an attenuator, the bandwidth of the fundamental frequency was measured with the spectrum analyzer using 3kHz RBW and 30kHz VBW, set sweep time = span/3kHz. The power spectral density was measured and recorded. The sweep time is allowed to be longer than span/3kHz for a full response of the mixer in the spectrum analyzer.

#### 4.5.4 DEVIATION FROM TEST STANDARD

No deviation

#### 4.5.5 TEST SETUP

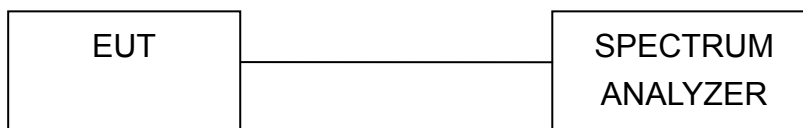

#### 4.5.6 EUT OPERATING CONDITION

Same as Item 4.3.6



## 4.5.7 TEST RESULTS

**802.11b DSSS modulation**

<b>EUT</b>	Wireless-G Game Adapter	<b>MODEL</b>	WGA54G ver. 2
<b>MODULATION TYPE</b>	CCK	<b>TRANSFER RATE</b>	11Mbps
<b>INPUT POWER (SYSTEM)</b>	120Vac, 60 Hz	<b>ENVIRONMENTAL CONDITIONS</b>	24deg. C, 53%RH, 991hPa
<b>TESTED BY</b>	Leo Hung		

<b>CHANNEL</b>	<b>CHANNEL FREQUENCY (MHz )</b>	<b>RF POWER LEVEL IN 3kHz BW (dBm)</b>	<b>MAXIMUM LIMIT (dBm)</b>	<b>PASS/FAIL</b>
1	2412	-7.67	8	PASS
6	2437	-7.52	8	PASS
11	2462	-8.91	8	PASS



CH1

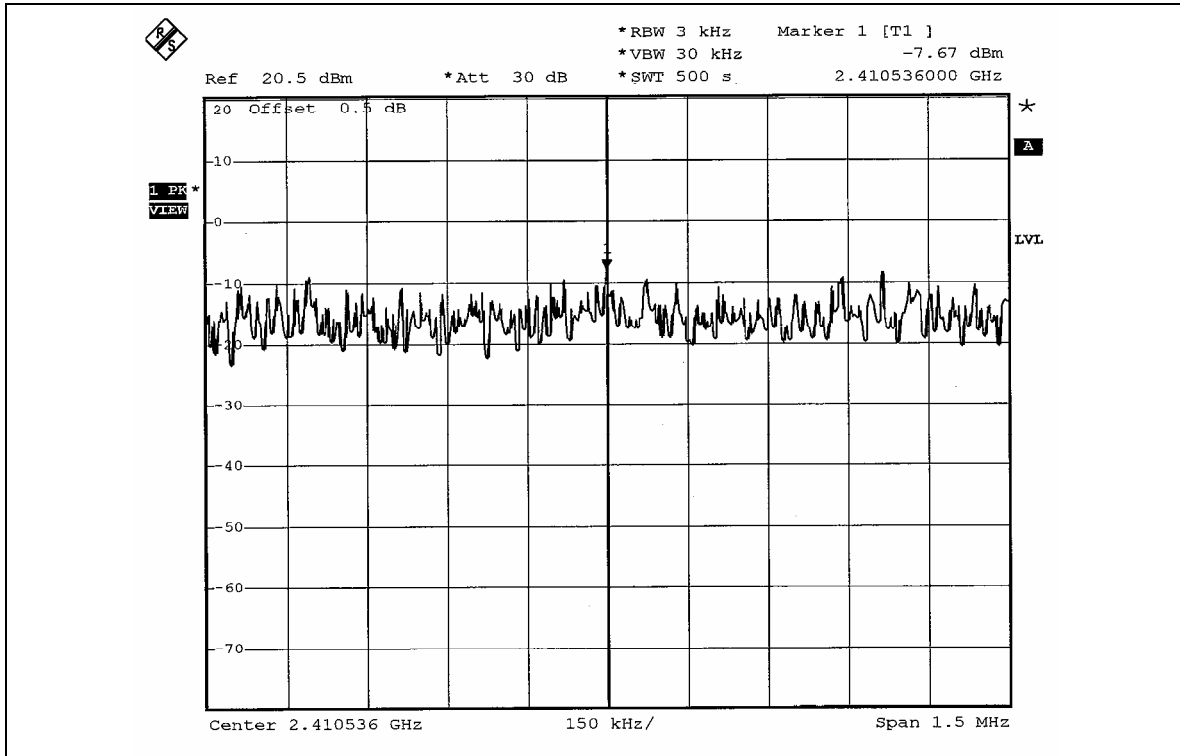

CH6

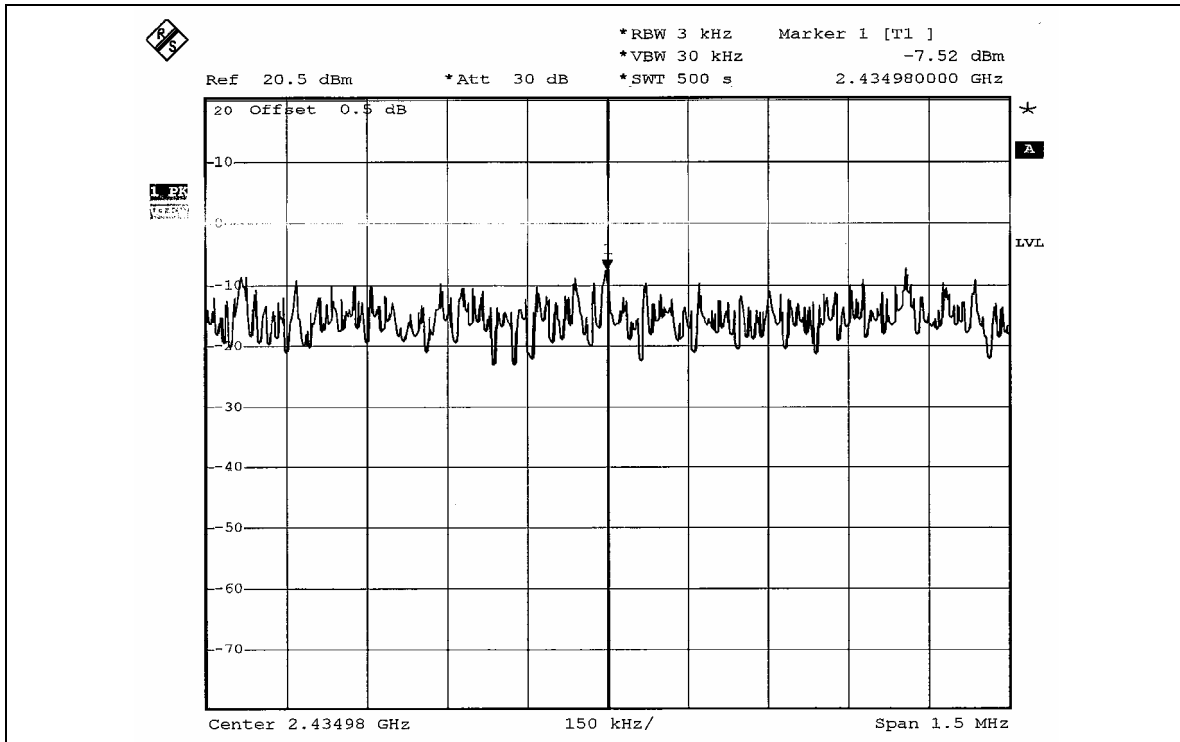



CH11

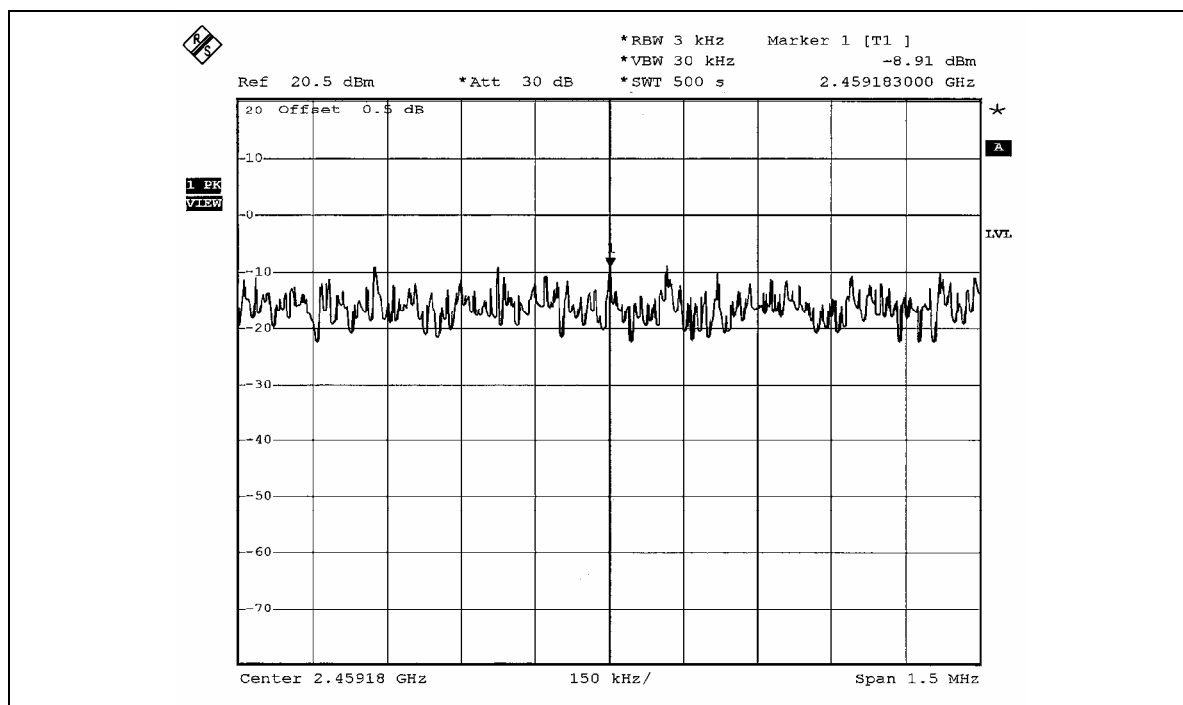

**802.11g OFDM modulation**

<b>EUT</b>	Wireless-G Game Adapter	<b>MODEL</b>	WGA54G ver. 2
<b>MODULATION TYPE</b>	BPSK	<b>TRANSFER RATE</b>	6Mbps
<b>INPUT POWER (SYSTEM)</b>	120Vac, 60 Hz	<b>ENVIRONMENTAL CONDITIONS</b>	24deg. C, 53%RH, 991hPa
<b>TESTED BY</b>	Leo Hung		

<b>CHANNEL</b>	<b>CHANNEL FREQUENCY (MHz )</b>	<b>RF POWER LEVEL IN 3kHz BW (dBm)</b>	<b>MAXIMUM LIMIT (dBm)</b>	<b>PASS/FAIL</b>
1	2412	-14.45	8	PASS
6	2437	-14.03	8	PASS
11	2462	-14.30	8	PASS



CH1

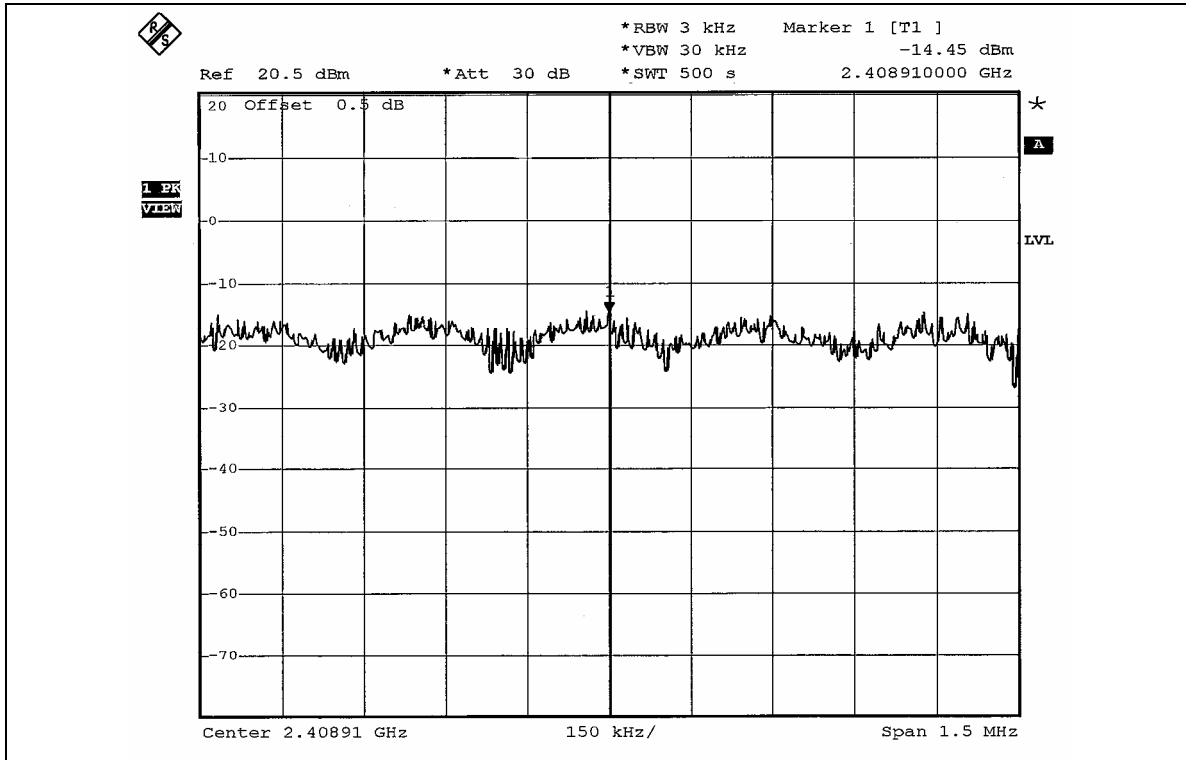

CH6

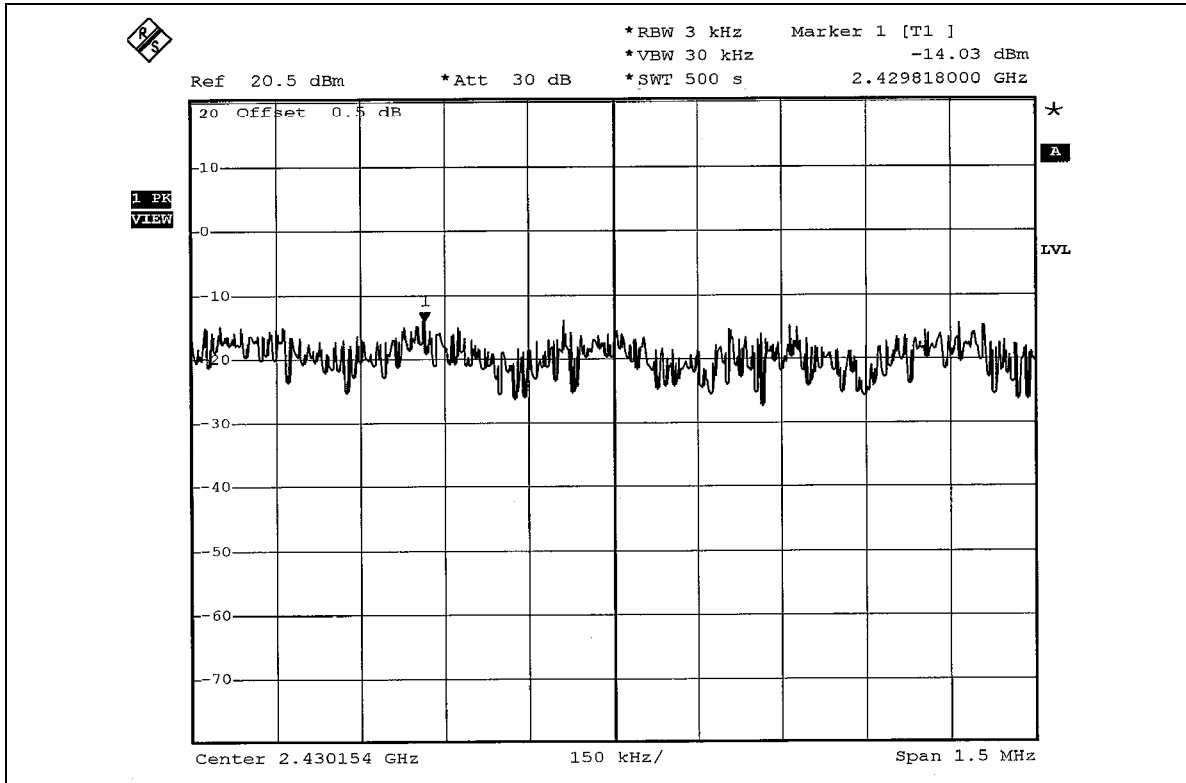





CH11

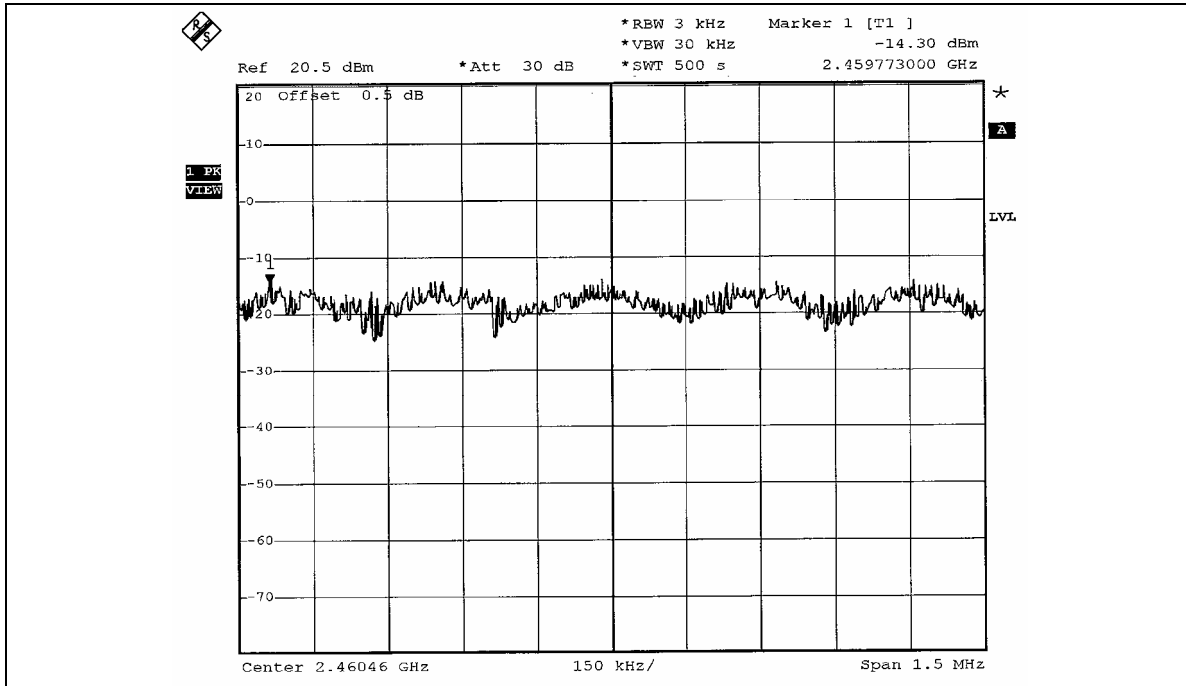



## 4.6 BAND EDGES MEASUREMENT

### 4.6.1 LIMITS OF BAND EDGES MEASUREMENT

Below –20dB of the highest emission level of operating band (in 100kHz Resolution Bandwidth).

### 4.6.2 TEST INSTRUMENTS

Description & Manufacturer	Model No.	Serial No.	Calibrated Until
R&S SPECTRUM ANALYZER	FSEK30	100049	Aug. 12, 2005

**NOTE:** The calibration interval of the above test instruments is 12 months and the calibrations are traceable to NML/ROC and NIST/USA.

### 4.6.3 TEST PROCEDURE

The transmitter output was connected to the spectrum analyzer via a low lose cable. Set both RBW and VBW of spectrum analyzer to 100 kHz and 100 kHz with suitable frequency span including 100 MHz bandwidth from band edge. The band edges was measured and recorded.

The spectrum plots (Peak RBW=VBW=100kHz ; Average RBW=1MHz, VBW=10kHz) are attached on the following pages.

### 4.6.4 DEVIATION FROM TEST STANDARD

No deviation

### 4.6.5 EUT OPERATING CONDITION

Same as Item 4.3.6



#### 4.6.6 TEST RESULTS

The spectrum plots are attached on the following 12 images. D2 line indicates the highest level, and D1 line indicates the 20dB offset below D2. It shows compliance with the requirement in part 15.247(d).

#### 4.6.7 TEST RESULTS

##### **802.11b DSSS modulation**

**NOTE 1:** The band edge emission plot of DSSS technique on page 58 show 47.05dBc delta between carrier maximum power and local maximum emission in restrict band (2.3860GHz). The emission of carrier strength list in the test result of channel 1 at the item 4.2.8 is 112.00dBuV/m (Peak), so the maximum field strength in restrict band is  $112.00-47.05=64.95$ dBuV/m which is under 74dBuV/m limit.

The band edge emission plot of DSSS technique on page 58 show 52.66dBc delta between carrier maximum power and local maximum emission in restrict band (2.3864GHz). The emission of carrier strength list in the test result of channel 1 at the item 4.2.8 is 104.53dBuV/m (Average), so the maximum field strength in restrict band is  $104.53-52.66=51.87$ dBuV/m which is under 54dBuV/m limit.

**NOTE 2:** The band edge emission plot of DSSS technique on the page 59 show 50.88dBc delta between carrier maximum power and local maximum emission in restrict band (2.4873GHz). The emission of carrier strength list in the test result of channel 11 at the item 4.2.8 is 111.23dBuV/m (Peak), so the maximum field strength in restrict band is  $111.23-50.88=60.35$ dBuV/m which is under 74dBuV/m limit.

The band edge emission plot of DSSS technique on the page 60 show 51.99dBc delta between carrier maximum power and local maximum emission in restrict band (2.4875GHz). The emission of carrier strength list in the test result of channel 11 at the item 4.2.8 is 103.64dBuV/m (Average), so the maximum field strength in restrict band is  $103.64-51.99=51.65$ dBuV/m which is under 54dBuV/m limit.

**802.11g OFDM modulation**

**NOTE 1:** The band edge emission plot of OFDM technique on page 61 show 42.83dBc delta between carrier maximum power and local maximum emission in restrict band (2.3900GHz). The emission of carrier strength list in the test result of channel 1 at the item 4.2.9 is 108.56dBuV/m (Peak), so the maximum field strength in restrict band is  $108.56-42.83=65.73$ dBuV/m which is under 74dBuV/m limit.

The band edge emission plot of OFDM technique on page 61 show 49.79dBc delta between carrier maximum power and local maximum emission in restrict band (2.3900GHz). The emission of carrier strength list in the test result of channel 1 at the item 4.2.9 is 99.98dBuV/m (Average), so the maximum field strength in restrict band is  $99.98-49.79=50.19$ dBuV/m which is under 54dBuV/m limit.

**NOTE 2:** The band edge emission plot of OFDM technique on page 62 show 43.91dBc delta between carrier maximum power and local maximum emission in restrict band (2.4865GHz). The emission of carrier strength list in the test result of channel 11 at the item 4.2.9 is 109.81dBuV/m (Peak), so the maximum field strength in restrict band is  $109.81-43.91=65.90$ dBuV/m which is under 74dBuV/m limit.

The band edge emission plot of OFDM technique on page 63 show 47.25dBc delta between carrier maximum power and local maximum emission in restrict band (2.4835GHz). The emission of carrier strength list in the test result of channel 11 at the item 4.2.9 is 100.77dBuV/m (Average), so the maximum field strength in restrict band is  $100.77-47.25=53.52$ dBuV/m which is under 54dBuV/m limit.



802.11b DSSS modulation

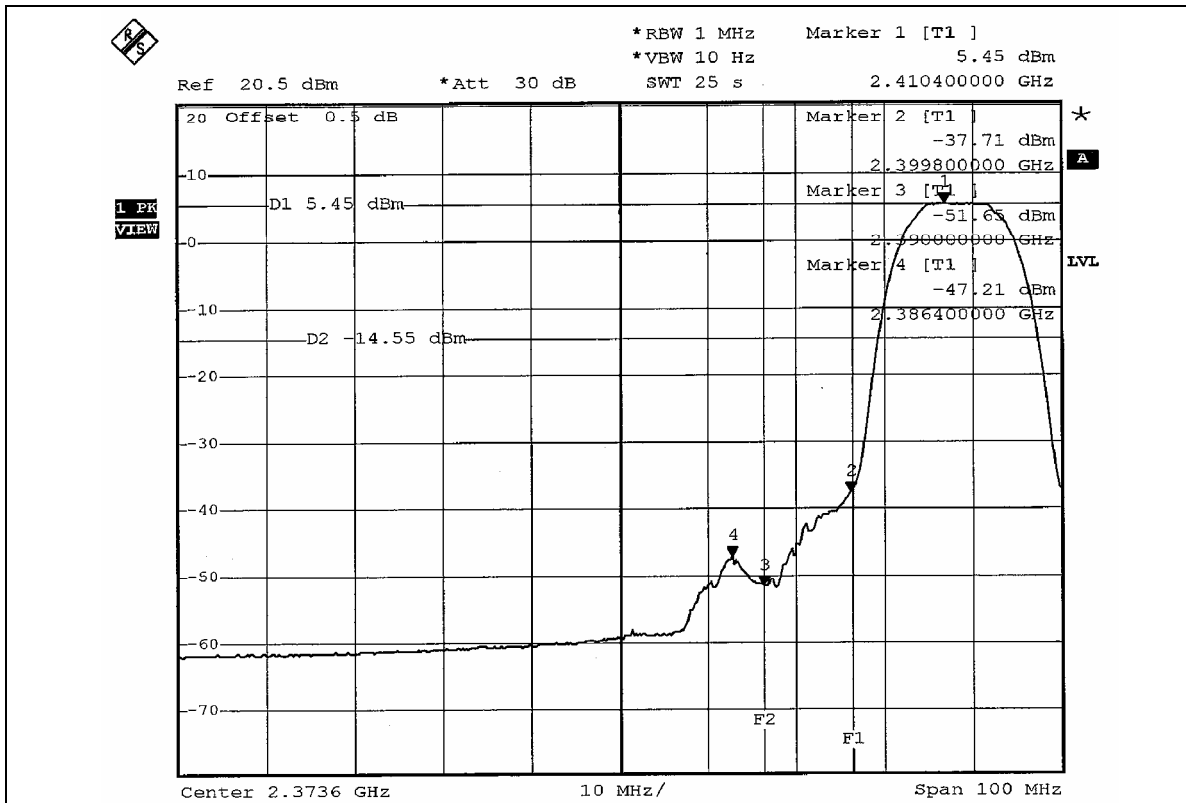
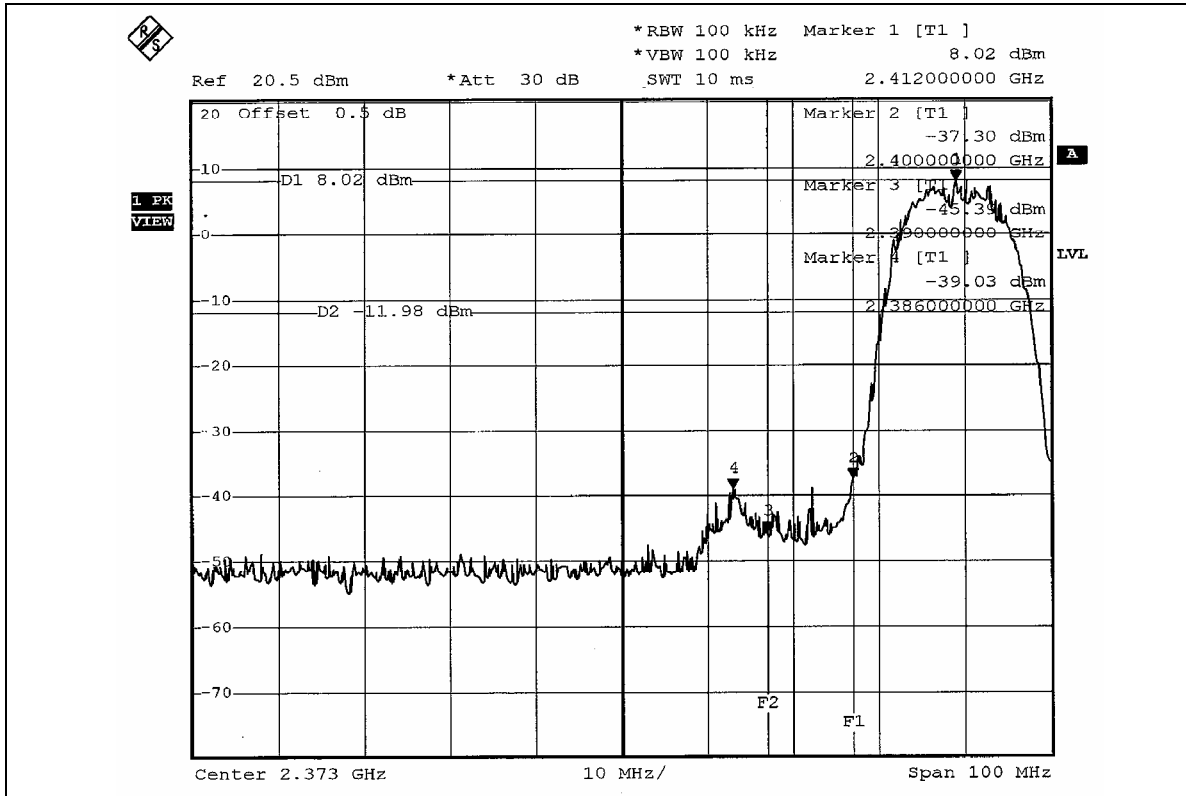

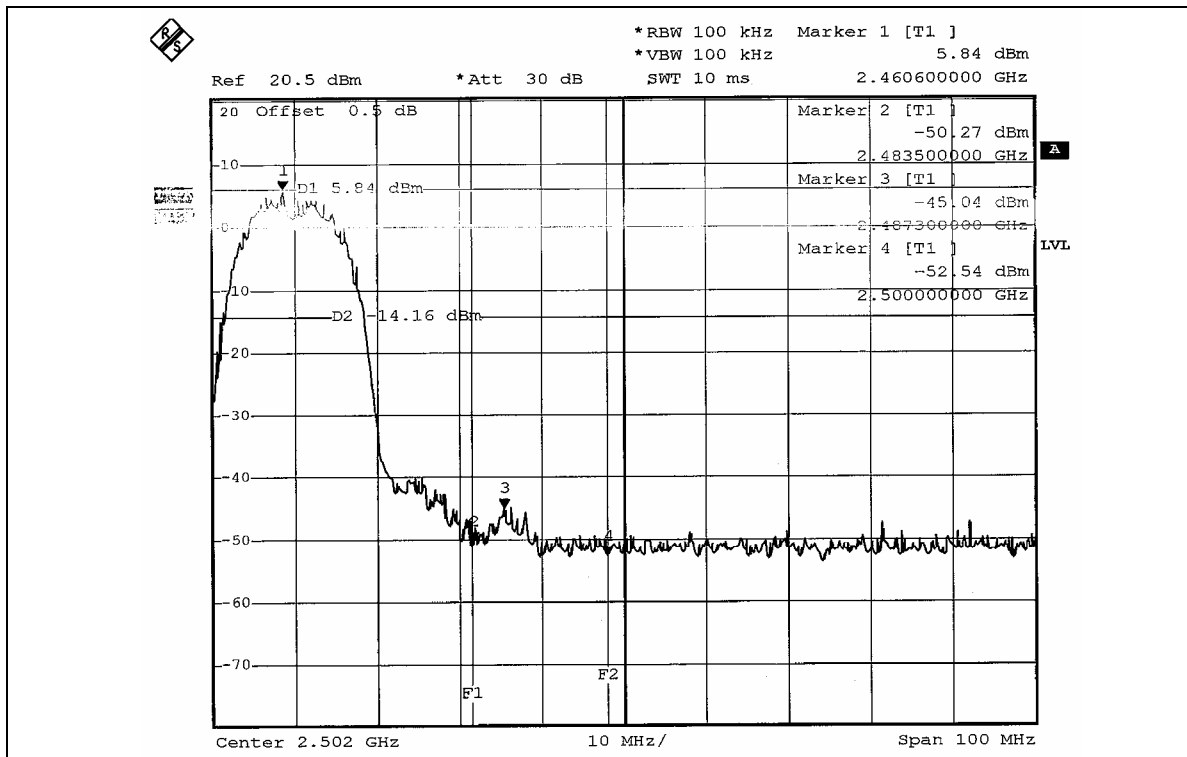
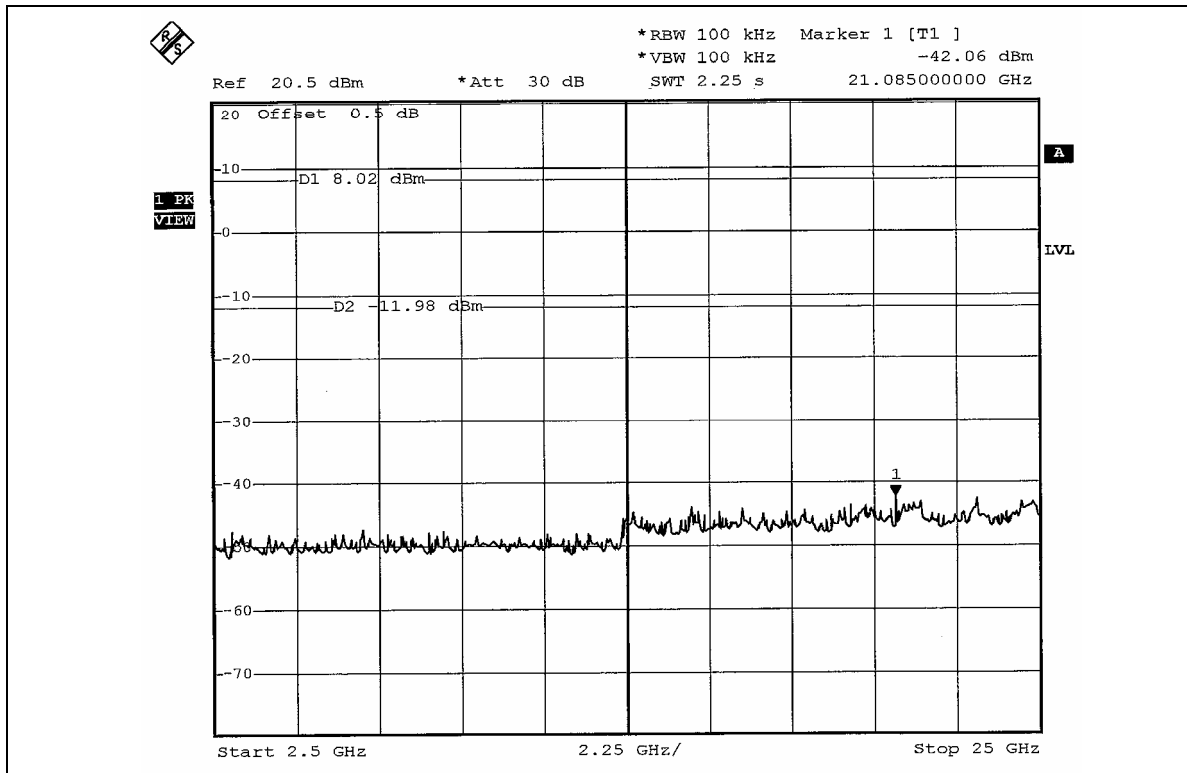

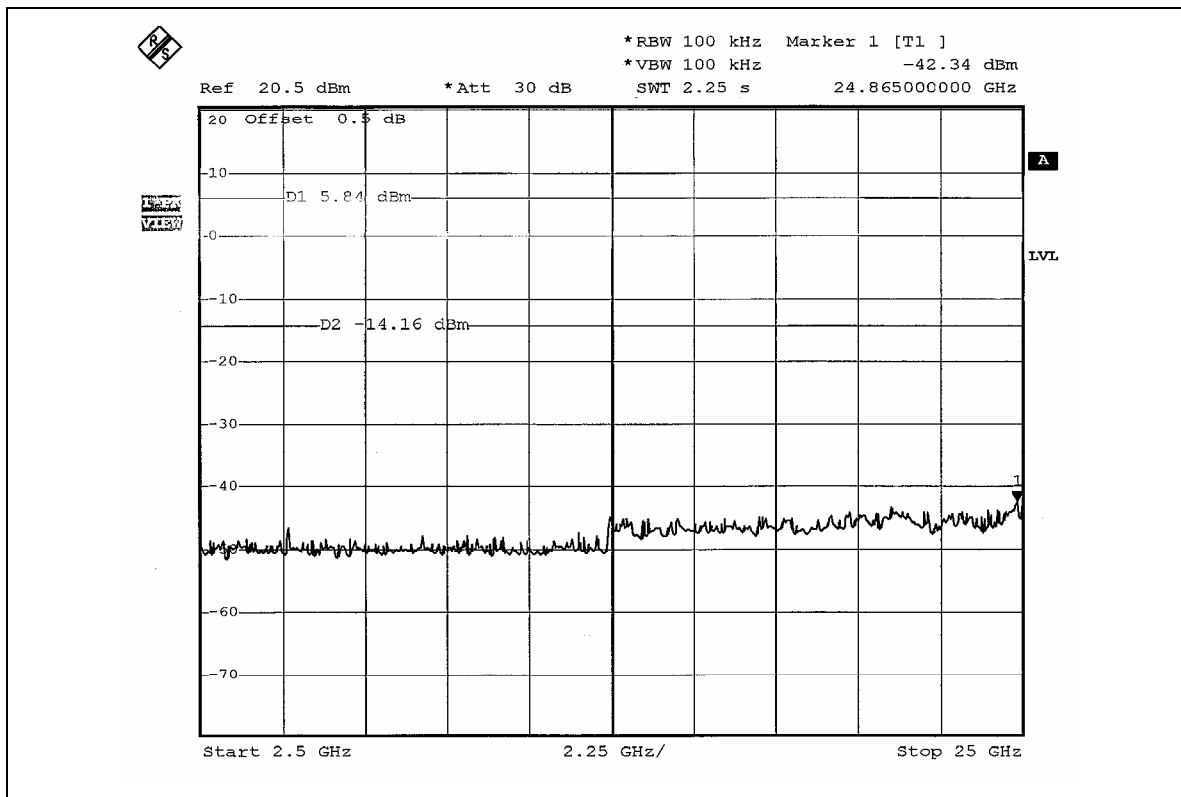
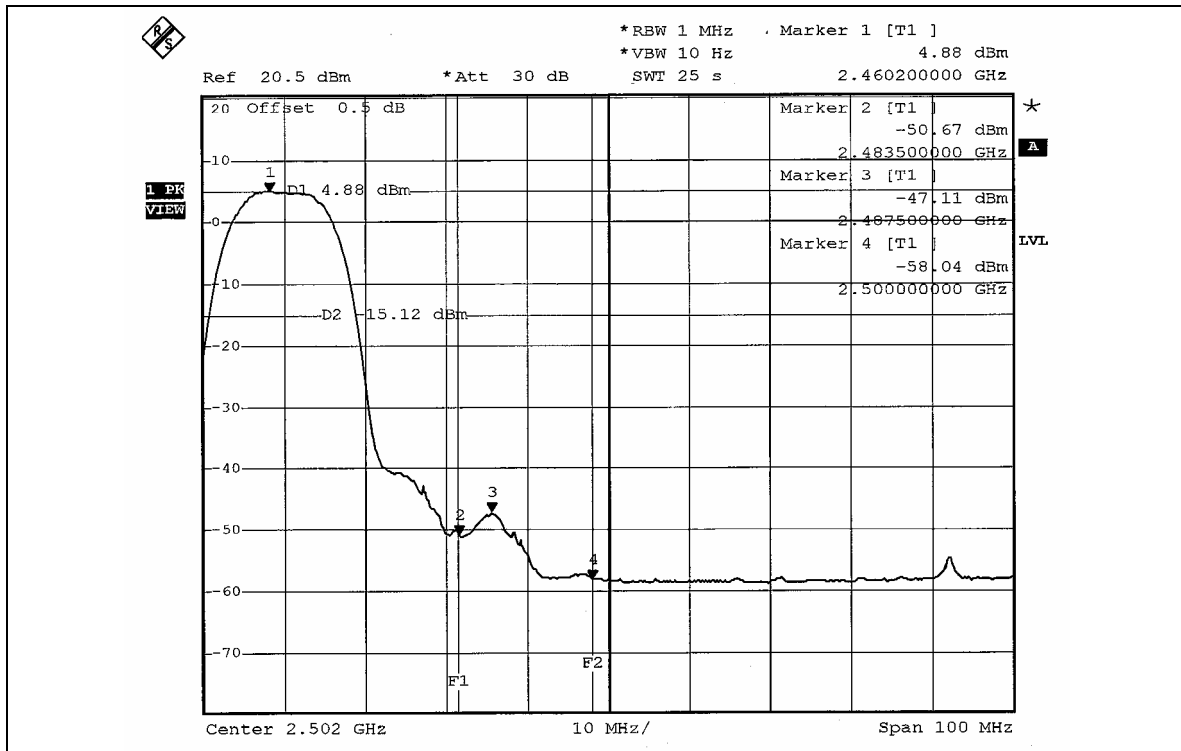



### 802.11g OFDM modulation

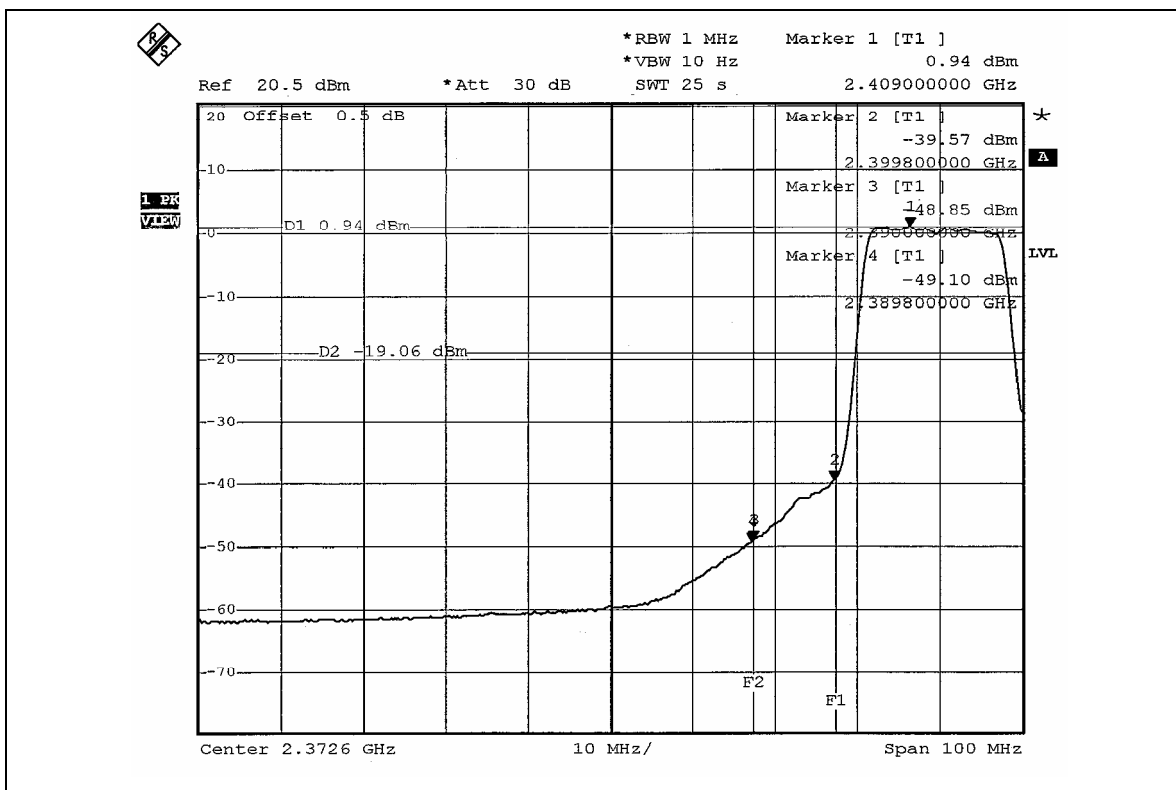
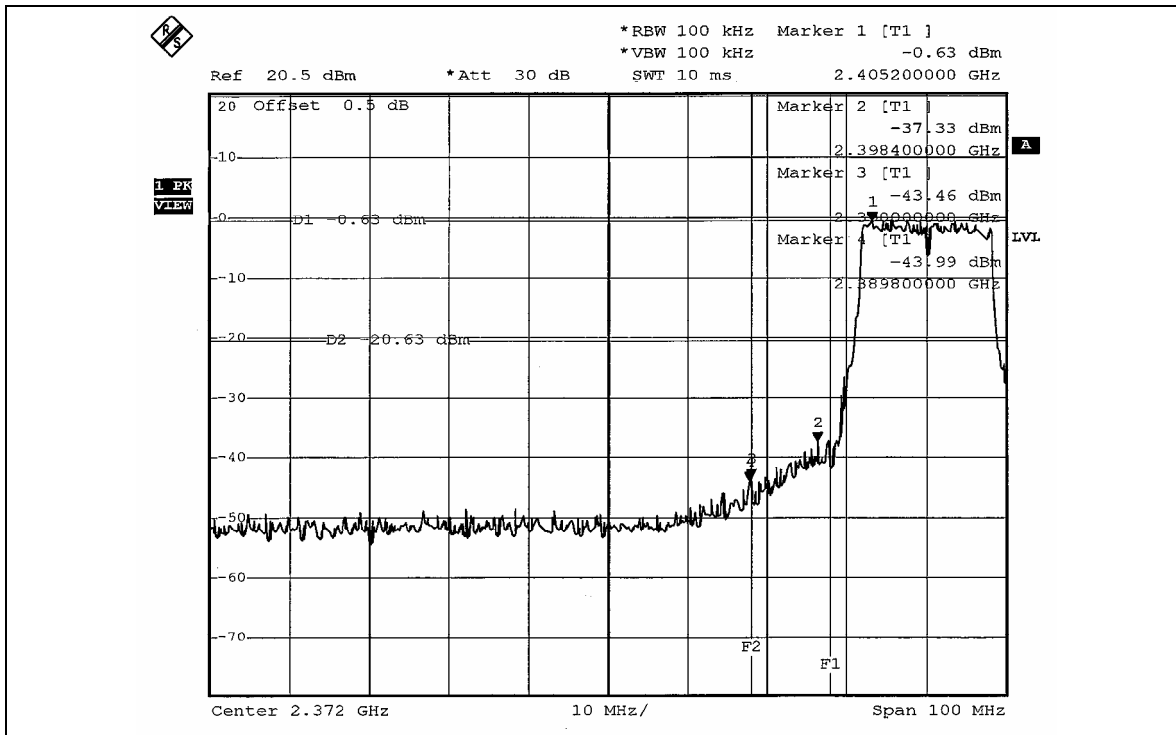



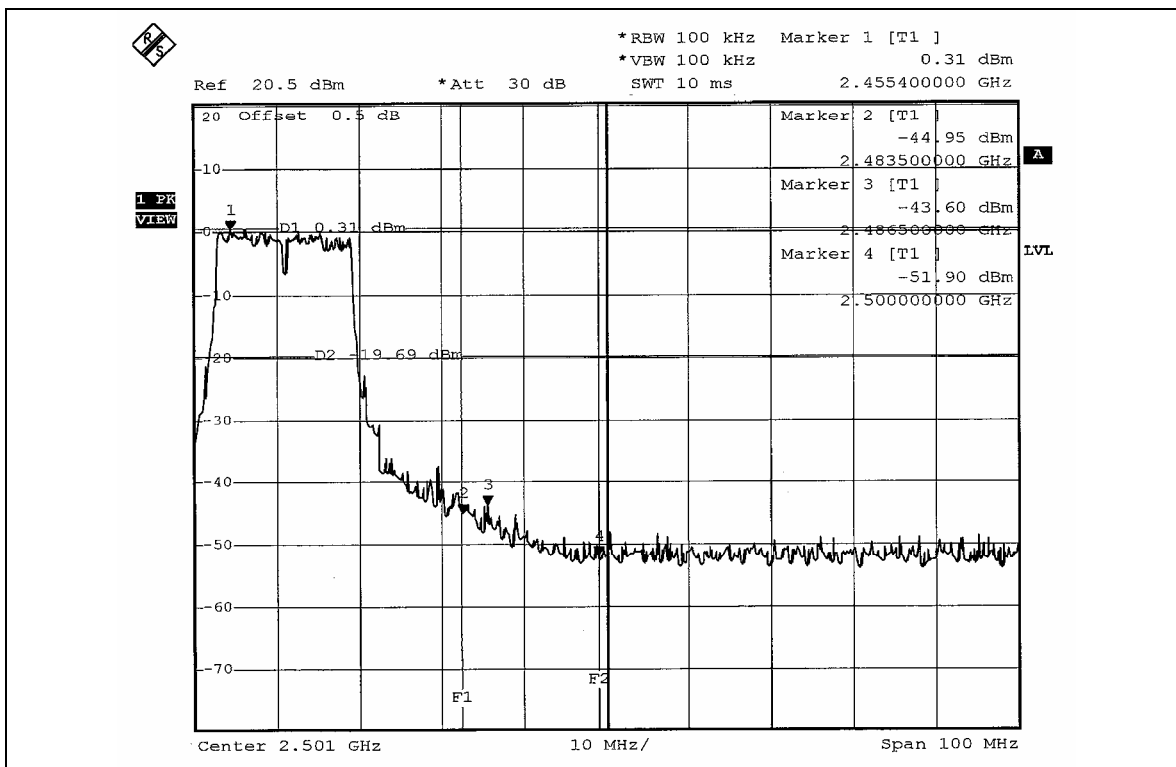
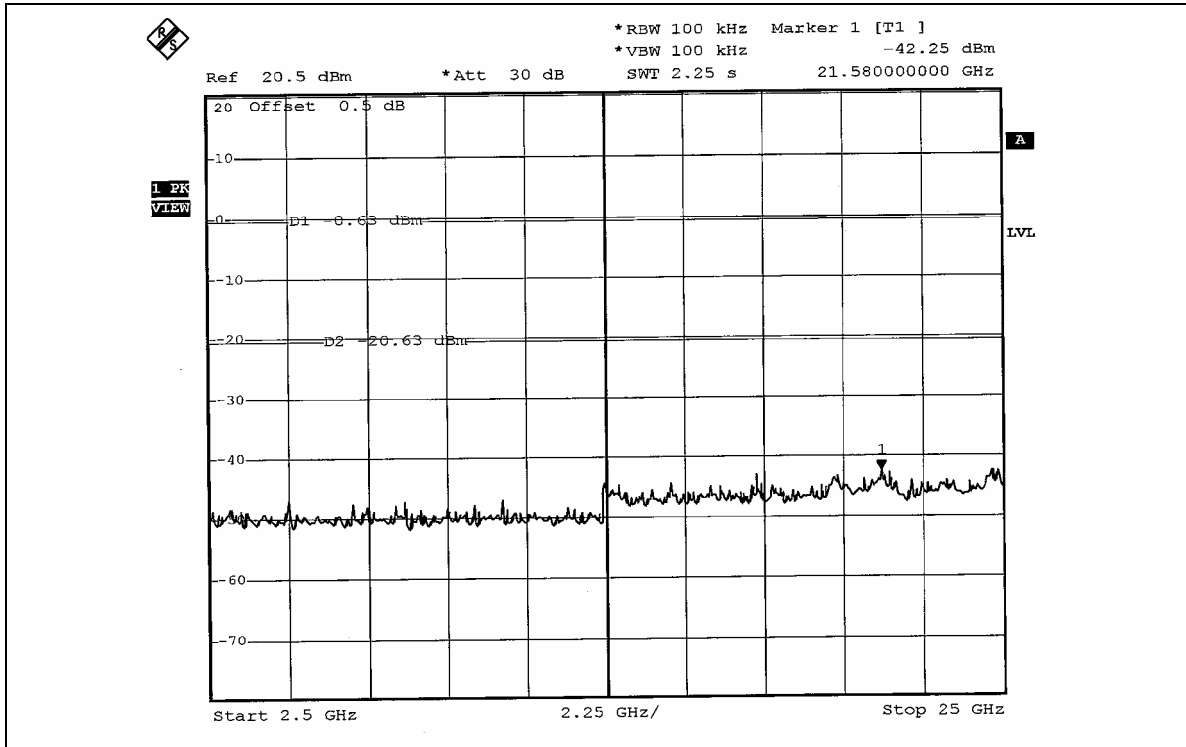

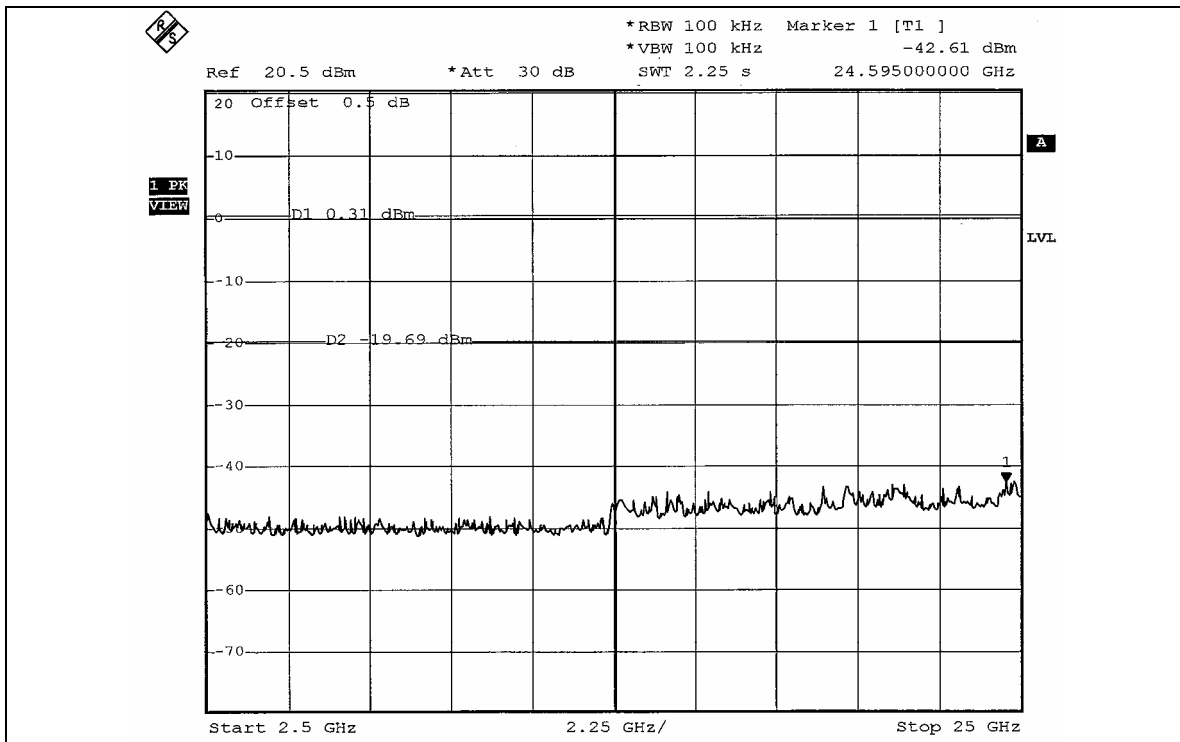
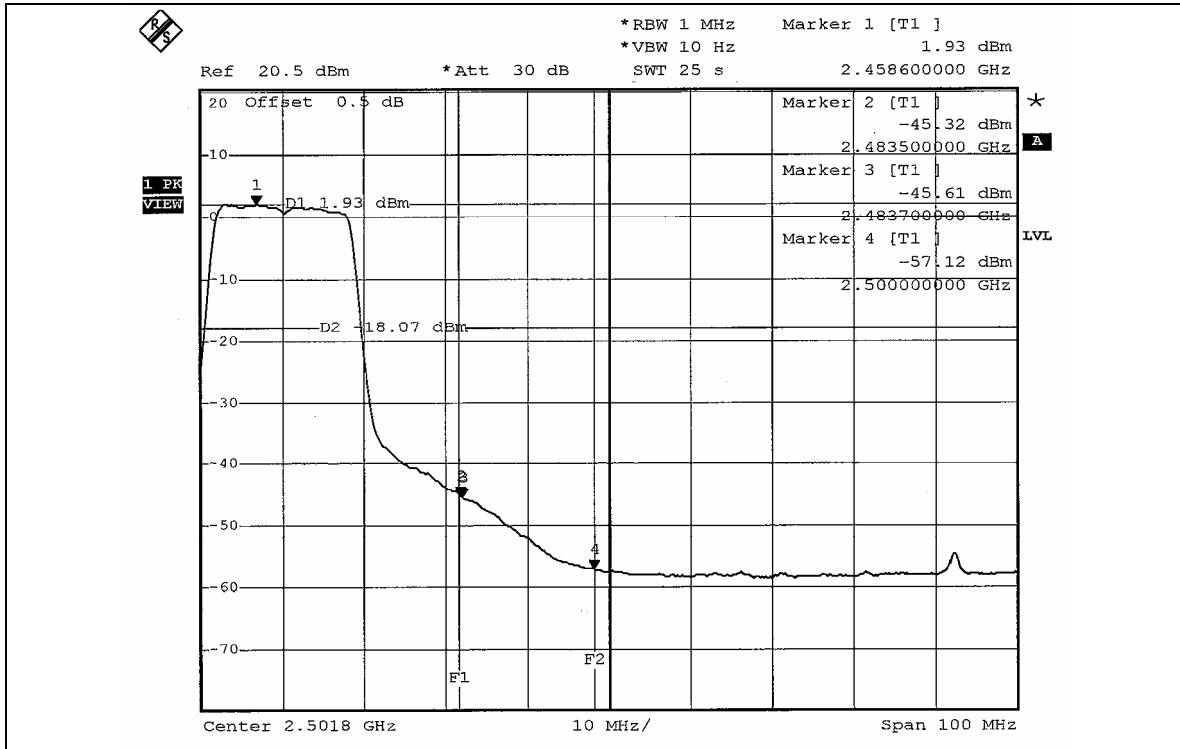



## **4.7 ANTENNA REQUIREMENT**

### **4.7.1 STANDARD APPLICABLE**

For intentional device, according to FCC 47 CFR Section 15.203, an intentional radiator shall be designed to ensure that no antenna other than that furnished by the responsible party shall be used with the device. And according to FCC 47 CFR Section 15.247 (b), if transmitting antennas of directional gain greater than 6dBi are used, the power shall be reduced by the amount in dB that the directional gain of the antenna exceeds 6dBi.

### **4.7.2 ANTENNA CONNECTED CONSTRUCTION**

The antenna used in this product is Dipole antenna without antenna connector. The maximum Gain of the antenna is 2dBi.

## 5. PHOTOGRAPHS OF THE TEST CONFIGURATION

CONDUCTED EMISSION TEST

Test Mode1 (with WD411200500 AC adapter)



Test Mode 2 (with 411210003CT AC Adapter)



RADIATED EMISSION TEST  
Test Mode1 (with WD411200500 AC adapter)

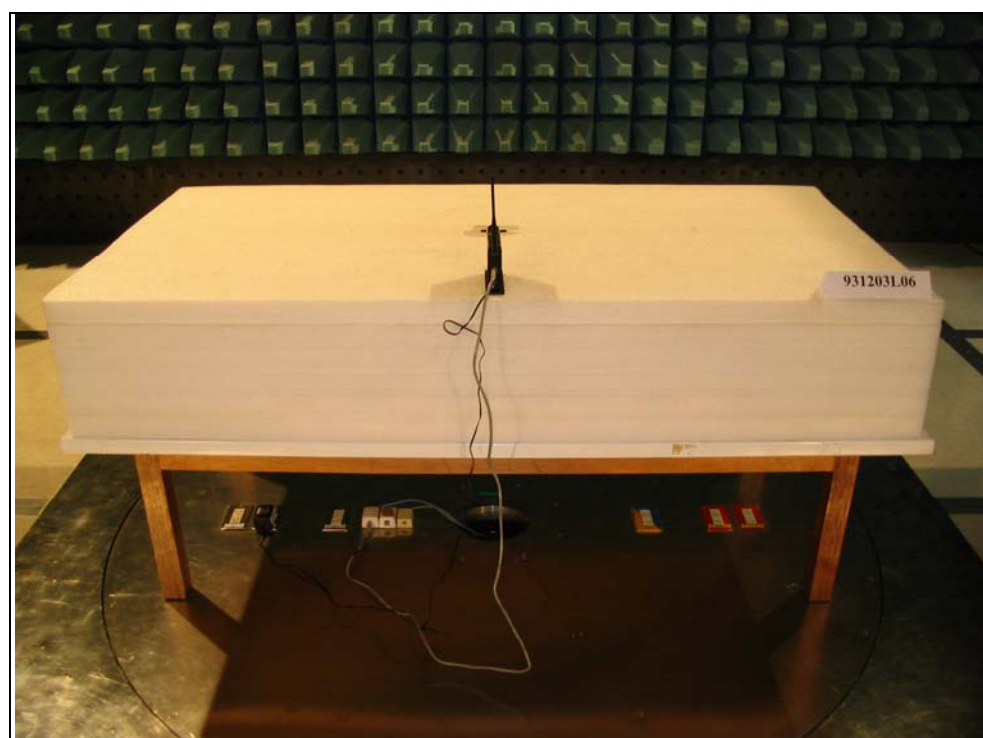

Test Mode 2 (with 411210003CT AC Adapter)

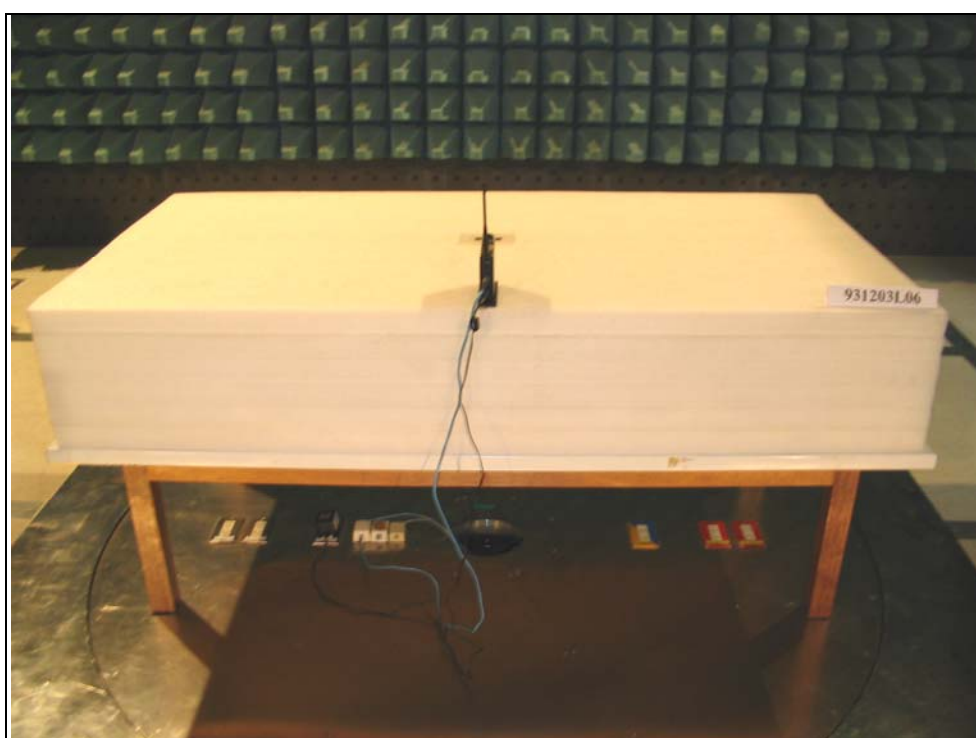
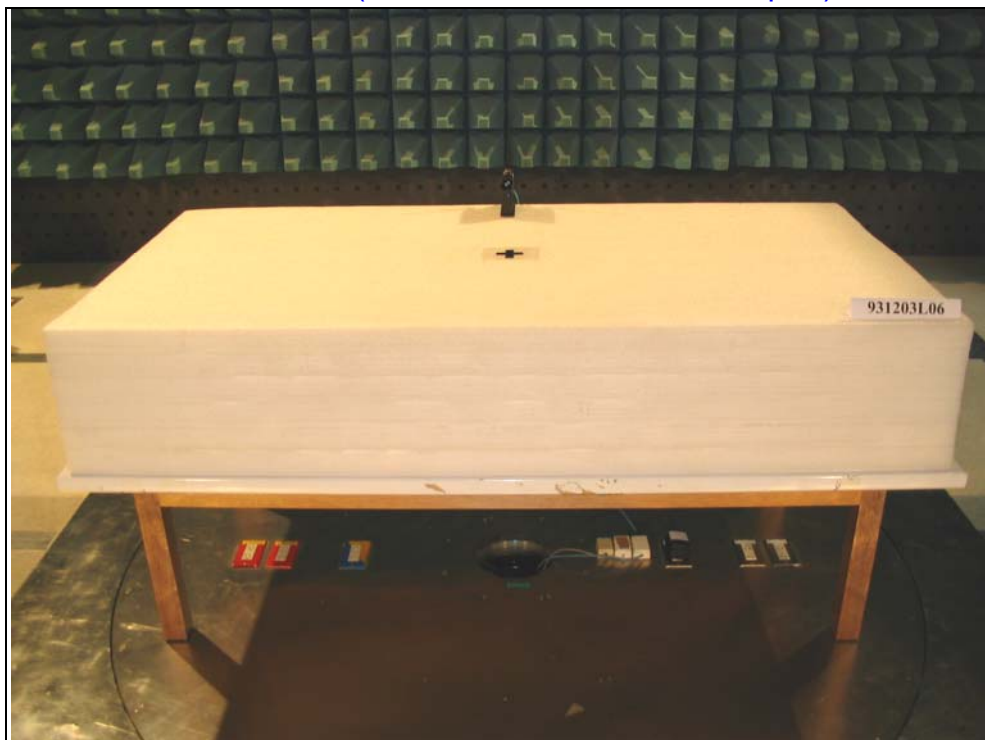



## 6. INFORMATION ON THE TESTING LABORATORIES

We, ADT Corp., were founded in 1988 to provide our best service in EMC, Radio, Telecom and Safety consultation. Our laboratories are accredited and approved by the following approval agencies according to ISO/IEC 17025.

<b>USA</b>	FCC, NVLAP, UL, A2LA
<b>Germany</b>	TUV Rheinland
<b>Japan</b>	VCCI
<b>Norway</b>	NEMKO
<b>Canada</b>	INDUSTRY CANADA , CSA
<b>R.O.C.</b>	CNLA, BSMI, DGT
<b>Netherlands</b>	Telefication
<b>Singapore</b>	PSB , GOST-ASIA(MOU)
<b>Russia</b>	CERTIS(MOU)

Copies of accreditation certificates of our laboratories obtained from approval agencies can be downloaded from our web site:

[www.adt.com.tw/index.5/phtml](http://www.adt.com.tw/index.5/phtml). If you have any comments, please feel free to contact us at the following:

**Linko EMC/RF Lab:**

Tel: 886-2-26052180

Fax: 886-2-26052943

**Hsin Chu EMC/RF Lab:**

Tel: 886-3-5935343

Fax: 886-3-5935342

**Hwa Ya EMC/RF/Safety Telecom Lab:**

Tel: 886-3-3183232

Fax: 886-3-3185050

**Linko RF Lab.**

Tel: 886-3-3270910

Fax: 886-3-3270892

**Web Site:** [www.adt.com.tw](http://www.adt.com.tw)

The address and road map of all our labs can be found in our web site also