



FCC TEST REPORT

REPORT NO.: RF950209H04

MODEL NO.: WAG54G v3

RECEIVED: Feb. 16, 2006

TESTED: Feb. 18 to March 10, 2006

ISSUED: March 10, 2006

APPLICANT: Cisco-Linksys LLC

ADDRESS: 121 Theory Drive Irvine, CA 92617, U.S.A.

ISSUED BY: Advance Data Technology Corporation

LAB LOCATION: No. 81-1, Lu Liao Keng, 9 Ling, Wu Lung Tsuen,
Chiung Lin Hsiang, Hsin Chu Hsien,
Taiwan, R.O.C.

This test report consists of 68 pages in total. It may be duplicated completely for legal use with the approval of the applicant. It should not be reproduced except in full, without the written approval of our laboratory. The client should not use it to claim product endorsement by CNLA, A2LA or any government agencies. The test results in the report only apply to the tested sample. The test results in this report are traceable to the national or international standards.





Table of Contents

1	CERTIFICATION.....	4
2	SUMMARY OF TEST RESULTS.....	5
3	GENERAL INFORMATION	6
3.1	GENERAL DESCRIPTION OF EUT.....	6
3.2	DESCRIPTION OF TEST MODES.....	8
3.3	TEST MODE APPLICABILITY AND TESTED CHANNEL DETAIL:.....	9
3.4	GENERAL DESCRIPTION OF APPLIED STANDARDS	11
3.5	DESCRIPTION OF SUPPORT UNITS.....	12
3.6	CONFIGURATION OF SYSTEM UNDER TEST	13
4	TEST TYPES AND RESULTS.....	15
4.1	CONDUCTED EMISSION MEASUREMENT	15
4.1.1	LIMITS OF CONDUCTED EMISSION MEASUREMENT	15
4.1.2	TEST INSTRUMENTS	15
4.1.3	TEST PROCEDURES.....	16
4.1.4	TEST SETUP	16
4.1.5	EUT OPERATING CONDITIONS.....	17
4.1.6	TEST RESULTS.....	18
4.2	RADIATED EMISSION MEASUREMENT	22
4.2.1	LIMITS OF RADIATED EMISSION MEASUREMENT	22
4.2.2	TEST INSTRUMENTS	23
4.2.3	TEST PROCEDURES.....	24
4.2.4	TEST SETUP	25
4.2.5	EUT OPERATING CONDITIONS.....	26
4.2.6	TEST RESULTS.....	27
4.2.7	TEST RESULTS – DSSS	29
4.2.8	TEST RESULTS – OFDM	32
4.3	6dB BANDWIDTH MEASUREMENT	35
4.3.1	LIMITS OF 6dB BANDWIDTH MEASUREMENT	35
4.3.2	TEST INSTRUMENTS	35
4.3.3	TEST PROCEDURE	36
4.3.4	TEST SETUP	36
4.3.5	EUT OPERATING CONDITIONS.....	36
4.3.6	TEST RESULTS –DSSS	37
4.3.7	TEST RESULTS-OFDM	40
4.4	MAXIMUM PEAK OUTPUT POWER	43
4.4.1	LIMITS OF MAXIMUM PEAK OUTPUT POWER MEASUREMENT.....	43
4.4.2	TEST INSTRUMENTS	43
4.4.3	TEST PROCEDURES.....	44
4.4.4	TEST SETUP.....	44



4.4.5	EUT OPERATING CONDITIONS.....	44
4.4.6	TEST RESULTS – DSSS	45
4.4.7	TEST RESULTS –OFDM	46
4.5	POWER SPECTRAL DENSITY MEASUREMENT.....	47
4.5.1	LIMITS OF POWER SPECTRAL DENSITY MEASUREMENT	47
4.5.2	TEST INSTRUMENTS	47
4.5.3	TEST PROCEDURE	48
4.5.4	TEST SETUP	48
4.5.5	EUT OPERATING CONDITIONS.....	48
4.5.6	TEST RESULTS –DSSS	49
4.5.7	TEST RESULTS –OFDM	52
4.6	BAND EDGES MEASUREMENT.....	55
4.6.1	LIMITS OF BAND EDGES MEASUREMENT	55
4.6.2	TEST INSTRUMENTS	55
4.6.3	TEST PROCEDURE	55
4.6.4	EUT OPERATING CONDITION.....	55
4.6.5	TEST RESULTS – DSSS	56
4.6.6	TEST RESULTS – OFDM	60
4.7	ANTENNA REQUIREMENT.....	64
4.7.1	STANDARD APPLICABLE	64
4.7.2	ANTENNA CONNECTED CONSTRUCTION.....	64
5	PHOTOGRAPHS OF THE TEST CONFIGURATION.....	65
6	INFORMATION ON THE TESTING LABORATORIES	67
	APPENDIX-A	A-1



1 CERTIFICATION

PRODUCT : Wireless-G ADSL Gateway
BRAND NAME : Linksys
MODEL NO. : WAG54G v3
TESTED: Feb. 18 to March 10, 2006
APPLICANT : Cisco-Linksys LLC
TEST ITEM: ENGINEERING SAMPLE
STANDARDS : 47 CFR Part 15, Subpart C (Section 15.247),
ANSI C63.4-2003

The above equipment (Model: WAG54G v3) has been tested by **Advance Data Technology Corporation**, and found compliance with the requirement of the above standards. The test record, data evaluation & Equipment Under Test (EUT) configurations represented herein are true and accurate accounts of the measurements of the sample's EMC characteristics under the conditions specified in this report.

PREPARED BY :  , **DATE:** March 10, 2006
(Midoli Peng)

TECHNICAL ACCEPTANCE :  , **DATE:** March 10, 2006
Responsible for RF
(Hank Chung)

APPROVED BY :  , **DATE:** March 10, 2006
(May Chen, Deputy Manager)



2 SUMMARY OF TEST RESULTS

The EUT has been tested according to the following specifications:

APPLIED STANDARD: 47 CFR Part 15, Subpart C			
Standard Section	Test Type and Limit	Result	REMARK
15.207	AC Power Conducted Emission	PASS	Meet the requirement of limit Minimum passing margin is -10.20 dB at 0.445 MHz
15.247(a)(2)	Spectrum Bandwidth of a Direct Sequence Spread Spectrum System Limit: min. 500kHz	PASS	Meet the requirement of limit
15.247(b)	Maximum Peak Output Power Limit: max. 30dBm	PASS	Meet the requirement of limit
15.247(c)	Transmitter Radiated Emissions Limit: Table 15.209	PASS	Meet the requirement of limit Minimum passing margin is -1.7 dB at 374.99 MHz
15.247(d)	Power Spectral Density Limit: max. 8dBm	PASS	Meet the requirement of limit
15.247(c)	Band Edge Measurement Limit: 20 dB less than the peak value of fundamental frequency	PASS	Meet the requirement of limit



3 GENERAL INFORMATION

3.1 GENERAL DESCRIPTION OF EUT

PRODUCT	Wireless-G ADSL Gateway
MODEL NO.	WAG54G v3
FCC ID	Q87-WAG54GV3
POWER SUPPLY	DC 12V from power adapter
MODULATION TYPE	CCK, DQPSK, DBPSK for DSSS 64QAM, 16QAM, QPSK, BPSK for OFDM
RADIO TECHNOLOGY	DSSS, OFDM
TRANSFER RATE	802.11b: 11/5.5/2/1Mbps 802.11g: 54/48/36/24/18/12/9/6Mbps
FREQUENCY RANGE	2412MHz ~ 2462MHz
NUMBER OF CHANNEL	11
CHANNEL SPACING	5MHz
OUTPUT POWER	802.11b: 51.404mW 802.11g: 41.020mW
ANTENNA TYPE	Dipole Antenna (Antenna gain : 2.0dBi)
DATA CABLE	NA
INTERFACE	ADSL Port x 1; LAN Port x4 (10/100Mbps)
ASSOCIATED DEVICES	NA

NOTE:

1. The EUT, operates in the 2.4GHz frequency range, lets you connect IEEE 802.11g or IEEE 802.11b devices to the network. With its high-speed data transmissions of up to 54Mbps.

2. The EUT must be supplied with a power adapter and following different models could be chosen:

Adapter 1:	
Brand:	Linksys
Model No.:	AM-1201000D41
Input power :	AC230V, 50Hz, 0.15A
Output power :	DC12V, 1A Cable:1.8m/unshielded/without core
Adapter 2:	
Brand:	Linksys
Model No.:	D12-1000
Input power :	AC230V, 50Hz, 0.15A
Output power :	DC12V, 1A Cable:1.8m/unshielded/without core

3. The above EUT information was declared by the manufacturer and for more detailed features description, please refer to the manufacturer's specifications or User's Manual.

3.2 DESCRIPTION OF TEST MODES

Operated in 2400 ~ 2483.5MHz band:

For 802.11b/g normal mode: Eleven channels are provided to this EUT.

Channel	Frequency	Channel	Frequency
1	2412 MHz	7	2442 MHz
2	2417 MHz	8	2447 MHz
3	2422 MHz	9	2452 MHz
4	2427 MHz	10	2457 MHz
5	2432 MHz	11	2462 MHz
6	2437 MHz		

3.3 TEST MODE APPLICABILITY AND TESTED CHANNEL DETAIL:

EUT configure mode	Applicable to				Description
	PLC	RE<1G	RE≥1G	APCM	
-	X	X	X	X	NA

Where PLC: Power Line Conducted Emission RE<1G RE: Radiated Emission below 1GHz
 RE≥1G: Radiated Emission above 1GHz APCM: Antenna Port Conducted Measurement

Power Line Conducted Emission Test:

- Pre-Scan has been conducted to determine the worst-case mode from all possible combinations between available modulations, data rates and antenna ports (if EUT with antenna diversity architecture).
- Following channel(s) was (were) selected for the final test as listed below.

Mode	Available Channel	Tested Channel	Modulation Technology	Modulation Type	Data Rate (Mbps)
802.11g	1 to 11	11	OFDM	BPSK	6

- For Conducted emissions, the EUT was tested as the following test modes:

Test Mode	Power
Mode 1	With adapter 1
Mode 2	Without adapter 2

Radiated Emission Test (Below 1 GHz):

- Pre-Scan has been conducted to determine the worst-case mode from all possible combinations between available modulations, data rates and antenna ports (if EUT with antenna diversity architecture).
- Following channel(s) was (were) selected for the final test as listed below.

Mode	Available Channel	Tested Channel	Modulation Technology	Modulation Type	Data Rate (Mbps)
802.11g	1 to 11	1	OFDM	BPSK	6

- For Radiated Emission Test (Below 1 GHz), the EUT was tested as the following test modes:

Test Mode	Power
Mode 1	With adapter 1
Mode 2	With adapter 2



Radiated Emission Test (Above 1 GHz):

- Pre-Scan has been conducted to determine the worst-case mode from all possible combinations between available modulations, data rates and antenna ports (if EUT with antenna diversity architecture).
- Following channel(s) was (were) selected for the final test as listed below.

Mode	Available Channel	Tested Channel	Modulation Technology	Modulation Type	Data Rate (Mbps)
802.11b	1 to 11	1, 6, 11	DSSS	CCK	11
802.11g	1 to 11	1, 6, 11	OFDM	BPSK	6

- For Radiated Emission Test (Above 1 GHz), the EUT was Pre-tested as the following test modes:

Test Mode	Power
Mode 1	With adapter 1
Mode 2	With adapter 2

The worst was found in Mode 2, the worse cases, were chosen for final test.

Bandedge Measurement:

- Pre-Scan has been conducted to determine the worst-case mode from all possible combinations between available modulations, data rates and antenna ports (if EUT with antenna diversity architecture).
- Following channel(s) was (were) selected for the final test as listed below.

Mode	Available Channel	Tested Channel	Modulation Technology	Modulation Type	Data Rate (Mbps)
802.11b	1 to 11	1, 11	DSSS	CCK	11
802.11g	1 to 11	1, 11	OFDM	BPSK	6

Antenna Port Conducted Measurement:

- Pre-Scan has been conducted to determine the worst-case mode from all possible combinations between available modulations, data rates and antenna ports (if EUT with antenna diversity architecture).
- Following channel(s) was (were) selected for the final test as listed below.

Mode	Available Channel	Tested Channel	Modulation Technology	Modulation Type	Data Rate (Mbps)
802.11b	1 to 11	1, 6, 11	DSSS	CCK	11
802.11g	1 to 11	1, 6, 11	OFDM	BPSK	6



3.4 GENERAL DESCRIPTION OF APPLIED STANDARDS

The EUT is a Wireless-G ADSL Gateway. According to the specifications of the manufacturer, it must comply with the requirements of the following standards:

47 CFR Part 15, Subpart C. (15.247)
ANSI C63.4 : 2003

All tests have been performed and recorded as per the above standards.

NOTE: The EUT is also considered as a kind of computer peripheral, because the connection to computer is necessary for typical use. It has been verified to comply with the requirements of 47 CFR Part 15, Subpart B, Class B (DoC). The test report has been issued separately.



3.5 DESCRIPTION OF SUPPORT UNITS

The EUT has been tested as an independent unit together with other necessary accessories or support units. The following support units or accessories were used to form a representative test configuration during the tests.

No.	Product	Brand	Model No.	Serial No.	FCC ID
1	NOTEBOOK COMPUTER	DELL	PP01L	TW-09C748-12800- 1A3-1999	FCC DoC
2	NOTEBOOK COMPUTER	DELL	PP01L	TW-09c748-12800- 165-3171	FCC DoC
3	CO-ROUTER	ZyXEL	IES-1000	S4Z3112558	NA
4	SWITCH HUB	HP	J4899B	PW418MZ00V	NA

No.	Signal cable description
1	NA
2	NA
3	NA
4	NA

Note: 1. All power cords of the above support units are unshielded (1.8m).

3.6 CONFIGURATION OF SYSTEM UNDER TEST

For Conduction test :

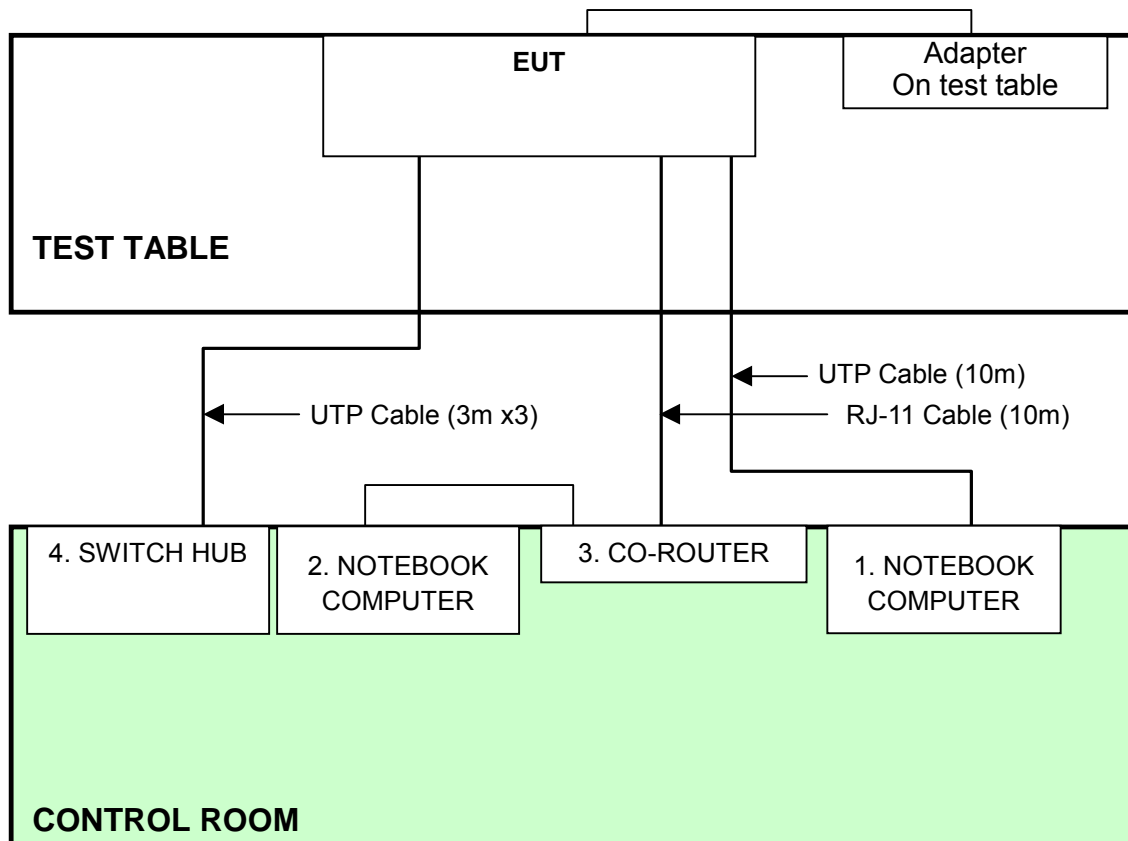

- NOTE:**
1. Support unit 1~4 were kept in the control room during the test.
 2. Please refer to the photos of test configuration in Item 5 also.

For Radiation test :

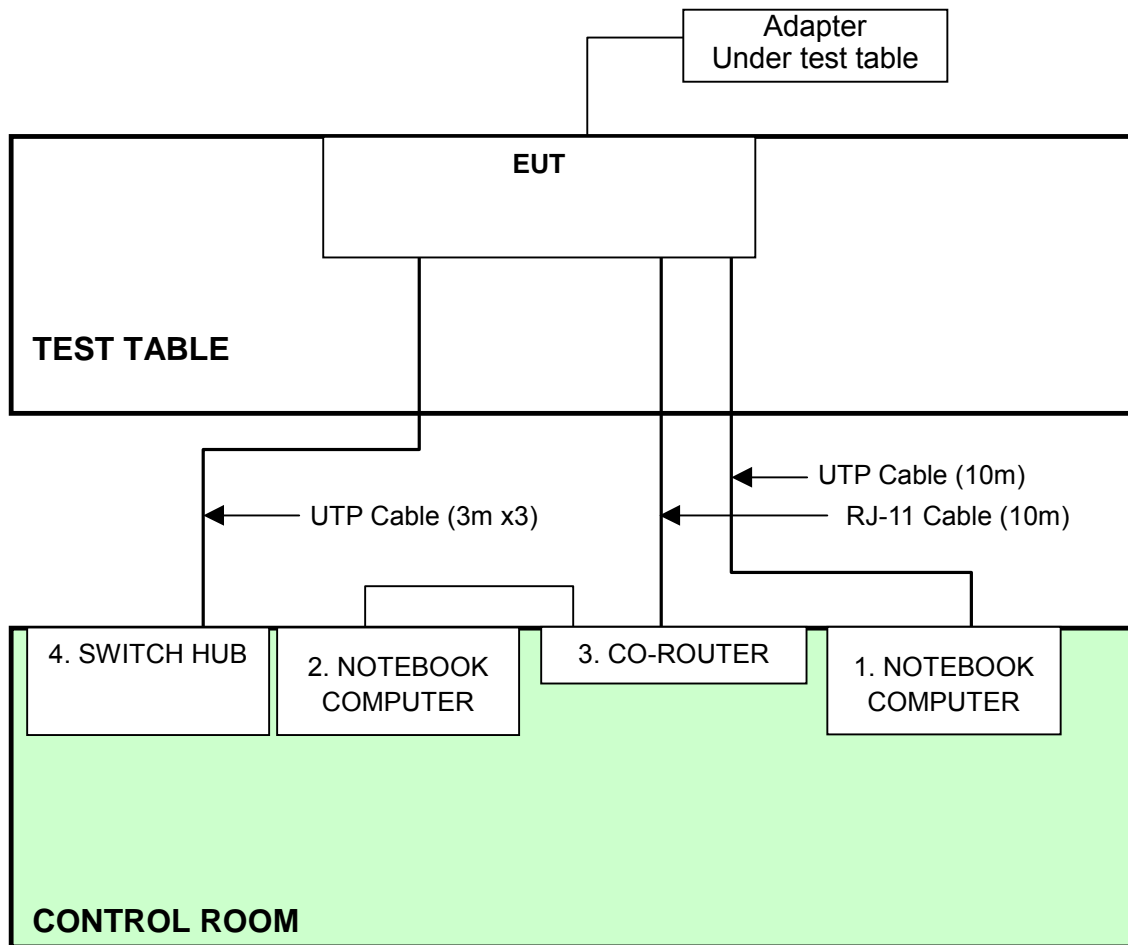

- NOTE:**
1. Support unit 1~4 were kept in the control room during the test.
 2. Please refer to the photos of test configuration in Item 5 also.

4 TEST TYPES AND RESULTS

4.1 CONDUCTED EMISSION MEASUREMENT

4.1.1 LIMITS OF CONDUCTED EMISSION MEASUREMENT

FREQUENCY OF EMISSION (MHz)	CONDUCTED LIMIT (dB μ V)	
	Quasi-peak	Average
0.15-0.5	66 to 56	56 to 46
0.5-5	56	46
5-30	60	50

NOTE:

1. The lower limit shall apply at the transition frequencies.
2. All emanations from a class B digital device or system, including any network of conductors and apparatus connected thereto, shall not exceed the level of field strengths specified above.

4.1.2 TEST INSTRUMENTS

DESCRIPTION & MANUFACTURER	MODEL NO.	SERIAL NO.	CALIBRATED UNTIL
Test Receiver	ESCS 30	100375	Sep. 19, 2006
Line-Impedance Stabilization Network(for EUT)	ENV-216	100071	Nov. 10, 2006
ROHDE & SCHWARZ LISN	ESH3-Z5	848773/004	Oct. 24, 2006
RF Signal Cable	RG233	COBCAB9K-30MHz	Dec. 10, 2006
Impedance-stabilization-network	ENY 41	838119/024	Jan. 09, 2007
Impedance-stabilization-network	ENY 22	837497/019	Jan. 09, 2007
Current Probe	SMZ11	18001	Jul. 13, 2006
Current Probe	SMZ11	18013	Jul. 13, 2006

- NOTE: 1. The calibration interval of the above test instruments is 12 months and the calibrations are traceable to NML/ROC and NIST/USA.
 2. The test was performed in ADT Shielded Room No. B.
 3. The VCCI Con B Registration No. is C-2193.

4.1.3 TEST PROCEDURES

- a. The EUT/HOST was placed 0.4 meters from the conducting wall of the shielded room with EUT/HOST being connected to the power mains through a line impedance stabilization network (LISN). Other support units were connected to the power mains through another LISN. The two LISNs provide 50 ohm/ 50uH of coupling impedance for the measuring instrument.
- b. Both lines of the power mains connected to the EUT/HOST were checked for maximum conducted interference.
- c. The frequency range from 150 kHz to 30 MHz was searched. Emission levels over 10dB under the prescribed limits could not be reported

4.1.4 TEST SETUP

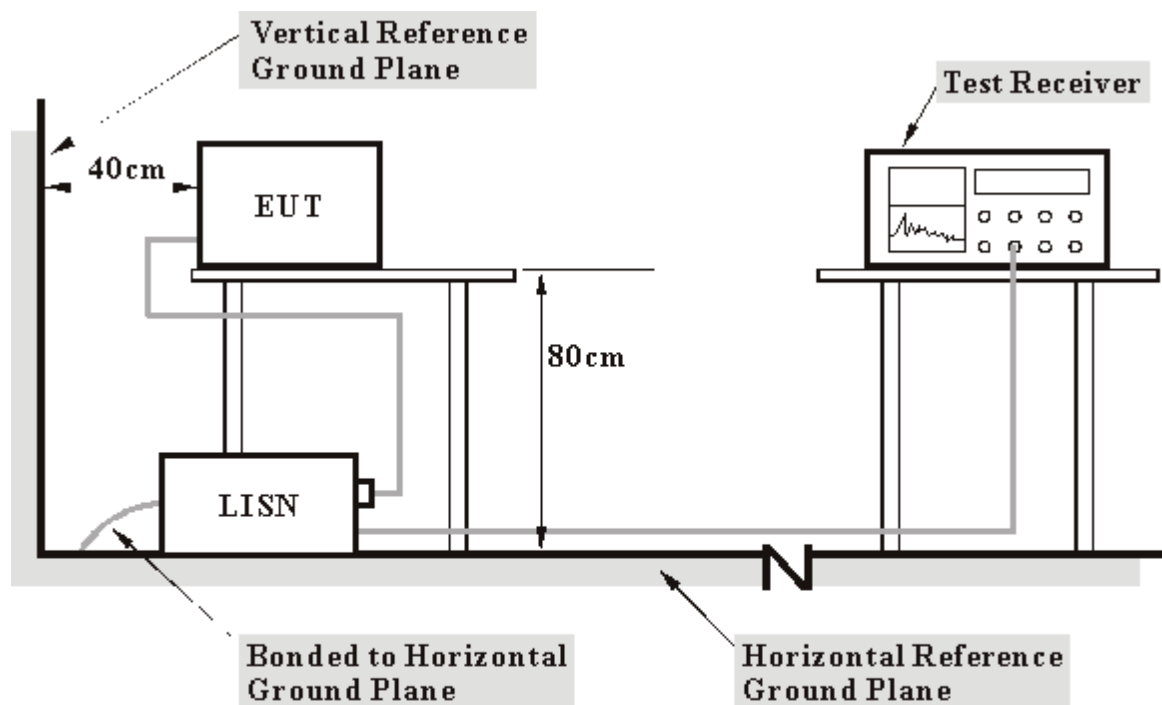

- Note:**
1. Support units were connected to second LISN.
 2. Both of LISNs (AMN) 80 cm from EUT and at the least 80 cm from other units and other metal planes support units.

For the actual test configuration, please refer to the related item – Photographs of the Test Configuration.

4.1.5 EUT OPERATING CONDITIONS

- a. Placed the EUT on the testing table.
- b. Prepared other computer systems (support unit 1~2) to act as communication partners and placed them outside of testing area.
- c. The communication partner run the test program "RadioScope" to enable EUT under transmission/receiving condition continuously via one UTP cable, RJ-11 cable and wireless transmission.

4.1.6 TEST RESULTS

TEST MODE	Adapter 1	CHANNEL	Channel 11
MODULATION TYPE	BPSK	6dB BANDWIDTH	9 kHz
INPUT POWER (SYSTEM)	120Vac, 60 Hz	TRANSFER RATE	6Mbps
ENVIRONMENTAL CONDITIONS	22deg. C, 66%RH, 968hPa	PHASE	Line (L)
TESTED BY	Eric Lee		

No	Freq. [MHz]	Corr. Factor (dB)	Reading Value		Emission Level		Limit		Margin	
			[dB (uV)]		[dB (uV)]		[dB (uV)]		(dB)	
			Q.P.	AV.	Q.P.	AV.	Q.P.	AV.	Q.P.	AV.
1	0.252	9.66	41.43	-	51.09	-	61.71	51.71	-10.62	-
2	0.500	9.68	35.26	-	44.94	-	56.00	46.00	-11.06	-
3	0.883	9.69	29.71	-	39.40	-	56.00	46.00	-16.60	-
4	1.621	9.73	20.74	-	30.47	-	56.00	46.00	-25.53	-
5	14.587	10.18	31.65	-	41.83	-	60.00	50.00	-18.17	-
6	19.154	10.31	28.32	-	38.63	-	60.00	50.00	-21.37	-

- REMARKS:**
1. Q.P. and AV. are abbreviations of quasi-peak and average individually.
 2. "-": The Quasi-peak reading value also meets average limit and measurement with the average detector is unnecessary.
 3. The emission levels of other frequencies were very low against the limit.
 4. Margin value = Emission level - Limit value
 5. Correction factor = Insertion loss + Cable loss
 6. Emission Level = Correction Factor + Reading Value.

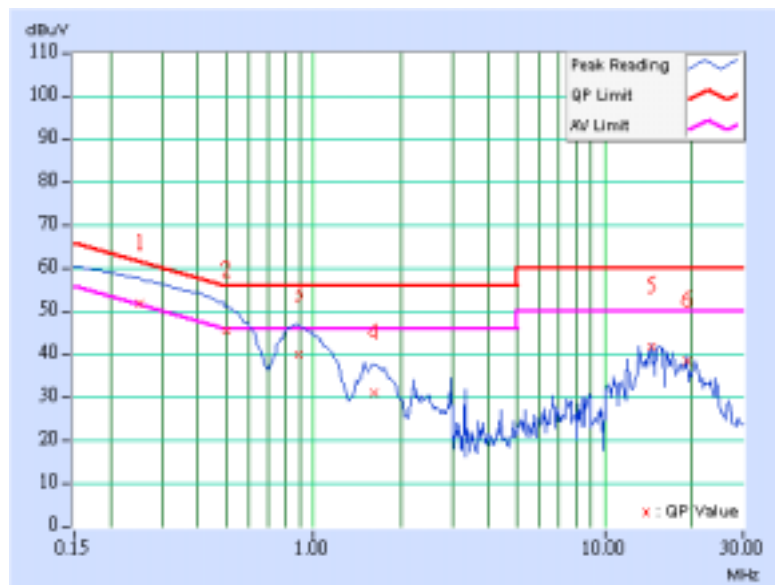

TEST MODE	Adapter 1	CHANNEL	Channel 11
MODULATION TYPE	BPSK	6dB BANDWIDTH	9 kHz
INPUT POWER (SYSTEM)	120Vac, 60 Hz	TRANSFER RATE	6Mbps
ENVIRONMENTAL CONDITIONS	22deg. C, 66%RH, 968hPa	PHASE	Neutral (N)
TESTED BY	Eric Lee		

No	Freq. [MHz]	Corr. Factor (dB)	Reading Value		Emission Level		Limit		Margin	
			[dB (uV)]		[dB (uV)]		[dB (uV)]		(dB)	
			Q.P.	AV.	Q.P.	AV.	Q.P.	AV.	Q.P.	AV.
1	0.205	9.65	42.05	-	51.70	-	63.42	53.42	-11.72	-
2	0.445	9.67	37.10	-	46.77	-	56.98	46.98	-10.20	-
3	1.031	9.70	26.38	-	36.08	-	56.00	46.00	-19.92	-
4	2.209	9.76	23.19	-	32.95	-	56.00	46.00	-23.05	-
5	2.963	9.80	25.85	-	35.65	-	56.00	46.00	-20.35	-
6	3.313	9.82	24.45	-	34.27	-	56.00	46.00	-21.73	-
7	14.891	10.09	31.18	-	41.27	-	60.00	50.00	-18.73	-

- REMARKS:**
1. Q.P. and AV. are abbreviations of quasi-peak and average individually.
 2. "-": The Quasi-peak reading value also meets average limit and measurement with the average detector is unnecessary.
 3. The emission levels of other frequencies were very low against the limit.
 4. Margin value = Emission level - Limit value
 5. Correction factor = Insertion loss + Cable loss
 6. Emission Level = Correction Factor + Reading Value.

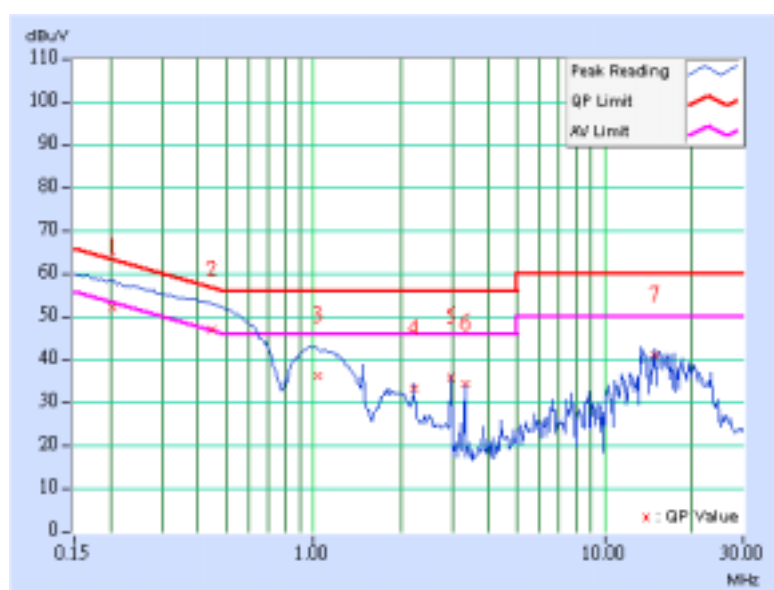

TEST MODE	Adapter 2	CHANNEL	Channel 11
MODULATION TYPE	BPSK	6dB BANDWIDTH	9 kHz
INPUT POWER (SYSTEM)	120Vac, 60 Hz	TRANSFER RATE	6Mbps
ENVIRONMENTAL CONDITIONS	22deg. C, 66%RH, 968hPa	PHASE	Line (L)
TESTED BY	Eric Lee		

No	Freq. [MHz]	Corr. Factor (dB)	Reading Value		Emission Level		Limit		Margin	
			[dB (uV)]		[dB (uV)]		[dB (uV)]		(dB)	
			Q.P.	AV.	Q.P.	AV.	Q.P.	AV.	Q.P.	AV.
1	0.201	9.65	43.56	-	53.21	-	63.58	53.58	-10.37	-
2	0.401	9.67	35.78	-	45.45	-	57.84	47.84	-12.39	-
3	0.401	9.67	35.96	-	45.63	-	57.84	47.84	-12.21	-
4	0.685	9.68	29.23	-	38.91	-	56.00	46.00	-17.09	-
5	1.256	9.71	25.98	-	35.69	-	56.00	46.00	-20.31	-
6	2.963	9.80	28.55	-	38.35	-	56.00	46.00	-17.65	-
7	3.313	9.82	28.26	-	38.08	-	56.00	46.00	-17.92	-
8	12.242	10.11	31.24	-	41.35	-	60.00	50.00	-18.65	-

- REMARKS:**
1. Q.P. and AV. are abbreviations of quasi-peak and average individually.
 2. "-": The Quasi-peak reading value also meets average limit and measurement with the average detector is unnecessary.
 3. The emission levels of other frequencies were very low against the limit.
 4. Margin value = Emission level - Limit value
 5. Correction factor = Insertion loss + Cable loss
 6. Emission Level = Correction Factor + Reading Value.

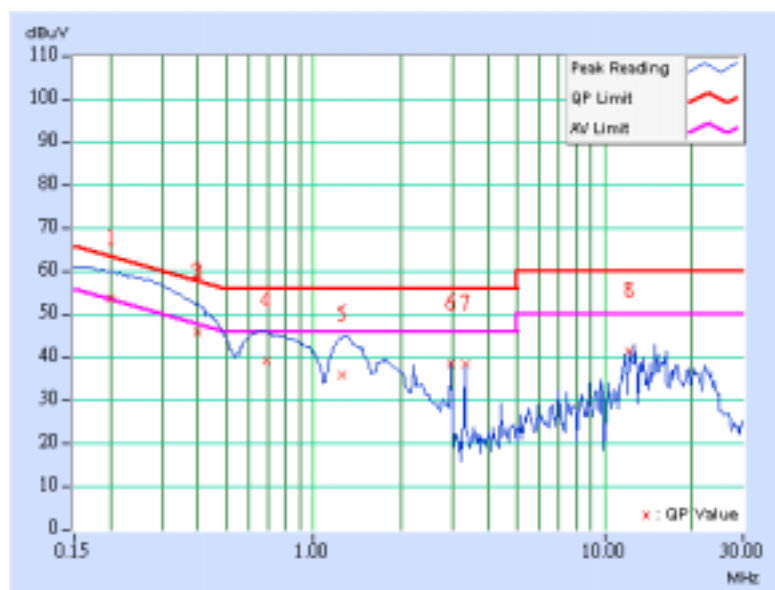

TEST MODE	Adapter 2	CHANNEL	Channel 11
MODULATION TYPE	BPSK	6dB BANDWIDTH	9 kHz
INPUT POWER (SYSTEM)	120Vac, 60 Hz	TRANSFER RATE	6Mbps
ENVIRONMENTAL CONDITIONS	22deg. C, 66%RH, 968hPa	PHASE	Neutral (N)
TESTED BY	Eric Lee		

No	Freq. [MHz]	Corr. Factor (dB)	Reading Value		Emission Level		Limit		Margin	
			[dB (uV)]		[dB (uV)]		[dB (uV)]		(dB)	
			Q.P.	AV.	Q.P.	AV.	Q.P.	AV.	Q.P.	AV.
1	0.213	9.65	42.05	-	51.70	-	63.11	53.11	-11.41	-
2	0.341	9.66	35.36	-	45.02	-	59.17	49.17	-14.14	-
3	0.789	9.69	24.59	-	34.28	-	56.00	46.00	-21.72	-
4	1.482	9.72	31.55	-	41.27	-	56.00	46.00	-14.73	-
5	2.209	9.76	28.90	-	38.66	-	56.00	46.00	-17.34	-
6	2.966	9.80	28.69	-	38.49	-	56.00	46.00	-17.51	-
7	16.300	10.15	37.89	-	48.04	-	60.00	50.00	-11.96	-

- REMARKS:**
1. Q.P. and AV. are abbreviations of quasi-peak and average individually.
 2. "-": The Quasi-peak reading value also meets average limit and measurement with the average detector is unnecessary.
 3. The emission levels of other frequencies were very low against the limit.
 4. Margin value = Emission level - Limit value
 5. Correction factor = Insertion loss + Cable loss
 6. Emission Level = Correction Factor + Reading Value.

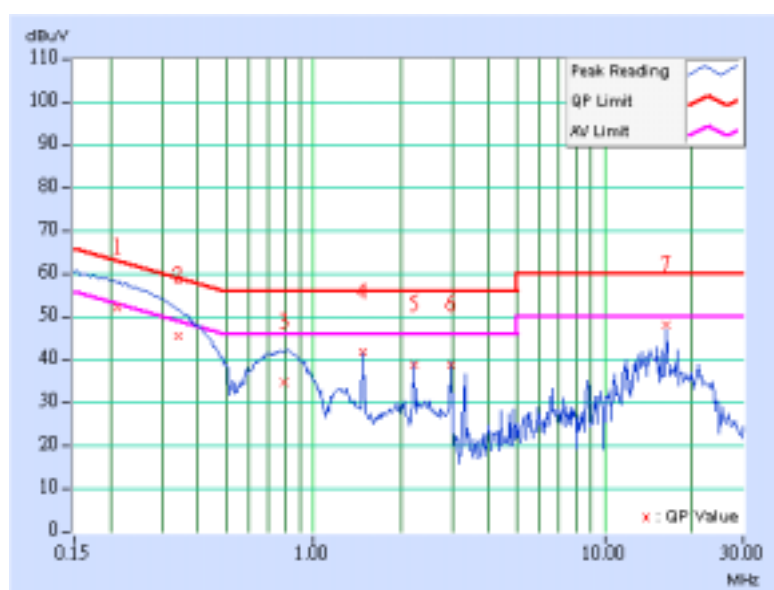



4.2 RADIATED EMISSION MEASUREMENT

4.2.1 LIMITS OF RADIATED EMISSION MEASUREMENT

Emissions radiated outside of the specified bands, shall be according to the general radiated limits in 15.209 as following:

Frequencies (MHz)	Field strength (microvolts/meter)	Measurement distance (meters)
0.009-0.490	2400/F(kHz)	300
0.490-1.705	24000/F(kHz)	30
1.705-30.0	30	30
30-88	100	3
88-216	150	3
216-960	200	3
Above 960	500	3

NOTE:

1. The lower limit shall apply at the transition frequencies.
2. Emission level (dBuV/m) = 20 log Emission level (uV/m).
3. As shown in 15.35(b), for frequencies above 1000MHz, the field strength limits are based on average detector, however, the peak field strength of any emission shall not exceed the maximum permitted average limits, specified above by more than 20dB under any condition of modulation.



4.2.2 TEST INSTRUMENTS

DESCRIPTION & MANUFACTURER	MODEL NO.	SERIAL NO.	CALIBRATED UNTIL
ADVANTEST Spectrum Analyzer	R3271A	85060311	July 07, 2006
HP Pre_Amplifier	8449B	3008A01922	Oct. 02, 2006
ROHDE & SCHWARZ Test Receiver	ESCS30	100287	Dec. 08, 2006
CHASE Broadband Antenna	VULB9168	138	Dec. 21, 2006
Schwarzbeck Horn_Antenna	BBHA9120	D124	Dec. 11, 2006
Schwarzbeck Horn_Antenna	BBHA 9170	BBHA9170153	Jan. 05, 2007
SCHWARZBECK Biconical Antenna	VHBA9123	459	Jun. 26, 2006
SCHWARZBECK Periodic Antenna	UPA6108	1148	Jun. 26, 2006
R&S Loop Antenna	HFH2-Z2	881058/15	May 06, 2006
RF Switches (ARNITSU)	CS-201	1565157	NA
RF CABLE (Chaintek) 1GHz-20GHz	SF102	22054-2	Nov. 16. 2006
RF Cable(RICHTEC)	9913-30M	STCCAB-30M-1GHz-021	Jul. 16, 2006
Software	ADT_Radiated_V 5.14	NA	NA
CHANCE MOST Antenna Tower	AT-100	0203	NA
CHANCE MOST Turn Table	TT-100	0203	NA

- Note: 1. The calibration interval of the above test instruments is 12 months (36 months for Periodic Antenna) and the calibrations are traceable to NML/ROC and NIST/USA.
2. The horn antenna and HP preamplifier (model: 8449B) are used only for the measurement of emission frequency above 1GHz if tested.
3. The test was performed in ADT Open Site No. C.
4. The FCC Site Registration No. is 656396.
5. The VCCI Site Registration No. is R-1626.
6. The CANADA Site Registration No. is IC 4824-3.
7. The following table is for the measurement uncertainty, which is calculated as per the document CISPR 16-4. This uncertainty represents an expanded uncertainty expressed at approximately the 95% confidence level using a coverage factor of k=2.

Measurement	Value
Radiated emissions (30MHz-1GHz)	2.98 dB
Radiated emissions (1GHz ~18GHz)	2.21 dB
Radiated emissions (18GHz ~20GHz)	1.88 dB

4.2.3 TEST PROCEDURES

- a. The EUT was placed on the top of a rotating table 0.8 meters above the ground at a 10 meter open area test site. The table was rotated 360 degrees to determine the position of the highest radiation.
- b. The EUT was set 3 meters away from the interference-receiving antenna, which was mounted on the top of a variable-height antenna tower.
- c. The antenna is a broadband antenna, and its height is varied from one meter to four meters above the ground to determine the maximum value of the field strength. Both horizontal and vertical polarizations of the antenna are set to make the measurement.
- d. For each suspected emission, the EUT was arranged to its worst case and then the antenna was tuned to heights from 1 meter to 4 meters and the rotatable table was turned from 0 degrees to 360 degrees to find the maximum reading.
- e. The test-receiver system was set to Peak Detect Function and Specified Bandwidth with Maximum Hold Mode.
- f. If the emission level of the EUT in peak mode was 10 dB lower than the limit specified, then testing could be stopped and the peak values of the EUT would be reported. Otherwise the emissions that did not have 10 dB margin would be re-tested one by one using peak, quasi-peak or average method as specified and then reported in a data sheet.

NOTE:

1. The resolution bandwidth and video bandwidth of test receiver/spectrum analyzer is 120kHz for Peak detection (PK) and Quasi-peak detection (QP) at frequency below 1GHz.
2. The resolution bandwidth and video bandwidth of test receiver/spectrum analyzer is 1 MHz for Peak detection at frequency above 1GHz.
3. The resolution bandwidth of test receiver/spectrum analyzer is 1 MHz and the video bandwidth is 10 Hz for Average detection (AV) at frequency above 1GHz.

4.2.4 TEST SETUP

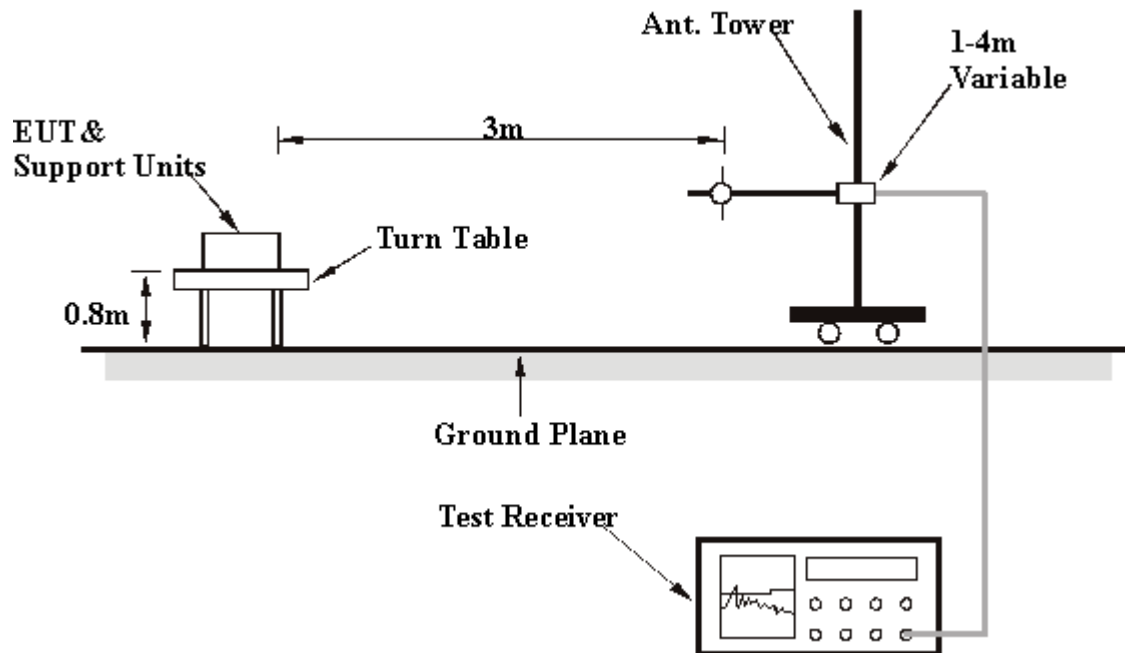

For the actual test configuration, please refer to the related item – Photographs of the Test Configuration.

4.2.5 EUT OPERATING CONDITIONS

Same as the 4.1.5



4.2.6 TEST RESULTS

Below 1GHz Worst-Case Data

TEST MODE	Adapter 1	CHANNEL	Channel 1
MODULATION TYPE	BPSK	FREQUENCY RANGE	30-1000 MHz
INPUT POWER (SYSTEM)	120Vac, 60 Hz	TRANSFER RATE	6Mbps
ENVIRONMENTAL CONDITIONS	16deg. C, 66%RH, 968hPa	DETECTOR FUNCTION	Quasi-Peak, 120kHz
TESTED BY	Rex Huang		

ANTENNA POLARITY & TEST DISTANCE: HORIZONTAL AT 3 M

No.	Freq. (MHz)	Emission Level (dBuV/m)	Limit (dBuV/m)	Margin (dB)	Antenna Height (m)	Table Angle (Degree)	Raw Value (dBuV)	Correction Factor (dB/m)
1	125.02	29.10 QP	43.50	-14.40	4.00 H	61	17.20	11.90
2	249.98	39.20 QP	46.00	-6.80	1.97 H	140	25.90	13.30
3	300.01	37.90 QP	46.00	-8.10	1.60 H	199	21.60	16.30
4	375.00	42.00 QP	46.00	-4.00	1.43 H	264	24.40	17.60
5	499.95	37.40 QP	46.00	-8.60	1.16 H	335	16.50	20.90
6	625.08	35.50 QP	46.00	-10.50	1.27 H	49	11.70	23.80
7	749.97	34.00 QP	46.00	-12.00	1.00 H	99	7.60	26.40
8	875.06	36.30 QP	46.00	-9.70	1.05 H	145	8.60	27.70
9	999.97	38.00 QP	54.00	-16.00	1.24 H	183	9.10	28.90

ANTENNA POLARITY & TEST DISTANCE: VERTICAL AT 3 M

No.	Freq. (MHz)	Emission Level (dBuV/m)	Limit (dBuV/m)	Margin (dB)	Antenna Height (m)	Table Angle (Degree)	Raw Value (dBuV)	Correction Factor (dB/m)
1	124.91	28.90 QP	43.50	-14.60	1.00 V	115	17.00	11.90
2	250.08	37.30 QP	46.00	-8.70	1.00 V	210	24.00	13.30
3	299.99	33.00 QP	46.00	-13.00	1.00 V	89	16.70	16.30
4	375.08	39.90 QP	46.00	-6.10	1.00 V	292	22.30	17.60
5	500.02	32.10 QP	46.00	-13.90	1.00 V	6	11.20	20.90
6	624.94	37.40 QP	46.00	-8.60	1.25 V	56	13.60	23.80
7	749.92	36.90 QP	46.00	-9.10	1.35 V	59	10.50	26.40
8	874.97	36.80 QP	46.00	-9.20	1.08 V	218	9.10	27.70
9	999.94	39.30 QP	54.00	-14.70	1.20 V	102	10.40	28.90

- REMARKS:**
1. Emission level(dBuV/m)=Raw Value(dBuV) + Correction Factor(dB/m)
 2. Correction Factor(dB/m) = Antenna Factor (dB/m) + Cable Factor (dB)
 3. The other emission levels were very low against the limit.
 4. Margin value = Emission level – Limit value.



Below 1GHz Worst-Case Data

TEST MODE	Adapter 2	CHANNEL	Channel 1
MODULATION TYPE	BPSK	FREQUENCY RANGE	30-1000 MHz
INPUT POWER (SYSTEM)	120Vac, 60 Hz	TRANSFER RATE	6Mbps
ENVIRONMENTAL CONDITIONS	21deg. C, 62%RH, 968hPa	DETECTOR FUNCTION	Quasi-Peak, 120kHz
TESTED BY	Moris Lin		

ANTENNA POLARITY & TEST DISTANCE: HORIZONTAL AT 3 M

No.	Freq. (MHz)	Emission Level (dBuV/m)	Limit (dBuV/m)	Margin (dB)	Antenna Height (m)	Table Angle (Degree)	Raw Value (dBuV)	Correction Factor (dB/m)
1	250.00	41.50 QP	46.00	-4.50	1.77 H	214	27.80	13.80
2	300.04	38.30 QP	46.00	-7.70	1.17 H	1	21.40	16.80
3	374.99	44.30 QP	46.00	-1.70	1.00 H	31	26.10	18.20
4	625.02	32.40 QP	46.00	-13.60	1.00 H	206	7.60	24.80
5	749.98	27.60 QP	46.00	-18.40	1.00 H	2	0.30	27.30
6	875.03	30.90 QP	46.00	-15.10	1.00 H	18	2.30	28.60
7	999.98	30.00 QP	54.00	-24.00	1.00 H	85	0.00	29.90

ANTENNA POLARITY & TEST DISTANCE: VERTICAL AT 3 M

No.	Freq. (MHz)	Emission Level (dBuV/m)	Limit (dBuV/m)	Margin (dB)	Antenna Height (m)	Table Angle (Degree)	Raw Value (dBuV)	Correction Factor (dB/m)
1	125.00	29.80 QP	43.50	-13.70	1.16 V	285	17.60	12.20
2	200.02	31.70 QP	43.50	-11.80	1.23 V	253	20.10	11.60
3	250.00	38.00 QP	46.00	-8.00	1.00 V	133	24.30	13.80
4	300.04	33.00 QP	46.00	-13.00	1.15 V	85	16.20	16.80
5	374.99	41.80 QP	46.00	-4.20	1.17 V	351	23.60	18.20
6	499.99	30.80 QP	46.00	-15.20	1.36 V	58	9.00	21.80
7	600.08	31.30 QP	46.00	-14.70	1.26 V	70	6.80	24.50
8	625.02	31.90 QP	46.00	-14.10	1.58 V	269	7.20	24.80
9	1000.02	28.90 QP	54.00	-25.10	1.69 V	1	-1.00	29.90

- REMARKS:**
1. Emission level(dBuV/m)=Raw Value(dBuV) + Correction Factor(dB/m)
 2. Correction Factor(dB/m) = Antenna Factor (dB/m) + Cable Factor (dB)
 3. The other emission levels were very low against the limit.
 4. Margin value = Emission level – Limit value.



**4.2.7 TEST RESULTS – DSSS
802.11b DSSS modulation**

MODE	Channel 1	FREQUENCY RANGE	1000~25000MHz
INPUT POWER (SYSTEM)	120Vac, 60 Hz	DETECTOR FUNCTION & BANDWIDTH	Peak (PK) Average (AV) 1 MHz
ENVIRONMENTAL CONDITIONS	22 deg. C, 66%RH, 968hPa	TESTED BY	Eric Lee

ANTENNA POLARITY & TEST DISTANCE: HORIZONTAL AT 3 M								
No.	Freq. (MHz)	Emission Level (dBuV/m)	Limit (dBuV/m)	Margin (dB)	Antenna Height (m)	Table Angle (Degree)	Raw Value (dBuV)	Correction Factor (dB/m)
1	2390.00	43.10 PK	74.00	-30.90	1.52 H	4	12.80	30.30
1	2390.00	35.20 AV	54.00	-18.80	1.52 H	4	4.90	30.30
2	*2412.00	99.70 PK			1.13 H	349	69.20	30.50
2	*2412.00	91.10 AV			1.13 H	349	60.60	30.50
3	4824.00	49.70 PK	74.00	-24.30	1.04 H	24	14.60	35.10
3	4824.00	44.00 AV	54.00	-10.00	1.04 H	24	8.90	35.10
4	7236.00	50.10 PK	74.00	-23.90	1.30 H	268	9.60	40.50
4	7236.00	41.40 AV	54.00	-12.60	1.30 H	268	0.90	40.50

ANTENNA POLARITY & TEST DISTANCE: VERTICAL AT 3 M								
No.	Freq. (MHz)	Emission Level (dBuV/m)	Limit (dBuV/m)	Margin (dB)	Antenna Height (m)	Table Angle (Degree)	Raw Value (dBuV)	Correction Factor (dB/m)
1	2390.00	59.40 PK	74.00	-14.60	1.01 V	6	29.10	30.30
1	2390.00	47.70 AV	54.00	-6.30	1.01 V	6	17.40	30.30
2	*2412.00	112.10 PK			1.20 V	357	81.60	30.50
2	*2412.00	103.60 AV			1.20 V	357	73.10	30.50
3	4824.00	49.30 PK	74.00	-24.70	1.16 V	206	14.20	35.10
3	4824.00	42.40 AV	54.00	-11.60	1.16 V	206	7.30	35.10
4	7236.00	49.10 PK	74.00	-24.90	1.02 V	25	8.60	40.50
4	7236.00	40.40 AV	54.00	-13.60	1.02 V	25	-0.10	40.50

- REMARKS:**
1. Emission level(dBuV/m)=Raw Value(dBuV) + Correction Factor(dB/m)
 2. Correction Factor(dB/m) = Antenna Factor (dB/m) + Cable Factor (dB)
 3. The other emission levels were very low against the limit.
 4. Margin value = Emission level – Limit value.
 5. The limit value is defined as per 15.247
 6. “ * “ : Fundamental frequency



MODE	Channel 6	FREQUENCY RANGE	1000~25000MHz
INPUT POWER (SYSTEM)	120Vac, 60 Hz	DETECTOR FUNCTION & BANDWIDTH	Peak (PK) Average (AV) 1 MHz
ENVIRONMENTAL CONDITIONS	22 deg. C, 66%RH, 968hPa	TESTED BY	Eric Lee

ANTENNA POLARITY & TEST DISTANCE: HORIZONTAL AT 3 M								
No.	Freq. (MHz)	Emission Level (dBuV/m)	Limit (dBuV/m)	Margin (dB)	Antenna Height (m)	Table Angle (Degree)	Raw Value (dBuV)	Correction Factor (dB/m)
1	*2437.00	100.60 PK			1.12 H	210	70.00	30.60
1	*2437.00	91.70 AV			1.12 H	210	61.10	30.60
2	4874.00	42.50 PK	74.00	-31.50	1.52 H	258	7.20	35.30
2	4874.00	35.50 AV	54.00	-18.50	1.52 H	258	0.20	35.30
3	7311.00	46.90 PK	74.00	-27.10	1.08 H	99	6.20	40.70
3	7311.00	38.50 AV	54.00	-15.50	1.08 H	99	-2.10	40.70

ANTENNA POLARITY & TEST DISTANCE: VERTICAL AT 3 M								
No.	Freq. (MHz)	Emission Level (dBuV/m)	Limit (dBuV/m)	Margin (dB)	Antenna Height (m)	Table Angle (Degree)	Raw Value (dBuV)	Correction Factor (dB/m)
1	*2437.00	112.00 PK			1.19 V	353	81.40	30.60
1	*2437.00	103.50 AV			1.19 V	353	72.90	30.60
2	4874.00	51.00 PK	74.00	-23.00	1.46 V	32	15.70	35.30
2	4874.00	44.20 AV	54.00	-9.80	1.46 V	32	8.90	35.30
3	7311.00	50.20 PK	74.00	-23.80	1.38 V	99	9.60	40.70
3	7311.00	41.50 AV	54.00	-12.50	1.38 V	99	0.90	40.70

- REMARKS:**
1. Emission level(dBuV/m)=Raw Value(dBuV) + Correction Factor(dB/m)
 2. Correction Factor(dB/m) = Antenna Factor (dB/m) + Cable Factor (dB)
 3. The other emission levels were very low against the limit.
 4. Margin value = Emission level – Limit value.
 5. The limit value is defined as per 15.247
 6. “ * “ : Fundamental frequency



MODE	Channel 11	FREQUENCY RANGE	1000~25000MHz
INPUT POWER (SYSTEM)	120Vac, 60 Hz	DETECTOR FUNCTION & BANDWIDTH	Peak (PK) Average (AV) 1 MHz
ENVIRONMENTAL CONDITIONS	22 deg. C, 66%RH, 968hPa	TESTED BY	Eric Lee

ANTENNA POLARITY & TEST DISTANCE: HORIZONTAL AT 3 M

No.	Freq. (MHz)	Emission Level (dBuV/m)	Limit (dBuV/m)	Margin (dB)	Antenna Height (m)	Table Angle (Degree)	Raw Value (dBuV)	Correction Factor (dB/m)
1	*2462.00	99.20 PK			1.25 H	151	68.40	30.80
1	*2462.00	90.80 AV			1.25 H	151	60.00	30.80
2	2483.50	43.10 PK	74.00	-30.90	1.00 H	2	12.20	30.90
2	2483.50	34.70 AV	54.00	-19.30	1.00 H	2	3.80	30.90
3	4924.00	44.40 PK	74.00	-29.60	1.30 H	208	8.90	35.50
3	4924.00	35.40 AV	54.00	-18.60	1.30 H	208	-0.10	35.50
4	7386.00	45.40 PK	74.00	-28.60	1.02 H	222	4.60	40.80
4	7386.00	35.40 AV	54.00	-18.60	1.02 H	222	-5.40	40.80

ANTENNA POLARITY & TEST DISTANCE: VERTICAL AT 3 M

No.	Freq. (MHz)	Emission Level (dBuV/m)	Limit (dBuV/m)	Margin (dB)	Antenna Height (m)	Table Angle (Degree)	Raw Value (dBuV)	Correction Factor (dB/m)
1	*2462.00	112.50 PK			1.18 V	1	81.70	30.80
1	*2462.00	104.70 AV			1.18 V	1	73.90	30.80
2	2483.50	60.20 PK	74.00	-13.80	1.10 V	2	29.30	30.90
2	2483.50	48.60 AV	54.00	-5.40	1.10 V	2	17.70	30.90
3	4924.00	51.40 PK	74.00	-22.60	1.20 V	310	15.80	35.50
3	4924.00	43.00 AV	54.00	-11.00	1.20 V	310	7.40	35.50
4	7386.00	51.10 PK	74.00	-22.90	1.07 V	248	10.30	40.80
4	7386.00	41.70 AV	54.00	-12.30	1.07 V	248	0.90	40.80

- REMARKS:**
1. Emission level(dBuV/m)=Raw Value(dBuV) + Correction Factor(dB/m)
 2. Correction Factor(dB/m) = Antenna Factor (dB/m) + Cable Factor (dB)
 3. The other emission levels were very low against the limit.
 4. Margin value = Emission level – Limit value.
 5. The limit value is defined as per 15.247
 6. “ * “ : Fundamental frequency



4.2.8 TEST RESULTS – OFDM
802.11g Normal OFDM modulation

MODE	Channel 1	FREQUENCY RANGE	1000~25000MHz
INPUT POWER (SYSTEM)	120Vac, 60 Hz	DETECTOR FUNCTION & BANDWIDTH	Peak (PK) Average (AV) 1 MHz
ENVIRONMENTAL CONDITIONS	22 deg. C, 66%RH, 968hPa	TESTED BY	Eric Lee

ANTENNA POLARITY & TEST DISTANCE: HORIZONTAL AT 3 M

No.	Freq. (MHz)	Emission Level (dBuV/m)	Limit (dBuV/m)	Margin (dB)	Antenna Height (m)	Table Angle (Degree)	Raw Value (dBuV)	Correction Factor (dB/m)
1	2390.00	52.20 PK	74.00	-21.80	1.02 H	253	21.90	30.30
1	2390.00	40.50 AV	54.00	-13.50	1.02 H	253	10.20	30.30
2	*2412.00	97.60 PK			1.20 H	352	67.10	30.50
2	*2412.00	89.70 AV			1.20 H	352	59.20	30.50
3	4824.00	42.80 PK	74.00	-31.20	1.07 H	66	7.70	35.10
3	4824.00	34.00 AV	54.00	-20.00	1.07 H	66	-1.10	35.10
4	7236.00	45.80 PK	74.00	-28.20	1.09 H	321	5.30	40.50
4	7236.00	36.40 AV	54.00	-17.60	1.09 H	321	-4.10	40.50

ANTENNA POLARITY & TEST DISTANCE: VERTICAL AT 3 M

No.	Freq. (MHz)	Emission Level (dBuV/m)	Limit (dBuV/m)	Margin (dB)	Antenna Height (m)	Table Angle (Degree)	Raw Value (dBuV)	Correction Factor (dB/m)
1	2390.00	61.40 PK	74.00	-12.60	1.01 V	2	31.00	30.30
1	2390.00	52.10 AV	54.00	-1.90	1.01 V	2	21.80	30.30
2	*2412.00	107.70 PK			1.20 V	359	77.20	30.50
2	*2412.00	101.30 AV			1.20 V	359	70.80	30.50
3	4824.00	48.50 PK	74.00	-25.50	1.16 V	256	13.40	35.10
3	4824.00	42.30 AV	54.00	-11.70	1.16 V	256	7.20	35.10
4	7236.00	47.00 PK	74.00	-27.00	1.02 V	32	6.50	40.50
4	7236.00	39.10 AV	54.00	-14.90	1.02 V	32	-1.40	40.50

- REMARKS:**
1. Emission level(dBuV/m)=Raw Value(dBuV) + Correction Factor(dB/m)
 2. Correction Factor(dB/m) = Antenna Factor (dB/m) + Cable Factor (dB)
 3. The other emission levels were very low against the limit.
 4. Margin value = Emission level – Limit value.
 5. The limit value is defined as per 15.247
 6. “ * ” : Fundamental frequency



MODE	Channel 6	FREQUENCY RANGE	1000~25000MHz
INPUT POWER (SYSTEM)	120Vac, 60 Hz	DETECTOR FUNCTION & BANDWIDTH	Peak (PK) Average (AV) 1 MHz
ENVIRONMENTAL CONDITIONS	22 deg. C, 66%RH, 968hPa	TESTED BY	Eric Lee

ANTENNA POLARITY & TEST DISTANCE: HORIZONTAL AT 3 M

No.	Freq. (MHz)	Emission Level (dBuV/m)	Limit (dBuV/m)	Margin (dB)	Antenna Height (m)	Table Angle (Degree)	Raw Value (dBuV)	Correction Factor (dB/m)
1	*2437.00	97.50 PK			1.20 H	350	66.90	30.60
1	*2437.00	89.50 AV			1.20 H	350	58.90	30.60
2	4874.00	44.20 PK	74.00	-29.80	1.32 H	64	8.90	35.30
2	4874.00	35.50 AV	54.00	-18.50	1.32 H	64	0.20	35.30
3	7311.00	45.30 PK	74.00	-28.70	1.53 H	62	4.60	40.70
3	7311.00	37.20 AV	54.00	-16.80	1.53 H	62	-3.50	40.70

ANTENNA POLARITY & TEST DISTANCE: VERTICAL AT 3 M

No.	Freq. (MHz)	Emission Level (dBuV/m)	Limit (dBuV/m)	Margin (dB)	Antenna Height (m)	Table Angle (Degree)	Raw Value (dBuV)	Correction Factor (dB/m)
1	*2437.00	108.50 PK			1.21 V	357	77.90	30.60
1	*2437.00	102.50 AV			1.21 V	357	71.90	30.60
2	4874.00	49.90 PK	74.00	-24.10	1.25 V	65	14.60	35.30
2	4874.00	43.50 AV	54.00	-10.50	1.25 V	65	8.20	35.30
3	7311.00	49.80 PK	74.00	-24.20	1.11 V	74	9.10	40.70
3	7311.00	40.50 AV	54.00	-13.50	1.11 V	74	-0.10	40.70

- REMARKS:**
1. Emission level(dBuV/m)=Raw Value(dBuV) + Correction Factor(dB/m)
 2. Correction Factor(dB/m) = Antenna Factor (dB/m) + Cable Factor (dB)
 3. The other emission levels were very low against the limit.
 4. Margin value = Emission level – Limit value.
 5. The limit value is defined as per 15.247
 6. “ * “ : Fundamental frequency



MODE	Channel 11	FREQUENCY RANGE	1000~25000MHz
INPUT POWER (SYSTEM)	120Vac, 60 Hz	DETECTOR FUNCTION & BANDWIDTH	Peak (PK) Average (AV) 1 MHz
ENVIRONMENTAL CONDITIONS	22 deg. C, 66%RH, 968hPa	TESTED BY	Eric Lee

ANTENNA POLARITY & TEST DISTANCE: HORIZONTAL AT 3 M

No.	Freq. (MHz)	Emission Level (dBuV/m)	Limit (dBuV/m)	Margin (dB)	Antenna Height (m)	Table Angle (Degree)	Raw Value (dBuV)	Correction Factor (dB/m)
1	*2462.00	96.40 PK			1.13 H	349	65.60	30.80
1	*2462.00	88.90 AV			1.13 H	349	58.10	30.80
2	2483.50	49.10 PK	74.00	-24.90	1.04 H	24	18.20	30.90
2	2483.50	38.40 AV	54.00	-15.60	1.04 H	24	7.50	30.90
3	4924.00	43.20 PK	74.00	-30.80	1.11 H	42	7.60	35.50
3	4924.00	36.70 AV	54.00	-17.30	1.11 H	42	1.20	35.50
4	7386.00	45.40 PK	74.00	-28.60	1.42 H	25	4.60	40.80
4	7386.00	37.40 AV	54.00	-16.60	1.42 H	25	-3.40	40.80

ANTENNA POLARITY & TEST DISTANCE: VERTICAL AT 3 M

No.	Freq. (MHz)	Emission Level (dBuV/m)	Limit (dBuV/m)	Margin (dB)	Antenna Height (m)	Table Angle (Degree)	Raw Value (dBuV)	Correction Factor (dB/m)
1	*2462.00	108.90 PK			1.18 V	1	78.10	30.80
1	*2462.00	102.00 AV			1.18 V	1	71.20	30.80
2	2483.50	61.60 PK	74.00	-12.40	1.20 V	222	30.70	30.90
2	2483.50	51.50 AV	54.00	-2.50	1.20 V	222	20.60	30.90
3	4924.00	52.00 PK	74.00	-22.00	1.20 V	260	16.40	35.50
3	4924.00	45.70 AV	54.00	-8.30	1.20 V	260	10.20	35.50
4	7386.00	47.40 PK	74.00	-26.60	1.32 V	65	6.60	40.80
4	7386.00	40.70 AV	54.00	-13.30	1.32 V	65	-0.10	40.80

- REMARKS:**
1. Emission level(dBuV/m)=Raw Value(dBuV) + Correction Factor(dB/m)
 2. Correction Factor(dB/m) = Antenna Factor (dB/m) + Cable Factor (dB)
 3. The other emission levels were very low against the limit.
 4. Margin value = Emission level – Limit value.
 5. The limit value is defined as per 15.247
 6. “ * “ : Fundamental frequency



4.3 6dB BANDWIDTH MEASUREMENT

4.3.1 LIMITS OF 6dB BANDWIDTH MEASUREMENT

The minimum of 6dB Bandwidth Measurement is 0.5 MHz.

4.3.2 TEST INSTRUMENTS

Description & Manufacturer	Model No.	Serial No.	Calibrated Until
R&S SPECTRUM ANALYZER	FSP40	100036	Nov. 23, 2006

NOTE:

- 1.The measurement uncertainty is less than +/- 2.6dB, which is calculated as per the NAMAS document NIS81.
- 2.The calibration interval of the above test instruments is 12 months and the calibrations are traceable to NML/ROC and NIST/USA.

4.3.3 TEST PROCEDURE

The transmitter output was connected to the spectrum analyzer through an attenuator. The bandwidth of the fundamental frequency was measured by spectrum analyzer with 100 kHz RBW and 100 kHz VBW. The 6 dB bandwidth is defined as the total spectrum the power of which is higher than peak power minus 6 dB.

4.3.4 TEST SETUP



For the actual test configuration, please refer to the related Item – Photographs of the Test Configuration.

4.3.5 EUT OPERATING CONDITIONS

The software provided by client to enable the EUT under transmission condition continuously at lowest, middle and highest channel frequencies individually.



4.3.6 TEST RESULTS –DSSS

802.11b DSSS modulation

MODULATION TYPE	CCK	TRANSFER RATE	11Mbps
INPUT POWER (SYSTEM)	120Vac, 60 Hz	ENVIRONMENTAL CONDITIONS	20deg. C, 60%RH, 968hPa
TESTED BY	Eric Lee		

CHANNEL	CHANNEL FREQUENCY (MHz)	6 dB BANDWIDTH (MHz)	MINIMUM LIMIT (MHz)	PASS/FAIL
1	2412	7.63	0.5	PASS
6	2437	7.42	0.5	PASS
11	2462	7.56	0.5	PASS

CH1

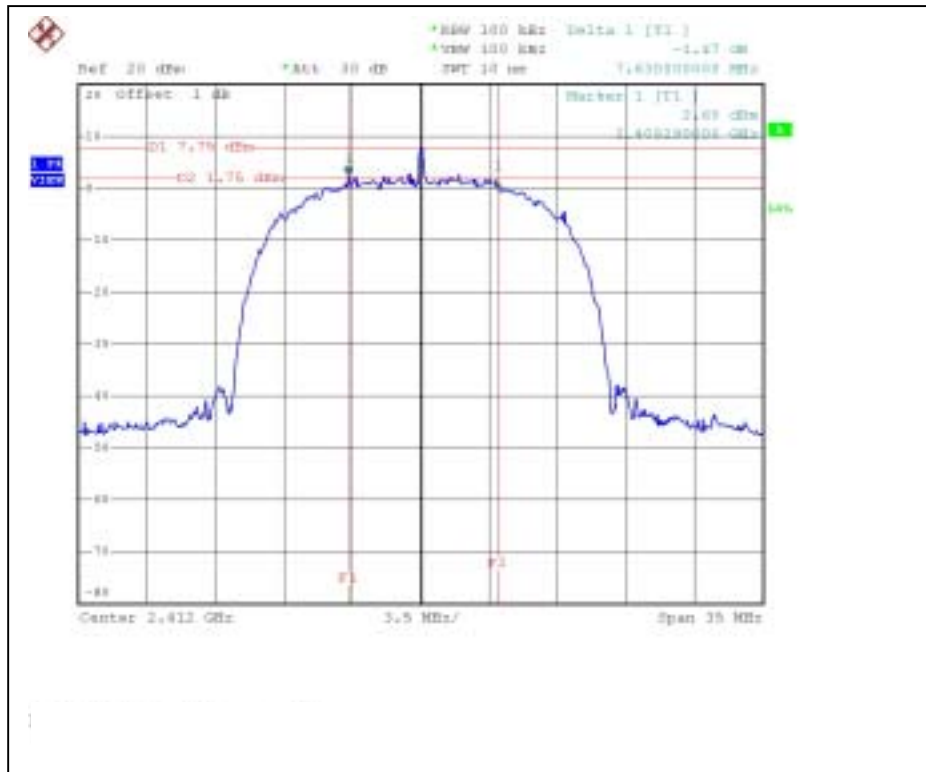

CH6

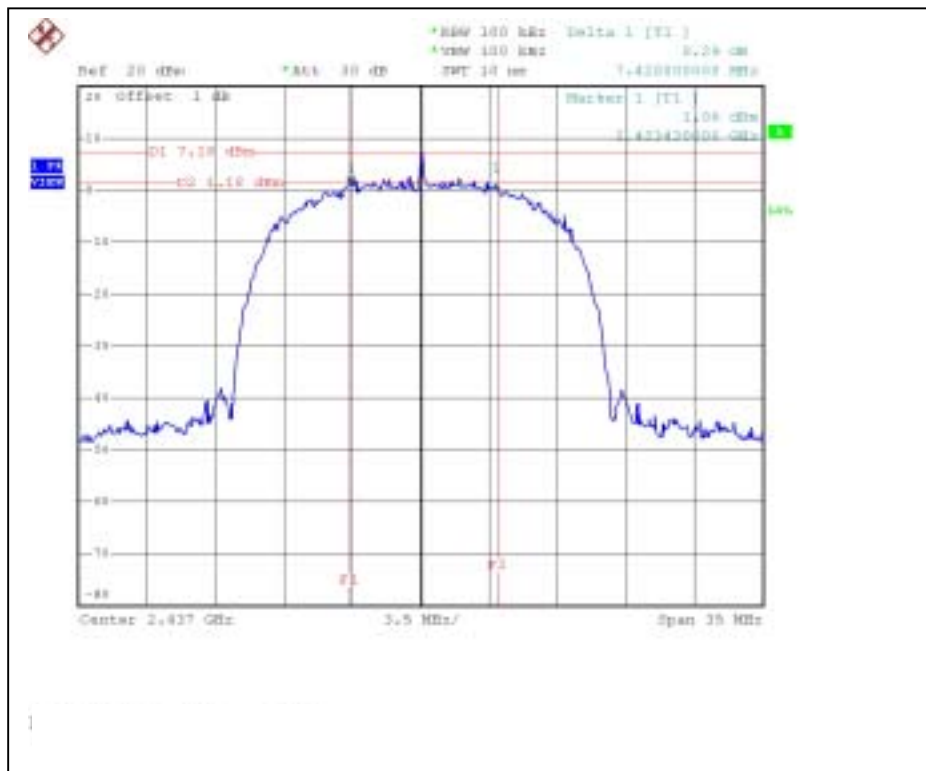

CH11

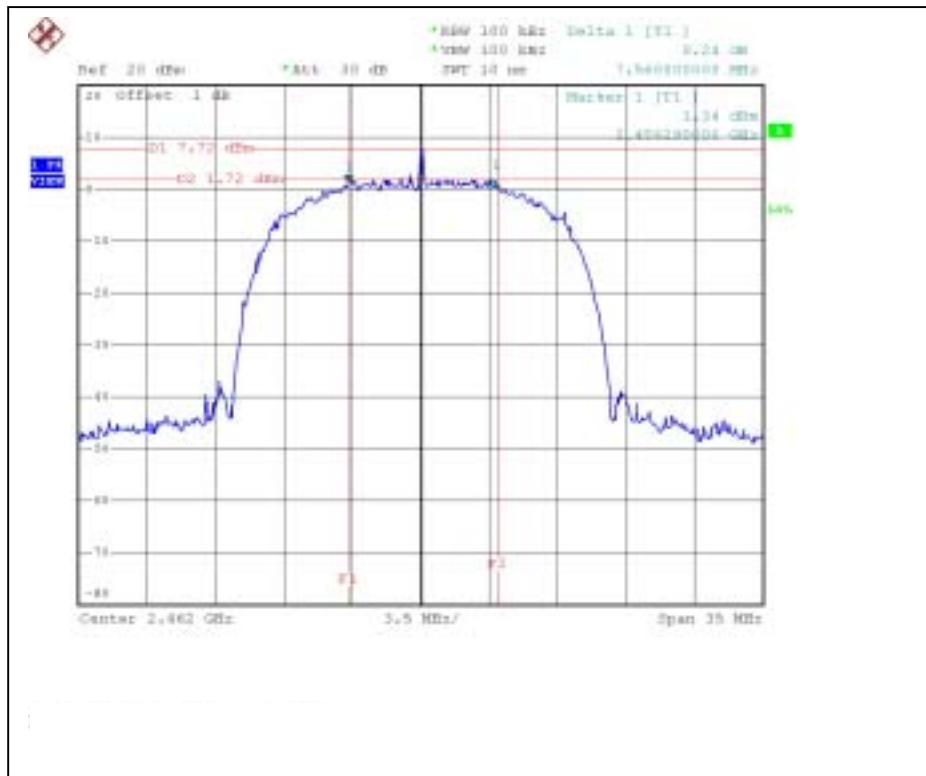



4.3.7 TEST RESULTS-OFDM

802.11g OFDM modulation

MODULATION TYPE	BPSK	TRANSFER RATE	6Mbps
INPUT POWER (SYSTEM)	120Vac, 60 Hz	ENVIRONMENTAL CONDITIONS	20deg. C, 60%RH, 968hPa
TESTED BY	Eric Lee		

CHANNEL	CHANNEL FREQUENCY (MHz)	6 dB BANDWIDTH (MHz)	MINIMUM LIMIT (MHz)	PASS/FAIL
1	2412	14.91	0.5	PASS
6	2437	14.98	0.5	PASS
11	2462	14.98	0.5	PASS

CH1

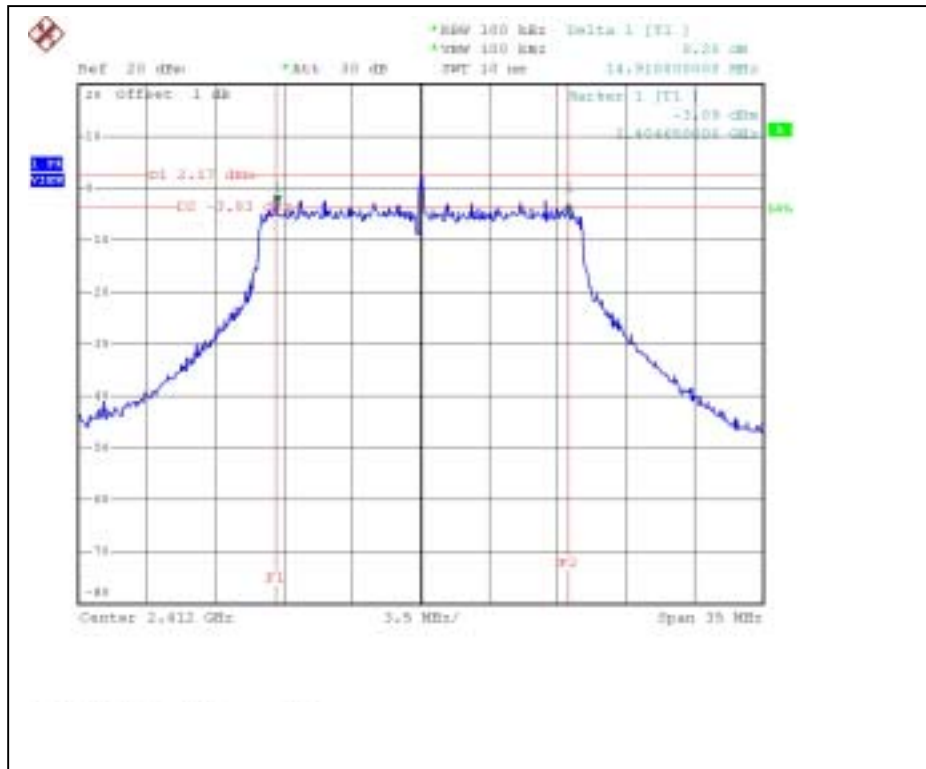

CH6

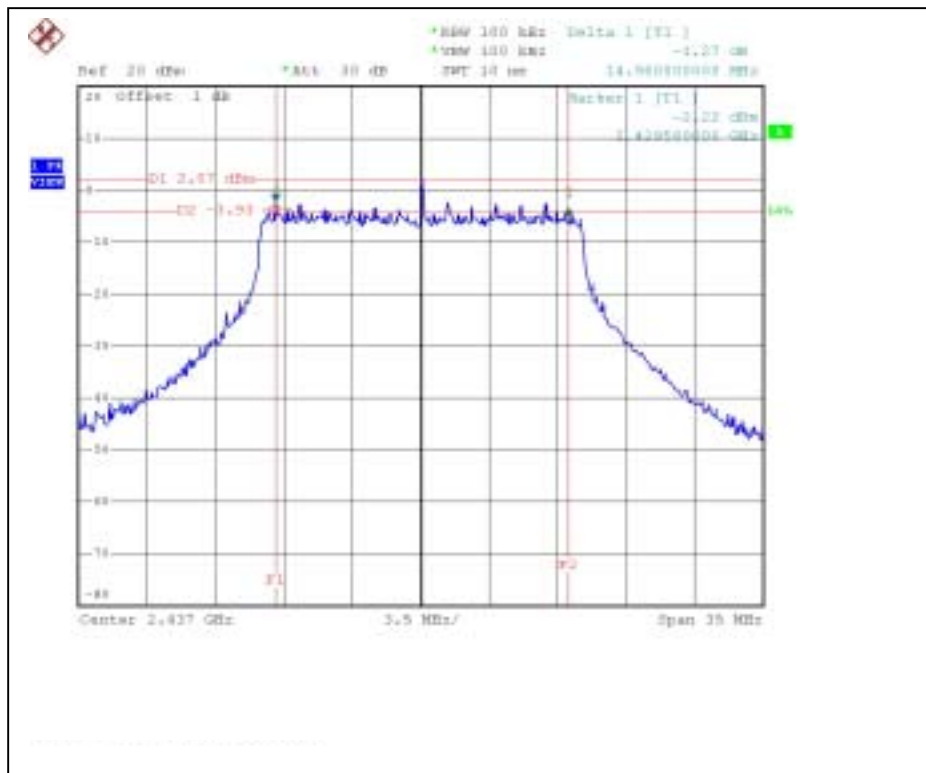

CH11

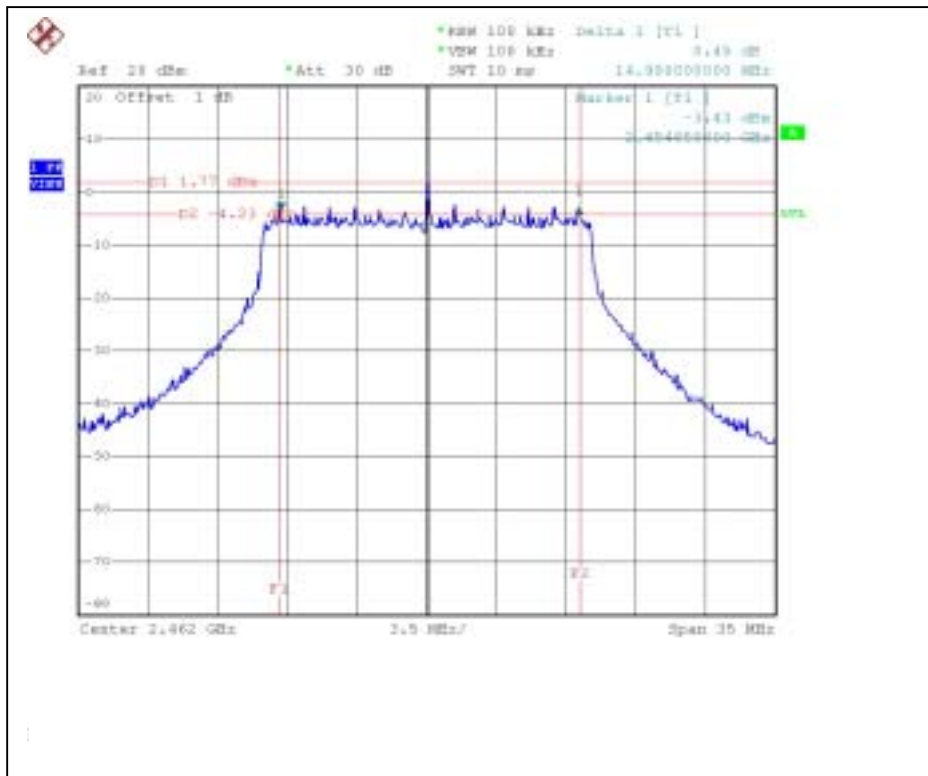



4.4 MAXIMUM PEAK OUTPUT POWER

4.4.1 LIMITS OF MAXIMUM PEAK OUTPUT POWER MEASUREMENT

The Maximum Peak Output Power Measurement is 30dBm.

4.4.2 TEST INSTRUMENTS

Description & Manufacturer	Model No.	Serial No.	Calibrated Until
R&S SPECTRUM ANALYZER	FSP40	100036	Nov. 23, 2006
Agilent SIGNAL GENERATOR	E8257C	MY43320668	Dec. 07, 2006
TEKTRONIX OSCILLOSCOPE	TDS380	B016335	Jun. 22, 2006
NARDA DETECTOR	4503A	FSCM99899	NA

NOTE:

The calibration interval of the above test instruments is 12 months and the calibrations are traceable to NML/ROC and NIST/USA.

4.4.3 TEST PROCEDURES

1. A detector was used on the output port of the EUT. An oscilloscope was used to read the peak response of the detector.
2. Replaced the EUT by the signal generator. The center frequency of the S.G was adjusted to the center frequency of the measured channel.
3. Adjusted the power to have the same peak reading on oscilloscope. Record the power level.

4.4.4 TEST SETUP

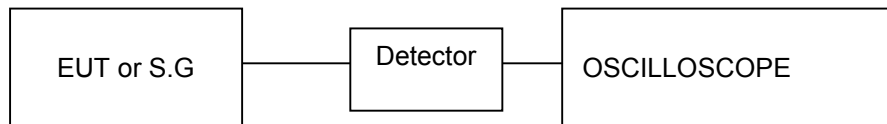

4.4.5 EUT OPERATING CONDITIONS

Same as Item 4.3.5



4.4.6 TEST RESULTS – DSSS

802.11b DSSS modulation

MODULATION TYPE	CCK	TRANSFER RATE	11Mbps
INPUT POWER (SYSTEM)	120Vac, 60Hz	ENVIRONMENTAL CONDITIONS	20deg. C, 60%RH, 968hPa
TESTED BY	Eric Lee		

CHANNEL	CHANNEL FREQUENCY (MHz)	PEAK POWER OUTPUT (mW)	PEAK POWER OUTPUT (dBm)	PEAK POWER LIMIT (dBm)	PASS/FAIL
1	2412	51.404	17.11	30	PASS
6	2437	51.050	17.08	30	PASS
11	2462	50.119	17.00	30	PASS



4.4.7 TEST RESULTS –OFDM

802.11g OFDM modulation

MODULATION TYPE	BPSK	TRANSFER RATE	6Mbps
INPUT POWER (SYSTEM)	120Vac, 60Hz	ENVIRONMENTAL CONDITIONS	20deg. C, 60%RH, 968hPa
TESTED BY	Eric Lee		

CHANNEL	CHANNEL FREQUENCY (MHz)	PEAK POWER OUTPUT (mW)	PEAK POWER OUTPUT (dBm)	PEAK POWER LIMIT (dBm)	PASS/FAIL
1	2412	40.551	16.08	30	PASS
6	2437	41.020	16.13	30	PASS
11	2462	40.365	16.06	30	PASS



4.5 POWER SPECTRAL DENSITY MEASUREMENT

4.5.1 LIMITS OF POWER SPECTRAL DENSITY MEASUREMENT

The Maximum of Power Spectral Density Measurement is 8dBm.

4.5.2 TEST INSTRUMENTS

Description & Manufacturer	Model No.	Serial No.	Calibrated Until
R&S SPECTRUM ANALYZER	FSP40	100036	Nov. 23, 2006

NOTE:

- 1.The measurement uncertainty is less than +/- 2.6dB, which is calculated as per the NAMAS document NIS81.
- 2.The calibration interval of the above test instruments is 12 months and the calibrations are traceable to NML/ROC and NIST/USA.

4.5.3 TEST PROCEDURE

The transmitter output was connected to the spectrum analyzer through an attenuator, the bandwidth of the fundamental frequency was measured with the spectrum analyzer using 3 kHz RBW and 30 kHz VBW, set sweep time=span/3kHz. The power spectral density was measured and recorded. The sweep time is allowed to be longer than span/3KHz for a full response of the mixer in the spectrum analyzer.

4.5.4 TEST SETUP

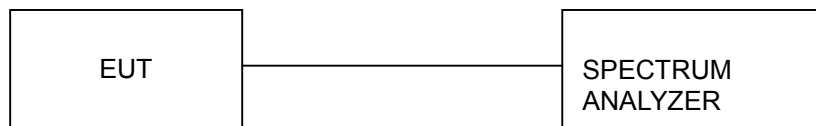

4.5.5 EUT OPERATING CONDITIONS

Same as 4.3.5



4.5.6 TEST RESULTS –DSSS

802.11b DSSS modulation

MODULATION TYPE	CCK	TRANSFER RATE	11Mbps
INPUT POWER (SYSTEM)	120Vac, 60Hz	ENVIRONMENTAL CONDITIONS	20deg. C, 60%RH, 968hPa
TESTED BY	Eric Lee		

CHANNEL NUMBER	CHANNEL FREQUENCY (MHz)	RF POWER LEVEL IN 3 KHz BW (dBm)	MAXIMUM LIMIT (dBm)	PASS/FAIL
1	2412	3.82	8	PASS
6	2437	3.65	8	PASS
11	2462	3.76	8	PASS

CH1

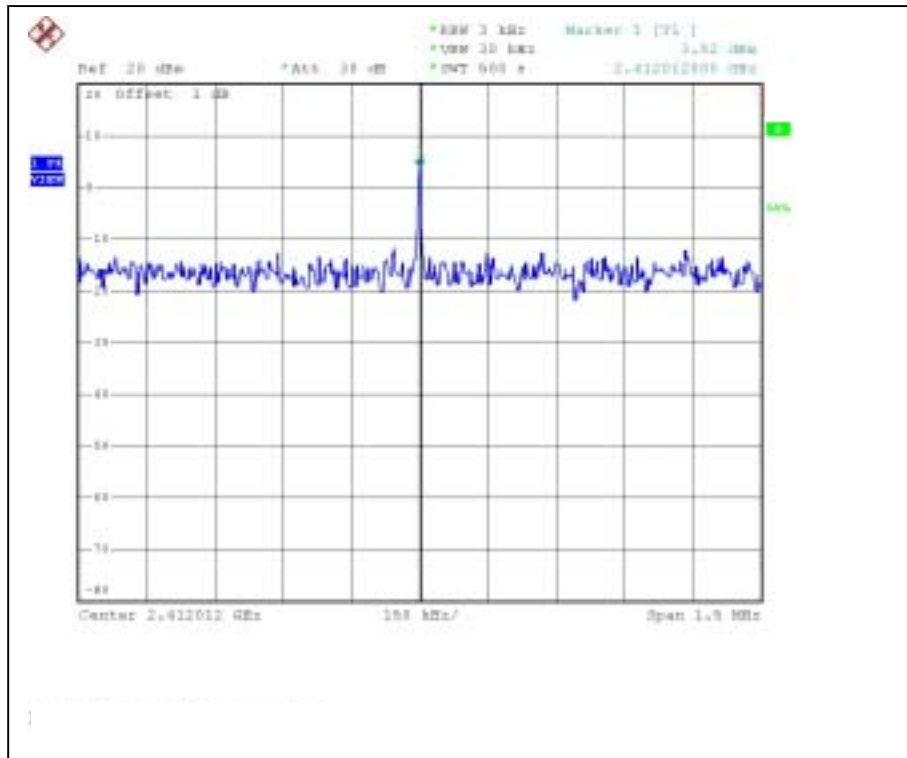

CH6

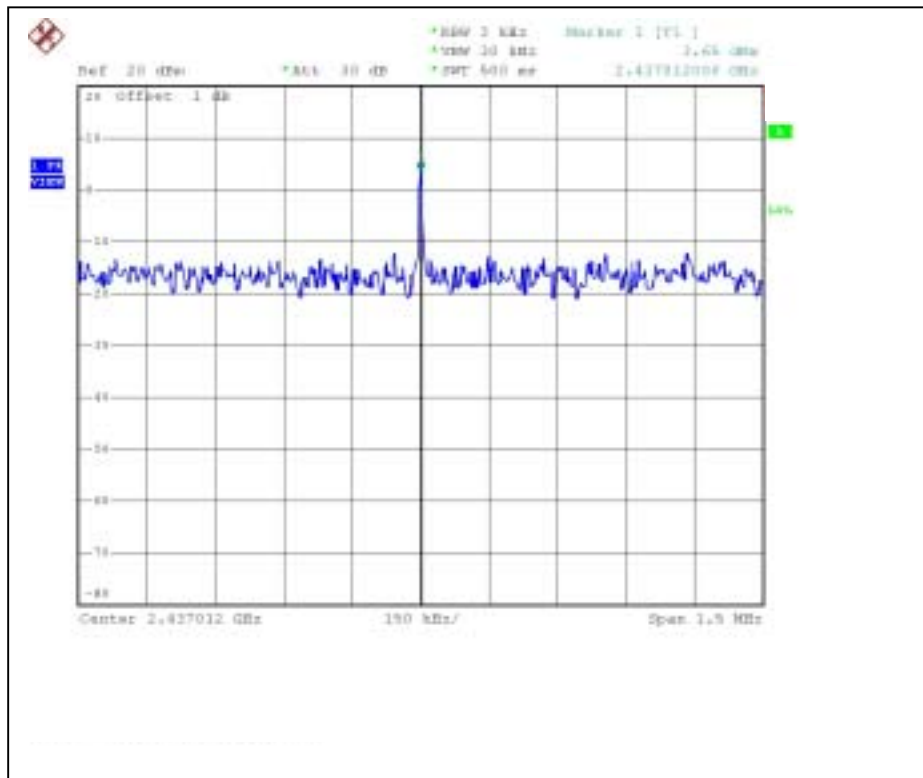

CH11

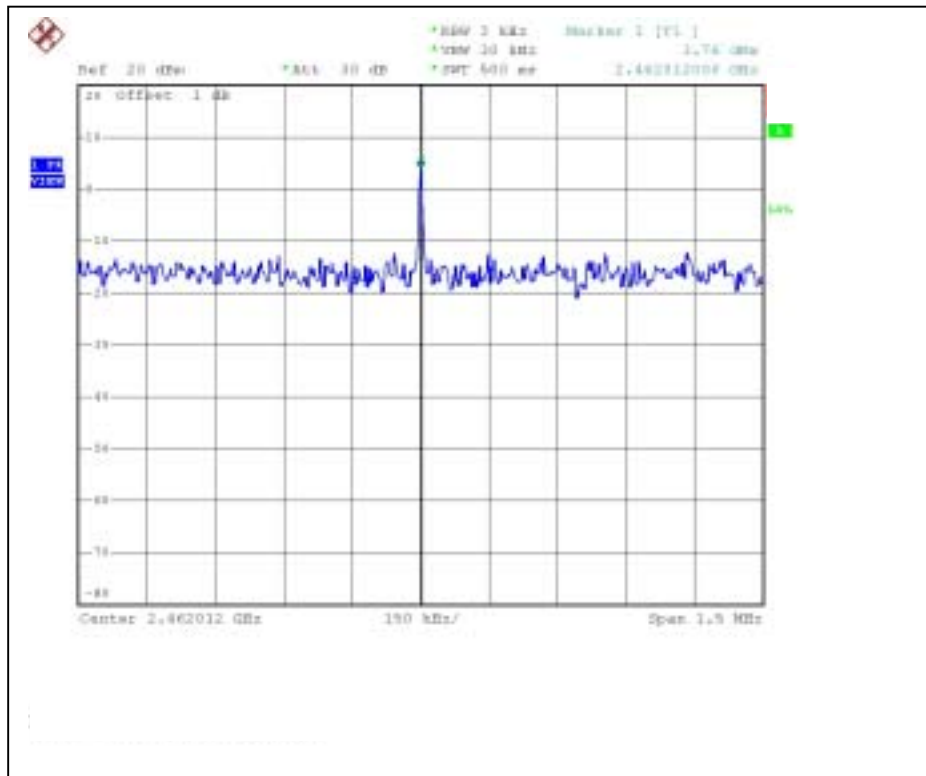



4.5.7 TEST RESULTS –OFDM

802.11g OFDM modulation

MODULATION TYPE	BPSK	TRANSFER RATE	6Mbps
INPUT POWER (SYSTEM)	120Vac, 60Hz	ENVIRONMENTAL CONDITIONS	20deg. C, 60%RH, 968hPa
TESTED BY	Eric Lee		

CHANNEL NUMBER	CHANNEL FREQUENCY (MHz)	RF POWER LEVEL IN 3 KHz BW (dBm)	MAXIMUM LIMIT (dBm)	PASS/FAIL
1	2412	1.29	8	PASS
6	2437	1.23	8	PASS
11	2462	1.01	8	PASS

CH1

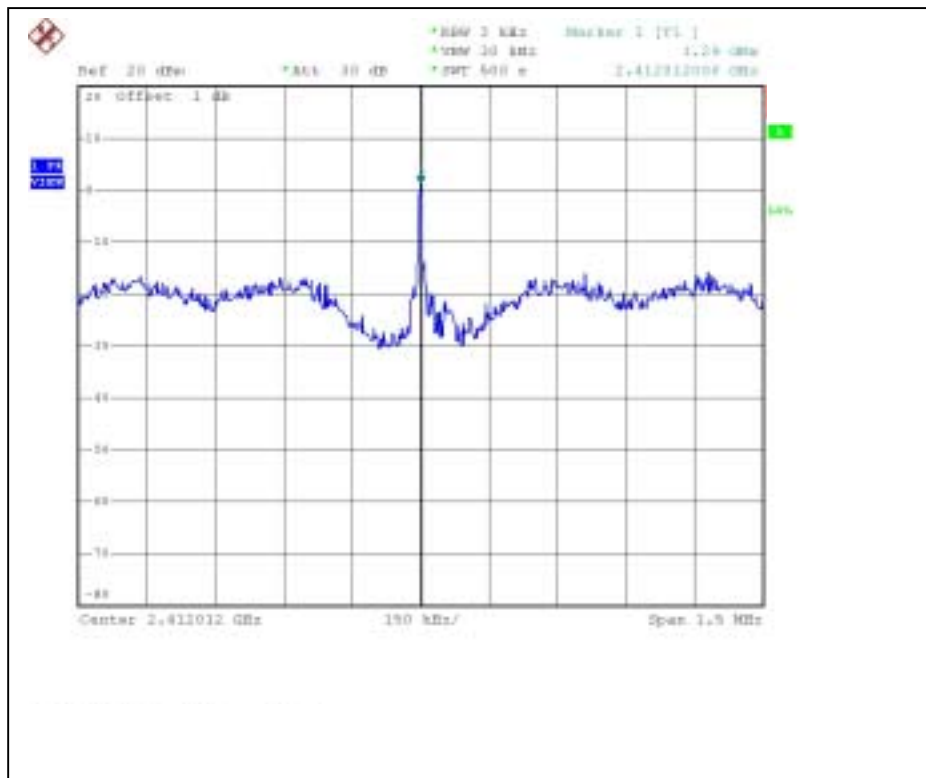

CH6

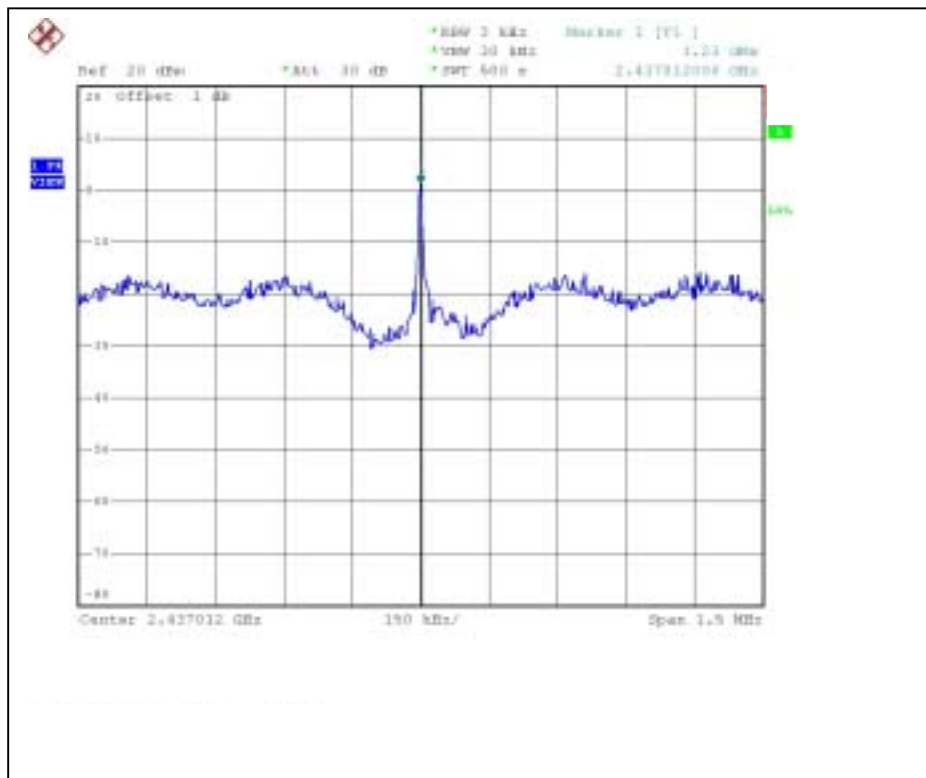

CH11

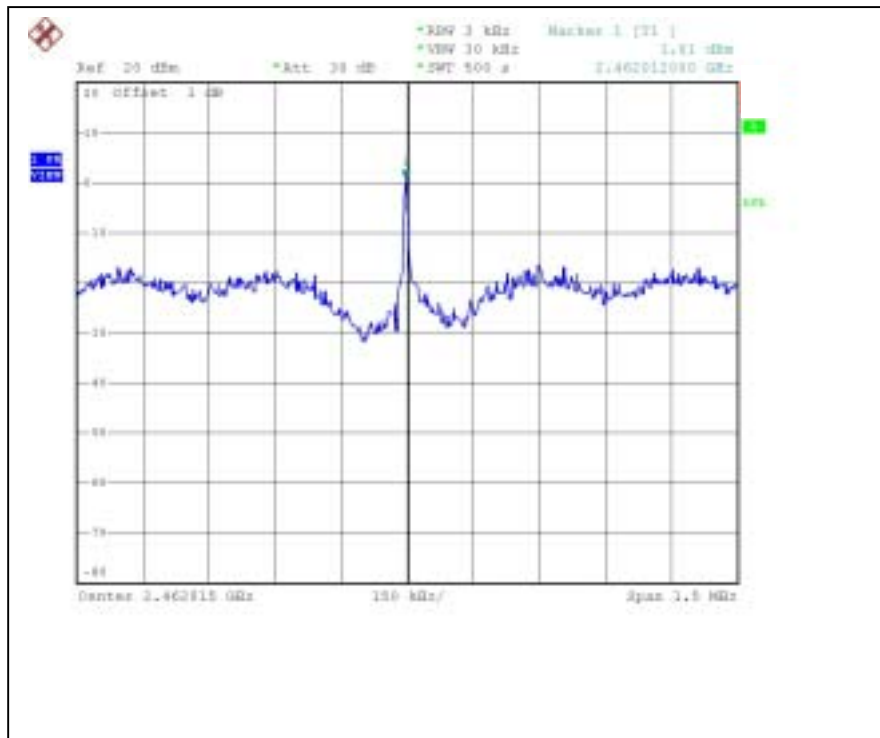



4.6 BAND EDGES MEASUREMENT

4.6.1 LIMITS OF BAND EDGES MEASUREMENT

Below -20dB of the highest emission level of operating band (in 1MHz Resolution Bandwidth).

4.6.2 TEST INSTRUMENTS

Description & Manufacturer	Model No.	Serial No.	Calibrated Until
R&S SPECTRUM ANALYZER	FSP40	100036	Nov. 23, 2006

NOTE:

- 1.The measurement uncertainty is less than $\pm 2.6\text{dB}$, which is calculated as per the NAMAS document NIS81.
- 2.The calibration interval of the above test instruments is 12 months and the calibrations are traceable to NML/ROC and NIST/USA.

4.6.3 TEST PROCEDURE

The transmitter output was connected to the spectrum analyzer via a low lose cable. Set RBW spectrum analyzer to 1 MHz and set VBW spectrum analyzer to 10 Hz with suitable frequency span including 1 MHz bandwidth from band edge. The band edges was measured and recorded.

The spectrum plots (Peak RBW=VBW=100kHz ; Average RBW=1MHz, VBW=10Hz) are attached on the following pages.

4.6.4 EUT OPERATING CONDITION

Same as Item 4.3.5

4.6.5 TEST RESULTS – DSSS

The spectrum plots are attached on the following page. D1 line indicates the highest level, D2 line indicates the 20dB offset below D1. It shows compliance with the requirement in part 15.247(C).

Note - The delta method is only used up to 2 MHz away from the restricted bandage, The radiated emissions which located in other restricted frequency band, the result, please refer to 4.2.

NOTE (Peak):

The band edge emission plot of DSSS technique on the following first page show 52.74dB delta between carrier maximum power and local maximum emission in restrict band (2.3900GHz). The emission of carrier strength list in the test result of channel 1 at the item 4.2 is 112.1dBuV/m, so the maximum field strength in restrict band is $112.1-52.74=59.36$ dBuV/m which is under 74 dBuV/m limit.

The band edge emission plot of DSSS technique on the following first page shows 52.26dB delta between carrier maximum power and local maximum emission in restrict band (2.4835GHz). The emission of carrier strength list in the test result of channel 11 at the item 4.2 is 112.5dBuV/m, so the maximum field strength in restrict band is $112.5-52.26=60.24$ dBuV/m which is under 74 dBuV/m limit.

NOTE (Average):

The band edge emission plot of DSSS technique on the following second page shows 55.95dB delta between carrier maximum power and local maximum emission in restrict band (2.3900GHz). The emission of carrier strength list in the test result of channel 1 at the item 4.2 is 103.6dBuV/m, so the maximum field strength in restrict band is $103.6-55.95=47.65$ dBuV/m which is under 54 dBuV/m limit.

The band edge emission plot of DSSS technique on the following second page shows 56.1dB delta between carrier maximum power and local maximum emission in restrict band (2.4835GHz). The emission of carrier strength list in the test result of channel 11 at the item 4.2 is 104.7dBuV/m, so the maximum field strength in restrict band is $104.7-56.1=48.6$ dBuV/m which is under 54 dBuV/m limit.

CH1

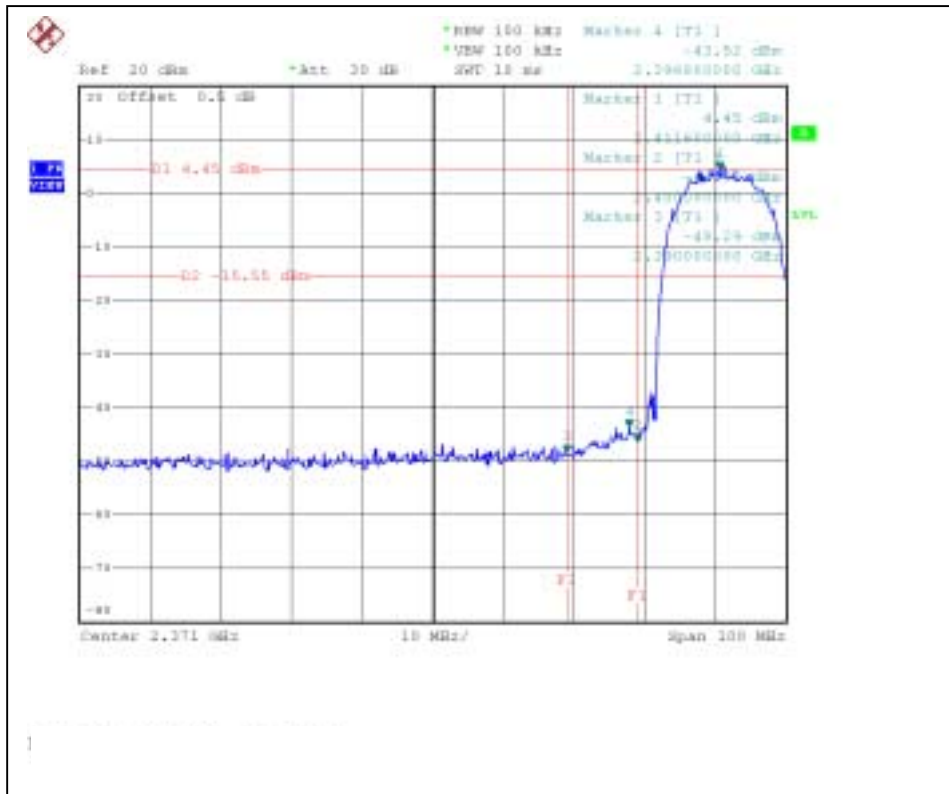

CH11

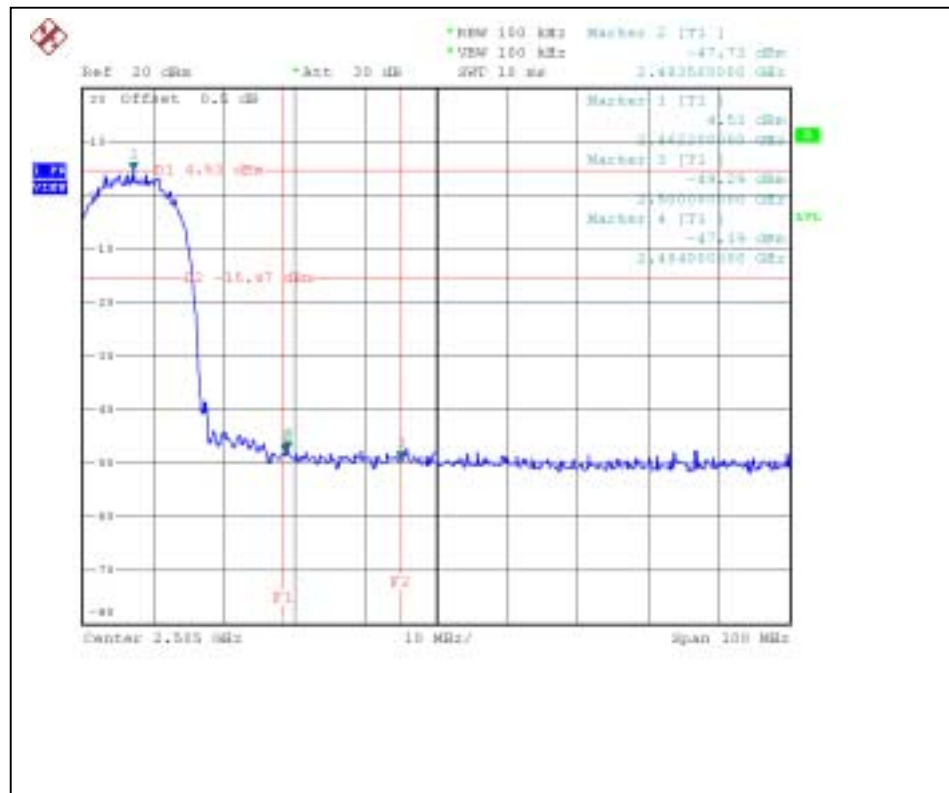

CH1

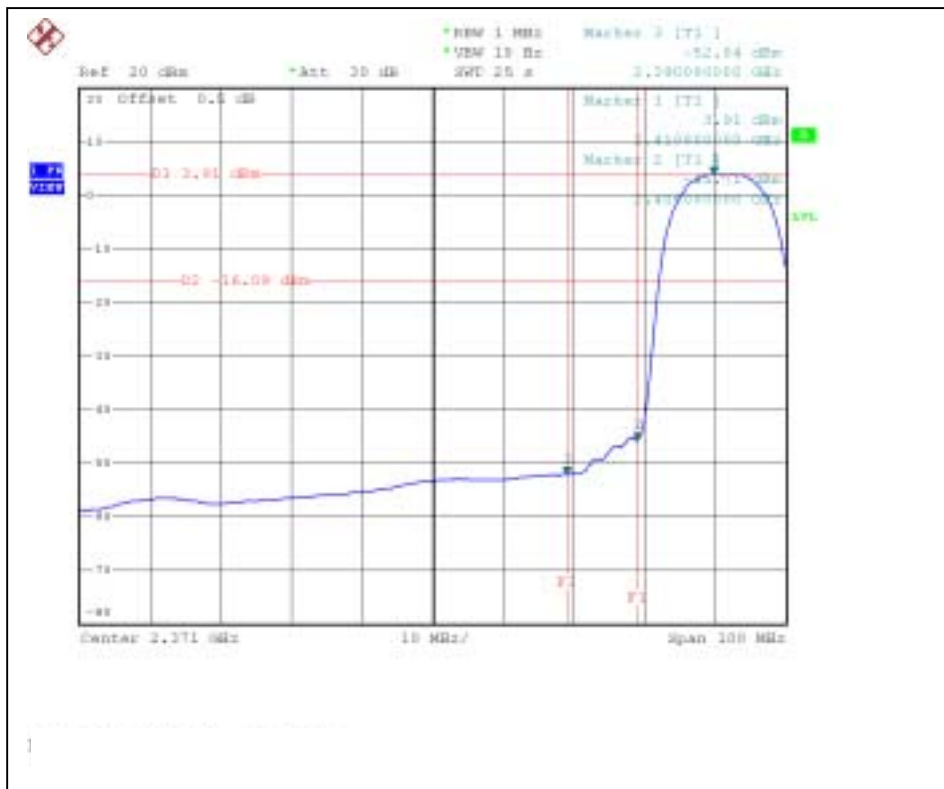

CH11

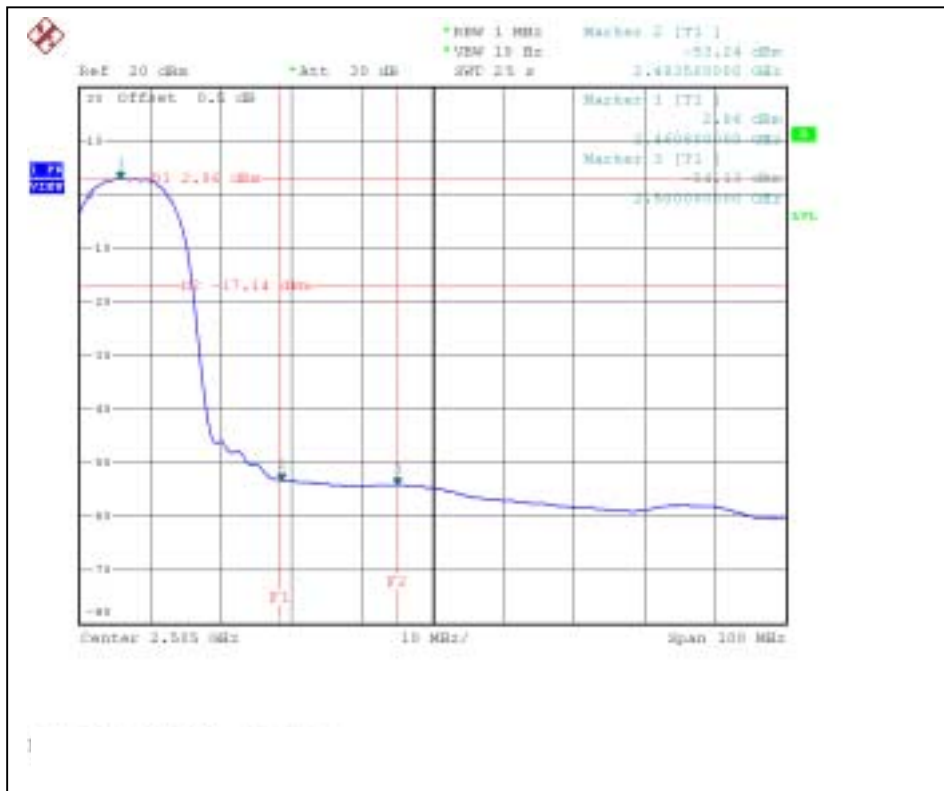

CH1

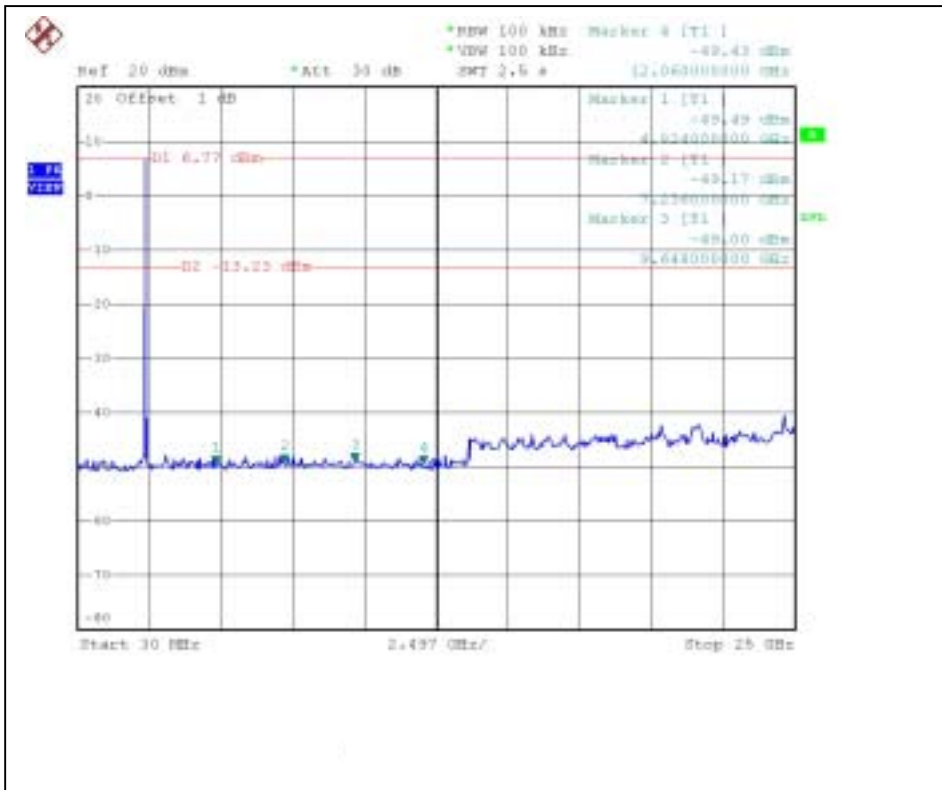

CH11

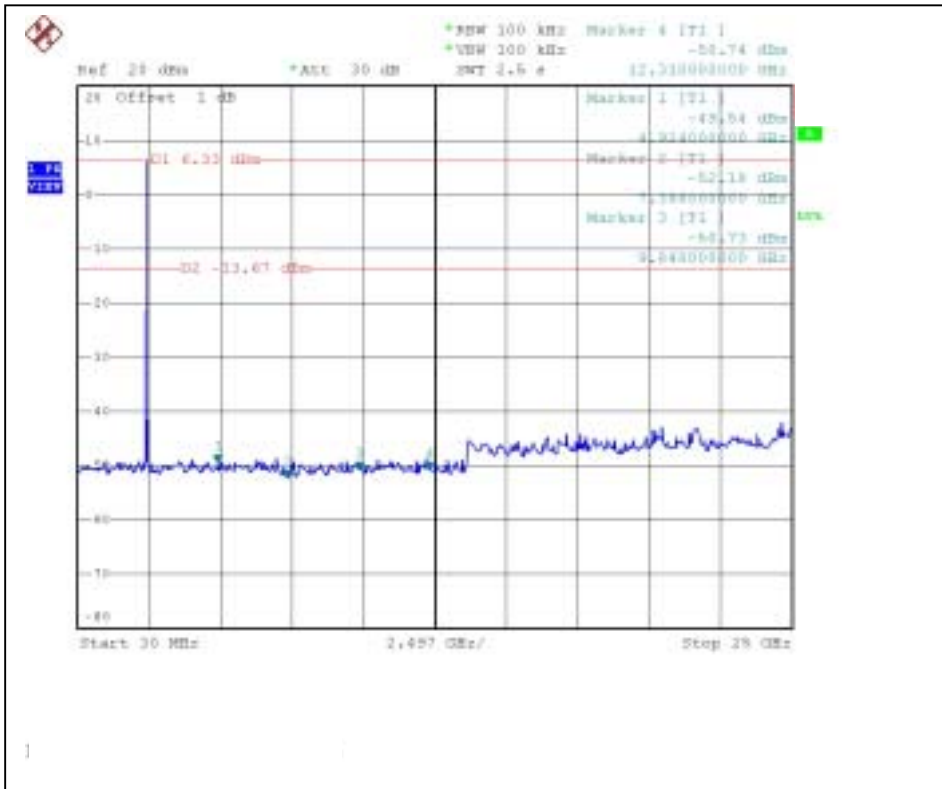

4.6.6 TEST RESULTS – OFDM

The spectrum plots are attached on the following page. D1 line indicates the highest level, D2 line indicates the 20dB offset below D1. It shows compliance with the requirement in part 15.247(C).

Note - The delta method is only used up to 2 MHz away from the restricted bandage, The radiated emissions which located in other restricted frequency band, the result, please refer to 4.2.

NOTE (Peak):

The band edge emission plot of OFDM technique on the following first page show 46.35dB delta between carrier maximum power and local maximum emission in restrict band (2.3900GHz). The emission of carrier strength list in the test result of channel 1 at the item 4.2 is 107.7dBuV/m, so the maximum field strength in restrict band is $107.7-46.35=61.35$ dBuV/m which is under 74 dBuV/m limit.

The band edge emission plot of OFDM technique on the following first page shows 47.31dB delta between carrier maximum power and local maximum emission in restrict band (2.4835GHz). The emission of carrier strength list in the test result of channel 11 at the item 4.2 is 108.9dBuV/m, so the maximum field strength in restrict band is $108.9-47.31=61.59$ dBuV/m which is under 74 dBuV/m limit.

NOTE (Average):

The band edge emission plot of OFDM technique on the following second page shows 49.16dB delta between carrier maximum power and local maximum emission in restrict band (2.3900GHz). The emission of carrier strength list in the test result of channel 1 at the item 4.2 is 101.3dBuV/m, so the maximum field strength in restrict band is $101.3-49.16=52.14$ dBuV/m which is under 54 dBuV/m limit.

The band edge emission plot of OFDM technique on the following second page shows 50.47dB delta between carrier maximum power and local maximum emission in restrict band (2.4835GHz). The emission of carrier strength list in the test result of channel 11 at the item 4.2 is 102.0dBuV/m, so the maximum field strength in restrict band is $102.0-50.47=51.53$ dBuV/m which is under 54 dBuV/m limit.

CH1

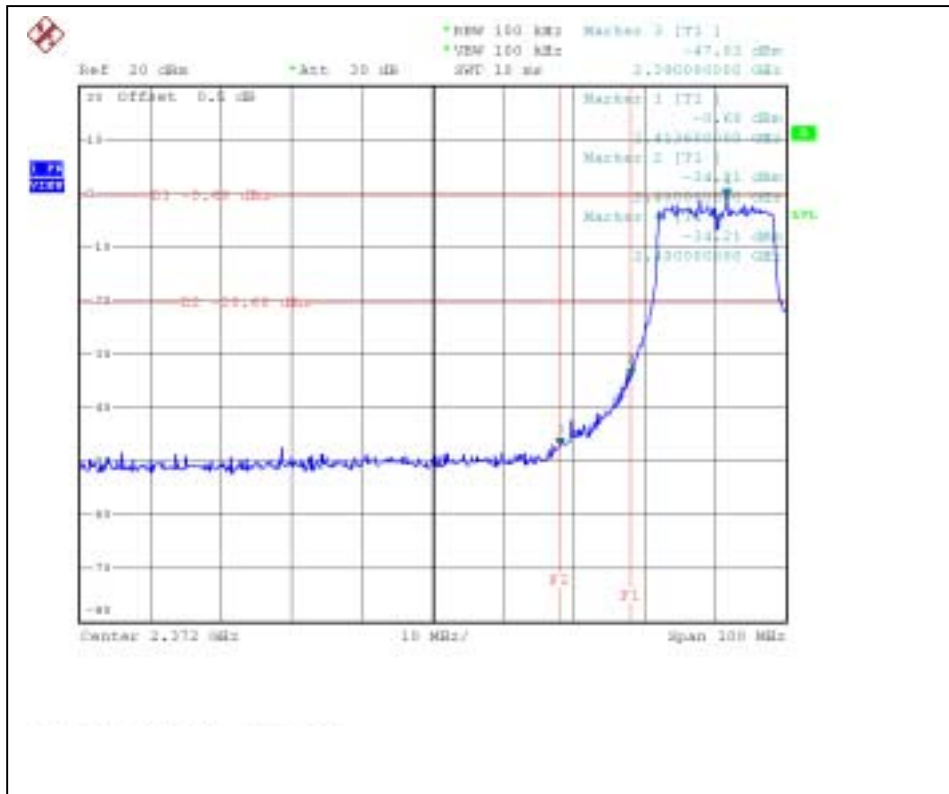

CH11

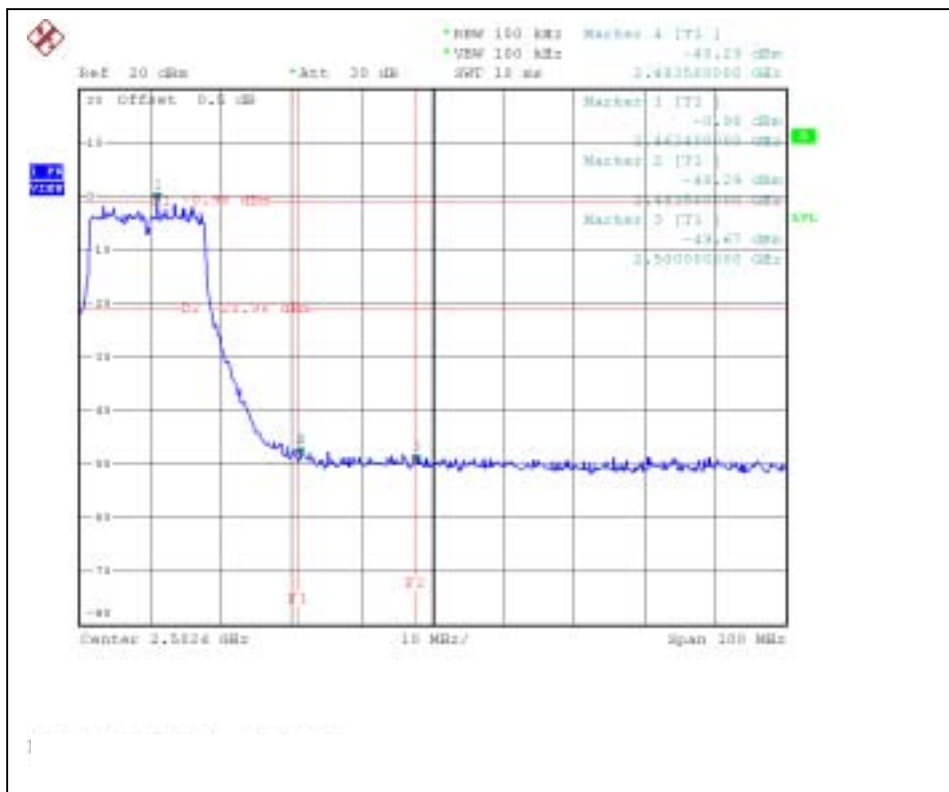

CH1

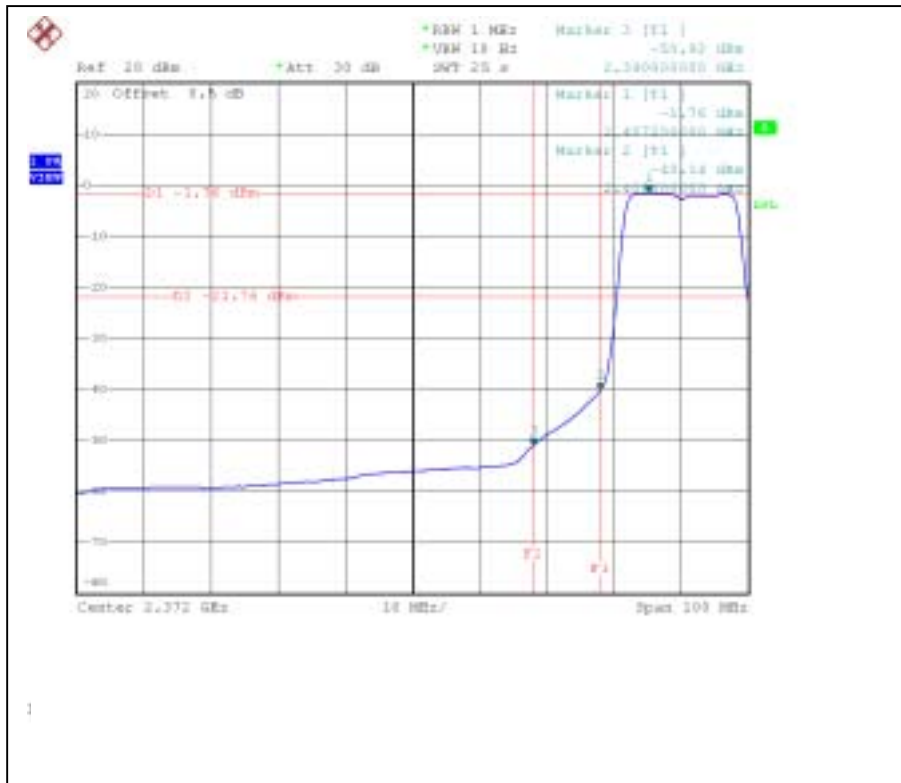

1

CH11

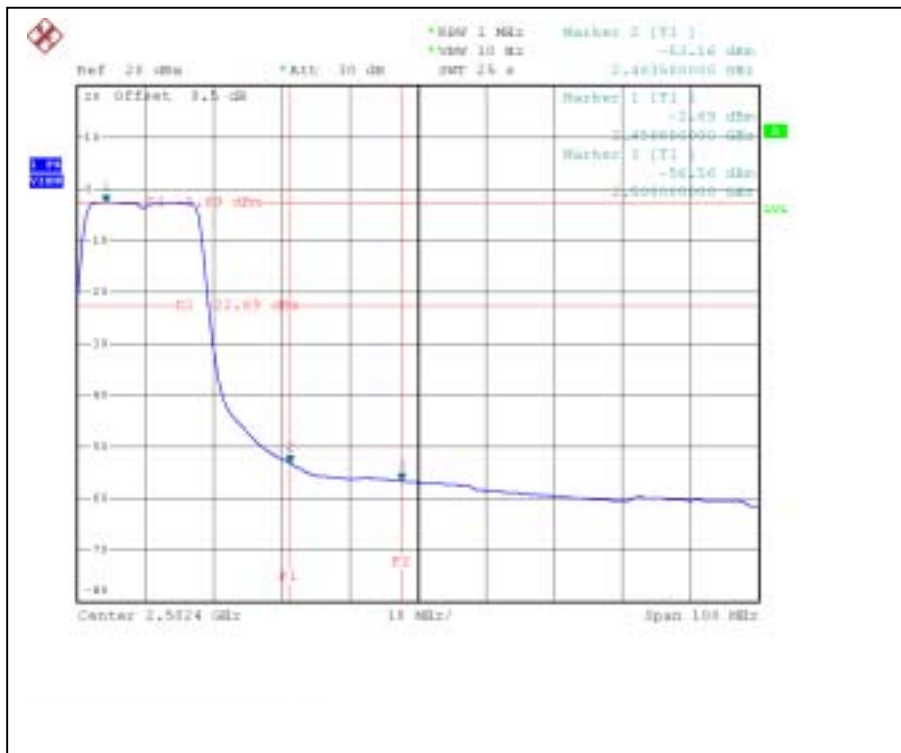

CH1

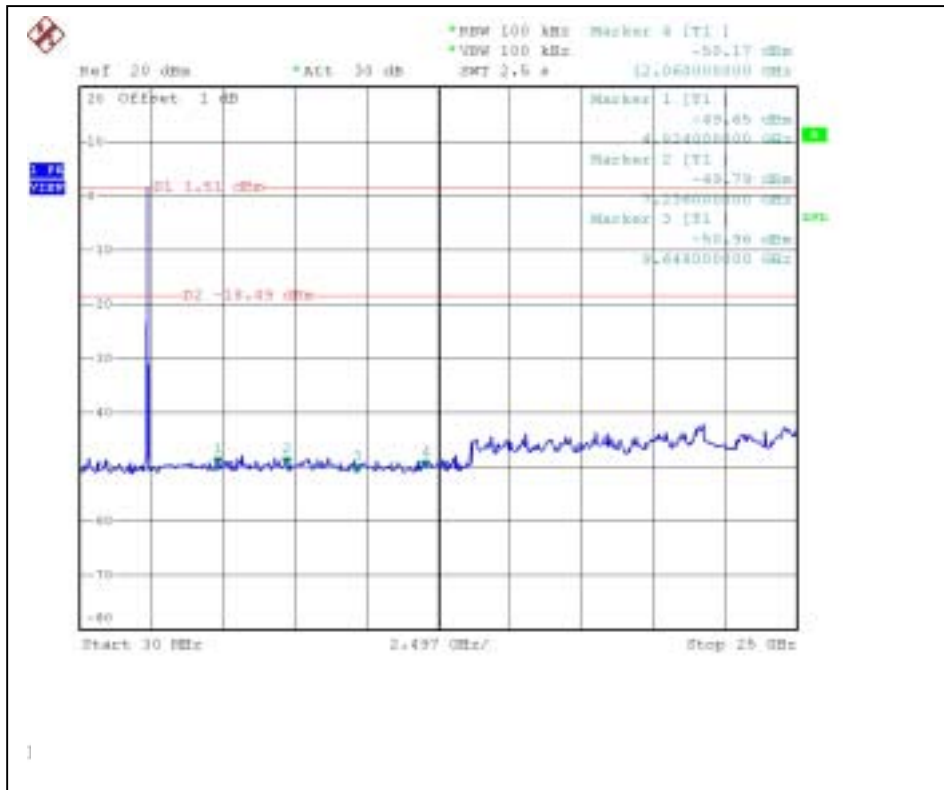

CH11

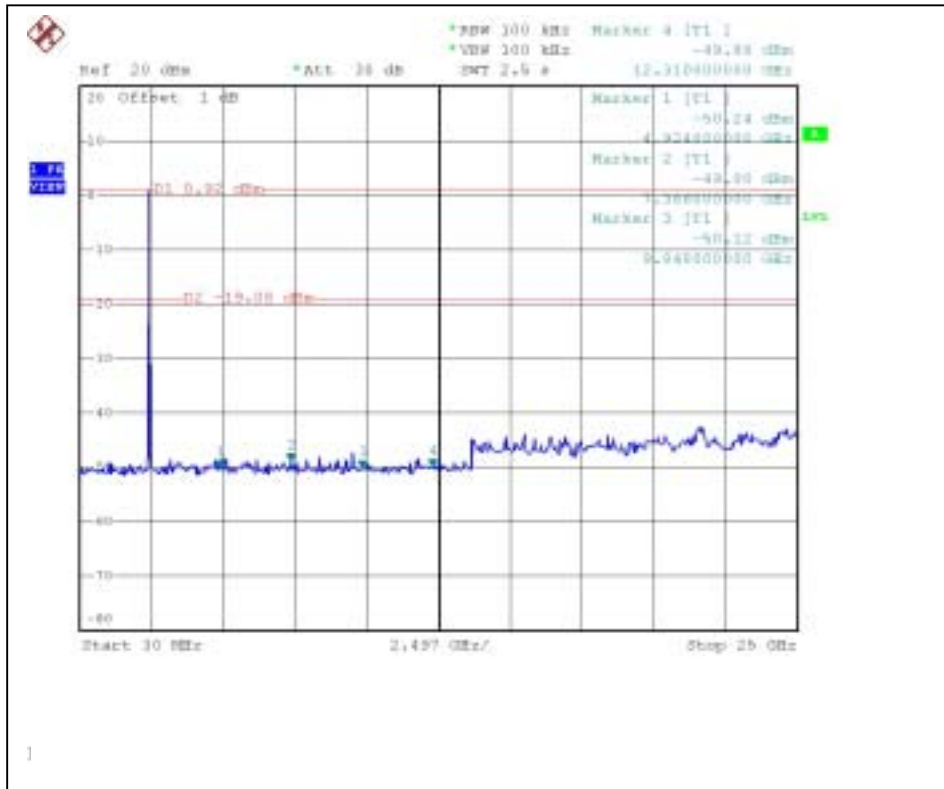



4.7 ANTENNA REQUIREMENT

4.7.1 STANDARD APPLICABLE

For intentional device, according to FCC 47 CFR Section 15.203, an intentional radiator shall be designed to ensure that no antenna other than that furnished by the responsible party shall be used with the device.

And according to FCC 47 CFR Section 15.247 (b), if transmitting antennas of directional gain greater than 6dBi are used, the power shall be reduced by the amount in dB that the directional gain of the antenna exceeds 6dBi.

4.7.2 ANTENNA CONNECTED CONSTRUCTION

The antenna used in this product is Dipole antenna with Reverse SMA connector. The maximum Gain of the antenna is 2 dBi.

5 PHOTOGRAPHS OF THE TEST CONFIGURATION CONDUCTED EMISSION TEST



RADIATED EMISSION TEST





6 INFORMATION ON THE TESTING LABORATORIES

We, ADT Corp., were founded in 1988 to provide our best service in EMC, Radio, Telecom and Safety consultation. Our laboratories are accredited and approved by the following approval agencies according to ISO/IEC 17025:

USA	FCC, UL, A2LA
Germany	TUV Rheinland
Japan	VCCI
Norway	NEMKO
Canada	INDUSTRY CANADA, CSA
R.O.C.	CNLA, BSMI, DGT
Netherlands	Telefication
Singapore	PSB, GOST-ASIA (MOU)
Russia	CERTIS (MOU)

Copies of accreditation certificates of our laboratories obtained from approval agencies can be downloaded from our web site: www.adt.com.tw/index.5/phtml.

If you have any comments, please feel free to contact us at the following:

Linko EMC/RF Lab:

Tel: 886-2-26052180

Fax: 886-2-26052943

Hsin Chu EMC/RF Lab:

Tel: 886-3-5935343

Fax: 886-3-5935342

Hwa Ya EMC/RF/Safety/Telecom Lab:

Tel: 886-3-3183232

Fax: 886-3-3185050

Email: service@adt.com.tw

Web Site: www.adt.com.tw

The address and road map of all our labs can be found in our web site also.



APPENDIX-A

MODIFICATIONS RECORDERS FOR ENGINEERING CHANGES TO THE EUT BY THE LAB

No any modifications are made to the EUT by the lab during the test.