

WHA YU INDUSTRIAL CO., LTD. (HEAD OFFICE)
 DONGGUAN AEON TECH CO.,LTD.(CHINA)
 TAI HWA ELECTRONIC CO., LTD.(CHINA)
 SHANGHAI HUA YU ELECTRONIC CO., LTD.(CHINA)
 SU ZHOU AEON TECH CO., LTD. (CHINA)

SPECIFICATION FOR APPROVAL

CUSTOMER: 中怡(蘇州)科技有限公司

PART NAME: RF Antenna Cable Assembly

PART NO.:

W. Y. P/NO.: C147-510381-A **REVISION:** X1

	MANUFACTURER SIGNATURE	CUSTOMER SIGNATURE
APPROVED BY :		
DATE :		

WHA YU GROUP

WHA YU INDUSTRIAL CO., LTD.(HEAD OFFICE)

譚裕實業股份有限公司

Address: No. 326, Sec. 2, Kung Tao 5 Road, Hsin Chu City, Taiwan, R.O.C.

Tel: +886-3-5714225(REP.) Fax: + 886-3-5713853 . + 886-3-5723600

DONGGUAN AEON TECH CO.,LTD.(CHINA)

東莞台霖電子通訊有限公司

Address: Lakeside Industrial Park, Da Ling Shan Town, Dong Guan City, Guangdong, China

Tel: + 86-769-85655858 Fax: + 86-769-856552

TAI HWA ELECTRONIC FACTORY

台樺電業製品廠

Address: Pak Ho District, Hou Street Town, Dong Guan City, Guangdong, China

Tel: + 86-769-85599375 . + 86-769-85912375 Fax: + 86-769-85599376

HUA HONG INTERNATIONAL LTD.

華弘國際有限公司

Address: Rm.1103A, President Commercial Centre, 608 Nathan Road, Mong Kok, Kowloon, Hong Kong

Tel: + 86-852-27712210 Fax: + 86-852-23843747

SHANGHAI HUA YU ELECTRONIC CO., LTD. (CHINA)

上海譚裕電子有限公司

Address: 3586, Wai Qing Song Road, Qing Pu County, Shanghai China

Tel: + 86-21-59741348 . + 86-21-59744101~4 Fax: + 86-21-59741347

SU ZHOU AEON TECH CO., LTD. (CHINA)

蘇州華廣電通有限公司

Address: Limin North Road, LiLi Town, LiLi Industrial Park, LinHu Economic Zone

Wujiang City, Jiangsu Province, China

Tel: + 86-512-63627980 Fax: + 86-512-63627981

Contents

<i>Item</i>	<i>Description</i>	<i>Page</i>
1.	天線規格表 1
2.	成品圖 2
3.	測試報告 3~5
4.	Cable 規格 6~8
5.	SGS報告 9
6.	SGS 測試 10~49
7.	RoHS排除條款 50
8.	其他 51~63

RF Antenna Cable Assembly

Specification

1. Electrical Properties :

- 1.1 Frequency Range..... 2.4GHz ~ 2.5GHz
- 1.2 Impedance 50Ω Nominal
- 1.3 VSWR 1.92 Max.
- 1.4 Return Loss..... -10 dB Max.
- 1.5 Radiation Omni-directional
- 1.6 Gain(peak)..... 1.8dBi (excluding cable loss)
- 1.7 Cable Loss..... 1.0dB
- 1.8 Polarization..... Linear Vertical
- 1.9 Admitted Power..... 1W
- 1.10 Cable..... φ1.13 Coaxial Cable

2. Physical Properties :

- 2.1 Antenna Cover..... TPE
- 2.2 Antenna Base..... PC
- 2.3 Antenna Base..... PBT
- 2.4 Operating Temp. -10 ~ +60
- 2.5 Storage Temp. -10 ~ +70
- 2.6 Color Black

REV	DATE	DESCRIPTION
X1	6/7-07	New Issue

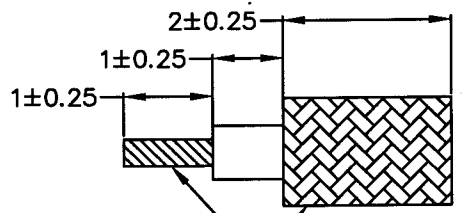
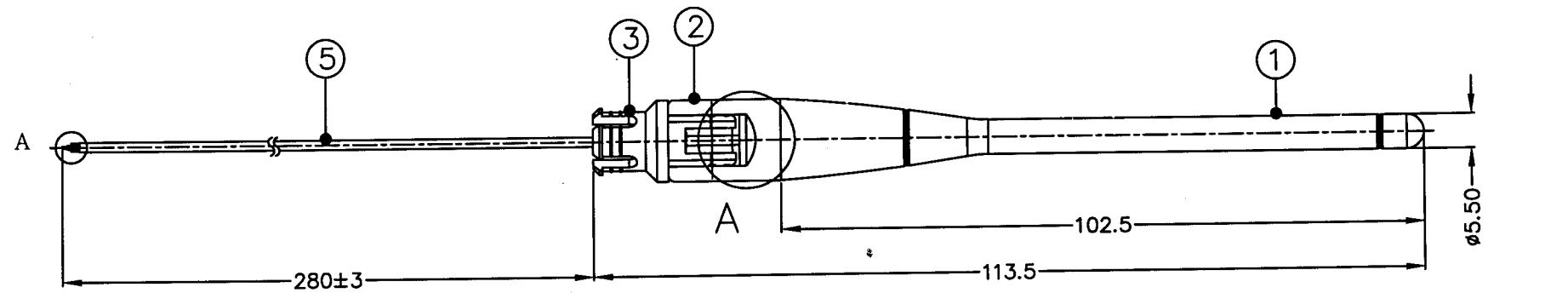

導體與編織網須鍍錫

Detail A

PE Bag
Shrink Line

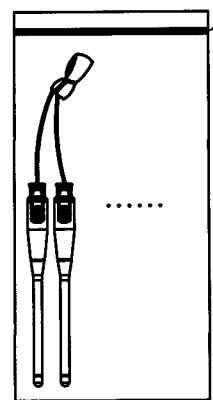

Packing : 10 pcs/bag

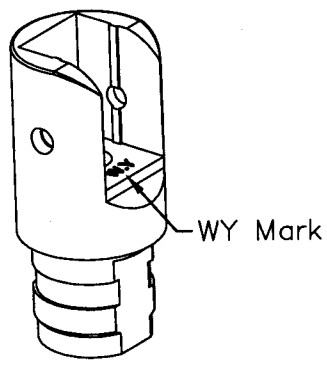

Detail A

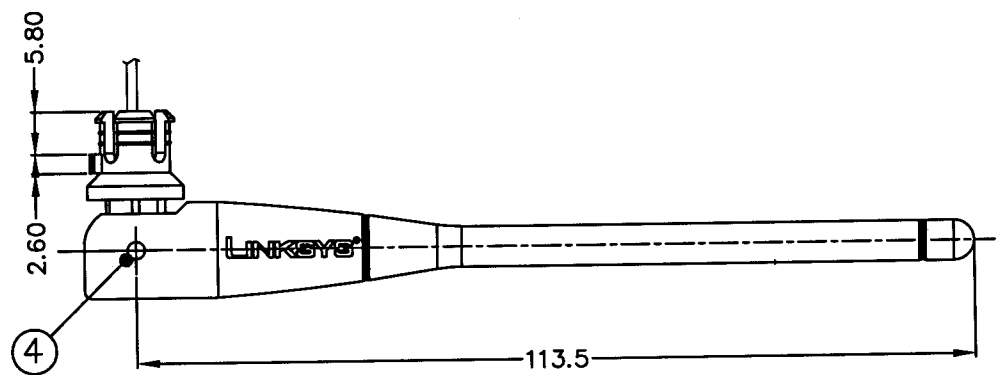

NO	DESCRIPTION	QTY	REMARK
5	Cable	1	Φ1.13 Coaxial Cable
4	Rivet	2	POM ; Color : Black
3	Antenna Base	1	PBT ; Color : Black
2	Antenna Base	1	PC ; Color : Black
1	Antenna Cap	1	TPE ; Color : Black

CUSTOMER'S SIGNATURE

XX	±5	APPROVED
X	±3.0	<i>[Signature]</i>
.X	±1.0	CHECKED
.XX	±0.5	<i>[Signature]</i>
.XXX	±0.1	DRAWING

CUSTOMER: 中怡科技股份有限公司		
PART NO :		
PARTNAME: RF Antenna Assembly		
W.Y PNO : C147-510381-A		
REV	UNIT	FILE : 0706-0005
X1	m/m	SHEET : 1/1

M.gear Wha Yu Group

THIS DRAWING, AND IT'S INHERANT DESIGN CONCEPTS, ARE THE PROPERTY OF WHA YU AND AS SUCH MAY NOT BE COPIED, REPRODUCED, OR GIVEN TO THIRD PARTIES WITHOUT THE WRITTEN CONSENT OF WHA YU.

RF Antenna Cable Assembly

P/NO: C147-510381-A

SPEC:2.4~2.5GHz

NO:0706-0005

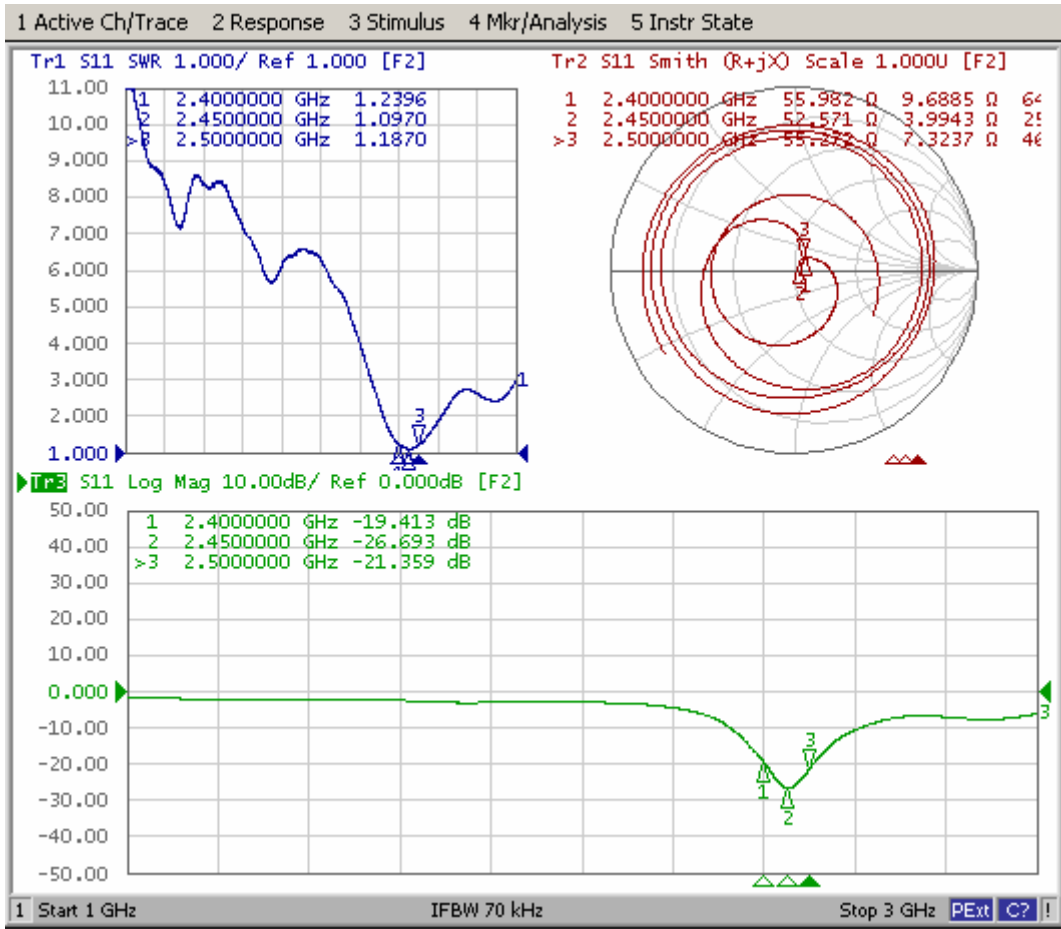



Wha Yu Group

RF Antenna Cable Assembly

P/NO:C147-510381-A SPEC:2.4GHz NO:0706-0005

Far-field amplitude of C147-510381-A (0706-0005) H.nsi

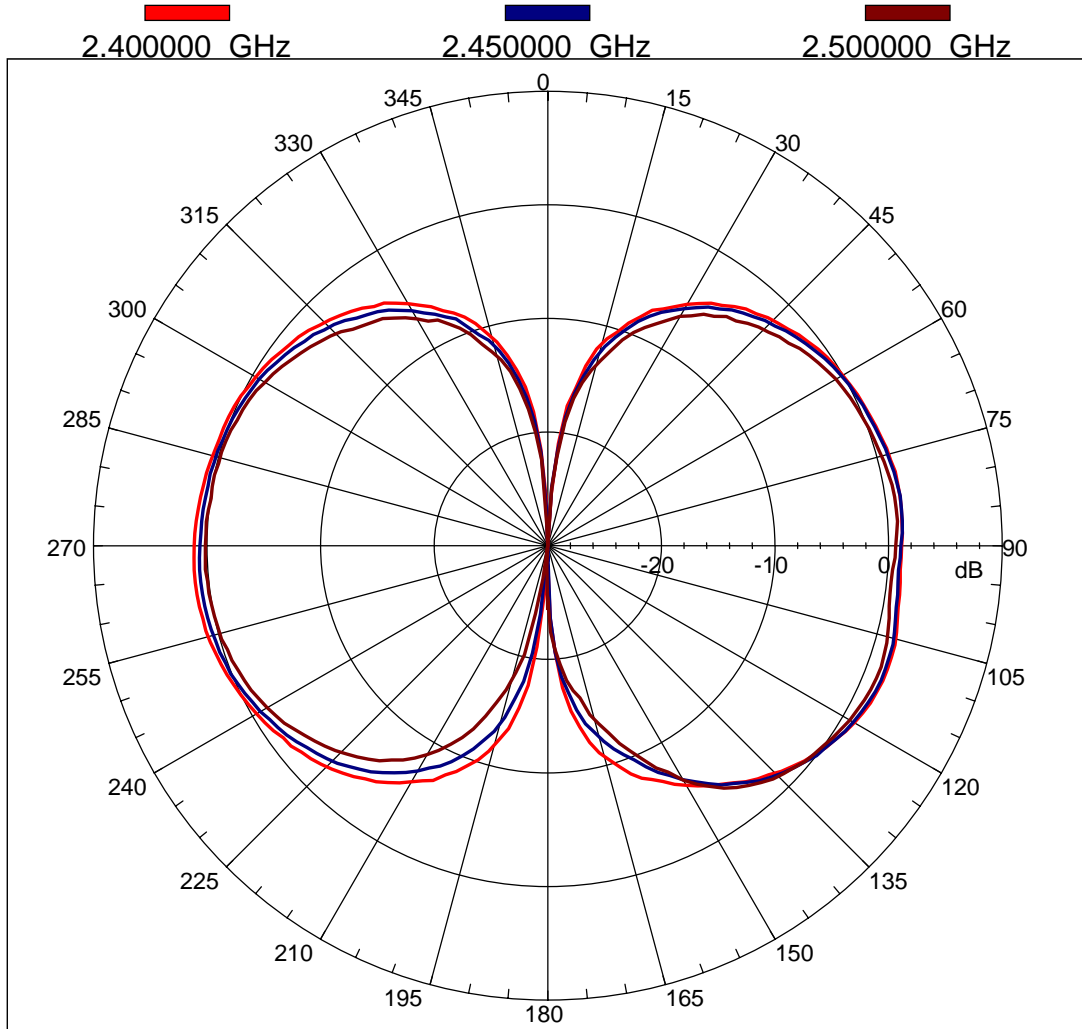

2007.6.7



Wha Yu Group

RF Antenna Cable Assembly

P/NO:C147-510381-A SPEC:2.4GHz NO:0706-0005

Far-field amplitude of C147-510381-A (0706-0005) V.nsi

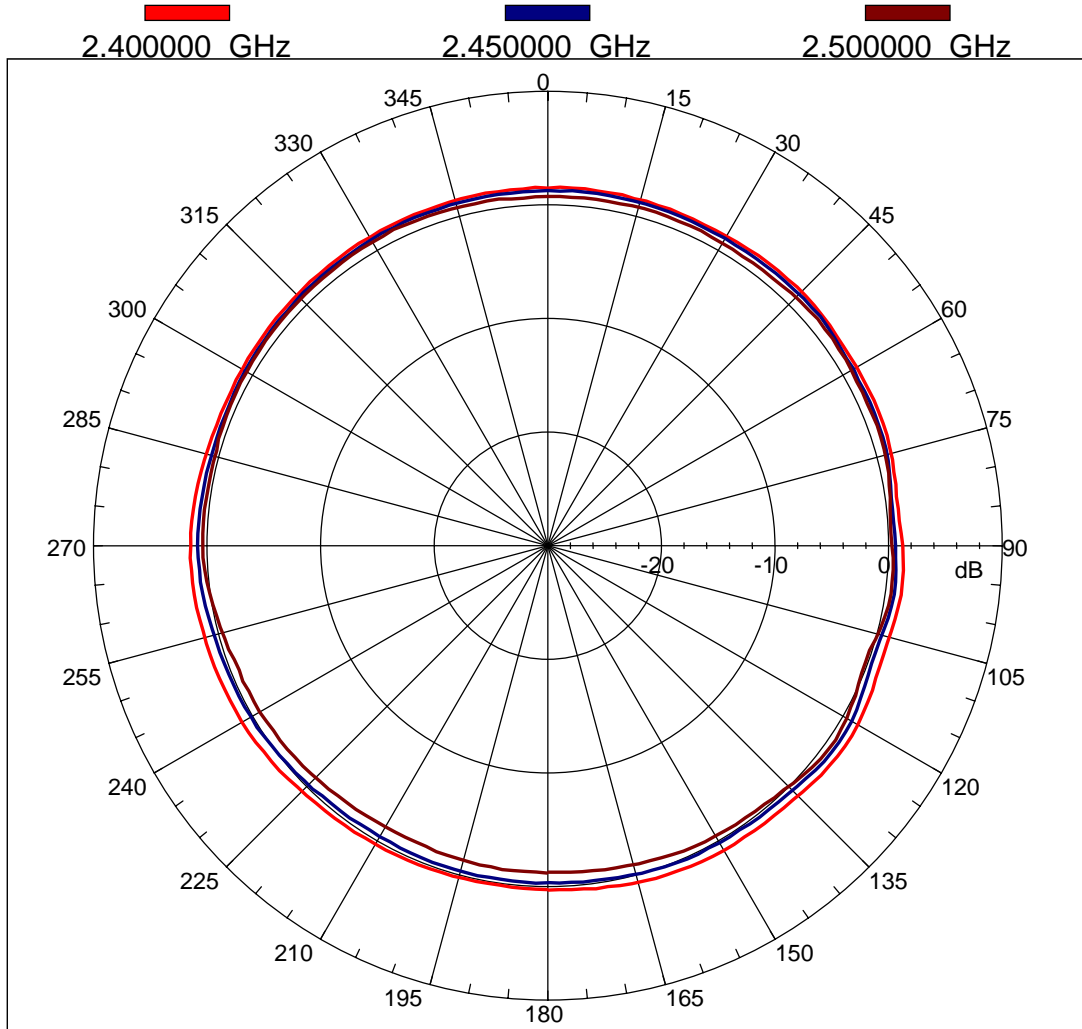

2007.6.7