



SPORTON International Inc.

No. 52, Hwa Ya 1st Rd., Hwa Ya Technology Park, Kwei-Shan Hsiang, Tao Yuan Hsien, Taiwan, R.O.C.
Ph: 886-3-327-3456 / FAX: 886-3-327-0973 / www.sporton.com.tw

FCC RADIO TEST REPORT

Applicant's company	Linksys LLC
Applicant Address	131 Theory Drive, Irvine, CA 92617, USA
FCC ID	Q87-RE6500

Product Name	Linksys AC1200 MAX Wi-Fi Range Extender
Brand Name	Linksys
Model No.	RE6500
Test Rule Part(s)	47 CFR FCC Part 15 Subpart E § 15.407
Test Freq. Range	5150 ~ 5250MHz
Received Date	Feb. 18, 2014
Final Test Date	Apr. 10, 2014
Submission Type	Original Equipment

Statement

Test result included is for the IEEE 802.11n and IEEE 802.11a/ac (5150 ~ 5250MHz) of the product.

The test result in this report refers exclusively to the presented test model / sample.

Without written approval of SPORTON International Inc., the test report shall not be reproduced except in full.

The measurements and test results shown in this test report were made in accordance with the procedures and found in compliance with the limit given in **ANSI C63.10-2009, 47 CFR FCC Part 15 Subpart E, KDB 789033 D01 v01r03, KDB 662911 D01 v02r01, KDB644545 D01v01r02.**

The test equipment used to perform the test is calibrated and traceable to NML/ROC.



Table of Contents

1. CERTIFICATE OF COMPLIANCE	1
2. SUMMARY OF THE TEST RESULT	2
3. GENERAL INFORMATION	3
3.1. Product Details.....	3
3.2. Accessories.....	5
3.3. Table for Filed Antenna.....	6
3.4. Table for Carrier Frequencies	6
3.5. Table for Test Modes	7
3.6. Table for Testing Locations.....	8
3.7. Table for Supporting Units	9
3.8. Table for Parameters of Test Software Setting	10
3.9. EUT Operation during Test	10
3.10. Duty Cycle.....	11
3.11. Test Configurations	13
4. TEST RESULT	16
4.1. AC Power Line Conducted Emissions Measurement.....	16
4.2. 26dB Bandwidth and 99% Occupied Bandwidth Measurement.....	20
4.3. Maximum Conducted Output Power Measurement.....	28
4.4. Power Spectral Density Measurement	31
4.5. Peak Excursion Measurement	37
4.6. Radiated Emissions Measurement	42
4.7. Band Edge Emissions Measurement	58
4.8. Frequency Stability Measurement	63
4.9. Antenna Requirements	65
5. LIST OF MEASURING EQUIPMENTS	66
6. MEASUREMENT UNCERTAINTY.....	68
APPENDIX A. TEST PHOTOS	A1 ~ A5
APPENDIX B. MAXIMUM PERMISSIBLE EXPOSURE	B1 ~ B3
APPENDIX C. RADIATED EMISSION CO-LOCATION REPORT	C1 ~ C3



History of This Test Report

REPORT NO.	VERSION	DESCRIPTION	ISSUED DATE
FR421849AB	Rev. 01	Initial issue of report	Apr. 17, 2014



1. CERTIFICATE OF COMPLIANCE

Product Name : Linksys AC1200 MAX Wi-Fi Range Extender
Brand Name : Linksys
Model No. : RE6500
Applicant : Linksys LLC
Test Rule Part(s) : 47 CFR FCC Part 15 Subpart E § 15.407

Sporton International as requested by the applicant to evaluate the EMC performance of the product sample received on Feb. 18, 2014 would like to declare that the tested sample has been evaluated and found to be in compliance with the tested rule parts. The data recorded as well as the test configuration specified is true and accurate for showing the sample's EMC nature.

A handwritten signature in blue ink, appearing to read 'Sam Chen', is written over a horizontal line.

Sam Chen

SPORTON INTERNATIONAL INC.

2. SUMMARY OF THE TEST RESULT

Applied Standard: 47 CFR FCC Part 15 Subpart E				
Part	Rule Section	Description of Test	Result	Under Limit
4.1	15.207	AC Power Line Conducted Emissions	Complies	12.52 dB
4.2	15.407(a)	26dB Spectrum Bandwidth and 99% Occupied Bandwidth	Complies	-
4.3	15.407(a)	Maximum Conducted Output Power	Complies	1.03 dB
4.4	15.407(a)	Power Spectral Density	Complies	1.54 dB
4.5	15.407(a)	Peak Excursion	Complies	3.70 dB
4.6	15.407(b)	Radiated Emissions	Complies	1.50 dB
4.7	15.407(b)	Band Edge Emissions	Complies	1.20 dB
4.8	15.407(g)	Frequency Stability	Complies	-
4.9	15.203	Antenna Requirements	Complies	-

3. GENERAL INFORMATION

3.1. Product Details

IEEE 802.11n/ac

Items	Description
Product Type	WLAN (2TX, 2RX)
Radio Type	Intentional Transceiver
Power Type	From power adapter
Modulation	see the below table for IEEE 802.11n/ac
Data Modulation	For 802.11n: OFDM (BPSK / QPSK / 16QAM / 64QAM) For 802.11ac: OFDM (BPSK / QPSK / 16QAM / 64QAM / 256QAM)
Data Rate (Mbps)	see the below table for IEEE 802.11n/ac
Frequency Range	5150 ~ 5250MHz
Channel Number	4 for 20MHz bandwidth ; 2 for 40MHz bandwidth 1 for 80MHz bandwidth
Channel Band Width (99%)	802.11ac MCS0, Nss1 (VHT20): 17.71 MHz ; 802.11ac MCS0, Nss1 (VHT40): 36.12 MHz ; 802.11ac MCS0, Nss1 (VHT80): 75.02 MHz
Maximum Conducted Output Power	802.11ac MCS0, Nss1 (VHT20): 15.87 dBm ; 802.11ac MCS0, Nss1 (VHT40): 15.88 dBm ; 802.11ac MCS0, Nss1 (VHT80): 15.97 dBm
Carrier Frequencies	Please refer to section 3.4
Antenna	Please refer to section 3.3

IEEE 802.11a

Items	Description
Product Type	WLAN (2TX, 2RX)
Radio Type	Intentional Transceiver
Power Type	From power adapter
Modulation	OFDM for IEEE 802.11a
Data Modulation	OFDM (BPSK / QPSK / 16QAM / 64QAM)
Data Rate (Mbps)	OFDM (6/9/12/18/24/36/48/54)
Frequency Range	5150 ~ 5250MHz
Channel Number	4
Channel Band Width (99%)	17.13 MHz
Maximum Conducted Output Power	15.92 dBm
Carrier Frequencies	Please refer to section 3.4
Antenna	Please refer to section 3.3

Items	Description	
Communication Mode	<input checked="" type="checkbox"/> IP Based (Load Based)	<input type="checkbox"/> Frame Based
Beamforming Function	<input type="checkbox"/> With beamforming	<input checked="" type="checkbox"/> Without beamforming

Antenna and Bandwidth

Antenna	Two (TX)		
	20 MHz	40 MHz	80 MHz
IEEE 802.11a	V	X	X
IEEE 802.11n	V	V	X
IEEE 802.11ac	V	V	V

IEEE 11n/ac Spec.

Protocol	Number of Transmit Chains (NTX)	Data Rate / MCS
802.11n (HT20)	2	MCS 0-15
802.11n (HT40)	2	MCS 0-15
802.11ac (VHT20)	2	MCS 0-9, Nss1-2
802.11ac (VHT40)	2	MCS 0-9, Nss1-2
802.11ac (VHT80)	2	MCS 0-9, Nss1-2

Note 1: IEEE Std. 802.11n modulation consists of HT20 and HT40 (HT: High Throughput).
Then EUT support HT20 and HT40.

Note 2: IEEE Std. 802.11ac modulation consists of VHT20, VHT40, VHT80 and VHT160 (VHT: Very High Throughput). Then EUT support VHT20, VHT40 and VHT80.

Note 3: Modulation modes consist of below configuration:
HT20/HT40: IEEE 802.11n, VHT20/VHT40/VHT80: IEEE 802.11ac

3.2. Accessories

Power	Brand	Model No.	Rating
Adapter 1 (Fixed plug)	Ktec	KSAS0121200100VU	INPUT: 100-240Vac, 50/60Hz, 0.4A OUTPUT: 12Vdc, 1.0A
Adapter 2 (Removable plug)	Ktec	KSAS0121200100D5	INPUT: 100-240Vac, 50/60Hz, 0.4A OUTPUT: 12Vdc, 1.0A
Others			
Plug*1 (Only for Adapter 2 use)			
RJ-45 cable*1: Non-shielded, 1.5m			

3.3. Table for Filed Antenna

Ant.	Brand	Model No.	Antenna Type	Connector	Gain (dBi)		Cable Loss (dB)		True Gain (dBi)	
					2.4GHz	5GHz	2.4GHz	5GHz	2.4GHz	5GHz
1	INVAX	AN2450	Dipole Antenna	RP SMA	3.5	3.5	1.0	2.8	2.5	0.7
2	INVAX	AN2450	Dipole Antenna	RP SMA	3.5	3.5	2.8	1.0	0.7	2.5

Note: The EUT has two antennas.

Ant. 1 and Ant. 2 could transmit/receive simultaneously.

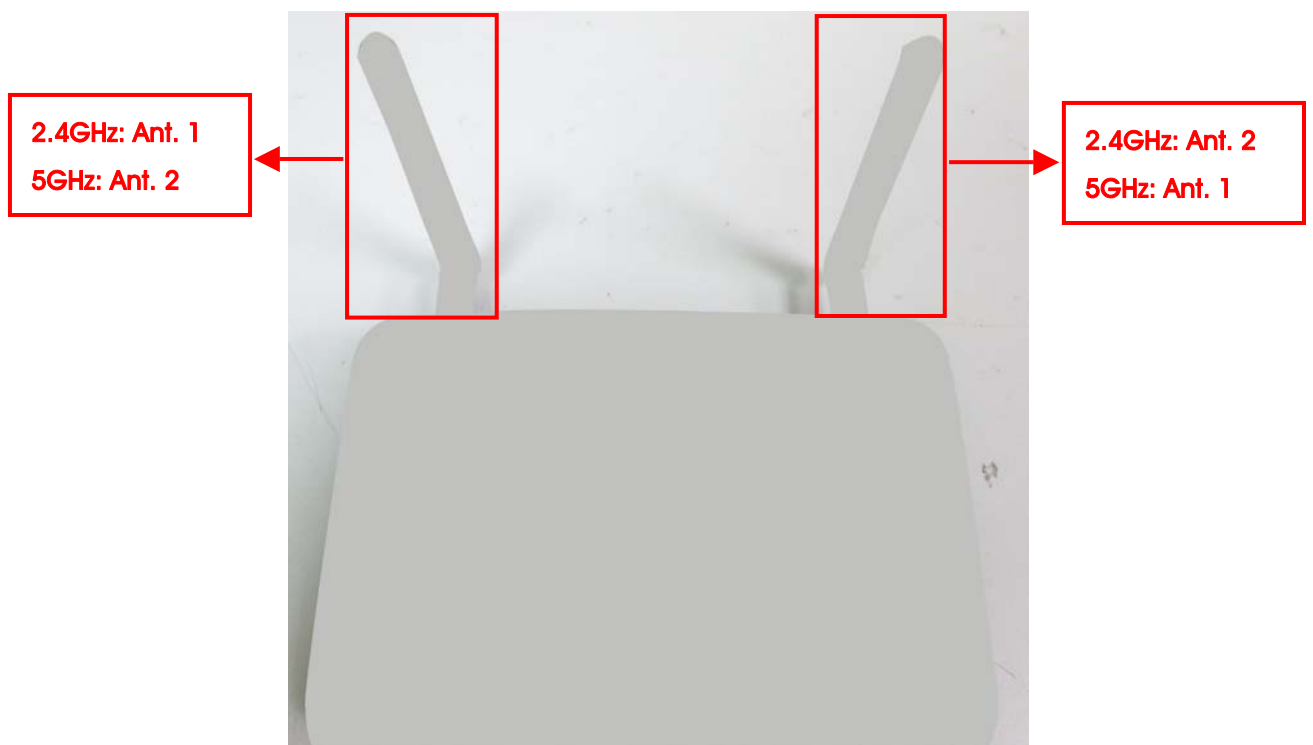

3.4. Table for Carrier Frequencies

There are three bandwidth systems.

For 20MHz bandwidth systems, use Channel 36, 40, 44, 48.

For 40MHz bandwidth systems, use Channel 38, 46.

For 80MHz bandwidth systems, use Channel 42.

Frequency Band	Channel No.	Frequency	Channel No.	Frequency
5150~5250 MHz Band 1	36	5180 MHz	44	5220 MHz
	38	5190 MHz	46	5230 MHz
	40	5200 MHz	48	5240 MHz
	42	5210 MHz	-	-

3.5. Table for Test Modes

Preliminary tests were performed in different data rate to find the worst radiated emission. The data rate shown in the table below is the worst-case rate with respect to the specific test item. Investigation has been done on all the possible configurations for searching the worst cases. The following table is a list of the test modes shown in this test report.

Test Items	Mode		Data Rate	Channel	Antenna
AC Power Conducted Emission	Normal Link		-	-	-
Max. Conducted Output Power	11ac VHT20	Band 1	MCS0, Nss1	36/40/48	1+2
	11ac VHT40	Band 1	MCS0, Nss1	38/46	1+2
	11ac VHT80	Band 1	MCS0, Nss1	42	1+2
	11a/BPSK	Band 1	6Mbps	36/40/48	1+2
Power Spectral Density	11ac VHT20	Band 1	MCS0, Nss1	36/40/48	1+2
	11ac VHT40	Band 1	MCS0, Nss1	38/46	1+2
	11ac VHT80	Band 1	MCS0, Nss1	42	1+2
	11a/BPSK	Band 1	6Mbps	36/40/48	1+2
26dB Spectrum Bandwidth 99% Occupied Bandwidth Measurement	11ac VHT20	Band 1	MCS0, Nss1	36/40/48	1+2
	11ac VHT40	Band 1	MCS0, Nss1	38/46	1+2
	11ac VHT80	Band 1	MCS0, Nss1	42	1+2
	11a/BPSK	Band 1	6Mbps	36/40/48	1+2
Peak Excursion	11ac VHT20	Band 1	MCS0, Nss1	40	1+2
	11ac VHT40	Band 1	MCS0, Nss1	46	1+2
	11ac VHT80	Band 1	MCS0, Nss1	42	1+2
	11a/BPSK	Band 1	6Mbps	48	1+2
Radiated Emission Below 1GHz	Normal Link		-	-	-
Radiated Emission Above 1GHz	11ac VHT20	Band 1	MCS0, Nss1	36/40/48	1+2
	11ac VHT40	Band 1	MCS0, Nss1	38/46	1+2
	11ac VHT80	Band 1	MCS0, Nss1	42	1+2
	11a/BPSK	Band 1	6Mbps	36/40/48	1+2
Band Edge Emission	11ac VHT20	Band 1	MCS0, Nss1	36/40/48	1+2
	11ac VHT40	Band 1	MCS0, Nss1	38/46	1+2
	11ac VHT80	Band 1	MCS0, Nss1	42	1+2
	11a/BPSK	Band 1	6Mbps	36/40/48	1+2
Frequency Stability	Un-modulation		-	40	1+2

Note: VHT20/VHT40 covers HT20/HT40, due to same modulation.

The following test modes were performed for all tests:

For AC Power Line Conducted Emissions test:

Mode 1. EUT + Adapter 1

Mode 2. EUT + Adapter 2

Mode 1 generated the worst test result, so it was recorded in this report.

For Radiated Emissions Below 1GHz test:

Mode 1. Laying of EUT + Adapter 1

Mode 2. Stand of EUT + Adapter 1

Mode 1 has been evaluated to be the worst case among Mode 1~2, thus measurement for Mode 3 will follow this same test mode.

Mode 3. Laying of EUT + Adapter 1

Mode 1 generated the worst test result, so it was recorded in this report.

For Radiated Emissions Above 1GHz, Band Edge Emissions and Radiated Emission Co-location tests:

The mode "Laying of EUT + Adapter" has been evaluated to be the worst case for Radiated Emissions Below 1GHz test.

Consequently, measurement for Radiated Emissions Above 1GHz, Band Edge Emissions and Radiated Emission Co-location tests will follow this same test mode.

The EUT could be applied with 2.4GHz WLAN function and 5GHz WLAN function; therefore Co-location Maximum Permissible Exposure (please refer to Appendix B) and Radiated Emission Co-location (please refer to Appendix C) tests are added for simultaneously transmit between 2.4GHz WLAN function and 5GHz WLAN function.

3.6. Table for Testing Locations

Test Site Location					
Address:	No.8, Lane 724, Bo-ai St., Jhubei City, Hsinchu County 302, Taiwan, R.O.C.				
TEL:	886-3-656-9065				
FAX:	886-3-656-9085				
Test Site No.	Site Category	Location	FCC Reg. No.	IC File No.	VCCI Reg. No
03CH01-CB	SAC	Hsin Chu	262045	IC 4086D	-
CO01-CB	Conduction	Hsin Chu	262045	IC 4086D	-
TH01-CB	OVEN Room	Hsin Chu	-	-	-

Open Area Test Site (OATS); Semi Anechoic Chamber (SAC).

3.7. Table for Supporting Units

For AC Power Line Conducted Emissions test:

Support Unit	Brand	Model	FCC ID
NB	DELL	E6430	DoC
NB	DELL	E6430	DoC
NB	DELL	E6430	DoC
AP Router	Planex	GW-AP54SGX	KA220030603014-1
Earphone	e-Power	S90W	N/A

For Radiated Emissions Below 1GHz test:

Support Unit	Brand	Model	FCC ID
NB	DELL	M1340	E2K4965AGNM
NB	DELL	E6430	DoC
NB	DELL	D420	E2KWM3945ABG
AP Router	Planex	GW-AP54SGX	KA220030603014-1
Earphone	E-BOOKI	E-EPC040	N/A

For Others test:

Support Unit	Brand	Model	FCC ID
NB	DELL	M1340	E2K4965AGNM

3.8. Table for Parameters of Test Software Setting

During testing, Channel and Power Controlling Software provided by the customer was used to control the operating channel as well as the output power level. The RF output power selection is for the setting of RF output power expected by the customer and is going to be fixed on the firmware of the final end product.

Power Parameters of IEEE 802.11ac MCS0, Nss1 VHT20

Test Software Version	MT 7662 QA V 0.0.2.3		
Frequency	5180 MHz	5200 MHz	5240 MHz
MCS0, Nss1 VHT20	19/1A	1A/1B	19/19

Power Parameters of IEEE 802.11ac MCS0, Nss1 VHT40

Test Software Version	MT 7662 QA V 0.0.2.3	
Frequency	5190 MHz	5230 MHz
MCS0, Nss1 VHT40	19/1A	1A/1B

Power Parameters of IEEE 802.11ac MCS0, Nss1 VHT80

Test Software Version	MT 7662 QA V 0.0.2.3
Frequency	5210 MHz
MCS0, Nss1 VHT80	1A/17

Power Parameters of IEEE 802.11a

Test Software Version	MT 7662 QA V 0.0.2.3		
Frequency	5180 MHz	5200 MHz	5240 MHz
IEEE 802.11a	1A/1B	19/1A	1A/1B

3.9. EUT Operation during Test

The EUT was programmed to be in continuously transmitting mode.

3.10. Duty Cycle

IEEE 802.11ac MCS0, Nss1 VHT20

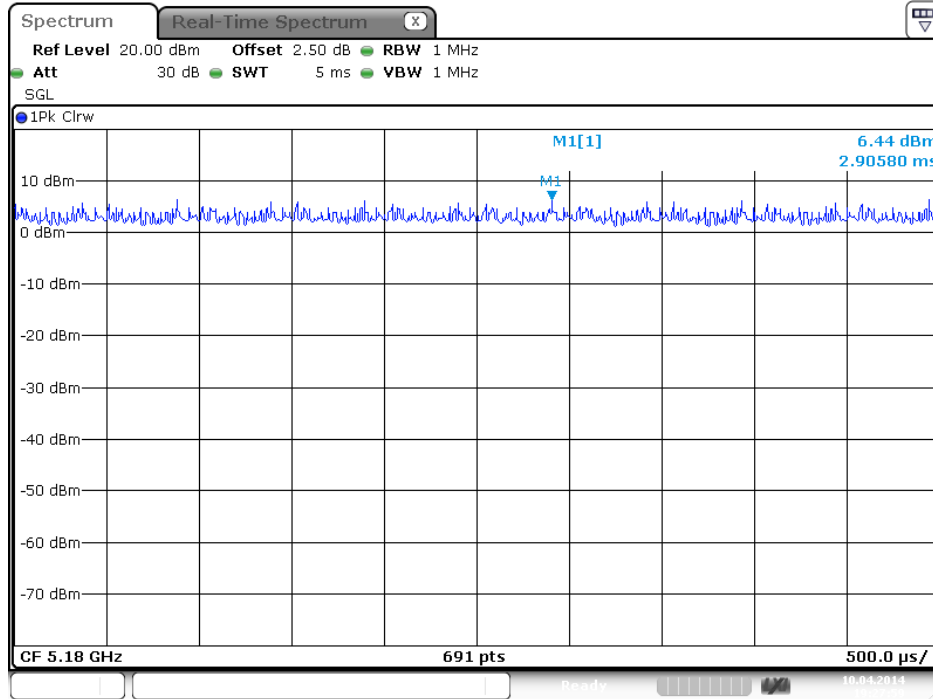

Date: 10.APR.2014 19:27:59

IEEE 802.11ac MCS0, Nss1 VHT40

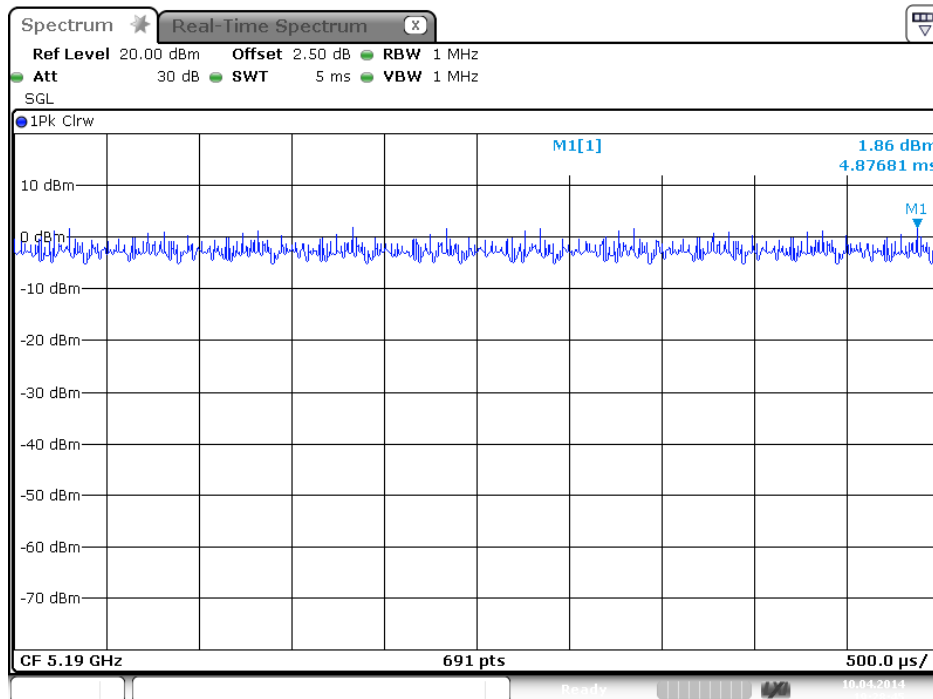

Date: 10.APR.2014 19:28:45

IEEE 802.11ac MCS0, Nss1 VHT80

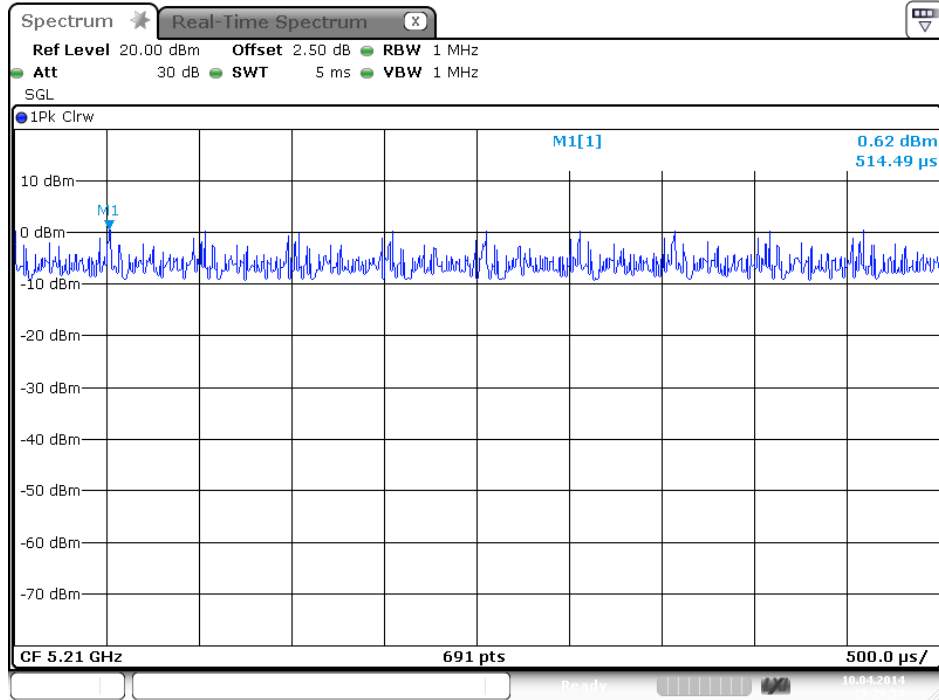

IEEE 802.11a

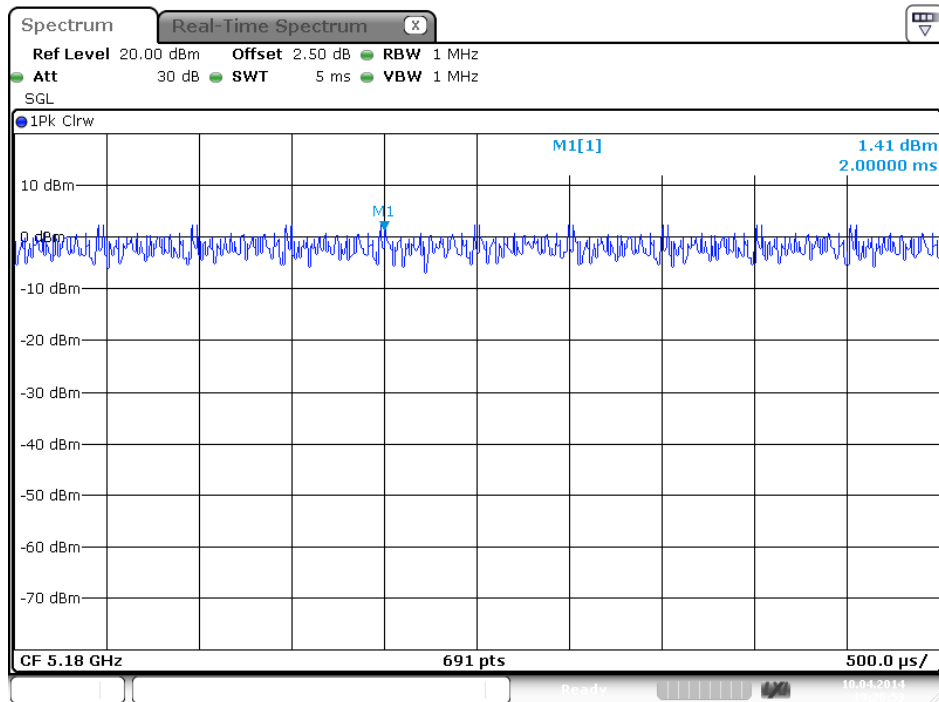

3.11. Test Configurations

3.11.1. AC Power Line Conduction Emissions Test Configuration

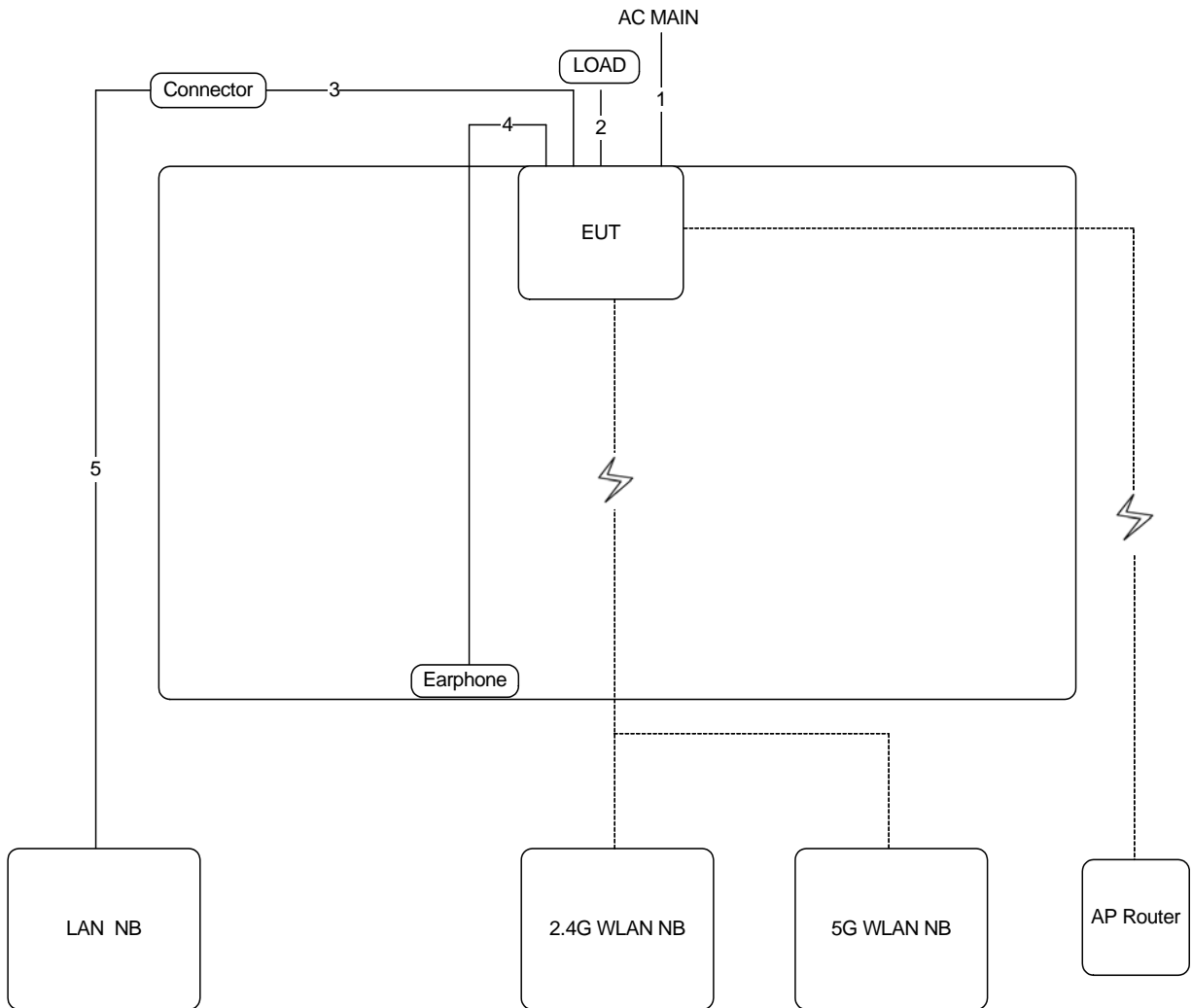

Item	Connection	Shielded	Length
1	Power cable	No	1.5m
2	RJ-45 cable*3	No	3m
3	RJ-45 cable	No	1.5m
4	Audio cable	No	1.1m
5	RJ-45 cable	No	10m

3.11.2. Radiation Emissions Test Configuration

Test Configuration: below 1GHz

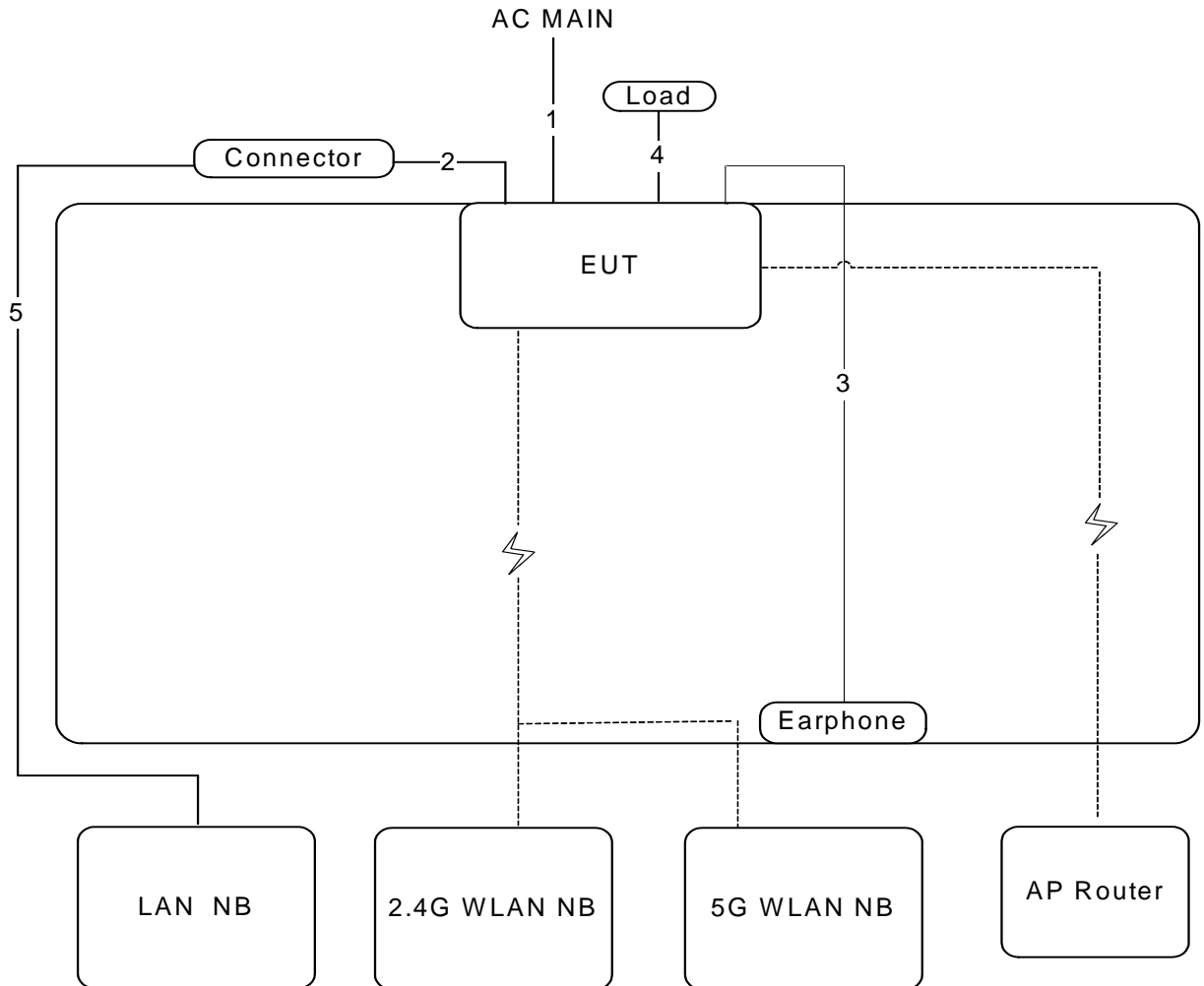

Item	Connection	Shielded	Length
1	Power cable	No	1.5m
2	RJ-45 cable	No	1.5m
3	Audio cable	No	1.1m
4	RJ-45 cable*3	No	0.4m
5	RJ-45 cable	No	10m

Test Configuration: above 1GHz

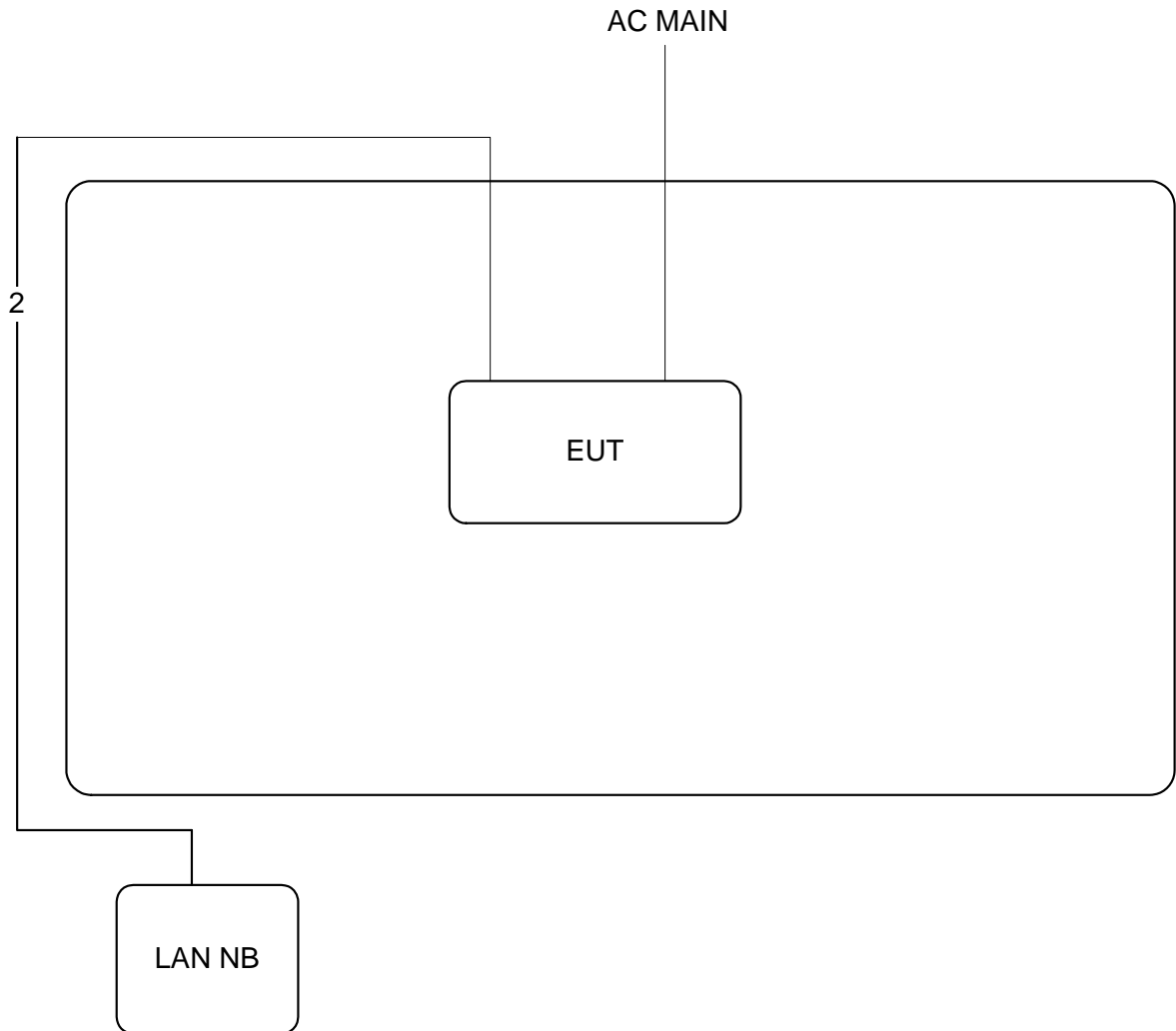

Item	Connection	Shielded	Length
1	Power cable	No	1.5m
2	RJ-45 cable	No	10m

4. TEST RESULT

4.1. AC Power Line Conducted Emissions Measurement

4.1.1. Limit

For this product that is designed to connect to the AC power line, the radio frequency voltage that is conducted back onto the AC power line on any frequency or frequencies within the band 150 kHz to 30 MHz shall not exceed below limits table.

Frequency (MHz)	QP Limit (dBuV)	AV Limit (dBuV)
0.15~0.5	66~56	56~46
0.5~5	56	46
5~30	60	50

4.1.2. Measuring Instruments and Setting

Please refer to section 5 of equipments list in this report. The following table is the setting of the receiver.

Receiver Parameters	Setting
Attenuation	10 dB
Start Frequency	0.15 MHz
Stop Frequency	30 MHz
IF Bandwidth	9 kHz

4.1.3. Test Procedures

1. Configure the EUT according to ANSI C63.10. The EUT or host of EUT has to be placed 0.4 meter far from the conducting wall of the shielding room and at least 80 centimeters from any other grounded conducting surface.
2. Connect EUT or host of EUT to the power mains through a line impedance stabilization network (LISN).
3. All the support units are connected to the other LISNs. The LISN should provide 50uH/50ohms coupling impedance.
4. The frequency range from 150 kHz to 30 MHz was searched.
5. Set the test-receiver system to Peak Detect Function and Specified Bandwidth with Maximum Hold Mode.
6. The measurement has to be done between each power line and ground at the power terminal.

4.1.4. Test Setup Layout

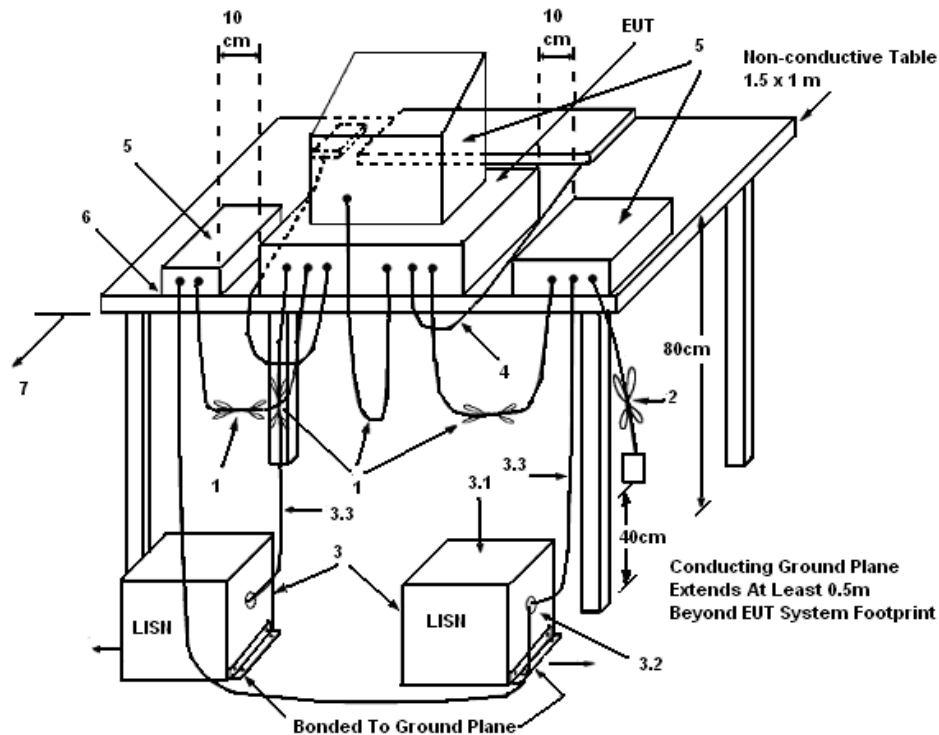

LEGEND:

- (1) Interconnecting cables that hang closer than 40 cm to the ground plane shall be folded back and forth in the center forming a bundle 30 to 40 cm long.
- (2) I/O cables that are not connected to a peripheral shall be bundled in the center. The end of the cable may be terminated, if required, using the correct terminating impedance. The overall length shall not exceed 1 m.
- (3) EUT connected to one LISN. Unused LISN measuring port connectors shall be terminated in 50 Ω . LISN can be placed on top of, or immediately beneath, reference ground plane.
 - (3.1) All other equipment powered from additional LISN(s).
 - (3.2) Multiple outlet strip can be used for multiple power cords of non-EUT equipment.
 - (3.3) LISN at least 80 cm from nearest part of EUT chassis.
- (4) Cables of hand-operated devices, such as keyboards, mice, etc., shall be placed as for normal use.
- (5) Non-EUT components of EUT system being tested.
- (6) Rear of EUT, including peripherals, shall all be aligned and flush with rear of tabletop.
- (7) Rear of tabletop shall be 40 cm removed from a vertical conducting plane that is bonded to the ground plane.

4.1.5. Test Deviation

There is no deviation with the original standard.

4.1.6. EUT Operation during Test

The EUT was placed on the test table and programmed in normal function.

4.1.7. Results of AC Power Line Conducted Emissions Measurement

Temperature	22°C	Humidity	52%
Test Engineer	Sollo Luo	Phase	Line
Configuration	Normal Link	Test Mode	Mode 1

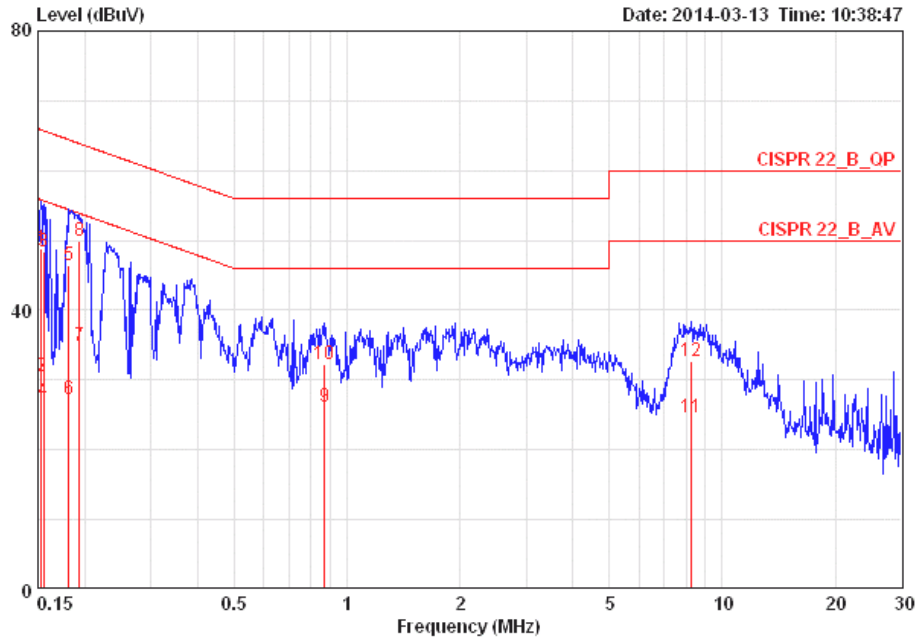

	Freq	Level	Over Limit	Limit Line	LISN Factor	Read Level	Cable Loss	Pol/Phase	Remark
	MHz	dBµV	dB	dBµV	dB	dBµV	dB		
1	0.15321	48.89	-16.93	65.82	0.15	48.58	0.16	LINE	QP
2	0.15321	30.51	-25.31	55.82	0.15	30.20	0.16	LINE	AVERAGE
3	0.15567	48.39	-17.30	65.69	0.15	48.08	0.16	LINE	QP
4	0.15567	27.08	-28.61	55.69	0.15	26.77	0.16	LINE	AVERAGE
5	0.18152	46.37	-18.04	64.42	0.15	46.06	0.16	LINE	QP
6	0.18152	27.27	-27.14	54.42	0.15	26.96	0.16	LINE	AVERAGE
7	0.19344	34.82	-19.06	53.89	0.15	34.51	0.16	LINE	AVERAGE
8	0.19344	50.02	-13.86	63.89	0.15	49.71	0.16	LINE	QP
9	0.87103	26.25	-19.75	46.00	0.16	25.89	0.20	LINE	AVERAGE
10	0.87103	32.31	-23.69	56.00	0.16	31.95	0.20	LINE	QP
11	8.279	24.58	-25.42	50.00	0.34	23.87	0.37	LINE	AVERAGE
12	8.279	32.59	-27.41	60.00	0.34	31.88	0.37	LINE	QP

Temperature	22°C	Humidity	52%
Test Engineer	Sollo Luo	Phase	Neutral
Configuration	Normal Link	Test Mode	Mode 1

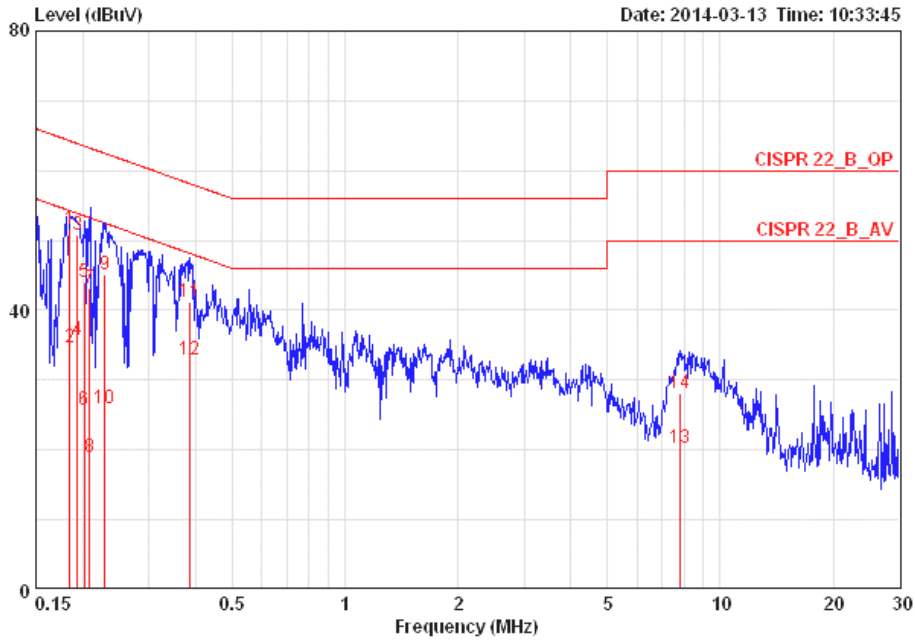

	Freq	Level	Over Limit	Limit	LISN	Read	Cable	Pol/Phase	Remark
	MHz	dBuV	dB	dBuV	dB	dBuV	dB		
1	0.18443	51.76	-12.52	64.28	0.07	51.53	0.16	NEUTRAL	QP
2	0.18443	34.57	-19.71	54.28	0.07	34.34	0.16	NEUTRAL	AVERAGE
3	0.19344	50.82	-13.06	63.89	0.07	50.59	0.16	NEUTRAL	QP
4	0.19344	35.76	-18.12	53.89	0.07	35.53	0.16	NEUTRAL	AVERAGE
5	0.20181	44.14	-19.40	63.54	0.07	43.90	0.17	NEUTRAL	QP
6	0.20181	25.83	-27.71	53.54	0.07	25.59	0.17	NEUTRAL	AVERAGE
7	0.20833	43.09	-20.19	63.27	0.07	42.85	0.17	NEUTRAL	QP
8	0.20833	18.96	-34.32	53.27	0.07	18.72	0.17	NEUTRAL	AVERAGE
9	0.22918	45.20	-17.28	62.48	0.07	44.96	0.17	NEUTRAL	QP
10	0.22918	25.99	-26.49	52.48	0.07	25.75	0.17	NEUTRAL	AVERAGE
11	0.38724	41.16	-16.96	58.12	0.07	40.91	0.18	NEUTRAL	QP
12	0.38724	32.86	-15.26	48.12	0.07	32.61	0.18	NEUTRAL	AVERAGE
13	7.810	20.20	-29.80	50.00	0.22	19.62	0.36	NEUTRAL	AVERAGE
14	7.810	28.15	-31.85	60.00	0.22	27.57	0.36	NEUTRAL	QP

Note:

$$\text{Level} = \text{Read Level} + \text{LISN Factor} + \text{Cable Loss}$$

4.2. 26dB Bandwidth and 99% Occupied Bandwidth Measurement

4.2.1. Limit

No restriction limits.

4.2.2. Measuring Instruments and Setting

Please refer to section 5 of equipments list in this report. The following table is the setting of the spectrum analyzer.

26dB Bandwidth	
Spectrum Parameters	Setting
Attenuation	Auto
Span Frequency	> 26dB Bandwidth
RBW	Approximately 1% of the emission bandwidth
VBW	VBW > RBW
Detector	Peak
Trace	Max Hold
Sweep Time	Auto
99% Occupied Bandwidth	
Spectrum Parameters	Setting
Span	1.5 times to 5.0 times the OBW
RBW	1 % to 5 % of the OBW
VBW	$\geq 3 \times \text{RBW}$
Detector	Peak
Trace	Max Hold

4.2.3. Test Procedures

For Radiated 26dB Bandwidth and 99% Occupied Bandwidth Measurement:

1. The transmitter was radiated to the spectrum analyzer in peak hold mode.
2. Measure the maximum width of the emission that is 26 dB down from the peak of the emission. Compare this with the RBW setting of the analyzer. Readjust RBW and repeat measurement as needed until the RBW/EBW ratio is approximately 1%.

4.2.4. Test Setup Layout

For Radiated 26dB Bandwidth and 99% Occupied Bandwidth Measurement:

This test setup layout is the same as that shown in section 4.6.4.

4.2.5. Test Deviation

There is no deviation with the original standard.

4.2.6. EUT Operation during Test

The EUT was programmed to be in continuously transmitting mode.

4.2.7. Test Result of 26dB Bandwidth and 99% Occupied Bandwidth

Temperature	20°C	Humidity	55%
Test Engineer	David Tseng	Configurations	IEEE 802.11ac

Configuration IEEE 802.11ac MCS0, Nss1 VHT20 / Ant. 1 + Ant. 2

Channel	Frequency	26dB Bandwidth (MHz)	99% Occupied Bandwidth (MHz)
36	5180 MHz	20.14	17.71
40	5200 MHz	20.26	17.71
48	5240 MHz	20.23	17.71

Configuration IEEE 802.11ac MCS0, Nss1 VHT40 / Ant. 1 + Ant. 2

Channel	Frequency	26dB Bandwidth (MHz)	99% Occupied Bandwidth (MHz)
38	5190 MHz	47.47	36.12
46	5230 MHz	39.83	36.12

Configuration IEEE 802.11ac MCS0, Nss1 VHT80 / Ant. 1 + Ant. 2

Channel	Frequency	26dB Bandwidth (MHz)	99% Occupied Bandwidth (MHz)
42	5210 MHz	79.04	75.02

Temperature	20°C	Humidity	55%
Test Engineer	David Tseng	Configurations	IEEE 802.11a

Configuration IEEE 802.11a / Ant. 1 + Ant. 2

Channel	Frequency	26dB Bandwidth (MHz)	99% Occupied Bandwidth (MHz)
36	5180 MHz	20.49	17.13
40	5200 MHz	20.29	17.13
48	5240 MHz	21.97	17.13

26dB Bandwidth and 99% Occupied Bandwidth Plot on Configuration IEEE 802.11 ac MCS0, Nss1 VHT20 / Ant. 1 + Ant. 2 / 5180 MHz

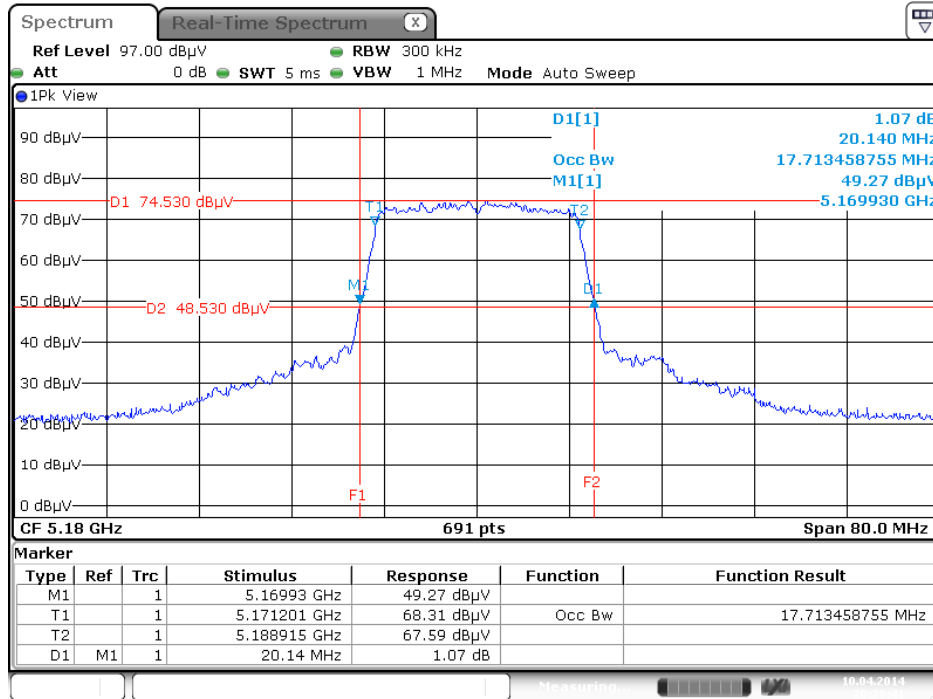

Date: 10. APR. 2014 20:29:41

26dB Bandwidth and 99% Occupied Bandwidth Plot on Configuration IEEE 802.11 ac MCS0, Nss1 VHT20 / Ant. 1 + Ant. 2 / 5200 MHz

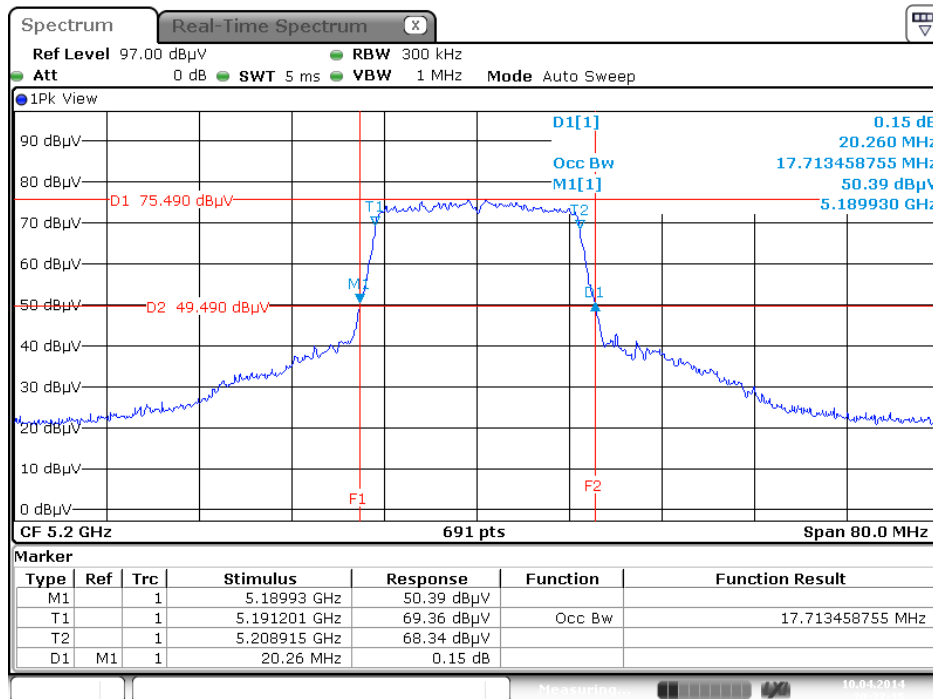

Date: 10. APR. 2014 20:27:15

26dB Bandwidth and 99% Occupied Bandwidth Plot on Configuration IEEE 802.11 ac MCS0, Nss1 VHT20 / Ant. 1 + Ant. 2 / 5240 MHz

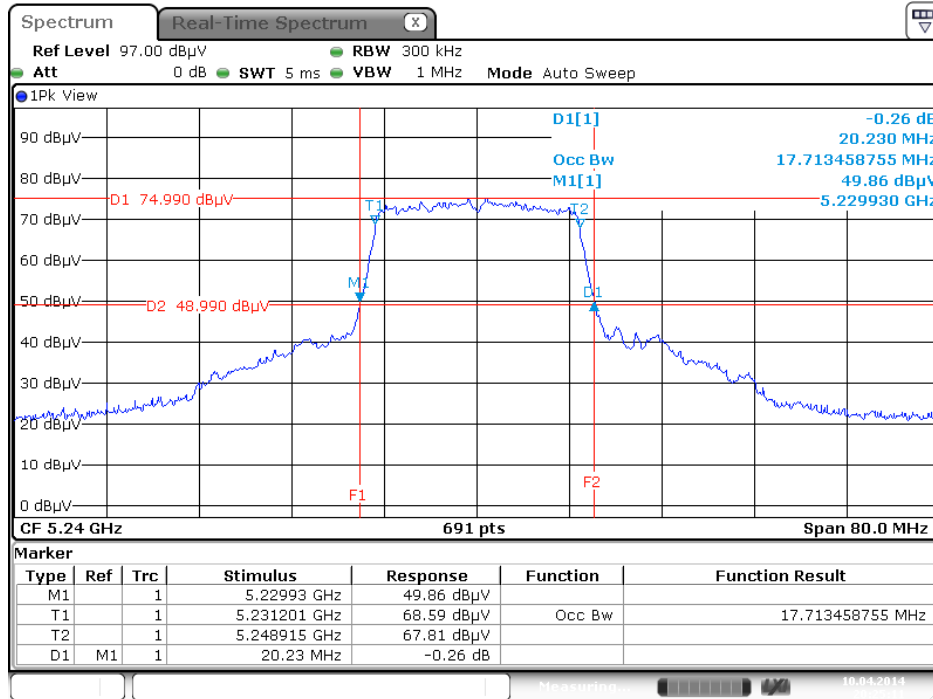

Date: 10. APR. 2014 20:25:11

26dB Bandwidth and 99% Occupied Bandwidth Plot on Configuration IEEE 802.11 ac MCS0, Nss1 VHT40 / Ant. 1 + Ant. 2 / 5190 MHz

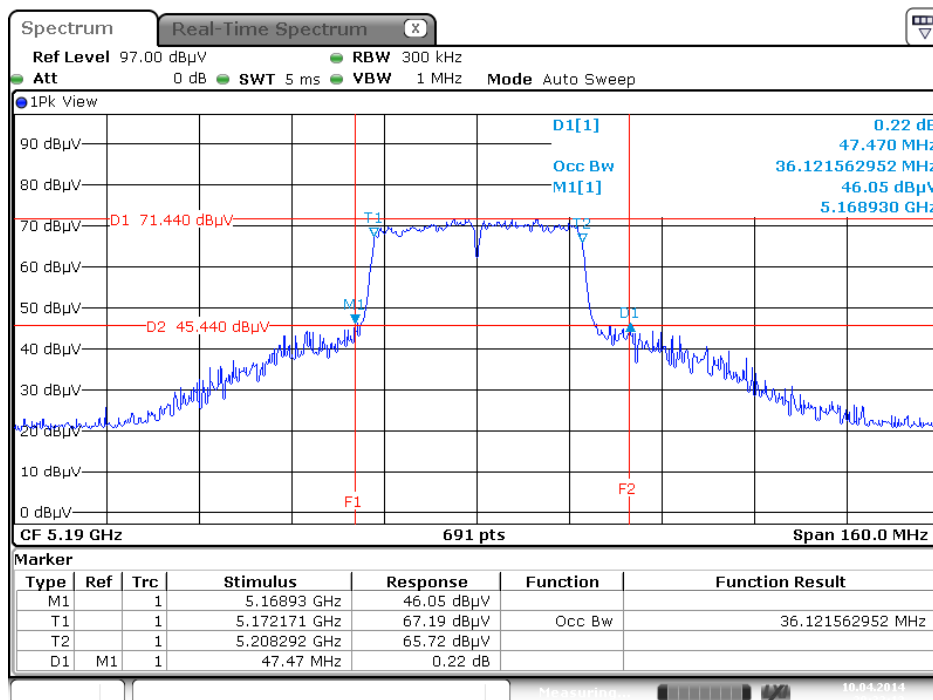

Date: 10. APR. 2014 20:32:13

26dB Bandwidth and 99% Occupied Bandwidth Plot on Configuration IEEE 802.11 ac MCS0, Nss1 VHT40 / Ant. 1 + Ant. 2 / 5230 MHz

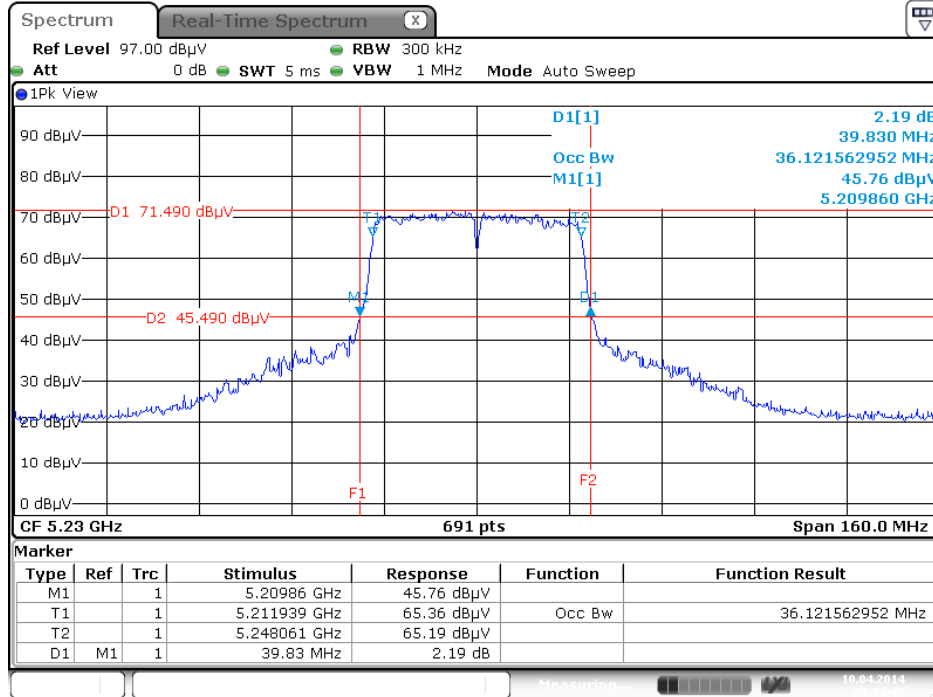

Date: 10. APR. 2014 20:34:46

26dB Bandwidth and 99% Occupied Bandwidth Plot on Configuration IEEE 802.11 ac MCS0, Nss1 VHT80 / Ant. 1 + Ant. 2 / 5210 MHz

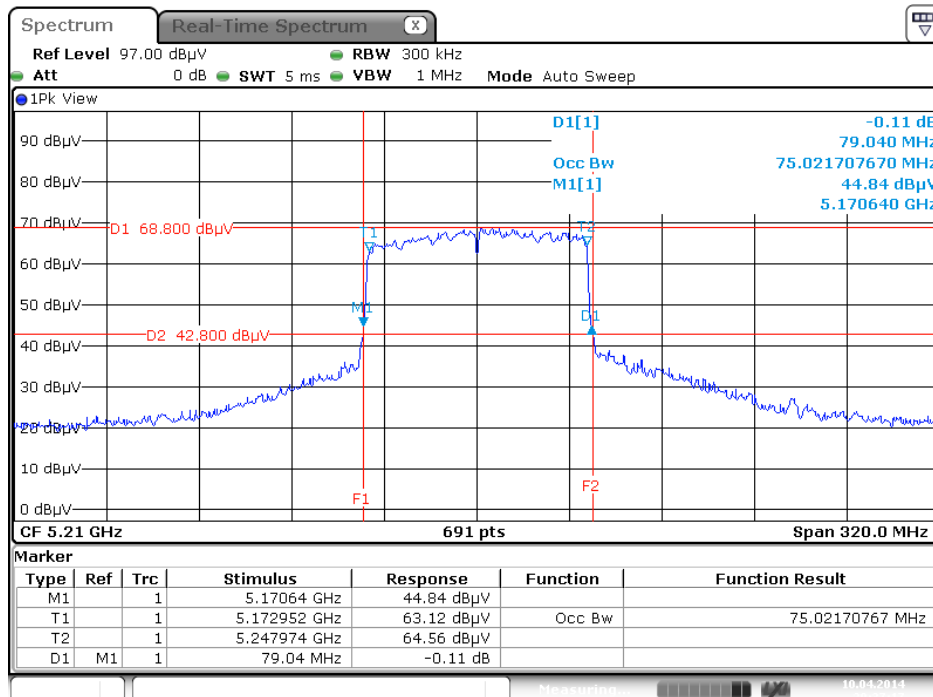

Date: 10. APR. 2014 20:37:18

26dB Bandwidth and 99% Occupied Bandwidth Plot on Configuration IEEE 802.11a / Ant. 1 + Ant. 2 / 5180 MHz

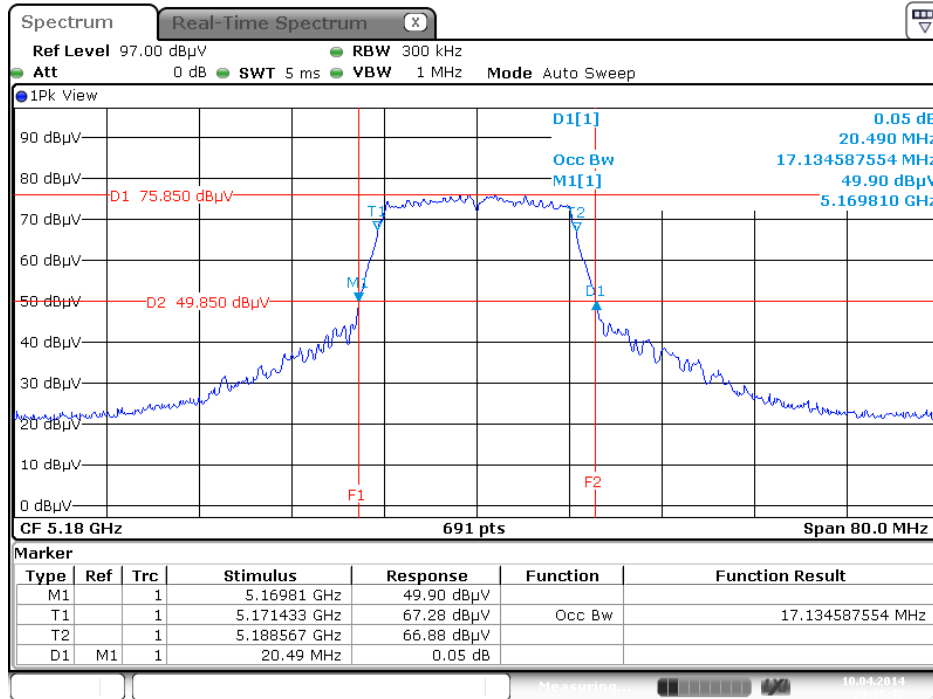

Date: 10. APR. 2014 20:15:32

26dB Bandwidth and 99% Occupied Bandwidth Plot on Configuration IEEE 802.11a / Ant. 1 + Ant. 2 / 5200 MHz

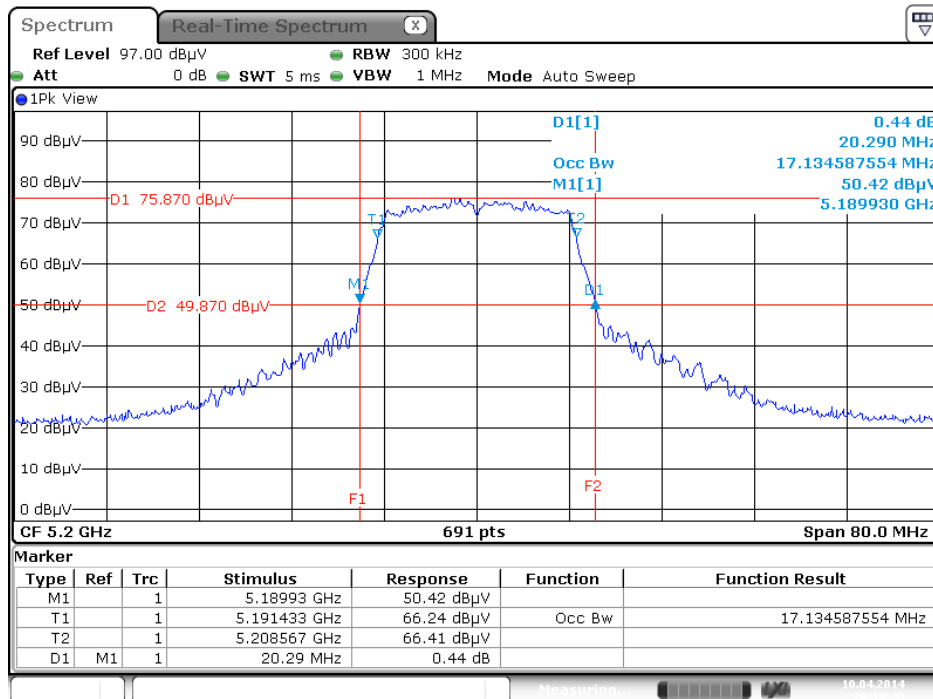

Date: 10. APR. 2014 20:19:41

26dB Bandwidth and 99% Occupied Bandwidth Plot on Configuration IEEE 802.11a / Ant. 1 + Ant. 2 / 5240 MHz

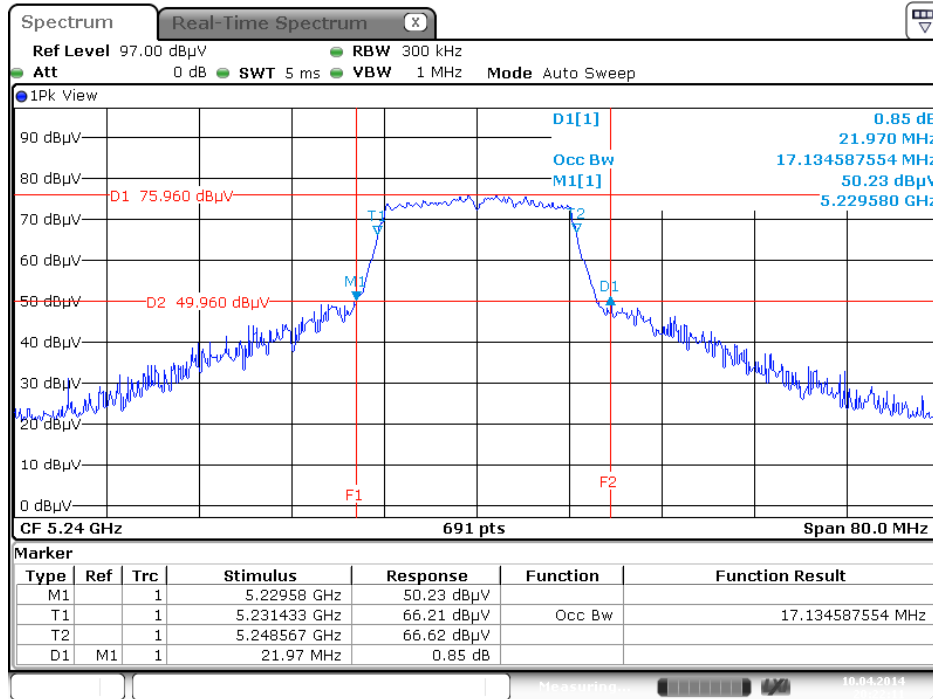

Date: 10.APR.2014 20:22:11

4.3. Maximum Conducted Output Power Measurement

4.3.1. Limit

For the band 5.15~5.25 GHz, the maximum conducted output power over the frequency band of operation shall not exceed the lesser of 50 mW (17dBm) or $4 \text{ dBm} + 10 \log B$, where B is the 26 dB emissions bandwidth in MHz. If transmitting antennas of directional gain greater than 6 dBi are used, both the maximum conducted output power and the peak power spectral density shall be reduced by the amount in dB that the directional gain of the antenna exceeds 6 dBi.

4.3.2. Measuring Instruments and Setting

Please refer to section 5 of equipments list in this report. The following table is the setting of the power meter.

Power Meter Parameter	Setting
Detector	AVERAGE

4.3.3. Test Procedures

1. The transmitter output (antenna port) was connected to the power meter.
2. Test was performed in accordance with KDB 789033 D01 v01r03 for Compliance Testing of Unlicensed National Information Infrastructure (U-NII) Devices - Part 15, Subpart E, section (E) Maximum conducted output power =>(3) Method PM (Measurement using an RF average power meter) Multiple antenna systems was performed in accordance with KDB 662911 D01 v02r01 Emissions Testing of Transmitters with Multiple Outputs in the Same Band.
3. When measuring maximum conducted output power with multiple antenna systems, add every result of the values by mathematic formula.

4.3.4. Test Setup Layout

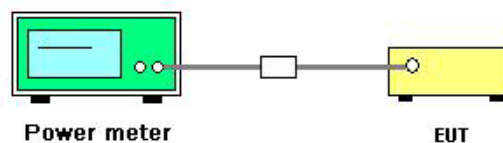

4.3.5. Test Deviation

There is no deviation with the original standard.

4.3.6. EUT Operation during Test

The EUT was programmed to be in continuously transmitting mode.

4.3.7. Test Result of Maximum Conducted Output Power

Temperature	20°C	Humidity	55%
Test Engineer	David Tseng	Configurations	IEEE 802.11ac
Test Date	Apr. 10, 2014		

Configuration IEEE 802.11ac MCS0, Nss1 VHT20

Channel	Frequency	Conducted Power (dBm)			Max. Limit (dBm)	Result
		Ant. 1	Ant. 2	Total		
36	5180 MHz	12.54	12.79	15.68	17.00	Complies
40	5200 MHz	12.91	12.81	15.87	17.00	Complies
48	5240 MHz	12.41	12.76	15.60	17.00	Complies

Configuration IEEE 802.11ac MCS0, Nss1 VHT40

Channel	Frequency	Conducted Power (dBm)			Max. Limit (dBm)	Result
		Ant. 1	Ant. 2	Total		
38	5190 MHz	12.45	12.55	15.51	17.00	Complies
46	5230 MHz	12.89	12.84	15.88	17.00	Complies

Configuration IEEE 802.11ac MCS0, Nss1 VHT80

Channel	Frequency	Conducted Power (dBm)			Max. Limit (dBm)	Result
		Ant. 1	Ant. 2	Total		
42	5210 MHz	13.22	12.68	15.97	17.00	Complies

Temperature	20°C	Humidity	55%
Test Engineer	David Tseng	Configurations	IEEE 802.11a
Test Date	Apr. 10, 2014		

Configuration IEEE 802.11a

Channel	Frequency	Conducted Power (dBm)			Max. Limit (dBm)	Result
		Ant. 1	Ant. 2	Total		
36	5180 MHz	12.75	12.82	15.80	17.00	Complies
40	5200 MHz	12.55	12.61	15.59	17.00	Complies
48	5240 MHz	13.18	12.62	15.92	17.00	Complies

4.4. Power Spectral Density Measurement

4.4.1. Limit

The power spectral density is defined as the highest level of power in dBm per MHz generated by the transmitter within the power envelope. The following table is power spectral density limits and decrease power density limit rule refer to section 4.3.1.

Frequency Range	Power Spectral Density limit (dBm/MHz)
5.15~5.25 GHz	4

4.4.2. Measuring Instruments and Setting

Please refer to section 5 of equipments list in this report. The following table is the setting of the spectrum analyzer.

Spectrum Parameter	Setting
Attenuation	Auto
Span Frequency	Encompass the entire emissions bandwidth (EBW) of the signal
RBW	1000 kHz
VBW	3000 kHz
Detector	RMS
Trace	AVERAGE
Sweep Time	Auto
Trace Average	100 times

4.4.3. Test Procedures

1. The transmitter output (antenna port) was connected RF switch to the spectrum analyzer.
2. Test was performed in accordance with KDB 789033 D01 v01r03 for Compliance Testing of Unlicensed National Information Infrastructure (U-NII) Devices - Part 15, Subpart E, section (C) Maximum conducted output power => (d) Method SA-2 (trace averaging across on and off times of the EUT transmissions, followed by duty cycle correction).
3. Multiple antenna systems was performed in accordance KDB 662911 D01 v02r01 in-Band Power Spectral Density (PSD) Measurements (a) Measure and sum the spectra across the outputs.
4. When measuring first spectral bin of output 1 is summed with that in the first spectral bin of output 2 and that from the first spectral bin of output 3 and so on up to the Nth output to obtain the value for the first frequency bin of the summed spectrum. The summed spectrum value for each of the other frequency bins is computed in the same way.

4.4.4. Test Setup Layout

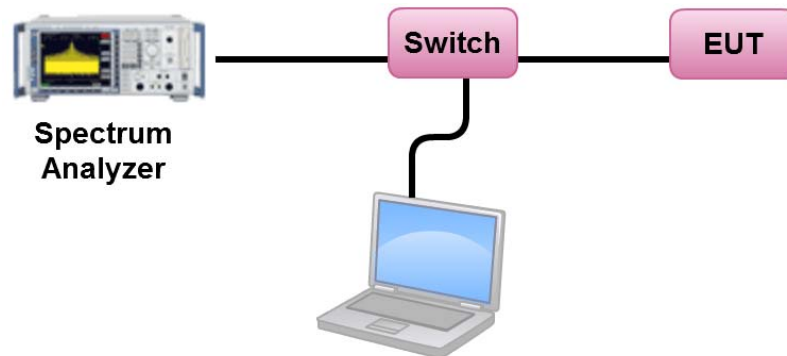

4.4.5. Test Deviation

There is no deviation with the original standard.

4.4.6. EUT Operation during Test

The EUT was programmed to be in continuously transmitting mode.

4.4.7. Test Result of Power Spectral Density

Temperature	20°C	Humidity	55%
Test Engineer	David Tseng	Configurations	IEEE 802.11ac
Test Date	Apr. 10, 2014		

Configuration IEEE 802.11ac MCS0, Nss1 VHT20 / Ant. 1 + Ant. 2

Channel	Frequency	Total Power Density (dBm/MHz)	Max. Limit (dBm/MHz)	Result
36	5180 MHz	2.35	4.00	Complies
40	5200 MHz	2.43	4.00	Complies
48	5240 MHz	2.46	4.00	Complies

Note: Directional gain = $G_{ANT} + 10\log(N_{ANT}/N_{ss}) = 4.70\text{dBi} < 6\text{dBi}$, so the limit doesn't reduce.

Configuration IEEE 802.11ac MCS0, Nss1 VHT40 / Ant. 1 + Ant. 2

Channel	Frequency	Total Power Density (dBm/MHz)	Max. Limit (dBm/MHz)	Result
38	5190 MHz	-2.51	4.00	Complies
46	5230 MHz	-0.53	4.00	Complies

Note: Directional gain = $G_{ANT} + 10\log(N_{ANT}/N_{ss}) = 4.70\text{dBi} < 6\text{dBi}$, so the limit doesn't reduce.

Configuration IEEE 802.11ac MCS0, Nss1 VHT80 / Ant. 1 + Ant. 2

Channel	Frequency	Total Power Density (dBm/MHz)	Max. Limit (dBm/MHz)	Result
42	5210 MHz	-6.52	4.00	Complies

Note: Directional gain = $G_{ANT} + 10\log(N_{ANT}/N_{ss}) = 4.70\text{dBi} < 6\text{dBi}$, so the limit doesn't reduce.

Temperature	20°C	Humidity	55%
Test Engineer	David Tseng	Configurations	IEEE 802.11a
Test Date	Apr. 10, 2014		

Configuration IEEE 802.11a / Ant. 1 + Ant. 2

Channel	Frequency	Total Power Density (dBm/MHz)	Max. Limit (dBm/MHz)	Result
36	5180 MHz	2.44	4.00	Complies
40	5200 MHz	2.33	4.00	Complies
48	5240 MHz	2.41	4.00	Complies

Note: Directional gain = $G_{ANT} + 10 \log(N_{ANT}/N_{ss}) = 4.70 \text{dBi} < 6 \text{dBi}$, so the limit doesn't reduce.

Note: All the test values were listed in the report.

For plots, only the channel with worse result was shown.

Power Density Plot on Configuration IEEE 802.11ac MCS0, Nss1 VHT20 / Ant. 1 + Ant. 2 / 5240 MHz

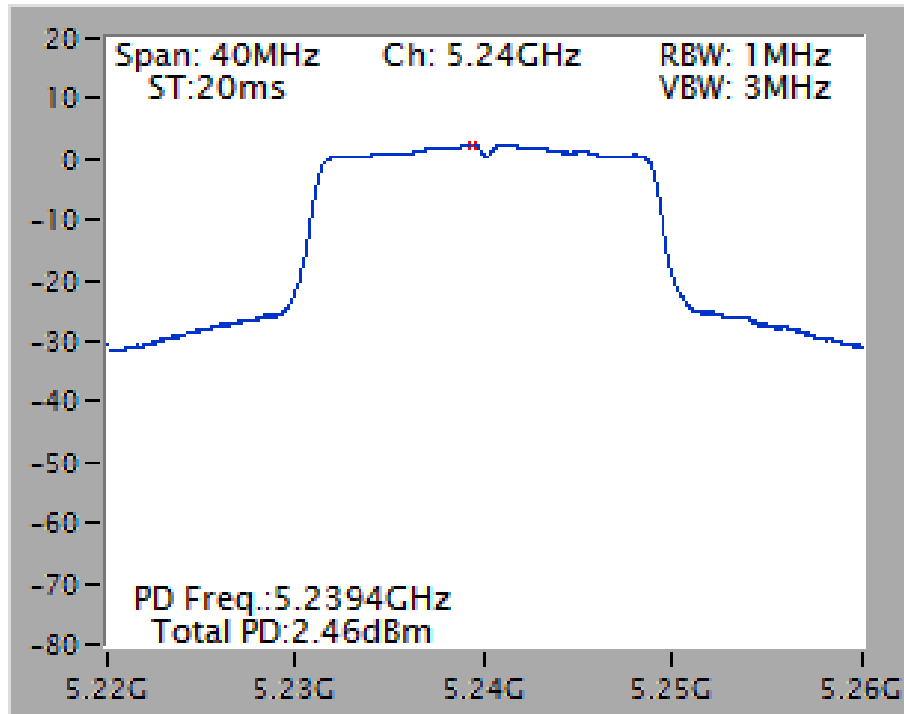

Power Density Plot on Configuration IEEE 802.11ac MCS0, Nss1 VHT40 / Ant. 1 + Ant. 2 / 5230 MHz

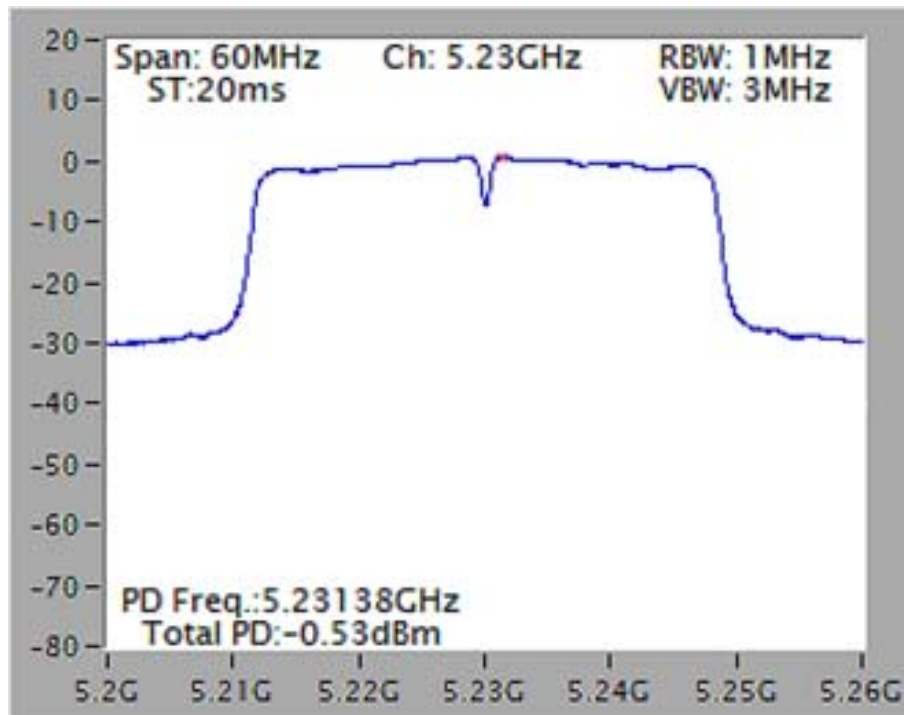

Power Density Plot on Configuration IEEE 802.11ac MCS0, Nss1 VHT80 / Ant. 1 + Ant. 2 / 5210 MHz

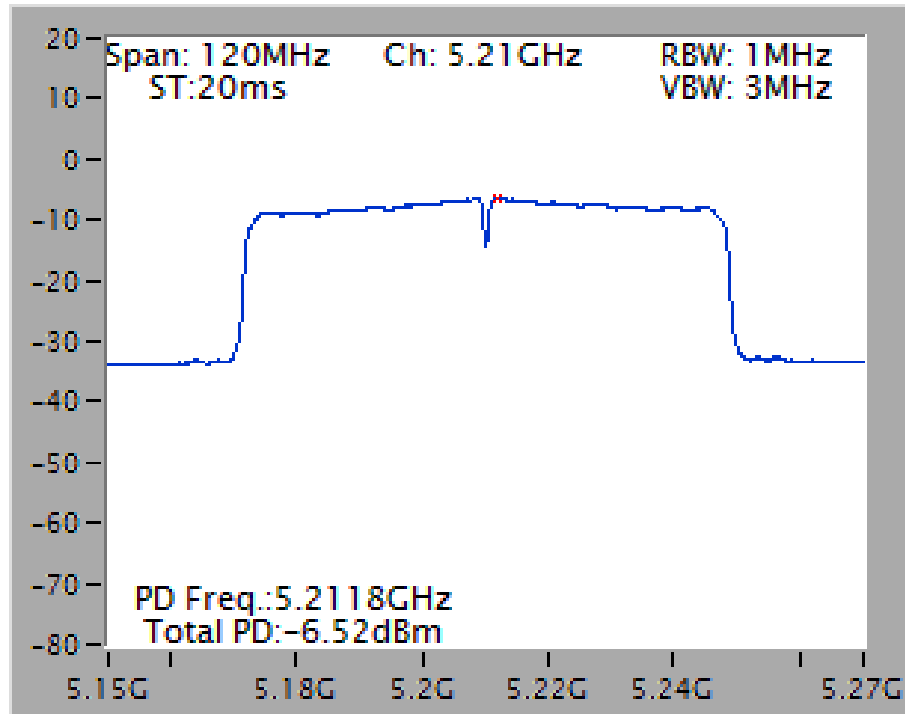

Power Density Plot on Configuration IEEE 802.11a / Ant. 1 + Ant. 2 / 5180 MHz

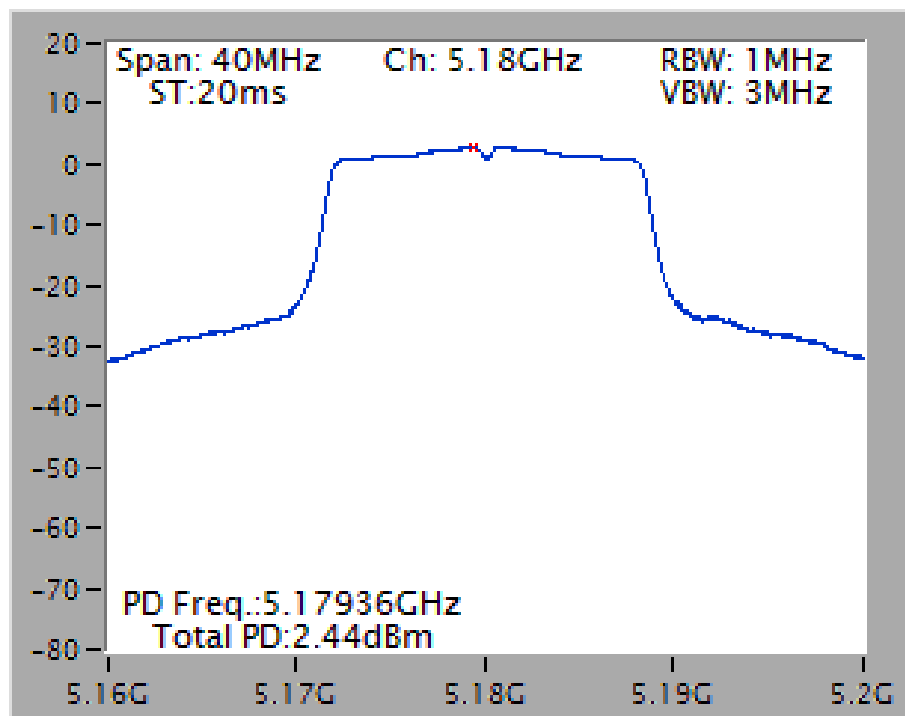

4.5. Peak Excursion Measurement

4.5.1. Limit

The ratio of the peak excursion of the modulation envelope (measured using a peak hold function) to the maximum conducted output power (measured as specified above) shall not exceed 13 dB across any 1 MHz bandwidth or the emissions bandwidth whichever is less.

4.5.2. Measuring Instruments and Setting

Please refer to section 5 of equipments list in this report. The following table is the setting of the spectrum analyzer.

Spectrum Parameter	Setting
Attenuation	Auto
Span Frequency	Encompass the entire emissions bandwidth (EBW) of the signal
RBW	1 MHz (Peak Trace) / 1 MHz (Average Trace)
VBW	≥ 3 MHz (Peak Trace) / ≥ 3 MHz (Average Trace)
Detector	Peak (Peak Trace) / RMS (Average Trace)
Trace	Trace: Max hold (Peak Trace) / Trace Average Sweep Count 100 (Average Trace)
Sweep Time	AUTO

4.5.3. Test Procedures

- Trace A, Set RBW = 1MHz, VBW = 3MHz, Span >26dB bandwidth, Max. hold.
- Delta Mark trace A Maximum frequency and trace B same frequency.
- Repeat the above procedure until measurements for all frequencies were complete.
- Testing each modulation mode on a single channel in single operating band at single output port.
All signal types need test (DSSS, OFDM). All modulation types need test (BPSK, QPSK, 16-QAM, 64-QAM, 256-QAM). All bandwidth modes need test.

4.5.4. Test Setup Layout

This test setup layout is the same as that shown in section 4.4.4.

4.5.5. Test Deviation

There is no deviation with the original standard.

4.5.6. EUT Operation during Test

The EUT was programmed to be in continuously transmitting mode.

4.5.7. Test Result of Peak Excursion

Temperature	20°C	Humidity	55%
Test Engineer	David Tseng	Configurations	IEEE 802.11ac

Configuration IEEE 802.11ac VHT20 / Ant. 1 + Ant. 2

Modulation	Frequency	Peak Excursion (dB)	Max. Limit (dB)	Result
BPSK (MCS0)	5200 MHz	8.25	13	Complies
QPSK (MCS1)	5200 MHz	8.95	13	Complies
16QAM (MCS3)	5200 MHz	9.30	13	Complies
64QAM (MCS5)	5200 MHz	9.02	13	Complies
256QAM (MCS8)	5200 MHz	8.71	13	Complies

Configuration IEEE 802.11ac VHT40 / Ant. 1 + Ant. 2

Modulation	Frequency	Peak Excursion (dB)	Max. Limit (dB)	Result
BPSK (MCS0)	5230 MHz	8.33	13	Complies
QPSK (MCS1)	5230 MHz	8.78	13	Complies
16QAM (MCS3)	5230 MHz	8.92	13	Complies
64QAM (MCS5)	5230 MHz	8.83	13	Complies
256QAM (MCS8)	5230 MHz	8.90	13	Complies

Configuration IEEE 802.11ac VHT80 / Ant. 1 + Ant. 2

Modulation	Frequency	Peak Excursion (dB)	Max. Limit (dB)	Result
BPSK (MCS0)	5210 MHz	8.01	13	Complies
QPSK (MCS1)	5210 MHz	8.03	13	Complies
16QAM (MCS3)	5210 MHz	8.59	13	Complies
64QAM (MCS5)	5210 MHz	9.01	13	Complies
256QAM (MCS8)	5210 MHz	8.16	13	Complies

Temperature	20°C	Humidity	55%
Test Engineer	David Tseng	Configurations	IEEE 802.11a

Configuration IEEE 802.11a / Ant. 1 + Ant. 2

Modulation	Frequency	Peak Excursion (dB)	Max. Limit (dB)	Result
BPSK (6Mbps)	5240 MHz	8.20	13	Complies
QPSK (12Mbps)	5240 MHz	8.21	13	Complies
16QAM (24Mbps)	5240 MHz	8.01	13	Complies
64QAM (48Mbps)	5240 MHz	9.05	13	Complies

Note: All the test values were listed in the report.

For plots, only the modulation with worse result was shown.

Peak Excursion Plot on Configuration IEEE 802.11ac VHT20 / Ant. 1 + Ant. 2 / 16QAM (MCS3) / 5200 MHz

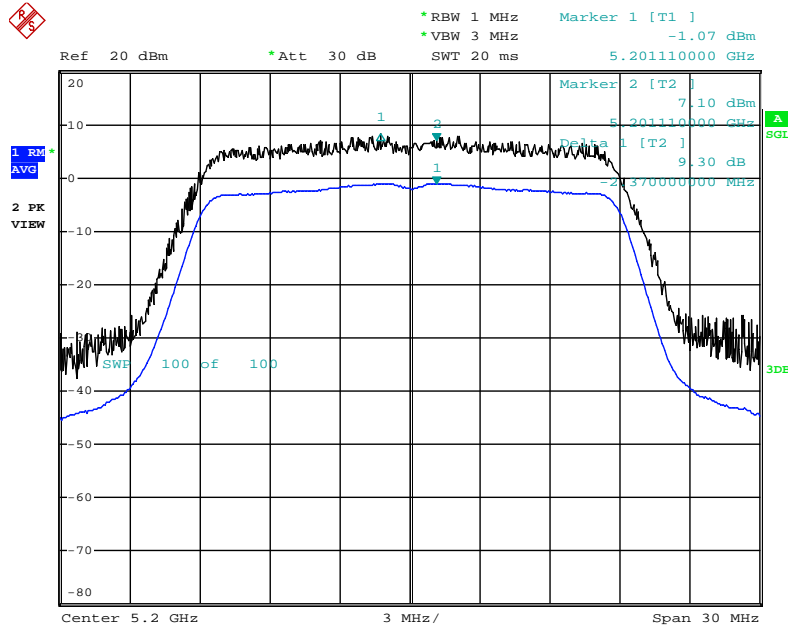

Date: 10.APR.2014 22:05:11

Peak Excursion Plot on Configuration IEEE 802.11ac VHT40 / Ant. 1 + Ant. 2 / 16QAM (MCS3) / 5230 MHz

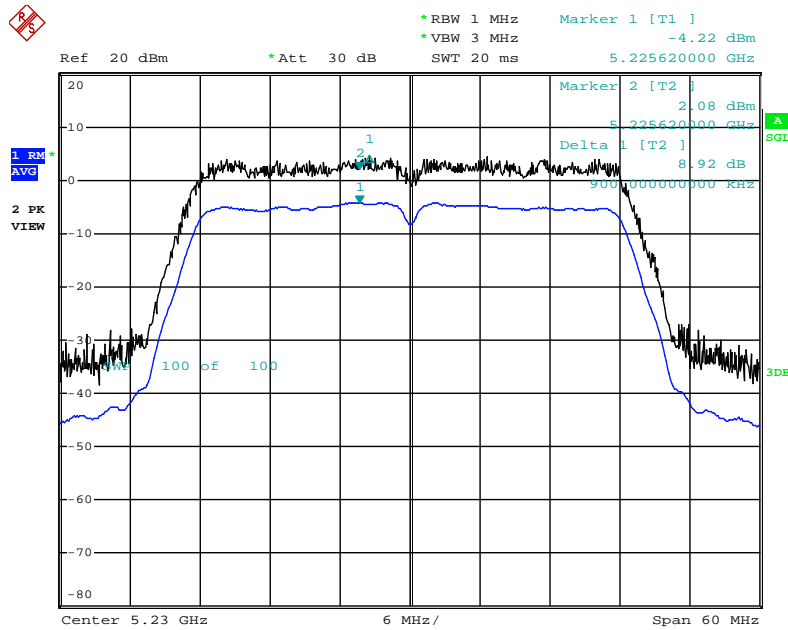

Date: 10.APR.2014 22:10:54

Peak Excursion Plot on Configuration IEEE 802.11ac VHT80 / Ant. 1 + Ant. 2 / 64QAM (MCS5) / 5210 MHz

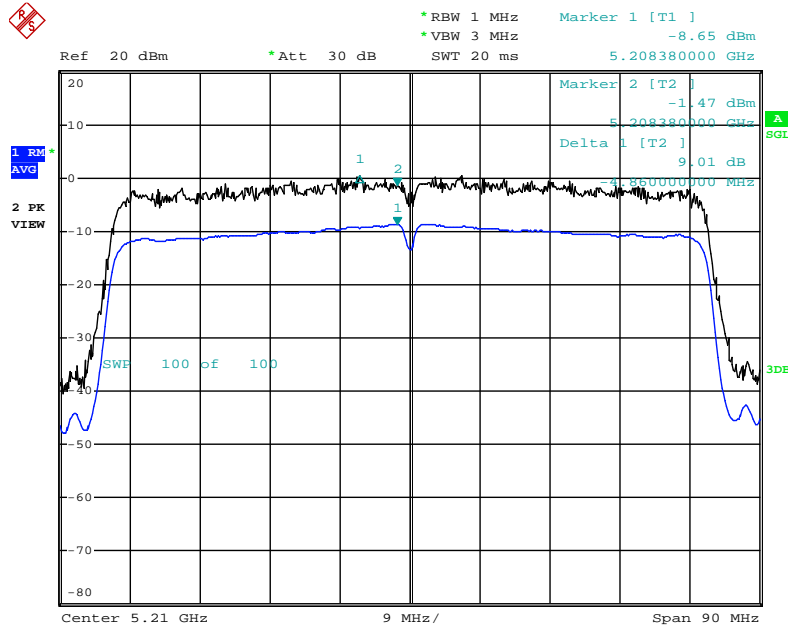

Date: 10.APR.2014 22:19:53

Peak Excursion Plot on Configuration IEEE 802.11a / Ant. 1 + Ant. 2 / 64QAM (48Mbps) / 5240 MHz

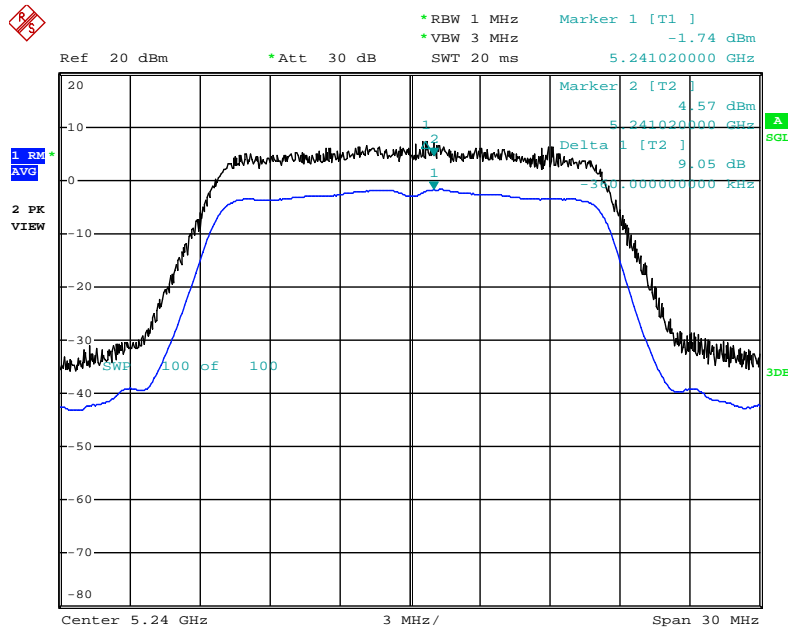

Date: 10.APR.2014 22:00:41

4.6. Radiated Emissions Measurement

4.6.1. Limit

For transmitters operating in the 5.15-5.25 GHz band: all emissions outside of the 5.15-5.35 GHz band shall not exceed a -27dBm peak limit or average 54dBuV/m and peak 74dBuV/m limits. In addition, in case the emission fall within the restricted band specified on 15.205(a), then the 15.209(a) limit in the table below has to be followed.

Frequencies (MHz)	Field Strength (micorvolts/meter)	Measurement Distance (meters)
0.009~0.490	2400/F(kHz)	300
0.490~1.705	24000/F(kHz)	30
1.705~30.0	30	30
30~88	100	3
88~216	150	3
216~960	200	3
Above 960	500	3

4.6.2. Measuring Instruments and Setting

Please refer to section 5 of equipments list in this report. The following table is the setting of spectrum analyzer and receiver.

Spectrum Parameter	Setting
Attenuation	Auto
Start Frequency	1000 MHz
Stop Frequency	40 GHz
RBW / VBW (Emission in restricted band)	1MHz / 3MHz for Peak, 1MHz / 10Hz for Average
RBW / VBW (Emission in non-restricted band)	1MHz / 3MHz for peak

Receiver Parameter	Setting
Attenuation	Auto
Start ~ Stop Frequency	9kHz~150kHz / RBW 200Hz for QP
Start ~ Stop Frequency	150kHz~30MHz / RBW 9kHz for QP
Start ~ Stop Frequency	30MHz~1000MHz / RBW 120kHz for QP

4.6.3. Test Procedures

1. Configure the EUT according to ANSI C63.10. The EUT was placed on the top of the turntable 0.8 meter above ground. The phase center of the receiving antenna mounted on the top of a height-variable antenna tower was placed 3 meters far away from the turntable.
2. Power on the EUT and all the supporting units. The turntable was rotated by 360 degrees to determine the position of the highest radiation.
3. The height of the broadband receiving antenna was varied between one meter and four meters above ground to find the maximum emissions field strength of both horizontal and vertical polarization.
4. For each suspected emissions, the antenna tower was scan (from 1 M to 4 M) and then the turntable was rotated (from 0 degree to 360 degrees) to find the maximum reading.
5. Set the test-receiver system to Peak or CISPR quasi-peak Detect Function with specified bandwidth under Maximum Hold Mode.
6. For emissions above 1GHz, use 1MHz VBW and RBW for peak reading. Then 1MHz RBW and 10Hz VBW for average reading in spectrum analyzer.
7. When the radiated emissions limits are expressed in terms of the average value of the emissions, and pulsed operation is employed, the measurement field strength shall be determined by averaging over one complete pulse train, including blanking intervals, as long as the pulse train does not exceed 0.1 seconds. As an alternative (provided the transmitter operates for longer than 0.1 seconds) or in cases where the pulse train exceeds 0.1 seconds, the measured field strength shall be determined from the average absolute voltage during a 0.1 second interval during which the field strength is at its maximum value.
8. If the emissions level of the EUT in peak mode was 3 dB lower than the average limit specified, then testing will be stopped and peak values of EUT will be reported, otherwise, the emissions which do not have 3 dB margin will be repeated one by one using the quasi-peak method for below 1GHz.
9. For testing above 1GHz, the emissions level of the EUT in peak mode was lower than average limit (that means the emissions level in peak mode also complies with the limit in average mode), then testing will be stopped and peak values of EUT will be reported, otherwise, the emissions will be measured in average mode again and reported.
10. In case the emission is lower than 30MHz, loop antenna has to be used for measurement and the recorded data should be QP measured by receiver. High – Low scan is not required in this case.

4.6.4. Test Setup Layout

For Radiated Emissions: 9kHz ~30MHz

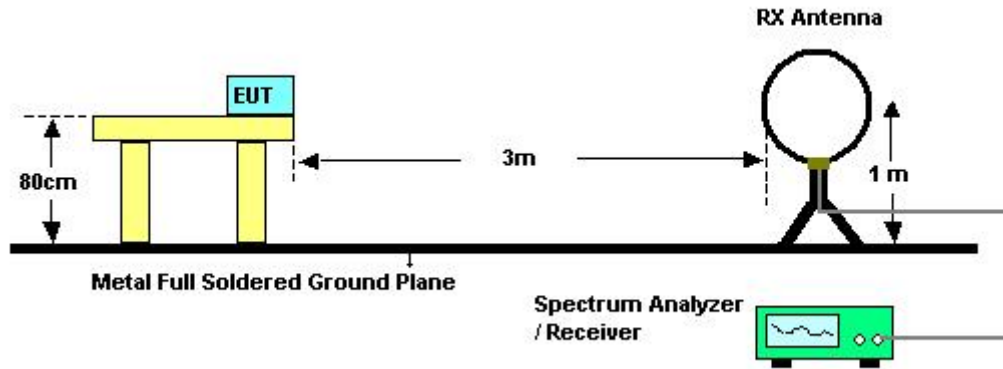

For Radiated Emissions: 30MHz~1GHz

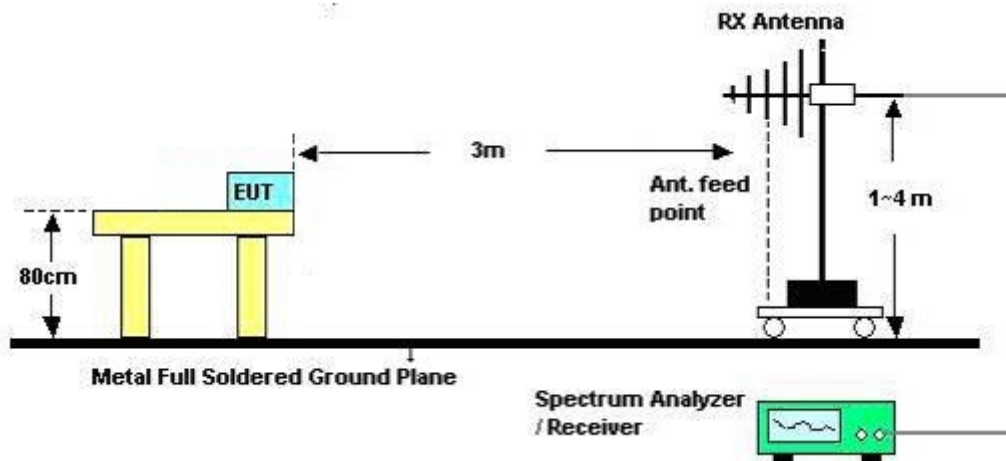

For Radiated Emissions: Above 1GHz

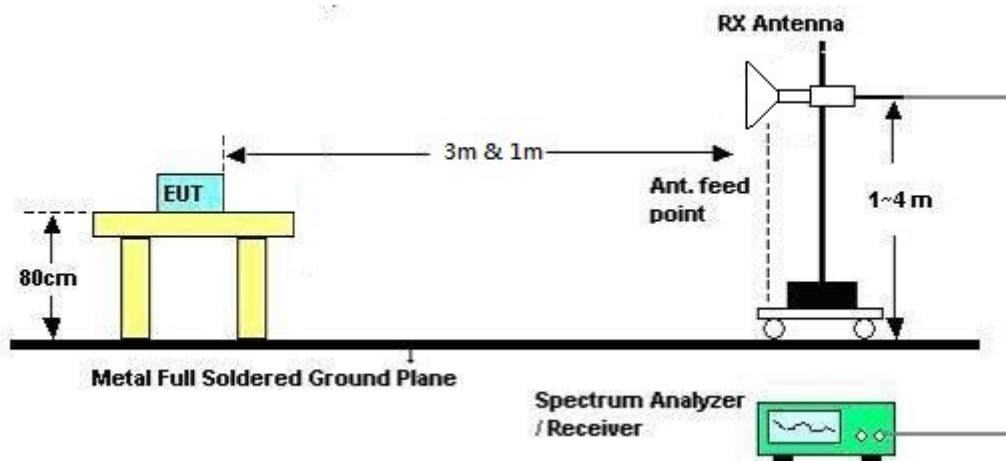

4.6.5. Test Deviation

There is no deviation with the original standard.

4.6.6. EUT Operation during Test

The EUT was programmed to be in continuously transmitting mode.

4.6.7. Results of Radiated Emissions (9kHz~30MHz)

Temperature	24°C	Humidity	55%
Test Engineer	David Tseng	Configurations	Normal Link
Test Date	Mar. 18, 2014	Test Mode	Mode 1

Freq. (MHz)	Level (dBuV)	Over Limit (dB)	Limit Line (dBuV)	Remark
-	-	-	-	See Note

Note:

The amplitude of spurious emissions that are attenuated by more than 20dB below the permissible value has no need to be reported.

Distance extrapolation factor = $40 \log(\text{specific distance} / \text{test distance})$ (dB);

Limit line = specific limits (dBuV) + distance extrapolation factor.

4.6.8. Results of Radiated Emissions (30MHz~1GHz)

Temperature	24°C	Humidity	55%
Test Engineer	David Tseng	Configurations	Normal Link
Test Mode	Mode 1		

Horizontal

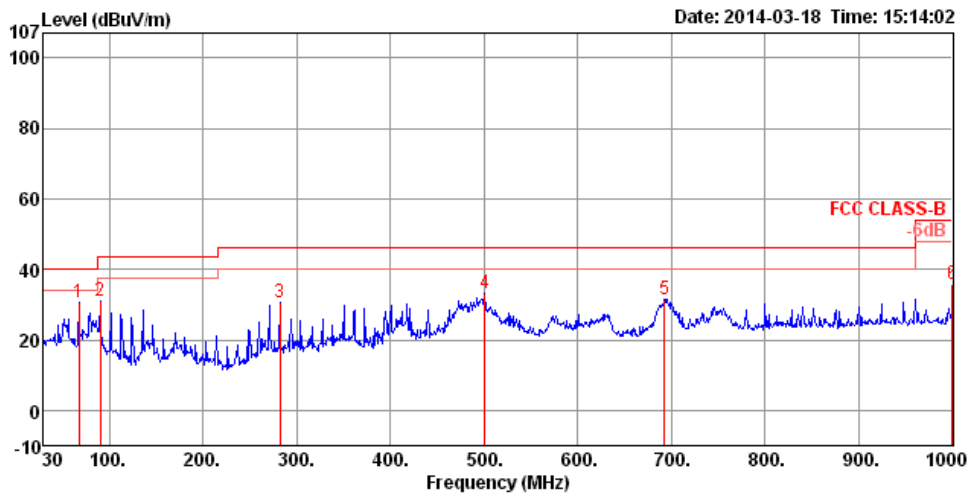

	Freq	Level	Limit	Over	Read	Cable	Antenna	Preamp	A/Pos	T/Pos	Pol/Phase	Remark
	MHz	dBuV/m	dBuV/m	dB	dBuV	dB	dB/m	dB	cm	deg		
1	67.83	30.75	40.00	-9.25	56.50	0.98	5.08	31.81	300	281	HORIZONTAL	Peak
2	90.14	30.93	43.50	-12.57	52.65	1.13	8.74	31.59	200	98	HORIZONTAL	Peak
3	282.20	30.37	46.00	-15.63	47.32	2.03	12.57	31.55	125	29	HORIZONTAL	Peak
4	500.45	33.25	46.00	-12.75	44.92	2.82	16.92	31.41	100	233	HORIZONTAL	Peak
5	692.51	31.60	46.00	-14.40	40.73	3.40	18.79	31.32	125	324	HORIZONTAL	Peak
6	1000.00	35.74	54.00	-18.26	41.27	4.21	21.44	31.18	150	169	HORIZONTAL	Peak

Vertical

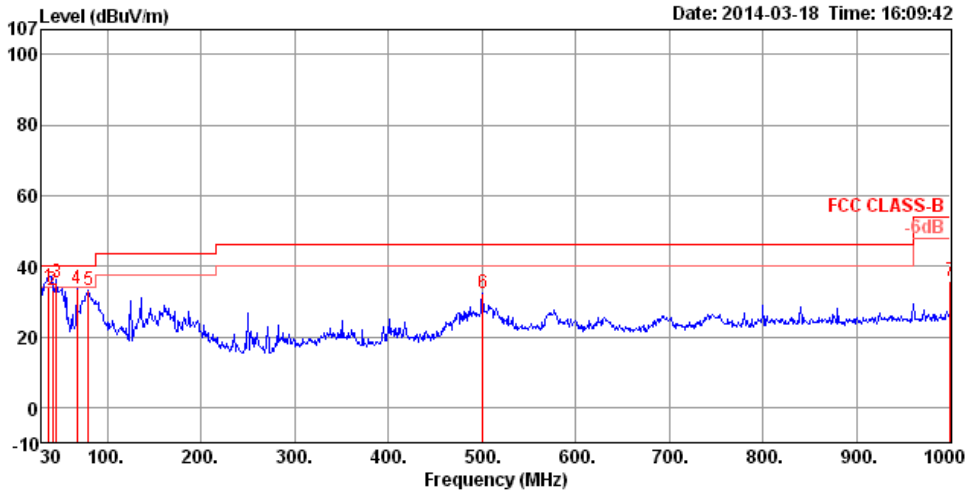

	Freq	Level	Limit	Over	Read	CableAntenna	Preamp	A/Pos	T/Pos	Pol/Phase	Remark
	MHz	dBuV/m	dBuV/m	dB	dBuV	dB	dB/m	dB	cm	deg	
1	37.76	33.92	40.00	-6.08	51.30	0.72	13.78	31.88	100	70 VERTICAL	QP
2	41.64	33.06	40.00	-6.94	52.89	0.76	11.27	31.86	100	1 VERTICAL	QP
3	45.52	35.45	40.00	-4.55	57.25	0.80	9.23	31.83	100	46 VERTICAL	QP
4	67.83	33.72	40.00	-6.28	59.47	0.98	5.08	31.81	200	352 VERTICAL	Peak
5	79.47	33.32	40.00	-6.68	57.26	1.04	6.73	31.71	100	255 VERTICAL	Peak
6	500.45	32.44	46.00	-13.56	44.11	2.82	16.92	31.41	100	212 VERTICAL	Peak
7	1000.00	35.67	54.00	-18.33	41.20	4.21	21.44	31.18	125	129 VERTICAL	Peak

Note:

The amplitude of spurious emissions that are attenuated by more than 20dB below the permissible value has no need to be reported.

Emission level (dBuV/m) = 20 log Emission level (uV/m).

Corrected Reading: Antenna Factor + Cable Loss + Read Level - Preamp Factor = Level.

4.6.9. Results for Radiated Emissions (1GHz~40GHz)

Temperature	24°C	Humidity	55%
Test Engineer	David Tseng	Configurations	IEEE 802.11ac MCS0, Nss1 VHT20 CH 36 / Ant. 1 + Ant. 2
Test Date	Feb. 26, 2014		

Horizontal

	Freq	Level	Limit Line	Over Limit	Read Level	CableAntenna Loss	Antenna Factor	Preamp Factor	Remark	A/Pos	T/Pos	Pol/Phase
	MHz	dBuV/m	dBuV/m	dB	dBuV	dB	dB/m	dB		cm	deg	
1	15532.68	57.46	74.00	-16.54	44.13	10.77	38.15	35.59	Peak	100	160	HORIZONTAL
2	15533.56	45.81	54.00	-8.19	32.48	10.77	38.15	35.59	Average	100	160	HORIZONTAL

Vertical

	Freq	Level	Limit Line	Over Limit	Read Level	CableAntenna Loss	Antenna Factor	Preamp Factor	Remark	A/Pos	T/Pos	Pol/Phase
	MHz	dBuV/m	dBuV/m	dB	dBuV	dB	dB/m	dB		cm	deg	
1	15545.68	48.45	54.00	-5.55	35.14	10.78	38.12	35.59	Average	142	212	VERTICAL
2	15547.48	60.34	74.00	-13.66	47.03	10.78	38.12	35.59	Peak	142	212	VERTICAL



Temperature	24°C	Humidity	55%
Test Engineer	David Tseng	Configurations	IEEE 802.11ac MCS0, Nss1 VHT20 CH 40 / Ant. 1 + Ant. 2
Test Date	Feb. 26, 2014		

Horizontal

	Freq	Level	Limit	Over	Read	CableAntenna	Preamp	Remark	A/Pos	T/Pos	Pol/Phase	
	MHz	dBuV/m	dBuV/m	dB	dBuV	dB	dB/m	dB	cm	deg		
1	10396.76	57.85	74.00	-16.15	44.79	8.55	39.81	35.30	Peak	121	243	HORIZONTAL
2	10400.72	44.51	54.00	-9.49	31.43	8.55	39.81	35.28	Average	121	243	HORIZONTAL
3	15593.44	46.57	54.00	-7.43	33.33	10.78	38.04	35.58	Average	100	243	HORIZONTAL
4	15598.04	58.02	74.00	-15.98	44.78	10.78	38.04	35.58	Peak	100	243	HORIZONTAL

Vertical

	Freq	Level	Limit	Over	Read	CableAntenna	Preamp	Remark	A/Pos	T/Pos	Pol/Phase	
	MHz	dBuV/m	dBuV/m	dB	dBuV	dB	dB/m	dB	cm	deg		
1	10400.28	52.50	54.00	-1.50	39.42	8.55	39.81	35.28	Average	153	7	VERTICAL
2	10402.96	66.12	74.00	-7.88	53.04	8.55	39.81	35.28	Peak	153	7	VERTICAL
3	15601.16	51.42	54.00	-2.58	38.18	10.78	38.04	35.58	Average	113	152	VERTICAL
4	15606.96	65.09	74.00	-8.91	51.88	10.78	38.01	35.58	Peak	113	152	VERTICAL



Temperature	24°C	Humidity	55%
Test Engineer	David Tseng	Configurations	IEEE 802.11ac MCS0, Nss1 VHT20 CH 48 / Ant. 1 + Ant. 2
Test Date	Feb. 26, 2014		

Horizontal

	Freq	Level	Limit	Over	Read	CableAntenna	Preamp	Remark	A/Pos	T/Pos	Pol/Phase	
	MHz	dBuV/m	dBuV/m	dB	dBuV	dB	dB/m	dB	cm	deg		
1	10479.88	47.00	54.00	-7.00	33.69	8.56	39.97	35.22	Average	127	252	HORIZONTAL
2	10480.24	59.56	74.00	-14.44	46.25	8.56	39.97	35.22	Peak	127	252	HORIZONTAL
3	15718.40	62.10	74.00	-11.90	49.02	10.79	37.85	35.56	Peak	125	265	HORIZONTAL
4	15718.52	48.16	54.00	-5.84	35.08	10.79	37.85	35.56	Average	125	265	HORIZONTAL

Vertical

	Freq	Level	Limit	Over	Read	CableAntenna	Preamp	Remark	A/Pos	T/Pos	Pol/Phase	
	MHz	dBuV/m	dBuV/m	dB	dBuV	dB	dB/m	dB	cm	deg		
1	10479.32	64.44	74.00	-9.56	51.13	8.56	39.97	35.22	Peak	145	30	VERTICAL
2	10479.68	52.15	54.00	-1.85	38.84	8.56	39.97	35.22	Average	145	30	VERTICAL
3	15718.56	52.29	54.00	-1.71	39.21	10.79	37.85	35.56	Average	138	209	VERTICAL
4	15727.08	66.28	74.00	-7.72	53.22	10.79	37.83	35.56	Peak	138	209	VERTICAL



Temperature	24°C	Humidity	55%
Test Engineer	David Tseng	Configurations	IEEE 802.11ac MCS0, Nss1 VHT40 CH 38 / Ant. 1 + Ant. 2
Test Date	Feb. 26, 2014		

Horizontal

	Freq	Level	Limit Line	Over Limit	Read Level	CableAntenna Loss	Antenna Factor	Preamp Factor	Remark	A/Pos	T/Pos	Pol/Phase
	MHz	dBuV/m	dBuV/m	dB	dBuV	dB	dB/m	dB		cm	deg	
1	15562.40	58.19	74.00	-15.81	44.90	10.78	38.09	35.58	Peak	100	243	HORIZONTAL
2	15576.80	44.48	54.00	-9.52	31.21	10.78	38.07	35.58	Average	100	243	HORIZONTAL

Vertical

	Freq	Level	Limit Line	Over Limit	Read Level	CableAntenna Loss	Antenna Factor	Preamp Factor	Remark	A/Pos	T/Pos	Pol/Phase
	MHz	dBuV/m	dBuV/m	dB	dBuV	dB	dB/m	dB		cm	deg	
1	15577.80	57.81	74.00	-16.19	44.54	10.78	38.07	35.58	Peak	111	178	VERTICAL
2	15578.80	44.92	54.00	-9.08	31.65	10.78	38.07	35.58	Average	111	178	VERTICAL



Temperature	24°C	Humidity	55%
Test Engineer	David Tseng	Configurations	IEEE 802.11ac MCS0, Nss1 VHT40 CH 46 / Ant. 1 + Ant. 2
Test Date	Feb. 26, 2014		

Horizontal

	Freq	Level	Limit Line	Over Limit	Read Level	Cable Loss	Antenna Factor	Preamp Factor	Remark	A/Pos	T/Pos	Pol/Phase
	MHz	dBuV/m	dBuV/m	dB	dBuV	dB	dB/m	dB		cm	deg	
1	15682.32	57.95	74.00	-16.05	44.81	10.79	37.91	35.56	Peak	113	262	HORIZONTAL
2	15682.44	45.36	54.00	-8.64	32.22	10.79	37.91	35.56	Average	113	262	HORIZONTAL

Vertical

	Freq	Level	Limit Line	Over Limit	Read Level	Cable Loss	Antenna Factor	Preamp Factor	Remark	A/Pos	T/Pos	Pol/Phase
	MHz	dBuV/m	dBuV/m	dB	dBuV	dB	dB/m	dB		cm	deg	
1	15685.00	59.87	74.00	-14.13	46.73	10.79	37.91	35.56	Peak	138	208	VERTICAL
2	15685.56	47.97	54.00	-6.03	34.83	10.79	37.91	35.56	Average	138	208	VERTICAL



Temperature	24°C	Humidity	55%
Test Engineer	David Tseng	Configurations	IEEE 802.11ac MCS0, Nss1 VHT80 CH 42 / Ant. 1 + Ant. 2
Test Date	Feb. 26, 2014		

Horizontal

	Freq	Level	Limit Line	Over Limit	Read Level	CableAntenna Loss	Antenna Factor	Preamp Factor	Remark	A/Pos	T/Pos	Pol/Phase
	MHz	dBuV/m	dBuV/m	dB	dBuV	dB	dB/m	dB		cm	deg	
1	2800.04	46.32	54.00	-7.68	47.69	4.49	29.26	35.12	Average	100	148	HORIZONTAL
2	2800.04	49.08	74.00	-24.92	50.45	4.49	29.26	35.12	Peak	100	148	HORIZONTAL
3	15620.20	44.94	54.00	-9.06	31.72	10.78	38.01	35.57	Average	100	227	HORIZONTAL
4	15636.44	57.21	74.00	-16.79	44.01	10.78	37.99	35.57	Peak	100	227	HORIZONTAL

Vertical

	Freq	Level	Limit Line	Over Limit	Read Level	CableAntenna Loss	Antenna Factor	Preamp Factor	Remark	A/Pos	T/Pos	Pol/Phase
	MHz	dBuV/m	dBuV/m	dB	dBuV	dB	dB/m	dB		cm	deg	
1	2800.03	51.36	54.00	-2.64	52.73	4.49	29.26	35.12	Average	100	154	VERTICAL
2	2800.03	52.59	74.00	-21.41	53.96	4.49	29.26	35.12	Peak	100	154	VERTICAL
3	15630.16	57.09	74.00	-16.91	43.89	10.78	37.99	35.57	Peak	100	44	VERTICAL
4	15642.32	44.66	54.00	-9.34	31.49	10.78	37.96	35.57	Average	100	44	VERTICAL



Temperature	24°C	Humidity	55%
Test Engineer	David Tseng	Configurations	IEEE 802.11a CH 36 / Ant. 1 + Ant. 2
Test Date	Feb. 26, 2014		

Horizontal

	Freq	Level	Limit Line	Over Limit	Read Level	Cable Loss	Antenna Factor	Preamp Factor	Remark	A/Pos	T/Pos	Pol/Phase
	MHz	dBuV/m	dBuV/m	dB	dBuV	dB	dB/m	dB		cm	deg	
1	10359.84	55.33	74.00	-18.67	42.36	8.54	39.75	35.32	Peak	100	335	HORIZONTAL
2	10362.04	44.07	54.00	-9.93	31.10	8.54	39.75	35.32	Average	100	335	HORIZONTAL
3	15535.64	45.93	54.00	-8.07	32.60	10.77	38.15	35.59	Average	114	82	HORIZONTAL
4	15536.72	59.12	74.00	-14.88	45.79	10.77	38.15	35.59	Peak	114	82	HORIZONTAL

Vertical

	Freq	Level	Limit Line	Over Limit	Read Level	Cable Loss	Antenna Factor	Preamp Factor	Remark	A/Pos	T/Pos	Pol/Phase
	MHz	dBuV/m	dBuV/m	dB	dBuV	dB	dB/m	dB		cm	deg	
1	10361.92	66.38	74.00	-7.62	53.41	8.54	39.75	35.32	Peak	162	3	VERTICAL
2	10362.28	49.61	54.00	-4.39	36.64	8.54	39.75	35.32	Average	162	3	VERTICAL
3	15534.76	63.81	74.00	-10.19	50.48	10.77	38.15	35.59	Peak	123	278	VERTICAL
4	15539.52	50.11	54.00	-3.89	36.81	10.77	38.12	35.59	Average	123	278	VERTICAL

Temperature	24°C	Humidity	55%
Test Engineer	David Tseng	Configurations	IEEE 802.11a CH 40 / Ant. 1 + Ant. 2
Test Date	Feb. 26, 2014		

Horizontal

	Freq	Level	Limit Line	Over Limit	Read Level	CableAntenna Loss Factor	Preamp Factor	Remark	A/Pos	T/Pos	Pol/Phase	
	MHz	dBuV/m	dBuV/m	dB	dBuV	dB	dB/m	dB	cm	deg		
1	10401.36	43.44	54.00	-10.56	30.36	8.55	39.81	35.28	Average	100	94	HORIZONTAL
2	10401.96	55.40	74.00	-18.60	42.32	8.55	39.81	35.28	Peak	100	94	HORIZONTAL
3	15592.80	61.27	74.00	-12.73	48.03	10.78	38.04	35.58	Peak	109	341	HORIZONTAL
4	15599.76	48.00	54.00	-6.00	34.76	10.78	38.04	35.58	Average	109	341	HORIZONTAL

Vertical

	Freq	Level	Limit Line	Over Limit	Read Level	CableAntenna Loss Factor	Preamp Factor	Remark	A/Pos	T/Pos	Pol/Phase	
	MHz	dBuV/m	dBuV/m	dB	dBuV	dB	dB/m	dB	cm	deg		
1	10398.52	51.99	54.00	-2.01	38.91	8.55	39.81	35.28	Average	154	4	VERTICAL
2	10400.96	65.67	74.00	-8.33	52.59	8.55	39.81	35.28	Peak	154	4	VERTICAL
3	15599.60	65.55	54.00	11.55	52.31	10.78	38.04	35.58	Average	114	187	VERTICAL
4	15599.68	51.50	54.00	-2.50	38.26	10.78	38.04	35.58	Average	114	187	VERTICAL



Temperature	24°C	Humidity	55%
Test Engineer	David Tseng	Configurations	IEEE 802.11a CH 48 / Ant. 1 + Ant. 2
Test Date	Feb. 26, 2014		

Horizontal

	Freq	Level	Limit Line	Over Limit	Read Level	Cable Loss	Antenna Factor	Preamp Factor	Remark	A/Pos	T/Pos	Pol/Phase
	MHz	dBuV/m	dBuV/m	dB	dBuV	dB	dB/m	dB		cm	deg	
1	10478.28	44.03	54.00	-9.97	30.72	8.56	39.97	35.22	Average	100	246	HORIZONTAL
2	10478.56	57.61	74.00	-16.39	44.30	8.56	39.97	35.22	Peak	100	246	HORIZONTAL
3	15719.64	45.67	54.00	-8.33	32.59	10.79	37.85	35.56	Average	100	131	HORIZONTAL
4	15722.48	57.94	74.00	-16.06	44.86	10.79	37.85	35.56	Peak	100	131	HORIZONTAL

Vertical

	Freq	Level	Limit Line	Over Limit	Read Level	Cable Loss	Antenna Factor	Preamp Factor	Remark	A/Pos	T/Pos	Pol/Phase
	MHz	dBuV/m	dBuV/m	dB	dBuV	dB	dB/m	dB		cm	deg	
1	10477.20	66.61	74.00	-7.39	53.30	8.56	39.97	35.22	Peak	152	22	VERTICAL
2	10478.32	52.15	54.00	-1.85	38.84	8.56	39.97	35.22	Average	152	22	VERTICAL
3	15715.20	65.51	74.00	-8.49	52.43	10.79	37.85	35.56	Peak	133	212	VERTICAL
4	15719.00	51.20	54.00	-2.80	38.12	10.79	37.85	35.56	Average	133	212	VERTICAL

Note:

The amplitude of spurious emissions that are attenuated by more than 20dB below the permissible value has no need to be reported.

Emission level (dBuV/m) = 20 log Emission level (uV/m).

Corrected Reading: Antenna Factor + Cable Loss + Read Level - Preamp Factor = Level.

4.7. Band Edge Emissions Measurement

4.7.1. Limit

For transmitters operating in the 5.15-5.25 GHz band: all emissions outside of the 5.15-5.35 GHz band shall not exceed a -27dBm peak limit or average 54dBuV/m and peak 74dBuV/m limits. In addition, in case the emission fall within the restricted band specified on 15.205(a), then the 15.209(a) limit in the table below has to be followed.

Frequencies (MHz)	Field Strength (microvolts/meter)	Measurement Distance (meters)
0.009~0.490	2400/F(kHz)	300
0.490~1.705	24000/F(kHz)	30
1.705~30.0	30	30
30~88	100	3
88~216	150	3
216~960	200	3
Above 960	500	3

4.7.2. Measuring Instruments and Setting

Please refer to section 5 of equipments list in this report. The following table is the setting of the spectrum analyzer.

Spectrum Parameter	Setting
Attenuation	Auto
Span Frequency	100 MHz
RBW / VBW (Emission in restricted band)	1 MHz / 3MHz for Peak, 1 MHz / 10Hz for Average
RBW / VBW (Emission in non-restricted band)	1 MHz / 3MHz for Peak

4.7.3. Test Procedures

The test procedure is the same as section 4.6.3, only the frequency range investigated is limited to 100MHz around bandedges.

4.7.4. Test Setup Layout

This test setup layout is the same as that shown in section 4.6.4.

4.7.5. Test Deviation

There is no deviation with the original standard.

4.7.6. EUT Operation during Test

The EUT was programmed to be in continuously transmitting mode.

4.7.7. Test Result of Band Edge and Fundamental Emissions

Temperature	24°C	Humidity	55%
Test Engineer	David Tseng	Configurations	IEEE 802.11ac MCS0, Nss1 VHT20 CH 36, 40, 48 / Ant. 1 + Ant. 2
Test Date	Feb. 26, 2014		

Channel 36

	Freq	Level	Limit Line	Over Limit	Read Level	CableAntenna Loss	Antenna Factor	Preamp Factor	Remark	A/Pos	T/Pos	Pol/Phase
	MHz	dBuV/m	dBuV/m	dB	dBuV	dB	dB/m	dB		cm	deg	
1	5149.40	68.83	74.00	-5.17	28.69	6.13	34.01	0.00	Peak	127	351	VERTICAL
2	5150.00	52.68	54.00	-1.32	12.54	6.13	34.01	0.00	Average	127	351	VERTICAL
3	5179.60	106.38			66.15	6.15	34.08	0.00	Average	127	351	VERTICAL
4	5180.40	115.69			75.46	6.15	34.08	0.00	Peak	127	351	VERTICAL

Item 3, 4 are the fundamental frequency at 5180 MHz.

Channel 40

	Freq	Level	Limit Line	Over Limit	Read Level	CableAntenna Loss	Antenna Factor	Preamp Factor	Remark	A/Pos	T/Pos	Pol/Phase
	MHz	dBuV/m	dBuV/m	dB	dBuV	dB	dB/m	dB		cm	deg	
1	5147.60	66.05	74.00	-7.95	25.91	6.13	34.01	0.00	Peak	125	17	VERTICAL
2	5150.00	47.12	54.00	-6.88	6.98	6.13	34.01	0.00	Average	125	17	VERTICAL
3	5200.40	118.10			77.83	6.16	34.11	0.00	Peak	125	17	VERTICAL
4	5200.80	107.67			67.40	6.16	34.11	0.00	Average	125	17	VERTICAL

Item 3, 4 are the fundamental frequency at 5200 MHz.

Channel 48

	Freq	Level	Limit Line	Over Limit	Read Level	CableAntenna Loss	Antenna Factor	Preamp Factor	Remark	A/Pos	T/Pos	Pol/Phase
	MHz	dBuV/m	dBuV/m	dB	dBuV	dB	dB/m	dB		cm	deg	
1	5150.00	43.47	54.00	-10.53	3.33	6.13	34.01	0.00	Average	124	17	VERTICAL
2	5150.00	56.25	74.00	-17.75	16.11	6.13	34.01	0.00	Peak	124	17	VERTICAL
3	5239.40	108.33			67.97	6.18	34.18	0.00	Average	124	17	VERTICAL
4	5240.60	118.62			78.26	6.18	34.18	0.00	Peak	124	17	VERTICAL
5	5350.00	43.15	54.00	-10.85	2.47	6.26	34.42	0.00	Average	124	17	VERTICAL
6	5352.40	55.25	74.00	-18.75	14.57	6.26	34.42	0.00	Peak	124	17	VERTICAL

Item 3, 4 are the fundamental frequency at 5240 MHz.

Temperature	24°C	Humidity	55%
Test Engineer	David Tseng	Configurations	IEEE 802.11ac MCS0, Nss1 VHT40 CH 38, 46 / Ant. 1 + Ant. 2
Test Date	Feb. 26, 2014		

Channel 38

	Freq	Level	Limit Line	Over Limit	Read Level	CableAntenna Loss	Antenna Factor	Preamp Factor	Remark	A/Pos	T/Pos	Pol/Phase
	MHz	dBuV/m	dBuV/m	dB	dBuV	dB	dB/m	dB		cm	deg	
1	5150.00	52.77	54.00	-1.23	12.63	6.13	34.01	0.00	Average	102	4	VERTICAL
2	5150.00	67.56	74.00	-6.44	27.42	6.13	34.01	0.00	Peak	102	4	VERTICAL
3	5188.00	108.33			68.10	6.15	34.08	0.00	Peak	102	4	VERTICAL
4	5188.40	97.76			57.53	6.15	34.08	0.00	Average	102	4	VERTICAL

Item 3, 4 are the fundamental frequency at 5190 MHz.

Channel 46

	Freq	Level	Limit Line	Over Limit	Read Level	CableAntenna Loss	Antenna Factor	Preamp Factor	Remark	A/Pos	T/Pos	Pol/Phase
	MHz	dBuV/m	dBuV/m	dB	dBuV	dB	dB/m	dB		cm	deg	
1	5150.00	52.42	54.00	-1.58	12.28	6.13	34.01	0.00	Average	137	18	VERTICAL
2	5150.00	69.04	74.00	-4.96	28.90	6.13	34.01	0.00	Peak	137	18	VERTICAL
3	5234.80	115.29			74.93	6.18	34.18	0.00	Peak	137	18	VERTICAL
4	5235.60	104.28			63.92	6.18	34.18	0.00	Average	137	18	VERTICAL

Item 3, 4 are the fundamental frequency at 5230 MHz.



Temperature	24°C	Humidity	55%
Test Engineer	David Tseng	Configurations	IEEE 802.11ac MCS0, Nss1 VHT80 CH 42 / Ant. 1 + Ant. 2
Test Date	Feb. 26, 2014		

Channel 42

	Freq	Level	Limit	Over	Read	Cable	Antenna	Preamp	Remark	A/Pos	T/Pos	Pol/Phase
	MHz	dBuV/m	dBuV/m	dB	dBuV	dB	dB/m	dB		cm	deg	
1	5146.00	69.80	74.00	-4.20	29.66	6.13	34.01	0.00	Peak	102	3	VERTICAL
2	5148.00	52.80	54.00	-1.20	12.66	6.13	34.01	0.00	Average	102	3	VERTICAL
3	5196.00	104.67			64.40	6.16	34.11	0.00	Peak	102	3	VERTICAL
4	5208.00	94.22			53.94	6.17	34.11	0.00	Average	102	3	VERTICAL
5	5350.00	42.78	54.00	-11.22	2.10	6.26	34.42	0.00	Average	102	3	VERTICAL
6	5350.00	54.91	74.00	-19.09	14.23	6.26	34.42	0.00	Peak	102	3	VERTICAL

Item 3, 4 are the fundamental frequency at 5210 MHz.

Temperature	24°C	Humidity	55%
Test Engineer	David Tseng	Configurations	IEEE 802.11a CH 36, 40, 48 / Ant. 1 + Ant. 2
Test Date	Feb. 26, 2014		

Channel 36

	Freq	Level	Limit Line	Over Limit	Read Level	Cable Loss	Antenna Factor	Preamp Factor	Remark	A/Pos	T/Pos	Pol/Phase
	MHz	dBuV/m	dBuV/m	dB	dBuV	dB	dB/m	dB		cm	deg	
1	5147.20	68.10	74.00	-5.90	27.96	6.13	34.01	0.00	Peak	127	7	VERTICAL
2	5150.00	52.48	54.00	-1.52	12.34	6.13	34.01	0.00	Average	127	7	VERTICAL
3	5179.40	105.76			65.53	6.15	34.08	0.00	Average	127	7	VERTICAL
4	5182.40	114.85			74.62	6.15	34.08	0.00	Peak	127	7	VERTICAL

Item 3, 4 are the fundamental frequency at 5180 MHz.

Channel 40

	Freq	Level	Limit Line	Over Limit	Read Level	Cable Loss	Antenna Factor	Preamp Factor	Remark	A/Pos	T/Pos	Pol/Phase
	MHz	dBuV/m	dBuV/m	dB	dBuV	dB	dB/m	dB		cm	deg	
1	5148.40	68.51	74.00	-5.49	28.37	6.13	34.01	0.00	Peak	103	3	VERTICAL
2	5150.00	50.57	54.00	-3.43	10.43	6.13	34.01	0.00	Average	103	3	VERTICAL
3	5198.40	119.42			79.15	6.16	34.11	0.00	Peak	103	3	VERTICAL
4	5199.20	109.63			69.36	6.16	34.11	0.00	Average	103	3	VERTICAL

Item 3, 4 are the fundamental frequency at 5200 MHz.

Channel 48

	Freq	Level	Limit Line	Over Limit	Read Level	Cable Loss	Antenna Factor	Preamp Factor	Remark	A/Pos	T/Pos	Pol/Phase
	MHz	dBuV/m	dBuV/m	dB	dBuV	dB	dB/m	dB		cm	deg	
1	5148.80	55.38	74.00	-18.62	15.24	6.13	34.01	0.00	Peak	125	3	VERTICAL
2	5150.00	43.48	54.00	-10.52	3.34	6.13	34.01	0.00	Average	125	3	VERTICAL
3	5238.80	118.48			78.12	6.18	34.18	0.00	Peak	125	3	VERTICAL
4	5239.40	108.87			68.51	6.18	34.18	0.00	Average	125	3	VERTICAL
5	5350.00	43.37	54.00	-10.63	2.69	6.26	34.42	0.00	Average	125	3	VERTICAL
6	5355.40	55.27	74.00	-18.73	14.59	6.26	34.42	0.00	Peak	125	3	VERTICAL

Item 3, 4 are the fundamental frequency at 5240 MHz.

Note:

Emission level (dBuV/m) = 20 log Emission level (uV/m)

Corrected Reading: Antenna Factor + Cable Loss + Read Level - Preamp Factor = Level

4.8. Frequency Stability Measurement

4.8.1. Limit

In-band emission is maintained within the band of operation under all conditions of normal operation as specified in the user's manual.

The transmitter center frequency tolerance shall be ± 20 ppm maximum for the 5 GHz band (IEEE 802.11n specification).

4.8.2. Measuring Instruments and Setting

Please refer to section 5 of equipments list in this report. The following table is the setting of the spectrum analyzer.

Spectrum Parameter	Setting
Attenuation	Auto
Span Frequency	Entire absence of modulation emissions bandwidth
RBW	10 kHz
VBW	10 kHz
Sweep Time	Auto

4.8.3. Test Procedures

1. The transmitter output (antenna port) was connected to the spectrum analyzer.
2. EUT have transmitted absence of modulation signal and fixed channelize.
3. Set the spectrum analyzer span to view the entire absence of modulation emissions bandwidth.
4. Set RBW = 10 kHz, VBW = 10 kHz with peak detector and maxhold settings.
5. f_c is declaring of channel frequency. Then the frequency error formula is $(f_c - f) / f_c \times 10^6$ ppm and the limit is less than ± 20 ppm (IEEE 802.11n specification).
6. The test extreme voltage is to change the primary supply voltage from 85 to 115 percent of the nominal value
7. Extreme temperature is $0^\circ\text{C} \sim 40^\circ\text{C}$.

4.8.4. Test Setup Layout

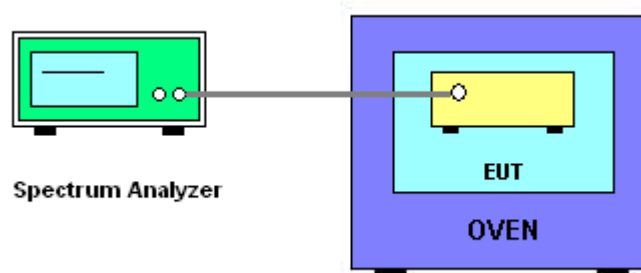

4.8.5. Test Deviation

There is no deviation with the original standard.

4.8.6. EUT Operation during Test

The EUT was programmed to be in continuously un-modulation transmitting mode.

4.8.7. Test Result of Frequency Stability

Temperature	20°C	Humidity	55%
Test Engineer	David Tseng	Test Date	Apr. 10, 2014

Voltage vs. Frequency Stability

Voltage	Measurement Frequency (MHz)
(V)	5200 MHz
126.50	5200.0792
110.00	5200.0789
93.50	5200.0921
Max. Deviation (MHz)	0.0921
Max. Deviation (ppm)	17.71

Temperature vs. Frequency Stability

Temperature	Measurement Frequency (MHz)
(°C)	5200 MHz
0	5200.0782
10	5200.0788
20	5200.0812
30	5200.0872
40	5200.0886
Max. Deviation (MHz)	0.0886
Max. Deviation (ppm)	17.04

4.9. Antenna Requirements

4.9.1. Limit

Except for special regulations, the Low-power Radio-frequency Devices must not be equipped with any jacket for installing an antenna with extension cable. An intentional radiator shall be designed to ensure that no antenna other than that furnished by the responsible party shall be used with the device. The use of a permanently attached antenna or of an antenna that uses a unique coupling to the intentional radiator shall be considered sufficient to comply with the provisions of this Section. The manufacturer may design the unit so that the user can replace a broken antenna, but the use of a standard antenna jack or electrical connector is prohibited. Further, this requirement does not apply to intentional radiators that must be professionally installed.

4.9.2. Antenna Connector Construction

Please refer to section 3.3 in this test report; antenna connector complied with the requirements.

5. LIST OF MEASURING EQUIPMENTS

Instrument	Manufacturer	Model No.	Serial No.	Characteristics	Calibration Date	Remark
EMI Test Receiver	R&S	ESCS 30	100355	9 kHz ~ 2.75 GHz	Apr. 12, 2013	Conduction (CO01-CB)
LISN	F.C.C.	FCC-LISN-50-16-2	04083	150 kHz ~ 100 MHz	Nov. 23, 2013	Conduction (CO01-CB)
LISN	Schwarzbeck	NSLK 8127	8127647	9kHz ~ 30MHz	Nov. 23, 2013	Conduction (CO01-CB)
COND Cable	Woken	Cable	01	150 kHz ~ 30 MHz	Dec. 04, 2013	Conduction (CO01-CB)
Software	Audix	E3	5.410e	-	N.C.R.	Conduction (CO01-CB)
BILOG ANTENNA	Schaffner	CBL6112D	22021	20MHz ~ 2GHz	Apr. 16, 2013	Radiation (03CH01-CB)
Loop Antenna	Teseq	HLA 6120	24155	9 kHz - 30 MHz	Nov. 05, 2012*	Radiation (03CH01-CB)
Horn Antenna	EMCO	3115	00075790	750MHz~18GHz	Nov. 01, 2013	Radiation (03CH01-CB)
Horn Antenna	SCHWARZBEAK	BBHA 9170	BBHA9170252	15GHz ~ 40GHz	Dec. 17, 2013	Radiation (03CH01-CB)
Pre-Amplifier	Agilent	8447D	2944A10991	0.1MHz ~ 1.3GHz	Nov. 12, 2013	Radiation (03CH01-CB)
Pre-Amplifier	Agilent	8449B	3008A02310	1GHz ~ 26.5GHz	Dec. 16, 2013	Radiation (03CH01-CB)
Pre-Amplifier	WM	TF-130N-R1	923365	26GHz ~ 40GHz	Oct. 23, 2013	Radiation (03CH01-CB)
Spectrum analyzer	R&S	FSP40	100019	9kHz~40GHz	Dec. 02, 2013	Radiation (03CH01-CB)
EMI Test Receiver	Agilent	N9038A	MY52260123	9kHz ~ 8GHz	Dec. 12, 2013	Radiation (03CH01-CB)
Turn Table	INN CO	CO 2000	N/A	0 ~ 360 degree	N.C.R.	Radiation (03CH01-CB)
Antenna Mast	INN CO	CO2000	N/A	1 m - 4 m	N.C.R.	Radiation (03CH01-CB)
RF Cable-low	Woken	Low Cable-1	N/A	30 MHz - 1 GHz	Nov. 17, 2013	Radiation (03CH01-CB)
RF Cable-high	Woken	High Cable-1	N/A	1 GHz - 26.5 GHz	Nov. 17, 2013	Radiation (03CH01-CB)
RF Cable-high	Woken	High Cable-2	N/A	1 GHz - 26.5 GHz	Nov. 17, 2013	Radiation (03CH01-CB)
RF Cable-high	Woken	High Cable-3	N/A	1 GHz - 40 GHz	Nov. 17, 2013	Radiation (03CH01-CB)
RF Cable-high	Woken	High Cable-4	N/A	1 GHz - 40 GHz	Nov. 17, 2013	Radiation (03CH01-CB)
Signal analyzer	R&S	FSV40	100979	9kHz~40GHz	Nov. 29, 2013	Conducted (TH01-CB)
Temp. and Humidity Chamber	Ten Billion	TTH-D3SP	TBN-931011	-30~100 degree	Jun. 04, 2013	Conducted (TH01-CB)
RF Power Divider	Woken	3 Way	MDC2366	2GHz ~ 18GHz	Nov. 17, 2013	Conducted (TH01-CB)
RF Cable-high	Woken	High Cable-7	-	1 GHz - 26.5 GHz	Nov. 17, 2013	Conducted (TH01-CB)
RF Cable-high	Woken	High Cable-8	-	1 GHz - 26.5 GHz	Nov. 17, 2013	Conducted (TH01-CB)



Instrument	Manufacturer	Model No.	Serial No.	Characteristics	Calibration Date	Remark
RF Cable-high	Woken	High Cable-9	-	1 GHz – 26.5 GHz	Nov. 17, 2013	Conducted (TH01-CB)
RF Cable-high	Woken	High Cable-10	-	1 GHz – 26.5 GHz	Nov. 17, 2013	Conducted (TH01-CB)
RF Cable-high	Woken	High Cable-11	-	1 GHz – 26.5 GHz	Nov. 17, 2013	Conducted (TH01-CB)
Power Sensor	Anritsu	MA2411B	0917223	300MHz~40GHz	Sep. 18, 2013	Conducted (TH01-CB)
Power Meter	Anritsu	ML2495A	1035008	300MHz~40GHz	Sep. 18, 2013	Conducted (TH01-CB)

Note: Calibration Interval of instruments listed above is one year.

“*” Calibration Interval of instruments listed above is two years.

N.C.R. means Non-Calibration required.

6. MEASUREMENT UNCERTAINTY

Uncertainty of Conducted Emission Measurement (150kHz ~ 30MHz)

Contribution	Uncertainty of x_i			$u(x_i)$
	Value	Unit	Probability Distribution k	
Receiver reading	0.026	dB	normal(k=2)	0.013
Cable loss	0.002	dB	normal(k=2)	0.001
AMN/LISN specification	1.200	dB	normal(k=2)	0.600
Mismatch Receiver VSWR 1= AMN/LISN VSWR 2=	-0.080	dB	U-shaped	0.060
Combined standard uncertainty $U_c(y)$				1.2
Measuring uncertainty for a level of confidence of 95% $U=2U_c(y)$				2.4

Uncertainty of Radiated Emission Measurement (30MHz ~ 1,000MHz)

Contribution	Uncertainty of x_i			$u(x_i)$
	Value	Unit	Probability Distribution k	
Receiver reading	± 0.173	dB	K=1	0.086
Cable loss	± 0.174	dB	K=2	0.087
Antenna gain	± 0.169	dB	K=2	0.084
Site imperfection	± 0.433	dB	Triangular	0.214
Pre-amplifier gain	± 0.366	dB	K=2	0.183
Transmitter antenna	± 1.200	dB	Rectangular	0.600
Signal generator	± 0.461	dB	Rectangular	0.231
Mismatch	± 0.080	dB	U-shape	0.040
Spectrum analyzer	± 0.500	dB	Rectangular	0.250
Combined standard uncertainty $U_c(y)$				1.778
Measuring uncertainty for a level of confidence of 95% $U=2U_c(y)$				3.555

Uncertainty of Radiated Emission Measurement (1GHz ~ 18GHz)

Contribution	Uncertainty of x_i			$u(x_i)$
	Value	Unit	Probability Distribution k	
Receiver reading	±0.191	dB	K=1	0.095
Cable loss	±0.169	dB	K=2	0.084
Antenna gain	±0.191	dB	K=2	0.096
Site imperfection	±0.582	dB	Triangular	0.291
Pre-amplifier gain	±0.304	dB	K=2	0.152
Transmitter antenna	±1.200	dB	Rectangular	0.600
Signal generator	±0.461	dB	Rectangular	0.231
Mismatch	±0.080	dB	U-shape	0.040
Spectrum analyzer	±0.500	dB	Rectangular	0.250
Combined standard uncertainty $U_c(y)$				1.839
Measuring uncertainty for a level of confidence of 95% $U=2U_c(y)$				3.678

Uncertainty of Radiated Emission Measurement (18GHz ~ 40GHz)

Contribution	Uncertainty of x_i			$u(x_i)$
	Value	Unit	Probability Distribution k	
Receiver reading	±0.186	dB	K=1	0.093
Cable loss	±0.167	dB	K=2	0.083
Antenna gain	±0.190	dB	K=2	0.095
Site imperfection	±0.488	dB	Triangular	0.244
Pre-amplifier gain	±0.269	dB	K=2	0.134
Transmitter antenna	±1.200	dB	Rectangular	0.600
Signal generator	±0.461	dB	Rectangular	0.231
Mismatch	±0.080	dB	U-shape	0.040
Spectrum analyzer	±0.500	dB	Rectangular	0.250
Combined standard uncertainty $U_c(y)$				1.771
Measuring uncertainty for a level of confidence of 95% $U=2U_c(y)$				3.541

Uncertainty of Conducted Emission Measurement

Contribution	Uncertainty of x_i			$u(x_i)$
	Value	Unit	Probability Distribution k	
Cable loss	±0.038	dB	K=2	0.019
Attenuator	±0.047	dB	K=2	0.024
Power Meter specification	±0.300	dB	Triangular	0.150
Power Sensor specification	±0.300	dB	Rectangular	0.150
Signal generator	±0.461	dB	Rectangular	0.231
Mismatch	±0.080	dB	U-shape	0.040
Spectrum analyzer	±0.500	dB	Rectangular	0.250
Combined standard uncertainty $U_c(y)$				0.863
Measuring uncertainty for a level of confidence of 95% $U=2U_c(y)$				1.726