

FCC Test Report

Report No.: RF131112D04E

FCC ID: Q87-LAPN600

Test Model: LAPN600

Received Date: Jul. 20, 2016

Test Date: Jul. 20, 2016

Issued Date: Jul. 21, 2016

Applicant: Linksys LLC

Address: 121 Theory Drive Irvine California 92617 United States

Issued By: Bureau Veritas Consumer Products Services (H.K.) Ltd., Taoyuan Branch

Lab Address: No. 47-2, 14th Ling, Chia Pau Vil., Lin Kou Dist., New Taipei City, Taiwan (R.O.C.)



This report is for your exclusive use. Any copying or replication of this report to or for any other person or entity, or use of our name or trademark, is permitted only with our prior written permission. This report sets forth our findings solely with respect to the test samples identified herein. The results set forth in this report are not indicative or representative of the quality or characteristics of the lot from which a test sample was taken or any similar or identical product unless specifically and expressly noted. Our report includes all of the tests requested by you and the results thereof based upon the information that you provided to us. You have 60 days from date of issuance of this report to notify us of any material error or omission caused by our negligence, provided, however, that such notice shall be in writing and shall specifically address the issue you wish to raise. A failure to raise such issue within the prescribed time shall constitute your unqualified acceptance of the completeness of this report, the tests conducted and the correctness of the report contents. Unless specific mention, the uncertainty of measurement has been explicitly taken into account to declare the compliance or non-compliance to the specification. The report must not be used by the client to claim product certification, approval, or endorsement by TAF or any government agencies.

Table of Contents

Report Issue History Record	4
Release Control Record	4
1 Certificate of Conformity	5
2 Summary of Test Results	6
2.1 Measurement Uncertainty	6
2.2 Modification Record	6
3 General Information	7
3.1 General Description of EUT	7
3.2 Description of Test Modes	9
3.2.1 Test Mode Applicability and Tested Channel Detail	10
3.3 Duty Cycle of Test Signal	12
3.4 Description of Support Units	13
3.4.1 Configuration of System under Test	13
3.5 General Description of Applied Standard	14
4 Test Types and Results	15
4.1 Radiated Emission and Bandedge Measurement	15
4.1.1 Limits of Radiated Emission and Bandedge Measurement	15
4.1.2 Test Instruments	16
4.1.3 Test Procedure	17
4.1.4 Deviation from Test Standard	17
4.1.5 Test Setup	18
4.1.6 EUT Operating Condition	18
4.1.7 Test Results	19
4.2 Conducted Emission Measurement	28
4.2.1 Limits of Conducted Emission Measurement	28
4.2.2 Test Instruments	28
4.2.3 Test Procedure	29
4.2.4 Deviation from Test Standard	29
4.2.5 Test Setup	29
4.2.6 EUT Operating Condition	29
4.2.7 Test Results	30
4.3 Transmit Power Measurement	32
4.3.1 Limits of Transmit Power Measurement	32
4.3.2 Test Setup	32
4.3.3 Test Instruments	32
4.3.4 Test Procedure	33
4.3.5 Deviation from Test Standard	33
4.3.6 EUT Operating Condition	33
4.3.7 Test Result	34
4.4 Peak Power Spectral Density Measurement	36
4.4.1 Limits of Peak Power Spectral Density Measurement	36
4.4.2 Test Setup	36
4.4.3 Test Instruments	36
4.4.4 Test Procedure	36
4.4.5 Deviation from Test Standard	36
4.4.6 EUT Operating Condition	36
4.4.7 Test Results	37
4.5 Frequency Stability Measurement	39
4.5.1 Limits of Frequency Stability Measurement	39
4.5.2 Test Setup	39
4.5.3 Test Instruments	39

4.5.4	Test Procedure	39
4.5.5	Deviation from Test Standard	39
4.5.6	EUT Operating Condition	39
4.5.7	Test Results	40
4.6	6dB Bandwidth Measurement	41
4.6.1	Limits of 6dB Bandwidth Measurement	41
4.6.2	Test Setup	41
4.6.3	Test Instruments	41
4.6.4	Test Procedure	41
4.6.5	Deviation from Test Standard	41
4.6.6	EUT Operating Condition	41
4.6.7	Test Results	42
5	Pictures of Test Arrangements	44
	Annex A- Radiated Out of Band Emisison (OOBE) Measurement (For U-NII-3 band)	45
	Appendix – Information on the Testing Laboratories	48

Report Issue History Record

Issue No.	Description	Date Issued
RF131112D04	Original	Dec. 16, 2013
RF131112D04B	Upgraded the standard to section 15.407 under new rule for U-NII-1 and U-NII-3 band.	Apr. 7, 2016
RF131112D04C-1	PCB re-layout of PoE IC & changing flash.	Jul. 7, 2016
RF131112D04E	Upgraded the standard to section 15.407 under new rule (16-24) for U-NII-3 band.	Jul. 21, 2016

Release Control Record

Issue No.	Description	Date Issued
RF131112D04E	Original release.	Jul. 21, 2016

1 Certificate of Conformity

Product: Wireless-N600 Dual Band Access Point with PoE

Brand: Linksys

Test Model: LAPN600

Sample Status: Engineering sample

Applicant: Linksys LLC

Test Date: Jul. 20, 2016

Standard: 47 CFR FCC Part 15, Subpart E (Section 15.407)
ANSI C63.10: 2013

The above equipment has been tested by **Bureau Veritas Consumer Products Services (H.K.) Ltd., Taoyuan Branch**, and found compliance with the requirement of the above standards. The test record, data evaluation & Equipment Under Test (EUT) configurations represented herein are true and accurate accounts of the measurements of the sample's EMC characteristics under the conditions specified in this report.

Prepared by : Annie Chang , **Date:** Jul. 21, 2016
Annie Chang / Senior Specialist

Approved by : Rex Lai , **Date:** Jul. 21, 2016
Rex Lai / Assistant Manager

2 Summary of Test Results

47 CFR FCC Part 15, Subpart E (SECTION 15.407)			
FCC Clause	Test Item	Result	Remarks
15.407(b)(6)	AC Power Conducted Emissions	Pass	Meet the requirement of limit. Minimum passing margin is -5.35dB at 25.87109 MHz.
15.407(b) (1/2/3/4(i/ii)/6)	Radiated Emissions & Band Edge Measurement*	Pass	Meet the requirement of limit. Minimum passing margin is -3.1dB at 5925.01 MHz.
15.407(a)(1/2/3)	Max Average Transmit Power	Pass	Meet the requirement of limit.
15.407(a)(1/2/3)	Peak Power Spectral Density	Pass	Meet the requirement of limit.
15.407(e)	6dB bandwidth	Pass	Meet the requirement of limit. (U-NII-3 Band only)
15.407(g)	Frequency Stability	Pass	Meet the requirement of limit.
15.203	Antenna Requirement	Pass	Antenna connector is I-PEX not a standard connector.

NOTE: This report is prepared for FCC Class II change. (Upgraded the standard to section 15.407 under new rule (16-24) for U-NII-3 band)

*For U-NII-3 band compliance with rule part 15.407(b)(i), the OOB test plots were recorded in Annex A.

2.1 Measurement Uncertainty

Where relevant, the following measurement uncertainty levels have been estimated for tests performed on the EUT as specified in CISPR 16-4-2:

Measurement	Frequency	Expanded Uncertainty (k=2) (\pm)
Conducted Emissions at mains ports	150kHz ~ 30MHz	2.78 dB
Radiated Emissions up to 1 GHz	30MHz ~ 1000MHz	4.00 dB
Radiated Emissions above 1 GHz	1GHz ~ 40GHz	3.36 dB

2.2 Modification Record

There were no modifications required for compliance.

3 General Information

3.1 General Description of EUT

Product	Wireless-N600 Dual Band Access Point with PoE
Brand	Linksys
Test Model	LAPN600
Status of EUT	Engineering Sample
Driver Version	v1.0.14.001
Power Supply Rating	12Vdc from AC Adapter or 48Vdc from PoE
Modulation Type	64QAM, 16QAM, QPSK, BPSK
Modulation Technology	OFDM
Transfer Rate	802.11a: 54/48/36/24/18/12/9/6Mbps 802.11n: up to 300Mbps
Operating Frequency	5180 ~ 5240MHz, 5745 ~ 5825MHz
Number of Channel	5180 ~ 5240MHz 4 for 802.11a, 802.11n (20MHz) 2 for 802.11n (40MHz) 5745 ~ 5825MHz 5 for 802.11a, 802.11n (20MHz) 2 for 802.11n (40MHz)
Output Power	5180 ~ 5240MHz: 576.853 mW 5745 ~ 5825MHz: 896.13mW
Antenna Type	5180 ~ 5240MHz: PIFA antenna with 3.5dBi gain 5745 ~ 5825MHz: PIFA antenna with 3.9dBi gain
Antenna Connector	N/A
Accessory Device	Adapter
Data Cable Supplied	N/A

Note:

- This report is a supplementary report of RF131112D04. The differences between them are as below information:
 - ✧ Upgraded the standard to section 15.407 under new rule (16-24) for U-NII-3 band
- According to above conditions, all test item of U-NII-3 band needs to be performed. And all data was verified to meet the requirements. And the **Transmit Power Measurement** of U-NII-1 band has no effect for this addendum, the U-NII-1 band was not re-tested.
- This report is prepared for FCC class II permissive change.
- The EUT incorporates a MIMO function. Physically, the EUT provides two completed transmitters and two receivers.

Modulation Mode	TX Function
802.11a	2TX
802.11n (20MHz)	2TX
802.11n (40MHz)	2TX

5. The EUT was power supplied from the following power adapters and PoE:

Item	Brand	Model No.	Plug Type	Rating
Adapter 1	LEI	MU12AB120100-A1	US Plug	AC I/P: 100-240V, 50/60Hz, 0.4A DC O/P: 12V 1.0A Non-shielded DC (1.8m)
	LEI	MU12AB120100-C5	EU Plug	
	LEI	MU12AB120100-B2	UK Plug	
	LEI	MU12AB120100-A3	AU Plug	
Four adapters are identical with each other except for their plug type difference				
Adapter 2	LEI	IU18-2120100-WP	US, EU, UK Plug	AC I/P: 100-240V, 50/60Hz, 0.6A DC O/P: 12V 1A Non-shielded DC (1.8m)
Adapter 3	DVE	DSA-12CA-12 120100	US, EU, UK Plug	AC I/P: 100-240V, 50/60Hz, 0.3A DC O/P: 12V 1A Non-shielded DC (1.8m)
Adapter 4	DVE	DSA-12G-12 FUS 120120	US Plug	AC I/P:100-240V, 50/60Hz 0.3A DC O/P:12V 1A Non-shielded DC (1.8m)
	DVE	DSA-12G-12 FEU 120120	EU Plug	
	DVE	DSA-12G-12 FUK 120120	UK Plug	
	DVE	DSA-12G-12 FAU 120120	AU Plug	
Four adapters are identical with each other except for their plug type difference				
PoE	-			48Vdc

Select the previous worse case (**Adapter 1**) for final test, therefore, only its test data was recorded in this report.

6. The above EUT information is declared by manufacturer and for more detailed features description, please refer to the manufacturer's specifications or user's manual.

3.2 Description of Test Modes

5 channels are provided for 802.11a, 802.11n (20MHz):

Channel	Frequency	Channel	Frequency
149	5745MHz	161	5805MHz
153	5765MHz	165	5825MHz
157	5785MHz		

2 channels are provided for 802.11n (40MHz):

Channel	Frequency	Channel	Frequency
151	5755MHz	159	5795MHz

3.2.1 Test Mode Applicability and Tested Channel Detail

EUT Configure Mode	Applicable To				Description
	RE≥1G	RE<1G	PLC	APCM	
-	√	√	√	√	-

Where **RE≥1G**: Radiated Emission above 1GHz **RE<1G**: Radiated Emission below 1GHz
PLC: Power Line Conducted Emission **APCM**: Antenna Port Conducted Measurement

Radiated Emission Test (Above 1GHz):

- Pre-Scan has been conducted to determine the worst-case mode from all possible combinations between available modulations, data rates and antenna ports (if EUT with antenna diversity architecture).
- Following channel(s) was (were) selected for the final test as listed below.

EUT CONFIGURE MODE	MODE	FREQ. BAND (MHz)	AVAILABLE CHANNEL	TESTED CHANNEL	MODULATION TECHNOLOGY	MODULATION TYPE	DATA RATE (Mbps)
-	802.11a	5745-5825	149 to 165	149, 157, 165	OFDM	BPSK	6.0
-	802.11n (20MHz)		149 to 165	149, 157, 165	OFDM	BPSK	6.5
-	802.11n (40MHz)		151 to 159	151, 159	OFDM	BPSK	13.0

Radiated Emission Test (Below 1GHz):

- Pre-Scan has been conducted to determine the worst-case mode from all possible combinations between available modulations, data rates and antenna ports (if EUT with antenna diversity architecture).
- Following channel(s) was (were) selected for the final test as listed below.

EUT CONFIGURE MODE	MODE	FREQ. BAND (MHz)	AVAILABLE CHANNEL	TESTED CHANNEL	MODULATION TECHNOLOGY	MODULATION TYPE	DATA RATE (Mbps)
-	802.11a	5745-5825	149 to 165	149	OFDM	BPSK	6.0

Power Line Conducted Emission Test:

- Pre-Scan has been conducted to determine the worst-case mode from all possible combinations between available modulations, data rates and antenna ports (if EUT with antenna diversity architecture).
- Following channel(s) was (were) selected for the final test as listed below.

EUT CONFIGURE MODE	MODE	FREQ. BAND (MHz)	AVAILABLE CHANNEL	TESTED CHANNEL	MODULATION TECHNOLOGY	MODULATION TYPE	DATA RATE (Mbps)
-	802.11a	5745-5825	149 to 165	149	OFDM	BPSK	6.0

Antenna Port Conducted Measurement:

- This item includes all test value of each mode, but only includes spectrum plot of worst value of each mode.
- Pre-Scan has been conducted to determine the worst-case mode from all possible combinations between available modulations, data rates and antenna ports (if EUT with antenna diversity architecture).
- Following channel(s) was (were) selected for the final test as listed below.

EUT CONFIGURE MODE	MODE	FREQ. BAND (MHz)	AVAILABLE CHANNEL	TESTED CHANNEL	MODULATION TECHNOLOGY	MODULATION TYPE	DATA RATE (Mbps)
-	802.11a	5745-5825	149 to 165	149, 157, 165	OFDM	BPSK	6.0
-	802.11n (20MHz)		149 to 165	149, 157, 165	OFDM	BPSK	6.5
-	802.11n (40MHz)		151 to 159	151, 159	OFDM	BPSK	13.0

Test Condition:

APPLICABLE TO	ENVIRONMENTAL CONDITIONS	INPUT POWER	TESTED BY
RE \geq 1G	16deg. C, 76%RH	120Vac, 60Hz	Aaron You
RE<1G	20deg. C, 66%RH	120Vac, 60Hz	Aaron You
PLC	23deg. C, 75%RH	120Vac, 60Hz	Aaron You
APCM	25deg. C, 60%RH	120Vac, 60Hz	Saxon Lee

3.3 Duty Cycle of Test Signal

Duty cycle of test signal is < 98 %, duty factor is required

802.11a: Duty cycle = 1.318/1.398 = 0.943, Duty factor = $10 * \log(1/0.943) = 0.26$

802.11n (20MHz): Duty cycle = 1.253/1.326 = 0.945, Duty factor = $10 * \log(1/0.945) = 0.25$

802.11n (40MHz): Duty cycle = 0.592/0.665 = 0.890, Duty factor = $10 * \log(1/0.890) = 0.50$

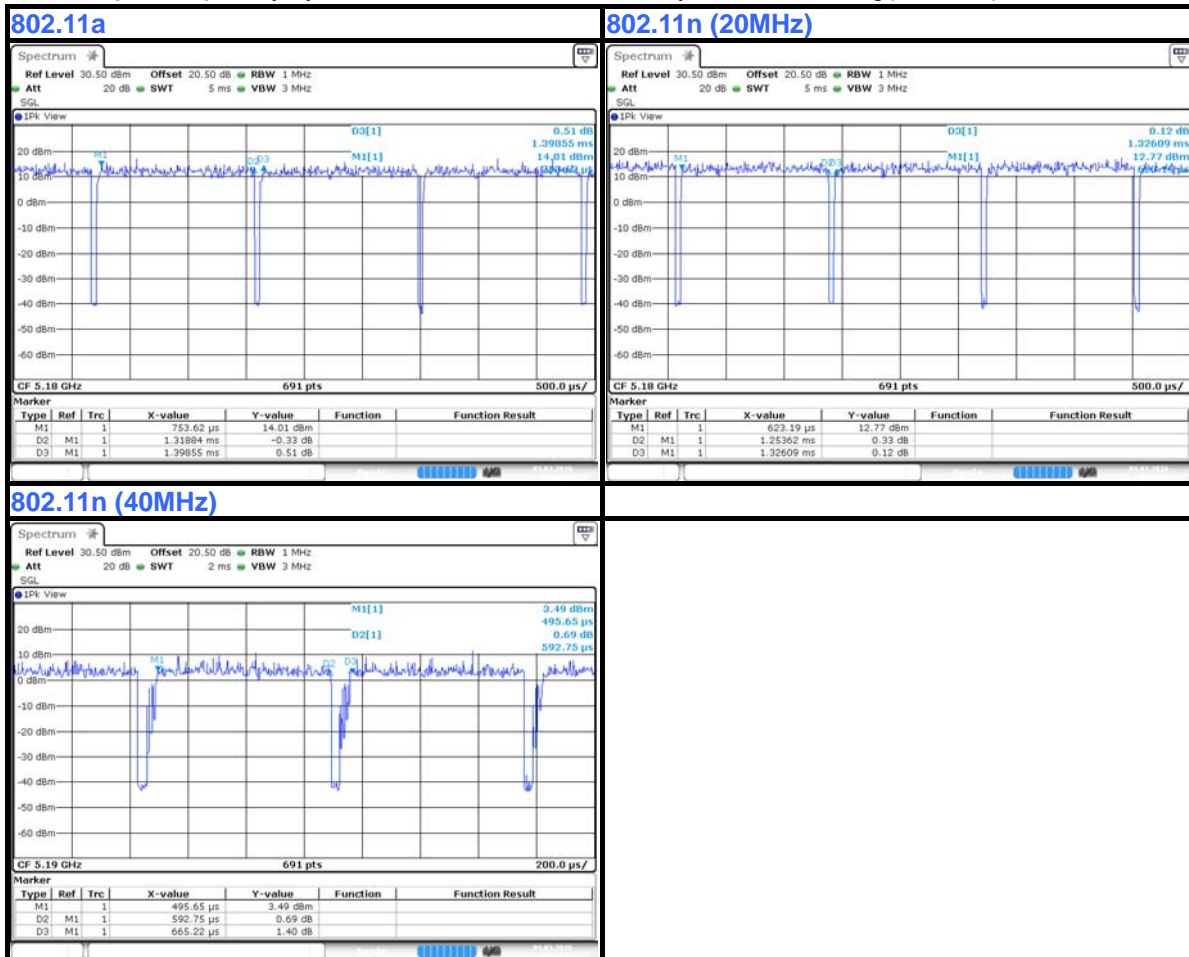

3.4 Description of Support Units

The EUT has been tested as an independent unit together with other necessary accessories or support units. The following support units or accessories were used to form a representative test configuration during the tests.

ID	Product	Brand	Model No.	Serial No.	FCC ID	Remarks
A.	Notebook PC	DELL	PP27L	8SNZ12S	FCC DoC Approved	Provided by Lab

Note:

1. All power cords of the above support units are non-shielded (1.8m).
2. Item A acted as communication partners to transfer data.

ID	Descriptions	Qty.	Length (m)	Shielding (Yes/No)	Cores (Qty.)	Remarks
1.	LAN cable	1	10	N	0	Provided by Lab

Note: The core(s) is(are) originally attached to the cable(s).

3.4.1 Configuration of System under Test

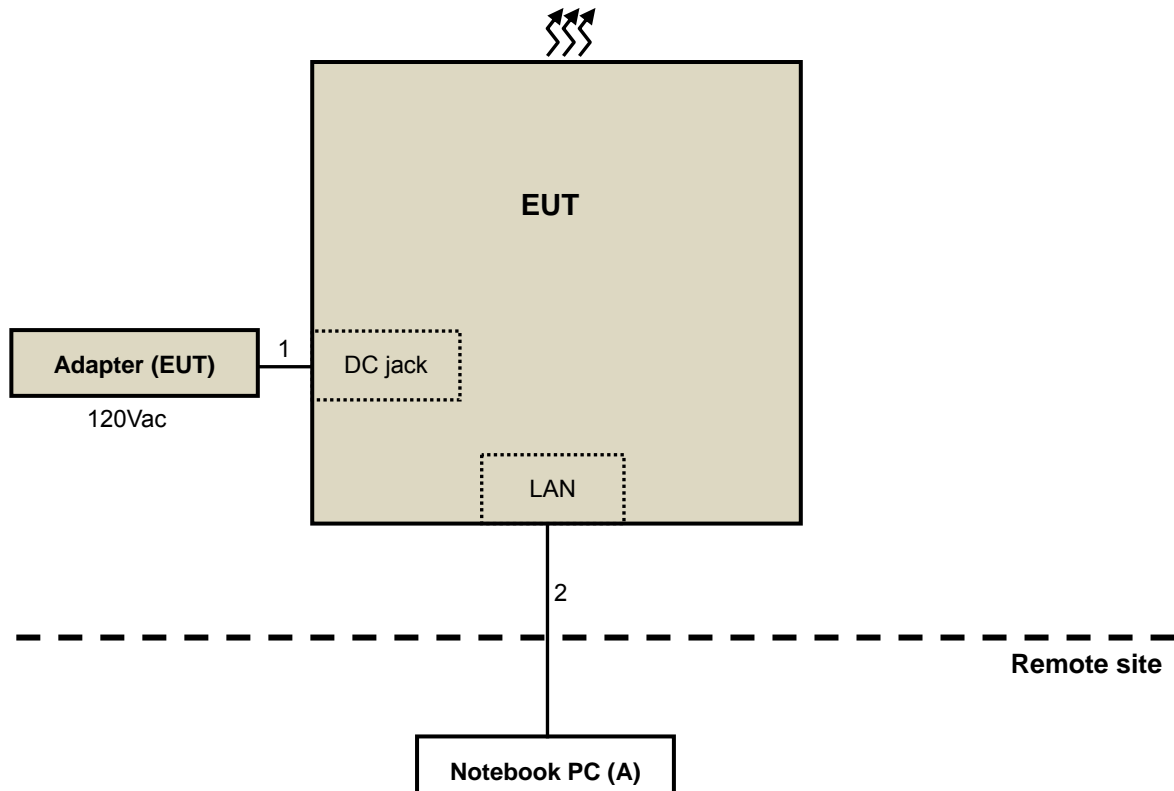

3.5 General Description of Applied Standard

The EUT is a RF Product. According to the specifications of the manufacturer, it must comply with the requirements of the following standards:

FCC Part 15, Subpart E (15.407)

KDB 789033 D02 General UNII Test Procedure New Rules v01r02

KDB 662911 D01 Multiple Transmitter Output v02r01

ANSI C63.10-2013

All test items have been performed and recorded as per the above standards.

NOTE: The EUT is also considered as a kind of computer peripheral, because the connection to computer is necessary for typical use. It has been verified to comply with the requirements of FCC Part 15, Subpart B, Class B (DoC). The test report has been issued separately.

4 Test Types and Results

4.1 Radiated Emission and Bandedge Measurement

4.1.1 Limits of Radiated Emission and Bandedge Measurement

Radiated emissions which fall in the restricted bands must comply with the radiated emission limits specified as below table.

Frequencies (MHz)	Field Strength (microvolts/meter)	Measurement Distance (meters)
0.009 ~ 0.490	2400/F(kHz)	300
0.490 ~ 1.705	24000/F(kHz)	30
1.705 ~ 30.0	30	30
30 ~ 88	100	3
88 ~ 216	150	3
216 ~ 960	200	3
Above 960	500	3

NOTE:

- The lower limit shall apply at the transition frequencies.
- Emission level (dBuV/m) = 20 log Emission level (uV/m).
- For frequencies above 1000MHz, the field strength limits are based on average detector, however, the peak field strength of any emission shall not exceed the maximum permitted average limits, specified above by more than 20dB under any condition of modulation.

Limits Of Unwanted Emission Out Of The Restricted Bands

Applicable To	Limit	
789033 D02 General UNII Test Procedure New Rules v01r02	FIELD STRENGTH at 3m	
	PK:74 (dBuV/m)	AV:54 (dBuV/m)
Applicable To	EIRP Limit	Equivalent Field Strength at 3m
15.407(b)(1)	PK:-27 (dBm/MHz)	PK:68.2(dBuV/m)
15.407(b)(2)		
15.407(b)(3)		
15.407(b)(4)(i)	PK:-27 (dBm/MHz) ^{*1} PK:10 (dBm/MHz) ^{*2} PK:15.6 (dBm/MHz) ^{*3} PK:27 (dBm/MHz) ^{*4}	PK: 68.2(dBuV/m) ^{*1} PK:105.2 (dBuV/m) ^{*2} PK: 110.8(dBuV/m) ^{*3} PK:122.2 (dBuV/m) ^{*4}
15.407(b)(4)(ii)	FIELD STRENGTH at 3m / § 15.247(d),	
	PK:74 (dBuV/m)	AV:54 (dBuV/m)
^{*1} beyond 75 MHz or more above of the band edge.		^{*2} below the band edge increasing linearly to 10 dBm/MHz at 25 MHz above.
^{*3} below the band edge increasing linearly to a level of 15.6 dBm/MHz at 5 MHz above.		^{*4} from 5 MHz above or below the band edge increasing linearly to a level of 27 dBm/MHz at the band edge.

NOTE: The following formula is used to convert the equipment isotropic radiated power (eirp) to field strength:

$$E = \frac{1000000\sqrt{30P}}{3} \mu\text{V/m, where P is the eirp (Watts).}$$

4.1.2 Test Instruments

DESCRIPTION & MANUFACTURER	MODEL NO.	SERIAL NO.	CALIBRATED DATE	CALIBRATED UNTIL
HP Preamplifier	8447D	2432A03504	Feb. 26, 2016	Feb. 25, 2017
HP Preamplifier	8449B	3008A01201	Feb. 26, 2016	Feb. 25, 2017
MITEQ Preamplifier	AMF-6F-260400-33-8P	892164	Mar. 01, 2016	Feb. 28, 2017
Agilent TEST RECEIVER	N9038A	MY51210129	Feb. 02, 2016	Feb. 01, 2017
Schwarzbeck Antenna	VULB 9168	139	Jan. 04, 2016	Jan. 03, 2017
Schwarzbeck Antenna	VHBA 9123	480	May 29, 2015	May 28, 2017
Schwarzbeck Horn Antenna	BBHA-9170	212	Jan. 08, 2016	Jan. 07, 2017
Schwarzbeck Horn Antenna	BBHA 9120-D1	D130	Jan. 21, 2016	Jan. 20, 2017
ADT. Turn Table	TT100	0306	NA	NA
ADT. Tower	AT100	0306	NA	NA
Software	Radiated_V7.6.15.9.4	NA	NA	NA
SUHNER RF cable With 4dB PAD	SF104	CABLE-CH6	Aug. 15, 2015	Aug. 14, 2016
SUHNER RF cable With 3dB PAD	SF102	Cable-CH8-3.6m	Aug. 15, 2015	Aug. 14, 2016
KEYSIGHT MIMO Powermeasurement Test set	U2021XA	U2021XA-001	May 25, 2016	May 24, 2017
EMCO Horn Antenna	3115	00028257	Jan. 19, 2016	Jan. 18, 2017
Highpass filter Wainwright Instruments	WHK 3.1/18G-10SS	SN 8	NA	NA
ROHDE & SCHWARZ Spectrum Analyzer	FSV40	101042	Sep. 23, 2015	Sep. 22, 2016
Anritsu Power Sensor	MA2411B	0738404	Apr. 28, 2016	Apr. 27, 2017
Anritsu Power Meter	ML2495A	0842014	Apr. 28, 2016	Apr. 27, 2017

- NOTE:**
1. The calibration interval of the above test instruments is 12/24 months. And the calibrations are traceable to NML/ROC and NIST/USA.
 2. The horn antenna and HP preamplifier (model: 8449B) are used only for the measurement of emission frequency above 1GHz if tested.
 3. The test was performed in Chamber No. 6.
 4. The Industry Canada Reference No. IC 7450E-6.
 5. The FCC Site Registration No. is 447212.

4.1.3 Test Procedure

- a. The EUT was placed on the top of a rotating table 0.8 meters (for below 1GHz) / 1.5 meters (for above 1GHz) above the ground at 3 meter chamber room for test. The table was rotated 360 degrees to determine the position of the highest radiation.
- b. The EUT was set 3 meters away from the interference-receiving antenna, which was mounted on the top of a variable-height antenna tower.
- c. The height of antenna is varied from one meter to four meters above the ground to determine the maximum value of the field strength. Both horizontal and vertical polarizations of the antenna are set to make the measurement.
- d. For each suspected emission, the EUT was arranged to its worst case and then the antenna was tuned to heights from 1 meter to 4 meters and the rotatable table was turned from 0 degrees to 360 degrees to find the maximum reading.
- e. The test-receiver system was set to quasi-peak detect function and specified bandwidth with maximum hold mode when the test frequency is below 1 GHz.
- f. The test-receiver system was set to peak and average detect function and specified bandwidth with maximum hold mode when the test frequency is above 1 GHz. If the peak reading value also meets average limit, measurement with the average detector is unnecessary.

Note:

1. The resolution bandwidth and video bandwidth of test receiver/spectrum analyzer is 120kHz for Quasi-peak detection (QP) at frequency below 1GHz.
2. The resolution bandwidth of test receiver/spectrum analyzer is 1 MHz and the video bandwidth is 3 MHz for Peak detection (PK) at frequency above 1GHz.
3. The resolution bandwidth of test receiver/spectrum analyzer is 1MHz and the video bandwidth is 3MHz for RMS Average (Duty cycle < 98%) for Average detection (AV) at frequency above 1GHz, then the measurement results was added to a correction factor ($10 \log(1/\text{duty cycle})$).
4. The resolution bandwidth of test receiver/spectrum analyzer is 1MHz and the video bandwidth is 10Hz (Duty cycle $\geq 98\%$) for Average detection (AV) at frequency above 1GHz.
5. All modes of operation were investigated and the worst-case emissions are reported.

4.1.4 Deviation from Test Standard

No deviation.

4.1.5 Test Setup

<Frequency Range below 1GHz>

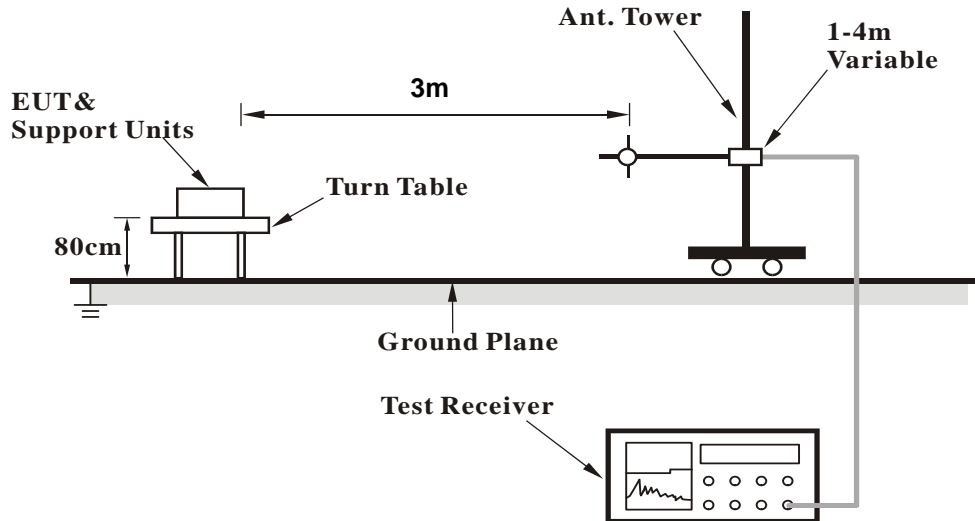

<Frequency Range above 1GHz>

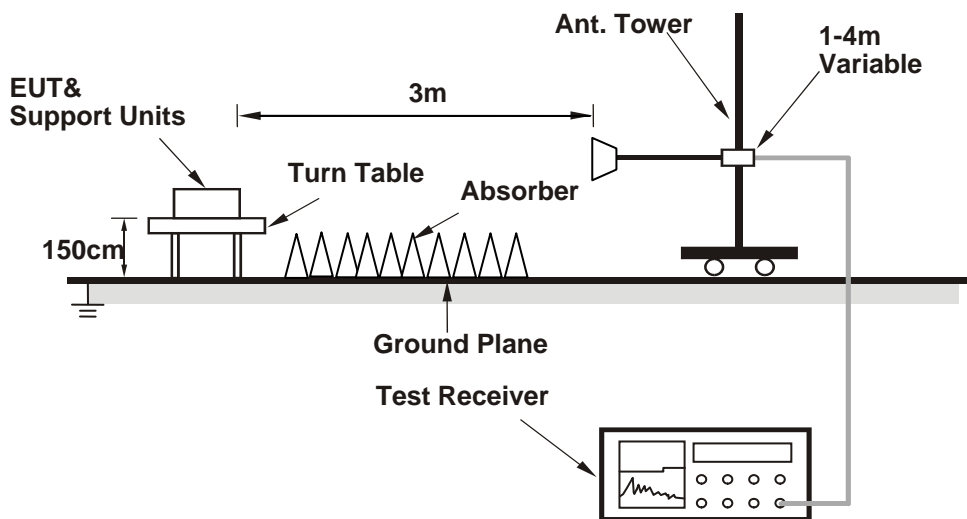

For the actual test configuration, please refer to the attached file (Test Setup Photo).

4.1.6 EUT Operating Condition

The Notebook connected with EUT via a LAN cable and run a test program (provided by manufacturer) to enable EUT under transmission condition continuously at specific channel frequency.

4.1.7 Test Results

ABOVE 1GHz DATA

802.11a

CHANNEL	TX Channel 149	DETECTOR FUNCTION	Peak (PK)
FREQUENCY RANGE	1GHz ~ 40GHz		Average (AV)

ANTENNA POLARITY & TEST DISTANCE: HORIZONTAL AT 3 M

NO.	FREQ. (MHz)	EMISSION LEVEL (dBuV/m)	LIMIT (dBuV/m)	MARGIN (dB)	ANTENNA HEIGHT (m)	TABLE ANGLE (Degree)	RAW VALUE (dBuV)	CORRECTION FACTOR (dB/m)
1	#5649.99	65.0 PK	68.2	-3.2	1.45 H	231	54.50	10.50
2	*5745.00	119.1 PK			1.45 H	231	108.71	10.35
3	*5745.00	108.4 AV			1.45 H	231	98.09	10.35
4	11490.00	61.8 PK	74.0	-12.2	1.82 H	116	39.52	22.26
5	11490.00	49.0 AV	54.0	-5.0	1.82 H	116	26.76	22.26

ANTENNA POLARITY & TEST DISTANCE: VERTICAL AT 3 M

NO.	FREQ. (MHz)	EMISSION LEVEL (dBuV/m)	LIMIT (dBuV/m)	MARGIN (dB)	ANTENNA HEIGHT (m)	TABLE ANGLE (Degree)	RAW VALUE (dBuV)	CORRECTION FACTOR (dB/m)
1	#5649.99	66.0 PK	68.2	-2.2	1.34 V	213	55.50	10.50
2	*5745.00	121.1 PK			1.34 V	213	110.74	10.35
3	*5745.00	111.5 AV			1.34 V	213	101.11	10.35
4	11490.00	61.8 PK	74.0	-12.2	2.31 V	123	39.58	22.26
5	11490.00	49.3 AV	54.0	-4.7	2.31 V	123	27.04	22.26

REMARKS:

- Emission Level(dBuV/m) = Raw Value(dBuV) + Correction Factor(dB/m)
- Correction Factor(dB/m) = Antenna Factor(dB/m) + Cable Factor(dB) – Pre-Amplifier Factor(dB)
- The other emission levels were very low against the limit.
- Margin value = Emission Level – Limit value
- " * ": Fundamental frequency.
- " # ": The radiated frequency is out of the restricted band.

CHANNEL	TX Channel 157	DETECTOR FUNCTION	Peak (PK)
FREQUENCY RANGE	1GHz ~ 40GHz		Average (AV)

ANTENNA POLARITY & TEST DISTANCE: HORIZONTAL AT 3 M

NO.	FREQ. (MHz)	EMISSION LEVEL (dBuV/m)	LIMIT (dBuV/m)	MARGIN (dB)	ANTENNA HEIGHT (m)	TABLE ANGLE (Degree)	RAW VALUE (dBuV)	CORRECTION FACTOR (dB/m)
1	*5785.00	119.5 PK			1.02 H	232	109.27	10.26
2	*5785.00	108.9 AV			1.02 H	232	98.68	10.26
3	11570.00	61.9 PK	74.0	-12.2	1.77 H	103	39.50	22.35
4	11570.00	48.9 AV	54.0	-5.1	1.77 H	103	26.55	22.35

ANTENNA POLARITY & TEST DISTANCE: VERTICAL AT 3 M

NO.	FREQ. (MHz)	EMISSION LEVEL (dBuV/m)	LIMIT (dBuV/m)	MARGIN (dB)	ANTENNA HEIGHT (m)	TABLE ANGLE (Degree)	RAW VALUE (dBuV)	CORRECTION FACTOR (dB/m)
1	*5785.00	121.1 PK			1.18 V	213	110.86	10.26
2	*5785.00	111.4 AV			1.18 V	213	101.14	10.26
3	11570.00	62.0 PK	74.0	-12.0	2.29 V	120	39.69	22.35
4	11570.00	49.5 AV	54.0	-4.5	2.29 V	120	27.13	22.35

REMARKS:

1. Emission Level(dBuV/m) = Raw Value(dBuV) + Correction Factor(dB/m)
2. Correction Factor(dB/m) = Antenna Factor(dB/m) + Cable Factor(dB) – Pre-Amplifier Factor(dB)
3. The other emission levels were very low against the limit.
4. Margin value = Emission Level – Limit value
5. " * ": Fundamental frequency.

CHANNEL	TX Channel 165	DETECTOR FUNCTION	Peak (PK)
FREQUENCY RANGE	1GHz ~ 40GHz		Average (AV)

ANTENNA POLARITY & TEST DISTANCE: HORIZONTAL AT 3 M

NO.	FREQ. (MHz)	EMISSION LEVEL (dBuV/m)	LIMIT (dBuV/m)	MARGIN (dB)	ANTENNA HEIGHT (m)	TABLE ANGLE (Degree)	RAW VALUE (dBuV)	CORRECTION FACTOR (dB/m)
1	*5825.00	118.4 PK			1.07 H	231	108.10	10.27
2	*5825.00	108.4 AV			1.07 H	231	98.12	10.27
3	#5925.01	63.6 PK	68.2	-4.6	1.08 H	231	53.14	10.50
4	11650.00	61.3 PK	74.0	-12.7	1.73 H	109	39.26	22.06
5	11650.00	48.6 AV	54.0	-5.4	1.73 H	109	26.50	22.06

ANTENNA POLARITY & TEST DISTANCE: VERTICAL AT 3 M

NO.	FREQ. (MHz)	EMISSION LEVEL (dBuV/m)	LIMIT (dBuV/m)	MARGIN (dB)	ANTENNA HEIGHT (m)	TABLE ANGLE (Degree)	RAW VALUE (dBuV)	CORRECTION FACTOR (dB/m)
1	*5825.00	118.9 PK			1.51 V	59	108.65	10.27
2	*5825.00	108.7 AV			1.51 V	59	98.40	10.27
3	#5925.01	64.1 PK	68.2	-4.1	1.51 V	59	53.60	10.50
4	11650.00	61.6 PK	74.0	-12.5	2.34 V	118	39.49	22.06
5	11650.00	49.1 AV	54.0	-4.9	2.34 V	118	27.00	22.06

REMARKS:

1. Emission Level(dBuV/m) = Raw Value(dBuV) + Correction Factor(dB/m)
2. Correction Factor(dB/m) = Antenna Factor(dB/m) + Cable Factor(dB) – Pre-Amplifier Factor(dB)
3. The other emission levels were very low against the limit.
4. Margin value = Emission Level – Limit value
5. " * ": Fundamental frequency.
6. " # ": The radiated frequency is out of the restricted band.

802.11n (20MHz)

CHANNEL	TX Channel 149	DETECTOR FUNCTION	Peak (PK)
FREQUENCY RANGE	1GHz ~ 40GHz		Average (AV)

ANTENNA POLARITY & TEST DISTANCE: HORIZONTAL AT 3 M								
NO.	FREQ. (MHz)	EMISSION LEVEL (dBuV/m)	LIMIT (dBuV/m)	MARGIN (dB)	ANTENNA HEIGHT (m)	TABLE ANGLE (Degree)	RAW VALUE (dBuV)	CORRECTION FACTOR (dB/m)
1	#5649.99	64.7 PK	68.2	-3.5	1.45 H	232	54.23	10.50
2	*5745.00	110.0 PK			1.45 H	232	108.59	10.40
3	*5745.00	100.9 AV			1.45 H	232	99.47	10.40
4	11490.00	61.4 PK	74.0	-12.6	1.79 H	118	39.14	22.26
5	11490.00	48.3 AV	54.0	-5.7	1.79 H	118	26.08	22.26

ANTENNA POLARITY & TEST DISTANCE: VERTICAL AT 3 M								
NO.	FREQ. (MHz)	EMISSION LEVEL (dBuV/m)	LIMIT (dBuV/m)	MARGIN (dB)	ANTENNA HEIGHT (m)	TABLE ANGLE (Degree)	RAW VALUE (dBuV)	CORRECTION FACTOR (dB/m)
1	#5649.99	65.0 PK	68.2	-3.2	1.05 V	210	54.54	10.50
2	*5745.00	120.9 PK			1.05 V	210	110.51	10.35
3	*5745.00	111.5 AV			1.05 V	210	101.15	10.35
4	11490.00	61.6 PK	74.0	-12.5	2.24 V	131	39.29	22.26
5	11490.00	49.0 AV	54.0	-5.0	2.24 V	131	26.77	22.26

REMARKS:

1. Emission Level(dBuV/m) = Raw Value(dBuV) + Correction Factor(dB/m)
2. Correction Factor(dB/m) = Antenna Factor(dB/m) + Cable Factor(dB) – Pre-Amplifier Factor(dB)
3. The other emission levels were very low against the limit.
4. Margin value = Emission Level – Limit value
5. " * ": Fundamental frequency.
6. " # ": The radiated frequency is out of the restricted band.

CHANNEL	TX Channel 157	DETECTOR FUNCTION	Peak (PK)
FREQUENCY RANGE	1GHz ~ 40GHz		Average (AV)

ANTENNA POLARITY & TEST DISTANCE: HORIZONTAL AT 3 M

NO.	FREQ. (MHz)	EMISSION LEVEL (dBuV/m)	LIMIT (dBuV/m)	MARGIN (dB)	ANTENNA HEIGHT (m)	TABLE ANGLE (Degree)	RAW VALUE (dBuV)	CORRECTION FACTOR (dB/m)
1	*5785.00	116.8 PK			1.44 H	237	106.58	10.26
2	*5785.00	107.1 AV			1.44 H	237	96.88	10.26
3	11570.00	61.6 PK	74.0	-12.5	1.62 H	115	39.20	22.35
4	11570.00	48.3 AV	54.0	-5.7	1.62 H	115	25.99	22.35

ANTENNA POLARITY & TEST DISTANCE: VERTICAL AT 3 M

NO.	FREQ. (MHz)	EMISSION LEVEL (dBuV/m)	LIMIT (dBuV/m)	MARGIN (dB)	ANTENNA HEIGHT (m)	TABLE ANGLE (Degree)	RAW VALUE (dBuV)	CORRECTION FACTOR (dB/m)
1	*5785.00	120.6 PK			1.12 V	216	110.31	10.26
2	*5785.00	110.9 AV			1.12 V	216	100.65	10.26
3	11570.00	61.8 PK	74.0	-12.2	2.20 V	128	39.48	22.35
4	11570.00	48.7 AV	54.0	-5.3	2.20 V	128	26.37	22.35

REMARKS:

1. Emission Level(dBuV/m) = Raw Value(dBuV) + Correction Factor(dB/m)
2. Correction Factor(dB/m) = Antenna Factor(dB/m) + Cable Factor(dB) – Pre-Amplifier Factor(dB)
3. The other emission levels were very low against the limit.
4. Margin value = Emission Level – Limit value
5. " * ": Fundamental frequency.

CHANNEL	TX Channel 165	DETECTOR FUNCTION	Peak (PK)
FREQUENCY RANGE	1GHz ~ 40GHz		Average (AV)

ANTENNA POLARITY & TEST DISTANCE: HORIZONTAL AT 3 M

NO.	FREQ. (MHz)	EMISSION LEVEL (dBuV/m)	LIMIT (dBuV/m)	MARGIN (dB)	ANTENNA HEIGHT (m)	TABLE ANGLE (Degree)	RAW VALUE (dBuV)	CORRECTION FACTOR (dB/m)
1	*5825.00	115.9 PK			1.30 H	230	105.67	10.27
2	*5825.00	106.3 AV			1.30 H	230	96.07	10.27
3	#5925.01	63.7 PK	68.2	-4.5	1.30 H	230	53.24	10.50
4	11650.00	61.2 PK	74.0	-12.8	1.68 H	121	39.18	22.06
5	11650.00	48.1 AV	54.0	-5.9	1.68 H	121	26.03	22.06

ANTENNA POLARITY & TEST DISTANCE: VERTICAL AT 3 M

NO.	FREQ. (MHz)	EMISSION LEVEL (dBuV/m)	LIMIT (dBuV/m)	MARGIN (dB)	ANTENNA HEIGHT (m)	TABLE ANGLE (Degree)	RAW VALUE (dBuV)	CORRECTION FACTOR (dB/m)
1	*5825.00	118.3 PK			1.50 V	61	108.06	10.27
2	*5825.00	108.6 AV			1.50 V	61	98.34	10.27
3	#5925.01	63.8 PK	68.2	-4.4	1.50 V	61	53.34	10.50
4	11650.00	61.4 PK	74.0	-12.6	2.00 V	151	39.38	22.06
5	11650.00	48.3 AV	54.0	-5.8	2.00 V	151	26.19	22.06

REMARKS:

1. Emission Level(dBuV/m) = Raw Value(dBuV) + Correction Factor(dB/m)
2. Correction Factor(dB/m) = Antenna Factor(dB/m) + Cable Factor(dB) – Pre-Amplifier Factor(dB)
3. The other emission levels were very low against the limit.
4. Margin value = Emission Level – Limit value
5. " * ": Fundamental frequency.
6. " # ": The radiated frequency is out of the restricted band.

802.11n (40MHz)

CHANNEL	TX Channel 151	DETECTOR FUNCTION	Peak (PK)
FREQUENCY RANGE	1GHz ~ 40GHz		Average (AV)

ANTENNA POLARITY & TEST DISTANCE: HORIZONTAL AT 3 M

NO.	FREQ. (MHz)	EMISSION LEVEL (dBuV/m)	LIMIT (dBuV/m)	MARGIN (dB)	ANTENNA HEIGHT (m)	TABLE ANGLE (Degree)	RAW VALUE (dBuV)	CORRECTION FACTOR (dB/m)
1	#5649.99	63.8 PK	68.2	-4.4	1.01 H	233	53.27	10.50
2	*5755.00	114.0 PK			1.01 H	233	103.62	10.34
3	*5755.00	104.7 AV			1.01 H	233	94.35	10.34
4	11510.00	61.2 PK	74.0	-12.8	1.55 H	100	38.87	22.29
5	11510.00	47.9 AV	54.0	-6.1	1.55 H	100	25.63	22.29

ANTENNA POLARITY & TEST DISTANCE: VERTICAL AT 3 M

NO.	FREQ. (MHz)	EMISSION LEVEL (dBuV/m)	LIMIT (dBuV/m)	MARGIN (dB)	ANTENNA HEIGHT (m)	TABLE ANGLE (Degree)	RAW VALUE (dBuV)	CORRECTION FACTOR (dB/m)
1	#5649.99	64.4 PK	68.2	-3.9	1.34 V	212	53.85	10.50
2	*5755.00	115.4 PK			1.34 V	212	105.07	10.34
3	*5755.00	106.4 AV			1.34 V	212	96.06	10.34
4	11510.00	61.4 PK	74.0	-12.6	1.73 V	125	39.14	22.29
5	11510.00	48.4 AV	54.0	-5.6	1.73 V	125	26.08	22.29

REMARKS:

1. Emission Level(dBuV/m) = Raw Value(dBuV) + Correction Factor(dB/m)
2. Correction Factor(dB/m) = Antenna Factor(dB/m) + Cable Factor(dB) – Pre-Amplifier Factor(dB)
3. The other emission levels were very low against the limit.
4. Margin value = Emission Level – Limit value
5. " * ": Fundamental frequency.
6. " # ": The radiated frequency is out of the restricted band.

CHANNEL	TX Channel 159	DETECTOR FUNCTION	Peak (PK)
FREQUENCY RANGE	1GHz ~ 40GHz		Average (AV)

ANTENNA POLARITY & TEST DISTANCE: HORIZONTAL AT 3 M

NO.	FREQ. (MHz)	EMISSION LEVEL (dBuV/m)	LIMIT (dBuV/m)	MARGIN (dB)	ANTENNA HEIGHT (m)	TABLE ANGLE (Degree)	RAW VALUE (dBuV)	CORRECTION FACTOR (dB/m)
1	*5795.00	113.2 PK			1.07 H	230	102.91	10.24
2	*5795.00	104.7 AV			1.07 H	230	94.49	10.24
3	#5925.01	64.9 PK	68.2	-3.3	1.07 H	230	54.41	10.50
4	11590.00	61.3 PK	74.0	-12.7	1.49 H	107	38.91	22.37
5	11590.00	47.9 AV	54.0	-6.1	1.49 H	107	25.55	22.37

ANTENNA POLARITY & TEST DISTANCE: VERTICAL AT 3 M

NO.	FREQ. (MHz)	EMISSION LEVEL (dBuV/m)	LIMIT (dBuV/m)	MARGIN (dB)	ANTENNA HEIGHT (m)	TABLE ANGLE (Degree)	RAW VALUE (dBuV)	CORRECTION FACTOR (dB/m)
1	*5795.00	114.8 PK			1.20 V	221	104.59	10.24
2	*5795.00	105.9 AV			1.20 V	221	95.61	10.24
3	#5925.01	65.1 PK	68.2	-3.1	1.20 V	221	54.61	10.50
4	11590.00	61.4 PK	74.0	-12.6	1.88 V	136	39.01	22.37
5	11590.00	48.1 AV	54.0	-5.9	1.88 V	136	25.69	22.37

REMARKS:

- Emission Level(dBuV/m) = Raw Value(dBuV) + Correction Factor(dB/m)
- Correction Factor(dB/m) = Antenna Factor(dB/m) + Cable Factor(dB) – Pre-Amplifier Factor(dB)
- The other emission levels were very low against the limit.
- Margin value = Emission Level – Limit value
- " * ": Fundamental frequency.
- " # ": The radiated frequency is out of the restricted band.

BELOW 1GHz WORST-CASE DATA

802.11a

CHANNEL	TX Channel 149	DETECTOR FUNCTION	Quasi-Peak (QP)
FREQUENCY RANGE	30MHz ~ 1GHz		

ANTENNA POLARITY & TEST DISTANCE: HORIZONTAL AT 3 M								
NO.	FREQ. (MHz)	EMISSION LEVEL (dBuV/m)	LIMIT (dBuV/m)	MARGIN (dB)	ANTENNA HEIGHT (m)	TABLE ANGLE (Degree)	RAW VALUE (dBuV)	CORRECTION FACTOR (dB/m)
1	69.09	18.9 QP	40.0	-21.1	4.00 H	352	30.14	-11.22
2	151.88	19.6 QP	43.5	-24.0	4.00 H	347	29.01	-9.46
3	374.93	23.2 QP	46.0	-22.8	2.98 H	195	29.33	-6.15
4	516.21	26.9 QP	46.0	-19.1	1.64 H	88	29.96	-3.10
5	779.57	31.5 QP	46.0	-14.5	1.10 H	198	29.92	1.54
6	916.73	33.4 QP	46.0	-12.7	1.00 H	205	29.29	4.06

ANTENNA POLARITY & TEST DISTANCE: VERTICAL AT 3 M								
NO.	FREQ. (MHz)	EMISSION LEVEL (dBuV/m)	LIMIT (dBuV/m)	MARGIN (dB)	ANTENNA HEIGHT (m)	TABLE ANGLE (Degree)	RAW VALUE (dBuV)	CORRECTION FACTOR (dB/m)
1	31.99	33.6 QP	40.0	-6.4	1.21 V	211	45.04	-11.44
2	159.88	25.0 QP	43.5	-18.5	1.00 V	320	34.33	-9.36
3	230.01	29.6 QP	46.0	-16.4	1.00 V	316	41.43	-11.79
4	574.99	34.2 QP	46.0	-11.8	2.47 V	349	36.34	-2.13
5	690.04	36.4 QP	46.0	-9.7	2.66 V	349	36.56	-0.21
6	932.44	33.6 QP	46.0	-12.4	2.08 V	40	29.37	4.22

REMARKS:

1. Emission Level(dBuV/m) = Raw Value(dBuV) + Correction Factor(dB/m)
2. Correction Factor(dB/m) = Antenna Factor(dB/m) + Cable Factor(dB) – Pre-Amplifier Factor(dB)
3. The other emission levels were very low against the limit.
4. Margin value = Emission Level – Limit value

4.2 Conducted Emission Measurement

4.2.1 Limits of Conducted Emission Measurement

Frequency (MHz)	Conducted Limit (dBUV)	
	Quasi-peak	Average
0.15 - 0.5	66 - 56	56 - 46
0.50 - 5.0	56	46
5.0 - 30.0	60	50

Note: 1. The lower limit shall apply at the transition frequencies.

2. The limit decreases in line with the logarithm of the frequency in the range of 0.15 to 0.50MHz.

4.2.2 Test Instruments

Description & Manufacturer	Model No.	Serial No.	Cal. Date	Cal. Due
ROHDE & SCHWARZ TEST RECEIVER	ESCS 30	100276	Apr. 12, 2016	Apr. 11, 2017
ROHDE & SCHWARZ Artificial Mains Network (for EUT)	ENV216	101197	May 04, 2016	May 03, 2017
LISN With Adapter (for EUT)	AD10	C10Ada-002	May 04, 2016	May 03, 2017
ROHDE & SCHWARZ Artificial Mains Network (for peripherals)	ESH3-Z5	100218	Nov. 25, 2015	Nov. 24, 2016
SCHWARZBECK Artificial Mains Network (For EUT)	NNLK8129	8129229	May 04, 2016	May 03, 2017
Software	Cond_V7.3.7	NA	NA	NA
RF cable (JYEBAO) With 10dB PAD	5D-FB	Cable-C10.01	Feb. 15, 2016	Feb. 14, 2017
SUHNER Terminator (For ROHDE & SCHWARZ LISN)	65BNC-5001	E1-011484	May 12, 2016	May 11, 2017
ROHDE & SCHWARZ Artificial Mains Network (For TV EUT)	ESH3-Z5	100220	Nov. 13, 2015	Nov. 12, 2016
LISN With Adapter (for TV EUT)	100220	N/A	Nov. 13, 2015	Nov. 12, 2016

Notes: 1. The calibration interval of the above test instruments is 12 months and the calibrations are traceable to NML/ROC and NIST/USA.

2. The test was performed in Shielded Room No. 10.

3. The VCCI Site Registration No. C-1852.

4.2.3 Test Procedure

- The EUT was placed 0.4 meters from the conducting wall of the shielded room with EUT being connected to the power mains through a line impedance stabilization network (LISN). Other support units were connected to the power mains through another LISN. The two LISNs provide 50 ohm/ 50uH of coupling impedance for the measuring instrument.
- Both lines of the power mains connected to the EUT were checked for maximum conducted interference.
- The frequency range from 150kHz to 30MHz was searched. Emission levels under (Limit - 20dB) was not recorded.

NOTE: All modes of operation were investigated and the worst-case emissions are reported.

4.2.4 Deviation from Test Standard

No deviation.

4.2.5 Test Setup

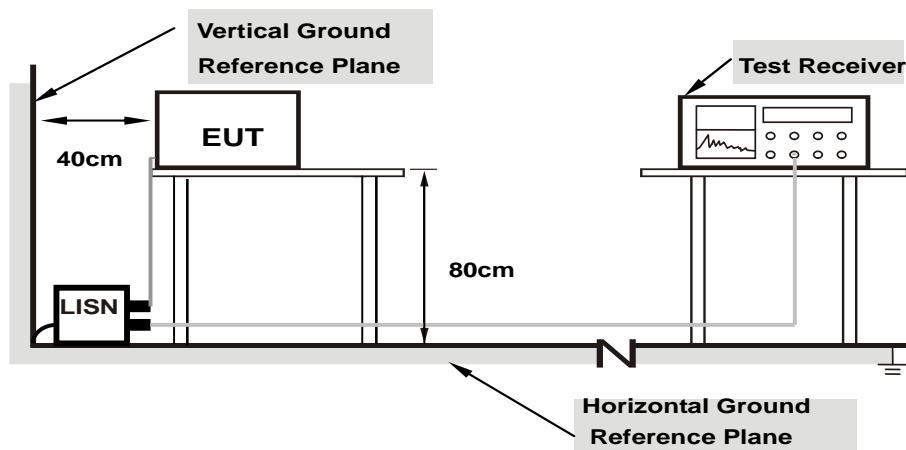

- Note:**
- Support units were connected to second LISN.
 - Both of LISNs (AMN) are 80 cm from EUT and at least 80 from other units and other metal planes

For the actual test configuration, please refer to the attached file (Test Setup Photo).

4.2.6 EUT Operating Condition

Same as 4.1.6.

4.2.7 Test Results

802.11a: CH 149

Phase	Line (L)	Detector Function	Quasi-Peak (QP) / Average (AV)
-------	----------	-------------------	--------------------------------

No	Frequency (MHz)	Correction Factor (dB)	Reading Value (dBuV)		Emission Level (dBuV)		Limit (dBuV)		Margin (dB)	
			Q.P.	AV.	Q.P.	AV.	Q.P.	AV.	Q.P.	AV.
1	0.25547	9.65	10.45	5.41	20.10	15.06	61.58	51.58	-41.48	-36.52
2	0.40391	9.64	18.08	13.80	27.72	23.44	57.77	47.77	-30.05	-24.33
3	1.73828	9.72	16.09	10.18	25.81	19.90	56.00	46.00	-30.19	-26.10
4	11.76172	9.89	22.14	22.03	32.03	31.92	60.00	50.00	-27.97	-18.08
5	16.46484	9.94	23.85	23.27	33.79	33.21	60.00	50.00	-26.21	-16.79
6	21.16797	9.98	27.95	27.86	37.93	37.84	60.00	50.00	-22.07	-12.16
7	25.87109	10.04	34.61	34.18	44.65	44.22	60.00	50.00	-15.35	-5.78

Remarks:

1. Q.P. and AV. are abbreviations of quasi-peak and average individually.
2. The emission levels of other frequencies were very low against the limit.
3. Margin value = Emission level – Limit value
4. Correction factor = Insertion loss + Cable loss
5. Emission Level = Correction Factor + Reading Value

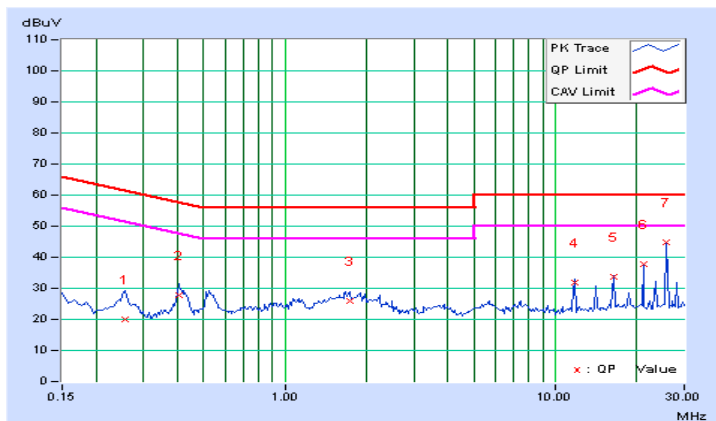

Phase	Neutral (N)	Detector Function	Quasi-Peak (QP) / Average (AV)
-------	-------------	-------------------	--------------------------------

No	Frequency (MHz)	Correction Factor (dB)	Reading Value (dBuV)		Emission Level (dBuV)		Limit (dBuV)		Margin (dB)	
			Q.P.	AV.	Q.P.	AV.	Q.P.	AV.	Q.P.	AV.
1	0.20469	9.69	24.84	20.55	34.53	30.24	63.42	53.42	-28.89	-23.18
2	0.54063	9.69	12.84	5.47	22.53	15.16	56.00	46.00	-33.47	-30.84
3	2.11328	9.77	16.34	11.30	26.11	21.07	56.00	46.00	-29.89	-24.93
4	16.46484	10.01	23.83	23.04	33.84	33.05	60.00	50.00	-26.16	-16.95
5	21.16797	10.06	28.09	27.96	38.15	38.02	60.00	50.00	-21.85	-11.98
6	25.87109	10.08	34.67	34.57	44.75	44.65	60.00	50.00	-15.25	-5.35

Remarks:

1. Q.P. and AV. are abbreviations of quasi-peak and average individually.
2. The emission levels of other frequencies were very low against the limit.
3. Margin value = Emission level – Limit value
4. Correction factor = Insertion loss + Cable loss
5. Emission Level = Correction Factor + Reading Value

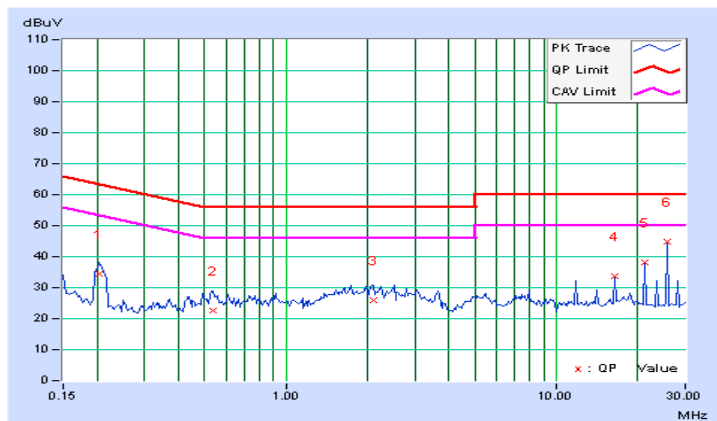

4.3 Transmit Power Measurement

4.3.1 Limits of Transmit Power Measurement

Operation Band	EUT Category		Limit
U-NII-1	---	Outdoor Access Point	1 Watt (30 dBm) (Max. e.i.r.p \leq 125mW(21 dBm) at any elevation angle above 30 degrees as measured from the horizon)
	---	Fixed point-to-point Access Point	1 Watt (30 dBm)
	---	Indoor Access Point	1 Watt (30 dBm)
	---	Mobile and Portable client device	250mW (24 dBm)
U-NII-2A	---		250mW (24 dBm) or 11 dBm+10 log B*
U-NII-2C	---		250mW (24 dBm) or 11 dBm+10 log B*
U-NII-3	√		1 Watt (30 dBm)

*B is the 26 dB emission bandwidth in megahertz

Per KDB 662911 Method of conducted output power measurement on IEEE 802.11 devices,

Array Gain = 0 dB (i.e., no array gain) for $N_{ANT} \leq 4$;

Array Gain = 0 dB (i.e., no array gain) for channel widths ≥ 40 MHz for any N_{ANT} ;

Array Gain = 5 log(N_{ANT}/N_{SS}) dB or 3 dB, whichever is less for 20-MHz channel widths with $N_{ANT} \geq 5$.

For power measurements on all other devices: Array Gain = 10 log(N_{ANT}/N_{SS}) dB.

4.3.2 Test Setup

FOR POWER OUTPUT MEASUREMENT

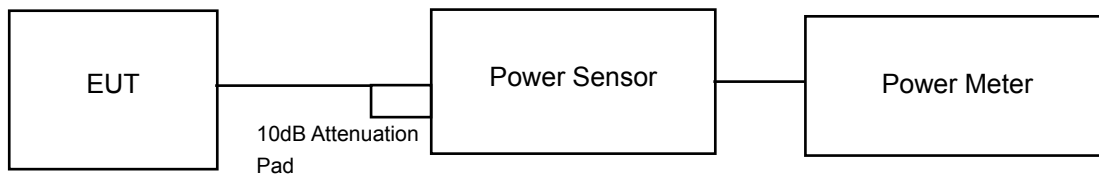

FOR 26dB & OCCUPIED BANDWIDTH

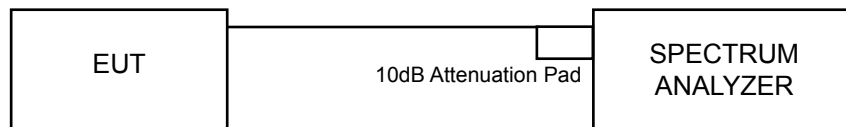

4.3.3 Test Instruments

Refer to section 4.1.2 to get information of above instrument.

4.3.4 Test Procedure

For Average Power Measurement

Method PM is used to perform output power measurement, trigger and gating function of wide band power meter is enabled to measure max output power of TX on burst. Duty factor is not added to measured value.

For Occupied Bandwidth

The transmitter output was connected to the spectrum analyzer through an attenuator. The bandwidth of the fundamental frequency was measured by spectrum analyzer with resolution bandwidth in the range of 1% to 5% of the anticipated emission bandwidth, and a video bandwidth at least 3x the resolution bandwidth and set the detector to SAMPLE. The width of a frequency band such that, below the lower and above the upper frequency limits, the mean powers emitted are each equal to a specified percentage 0.5 %of the total mean power of a given emission.

4.3.5 Deviation from Test Standard

No deviation.

4.3.6 EUT Operating Condition

The software provided by client to enable the EUT under transmission condition continuously at lowest, middle and highest channel frequencies individually.

4.3.7 Test Result

POWER OUTPUT:

802.11a

CHAN.	FREQ. (MHz)	MAXIMUM CONDUCTED POWER (dBm)		TOTAL POWER (mW)	TOTAL POWER (dBm)	POWER LIMIT (dBm)	PASS / FAIL
		CHAIN 0	CHAIN 1				
149	5745	26.97	25.72	870.987	29.40	30	PASS
157	5785	26.99	25.98	896.313	29.52	30	PASS
165	5825	26.58	25.71	827.380	29.18	30	PASS

802.11n (20MHz)

CHAN.	FREQ. (MHz)	MAXIMUM CONDUCTED POWER (dBm)		TOTAL POWER (mW)	TOTAL POWER (dBm)	POWER LIMIT (dBm)	PASS / FAIL
		CHAIN 0	CHAIN 1				
149	5745	27.06	25.78	886.602	29.48	30	PASS
157	5785	26.69	25.62	831.413	29.20	30	PASS
165	5825	26.73	25.74	845.950	29.27	30	PASS

802.11n (40MHz)

CHAN.	FREQ. (MHz)	MAXIMUM CONDUCTED POWER (dBm)		TOTAL POWER (mW)	TOTAL POWER (dBm)	POWER LIMIT (dBm)	PASS / FAIL
		CHAIN 0	CHAIN 1				
151	5755	26.92	25.57	852.619	29.31	30	PASS
159	5795	26.63	25.67	829.235	29.19	30	PASS

OCCUPIED BANDWIDTH:

802.11a

CHANNEL	CHANNEL FREQUENCY (MHz)	OCCUPIED BANDWIDTH (MHz)		PASS / FAIL
		CHAIN 0	CHAIN 1	
149	5745	32.87	27.10	PASS
157	5785	33.70	29.00	PASS
165	5825	31.70	28.40	PASS

802.11n (20MHz)

CHANNEL	CHANNEL FREQUENCY (MHz)	OCCUPIED BANDWIDTH (MHz)		PASS / FAIL
		CHAIN 0	CHAIN 1	
149	5745	34.61	31.48	PASS
157	5785	35.04	31.50	PASS
165	5825	31.80	30.40	PASS

802.11n (40MHz)

CHANNEL	CHANNEL FREQUENCY (MHz)	OCCUPIED BANDWIDTH (MHz)		PASS / FAIL
		CHAIN 0	CHAIN 1	
151	5755	58.38	59.17	PASS
159	5795	66.00	56.00	PASS

SPECTRUM PLOT OF WORST VALUE

802.11a

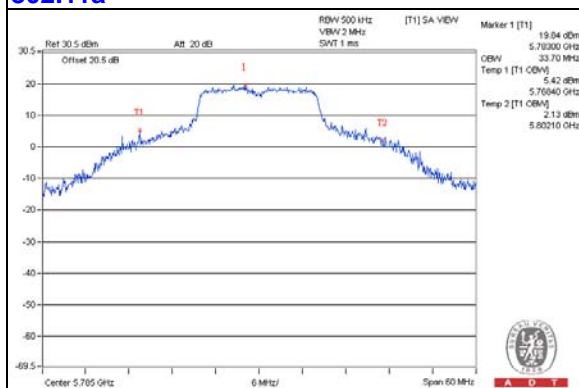

802.11n (20MHz)

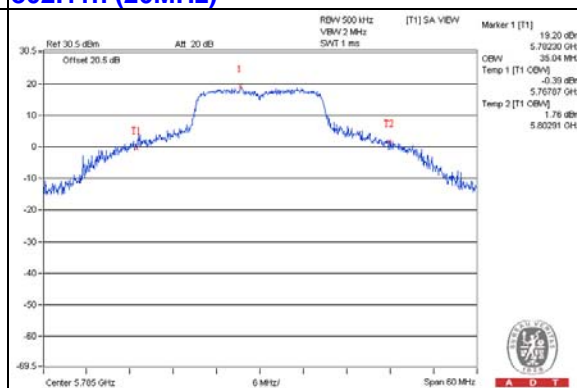

802.11n (40MHz)

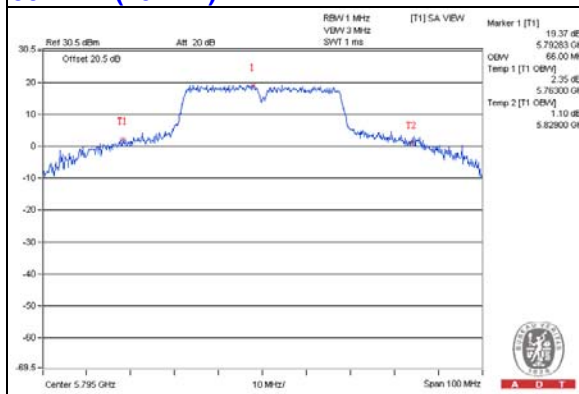

4.4 Peak Power Spectral Density Measurement

4.4.1 Limits of Peak Power Spectral Density Measurement

Operation Band	EUT Category		Limit
U-NII-1	---	Outdoor Access Point	17dBm/ MHz
	---	Fixed point-to-point Access Point	
	---	Indoor Access Point	
	---	Mobile and Portable client device	11dBm/ MHz
U-NII-2A	---		11dBm/ MHz
U-NII-2C	---		11dBm/ MHz
U-NII-3	√		30dBm/ 500kHz

4.4.2 Test Setup

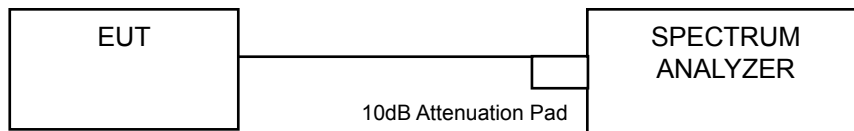

4.4.3 Test Instruments

Refer to section 4.1.2 to get information of above instrument.

4.4.4 Test Procedure

For U-NII-3 band:

- 1) Set span to encompass the entire emission bandwidth (EBW) of the signal.
- 2) Set RBW = 500 kHz, Set VBW \geq 3 RBW, Detector = RMS
- 3) Sweep time = auto, trigger set to "free run".
- 4) Trace average at least 100 traces in power averaging mode.
- 5) Record the max value and add $10 \log (1/\text{duty cycle})$

4.4.5 Deviation from Test Standard

No deviation.

4.4.6 EUT Operating Condition

Same as Item 4.3.6.

4.4.7 Test Results

For U-NII-3 Band

802.11a

TX chain	Channel	Freq. (MHz)	PSD (dBm/500kHz)	10 log (N=2) dB	DUTY FACTOR	Total PSD (dBm/500kHz)	Limit (dBm/500kHz)	PASS /FAIL
0	149	5745	20.80	3.01	0.26	24.07	29.09	PASS
	157	5785	19.94	3.01	0.26	23.21	29.09	PASS
	165	5825	19.41	3.01	0.26	22.68	29.09	PASS
1	149	5745	20.54	3.01	0.26	23.81	29.09	PASS
	157	5785	20.18	3.01	0.26	23.45	29.09	PASS
	165	5825	19.95	3.01	0.26	23.22	29.09	PASS

NOTE: Directional gain = $3.9\text{dBi} + 10\log(2) = 6.91 > 6\text{dBi}$, so the power density limit shall be reduced to $30 - (6.91 - 6) = 29.09\text{dBm}$.

802.11n (20MHz)

TX chain	Channel	Freq. (MHz)	PSD (dBm/500kHz)	10 log (N=2) dB	DUTY FACTOR	Total PSD (dBm/500kHz)	Limit (dBm/500kHz)	PASS /FAIL
0	149	5745	19.99	3.01	0.25	23.25	29.09	PASS
	157	5785	19.36	3.01	0.25	22.62	29.09	PASS
	165	5825	19.35	3.01	0.25	22.61	29.09	PASS
1	149	5745	18.42	3.01	0.25	21.68	29.09	PASS
	157	5785	18.54	3.01	0.25	21.80	29.09	PASS
	165	5825	18.54	3.01	0.25	21.80	29.09	PASS

NOTE: Directional gain = $3.9\text{dBi} + 10\log(2) = 6.91 > 6\text{dBi}$, so the power density limit shall be reduced to $30 - (6.91 - 6) = 29.09\text{dBm}$.

802.11n (40MHz)

TX chain	Channel	Freq. (MHz)	PSD (dBm/500kHz)	10 log (N=2) dB	DUTY FACTOR	Total PSD (dBm/500kHz)	Limit (dBm/500kHz)	PASS /FAIL
0	151	5755	17.56	3.01	0.50	21.07	29.09	PASS
	159	5795	16.95	3.01	0.50	20.46	29.09	PASS
1	151	5755	16.28	3.01	0.50	19.79	29.09	PASS
	159	5795	15.24	3.01	0.50	18.75	29.09	PASS

NOTE: Directional gain = $3.9\text{dBi} + 10\log(2) = 6.91 > 6\text{dBi}$, so the power density limit shall be reduced to $30 - (6.91 - 6) = 29.09\text{dBm}$.

SPECTRUM PLOT OF WORST VALUE

802.11a

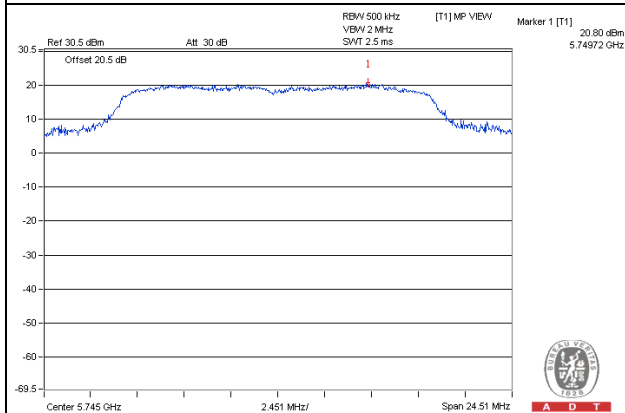

802.11n (20MHz)

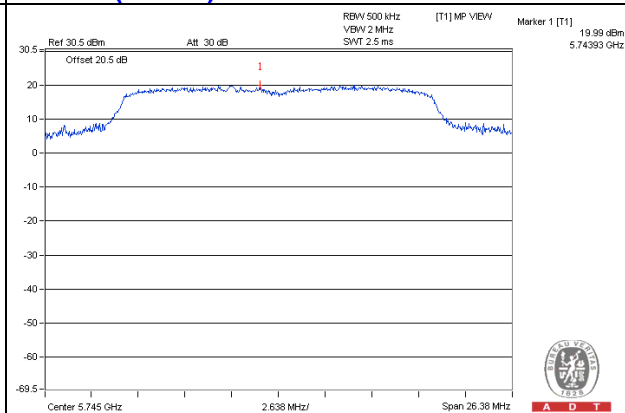

802.11n (40MHz)

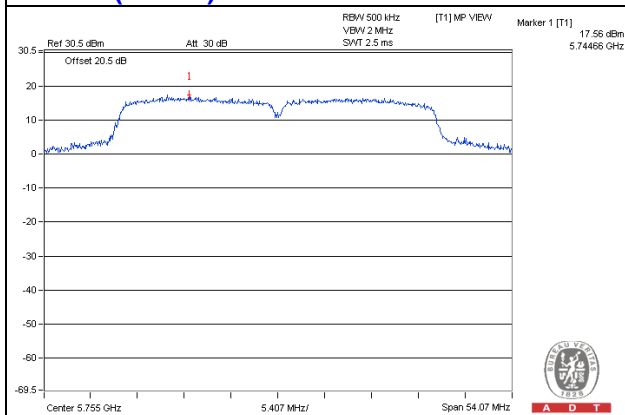

4.5 Frequency Stability Measurement

4.5.1 Limits of Frequency Stability Measurement

The frequency of the carrier signal shall be maintained within band of operation

4.5.2 Test Setup

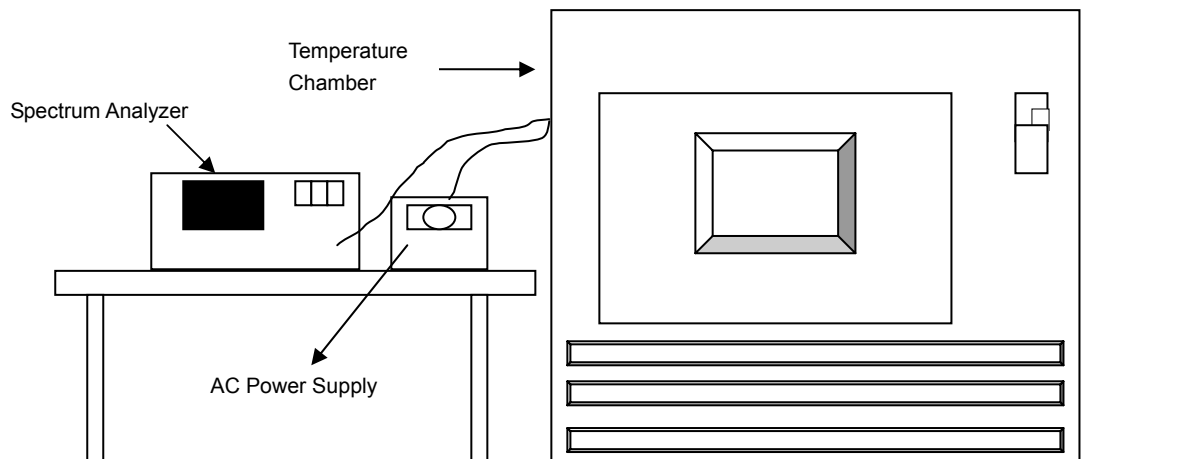

4.5.3 Test Instruments

Refer to section 4.1.2 to get information of above instrument.

4.5.4 Test Procedure

- The EUT was placed inside the environmental test chamber and powered by nominal AC voltage.
- Turn the EUT on and couple its output to a spectrum analyzer.
- Turn the EUT off and set the chamber to the highest temperature specified.
- Allow sufficient time (approximately 30 min) for the temperature of the chamber to stabilize, turn the EUT on and measure the operating frequency after 2, 5, and 10 Minutes.
- Repeat step 2 and 3 with the temperature chamber set to the lowest temperature.
- The test chamber was allowed to stabilize at +20 degree C for a minimum of 30 Minutes. The supply voltage was then adjusted on the EUT from 85% to 115% and the frequency record.

4.5.5 Deviation from Test Standard

No deviation.

4.5.6 EUT Operating Condition

Set the EUT transmit at un-modulation mode to test frequency stability.

4.5.7 Test Results

FREQUENCY STABILITY VERSUS TEMP.									
OPERATING FREQUENCY: 5745MHz									
TEMP. (°C)	POWER SUPPLY (Vac)	0 MINUTE		2 MINUTE		5 MINUTE		10 MINUTE	
		Measured Frequency(MHz)	Pass/Fail	Measured Frequency(MHz)	Pass/Fail	Measured Frequency(MHz)	Pass/Fail	Measured Frequency(MHz)	Pass/Fail
50	120	5745.042963	Pass	5745.042633	Pass	5745.043135	Pass	5745.043141	Pass
40	120	5745.043464	Pass	5745.043281	Pass	5745.043061	Pass	5745.043222	Pass
30	120	5745.043295	Pass	5745.042959	Pass	5745.043465	Pass	5745.043374	Pass
20	120	5745.042409	Pass	5745.042539	Pass	5745.042683	Pass	5745.042721	Pass
10	120	5745.04305	Pass	5745.04293	Pass	5745.043106	Pass	5745.04293	Pass
0	120	5745.04347	Pass	5745.043337	Pass	5745.043342	Pass	5745.043536	Pass
-10	120	5745.042237	Pass	5745.042564	Pass	5745.042372	Pass	5745.042376	Pass
-20	120	5745.043215	Pass	5745.043369	Pass	5745.043362	Pass	5745.042805	Pass

FREQUENCY STABILITY VERSUS VOLTAGE									
OPERATING FREQUENCY: 5745MHz									
TEMP. (°C)	POWER SUPPLY (Vac)	0 MINUTE		2 MINUTE		5 MINUTE		10 MINUTE	
		Measured Frequency(MHz)	Pass/Fail	Measured Frequency(MHz)	Pass/Fail	Measured Frequency(MHz)	Pass/Fail	Measured Frequency(MHz)	Pass/Fail
20	138	5745.042892	Pass	5745.042924	Pass	5745.043026	Pass	5745.04298	Pass
	120	5745.042409	Pass	5745.042539	Pass	5745.042683	Pass	5745.042721	Pass
	102	5745.042763	Pass	5745.042849	Pass	5745.043099	Pass	5745.042828	Pass

4.6 6dB Bandwidth Measurement

4.6.1 Limits of 6dB Bandwidth Measurement

The minimum of 6dB Bandwidth Measurement is 0.5MHz.

4.6.2 Test Setup

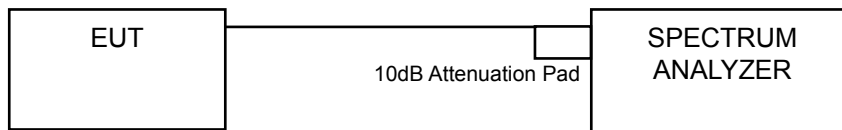

4.6.3 Test Instruments

Refer to section 4.1.2 to get information of above instrument.

4.6.4 Test Procedure

MEASUREMENT PROCEDURE REF

- a. Set resolution bandwidth (RBW) = 100kHz
- b. Set the video bandwidth (VBW) $\geq 3 \times$ RBW, Detector = Peak.
- c. Trace mode = max hold.
- d. Sweep = auto couple.
- e. Measure the maximum width of the emission that is constrained by the frequencies associated with the two amplitude points (upper and lower) that are attenuated by 6 dB relative to the maximum level measured in the fundamental emission

4.6.5 Deviation from Test Standard

No deviation.

4.6.6 EUT Operating Condition

The software provided by client to enable the EUT under transmission condition continuously at lowest, middle and highest channel frequencies individually.

4.6.7 Test Results

802.11a

Channel	Frequency (MHz)	6dB Bandwidth (MHz)		Minimum Limit (MHz)	Pass / Fail
		Chain 0	Chain 1		
149	5745	16.35	16.33	0.5	Pass
157	5785	16.41	16.41	0.5	Pass
165	5825	16.40	16.42	0.5	Pass

802.11n (20MHz)

Channel	Frequency (MHz)	6dB Bandwidth (MHz)		Minimum Limit (MHz)	Pass / Fail
		Chain 0	Chain 1		
149	5745	17.59	17.62	0.5	Pass
157	5785	17.60	17.63	0.5	Pass
165	5825	17.31	16.67	0.5	Pass

802.11n (40MHz)

Channel	Frequency (MHz)	6dB Bandwidth (MHz)		Minimum Limit (MHz)	Pass / Fail
		Chain 0	Chain 1		
151	5755	36.05	35.64	0.5	Pass
159	5795	36.41	36.36	0.5	Pass



SPECTRUM PLOT OF WORST VALUE

802.11a

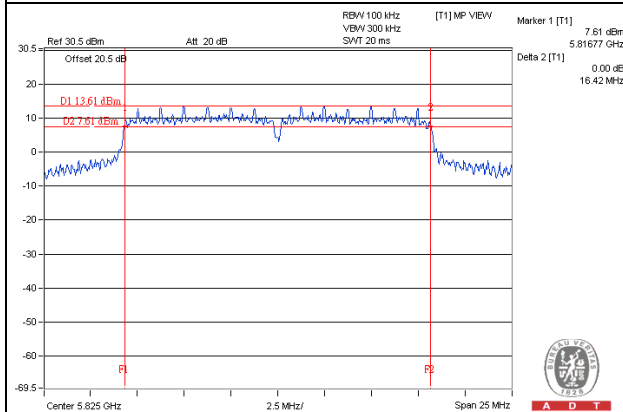

802.11n (20MHz)

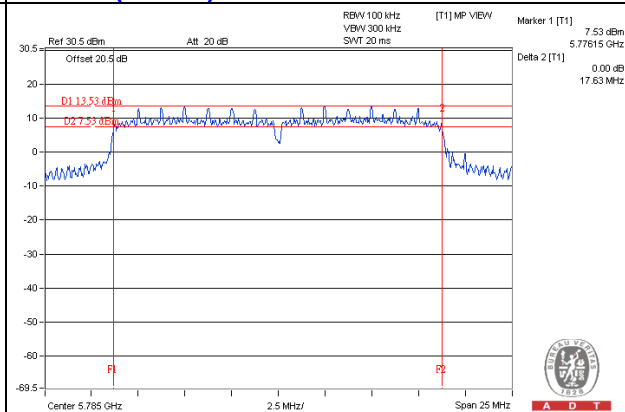

802.11n (40MHz)

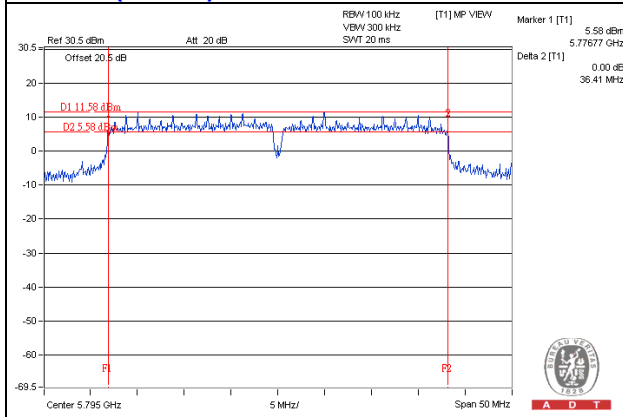

5 Pictures of Test Arrangements

Please refer to the attached file (Test Setup Photo).

Annex A- Radiated Out of Band Emisison (OOBE) Measurement (For U-NII-3 band)

802.11a

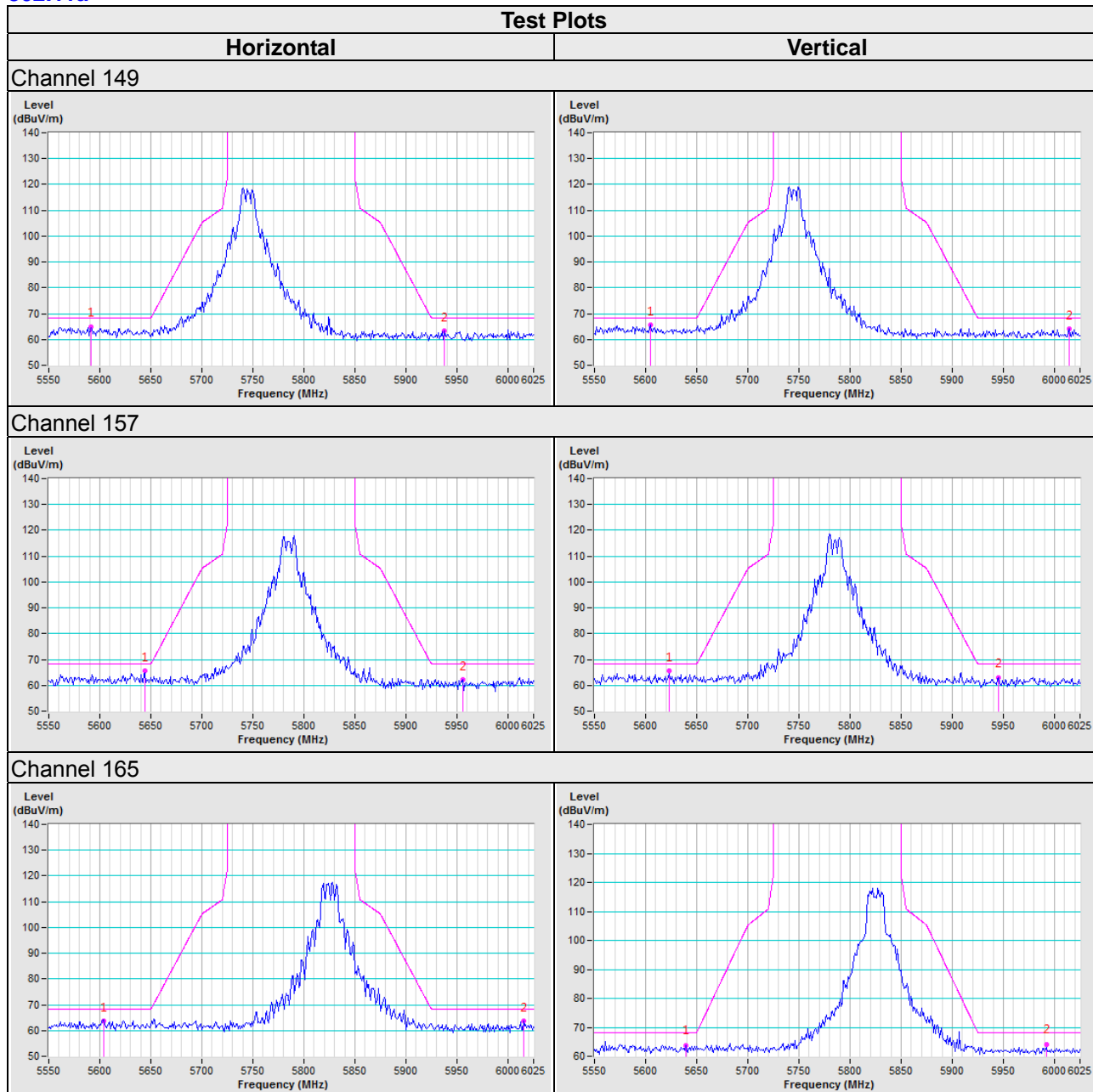

802.11n (20MHz)

Test Plots

Horizontal

Vertical

Channel 149

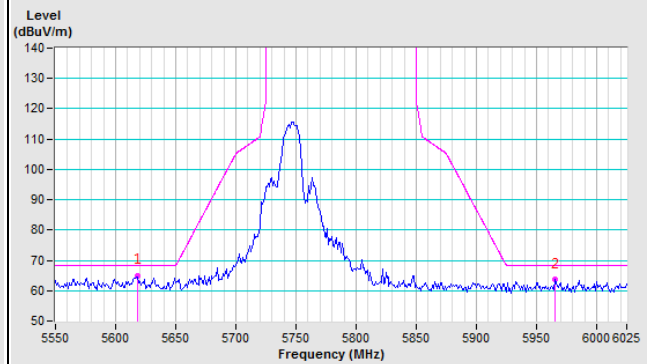
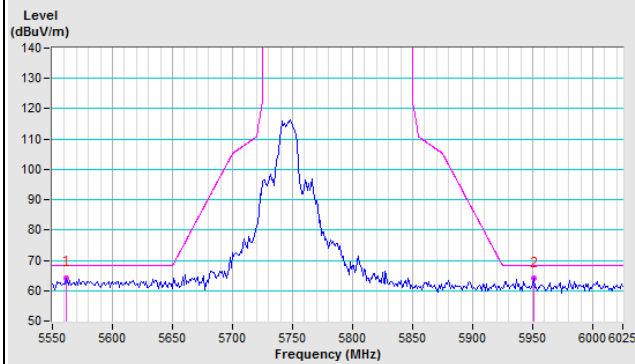

Channel 157

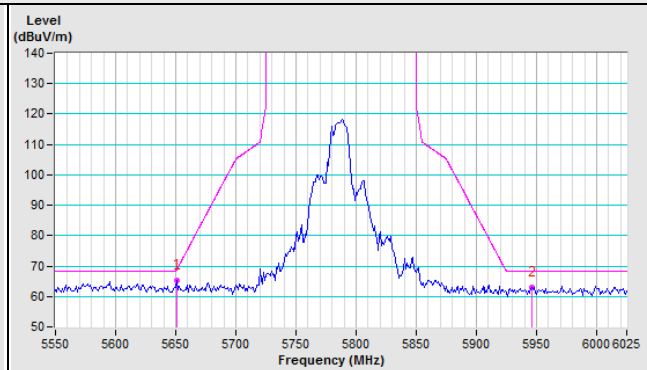
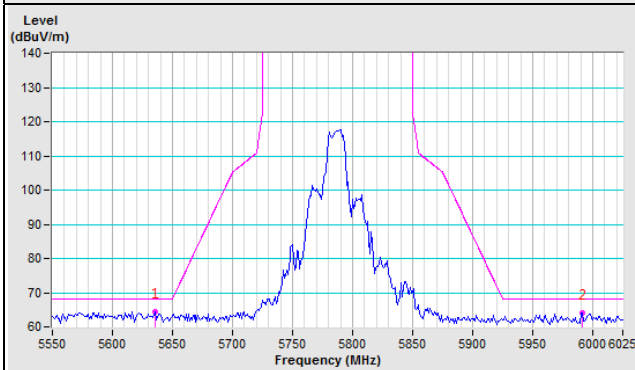

Channel 165

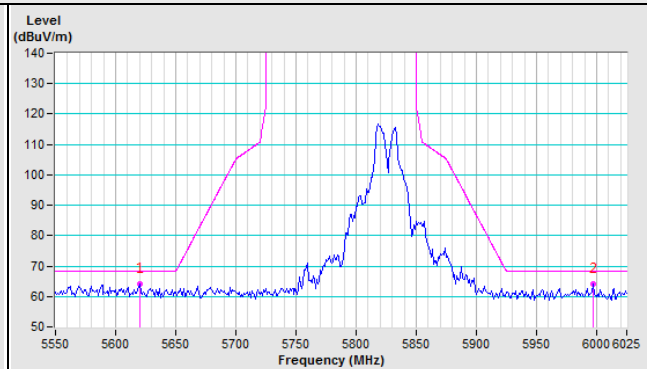
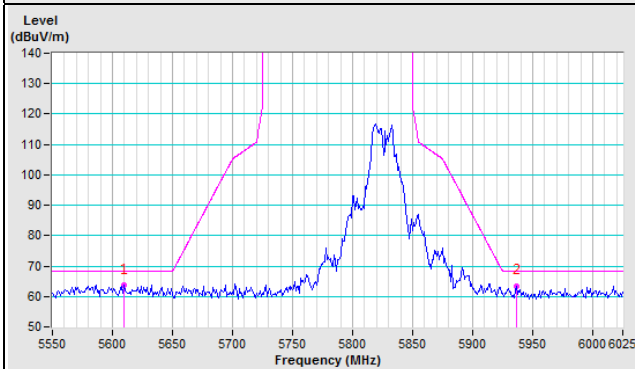

802.11n (40MHz)

Test Plots

Horizontal

Vertical

Channel 151

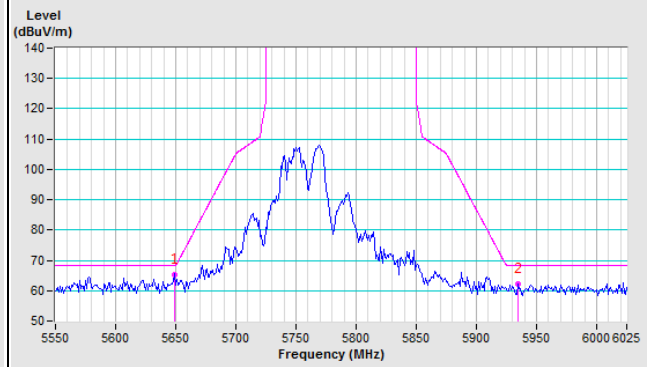
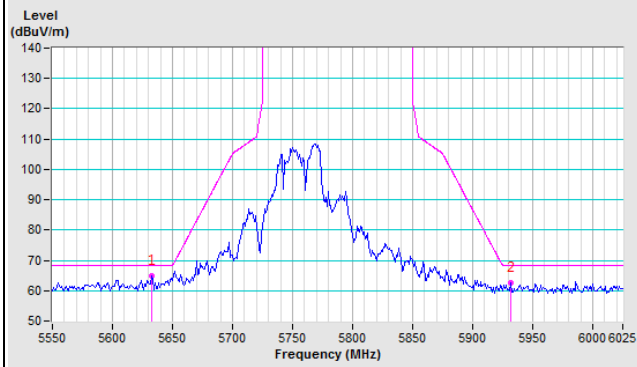

Channel 159

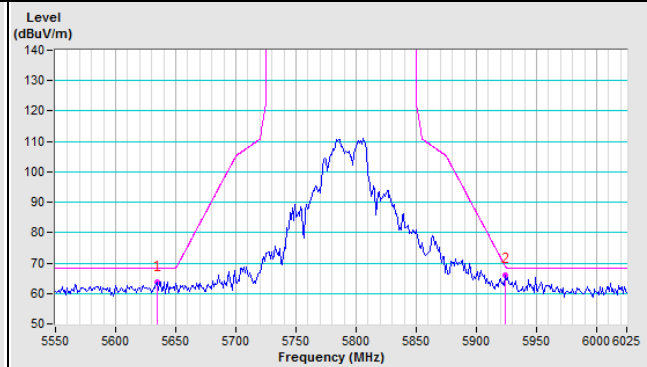
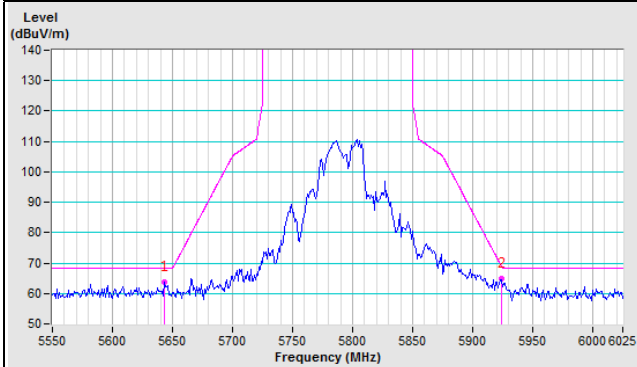

Appendix – Information on the Testing Laboratories

We, Bureau Veritas Consumer Products Services (H.K.) Ltd., Taoyuan Branch, were founded in 1988 to provide our best service in EMC, Radio, Telecom and Safety consultation. Our laboratories are accredited and approved according to ISO/IEC 17025.

If you have any comments, please feel free to contact us at the following:

Linko EMC/RF Lab

Tel: 886-2-26052180

Fax: 886-2-26051924

Hsin Chu EMC/RF/Telecom Lab

Tel: 886-3-6668565

Fax: 886-3-6668323

Hwa Ya EMC/RF/Safety Lab

Tel: 886-3-3183232

Fax: 886-3-3270892

Email: service.adt@tw.bureauveritas.com

Web Site: www.bureauveritas-adt.com

The address and road map of all our labs can be found in our web site also.

--- END ---