

1	2	3	4	5
REV.	ZONE	DATE	EXPLAIN	

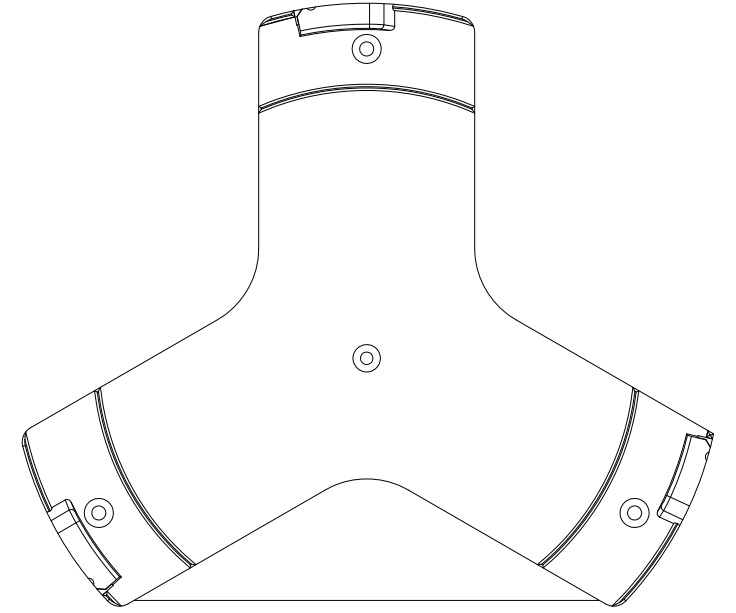
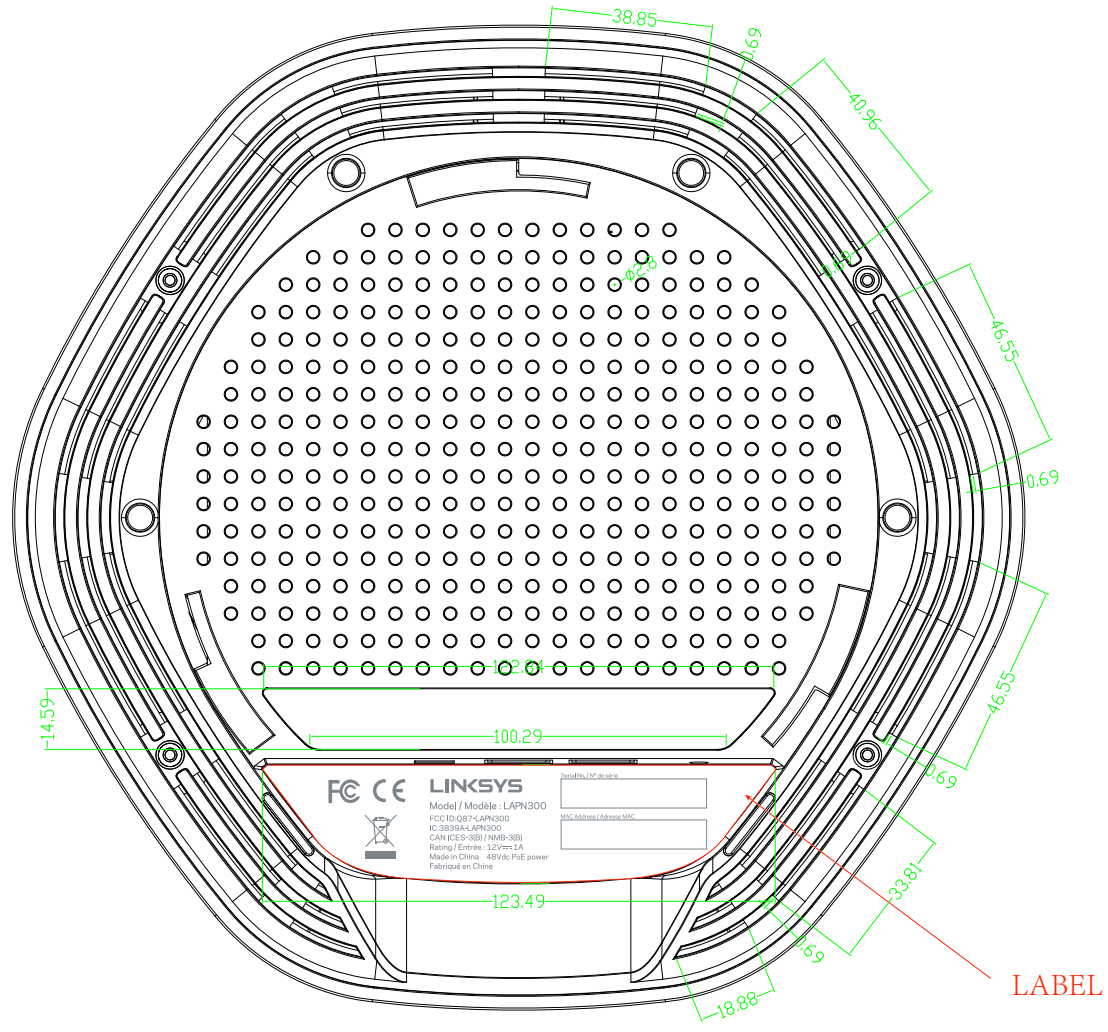
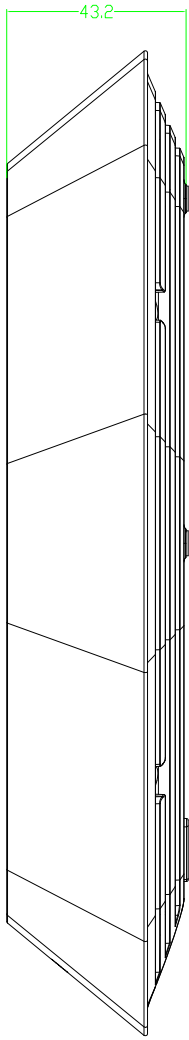
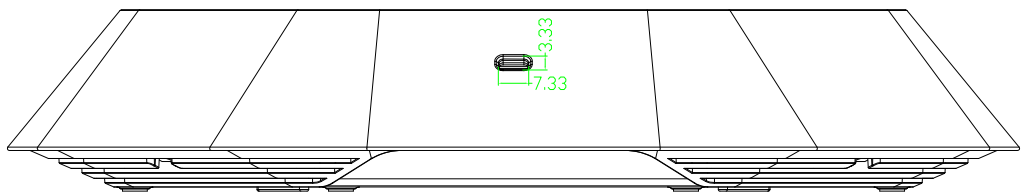
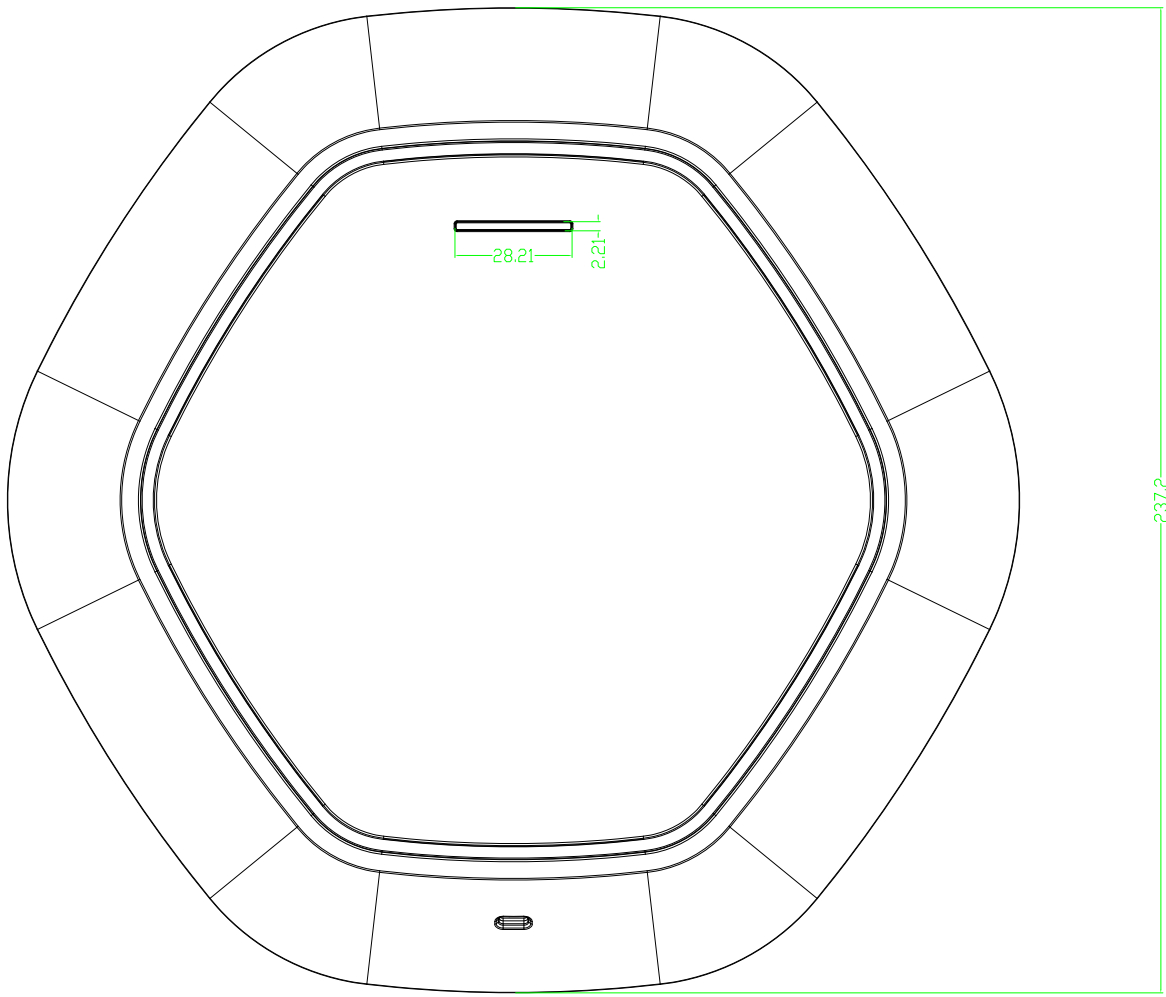
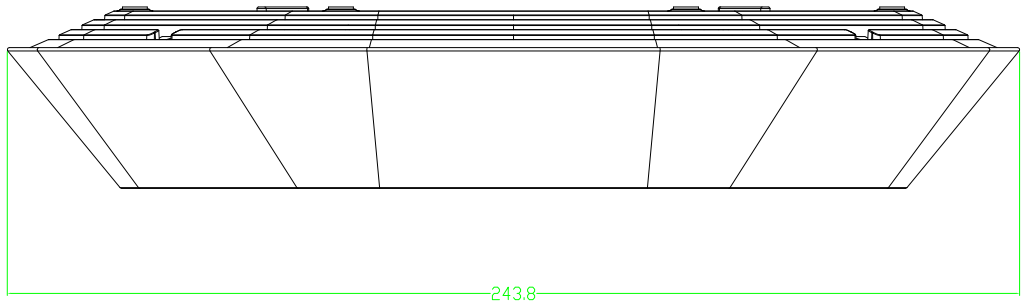

MODEL	LAP N600	NAME	LAP N600_Outline	SCALE	1 / 1
DSN	Leiz Shi	PART. NO		SHEET	1 OF 1
CHK		MATERIAL		Q'TY	1/PC
APV				REV.	1
FILE	SERCORIN			REV. DATE	2013/10/08

1

2

3

4

5

1	← 訂正		

A

123.49mm

28.19mm

B

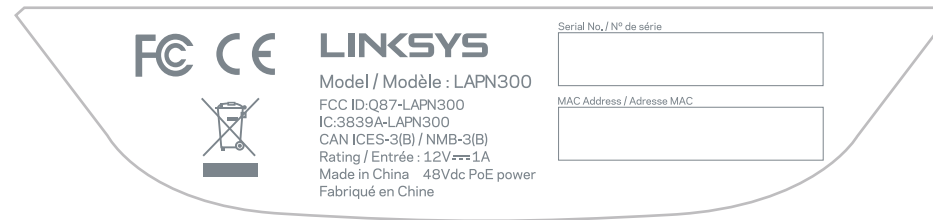

Pantone 430C

C

請注意來料方式
 出紙方向和Label印刷等方向相反

出紙方向(紙邊需撕除, 紙邊需小於3mm)
 每片间距3mm, 中间加齿刀线

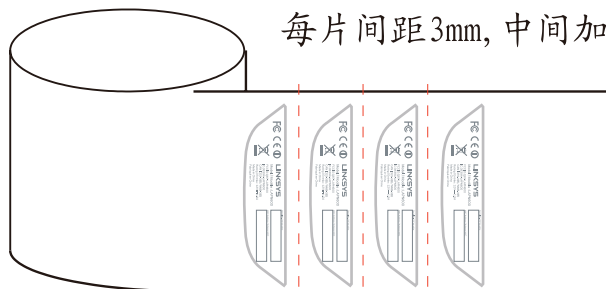

D

Notes:

1. 材質: 75#白色Mylar, 上打字用霧PET, 背壓花膠
2. 印刷顏色: 如图
3. 尺寸公差: 0/-0.2mm
4. 所使用材料需符合Rohs

NOTES:

1. Material: #75 white Mylar, coated with matte printing PET, Adhesive backed: grid adhesive
2. Printing color: as the drawing shows
3. Dimension tolerance: 0/-0.2mm
4. All material should comply with ROHS

DONOTSCALEDRAWING

MODEL	LAPN300	NAME	Label/Linksys		SCALE	1 / 1
DSN		PART. NO	932ATL0008		SHEET	OF
CHK		MATERIAL	white Mylar	Q'TY	PC	REV. 4
APV					REV. DATE	
FILE						

USED