



FCC TEST REPORT

REPORT NO.: RF931009L02

MODEL NO.: WMP54Gv4

RECEIVED: Oct. 11, 2004

TESTED: Oct. 12 ~ Oct. 14, 2004

APPLICANT: Cisco-Linksys, LLC

ADDRESS: 121 Theory Drive, Irvine, CA 92612, U.S.A.

ISSUED BY: Advance Data Technology Corporation

LAB ADDRESS: No. 47, 14th Ling, Chia Pau Tsuen, Lin Kou
Hsiang 244, Taipei Hsien, Taiwan, R.O.C.

TEST LOCATION: No. 19, Hwa Ya 2nd Rd., Wen Hwa Tsuen, Kwei
Shan Hsiang, Taoyuan Hsien 333, Taiwan,
R.O.C.

This test report consists of 66 pages in total. It may be duplicated completely for legal use with the approval of the applicant. It should not be reproduced except in full, without the written approval of our laboratory. The client should not use it to claim product endorsement by CNLA, A2LA or any government agencies. The test results in the report only apply to the tested sample.



No. 2177-01



0528
ILAC MRA



Table of Contents

| | | |
|-------|---|----|
| 1 | CERTIFICATION | 4 |
| 2 | SUMMARY OF TEST RESULTS | 5 |
| 2.1 | MEASUREMENT UNCERTAINTY | 5 |
| 3 | GENERAL INFORMATION | 6 |
| 3.1 | GENERAL DESCRIPTION OF EUT | 6 |
| 3.2 | DESCRIPTION OF TEST MODES | 7 |
| 3.3 | GENERAL DESCRIPTION OF APPLIED STANDARDS | 7 |
| 3.4 | DESCRIPTION OF SUPPORT UNITS | 8 |
| 3.5 | CONFIGURATION OF SYSTEM UNDER TEST | 8 |
| 4 | TEST TYPES AND RESULTS | 9 |
| 4.1 | CONDUCTED EMISSION MEASUREMENT | 9 |
| 4.1.1 | LIMITS OF CONDUCTED EMISSION MEASUREMENT | 9 |
| 4.1.2 | TEST INSTRUMENTS | 9 |
| 4.1.3 | TEST PROCEDURES | 10 |
| 4.1.4 | DEVIATION FROM TEST STANDARD | 10 |
| 4.1.5 | TEST SETUP | 11 |
| 4.1.6 | EUT OPERATING CONDITIONS | 11 |
| 4.1.7 | TEST RESULTS | 12 |
| 4.2 | RADIATED EMISSION MEASUREMENT | 18 |
| 4.2.1 | LIMITS OF RADIATED EMISSION MEASUREMENT | 18 |
| 4.2.2 | TEST INSTRUMENTS | 19 |
| 4.2.3 | TEST PROCEDURES | 20 |
| 4.2.4 | DEVIATION FROM TEST STANDARD | 20 |
| 4.2.5 | TEST SETUP | 21 |
| 4.2.6 | EUT OPERATING CONDITIONS | 21 |
| 4.2.7 | TEST RESULTS | 22 |
| 4.2.8 | TEST RESULTS (A) | 24 |
| 4.2.9 | TEST RESULTS (B) | 27 |
| 4.3 | 6dB BANDWIDTH MEASUREMENT | 30 |
| 4.3.1 | LIMITS OF 6dB BANDWIDTH MEASUREMENT | 30 |
| 4.3.2 | TEST INSTRUMENTS | 30 |
| 4.3.3 | TEST PROCEDURE | 31 |
| 4.3.4 | DEVIATION FROM TEST STANDARD | 31 |
| 4.3.5 | TEST SETUP | 31 |
| 4.3.6 | EUT OPERATING CONDITIONS | 31 |
| 4.3.7 | TEST RESULTS (A) | 32 |
| 4.3.8 | TEST RESULTS (B) | 32 |
| 4.4 | MAXIMUM PEAK OUTPUT POWER | 40 |
| 4.4.1 | LIMITS OF MAXIMUM PEAK OUTPUT POWER MEASUREMENT | 40 |
| 4.4.2 | TEST INSTRUMENTS | 40 |
| 4.4.3 | TEST PROCEDURES | 41 |
| 4.4.4 | DEVIATION FROM TEST STANDARD | 41 |
| 4.4.5 | TEST SETUP | 41 |



| | | |
|-------|--|----|
| 4.4.6 | EUT OPERATING CONDITIONS | 41 |
| 4.4.7 | TEST RESULTS (A) | 42 |
| 4.4.8 | TEST RESULTS (B)..... | 42 |
| 4.5 | POWER SPECTRAL DENSITY MEASUREMENT | 43 |
| 4.5.1 | LIMITS OF POWER SPECTRAL DENSITY MEASUREMENT | 43 |
| 4.5.2 | TEST INSTRUMENTS..... | 43 |
| 4.5.3 | TEST PROCEDURE..... | 44 |
| 4.5.4 | DEVIATION FROM TEST STANDARD | 44 |
| 4.5.5 | TEST SETUP | 44 |
| 4.5.6 | EUT OPERATING CONDITIONS | 44 |
| 4.5.7 | TEST RESULTS (A) | 45 |
| 4.5.8 | TEST RESULTS (B) | 45 |
| 4.6 | BAND EDGES MEASUREMENT | 53 |
| 4.6.1 | LIMITS OF BAND EDGES MEASUREMENT | 53 |
| 4.6.2 | TEST INSTRUMENTS..... | 53 |
| 4.6.3 | TEST PROCEDURE..... | 53 |
| 4.6.4 | DEVIATION FROM TEST STANDARD | 53 |
| 4.6.5 | EUT OPERATING CONDITION | 53 |
| 4.6.6 | TEST RESULTS | 54 |
| 4.6.7 | TEST RESULTS(A) | 54 |
| 4.6.8 | TEST RESULTS(B) | 54 |
| 4.7 | ANTENNA REQUIREMENT | 59 |
| 4.7.1 | STANDARD APPLICABLE | 63 |
| 4.7.2 | ANTENNA CONNECTED CONSTRUCTION | 63 |
| 5 | PHOTOGRAPHS OF THE TEST CONFIGURATION | 64 |
| 6 | INFORMATION ON THE TESTING LABORATORIES | 66 |



1 CERTIFICATION

PRODUCT : Wireless-G PCI Adapter
BRAND NAME : Linksys
MODEL NO. : WMP54Gv4
APPLICANT : Cisco-Linksys, LLC
TESTED : Oct. 12 ~ Oct. 13, 2004
TEST SAMPLE : ENGINEERING SAMPLE
STANDARDS : FCC Part 15, Subpart C (Section 15.247),
ANSI C63.4-2003

The above equipment has been tested by **Advance Data Technology Corporation**, and found compliance with the requirement of the above standards. The test record, data evaluation & Equipment Under Test (EUT) configurations represented herein are true and accurate accounts of the measurements of the sample's EMC characteristics under the conditions specified in this report.

PREPARED BY : Andrea Hsia , **DATE:** Oct. 15, 2004
(Andrea Hsia)

TECHNICAL
ACCEPTANCE : Gary Chang , **DATE:** Oct. 15, 2004
Responsible for RF (Gary Chang)

APPROVED BY : Cody Chang , **DATE:** Oct. 15, 2004
(Cody Chang, Deputy Manager)

2 SUMMARY OF TEST RESULTS

The EUT has been tested according to the following specifications:

| APPLIED STANDARD: FCC Part 15, Subpart C | | | |
|---|---|---------------|---|
| Standard Section | Test Type and Limit | Result | REMARK |
| 15.207 | AC Power Conducted Emission | PASS | Meet the requirement of limit. Minimum passing margin is -12.06dB at 22.906MHz |
| 15.247(a)(2) | Spectrum Bandwidth of a Direct Sequence Spread Spectrum System Limit : min. 500kHz | PASS | Meet the requirement of limit. |
| 15.247(b) | Maximum Peak Output Power Limit: max. 30dBm | PASS | Meet the requirement of limit. |
| 15.247(c) | Transmitter Radiated Emissions Limit: Table 15.209 | PASS | Meet the requirement of limit. Minimum passing margin is -1.26dB at 698.70MHz |
| 15.247(d) | Power Spectral Density Limit: max. 8dBm | PASS | Meet the requirement of limit. |
| 15.247(c) | Band Edge Measurement Limit: 20 dB less than the peak value of fundamental frequency | PASS | Meet the requirement of limit. |

2.1 MEASUREMENT UNCERTAINTY

Where relevant, the following measurement uncertainty levels have been estimated for tests performed on the EUT as specified in CISPR 16-4:

| Measurement | Frequency | Uncertainty |
|---------------------|------------------|--------------------|
| Conducted emissions | 9k~30MHz | 2.44 dB |
| Radiated emissions | 30MHz ~ 200MHz | 3.73 dB |
| | 200MHz ~ 1000MHz | 3.74 dB |
| | 1GHz ~ 18GHz | 2.20 dB |
| | 18GHz ~ 40GHz | 1.88 dB |



3 GENERAL INFORMATION

3.1 GENERAL DESCRIPTION OF EUT

| | |
|-----------------------------|---|
| PRODUCT | Wireless-G PCI Adapter |
| MODEL NO. | WMP54Gv4 |
| POWER SUPPLY | 5.0Vdc from host equipment |
| MODULATION TYPE | BPSK, QPSK, CCK, 16QAM, 64QAM |
| RADIO TECHNOLOGY | DSSS, OFDM |
| TRANSFER RATE | 802.11b: 11/5.5/2/1Mbps 802.11g: 54/48/36/24/18/12/9/6Mbps |
| FREQUENCY RANGE | 2412MHz ~ 2462MHz |
| NUMBER OF CHANNEL | 11 |
| MAXIMUM OUTPUT POWER | 20.89mW |
| ANTENNA TYPE | Dipole antenna with 5dBi gain |
| DATA CABLE | NA |
| I/O PORTS | NA |
| ASSOCIATED DEVICES | NA |

NOTE:

1. The EUT operates in the 2.4GHz frequency spectrum with throughput of up to 54Mbps.
2. The EUT complies with IEEE 802.11g standards and backwards compatible with IEEE 802.11b products.
3. The above EUT information was declared by manufacturer and for more detailed features description, please refer to the manufacturer's specifications or User's Manual.



3.2 DESCRIPTION OF TEST MODES

Eleven channels are provided to this EUT.

| Channel | Frequency | Channel | Frequency |
|---------|-----------|---------|-----------|
| 1 | 2412 MHz | 7 | 2442 MHz |
| 2 | 2417 MHz | 8 | 2447 MHz |
| 3 | 2422 MHz | 9 | 2452 MHz |
| 4 | 2427 MHz | 10 | 2457 MHz |
| 5 | 2432 MHz | 11 | 2462 MHz |
| 6 | 2437 MHz | | |

NOTE:

1. Below 1GHz, the channel 1, 6, and 11 were pre-tested in chamber. The channel 11, the worst case, was chosen for final test.
2. Above 1GHz, the channel 1, 6, and 11 were tested individually.
3. From our experience and technical viewpoint, we have chosen data rates 11Mbps for CCK technique and 6Mbps for OFDM technique, as the worst cases for the test among other data rates.
4. Two test results were presented in the following sections. The test result A was for CCK technique and the test result B was for OFDM technique.

3.3 GENERAL DESCRIPTION OF APPLIED STANDARDS

The EUT is a Wireless-G PCI Adapter . According to the specifications of the manufacturer, it must comply with the requirements of the following standards:

FCC Part 15, Subpart C. (15.247)
ANSI C63.4-2003

All test items have been performed and recorded as per the above standards.

NOTE: The EUT is also considered as a kind of computer peripheral, because the connection to computer is necessary for typical use. It has been verified to comply with the requirements of FCC Part 15, Subpart B, Class B (DoC). The test report has been issued separately.



3.4 DESCRIPTION OF SUPPORT UNITS

The EUT has been tested as an independent unit together with other necessary accessories or support units. The following support units or accessories were used to form a representative test configuration during the tests.

| NO. | PRODUCT | BRAND | MODEL NO. | SERIAL NO. | FCC ID |
|-----|-------------|-------|-----------------|------------------------------|------------------|
| 1 | PC | MSI | Hetis 865G Giga | 3AS0119581 | FCC DoC Approved |
| 2 | LCD MONITOR | ACER | AL1721 | ET.L0408.01040 4001E6PK00 | FCC DoC Approved |
| 3 | KEYBOARD | HP | SK-1688 | C0306115114 | GYUR84SK |
| 4 | MOUSE | HP | M-S69 | N/A | INZ211443 |
| 5 | PRINTER | EPSON | LQ-300+ | DCGY054147 | FCC DoC Approved |
| 6 | MODEM | ACEEX | 1414V/3 | 0401008269 | IFAXDM1414 |

| NO. | SIGNAL CABLE DESCRIPTION OF THE ABOVE SUPPORT UNITS |
|-----|---|
| 1 | NA |
| 2 | 1.8m shielded cable without core |
| 3 | 2.0m shielded cable without core |
| 4 | 1.8m shielded cable without core |
| 5 | 1.2m shielded cable without core |
| 6 | 1.2m shielded cable without core |

NOTE: All power cords of the above support units are non shielded (1.8m).

3.5 CONFIGURATION OF SYSTEM UNDER TEST

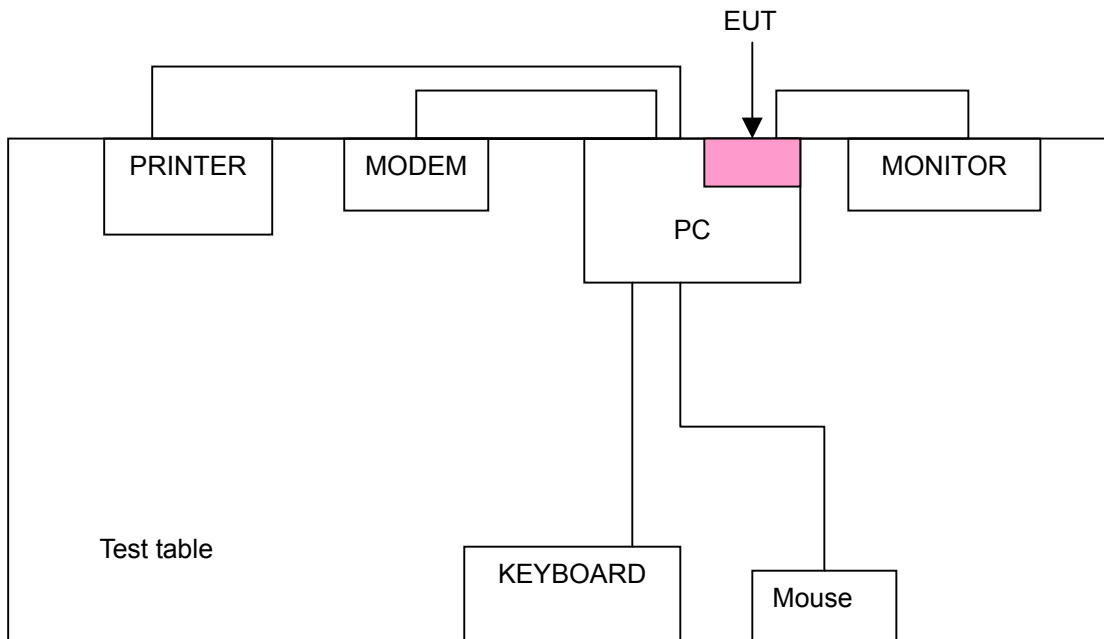



4 TEST TYPES AND RESULTS

4.1 CONDUCTED EMISSION MEASUREMENT

4.1.1 LIMITS OF CONDUCTED EMISSION MEASUREMENT

| FREQUENCY OF EMISSION (MHz) | CONDUCTED LIMIT (dB μ V) | |
|-----------------------------|------------------------------|----------|
| | Quasi-peak | Average |
| 0.15-0.5 | 66 to 56 | 56 to 46 |
| 0.5-5 | 56 | 46 |
| 5-30 | 60 | 50 |

- NOTE:**
1. The lower limit shall apply at the transition frequencies.
 2. The limit decreases in line with the logarithm of the frequency in the range of 0.15 to 0.50 MHz.
 3. All emanations from a class A/B digital device or system, including any network of conductors and apparatus connected thereto, shall not exceed the level of field strengths specified above.

4.1.2 TEST INSTRUMENTS

| DESCRIPTION & MANUFACTURER | MODEL NO. | SERIAL NO. | CALIBRATED UNTIL |
|----------------------------------|-------------|----------------|------------------|
| Test Receiver ROHDE & SCHWARZ | ESCS30 | 100291 | Dec. 12, 2004 |
| RF signal cable Woken | 5D-FB | Cable-HYC01-01 | Mar. 02, 2005 |
| LISN ROHDE & SCHWARZ | ESH3-Z5 | 100312 | Mar. 03, 2005 |
| LISN ROHDE & SCHWARZ | ESH2-Z5 | 100104 | Mar. 02, 2005 |
| Software ADT | ADT_Cond_V3 | NA | NA |

- NOTE:**
1. The calibration interval of the above test instruments is 12 months and the calibrations are traceable to NML/ROC and NIST/USA.
 2. The test was performed in HwaYa Shielded Room 1.
 3. The VCCI Site Registration No. is C-2040.



4.1.3 TEST PROCEDURES

- a. The EUT was placed 0.4 meters from the conducting wall of the shielded room with EUT being connected to the power mains through a line impedance stabilization network (LISN). Other support units were connected to the power mains through another LISN. The two LISNs provide 50 ohm/ 50uH of coupling impedance for the measuring instrument.
- b. Both lines of the power mains connected to the EUT were checked for maximum conducted interference.
- c. The frequency range from 150kHz to 30MHz was searched. Emission levels under Limit - 20dB was not recorded.

4.1.4 DEVIATION FROM TEST STANDARD

No deviation

4.1.5 TEST SETUP

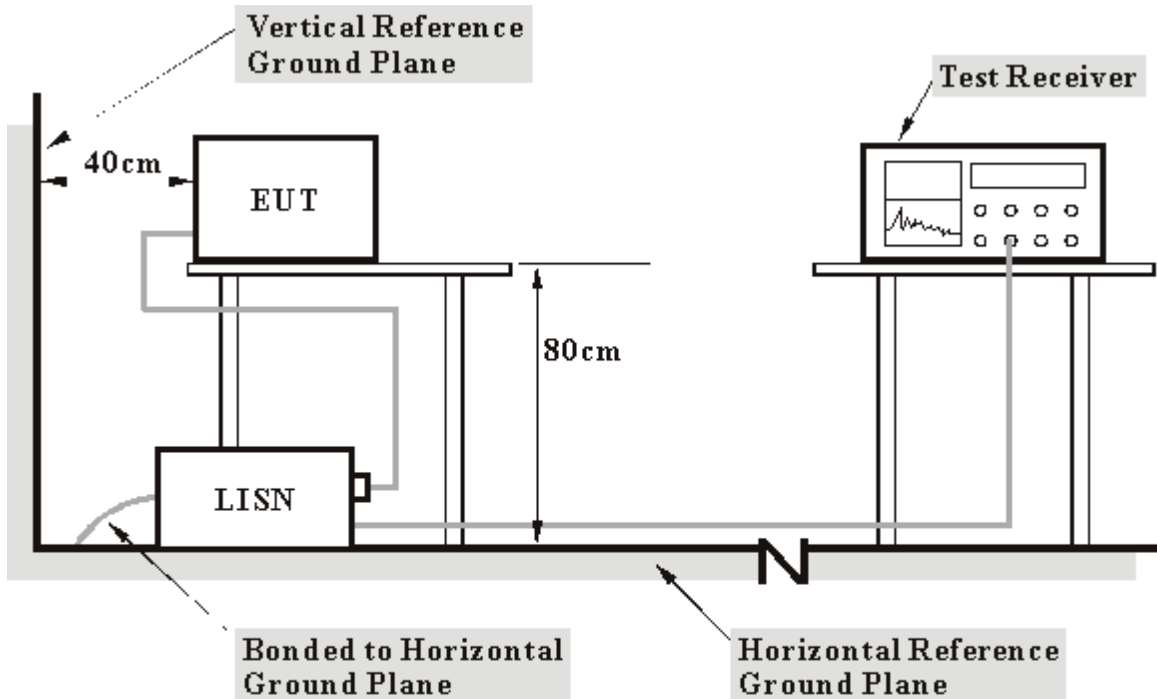

- Note:**
1. Support units were connected to second LISN.
 2. Both of LISNs (AMN) 80 cm from EUT and at the least 80 cm from other units and other metal planes support units.

For the actual test configuration, please refer to the related item – Photographs of the Test Configuration.

4.1.6 EUT OPERATING CONDITIONS

- a. Connected the EUT to a personal computer system placed on a testing table.
- b. The personal computer system ran a test program (provided by manufacturer) to enable EUT under transmission/receiving condition continuously at specific channel frequency.
- c. The personal computer system sent "H" messages to its screen.
- d. The personal computer system sent "H" messages to modem.
- e. The personal computer system sent "H" messages to printer, and the printer printed them on paper.
- f. Steps c ~ e were repeated.



4.1.7 TEST RESULTS

| | | | |
|---------------------------------|---------------------------|----------------------|----------|
| EUT | Wireless-G PCI Adapter | MODEL | WMP54Gv4 |
| CHANNEL | 1 | 6dB BANDWIDTH | 9 kHz |
| INPUT POWER (SYSTEM) | 120 Vac, 60 Hz | PHASE | Line (L) |
| ENVIRONMENTAL CONDITIONS | 24deg. C, 64% RH, 991 hPa | TESTED BY | Leo Hung |

| No | Freq. [MHz] | Corr. Factor (dB) | Reading Value [dB (uV)] | | Emission Level [dB (uV)] | | Limit [dB (uV)] | | Margin (dB) | |
|----|-------------|-------------------|-------------------------|-------|--------------------------|-------|-----------------|-------|-------------|-------|
| | | | Q.P. | AV. | Q.P. | AV. | Q.P. | AV. | Q.P. | AV. |
| | | | 1 | 0.193 | 0.12 | 40.13 | - | 40.25 | - | 63.91 |
| 2 | 0.388 | 0.13 | 37.89 | - | 38.02 | - | 58.10 | 48.10 | -20.08 | - |
| 3 | 0.970 | 0.15 | 37.60 | - | 37.75 | - | 56.00 | 46.00 | -18.25 | - |
| 4 | 1.234 | 0.15 | 37.93 | - | 38.08 | - | 56.00 | 46.00 | -17.92 | - |
| 5 | 3.047 | 0.18 | 34.06 | - | 34.24 | - | 56.00 | 46.00 | -21.76 | - |
| 6 | 23.469 | 1.12 | 36.06 | - | 37.18 | - | 60.00 | 50.00 | -22.82 | - |

- REMARKS:**
1. Q.P. and AV. are abbreviations of quasi-peak and average individually.
 2. "-": The Quasi-peak reading value also meets average limit and measurement with the average detector is unnecessary.
 3. The emission levels of other frequencies were very low against the limit.
 4. Margin value = Emission level - Limit value
 5. Correction factor = Insertion loss + Cable loss
 6. Emission Level = Correction Factor + Reading Value.

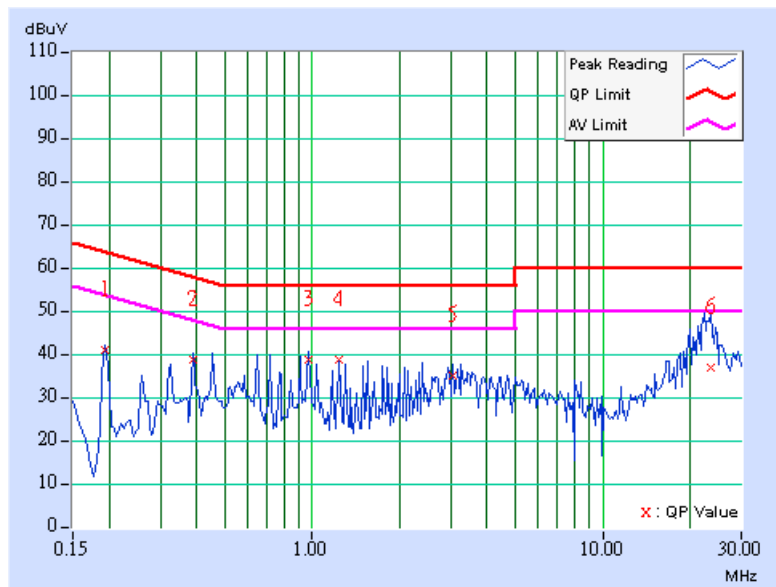



| | | | |
|---------------------------------|------------------------------|----------------------|-------------|
| EUT | Wireless-G PCI Adapter | MODEL | WMP54Gv4 |
| CHANNEL | 1 | 6dB BANDWIDTH | 9 kHz |
| INPUT POWER (SYSTEM) | 120 Vac, 60 Hz | PHASE | Neutral (N) |
| ENVIRONMENTAL CONDITIONS | 24deg. C, 64% RH, 991 hPa | TESTED BY | Leo Hung |

| No | Freq. [MHz] | Corr. Factor (dB) | Reading Value | | Emission Level | | Limit | | Margin | |
|----|----------------|-------------------------|---------------|-----|----------------|-----|-----------|-------|--------|-----|
| | | | [dB (uV)] | | [dB (uV)] | | [dB (uV)] | | (dB) | |
| | | | Q.P. | AV. | Q.P. | AV. | Q.P. | AV. | Q.P. | AV. |
| 1 | 0.197 | 0.11 | 41.52 | - | 41.63 | - | 63.74 | 53.74 | -22.11 | - |
| 2 | 0.388 | 0.12 | 40.09 | - | 40.21 | - | 58.10 | 48.10 | -17.89 | - |
| 3 | 0.713 | 0.13 | 38.56 | - | 38.69 | - | 56.00 | 46.00 | -17.31 | - |
| 4 | 1.234 | 0.15 | 38.09 | - | 38.24 | - | 56.00 | 46.00 | -17.76 | - |
| 5 | 2.922 | 0.18 | 35.28 | - | 35.46 | - | 56.00 | 46.00 | -20.54 | - |
| 6 | 23.379 | 0.68 | 44.97 | - | 45.65 | - | 60.00 | 50.00 | -14.35 | - |

- REMARKS:**
1. Q.P. and AV. are abbreviations of quasi-peak and average individually.
 2. "-": The Quasi-peak reading value also meets average limit and measurement with the average detector is unnecessary.
 3. The emission levels of other frequencies were very low against the limit.
 4. Margin value = Emission level - Limit value
 5. Correction factor = Insertion loss + Cable loss
 6. Emission Level = Correction Factor + Reading Value.

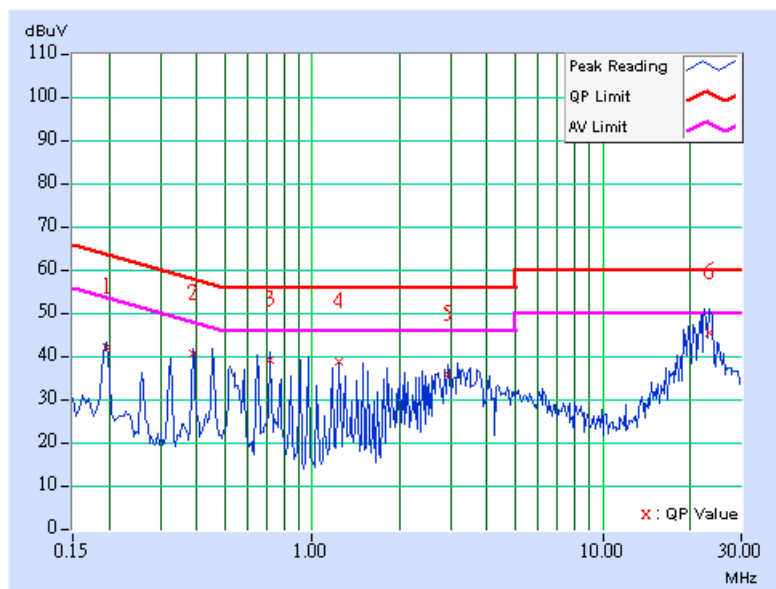



| | | | |
|---------------------------------|------------------------------|----------------------|----------|
| EUT | Wireless-G PCI Adapter | MODEL | WMP54Gv4 |
| CHANNEL | 6 | 6dB BANDWIDTH | 9 kHz |
| INPUT POWER (SYSTEM) | 120 Vac, 60 Hz | PHASE | Line (L) |
| ENVIRONMENTAL CONDITIONS | 24deg. C, 64% RH, 991 hPa | TESTED BY | Leo Hung |

| No | Freq. [MHz] | Corr. Factor (dB) | Reading Value | | Emission Level | | Limit | | Margin | |
|----------|----------------|-------------------------|---------------|-----|----------------|-----|--------------|--------------|---------------|-----|
| | | | [dB (uV)] | | [dB (uV)] | | [dB (uV)] | | (dB) | |
| | | | Q.P. | AV. | Q.P. | AV. | Q.P. | AV. | Q.P. | AV. |
| 1 | 0.197 | 0.12 | 39.99 | - | 40.11 | - | 63.74 | 53.74 | -23.63 | - |
| 2 | 0.455 | 0.13 | 38.27 | - | 38.40 | - | 56.79 | 46.79 | -18.39 | - |
| 3 | 0.974 | 0.15 | 38.73 | - | 38.88 | - | 56.00 | 46.00 | -17.12 | - |
| 4 | 1.297 | 0.15 | 37.98 | - | 38.13 | - | 56.00 | 46.00 | -17.87 | - |
| 5 | 3.570 | 0.20 | 34.85 | - | 35.05 | - | 56.00 | 46.00 | -20.95 | - |
| 6 | 22.906 | 1.10 | 46.84 | - | 47.94 | - | 60.00 | 50.00 | -12.06 | - |

- REMARKS:**
1. Q.P. and AV. are abbreviations of quasi-peak and average individually.
 2. "-": The Quasi-peak reading value also meets average limit and measurement with the average detector is unnecessary.
 3. The emission levels of other frequencies were very low against the limit.
 4. Margin value = Emission level - Limit value
 5. Correction factor = Insertion loss + Cable loss
 6. Emission Level = Correction Factor + Reading Value.

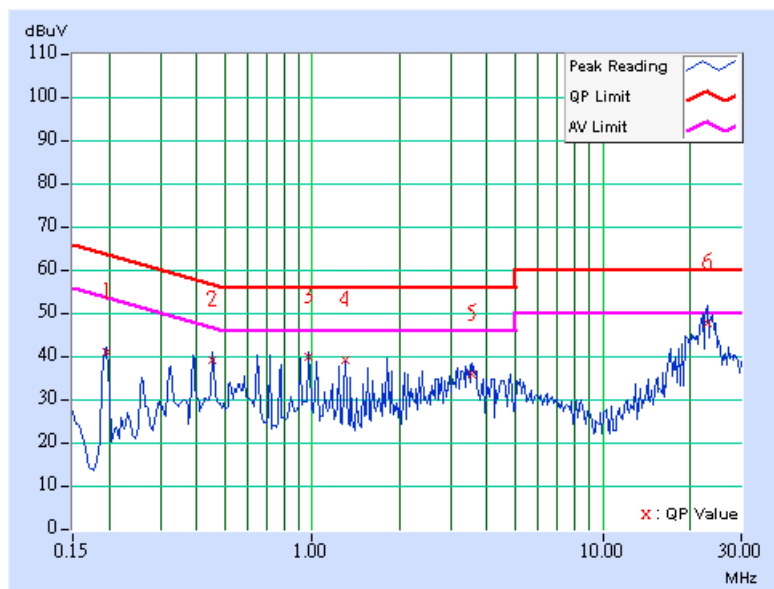



| | | | |
|---------------------------------|---------------------------|----------------------|-------------|
| EUT | Wireless-G PCI Adapter | MODEL | WMP54Gv4 |
| CHANNEL | 6 | 6dB BANDWIDTH | 9 kHz |
| INPUT POWER (SYSTEM) | 120 Vac, 60 Hz | PHASE | Neutral (N) |
| ENVIRONMENTAL CONDITIONS | 24deg. C, 64% RH, 991 hPa | TESTED BY | Leo Hung |

| No | Freq. [MHz] | Corr. Factor (dB) | Reading Value | | Emission Level | | Limit | | Margin | |
|----|----------------|-------------------------|---------------|-----|----------------|-----|-----------|-------|--------|-----|
| | | | [dB (uV)] | | [dB (uV)] | | [dB (uV)] | | (dB) | |
| | | | Q.P. | AV. | Q.P. | AV. | Q.P. | AV. | Q.P. | AV. |
| 1 | 0.197 | 0.11 | 41.24 | - | 41.35 | - | 63.74 | 53.74 | -22.39 | - |
| 2 | 0.388 | 0.12 | 40.17 | - | 40.29 | - | 58.10 | 48.10 | -17.81 | - |
| 3 | 0.650 | 0.12 | 38.62 | - | 38.74 | - | 56.00 | 46.00 | -17.26 | - |
| 4 | 1.234 | 0.15 | 37.51 | - | 37.66 | - | 56.00 | 46.00 | -18.34 | - |
| 5 | 3.375 | 0.19 | 36.23 | - | 36.42 | - | 56.00 | 46.00 | -19.58 | - |
| 6 | 23.094 | 0.69 | 46.85 | - | 47.54 | - | 60.00 | 50.00 | -12.46 | - |

- REMARKS:**
1. Q.P. and AV. are abbreviations of quasi-peak and average individually.
 2. "-": The Quasi-peak reading value also meets average limit and measurement with the average detector is unnecessary.
 3. The emission levels of other frequencies were very low against the limit.
 4. Margin value = Emission level - Limit value
 5. Correction factor = Insertion loss + Cable loss
 6. Emission Level = Correction Factor + Reading Value.

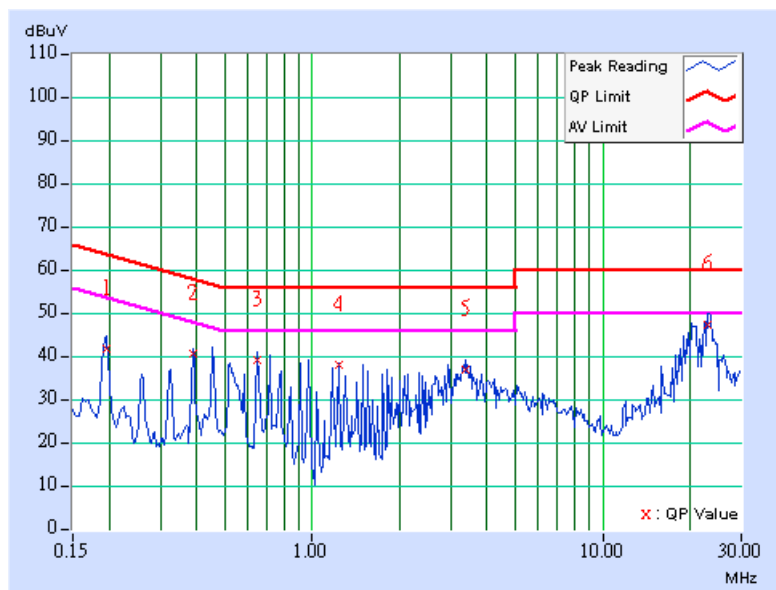



| | | | |
|---------------------------------|---------------------------|----------------------|----------|
| EUT | Wireless-G PCI Adapter | MODEL | WMP54Gv4 |
| CHANNEL | 11 | 6dB BANDWIDTH | 9 kHz |
| INPUT POWER (SYSTEM) | 120 Vac, 60 Hz | PHASE | Line (L) |
| ENVIRONMENTAL CONDITIONS | 24deg. C, 64% RH, 991 hPa | TESTED BY | Leo Hung |

| No | Freq. [MHz] | Corr. Factor (dB) | Reading Value [dB (uV)] | | Emission Level [dB (uV)] | | Limit [dB (uV)] | | Margin (dB) | |
|----|-------------|-------------------|-------------------------|-------|--------------------------|-------|-----------------|-------|-------------|-------|
| | | | Q.P. | AV. | Q.P. | AV. | Q.P. | AV. | Q.P. | AV. |
| | | | 1 | 0.197 | 0.12 | 39.85 | - | 39.97 | - | 63.74 |
| 2 | 0.388 | 0.13 | 37.97 | - | 38.10 | - | 58.10 | 48.10 | -20.00 | - |
| 3 | 0.646 | 0.13 | 36.76 | - | 36.89 | - | 56.00 | 46.00 | -19.11 | - |
| 4 | 1.230 | 0.15 | 36.90 | - | 37.05 | - | 56.00 | 46.00 | -18.95 | - |
| 5 | 3.500 | 0.20 | 34.02 | - | 34.22 | - | 56.00 | 46.00 | -21.78 | - |
| 6 | 23.340 | 1.11 | 37.34 | - | 38.45 | - | 60.00 | 50.00 | -21.55 | - |

- REMARKS:**
1. Q.P. and AV. are abbreviations of quasi-peak and average individually.
 2. "-": The Quasi-peak reading value also meets average limit and measurement with the average detector is unnecessary.
 3. The emission levels of other frequencies were very low against the limit.
 4. Margin value = Emission level - Limit value
 5. Correction factor = Insertion loss + Cable loss
 6. Emission Level = Correction Factor + Reading Value.

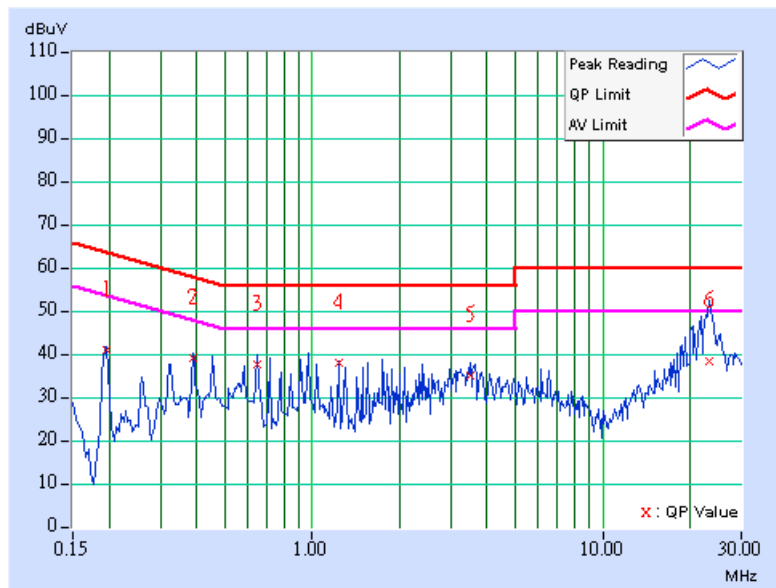



| | | | |
|---------------------------------|---------------------------|----------------------|-------------|
| EUT | Wireless-G PCI Adapter | MODEL | WMP54Gv4 |
| CHANNEL | 11 | 6dB BANDWIDTH | 9 kHz |
| INPUT POWER (SYSTEM) | 120 Vac, 60 Hz | PHASE | Netural (N) |
| ENVIRONMENTAL CONDITIONS | 24deg. C, 64% RH, 991 hPa | TESTED BY | Match Tsui |

| No | Freq. [MHz] | Corr. Factor (dB) | Reading Value | | Emission Level | | Limit | | Margin | |
|----|----------------|-------------------------|---------------|-----|----------------|-----|-----------|-------|--------|-----|
| | | | [dB (uV)] | | [dB (uV)] | | [dB (uV)] | | (dB) | |
| | | | Q.P. | AV. | Q.P. | AV. | Q.P. | AV. | Q.P. | AV. |
| 1 | 0.197 | 0.11 | 41.64 | - | 41.75 | - | 63.74 | 53.74 | -21.99 | - |
| 2 | 0.392 | 0.12 | 39.33 | - | 39.45 | - | 58.02 | 48.02 | -18.57 | - |
| 3 | 0.716 | 0.13 | 38.71 | - | 38.84 | - | 56.00 | 46.00 | -17.16 | - |
| 4 | 1.492 | 0.15 | 36.34 | - | 36.49 | - | 56.00 | 46.00 | -19.51 | - |
| 5 | 3.316 | 0.19 | 34.75 | - | 34.94 | - | 56.00 | 46.00 | -21.06 | - |
| 6 | 23.266 | 0.68 | 38.99 | - | 39.67 | - | 60.00 | 50.00 | -20.33 | - |

- REMARKS:**
1. Q.P. and AV. are abbreviations of quasi-peak and average individually.
 2. "-": The Quasi-peak reading value also meets average limit and measurement with the average detector is unnecessary.
 3. The emission levels of other frequencies were very low against the limit.
 4. Margin value = Emission level - Limit value
 5. Correction factor = Insertion loss + Cable loss
 6. Emission Level = Correction Factor + Reading Value.

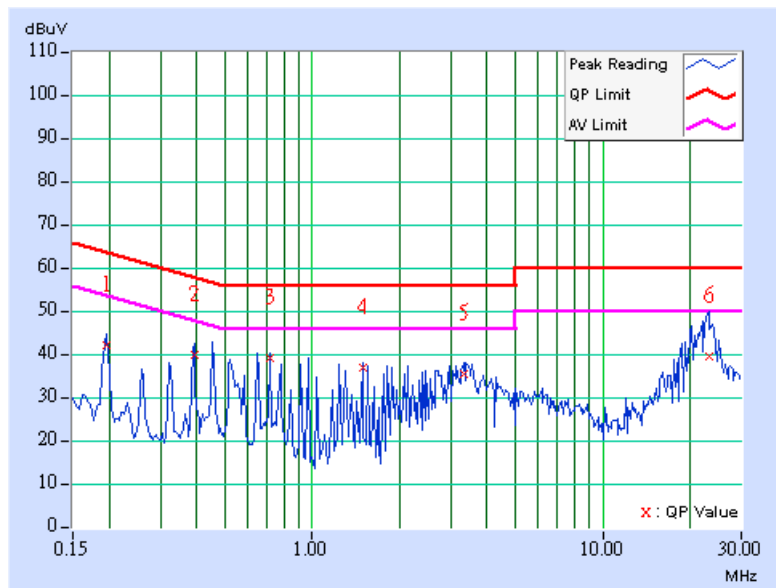



4.2 RADIATED EMISSION MEASUREMENT

4.2.1 LIMITS OF RADIATED EMISSION MEASUREMENT

Emissions radiated outside of the specified bands, shall be according to the general radiated limits in 15.209 as following:

| Frequencies (MHz) | Field strength (microvolts/meter) | Measurement distance (meters) |
|-------------------|-----------------------------------|-------------------------------|
| 0.009-0.490 | 2400/F(kHz) | 300 |
| 0.490-1.705 | 24000/F(kHz) | 30 |
| 1.705-30.0 | 30 | 30 |
| 30-88 | 100 | 3 |
| 88-216 | 150 | 3 |
| 216-960 | 200 | 3 |
| Above 960 | 500 | 3 |

NOTE:

1. The lower limit shall apply at the transition frequencies.
2. Emission level (dBuV/m) = 20 log Emission level (uV/m).
3. As shown in 15.35(b), for frequencies above 1000MHz, the field strength limits are based on average detector, however, the peak field strength of any emission shall not exceed the maximum permitted average limits, specified above by more than 20dB under any condition of modulation.



4.2.2 TEST INSTRUMENTS

| DESCRIPTION & MANUFACTURER | MODEL NO. | SERIAL NO. | CALIBRATED UNTIL |
|--------------------------------------|--------------------|--------------|------------------|
| Test Receiver ROHDE & SCHWARZ | ESIB7 | 100188 | Jan. 13, 2005 |
| Spectrum Analyzer ROHDE & SCHWARZ | FSP40 | 100039 | Dec. 15, 2004 |
| BILOG Antenna SCHWARZBECK | VULB9168 | 9168-157 | Feb. 03, 2005 |
| HORN Antenna SCHWARZBECK | BBHA 9120 D | 9120D-407 | Feb. 03, 2005 |
| HORN Antenna SCHWARZBECK | BBHA 9170 | BBHA 9170241 | Feb. 23, 2005 |
| Preamplifier Agilent | 8449B | 3008A01961 | Jan. 22, 2005 |
| Preamplifier Agilent | 8447D | 2944A10629 | Jan. 14, 2005 |
| RF signal cable HUBER+SUHNER | SUCOFLEX 104 | 218182/4 | Mar. 04, 2005 |
| RF signal cable HUBER+SUHNER | SUCOFLEX 104 | 218194/4 | Mar. 04, 2005 |
| Software ADT. | ADT_Radiated_V5.14 | NA | NA |
| Antenna Tower ADT. | AT100 | AT93021702 | NA |
| Turn Table ADT. | TT100. | TT93021702 | NA |
| Controller ADT. | SC100. | SC93021702 | NA |

- NOTE:**
1. The calibration interval of the above test instruments is 12 months and the calibrations are traceable to NML/ROC and NIST/USA.
 2. The test was performed in HwaYa Chamber 1.
 3. The horn antenna and HP preamplifier (model: 8449B) are used only for the measurement of emission frequency above 1GHz if tested.
 4. The IC Site Registration No. is IC4924-2.



4.2.3 TEST PROCEDURES

- a. The EUT was placed on the top of a rotating table 0.8 meters above the ground at a 3 meter semi-anechoic chamber. The table was rotated 360 degrees to determine the position of the highest radiation.
- b. The EUT was set 3 meters away from the interference-receiving antenna, which was mounted on the top of a variable-height antenna tower.
- c. The antenna is a broadband antenna, and its height is varied from one meter to four meters above the ground to determine the maximum value of the field strength. Both horizontal and vertical polarizations of the antenna are set to make the measurement.
- d. For each suspected emission, the EUT was arranged to its worst case and then the antenna was tuned to heights from 1 meter to 4 meters and the rotatable table was turned from 0 degrees to 360 degrees to find the maximum reading.
- e. The test-receiver system was set to Peak Detect Function and Specified Bandwidth with Maximum Hold Mode.
- f. If the emission level of the EUT in peak mode was 10 dB lower than the limit specified, then testing could be stopped and the peak values of the EUT would be reported. Otherwise the emissions that did not have 10 dB margin would be re-tested one by one using peak, quasi-peak or average method as specified and then reported in a data sheet.

NOTE:

1. The resolution bandwidth and video bandwidth of test receiver/spectrum analyzer is 120kHz for Peak detection (PK) and Quasi-peak detection (QP) at frequency below 1GHz.
2. The resolution bandwidth and video bandwidth of test receiver/spectrum analyzer is 1 MHz for Peak detection at frequency above 1GHz.
3. The resolution bandwidth of test receiver/spectrum analyzer is 1 MHz and the video bandwidth is 10 Hz for Average detection (AV) at frequency above 1GHz.

4.2.4 DEVIATION FROM TEST STANDARD

No deviation

4.2.5 TEST SETUP

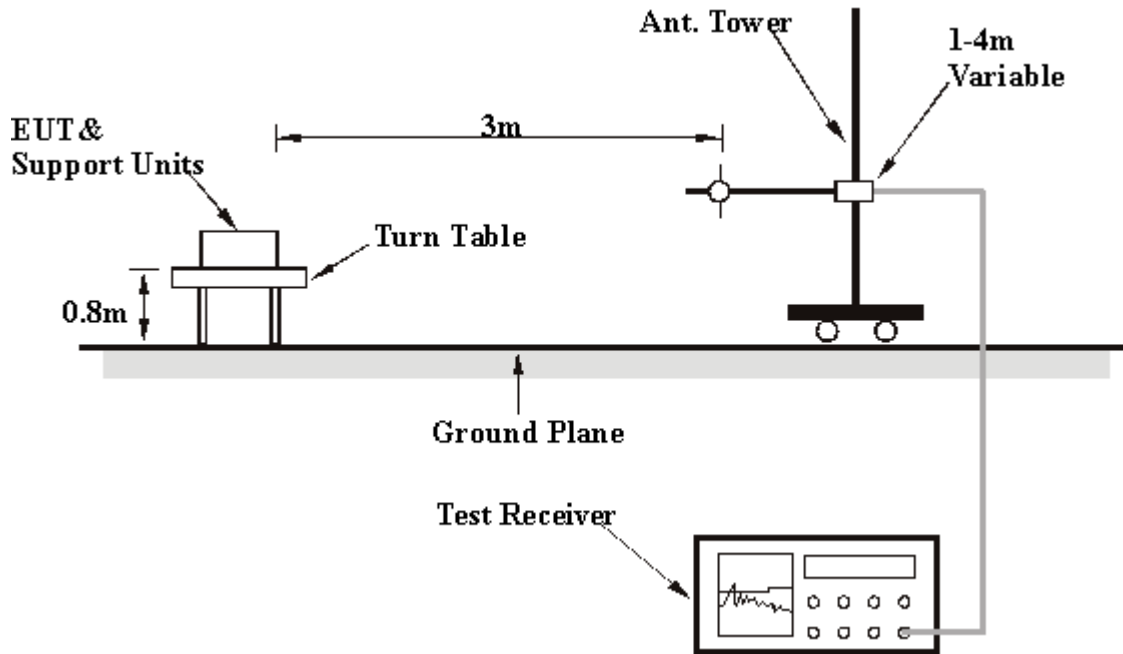

For the actual test configuration, please refer to the related item – Photographs of the Test Configuration.

4.2.6 EUT OPERATING CONDITIONS

Same as 4.1.6

4.2.7 TEST RESULTS

| | | | |
|---------------------------------|----------------------------|--------------------------|----------------|
| EUT | Wireless-G PCI Adapter | MODEL | WMP54Gv4 |
| CHANNEL | 11 | FREQUENCY RANGE | Below 1000 MHz |
| INPUT POWER (SYSTEM) | 120 Vac, 60Hz | DETECTOR FUNCTION | Quasi-Peak |
| ENVIRONMENTAL CONDITIONS | 25 deg. C, 60% RH, 991 hPa | TESTED BY | Match Tsui |

ANTENNA POLARITY & TEST DISTANCE: HORIZONTAL AT 3 M

| No. | Freq. (MHz) | Emission Level (dBuV/m) | Limit (dBuV/m) | Margin (dB) | Antenna Height (m) | Table Angle (Degree) | Raw Value (dBuV) | Correction Factor (dB/m) |
|-----------|---------------|-------------------------|----------------|--------------|--------------------|----------------------|------------------|--------------------------|
| 1 | 47.49 | 32.02 QP | 40.00 | -7.98 | 1.50 H | 250 | 17.02 | 15.00 |
| 2 | 99.98 | 34.82 QP | 43.50 | -8.68 | 2.00 H | 37 | 23.84 | 10.98 |
| 3 | 208.84 | 36.61 QP | 43.50 | -6.89 | 1.50 H | 1 | 25.02 | 11.59 |
| 4 | 335.19 | 39.41 QP | 46.00 | -6.59 | 1.00 H | 127 | 24.10 | 15.31 |
| 5 | 399.34 | 37.69 QP | 46.00 | -8.31 | 1.00 H | 4 | 20.96 | 16.74 |
| 6 | 496.53 | 41.13 QP | 46.00 | -4.87 | 1.75 H | 25 | 22.44 | 18.68 |
| 7 | 539.30 | 40.48 QP | 46.00 | -5.52 | 1.50 H | 298 | 21.00 | 19.48 |
| 8 | 574.29 | 38.54 QP | 46.00 | -7.46 | 1.25 H | 301 | 18.21 | 20.33 |
| 9 | 638.44 | 40.23 QP | 46.00 | -5.77 | 1.00 H | 286 | 18.71 | 21.53 |
| 10 | 665.65 | 40.74 QP | 46.00 | -5.26 | 1.00 H | 277 | 18.87 | 21.87 |
| 11 | 698.70 | 44.74 QP | 46.00 | -1.26 | 1.00 H | 271 | 22.46 | 22.28 |
| 12 | 737.58 | 38.95 QP | 46.00 | -7.05 | 2.00 H | 295 | 15.73 | 23.22 |
| 13 | 875.59 | 40.28 QP | 46.00 | -5.72 | 1.50 H | 298 | 15.62 | 24.66 |
| 14 | 945.57 | 37.30 QP | 46.00 | -8.70 | 1.25 H | 265 | 11.71 | 25.59 |

- REMARKS:**
1. Emission level(dBuV/m)=Raw Value(dBuV) + Correction Factor(dB/m)
 2. Correction Factor(dB/m) = Antenna Factor (dB/m) + Cable Factor (dB)
 3. The other emission levels were very low against the limit.
 4. Margin value = Emission level – Limit value.



| | | | |
|---------------------------------|----------------------------|--------------------------|----------------|
| EUT | Wireless-G PCI Adapter | MODEL | WMP54Gv4 |
| CHANNEL | 11 | FREQUENCY RANGE | Below 1000 MHz |
| INPUT POWER (SYSTEM) | 120 Vac, 60Hz | DETECTOR FUNCTION | Quasi-Peak |
| ENVIRONMENTAL CONDITIONS | 25 deg. C, 60% RH, 991 hPa | TESTED BY | Match Tsui |

ANTENNA POLARITY & TEST DISTANCE: VERTICAL AT 3 M

| No. | Freq. (MHz) | Emission Level (dBuV/m) | Limit (dBuV/m) | Margin (dB) | Antenna Height (m) | Table Angle (Degree) | Raw Value (dBuV) | Correction Factor (dB/m) |
|-----|-------------|-------------------------|----------------|-------------|--------------------|----------------------|------------------|--------------------------|
| 1 | 38.73 | 37.96 QP | 40.00 | -2.04 | 1.00 V | 73 | 22.94 | 15.02 |
| 2 | 48.48 | 37.19 QP | 40.00 | -2.81 | 1.00 V | 119 | 22.31 | 14.88 |
| 3 | 138.86 | 31.94 QP | 43.50 | -11.56 | 1.00 V | 76 | 17.60 | 14.34 |
| 4 | 304.09 | 37.71 QP | 46.00 | -8.29 | 1.25 V | 322 | 23.12 | 14.59 |
| 5 | 337.13 | 40.27 QP | 46.00 | -5.73 | 1.25 V | 343 | 24.92 | 15.35 |
| 6 | 399.34 | 40.88 QP | 46.00 | -5.12 | 1.00 V | 298 | 24.15 | 16.74 |
| 7 | 438.22 | 37.48 QP | 46.00 | -8.52 | 1.00 V | 343 | 19.73 | 17.76 |
| 8 | 488.76 | 41.37 QP | 46.00 | -4.63 | 1.00 V | 340 | 22.79 | 18.58 |
| 9 | 537.35 | 37.91 QP | 46.00 | -8.09 | 1.75 V | 157 | 18.46 | 19.45 |
| 10 | 642.32 | 41.50 QP | 46.00 | -4.50 | 1.25 V | 307 | 19.92 | 21.58 |
| 11 | 665.65 | 42.35 QP | 46.00 | -3.65 | 1.00 V | 301 | 20.48 | 21.87 |
| 12 | 690.92 | 44.01 QP | 46.00 | -1.99 | 1.25 V | 349 | 21.82 | 22.19 |
| 13 | 737.58 | 38.37 QP | 46.00 | -7.63 | 1.25 V | 304 | 15.14 | 23.22 |
| 14 | 817.27 | 38.41 QP | 46.00 | -7.59 | 1.00 V | 331 | 14.46 | 23.95 |
| 15 | 875.59 | 43.49 QP | 46.00 | -2.51 | 1.25 V | 316 | 18.83 | 24.66 |

- REMARKS:**
1. Emission level(dBuV/m)=Raw Value(dBuV) + Correction Factor(dB/m)
 2. Correction Factor(dB/m) = Antenna Factor (dB/m) + Cable Factor (dB)
 3. The other emission levels were very low against the limit.
 4. Margin value = Emission level – Limit value.



4.2.8 TEST RESULTS (A)

| | | | |
|---------------------------------|------------------------------|--------------------------|---------------------------|
| EUT | Wireless-G PCI Adapter | MODEL | WMP54Gv4 |
| CHANNEL | 1 | FREQUENCY RANGE | 1~25 GHz |
| INPUT POWER (SYSTEM) | 120 Vac, 60 Hz | DETECTOR FUNCTION | Peak (PK) Average (AV) |
| ENVIRONMENTAL CONDITIONS | 25deg. C, 60% RH, 991 hPa | TESTED BY | Match Tsui |

ANTENNA POLARITY & TEST DISTANCE: HORIZONTAL AT 3 M

| No. | Freq. (MHz) | Emission Level (dBuV/m) | Limit (dBuV/m) | Margin (dB) | Antenna Height (m) | Table Angle (Degree) | Raw Value (dBuV) | Correction Factor (dB/m) |
|-----|-------------|-------------------------|----------------|-------------|--------------------|----------------------|------------------|--------------------------|
| 1 | 2038.00 | 48.24 PK | 74.00 | -25.76 | 1.04 H | 19 | 17.59 | 30.65 |
| 1 | 2038.00 | 44.90 AV | 54.00 | -9.10 | 1.04 H | 19 | 14.25 | 30.65 |
| 2 | 2390.00 | 31.88 PK | 74.00 | -42.12 | 1.09 H | 1 | 0.08 | 31.80 |
| 2 | 2390.00 | 30.35 AV | 54.00 | -23.65 | 1.09 H | 1 | -1.45 | 31.80 |
| 3 | *2412.00 | 100.09 PK | | | 1.09 H | 1 | 68.22 | 31.87 |
| 3 | *2412.00 | 92.56 AV | | | 1.09 H | 1 | 60.69 | 31.87 |
| 4 | 4824.00 | 49.56 PK | 74.00 | -24.44 | 1.10 H | 278 | 11.45 | 38.11 |
| 4 | 4824.00 | 37.42 AV | 54.00 | -16.58 | 1.10 H | 278 | -0.69 | 38.11 |

ANTENNA POLARITY & TEST DISTANCE: VERTICAL AT 3 M

| No. | Freq. (MHz) | Emission Level (dBuV/m) | Limit (dBuV/m) | Margin (dB) | Antenna Height (m) | Table Angle (Degree) | Raw Value (dBuV) | Correction Factor (dB/m) |
|-----|-------------|-------------------------|----------------|-------------|--------------------|----------------------|------------------|--------------------------|
| 1 | 2038.00 | 50.21 PK | 74.00 | -23.79 | 1.00 V | 36 | 19.56 | 30.65 |
| 1 | 2038.00 | 47.19 AV | 54.00 | -6.81 | 1.00 V | 36 | 16.54 | 30.65 |
| 2 | 2390.00 | 48.89 PK | 74.00 | -25.11 | 1.00 V | 51 | 17.09 | 31.80 |
| 2 | 2390.00 | 41.17 AV | 54.00 | -12.83 | 1.00 V | 51 | 9.37 | 31.80 |
| 3 | *2412.00 | 111.10 PK | | | 1.00 V | 51 | 79.23 | 31.87 |
| 3 | *2412.00 | 103.38 AV | | | 1.00 V | 51 | 71.51 | 31.87 |
| 4 | 2518.00 | 54.08 PK | 74.00 | -19.92 | 1.20 V | 193 | 21.87 | 32.21 |
| 4 | 2518.00 | 44.23 AV | 54.00 | -9.77 | 1.20 V | 193 | 12.02 | 32.21 |
| 5 | 4824.00 | 57.60 PK | 74.00 | -16.40 | 1.03 V | 319 | 19.49 | 38.11 |
| 5 | 4824.00 | 44.44 AV | 54.00 | -9.56 | 1.03 V | 319 | 6.33 | 38.11 |

- REMARKS:**
1. Emission level(dBuV/m)=Raw Value(dBuV) + Correction Factor(dB)
 2. Correction Factor(dB/m) = Antenna Factor (dB/m) + Cable Factor (dB)
 3. The other emission levels were very low against the limit.
 4. Margin value = Emission level – Limit value.
 5. “ * “ : Fundamental frequency.



| | | | |
|---------------------------------|------------------------------|--------------------------|--------------------------|
| EUT | Wireless-G PCI Adapter | MODEL | WMP54Gv4 |
| CHANNEL | 6 | FREQUENCY RANGE | 1~25 GHz |
| INPUT POWER (SYSTEM) | 120 Vac, 60 Hz | DETECTOR FUNCTION | Peak(PK) Average (AV) |
| ENVIRONMENTAL CONDITIONS | 25deg. C, 60% RH, 991 hPa | TESTED BY | Match Tsui |

ANTENNA POLARITY & TEST DISTANCE: HORIZONTAL AT 3 M

| No. | Freq. (MHz) | Emission Level (dBuV/m) | Limit (dBuV/m) | Margin (dB) | Antenna Height (m) | Table Angle (Degree) | Raw Value (dBuV) | Correction Factor (dB/m) |
|-----|-------------|-------------------------|----------------|-------------|--------------------|----------------------|------------------|--------------------------|
| 1 | 2063.00 | 48.37 PK | 74.00 | -25.63 | 1.00 H | 21 | 17.68 | 30.69 |
| 1 | 2063.00 | 45.13 AV | 54.00 | -8.87 | 1.00 H | 21 | 14.44 | 30.69 |
| 2 | *2437.00 | 101.33 PK | | | 1.08 H | 304 | 69.38 | 31.95 |
| 2 | *2437.00 | 93.79 AV | | | 1.08 H | 304 | 61.84 | 31.95 |
| 3 | 4874.00 | 51.18 PK | 74.00 | -22.82 | 1.04 H | 330 | 12.90 | 38.28 |
| 3 | 4874.00 | 38.76 AV | 54.00 | -15.24 | 1.04 H | 330 | 0.48 | 38.28 |

ANTENNA POLARITY & TEST DISTANCE: VERTICAL AT 3 M

| No. | Freq. (MHz) | Emission Level (dBuV/m) | Limit (dBuV/m) | Margin (dB) | Antenna Height (m) | Table Angle (Degree) | Raw Value (dBuV) | Correction Factor (dB/m) |
|-----|-------------|-------------------------|----------------|-------------|--------------------|----------------------|------------------|--------------------------|
| 1 | 2063.00 | 51.56 PK | 74.00 | -22.44 | 1.19 V | 47 | 20.87 | 30.69 |
| 1 | 2063.00 | 49.33 AV | 54.00 | -4.67 | 1.19 V | 47 | 18.64 | 30.69 |
| 2 | *2437.00 | 111.26 PK | | | 1.08 V | 321 | 79.31 | 31.95 |
| 2 | *2437.00 | 103.71 AV | | | 1.08 V | 321 | 71.76 | 31.95 |
| 3 | 2528.00 | 54.86 PK | 74.00 | -19.14 | 1.04 V | 326 | 22.62 | 32.24 |
| 3 | 2528.00 | 42.98 AV | 54.00 | -11.02 | 1.04 V | 326 | 10.74 | 32.24 |
| 4 | 4874.00 | 58.39 PK | 74.00 | -15.61 | 1.03 V | 278 | 20.11 | 38.28 |
| 4 | 4874.00 | 45.92 AV | 54.00 | -8.08 | 1.03 V | 278 | 7.64 | 38.28 |

- REMARKS:**
1. Emission level(dBuV/m)=Raw Value(dBuV) + Correction Factor(dB)
 2. Correction Factor(dB/m) = Antenna Factor (dB/m) + Cable Factor (dB)
 3. The other emission levels were very low against the limit.
 4. Margin value = Emission level – Limit value.
 5. “ * “ : Fundamental frequency.



| | | | |
|---------------------------------|------------------------------|--------------------------|--------------------------|
| EUT | Wireless-G PCI Adapter | MODEL | WMP54Gv4 |
| CHANNEL | 11 | FREQUENCY RANGE | 1~25 GHz |
| INPUT POWER (SYSTEM) | 120 Vac, 60 Hz | DETECTOR FUNCTION | Peak(PK) Average (AV) |
| ENVIRONMENTAL CONDITIONS | 25deg. C, 60% RH, 991 hPa | TESTED BY | Match Tsui |

ANTENNA POLARITY & TEST DISTANCE: HORIZONTAL AT 3 M

| No. | Freq. (MHz) | Emission Level (dBuV/m) | Limit (dBuV/m) | Margin (dB) | Antenna Height (m) | Table Angle (Degree) | Raw Value (dBuV) | Correction Factor (dB/m) |
|-----|-------------|-------------------------|----------------|-------------|--------------------|----------------------|------------------|--------------------------|
| 1 | 2088.00 | 49.87 PK | 74.00 | -24.13 | 1.08 H | 25 | 19.14 | 30.73 |
| 1 | 2088.00 | 47.45 AV | 54.00 | -6.55 | 1.08 H | 25 | 16.72 | 30.73 |
| 2 | *2462.00 | 102.17 PK | | | 1.10 H | 295 | 70.15 | 32.02 |
| 2 | *2462.00 | 94.62 AV | | | 1.10 H | 295 | 62.60 | 32.02 |
| 3 | 2483.50 | 42.28 PK | 74.00 | -31.72 | 1.10 H | 295 | 10.19 | 32.09 |
| 3 | 2483.50 | 34.73 AV | 54.00 | -19.27 | 1.10 H | 295 | 2.64 | 32.09 |
| 4 | 4924.00 | 53.90 PK | 74.00 | -20.10 | 1.07 H | 317 | 15.41 | 38.49 |
| 4 | 4924.00 | 40.66 AV | 54.00 | -13.34 | 1.07 H | 317 | 2.17 | 38.49 |

ANTENNA POLARITY & TEST DISTANCE: VERTICAL AT 3 M

| No. | Freq. (MHz) | Emission Level (dBuV/m) | Limit (dBuV/m) | Margin (dB) | Antenna Height (m) | Table Angle (Degree) | Raw Value (dBuV) | Correction Factor (dB/m) |
|-----|-------------|-------------------------|----------------|-------------|--------------------|----------------------|------------------|--------------------------|
| 1 | 2088.00 | 53.36 PK | 74.00 | -20.64 | 1.18 V | 50 | 22.63 | 30.73 |
| 1 | 2088.00 | 51.70 AV | 54.00 | -2.30 | 1.18 V | 50 | 20.97 | 30.73 |
| 2 | *2462.00 | 110.07 PK | | | 1.08 V | 7 | 78.05 | 32.02 |
| 2 | *2462.00 | 102.43 AV | | | 1.08 V | 7 | 70.41 | 32.02 |
| 3 | 2483.50 | 50.18 PK | 74.00 | -23.82 | 1.08 V | 7 | 18.09 | 32.09 |
| 3 | 2483.50 | 42.54 AV | 54.00 | -11.46 | 1.08 V | 7 | 10.45 | 32.09 |
| 4 | 2544.00 | 57.22 PK | 74.00 | -16.78 | 1.07 V | 318 | 24.91 | 32.31 |
| 4 | 2544.00 | 50.74 AV | 54.00 | -3.26 | 1.07 V | 318 | 18.43 | 32.31 |
| 5 | 4924.00 | 60.55 PK | 74.00 | -13.45 | 1.02 V | 325 | 22.06 | 38.49 |
| 5 | 4924.00 | 47.66 AV | 54.00 | -6.34 | 1.02 V | 325 | 9.17 | 38.49 |

- REMARKS:**
1. Emission level(dBuV/m)=Raw Value(dBuV) + Correction Factor(dB)
 2. Correction Factor(dB/m) = Antenna Factor (dB/m) + Cable Factor (dB)
 3. The other emission levels were very low against the limit.
 4. Margin value = Emission level – Limit value.
 5. “ * “ : Fundamental frequency.



4.2.9 TEST RESULTS (B)

| | | | |
|---------------------------------|------------------------------|--------------------------|--------------------------|
| EUT | Wireless-G PCI Adapter | MODEL | WMP54Gv4 |
| CHANNEL | 1 | FREQUENCY RANGE | 1~25 GHz |
| INPUT POWER (SYSTEM) | 120 Vac, 60 Hz | DETECTOR FUNCTION | Peak(PK) Average (AV) |
| ENVIRONMENTAL CONDITIONS | 25deg. C, 60% RH, 991 hPa | TESTED BY | Match Tsui |

ANTENNA POLARITY & TEST DISTANCE: HORIZONTAL AT 3 M

| No. | Freq. (MHz) | Emission Level (dBuV/m) | Limit (dBuV/m) | Margin (dB) | Antenna Height (m) | Table Angle (Degree) | Raw Value (dBuV) | Correction Factor (dB/m) |
|-----|-------------|-------------------------|----------------|-------------|--------------------|----------------------|------------------|--------------------------|
| 1 | 2038.00 | 48.43 PK | 74.00 | -25.57 | 1.00 H | 360 | 17.78 | 30.65 |
| 1 | 2038.00 | 45.30 AV | 54.00 | -8.70 | 1.00 H | 360 | 14.65 | 30.65 |
| 2 | 2390.00 | 41.21 PK | 74.00 | -32.79 | 1.08 H | 1 | 9.41 | 31.80 |
| 2 | 2390.00 | 31.78 AV | 54.00 | -22.22 | 1.08 G | 1 | -0.02 | 31.80 |
| 3 | *2412.00 | 97.37 PK | | | 1.08 H | 1 | 65.50 | 31.87 |
| 3 | *2412.00 | 87.94 AV | | | 1.08 H | 1 | 56.07 | 31.87 |
| 4 | 4824.00 | 49.61 PK | 74.00 | -24.39 | 1.16 H | 58 | 11.50 | 38.11 |
| 4 | 4824.00 | 37.71 AV | 54.00 | -16.29 | 1.16 H | 58 | -0.40 | 38.11 |

ANTENNA POLARITY & TEST DISTANCE: VERTICAL AT 3 M

| No. | Freq. (MHz) | Emission Level (dBuV/m) | Limit (dBuV/m) | Margin (dB) | Antenna Height (m) | Table Angle (Degree) | Raw Value (dBuV) | Correction Factor (dB/m) |
|-----|-------------|-------------------------|----------------|-------------|--------------------|----------------------|------------------|--------------------------|
| 1 | 2038.00 | 50.83 PK | 74.00 | -23.17 | 1.21 V | 329 | 20.18 | 30.65 |
| 1 | 2038.00 | 48.26 AV | 54.00 | -5.74 | 1.21 V | 329 | 17.61 | 30.65 |
| 2 | 2360.00 | 52.51 PK | 74.00 | -21.49 | 1.00 V | 52 | 20.80 | 31.71 |
| 2 | 2360.00 | 39.89 AV | 54.00 | -14.11 | 1.00 V | 52 | 8.18 | 31.71 |
| 3 | 2390.00 | 49.42 PK | 74.00 | -24.58 | 1.23 V | 298 | 17.62 | 31.80 |
| 3 | 2390.00 | 40.20 AV | 54.00 | -13.80 | 1.23 V | 298 | 8.40 | 31.80 |
| 4 | *2412.00 | 107.58 PK | | | 1.09 V | 360 | 75.71 | 31.87 |
| 4 | *2412.00 | 98.36 AV | | | 1.09 V | 360 | 66.49 | 31.87 |
| 5 | 4824.00 | 54.97 PK | 74.00 | -19.03 | 1.03 V | 336 | 16.86 | 38.11 |
| 5 | 4824.00 | 42.12 AV | 54.00 | -11.88 | 1.03 V | 336 | 4.01 | 38.11 |

- REMARKS:**
1. Emission level(dBuV/m)=Raw Value(dBuV) + Correction Factor(dB)
 2. Correction Factor(dB/m) = Antenna Factor (dB/m) + Cable Factor (dB)
 3. The other emission levels were very low against the limit.
 4. Margin value = Emission level – Limit value.
 5. “ * “ : Fundamental frequency.



| | | | |
|---------------------------------|------------------------------|--------------------------|--------------------------|
| EUT | Wireless-G PCI Adapter | MODEL | WMP54Gv4 |
| CHANNEL | 6 | FREQUENCY RANGE | 1~25 GHz |
| INPUT POWER (SYSTEM) | 120 Vac, 60 Hz | DETECTOR FUNCTION | Peak(PK) Average (AV) |
| ENVIRONMENTAL CONDITIONS | 25deg. C, 60% RH, 991 hPa | TESTED BY | Match Tsui |

ANTENNA POLARITY & TEST DISTANCE: HORIZONTAL AT 3 M

| No. | Freq. (MHz) | Emission Level (dBuV/m) | Limit (dBuV/m) | Margin (dB) | Antenna Height (m) | Table Angle (Degree) | Raw Value (dBuV) | Correction Factor (dB/m) |
|-----|-------------|-------------------------|----------------|-------------|--------------------|----------------------|------------------|--------------------------|
| 1 | 2063.00 | 47.17 PK | 74.00 | -26.83 | 1.06 H | 304 | 16.48 | 30.69 |
| 1 | 2063.00 | 43.77 AV | 54.00 | -10.23 | 1.06 H | 304 | 13.08 | 30.69 |
| 2 | *2437.00 | 99.03 PK | | | 1.08 H | 304 | 67.08 | 31.95 |
| 2 | *2437.00 | 89.64 AV | | | 1.08 H | 304 | 57.69 | 31.95 |
| 3 | 4874.00 | 50.88 PK | 74.00 | -23.12 | 1.06 H | 62 | 12.60 | 38.28 |
| 3 | 4874.00 | 38.66 AV | 54.00 | -15.34 | 1.06 H | 62 | 0.38 | 38.28 |

ANTENNA POLARITY & TEST DISTANCE: VERTICAL AT 3 M

| No. | Freq. (MHz) | Emission Level (dBuV/m) | Limit (dBuV/m) | Margin (dB) | Antenna Height (m) | Table Angle (Degree) | Raw Value (dBuV) | Correction Factor (dB/m) |
|-----|-------------|-------------------------|----------------|-------------|--------------------|----------------------|------------------|--------------------------|
| 1 | 2063.00 | 51.74 PK | 74.00 | -22.26 | 1.20 V | 47 | 21.05 | 30.69 |
| 1 | 2063.00 | 49.82 AV | 54.00 | -4.18 | 1.20 V | 47 | 19.13 | 30.69 |
| 2 | 2360.00 | 52.59 PK | 74.00 | -21.41 | 1.00 V | 52 | 20.88 | 31.71 |
| 2 | 2360.00 | 40.78 AV | 54.00 | -13.22 | 1.00 V | 52 | 9.07 | 31.71 |
| 3 | *2437.00 | 109.43 PK | | | 1.11 V | 360 | 77.48 | 31.95 |
| 3 | *2437.00 | 100.41 AV | | | 1.11 V | 360 | 68.46 | 31.95 |
| 4 | 4874.00 | 56.55 PK | 74.00 | -17.45 | 1.05 V | 13 | 18.27 | 38.28 |
| 4 | 4874.00 | 43.32 AV | 54.00 | -10.68 | 1.05 V | 13 | 5.04 | 38.28 |

- REMARKS:**
1. Emission level(dBuV/m)=Raw Value(dBuV) + Correction Factor(dB)
 2. Correction Factor(dB/m) = Antenna Factor (dB/m) + Cable Factor (dB)
 3. The other emission levels were very low against the limit.
 4. Margin value = Emission level – Limit value.
 5. " * " : Fundamental frequency.



| | | | |
|---------------------------------|------------------------------|--------------------------|--------------------------|
| EUT | Wireless-G PCI Adapter | MODEL | WMP54Gv4 |
| CHANNEL | 11 | FREQUENCY RANGE | 1~25 GHz |
| INPUT POWER (SYSTEM) | 120 Vac, 60 Hz | DETECTOR FUNCTION | Peak(PK) Average (AV) |
| ENVIRONMENTAL CONDITIONS | 25deg. C, 60% RH, 991 hPa | TESTED BY | Match Tsui |

ANTENNA POLARITY & TEST DISTANCE: HORIZONTAL AT 3 M

| No. | Freq. (MHz) | Emission Level (dBuV/m) | Limit (dBuV/m) | Margin (dB) | Antenna Height (m) | Table Angle (Degree) | Raw Value (dBuV) | Correction Factor (dB/m) |
|-----|-------------|-------------------------|----------------|-------------|--------------------|----------------------|------------------|--------------------------|
| 1 | 2088.00 | 49.73 PK | 74.00 | -24.27 | 1.10 H | 35 | 19.00 | 30.73 |
| 1 | 2088.00 | 46.89 AV | 54.00 | -7.11 | 1.10 H | 35 | 16.16 | 30.73 |
| 2 | *2462.00 | 99.85 PK | | | 1.09 H | 295 | 67.83 | 32.02 |
| 2 | *2462.00 | 90.72 AV | | | 1.09 H | 295 | 58.70 | 32.02 |
| 3 | 2483.50 | 45.40 PK | 74.00 | -28.60 | 1.09 H | 295 | 13.31 | 32.09 |
| 3 | 2483.50 | 36.27 AV | 54.00 | -17.73 | 1.09 H | 295 | 4.18 | 32.09 |
| 4 | 4924.00 | 48.90 PK | 74.00 | -25.10 | 1.07 H | 131 | 10.41 | 38.49 |
| 4 | 4924.00 | 38.95 AV | 54.00 | -15.05 | 1.07 H | 131 | 0.46 | 38.49 |

ANTENNA POLARITY & TEST DISTANCE: VERTICAL AT 3 M

| No. | Freq. (MHz) | Emission Level (dBuV/m) | Limit (dBuV/m) | Margin (dB) | Antenna Height (m) | Table Angle (Degree) | Raw Value (dBuV) | Correction Factor (dB/m) |
|-----|-------------|-------------------------|----------------|-------------|--------------------|----------------------|------------------|--------------------------|
| 1 | 2088.00 | 53.26 PK | 74.00 | -20.74 | 1.18 V | 49 | 22.53 | 30.73 |
| 1 | 2088.00 | 51.68 AV | 54.00 | -2.32 | 1.18 V | 49 | 20.95 | 30.73 |
| 2 | *2462.00 | 108.68 PK | | | 1.12 V | 25 | 76.66 | 32.02 |
| 2 | *2462.00 | 99.19 AV | | | 1.12 V | 25 | 67.17 | 32.02 |
| 3 | 2483.50 | 54.23 PK | 74.00 | -19.77 | 1.12 V | 25 | 22.14 | 32.09 |
| 3 | 2483.50 | 44.74 AV | 54.00 | -9.26 | 1.12 V | 25 | 12.65 | 32.09 |
| 4 | 2544.00 | 57.46 PK | 74.00 | -16.54 | 1.10 V | 299 | 25.15 | 32.31 |
| 4 | 2544.00 | 50.45 AV | 54.00 | -3.55 | 1.10 V | 299 | 18.14 | 32.31 |
| 5 | 4924.00 | 58.50 PK | 74.00 | -15.50 | 1.05 V | 309 | 20.01 | 38.49 |
| 5 | 4924.00 | 45.83 AV | 54.00 | -8.17 | 1.05 V | 309 | 7.34 | 38.49 |

- REMARKS:**
1. Emission level(dBuV/m)=Raw Value(dBuV) + Correction Factor(dB)
 2. Correction Factor(dB/m) = Antenna Factor (dB/m) + Cable Factor (dB)
 3. The other emission levels were very low against the limit.
 4. Margin value = Emission level – Limit value.
 5. “ * “ : Fundamental frequency.



4.3 6dB BANDWIDTH MEASUREMENT

4.3.1 LIMITS OF 6dB BANDWIDTH MEASUREMENT

The minimum of 6dB Bandwidth Measurement is 0.5 MHz.

4.3.2 TEST INSTRUMENTS

| Description & Manufacturer | Model No. | Serial No. | Calibrated Until |
|----------------------------|-----------|------------|------------------|
| SPECTRUM ANALYZER | FSEK30 | 100049 | Aug. 12, 2005 |

NOTE: The calibration interval of the above test instruments is 12 months and the calibrations are traceable to NML/ROC and NIST/USA.

4.3.3 TEST PROCEDURE

The transmitter output was connected to the spectrum analyzer through an attenuator. The bandwidth of the fundamental frequency was measured by spectrum analyzer with 100 kHz RBW and 100kHz VBW. The 6dB bandwidth is defined as the total spectrum the power of which is higher than peak power minus 6dB.

4.3.4 DEVIATION FROM TEST STANDARD

No deviation

4.3.5 TEST SETUP

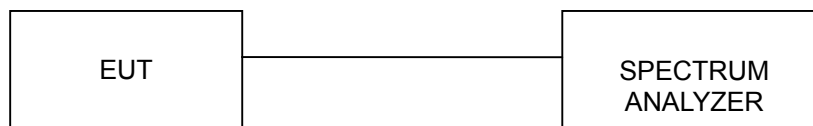

For the actual test configuration, please refer to the related Item – Photographs of the Test Configuration.

4.3.6 EUT OPERATING CONDITIONS

The software provided by client to enable the EUT under transmission condition continuously at lowest, middle and highest channel frequencies individually.



4.3.7 TEST RESULTS (A)

| | | | |
|-----------------------------|------------------------|---------------------------------|----------------------------|
| EUT | Wireless-G PCI Adapter | MODEL | WMP54Gv4 |
| INPUT POWER (SYSTEM) | 120 Vac, 60 Hz | ENVIRONMENTAL CONDITIONS | 23 deg. C, 67% RH, 991 hPa |
| TESTED BY | Leo Hung | | |

| CHANNEL | CHANNEL FREQUENCY (MHz) | 6dB BANDWIDTH (MHz) | MINIMUM LIMIT (MHz) | PASS/FAIL |
|----------------|--------------------------------|----------------------------|----------------------------|------------------|
| 1 | 2412 | 12.10 | 0.5 | PASS |
| 6 | 2437 | 12.02 | 0.5 | PASS |
| 11 | 2462 | 12.06 | 0.5 | PASS |



CH1

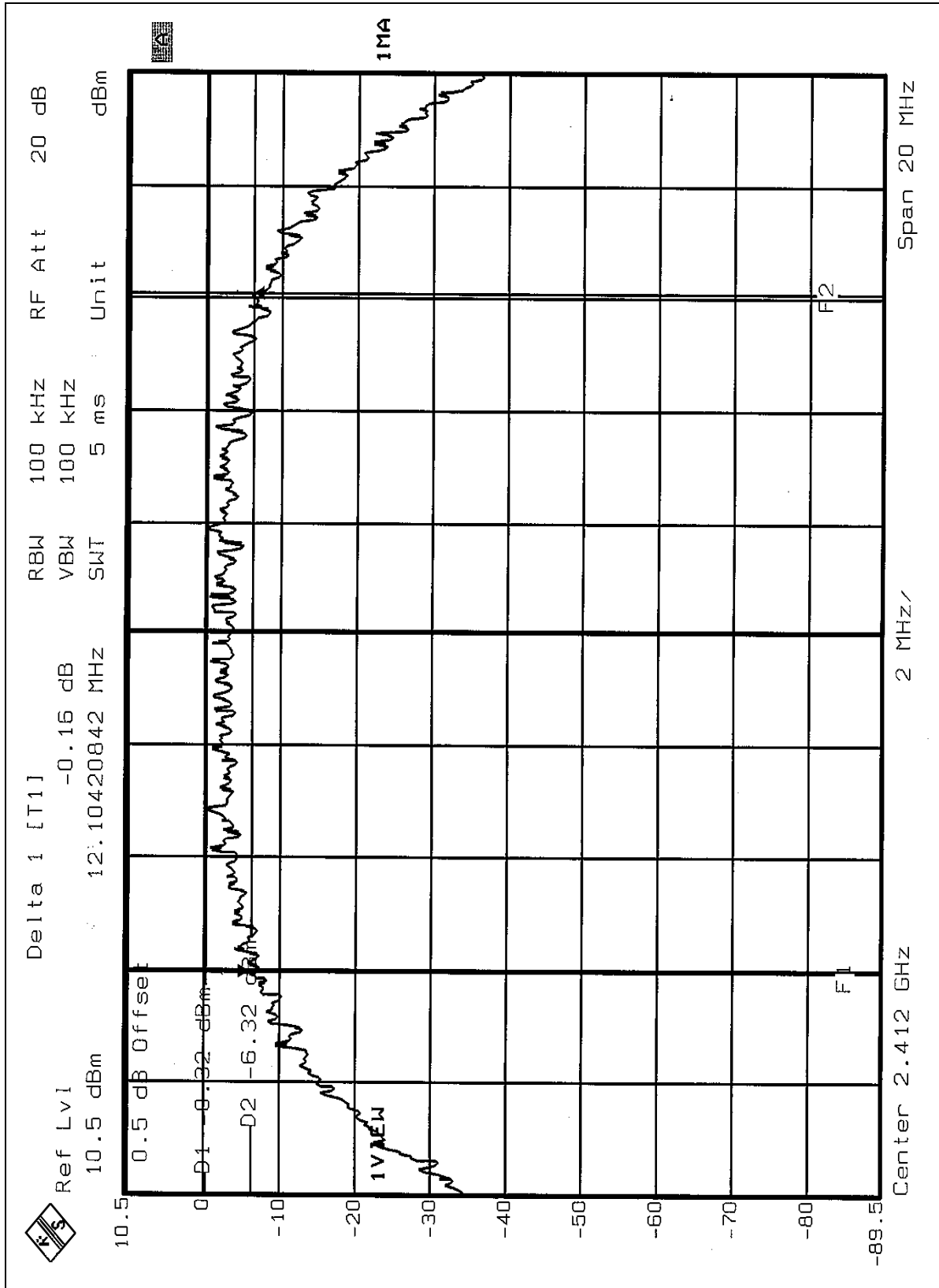



CH11

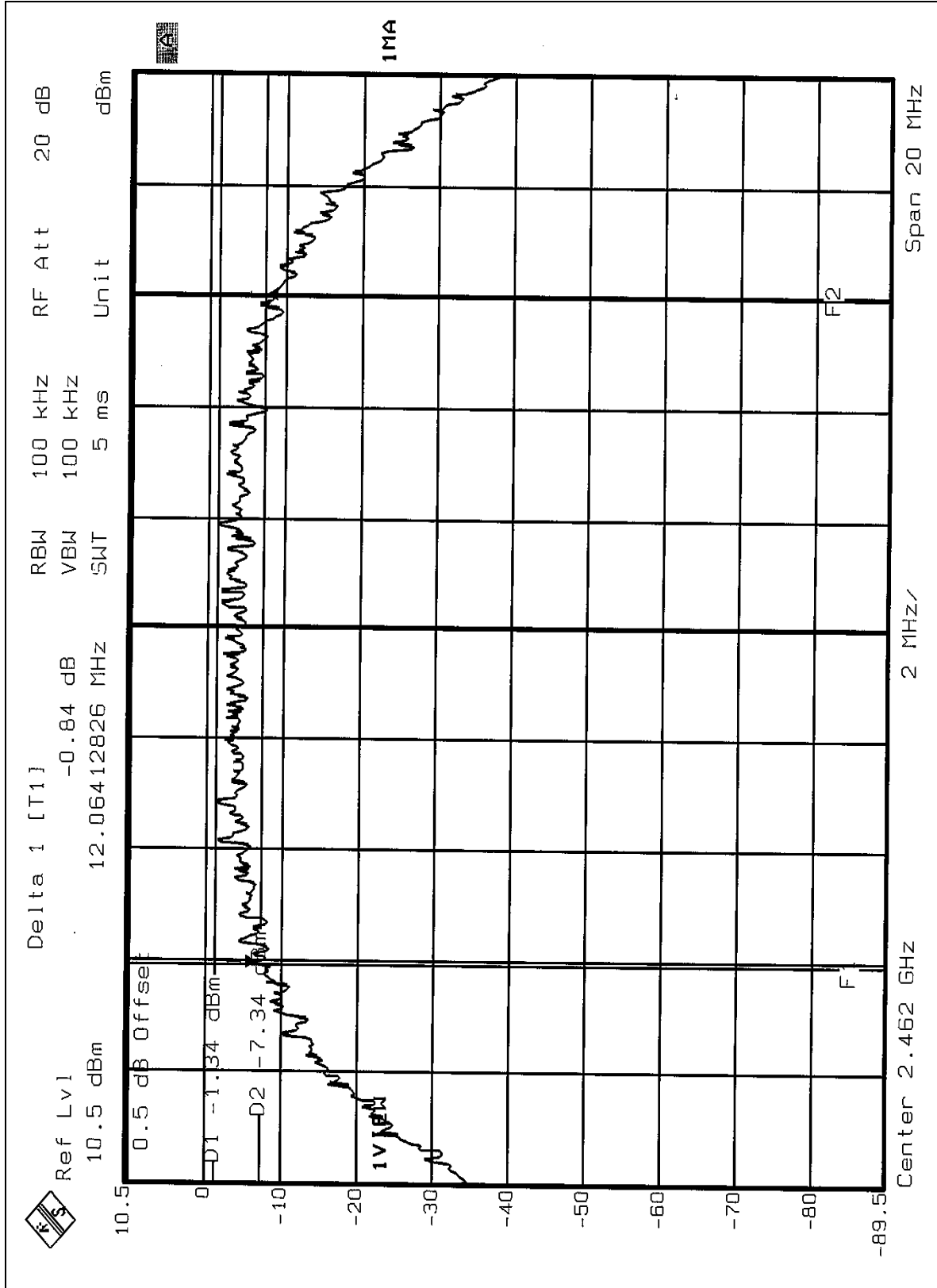



4.3.8 TEST RESULTS (B)

| | | | |
|-----------------------------|------------------------|---------------------------------|----------------------------|
| EUT | Wireless-G PCI Adapter | MODEL | WMP54Gv4 |
| INPUT POWER (SYSTEM) | 120 Vac, 60 Hz | ENVIRONMENTAL CONDITIONS | 23 deg. C, 67% RH, 991 hPa |
| TESTED BY | Leo Hung | | |

| CHANNEL | CHANNEL FREQUENCY (MHz) | 6 dB BANDWIDTH (MHz) | MINIMUM LIMIT (MHz) | PASS/FAIL |
|----------------|--------------------------------|-----------------------------|----------------------------|------------------|
| 1 | 2412 | 16.51 | 0.5 | PASS |
| 6 | 2437 | 16.55 | 0.5 | PASS |
| 11 | 2462 | 16.51 | 0.5 | PASS |



CH1

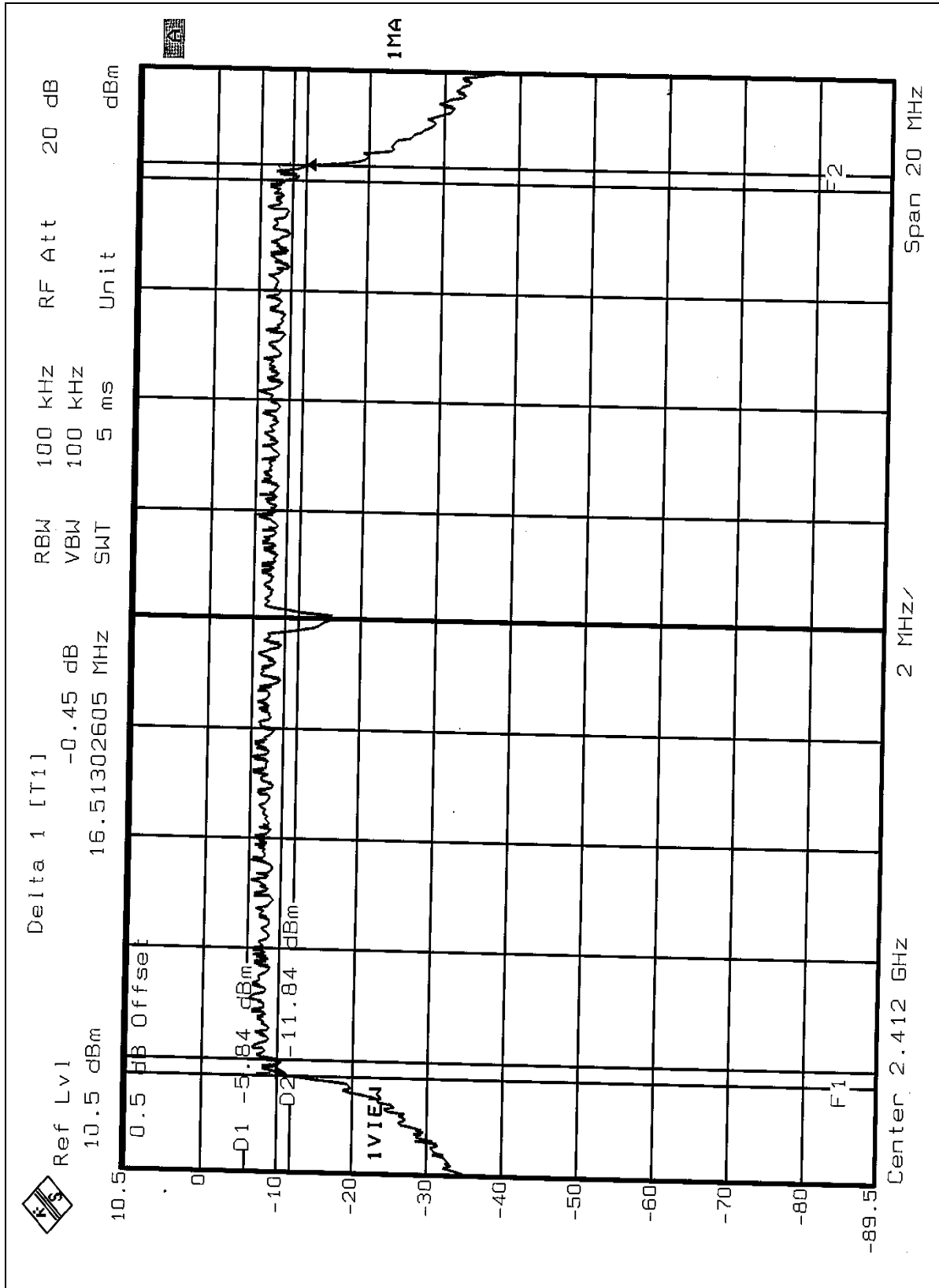



CH6

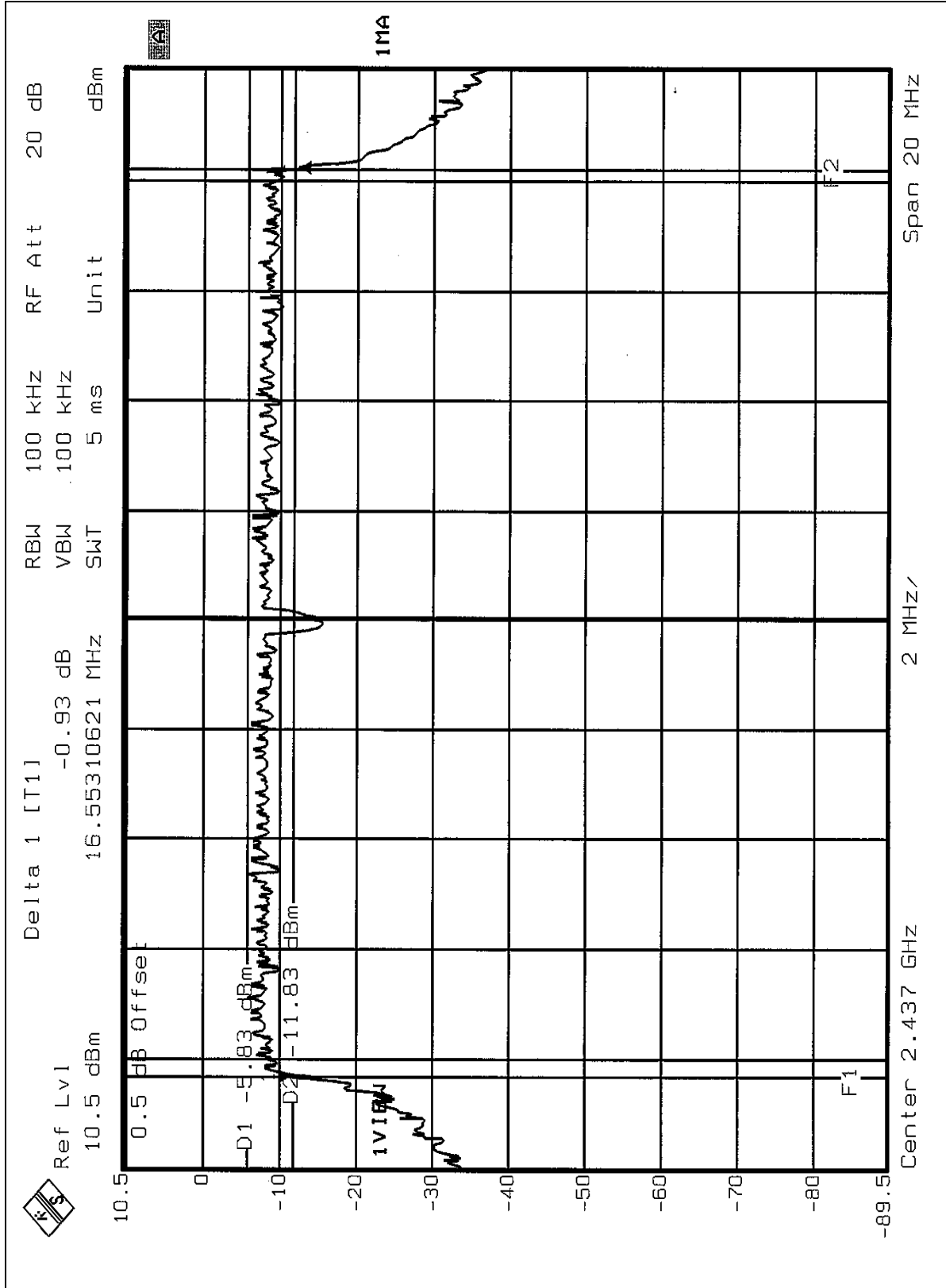



CH11

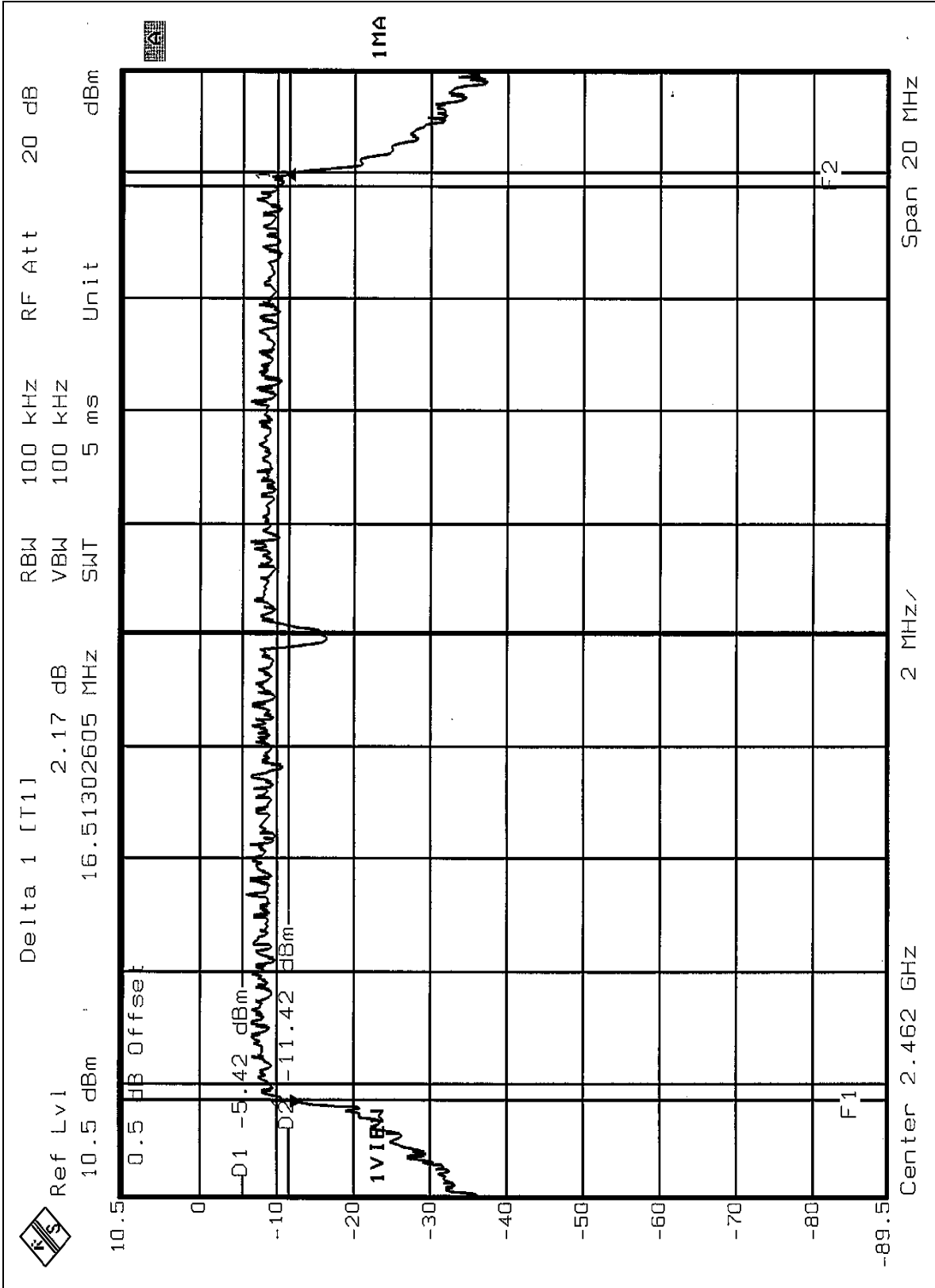



4.4 MAXIMUM PEAK OUTPUT POWER

4.4.1 LIMITS OF MAXIMUM PEAK OUTPUT POWER MEASUREMENT

The Maximum Peak Output Power Measurement is 30dBm. .

4.4.2 TEST INSTRUMENTS

| Description & Manufacturer | Model No. | Serial No. | Calibrated Until |
|----------------------------|-----------|------------|------------------|
| R&S SPECTRUM ANALYZER | FSEK30 | 100049 | Aug. 12, 2005 |
| AGILENT SIGNAL GENERATOR | E8257C | MY43320668 | Dec. 31, 2004 |
| TEKTRONIX OSCILLOSCOPE | TDS 220 | C019167 | Feb. 1, 2005 |
| NARDA DETECTOR | 4503A | FSCM99899 | NA |

NOTE:

The calibration interval of the above test instruments is 12 months and the calibrations are traceable to NML/ROC and NIST/USA.

4.4.3 TEST PROCEDURES

1. A detector was used on the output port of the EUT. An oscilloscope was used to peak the response of the detector.
2. Replaced the EUT by the signal generator. The center frequency of the S.G was adjusted to the center frequency of the measured channel.
3. Adjusted the power to have the same peak reading on oscilloscope. Record the power level.

4.4.4 DEVIATION FROM TEST STANDARD

No deviation

4.4.5 TEST SETUP



4.4.6 EUT OPERATING CONDITIONS

Same as Item 4.3.6



4.4.7 TEST RESULTS (A)

| | | | |
|-----------------------------|------------------------|---------------------------------|----------------------------|
| EUT | Wireless-G PCI Adapter | MODEL | WMP54Gv4 |
| INPUT POWER (SYSTEM) | 120 Vac, 60 Hz | ENVIRONMENTAL CONDITIONS | 23 deg. C, 67% RH, 991 hPa |
| TESTED BY | Leo Hung | | |

| CHANNEL | CHANNEL FREQUENCY (MHz) | PEAK POWER OUTPUT (mW) | PEAK POWER OUTPUT (dBm) | PEAK POWER LIMIT (dBm) | PASS/FAIL |
|---------|-------------------------|------------------------|-------------------------|------------------------|-----------|
| 1 | 2412 | 20.42 | 13.10 | 30 | PASS |
| 6 | 2437 | 19.95 | 13.00 | 30 | PASS |
| 11 | 2462 | 20.89 | 13.20 | 30 | PASS |

4.4.8 TEST RESULTS (B)

| | | | |
|-----------------------------|------------------------|---------------------------------|----------------------------|
| EUT | Wireless-G PCI Adapter | MODEL | WMP54Gv4 |
| INPUT POWER (SYSTEM) | 120 Vac, 60 Hz | ENVIRONMENTAL CONDITIONS | 23 deg. C, 67% RH, 991 hPa |
| TESTED BY | Leo Hung | | |

| CHANNEL | CHANNEL FREQUENCY (MHz) | PEAK POWER OUTPUT (mW) | PEAK POWER OUTPUT (dBm) | PEAK POWER LIMIT (dBm) | PASS/FAIL |
|---------|-------------------------|------------------------|-------------------------|------------------------|-----------|
| 1 | 2412 | 20.89 | 13.20 | 30 | PASS |
| 6 | 2437 | 19.95 | 13.00 | 30 | PASS |
| 11 | 2462 | 20.42 | 13.10 | 30 | PASS |



4.5 POWER SPECTRAL DENSITY MEASUREMENT

4.5.1 LIMITS OF POWER SPECTRAL DENSITY MEASUREMENT

The Maximum of Power Spectral Density Measurement is 8dBm.

4.5.2 TEST INSTRUMENTS

| Description & Manufacturer | Model No. | Serial No. | Calibrated Until |
|----------------------------|-----------|------------|------------------|
| SPECTRUM ANALYZER | FSEK30 | 100049 | Aug. 12, 2005 |

NOTE: The calibration interval of the above test instruments is 12 months and the calibrations are traceable to NML/ROC and NIST/USA.

4.5.3 TEST PROCEDURE

The transmitter output was connected to the spectrum analyzer through an attenuator, the bandwidth of the fundamental frequency was measured with the spectrum analyzer using 3kHz RBW and 30kHz VBW, set sweep time=span/3kHz. The power spectral density was measured and recorded. The sweep time is allowed to be longer than span/3kHz for a full response of the mixer in the spectrum analyzer.

4.5.4 DEVIATION FROM TEST STANDARD

No deviation

4.5.5 TEST SETUP

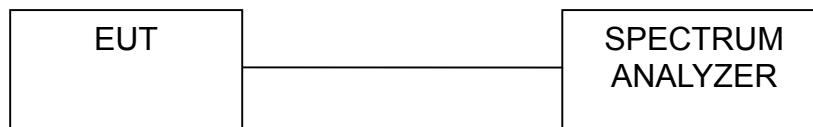

4.5.6 EUT OPERATING CONDITIONS

Same as 4.3.6



4.5.7 TEST RESULTS (A)

| | | | |
|-----------------------------|------------------------|---------------------------------|----------------------------|
| EUT | Wireless-G PCI Adapter | MODEL | WMP54Gv4 |
| INPUT POWER (SYSTEM) | 120 Vac, 60 Hz | ENVIRONMENTAL CONDITIONS | 23 deg. C, 67% RH, 991 hPa |
| TESTED BY | Leo Hung | | |

| CHANNEL NUMBER | CHANNEL FREQUENCY (MHz) | RF POWER LEVEL IN 3KHz BW (dBm) | MAXIMUM LIMIT (dBm) | PASS/FAIL |
|-----------------------|---------------------------------|--|----------------------------|------------------|
| 1 | 2412 | -13.43 | 8 | PASS |
| 6 | 2437 | -14.75 | 8 | PASS |
| 11 | 2462 | -13.30 | 8 | PASS |



CH1

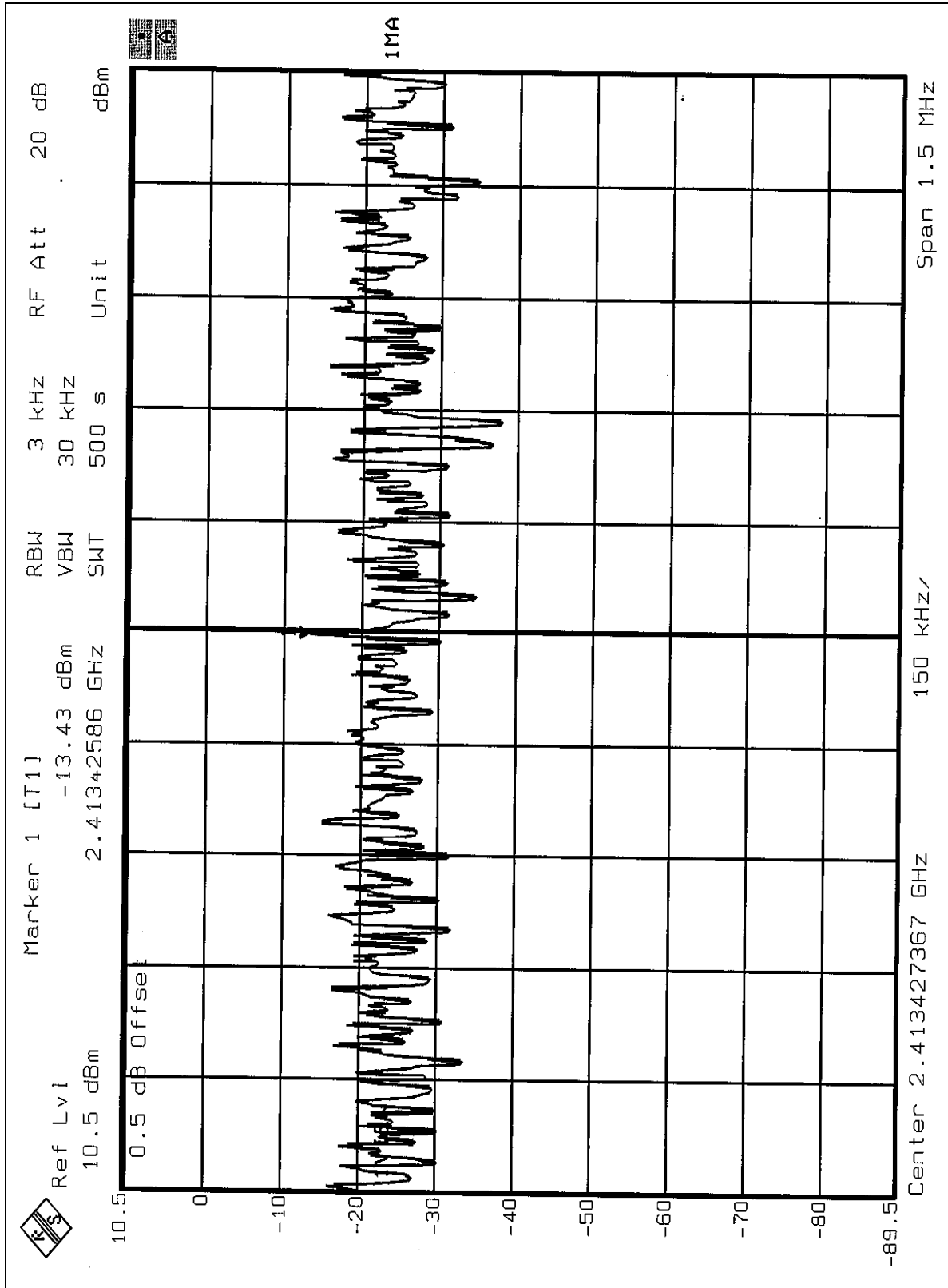



CH6

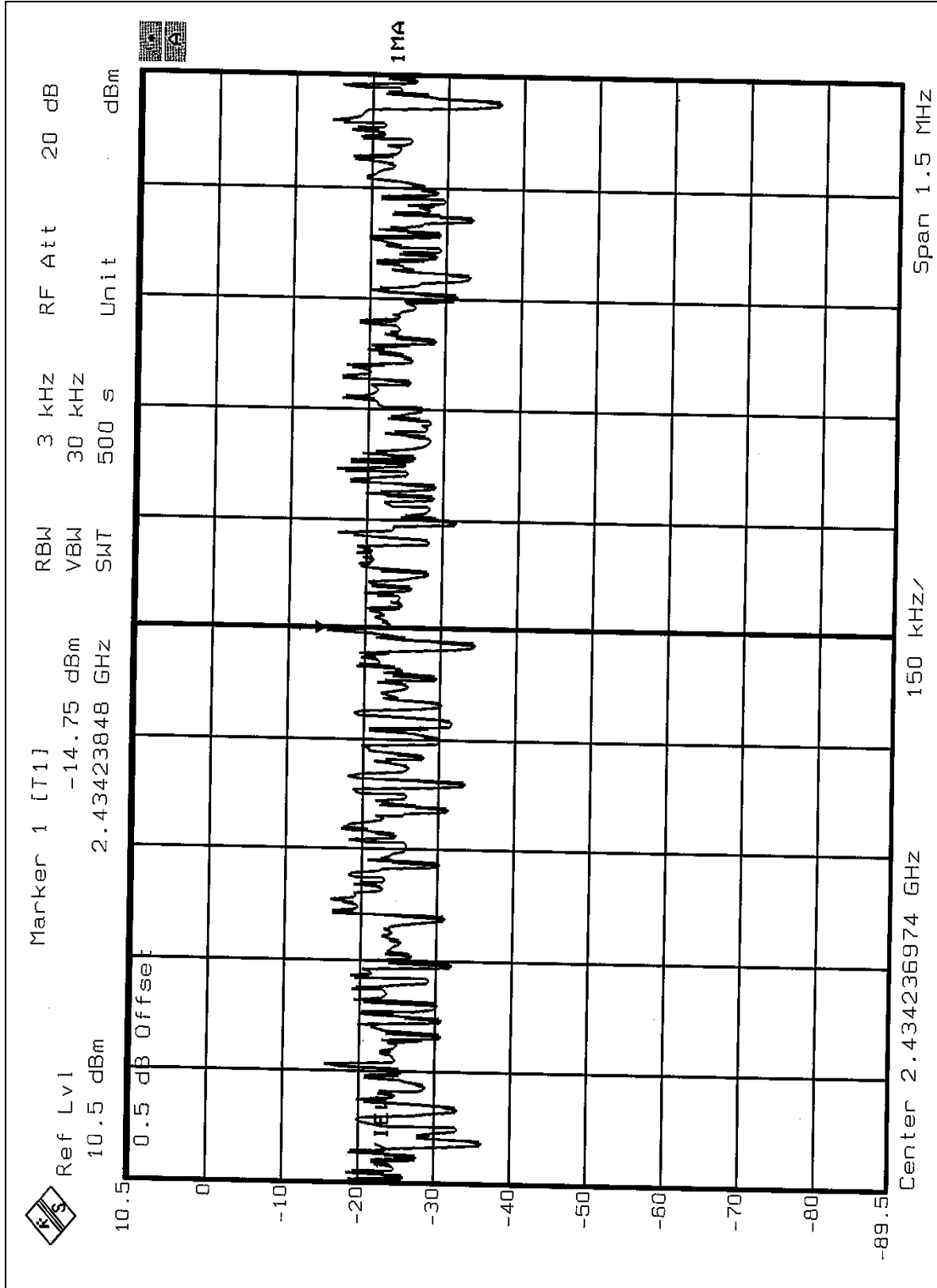



CH11

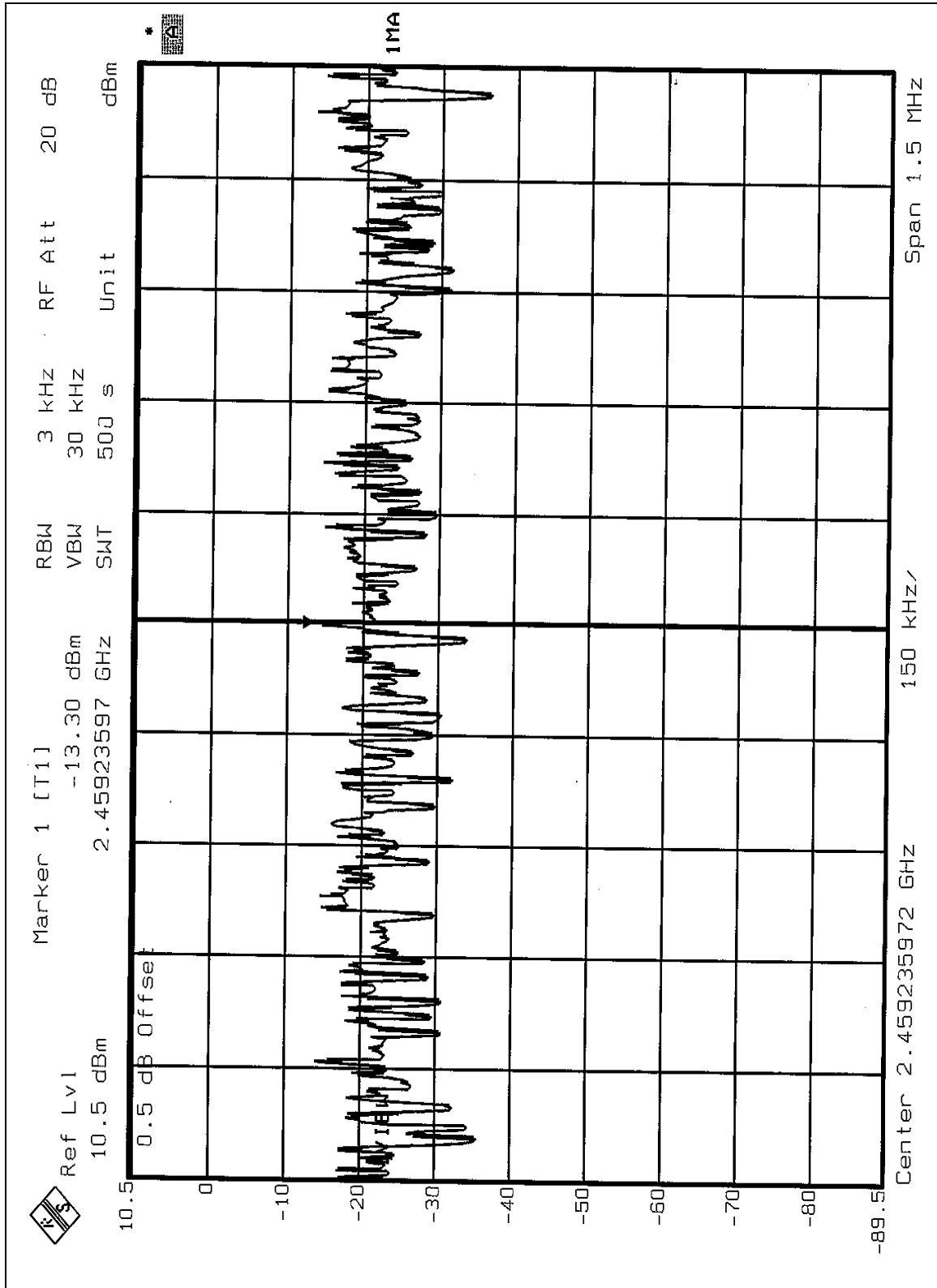



4.5.8 TEST RESULTS (B)

| | | | |
|-----------------------------|------------------------|---------------------------------|----------------------------|
| EUT | Wireless-G PCI Adapter | MODEL | WMP54Gv4 |
| INPUT POWER (SYSTEM) | 120 Vac, 60 Hz | ENVIRONMENTAL CONDITIONS | 23 deg. C, 67% RH, 991 hPa |
| TESTED BY | Leo Hung | | |

| CHANNEL NUMBER | CHANNEL FREQUENCY (MHz) | RF POWER LEVEL IN 3KHz BW (dBm) | MAXIMUM LIMIT (dBm) | PASS/FAIL |
|-----------------------|---------------------------------|--|----------------------------|------------------|
| 1 | 2412 | -20.68 | 8 | PASS |
| 6 | 2437 | -20.96 | 8 | PASS |
| 11 | 2462 | -20.64 | 8 | PASS |



CH1

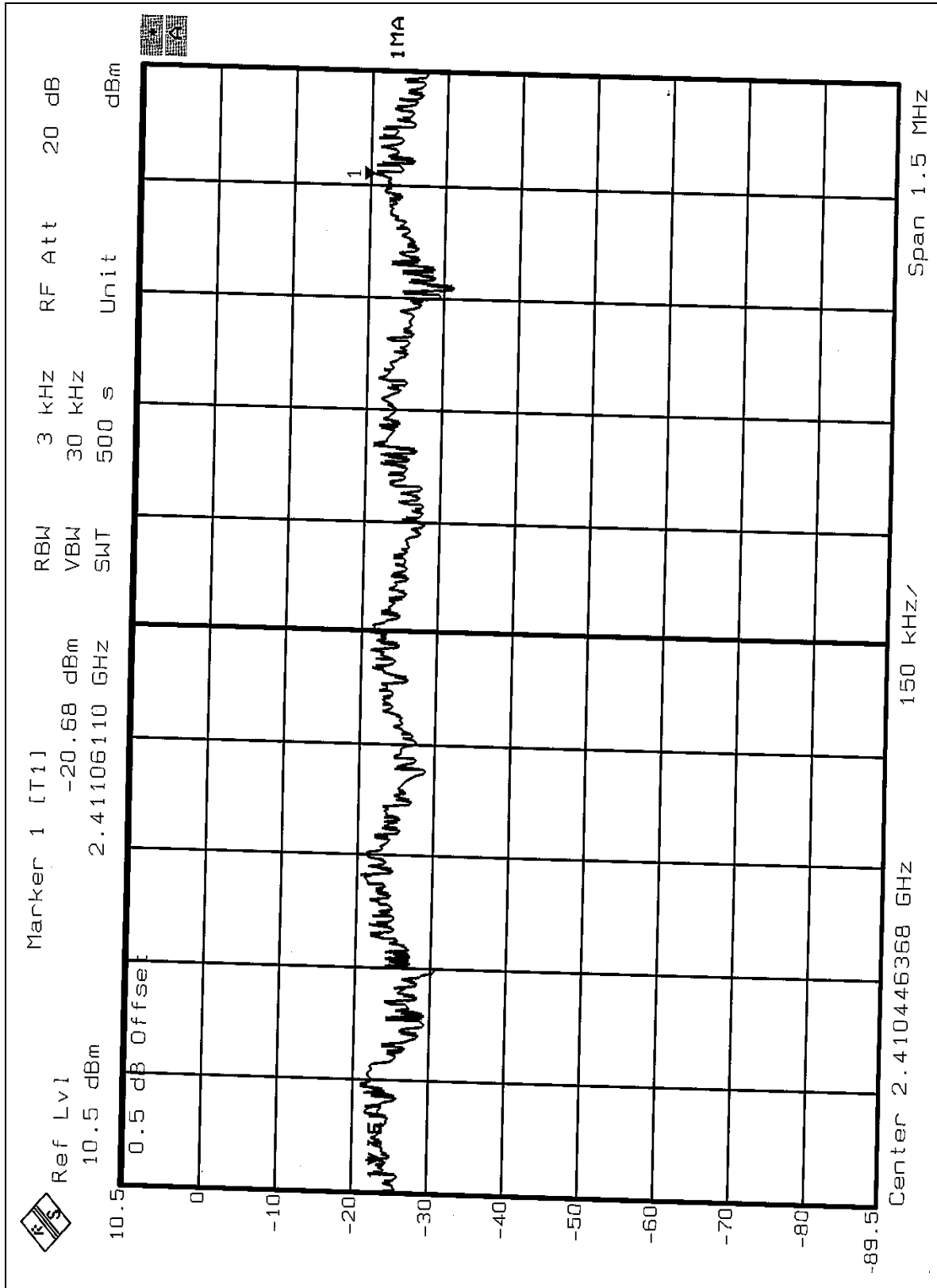



CH6

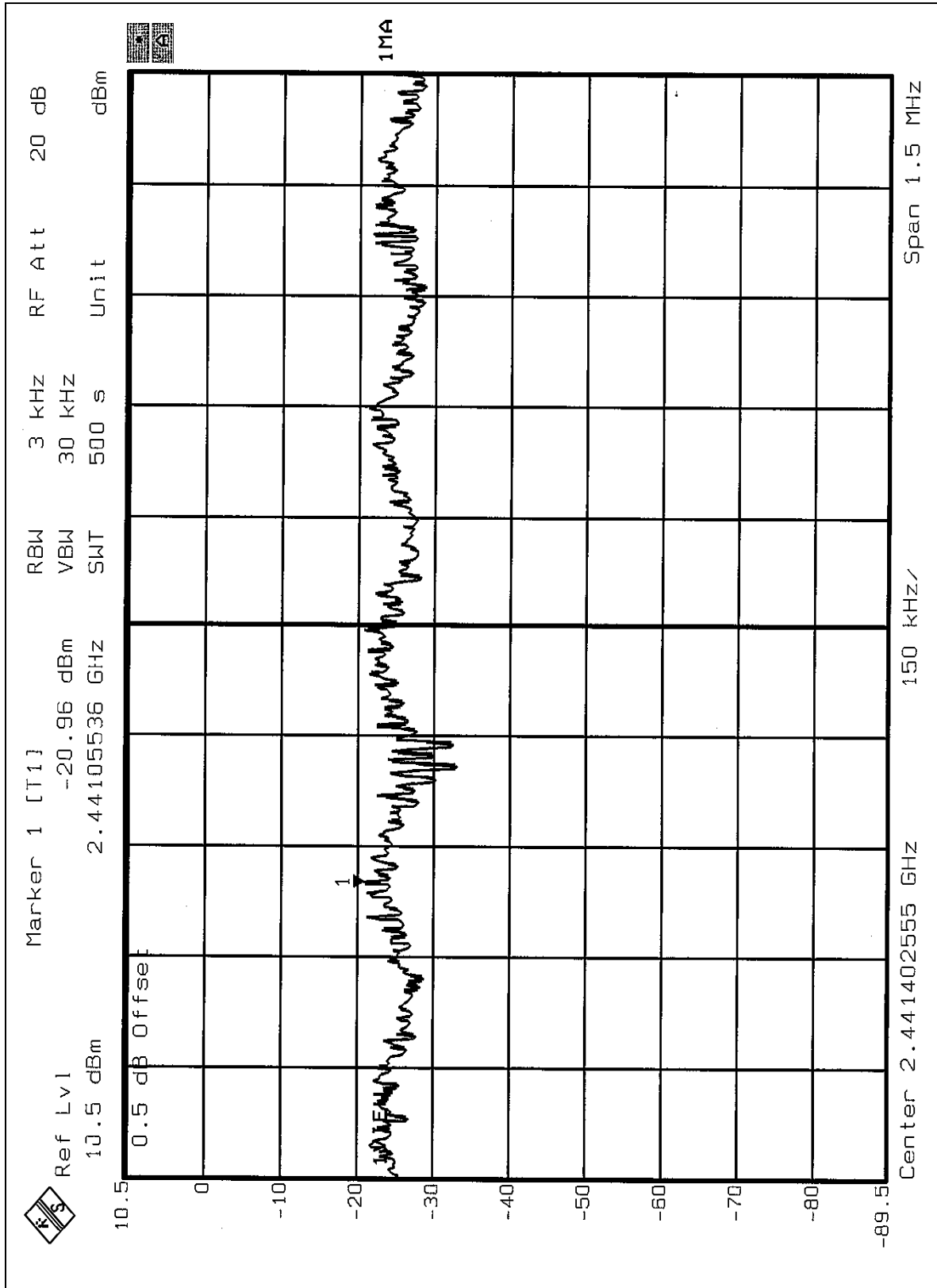



CH11

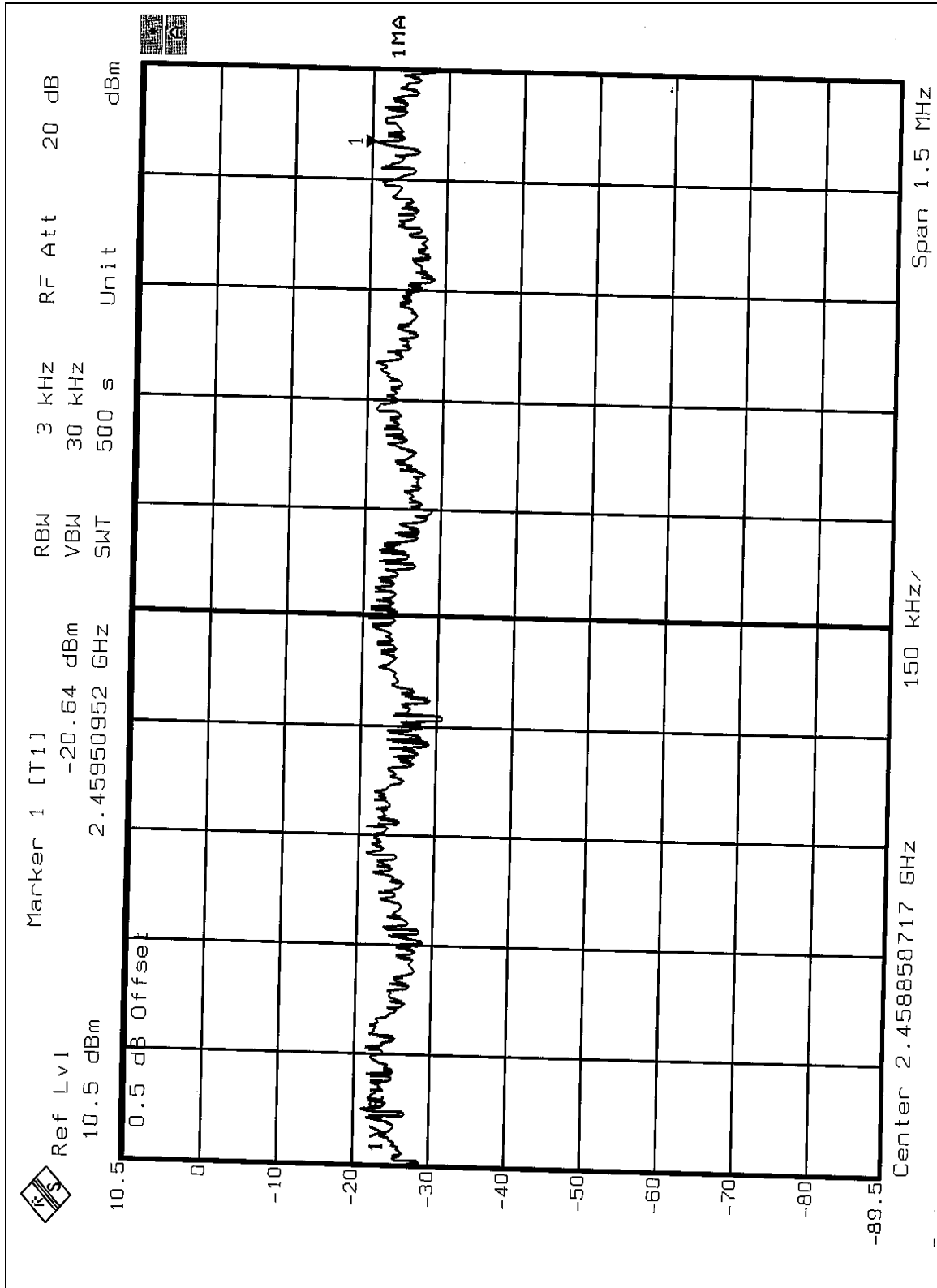



4.6 BAND EDGES MEASUREMENT

4.6.1 LIMITS OF BAND EDGES MEASUREMENT

Below -20dB of the highest emission level of operating band (in 100kHz Resolution Bandwidth).

4.6.2 TEST INSTRUMENTS

| Description & Manufacturer | Model No. | Serial No. | Calibrated Until |
|----------------------------|-----------|------------|------------------|
| SPECTRUM ANALYZER | FSEK30 | 100049 | Aug. 12, 2005 |

NOTE: The calibration interval of the above test instruments is 12 months and the calibrations are traceable to NML/ROC and NIST/USA.

4.6.3 TEST PROCEDURE

The transmitter output was connected to the spectrum analyzer via a low lose cable. Set both RBW and VBW of spectrum analyzer to 100kHz with suitable frequency span including 100MHz bandwidth from band edge. The band edges was measured and recorded.

4.6.4 DEVIATION FROM TEST STANDARD

No deviation

4.6.5 EUT OPERATING CONDITION

Same as Item 4.3.6



4.6.6 TEST RESULTS

The spectrum plots are attached on the following 8 pages. D2 line indicates the highest level, D1 line indicates the 20dB offset below D2. It shows compliance with the requirement in part 15.247(C).

4.6.7 TEST RESULTS(A)

NOTE:

The band edge emission plot of CCK technique on the following 1~2 pages show 58.75dB delta between carrier maximum power and local maximum emission in restrict band (2.3884GHz). The emission of carrier strength list in the test result of channel 1 at the item 4.2.8 is 103.38dBuV/m, so the maximum field strength in restrict band is $103.38-58.75=44.63$ dBuV/m which is under 54dBuV/m limit.

The band edge emission plot of CCK technique on the following 3~4 pages show 58.51dB delta between carrier maximum power and local maximum emission in restrict band (2.4835GHz). The emission of carrier strength list in the test result of channel 11 at the item 4.2.8 is 102.43dBuV/m, so the maximum field strength in restrict band is $102.43-58.51=43.92$ dBuV/m which is under 54dBuV/m limit.

4.6.8 TEST RESULTS(B)

NOTE:

The band edge emission plot of OFDM technique on the following 5~6 pages show 45.59dB delta between carrier maximum power and local maximum emission in restrict band (2.3886GHz). The emission of carrier strength list in the test result of channel 1 at the item 4.2.9 is 98.36dBuV/m, so the maximum field strength in restrict band is $98.36-45.59=52.77$ dBuV/m which is under 54dBuV/m limit.

The band edge emission plot of OFDM technique on the following 7~8 pages show 52.80dB delta between carrier maximum power and local maximum emission in restrict band (2.4843GHz). The emission of carrier strength list in the test result of channel 11 at the item 4.2.9 is 99.19dBuV/m, so the maximum field strength in restrict band is $99.19-52.80=46.39$ dBuV/m which is under 54dBuV/m limit.

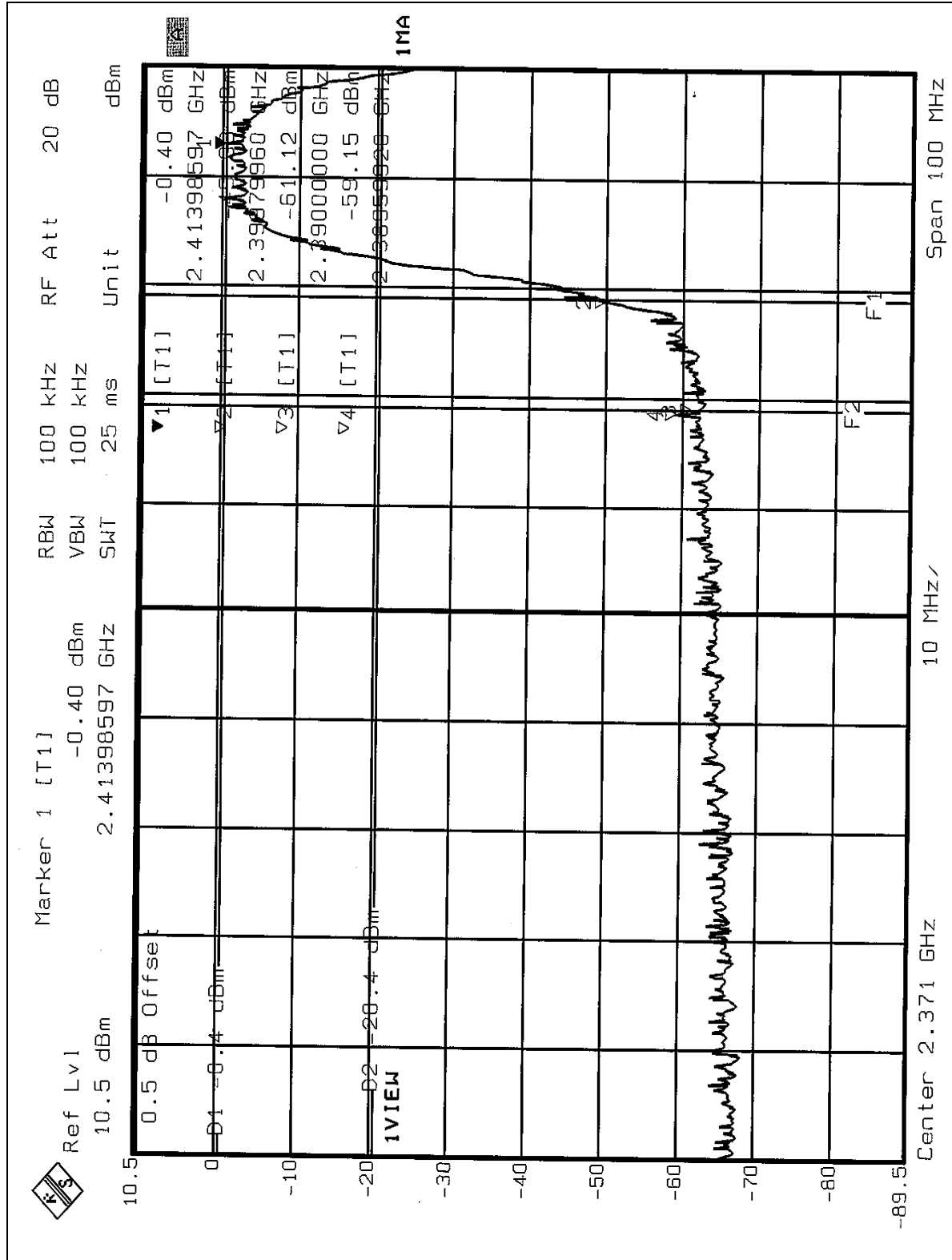

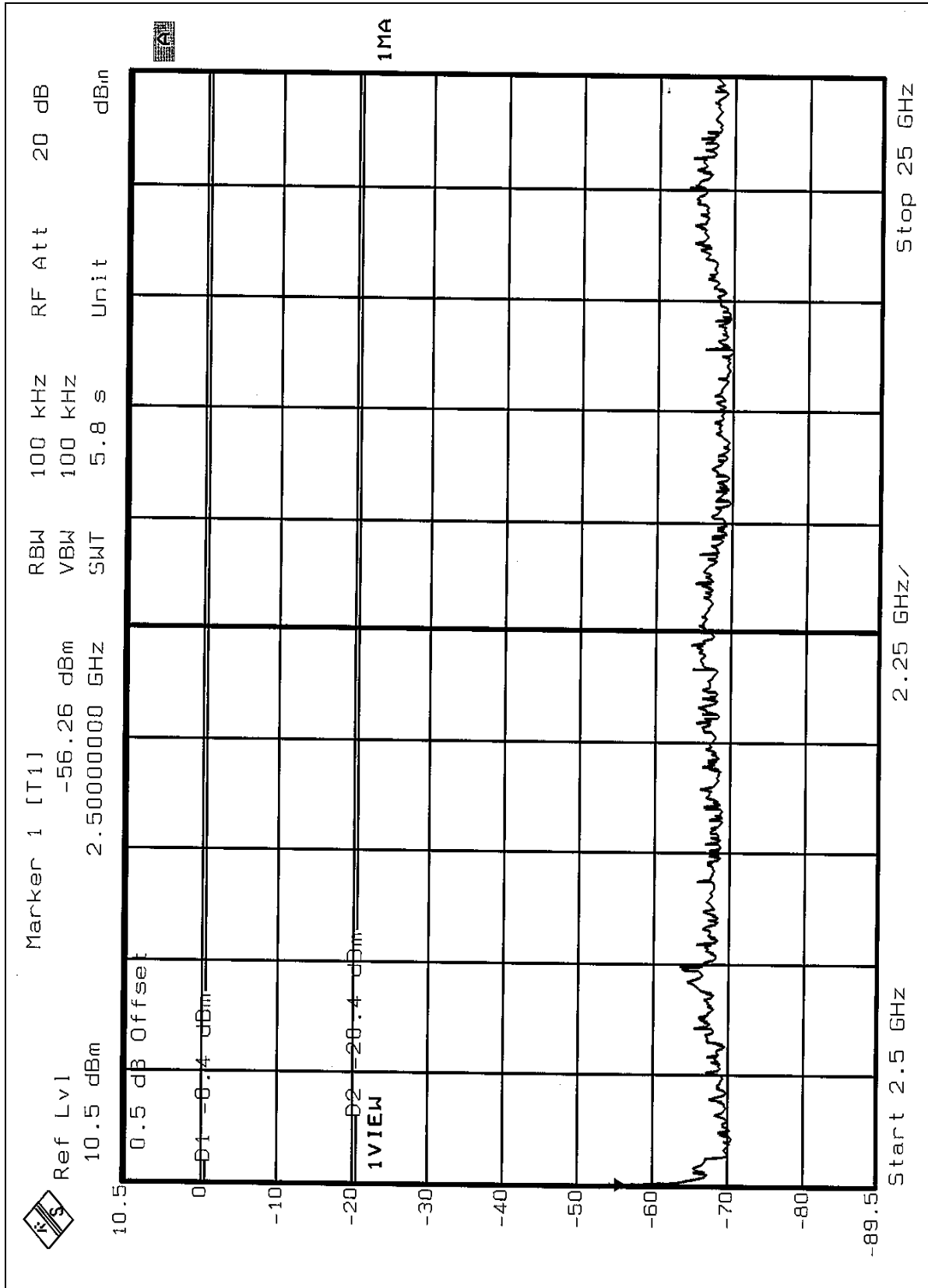

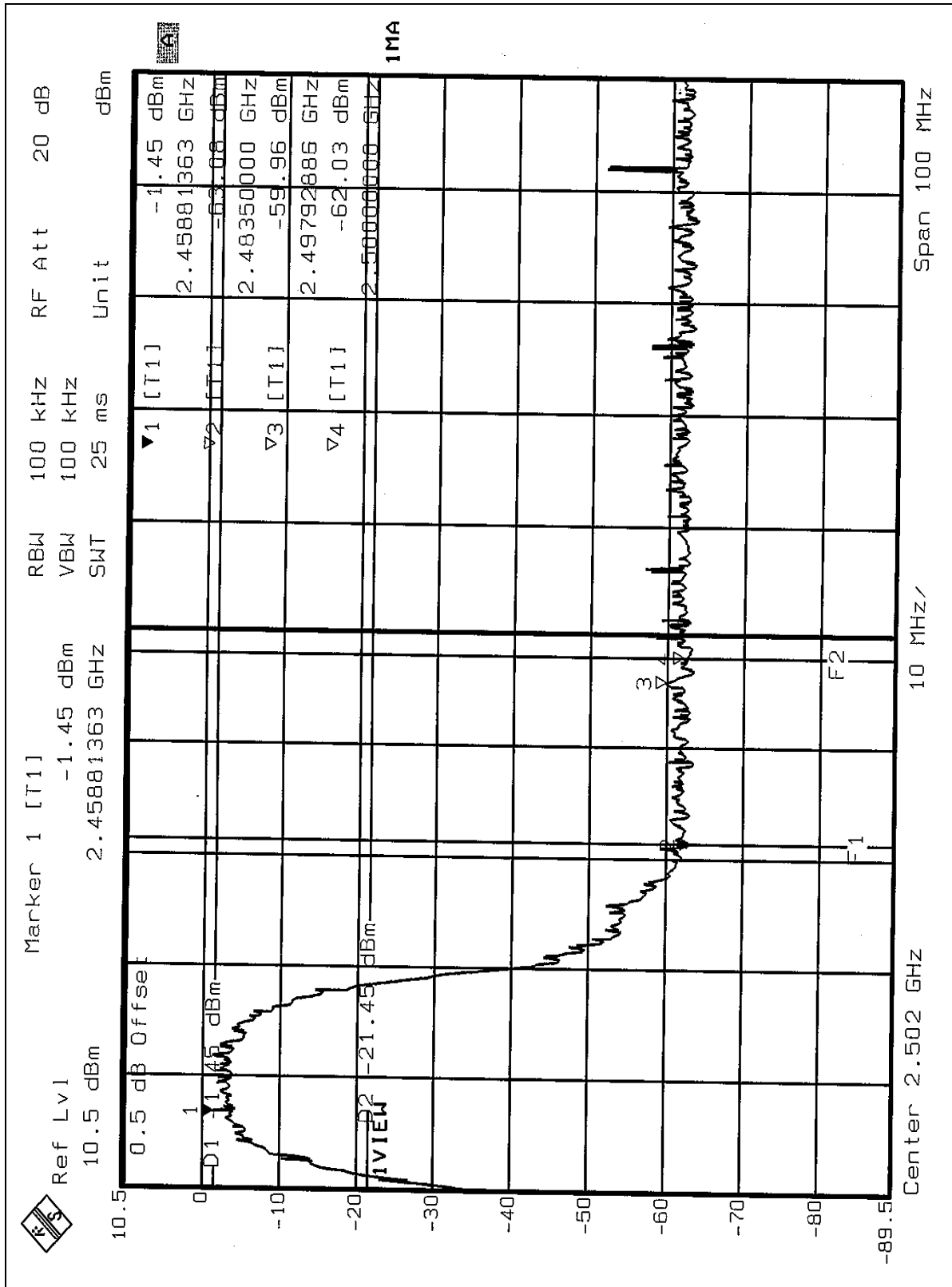

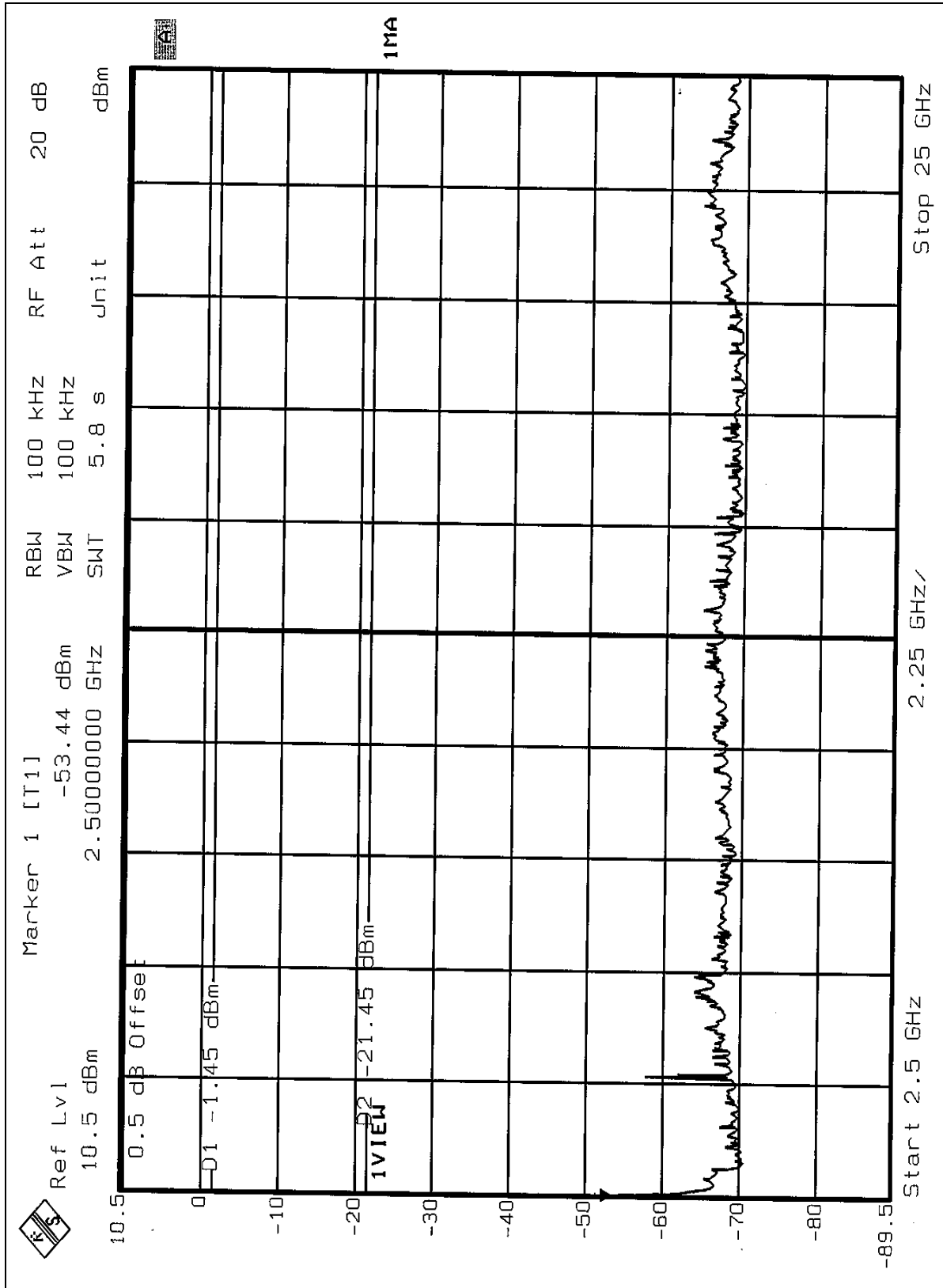

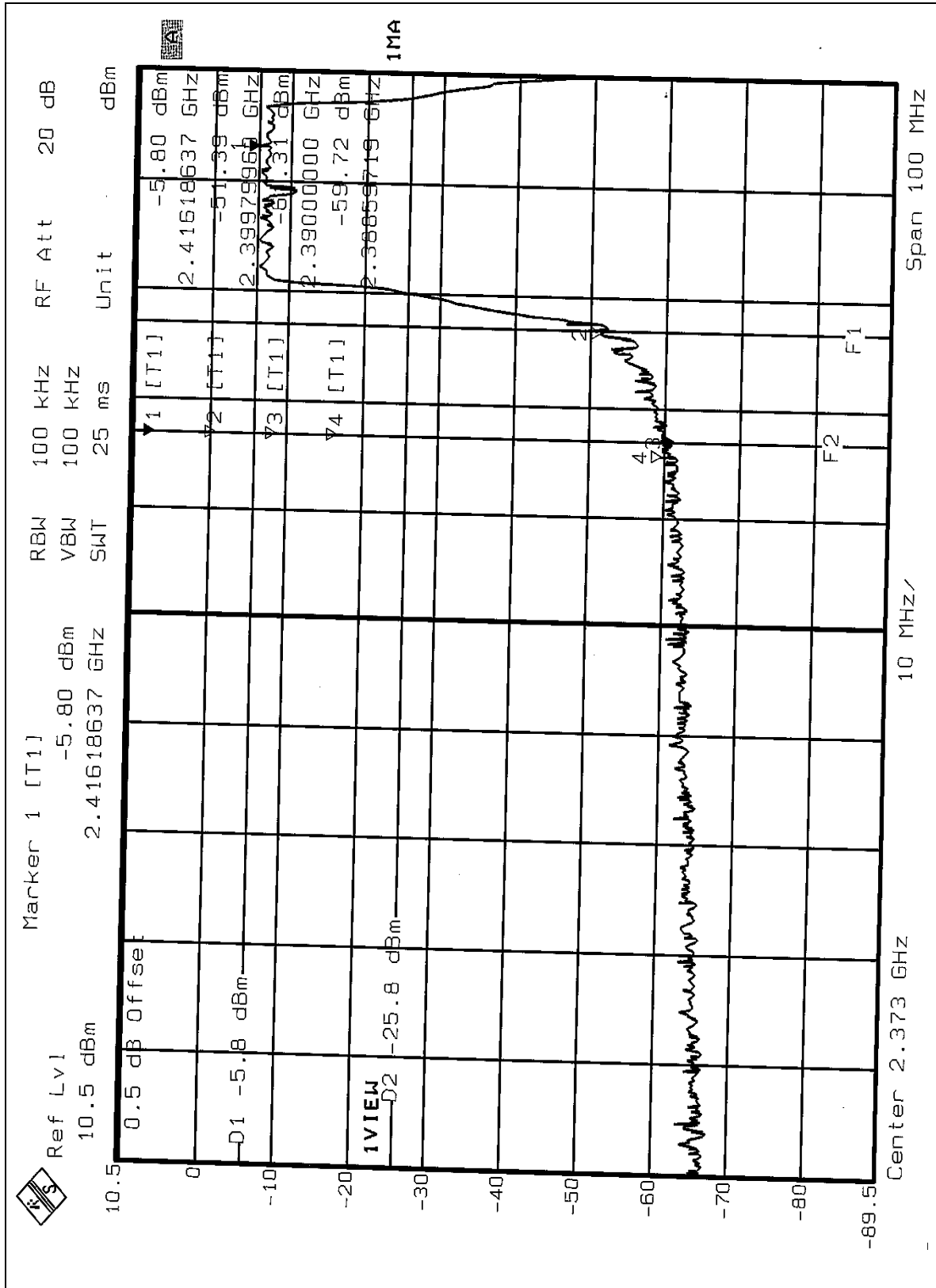

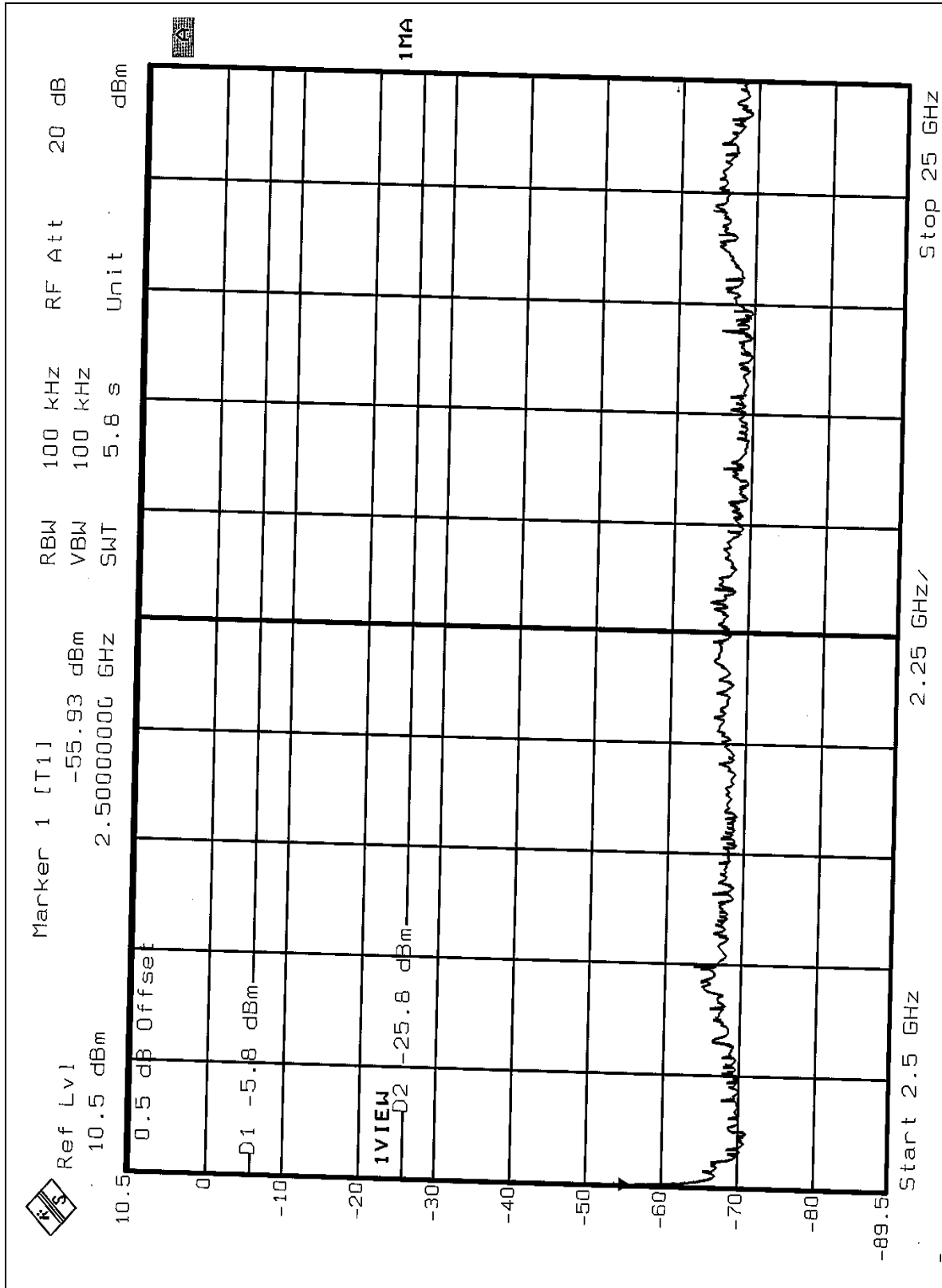

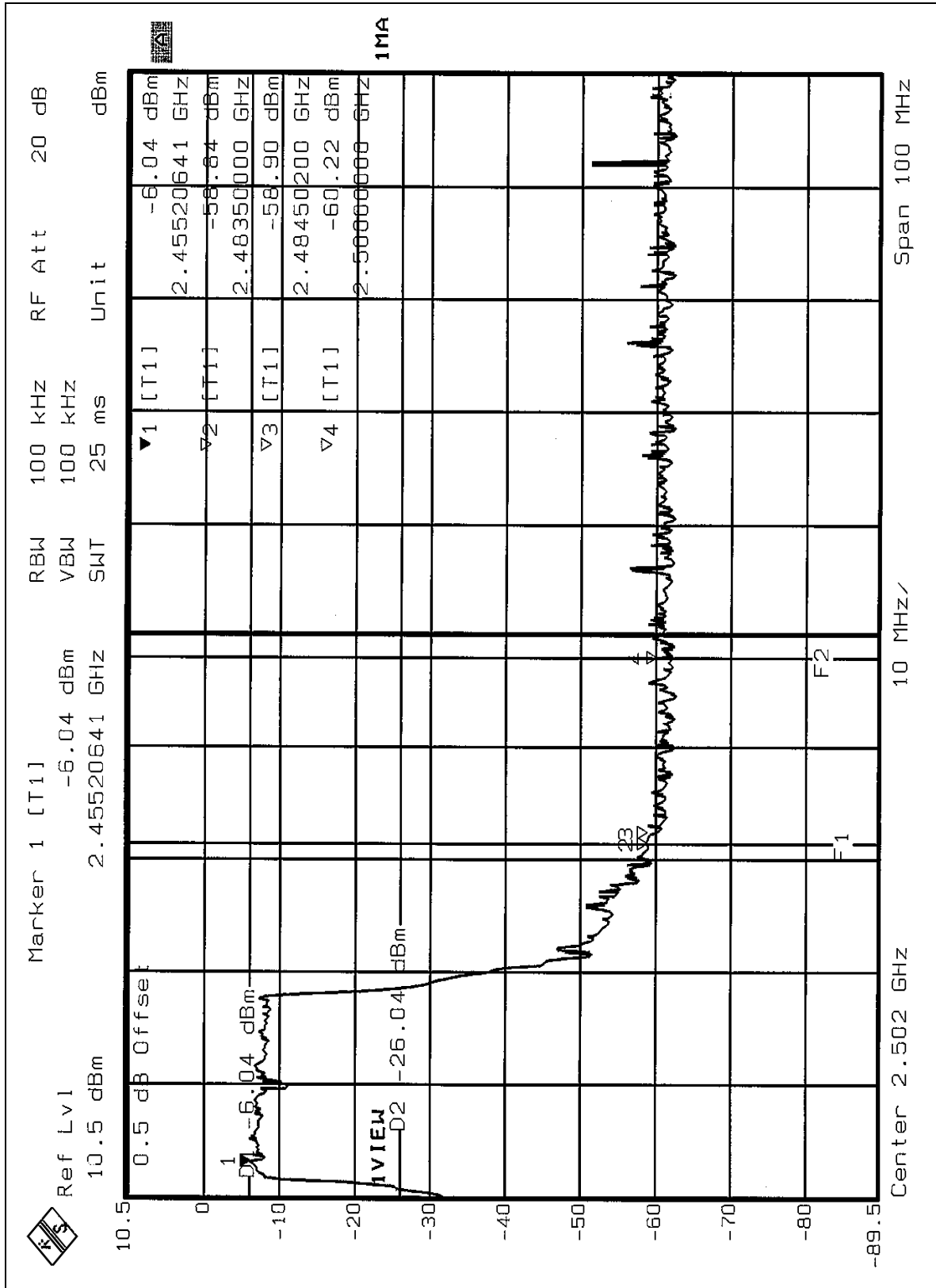

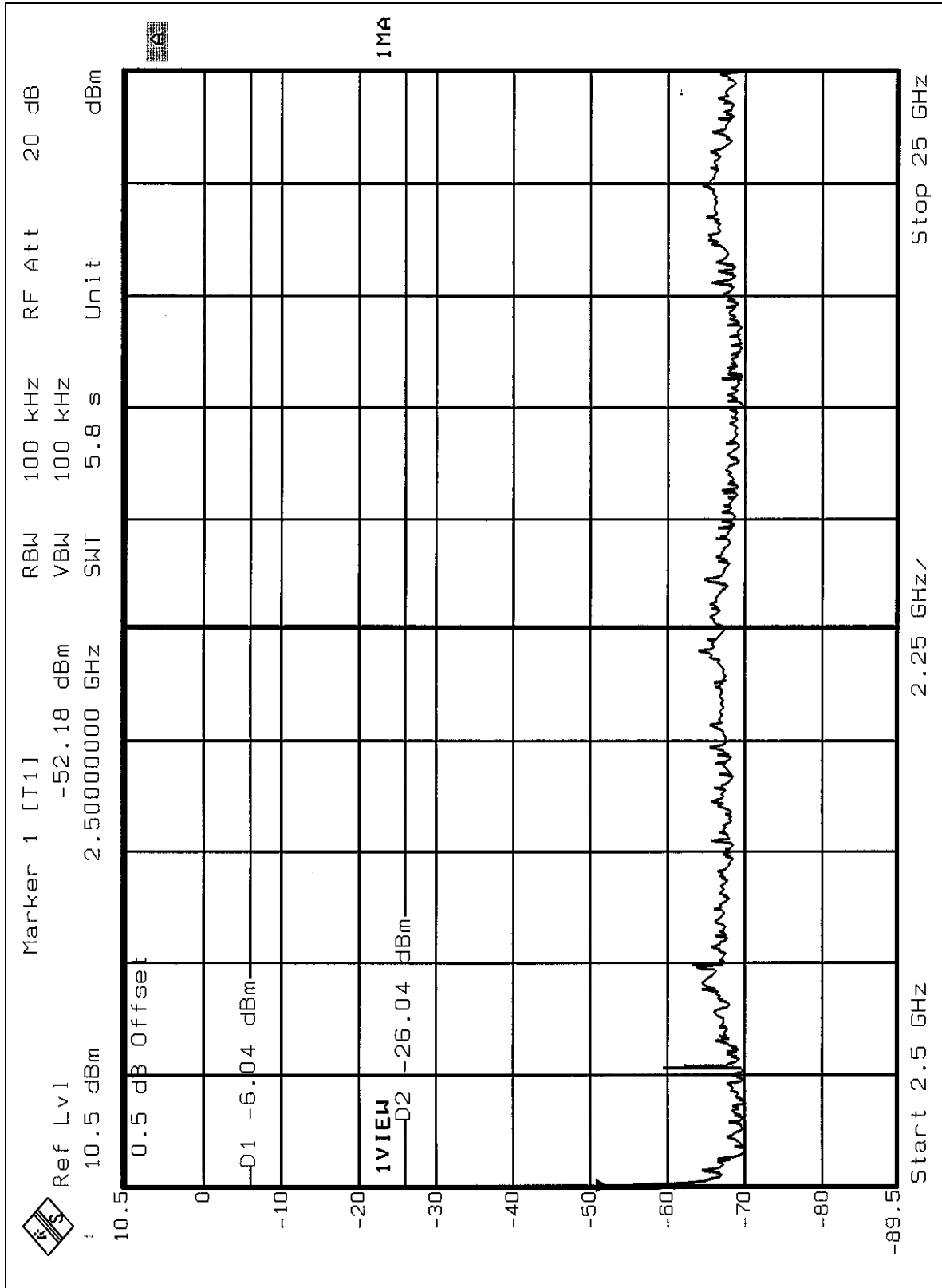



4.7 ANTENNA REQUIREMENT

4.7.1 STANDARD APPLICABLE

For intentional device, according to FCC 47 CFR Section 15.203, an intentional radiator shall be designed to ensure that no antenna other than that furnished by the responsible party shall be used with the device.

And according to FCC 47 CFR Section 15.247 (b), if transmitting antennas of directional gain greater than 6dBi are used, the power shall be reduced by the amount in dB that the directional gain of the antenna exceeds 6dBi.

4.7.2 ANTENNA CONNECTED CONSTRUCTION

The antenna used in this product is dipole antenna with RSMA connector. And the maximum Gain of this antenna is 5dBi.

**5 PHOTOGRAPHS OF THE TEST CONFIGURATION
CONDUCTED EMISSION TEST**



RADIATED EMISSION TEST

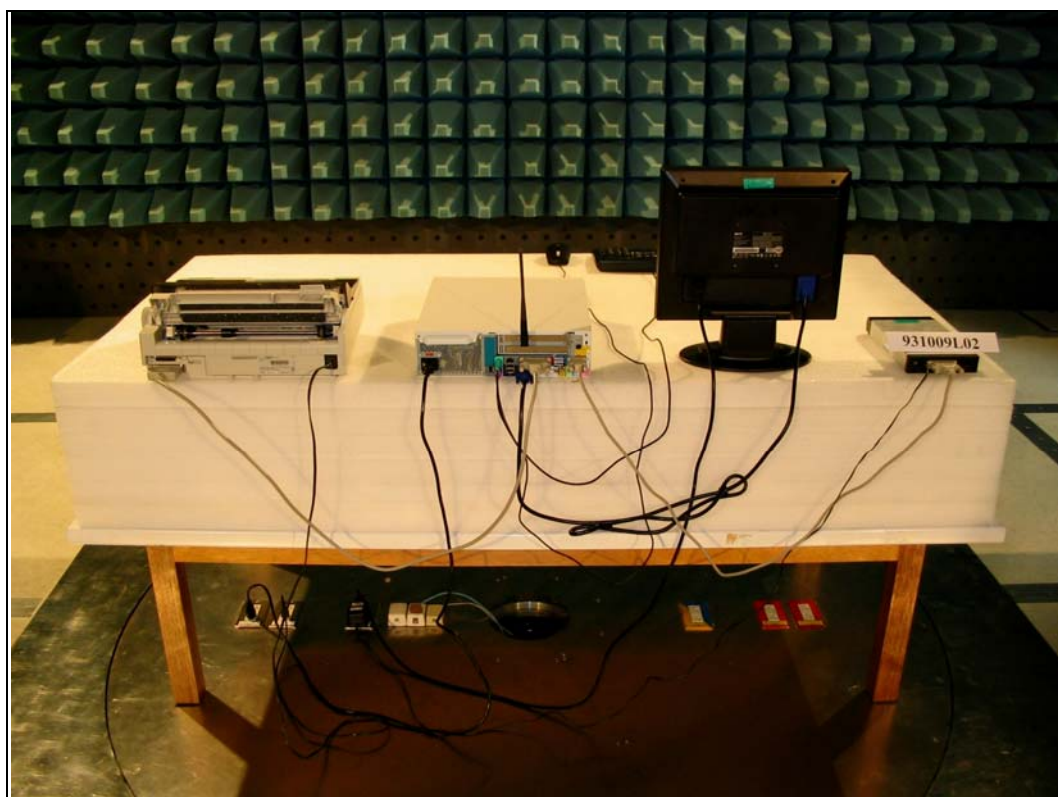



6 INFORMATION ON THE TESTING LABORATORIES

We, ADT Corp., were founded in 1988 to provide our best service in EMC, Radio, Telecom and Safety consultation. Our laboratories are accredited and approved by the following approval agencies according to ISO/IEC 17025, Guide 25 or EN 45001:

| | |
|--------------------|-----------------------|
| USA | FCC, NVLAP, UL, A2LA |
| Germany | TUV Rheinland |
| Japan | VCCI |
| Norway | NEMKO |
| Canada | INDUSTRY CANADA , CSA |
| R.O.C. | CNLA, BSMI, DGT |
| Netherlands | Telefication |
| Singapore | PSB , GOST-ASIA(MOU) |
| Russia | CERTIS(MOU) |

Copies of accreditation certificates of our laboratories obtained from approval agencies can be downloaded from our web site:

www.adt.com.tw/index.5/phtml. If you have any comments, please feel free to contact us at the following:

Linko EMC/RF Lab:

Tel: 886-2-26052180
Fax: 886-2-26052943

Hsin Chu EMC/RF Lab:

Tel: 886-3-5935343
Fax: 886-3-5935342

Hwa Ya EMC/RF/Safety/Telecom Lab:

Tel: 886-3-3183232
Fax: 886-3-3185050

Linko RF Lab.

Tel: 886-3-3270910
Fax: 886-3-3270892

Web Site: www.adt.com.tw

The address and road map of all our labs can be found in our web site also.

Report Format Version 1.5