



SPORTON International Inc.

No. 52, Hwa Ya 1st Rd., Hwa Ya Technology Park, Kwei-Shan Hsiang, Tao Yuan Hsien, Taiwan, R.O.C.
Ph: 886-3-327-3456 / FAX: 886-3-327-0973 / www.sporton.com.tw

FCC RADIO TEST REPORT

Applicant's company	Linksys LLC
Applicant Address	121 Theory, Irvine CA 92617, United States
FCC ID	Q87-EA7500

Product Name	LINKSYS MAX-STREAM AC1900 MU-MIMO GIGABIT ROUTER
Brand Name	LINKSYS
Model No.	EA7500
Test Rule Part(s)	47 CFR FCC Part 15 Subpart E § 15.407
Test Freq. Range	5725 ~ 5850 MHz
Received Date	Aug. 14, 2015
Final Test Date	May 13, 2016
Submission Type	Class II Change

Statement

Test result included is for the IEEE 802.11n and IEEE 802.11a/ac of the product.

The test result in this report refers exclusively to the presented test model / sample.

Without written approval of SPORTON International Inc., the test report shall not be reproduced except in full.

The measurements and test results shown in this test report were made in accordance with the procedures and found in compliance with the limit given in **ANSI C63.10-2013, 47 CFR FCC Part 15 Subpart E, KDB789033 D02 v01r02, KDB662911 D01 v02r01, KDB644545 D03 v01, ET Docket No. 13-49; FCC 16-24.**

The test equipment used to perform the test is calibrated and traceable to NML/ROC.



Table of Contents

1. VERIFICATION OF COMPLIANCE	1
2. SUMMARY OF THE TEST RESULT	2
3. GENERAL INFORMATION	3
3.1. Product Details.....	3
3.2. Accessories.....	4
3.3. Table for Filed Antenna.....	5
3.4. Table for Carrier Frequencies	6
3.5. Table for Test Modes	7
3.6. Table for Testing Locations.....	8
3.7. Table for Class II Change	9
3.8. Table for Supporting Units	9
3.9. Table for Parameters of Test Software Setting	9
3.10. EUT Operation during Test	10
3.11. Duty Cycle	10
3.12. Test Configurations	11
4. TEST RESULT	12
4.1. 26dB Bandwidth and 99% Occupied Bandwidth Measurement.....	12
4.2. 6dB Spectrum Bandwidth Measurement	19
4.3. Maximum Conducted Output Power Measurement.....	23
4.4. Power Spectral Density Measurement	26
4.5. Radiated Emissions Measurement	31
4.6. Band Edge Emissions Measurement	43
4.7. Frequency Stability Measurement	48
4.8. Antenna Requirements	52
5. LIST OF MEASURING EQUIPMENTS	53
6. MEASUREMENT UNCERTAINTY	54
APPENDIX A. TEST PHOTOS	A1 ~ A3

History of This Test Report

REPORT NO.	VERSION	DESCRIPTION	ISSUED DATE
FR4N1172-41	Rev. 01	Initial issue of report	Jun. 22, 2016



1. VERIFICATION OF COMPLIANCE

Product Name : LINKSYS MAX-STREAM AC1900 MU-MIMO GIGABIT ROUTER
Brand Name : LINKSYS
Model No. : EA7500
Applicant : Linksys LLC
Test Rule Part(s) : 47 CFR FCC Part 15 Subpart E § 15.407

Sporton International as requested by the applicant to evaluate the EMC performance of the product sample received on Aug. 14, 2015 would like to declare that the tested sample has been evaluated and found to be in compliance with the tested rule parts. The data recorded as well as the test configuration specified is true and accurate for showing the sample's EMC nature.

A handwritten signature in blue ink that reads 'Sam Chen'. The signature is written over a horizontal line.

Sam Chen

SPORTON INTERNATIONAL INC.

2. SUMMARY OF THE TEST RESULT

Applied Standard: 47 CFR FCC Part 15 Subpart E				
Part	Rule Section	Description of Test	Result	Under Limit
4.1	15.407(a)	26dB Spectrum Bandwidth and 99% Occupied Bandwidth	Complies	-
4.2	15.407(e)	6dB Spectrum Bandwidth	Complies	-
4.3	15.407(a)	Maximum Conducted Output Power	Complies	0.28 dB
4.4	15.407(a)	Power Spectral Density	Complies	16.49 dB
4.5	15.407(b)	Radiated Emissions	Complies	5.33 dB
4.6	15.407(b)	Band Edge Emissions	Complies	0.53 dB
4.7	15.407(g)	Frequency Stability	Complies	-
4.8	15.203	Antenna Requirements	Complies	-

3. GENERAL INFORMATION

3.1. Product Details

Items	Description
Product Type	WLAN (3TX, 3RX)
Radio Type	Intentional Transceiver
Power Type	From power adapter
Modulation	IEEE 802.11a: OFDM IEEE 802.11n/ac: see the below table
Data Modulation	IEEE 802.11a/n: OFDM (BPSK / QPSK / 16QAM / 64QAM) IEEE 802.11ac: OFDM (BPSK / QPSK / 16QAM / 64QAM / 256QAM)
Data Rate (Mbps)	IEEE 802.11a: OFDM (6/9/12/18/24/36/48/54) IEEE 802.11n/ac: see the below table
Frequency Range	5725 ~ 5850 MHz
Channel Number	5 for 20MHz bandwidth ; 2 for 40MHz bandwidth 1 for 80MHz bandwidth
Channel Band Width (99%)	IEEE 802.11a: 16.59 MHz IEEE 802.11ac MCS0/Nss1 (VHT20): 17.80 MHz IEEE 802.11ac MCS0/Nss1 (VHT40): 37.05 MHz IEEE 802.11ac MCS0/Nss1 (VHT80): 76.12 MHz
Maximum Conducted Output Power	IEEE 802.11a: 29.32 dBm IEEE 802.11ac MCS0/Nss1 (VHT20): 29.28 dBm IEEE 802.11ac MCS0/Nss1 (VHT40): 29.20 dBm IEEE 802.11ac MCS0/Nss1 (VHT80): 29.04 dBm
Carrier Frequencies	Please refer to section 3.4
Antenna	Please refer to section 3.3

Items	Description
Beamforming Function	<input checked="" type="checkbox"/> With beamforming <input type="checkbox"/> Without beamforming

Note: 802.11b supports non-beamforming function only.

802.11g/n/ac in 2.4GHz and 802.11a/n/ac in 5GHz support beamforming function only.

Antenna and Band width

Antenna	Three (TX)		
	20 MHz	40 MHz	80 MHz
Band width Mode			
IEEE 802.11a	V	X	X
IEEE 802.11n	V	V	X
IEEE 802.11ac	V	V	V

IEEE 11n/ac Spec.

Protocol	Number of Transmit Chains (NTX)	Data Rate / MCS
802.11n (HT20)	3	MCS 0-23
802.11n (HT40)	3	MCS 0-23
802.11ac (VHT20)	3	MCS 0-9/Nss1-3
802.11ac (VHT40)	3	MCS 0-9/Nss1-3
802.11ac (VHT80)	3	MCS 0-9/Nss1-3

Note 1: IEEE Std. 802.11n modulation consists of HT20 and HT40 (HT: High Throughput).

Then EUT supports HT20 and HT40.

Note 2: IEEE Std. 802.11ac modulation consists of VHT20, VHT40, VHT80 and VHT160 (VHT: Very High Throughput). Then EUT supports VHT20, VHT40 and VHT80.

Note 3: Modulation modes consist of below configuration:

HT20/HT40: IEEE 802.11n, VHT20/VHT40/VHT80: IEEE 802.11ac

3.2. Accessories

Power	Brand	Model	Rating
Adapter	LINKSYS	KSAS0501200350HU	Input:100-240V, 50/60Hz 1.2A Output:12V, 3.5A
Others			
RJ-45 cable*1, non-shielded, 0.9m			

3.3. Table for Filed Antenna

Ant.	Brand	Model No.	Type	Connector	Antenna Cable	
					Brand	Model No.
1	Galtronics Electronics	02109140-05960	Dipole	Reversed-SMA	M.gear	C120-510456-A (SRF20151271)
2	Galtronics Electronics	02109140-05960	Dipole	Reversed-SMA	M.gear	C120-510457-A (SRF20151272)
3	Galtronics Electronics	02109140-05960	Dipole	Reversed-SMA	M.gear	C120-510458-A (SRF20151273)

Ant.	Band	Gain (dBi)	Cable Loss (dB)	True Gain (dBi)
1	2.4GHz	1.44	1	0.44
	5GHz Band 1	2.29	1.6	0.69
	5GHz Band 4	3.05	1.7	1.35
2	2.4GHz	1.44	0.9	0.54
	5GHz Band 1	2.29	1.6	0.69
	5GHz Band 4	3.05	1.7	1.35
3	2.4GHz	1.44	0.5	0.94
	5GHz Band 1	2.29	0.8	1.49
	5GHz Band 4	3.05	0.9	2.15

Note: The EUT has three antennas.

<For 2.4GHz Band>

For IEEE 802.11b/g/n/ac mode (3TX/3RX)

Ant. 1, Ant. 2 and Ant. 3 could transmit/receive simultaneously.

<For 5GHz Band >

For IEEE 802.11a/n/ac mode (3TX/3RX):

Ant. 1, Ant. 2 and Ant. 3 could transmit/receive simultaneously.

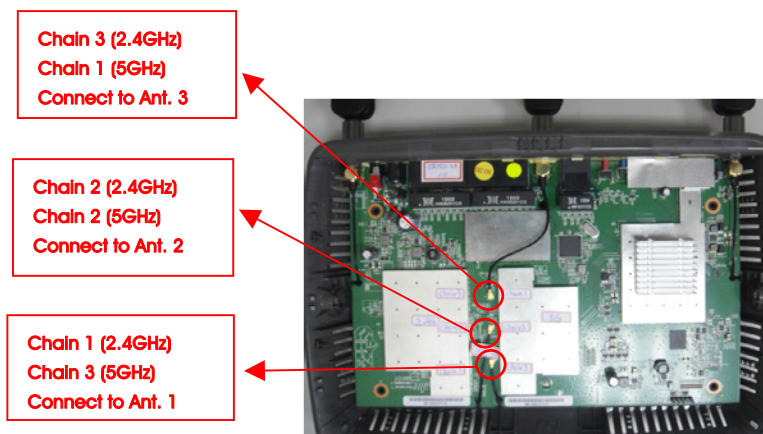

3.4. Table for Carrier Frequencies

There are three bandwidth systems.

For 20MHz bandwidth systems, use Channel 149, 153, 157, 161, 165.

For 40MHz bandwidth systems, use Channel 151, 159.

For 80MHz bandwidth systems, use Channel 155.

Frequency Band	Channel No.	Frequency	Channel No.	Frequency
5725~5850 MHz Band 4	149	5745 MHz	157	5785 MHz
	151	5755 MHz	159	5795 MHz
	153	5765 MHz	161	5805 MHz
	155	5775 MHz	165	5825 MHz

3.5. Table for Test Modes

Preliminary tests were performed in different data rate to find the worst radiated emission. The data rate shown in the table below is the worst-case rate with respect to the specific test item. Investigation has been done on all the possible configurations for searching the worst cases. The following table is a list of the test modes shown in this test report.

Test Items	Mode		Data Rate	Channel	Chain
Max. Conducted Output Power	11a/BPSK	Band 4	6Mbps	149/157/165	1+2+3
	11ac VHT20	Band 4	MCS0/Nss1	149/157/165	1+2+3
	11ac VHT40	Band 4	MCS0/Nss1	151/159	1+2+3
	11ac VHT80	Band 4	MCS0/Nss1	155	1+2+3
Power Spectral Density	11a/BPSK	Band 4	6Mbps	149/157/165	1+2+3
	11ac VHT20	Band 4	MCS0/Nss1	149/157/165	1+2+3
	11ac VHT40	Band 4	MCS0/Nss1	151/159	1+2+3
	11ac VHT80	Band 4	MCS0/Nss1	155	1+2+3
26dB Spectrum Bandwidth & 99% Occupied Bandwidth Measurement	11a/BPSK	Band 4	6Mbps	149/157/165	1+2+3
	11ac VHT20	Band 4	MCS0/Nss1	149/157/165	1+2+3
	11ac VHT40	Band 4	MCS0/Nss1	151/159	1+2+3
	11ac VHT80	Band 4	MCS0/Nss1	155	1+2+3
6dB Spectrum Bandwidth Measurement	11a/BPSK	Band 4	6Mbps	149/157/165	1+2+3
	11ac VHT20	Band 4	MCS0/Nss1	149/157/165	1+2+3
	11ac VHT40	Band 4	MCS0/Nss1	151/159	1+2+3
	11ac VHT80	Band 4	MCS0/Nss1	155	1+2+3
Radiated Emission Above 1GHz	11a/BPSK	Band 4	6Mbps	149/157/165	1+2+3
	11ac VHT20	Band 4	MCS0/Nss1	149/157/165	1+2+3
	11ac VHT40	Band 4	MCS0/Nss1	151/159	1+2+3
	11ac VHT80	Band 4	MCS0/Nss1	155	1+2+3
Band Edge Emission	11a/BPSK	Band 4	6Mbps	149/157/165	1+2+3
	11ac VHT20	Band 4	MCS0/Nss1	149/157/165	1+2+3
	11ac VHT40	Band 4	MCS0/Nss1	151/159	1+2+3
	11ac VHT80	Band 4	MCS0/Nss1	155	1+2+3
Frequency Stability	20 MHz	Band 4	-	157	1
	40 MHz	Band 4	-	151	1
	80 MHz	Band 4	-	155	1

Note: VHT20/VHT40 covers HT20/HT40, due to same modulation. The power setting for 802.11n HT20 and HT40 are the same or lower than 802.11ac VHT20 and VHT40.

The following test modes were performed for all tests:

For Radiated Emission test above 1GHz:

The EUT was performed at Z axis and Y axis position for Radiated emission above 1GHz test, and the worst case was found at Y axis. So the measurement will follow this same test configuration.

Mode 1. CTX – Place EUT in Y axis

For Band Edge Emissions test:

The EUT was performed at Z axis and Y axis position for Band Edge Emissions test, and the worst case was found at Z axis. So the measurement will follow this same test configuration.

Mode 1. CTX – Place EUT in Z axis

For Co-location MPE:

The EUT could be applied with 2.4GHz WLAN function and 5GHz WLAN function; therefore Co-location Maximum Permissible Exposure (Please refer to FA4N1172-41) test is added for simultaneously transmit between 2.4GHz WLAN function and 5GHz WLAN function.

3.6. Table for Testing Locations

Test Site Location					
Address:	No.8, Lane 724, Bo-ai St., Jhubei City, Hsinchu County 302, Taiwan, R.O.C.				
TEL:	886-3-656-9065				
FAX:	886-3-656-9085				
Test Site No.	Site Category	Location	FCC Designation No.	IC File No.	VCCI Reg. No
03CH01-CB	SAC	Hsin Chu	TW0006	IC 4086D	-
TH01-CB	OVEN Room	Hsin Chu	-	-	-

Open Area Test Site (OATS); Semi Anechoic Chamber (SAC).

3.7. Table for Class II Change

This product is an extension of original one reported under Sporton project number: FR582115AA

Below is the table for the change of the product with respect to the original one.

Modifications	Performance Checking
Updating test rule of 5GHz band 4 to "15.407 (b)(4)(i) of New Rules (ET Docket No. 13-49; FCC 16-24)" from "Old Rules".	1. 26dB Bandwidth and 99% Occupied Bandwidth 2. 6dB Spectrum Bandwidth 3. Maximum Conducted Output Power 4. Power Spectral Density 5. Radiated Emissions above 1GHz 6. Band Edge Emissions 7. Frequency Stability
Remove three adapters. Model No.: HK-X142-A12S, KSAS0451200350D5, HK-X142-A12.	Do not effect the test results.

3.8. Table for Supporting Units

For Test Site No: 03CH01-CB

Support Unit	Brand	Model	FCC ID
Notebook*2	DELL	E4300	DoC
RX Device	Belkin	EA8500	DoC

For Test Site No: TH01-CB

Support Unit	Brand	Model	FCC ID
Notebook	DELL	E4300	DoC

3.9. Table for Parameters of Test Software Setting

During testing, Channel and Power Controlling Software provided by the customer was used to control the operating channel as well as the output power level. The RF output power selection is for the setting of RF output power expected by the customer and is going to be fixed on the firmware of the final end product.

Test Software Version	QCARCT					
	Test Frequency (MHz)					
Mode	5745 MHz	5785 MHz	5825 MHz	5755 MHz	5795 MHz	5775 MHz
802.11a	23.5	23.5	23.5	-	-	-
802.11ac MCS0/Nss1 VHT20	23.5	23.5	23.5	-	-	-
802.11ac MCS0/Nss1 VHT40	-	-	-	23	23	-
802.11ac MCS0/Nss1 VHT80	-	-	-	-	-	23.5

3.10. EUT Operation during Test

For Conducted Mode:

The EUT was programmed to be in continuously transmitting mode.

For Radiated Mode:

During the test, the following programs under WIN XP were executed.

The program was executed as follows:

1. During the test, the EUT operation to normal function.
2. Executed command fixed test channel under DOS.
3. Executed "Lantest.exe " to link with the remote workstation to receive and transmit packet by and RX
Device transmit duty cycle no less 98%

3.11. Duty Cycle

Mode	On Time (ms)	On+Off Time (ms)	Duty Cycle (%)	Duty Factor (dB)	1/T Minimum VBW (kHz)
802.11a	1.905	2.094	90.97%	0.41	0.52
802.11ac MCS0/Nss1 VHT20	1.927	2.144	89.88%	0.46	0.52
802.11ac MCS0/Nss1 VHT40	1.724	2.007	85.90%	0.66	0.58
802.11ac MCS0/Nss1 VHT80	1.021	1.289	79.21%	1.01	0.98

3.12. Test Configurations

3.12.1. Radiation Emissions Test Configuration

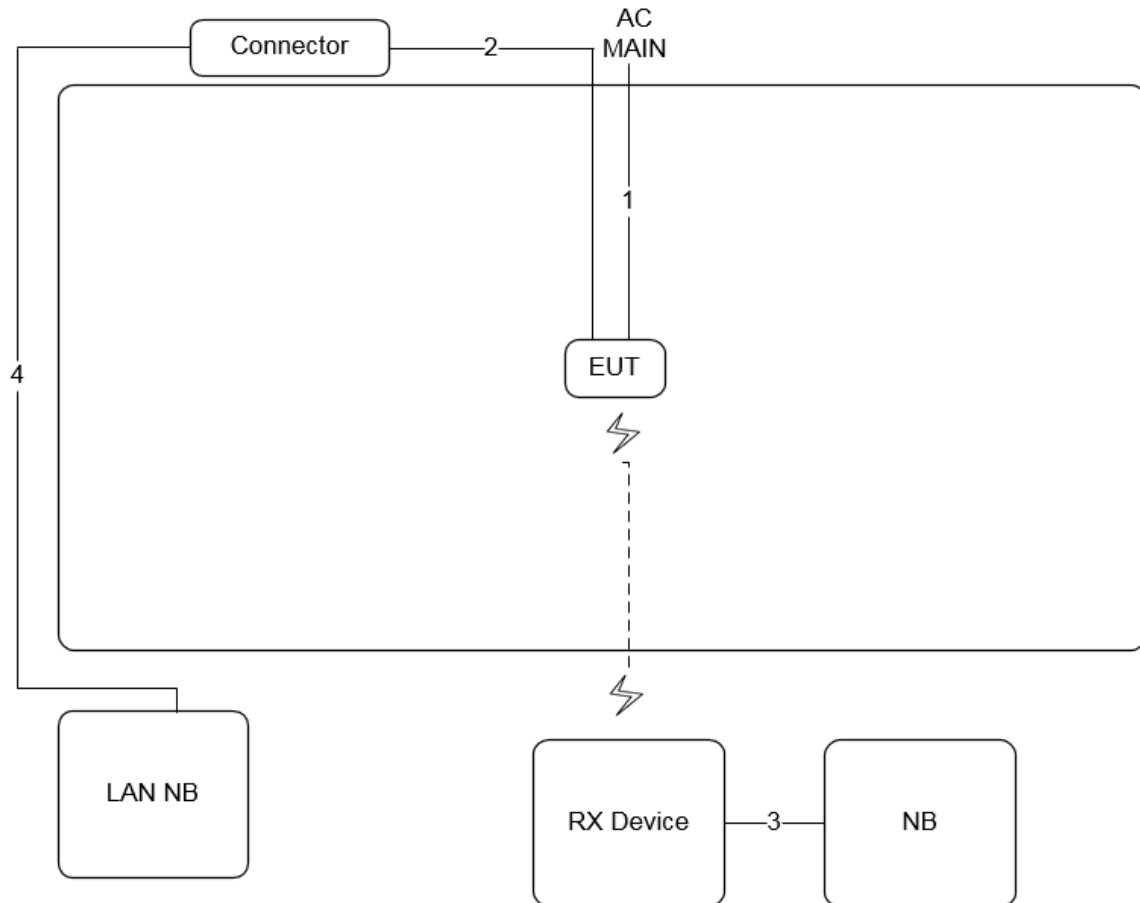

Item	Connection	Shielded	Length
1	Power cable	No	1.5m
2	RJ-45 cable	No	0.9m
3	RJ-45 cable	No	1.5m
4	RJ-45 cable	No	10m

4. TEST RESULT

4.1. 26dB Bandwidth and 99% Occupied Bandwidth Measurement

4.1.1. Limit

No restriction limits.

4.1.2. Measuring Instruments and Setting

Please refer to section 5 of equipments list in this report. The following table is the setting of the spectrum analyzer.

26dB Bandwidth	
Spectrum Parameters	Setting
Attenuation	Auto
Span Frequency	> 26dB Bandwidth
RBW	Approximately 1% of the emission bandwidth
VBW	VBW > RBW
Detector	Peak
Trace	Max Hold
Sweep Time	Auto
99% Occupied Bandwidth	
Spectrum Parameters	Setting
Span	1.5 times to 5.0 times the OBW
RBW	1 % to 5 % of the OBW
VBW	$\geq 3 \times \text{RBW}$
Detector	Peak
Trace	Max Hold

4.1.3. Test Procedures

For Radiated 26dB Bandwidth and 99% Occupied Bandwidth Measurement:

1. The transmitter was radiated to the spectrum analyzer in peak hold mode.
2. Measure the maximum width of the emission that is 26 dB down from the peak of the emission. Compare this with the RBW setting of the analyzer. Readjust RBW and repeat measurement as needed until the RBW/EBW ratio is approximately 1%.

4.1.4. Test Setup Layout

For Radiated 26dB Bandwidth and 99% Occupied Bandwidth Measurement:

This test setup layout is the same as that shown in section 4.5.4.

4.1.5. Test Deviation

There is no deviation with the original standard.

4.1.6. EUT Operation during Test

The EUT was programmed to be in continuously transmitting mode.

4.1.7. Test Result of 26dB Bandwidth and 99% Occupied Bandwidth

Temperature	25°C	Humidity	65%
Test Engineer	Andy Tsai		

Mode	Frequency	26dB Bandwidth (MHz)	99% Occupied Bandwidth (MHz)
802.11a	5745 MHz	21.04	16.59
	5785 MHz	20.78	16.59
	5825 MHz	20.96	16.59
802.11ac MCS0/Nss1 VHT20	5745 MHz	29.30	17.80
	5785 MHz	28.17	17.80
	5825 MHz	25.83	17.80
802.11ac MCS0/Nss1 VHT40	5755 MHz	73.48	37.05
	5795 MHz	72.32	36.76
802.11ac MCS0/Nss1 VHT80	5775 MHz	86.67	76.12

26dB Bandwidth and 99% Occupied Bandwidth Plot on Configuration IEEE 802.11a / Chain 1 + Chain 2 + Chain 3 / 5745 MHz

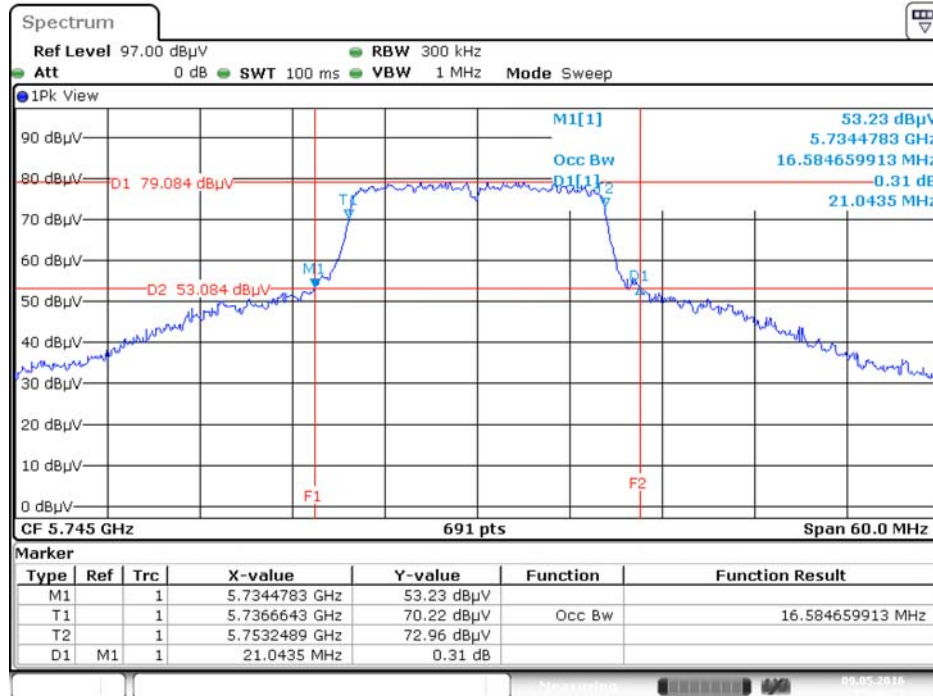

Date: 9.MAY.2016 15:46:21

26dB Bandwidth and 99% Occupied Bandwidth Plot on Configuration IEEE 802.11a / Chain 1 + Chain 2 + Chain 3 / 5785 MHz

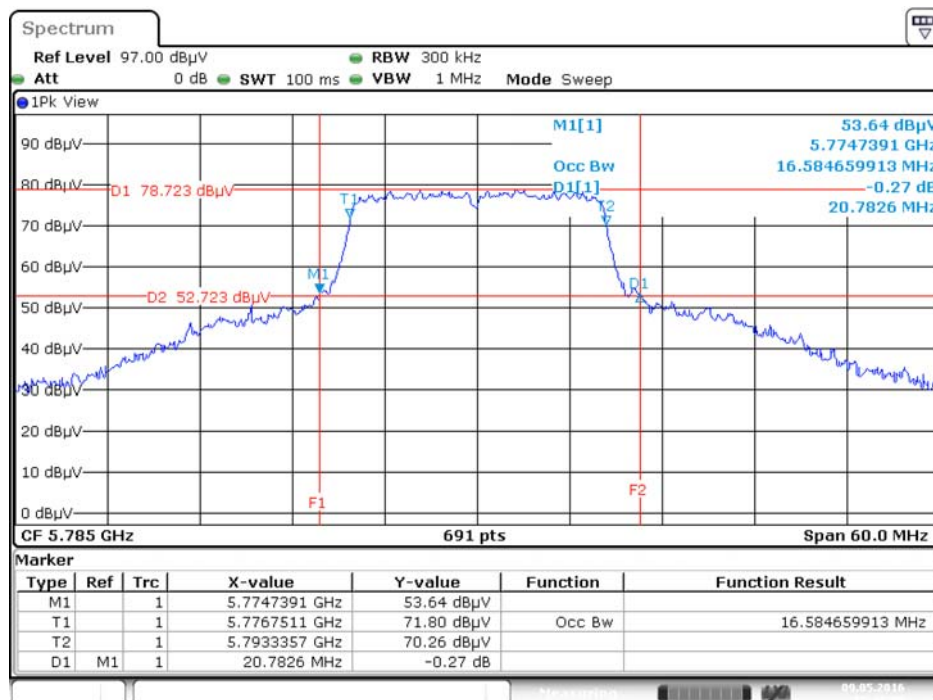

Date: 9.MAY.2016 15:47:08

26dB Bandwidth and 99% Occupied Bandwidth Plot on Configuration IEEE 802.11a / Chain 1 + Chain 2 + Chain 3 / 5825 MHz

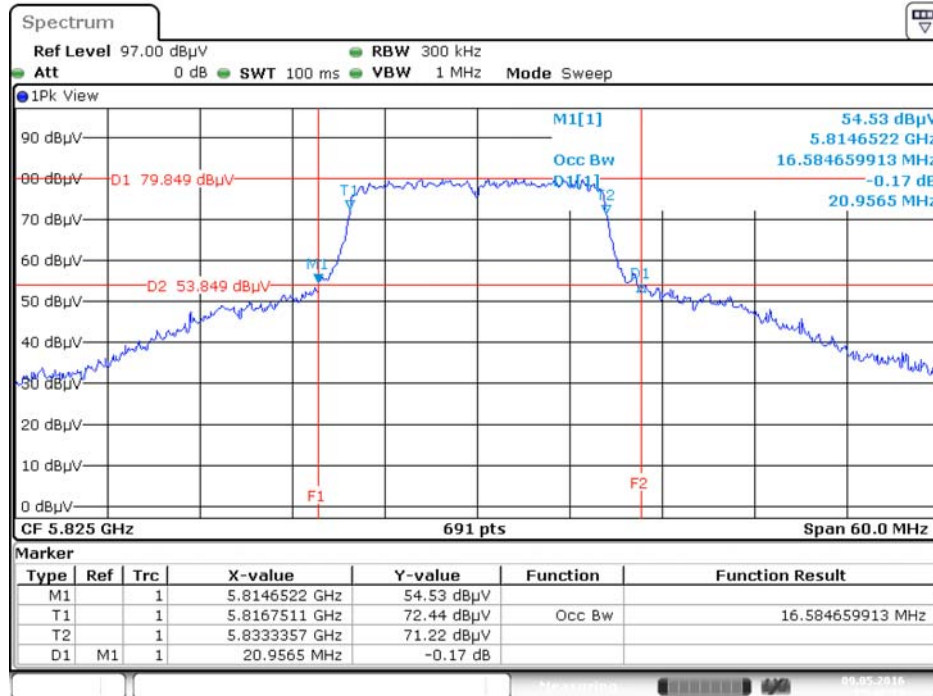

Date: 9.MAY.2016 15:47:33

26dB Bandwidth and 99% Occupied Bandwidth Plot on Configuration IEEE 802.11ac MCS0/Nss1 VHT20 / Chain 1 + Chain 2 + Chain 3 / 5745 MHz

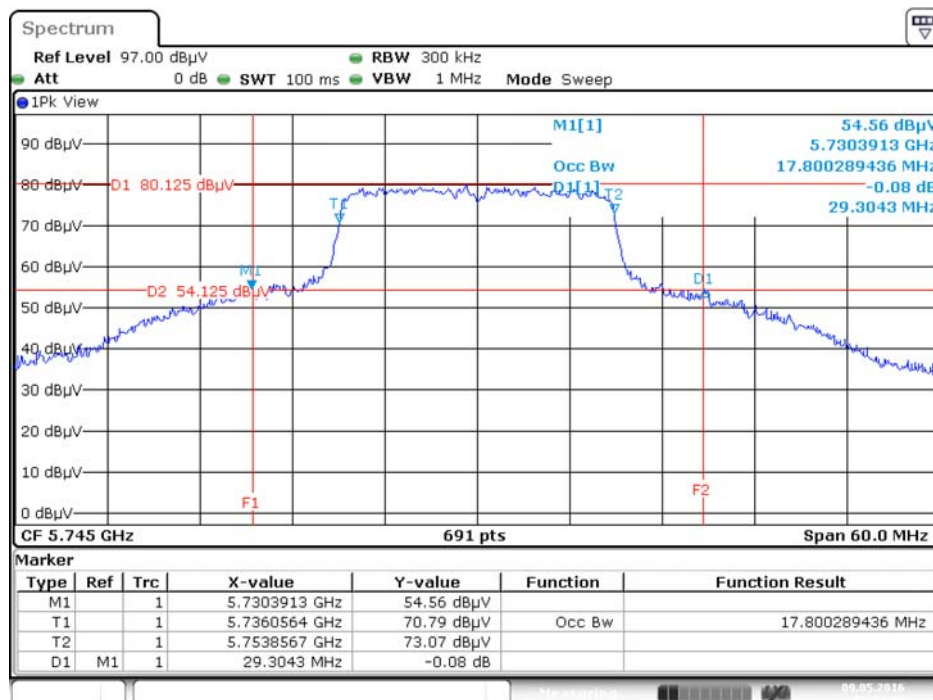

Date: 9.MAY.2016 15:59:28

26dB Bandwidth and 99% Occupied Bandwidth Plot on Configuration IEEE 802.11ac MCS0/Nss1 VHT20 / Chain 1 + Chain 2 + Chain 3 / 5785 MHz

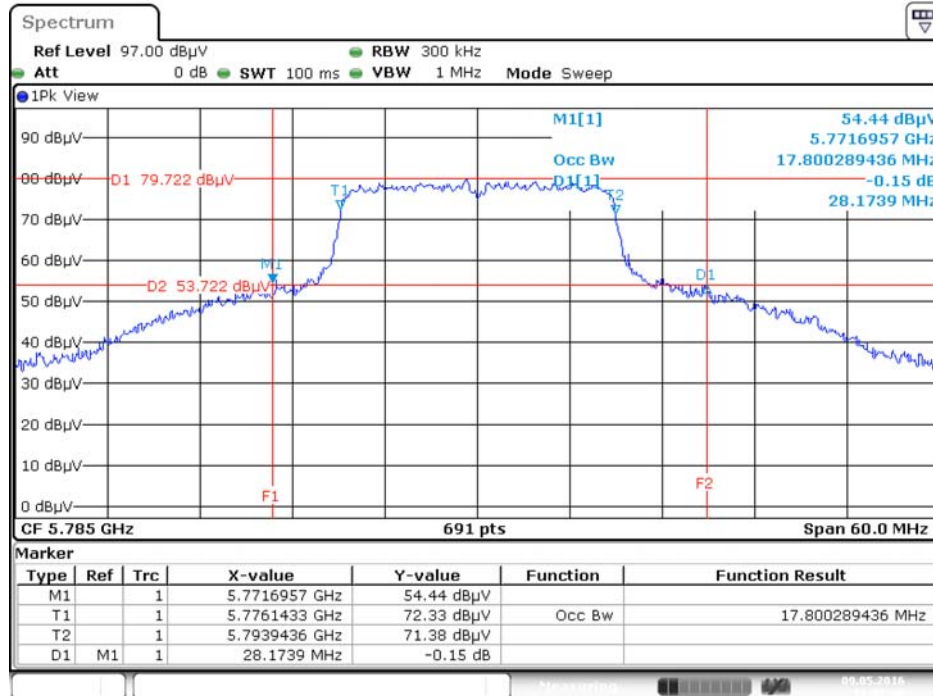

Date: 9.MAY.2016 16:07:49

26dB Bandwidth and 99% Occupied Bandwidth Plot on Configuration IEEE 802.11ac MCS0/Nss1 VHT20 / Chain 1 + Chain 2 + Chain 3 / 5825 MHz

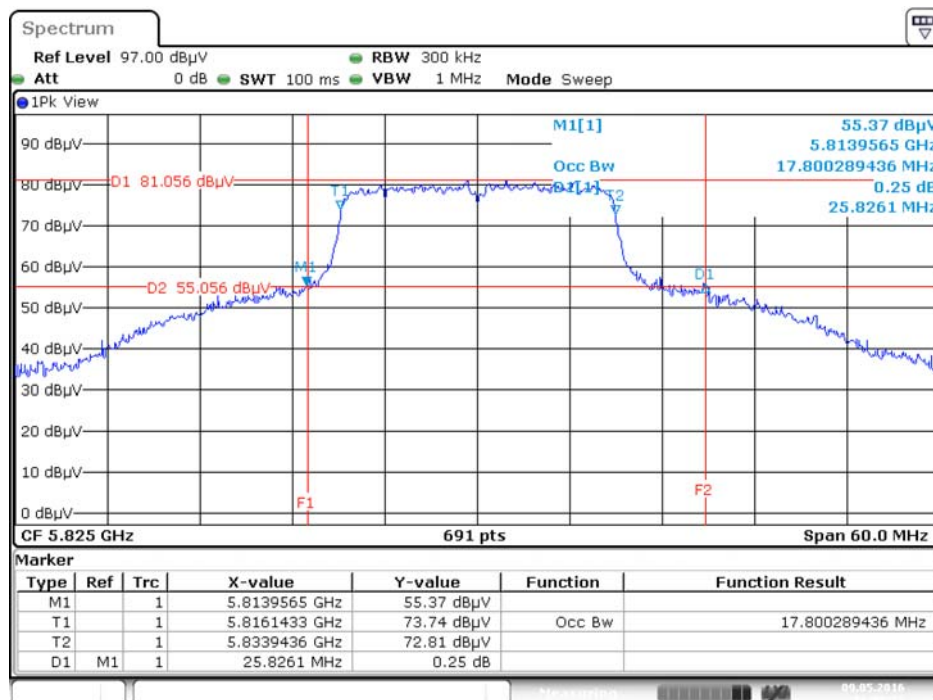

Date: 9.MAY.2016 16:08:21

26dB Bandwidth and 99% Occupied Bandwidth Plot on Configuration IEEE 802.11ac MCS0/Nss1 VHT40 / Chain 1 + Chain 2 + Chain 3 / 5755 MHz

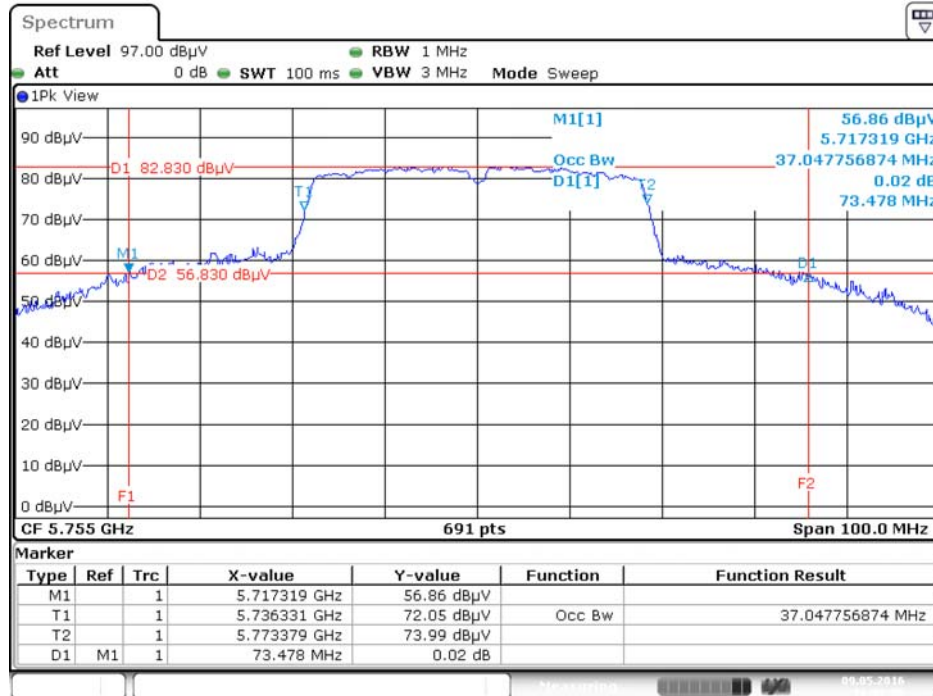

Date: 9.MAY.2016 16:08:57

26dB Bandwidth and 99% Occupied Bandwidth Plot on Configuration IEEE 802.11ac MCS0/Nss1 VHT40 / Chain 1 + Chain 2 + Chain 3 / 5795 MHz

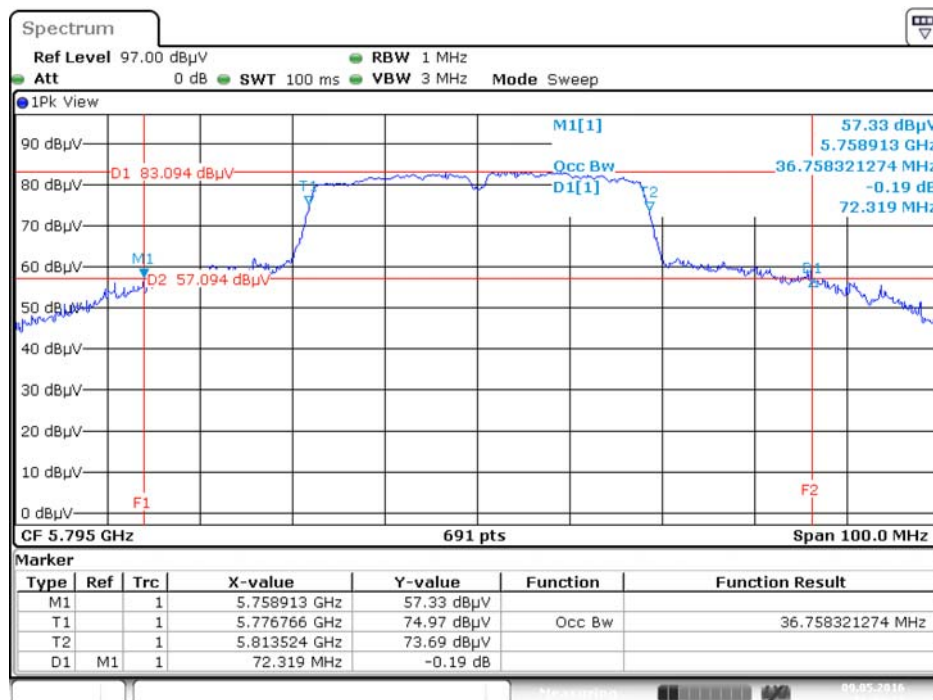

Date: 9.MAY.2016 16:09:32

26dB Bandwidth and 99% Occupied Bandwidth Plot on Configuration IEEE 802.11ac MCS0/Nss1 VHT80 / Chain 1 + Chain 2 + Chain 3 / 5775 MHz

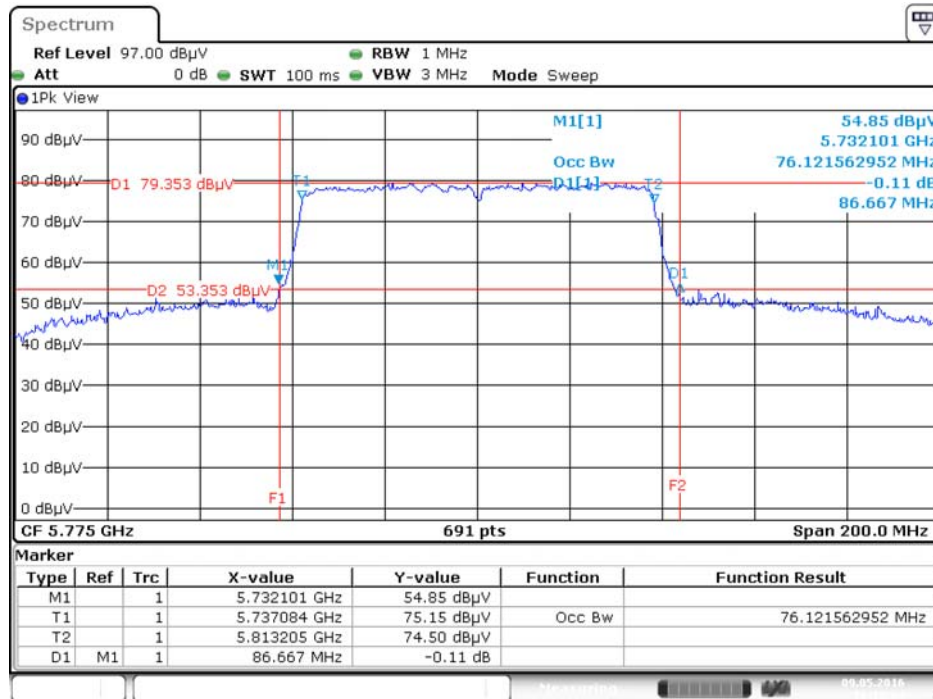

Date: 9.MAY.2016 16:10:04

4.2. 6dB Spectrum Bandwidth Measurement

4.2.1. Limit

For digital modulation systems, the minimum 6dB bandwidth shall be at least 500 kHz.

4.2.2. Measuring Instruments and Setting

Please refer to section 5 of equipments list in this report. The following table is the setting of spectrum analyzer.

6dB Spectrum Bandwidth	
Spectrum Parameters	Setting
Attenuation	Auto
Span Frequency	> 6dB Bandwidth
RBW	100kHz
VBW	$\geq 3 \times \text{RBW}$
Detector	Peak
Trace	Max Hold
Sweep Time	Auto

4.2.3. Test Procedures

For Radiated 6dB Bandwidth Measurement:

1. The transmitter was radiated to the spectrum analyzer in peak hold mode.
2. Test was performed in accordance with KDB789033 D02 v01r02 for Compliance Testing of Unlicensed National Information Infrastructure (U-NII) Devices - section (C) Emission Bandwidth.
3. Multiple antenna system was performed in accordance with KDB662911 D01 v02r01 Emissions Testing of Transmitters with Multiple Outputs in the Same Band.
4. Measured the spectrum width with power higher than 6dB below carrier.

4.2.4. Test Setup Layout

For Radiated 6dB Bandwidth Measurement:

This test setup layout is the same as that shown in section 4.5.4.

4.2.5. Test Deviation

There is no deviation with the original standard.

4.2.6. EUT Operation during Test

The EUT was programmed to be in continuously transmitting mode.

4.2.7. Test Result of 6dB Spectrum Bandwidth

Temperature	25°C	Humidity	65%
Test Engineer	Andy Tsai		

Mode	Frequency	6dB Bandwidth (MHz)	Min. Limit (kHz)	Test Result
802.11a	5745 MHz	16.35	500	Complies
	5785 MHz	16.29	500	Complies
	5825 MHz	16.35	500	Complies
802.11ac MCS0/Nss1 VHT20	5745 MHz	17.28	500	Complies
	5785 MHz	17.57	500	Complies
	5825 MHz	17.57	500	Complies
802.11ac MCS0/Nss1 VHT40	5755 MHz	32.58	500	Complies
	5795 MHz	35.01	500	Complies
802.11ac MCS0/Nss1 VHT80	5775 MHz	75.65	500	Complies

Note: All the test values were listed in the report.

For plots, only the channel with worse result was shown.

6 dB Bandwidth Plot on Configuration IEEE 802.11a / Chain 1 + Chain 2 + Chain 3 / 5785 MHz

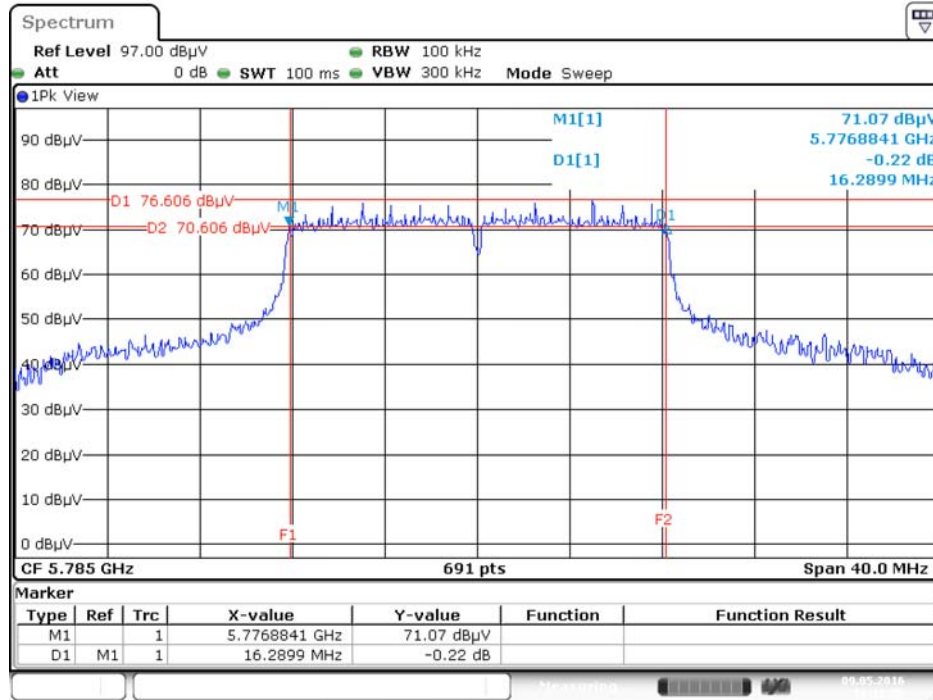

Date: 9.MAY.2016 16:12:56

6 dB Bandwidth Plot on Configuration IEEE 802.11ac MCS0/Nss1 VHT20 / Chain 1 + Chain 2 + Chain 3 / 5745 MHz

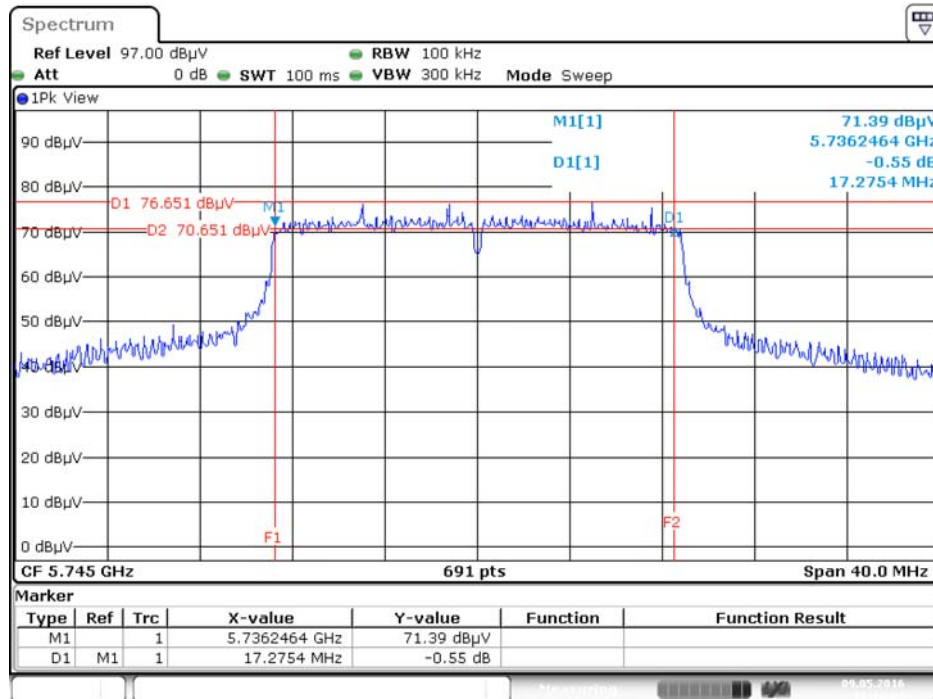

Date: 9.MAY.2016 16:14:04

6 dB Bandwidth Plot on Configuration IEEE 802.11ac MCS0/Nss1 VHT40 / Chain 1 + Chain 2 + Chain 3 / 5755MHz

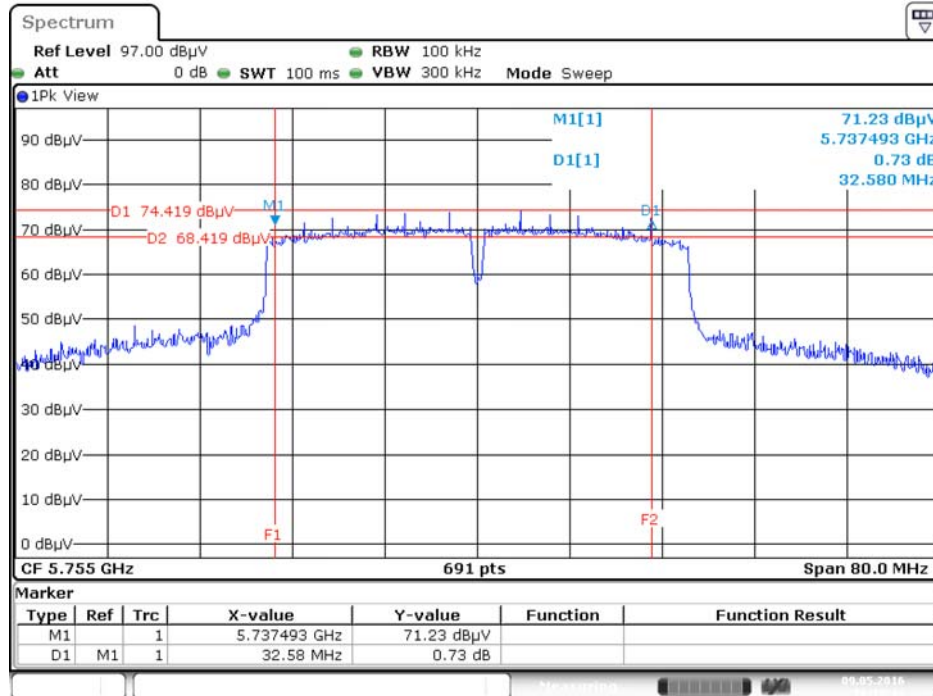

Date: 9.MAY.2016 16:15:41

6 dB Bandwidth Plot on Configuration IEEE 802.11ac MCS0/Nss1 VHT80 / Chain 1 + Chain 2 + Chain 3 / 5775 MHz

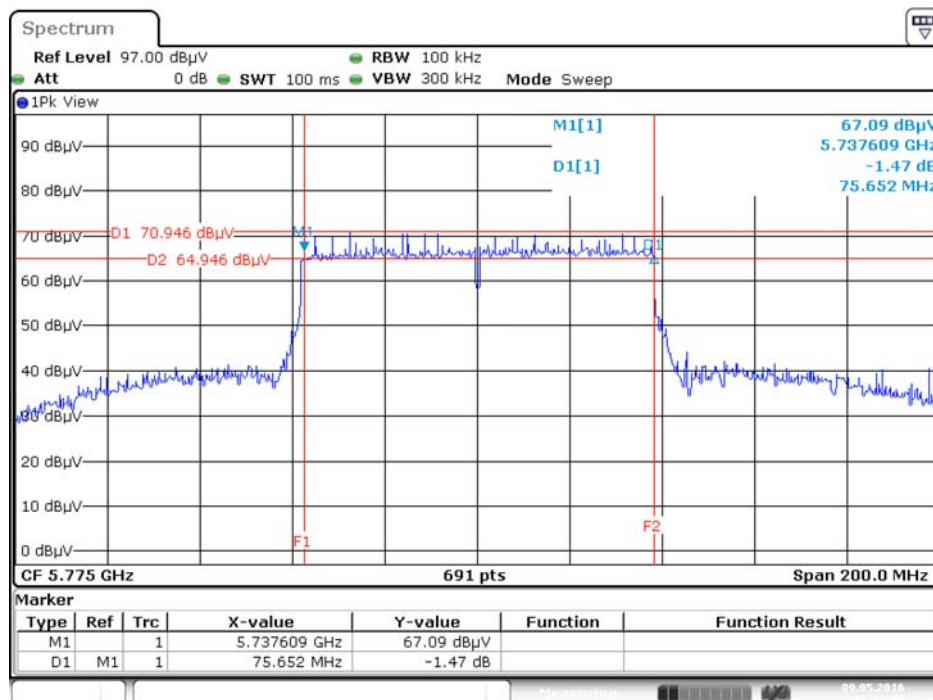

Date: 9.MAY.2016 16:11:09

4.3. Maximum Conducted Output Power Measurement

4.3.1. Limit

Frequency Band	Limit
<input checked="" type="checkbox"/> 5.725~5.85 GHz	The maximum conducted output power over the frequency band of operation shall not exceed 1 W (30dBm). If transmitting antennas of directional gain greater than 6 dBi are used, both the maximum conducted output power and the maximum power spectral density shall be reduced by the amount in dB that the directional gain of the antenna exceeds 6 dBi. However, fixed point-to-point U-NII devices operating in this band may employ transmitting antennas with directional gain greater than 6 dBi without any corresponding reduction in transmitter conducted power.

4.3.2. Measuring Instruments and Setting

Please refer to section 5 of equipments list in this report. The following table is the setting of the power meter.

Power Meter Parameter	Setting
Detector	AVERAGE

4.3.3. Test Procedures

1. The transmitter output (antenna port) was connected to the power meter.
2. Test was performed in accordance with KDB789033 D02 v01r02 for Compliance Testing of Unlicensed National Information Infrastructure (U-NII) Devices - section (E) Maximum conducted output power =>3. Measurement using a Power Meter (PM) =>b) Method PM-G (Measurement using a gated RF average power meter).
3. Multiple antenna systems was performed in accordance with KDB662911 D01 v02r01 Emissions Testing of Transmitters with Multiple Outputs in the Same Band.
4. When measuring maximum conducted output power with multiple antenna systems, add every result of the values by mathematic formula.

4.3.4. Test Setup Layout

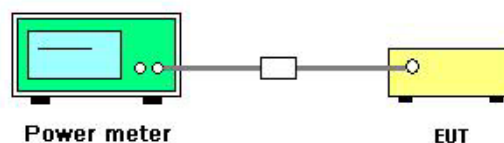

4.3.5. Test Deviation

There is no deviation with the original standard.

4.3.6. EUT Operation during Test

The EUT was programmed to be in continuously transmitting mode.

4.3.7. Test Result of Maximum Conducted Output Power

Temperature	25°C	Humidity	65%
Test Engineer	Andy Tsai	Test Date	May 09, 2016

Mode	Frequency	Conducted Power (dBm)				Max. Limit (dBm)	Result
		Chain 1	Chain 2	Chain 3	Total		
802.11a	5745 MHz	24.85	24.46	24.33	29.32	29.60	Complies
	5785 MHz	24.76	24.51	24.17	29.26	29.60	Complies
	5825 MHz	24.73	24.35	24.28	29.23	29.60	Complies
802.11ac MCS0/Nss1 VHT20	5745 MHz	24.72	24.36	24.45	29.28	29.60	Complies
	5785 MHz	24.55	24.48	24.22	29.19	29.60	Complies
	5825 MHz	24.64	24.53	24.35	29.28	29.60	Complies
802.11ac MCS0/Nss1 VHT40	5755 MHz	24.56	24.44	24.29	29.20	29.60	Complies
	5795 MHz	24.35	24.38	24.37	29.14	29.60	Complies
802.11ac MCS0/Nss1 VHT80	5775 MHz	24.38	24.29	24.14	29.04	29.60	Complies

Note: $DirectionalGain = 10 \cdot \log \left[\frac{\sum_{j=1}^{N_{SS}} \left\{ \sum_{k=1}^{N_{ANT}} g_{j,k} \right\}^2}{N_{ANT}} \right] = 6.40\text{dBi}$, so limit=30-(6.40-6)=29.60 dBm.

4.4. Power Spectral Density Measurement

4.4.1. Limit

The following table is power spectral density limits and decrease power density limit rule refer to section 4.3.1.

Frequency Band		Limit
<input checked="" type="checkbox"/>	5.725~5.85 GHz	30 dBm/500kHz

4.4.2. Measuring Instruments and Setting

Please refer to section 5 of equipments list in this report. The following table is the setting of the spectrum analyzer.

Spectrum Parameter	Setting
Attenuation	Auto
Span Frequency	Encompass the entire emissions bandwidth (EBW) of the signal
RBW	1000 kHz
VBW	3000 kHz
Detector	RMS
Trace	AVERAGE
Sweep Time	Auto
Trace Average	100 times
Note: If measurement bandwidth of Maximum PSD is specified in 500 kHz, add $10\log(500\text{kHz}/\text{RBW})$ to the measured result, whereas RBW (< 500 kHz) is the reduced resolution bandwidth of the spectrum analyzer set during measurement.	

4.4.3. Test Procedures

1. The transmitter output (antenna port) was connected RF switch to the spectrum analyzer.
2. Test was performed in accordance with KDB789033 D02 v01r02 for Compliance Testing of Unlicensed National Information Infrastructure (U-NII) Devices - section (F) Maximum Power Spectral Density (PSD).
3. Multiple antenna systems was performed in accordance KDB662911 D01 v02r01 in-Band Power Spectral Density (PSD) Measurements and sum the spectra across the outputs.
4. For 5.725~5.85 GHz, the measured result of PSD level must add $10\log(500\text{kHz}/\text{RBW})$ and the final result should ≤ 30 dBm.

4.4.4. Test Setup Layout

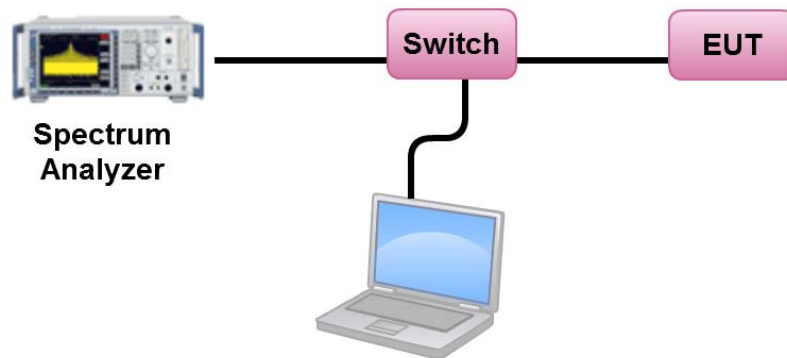

4.4.5. Test Deviation

There is no deviation with the original standard.

4.4.6. EUT Operation during Test

The EUT was programmed to be in continuously transmitting mode.

4.4.7. Test Result of Power Spectral Density

Temperature	25°C	Humidity	65%
Test Engineer	Andy Tsai		

Configuration IEEE 802.11a / Chain 1 + Chain 2 + Chain 3

Channel	Frequency	Power Density (dBm/MHz)	10log(500kHz/RBW) Factor (dB)	Power Density (dBm/500kHz)	Power Density Limit (dBm/500kHz)	Result
149	5745 MHz	16.12	-3.01	13.11	29.60	Complies
157	5785 MHz	16.07	-3.01	13.06	29.60	Complies
165	5825 MHz	16.03	-3.01	13.02	29.60	Complies

Configuration IEEE 802.11ac MCS0/Nss1 VHT20 / Chain 1 + Chain 2 + Chain 3

Channel	Frequency	Power Density (dBm/MHz)	10log(500kHz/RBW) Factor (dB)	Power Density (dBm/500kHz)	Power Density Limit (dBm/500kHz)	Result
149	5745 MHz	15.86	-3.01	12.85	29.60	Complies
157	5785 MHz	15.93	-3.01	12.92	29.60	Complies
165	5825 MHz	15.97	-3.01	12.96	29.60	Complies

Configuration IEEE 802.11ac MCS0/Nss1 VHT40 / Chain 1 + Chain 2 + Chain 3

Channel	Frequency	Power Density (dBm/MHz)	10log(500kHz/RBW) Factor (dB)	Power Density (dBm/500kHz)	Power Density Limit (dBm/500kHz)	Result
151	5755 MHz	12.94	-3.01	9.93	29.60	Complies
159	5795 MHz	12.91	-3.01	9.90	29.60	Complies

Configuration IEEE 802.11ac MCS0/Nss1 VHT80 / Chain 1 + Chain 2 + Chain 3

Channel	Frequency	Power Density (dBm/MHz)	10log(500kHz/RBW) Factor (dB)	Power Density (dBm/500kHz)	Power Density Limit (dBm/500kHz)	Result
155	5775 MHz	9.88	-3.01	6.87	29.60	Complies

Note: $DirectionalGain = 10 \cdot \log \left[\frac{\sum_{j=1}^{N_{SS}} \left\{ \sum_{k=1}^{N_{ANT}} g_{j,k} \right\}^2}{N_{ANT}} \right] = 6.40\text{dBi}$, so limit=30-(6.40-6)=29.60 dBm/500kHz.

Note: All the test values were listed in the report.

For plots, only the channel with worse result was shown.

Power Density Plot on Configuration IEEE 802.11a / Chain 1 + Chain 2 + Chain 3 / 5745 MHz

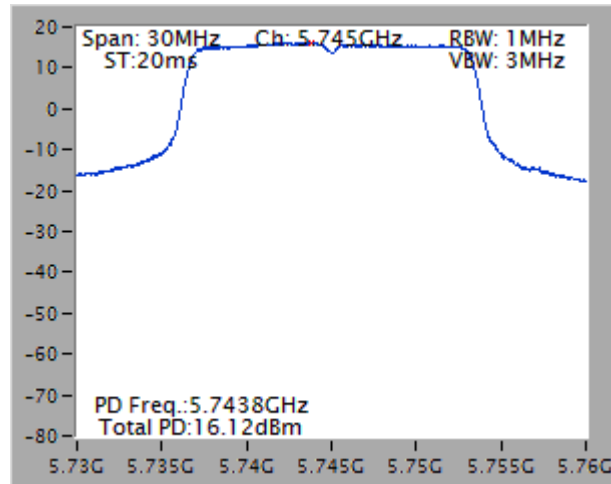

Power Density Plot on Configuration IEEE 802.11ac MCS0/Nss1 VHT20 / Chain 1 + Chain 2 + Chain 3 / 5825 MHz

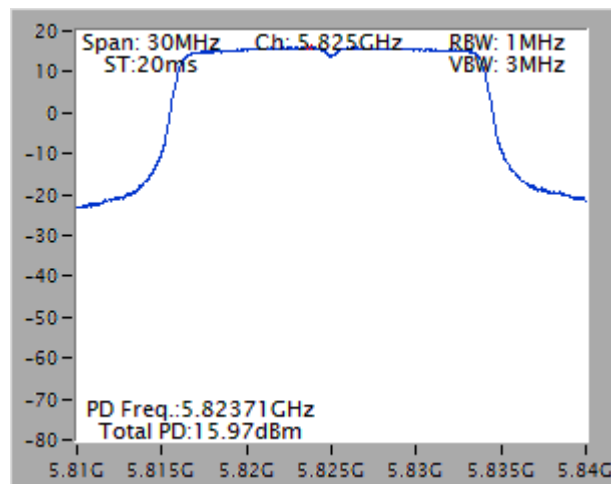

Power Density Plot on Configuration IEEE 802.11ac MCS0/Nss1 VHT40 / Chain 1 + Chain 2 + Chain 3 /
5755 MHz

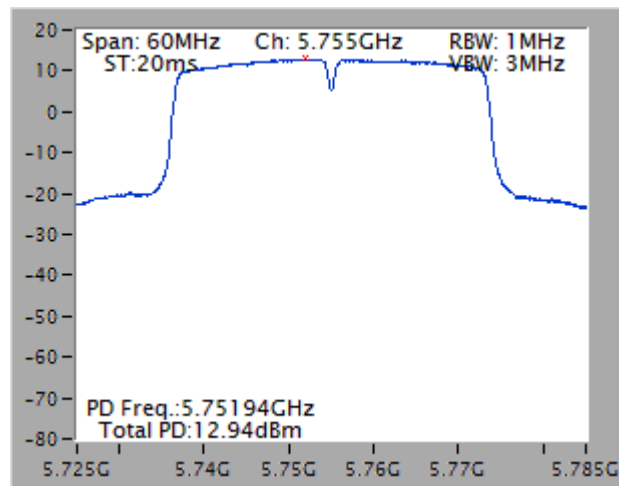

Power Density Plot on Configuration IEEE 802.11ac MCS0/Nss1 VHT80 / Chain 1 + Chain 2 + Chain 3 /
5775 MHz

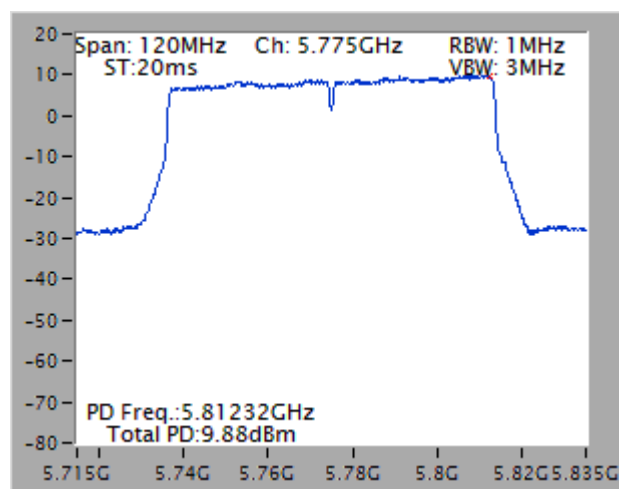

4.5. Radiated Emissions Measurement

4.5.1. Limit

For transmitters operating in the 5.725-5.85 GHz band: all emissions shall be limited to a level of -27 dBm/MHz at 75 MHz or more above or below the band edge increasing linearly to 10 dBm/MHz at 25 MHz above or below the band edge, and from 25 MHz above or below the band edge increasing linearly to a level of 15.6 dBm/MHz at 5 MHz above or below the band edge, and from 5 MHz above or below the band edge increasing linearly to a level of 27 dBm/MHz at the band edge.

In addition, In case the emission fall within the restricted band specified on 15.205(a), then the 15.209(a) limit in the table below has to be followed.

Frequencies (MHz)	Field Strength (microrvolts/meter)	Measurement Distance (meters)
0.009~0.490	2400/F(kHz)	300
0.490~1.705	24000/F(kHz)	30
1.705~30.0	30	30
30~88	100	3
88~216	150	3
216~960	200	3
Above 960	500	3

4.5.2. Measuring Instruments and Setting

Please refer to section 5 of equipments list in this report. The following table is the setting of spectrum analyzer and receiver.

Spectrum Parameter	Setting
Attenuation	Auto
Start Frequency	1000 MHz
Stop Frequency	40 GHz
RBW / VBW (Emission in restricted band)	1 MHz / 3MHz for Peak, 1 MHz / 1/T for Average
RBW / VBW (Emission in non-restricted band)	1 MHz / 3MHz for peak

Receiver Parameter	Setting
Attenuation	Auto
Start ~ Stop Frequency	9kHz~150kHz / RBW 200Hz for QP
Start ~ Stop Frequency	150kHz~30MHz / RBW 9kHz for QP
Start ~ Stop Frequency	30MHz~1000MHz / RBW 120kHz for QP

4.5.3. Test Procedures

1. Configure the EUT according to ANSI C63.10. The EUT was placed on the top of the turntable 1.5 meter above ground. The phase center of the receiving antenna mounted on the top of a height-variable antenna tower was placed 1m & 3m far away from the turntable.
2. Power on the EUT and all the supporting units. The turntable was rotated by 360 degrees to determine the position of the highest radiation.
3. The height of the broadband receiving antenna was varied between one meter and four meters above ground to find the maximum emissions field strength of both horizontal and vertical polarization.
4. For each suspected emissions, the antenna tower was scan (from 1 M to 4 M) and then the turntable was rotated (from 0 degree to 360 degrees) to find the maximum reading.
5. Set the test-receiver system to Peak or CISPR quasi-peak Detect Function with specified bandwidth under Maximum Hold Mode.
6. For emissions above 1GHz, use 1MHz VBW and 3MHz RBW for peak reading. Then 1MHz RBW and 1/T VBW for average reading in spectrum analyzer.
7. If the emissions level of the EUT in peak mode was 3 dB lower than the average limit specified, then testing will be stopped and peak values of EUT will be reported, otherwise, the emissions which do not have 3 dB margin will be repeated one by one using the quasi-peak method for below 1GHz.
8. For testing above 1GHz, the emissions level of the EUT in peak mode was lower than average limit (that means the emissions level in peak mode also complies with the limit in average mode), then testing will be stopped and peak values of EUT will be reported, otherwise, the emissions will be measured in average mode again and reported.
9. In case the emission is lower than 30MHz, loop antenna has to be used for measurement and the recorded data should be QP measured by receiver. High – Low scan is not required in this case.

4.5.4. Test Setup Layout

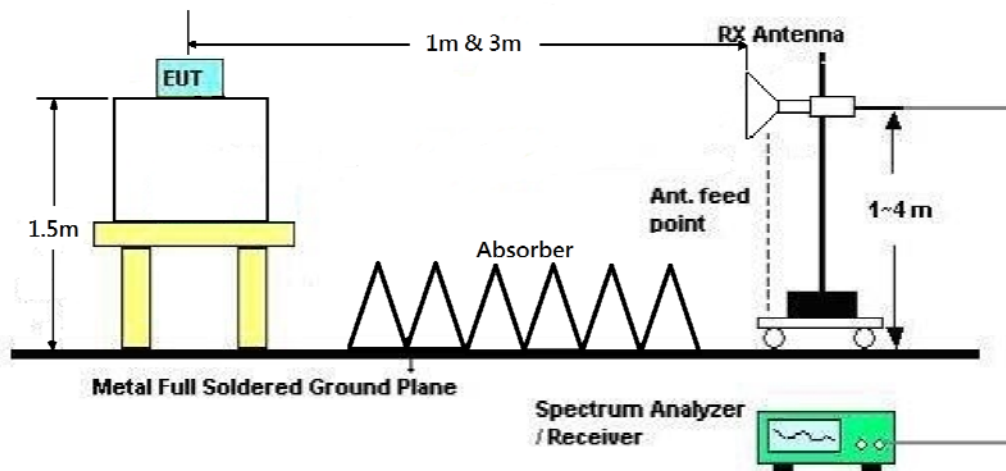

4.5.5. Test Deviation

There is no deviation with the original standard.

4.5.6. EUT Operation during Test

The EUT was programmed to be in beamforming transmitting mode.

4.5.7. Results for Radiated Emissions (1GHz~40GHz)

Temperature	25°C	Humidity	58%
Test Engineer	Eric Fu	Configurations	IEEE 802.11a CH 149 / Chain 1 + Chain 2 + Chain 3
Test Date	May 04, 2016 ~ May 13, 2016		

Horizontal

	Freq	Level	Limit Line	Over Limit	Read Level	CableAntenna Loss	Antenna Factor	Preamp Factor	A/Pos	T/Pos	Remark	Pol/Phase
	MHz	dBuV/m	dBuV/m	dB	dBuV	dB	dB/m	dB	cm	deg		
1	11493.59	59.93	74.00	-14.07	43.56	11.60	40.00	35.23	154	128	Peak	HORIZONTAL
2	11499.09	46.85	54.00	-7.15	30.48	11.60	40.00	35.23	154	128	Average	HORIZONTAL

Vertical

	Freq	Level	Limit Line	Over Limit	Read Level	CableAntenna Loss	Antenna Factor	Preamp Factor	A/Pos	T/Pos	Remark	Pol/Phase
	MHz	dBuV/m	dBuV/m	dB	dBuV	dB	dB/m	dB	cm	deg		
1	11482.16	46.90	54.00	-7.10	30.55	11.57	40.01	35.23	180	112	Average	VERTICAL
2	11499.87	59.97	74.00	-14.03	43.60	11.60	40.00	35.23	180	112	Peak	VERTICAL

Temperature	25°C	Humidity	58%
Test Engineer	Eric Fu	Configurations	IEEE 802.11a CH 157 / Chain 1 + Chain 2 + Chain 3
Test Date	May 04, 2016 ~ May 13, 2016		

Horizontal

	Freq	Level	Limit Line	Over Limit	Read Level	CableAntenna Loss	Antenna Factor	Preamp Factor	A/Pos	T/Pos	Remark	Pol/Phase
	MHz	dBuV/m	dBuV/m	dB	dBuV	dB	dB/m	dB	cm	deg		
1	11572.37	48.09	54.00	-5.91	31.81	11.64	39.87	35.23	173	94	Average	HORIZONTAL
2	11572.52	60.49	74.00	-13.51	44.21	11.64	39.87	35.23	173	94	Peak	HORIZONTAL

Vertical

	Freq	Level	Limit Line	Over Limit	Read Level	CableAntenna Loss	Antenna Factor	Preamp Factor	A/Pos	T/Pos	Remark	Pol/Phase
	MHz	dBuV/m	dBuV/m	dB	dBuV	dB	dB/m	dB	cm	deg		
1	11561.84	60.49	74.00	-13.51	44.21	11.64	39.87	35.23	197	123	Peak	VERTICAL
2	11577.32	48.00	54.00	-6.00	31.72	11.64	39.87	35.23	197	123	Average	VERTICAL

Temperature	25°C	Humidity	58%
Test Engineer	Eric Fu	Configurations	IEEE 802.11a CH 165 / Chain 1 + Chain 2 + Chain 3
Test Date	May 04, 2016 ~ May 13, 2016		

Horizontal

	Freq	Level	Limit Line	Over Limit	Read Level	CableAntenna Loss	Antenna Factor	Preamp Factor	A/Pos	T/Pos	Remark	Pol/Phase
	MHz	dBuV/m	dBuV/m	dB	dBuV	dB	dB/m	dB	cm	deg		
1	11640.48	59.35	74.00	-14.65	43.15	11.69	39.73	35.22	199	143	Peak	HORIZONTAL
2	11649.54	47.21	54.00	-6.79	31.01	11.69	39.73	35.22	199	143	Average	HORIZONTAL

Vertical

	Freq	Level	Limit Line	Over Limit	Read Level	CableAntenna Loss	Antenna Factor	Preamp Factor	A/Pos	T/Pos	Remark	Pol/Phase
	MHz	dBuV/m	dBuV/m	dB	dBuV	dB	dB/m	dB	cm	deg		
1	11646.09	48.46	54.00	-5.54	32.26	11.69	39.73	35.22	166	114	Average	VERTICAL
2	11654.80	61.20	74.00	-12.80	45.04	11.71	39.67	35.22	166	114	Peak	VERTICAL

Temperature	25°C	Humidity	58%
Test Engineer	Eric Fu	Configurations	IEEE 802.11ac MCS0/Nss1 VHT20 CH 149 / Chain 1 + Chain 2 + Chain 3
Test Date	May 04, 2016 ~ May 13, 2016		

Horizontal

	Freq	Level	Limit Line	Over Limit	Read Level	CableAntenna Loss	Antenna Factor	Preamp Factor	A/Pos	T/Pos	Remark	Pol/Phase
	MHz	dBuV/m	dBuV/m	dB	dBuV	dB	dB/m	dB	cm	deg		
1	11492.75	59.73	74.00	-14.27	43.36	11.60	40.00	35.23	143	292	Peak	HORIZONTAL
2	11493.53	46.72	54.00	-7.28	30.35	11.60	40.00	35.23	143	292	Average	HORIZONTAL

Vertical

	Freq	Level	Limit Line	Over Limit	Read Level	CableAntenna Loss	Antenna Factor	Preamp Factor	A/Pos	T/Pos	Remark	Pol/Phase
	MHz	dBuV/m	dBuV/m	dB	dBuV	dB	dB/m	dB	cm	deg		
1	11494.69	59.55	74.00	-14.45	43.18	11.60	40.00	35.23	166	310	Peak	VERTICAL
2	11496.57	46.61	54.00	-7.39	30.24	11.60	40.00	35.23	166	310	Average	VERTICAL

Temperature	25°C	Humidity	58%
Test Engineer	Eric Fu	Configurations	IEEE 802.11ac MCS0/Nss1 VHT20 CH 157 / Chain 1 + Chain 2 + Chain 3
Test Date	May 04, 2016 ~ May 13, 2016		

Horizontal

	Freq	Level	Limit Line	Over Limit	Read Level	CableAntenna Loss	Antenna Factor	Preamp Factor	A/Pos	T/Pos	Remark	Pol/Phase
	MHz	dBuV/m	dBuV/m	dB	dBuV	dB	dB/m	dB	cm	deg		
1	11572.84	48.02	54.00	-5.98	31.74	11.64	39.87	35.23	137	277	Average	HORIZONTAL
2	11578.65	61.01	74.00	-12.99	44.73	11.64	39.87	35.23	137	277	Peak	HORIZONTAL

Vertical

	Freq	Level	Limit Line	Over Limit	Read Level	CableAntenna Loss	Antenna Factor	Preamp Factor	A/Pos	T/Pos	Remark	Pol/Phase
	MHz	dBuV/m	dBuV/m	dB	dBuV	dB	dB/m	dB	cm	deg		
1	11562.42	48.00	54.00	-6.00	31.72	11.64	39.87	35.23	121	260	Average	VERTICAL
2	11565.63	61.09	74.00	-12.91	44.81	11.64	39.87	35.23	121	260	Peak	VERTICAL



Temperature	25°C	Humidity	58%
Test Engineer	Eric Fu	Configurations	IEEE 802.11ac MCS0/Nss1 VHT20 CH 165 / Chain 1 + Chain 2 + Chain 3
Test Date	May 04, 2016 ~ May 13, 2016		

Horizontal

	Freq	Level	Limit Line	Over Limit	Read Level	CableAntenna Loss	Antenna Factor	Preamp Factor	A/Pos	T/Pos	Remark	Pol/Phase
	MHz	dBuV/m	dBuV/m	dB	dBuV	dB	dB/m	dB	cm	deg		
1	11646.76	48.54	54.00	-5.46	32.34	11.69	39.73	35.22	164	235	Average	HORIZONTAL
2	11647.60	61.38	74.00	-12.62	45.18	11.69	39.73	35.22	164	235	Peak	HORIZONTAL

Vertical

	Freq	Level	Limit Line	Over Limit	Read Level	CableAntenna Loss	Antenna Factor	Preamp Factor	A/Pos	T/Pos	Remark	Pol/Phase
	MHz	dBuV/m	dBuV/m	dB	dBuV	dB	dB/m	dB	cm	deg		
1	11650.87	48.35	54.00	-5.65	32.19	11.71	39.67	35.22	198	183	Average	VERTICAL
2	11654.37	61.32	74.00	-12.68	45.16	11.71	39.67	35.22	198	183	Peak	VERTICAL



Temperature	25°C	Humidity	58%
Test Engineer	Eric Fu	Configurations	IEEE 802.11ac MCS0/Nss1 VHT40 CH 151 / Chain 1 + Chain 2 + Chain 3
Test Date	May 04, 2016 ~ May 13, 2016		

Horizontal

	Freq	Level	Limit Line	Over Limit	Read Level	CableAntenna Loss	Antenna Factor	Preamp Factor	A/Pos	T/Pos	Remark	Pol/Phase
	MHz	dBuV/m	dBuV/m	dB	dBuV	dB	dB/m	dB	cm	deg		
1	11502.10	62.05	74.00	-11.95	45.68	11.60	40.00	35.23	145	313	Peak	HORIZONTAL
2	11506.84	48.63	54.00	-5.37	32.26	11.60	40.00	35.23	145	313	Average	HORIZONTAL

Vertical

	Freq	Level	Limit Line	Over Limit	Read Level	CableAntenna Loss	Antenna Factor	Preamp Factor	A/Pos	T/Pos	Remark	Pol/Phase
	MHz	dBuV/m	dBuV/m	dB	dBuV	dB	dB/m	dB	cm	deg		
1	11509.86	48.67	54.00	-5.33	32.30	11.60	40.00	35.23	175	348	Average	VERTICAL
2	11514.60	63.15	74.00	-10.85	46.78	11.60	40.00	35.23	175	348	Peak	VERTICAL

Temperature	25°C	Humidity	58%
Test Engineer	Eric Fu	Configurations	IEEE 802.11ac MCS0/Nss1 VHT40 CH 159 / Chain 1 + Chain 2 + Chain 3
Test Date	May 04, 2016 ~ May 13, 2016		

Horizontal

	Freq	Level	Limit Line	Over Limit	Read Level	CableAntenna Loss	Antenna Factor	Preamp Factor	A/Pos	T/Pos	Remark	Pol/Phase
	MHz	dBuV/m	dBuV/m	dB	dBuV	dB	dB/m	dB	cm	deg		
1	11593.94	61.47	74.00	-12.53	45.22	11.67	39.80	35.22	124	284	Peak	HORIZONTAL
2	11598.48	48.21	54.00	-5.79	31.96	11.67	39.80	35.22	124	284	Average	HORIZONTAL

Vertical

	Freq	Level	Limit Line	Over Limit	Read Level	CableAntenna Loss	Antenna Factor	Preamp Factor	A/Pos	T/Pos	Remark	Pol/Phase
	MHz	dBuV/m	dBuV/m	dB	dBuV	dB	dB/m	dB	cm	deg		
1	11581.61	61.16	74.00	-12.84	44.88	11.64	39.87	35.23	103	256	Peak	VERTICAL
2	11586.82	48.29	54.00	-5.71	32.04	11.67	39.80	35.22	103	256	Average	VERTICAL



Temperature	25°C	Humidity	58%
Test Engineer	Eric Fu	Configurations	IEEE 802.11ac MCS0/Nss1 VHT80 CH 155 / Chain 1 + Chain 2 + Chain 3
Test Date	May 04, 2016 ~ May 13, 2016		

Horizontal

	Freq	Level	Limit Line	Over Limit	Read Level	CableAntenna Loss	Antenna Factor	Preamp Factor	A/Pos	T/Pos	Remark	Pol/Phase
	MHz	dBuV/m	dBuV/m	dB	dBuV	dB	dB/m	dB	cm	deg		
1	11555.53	47.62	54.00	-6.38	31.34	11.64	39.87	35.23	152	342	Average	HORIZONTAL
2	11558.71	60.05	74.00	-13.95	43.77	11.64	39.87	35.23	152	342	Peak	HORIZONTAL

Vertical

	Freq	Level	Limit Line	Over Limit	Read Level	CableAntenna Loss	Antenna Factor	Preamp Factor	A/Pos	T/Pos	Remark	Pol/Phase
	MHz	dBuV/m	dBuV/m	dB	dBuV	dB	dB/m	dB	cm	deg		
1	11547.39	60.02	74.00	-13.98	43.70	11.62	39.93	35.23	145	67	Peak	VERTICAL
2	11558.42	47.48	54.00	-6.52	31.20	11.64	39.87	35.23	145	67	Average	VERTICAL

Note:

The amplitude of spurious emissions that are attenuated by more than 20dB below the permissible value has no need to be reported.

Emission level (dBuV/m) = 20 log Emission level (uV/m).

Corrected Reading: Antenna Factor + Cable Loss + Read Level - Preamp Factor = Level.

4.6. Band Edge Emissions Measurement

4.6.1. Limit

For transmitters operating in the 5.725-5.85 GHz band: all emissions shall be limited to a level of -27 dBm/MHz at 75 MHz or more above or below the band edge increasing linearly to 10 dBm/MHz at 25 MHz above or below the band edge, and from 25 MHz above or below the band edge increasing linearly to a level of 15.6 dBm/MHz at 5 MHz above or below the band edge, and from 5 MHz above or below the band edge increasing linearly to a level of 27 dBm/MHz at the band edge.

In addition, In case the emission fall within the restricted band specified on 15.205(a), then the 15.209(a) limit in the table below has to be followed.

Frequencies (MHz)	Field Strength (microvolts/meter)	Measurement Distance (meters)
0.009~0.490	2400/F(kHz)	300
0.490~1.705	24000/F(kHz)	30
1.705~30.0	30	30
30~88	100	3
88~216	150	3
216~960	200	3
Above 960	500	3

4.6.2. Measuring Instruments and Setting

Please refer to section 5 of equipments list in this report. The following table is the setting of the spectrum analyzer.

Spectrum Parameter	Setting
Attenuation	Auto
Span Frequency	100 MHz
RBW / VBW (Emission in restricted band)	1 MHz / 3MHz for Peak, 1 MHz / 1/T for Average
RBW / VBW (Emission in non-restricted band)	1 MHz / 3MHz for Peak

4.6.3. Test Procedures

The test procedure is the same as section 4.5.3.

4.6.4. Test Setup Layout

This test setup layout is the same as that shown in section 4.5.4.

4.6.5. Test Deviation

There is no deviation with the original standard.

4.6.6. EUT Operation during Test

The EUT was programmed to be in beamforming transmitting mode.

4.6.7. Test Result of Band Edge and Fundamental Emissions

Temperature	25°C	Humidity	58%
Test Engineer	Eric Fu	Configurations	IEEE 802.11a CH 149, 157, 165 / Chain 1 + Chain 2 + Chain 3
Test Date	May 04, 2016 ~ May 13, 2016		

Channel 149

	Freq	Level	Limit Line	Over Limit	Read Level	CableAntenna Loss	Antenna Factor	Preamp Factor	A/Pos	T/Pos	Remark	Pol/Phase
	MHz	dBuV/m	dBuV/m	dB	dBuV	dB	dB/m	dB	cm	deg		
1	5503.00	63.97	68.20	-4.23	57.58	7.51	31.80	32.92	200	218	Peak	VERTICAL
2	5742.11	109.99			103.17	7.73	32.10	33.01	200	218	Average	VERTICAL
3	5748.00	120.44			113.63	7.73	32.10	33.02	200	218	Peak	VERTICAL
4	5932.00	64.25	68.20	-3.95	57.19	7.82	32.32	33.08	200	218	Peak	VERTICAL

Item 3, 4 are the fundamental frequency at 5745 MHz.

Channel 157

	Freq	Level	Limit Line	Over Limit	Read Level	CableAntenna Loss	Antenna Factor	Preamp Factor	A/Pos	T/Pos	Remark	Pol/Phase
	MHz	dBuV/m	dBuV/m	dB	dBuV	dB	dB/m	dB	cm	deg		
1	5601.00	64.12	68.20	-4.08	57.56	7.60	31.92	32.96	216	184	Peak	VERTICAL
2	5787.17	111.79			104.92	7.76	32.14	33.03	216	184	Average	VERTICAL
3	5788.00	122.19			115.32	7.76	32.14	33.03	216	184	Peak	VERTICAL
4	5931.50	63.96	68.20	-4.24	56.90	7.82	32.32	33.08	216	184	Peak	VERTICAL

Item 3, 4 are the fundamental frequency at 5785 MHz.

Channel 165

	Freq	Level	Limit Line	Over Limit	Read Level	CableAntenna Loss	Antenna Factor	Preamp Factor	A/Pos	T/Pos	Remark	Pol/Phase
	MHz	dBuV/m	dBuV/m	dB	dBuV	dB	dB/m	dB	cm	deg		
1	5636.50	64.00	68.20	-4.20	57.39	7.63	31.96	32.98	226	183	Peak	VERTICAL
2	5827.00	121.44			114.51	7.78	32.20	33.05	226	183	Peak	VERTICAL
3	5827.17	110.87			103.94	7.78	32.20	33.05	226	183	Average	VERTICAL
4	5963.50	63.97	68.20	-4.23	56.88	7.83	32.36	33.10	226	183	Peak	VERTICAL

Item 3, 4 are the fundamental frequency at 5825 MHz.

Temperature	25°C	Humidity	58%
Test Engineer	Eric Fu	Configurations	IEEE 802.11ac MCS0/Nss1 VHT20 CH 149, 157, 165 / Chain 1 + Chain 2 + Chain 3
Test Date	May 04, 2016 ~ May 13, 2016		

Channel 149

	Freq	Level	Limit	Over	Read	CableAntenna	Preamp	A/Pos	T/Pos	Remark	Pol/Phase	
	MHz	dBuV/m	dBuV/m	dB	dBuV	dB	dB/m	dB	cm	deg		
1	5632.00	63.51	68.20	-4.69	56.89	7.63	31.96	32.97	227	168	Peak	VERTICAL
2	5743.00	121.97			115.15	7.73	32.10	33.01	227	168	Peak	VERTICAL
3	5746.45	110.06			103.25	7.73	32.10	33.02	227	168	Average	VERTICAL
4	5994.50	64.04	68.20	-4.16	56.90	7.84	32.40	33.10	227	168	Peak	VERTICAL

Item 3, 4 are the fundamental frequency at 5745 MHz.

Channel 157

	Freq	Level	Limit	Over	Read	CableAntenna	Preamp	A/Pos	T/Pos	Remark	Pol/Phase	
	MHz	dBuV/m	dBuV/m	dB	dBuV	dB	dB/m	dB	cm	deg		
1	5606.00	63.45	68.20	-4.75	56.89	7.60	31.92	32.96	225	182	Peak	VERTICAL
2	5786.45	111.46			104.59	7.76	32.14	33.03	225	182	Average	VERTICAL
3	5786.50	122.11			115.24	7.76	32.14	33.03	225	182	Peak	VERTICAL
4	5996.00	63.64	68.20	-4.56	56.51	7.84	32.40	33.11	225	182	Peak	VERTICAL

Item 3, 4 are the fundamental frequency at 5785 MHz.

Channel 165

	Freq	Level	Limit	Over	Read	CableAntenna	Preamp	A/Pos	T/Pos	Remark	Pol/Phase	
	MHz	dBuV/m	dBuV/m	dB	dBuV	dB	dB/m	dB	cm	deg		
1	5600.50	63.70	68.20	-4.50	57.14	7.60	31.92	32.96	223	184	Peak	VERTICAL
2	5827.00	121.64			114.71	7.78	32.20	33.05	223	184	Peak	VERTICAL
3	5827.89	111.20			104.27	7.78	32.20	33.05	223	184	Average	VERTICAL
4	6039.50	64.20	68.20	-4.00	56.93	7.88	32.52	33.13	223	184	Peak	VERTICAL

Item 3, 4 are the fundamental frequency at 5825 MHz.

Temperature	25°C	Humidity	58%
Test Engineer	Eric Fu	Configurations	IEEE 802.11ac MCS0/Nss1 VHT40 CH 151, 159 / Chain 1 + Chain 2 + Chain 3
Test Date	May 04, 2016 ~ May 13, 2016		

Channel 151

	Freq	Level	Limit	Over	Read	CableAntenna	Preamp	A/Pos	T/Pos	Remark	Pol/Phase	
	MHz	dBuV/m	dBuV/m	dB	dBuV	dB	dB/m	dB	cm	deg		
1	5650.00	67.67	68.20	-0.53	61.03	7.64	31.98	32.98	194	270	Peak	VERTICAL
2	5764.50	119.78			112.95	7.74	32.12	33.03	194	270	Peak	VERTICAL
3	5765.85	109.44			102.61	7.74	32.12	33.03	194	270	Average	VERTICAL
4	5955.00	63.86	68.20	-4.34	56.79	7.82	32.34	33.09	194	270	Peak	VERTICAL

Item 3, 4 are the fundamental frequency at 5755 MHz.

Channel 159

	Freq	Level	Limit	Over	Read	CableAntenna	Preamp	A/Pos	T/Pos	Remark	Pol/Phase	
	MHz	dBuV/m	dBuV/m	dB	dBuV	dB	dB/m	dB	cm	deg		
1	5590.50	63.15	68.20	-5.05	56.63	7.58	31.90	32.96	211	223	Peak	VERTICAL
2	5784.00	120.88			114.01	7.76	32.14	33.03	211	223	Peak	VERTICAL
3	5785.59	110.20			103.33	7.76	32.14	33.03	211	223	Average	VERTICAL
4	5928.50	63.90	68.20	-4.30	56.84	7.82	32.32	33.08	211	223	Peak	VERTICAL

Item 3, 4 are the fundamental frequency at 5795 MHz.



Temperature	25°C	Humidity	58%
Test Engineer	Eric Fu	Configurations	IEEE 802.11ac MCS0/Nss1 VHT80 CH 155 / Chain 1 + Chain 2 + Chain 3
Test Date	May 04, 2016 ~ May 13, 2016		

Channel 155

	Freq	Level	Limit	Over	Read	CableAntenna	Preamp	A/Pos	T/Pos	Remark	Pol/Phase	
	MHz	dBuV/m	dBuV/m	dB	dBuV	dB	dB/m	dB	cm	deg		
1	5646.50	67.63	68.20	-0.57	60.99	7.64	31.98	32.98	180	269	Peak	VERTICAL
2	5787.50	115.73			108.86	7.76	32.14	33.03	180	269	Peak	VERTICAL
3	5795.98	104.38			97.48	7.77	32.16	33.03	180	269	Average	VERTICAL
4	5930.00	66.88	68.20	-1.32	59.82	7.82	32.32	33.08	180	269	Peak	VERTICAL

Item 4, 5 are the fundamental frequency at 5775 MHz.

Note:

Emission level (dBuV/m) = 20 log Emission level (uV/m)

Corrected Reading: Antenna Factor + Cable Loss + Read Level - Preamp Factor = Level

4.7. Frequency Stability Measurement

4.7.1. Limit

In-band emission is maintained within the band of operation under all conditions of normal operation as specified in the user's manual.

The transmitter center frequency tolerance shall be ± 20 ppm maximum for the 5 GHz band (IEEE 802.11n specification).

4.7.2. Measuring Instruments and Setting

Please refer to section 5 of equipments list in this report. The following table is the setting of the spectrum analyzer.

Spectrum Parameter	Setting
Attenuation	Auto
Span Frequency	Entire absence of modulation emissions bandwidth
RBW	10 kHz
VBW	10 kHz
Sweep Time	Auto

4.7.3. Test Procedures

1. The transmitter output (antenna port) was connected to the spectrum analyzer.
2. EUT have transmitted absence of modulation signal and fixed channelize.
3. Set the spectrum analyzer span to view the entire absence of modulation emissions bandwidth.
4. Set RBW = 10 kHz, VBW = 10 kHz with peak detector and maxhold settings.
5. f_c is declaring of channel frequency. Then the frequency error formula is $(f_c - f) / f_c \times 10^6$ ppm and the limit is less than ± 20 ppm (IEEE 802.11n specification).
6. Allow sufficient time (approximately 30 min) for the temperature of the chamber to stabilize, turn the EUT on and measure the operating frequency after 2, 5, and 10 minutes.
7. The test extreme voltage is to change the primary supply voltage from 85 to 115 percent of the nominal value
8. Extreme temperature is $-30^\circ\text{C} \sim 50^\circ\text{C}$.

4.7.4. Test Setup Layout

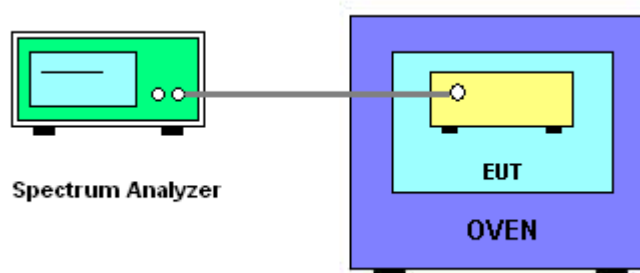

4.7.5. Test Deviation

There is no deviation with the original standard.

4.7.6. EUT Operation during Test

The EUT was programmed to be in continuously un-modulation transmitting mode.

4.7.7. Test Result of Frequency Stability

Temperature	25°C	Humidity	65%
Test Engineer	Andy Tsai	Test Date	May 09, 2016

Mode: 20 MHz / Chain 1

Voltage vs. Frequency Stability

Voltage (V)	Measurement Frequency (MHz)			
	5785 MHz			
	0 Minute	2 Minute	5 Minute	10 Minute
126.50	5785.0051	5785.0044	5785.0035	5785.0031
110.00	5785.0048	5785.0038	5785.0037	5785.0035
93.50	5785.0043	5785.0041	5785.0034	5785.0024
Max. Deviation (MHz)	0.0051	0.0044	0.0037	0.0035
Max. Deviation (ppm)	0.88	0.76	0.64	0.60
Result	Complies			

Temperature vs. Frequency Stability

Temperature (°C)	Measurement Frequency (MHz)			
	5785 MHz			
	0 Minute	2 Minute	5 Minute	10 Minute
-30	5785.0115	5785.0106	5785.0099	5785.0098
-20	5785.0103	5785.0094	5785.0088	5785.0086
-10	5785.0083	5785.0076	5785.0066	5785.0064
0	5785.0071	5785.0063	5785.0059	5785.0055
10	5785.0057	5785.0054	5785.0052	5785.0045
20	5785.0048	5785.0038	5785.0031	5785.0027
30	5785.0043	5785.0040	5785.0036	5785.0033
40	5785.0038	5785.0031	5785.0025	5785.0015
50	5785.0025	5785.0016	5785.0015	5785.0007
Max. Deviation (MHz)	0.0115	0.0106	0.0099	0.0098
Max. Deviation (ppm)	1.98	1.83	1.71	1.69
Result	Complies			

Mode: 40 MHz / Chain 1

Voltage vs. Frequency Stability

Voltage	Measurement Frequency (MHz)			
(V)	5755 MHz			
	0 Minute	2 Minute	5 Minute	10 Minute
126.50	5755.0054	5755.0044	5755.0039	5755.0037
110.00	5755.0052	5755.0051	5755.0044	5755.0043
93.50	5755.0044	5755.0037	5755.0031	5755.0027
Max. Deviation (MHz)	0.0054	0.0051	0.0044	0.0043
Max. Deviation (ppm)	0.94	0.89	0.77	0.75
Result	Complies			

Temperature vs. Frequency Stability

Temperature	Measurement Frequency (MHz)			
(°C)	5755 MHz			
	0 Minute	2 Minute	5 Minute	10 Minute
-30	5755.0008	5755.0005	5755.0000	5754.9993
-20	5755.0010	5755.0007	5754.9997	5754.9992
-10	5755.0019	5755.0009	5755.0005	5755.0004
0	5755.0035	5755.0033	5755.0031	5755.0028
10	5755.0037	5755.0028	5755.0020	5755.0013
20	5755.0052	5755.0043	5755.0035	5755.0033
30	5755.0062	5755.0052	5755.0051	5755.0049
40	5755.0082	5755.0076	5755.0071	5755.0064
50	5755.0088	5755.0086	5755.0082	5755.0077
Max. Deviation (MHz)	0.0088	0.0086	0.0082	0.0077
Max. Deviation (ppm)	1.53	1.50	1.43	1.34
Result	Complies			

Mode: 80 MHz / Chain 1

Voltage vs. Frequency Stability

Voltage	Measurement Frequency (MHz)			
(V)	5775 MHz			
	0 Minute	2 Minute	5 Minute	10 Minute
126.50	5775.0056	5775.0055	5775.0045	5775.0043
110.00	5775.0055	5775.0053	5775.0048	5775.0041
93.50	5775.0050	5775.0049	5775.0039	5775.0030
Max. Deviation (MHz)	0.0056	0.0055	0.0048	0.0043
Max. Deviation (ppm)	0.97	0.96	0.83	0.75
Result	Complies			

Temperature vs. Frequency Stability

Temperature	Measurement Frequency (MHz)			
(°C)	5775 MHz			
	0 Minute	2 Minute	5 Minute	10 Minute
-30	5774.9998	5774.9989	5774.9984	5774.9981
-20	5775.0014	5775.0007	5775.0005	5775.0002
-10	5775.0029	5775.0028	5775.0018	5775.0017
0	5775.0033	5775.0028	5775.0019	5775.0013
10	5775.0044	5775.0041	5775.0040	5775.0037
20	5775.0055	5775.0049	5775.0042	5775.0040
30	5775.0063	5775.0054	5775.0049	5775.0041
40	5775.0075	5775.0072	5775.0066	5775.0062
50	5775.0078	5775.0070	5775.0061	5775.0059
Max. Deviation (MHz)	0.0078	0.0072	0.0066	0.0062
Max. Deviation (ppm)	1.36	1.25	1.15	1.08
Result	Complies			

4.8. Antenna Requirements

4.8.1. Limit

Except for special regulations, the Low-power Radio-frequency Devices must not be equipped with any jacket for installing an antenna with extension cable. An intentional radiator shall be designed to ensure that no antenna other than that furnished by the responsible party shall be used with the device. The use of a permanently attached antenna or of an antenna that uses a unique coupling to the intentional radiator shall be considered sufficient to comply with the provisions of this Section. The manufacturer may design the unit so that the user can replace a broken antenna, but the use of a standard antenna jack or electrical connector is prohibited. Further, this requirement does not apply to intentional radiators that must be professionally installed.

4.8.2. Antenna Connector Construction

Please refer to section 3.3 in this test report; antenna connector complied with the requirements.

5. LIST OF MEASURING EQUIPMENTS

Instrument	Manufacturer	Model No.	Serial No.	Characteristics	Calibration Date	Remark
Horn Antenna	EMCO	3115	00075790	750MHz ~ 18GHz	Oct. 22, 2015	Radiation (03CH01-CB)
Horn Antenna	Schwarzbeck	BBHA 9170	BBHA9170252	15GHz ~ 40GHz	Jul. 21, 2015	Radiation (03CH01-CB)
Pre-Amplifier	Agilent	8449B	3008A02310	1GHz ~ 26.5GHz	Jan. 18, 2016	Radiation (03CH01-CB)
Pre-Amplifier	WM	TF-130N-R1	923365	26GHz ~ 40GHz	Nov. 13, 2015	Radiation (03CH01-CB)
Spectrum Analyzer	R&S	FSP40	100056	9kHz ~ 40GHz	Oct. 27, 2015	Radiation (03CH01-CB)
RF Cable-high	Woken	High Cable-16	N/A	1 GHz ~ 18 GHz	Nov. 02, 2015	Radiation (03CH01-CB)
RF Cable-high	Woken	High Cable-17	N/A	1 GHz ~ 18 GHz	Nov. 02, 2015	Radiation (03CH01-CB)
RF Cable-high	Woken	High Cable-40G-1	N/A	18GHz ~ 40 GHz	Nov. 02, 2015	Radiation (03CH01-CB)
RF Cable-high	Woken	High Cable-40G-2	N/A	18GHz ~ 40 GHz	Nov. 02, 2015	Radiation (03CH01-CB)
Test Software	Audix	E3	6.2009-10-7	N/A	N/A	Radiation (03CH01-CB)
Spectrum analyzer	R&S	FSV40	100979	9kHz~40GHz	Dec. 09, 2015	Conducted (TH01-CB)
Temp. and Humidity Chamber	Ten Billion	TTH-D3SP	TBN-931011	-30~100 degree	Jun. 02, 2015	Conducted (TH01-CB)
RF Cable-high	Woken	RG402	High Cable-6	1 GHz – 26.5 GHz	Nov. 02, 2015	Conducted (TH01-CB)
RF Cable-high	Woken	RG402	High Cable-7	1 GHz – 26.5 GHz	Nov. 02, 2015	Conducted (TH01-CB)
RF Cable-high	Woken	RG402	High Cable-8	1 GHz – 26.5 GHz	Nov. 02, 2015	Conducted (TH01-CB)
RF Cable-high	Woken	RG402	High Cable-9	1 GHz – 26.5 GHz	Nov. 02, 2015	Conducted (TH01-CB)
RF Cable-high	Woken	RG402	High Cable-10	1 GHz – 26.5 GHz	Nov. 02, 2015	Conducted (TH01-CB)
Power Sensor	Agilent	U2021XA	MY53410001	50MHz~18GHz	Nov. 02, 2015	Conducted (TH01-CB)

Note: Calibration Interval of instruments listed above is one year.

6. MEASUREMENT UNCERTAINTY

Test Items	Uncertainty	Remark
Radiated Emission (1GHz ~ 18GHz)	3.7 dB	Confidence levels of 95%
Radiated Emission (18GHz ~ 40GHz)	3.5 dB	Confidence levels of 95%
Conducted Emission	1.7 dB	Confidence levels of 95%