



# FCC TEST REPORT (15.407)

**REPORT NO.:** RF130725E01A-1

**MODEL NO.:** EA6900 V1.1

**FCC ID:** Q87-EA6900V11

**RECEIVED:** July 26, 2013

**TESTED:** July 26, 2013 to Jan. 17, 2014

**ISSUED:** Feb. 17, 2014

**APPLICANT:** Linksys LLC

**ADDRESS:** 131 Theory Drive Irvine California 92617  
United States

**ISSUED BY:** Bureau Veritas Consumer Products Services  
(H.K.) Ltd., Taoyuan Branch Hsin Chu Laboratory

**LAB ADDRESS :** No. 81-1, Lu Liao Keng, 9th Ling, Wu Lung Tsuen,  
Chiung Lin Hsiang, Hsin Chu Hsien 307, Taiwan,  
R.O.C.

**TEST LOCATION (1):** No. 81-1, Lu Liao Keng, 9th Ling, Wu Lung Tsuen,  
Chiung Lin Hsiang, Hsin Chu Hsien 307, Taiwan,  
R.O.C.

**TEST LOCATION (2):** No. 49, Ln. 206, Wende Rd., Shangshan Tsuen,  
Chiung Lin Hsiang, Hsin Chu Hsien 307, Taiwan,  
R.O.C.

This report should not be used by the client to claim product certification, approval, or endorsement by TAF or any government agencies.



This report is for your exclusive use. Any copying or replication of this report to or for any other person or entity, or use of our name or trademark, is permitted only with our prior written permission. This report sets forth our findings solely with respect to the test samples identified herein. The results set forth in this report are not indicative or representative of the quality or characteristics of the lot from which a test sample was taken or any similar or identical product unless specifically and expressly noted. Our report includes all of the tests requested by you and the results thereof based upon the information that you provided to us. You have 60 days from date of issuance of this report to notify us of any material error or omission caused by our negligence, provided, however, that such notice shall be in writing and shall specifically address the issue you wish to raise. A failure to raise such issue within the prescribed time shall constitute your unqualified acceptance of the completeness of this report, the tests conducted and the correctness of the report contents. Unless specific mention, the uncertainty of measurement has been explicitly taken into account to declare the compliance or non-compliance to the specification



A D T

## Table of Contents

RELEASE CONTROL RECORD .....	4
1. CERTIFICATION .....	5
2. SUMMARY OF TEST RESULTS .....	6
2.1 MEASUREMENT UNCERTAINTY .....	7
3. GENERAL INFORMATION .....	8
3.1 GENERAL DESCRIPTION OF EUT .....	8
3.2 DESCRIPTION OF TEST MODES .....	12
3.2.1 TEST MODE APPLICABILITY AND TESTED CHANNEL DETAIL .....	13
3.3 GENERAL DESCRIPTION OF APPLIED STANDARDS .....	15
3.4 DUTY CYCLE OF TEST SIGNAL .....	16
3.5 DESCRIPTION OF SUPPORT UNITS.....	20
3.6 CONFIGURATION OF SYSTEM UNDER TEST.....	21
4. TEST TYPES AND RESULTS .....	23
4.1 CONDUCTED EMISSION MEASUREMENT .....	23
4.1.1 LIMITS OF CONDUCTED EMISSION MEASUREMENT .....	23
4.1.2 TEST INSTRUMENTS.....	23
4.1.3 TEST PROCEDURES .....	24
4.1.4 DEVIATION FROM TEST STANDARD .....	24
4.1.5 TEST SETUP .....	24
4.1.6 EUT OPERATING CONDITIONS .....	25
4.1.7 TEST RESULTS (MODE 1) .....	26
4.1.8 TEST RESULTS (MODE 2) .....	28
4.2 RADIATED EMISSION AND BANDEDGE MEASUREMENT .....	30
4.2.1 LIMITS OF RADIATED EMISSION AND BANDEDGE MEASUREMENT.....	30
4.2.2 LIMITS OF UNWANTED EMISSION OUT OF THE RESTRICTED BANDS.....	30
4.2.3 TEST INSTRUMENTS.....	31
4.2.4 TEST PROCEDURES .....	32
4.2.5 DEVIATION FROM TEST STANDARD .....	32
4.2.6 TEST SETUP .....	33
4.2.7 EUT OPERATING CONDITION.....	33
4.2.8 TEST RESULTS (MODE 1) .....	34
4.2.9 TEST RESULTS (MODE 2) .....	47
4.3 TRANSMIT POWER MEASUREMENT .....	50
4.3.1 LIMITS OF TRANSMIT POWER MEASUREMENT .....	50
4.3.2 TEST INSTRUMENTS.....	51
4.3.3 TEST PROCEDURE.....	51
4.3.4 DEVIATION FROM TEST STANDARD .....	52
4.3.5 TEST SETUP .....	52
4.3.6 EUT OPERATING CONDITIONS .....	52



A D T

4.3.7	TEST RESULTS (MODE 1) .....	53
4.3.8	TEST RESULTS (MODE 2) .....	56
4.4	PEAK POWER SPECTRAL DENSITY MEASUREMENT .....	57
4.4.1	LIMITS OF PEAK POWER SPECTRAL DENSITY MEASUREMENT .....	57
4.4.2	TEST INSTRUMENTS.....	57
4.4.3	TEST PROCEDURES .....	57
4.4.4	DEVIATION FROM TEST STANDARD .....	57
4.4.5	TEST SETUP .....	57
4.4.6	EUT OPERATING CONDITIONS .....	58
4.4.7	TEST RESULTS (MODE 1) .....	59
4.4.8	TEST RESULTS (MODE 2) .....	63
4.5	PEAK POWER EXCURSION MEASUREMENT .....	64
4.5.1	LIMITS OF PEAK POWER EXCURSION MEASUREMENT .....	64
4.5.2	TEST INSTRUMENTS.....	64
4.5.3	TEST PROCEDURE.....	64
4.5.4	DEVIATION FROM TEST STANDARD .....	64
4.5.5	TEST SETUP .....	64
4.5.6	EUT OPERATING CONDITIONS .....	64
4.5.7	TEST RESULTS (MODE 1) .....	65
4.5.8	TEST RESULTS (MODE 2) .....	71
4.6	FREQUENCY STABILITY.....	72
4.6.1	LIMITS OF FREQUENCY STABILITY MEASUREMENT .....	72
4.6.2	TEST INSTRUMENTS.....	72
4.6.3	TEST PROCEDURE.....	72
4.6.4	DEVIATION FROM TEST STANDARD .....	73
4.6.5	TEST SETUP .....	73
4.6.6	EUT OPERATING CONDITION.....	73
4.6.7	TEST RESULTS .....	74
5.	PHOTOGRAPHS OF THE TEST CONFIGURATION.....	75
6.	INFORMATION ON THE TESTING LABORATORIES .....	76
7.	APPENDIX A - MODIFICATIONS RECORDERS FOR ENGINEERING CHANGES TO THE EUT BY THE LAB.....	77



A D T

## RELEASE CONTROL RECORD

ISSUE NO.	REASON FOR CHANGE	DATE ISSUED
RF130725E01A-1	Original release	Feb. 17, 2014



## 1. CERTIFICATION

**PRODUCT:** Linksys Smart Wi-Fi Router AC1900  
**BRAND NAME:** Linksys  
**MODEL NO.:** EA6900 V1.1  
**TEST SAMPLE:** ENGINEERING SAMPLE  
**APPLICANT:** Linksys LLC  
**TESTED:** July 26, 2013 to Jan. 17, 2014  
**STANDARDS:** FCC Part 15, Subpart E (Section 15.407)  
ANSI C63.10-2009

The above equipment (Model: EA6900 V1.1) has been tested by **Bureau Veritas Consumer Products Services (H.K.) Ltd., Taoyuan Branch**, and found compliance with the requirement of the above standards. The test record, data evaluation & Equipment Under Test (EUT) configurations represented herein are true and accurate accounts of the measurements of the sample's EMC characteristics under the conditions specified in this report.

**PREPARED BY :** Phoenix Huang , **DATE:** Feb. 17, 2014  
( Phoenix Huang, Specialist )

**APPROVED BY :** May Chen , **DATE:** Feb. 17, 2014  
( May Chen, Manager )



A D T

## 2. SUMMARY OF TEST RESULTS

The EUT has been tested according to the following specifications:

For 5GHz, 5150~5250MHz

APPLIED STANDARD: FCC PART 15, SUBPART E (SECTION 15.407)			
STANDARD SECTION	TEST TYPE	RESULT	REMARK
15.407(b)(6)	AC Power Conducted Emission	PASS	Meet the requirement of limit. Minimum passing margin is -7.39dB at 0.15781MHz
15.407(b/1/2/3) (b)(6)	Spurious Emissions	PASS	Meet the requirement of limit. Minimum passing margin is -0.2dB at 5101.20MHz
15.407(a/1/2)	Transmit Power	PASS	Meet the requirement of limit.
15.407(a)(6)	Peak Power Excursion	PASS	Meet the requirement of limit.
15.407(a/1/2)	Peak Power Spectral Density	PASS	Meet the requirement of limit.
15.407(g)	Frequency Stability	PASS	Meet the requirement of limit.
15.203	Antenna Requirement	PASS	Antenna connector is R-SMA not a standard connector.

**NOTE:** 1. For WLAN: The EUT was operating in 2.400 ~ 2.4835GHz, 5.15~5.25GHz and 5.725~5.850GHz frequencies band. This report was recorded the RF parameters including 5.15~5.25GHz. For the 2.400 ~ 2.4835GHz and 5.725~5.850GHz RF parameters was recorded in another test report.



A D T

## 2.1 MEASUREMENT UNCERTAINTY

Where relevant, the following measurement uncertainty levels have been estimated for tests performed on the EUT as specified in CISPR 16-4-2:

This uncertainty represents an expanded uncertainty expressed at approximately the 95% confidence level using a coverage factor of  $k=2$ .

Measurement	Value
Conducted emissions	2.98 dB
Radiated emissions (30MHz-1GHz)	4.53 dB
Radiated emissions (1GHz -6GHz)	3.72 dB
Radiated emissions (6GHz -18GHz)	4.00 dB
Radiated emissions (18GHz -40GHz)	4.11 dB



A D T

### 3. GENERAL INFORMATION

#### 3.1 GENERAL DESCRIPTION OF EUT

<b>PRODUCT</b>	Linksys Smart Wi-Fi Router AC1900
<b>MODEL NO.</b>	EA6900 V1.1
<b>POWER SUPPLY</b>	DC 12V from power adapter
<b>MODULATION TYPE</b>	CCK, DQPSK, DBPSK for DSSS 64QAM, 16QAM, QPSK, BPSK for OFDM 256QAM for OFDM in 11ac mode and 11n (HT40) mode of 2.4GHz Band.
<b>MODULATION TECHNOLOGY</b>	DSSS,OFDM
<b>TRANSFER RATE</b>	802.11b: up to 11Mbps 802.11a / g: up to 54Mbps 802.11n: up to 450Mbps(HT40), up to 600Mbps(VHT40) 802.11ac: up to 1300Mbps
<b>OPERATING FREQUENCY</b>	<b>For 15.407</b> <b>5GHz:</b> 5.18 ~ 5.24GHz <b>For 15.247</b> <b>2.4GHz:</b> 2.412 ~ 2.462GHz <b>5GHz:</b> 5.745 ~ 5.825GHz
<b>NUMBER OF CHANNEL</b>	<b>For 15.407</b> 4 for 802.11a, 802.11n (HT20), 802.11ac (VHT20) 2 for 802.11n (HT40), 802.11ac (VHT40) 1 for 802.11ac (VHT80) <b>For 15.247 (2.4GHz)</b> 11 for 802.11b, 802.11g, 802.11n(HT20), 802.11n_256QAM(VHT20) 7 for 802.11n(HT40), 802.11n_256QAM(VHT40) <b>For 15.247 (5GHz)</b> 5 for 802.11a, 802.11n (HT20), 802.11ac (VHT20) 2 for 802.11n (HT40), 802.11ac (VHT40) 1 for 802.11ac (VHT80)
<b>MAXIMUM OUTPUT POWER</b>	Please see NOTE





A D T

<b>ANTENNA TYPE</b>	Please see NOTE
<b>DATA CABLE</b>	NA
<b>I/O PORTS</b>	Refer to user's manual
<b>ASSOCIATED DEVICES</b>	Adapter x1

**NOTE:**

1. The EUT is a 2.4GHz & 5GHz WLAN device.
2. The maximum output power table as below table:

<b>MAXIMUM OUTPUT POWER (mW)</b>											
<b>15.247 (2.4GHz)</b>											
<b>Test Mode</b>	<b>802.11b</b>	<b>802.11g</b>			<b>802.11n (HT20)</b>			<b>802.11n (HT40)</b>			
<b>1Tx</b>	497.737	454.988									
<b>3Tx</b>					<b>CDD</b>	<b>STBC</b>	<b>Beam forming</b>	<b>CDD</b>	<b>STBC</b>	<b>Beam forming</b>	
					986.826	986.826	986.826	336.396	417.997	336.396	
<b>15.247 (5GHz)</b>											
<b>Test Mode</b>	<b>802.11a</b>	<b>802.11ac (VHT20)</b>			<b>802.11ac (VHT40)</b>			<b>802.11ac (VHT80)</b>			
<b>1Tx</b>	409.261										
<b>3Tx</b>			<b>CDD</b>	<b>STBC</b>	<b>Beam forming</b>	<b>CDD</b>	<b>STBC</b>	<b>Beam forming</b>	<b>CDD</b>	<b>STBC</b>	<b>Beam forming</b>
			957.686	957.686	747.871	934.916	934.916	739.090	457.400	457.400	457.400
<b>15.407</b>											
<b>Test Mode</b>	<b>802.11a</b>	<b>802.11ac (VHT20)</b>			<b>802.11ac (VHT40)</b>			<b>802.11ac (VHT80)</b>			
<b>1Tx</b>	44.361										
<b>3Tx</b>			<b>CDD</b>	<b>STBC</b>	<b>Beam forming</b>	<b>CDD</b>	<b>STBC</b>	<b>Beam forming</b>	<b>CDD</b>	<b>STBC</b>	<b>Beam forming</b>
			44.417	44.417	44.417	45.834	45.834	45.834	40.331	47.399	40.331



3. The EUT has two different RJ45 XFRM Transformer types could be chosen and please refer the below table:

Type 1(Vendor: MINGTEK)			
Vendor P/N	Different	Vendor	Location
HN1878CG	TRANSFORMER VARIABLE COILS,DIP,350UH,HN1878CG	MINGTEK	T1
HN3678CG	TRANSFORMER VARIABLE COILS,DIP,350UH,HN3678CG	MINGTEK	T2, T3
Type 2(Vendor: MYJWD)			
Vendor P/N	Different	Vendor	Location
DG18107-1 G	TRANSFORMER,DIP,350UH,16.8*8.5*1 1.85MM,18PIN,DG18107-1 G	MYJWD	T1
DG36005-1 G	TRANSFORMER,DIP,350UH,32.7*8.5*1 1.85MM,36PIN	MYJWD	T2, T3

From the above types, the worst case was found in **Type 2(Vendor: MYJWD)**. Therefore only the test data of the type were recorded in this report.

4. The EUT must be supplied with a power adapter and following two different model names could be chosen:

No.	Brand	Model No.	Spec.
1	Ktec	KSAS0451200350HU	AC Input : 100-240V, 1.2A, 50-60Hz DC Output : 12V, 3.5A DC output cable(unshielded ,1.5m)
2	LEI	MU42-1120350-A1	AC Input : 100-240V, 1.5A, 50-60Hz DC Output : 12V, 3.5A DC output cable(unshielded ,1.5m)

From the above adapters, the worst radiated emission was found in **Adapter 2**. Therefore only the test data of the modes were recorded in this report.

5. The antennas provided to the EUT, please refer to the following table:

Transmitter Circuit	Brand	Antenna Type	Peak Gain(dBi) (Include cable loss )		Connector Type	Cable Loss (dB)	Cable Length (mm)
			For 2.4GHz (2.4GHz to 2.4835GHz)	For 5GHz (Band 1: 5.15 to 5.25GHz Band 4: 5.725 to 5.85GHz)			
Right Side Chain (0)	Galtronics	Dipole	1.3	5G Band1: 0.87 5G Band4: 1.95	R-SMA	NA	168
In center Chain (1)	Galtronics	Dipole	1.1	5G Band1: 0.47 5G Band4: 1.55	R-SMA	NA	262
Left Side Chain (2)	Galtronics	Dipole	1.1	5G Band1: 0.47 5G Band4: 1.55	R-SMA	NA	260

Note: From the above antennas, Chain (0) was selected as representative antenna for the 802.11a/b/g test and its data was recorded in this report.

6. The specifications of EUT listed as below:

<b>MODULATION MODE</b>	<b>TX/RX FUNCTION</b>
<b>802.11b</b>	1TX (Diversity) /3RX
<b>802.11g</b>	1TX (Diversity) /3RX
<b>802.11n (HT20)</b>	3TX/3RX (CDD Mode)
	3TX/3RX (STBC Mode)
	3TX/3RX (Beam forming Mode)
<b>802.11n (HT40)</b>	3TX/3RX (CDD Mode)
	3TX/3RX (STBC Mode)
	3TX/3RX (Beam forming Mode)
<b>802.11a</b>	1TX (Diversity) /3RX
<b>802.11ac (VHT20)</b>	3TX/3RX (CDD Mode)
	3TX/3RX (STBC Mode)
	3TX/3RX (Beam forming Mode)
<b>802.11ac (VHT40)</b>	3TX/3RX (CDD Mode)
	3TX/3RX (STBC Mode)
	3TX/3RX (Beam forming Mode)
<b>802.11ac (VHT80)</b>	3TX/3RX (CDD Mode)
	3TX/3RX (STBC Mode)
	3TX/3RX (Beam forming Mode)

Note: The modulation and bandwidth are similar for 802.11n mode for 20MHz (40MHz) and 802.11ac mode for 20MHz (40MHz), therefore investigated worst case to representative mode in test report. (Final test mode refer section 3.2.1)

7. When the EUT operating in 802.11n, the software operation, which is defined by manufacturer, MCS (Modulation and Coding Schemes) from 0 to 23.
8. When the EUT operating in 802.11ac and support 256QAM of VHT40 for 2.4GHz band, the software operation, which is defined by manufacturer, MCS (Modulation and Coding Schemes) from 0 to 9.
9. The above EUT information was declared by the manufacturer and for more detailed features description, please refer to the manufacturer's specifications or User's Manual.



A D T

### 3.2 DESCRIPTION OF TEST MODES

#### Operated in 5150 ~ 5350MHz band:

4 channels are provided for 802.11a, 802.11n (HT20), 802.11ac (VHT20):

CHANNEL	FREQUENCY	CHANNEL	FREQUENCY
36	5180 MHz	44	5220 MHz
40	5200 MHz	48	5240 MHz

2 channels are provided for 802.11n (HT40), 802.11ac (VHT40):

CHANNEL	FREQUENCY
38	5190 MHz
46	5230 MHz

1 channel is provided for 802.11ac (VHT80):

CHANNEL	FREQUENCY
42	5210 MHz

### 3.2.1 TEST MODE APPLICABILITY AND TESTED CHANNEL DETAIL

EUT CONFIGURE MODE	APPLICABLE TO				DESCRIPTION
	PLC	RE < 1G	RE ≥ 1G	APCM	
1	√	√	√	√	3TX configuration (with Adapter 2)
2	√	-	-	-	3TX configuration (with Adapter 1)
	-	√	√	√	1TX configuration (with Adapter 2)

Where **PLC**: Power Line Conducted Emission      **RE < 1G**: Radiated Emission below 1GHz  
**RE ≥ 1G**: Radiated Emission above 1GHz      **APCM**: Antenna Port Conducted Measurement

**Notes:**

1. The EUT had been pre-tested on the positioned of each 2 axis. The worst case was found when positioned on **X-plane**.

**POWER LINE CONDUCTED EMISSION TEST:**

- Pre-Scan has been conducted to determine the worst-case mode from all possible combinations between available modulations, data rates and antenna ports (if EUT with antenna diversity architecture).
- Following channel(s) was (were) selected for the final test as listed below.

3TX CONFIGURATION					
CDD_MODE	AVAILABLE CHANNEL	TESTED CHANNEL	MODULATION TECHNOLOGY	MODULATION TYPE	DATA RATE (MBPS)
802.11n (HT40)	38 to 46	38	OFDM	BPSK	13.5

**RADIATED EMISSION TEST (BELOW 1 GHz):**

- Pre-Scan has been conducted to determine the worst-case mode from all possible combinations between available modulations, data rates and antenna ports (if EUT with antenna diversity architecture).
- Following channel(s) was (were) selected for the final test as listed below.

3TX CONFIGURATION					
CDD_MODE	AVAILABLE CHANNEL	TESTED CHANNEL	MODULATION TECHNOLOGY	MODULATION TYPE	DATA RATE (MBPS)
802.11ac (VHT40)	38 to 46	38	OFDM	BPSK	13.5



**RADIATED EMISSION TEST (ABOVE 1 GHz):**

- Pre-Scan has been conducted to determine the worst-case mode from all possible combinations between available modulations, data rates and antenna ports (if EUT with antenna diversity architecture).
- Following channel(s) was (were) selected for the final test as listed below.

3TX CONFIGURATION					
CDD & STBC_MODE	AVAILABLE CHANNEL	TESTED CHANNEL	MODULATION TECHNOLOGY	MODULATION TYPE	DATA RATE (Mbps)
802.11ac (VHT20)	36 to 48	36, 40, 48	OFDM	BPSK	6.5
802.11ac (VHT40)	38 to 46	38, 46	OFDM	BPSK	13.5
802.11ac (VHT80)	42	42	OFDM	BPSK	29.3
1TX CONFIGURATION					
MODE	AVAILABLE CHANNEL	TESTED CHANNEL	MODULATION TECHNOLOGY	MODULATION TYPE	DATA RATE (Mbps)
802.11a	36 to 48	36, 40, 48	OFDM	BPSK	6

**ANTENNA PORT CONDUCTED MEASUREMENT:**

- Pre-Scan has been conducted to determine the worst-case mode from all possible combinations between available modulations, data rates and antenna ports (if EUT with antenna diversity architecture).
- Following channel(s) was (were) selected for the final test as listed below.

3TX CONFIGURATION					
CDD, STBC & Beam forming_MODE	AVAILABLE CHANNEL	TESTED CHANNEL	MODULATION TECHNOLOGY	MODULATION TYPE	DATA RATE (Mbps)
802.11ac (VHT20)	36 to 48	36, 40, 48	OFDM	BPSK	6.5
802.11ac (VHT40)	38 to 46	38, 46	OFDM	BPSK	13.5
802.11ac (VHT80)	42	42	OFDM	BPSK	29.3
1TX CONFIGURATION					
MODE	AVAILABLE CHANNEL	TESTED CHANNEL	MODULATION TECHNOLOGY	MODULATION TYPE	DATA RATE (Mbps)
802.11a	36 to 48	36, 40, 48	OFDM	BPSK	6

**TEST CONDITION:**

APPLICABLE TO	ENVIRONMENTAL CONDITIONS	INPUT POWER	TESTED BY
PLC	26deg. C, 66%RH	120Vac, 60Hz	JyunChun Lin
RE<1G	22deg. C, 73%RH	120Vac, 60Hz	Andy Ho
RE≥1G	21deg. C, 67%RH	120Vac, 60Hz	Chilin Lee
APCM	25deg. C, 60%RH	120Vac, 60Hz	Robert Cheng

### 3.3 GENERAL DESCRIPTION OF APPLIED STANDARDS

The EUT is a RF product. According to the specifications of the manufacturer, it must comply with the requirements of the following standards:

**FCC Part 15, Subpart E (15.407)**

**789033 D01 General UNII Test Procedures v01 r03**

**662911 D01 Multiple Transmitter Output v02**

**ANSI C63.10-2009**

All test items have been performed and recorded as per the above standards.

**Note:** The EUT has been verified to comply with the requirements of FCC Part 15, Subpart B, Class B (DoC). The test report has been issued separately.

### 3.4 DUTY CYCLE OF TEST SIGNAL

If duty cycle of test signal is  $\geq 98\%$ , duty factor is not required.

If duty cycle of test signal is  $< 98\%$ , duty factor shall be considered.

#### 802.11a

**BPSK:** Duty cycle =  $2.056 \text{ ms} / 2.082 \text{ ms} = 0.988$

**QPSK:** Duty cycle =  $1.042 \text{ ms} / 1.062 \text{ ms} = 0.981$

**16QAM:** Duty cycle =  $0.533 \text{ ms} / 0.558 \text{ ms} = 0.955$ , Duty factor =  $10 * \log(1/0.955) = 0.2$

**64QAM:** Duty cycle =  $0.276 \text{ ms} / 0.294 \text{ ms} = 0.939$ , Duty factor =  $10 * \log(1/0.939) = 0.27$

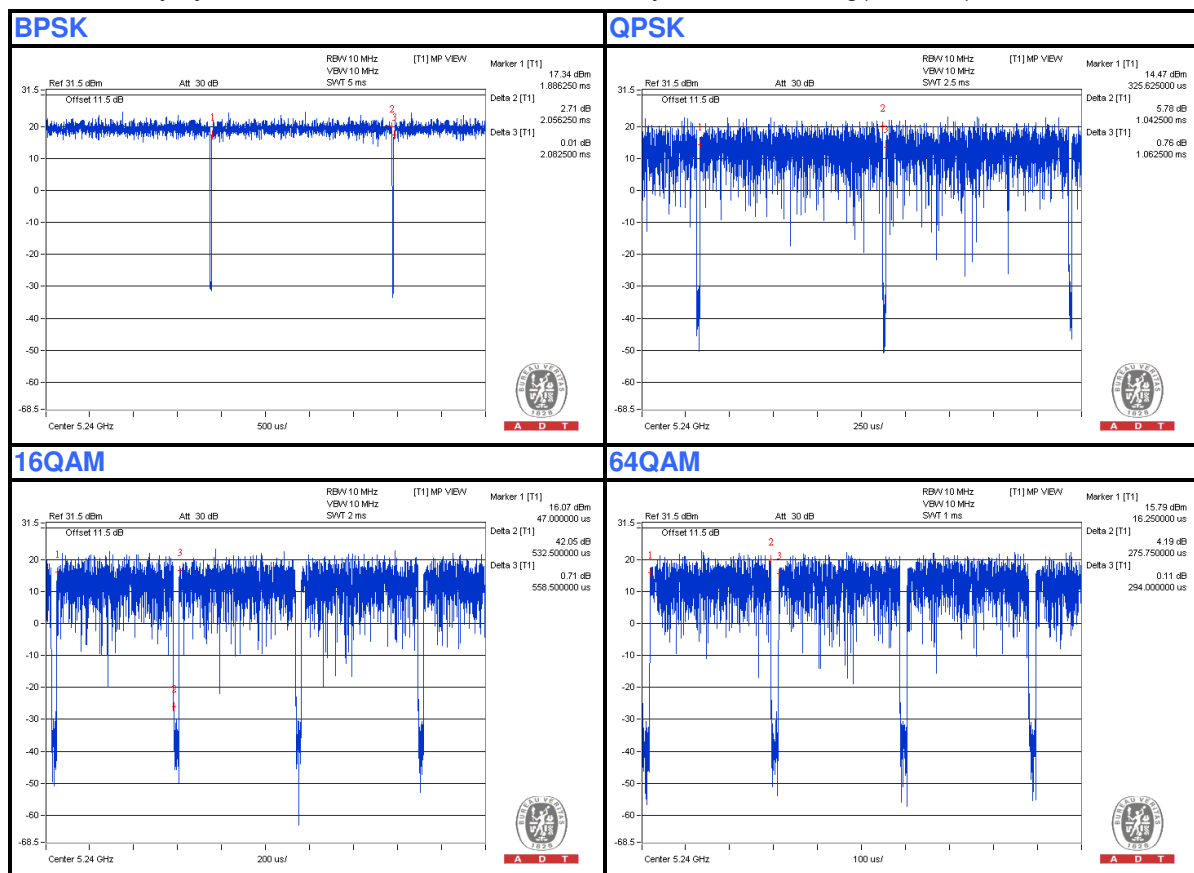





A D T

### 802.11ac (VHT20)

**BPSK:** Duty cycle = 1.919 ms/1.946 ms = 0.986

**QPSK:** Duty cycle = 0.982 ms/1.002 ms = 0.98

**16QAM:** Duty cycle = 0.512 ms/0.531 ms = 0.964, Duty factor =  $10 * \log(1/0.964) = 0.16$

**64QAM:** Duty cycle = 0.275 ms/0.294 ms = 0.935, Duty factor =  $10 * \log(1/0.935) = 0.29$

**256QAM:** Duty cycle = 0.199 ms/0.22 ms = 0.913, Duty factor =  $10 * \log(1/0.913) = 0.4$

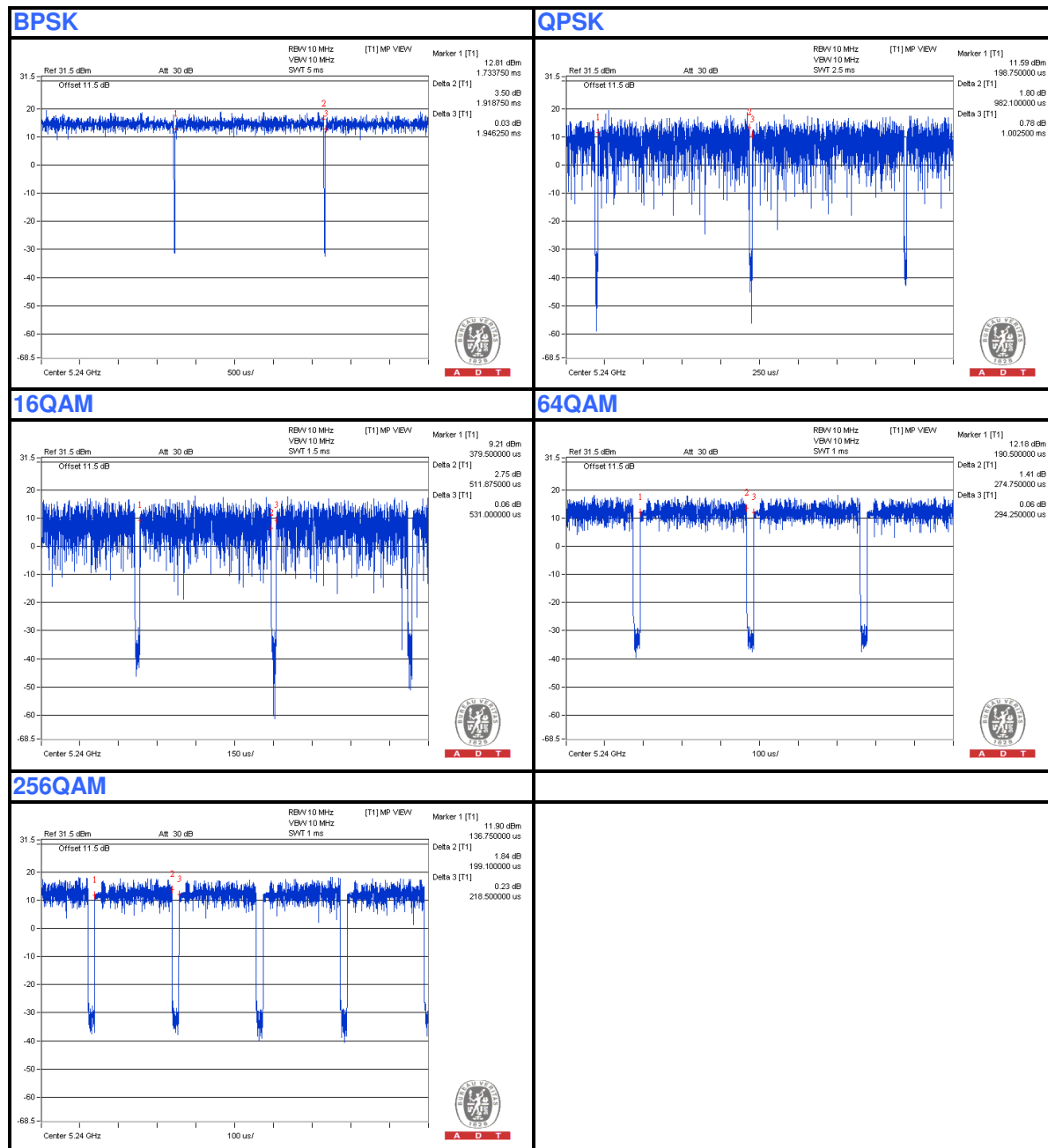



A D T

### 802.11ac (VHT40)

**BPSK:** Duty cycle = 0.954 ms/0.971 ms = 0.982

**QPSK:** Duty cycle = 0.495 ms/0.515 ms = 0.961, Duty factor =  $10 * \log(1/0.961) = 0.17$

**16QAM:** Duty cycle = 0.267 ms/0.286 ms = 0.934, Duty factor =  $10 * \log(1/0.934) = 0.3$

**64QAM:** Duty cycle = 0.156 ms/0.174 ms = 0.897, Duty factor =  $10 * \log(1/0.897) = 0.47$

**256QAM:** Duty cycle = 0.116 ms/0.13 ms = 0.866, Duty factor =  $10 * \log(1/0.866) = 0.63$

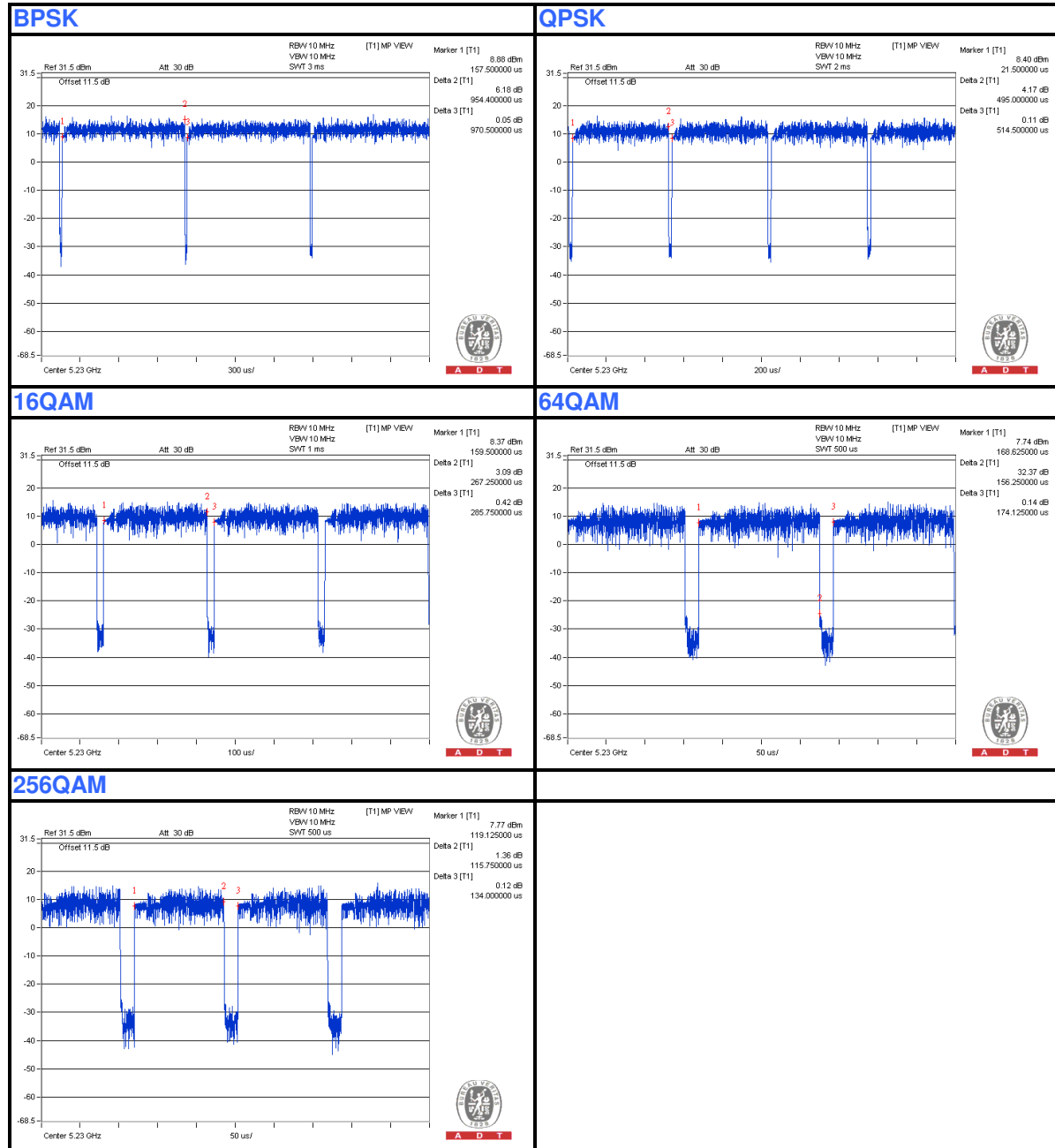



A D T

### 802.11ac (VHT80)

**BPSK:** Duty cycle = 0.46 ms/0.478 ms = 0.962, Duty factor =  $10 * \log(1/0.962) = 0.17$

**QPSK:** Duty cycle = 0.457 ms/0.478 ms = 0.956, Duty factor =  $10 * \log(1/0.956) = 0.2$

**16QAM:** Duty cycle = 0.148 ms/0.166 ms = 0.892, Duty factor =  $10 * \log(1/0.892) = 0.5$

**64QAM:** Duty cycle = 0.096 ms/0.114 ms = 0.842, Duty factor =  $10 * \log(1/0.842) = 0.75$

**256QAM:** Duty cycle = 0.076 ms/0.09 ms = 0.809, Duty factor =  $10 * \log(1/0.809) = 0.92$

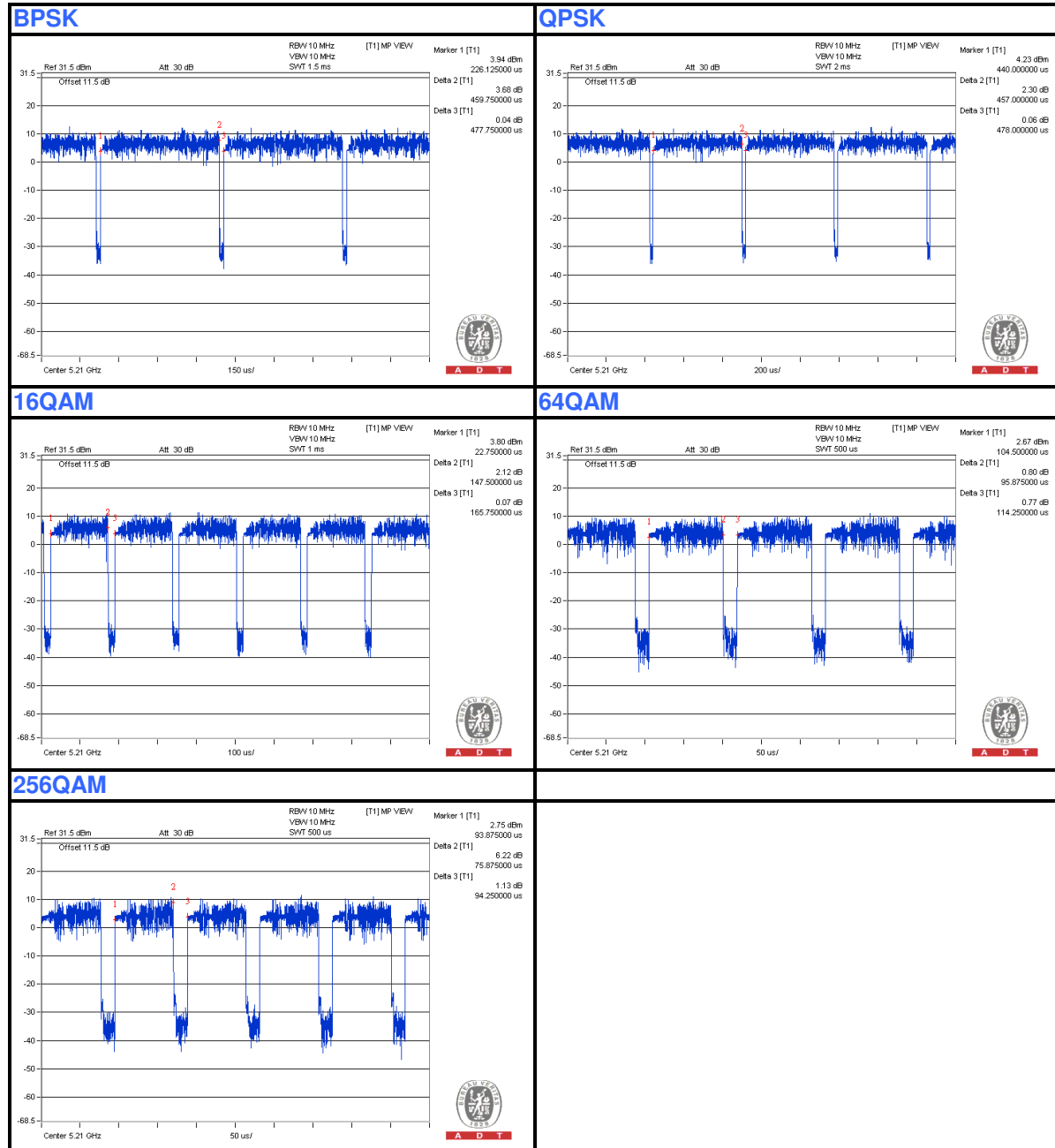



A D T

### 3.5 DESCRIPTION OF SUPPORT UNITS

The EUT has been tested as an independent unit together with other necessary accessories or support units. The following support units or accessories were used to form a representative test configuration during the tests.

NO.	PRODUCT	BRAND	MODEL NO.	SERIAL NO.	FCC ID
1	NOTEBOOK COMPUTER	DELL	PP32LA	FSLB32S	FCC DoC
2	NOTEBOOK COMPUTER	DELL	PP32LA	GSLB32S	FCC DoC
3	HUB	ZyXEL	ES-116P	S060H0200021 5	FCC DoC
4	iPod shuffle	Apple	MC749TA/A	CC4DMFJUDFD M	NA
5	External Hard Drive (for other test items)	WD	WDBACW0010H BK-SESN	WCAZAL62578 7	FCC DoC
	HDD (for conducted test)	WD	WDBACW0010H BK-SESN	WXK1A51E581 9	FCC DoC

NO.	SIGNAL CABLE DESCRIPTION OF THE ABOVE SUPPORT UNITS
1	UTP cable, 10m
2	UTP cable, 10m
3	UTP cable, 10m
4	USB cable, 0.1m
5	USB cable, 0.5m (for other test items)
	USB cable, 0.6m (for conducted test)

**NOTE:** All power cords of the above support units are non shielded (1.8m).

### 3.6 CONFIGURATION OF SYSTEM UNDER TEST

For Conducted Emission Test:

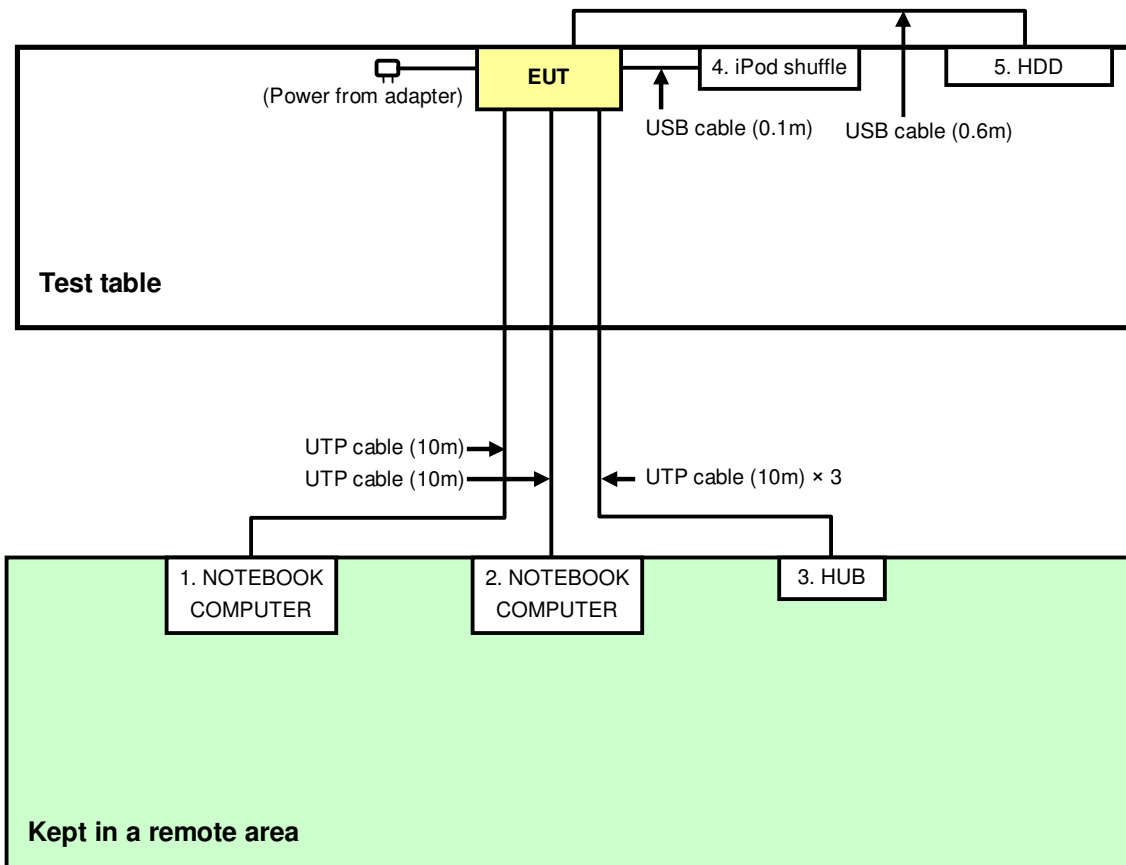

For other test items:

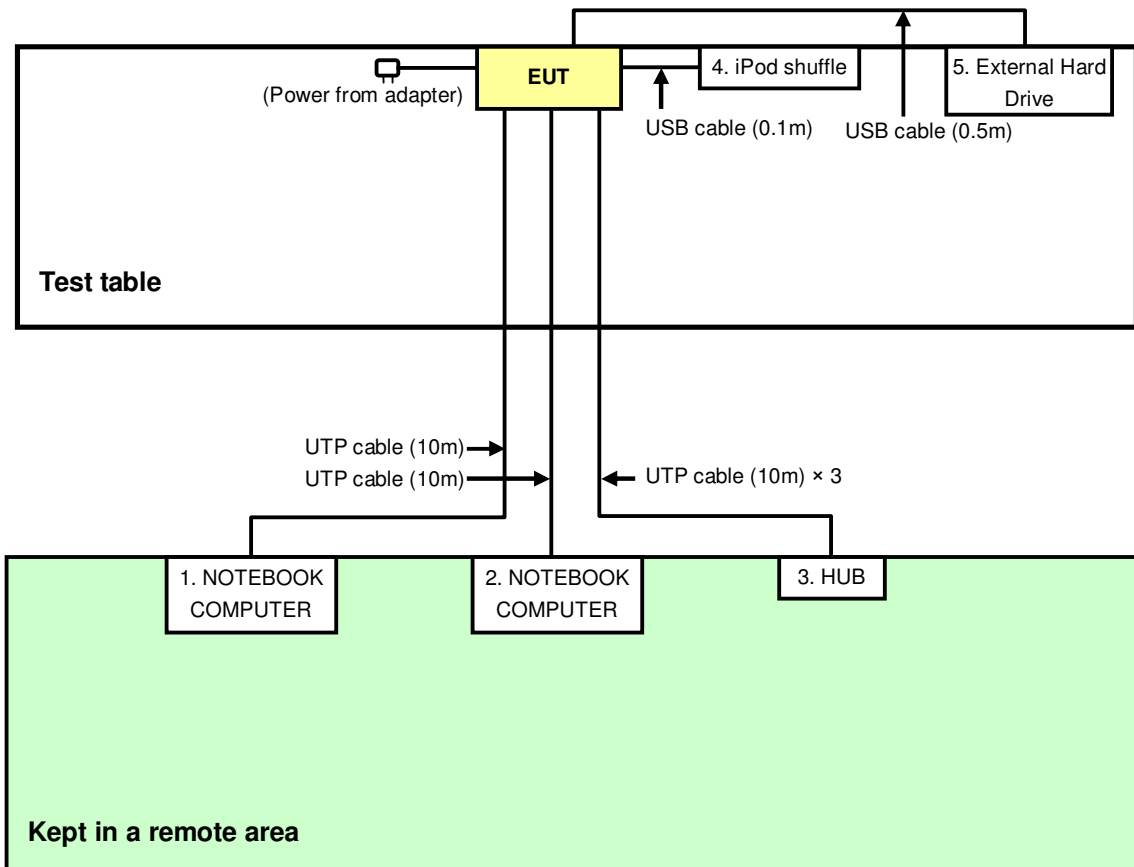



A D T

## 4. TEST TYPES AND RESULTS

### 4.1 CONDUCTED EMISSION MEASUREMENT

#### 4.1.1 LIMITS OF CONDUCTED EMISSION MEASUREMENT

FREQUENCY OF EMISSION (MHz)	CONDUCTED LIMIT (dB $\mu$ V)	
	Quasi-peak	Average
0.15-0.5	66 to 56	56 to 46
0.5-5	56	46
5-30	60	50

- NOTE:** 1. The lower limit shall apply at the transition frequencies.  
2. The limit decreases in line with the logarithm of the frequency in the range of 0.15 to 0.50 MHz.

#### 4.1.2 TEST INSTRUMENTS

DESCRIPTION & MANUFACTURER	MODEL NO.	SERIAL NO.	CALIBRATED DATE	CALIBRATED UNTIL
Test Receiver ROHDE & SCHWARZ	ESCS 30	100375	Mar. 08, 2013	Mar. 07, 2014
Line-Impedance Stabilization Network (for EUT) SCHWARZBECK	NSLK8127	8127-522	Sep. 06, 2012	Sep. 05, 2013
Line-Impedance Stabilization Network (for Peripheral)	ENV216	100072	June 07, 2013	June 06, 2014
RF Cable (JYEBAO)	5DFB	COCCAB-001	Mar. 11, 2013	Mar. 10, 2014
50 ohms Terminator	50	EMC-3	Sep. 25, 2012	Sep. 24, 2013
Software ADT	BV ADT_Cond_V7.3.7. 3	NA	NA	NA

**Note:**

1. The calibration interval of the above test instruments is 12 months and the calibrations are traceable to NML/ROC and NIST/USA.
2. The test was performed in Shielded Room No. C.
3. The VCCI Con C Registration No. is C-3611.
4. Tested Date: July 26, 2013

### 4.1.3 TEST PROCEDURES

- a. The EUT was placed 0.4 meters from the conducting wall of the shielded room with EUT being connected to the power mains through a line impedance stabilization network (LISN). Other support units were connected to the power mains through another LISN.
- b. The two LISNs provide 50 ohm/ 50uH of coupling impedance for the measuring instrument.
- c. Both lines of the power mains connected to the EUT were checked for maximum conducted interference.
- d. The frequency range from 150kHz to 30MHz was searched. Emission level under (Limit – 20dB) was not recorded.

#### NOTE:

1. The resolution bandwidth of test receiver is 9kHz for Quasi-peak detection (QP) & Average detection (AV).

### 4.1.4 DEVIATION FROM TEST STANDARD

No deviation

### 4.1.5 TEST SETUP

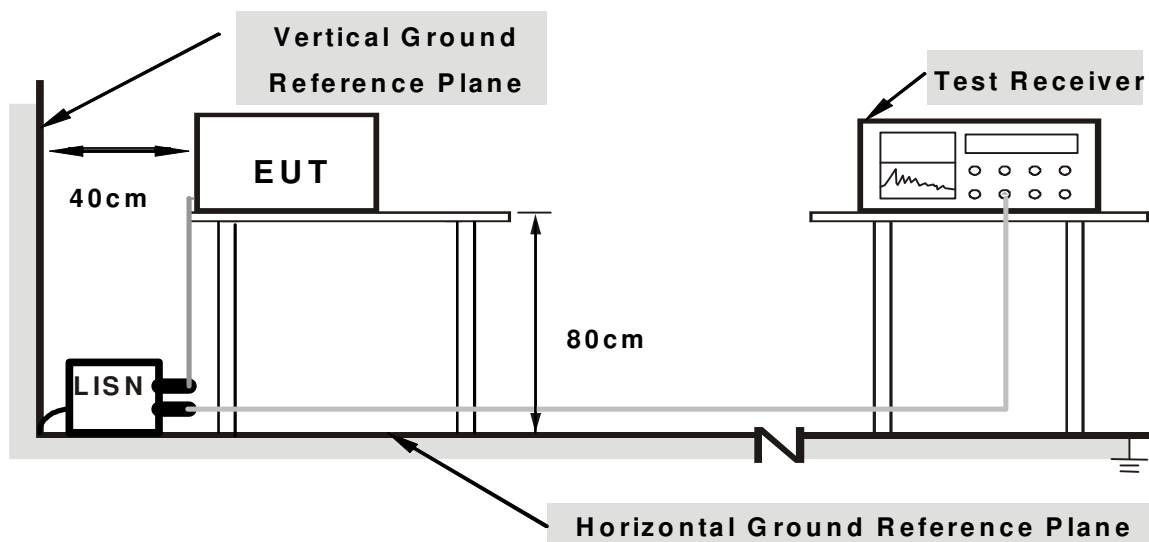

**Note: 1.Support units were connected to second LISN.**

For the actual test configuration, please refer to the related item – Photographs of the Test Configuration.





A D T

#### 4.1.6 EUT OPERATING CONDITIONS

1. Placed the EUT on testing table.
2. Prepared computer system (support unit 1) to act as communication partner.
3. The communication partner run test program “MTool\_2.0.0.8.msi.exe” to enable EUT under transmission/receiving condition continuously at specific channel frequency.

### 4.1.7 TEST RESULTS (MODE 1)

<b>PHASE</b>	Line (L)	<b>DETECTOR FUNCTION</b>	Quasi-Peak (QP) / Average (AV)
--------------	----------	--------------------------	--------------------------------

No	Freq. [MHz]	Corr. Factor [dB]	Reading Value [dB (uV)]		Emission Level [dB (uV)]		Limit [dB (uV)]		Margin (dB)	
			Q.P.	AV.	Q.P.	AV.	Q.P.	AV.	Q.P.	AV.
			1	0.15881	0.13	57.40	46.54	57.53	46.67	65.53
2	0.19872	0.15	50.11	38.19	50.26	38.34	63.66	53.66	-13.40	-15.32
3	0.53281	0.21	37.67	31.86	37.88	32.07	56.00	46.00	-18.12	-13.93
4	2.16797	0.35	30.01	23.99	30.36	24.34	56.00	46.00	-25.64	-21.66
5	7.99609	0.76	32.87	27.79	33.63	28.55	60.00	50.00	-26.37	-21.45
6	16.64844	1.29	32.76	27.80	34.05	29.09	60.00	50.00	-25.95	-20.91

**REMARKS:**

1. Q.P. and AV. are abbreviations of quasi-peak and average individually.
2. The emission levels of other frequencies were very low against the limit.
3. Margin value = Emission Level – Limit value
4. Correction Factor = Insertion loss + Cable loss
5. Emission Level = Correction Factor + Reading Value

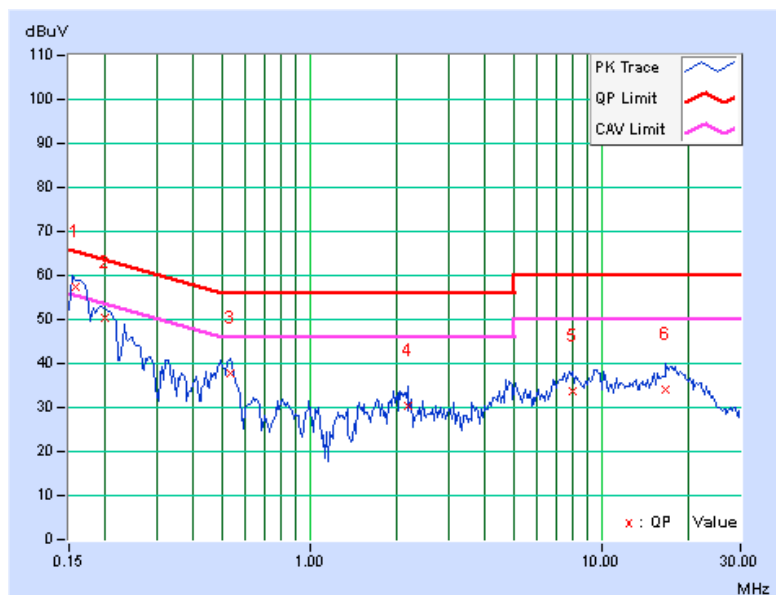

<b>PHASE</b>	Neutral (N)	<b>DETECTOR FUNCTION</b>	Quasi-Peak (QP) / Average (AV)
--------------	-------------	--------------------------	--------------------------------

No	Freq. [MHz]	Corr. Factor (dB)	Reading Value [dB (uV)]		Emission Level [dB (uV)]		Limit [dB (uV)]		Margin (dB)	
			Q.P.	AV.	Q.P.	AV.	Q.P.	AV.	Q.P.	AV.
1	0.15781	0.11	57.40	48.08	57.51	48.19	65.58	55.58	-8.07	-7.39
2	0.19331	0.13	49.68	35.87	49.81	36.00	63.89	53.89	-14.09	-17.90
3	0.53350	0.20	37.89	32.74	38.09	32.94	56.00	46.00	-17.91	-13.06
4	2.15625	0.31	31.53	26.05	31.84	26.36	56.00	46.00	-24.16	-19.64
5	7.29297	0.60	33.76	28.99	34.36	29.59	60.00	50.00	-25.64	-20.41
6	17.78906	1.05	32.75	28.13	33.80	29.18	60.00	50.00	-26.20	-20.82

**REMARKS:**

1. Q.P. and AV. are abbreviations of quasi-peak and average individually.
2. The emission levels of other frequencies were very low against the limit.
3. Margin value = Emission Level – Limit value
4. Correction Factor = Insertion loss + Cable loss
5. Emission Level = Correction Factor + Reading Value

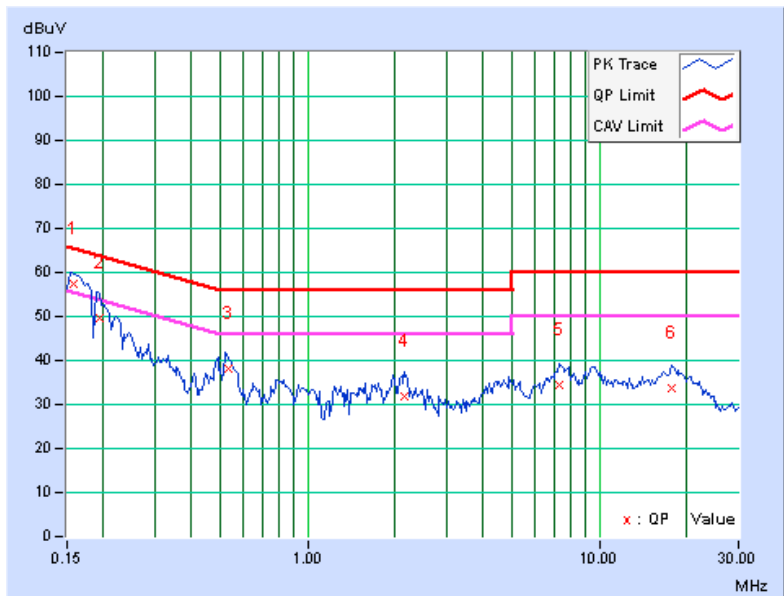

#### 4.1.8 TEST RESULTS (MODE 2)

<b>PHASE</b>	Line (L)	<b>DETECTOR FUNCTION</b>	Quasi-Peak (QP) / Average (AV)
--------------	----------	--------------------------	--------------------------------

No	Freq.	Corr.	Reading Value		Emission Level		Limit		Margin	
	[MHz]	[dB]	Q.P.	AV.	Q.P.	AV.	Q.P.	AV.	Q.P.	AV.
			[dB (uV)]	[dB (uV)]	[dB (uV)]	[dB (uV)]	[dB (uV)]	[dB (uV)]	(dB)	(dB)
1	0.15781	0.13	51.29	38.13	51.42	38.26	65.58	55.58	-14.16	-17.32
2	0.21641	0.15	45.41	34.10	45.56	34.25	62.96	52.96	-17.39	-18.70
3	0.36484	0.19	40.30	26.85	40.49	27.04	58.62	48.62	-18.13	-21.58
4	0.48203	0.21	43.08	33.75	43.29	33.96	56.30	46.30	-13.02	-12.35
5	2.01172	0.34	39.91	30.56	40.25	30.90	56.00	46.00	-15.75	-15.10
6	5.07813	0.55	37.25	29.62	37.80	30.17	60.00	50.00	-22.20	-19.83

#### REMARKS:

1. Q.P. and AV. are abbreviations of quasi-peak and average individually.
2. The emission levels of other frequencies were very low against the limit.
3. Margin value = Emission Level – Limit value
4. Correction Factor = Insertion loss + Cable loss
5. Emission Level = Correction Factor + Reading Value

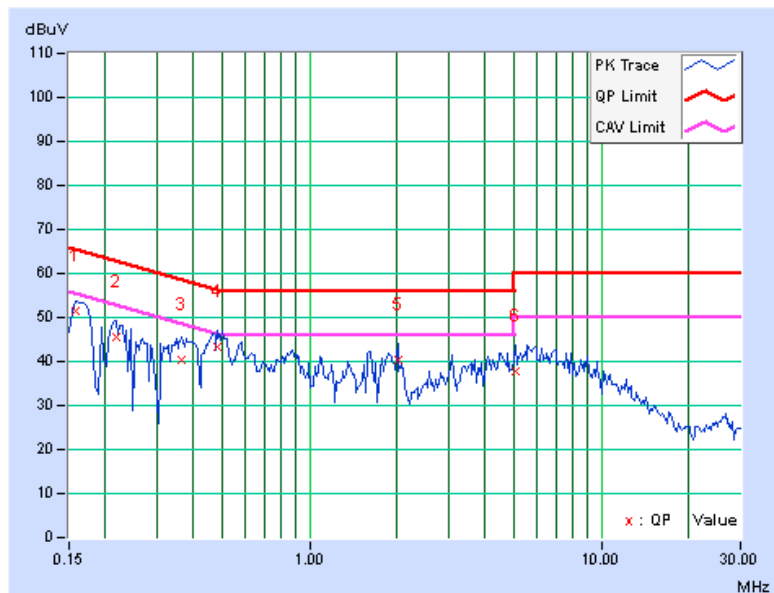



A D T

<b>PHASE</b>	Neutral (N)	<b>DETECTOR FUNCTION</b>	Quasi-Peak (QP) / Average (AV)
--------------	-------------	--------------------------	--------------------------------

No	Freq. [MHz]	Corr. Factor (dB)	Reading Value [dB (uV)]		Emission Level [dB (uV)]		Limit [dB (uV)]		Margin (dB)	
			Q.P.	AV.	Q.P.	AV.	Q.P.	AV.	Q.P.	AV.
1	0.16172	0.11	51.76	39.92	51.87	40.03	65.38	55.38	-13.50	-15.34
2	0.20859	0.13	45.05	29.73	45.18	29.86	63.26	53.26	-18.08	-23.40
3	0.48203	0.19	39.32	28.85	39.51	29.04	56.30	46.30	-16.79	-17.26
4	0.90781	0.22	32.21	21.92	32.43	22.14	56.00	46.00	-23.57	-23.86
5	1.85938	0.29	34.34	26.01	34.63	26.30	56.00	46.00	-21.37	-19.70
6	7.16016	0.59	32.56	24.53	33.15	25.12	60.00	50.00	-26.85	-24.88

**REMARKS:**

1. Q.P. and AV. are abbreviations of quasi-peak and average individually.
2. The emission levels of other frequencies were very low against the limit.
3. Margin value = Emission Level – Limit value
4. Correction Factor = Insertion loss + Cable loss
5. Emission Level = Correction Factor + Reading Value

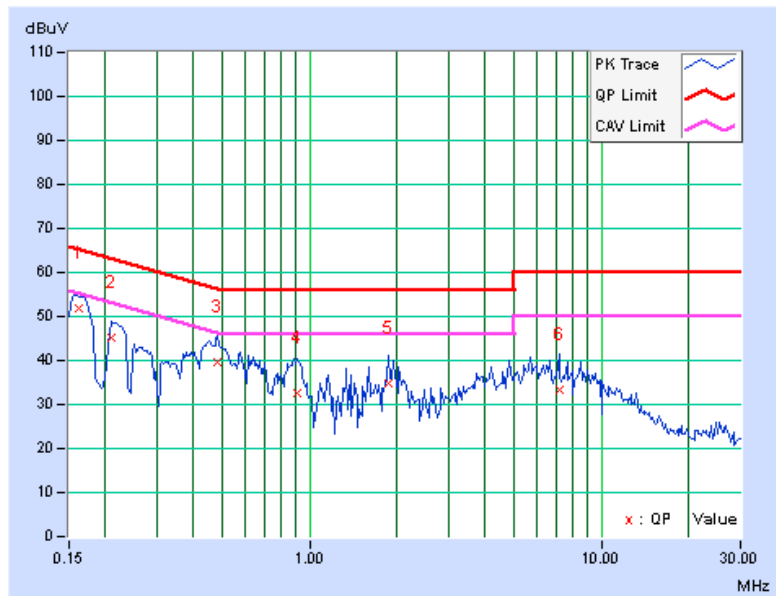

## 4.2 RADIATED EMISSION AND BANDEGE MEASUREMENT

### 4.2.1 LIMITS OF RADIATED EMISSION AND BANDEGE MEASUREMENT

Radiated emissions which fall in the restricted bands must comply with the radiated emission limits specified as below table:

Frequencies (MHz)	Field strength (microvolts/meter)	Measurement distance (meters)
0.009-0.490	2400/F(kHz)	300
0.490-1.705	24000/F(kHz)	30
1.705-30.0	30	30
30-88	100	3
88-216	150	3
216-960	200	3
Above 960	500	3

**NOTE:**

1. The lower limit shall apply at the transition frequencies.
2. Emission level (dBuV/m) = 20 log Emission level (uV/m).
3. For frequencies above 1000MHz, the field strength limits are based on average detector, however, the peak field strength of any emission shall not exceed the maximum permitted average limits, specified above by more than 20dB under any condition of modulation.

### 4.2.2 LIMITS OF UNWANTED EMISSION OUT OF THE RESTRICTED BANDS

APPLICABLE TO	LIMIT	
		FIELD STRENGTH AT 3m (dBµV/m)
	PK	AV
	74	54
√	EIRP LIMIT (dBm)	EQUIVALENT FIELD STRENGTH AT 3m (dBµV/m)
	PK	PK
	-27	68.3

**NOTE:**

1. The following formula is used to convert the equipment isotropic radiated power (eirp) to field strength:

$$E = \frac{1000000\sqrt{30P}}{3} \mu\text{V/m, where P is the eirp (Watts).}$$



A D T

#### 4.2.3 TEST INSTRUMENTS

DESCRIPTION & MANUFACTURER	MODEL NO.	SERIAL NO.	CALIBRATED DATE	CALIBRATED UNTIL
MXE EMI Receiver Agilent	N9038A	MY50010156	Jan. 15, 2014	Jan. 14, 2015
Pre-Amplifier Mini-Circuits	ZFL-1000VH2 B	AMP-ZFL-04	Nov. 13, 2013	Nov. 12, 2014
Trilog Broadband Antenna SCHWARZBECK	VULB 9168	9168-361	Mar. 25, 2013	Mar. 24, 2014
RF Cable	NA	CHHCAB_001	Oct. 06, 2013	Oct. 05, 2014
Spectrum Analyzer R&S	FSV40	100964	July 15, 2013	July 14, 2014
Horn_Antenna AISL	AIH.8018	0000220091110	Dec. 06, 2013	Dec. 05, 2014
Pre-Amplifier Agilent	8449B	3008A01923	Oct. 29, 2013	Oct. 28, 2014
RF Cable	NA	RF104-205 RF104-207 RF104-202	Dec. 12, 2013	Dec. 11, 2014
Spectrum Analyzer Agilent	E4446A	MY48250253	Aug. 28, 2013	Aug. 27, 2014
Pre-Amplifier SPACEK LABS	SLKKa-48-6	9K16	Nov. 13, 2013	Nov. 12, 2014
Horn_Antenna SCHWARZBECK	BBHA 9170	9170-424	Oct. 08, 2013	Oct. 07, 2014
Software	ADT_Radiated _V8.7.07	NA	NA	NA
Antenna Tower & Turn Table CT	NA	NA	NA	NA

**Note:**

1. The calibration interval of the above test instruments is 12 months and the calibrations are traceable to NML/ROC and NIST/USA.
2. The horn antenna, preamplifier (model: 8449B) are used only for the measurement of emission frequency above 1GHz if tested.
3. The test was performed in 966 Chamber No. H.
4. The FCC Site Registration No. is 797305.
5. The CANADA Site Registration No. is IC 7450H-3.
6. Tested Date: Jan. 16 to 17, 2014

#### 4.2.4 TEST PROCEDURES

- a. The EUT was placed on the top of a rotating table 0.8 meters above the ground at 3 meter chamber room for test. The table was rotated 360 degrees to determine the position of the highest radiation.
- b. The EUT was set 3 meters away from the interference-receiving antenna, which was mounted on the top of a variable-height antenna tower.
- c. The height of antenna is varied from one meter to four meters above the ground to determine the maximum value of the field strength. Both horizontal and vertical polarizations of the antenna are set to make the measurement.
- d. For each suspected emission, the EUT was arranged to its worst case and then the antenna was tuned to heights from 1 meter to 4 meters and the rotatable table was turned from 0 degrees to 360 degrees to find the maximum reading.
- e. The test-receiver system was set to quasi-peak detect function and specified bandwidth with maximum hold mode when the test frequency is below 1 GHz.
- f. The test-receiver system was set to peak and average detect function and specified bandwidth with maximum hold mode when the test frequency is above 1 GHz. If the peak reading value also meets average limit, measurement with the average detector is unnecessary.

**Note:**

1. The resolution bandwidth and video bandwidth of test receiver/spectrum analyzer is 120kHz for Quasi-peak detection (QP) at frequency below 1GHz.
2. The resolution bandwidth of test receiver/spectrum analyzer is 1 MHz and the video bandwidth is 3 MHz for Peak detection (PK) at frequency above 1GHz.
3. The resolution bandwidth of test receiver/spectrum analyzer is 1MHz and the video bandwidth is 3MHz for RMS Average (Duty cycle < 98%) for Average detection (AV) at frequency above 1GHz, then the measurement results was added to a correction factor ( $10 \log(1/\text{duty cycle})$ ).
4. The resolution bandwidth of test receiver/spectrum analyzer is 1MHz and the video bandwidth is 10Hz (Duty cycle  $\geq 98\%$ ) for Average detection (AV) at frequency above 1GHz.
5. All modes of operation were investigated and the worst-case emissions are reported.

#### 4.2.5 DEVIATION FROM TEST STANDARD

No deviation



#### 4.2.6 TEST SETUP

##### <Frequency Range below 1GHz>

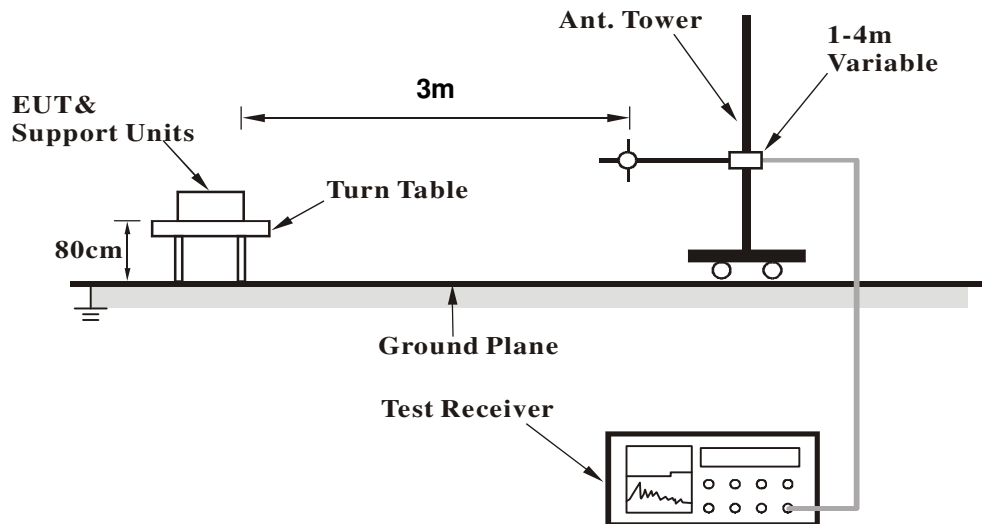

##### <Frequency Range above 1GHz>

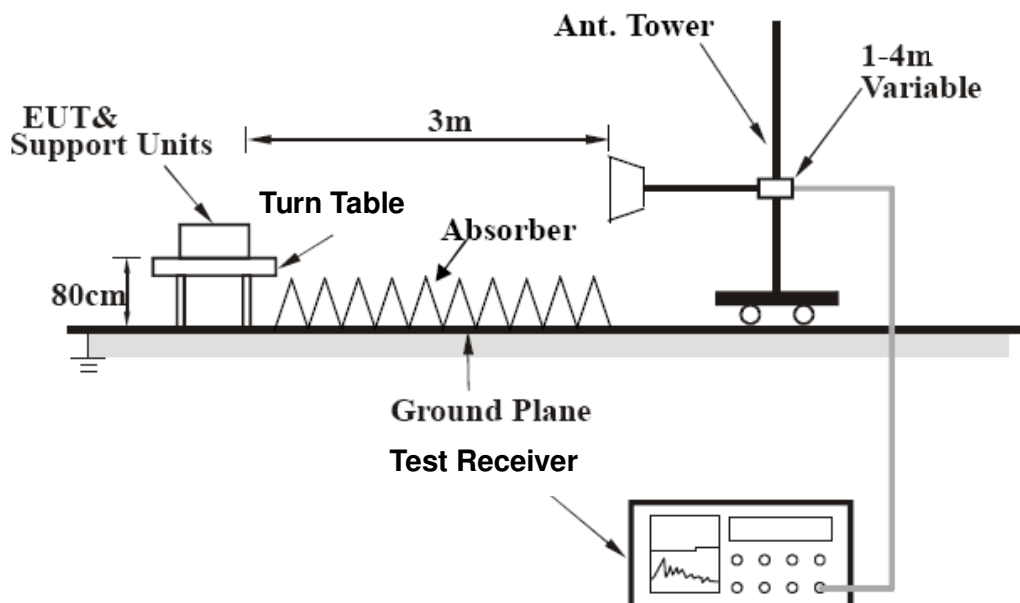

For the actual test configuration, please refer to the related item – Photographs of the Test Configuration.

#### 4.2.7 EUT OPERATING CONDITION

Same as 4.1.6



A D T

### 4.2.8 TEST RESULTS (MODE 1)

#### CDD\_MODE

#### BELOW 1GHz WORST-CASE DATA

#### 802.11ac (VHT40)

<b>CHANNEL</b>	TX Channel 38	<b>DETECTOR FUNCTION</b>	Quasi-Peak (QP)
<b>FREQUENCY RANGE</b>	Below 1GHz		

ANTENNA POLARITY & TEST DISTANCE: HORIZONTAL AT 3 M								
NO.	FREQ. (MHz)	EMISSION LEVEL (dBuV/m)	LIMIT (dBuV/m)	MARGIN (dB)	ANTENNA HEIGHT (m)	TABLE ANGLE (Degree)	RAW VALUE (dBuV)	CORRECTION FACTOR (dB/m)
1	89.01	31.1 QP	43.5	-12.4	1.55 H	214	49.62	-18.54
2	188.21	34.6 QP	43.5	-8.9	1.46 H	183	49.62	-15.00
3	209.16	38.1 QP	43.5	-5.4	2.00 H	224	53.88	-15.82
4	219.68	38.9 QP	46.0	-7.1	1.06 H	187	54.46	-15.52
5	296.07	38.4 QP	46.0	-7.6	1.00 H	133	50.22	-11.79
6	500.01	34.4 QP	46.0	-11.6	2.00 H	174	41.27	-6.91

ANTENNA POLARITY & TEST DISTANCE: VERTICAL AT 3 M								
NO.	FREQ. (MHz)	EMISSION LEVEL (dBuV/m)	LIMIT (dBuV/m)	MARGIN (dB)	ANTENNA HEIGHT (m)	TABLE ANGLE (Degree)	RAW VALUE (dBuV)	CORRECTION FACTOR (dB/m)
1	35.44	35.4 QP	40.0	-4.6	1.00 V	126	48.97	-13.54
2	65.61	36.8 QP	40.0	-3.2	1.00 V	249	51.33	-14.49
3	219.83	35.4 QP	46.0	-10.6	1.00 V	205	50.93	-15.52
4	500.01	38.2 QP	46.0	-7.8	1.69 V	228	45.14	-6.91
5	666.66	33.8 QP	46.0	-12.2	1.44 V	271	37.51	-3.67
6	825.02	33.7 QP	46.0	-12.3	1.44 V	360	34.19	-0.52

#### REMARKS:

1. Emission Level(dBuV/m) = Raw Value(dBuV) + Correction Factor(dB/m)
2. Correction Factor(dB/m) = Antenna Factor(dB/m) + Cable Factor(dB) – Pre-Amplifier Factor(dB)
3. The other emission levels were very low against the limit.
4. Margin value = Emission Level – Limit value



A D T

ABOVE 1GHz DATA

802.11ac (VHT20)

<b>CHANNEL</b>	TX Channel 36	<b>DETECTOR FUNCTION</b>	Peak (PK)
<b>FREQUENCY RANGE</b>	1GHz ~ 40GHz		Average (AV)

**ANTENNA POLARITY & TEST DISTANCE: HORIZONTAL AT 3 M**

NO.	FREQ. (MHz)	EMISSION LEVEL (dBuV/m)	LIMIT (dBuV/m)	MARGIN (dB)	ANTENNA HEIGHT (m)	TABLE ANGLE (Degree)	RAW VALUE (dBuV)	CORRECTION FACTOR (dB/m)
1	5101.20	56.5 PK	74.0	-17.5	1.07 H	6	13.03	43.47
2	5101.20	44.8 AV	54.0	-9.2	1.07 H	6	1.33	43.47
3	*5180.00	102.5 PK			1.07 H	6	58.86	43.64
4	*5180.00	92.2 AV			1.07 H	6	48.56	43.64
5	#10360.00	50.6 PK	68.3	-17.7	1.10 H	327	-0.14	50.74
6	15540.00	55.3 PK	74.0	-18.7	1.13 H	233	-0.76	56.06
7	15540.00	43.3 AV	54.0	-10.7	1.13 H	233	-12.76	56.06

**ANTENNA POLARITY & TEST DISTANCE: VERTICAL AT 3 M**

NO.	FREQ. (MHz)	EMISSION LEVEL (dBuV/m)	LIMIT (dBuV/m)	MARGIN (dB)	ANTENNA HEIGHT (m)	TABLE ANGLE (Degree)	RAW VALUE (dBuV)	CORRECTION FACTOR (dB/m)
1	5101.20	64.8 PK	74.0	-9.2	1.00 V	330	21.33	43.47
2	5101.20	53.8 AV	54.0	-0.2	1.00 V	330	10.33	43.47
3	*5180.00	112.9 PK			1.08 V	321	69.26	43.64
4	*5180.00	103.1 AV			1.08 V	321	59.46	43.64
5	#10360.00	51.7 PK	68.3	-16.6	1.00 V	210	0.96	50.74
6	15540.00	57.9 PK	74.0	-16.1	1.10 V	245	1.84	56.06
7	15540.00	45.5 AV	54.0	-8.5	1.10 V	245	-10.56	56.06

**REMARKS:**

1. Emission Level(dBuV/m) = Raw Value(dBuV) + Correction Factor(dB/m)
2. Correction Factor(dB/m) = Antenna Factor(dB/m) + Cable Factor(dB) – Pre-Amplifier Factor(dB)
3. The other emission levels were very low against the limit.
4. Margin value = Emission Level – Limit value
5. " \* ": Fundamental frequency.
6. " # ": The radiated frequency is out of the restricted band.



A D T

<b>CHANNEL</b>	TX Channel 40	<b>DETECTOR FUNCTION</b>	Peak (PK)
<b>FREQUENCY RANGE</b>	1GHz ~ 40GHz		Average (AV)

**ANTENNA POLARITY & TEST DISTANCE: HORIZONTAL AT 3 M**

NO.	FREQ. (MHz)	EMISSION LEVEL (dBuV/m)	LIMIT (dBuV/m)	MARGIN (dB)	ANTENNA HEIGHT (m)	TABLE ANGLE (Degree)	RAW VALUE (dBuV)	CORRECTION FACTOR (dB/m)
1	5118.90	55.4 PK	74.0	-18.6	1.04 H	5	11.89	43.51
2	5118.90	45.8 AV	54.0	-8.2	1.04 H	5	2.29	43.51
3	*5200.00	102.5 PK			1.04 H	5	58.82	43.68
4	*5200.00	93.7 AV			1.04 H	5	50.02	43.68
5	#10400.00	51.4 PK	68.3	-16.9	1.17 H	340	0.73	50.67
6	15600.00	54.9 PK	74.0	-19.1	1.03 H	206	-1.11	56.01
7	15600.00	42.9 AV	54.0	-11.1	1.03 H	206	-13.11	56.01

**ANTENNA POLARITY & TEST DISTANCE: VERTICAL AT 3 M**

NO.	FREQ. (MHz)	EMISSION LEVEL (dBuV/m)	LIMIT (dBuV/m)	MARGIN (dB)	ANTENNA HEIGHT (m)	TABLE ANGLE (Degree)	RAW VALUE (dBuV)	CORRECTION FACTOR (dB/m)
1	5118.90	65.2 PK	74.0	-8.8	1.10 V	322	21.69	43.51
2	5118.90	53.7 AV	54.0	-0.3	1.10 V	322	10.19	43.51
3	*5200.00	113.7 PK			1.08 V	322	70.02	43.68
4	*5200.00	104.0 AV			1.08 V	322	60.32	43.68
5	#10400.00	50.9 PK	68.3	-17.4	1.02 V	223	0.23	50.67
6	15600.00	57.8 PK	74.0	-16.2	1.13 V	250	1.79	56.01
7	15600.00	45.7 AV	54.0	-8.3	1.13 V	250	-10.31	56.01

**REMARKS:**

1. Emission Level(dBuV/m) = Raw Value(dBuV) + Correction Factor(dB/m)
2. Correction Factor(dB/m) = Antenna Factor(dB/m) + Cable Factor(dB) – Pre-Amplifier Factor(dB)
3. The other emission levels were very low against the limit.
4. Margin value = Emission Level – Limit value
5. " \* ": Fundamental frequency.
6. " # ": The radiated frequency is out of the restricted band.



A D T

<b>CHANNEL</b>	TX Channel 48	<b>DETECTOR FUNCTION</b>	Peak (PK)
<b>FREQUENCY RANGE</b>	1GHz ~ 40GHz		Average (AV)

**ANTENNA POLARITY & TEST DISTANCE: HORIZONTAL AT 3 M**

NO.	FREQ. (MHz)	EMISSION LEVEL (dBuV/m)	LIMIT (dBuV/m)	MARGIN (dB)	ANTENNA HEIGHT (m)	TABLE ANGLE (Degree)	RAW VALUE (dBuV)	CORRECTION FACTOR (dB/m)
1	5080.00	56.5 PK	74.0	-17.5	1.04 H	354	13.07	43.43
2	5080.00	43.8 AV	54.0	-10.2	1.04 H	354	0.37	43.43
3	*5240.00	113.2 PK			1.01 H	6	69.47	43.73
4	*5240.00	104.2 AV			1.01 H	6	60.47	43.73
5	5400.00	55.8 PK	74.0	-18.2	1.20 H	8	11.83	43.97
6	5400.00	44.6 AV	54.0	-9.4	1.20 H	8	0.63	43.97
7	#10480.00	50.9 PK	68.3	-17.4	1.15 H	333	-0.13	51.03
8	15720.00	55.5 PK	74.0	-18.5	1.12 H	234	-0.38	55.88
9	15720.00	43.6 AV	54.0	-10.4	1.12 H	234	-12.28	55.88

**ANTENNA POLARITY & TEST DISTANCE: VERTICAL AT 3 M**

NO.	FREQ. (MHz)	EMISSION LEVEL (dBuV/m)	LIMIT (dBuV/m)	MARGIN (dB)	ANTENNA HEIGHT (m)	TABLE ANGLE (Degree)	RAW VALUE (dBuV)	CORRECTION FACTOR (dB/m)
1	5080.00	64.1 PK	74.0	-9.9	1.13 V	322	20.67	43.43
2	5080.00	52.1 AV	54.0	-1.9	1.13 V	322	8.67	43.43
3	*5240.00	125.1 PK			1.08 V	323	81.37	43.73
4	*5240.00	113.9 AV			1.08 V	323	70.17	43.73
5	5400.00	64.8 PK	74.0	-9.2	1.26 V	252	20.83	43.97
6	5400.00	53.5 AV	54.0	-0.5	1.26 V	252	9.53	43.97
7	#10480.00	50.8 PK	68.3	-17.5	1.00 V	210	-0.23	51.03
8	15720.00	57.6 PK	74.0	-16.4	1.06 V	258	1.72	55.88
9	15720.00	45.4 AV	54.0	-8.6	1.06 V	258	-10.48	55.88

**REMARKS:**

1. Emission Level(dBuV/m) = Raw Value(dBuV) + Correction Factor(dB/m)
2. Correction Factor(dB/m) = Antenna Factor(dB/m) + Cable Factor(dB) – Pre-Amplifier Factor(dB)
3. The other emission levels were very low against the limit.
4. Margin value = Emission Level – Limit value
5. " \* ": Fundamental frequency.
6. " # ": The radiated frequency is out of the restricted band.



A D T

802.11ac (VHT40)

<b>CHANNEL</b>	TX Channel 38	<b>DETECTOR FUNCTION</b>	Peak (PK)
<b>FREQUENCY RANGE</b>	1GHz ~ 40GHz		Average (AV)

**ANTENNA POLARITY & TEST DISTANCE: HORIZONTAL AT 3 M**

NO.	FREQ. (MHz)	EMISSION LEVEL (dBuV/m)	LIMIT (dBuV/m)	MARGIN (dB)	ANTENNA HEIGHT (m)	TABLE ANGLE (Degree)	RAW VALUE (dBuV)	CORRECTION FACTOR (dB/m)
1	5000.00	55.2 PK	74.0	-18.8	1.10 H	4	11.93	43.27
2	5000.00	43.6 AV	54.0	-10.4	1.10 H	4	0.33	43.27
3	5150.00	55.8 PK	74.0	-18.2	1.10 H	6	12.23	43.57
4	5150.00	44.6 AV	54.0	-9.4	1.10 H	6	1.03	43.57
5	*5190.00	100.2 PK			1.11 H	4	56.54	43.66
6	*5190.00	89.1 AV			1.11 H	4	45.44	43.66
7	#10380.00	50.2 PK	68.3	-18.1	1.13 H	323	-0.51	50.71
8	15570.00	54.8 PK	74.0	-19.2	1.11 H	234	-1.23	56.03
9	15570.00	42.7 AV	54.0	-11.3	1.11 H	234	-13.33	56.03

**ANTENNA POLARITY & TEST DISTANCE: VERTICAL AT 3 M**

NO.	FREQ. (MHz)	EMISSION LEVEL (dBuV/m)	LIMIT (dBuV/m)	MARGIN (dB)	ANTENNA HEIGHT (m)	TABLE ANGLE (Degree)	RAW VALUE (dBuV)	CORRECTION FACTOR (dB/m)
1	5110.00	60.0 PK	74.0	-14.0	1.00 V	352	16.50	43.50
2	5110.00	49.7 AV	54.0	-4.3	1.00 V	352	6.20	43.50
3	5150.00	66.9 PK	74.0	-7.1	1.00 V	360	23.30	43.60
4	5150.00	51.7 AV	54.0	-2.3	1.00 V	360	8.10	43.60
5	*5190.00	109.4 PK			1.00 V	0	65.70	43.70
6	*5190.00	99.7 AV			1.00 V	0	56.00	43.70
7	#10380.00	51.2 PK	68.3	-17.1	1.04 V	228	0.50	50.70
8	15570.00	57.5 PK	74.0	-16.5	1.08 V	243	1.50	56.00
9	15570.00	45.2 AV	54.0	-8.8	1.08 V	243	-10.80	56.00

**REMARKS:**

1. Emission Level(dBuV/m) = Raw Value(dBuV) + Correction Factor(dB/m)
2. Correction Factor(dB/m) = Antenna Factor(dB/m) + Cable Factor(dB) – Pre-Amplifier Factor(dB)
3. The other emission levels were very low against the limit.
4. Margin value = Emission Level – Limit value
5. " \* ": Fundamental frequency.
6. " # ": The radiated frequency is out of the restricted band.



A D T

<b>CHANNEL</b>	TX Channel 46	<b>DETECTOR FUNCTION</b>	Peak (PK)
<b>FREQUENCY RANGE</b>	1GHz ~ 40GHz		Average (AV)

**ANTENNA POLARITY & TEST DISTANCE: HORIZONTAL AT 3 M**

NO.	FREQ. (MHz)	EMISSION LEVEL (dBuV/m)	LIMIT (dBuV/m)	MARGIN (dB)	ANTENNA HEIGHT (m)	TABLE ANGLE (Degree)	RAW VALUE (dBuV)	CORRECTION FACTOR (dB/m)
1	5146.00	56.8 PK	74.0	-17.2	1.04 H	360	13.23	43.57
2	5146.00	44.5 AV	54.0	-9.5	1.04 H	360	0.93	43.57
3	*5230.00	103.4 PK			1.04 H	360	59.68	43.72
4	*5230.00	93.6 AV			1.04 H	360	49.88	43.72
5	#5665.90	57.6 PK	68.3	-10.7	1.04 H	8	13.18	44.42
6	#10460.00	50.9 PK	68.3	-17.4	1.12 H	324	-0.04	50.94
7	15690.00	55.3 PK	74.0	-18.7	1.06 H	210	-0.62	55.92
8	15690.00	43.5 AV	54.0	-10.5	1.06 H	210	-12.42	55.92

**ANTENNA POLARITY & TEST DISTANCE: VERTICAL AT 3 M**

NO.	FREQ. (MHz)	EMISSION LEVEL (dBuV/m)	LIMIT (dBuV/m)	MARGIN (dB)	ANTENNA HEIGHT (m)	TABLE ANGLE (Degree)	RAW VALUE (dBuV)	CORRECTION FACTOR (dB/m)
1	5146.00	63.7 PK	74.0	-10.3	1.30 V	234	20.13	43.57
2	5146.00	53.6 AV	54.0	-0.4	1.30 V	234	10.03	43.57
3	*5230.00	115.5 PK			1.08 V	323	71.78	43.72
4	*5230.00	104.1 AV			1.08 V	323	60.38	43.72
5	#5665.90	62.8 PK	68.3	-5.5	1.29 V	274	18.38	44.42
6	#10460.00	51.0 PK	68.3	-17.3	1.04 V	220	0.06	50.94
7	15690.00	57.7 PK	74.0	-16.3	1.14 V	253	1.78	55.92
8	15690.00	45.6 AV	54.0	-8.4	1.14 V	253	-10.32	55.92

**REMARKS:**

1. Emission Level(dBuV/m) = Raw Value(dBuV) + Correction Factor(dB/m)
2. Correction Factor(dB/m) = Antenna Factor(dB/m) + Cable Factor(dB) – Pre-Amplifier Factor(dB)
3. The other emission levels were very low against the limit.
4. Margin value = Emission Level – Limit value
5. " \* ": Fundamental frequency.
6. " # ": The radiated frequency is out of the restricted band.



A D T

802.11ac (VHT80)

<b>CHANNEL</b>	TX Channel 42	<b>DETECTOR FUNCTION</b>	Peak (PK)
<b>FREQUENCY RANGE</b>	1GHz ~ 40GHz		Average (AV)

**ANTENNA POLARITY & TEST DISTANCE: HORIZONTAL AT 3 M**

NO.	FREQ. (MHz)	EMISSION LEVEL (dBuV/m)	LIMIT (dBuV/m)	MARGIN (dB)	ANTENNA HEIGHT (m)	TABLE ANGLE (Degree)	RAW VALUE (dBuV)	CORRECTION FACTOR (dB/m)
1	5150.00	56.2 PK	74.0	-17.8	1.02 H	3	12.63	43.57
2	5150.00	45.1 AV	54.0	-8.9	1.02 H	3	1.53	43.57
3	*5210.00	95.3 PK			1.02 H	3	51.61	43.69
4	*5210.00	85.2 AV			1.02 H	3	41.51	43.69
5	#5788.00	56.4 PK	68.3	-11.9	1.02 H	321	11.88	44.52
6	#10420.00	50.6 PK	68.3	-17.7	1.18 H	314	-0.16	50.76
7	15630.00	54.4 PK	74.0	-19.6	1.04 H	221	-1.58	55.98
8	15630.00	42.7 AV	54.0	-11.3	1.04 H	221	-13.28	55.98

**ANTENNA POLARITY & TEST DISTANCE: VERTICAL AT 3 M**

NO.	FREQ. (MHz)	EMISSION LEVEL (dBuV/m)	LIMIT (dBuV/m)	MARGIN (dB)	ANTENNA HEIGHT (m)	TABLE ANGLE (Degree)	RAW VALUE (dBuV)	CORRECTION FACTOR (dB/m)
1	5150.00	66.7 PK	74.0	-7.3	1.00 V	328	23.13	43.57
2	5150.00	53.7 AV	54.0	-0.3	1.00 V	328	10.13	43.57
3	*5210.00	107.3 PK			1.09 V	325	63.61	43.69
4	*5210.00	95.7 AV			1.09 V	325	52.01	43.69
5	#5788.00	62.4 PK	68.3	-5.9	1.02 V	198	17.88	44.52
6	#10420.00	51.8 PK	68.3	-16.5	1.01 V	238	1.04	50.76
7	15630.00	57.9 PK	74.0	-16.1	1.07 V	262	1.92	55.98
8	15630.00	45.4 AV	54.0	-8.6	1.07 V	262	-10.58	55.98

**REMARKS:**

1. Emission Level(dBuV/m) = Raw Value(dBuV) + Correction Factor(dB/m)
2. Correction Factor(dB/m) = Antenna Factor(dB/m) + Cable Factor(dB) – Pre-Amplifier Factor(dB)
3. The other emission levels were very low against the limit.
4. Margin value = Emission Level – Limit value
5. " \* ": Fundamental frequency.
6. " # ": The radiated frequency is out of the restricted band.





A D T

STBC\_MODE

ABOVE 1GHz DATA

802.11ac (VHT20)

<b>CHANNEL</b>	TX Channel 36	<b>DETECTOR FUNCTION</b>	Peak (PK)
<b>FREQUENCY RANGE</b>	1GHz ~ 40GHz		Average (AV)

**ANTENNA POLARITY & TEST DISTANCE: HORIZONTAL AT 3 M**

NO.	FREQ. (MHz)	EMISSION LEVEL (dBuV/m)	LIMIT (dBuV/m)	MARGIN (dB)	ANTENNA HEIGHT (m)	TABLE ANGLE (Degree)	RAW VALUE (dBuV)	CORRECTION FACTOR (dB/m)
1	5100.00	57.2 PK	74.0	-16.8	1.02 H	47	13.73	43.47
2	5100.00	46.8 AV	54.0	-7.2	1.02 H	47	3.33	43.47
3	*5180.00	104.3 PK			1.00 H	45	60.66	43.64
4	*5180.00	94.3 AV			1.00 H	45	50.66	43.64
5	#10360.00	54.4 PK	68.3	-13.9	1.00 H	113	3.66	50.74
6	15540.00	57.6 PK	74.0	-16.4	1.00 H	72	1.54	56.06
7	15540.00	44.9 AV	54.0	-9.1	1.00 H	72	-11.16	56.06

**ANTENNA POLARITY & TEST DISTANCE: VERTICAL AT 3 M**

NO.	FREQ. (MHz)	EMISSION LEVEL (dBuV/m)	LIMIT (dBuV/m)	MARGIN (dB)	ANTENNA HEIGHT (m)	TABLE ANGLE (Degree)	RAW VALUE (dBuV)	CORRECTION FACTOR (dB/m)
1	5100.00	62.1 PK	74.0	-11.9	1.45 V	325	18.63	43.47
2	5100.00	53.4 AV	54.0	-0.6	1.45 V	325	9.93	43.47
3	*5180.00	113.4 PK			1.43 V	325	69.76	43.64
4	*5180.00	103.2 AV			1.43 V	325	59.56	43.64
5	#10360.00	54.8 PK	68.3	-13.5	1.00 V	24	4.06	50.74
6	15540.00	58.1 PK	74.0	-15.9	1.04 V	31	2.04	56.06
7	15540.00	45.3 AV	54.0	-8.7	1.04 V	31	-10.76	56.06

**REMARKS:**

1. Emission Level(dBuV/m) = Raw Value(dBuV) + Correction Factor(dB/m)
2. Correction Factor(dB/m) = Antenna Factor(dB/m) + Cable Factor(dB) – Pre-Amplifier Factor(dB)
3. The other emission levels were very low against the limit.
4. Margin value = Emission Level – Limit value
5. " \* ": Fundamental frequency.
6. " # ": The radiated frequency is out of the restricted band.



A D T

<b>CHANNEL</b>	TX Channel 40	<b>DETECTOR FUNCTION</b>	Peak (PK)
<b>FREQUENCY RANGE</b>	1GHz ~ 40GHz		Average (AV)

**ANTENNA POLARITY & TEST DISTANCE: HORIZONTAL AT 3 M**

NO.	FREQ. (MHz)	EMISSION LEVEL (dBuV/m)	LIMIT (dBuV/m)	MARGIN (dB)	ANTENNA HEIGHT (m)	TABLE ANGLE (Degree)	RAW VALUE (dBuV)	CORRECTION FACTOR (dB/m)
1	5120.00	56.9 PK	74.0	-17.1	1.02 H	60	13.39	43.51
2	5120.00	46.7 AV	54.0	-7.3	1.02 H	60	3.19	43.51
3	*5200.00	104.8 PK			1.00 H	53	61.12	43.68
4	*5200.00	94.8 AV			1.00 H	53	51.12	43.68
5	#10400.00	54.5 PK	68.3	-13.8	1.02 H	128	3.83	50.67
6	15600.00	58.1 PK	74.0	-15.9	1.00 H	87	2.09	56.01
7	15600.00	45.2 AV	54.0	-8.8	1.00 H	87	-10.81	56.01

**ANTENNA POLARITY & TEST DISTANCE: VERTICAL AT 3 M**

NO.	FREQ. (MHz)	EMISSION LEVEL (dBuV/m)	LIMIT (dBuV/m)	MARGIN (dB)	ANTENNA HEIGHT (m)	TABLE ANGLE (Degree)	RAW VALUE (dBuV)	CORRECTION FACTOR (dB/m)
1	5120.00	63.1 PK	74.0	-10.9	1.44 V	324	19.59	43.51
2	5120.00	53.6 AV	54.0	-0.4	1.44 V	324	10.09	43.51
3	*5200.00	113.3 PK			1.41 V	326	69.62	43.68
4	*5200.00	104.3 AV			1.41 V	326	60.62	43.68
5	#10400.00	54.1 PK	68.3	-14.2	1.02 V	11	3.43	50.67
6	15600.00	57.5 PK	74.0	-16.5	1.00 V	27	1.49	56.01
7	15600.00	45.3 AV	54.0	-8.7	1.00 V	27	-10.71	56.01

**REMARKS:**

1. Emission Level(dBuV/m) = Raw Value(dBuV) + Correction Factor(dB/m)
2. Correction Factor(dB/m) = Antenna Factor(dB/m) + Cable Factor(dB) – Pre-Amplifier Factor(dB)
3. The other emission levels were very low against the limit.
4. Margin value = Emission Level – Limit value
5. " \* ": Fundamental frequency.
6. " # ": The radiated frequency is out of the restricted band.



A D T

<b>CHANNEL</b>	TX Channel 48	<b>DETECTOR FUNCTION</b>	Peak (PK)
<b>FREQUENCY RANGE</b>	1GHz ~ 40GHz		Average (AV)

**ANTENNA POLARITY & TEST DISTANCE: HORIZONTAL AT 3 M**

NO.	FREQ. (MHz)	EMISSION LEVEL (dBuV/m)	LIMIT (dBuV/m)	MARGIN (dB)	ANTENNA HEIGHT (m)	TABLE ANGLE (Degree)	RAW VALUE (dBuV)	CORRECTION FACTOR (dB/m)
1	*5240.00	110.2 PK			1.00 H	49	66.47	43.73
2	*5240.00	100.1 AV			1.00 H	49	56.37	43.73
3	5400.00	57.8 PK	74.0	-16.2	1.00 H	49	13.83	43.97
4	5400.00	44.6 AV	54.0	-9.4	1.00 H	49	0.63	43.97
5	#10480.00	54.0 PK	68.3	-14.3	1.00 H	115	2.97	51.03
6	15720.00	58.0 PK	74.0	-16.0	1.00 H	75	2.12	55.88
7	15720.00	45.3 AV	54.0	-8.7	1.00 H	75	-10.58	55.88

**ANTENNA POLARITY & TEST DISTANCE: VERTICAL AT 3 M**

NO.	FREQ. (MHz)	EMISSION LEVEL (dBuV/m)	LIMIT (dBuV/m)	MARGIN (dB)	ANTENNA HEIGHT (m)	TABLE ANGLE (Degree)	RAW VALUE (dBuV)	CORRECTION FACTOR (dB/m)
1	*5240.00	119.8 PK			1.40 V	326	76.07	43.73
2	*5240.00	110.3 AV			1.40 V	326	66.57	43.73
3	5400.00	60.8 PK	74.0	-13.2	1.00 V	307	16.83	43.97
4	5400.00	50.5 AV	54.0	-3.5	1.00 V	307	6.53	43.97
5	#10480.00	54.5 PK	68.3	-13.8	1.00 V	26	3.47	51.03
6	15720.00	57.7 PK	74.0	-16.3	1.00 V	41	1.82	55.88
7	15720.00	45.8 AV	54.0	-8.2	1.00 V	41	-10.08	55.88

**REMARKS:**

1. Emission Level(dBuV/m) = Raw Value(dBuV) + Correction Factor(dB/m)
2. Correction Factor(dB/m) = Antenna Factor(dB/m) + Cable Factor(dB) – Pre-Amplifier Factor(dB)
3. The other emission levels were very low against the limit.
4. Margin value = Emission Level – Limit value
5. " \* ": Fundamental frequency.
6. " # ": The radiated frequency is out of the restricted band.



A D T

### 802.11ac (VHT40)

<b>CHANNEL</b>	TX Channel 38	<b>DETECTOR FUNCTION</b>	Peak (PK)
<b>FREQUENCY RANGE</b>	1GHz ~ 40GHz		Average (AV)

#### ANTENNA POLARITY & TEST DISTANCE: HORIZONTAL AT 3 M

NO.	FREQ. (MHz)	EMISSION LEVEL (dBuV/m)	LIMIT (dBuV/m)	MARGIN (dB)	ANTENNA HEIGHT (m)	TABLE ANGLE (Degree)	RAW VALUE (dBuV)	CORRECTION FACTOR (dB/m)
1	5150.00	57.2 PK	74.0	-16.8	1.00 H	48	13.63	43.57
2	5150.00	45.1 AV	54.0	-8.9	1.00 H	48	1.53	43.57
3	*5190.00	100.9 PK			1.00 H	48	57.24	43.66
4	*5190.00	91.2 AV			1.00 H	48	47.54	43.66
5	#5622.00	57.7 PK	68.3	-10.6	1.00 H	64	13.29	44.41
6	#10380.00	54.2 PK	68.3	-14.1	1.00 H	128	3.49	50.71
7	15570.00	58.4 PK	74.0	-15.6	1.00 H	78	2.37	56.03
8	15570.00	45.4 AV	54.0	-8.6	1.00 H	78	-10.63	56.03

#### ANTENNA POLARITY & TEST DISTANCE: VERTICAL AT 3 M

NO.	FREQ. (MHz)	EMISSION LEVEL (dBuV/m)	LIMIT (dBuV/m)	MARGIN (dB)	ANTENNA HEIGHT (m)	TABLE ANGLE (Degree)	RAW VALUE (dBuV)	CORRECTION FACTOR (dB/m)
1	5150.00	65.4 PK	74.0	-8.6	1.43 V	327	21.83	43.57
2	5150.00	53.6 AV	54.0	-0.4	1.43 V	327	10.03	43.57
3	*5190.00	107.8 PK			1.43 V	327	64.14	43.66
4	*5190.00	100.1 AV			1.43 V	327	56.44	43.66
5	#5622.00	61.3 PK	68.3	-7.0	1.26 V	265	16.89	44.41
6	#10380.00	54.8 PK	68.3	-13.5	1.00 V	27	4.09	50.71
7	15570.00	57.9 PK	74.0	-16.1	1.03 V	27	1.87	56.03
8	15570.00	45.7 AV	54.0	-8.3	1.03 V	27	-10.33	56.03

#### REMARKS:

1. Emission Level(dBuV/m) = Raw Value(dBuV) + Correction Factor(dB/m)
2. Correction Factor(dB/m) = Antenna Factor(dB/m) + Cable Factor(dB) – Pre-Amplifier Factor(dB)
3. The other emission levels were very low against the limit.
4. Margin value = Emission Level – Limit value
5. " \* ": Fundamental frequency.
6. " # ": The radiated frequency is out of the restricted band.



A D T

<b>CHANNEL</b>	TX Channel 46	<b>DETECTOR FUNCTION</b>	Peak (PK)
<b>FREQUENCY RANGE</b>	1GHz ~ 40GHz		Average (AV)

**ANTENNA POLARITY & TEST DISTANCE: HORIZONTAL AT 3 M**

NO.	FREQ. (MHz)	EMISSION LEVEL (dBuV/m)	LIMIT (dBuV/m)	MARGIN (dB)	ANTENNA HEIGHT (m)	TABLE ANGLE (Degree)	RAW VALUE (dBuV)	CORRECTION FACTOR (dB/m)
1	*5230.00	104.6 PK			1.00 H	61	60.88	43.72
2	*5230.00	94.5 AV			1.00 H	61	50.78	43.72
3	5350.00	57.8 PK	74.0	-16.2	1.00 H	75	13.91	43.89
4	5350.00	44.8 AV	54.0	-9.2	1.00 H	75	0.91	43.89
5	#5666.00	57.5 PK	68.3	-10.8	1.00 H	36	13.08	44.42
6	#10460.00	54.4 PK	68.3	-13.9	1.00 H	110	3.46	50.94
7	15690.00	58.3 PK	74.0	-15.7	1.06 H	64	2.38	55.92
8	15690.00	45.3 AV	54.0	-8.7	1.06 H	64	-10.62	55.92

**ANTENNA POLARITY & TEST DISTANCE: VERTICAL AT 3 M**

NO.	FREQ. (MHz)	EMISSION LEVEL (dBuV/m)	LIMIT (dBuV/m)	MARGIN (dB)	ANTENNA HEIGHT (m)	TABLE ANGLE (Degree)	RAW VALUE (dBuV)	CORRECTION FACTOR (dB/m)
1	*5230.00	110.4 PK			1.42 V	326	66.68	43.72
2	*5230.00	102.6 AV			1.42 V	326	58.88	43.72
3	5350.00	61.4 PK	74.0	-12.6	1.87 V	179	17.51	43.89
4	5350.00	53.4 AV	54.0	-0.6	1.87 V	179	9.51	43.89
5	#5666.00	61.8 PK	68.3	-6.5	1.26 V	223	17.38	44.42
6	#10460.00	54.4 PK	68.3	-13.9	1.04 V	31	3.46	50.94
7	15690.00	57.6 PK	74.0	-16.4	1.02 V	40	1.68	55.92
8	15690.00	45.9 AV	54.0	-8.1	1.02 V	40	-10.02	55.92

**REMARKS:**

1. Emission Level(dBuV/m) = Raw Value(dBuV) + Correction Factor(dB/m)
2. Correction Factor(dB/m) = Antenna Factor(dB/m) + Cable Factor(dB) – Pre-Amplifier Factor(dB)
3. The other emission levels were very low against the limit.
4. Margin value = Emission Level – Limit value
5. " \* ": Fundamental frequency.
6. " # ": The radiated frequency is out of the restricted band.



802.11ac (VHT80)

<b>CHANNEL</b>	TX Channel 42	<b>DETECTOR FUNCTION</b>	Peak (PK)
<b>FREQUENCY RANGE</b>	1GHz ~ 40GHz		Average (AV)

**ANTENNA POLARITY & TEST DISTANCE: HORIZONTAL AT 3 M**

NO.	FREQ. (MHz)	EMISSION LEVEL (dBuV/m)	LIMIT (dBuV/m)	MARGIN (dB)	ANTENNA HEIGHT (m)	TABLE ANGLE (Degree)	RAW VALUE (dBuV)	CORRECTION FACTOR (dB/m)
1	5150.00	57.3 PK	74.0	-16.7	1.00 H	75	13.73	43.57
2	5150.00	45.3 AV	54.0	-8.7	1.00 H	75	1.73	43.57
3	*5210.00	99.3 PK			1.00 H	46	55.61	43.69
4	*5210.00	90.7 AV			1.00 H	46	47.01	43.69
5	#5788.00	57.6 PK	68.3	-10.7	1.00 H	31	13.08	44.52
6	#10420.00	54.3 PK	68.3	-14.0	1.01 H	107	3.54	50.76
7	15630.00	58.0 PK	74.0	-16.0	1.00 H	78	2.02	55.98
8	15630.00	45.4 AV	54.0	-8.6	1.00 H	78	-10.58	55.98

**ANTENNA POLARITY & TEST DISTANCE: VERTICAL AT 3 M**

NO.	FREQ. (MHz)	EMISSION LEVEL (dBuV/m)	LIMIT (dBuV/m)	MARGIN (dB)	ANTENNA HEIGHT (m)	TABLE ANGLE (Degree)	RAW VALUE (dBuV)	CORRECTION FACTOR (dB/m)
1	5150.00	64.4 PK	74.0	-9.6	1.41 V	328	20.83	43.57
2	5150.00	53.5 AV	54.0	-0.5	1.41 V	328	9.93	43.57
3	*5210.00	106.7 PK			1.41 V	328	63.01	43.69
4	*5210.00	98.9 AV			1.41 V	328	55.21	43.69
5	#5788.00	62.3 PK	68.3	-6.0	1.69 V	235	17.78	44.52
6	#10420.00	54.3 PK	68.3	-14.0	1.00 V	18	3.54	50.76
7	15630.00	57.5 PK	74.0	-16.5	1.00 V	51	1.52	55.98
8	15630.00	45.4 AV	54.0	-8.6	1.00 V	51	-10.58	55.98

**REMARKS:**

1. Emission Level(dBuV/m) = Raw Value(dBuV) + Correction Factor(dB/m)
2. Correction Factor(dB/m) = Antenna Factor(dB/m) + Cable Factor(dB) – Pre-Amplifier Factor(dB)
3. The other emission levels were very low against the limit.
4. Margin value = Emission Level – Limit value
5. " \* ": Fundamental frequency.
6. " # ": The radiated frequency is out of the restricted band.



## 4.2.9 TEST RESULTS (MODE 2)

### ABOVE 1GHz DATA

#### 802.11a

<b>CHANNEL</b>	TX Channel 36	<b>DETECTOR FUNCTION</b>	Peak (PK)
<b>FREQUENCY RANGE</b>	1GHz ~ 40GHz		Average (AV)

#### ANTENNA POLARITY & TEST DISTANCE: HORIZONTAL AT 3 M

NO.	FREQ. (MHz)	EMISSION LEVEL (dBuV/m)	LIMIT (dBuV/m)	MARGIN (dB)	ANTENNA HEIGHT (m)	TABLE ANGLE (Degree)	RAW VALUE (dBuV)	CORRECTION FACTOR (dB/m)
1	5101.00	55.4 PK	74.0	-18.6	1.13 H	6	11.93	43.47
2	5101.00	42.7 AV	54.0	-11.3	1.13 H	6	-0.77	43.47
3	5150.00	55.3 PK	74.0	-18.7	1.13 H	6	11.73	43.57
4	5150.00	43.6 AV	54.0	-10.4	1.13 H	6	0.03	43.57
5	*5180.00	94.1 PK			1.13 H	6	50.46	43.64
6	*5180.00	84.1 AV			1.13 H	6	40.46	43.64
7	#10360.00	51.3 PK	68.3	-17.0	1.15 H	330	0.56	50.74
8	15540.00	54.5 PK	74.0	-19.5	1.02 H	234	-1.56	56.06
9	15540.00	42.7 AV	54.0	-11.3	1.02 H	234	-13.36	56.06

#### ANTENNA POLARITY & TEST DISTANCE: VERTICAL AT 3 M

NO.	FREQ. (MHz)	EMISSION LEVEL (dBuV/m)	LIMIT (dBuV/m)	MARGIN (dB)	ANTENNA HEIGHT (m)	TABLE ANGLE (Degree)	RAW VALUE (dBuV)	CORRECTION FACTOR (dB/m)
1	5101.00	64.9 PK	74.0	-9.1	1.10 V	329	21.43	43.47
2	5101.00	53.6 AV	54.0	-0.4	1.10 V	329	10.13	43.47
3	5150.00	63.5 PK	74.0	-10.5	1.09 V	327	19.93	43.57
4	5150.00	48.5 AV	54.0	-5.5	1.09 V	327	4.93	43.57
5	*5180.00	112.4 PK			1.09 V	327	68.76	43.64
6	*5180.00	102.6 AV			1.09 V	327	58.96	43.64
7	#10360.00	51.0 PK	68.3	-17.3	1.06 V	237	0.26	50.74
8	15540.00	57.2 PK	74.0	-16.8	1.13 V	249	1.14	56.06
9	15540.00	44.7 AV	54.0	-9.3	1.13 V	249	-11.36	56.06

#### REMARKS:

1. Emission Level(dBuV/m) = Raw Value(dBuV) + Correction Factor(dB/m)
2. Correction Factor(dB/m) = Antenna Factor(dB/m) + Cable Factor(dB) – Pre-Amplifier Factor(dB)
3. The other emission levels were very low against the limit.
4. Margin value = Emission Level – Limit value
5. " \* ": Fundamental frequency.
6. " # ": The radiated frequency is out of the restricted band.



A D T

<b>CHANNEL</b>	TX Channel 40	<b>DETECTOR FUNCTION</b>	Peak (PK)
<b>FREQUENCY RANGE</b>	1GHz ~ 40GHz		Average (AV)

**ANTENNA POLARITY & TEST DISTANCE: HORIZONTAL AT 3 M**

NO.	FREQ. (MHz)	EMISSION LEVEL (dBuV/m)	LIMIT (dBuV/m)	MARGIN (dB)	ANTENNA HEIGHT (m)	TABLE ANGLE (Degree)	RAW VALUE (dBuV)	CORRECTION FACTOR (dB/m)
1	5121.40	55.2 PK	74.0	-18.8	1.18 H	315	11.69	43.51
2	5121.40	42.7 AV	54.0	-11.3	1.18 H	315	-0.81	43.51
3	*5200.00	91.3 PK			1.18 H	315	47.62	43.68
4	*5200.00	82.7 AV			1.18 H	315	39.02	43.68
5	#10400.00	51.0 PK	68.3	-17.3	1.15 H	329	0.33	50.67
6	15600.00	55.0 PK	74.0	-19.0	1.08 H	219	-1.01	56.01
7	15600.00	43.1 AV	54.0	-10.9	1.08 H	219	-12.91	56.01

**ANTENNA POLARITY & TEST DISTANCE: VERTICAL AT 3 M**

NO.	FREQ. (MHz)	EMISSION LEVEL (dBuV/m)	LIMIT (dBuV/m)	MARGIN (dB)	ANTENNA HEIGHT (m)	TABLE ANGLE (Degree)	RAW VALUE (dBuV)	CORRECTION FACTOR (dB/m)
1	5121.40	64.1 PK	74.0	-9.9	1.10 V	324	20.59	43.51
2	5121.40	53.6 AV	54.0	-0.4	1.10 V	324	10.09	43.51
3	*5200.00	112.0 PK			1.07 V	329	68.32	43.68
4	*5200.00	102.2 AV			1.07 V	329	58.52	43.68
5	#10400.00	51.8 PK	68.3	-16.5	1.00 V	231	1.13	50.67
6	15600.00	57.8 PK	74.0	-16.2	1.16 V	261	1.79	56.01
7	15600.00	45.6 AV	54.0	-8.4	1.16 V	261	-10.41	56.01

**REMARKS:**

1. Emission Level(dBuV/m) = Raw Value(dBuV) + Correction Factor(dB/m)
2. Correction Factor(dB/m) = Antenna Factor(dB/m) + Cable Factor(dB) – Pre-Amplifier Factor(dB)
3. The other emission levels were very low against the limit.
4. Margin value = Emission Level – Limit value
5. " \* ": Fundamental frequency.
6. " # ": The radiated frequency is out of the restricted band.





A D T

<b>CHANNEL</b>	TX Channel 48	<b>DETECTOR FUNCTION</b>	Peak (PK)
<b>FREQUENCY RANGE</b>	1GHz ~ 40GHz		Average (AV)

**ANTENNA POLARITY & TEST DISTANCE: HORIZONTAL AT 3 M**

NO.	FREQ. (MHz)	EMISSION LEVEL (dBuV/m)	LIMIT (dBuV/m)	MARGIN (dB)	ANTENNA HEIGHT (m)	TABLE ANGLE (Degree)	RAW VALUE (dBuV)	CORRECTION FACTOR (dB/m)
1	5127.00	55.2 PK	74.0	-18.8	1.00 H	89	11.67	43.53
2	5127.00	43.5 AV	54.0	-10.5	1.00 H	89	-0.03	43.53
3	*5240.00	100.1 PK			1.00 H	89	56.37	43.73
4	*5240.00	91.5 AV			1.00 H	89	47.77	43.73
5	#5676.70	57.1 PK	68.3	-11.2	1.00 H	89	12.67	44.43
6	#10480.00	51.4 PK	68.3	-16.9	1.12 H	316	0.37	51.03
7	15720.00	55.4 PK	74.0	-18.6	1.08 H	211	-0.48	55.88
8	15720.00	43.6 AV	54.0	-10.4	1.08 H	211	-12.28	55.88

**ANTENNA POLARITY & TEST DISTANCE: VERTICAL AT 3 M**

NO.	FREQ. (MHz)	EMISSION LEVEL (dBuV/m)	LIMIT (dBuV/m)	MARGIN (dB)	ANTENNA HEIGHT (m)	TABLE ANGLE (Degree)	RAW VALUE (dBuV)	CORRECTION FACTOR (dB/m)
1	5127.00	60.8 PK	74.0	-13.2	1.10 V	328	17.27	43.53
2	5127.00	49.1 AV	54.0	-4.9	1.10 V	328	5.57	43.53
3	*5240.00	118.3 PK			1.00 V	326	74.57	43.73
4	*5240.00	108.1 AV			1.00 V	326	64.37	43.73
5	#5676.70	63.6 PK	68.3	-4.7	1.00 V	324	19.17	44.43
6	#10480.00	51.2 PK	68.3	-17.1	1.00 V	224	0.17	51.03
7	15720.00	57.5 PK	74.0	-16.5	1.11 V	249	1.62	55.88
8	15720.00	45.2 AV	54.0	-8.8	1.11 V	249	-10.68	55.88

**REMARKS:**

1. Emission Level(dBuV/m) = Raw Value(dBuV) + Correction Factor(dB/m)
2. Correction Factor(dB/m) = Antenna Factor(dB/m) + Cable Factor(dB) – Pre-Amplifier Factor(dB)
3. The other emission levels were very low against the limit.
4. Margin value = Emission Level – Limit value
5. " \* ": Fundamental frequency.
6. " # ": The radiated frequency is out of the restricted band.

### 4.3 TRANSMIT POWER MEASUREMENT

#### 4.3.1 LIMITS OF TRANSMIT POWER MEASUREMENT

FREQUENCY BAND	LIMIT
5.150 ~ 5.250GHz	The lesser of 50mW (17dBm) or 4dBm + 10logB
5.250 ~ 5.350GHz	The lesser of 250mW (24dBm) or 11dBm + 10logB
5.470 ~ 5.725GHz	The lesser of 250mW (24dBm) or 11dBm + 10logB

**NOTE:** Where B is the 26dB emission bandwidth in MHz.

Per KDB 662911 D01 Multiple Transmitter Output Method of conducted output power measurement on IEEE 802.11 devices,

Array Gain = 0 dB (i.e., no array gain) for NANT  $\leq$  4;

Array Gain = 0 dB (i.e., no array gain) for channel widths  $\geq$  40 MHz for any NANT;

Array Gain = 5 log(NANT/NSS) dB or 3 dB, whichever is less for 20-MHz channel widths with NANT  $\geq$  5.

For power measurements on all other devices: Array Gain = 10 log(NANT/NSS) dB.



A D T

### 4.3.2 TEST INSTRUMENTS

#### FOR POWER OUTPUT MEASUREMENT

DESCRIPTION & MANUFACTURER	MODEL NO.	SERIAL NO.	CALIBRATED DATE	CALIBRATED UNTIL
Power meter Anritsu	ML2495A	0824006	May 20, 2013	May 19, 2014
Power sensor Anritsu	MA2411B	0738172	May 20, 2013	May 19, 2014

**Note:**

1. The calibration interval of the above test instruments is 12 months and the calibrations are traceable to NML/ROC and NIST/USA.
2. Tested date : Jan. 17, 2014

#### FOR 26dB OCCUPIED BANDWIDTH

DESCRIPTION & MANUFACTURER	MODEL NO.	SERIAL NO.	CALIBRATED DATE	CALIBRATED UNTIL
Spectrum Analyzer R&S	FSP 40	100036	Jan. 21, 2013	Jan. 20, 2014

**Note:**

1. The calibration interval of the above test instruments is 12 months and the calibrations are traceable to NML/ROC and NIST/USA.
2. Tested date : Jan. 17, 2014

### 4.3.3 TEST PROCEDURE

#### FOR POWER OUTPUT MEASUREMENT

Method PM is used to perform output power measurement, trigger and gating function of wide band power meter is enabled to measure max output power of TX on burst. Duty factor is not added to measured value.

#### FOR 26dB OCCUPIED BANDWIDTH

1. Set RBW = approximately 1% of the emission bandwidth.
2. Set the VBW > RBW.
3. Detector = Peak.
4. Trace mode = max hold.
5. Measure the maximum width of the emission that is 26 dB down from the peak of the emission. Compare this with the RBW setting of the analyzer. Readjust RBW and repeat measurement as needed until the RBW/EBW ratio is approximately 1%.

#### 4.3.4 DEVIATION FROM TEST STANDARD

No deviation

#### 4.3.5 TEST SETUP

##### FOR POWER OUTPUT MEASUREMENT

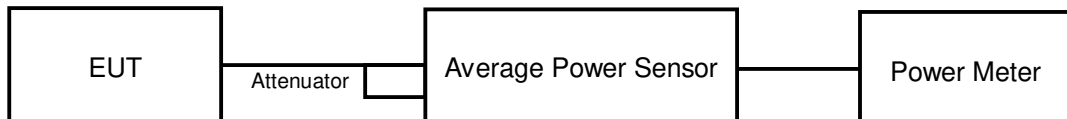

##### FOR 26dB OCCUPIED BANDWIDTH

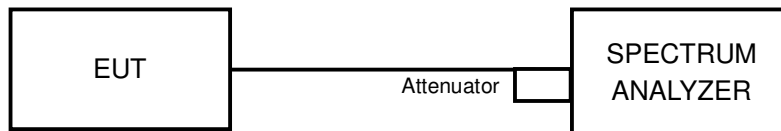

#### 4.3.6 EUT OPERATING CONDITIONS

The software provided by client to enable the EUT under transmission condition continuously at specific channel frequencies individually.



A D T

### 4.3.7 TEST RESULTS (MODE 1)

#### POWER OUTPUT:

CDD_MODE								
CHANNEL	FREQUENCY (MHz)	AVERAGE POWER (dBm)			TOTAL POWER (mW)	TOTAL POWER (dBm)	POWER LIMIT (dBm)	PASS / FAIL
		CHAIN 0	CHAIN 1	CHAIN 2				
<b>802.11ac (VHT20)</b>								
36	5180	11.81	11.71	11.59	44.417	16.48	17	PASS
40	5200	11.41	11.52	11.71	42.852	16.32	17	PASS
48	5240	11.56	11.56	11.62	43.165	16.35	17	PASS
<b>802.11ac (VHT40)</b>								
38	5190	11.93	11.84	11.75	45.834	16.61	17	PASS
46	5230	11.55	12.00	11.39	43.910	16.43	17	PASS
<b>802.11ac (VHT80)</b>								
42	5210	11.25	11.15	11.45	40.331	16.06	17	PASS

#### 26dB OCCUPIED BANDWIDTH:

CHANNEL	CHANNEL FREQUENCY (MHz)	26dBc BANDWIDTH (MHz)		
		CHAIN 0	CHAIN 1	CHAIN 2
<b>802.11ac (VHT20)</b>				
36	5180	20.67	20.55	20.67
40	5200	20.63	20.51	20.61
48	5240	20.90	20.63	20.75
<b>802.11ac (VHT40)</b>				
38	5190	41.17	40.58	40.53
46	5230	40.85	40.61	40.46
<b>802.11ac (VHT80)</b>				
42	5210	82.98	82.56	82.08

Note: For FCC output power limitation is determined based on 26dBc bandwidth.

Power Limit = 4dBm + 10logB < UNII Band 1 >			
Channel Number	Freq.(MHz)	Min. B(MHz)	Determined Conducted Limit (dBm)
<b>802.11ac (VHT20)</b>			
36	5180	20.55	17.12 > 17
40	5200	20.51	17.11 > 17
48	5240	20.63	17.14 > 17
<b>802.11ac (VHT40)</b>			
38	5190	40.53	20.07 > 17
46	5230	40.46	20.07 > 17
<b>802.11ac (VHT80)</b>			
42	5210	82.08	23.14 > 17



A D T

**POWER OUTPUT:**

STBC_MODE								
CHANNEL	FREQUENCY (MHz)	AVERAGE POWER (dBm)			TOTAL POWER (mW)	TOTAL POWER (dBm)	POWER LIMIT (dBm)	PASS / FAIL
		CHAIN 0	CHAIN 1	CHAIN 2				
<b>802.11ac (VHT20)</b>								
36	5180	11.81	11.71	11.59	44.417	16.48	17	PASS
40	5200	11.41	11.52	11.71	42.852	16.32	17	PASS
48	5240	11.56	11.56	11.62	43.165	16.35	17	PASS
<b>802.11ac (VHT40)</b>								
38	5190	11.93	11.84	11.75	45.834	16.61	17	PASS
46	5230	11.55	12.00	11.39	43.910	16.43	17	PASS
<b>802.11ac (VHT80)</b>								
42	5210	11.92	11.82	12.21	47.399	16.76	17	PASS

**26dB OCCUPIED BANDWIDTH:**

CHANNEL	CHANNEL FREQUENCY (MHz)	26dBc BANDWIDTH (MHz)		
		CHAIN 0	CHAIN 1	CHAIN 2
<b>802.11ac (VHT20)</b>				
36	5180	20.67	20.55	20.67
40	5200	20.63	20.51	20.61
48	5240	20.90	20.63	20.75
<b>802.11ac (VHT40)</b>				
38	5190	41.17	40.58	40.53
46	5230	40.85	40.61	40.46
<b>802.11ac (VHT80)</b>				
42	5210	82.94	82.44	81.94

**Note: For FCC output power limitation is determined based on 26dBc bandwidth.**

Power Limit = 4dBm + 10logB < UNII Band 1 >			
Channel Number	Freq.(MHz)	Min. B(MHz)	Determined Conducted Limit (dBm)
<b>802.11ac (VHT20)</b>			
36	5180	20.55	17.12 > 17
40	5200	20.51	17.11 > 17
48	5240	20.63	17.14 > 17
<b>802.11ac (VHT40)</b>			
38	5190	40.53	20.07 > 17
46	5230	40.46	20.07 > 17
<b>802.11ac (VHT80)</b>			
42	5210	81.94	23.13 > 17



A D T

**POWER OUTPUT:**

Beam forming_MODE								
CHANNEL	FREQUENCY (MHz)	AVERAGE POWER (dBm)			TOTAL POWER (mW)	TOTAL POWER (dBm)	POWER LIMIT (dBm)	PASS / FAIL
		CHAIN 0	CHAIN 1	CHAIN 2				
<b>802.11ac (VHT20)</b>								
36	5180	11.81	11.71	11.59	44.417	16.48	17	PASS
40	5200	11.41	11.52	11.71	42.852	16.32	17	PASS
48	5240	11.56	11.56	11.62	43.165	16.35	17	PASS
<b>802.11ac (VHT40)</b>								
38	5190	11.93	11.84	11.75	45.834	16.61	17	PASS
46	5230	11.55	12.00	11.39	43.910	16.43	17	PASS
<b>802.11ac (VHT80)</b>								
42	5210	11.25	11.15	11.45	40.331	16.06	17	PASS
<b>NOTE:</b> Directional gain = $10 \log[(10^{G1/20} + 10^{G2/20} + 10^{G3/20})^2 / 3] = 5.38\text{dBi} < 6\text{dBi}$ , so the power limit shall not be reduced.								

**26dB OCCUPIED BANDWIDTH:**

CHANNEL	CHANNEL FREQUENCY (MHz)	26dBc BANDWIDTH (MHz)		
		CHAIN 0	CHAIN 1	CHAIN 2
<b>802.11ac (VHT20)</b>				
36	5180	20.67	20.55	20.67
40	5200	20.63	20.51	20.61
48	5240	20.90	20.63	20.75
<b>802.11ac (VHT40)</b>				
38	5190	41.17	40.58	40.53
46	5230	40.85	40.61	40.46
<b>802.11ac (VHT80)</b>				
42	5210	82.98	82.56	82.08

**Note: For FCC output power limitation is determined based on 26dBc bandwidth.**

Power Limit = 4dBm + 10logB < UNII Band 1 >			
Channel Number	Freq.(MHz)	Min. B(MHz)	Determined Conducted Limit (dBm)
<b>802.11ac (VHT20)</b>			
36	5180	20.55	17.12 > 17
40	5200	20.51	17.11 > 17
48	5240	20.63	17.14 > 17
<b>802.11ac (VHT40)</b>			
38	5190	40.53	20.07 > 17
46	5230	40.46	20.07 > 17
<b>802.11ac (VHT80)</b>			
42	5210	82.08	23.14 > 17

#### 4.3.8 TEST RESULTS (MODE 2)

##### POWER OUTPUT:

802.11a					
CHANNEL	CHANNEL FREQUENCY (MHz)	AVERAGE POWER (mW)	AVERAGE POWER (dBm)	POWER LIMIT (dBm)	PASS/FAIL
36	5180	44.361	16.47	17	PASS
40	5200	39.355	15.95	17	PASS
48	5240	43.451	16.38	17	PASS

##### 26dB OCCUPIED BANDWIDTH:

CHANNEL	CHANNEL FREQUENCY (MHz)	26dBc BANDWIDTH (MHz)
36	5180	20.41
40	5200	20.26
48	5240	20.30

**Note: For output power limitation is determined based on 26dBc bandwidth.**

Power Limit = $4\text{dBm} + 10\log B < \text{UNII Band 1}>$			
Channel Number	Freq.(MHz)	Min. B(MHz)	Determined Conducted Limit (dBm)
36	5180	20.41	17.09 > 17
40	5200	20.26	17.06 > 17
48	5240	20.30	17.07 > 17



#### 4.4 PEAK POWER SPECTRAL DENSITY MEASUREMENT

##### 4.4.1 LIMITS OF PEAK POWER SPECTRAL DENSITY MEASUREMENT

FREQUENCY BAND	LIMIT
5.15 ~ 5.25GHz	4dBm
5.25 ~ 5.35GHz	11dBm
5.47 – 5.725GHz	11dBm
5.725 ~ 5.825GHz	17dBm

##### 4.4.2 TEST INSTRUMENTS

DESCRIPTION & MANUFACTURER	MODEL NO.	SERIAL NO.	CALIBRATED DATE	CALIBRATED UNTIL
Spectrum Analyzer R&S	FSP40	100036	Jan. 21, 2013	Jan. 20, 2014

**Note:**

1. The calibration interval of the above test instruments is 12 months and the calibrations are traceable to NML/ROC and NIST/USA.
2. Tested date : Jan. 17, 2014

##### 4.4.3 TEST PROCEDURES

1. Set span to encompass the entire emission bandwidth (EBW) of the signal.
2. Set RBW = 1 MHz, Set VBW ≥ 3 MHz, Detector = RMS
3. Sweep time = auto, trigger set to “free run”.
4. Trace average at least 100 traces in power averaging mode.
5. Record the max value and for duty cycle of test signal is < 98% add 10 log (1/duty cycle)

##### 4.4.4 DEVIATION FROM TEST STANDARD

No deviation

##### 4.4.5 TEST SETUP

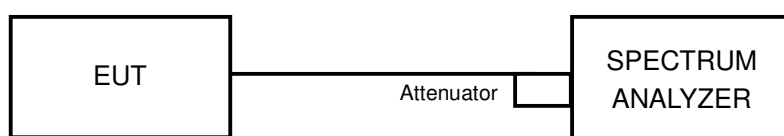



A D T

#### 4.4.6 EUT OPERATING CONDITIONS

Same as 4.3.6



#### 4.4.7 TEST RESULTS (MODE 1)

##### CDD\_MODE

802.11ac (VHT20)							
CHANNEL	CHANNEL FREQUENCY (MHz)	PSD (dBm)			TOTAL POWER DENSITY (dBm)	MAX. LIMIT (dBm)	PASS/FAIL
		CHAIN 0	CHAIN 1	CHAIN 2			
36	5180	-1.29	-1.01	-1.66	3.46	4	PASS
40	5200	-1.43	-1.12	-1.62	3.39	4	PASS
48	5240	-1.34	-0.87	-1.65	3.50	4	PASS
<b>NOTE:</b> 1. Method a) of power density measurement of KDB 662911 is using for calculating total power density. Total power density is summing entire spectra across corresponding frequency bins on the various outputs by computer. 2. Directional gain = $10 \log[(10^{G1/20} + 10^{G2/20} + 10^{G3/20})^2 / 3] = 5.38\text{dBi} < 6\text{dBi}$ , so the power density limit shall not be reduced.							

802.11ac (VHT40)							
CHANNEL	CHANNEL FREQUENCY (MHz)	PSD (dBm)			TOTAL POWER DENSITY (dBm)	MAX. LIMIT (dBm)	PASS/FAIL
		CHAIN 0	CHAIN 1	CHAIN 2			
38	5190	-4.14	-4.15	-4.09	0.64	4	PASS
46	5230	-3.97	-3.96	-3.95	0.81	4	PASS
<b>NOTE:</b> 1. Method a) of power density measurement of KDB 662911 is using for calculating total power density. Total power density is summing entire spectra across corresponding frequency bins on the various outputs by computer. 2. Directional gain = $10 \log[(10^{G1/20} + 10^{G2/20} + 10^{G3/20})^2 / 3] = 5.38\text{dBi} < 6\text{dBi}$ , so the power density limit shall not be reduced.							

802.11ac (VHT80)								
CHANNEL	CHANNEL FREQUENCY (MHz)	PSD W/O DUTY FACTOR (dBm)			DUTY FACTOR (dB)	TOTAL PSD WITH DUTY FACTOR (dBm)	MAX. LIMIT (dBm)	PASS/FAIL
		CHAIN 0	CHAIN 1	CHAIN 2				
155	5775	-7.95	-7.30	-7.43	0.17	-2.61	4	PASS
<b>NOTE:</b> 1. Method a) of power density measurement of KDB 662911 is using for calculating total power density. Total power density is summing entire spectra across corresponding frequency bins on the various outputs by computer. 2. Directional gain = $10 \log[(10^{G1/20} + 10^{G2/20} + 10^{G3/20})^2 / 3] = 5.38\text{dBi} < 6\text{dBi}$ , so the power density limit shall not be reduced. 3. Refer to section 3.4 for duty cycle spectrum plot.								



**STBC\_MODE**

802.11ac (VHT20)							
CHANNEL	CHANNEL FREQUENCY (MHz)	PSD (dBm)			TOTAL POWER DENSITY (dBm)	MAX. LIMIT (dBm)	PASS/FAIL
		CHAIN 0	CHAIN 1	CHAIN 2			
36	5180	-1.29	-1.01	-1.66	3.46	4	PASS
40	5200	-1.43	-1.12	-1.62	3.39	4	PASS
48	5240	-1.34	-0.87	-1.65	3.50	4	PASS
<b>NOTE:</b> 1. Method a) of power density measurement of KDB 662911 is using for calculating total power density. Total power density is summing entire spectra across corresponding frequency bins on the various outputs by computer.							

802.11ac (VHT40)							
CHANNEL	CHANNEL FREQUENCY (MHz)	PSD (dBm)			TOTAL POWER DENSITY (dBm)	MAX. LIMIT (dBm)	PASS/FAIL
		CHAIN 0	CHAIN 1	CHAIN 2			
38	5190	-4.14	-4.15	-4.09	0.64	4	PASS
46	5230	-3.97	-3.96	-3.95	0.81	4	PASS
<b>NOTE:</b> 1. Method a) of power density measurement of KDB 662911 is using for calculating total power density. Total power density is summing entire spectra across corresponding frequency bins on the various outputs by computer.							

802.11ac (VHT80)								
CHANNEL	CHANNEL FREQUENCY (MHz)	PSD W/O DUTY FACTOR (dBm)			DUTY FACTOR (dB)	TOTAL PSD WITH DUTY FACTOR (dBm)	MAX. LIMIT (dBm)	PASS/FAIL
		CHAIN 0	CHAIN 1	CHAIN 2				
155	5775	-7.00	-6.34	-6.53	0.17	-1.67	4	PASS
<b>NOTE:</b> 1. Method a) of power density measurement of KDB 662911 is using for calculating total power density. Total power density is summing entire spectra across corresponding frequency bins on the various outputs by computer.								
2. Refer to section 3.4 for duty cycle spectrum plot.								



**Beam forming\_MODE**

**802.11ac (VHT20)**

CHANNEL	CHANNEL FREQUENCY (MHz)	PSD (dBm)			TOTAL POWER DENSITY (dBm)	MAX. LIMIT (dBm)	PASS/FAIL
		CHAIN 0	CHAIN 1	CHAIN 2			
36	5180	-1.29	-1.01	-1.66	3.46	4	PASS
40	5200	-1.43	-1.12	-1.62	3.39	4	PASS
48	5240	-1.34	-0.87	-1.65	3.50	4	PASS

**NOTE:** 1. Method a) of power density measurement of KDB 662911 is using for calculating total power density. Total power density is summing entire spectra across corresponding frequency bins on the various outputs by computer.  
 2. Directional gain =  $10 \log[(10^{G1/20} + 10^{G2/20} + 10^{G3/20})^2 / 3] = 9.29\text{dBi} > 5.38\text{dBi} < 6\text{dBi}$ , so the power density limit shall not be reduced.

**802.11ac (VHT40)**

CHANNEL	CHANNEL FREQUENCY (MHz)	PSD (dBm)			TOTAL POWER DENSITY (dBm)	MAX. LIMIT (dBm)	PASS/FAIL
		CHAIN 0	CHAIN 1	CHAIN 2			
38	5190	-4.14	-4.15	-4.09	0.64	4	PASS
46	5230	-3.97	-3.96	-3.95	0.81	4	PASS

**NOTE:** 1. Method a) of power density measurement of KDB 662911 is using for calculating total power density. Total power density is summing entire spectra across corresponding frequency bins on the various outputs by computer.  
 2. Directional gain =  $10 \log[(10^{G1/20} + 10^{G2/20} + 10^{G3/20})^2 / 3] = 5.38\text{dBi} < 6\text{dBi}$ , so the power density limit shall not be reduced.

**802.11ac (VHT80)**

CHANNEL	CHANNEL FREQUENCY (MHz)	PSD W/O DUTY FACTOR (dBm)			DUTY FACTOR (dB)	TOTAL PSD WITH DUTY FACTOR (dBm)	MAX. LIMIT (dBm)	PASS/FAIL
		CHAIN 0	CHAIN 1	CHAIN 2				
155	5775	-7.95	-7.30	-7.43	0.17	-2.61	4	PASS

**NOTE:** 1. Method a) of power density measurement of KDB 662911 is using for calculating total power density. Total power density is summing entire spectra across corresponding frequency bins on the various outputs by computer.  
 2. Directional gain =  $10 \log[(10^{G1/20} + 10^{G2/20} + 10^{G3/20})^2 / 3] = 5.38\text{dBi} < 6\text{dBi}$ , so the power density limit shall not be reduced.  
 3. Refer to section 3.4 for duty cycle spectrum plot.



A D T

### SPECTRUM PLOT OF WORST VALUE

#### CDD\_MODE <802.11ac (VHT20)\_Chain (1) / CH48>

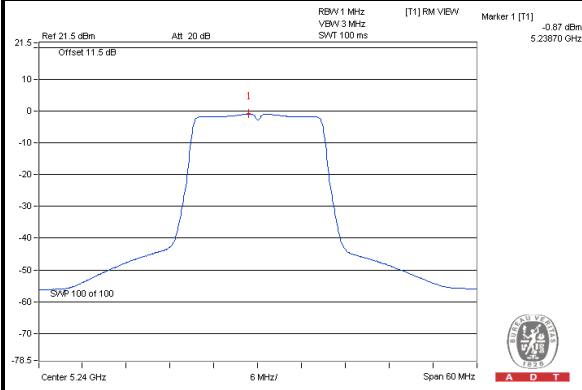

#### CDD\_MODE <802.11ac (VHT40)\_Chain (2) / CH46>

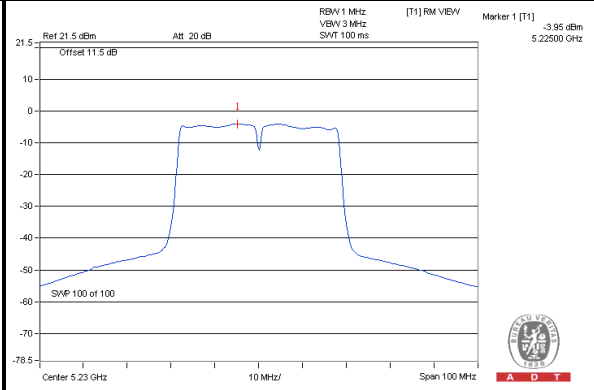

#### STBC\_MODE <802.11ac (VHT80)\_Chain (1) / CH42>

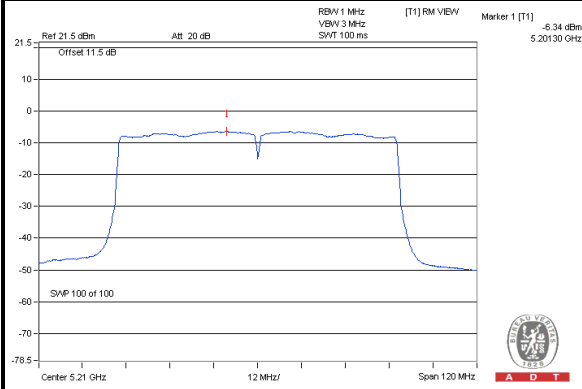



A D T

### 4.4.8 TEST RESULTS (MODE 2)

802.11a				
CHANNEL	FREQUENCY (MHz)	PSD (dBm)	MAXIMUM LIMIT (dBm)	PASS/FAIL
36	5180	3.73	4	PASS
40	5200	3.59	4	PASS
48	5240	3.71	4	PASS

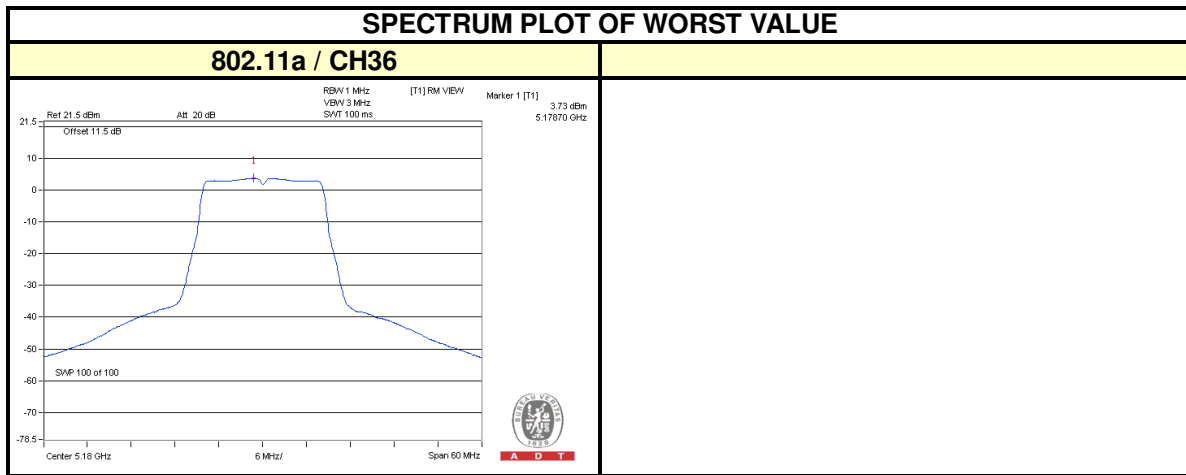



A D T

## 4.5 PEAK POWER EXCURSION MEASUREMENT

### 4.5.1 LIMITS OF PEAK POWER EXCURSION MEASUREMENT

Shall not exceed 13 dB

### 4.5.2 TEST INSTRUMENTS

DESCRIPTION & MANUFACTURER	MODEL NO.	SERIAL NO.	CALIBRATED DATE	CALIBRATED UNTIL
Spectrum Analyzer R&S	FSP 40	100036	Jan. 21, 2013	Jan. 20, 2014

**Note:**

1. The calibration interval of the above test instruments is 12 months and the calibrations are traceable to NML/ROC and NIST/USA.
2. Tested date : Jan. 17, 2014

### 4.5.3 TEST PROCEDURE

1. Set RBW = 1 MHz, VBW  $\geq$  3 MHz, Detector = peak.
2. Trace mode = max-hold. Allow the sweeps to continue until the trace stabilizes.
3. Use the peak search function to find the peak of the spectrum.
4. Measure the PPSD.
5. Compute the ratio of the maximum of the peak-max-hold spectrum to the PPSD.

### 4.5.4 DEVIATION FROM TEST STANDARD

No deviation

### 4.5.5 TEST SETUP

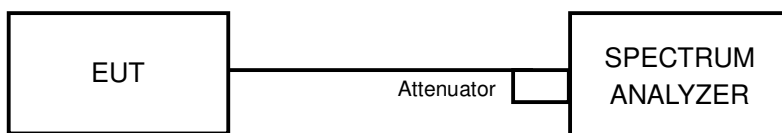

### 4.5.6 EUT OPERATING CONDITIONS

The software provided by client to enable the EUT under transmission condition continuously at specific channel frequencies individually.





A D T

#### 4.5.7 TEST RESULTS (MODE 1)

##### CDD\_MODE

MODULATION MODE	MODULATION TYPE	CHANNEL FREQUENCY (MHz)	PEAK VALUE (dBm)	PPSD (dBm)	PEAK EXCURSION (dB)	LIMIT (dB)	PASS/ FAIL
802.11ac (VHT20)	BPSK	5240	8.94	-1.65	10.59	13	PASS
	QPSK		8.95	-1.15	10.1	13	PASS
802.11ac (VHT40)	BPSK	5230	6.51	-3.95	10.46	13	PASS

MODULATION MODE	MODULATION TYPE	CHAN. FREQ. (MHz)	PEAK VALUE (dBm)	PPSD WITHOUT DUTY FACTOR (dBm)	PPSD WITH DUTY FACTOR (dBm)	PEAK EXCURSION (dB)	LIMIT (dB)	PASS /FAIL
802.11ac (VHT20)	16QAM	5240	8.66	-1.33	-1.17	9.83	13	PASS
	64QAM		9.02	-1.41	-1.12	10.14	13	PASS
	256QAM		8.73	-1.48	-1.08	9.81	13	PASS
802.11ac (VHT40)	QPSK	5230	5.96	-4.04	-3.87	9.83	13	PASS
	16QAM		6.2	-4.1	-3.8	10	13	PASS
	64QAM		6.45	-4.22	-3.75	10.2	13	PASS
	256QAM		5.98	-4.37	-3.74	9.72	13	PASS
802.11ac (VHT80)	BPSK	5210	2.69	-7.43	-7.26	9.95	13	PASS
	QPSK		1.86	-7.84	-7.64	9.5	13	PASS
	16QAM		3.64	-7.89	-7.39	11.03	13	PASS
	64QAM		2.53	-7.94	-7.19	9.72	13	PASS
	256QAM		2.66	-8.01	-7.09	9.75	13	PASS

**NOTE:** 1. Refer to section 3.4 for duty cycle spectrum plot.



A D T

### SPECTRUM PLOT OF WORST VALUE

#### 802.11ac (VHT20) / BPSK

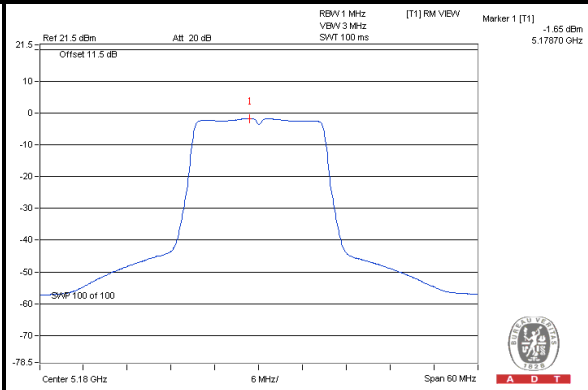
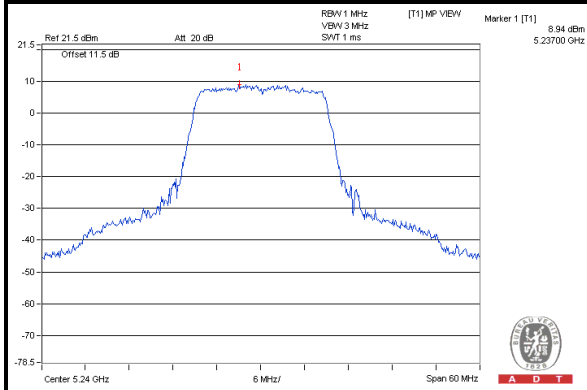

#### 802.11ac (VHT40) / BPSK

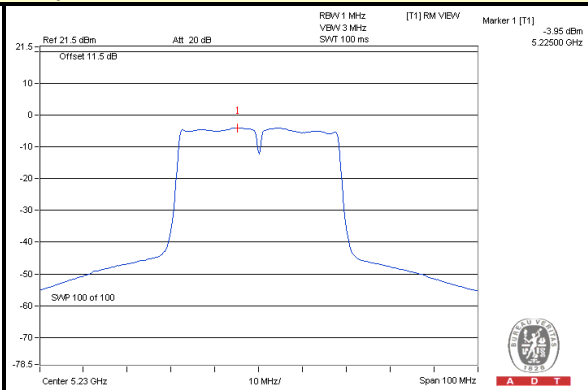
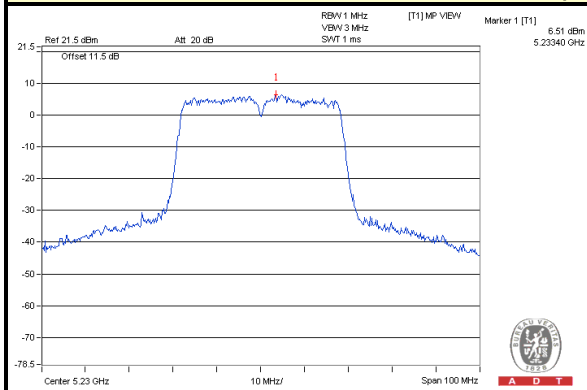

#### 802.11ac (VHT80) / 16QAM

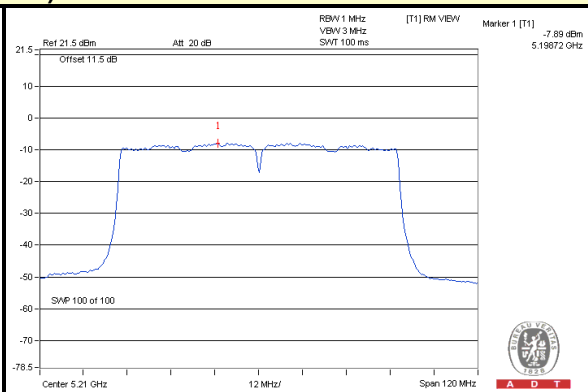
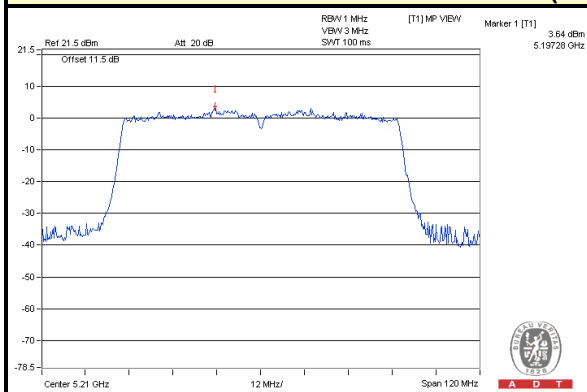



A D T

### STBC\_MODE

MODULATION MODE	MODULATION TYPE	CHANNEL FREQUENCY (MHz)	PEAK VALUE (dBm)	PPSD (dBm)	PEAK EXCURSION (dB)	LIMIT (dB)	PASS/ FAIL
802.11ac (VHT20)	BPSK	5240	8.94	-1.65	10.59	13	PASS
	QPSK		8.95	-1.15	10.1	13	PASS
802.11ac (VHT40)	BPSK	5230	6.51	-3.95	10.46	13	PASS

MODULATION MODE	MODULATION TYPE	CHAN. FREQ. (MHz)	PEAK VALUE (dBm)	PPSD WITHOUT DUTY FACTOR (dBm)	PPSD WITH DUTY FACTOR (dBm)	PEAK EXCURSION (dB)	LIMIT (dB)	PASS /FAIL
802.11ac (VHT20)	16QAM	5240	8.66	-1.33	-1.17	9.83	13	PASS
	64QAM		9.02	-1.41	-1.12	10.14	13	PASS
	256QAM		8.73	-1.48	-1.08	9.81	13	PASS
802.11ac (VHT40)	QPSK	5230	5.96	-4.04	-3.87	9.83	13	PASS
	16QAM		6.2	-4.1	-3.8	10	13	PASS
	64QAM		6.45	-4.22	-3.75	10.2	13	PASS
	256QAM		5.98	-4.37	-3.74	9.72	13	PASS
802.11ac (VHT80)	BPSK	5210	3.33	-6.47	-6.3	9.63	13	PASS
	QPSK		1.86	-7.84	-7.64	9.5	13	PASS
	16QAM		3.64	-7.89	-7.39	11.03	13	PASS
	64QAM		2.53	-7.94	-7.19	9.72	13	PASS
	256QAM		2.66	-8.01	-7.09	9.75	13	PASS

**NOTE:** 1. Refer to section 3.4 for duty cycle spectrum plot.



A D T

### SPECTRUM PLOT OF WORST VALUE

#### 802.11ac (VHT20) / BPSK

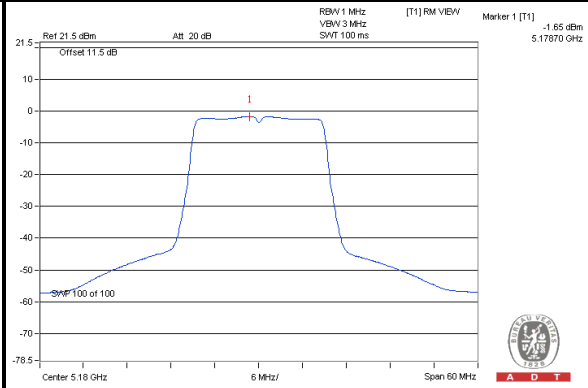
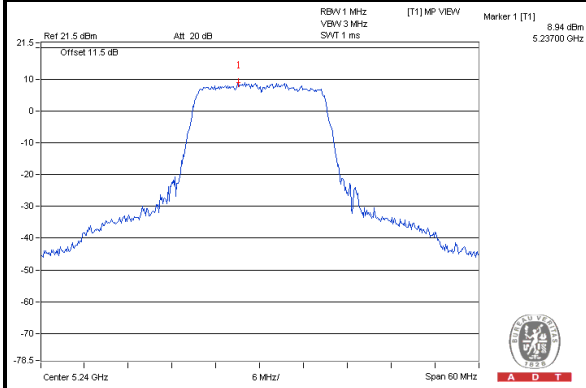

#### 802.11ac (VHT40) / BPSK

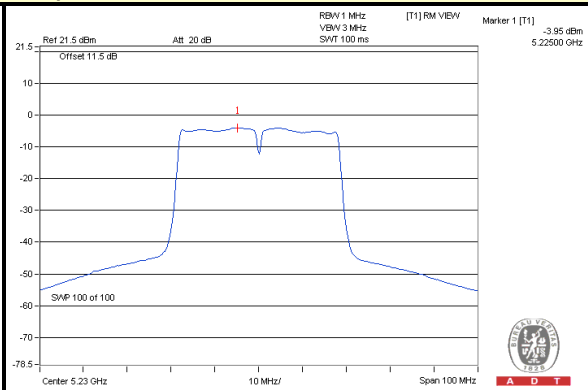
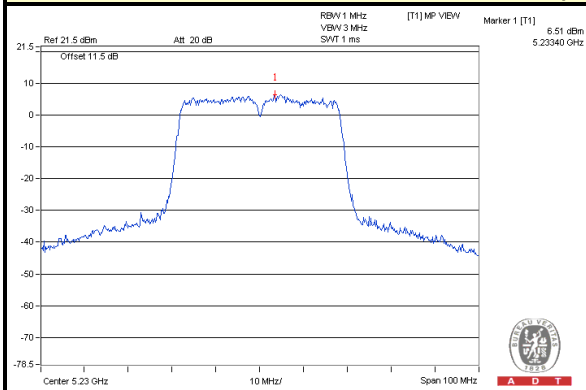

#### 802.11ac (VHT80) / 16QAM

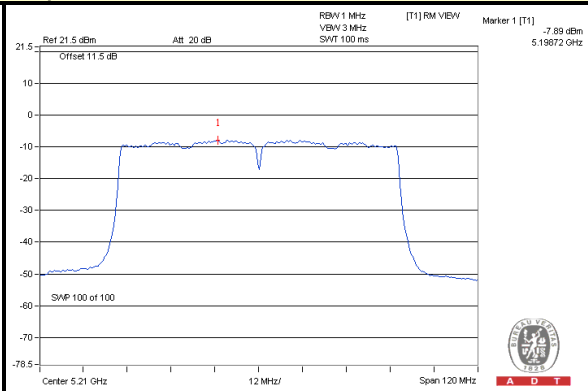
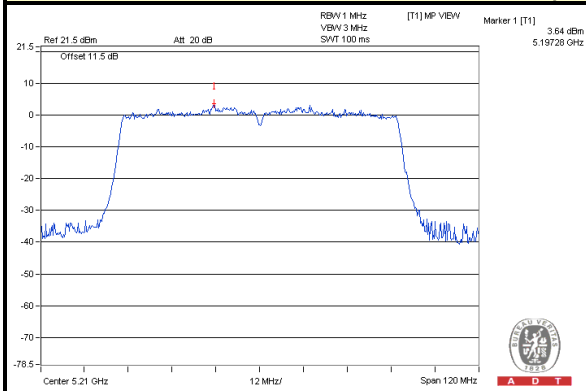



A D T

**Beam forming\_MODE**

MODULATION MODE	MODULATION TYPE	CHANNEL FREQUENCY (MHz)	PEAK VALUE (dBm)	PPSD (dBm)	PEAK EXCURSION (dB)	LIMIT (dB)	PASS/ FAIL
802.11ac (VHT20)	BPSK	5240	8.94	-1.65	10.59	13	PASS
	QPSK		8.95	-1.15	10.1	13	PASS
802.11ac (VHT40)	BPSK	5230	6.51	-3.95	10.46	13	PASS

MODULATION MODE	MODULATION TYPE	CHAN. FREQ. (MHz)	PEAK VALUE (dBm)	PPSD WITHOUT DUTY FACTOR (dBm)	PPSD WITH DUTY FACTOR (dBm)	PEAK EXCURSION (dB)	LIMIT (dB)	PASS /FAIL
802.11ac (VHT20)	16QAM	5240	8.66	-1.33	-1.17	9.83	13	PASS
	64QAM		9.02	-1.41	-1.12	10.14	13	PASS
	256QAM		8.73	-1.48	-1.08	9.81	13	PASS
802.11ac (VHT40)	QPSK	5230	5.96	-4.04	-3.87	9.83	13	PASS
	16QAM		6.2	-4.1	-3.8	10	13	PASS
	64QAM		6.45	-4.22	-3.75	10.2	13	PASS
	256QAM		5.98	-4.37	-3.74	9.72	13	PASS
802.11ac (VHT80)	BPSK	5210	2.69	-7.43	-7.26	9.95	13	PASS
	QPSK		1.86	-7.84	-7.64	9.5	13	PASS
	16QAM		3.64	-7.89	-7.39	11.03	13	PASS
	64QAM		2.53	-7.94	-7.19	9.72	13	PASS
	256QAM		2.66	-8.01	-7.09	9.75	13	PASS

**NOTE:** 1. Refer to section 3.4 for duty cycle spectrum plot.



A D T

### SPECTRUM PLOT OF WORST VALUE

#### 802.11ac (VHT20) / BPSK

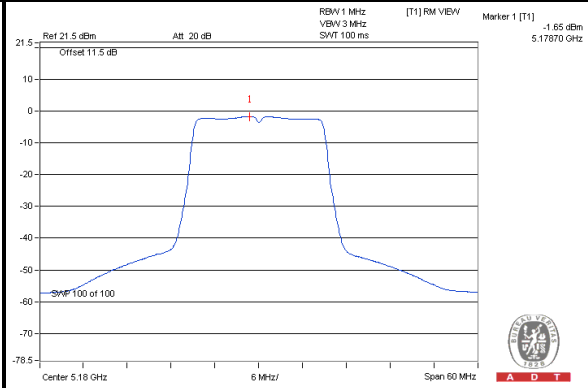
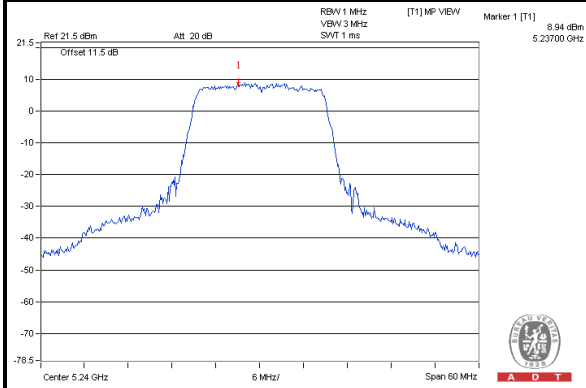

#### 802.11ac (VHT40) / BPSK

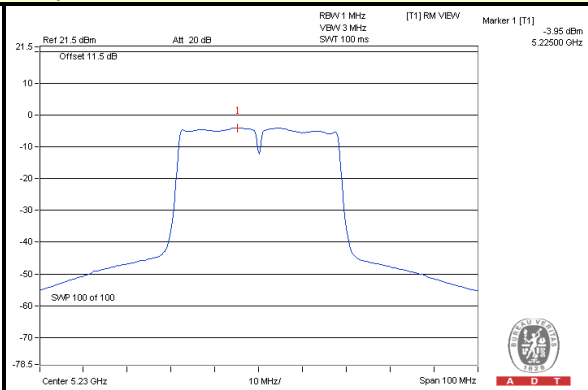
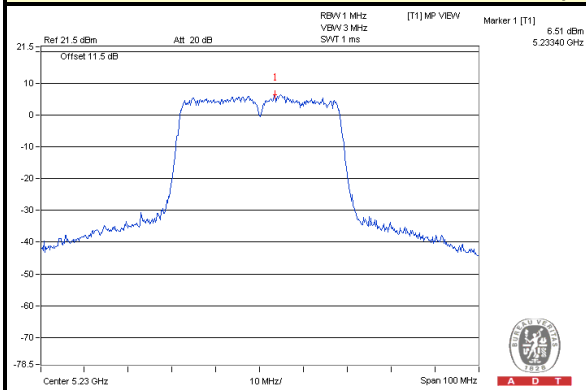

#### 802.11ac (VHT80) / 16QAM

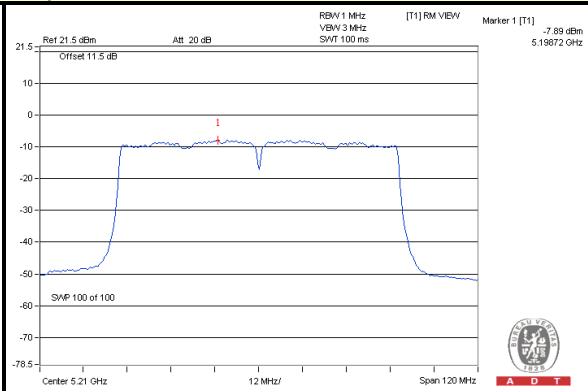
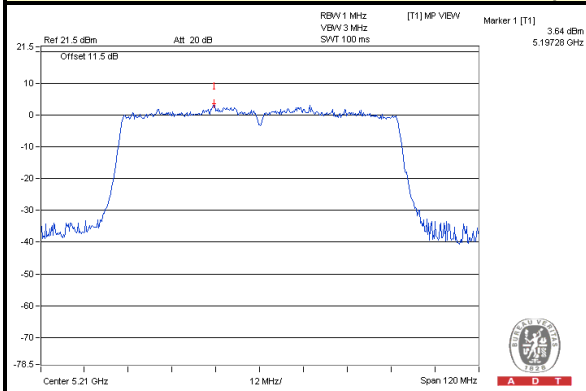



A D T

### 4.5.8 TEST RESULTS (MODE 2)

MODULATION MODE	MODULATION TYPE	CHANNEL FREQUENCY (MHz)	PEAK VALUE (dBm)	PPSD (dBm)	PEAK EXCURSION (dB)	LIMIT (dB)	PASS/ FAIL
802.11a	BPSK	5240	11.69	3.71	7.98	13	PASS
	QPSK		12.4	3.86	8.54	13	PASS

MODULATION MODE	MODULATION TYPE	CHAN. FREQ. (MHz)	PEAK VALUE (dBm)	PPSD WITHOUT DUTY FACTOR (dBm)	PPSD WITH DUTY FACTOR (dBm)	PEAK EXCURSION (dB)	LIMIT (dB)	PASS /FAIL
802.11a	16QAM	5240	12.53	3.99	4.19	8.34	13	PASS
	64QAM		12.69	4.04	4.31	8.38	13	PASS

**NOTE:** 1. Refer to section 3.4 for duty cycle spectrum plot.

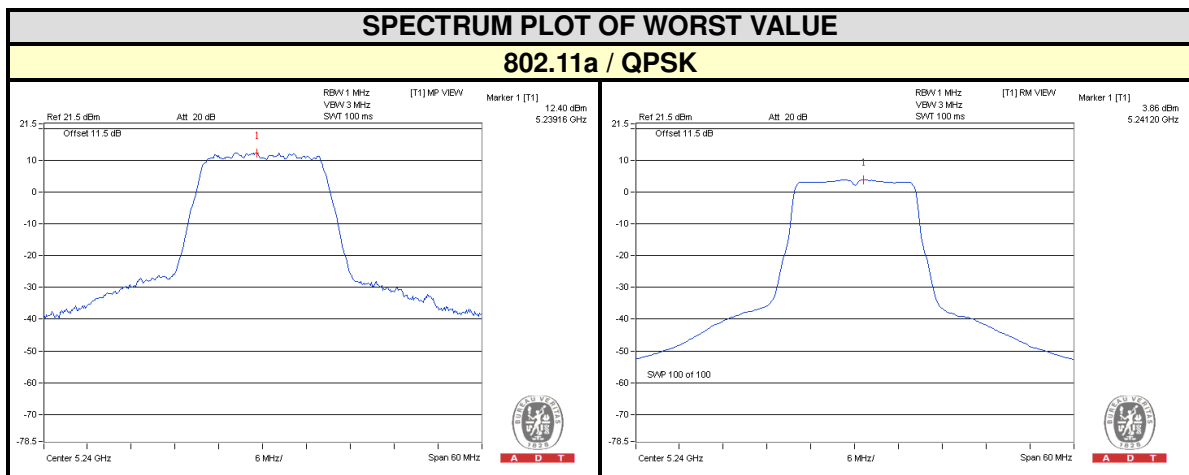

## 4.6 FREQUENCY STABILITY

### 4.6.1 LIMITS OF FREQUENCY STABILITY MEASUREMENT

The frequency of the carrier signal shall be maintained within band of operation

### 4.6.2 TEST INSTRUMENTS

DESCRIPTION & MANUFACTURER	MODEL NO.	SERIAL NO.	CALIBRATED DATE	CALIBRATED UNTIL
Spectrum Analyzer R&S	FSP 40	100036	Jan. 21, 2013	Jan. 20, 2014
Temperature & Humidity Chamber GIANTFORCE	GTH-150-40 -SP-AR	MAA0812-008	Jan. 17, 2013	Jan. 16, 2014

**Note:**

1. The calibration interval of the above test instruments is 12 months and the calibrations are traceable to NML/ROC and NIST/USA.
2. Tested date : Jan. 17, 2014

### 4.6.3 TEST PROCEDURE

1. The EUT was placed inside the environmental test chamber and powered by nominal AC voltage.
2. Turn the EUT on and couple its output to a spectrum analyzer.
3. Turn the EUT off and set the chamber to the highest temperature specified.
4. Allow sufficient time (approximately 30 min) for the temperature of the chamber to stabilize, turn the EUT on and measure the operating frequency after 2, 5, and 10 minutes.
5. Repeat step 2 and 3 with the temperature chamber set to the lowest temperature.
6. The test chamber was allowed to stabilize at +20 degree C for a minimum of 30 minutes. The supply voltage was then adjusted on the EUT from 85% to 115% and the frequency record.



#### 4.6.4 DEVIATION FROM TEST STANDARD

No deviation

#### 4.6.5 TEST SETUP

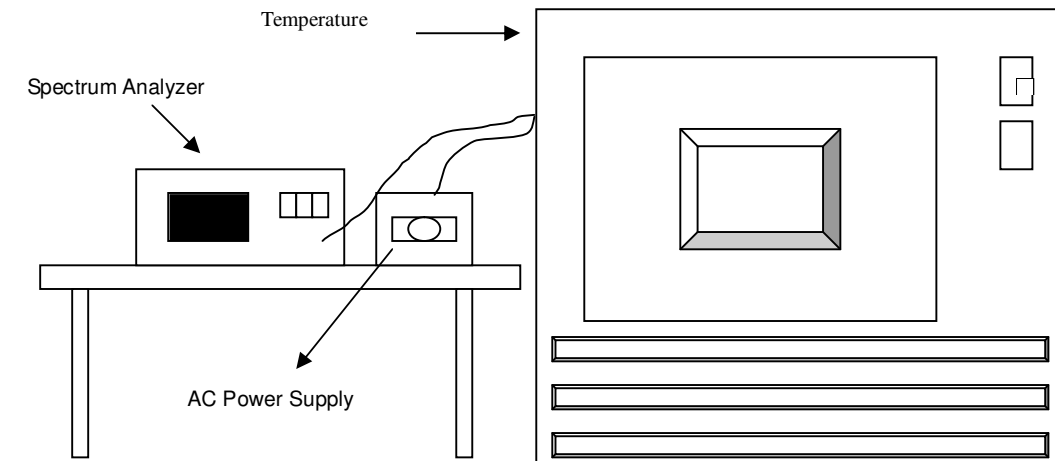

#### 4.6.6 EUT OPERATING CONDITION

Set the EUT transmit at un-modulation mode to test frequency stability.



A D T

### 4.6.7 TEST RESULTS

FREQUENCY STABILITY VERSUS TEMP.									
OPERATING FREQUENCY: 5240MHz									
TEMP. (°C)	POWER SUPPLY (Vac)	0 MINUTE		2 MINUTE		5 MINUTE		10 MINUTE	
		Measured Frequency	Frequency Drift	Measured Frequency	Frequency Drift	Measured Frequency	Frequency Drift	Measured Frequency	Frequency Drift
		(MHz)	%	(MHz)	%	(MHz)	%	(MHz)	%
50	120	5240.0018	0.00003	5239.9996	-0.00001	5239.9916	-0.00016	5239.9956	-0.00008
40	120	5240.0126	0.00024	5240.008	0.00015	5240.0063	0.00012	5240.0072	0.00014
30	120	5239.9945	-0.00010	5239.9981	-0.00004	5239.9954	-0.00009	5240.0008	0.00002
20	120	5240.0227	0.00043	5240.0291	0.00056	5240.0236	0.00045	5240.0238	0.00045
10	120	5239.9885	-0.00022	5239.9818	-0.00035	5239.9832	-0.00032	5239.9844	-0.00030
0	120	5239.9953	-0.00009	5239.9935	-0.00012	5239.9905	-0.00018	5239.999	-0.00002
-10	120	5239.9923	-0.00015	5239.9909	-0.00017	5239.9846	-0.00029	5239.9883	-0.00022
-20	120	5240.0043	0.00008	5240.0007	0.00001	5239.9988	-0.00002	5239.9991	-0.00002
-30	120	5240.0114	0.00022	5240.0116	0.00022	5240.0065	0.00012	5240.0101	0.00019

FREQUENCY STABILITY VERSUS VOLTAGE									
OPERATING FREQUENCY: 5240MHz									
TEMP. (°C)	POWER SUPPLY (Vac)	0 MINUTE		2 MINUTE		5 MINUTE		10 MINUTE	
		Measured Frequency	Frequency Drift	Measured Frequency	Frequency Drift	Measured Frequency	Frequency Drift	Measured Frequency	Frequency Drift
		(MHz)	%	(MHz)	%	(MHz)	%	(MHz)	%
20	138	5240.0227	0.00043	5240.0286	0.00055	5240.0227	0.00043	5240.0245	0.00047
	120	5240.0227	0.00043	5240.0291	0.00056	5240.0236	0.00045	5240.0238	0.00045
	102	5240.0229	0.00044	5240.0287	0.00055	5240.023	0.00044	5240.0243	0.00046



A D T

## 5. PHOTOGRAPHS OF THE TEST CONFIGURATION

Please refer to the attached file (Test Setup Photo).





## 6. INFORMATION ON THE TESTING LABORATORIES

We, Bureau Veritas Consumer Products Services (H.K.) Ltd., Taoyuan Branch, were founded in 1988 to provide our best service in EMC, Radio, Telecom and Safety consultation. Our laboratories are accredited and approved according to ISO/IEC 17025.

If you have any comments, please feel free to contact us at the following:

**Linko EMC/RF Lab:**

Tel: 886-2-26052180

Fax: 886-2-26052943

**Hsin Chu EMC/RF Lab:**

Tel: 886-3-5935343

Fax: 886-3-5935342

**Hwa Ya EMC/RF/Safety/Telecom Lab:**

Tel: 886-3-3183232

Fax: 886-3-3270892

**Email:** [service.adt@tw.bureauveritas.com](mailto:service.adt@tw.bureauveritas.com)

**Web Site:** [www.bureauveritas-adt.com](http://www.bureauveritas-adt.com)

The address and road map of all our labs can be found in our web site also.



A D T

## 7. APPENDIX A - MODIFICATIONS RECORDERS FOR ENGINEERING CHANGES TO THE EUT BY THE LAB

No modifications were made to the EUT by the lab during the test.

--- END ---