

FCC Test Report

Report No.: RF130725E01E

FCC ID: Q87-EA6900V11

Test Model: EA6900 V1.1

Received Date: Mar. 17, 2016

Test Date: Mar. 22 to Apr. 06, 2016

Issued Date: May 19, 2016

Applicant: Linksys LLC

Address: 121 Theory Drive Irvine California 92617 United State

Issued By: Bureau Veritas Consumer Products Services (H.K.) Ltd., Taoyuan Branch
Hsin Chu Laboratory

Lab Address: E-2, No.1, Li Hsin 1st Road, Hsinchu Science Park, Hsinchu City 300,
Taiwan R.O.C.

Test Location (1): E-2, No.1, Li Hsin 1st Road, Hsinchu Science Park, Hsinchu City 300,
Taiwan R.O.C.

Test Location (2): No. 49, Ln. 206, Wende Rd., Shangshan Tsuen, Chiung Lin Hsiang, Hsin
Chu Hsien 307, Taiwan R.O.C.



This report is for your exclusive use. Any copying or replication of this report to or for any other person or entity, or use of our name or trademark, is permitted only with our prior written permission. This report sets forth our findings solely with respect to the test samples identified herein. The results set forth in this report are not indicative or representative of the quality or characteristics of the lot from which a test sample was taken or any similar or identical product unless specifically and expressly noted. Our report includes all of the tests requested by you and the results thereof based upon the information that you provided to us. You have 60 days from date of issuance of this report to notify us of any material error or omission caused by our negligence, provided, however, that such notice shall be in writing and shall specifically address the issue you wish to raise. A failure to raise such issue within the prescribed time shall constitute your unqualified acceptance of the completeness of this report, the tests conducted and the correctness of the report contents. Unless specific mention, the uncertainty of measurement has been explicitly taken into account to declare the compliance or non-compliance to the specification. The report must not be used by the client to claim product certification, approval, or endorsement by TAF or any government agencies.

Table of Contents

Report Issue History Record	4
Release Control Record	4
1 Certificate of Conformity	5
2 Summary of Test Results	6
2.1 Measurement Uncertainty	6
2.2 Modification Record	6
3 General Information	7
3.1 General Description of EUT	7
3.2 Description of Test Modes	10
3.2.1 Test Mode Applicability and Tested Channel Detail	11
3.3 Duty Cycle of Test Signal	14
3.4 Description of Support Units	15
3.4.1 Configuration of System under Test	16
3.5 General Description of Applied Standard	17
4 Test Types and Results	18
4.1 Radiated Emission and Bandedge Measurement	18
4.1.1 Limits of Radiated Emission and Bandedge Measurement	18
4.1.2 Test Instruments	19
4.1.3 Test Procedure	20
4.1.4 Deviation from Test Standard	20
4.1.5 Test Setup	21
4.1.6 EUT Operating Condition	21
4.1.7 Test Results	22
4.2 Conducted Emission Measurement	41
4.2.1 Limits of Conducted Emission Measurement	41
4.2.2 Test Instruments	41
4.2.3 Test Procedure	42
4.2.4 Deviation from Test Standard	42
4.2.5 Test Setup	42
4.2.6 EUT Operating Condition	42
4.2.7 Test Results	43
4.3 Transmit Power Measurement	45
4.3.1 Limits of Transmit Power Measurement	45
4.3.2 Test Setup	46
4.3.3 Test Instruments	46
4.3.4 Test Procedure	46
4.3.5 Deviation from Test Standard	46
4.3.6 EUT Operating Condition	46
4.3.7 Test Result	47
4.4 Peak Power Spectral Density Measurement	50
4.4.1 Limits of Peak Power Spectral Density Measurement	50
4.4.2 Test Setup	50
4.4.3 Test Instruments	50
4.4.4 Test Procedure	51
4.4.5 Deviation from Test Standard	51
4.4.6 EUT Operating Condition	51
4.4.7 Test Results	52
4.5 Frequency Stability Measurement	58
4.5.1 Limits of Frequency Stability Measurement	58
4.5.2 Test Setup	58
4.5.3 Test Instruments	58
4.5.4 Test Procedure	58



4.5.5	Deviation from Test Standard	58
4.5.6	EUT Operating Condition	58
4.5.7	Test Results	59
4.6	6dB Bandwidth Measurement	60
4.6.1	Limits of 6dB Bandwidth Measurement	60
4.6.2	Test Setup	60
4.6.3	Test Instruments	60
4.6.4	Test Procedure	60
4.6.5	Deviation from Test Standard	60
4.6.6	EUT Operating Condition	60
4.6.7	Test Results	61
5	Pictures of Test Arrangements	63
	Appendix – Information on the Testing Laboratories	64



Report Issue History Record

Issue No.	Reason for Change	Date Issued
RF130725E01A RF130725E01A-1	Original	Feb. 17, 2014
RF130725E01E	Upgraded the standard to section 15.407 under new rule for U-NII-1 and U-NII-3 band.	May 19, 2016

Release Control Record

Issue No.	Description	Date Issued
RF130725E01E	Original release.	May 19, 2016



1 Certificate of Conformity

Product: Linksys Smart Wi-Fi Router AC1900
Brand: Linksys
Test Model: EA6900 V1.1
Sample Status: ENGINEERING SAMPLE
Applicant: Linksys LLC
Test Date: Mar. 22 to Apr. 06, 2016
Standard: 47 CFR FCC Part 15, Subpart E (Section 15.407)
ANSI C63.10: 2013

The above equipment has been tested by **Bureau Veritas Consumer Products Services (H.K.) Ltd., Taoyuan Branch**, and found compliance with the requirement of the above standards. The test record, data evaluation & Equipment Under Test (EUT) configurations represented herein are true and accurate accounts of the measurements of the sample's EMC characteristics under the conditions specified in this report.

Prepared by : Wendy Wu. , **Date:** May 19, 2016
Wendy Wu / Specialist

Approved by : May Chen , **Date:** May 19, 2016
May Chen / Manager

2 Summary of Test Results

47 CFR FCC Part 15, Subpart E (SECTION 15.407)			
FCC Clause	Test Item	Result	Remarks
15.407(b)(6)	AC Power Conducted Emissions	PASS	Meet the requirement of limit. Minimum passing margin is -7.95dB at 0.35313MHz.
15.407(b)(1/2/3/4/6)	Radiated Emissions & Band Edge Measurement	PASS	Meet the requirement of limit. Minimum passing margin is -0.1dB at 5150.00MHz, 5146.00MHz, 5725.00MHz, 5712.00MHz and 5850.00MHz.
15.407(a)(1/2/3)	Max Average Transmit Power	PASS	Meet the requirement of limit.
15.407(a)(1/2/3)	Peak Power Spectral Density	PASS	Meet the requirement of limit.
15.407(e)	6dB bandwidth	PASS	Meet the requirement of limit. (U-NII-3 Band only)
15.407(g)	Frequency Stability	PASS	Meet the requirement of limit.
15.203	Antenna Requirement	PASS	Antenna connector is RSMA not a standard connector.

NOTE: 1. This report is prepared for FCC Class II change. (Upgraded the standard to section 15.407 under new rule for U-NII-1 and U-NII-3 band)

2.1 Measurement Uncertainty

Where relevant, the following measurement uncertainty levels have been estimated for tests performed on the EUT as specified in CISPR 16-4-2:

Measurement	Frequency	Expanded Uncertainty (k=2) (±)
Radiated Emissions up to 1 GHz	30MHz ~ 1GHz	5.19 dB
Radiated Emissions above 1 GHz	1GHz ~ 6GHz	3.43 dB
	6GHz ~ 18GHz	3.49 dB
	18GHz ~ 40GHz	4.11 dB

2.2 Modification Record

There were no modifications required for compliance.

3 General Information

3.1 General Description of EUT

Product	Linksys Smart Wi-Fi Router AC1900
Brand	Linksys
Test Model	EA6900 V1.1
Status of EUT	ENGINEERING SAMPLE
Driver version	v6.37.14.62
Power Supply Rating	DC 12V from power adapter
Modulation Type	CCK, DQPSK, DBPSK for DSSS 64QAM, 16QAM, QPSK, BPSK for OFDM 256QAM for OFDM in 11ac mode only 256QAM for OFDM in 11ac mode and HT(40) mode in 2.4GHz
Modulation Technology	DSSS,OFDM
Transfer Rate	802.11b: up to 11Mbps 802.11a/g: up to 54Mbps 802.11n: up to 600Mbps 802.11ac: up to 1300Mbps
Operating Frequency	For 15.407: 5.18 ~ 5.24GHz, 5.745 ~ 5.825GHz
	For 15.247: 2.412 ~ 2.462GHz
Number of Channel	For 15.407: 802.11a, 802.11n (HT20), 802.11ac (VHT20): 9 802.11n (HT40), 802.11ac (VHT40): 4 802.11ac (VHT80): 2
	For 15.247: 802.11b, 802.11g, 802.11n (HT20): 11 802.11n (HT40): 7
Output Power	For 15.407: 5.18 ~ 5.24GHz CDD Mode 484.282mW STBC Mode 484.282mW Beamforming Mode 562.98Mw
	5.745 ~ 5.825GHz CDD Mode 989.626mW STBC Mode 989.626mW Beamforming Mode 616.884Mw
	For 15.247: 986.826mW
Antenna Type	Refer to Note
Antenna Connector	Refer to Note
Accessory Device	Adapter x 1
Data Cable Supplied	NA

Note:

1. This is a supplementary report of Report No.: RF130725E01A and RF130725E01A -1. The differences between them are as below information:

- ◆ Upgraded the standard to section 15.407 under new rule for U-NII-1 and U-NII-3 band.
- ◆ Added one new adapter as the following table:

Original			
Item	Brand	Model	Spec.
1	Ktec	KSAS0451200350HU	AC Input : 100-240V, 1.2A, 50-60Hz DC Output : 12V, 3.5A DC output cable(unshielded ,1.5m)
2	LEI	MU42-1120350-A1	AC Input : 100-240V, 1.5A, 50-60Hz DC Output : 12V, 3.5A DC cable(unshielded ,1.5m)

From the above adapters, the worst radiated emission was found in **Adapter 2**. Therefore only the test data of the modes were recorded in this report.

Newly			
Item	Brand	Model	Spec.
1	LEI	MU42-3120350-A1	AC Input : 100-240V, 1.5A, 50/60Hz DC Output : 12V, 3.5A DC cable(unshielded, 1.5m)

2. According to above conditions, all test items of U-NII-1 and U-NII-3 band need to be performed. And all data was verified to meet the requirements.
3. There are 2.4GHz and 5GHz WLAN technology used for the EUT.
4. The EUT has two different RJ45 XFRM Transformer types could be chosen and please refer the below table:

Type 1 (Vendor: MINGTEK)			
Vendor P/N	Different	Vendor	Location
HN1878CG	TRANSFORMER VARIABLE COILS,DIP,350UH,HN1878CG	MINGTEK	T1
HN3678CG	TRANSFORMER VARIABLE COILS,DIP,350UH,HN3678CG	MINGTEK	T2, T3
Type 2 (Vendor: MYJWD)			
Vendor P/N	Different	Vendor	Location
DG18107-1 G	TRANSFORMER,DIP,350UH,16.8*8.5*11.85MM,18PIN,DG18107-1 G	MYJWD	T1
DG36005-1 G	TRANSFORMER,DIP,350UH,32.7*8.5*11.85MM,36PIN	MYJWD	T2, T3

From the above types, the worst case was found in **Type 2 (Vendor: MYJWD)**. Therefore only the test data of the type were recorded in this report.

5. The antennas provided to the EUT, please refer to the following table:

Transmitter Circuit	Brand	Antenna Type	Peak Gain(dBi) (Include cable loss)		Connector Type	Cable Loss (dB)	Cable Length (mm)
			For 2.4GHz (2.4GHz to 2.4835GHz)	For 5GHz (Band 1: 5.18 to 5.24GHz Band 4: 5.745 to 5.85GHz)			
Right Side Chain (0)	Galtronics	Dipole	1.3	5G Band1: 0.87 5G Band4: 1.95	R-SMA	NA	168
In center Chain (1)	Galtronics	Dipole	1.1	5G Band1: 0.47 5G Band4: 1.55	R-SMA	NA	262
Left Side Chain (2)	Galtronics	Dipole	1.1	5G Band1: 0.47 5G Band4: 1.55	R-SMA	NA	260

Note: From the above antennas, Chain (0) was selected as representative antenna for the 802.11a/b/g test and its data was recorded in this report.

6. The EUT incorporates a MIMO function.

MODULATION MODE	TX/RX FUNCTION
802.11b	1TX (Diversity) /3RX
802.11g	1TX (Diversity) /3RX
802.11n (HT20)	3TX/3RX (CDD Mode)
	3TX/3RX (STBC Mode)
	3TX/3RX (Beam forming Mode)
802.11n (HT40)	3TX/3RX (CDD Mode)
	3TX/3RX (STBC Mode)
	3TX/3RX (Beam forming Mode)
802.11a	1TX (Diversity) /3RX
802.11ac (VHT20)	3TX/3RX (CDD Mode)
	3TX/3RX (STBC Mode)
	3TX/3RX (Beam forming Mode)
802.11ac (VHT40)	3TX/3RX (CDD Mode)
	3TX/3RX (STBC Mode)
	3TX/3RX (Beam forming Mode)
802.11ac (VHT80)	3TX/3RX (CDD Mode)
	3TX/3RX (STBC Mode)
	3TX/3RX (Beam forming Mode)

Note: 1. The modulation and bandwidth are similar for 802.11n mode for 20MHz (40MHz) and 802.11ac mode for 20MHz (40MHz), therefore investigated worst case to representative mode in test report. (Final test mode refer section 3.2.1)

7. When the EUT operating in 802.11n, the software operation, which is defined by manufacturer, MCS (Modulation and Coding Schemes) from 0 to 23.
8. When the EUT operating in 802.11ac and support 256QAM of VHT40 for 2.4GHz, the software operation, which is defined by manufacturer, MCS (Modulation and Coding Schemes) from 0 to 9.
9. The above EUT information is declared by manufacturer and for more detailed features description, please refer to the manufacturer's specifications or user's manual.

3.2 Description of Test Modes

FOR 5180 ~ 5240MHz

4 channels are provided for 802.11a, 802.11n (HT20), 802.11ac (VHT20):

Channel	Frequency	Channel	Frequency
36	5180 MHz	44	5220 MHz
40	5200 MHz	48	5240 MHz

2 channels are provided for 802.11n (HT40), 802.11ac (VHT40):

Channel	Frequency	Channel	Frequency
38	5190 MHz	46	5230 MHz

1 channel is provided for 802.11ac (VHT80):

Channel	Frequency
42	5210MHz

FOR 5745 ~ 5825MHz:

5 channels are provided for 802.11a, 802.11n (HT20), 802.11ac (VHT20):

Channel	Frequency	Channel	Frequency
149	5745MHz	161	5805MHz
153	5765MHz	165	5825MHz
157	5785MHz		

2 channels are provided for 802.11n (HT40), 802.11ac (VHT40):

Channel	Frequency	Channel	Frequency
151	5755MHz	159	5795MHz

1 channel is provided for 802.11ac (VHT80):

Channel	Frequency
155	5775MHz

3.2.1 Test Mode Applicability and Tested Channel Detail

EUT CONFIGURE MODE	APPLICABLE TO				DESCRIPTION
	RE≥1G	RE<1G	PLC	APCM	
-	√	√	√	√	-

Where **RE≥1G**: Radiated Emission above 1GHz **RE<1G**: Radiated Emission below 1GHz
PLC: Power Line Conducted Emission **APCM**: Antenna Port Conducted Measurement

NOTE:

1. The EUT had been pre-tested on the positioned of each 3 axis. The worst case was found when positioned on **X-plane**.

Radiated Emission Test (Above 1GHz):

- Pre-Scan has been conducted to determine the worst-case mode from all possible combinations between available modulations, data rates and antenna ports (if EUT with antenna diversity architecture).
- Following channel(s) was (were) selected for the final test as listed below.

MODE	FREQ. BAND (MHz)	AVAILABLE CHANNEL	TESTED CHANNEL	MODULATION TECHNOLOGY	MODULATION TYPE	DATA RATE (Mbps)
802.11a	5180-5240	36 to 48	36, 40, 48	OFDM	BPSK	6
	5745-5825	149 to 165	149, 157, 165			
CDD Mode						
MODE	FREQ. BAND (MHz)	AVAILABLE CHANNEL	TESTED CHANNEL	MODULATION TECHNOLOGY	MODULATION TYPE	DATA RATE (Mbps)
802.11ac (VHT20)	5180-5240	36 to 48	36, 40, 48	OFDM	BPSK	6.5
802.11ac (VHT40)		38 to 46	38, 46	OFDM	BPSK	13.5
802.11ac (VHT80)		42	42	OFDM	BPSK	29.3
802.11ac (VHT20)	5745-5825	149 to 165	149, 157, 165	OFDM	BPSK	6.5
802.11ac (VHT40)		151 to 159	151, 159	OFDM	BPSK	13.5
802.11ac (VHT80)		155	155	OFDM	BPSK	29.3

Radiated Emission Test (Below 1GHz):

- Pre-Scan has been conducted to determine the worst-case mode from all possible combinations between available modulations, data rates and antenna ports (if EUT with antenna diversity architecture).
- Following channel(s) was (were) selected for the final test as listed below.

CDD Mode						
MODE	FREQ. BAND (MHz)	AVAILABLE CHANNEL	TESTED CHANNEL	MODULATION TECHNOLOGY	MODULATION TYPE	DATA RATE (Mbps)
802.11ac (VHT20)	5745-5825	149 to 165	157	OFDM	BPSK	6.5

Power Line Conducted Emission Test:

- Pre-Scan has been conducted to determine the worst-case mode from all possible combinations between available modulations, data rates and antenna ports (if EUT with antenna diversity architecture).
- Following channel(s) was (were) selected for the final test as listed below.

CDD Mode						
MODE	FREQ. BAND (MHz)	AVAILABLE CHANNEL	TESTED CHANNEL	MODULATION TECHNOLOGY	MODULATION TYPE	DATA RATE (Mbps)
802.11ac (VHT20)	5745-5825	149 to 165	157	OFDM	BPSK	6.5

Antenna Port Conducted Measurement:

- This item includes all test value of each mode, but only includes spectrum plot of worst value of each mode.
- Pre-Scan has been conducted to determine the worst-case mode from all possible combinations between available modulations, data rates and antenna ports (if EUT with antenna diversity architecture).
- Following channel(s) was (were) selected for the final test as listed below.

MODE	FREQ. BAND (MHz)	AVAILABLE CHANNEL	TESTED CHANNEL	MODULATION TECHNOLOGY	MODULATION TYPE	DATA RATE (Mbps)
802.11a	5180-5240	36 to 48	36, 40, 48	OFDM	BPSK	6
	5745-5825	149 to 165	149, 157, 165			
CDD Mode						
MODE	FREQ. BAND (MHz)	AVAILABLE CHANNEL	TESTED CHANNEL	MODULATION TECHNOLOGY	MODULATION TYPE	DATA RATE (Mbps)
802.11ac (VHT20)	5180-5240	36 to 48	36, 40, 48	OFDM	BPSK	6.5
802.11ac (VHT40)		38 to 46	38, 46	OFDM	BPSK	13.5
802.11ac (VHT80)		42	42	OFDM	BPSK	29.3
802.11ac (VHT20)	5745-5825	149 to 165	149, 157, 165	OFDM	BPSK	6.5
802.11ac (VHT40)		151 to 159	151, 159	OFDM	BPSK	13.5
802.11ac (VHT80)		155	155	OFDM	BPSK	29.3
STBC Mode						
MODE	FREQ. BAND (MHz)	AVAILABLE CHANNEL	TESTED CHANNEL	MODULATION TECHNOLOGY	MODULATION TYPE	DATA RATE (Mbps)
802.11ac (VHT20)	5180-5240	36 to 48	36, 40, 48	OFDM	BPSK	6.5
802.11ac (VHT40)		38 to 46	38, 46	OFDM	BPSK	13.5
802.11ac (VHT80)		42	42	OFDM	BPSK	29.3
802.11ac (VHT20)	5745-5825	149 to 165	149, 157, 165	OFDM	BPSK	6.5
802.11ac (VHT40)		151 to 159	151, 159	OFDM	BPSK	13.5
802.11ac (VHT80)		155	155	OFDM	BPSK	29.3
Beamforming Mode						
MODE	FREQ. BAND (MHz)	AVAILABLE CHANNEL	TESTED CHANNEL	MODULATION TECHNOLOGY	MODULATION TYPE	DATA RATE (Mbps)
802.11ac (VHT20)	5180-5240	36 to 48	36, 40, 48	OFDM	BPSK	6.5
802.11ac (VHT40)		38 to 46	38, 46	OFDM	BPSK	13.5
802.11ac (VHT80)		42	42	OFDM	BPSK	29.3
802.11ac (VHT20)	5745-5825	149 to 165	149, 157, 165	OFDM	BPSK	6.5
802.11ac (VHT40)		151 to 159	151, 159	OFDM	BPSK	13.5
802.11ac (VHT80)		155	155	OFDM	BPSK	29.3

Test Condition:

APPLICABLE TO	ENVIRONMENTAL CONDITIONS	INPUT POWER	TESTED BY	TEST LOCATION
RE_≥1G	19deg. C, 65%RH	120Vac, 60Hz	Andy Ho	1
RE_{<}1G	23deg. C, 66%RH	120Vac, 60Hz	Andy Ho	1
PLC	26deg. C, 75%RH	120Vac, 60Hz	Eagle Chen	2
APCM	16deg. C, 66%RH	120Vac, 60Hz	Anderson Chen	1

3.3 Duty Cycle of Test Signal

If duty cycle of test signal is $\geq 98\%$, duty factor is not required.

If duty cycle of test signal is $< 98\%$, duty factor shall be considered.

802.11a: Duty cycle = $2.059 \text{ ms} / 2.09 \text{ ms} = 0.985$

802.11ac (VHT20): Duty cycle = $1.928 \text{ ms} / 1.959 \text{ ms} = 0.984$

802.11ac (VHT40): Duty cycle = $0.957 \text{ ms} / 0.975 \text{ ms} = 0.982$

802.11ac (VHT80): Duty cycle = $0.459 \text{ ms} / 0.489 \text{ ms} = 0.939$, Duty factor = $10 * \log(1/0.939) = 0.27$

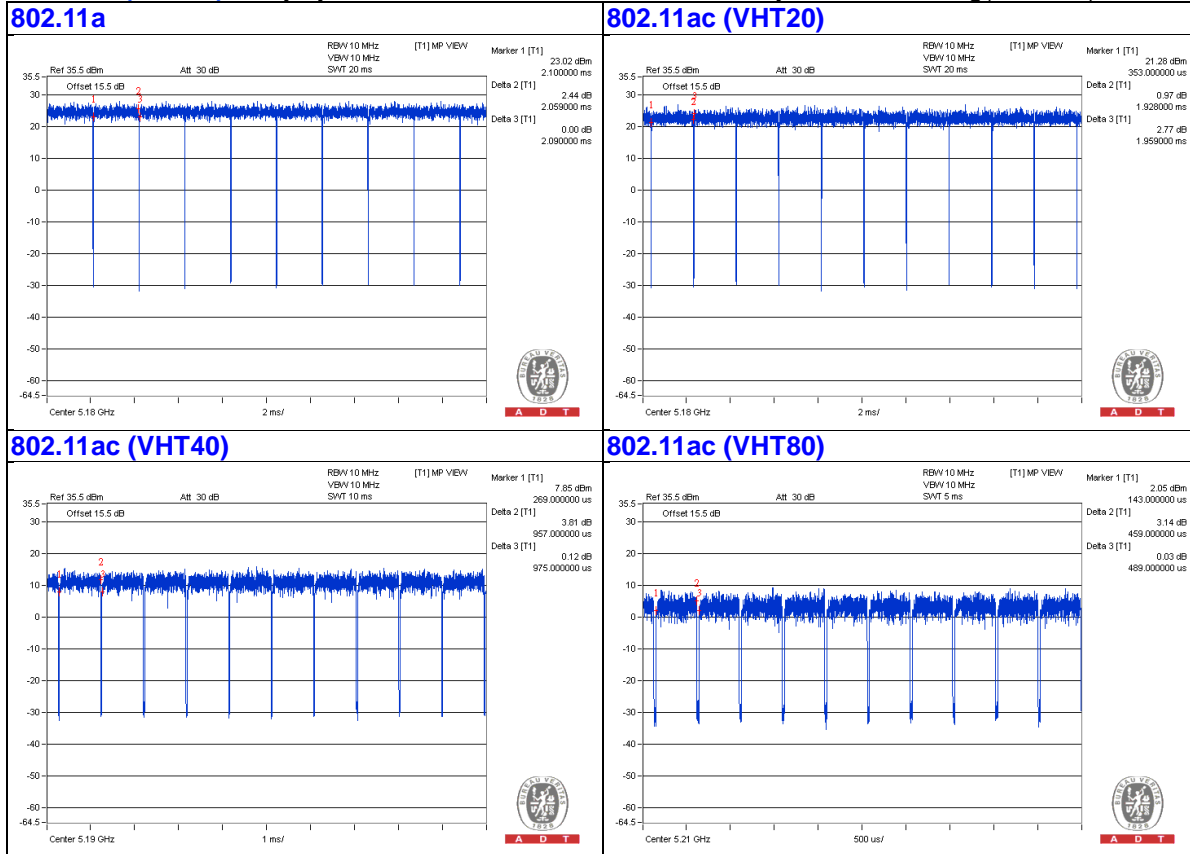

3.4 Description of Support Units

The EUT has been tested as an independent unit together with other necessary accessories or support units. The following support units or accessories were used to form a representative test configuration during the tests.

ID	Product	Brand	Model No.	Serial No.	FCC ID	Remarks
A.	USB 3.0 Dongle	TCELL	TC-025-005	NA	NA	Provided by Lab
B.	Notebook Computer	HP	Pavilion 14-ab023TU	5CD5340WXZ	NA	Provided by Lab
C.	HUB	PCI	FX-05EA	NA	NA	Provided by Lab
D.	Notebook Computer	DELL	E5430	HL3SKV1	FCC DoC	Provided by Lab
E.	iPod shuffle	Apple	MD778TA/A	CC4JG680F4T1	NA	Provided by Lab

Note:

1. All power cords of the above support units are non-shielded (1.8m).

ID	Descriptions	Qty.	Length (m)	Shielding (Yes/No)	Cores (Qty.)	Remarks
1.	RJ45 cable	1	10	No	0	Provided by Lab
2.	RJ45 cable	3	10	No	0	Provided by Lab
3.	RJ45 cable	1	10	No	0	Provided by Lab
4.	DC cable	1	1.5	No	0	Supplied by Client
5.	USB cable	1	0.1	Yes	0	Provided by Lab

Note: The core(s) is(are) originally attached to the cable(s).

3.4.1 Configuration of System under Test

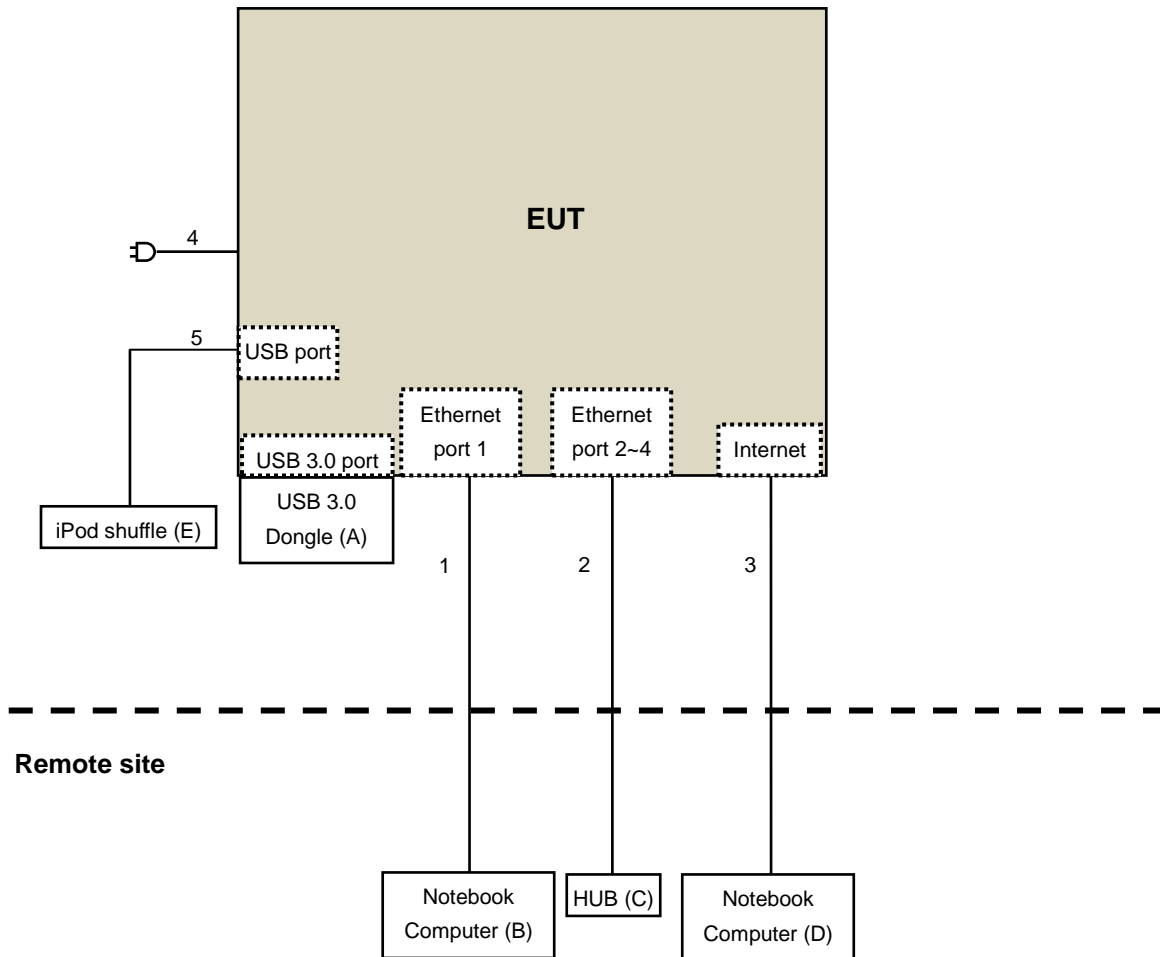

3.5 General Description of Applied Standard

The EUT is a RF Product. According to the specifications of the manufacturer, it must comply with the requirements of the following standards:

FCC Part 15, Subpart E (15.407)

KDB 789033 D02 General UNII Test Procedure New Rules v01r01

KDB 662911 D01 Multiple Transmitter Output v02r01

ANSI C63.10-2013

All test items have been performed and recorded as per the above standards.

NOTE: The EUT has been verified to comply with the requirements of FCC Part 15, Subpart B, Class B (DoC). The test report has been issued separately.

4 Test Types and Results

4.1 Radiated Emission and Bandedge Measurement

4.1.1 Limits of Radiated Emission and Bandedge Measurement

Radiated emissions which fall in the restricted bands must comply with the radiated emission limits specified as below table.

Frequencies (MHz)	Field Strength (microvolts/meter)	Measurement Distance (meters)
0.009 ~ 0.490	2400/F(kHz)	300
0.490 ~ 1.705	24000/F(kHz)	30
1.705 ~ 30.0	30	30
30 ~ 88	100	3
88 ~ 216	150	3
216 ~ 960	200	3
Above 960	500	3

NOTE:

1. The lower limit shall apply at the transition frequencies.
2. Emission level (dBuV/m) = 20 log Emission level (uV/m).
3. For frequencies above 1000MHz, the field strength limits are based on average detector, however, the peak field strength of any emission shall not exceed the maximum permitted average limits, specified above by more than 20dB under any condition of modulation.

LIMITS OF UNWANTED EMISSION OUT OF THE RESTRICTED BANDS

APPLICABLE TO	LIMIT	
789033 D02 General UNII Test Procedure New Rules v01r01	FIELD STRENGTH AT 3m	
	PK:74 (dBμV/m)	AV:54 (dBμV/m)
APPLICABLE TO	EIRP LIMIT	EQUIVALENT FIELD STRENGTH AT 3m
15.407(b)(1)	PK:-27 (dBm/MHz)	PK:68.2(dBμV/m)
15.407(b)(2)		
15.407(b)(3)		
15.407(b)(4)	PK:-27 (dBm/MHz) ^{*1} PK:-17 (dBm/MHz) ^{*2}	PK: 68.2(dBμV/m) ^{*1} PK:78.2 (dBμV/m) ^{*2}

NOTE: ^{*1} beyond 10MHz of the band edge ^{*2} within 10 MHz of band edge

The following formula is used to convert the equipment isotropic radiated power (eirp) to field strength:

$$E = \frac{1000000\sqrt{30P}}{3} \mu\text{V/m, where P is the eirp (Watts).}$$



4.1.2 Test Instruments

DESCRIPTION & MANUFACTURER	MODEL NO.	SERIAL NO.	CALIBRATED DATE	CALIBRATED UNTIL
Test Receiver Agilent	N9038A	MY54450088	July 24, 2015	July 23, 2016
Pre-Amplifier ^(*) EMCI	EMC001340	980142	Jan. 20, 2016	Jan. 19, 2018
Loop Antenna ^(*) Electro-Metrics	EM-6879	264	Dec. 16, 2014	Dec. 15, 2016
RF Cable	NA	LOOPCAB-001 LOOPCAB-002	Jan. 18, 2016	Jan. 17, 2017
Pre-Amplifier Mini-Circuits	ZFL-1000VH2B	AMP-ZFL-01	Nov. 11, 2015	Nov. 10, 2016
Trilog Broadband Antenna SCHWARZBECK	VULB 9168	9168-406	Jan. 04, 2016	Jan. 03, 2017
RF Cable	8D	966-4-1 966-4-2 966-4-3	Apr. 03, 2015	Apr. 02, 2016
Horn_Antenna SCHWARZBECK	BBHA 9120D	9120D-783	Jan. 19, 2016	Jan. 18, 2017
Pre-Amplifier Agilent	8449B	3008A01922	Sep. 19, 2015	Sep. 18, 2016
RF Cable	EMC104-SM-SM-2000 EMC104-SM-SM-5000 EMC104-SM-SM-5000	150318 150323 150324	Mar. 31, 2015	Mar. 30, 2016
Pre-Amplifier EMCI	EMC184045	980143	Jan. 15, 2016	Jan. 14, 2017
Horn_Antenna SCHWARZBECK	BBHA 9170	BBHA9170608	Jan. 08, 2016	Jan. 07, 2017
RF Cable	SUCOFLEX 102	36432/2 36441/2	Jan. 16, 2016	Jan. 15, 2017
Software	ADT_Radiated_V8.7.07	NA	NA	NA
Antenna Tower & Turn Table CT	NA	NA	NA	NA
Boresight Antenna Fixture	NA	NA	NA	NA
SPECTRUM ANALYZER R&S	FSP 40	100060	May 08, 2015	May 07, 2016
Power meter Anritsu	ML2495A	1014008	Apr. 28, 2015	Apr. 27, 2016
Power sensor Anritsu	MA2411B	0917122	Apr. 28, 2015	Apr. 27, 2016
Temperature & Humidity Chamber GIANTFORCE	GTH-150-40-SP-AR	MAA0812-008	Jan. 15, 2016	Jan. 14, 2017

Note:

1. The calibration interval of the above test instruments is 12 months and the calibrations are traceable to NML/ROC and NIST/USA.
2. *The calibration interval of the above test instruments is 24 months and the calibrations are traceable to NML/ROC and NIST/USA.
3. Loop antenna was used for all emissions below 30 MHz.
4. The test was performed in 966 Chamber No. 4.
5. The FCC Site Registration No. is 292998
6. The CANADA Site Registration No. is 20331-2
7. Tested Date: Mar. 22 to 29, 2016

4.1.3 Test Procedure

- a. The EUT was placed on the top of a rotating table 0.8 meters (for below 1GHz) / 1.5 meters (for above 1GHz) above the ground at 3 meter chamber room for test. The table was rotated 360 degrees to determine the position of the highest radiation.
- b. The EUT was set 3 meters away from the interference-receiving antenna, which was mounted on the top of a variable-height antenna tower.
- c. The height of antenna is varied from one meter to four meters above the ground to determine the maximum value of the field strength. Both horizontal and vertical polarizations of the antenna are set to make the measurement.
- d. For each suspected emission, the EUT was arranged to its worst case and then the antenna was tuned to heights from 1 meter to 4 meters and the rotatable table was turned from 0 degrees to 360 degrees to find the maximum reading.
- e. The test-receiver system was set to quasi-peak detect function and specified bandwidth with maximum hold mode when the test frequency is below 1 GHz.
- f. The test-receiver system was set to peak and average detect function and specified bandwidth with maximum hold mode when the test frequency is above 1 GHz. If the peak reading value also meets average limit, measurement with the average detector is unnecessary.

Note:

1. The resolution bandwidth and video bandwidth of test receiver/spectrum analyzer is 120kHz for Quasi-peak detection (QP) at frequency below 1GHz.
2. The resolution bandwidth of test receiver/spectrum analyzer is 1 MHz and the video bandwidth is 3 MHz for Peak detection (PK) at frequency above 1GHz.
3. The resolution bandwidth of test receiver/spectrum analyzer is 1MHz and the video bandwidth is 3MHz for RMS Average (Duty cycle < 98%) for Average detection (AV) at frequency above 1GHz, then the measurement results was added to a correction factor ($10 \log(1/\text{duty cycle})$).
4. The resolution bandwidth of test receiver/spectrum analyzer is 1MHz and the video bandwidth is 10Hz (Duty cycle $\geq 98\%$) for Average detection (AV) at frequency above 1GHz.
5. All modes of operation were investigated and the worst-case emissions are reported.

4.1.4 Deviation from Test Standard

No deviation.

4.1.5 Test Setup

<Frequency Range below 1GHz>

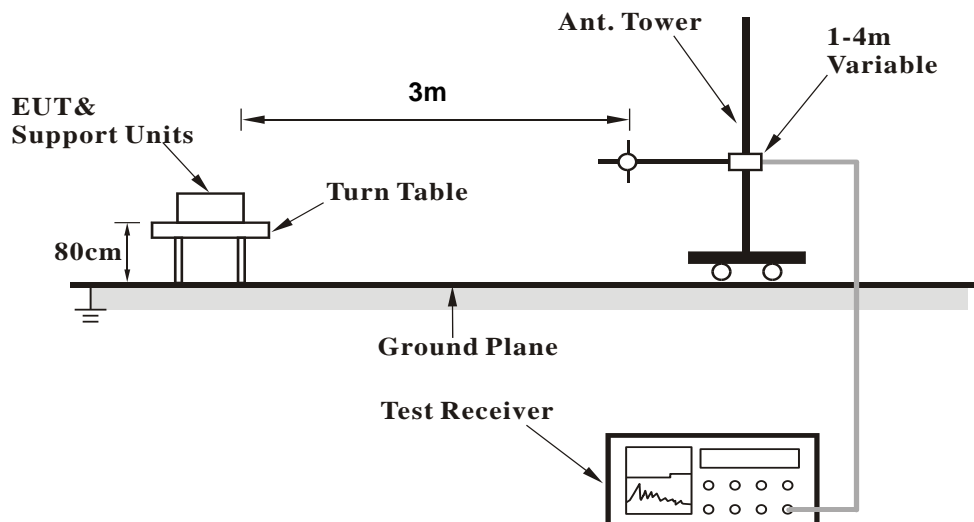

<Frequency Range above 1GHz>

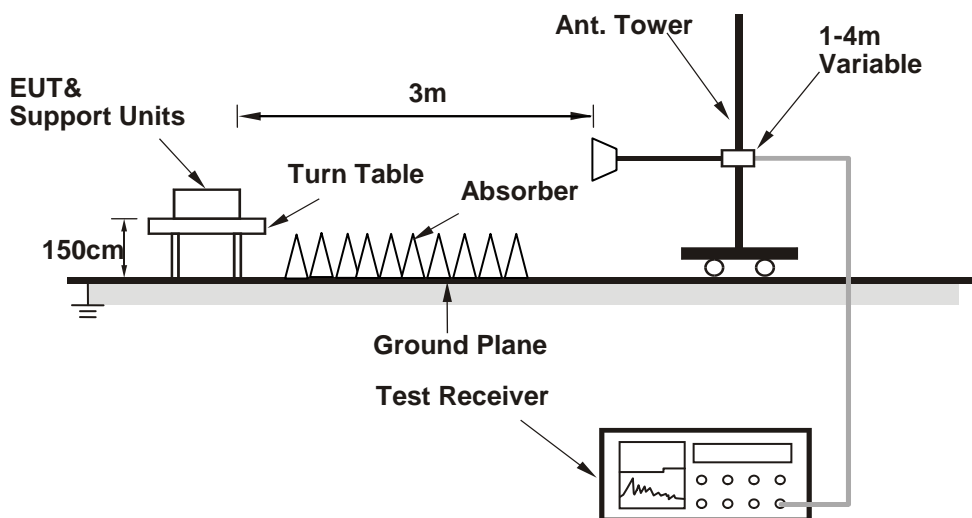

For the actual test configuration, please refer to the attached file (Test Setup Photo).

4.1.6 EUT Operating Condition

1. Connect the EUT with the support unit B & D (Notebook computer) which are placed in remote site.
2. The communication partner run test program "DutApiClient_Udp.exe[Ver 1.0.0.8]" to enable EUT under transmission/receiving condition continuously at specific channel frequency.
3. Support unit A,C and E (USB 3.0 Dongle,HUB and iPod shuffle) were connected to EUT via one USB cable and RJ45 cable to simulate real connection.

4.1.7 Test Results
Above 1GHz Data:
802.11a

CHANNEL	TX Channel 36	DETECTOR FUNCTION	Peak (PK)
FREQUENCY RANGE	1GHz ~ 40GHz		Average (AV)

ANTENNA POLARITY & TEST DISTANCE: HORIZONTAL AT 3 M

NO.	FREQ. (MHz)	EMISSION LEVEL (dBuV/m)	LIMIT (dBuV/m)	MARGIN (dB)	ANTENNA HEIGHT (m)	TABLE ANGLE (Degree)	RAW VALUE (dBuV)	CORRECTION FACTOR (dB/m)
1	5000.00	50.2 PK	74.0	-23.8	1.12 H	347	49.75	0.45
2	5000.00	45.2 AV	54.0	-8.8	1.12 H	347	44.75	0.45
3	5150.00	61.8 PK	74.0	-12.2	2.06 H	360	61.00	0.80
4	5150.00	46.9 AV	54.0	-7.1	2.06 H	360	46.10	0.80
5	*5180.00	108.1 PK			2.06 H	360	107.21	0.89
6	*5180.00	97.6 AV			2.06 H	360	96.71	0.89
7	#10360.00	50.4 PK	74.0	-23.6	1.59 H	132	39.42	10.98
8	#10360.00	37.7 AV	54.0	-16.3	1.59 H	132	26.72	10.98
9	15540.00	55.8 PK	74.0	-18.2	1.92 H	258	43.07	12.73
10	15540.00	42.6 AV	54.0	-11.4	1.92 H	258	29.87	12.73

ANTENNA POLARITY & TEST DISTANCE: VERTICAL AT 3 M

NO.	FREQ. (MHz)	EMISSION LEVEL (dBuV/m)	LIMIT (dBuV/m)	MARGIN (dB)	ANTENNA HEIGHT (m)	TABLE ANGLE (Degree)	RAW VALUE (dBuV)	CORRECTION FACTOR (dB/m)
1	5000.00	55.0 PK	74.0	-19.0	2.35 V	216	54.55	0.45
2	5000.00	49.9 AV	54.0	-4.1	2.35 V	216	49.45	0.45
3	5150.00	67.7 PK	74.0	-6.3	2.35 V	225	66.90	0.80
4	5150.00	52.1 AV	54.0	-1.9	2.35 V	225	51.30	0.80
5	*5180.00	114.7 PK			2.46 V	227	113.81	0.89
6	*5180.00	103.7 AV			2.46 V	227	102.81	0.89
7	#10360.00	50.6 PK	74.0	-23.4	1.43 V	206	39.62	10.98
8	#10360.00	38.1 AV	54.0	-15.9	1.43 V	206	27.12	10.98
9	15540.00	57.2 PK	74.0	-16.8	1.46 V	237	44.47	12.73
10	15540.00	43.9 AV	54.0	-10.1	1.46 V	237	31.17	12.73

REMARKS:

1. Emission Level(dBuV/m) = Raw Value(dBuV) + Correction Factor(dB/m)
2. Correction Factor(dB/m) = Antenna Factor(dB/m) + Cable Factor(dB) – Pre-Amplifier Factor(dB)
3. The other emission levels were very low against the limit.
4. Margin value = Emission Level – Limit value
5. " * ": Fundamental frequency.
6. " # ": The radiated frequency is out of the restricted band.

CHANNEL	TX Channel 40	DETECTOR FUNCTION	Peak (PK)
FREQUENCY RANGE	1GHz ~ 40GHz		Average (AV)

ANTENNA POLARITY & TEST DISTANCE: HORIZONTAL AT 3 M

NO.	FREQ. (MHz)	EMISSION LEVEL (dBuV/m)	LIMIT (dBuV/m)	MARGIN (dB)	ANTENNA HEIGHT (m)	TABLE ANGLE (Degree)	RAW VALUE (dBuV)	CORRECTION FACTOR (dB/m)
1	5119.00	55.1 PK	74.0	-18.9	1.01 H	346	54.38	0.72
2	5119.00	42.0 AV	54.0	-12.0	1.01 H	346	41.28	0.72
3	*5200.00	107.2 PK			2.06 H	360	106.26	0.94
4	*5200.00	96.9 AV			2.06 H	360	95.96	0.94
5	#10400.00	50.7 PK	74.0	-23.3	1.62 H	139	39.37	11.33
6	#10400.00	38.3 AV	54.0	-15.7	1.62 H	139	26.97	11.33
7	15600.00	55.0 PK	74.0	-19.0	1.92 H	264	42.13	12.87
8	15600.00	41.9 AV	54.0	-12.1	1.92 H	264	29.03	12.87

ANTENNA POLARITY & TEST DISTANCE: VERTICAL AT 3 M

NO.	FREQ. (MHz)	EMISSION LEVEL (dBuV/m)	LIMIT (dBuV/m)	MARGIN (dB)	ANTENNA HEIGHT (m)	TABLE ANGLE (Degree)	RAW VALUE (dBuV)	CORRECTION FACTOR (dB/m)
1	5119.00	60.4 PK	74.0	-13.6	2.31 V	326	59.68	0.72
2	5119.00	49.2 AV	54.0	-4.8	2.31 V	326	48.48	0.72
3	*5200.00	114.1 PK			2.31 V	228	113.16	0.94
4	*5200.00	103.2 AV			2.31 V	228	102.26	0.94
5	#10400.00	50.4 PK	74.0	-23.6	1.48 V	201	39.07	11.33
6	#10400.00	38.0 AV	54.0	-16.0	1.48 V	201	26.67	11.33
7	15600.00	56.0 PK	74.0	-18.0	1.58 V	243	43.13	12.87
8	15600.00	42.9 AV	54.0	-11.1	1.58 V	243	30.03	12.87

REMARKS:

1. Emission Level(dBuV/m) = Raw Value(dBuV) + Correction Factor(dB/m)
2. Correction Factor(dB/m) = Antenna Factor(dB/m) + Cable Factor(dB) – Pre-Amplifier Factor(dB)
3. The other emission levels were very low against the limit.
4. Margin value = Emission Level – Limit value
5. " * ": Fundamental frequency.
6. " # ": The radiated frequency is out of the restricted band.

CHANNEL	TX Channel 48	DETECTOR FUNCTION	Peak (PK)
FREQUENCY RANGE	1GHz ~ 40GHz		Average (AV)

ANTENNA POLARITY & TEST DISTANCE: HORIZONTAL AT 3 M

NO.	FREQ. (MHz)	EMISSION LEVEL (dBuV/m)	LIMIT (dBuV/m)	MARGIN (dB)	ANTENNA HEIGHT (m)	TABLE ANGLE (Degree)	RAW VALUE (dBuV)	CORRECTION FACTOR (dB/m)
1	*5240.00	108.1 PK			1.98 H	360	107.04	1.06
2	*5240.00	97.6 AV			1.98 H	360	96.54	1.06
3	5350.00	47.8 PK	74.0	-26.2	1.98 H	360	46.50	1.30
4	5350.00	36.0 AV	54.0	-18.0	1.98 H	360	34.70	1.30
5	5400.00	55.2 PK	74.0	-18.8	1.11 H	354	53.89	1.31
6	5400.00	42.2 AV	54.0	-11.8	1.11 H	354	40.89	1.31
7	#10480.00	50.5 PK	74.0	-23.5	1.66 H	134	39.31	11.19
8	#10480.00	37.8 AV	54.0	-16.2	1.66 H	134	26.61	11.19
9	15720.00	56.1 PK	74.0	-17.9	1.90 H	248	43.79	12.31
10	15720.00	42.6 AV	54.0	-11.4	1.90 H	248	30.29	12.31

ANTENNA POLARITY & TEST DISTANCE: VERTICAL AT 3 M

NO.	FREQ. (MHz)	EMISSION LEVEL (dBuV/m)	LIMIT (dBuV/m)	MARGIN (dB)	ANTENNA HEIGHT (m)	TABLE ANGLE (Degree)	RAW VALUE (dBuV)	CORRECTION FACTOR (dB/m)
1	*5240.00	114.0 PK			2.04 V	284	112.94	1.06
2	*5240.00	103.2 AV			2.04 V	284	102.14	1.06
3	5350.00	53.7 PK	74.0	-20.3	2.04 V	284	52.40	1.30
4	5350.00	41.1 AV	54.0	-12.9	2.04 V	284	39.80	1.30
5	5400.00	59.2 PK	74.0	-14.8	2.04 V	284	57.89	1.31
6	5400.00	48.7 AV	54.0	-5.3	2.04 V	284	47.39	1.31
7	#10480.00	50.7 PK	74.0	-23.3	1.46 V	209	39.51	11.19
8	#10480.00	38.2 AV	54.0	-15.8	1.46 V	209	27.01	11.19
9	15720.00	56.6 PK	74.0	-17.4	1.48 V	222	44.29	12.31
10	15720.00	43.4 AV	54.0	-10.6	1.48 V	222	31.09	12.31

REMARKS:

1. Emission Level(dBuV/m) = Raw Value(dBuV) + Correction Factor(dB/m)
2. Correction Factor(dB/m) = Antenna Factor(dB/m) + Cable Factor(dB) – Pre-Amplifier Factor(dB)
3. The other emission levels were very low against the limit.
4. Margin value = Emission Level – Limit value
5. " * ": Fundamental frequency.
6. " # ": The radiated frequency is out of the restricted band.

CHANNEL	TX Channel 149	DETECTOR FUNCTION	Peak (PK)
FREQUENCY RANGE	1GHz ~ 40GHz		Average (AV)

ANTENNA POLARITY & TEST DISTANCE: HORIZONTAL AT 3 M

NO.	FREQ. (MHz)	EMISSION LEVEL (dBuV/m)	LIMIT (dBuV/m)	MARGIN (dB)	ANTENNA HEIGHT (m)	TABLE ANGLE (Degree)	RAW VALUE (dBuV)	CORRECTION FACTOR (dB/m)
1	#5715.00	61.1 PK	74.0	-12.9	2.02 H	360	59.18	1.92
2	#5715.00	46.8 AV	54.0	-7.2	2.02 H	360	44.88	1.92
3	#5725.00	70.4 PK	78.2	-7.8	2.02 H	360	68.47	1.93
4	*5745.00	104.3 PK			2.02 H	360	102.32	1.98
5	*5745.00	94.2 AV			2.02 H	360	92.22	1.98
6	11490.00	50.3 PK	74.0	-23.7	1.61 H	126	37.43	12.87
7	11490.00	37.7 AV	54.0	-16.3	1.61 H	126	24.83	12.87
8	#17235.00	56.3 PK	74.0	-17.7	1.88 H	253	38.74	17.56
9	#17235.00	42.8 AV	54.0	-11.2	1.88 H	253	25.24	17.56

ANTENNA POLARITY & TEST DISTANCE: VERTICAL AT 3 M

NO.	FREQ. (MHz)	EMISSION LEVEL (dBuV/m)	LIMIT (dBuV/m)	MARGIN (dB)	ANTENNA HEIGHT (m)	TABLE ANGLE (Degree)	RAW VALUE (dBuV)	CORRECTION FACTOR (dB/m)
1	#5715.00	66.7 PK	74.0	-7.3	2.18 V	314	64.78	1.92
2	#5715.00	51.5 AV	54.0	-2.5	2.18 V	314	49.58	1.92
3	#5725.00	77.7 PK	78.2	-0.5	2.18 V	314	75.77	1.93
4	*5745.00	111.8 PK			2.18 V	314	109.82	1.98
5	*5745.00	101.1 AV			2.18 V	314	99.12	1.98
6	11490.00	51.1 PK	74.0	-22.9	1.46 V	206	38.23	12.87
7	11490.00	38.3 AV	54.0	-15.7	1.46 V	206	25.43	12.87
8	#17235.00	55.9 PK	74.0	-18.1	1.57 V	227	38.34	17.56
9	#17235.00	43.1 AV	54.0	-10.9	1.57 V	227	25.54	17.56

REMARKS:

1. Emission Level(dBuV/m) = Raw Value(dBuV) + Correction Factor(dB/m)
2. Correction Factor(dB/m) = Antenna Factor(dB/m) + Cable Factor(dB) – Pre-Amplifier Factor(dB)
3. The other emission levels were very low against the limit.
4. Margin value = Emission Level – Limit value
5. " * ": Fundamental frequency.
6. " # ": The radiated frequency is out of the restricted band.



CHANNEL	TX Channel 157	DETECTOR FUNCTION	Peak (PK)
FREQUENCY RANGE	1GHz ~ 40GHz		Average (AV)

ANTENNA POLARITY & TEST DISTANCE: HORIZONTAL AT 3 M

NO.	FREQ. (MHz)	EMISSION LEVEL (dBuV/m)	LIMIT (dBuV/m)	MARGIN (dB)	ANTENNA HEIGHT (m)	TABLE ANGLE (Degree)	RAW VALUE (dBuV)	CORRECTION FACTOR (dB/m)
1	#5703.00	56.8 PK	74.0	-17.2	1.03 H	349	54.91	1.89
2	#5703.00	44.9 AV	54.0	-9.1	1.03 H	349	43.01	1.89
3	#5725.00	58.7 PK	78.2	-19.5	2.03 H	360	56.77	1.93
4	*5785.00	108.0 PK			2.03 H	360	105.94	2.06
5	*5785.00	97.4 AV			2.03 H	360	95.34	2.06
6	#5850.00	58.3 PK	78.2	-19.9	2.03 H	360	56.17	2.13
7	#5860.00	57.4 PK	74.0	-16.6	2.03 H	360	55.27	2.13
8	#5860.00	45.0 AV	54.0	-9.0	2.03 H	360	42.87	2.13
9	11570.00	50.7 PK	74.0	-23.3	1.65 H	128	38.08	12.62
10	11570.00	38.1 AV	54.0	-15.9	1.65 H	128	25.48	12.62
11	#17355.00	55.7 PK	74.0	-18.3	1.87 H	255	37.52	18.18
12	#17355.00	42.4 AV	54.0	-11.6	1.87 H	255	24.22	18.18

ANTENNA POLARITY & TEST DISTANCE: VERTICAL AT 3 M

NO.	FREQ. (MHz)	EMISSION LEVEL (dBuV/m)	LIMIT (dBuV/m)	MARGIN (dB)	ANTENNA HEIGHT (m)	TABLE ANGLE (Degree)	RAW VALUE (dBuV)	CORRECTION FACTOR (dB/m)
1	#5703.00	64.5 PK	74.0	-9.5	2.15 V	127	62.61	1.89
2	#5703.00	52.7 AV	54.0	-1.3	2.15 V	127	50.81	1.89
3	#5725.00	65.6 PK	78.2	-12.6	2.15 V	311	63.67	1.93
4	*5785.00	114.7 PK			2.15 V	311	112.64	2.06
5	*5785.00	104.2 AV			2.15 V	311	102.14	2.06
6	#5850.00	65.9 PK	78.2	-12.3	2.15 V	311	63.77	2.13
7	#5860.00	64.1 PK	74.0	-9.9	2.15 V	311	61.97	2.13
8	#5860.00	51.9 AV	54.0	-2.1	2.15 V	311	49.77	2.13
9	11570.00	51.1 PK	74.0	-22.9	1.47 V	189	38.48	12.62
10	11570.00	38.5 AV	54.0	-15.5	1.47 V	189	25.88	12.62
11	#17355.00	56.2 PK	74.0	-17.8	1.56 V	218	38.02	18.18
12	#17355.00	42.9 AV	54.0	-11.1	1.56 V	218	24.72	18.18

REMARKS:

1. Emission Level(dBuV/m) = Raw Value(dBuV) + Correction Factor(dB/m)
2. Correction Factor(dB/m) = Antenna Factor(dB/m) + Cable Factor(dB) – Pre-Amplifier Factor(dB)
3. The other emission levels were very low against the limit.
4. Margin value = Emission Level – Limit value
5. " * ": Fundamental frequency.
6. " # ": The radiated frequency is out of the restricted band.

CHANNEL	TX Channel 165	DETECTOR FUNCTION	Peak (PK)
FREQUENCY RANGE	1GHz ~ 40GHz		Average (AV)

ANTENNA POLARITY & TEST DISTANCE: HORIZONTAL AT 3 M

NO.	FREQ. (MHz)	EMISSION LEVEL (dBuV/m)	LIMIT (dBuV/m)	MARGIN (dB)	ANTENNA HEIGHT (m)	TABLE ANGLE (Degree)	RAW VALUE (dBuV)	CORRECTION FACTOR (dB/m)
1	*5825.00	104.0 PK			2.01 H	360	101.88	2.12
2	*5825.00	93.9 AV			2.01 H	360	91.78	2.12
3	#5850.00	65.9 PK	78.2	-12.3	2.01 H	360	63.77	2.13
4	#5860.00	64.2 PK	74.0	-9.8	2.01 H	360	62.07	2.13
5	#5860.00	48.2 AV	54.0	-5.8	2.01 H	360	46.07	2.13
6	11650.00	50.5 PK	74.0	-23.5	1.61 H	120	38.05	12.45
7	11650.00	38.1 AV	54.0	-15.9	1.61 H	120	25.65	12.45
8	#17475.00	56.0 PK	74.0	-18.0	1.90 H	262	37.25	18.75
9	#17475.00	42.7 AV	54.0	-11.3	1.90 H	262	23.95	18.75

ANTENNA POLARITY & TEST DISTANCE: VERTICAL AT 3 M

NO.	FREQ. (MHz)	EMISSION LEVEL (dBuV/m)	LIMIT (dBuV/m)	MARGIN (dB)	ANTENNA HEIGHT (m)	TABLE ANGLE (Degree)	RAW VALUE (dBuV)	CORRECTION FACTOR (dB/m)
1	*5825.00	112.3 PK			2.23 V	313	110.18	2.12
2	*5825.00	101.5 AV			2.23 V	313	99.38	2.12
3	#5850.00	73.6 PK	78.2	-4.6	2.23 V	313	71.47	2.13
4	#5860.00	69.5 PK	74.0	-4.5	2.23 V	313	67.37	2.13
5	#5860.00	53.6 AV	54.0	-0.4	2.23 V	313	51.47	2.13
6	11650.00	50.6 PK	74.0	-23.4	1.48 V	202	38.15	12.45
7	11650.00	38.4 AV	54.0	-15.6	1.48 V	202	25.95	12.45
8	#17475.00	56.5 PK	74.0	-17.5	1.52 V	241	37.75	18.75
9	#17475.00	43.7 AV	54.0	-10.3	1.52 V	241	24.95	18.75

REMARKS:

1. Emission Level(dBuV/m) = Raw Value(dBuV) + Correction Factor(dB/m)
2. Correction Factor(dB/m) = Antenna Factor(dB/m) + Cable Factor(dB) – Pre-Amplifier Factor(dB)
3. The other emission levels were very low against the limit.
4. Margin value = Emission Level – Limit value
5. " * ": Fundamental frequency.
6. " # ": The radiated frequency is out of the restricted band.

802.11ac (VHT20)

CHANNEL	TX Channel 36	DETECTOR FUNCTION	Peak (PK)
FREQUENCY RANGE	1GHz ~ 40GHz		Average (AV)

ANTENNA POLARITY & TEST DISTANCE: HORIZONTAL AT 3 M

NO.	FREQ. (MHz)	EMISSION LEVEL (dBuV/m)	LIMIT (dBuV/m)	MARGIN (dB)	ANTENNA HEIGHT (m)	TABLE ANGLE (Degree)	RAW VALUE (dBuV)	CORRECTION FACTOR (dB/m)
1	5102.00	60.2 PK	74.0	-13.8	1.09 H	360	59.53	0.67
2	5102.00	45.8 AV	54.0	-8.2	1.09 H	360	45.13	0.67
3	5146.00	62.7 PK	74.0	-11.3	1.06 H	343	61.91	0.79
4	5146.00	47.9 AV	54.0	-6.1	1.06 H	343	47.11	0.79
5	*5180.00	108.2 PK			1.10 H	351	107.31	0.89
6	*5180.00	97.2 AV			1.10 H	351	96.31	0.89
7	#10360.00	51.2 PK	74.0	-22.8	1.62 H	113	40.22	10.98
8	#10360.00	38.5 AV	54.0	-15.5	1.62 H	113	27.52	10.98
9	15540.00	55.9 PK	74.0	-18.1	1.92 H	246	43.17	12.73
10	15540.00	42.8 AV	54.0	-11.2	1.92 H	246	30.07	12.73

ANTENNA POLARITY & TEST DISTANCE: VERTICAL AT 3 M

NO.	FREQ. (MHz)	EMISSION LEVEL (dBuV/m)	LIMIT (dBuV/m)	MARGIN (dB)	ANTENNA HEIGHT (m)	TABLE ANGLE (Degree)	RAW VALUE (dBuV)	CORRECTION FACTOR (dB/m)
1	5102.00	62.5 PK	74.0	-11.5	2.22 V	282	61.83	0.67
2	5102.00	51.8 AV	54.0	-2.2	2.22 V	282	51.13	0.67
3	5146.00	69.1 PK	74.0	-4.9	1.36 V	307	68.31	0.79
4	5146.00	53.9 AV	54.0	-0.1	1.36 V	307	53.11	0.79
5	*5180.00	117.8 PK			1.36 V	307	116.91	0.89
6	*5180.00	106.7 AV			1.36 V	307	105.81	0.89
7	#10360.00	50.7 PK	74.0	-23.3	1.45 V	213	39.72	10.98
8	#10360.00	38.2 AV	54.0	-15.8	1.45 V	213	27.22	10.98
9	15540.00	56.4 PK	74.0	-17.6	1.58 V	238	43.67	12.73
10	15540.00	43.5 AV	54.0	-10.5	1.58 V	238	30.77	12.73

REMARKS:

- Emission Level(dBuV/m) = Raw Value(dBuV) + Correction Factor(dB/m)
- Correction Factor(dB/m) = Antenna Factor(dB/m) + Cable Factor(dB) – Pre-Amplifier Factor(dB)
- The other emission levels were very low against the limit.
- Margin value = Emission Level – Limit value
- " * ": Fundamental frequency.
- " # ": The radiated frequency is out of the restricted band.



CHANNEL	TX Channel 40	DETECTOR FUNCTION	Peak (PK)
FREQUENCY RANGE	1GHz ~ 40GHz		Average (AV)

ANTENNA POLARITY & TEST DISTANCE: HORIZONTAL AT 3 M

NO.	FREQ. (MHz)	EMISSION LEVEL (dBuV/m)	LIMIT (dBuV/m)	MARGIN (dB)	ANTENNA HEIGHT (m)	TABLE ANGLE (Degree)	RAW VALUE (dBuV)	CORRECTION FACTOR (dB/m)
1	5118.00	62.6 PK	74.0	-11.4	1.11 H	337	61.88	0.72
2	5118.00	47.5 AV	54.0	-6.5	1.11 H	337	46.78	0.72
3	*5200.00	111.6 PK			1.09 H	346	110.66	0.94
4	*5200.00	100.1 AV			1.09 H	346	99.16	0.94
5	#10400.00	50.6 PK	74.0	-23.4	1.67 H	116	39.27	11.33
6	#10400.00	38.0 AV	54.0	-16.0	1.67 H	116	26.67	11.33
7	15600.00	55.1 PK	74.0	-18.9	1.81 H	262	42.23	12.87
8	15600.00	42.1 AV	54.0	-11.9	1.81 H	262	29.23	12.87

ANTENNA POLARITY & TEST DISTANCE: VERTICAL AT 3 M

NO.	FREQ. (MHz)	EMISSION LEVEL (dBuV/m)	LIMIT (dBuV/m)	MARGIN (dB)	ANTENNA HEIGHT (m)	TABLE ANGLE (Degree)	RAW VALUE (dBuV)	CORRECTION FACTOR (dB/m)
1	5118.00	63.0 PK	74.0	-11.0	2.21 V	257	62.28	0.72
2	5118.00	52.7 AV	54.0	-1.3	2.21 V	257	51.98	0.72
3	*5200.00	119.6 PK			2.21 V	262	118.66	0.94
4	*5200.00	108.8 AV			2.21 V	262	107.86	0.94
5	#10400.00	50.7 PK	74.0	-23.3	1.47 V	198	39.37	11.33
6	#10400.00	38.2 AV	54.0	-15.8	1.47 V	198	26.87	11.33
7	15600.00	56.5 PK	74.0	-17.5	1.52 V	228	43.63	12.87
8	15600.00	43.4 AV	54.0	-10.6	1.52 V	228	30.53	12.87

REMARKS:

1. Emission Level(dBuV/m) = Raw Value(dBuV) + Correction Factor(dB/m)
2. Correction Factor(dB/m) = Antenna Factor(dB/m) + Cable Factor(dB) – Pre-Amplifier Factor(dB)
3. The other emission levels were very low against the limit.
4. Margin value = Emission Level – Limit value
5. " * ": Fundamental frequency.
6. " # ": The radiated frequency is out of the restricted band.

CHANNEL	TX Channel 48	DETECTOR FUNCTION	Peak (PK)
FREQUENCY RANGE	1GHz ~ 40GHz		Average (AV)

ANTENNA POLARITY & TEST DISTANCE: HORIZONTAL AT 3 M

NO.	FREQ. (MHz)	EMISSION LEVEL (dBuV/m)	LIMIT (dBuV/m)	MARGIN (dB)	ANTENNA HEIGHT (m)	TABLE ANGLE (Degree)	RAW VALUE (dBuV)	CORRECTION FACTOR (dB/m)
1	5000.00	62.6 PK	74.0	-11.4	1.07 H	338	62.15	0.45
2	5000.00	47.6 AV	54.0	-6.4	1.07 H	338	47.15	0.45
3	*5240.00	111.1 PK			1.05 H	342	110.04	1.06
4	*5240.00	99.7 AV			1.05 H	342	98.64	1.06
5	5399.00	54.4 PK	74.0	-19.6	1.05 H	348	53.09	1.31
6	5399.00	41.4 AV	54.0	-12.6	1.05 H	348	40.09	1.31
7	#10480.00	50.7 PK	74.0	-23.3	1.63 H	138	39.51	11.19
8	#10480.00	37.8 AV	54.0	-16.2	1.63 H	138	26.61	11.19
9	15720.00	55.1 PK	74.0	-18.9	1.87 H	255	42.79	12.31
10	15720.00	42.0 AV	54.0	-12.0	1.87 H	255	29.69	12.31

ANTENNA POLARITY & TEST DISTANCE: VERTICAL AT 3 M

NO.	FREQ. (MHz)	EMISSION LEVEL (dBuV/m)	LIMIT (dBuV/m)	MARGIN (dB)	ANTENNA HEIGHT (m)	TABLE ANGLE (Degree)	RAW VALUE (dBuV)	CORRECTION FACTOR (dB/m)
1	5000.00	58.1 PK	74.0	-15.9	2.19 V	259	57.65	0.45
2	5000.00	51.6 AV	54.0	-2.4	2.19 V	259	51.15	0.45
3	*5240.00	120.3 PK			2.19 V	262	119.24	1.06
4	*5240.00	109.7 AV			2.19 V	262	108.64	1.06
5	5399.00	59.8 PK	74.0	-14.2	2.19 V	260	58.49	1.31
6	5399.00	48.7 AV	54.0	-5.3	2.19 V	260	47.39	1.31
7	#10480.00	50.3 PK	74.0	-23.7	1.50 V	197	39.11	11.19
8	#10480.00	37.7 AV	54.0	-16.3	1.50 V	197	26.51	11.19
9	15720.00	56.3 PK	74.0	-17.7	1.54 V	230	43.99	12.31
10	15720.00	43.2 AV	54.0	-10.8	1.54 V	230	30.89	12.31

REMARKS:

- Emission Level(dBuV/m) = Raw Value(dBuV) + Correction Factor(dB/m)
- Correction Factor(dB/m) = Antenna Factor(dB/m) + Cable Factor(dB) – Pre-Amplifier Factor(dB)
- The other emission levels were very low against the limit.
- Margin value = Emission Level – Limit value
- " * ": Fundamental frequency.
- " # ": The radiated frequency is out of the restricted band.

CHANNEL	TX Channel 149	DETECTOR FUNCTION	Peak (PK)
FREQUENCY RANGE	1GHz ~ 40GHz		Average (AV)

ANTENNA POLARITY & TEST DISTANCE: HORIZONTAL AT 3 M

NO.	FREQ. (MHz)	EMISSION LEVEL (dBuV/m)	LIMIT (dBuV/m)	MARGIN (dB)	ANTENNA HEIGHT (m)	TABLE ANGLE (Degree)	RAW VALUE (dBuV)	CORRECTION FACTOR (dB/m)
1	#5667.00	62.9 PK	74.0	-11.1	1.01 H	352	61.08	1.82
2	#5667.00	48.0 AV	54.0	-6.0	1.01 H	352	46.18	1.82
3	#5715.00	54.7 PK	74.0	-19.3	1.01 H	339	52.78	1.92
4	#5715.00	41.5 AV	54.0	-12.5	1.01 H	339	39.58	1.92
5	#5725.00	70.6 PK	78.2	-7.6	1.01 H	339	68.67	1.93
6	*5745.00	106.4 PK			1.01 H	339	104.42	1.98
7	*5745.00	95.6 AV			1.01 H	339	93.62	1.98
8	11490.00	50.0 PK	74.0	-24.0	1.62 H	115	37.13	12.87
9	11490.00	37.7 AV	54.0	-16.3	1.62 H	115	24.83	12.87
10	#17235.00	55.5 PK	74.0	-18.5	1.84 H	259	37.94	17.56
11	#17235.00	42.5 AV	54.0	-11.5	1.84 H	259	24.94	17.56

ANTENNA POLARITY & TEST DISTANCE: VERTICAL AT 3 M

NO.	FREQ. (MHz)	EMISSION LEVEL (dBuV/m)	LIMIT (dBuV/m)	MARGIN (dB)	ANTENNA HEIGHT (m)	TABLE ANGLE (Degree)	RAW VALUE (dBuV)	CORRECTION FACTOR (dB/m)
1	#5667.00	63.3 PK	74.0	-10.7	1.97 V	299	61.48	1.82
2	#5667.00	52.1 AV	54.0	-1.9	1.97 V	299	50.28	1.82
3	#5715.00	66.1 PK	74.0	-7.9	1.97 V	317	64.18	1.92
4	#5715.00	49.9 AV	54.0	-4.1	1.97 V	317	47.98	1.92
5	#5725.00	78.1 PK	78.2	-0.1	1.97 V	317	76.17	1.93
6	*5745.00	115.0 PK			1.97 V	317	113.02	1.98
7	*5745.00	104.0 AV			1.97 V	317	102.02	1.98
8	11490.00	50.6 PK	74.0	-23.4	1.47 V	225	37.73	12.87
9	11490.00	38.5 AV	54.0	-15.5	1.47 V	225	25.63	12.87
10	#17235.00	56.4 PK	74.0	-17.6	1.56 V	230	38.84	17.56
11	#17235.00	43.2 AV	54.0	-10.8	1.56 V	230	25.64	17.56

REMARKS:

- Emission Level(dBuV/m) = Raw Value(dBuV) + Correction Factor(dB/m)
- Correction Factor(dB/m) = Antenna Factor(dB/m) + Cable Factor(dB) – Pre-Amplifier Factor(dB)
- The other emission levels were very low against the limit.
- Margin value = Emission Level – Limit value
- " * ": Fundamental frequency.
- " # ": The radiated frequency is out of the restricted band.

CHANNEL	TX Channel 157	DETECTOR FUNCTION	Peak (PK)
FREQUENCY RANGE	1GHz ~ 40GHz		Average (AV)

ANTENNA POLARITY & TEST DISTANCE: HORIZONTAL AT 3 M

NO.	FREQ. (MHz)	EMISSION LEVEL (dBuV/m)	LIMIT (dBuV/m)	MARGIN (dB)	ANTENNA HEIGHT (m)	TABLE ANGLE (Degree)	RAW VALUE (dBuV)	CORRECTION FACTOR (dB/m)
1	#5712.00	62.5 PK	68.2	-5.7	1.01 H	347	60.59	1.91
2	#5725.00	61.4 PK	78.2	-16.8	1.13 H	351	59.47	1.93
3	*5785.00	111.5 PK			1.13 H	351	109.44	2.06
4	*5785.00	99.8 AV			1.13 H	351	97.74	2.06
5	#5850.00	63.4 PK	78.2	-14.8	1.13 H	351	61.27	2.13
6	#5863.00	62.4 PK	68.2	-5.8	1.04 H	347	60.26	2.14
7	11570.00	50.8 PK	74.0	-23.2	1.60 H	142	38.18	12.62
8	11570.00	38.1 AV	54.0	-15.9	1.60 H	142	25.48	12.62
9	#17355.00	55.4 PK	68.2	-12.8	1.92 H	242	37.22	18.18

ANTENNA POLARITY & TEST DISTANCE: VERTICAL AT 3 M

NO.	FREQ. (MHz)	EMISSION LEVEL (dBuV/m)	LIMIT (dBuV/m)	MARGIN (dB)	ANTENNA HEIGHT (m)	TABLE ANGLE (Degree)	RAW VALUE (dBuV)	CORRECTION FACTOR (dB/m)
1	#5712.00	68.1 PK	68.2	-0.1	2.09 V	316	66.19	1.91
2	#5725.00	67.2 PK	78.2	-11.0	1.81 V	281	65.27	1.93
3	*5785.00	120.7 PK			1.81 V	281	118.64	2.06
4	*5785.00	110.0 AV			1.81 V	281	107.94	2.06
5	#5850.00	69.0 PK	78.2	-9.2	1.81 V	281	66.87	2.13
6	#5863.00	67.4 PK	68.2	-0.8	1.81 V	314	65.26	2.14
7	11570.00	54.4 PK	74.0	-19.6	1.50 V	168	41.78	12.62
8	11570.00	41.5 AV	54.0	-12.5	1.50 V	168	28.88	12.62
9	#17355.00	56.2 PK	68.2	-12.0	1.49 V	234	38.02	18.18

REMARKS:

1. Emission Level(dBuV/m) = Raw Value(dBuV) + Correction Factor(dB/m)
2. Correction Factor(dB/m) = Antenna Factor(dB/m) + Cable Factor(dB) – Pre-Amplifier Factor(dB)
3. The other emission levels were very low against the limit.
4. Margin value = Emission Level – Limit value
5. " * ": Fundamental frequency.
6. " # ": The radiated frequency is out of the restricted band.



CHANNEL	TX Channel 165	DETECTOR FUNCTION	Peak (PK)
FREQUENCY RANGE	1GHz ~ 40GHz		Average (AV)

ANTENNA POLARITY & TEST DISTANCE: HORIZONTAL AT 3 M

NO.	FREQ. (MHz)	EMISSION LEVEL (dBuV/m)	LIMIT (dBuV/m)	MARGIN (dB)	ANTENNA HEIGHT (m)	TABLE ANGLE (Degree)	RAW VALUE (dBuV)	CORRECTION FACTOR (dB/m)
1	*5825.00	108.4 PK			1.14 H	321	106.28	2.12
2	*5825.00	97.3 AV			1.14 H	321	95.18	2.12
3	#5850.00	70.4 PK	78.2	-7.8	1.14 H	321	68.27	2.13
4	#5860.00	62.1 PK	74.0	-11.9	1.14 H	321	59.97	2.13
5	#5860.00	47.6 AV	54.0	-6.4	1.14 H	321	45.47	2.13
6	#5906.00	61.4 PK	74.0	-12.6	1.11 H	360	59.23	2.17
7	#5906.00	46.2 AV	54.0	-7.8	1.11 H	360	44.03	2.17
8	11650.00	50.3 PK	74.0	-23.7	1.60 H	125	37.85	12.45
9	11650.00	37.9 AV	54.0	-16.1	1.60 H	125	25.45	12.45
10	#17475.00	55.5 PK	74.0	-18.5	1.90 H	248	36.75	18.75
11	#17475.00	42.3 AV	54.0	-11.7	1.90 H	248	23.55	18.75

ANTENNA POLARITY & TEST DISTANCE: VERTICAL AT 3 M

NO.	FREQ. (MHz)	EMISSION LEVEL (dBuV/m)	LIMIT (dBuV/m)	MARGIN (dB)	ANTENNA HEIGHT (m)	TABLE ANGLE (Degree)	RAW VALUE (dBuV)	CORRECTION FACTOR (dB/m)
1	*5825.00	117.1 PK			1.90 V	280	114.98	2.12
2	*5825.00	106.3 AV			1.90 V	280	104.18	2.12
3	#5850.00	78.1 PK	78.2	-0.1	1.90 V	280	75.97	2.13
4	#5860.00	70.3 PK	74.0	-3.7	1.90 V	280	68.17	2.13
5	#5860.00	53.8 AV	54.0	-0.2	1.90 V	280	51.67	2.13
6	#5906.00	63.3 PK	74.0	-10.7	1.90 V	258	61.13	2.17
7	#5906.00	52.8 AV	54.0	-1.2	1.90 V	258	50.63	2.17
8	11650.00	50.7 PK	74.0	-23.3	1.50 V	210	38.25	12.45
9	11650.00	38.4 AV	54.0	-15.6	1.50 V	210	25.95	12.45
10	#17475.00	56.9 PK	74.0	-17.1	1.58 V	235	38.15	18.75
11	#17475.00	43.6 AV	54.0	-10.4	1.58 V	235	24.85	18.75

REMARKS:

1. Emission Level(dBuV/m) = Raw Value(dBuV) + Correction Factor(dB/m)
2. Correction Factor(dB/m) = Antenna Factor(dB/m) + Cable Factor(dB) – Pre-Amplifier Factor(dB)
3. The other emission levels were very low against the limit.
4. Margin value = Emission Level – Limit value
5. " * ": Fundamental frequency.
6. " # ": The radiated frequency is out of the restricted band.



802.11ac (VHT40)

CHANNEL	TX Channel 38	DETECTOR FUNCTION	Peak (PK)
FREQUENCY RANGE	1GHz ~ 40GHz		Average (AV)

ANTENNA POLARITY & TEST DISTANCE: HORIZONTAL AT 3 M								
NO.	FREQ. (MHz)	EMISSION LEVEL (dBuV/m)	LIMIT (dBuV/m)	MARGIN (dB)	ANTENNA HEIGHT (m)	TABLE ANGLE (Degree)	RAW VALUE (dBuV)	CORRECTION FACTOR (dB/m)
1	5000.00	61.4 PK	74.0	-12.6	1.10 H	343	60.95	0.45
2	5000.00	45.7 AV	54.0	-8.3	1.10 H	343	45.25	0.45
3	5150.00	57.9 PK	74.0	-16.1	1.00 H	335	57.10	0.80
4	5150.00	46.6 AV	54.0	-7.4	1.00 H	335	45.80	0.80
5	*5190.00	101.2 PK			1.00 H	335	100.29	0.91
6	*5190.00	90.7 AV			1.00 H	335	89.79	0.91
7	5350.00	47.3 PK	74.0	-26.7	1.00 H	335	46.00	1.30
8	5350.00	35.7 AV	54.0	-18.3	1.00 H	335	34.40	1.30
9	#10380.00	50.5 PK	74.0	-23.5	1.55 H	124	39.34	11.16
10	#10380.00	38.5 AV	54.0	-15.5	1.55 H	124	27.34	11.16
11	15570.00	55.2 PK	74.0	-18.8	1.89 H	250	42.40	12.80
12	15570.00	41.2 AV	54.0	-12.8	1.89 H	250	28.40	12.80

ANTENNA POLARITY & TEST DISTANCE: VERTICAL AT 3 M								
NO.	FREQ. (MHz)	EMISSION LEVEL (dBuV/m)	LIMIT (dBuV/m)	MARGIN (dB)	ANTENNA HEIGHT (m)	TABLE ANGLE (Degree)	RAW VALUE (dBuV)	CORRECTION FACTOR (dB/m)
1	5000.00	57.1 PK	74.0	-16.9	2.70 V	213	56.65	0.45
2	5000.00	51.5 AV	54.0	-2.5	2.70 V	213	51.05	0.45
3	5150.00	62.3 PK	74.0	-11.7	2.77 V	216	61.50	0.80
4	5150.00	53.9 AV	54.0	-0.1	2.77 V	216	53.10	0.80
5	*5190.00	110.6 PK			2.77 V	216	109.69	0.91
6	*5190.00	99.6 AV			2.77 V	216	98.69	0.91
7	5350.00	53.5 PK	74.0	-20.5	2.77 V	216	52.20	1.30
8	5350.00	41.7 AV	54.0	-12.3	2.77 V	216	40.40	1.30
9	#10380.00	50.5 PK	74.0	-23.5	1.50 V	198	39.34	11.16
10	#10380.00	38.5 AV	54.0	-15.5	1.50 V	198	27.34	11.16
11	15570.00	55.2 PK	74.0	-18.8	1.55 V	226	42.40	12.80
12	15570.00	41.2 AV	54.0	-12.8	1.55 V	226	28.40	12.80

REMARKS:

1. Emission Level(dBuV/m) = Raw Value(dBuV) + Correction Factor(dB/m)
2. Correction Factor(dB/m) = Antenna Factor(dB/m) + Cable Factor(dB) – Pre-Amplifier Factor(dB)
3. The other emission levels were very low against the limit.
4. Margin value = Emission Level – Limit value
5. " * ": Fundamental frequency.
6. " # ": The radiated frequency is out of the restricted band.

CHANNEL	TX Channel 46	DETECTOR FUNCTION	Peak (PK)
FREQUENCY RANGE	1GHz ~ 40GHz		Average (AV)

ANTENNA POLARITY & TEST DISTANCE: HORIZONTAL AT 3 M

NO.	FREQ. (MHz)	EMISSION LEVEL (dBuV/m)	LIMIT (dBuV/m)	MARGIN (dB)	ANTENNA HEIGHT (m)	TABLE ANGLE (Degree)	RAW VALUE (dBuV)	CORRECTION FACTOR (dB/m)
1	5150.00	62.6 PK	74.0	-11.4	1.06 H	339	61.80	0.80
2	5150.00	47.8 AV	54.0	-6.2	1.06 H	339	47.00	0.80
3	*5230.00	106.2 PK			1.06 H	339	105.16	1.04
4	*5230.00	95.1 AV			1.06 H	339	94.06	1.04
5	#5665.00	63.1 PK	74.0	-10.9	1.01 H	352	61.28	1.82
6	#5665.00	48.3 AV	54.0	-5.7	1.01 H	352	46.48	1.82
7	#10460.00	50.6 PK	74.0	-23.4	1.52 H	119	39.38	11.22
8	#10460.00	38.8 AV	54.0	-15.2	1.52 H	119	27.58	11.22
9	15690.00	55.7 PK	74.0	-18.3	1.88 H	263	43.32	12.38
10	15690.00	41.7 AV	54.0	-12.3	1.88 H	263	29.32	12.38

ANTENNA POLARITY & TEST DISTANCE: VERTICAL AT 3 M

NO.	FREQ. (MHz)	EMISSION LEVEL (dBuV/m)	LIMIT (dBuV/m)	MARGIN (dB)	ANTENNA HEIGHT (m)	TABLE ANGLE (Degree)	RAW VALUE (dBuV)	CORRECTION FACTOR (dB/m)
1	5150.00	65.7 PK	74.0	-8.3	2.22 V	325	64.90	0.80
2	5150.00	53.3 AV	54.0	-0.7	2.22 V	325	52.50	0.80
3	*5230.00	116.8 PK			2.18 V	149	115.76	1.04
4	*5230.00	105.3 AV			2.18 V	149	104.26	1.04
5	#5665.00	58.6 PK	74.0	-15.4	2.22 V	223	56.78	1.82
6	#5665.00	53.6 AV	54.0	-0.4	2.22 V	223	51.78	1.82
7	#10460.00	50.4 PK	74.0	-23.6	1.55 V	201	39.18	11.22
8	#10460.00	38.5 AV	54.0	-15.5	1.55 V	201	27.28	11.22
9	15690.00	55.7 PK	74.0	-18.3	1.60 V	226	43.32	12.38
10	15690.00	41.6 AV	54.0	-12.4	1.60 V	226	29.22	12.38

REMARKS:

1. Emission Level(dBuV/m) = Raw Value(dBuV) + Correction Factor(dB/m)
2. Correction Factor(dB/m) = Antenna Factor(dB/m) + Cable Factor(dB) – Pre-Amplifier Factor(dB)
3. The other emission levels were very low against the limit.
4. Margin value = Emission Level – Limit value
5. " * ": Fundamental frequency.
6. " # ": The radiated frequency is out of the restricted band.

CHANNEL	TX Channel 151	DETECTOR FUNCTION	Peak (PK)
FREQUENCY RANGE	1GHz ~ 40GHz		Average (AV)

ANTENNA POLARITY & TEST DISTANCE: HORIZONTAL AT 3 M

NO.	FREQ. (MHz)	EMISSION LEVEL (dBuV/m)	LIMIT (dBuV/m)	MARGIN (dB)	ANTENNA HEIGHT (m)	TABLE ANGLE (Degree)	RAW VALUE (dBuV)	CORRECTION FACTOR (dB/m)
1	#5715.00	62.4 PK	74.0	-11.6	1.10 H	338	60.48	1.92
2	#5715.00	47.7 AV	54.0	-6.3	1.10 H	338	45.78	1.92
3	#5725.00	63.1 PK	78.2	-15.1	1.10 H	338	61.17	1.93
4	*5755.00	101.1 PK			1.10 H	338	99.10	2.00
5	*5755.00	89.7 AV			1.10 H	338	87.70	2.00
6	11510.00	50.2 PK	74.0	-23.8	1.55 H	134	37.37	12.83
7	11510.00	38.3 AV	54.0	-15.7	1.55 H	134	25.47	12.83
8	#17265.00	55.6 PK	74.0	-18.4	1.92 H	266	37.95	17.65
9	#17265.00	41.6 AV	54.0	-12.4	1.92 H	266	23.95	17.65

ANTENNA POLARITY & TEST DISTANCE: VERTICAL AT 3 M

NO.	FREQ. (MHz)	EMISSION LEVEL (dBuV/m)	LIMIT (dBuV/m)	MARGIN (dB)	ANTENNA HEIGHT (m)	TABLE ANGLE (Degree)	RAW VALUE (dBuV)	CORRECTION FACTOR (dB/m)
1	#5715.00	68.0 PK	74.0	-6.0	1.98 V	316	66.08	1.92
2	#5715.00	53.8 AV	54.0	-0.2	1.98 V	316	51.88	1.92
3	#5725.00	70.9 PK	78.2	-7.3	1.98 V	316	68.97	1.93
4	*5755.00	109.1 PK			1.98 V	316	107.10	2.00
5	*5755.00	98.6 AV			1.98 V	316	96.60	2.00
6	11510.00	50.8 PK	74.0	-23.2	1.51 V	196	37.97	12.83
7	11510.00	38.6 AV	54.0	-15.4	1.51 V	196	25.77	12.83
8	#17265.00	55.5 PK	74.0	-18.5	1.55 V	232	37.85	17.65
9	#17265.00	41.4 AV	54.0	-12.6	1.55 V	232	23.75	17.65

REMARKS:

1. Emission Level(dBuV/m) = Raw Value(dBuV) + Correction Factor(dB/m)
2. Correction Factor(dB/m) = Antenna Factor(dB/m) + Cable Factor(dB) – Pre-Amplifier Factor(dB)
3. The other emission levels were very low against the limit.
4. Margin value = Emission Level – Limit value
5. " * ": Fundamental frequency.
6. " # ": The radiated frequency is out of the restricted band.

CHANNEL	TX Channel 159	DETECTOR FUNCTION	Peak (PK)
FREQUENCY RANGE	1GHz ~ 40GHz		Average (AV)

ANTENNA POLARITY & TEST DISTANCE: HORIZONTAL AT 3 M

NO.	FREQ. (MHz)	EMISSION LEVEL (dBuV/m)	LIMIT (dBuV/m)	MARGIN (dB)	ANTENNA HEIGHT (m)	TABLE ANGLE (Degree)	RAW VALUE (dBuV)	CORRECTION FACTOR (dB/m)
1	#5715.00	57.8 PK	68.2	-10.4	1.04 H	336	55.88	1.92
2	*5795.00	106.3 PK			1.04 H	336	104.21	2.09
3	*5795.00	95.2 AV			1.04 H	336	93.11	2.09
4	#5850.00	62.7 PK	78.2	-15.5	1.04 H	336	60.57	2.13
5	#5860.00	62.7 PK	68.2	-5.5	1.04 H	336	60.57	2.13
6	11590.00	50.2 PK	74.0	-23.8	1.56 H	111	37.65	12.55
7	11590.00	38.3 AV	54.0	-15.7	1.56 H	111	25.75	12.55
8	#17385.00	54.9 PK	68.2	-13.3	1.84 H	241	36.51	18.39

ANTENNA POLARITY & TEST DISTANCE: VERTICAL AT 3 M

NO.	FREQ. (MHz)	EMISSION LEVEL (dBuV/m)	LIMIT (dBuV/m)	MARGIN (dB)	ANTENNA HEIGHT (m)	TABLE ANGLE (Degree)	RAW VALUE (dBuV)	CORRECTION FACTOR (dB/m)
1	#5715.00	63.3 PK	68.2	-4.9	2.03 V	268	61.38	1.92
2	*5795.00	114.2 PK			2.13 V	271	112.11	2.09
3	*5795.00	104.1 AV			2.13 V	271	102.01	2.09
4	#5850.00	70.7 PK	78.2	-7.5	2.09 V	266	68.57	2.13
5	#5860.00	67.8 PK	68.2	-0.4	2.05 V	270	65.67	2.13
6	11590.00	50.8 PK	74.0	-23.2	1.56 V	196	38.25	12.55
7	11590.00	38.6 AV	54.0	-15.4	1.56 V	196	26.05	12.55
8	#17385.00	55.2 PK	68.2	-13.0	1.57 V	229	36.81	18.39

REMARKS:

1. Emission Level(dBuV/m) = Raw Value(dBuV) + Correction Factor(dB/m)
2. Correction Factor(dB/m) = Antenna Factor(dB/m) + Cable Factor(dB) – Pre-Amplifier Factor(dB)
3. The other emission levels were very low against the limit.
4. Margin value = Emission Level – Limit value
5. " * ": Fundamental frequency.
6. " # ": The radiated frequency is out of the restricted band.



802.11ac (VHT80)

CHANNEL	TX Channel 42	DETECTOR FUNCTION	Peak (PK)
FREQUENCY RANGE	1GHz ~ 40GHz		Average (AV)

ANTENNA POLARITY & TEST DISTANCE: HORIZONTAL AT 3 M								
NO.	FREQ. (MHz)	EMISSION LEVEL (dBuV/m)	LIMIT (dBuV/m)	MARGIN (dB)	ANTENNA HEIGHT (m)	TABLE ANGLE (Degree)	RAW VALUE (dBuV)	CORRECTION FACTOR (dB/m)
1	5000.00	51.1 PK	74.0	-22.9	1.01 H	359	50.65	0.45
2	5000.00	45.4 AV	54.0	-8.6	1.01 H	359	44.95	0.45
3	5150.00	62.6 PK	74.0	-11.4	1.05 H	356	61.80	0.80
4	5150.00	47.7 AV	54.0	-6.3	1.05 H	356	46.90	0.80
5	*5210.00	98.6 PK			1.05 H	356	97.62	0.98
6	*5210.00	87.5 AV			1.05 H	356	86.52	0.98
7	5350.00	47.8 PK	74.0	-26.2	1.05 H	356	46.50	1.30
8	5350.00	36.2 AV	54.0	-17.8	1.05 H	356	34.90	1.30
9	#5788.00	62.6 PK	68.2	-5.6	1.07 H	360	60.53	2.07
10	#10420.00	50.4 PK	68.2	-17.8	1.52 H	123	39.11	11.29
11	15630.00	55.4 PK	74.0	-18.6	1.86 H	259	42.69	12.71
12	15630.00	41.6 AV	54.0	-12.4	1.86 H	259	28.89	12.71

ANTENNA POLARITY & TEST DISTANCE: VERTICAL AT 3 M								
NO.	FREQ. (MHz)	EMISSION LEVEL (dBuV/m)	LIMIT (dBuV/m)	MARGIN (dB)	ANTENNA HEIGHT (m)	TABLE ANGLE (Degree)	RAW VALUE (dBuV)	CORRECTION FACTOR (dB/m)
1	5000.00	57.4 PK	74.0	-16.6	2.61 V	216	56.95	0.45
2	5000.00	51.5 AV	54.0	-2.5	2.61 V	216	51.05	0.45
3	5150.00	64.2 PK	74.0	-9.8	2.15 V	271	63.40	0.80
4	5150.00	53.9 AV	54.0	-0.1	2.15 V	271	53.10	0.80
5	*5210.00	105.4 PK			2.15 V	271	104.42	0.98
6	*5210.00	96.2 AV			2.15 V	271	95.22	0.98
7	5350.00	52.9 PK	74.0	-21.1	2.15 V	271	51.60	1.30
8	5350.00	41.0 AV	54.0	-13.0	2.15 V	271	39.70	1.30
9	#5788.00	60.4 PK	68.2	-7.8	2.15 V	236	58.33	2.07
10	#10420.00	50.6 PK	68.2	-17.6	1.49 V	210	39.31	11.29
11	15630.00	55.1 PK	74.0	-18.9	1.58 V	239	42.39	12.71
12	15630.00	40.9 AV	54.0	-13.1	1.58 V	239	28.19	12.71

REMARKS:

1. Emission Level(dBuV/m) = Raw Value(dBuV) + Correction Factor(dB/m)
2. Correction Factor(dB/m) = Antenna Factor(dB/m) + Cable Factor(dB) – Pre-Amplifier Factor(dB)
3. The other emission levels were very low against the limit.
4. Margin value = Emission Level – Limit value
5. " * ": Fundamental frequency.
6. " # ": The radiated frequency is out of the restricted band.



CHANNEL	TX Channel 155	DETECTOR FUNCTION	Peak (PK)
FREQUENCY RANGE	1GHz ~ 40GHz		Average (AV)

ANTENNA POLARITY & TEST DISTANCE: HORIZONTAL AT 3 M

NO.	FREQ. (MHz)	EMISSION LEVEL (dBuV/m)	LIMIT (dBuV/m)	MARGIN (dB)	ANTENNA HEIGHT (m)	TABLE ANGLE (Degree)	RAW VALUE (dBuV)	CORRECTION FACTOR (dB/m)
1	#5715.00	62.1 PK	68.2	-6.1	1.06 H	352	60.18	1.92
2	#5725.00	63.8 PK	78.2	-14.4	1.06 H	352	61.87	1.93
3	*5775.00	99.2 PK			1.06 H	352	97.15	2.05
4	*5775.00	87.9 AV			1.06 H	352	85.85	2.05
5	#5850.00	60.4 PK	78.2	-17.8	1.06 H	352	58.27	2.13
6	#5860.00	57.8 PK	68.2	-10.4	1.06 H	352	55.67	2.13
7	11550.00	50.1 PK	74.0	-23.9	1.51 H	129	37.42	12.68
8	11550.00	38.2 AV	54.0	-15.8	1.51 H	129	25.52	12.68
9	#17325.00	55.3 PK	68.2	-12.9	1.91 H	254	37.36	17.94

ANTENNA POLARITY & TEST DISTANCE: VERTICAL AT 3 M

NO.	FREQ. (MHz)	EMISSION LEVEL (dBuV/m)	LIMIT (dBuV/m)	MARGIN (dB)	ANTENNA HEIGHT (m)	TABLE ANGLE (Degree)	RAW VALUE (dBuV)	CORRECTION FACTOR (dB/m)
1	#5715.00	68.0 PK	68.2	-0.2	2.10 V	271	66.08	1.92
2	#5725.00	70.2 PK	78.2	-8.0	2.10 V	271	68.27	1.93
3	*5775.00	106.2 PK			2.10 V	271	104.15	2.05
4	*5775.00	96.8 AV			2.10 V	271	94.75	2.05
5	#5850.00	66.1 PK	78.2	-12.1	2.10 V	271	63.97	2.13
6	#5860.00	63.8 PK	68.2	-4.4	2.10 V	271	61.67	2.13
7	11550.00	50.7 PK	74.0	-23.3	1.53 V	204	38.02	12.68
8	11550.00	39.0 AV	54.0	-15.0	1.53 V	204	26.32	12.68
9	#17325.00	55.6 PK	68.2	-12.6	1.58 V	236	37.66	17.94

REMARKS:

1. Emission Level(dBuV/m) = Raw Value(dBuV) + Correction Factor(dB/m)
2. Correction Factor(dB/m) = Antenna Factor(dB/m) + Cable Factor(dB) – Pre-Amplifier Factor(dB)
3. The other emission levels were very low against the limit.
4. Margin value = Emission Level – Limit value
5. " * ": Fundamental frequency.
6. " # ": The radiated frequency is out of the restricted band.

Below 1GHz Data:

802.11ac VHT20

CHANNEL	TX Channel 157	DETECTOR FUNCTION	Quasi-Peak (QP)
FREQUENCY RANGE	30MHz ~ 1GHz		

ANTENNA POLARITY & TEST DISTANCE: HORIZONTAL AT 3 M

NO.	FREQ. (MHz)	EMISSION LEVEL (dBuV/m)	LIMIT (dBuV/m)	MARGIN (dB)	ANTENNA HEIGHT (m)	TABLE ANGLE (Degree)	RAW VALUE (dBuV)	CORRECTION FACTOR (dB/m)
1	32.59	35.3 QP	40.0	-4.7	1.00 H	318	45.16	-9.87
2	163.25	32.1 QP	43.5	-11.4	1.50 H	240	40.72	-8.62
3	294.47	32.9 QP	46.0	-13.1	1.00 H	292	40.93	-8.06
4	600.00	32.3 QP	46.0	-13.7	1.50 H	335	32.84	-0.58
5	750.01	33.1 QP	46.0	-12.9	1.00 H	329	31.19	1.88
6	1000.00	33.0 QP	54.0	-21.0	1.00 H	345	28.16	4.83

ANTENNA POLARITY & TEST DISTANCE: VERTICAL AT 3 M

NO.	FREQ. (MHz)	EMISSION LEVEL (dBuV/m)	LIMIT (dBuV/m)	MARGIN (dB)	ANTENNA HEIGHT (m)	TABLE ANGLE (Degree)	RAW VALUE (dBuV)	CORRECTION FACTOR (dB/m)
1	38.96	36.8 QP	40.0	-3.3	1.00 V	18	45.95	-9.20
2	74.60	32.9 QP	40.0	-7.1	1.50 V	184	44.88	-12.02
3	102.48	31.6 QP	43.5	-11.9	1.50 V	360	44.17	-12.61
4	204.70	29.6 QP	43.5	-13.9	1.00 V	219	41.47	-11.88
5	849.99	32.4 QP	46.0	-13.6	1.00 V	9	29.36	3.03
6	1000.00	35.5 QP	54.0	-18.5	1.00 V	117	30.69	4.83

REMARKS:

1. Emission Level(dBuV/m) = Raw Value(dBuV) + Correction Factor(dB/m)
2. Correction Factor(dB/m) = Antenna Factor(dB/m) + Cable Factor(dB) – Pre-Amplifier Factor(dB)
3. The other emission levels were very low against the limit.
4. Margin value = Emission Level – Limit value

4.2 Conducted Emission Measurement

4.2.1 Limits of Conducted Emission Measurement

Frequency (MHz)	Conducted Limit (dBuV)	
	Quasi-peak	Average
0.15 - 0.5	66 - 56	56 - 46
0.50 - 5.0	56	46
5.0 - 30.0	60	50

Note: 1. The lower limit shall apply at the transition frequencies.

2. The limit decreases in line with the logarithm of the frequency in the range of 0.15 to 0.50MHz.

4.2.2 Test Instruments

DESCRIPTION & MANUFACTURER	MODEL NO.	SERIAL NO.	CALIBRATED DATE	CALIBRATED UNTIL
Test Receiver R&S	ESCS 30	100375	May 06, 2015	May 05, 2016
Line-Impedance Stabilization Network (for EUT) SCHWARZBECK	NSLK-8127	8127-522	Sep. 01, 2015	Aug. 31, 2016
Line-Impedance Stabilization Network (for Peripheral) R&S	ENV216	100072	June 11, 2015	June 10, 2016
RF Cable	5D-FB	COCCAB-001	Mar. 08, 2016	Mar. 07, 2017
50 ohms Terminator	N/A	EMC-03	Sep. 23, 2015	Sep. 22, 2016
50 ohms Terminator	N/A	EMC-02	Oct. 01, 2015	Sep. 30, 2016
50 ohms Terminator	E1-011315	13	Dec. 11 2015	Dec. 10 2016
Software BVADT	BVADT_Cond_ V7.3.7.3	NA	NA	NA

Note:

1. The calibration interval of the above test instruments are 12 months and the calibrations are traceable to NML/ROC and NIST/USA.
2. The test was performed in Shielded Room No. C.
3. The VCCI Con C Registration No. is C-3611.
4. Tested Date: Apr. 06, 2016

4.2.3 Test Procedure

- a. The EUT was placed 0.4 meters from the conducting wall of the shielded room with EUT being connected to the power mains through a line impedance stabilization network (LISN). Other support units were connected to the power mains through another LISN. The two LISNs provide 50 ohm/ 50uH of coupling impedance for the measuring instrument.
- b. Both lines of the power mains connected to the EUT were checked for maximum conducted interference.
- c. The frequency range from 150kHz to 30MHz was searched. Emission levels under (Limit - 20dB) was not recorded.

NOTE: All modes of operation were investigated and the worst-case emissions are reported.

4.2.4 Deviation from Test Standard

No deviation.

4.2.5 Test Setup

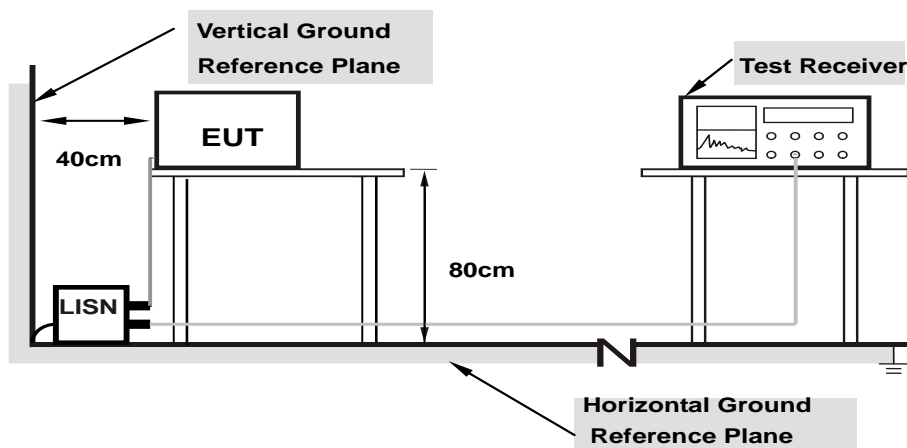

Note: 1.Support units were connected to second LISN.

For the actual test configuration, please refer to the attached file (Test Setup Photo).

4.2.6 EUT Operating Condition

Same as 4.1.6.

4.2.7 Test Results

Phase	Line (L)	Detector Function	Quasi-Peak (QP) / Average (AV)
-------	----------	-------------------	--------------------------------

No	Freq. [MHz]	Corr.	Reading Value		Emission Level		Limit		Margin	
		Factor (dB)	[dB (uV)]		[dB (uV)]		[dB (uV)]		(dB)	
			Q.P.	AV.	Q.P.	AV.	Q.P.	AV.	Q.P.	AV.
1	0.15781	10.44	39.70	28.72	50.14	39.16	65.58	55.58	-15.44	-16.42
2	0.17734	10.42	37.26	25.66	47.68	36.08	64.61	54.61	-16.93	-18.53
3	0.20078	10.40	33.48	22.10	43.88	32.50	63.58	53.58	-19.70	-21.08
4	0.29063	10.41	29.86	24.88	40.27	35.29	60.51	50.51	-20.23	-15.21
5	0.35313	10.42	33.02	30.52	43.44	40.94	58.89	48.89	-15.45	-7.95
6	10.91797	10.98	16.98	11.32	27.96	22.30	60.00	50.00	-32.04	-27.70
7	14.78906	11.24	17.22	12.84	28.46	24.08	60.00	50.00	-31.54	-25.92

REMARKS:

1. Q.P. and AV. are abbreviations of quasi-peak and average individually.
2. The emission levels of other frequencies were very low against the limit.
3. Margin value = Emission level - Limit value
4. Correction factor = Insertion loss + Cable loss
5. Emission Level = Correction Factor + Reading Value

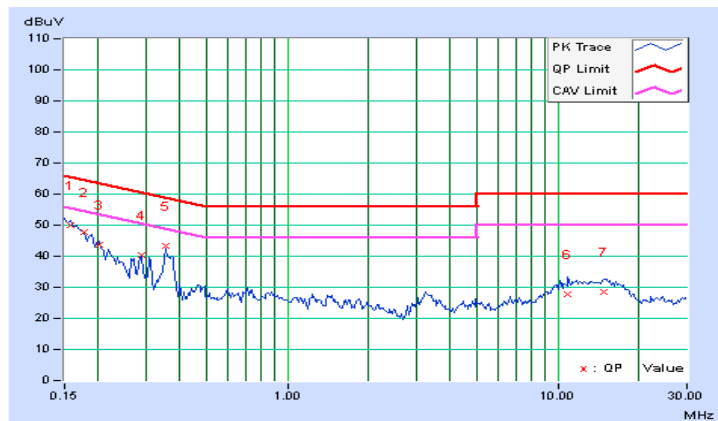

Phase	Neutral (N)	Detector Function	Quasi-Peak (QP) / Average (AV)
-------	-------------	-------------------	--------------------------------

No	Freq. [MHz]	Corr.	Reading Value		Emission Level		Limit		Margin	
		Factor	[dB (uV)]		[dB (uV)]		[dB (uV)]		(dB)	
		(dB)	Q.P.	AV.	Q.P.	AV.	Q.P.	AV.	Q.P.	AV.
1	0.15391	10.45	40.44	27.50	50.89	37.95	65.79	55.79	-14.90	-17.84
2	0.16953	10.45	35.64	24.52	46.09	34.97	64.98	54.98	-18.90	-20.02
3	0.18906	10.45	32.28	19.36	42.73	29.81	64.08	54.08	-21.35	-24.27
4	0.23984	10.46	25.88	15.08	36.34	25.54	62.10	52.10	-25.77	-26.57
5	0.35703	10.47	28.84	23.60	39.31	34.07	58.80	48.80	-19.48	-14.72
6	3.33984	10.65	14.06	7.16	24.71	17.81	56.00	46.00	-31.29	-28.19
7	10.39844	10.97	16.64	11.08	27.61	22.05	60.00	50.00	-32.39	-27.95

REMARKS:

1. Q.P. and AV. are abbreviations of quasi-peak and average individually.
2. The emission levels of other frequencies were very low against the limit.
3. Margin value = Emission level - Limit value
4. Correction factor = Insertion loss + Cable loss
5. Emission Level = Correction Factor + Reading Value

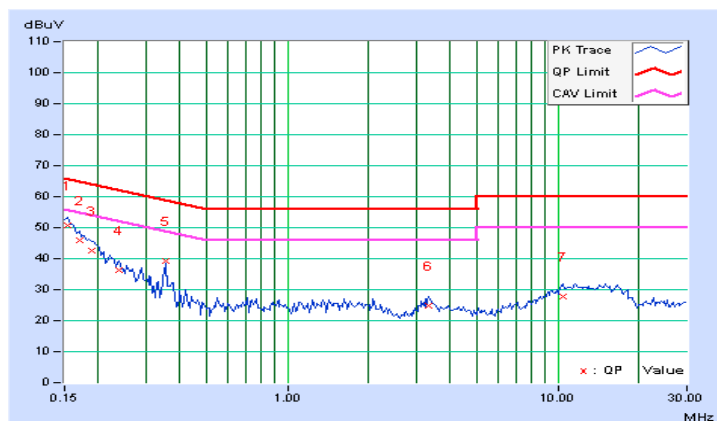

4.3 Transmit Power Measurement

4.3.1 Limits of Transmit Power Measurement

Operation Band	EUT Category		LIMIT
U-NII-1		Outdoor Access Point	1 Watt (30 dBm) (Max. e.i.r.p \leq 125mW(21 dBm) at any elevation angle above 30 degrees as measured from the horizon)
		Fixed point-to-point Access Point	1 Watt (30 dBm)
	√	Indoor Access Point	1 Watt (30 dBm)
		Mobile and Portable client device	250mW (24 dBm)
U-NII-2A			250mW (24 dBm) or 11 dBm+10 log B*
U-NII-2C			250mW (24 dBm) or 11 dBm+10 log B*
U-NII-3	√		1 Watt (30 dBm)

*B is the 26 dB emission bandwidth in megahertz

Per KDB 662911 Method of conducted output power measurement on IEEE 802.11 devices,

Array Gain = 0 dB (i.e., no array gain) for $N_{ANT} \leq 4$;

Array Gain = 0 dB (i.e., no array gain) for channel widths ≥ 40 MHz for any N_{ANT} ;

Array Gain = $5 \log(N_{ANT}/N_{SS})$ dB or 3 dB, whichever is less for 20-MHz channel widths with $N_{ANT} \geq 5$.

For power measurements on all other devices: Array Gain = $10 \log(N_{ANT}/N_{SS})$ dB.

4.3.2 Test Setup

FOR POWER OUTPUT MEASUREMENT

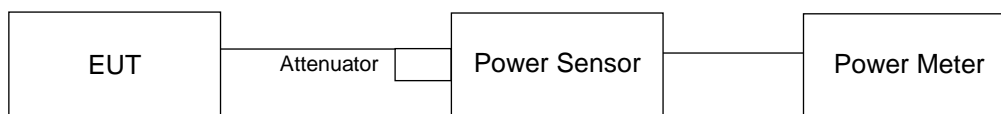

4.3.3 Test Instruments

Refer to section 4.1.2 to get information of above instrument.

4.3.4 Test Procedure

FOR POWER OUTPUT MEASUREMENT

Method PM is used to perform output power measurement, trigger and gating function of wide band power meter is enabled to measure max output power of TX on burst. Duty factor is not added to measured value.

4.3.5 Deviation from Test Standard

No deviation.

4.3.6 EUT Operating Condition

The software provided by client to enable the EUT under transmission condition continuously at lowest, middle and highest channel frequencies individually.

4.3.7 Test Result

POWER OUTPUT:

CDD Mode

802.11a

Chan.	Chan. Freq. (MHz)	Average Power (mW)	Average Power (dBm)	Limit (dBm)	Pass / Fail
36	5180	205.116	23.12	30	Pass
40	5200	209.411	23.21	30	Pass
48	5240	213.304	23.29	30	Pass
149	5745	139.316	21.44	30	Pass
157	5785	372.392	25.71	30	Pass
165	5825	224.905	23.52	30	Pass

802.11ac (VHT20)

Chan.	Chan. Freq. (MHz)	Average Power (dBm)			Total Power (mW)	Total Power (dBm)	Limit (dBm)	Pass / Fail
		Chain 0	Chain 1	Chain 2				
36	5180	21.75	22.53	21.92	484.282	26.85	30	Pass
40	5200	22.38	23.26	22.45	560.61	27.49	30	Pass
48	5240	22.38	23.25	22.52	562.98	27.50	30	Pass
149	5745	18.32	19.07	18.30	216.252	23.35	30	Pass
157	5785	24.98	25.59	24.95	989.626	29.95	30	Pass
165	5825	20.90	21.40	20.75	379.915	25.80	30	Pass

802.11ac (VHT40)

Chan.	Chan. Freq. (MHz)	Average Power (dBm)			Total Power (mW)	Total Power (dBm)	Limit (dBm)	Pass / Fail
		Chain 0	Chain 1	Chain 2				
38	5190	14.29	14.98	14.95	89.591	19.52	30	Pass
46	5230	21.36	21.87	21.52	432.494	26.36	30	Pass
151	5755	13.19	14.18	13.72	70.577	18.49	30	Pass
159	5795	19.26	19.85	19.24	264.884	24.23	30	Pass

802.11ac (VHT80)

Chan.	Chan. Freq. (MHz)	Average Power (dBm)			Total Power (mW)	Total Power (dBm)	Limit (dBm)	Pass / Fail
		Chain 0	Chain 1	Chain 2				
42	5210	12.68	13.56	13.47	63.467	18.03	30	Pass
155	5775	13.40	14.58	14.26	77.255	18.88	30	Pass

STBC Mode
802.11ac (VHT20)

Chan.	Chan. Freq. (MHz)	Average Power (dBm)			Total Power (mW)	Total Power (dBm)	Limit (dBm)	Pass / Fail
		Chain 0	Chain 1	Chain 2				
36	5180	21.75	22.53	21.92	484.282	26.85	30	Pass
40	5200	22.38	23.26	22.45	560.61	27.49	30	Pass
48	5240	22.38	23.25	22.52	562.98	27.50	30	Pass
149	5745	18.32	19.07	18.30	216.252	23.35	30	Pass
157	5785	24.98	25.59	24.95	989.626	29.95	30	Pass
165	5825	20.90	21.40	20.75	379.915	25.80	30	Pass

802.11ac (VHT40)

Chan.	Chan. Freq. (MHz)	Average Power (dBm)			Total Power (mW)	Total Power (dBm)	Limit (dBm)	Pass / Fail
		Chain 0	Chain 1	Chain 2				
38	5190	14.29	14.98	14.95	89.591	19.52	30	Pass
46	5230	21.36	21.87	21.52	432.494	26.36	30	Pass
151	5755	13.19	14.18	13.72	70.577	18.49	30	Pass
159	5795	19.26	19.85	19.24	264.884	24.23	30	Pass

802.11ac (VHT80)

Chan.	Chan. Freq. (MHz)	Average Power (dBm)			Total Power (mW)	Total Power (dBm)	Limit (dBm)	Pass / Fail
		Chain 0	Chain 1	Chain 2				
42	5210	12.68	13.56	13.47	63.467	18.03	30	Pass
155	5775	13.40	14.58	14.26	77.255	18.88	30	Pass

Beamforming Mode
802.11ac (VHT20)

Chan.	Chan. Freq. (MHz)	Average Power (dBm)			Total Power (mW)	Total Power (dBm)	Limit (dBm)	Pass / Fail
		Chain 0	Chain 1	Chain 2				
36	5180	21.75	22.53	21.92	484.282	26.85	30	Pass
40	5200	22.38	23.26	22.45	560.61	27.49	30	Pass
48	5240	22.38	23.25	22.52	562.98	27.50	30	Pass
149	5745	18.32	19.07	18.30	216.252	23.35	29.54	Pass
157	5785	22.89	23.55	22.92	616.884	27.90	29.54	Pass
165	5825	20.90	21.40	20.75	379.915	25.80	29.54	Pass

Note: 1. For 5745-5825MHz: Directional gain = $10 \log[(10^{G1/20} + 10^{G2/20} + 10^{G3/20})^2 / 3] = 6.46\text{dBi} > 6\text{dBi}$, so the power density limit shall be reduced to $30 - (6.46 - 6) = 29.54\text{dBm}$.

802.11ac (VHT40)

Chan.	Chan. Freq. (MHz)	Average Power (dBm)			Total Power (mW)	Total Power (dBm)	Limit (dBm)	Pass / Fail
		Chain 0	Chain 1	Chain 2				
38	5190	14.29	14.98	14.95	89.591	19.52	30	Pass
46	5230	21.36	21.87	21.52	432.494	26.36	30	Pass
151	5755	13.19	14.18	13.72	70.577	18.49	29.54	Pass
159	5795	19.26	19.85	19.24	264.884	24.23	29.54	Pass

Note: 1. For 5745-5825MHz: Directional gain = $10 \log[(10^{G1/20} + 10^{G2/20} + 10^{G3/20})^2 / 3] = 6.46\text{dBi} > 6\text{dBi}$, so the power density limit shall be reduced to $30 - (6.46 - 6) = 29.54\text{dBm}$.

802.11ac (VHT80)

Chan.	Chan. Freq. (MHz)	Average Power (dBm)			Total Power (mW)	Total Power (dBm)	Limit (dBm)	Pass / Fail
		Chain 0	Chain 1	Chain 2				
42	5210	12.68	13.56	13.47	63.467	18.03	30	Pass
155	5775	13.40	14.58	14.26	77.255	18.88	29.54	Pass

Note: 1. For 5745-5825MHz: Directional gain = $10 \log[(10^{G1/20} + 10^{G2/20} + 10^{G3/20})^2 / 3] = 6.46\text{dBi} > 6\text{dBi}$, so the power density limit shall be reduced to $30 - (6.46 - 6) = 29.54\text{dBm}$.

4.4 Peak Power Spectral Density Measurement

4.4.1 Limits of Peak Power Spectral Density Measurement

Operation Band	EUT Category		LIMIT
U-NII-1		Outdoor Access Point	17dBm/ MHz
		Fixed point-to-point Access Point	
	√	Indoor Access Point	
		Mobile and Portable client device	11dBm/ MHz
U-NII-2A			11dBm/ MHz
U-NII-2C			11dBm/ MHz
U-NII-3	√		30dBm/ 500kHz

4.4.2 Test Setup

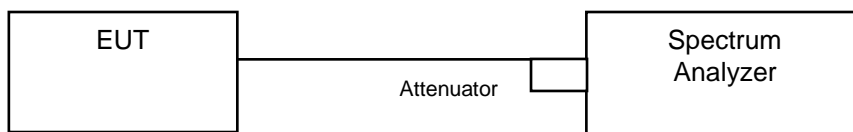

4.4.3 Test Instruments

Refer to section 4.1.2 to get information of above instrument.

4.4.4 Test Procedure

802.11a, 802.11ac (VHT20), 802.11ac (VHT40)

For U-NII-1:

Using method SA-1

1. Set span to encompass the entire emission bandwidth (EBW) of the signal.
2. Set RBW = 1 MHz, Set VBW \geq 3 MHz, Detector = RMS
3. Sweep time = auto, trigger set to "free run".
4. Trace average at least 100 traces in power averaging mode.
5. Record the max value

For U-NII-3:

1. Set span to encompass the entire emission bandwidth (EBW) of the signal.
2. Set RBW = 300 kHz, Set VBW \geq 1 MHz, Detector = RMS
3. Use the peak marker function to determine the maximum power level in any 300 kHz band segment within the fundamental EBW.
4. Scale the observed power level to an equivalent value in 500 kHz by adjusting (reducing) the measured power by a bandwidth correction factor (BWCF) where $BWCF = 10\log(500 \text{ kHz}/300\text{kHz})$
5. Sweep time = auto, trigger set to "free run".
6. Trace average at least 100 traces in power averaging mode.
7. Record the max value

802.11ac (VHT80)

For U-NII-1:

Using method SA-2

1. Set span to encompass the entire emission bandwidth (EBW) of the signal.
2. Set RBW = 1 MHz, Set VBW \geq 3 MHz, Detector = RMS
3. Sweep time = auto, trigger set to "free run".
4. Trace average at least 100 traces in power averaging mode.
5. Record the max value and add $10 \log (1/\text{duty cycle})$

For U-NII-3:

1. Set span to encompass the entire emission bandwidth (EBW) of the signal.
2. Set RBW = 300 kHz, Set VBW \geq 1 MHz, Detector = RMS
3. Use the peak marker function to determine the maximum power level in any 300 kHz band segment within the fundamental EBW.
4. Scale the observed power level to an equivalent value in 500 kHz by adjusting (reducing) the measured power by a bandwidth correction factor (BWCF) where $BWCF = 10\log(500 \text{ kHz}/300\text{kHz})$
5. Sweep time = auto, trigger set to "free run".
6. Trace average at least 100 traces in power averaging mode.
7. Record the max value and add $10 \log (1/\text{duty cycle})$

4.4.5 Deviation from Test Standard

No deviation.

4.4.6 EUT Operating Condition

Same as Item 4.3.6.

4.4.7 Test Results

For U-NII-1:

CDD Mode

802.11a

Chan.	Chan. Freq. (MHz)	PSD (dBm/MHz)	MAX. Limit (dBm/MHz)	Pass / Fail
36	5180	8.47	17	Pass
40	5200	8.54	17	Pass
48	5240	9.29	17	Pass

802.11ac (VHT20)

Chan.	Chan. Freq. (MHz)	PSD (dBm/MHz)			Total Power Density (dBm/MHz)	MAX. Limit (dBm/MHz)	Pass / Fail
		Chain 0	Chain 1	Chain 2			
36	5180	6.83	8.02	7.48	12.24	17	Pass
40	5200	8.02	8.99	8.37	13.25	17	Pass
48	5240	8.46	9.73	9.05	13.88	17	Pass

- Note:** 1. Method a) of power density measurement of KDB 662911 is using for calculating total power density. Total power density is summing entire spectra across corresponding frequency bins on the various outputs by computer.
 2. Directional gain = $10 \log[(10^{G1/20} + 10^{G2/20} + 10^{G3/20})^2 / 3] = 5.38\text{dBi} < 6\text{dBi}$, so the power density limit shall not be reduced.

802.11ac (VHT40)

Chan.	Chan. Freq. (MHz)	PSD (dBm/MHz)			Total Power Density (dBm/MHz)	MAX. Limit (dBm/MHz)	Pass / Fail
		Chain 0	Chain 1	Chain 2			
38	5190	-3.82	-2.85	-3.80	1.31	17	Pass
46	5230	4.24	5.40	4.94	9.66	17	Pass

- Note:** 1. Method a) of power density measurement of KDB 662911 is using for calculating total power density. Total power density is summing entire spectra across corresponding frequency bins on the various outputs by computer.
 2. Directional gain = $10 \log[(10^{G1/20} + 10^{G2/20} + 10^{G3/20})^2 / 3] = 5.38\text{dBi} < 6\text{dBi}$, so the power density limit shall not be reduced.

802.11ac (VHT80)

Chan.	Chan. Freq. (MHz)	PSD W/O Duty Factor (dBm)			Duty Factor (dB)	Total PSD With Duty Factor (dBm)	MAX. Limit (dBm)	Pass / Fail
		Chain 0	Chain 1	Chain 2				
42	5210	-8.23	-6.68	-7.10	0.27	-2.24	17	Pass

- Note:**
- Method a) of power density measurement of KDB 662911 is using for calculating total power density. Total power density is summing entire spectra across corresponding frequency bins on the various outputs by computer.
 - Directional gain = $10 \log[(10^{G1/20} + 10^{G2/20} + 10^{G3/20})^2 / 3] = 5.38\text{dBi} < 6\text{dBi}$, so the power density limit shall not be reduced.

Spectrum Plot of Worst Value

802.11a_CH48

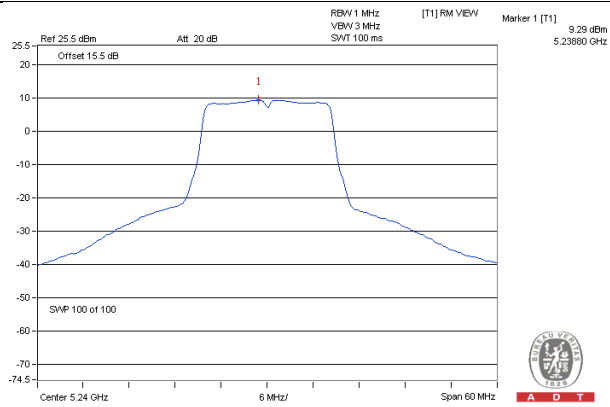

802.11ac (VHT20)_Chain 1 / CH48

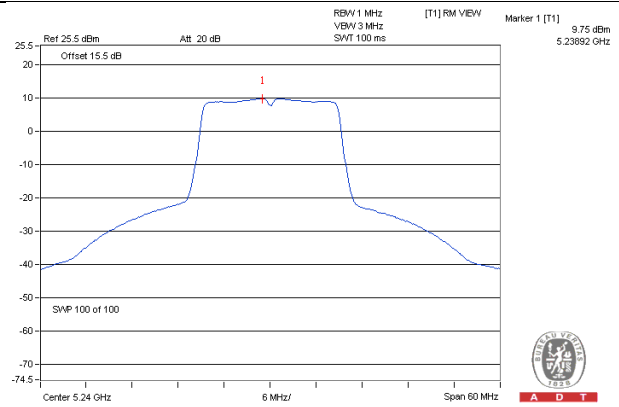

802.11ac (VHT40)_Chain 1 / CH46

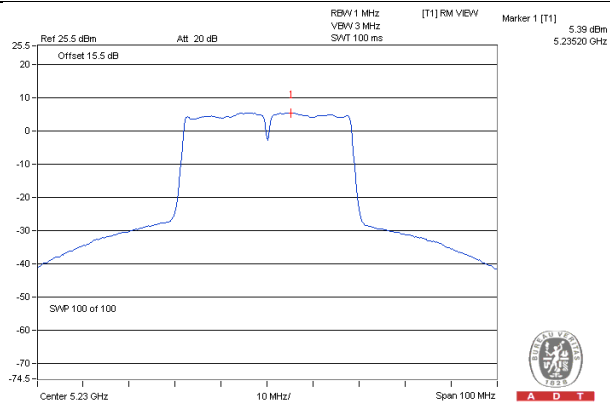

802.11ac (VHT80)_Chain 1 / CH42

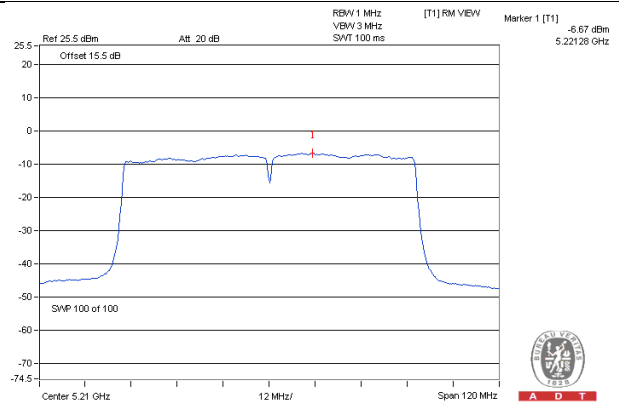

For U-NII-3:
CDD Mode
802.11a

Chan.	Chan. Freq. (MHz)	PSD (dBm/300kHz)	PSD (dBm/500kHz)	Limit (dBm/500kHz)	Pass /Fail
149	5745	-0.43	1.79	30	Pass
157	5785	3.67	5.89	30	Pass
165	5825	1.51	3.73	30	Pass

802.11ac (VHT20)

TX chain	Channel	Freq. (MHz)	PSD (dBm/300kHz)	PSD (dBm/500kHz)	10 log (N=3) dB	Total PSD (dBm/500kHz)	Limit (dBm/500kHz)	Pass /Fail
0	149	5745	-3.88	-1.66	4.77	3.11	29.54	Pass
	157	5785	2.58	4.80	4.77	9.57	29.54	Pass
	165	5825	-1.63	0.59	4.77	5.36	29.54	Pass
1	149	5745	-2.75	-0.53	4.77	4.24	29.54	Pass
	157	5785	3.92	6.14	4.77	10.91	29.54	Pass
	165	5825	-0.25	1.97	4.77	6.74	29.54	Pass
2	149	5745	-3.66	-1.44	4.77	3.33	29.54	Pass
	157	5785	3.08	5.30	4.77	10.07	29.54	Pass
	165	5825	-1.20	1.02	4.77	5.79	29.54	Pass

Note: 1. Directional gain = $10 \log[(10^{G1/20} + 10^{G2/20} + 10^{G3/20})^2 / 3] = 6.46\text{dBi} > 6\text{dBi}$, so the power density limit shall be reduced to $30 - (6.46 - 6) = 29.54\text{dBm}$.

802.11ac (VHT40)

TX chain	Channel	Freq. (MHz)	PSD (dBm/300kHz)	PSD (dBm/500kHz)	10 log (N=3) dB	Total PSD (dBm/500kHz)	Limit (dBm/500kHz)	Pass /Fail
0	151	5755	-12.30	-10.08	4.77	-5.31	29.54	Pass
	159	5795	-6.63	-4.41	4.77	0.36	29.54	Pass
1	151	5755	-10.77	-8.55	4.77	-3.78	29.54	Pass
	159	5795	-5.21	-2.99	4.77	1.78	29.54	Pass
2	151	5755	-11.22	-9.00	4.77	-4.23	29.54	Pass
	159	5795	-6.09	-3.87	4.77	0.90	29.54	Pass

Note: 1. Directional gain = $10 \log[(10^{G1/20} + 10^{G2/20} + 10^{G3/20})^2 / 3] = 6.46\text{dBi} > 6\text{dBi}$, so the power density limit shall be reduced to $30 - (6.46 - 6) = 29.54\text{dBm}$.

802.11ac (VHT80)

TX chain	Chan.	Chan. Freq. (MHz)	PSD W/O Duty Factor		10 log (N=3) dB	Duty Factor (dB)	Total PSD With Duty Factor (dBm/500kHz)	Limit (dBm/500kHz)	Pass /Fail
			(dBm/300kHz)	(dBm/500kHz)					
0	155	5775	-14.22	-12.00	4.77	0.27	-6.96	29.54	Pass
1	155	5775	-13.47	-11.25	4.77	0.27	-6.21	29.54	Pass
2	155	5775	-13.91	-11.69	4.77	0.27	-6.65	29.54	Pass

Note: 1. Directional gain = $10 \log[(10^{G1/20} + 10^{G2/20} + 10^{G3/20})^2 / 3] = 6.46\text{dBi} > 6\text{dBi}$, so the power density limit shall be reduced to $30-(6.46-6) = 29.54\text{dBm}$.

2. Refer to section 3.3 for duty cycle spectrum plot.

Spectrum Plot of Worst Value

802.11a / CH157

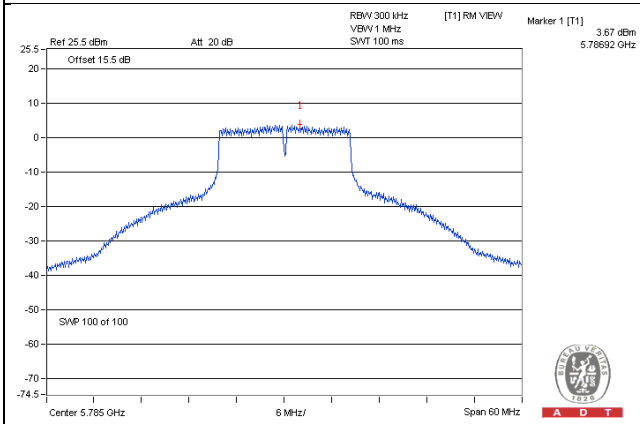

802.11ac (VHT20)_Chain 1 / CH157

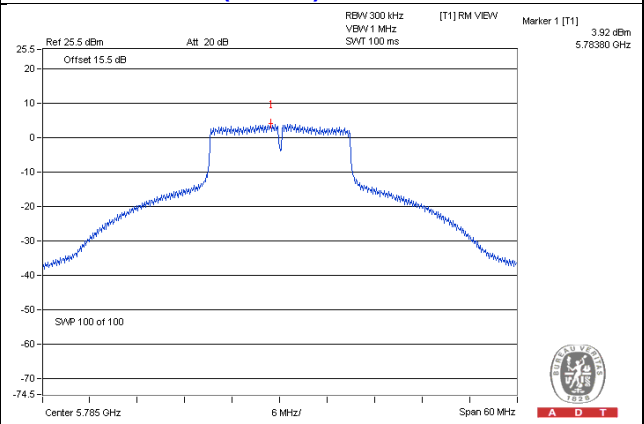

802.11ac (VHT40)_Chain 1 / CH159

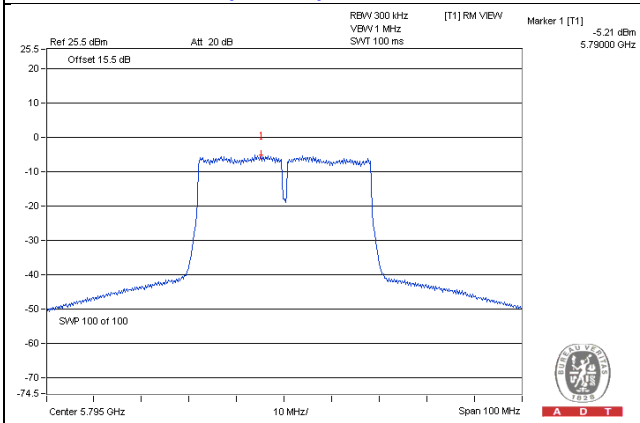

802.11ac (VHT80)_Chain 1 / CH155

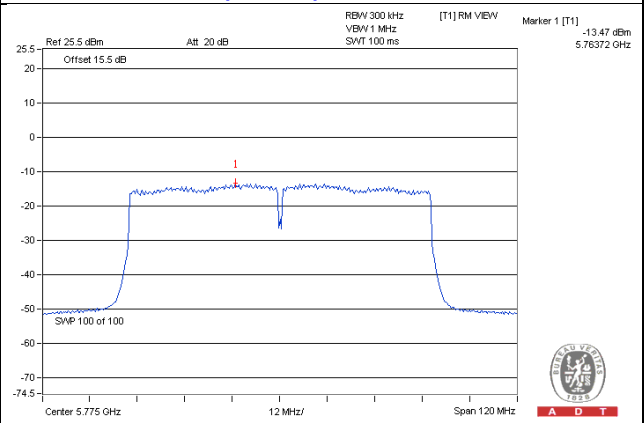

4.5 Frequency Stability Measurement

4.5.1 Limits of Frequency Stability Measurement

The frequency of the carrier signal shall be maintained within band of operation

4.5.2 Test Setup

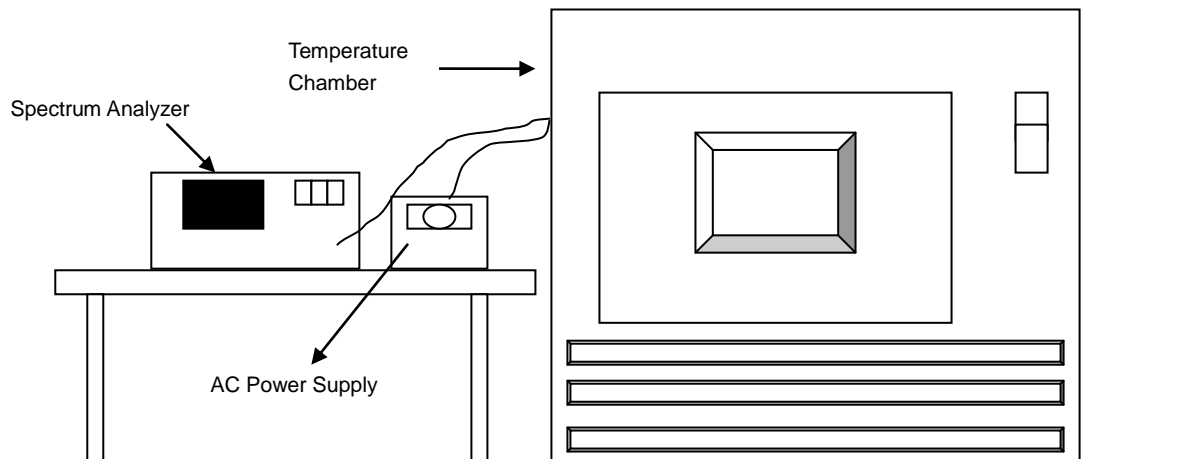

4.5.3 Test Instruments

Refer to section 4.1.2 to get information of above instrument.

4.5.4 Test Procedure

- The EUT was placed inside the environmental test chamber and powered by nominal AC voltage.
- Turn the EUT on and couple its output to a spectrum analyzer.
- Turn the EUT off and set the chamber to the highest temperature specified.
- Allow sufficient time (approximately 30 min) for the temperature of the chamber to stabilize, turn the EUT on and measure the operating frequency after 2, 5, and 10 minutes.
- Repeat step 2 and 3 with the temperature chamber set to the lowest temperature.
- The test chamber was allowed to stabilize at +20 degree C for a minimum of 30 minutes. The supply voltage was then adjusted on the EUT from 85% to 115% and the frequency record.

4.5.5 Deviation from Test Standard

No deviation.

4.5.6 EUT Operating Condition

Set the EUT transmit at un-modulation mode to test frequency stability.

4.5.7 Test Results

FREQUENCY STABILITY VERSUS TEMP.									
OPERATING FREQUENCY: 5180MHz									
TEMP. (°C)	POWER SUPPLY (Vac)	0 MINUTE		2 MINUTE		5 MINUTE		10 MINUTE	
		Measured Frequency (MHz)	Frequency Drift (%)	Measured Frequency (MHz)	Frequency Drift (%)	Measured Frequency (MHz)	Frequency Drift (%)	Measured Frequency (MHz)	Frequency Drift (%)
50	120	5179.9896	-0.00020	5179.9915	-0.00016	5179.9888	-0.00022	5179.9913	-0.00017
40	120	5180.0132	0.00025	5180.0098	0.00019	5180.0098	0.00019	5180.014	0.00027
30	120	5179.9838	-0.00031	5179.9854	-0.00028	5179.9858	-0.00027	5179.9853	-0.00028
20	120	5180.0196	0.00038	5180.021	0.00041	5180.023	0.00044	5180.0213	0.00041
10	120	5180.0027	0.00005	5180.0023	0.00004	5180.0042	0.00008	5180.0049	0.00009
0	120	5180.015	0.00029	5180.0132	0.00025	5180.0159	0.00031	5180.016	0.00031
-10	120	5179.9895	-0.00020	5179.9884	-0.00022	5179.9889	-0.00021	5179.9868	-0.00025
-20	120	5179.9917	-0.00016	5179.9935	-0.00013	5179.9926	-0.00014	5179.9944	-0.00011
-30	120	5179.9732	-0.00052	5179.9736	-0.00051	5179.9732	-0.00052	5179.9759	-0.00047

FREQUENCY STABILITY VERSUS VOLTAGE									
OPERATING FREQUENCY: 5180MHz									
TEMP. (°C)	POWER SUPPLY (Vac)	0 MINUTE		2 MINUTE		5 MINUTE		10 MINUTE	
		Measured Frequency (MHz)	Frequency Drift (%)	Measured Frequency (MHz)	Frequency Drift (%)	Measured Frequency (MHz)	Frequency Drift (%)	Measured Frequency (MHz)	Frequency Drift (%)
20	138	5180.0205	0.00040	5180.0202	0.00039	5180.0229	0.00044	5180.0221	0.00043
	120	5180.0196	0.00038	5180.021	0.00041	5180.023	0.00044	5180.0213	0.00041
	102	5180.0188	0.00036	5180.0208	0.00040	5180.0231	0.00045	5180.0221	0.00043

4.6 6dB Bandwidth Measurement

4.6.1 Limits of 6dB Bandwidth Measurement

The minimum of 6dB Bandwidth Measurement is 0.5MHz.

4.6.2 Test Setup

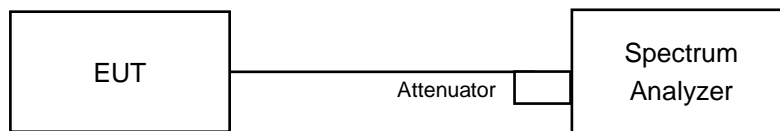

4.6.3 Test Instruments

Refer to section 4.1.2 to get information of above instrument.

4.6.4 Test Procedure

MEASUREMENT PROCEDURE REF

- a. Set resolution bandwidth (RBW) = 100kHz
- b. Set the video bandwidth (VBW) $\geq 3 \times$ RBW, Detector = Peak.
- c. Trace mode = max hold.
- d. Sweep = auto couple.
- e. Measure the maximum width of the emission that is constrained by the frequencies associated with the two amplitude points (upper and lower) that are attenuated by 6 dB relative to the maximum level measured in the fundamental emission

4.6.5 Deviation from Test Standard

No deviation.

4.6.6 EUT Operating Condition

The software provided by client to enable the EUT under transmission condition continuously at lowest, middle and highest channel frequencies individually.

4.6.7 Test Results

CDD Mode

802.11a

Channel	Frequency (MHz)	6dB Bandwidth (MHz)	Minimum Limit (MHz)	Pass / Fail
149	5745	16.43	0.5	Pass
157	5785	16.38	0.5	Pass
165	5825	16.40	0.5	Pass

802.11ac (VHT20)

Channel	Frequency (MHz)	6dB Bandwidth (MHz)			Minimum Limit (MHz)	Pass / Fail
		Chain 0	Chain 1	Chain 2		
149	5745	17.69	17.69	17.69	0.5	Pass
157	5785	17.65	17.64	17.66	0.5	Pass
165	5825	17.67	17.69	17.68	0.5	Pass

802.11ac (VHT40)

Channel	Frequency (MHz)	6dB Bandwidth (MHz)			Minimum Limit (MHz)	Pass / Fail
		Chain 0	Chain 1	Chain 2		
151	5755	36.45	36.44	36.45	0.5	Pass
159	5795	36.46	36.48	36.45	0.5	Pass

802.11ac (VHT80)

Channel	Frequency (MHz)	6dB Bandwidth (MHz)			Minimum Limit (MHz)	Pass / Fail
		Chain 0	Chain 1	Chain 2		
155	5775	76.29	75.75	75.77	0.5	Pass

Spectrum Plot of Worst Value

802.11a / CH157

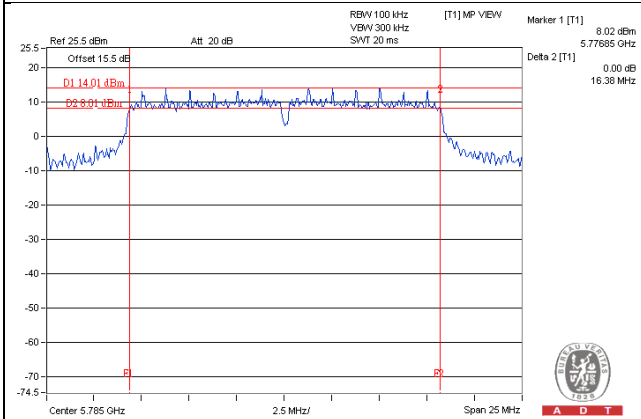

802.11ac (VHT20)_Chain 1 / CH157

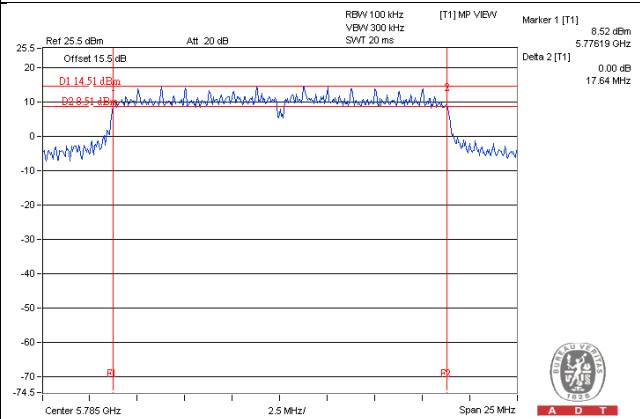

802.11ac (VHT40)_Chain 1 / CH151

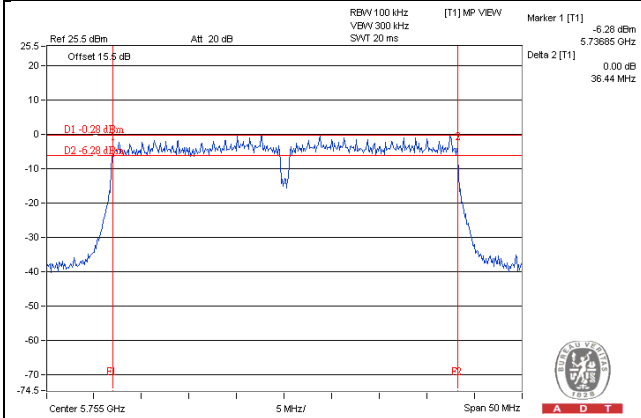

802.11ac (VHT80)_Chain 1 / CH155

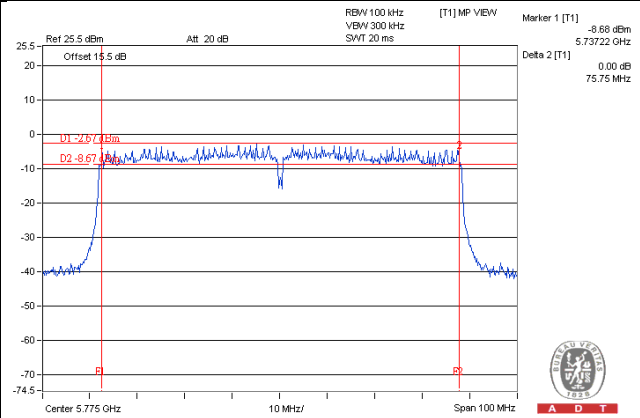

5 Pictures of Test Arrangements

Please refer to the attached file (Test Setup Photo).





Appendix – Information on the Testing Laboratories

We, Bureau Veritas Consumer Products Services (H.K.) Ltd., Taoyuan Branch, were founded in 1988 to provide our best service in EMC, Radio, Telecom and Safety consultation. Our laboratories are accredited and approved according to ISO/IEC 17025.

If you have any comments, please feel free to contact us at the following:

Linko EMC/RF Lab

Tel: 886-2-26052180

Fax: 886-2-26051924

Hsin Chu EMC/RF/Telecom Lab

Tel: 886-3-6668565

Fax: 886-3-6668323

Hwa Ya EMC/RF/Safety Lab

Tel: 886-3-3183232

Fax: 886-3-3270892

Email: service.adt@tw.bureauveritas.com

Web Site: www.bureauveritas-adt.com

The address and road map of all our labs can be found in our web site also.

--- END ---