



FCC TEST REPORT (15.247)

REPORT NO.: RF130725E01A
MODEL NO.: EA6900 V1.1
FCC ID: Q87-EA6900V11
RECEIVED: July 26, 2013
TESTED: July 26, 2013 to Jan. 17, 2014
ISSUED: Feb. 17, 2014

APPLICANT: Linksys LLC
ADDRESS: 131 Theory Drive Irvine California 92617
United States

ISSUED BY: Bureau Veritas Consumer Products Services
(H.K.) Ltd., Taoyuan Branch Hsin Chu Laboratory
LAB ADDRESS : No. 81-1, Lu Liao Keng, 9th Ling, Wu Lung Tsuen,
Chiung Lin Hsiang, Hsin Chu Hsien 307, Taiwan,
R.O.C.
TEST LOCATION (1): No. 81-1, Lu Liao Keng, 9th Ling, Wu Lung Tsuen,
Chiung Lin Hsiang, Hsin Chu Hsien 307, Taiwan,
R.O.C.
TEST LOCATION (2): No. 49, Ln. 206, Wende Rd., Shangshan Tsuen,
Chiung Lin Hsiang, Hsin Chu Hsien 307, Taiwan,
R.O.C.

This report should not be used by the client to claim product certification, approval, or endorsement by TAF or any government agencies.



This report is for your exclusive use. Any copying or replication of this report to or for any other person or entity, or use of our name or trademark, is permitted only with our prior written permission. This report sets forth our findings solely with respect to the test samples identified herein. The results set forth in this report are not indicative or representative of the quality or characteristics of the lot from which a test sample was taken or any similar or identical product unless specifically and expressly noted. Our report includes all of the tests requested by you and the results thereof based upon the information that you provided to us. You have 60 days from date of issuance of this report to notify us of any material error or omission caused by our negligence, provided, however, that such notice shall be in writing and shall specifically address the issue you wish to raise. A failure to raise such issue within the prescribed time shall constitute your unqualified acceptance of the completeness of this report, the tests conducted and the correctness of the report contents. Unless specific mention, the uncertainty of measurement has been explicitly taken into account to declare the compliance or non-compliance to the specification



Table of Contents

RELEASE CONTROL RECORD.....	6
1. CERTIFICATION.....	7
2. SUMMARY OF TEST RESULTS.....	8
2.1 MEASUREMENT UNCERTAINTY.....	9
3. GENERAL INFORMATION.....	10
3.1 GENERAL DESCRIPTION OF EUT.....	10
3.2 DESCRIPTION OF TEST MODES.....	14
3.2.1 TEST MODE APPLICABILITY AND TESTED CHANNEL DETAIL.....	15
3.3 GENERAL DESCRIPTION OF APPLIED STANDARDS.....	19
3.4 DUTY CYCLE OF TEST SIGNAL.....	20
3.5 DESCRIPTION OF SUPPORT UNITS.....	22
3.6 CONFIGURATION OF SYSTEM UNDER TEST.....	23
4. TEST TYPES AND RESULTS (FOR 2.4GHz, 2.400 ~ 2.4835GHz BAND).....	25
4.1 CONDUCTED EMISSION MEASUREMENT.....	25
4.1.1 LIMITS OF CONDUCTED EMISSION MEASUREMENT.....	25
4.1.2 TEST INSTRUMENTS.....	25
4.1.3 TEST PROCEDURES.....	26
4.1.4 DEVIATION FROM TEST STANDARD.....	26
4.1.5 TEST SETUP.....	26
4.1.6 EUT OPERATING CONDITIONS.....	27
4.1.7 TEST RESULTS (MODE 1).....	28
4.1.8 TEST RESULTS (MODE 2).....	30
4.2 RADIATED EMISSION AND BANDEDGE MEASUREMENT.....	32
4.2.1 LIMITS OF RADIATED EMISSION AND BANDEDGE MEASUREMENT.....	32
4.2.2 TEST INSTRUMENTS.....	33
4.2.3 TEST PROCEDURES.....	34
4.2.4 DEVIATION FROM TEST STANDARD.....	34
4.2.5 TEST SETUP.....	35
4.2.6 EUT OPERATING CONDITIONS.....	35
4.2.7 TEST RESULTS (MODE 1).....	36
4.2.8 TEST RESULTS (MODE 2).....	49
4.3 6DB BANDWIDTH MEASUREMENT.....	55
4.3.1 LIMITS OF 6DB BANDWIDTH MEASUREMENT.....	55
4.3.2 TEST INSTRUMENTS.....	55
4.3.3 TEST PROCEDURE.....	55
4.3.4 DEVIATION FROM TEST STANDARD.....	55
4.3.5 TEST SETUP.....	55
4.3.6 EUT OPERATING CONDITIONS.....	55
4.3.7 TEST RESULTS (MODE 1).....	56



4.3.8	TEST RESULTS (MODE 2).....	58
4.4	CONDUCTED OUTPUT POWER MEASUREMENT	59
4.4.1	LIMITS OF MAXIMUM OUTPUT POWER MEASUREMENT.....	59
4.4.2	INSTRUMENTS	59
4.4.3	TEST PROCEDURES.....	59
4.4.4	DEVIATION FROM TEST STANDARD	59
4.4.5	TEST SETUP	60
4.4.6	EUT OPERATING CONDITIONS.....	60
4.4.7	TEST RESULTS (MODE 1).....	61
4.4.8	TEST RESULTS (MODE 2).....	62
4.5	POWER SPECTRAL DENSITY MEASUREMENT.....	63
4.5.1	LIMITS OF POWER SPECTRAL DENSITY MEASUREMENT	63
4.5.2	TEST INSTRUMENTS	63
4.5.3	TEST PROCEDURE	63
4.5.4	DEVIATION FROM TEST STANDARD	63
4.5.5	TEST SETUP	63
4.5.6	EUT OPERATING CONDITION	63
4.5.7	TEST RESULTS (MODE 1).....	64
4.5.8	TEST RESULTS (MODE 2).....	68
4.6	CONDUCTED OUT-BAND EMISSION MEASUREMENT.....	69
4.6.1	LIMITS OF CONDUCTED OUT-BAND EMISSION MEASUREMENT	69
4.6.2	TEST INSTRUMENTS	69
4.6.3	TEST PROCEDURE	69
4.6.4	DEVIATION FROM TEST STANDARD	70
4.6.5	TEST SETUP	70
4.6.6	EUT OPERATING CONDITION	70
4.6.7	TEST RESULTS.....	70
4.6.7.1	TEST RESULTS (MODE 1).....	71
4.6.7.2	TEST RESULTS (MODE 2).....	89
5.	TEST TYPES AND RESULTS (FOR 5GHz, 5.725~5.850GHz BAND).....	91
5.1	CONDUCTED EMISSION MEASUREMENT	91
5.1.1	LIMITS OF CONDUCTED EMISSION MEASUREMENT.....	91
5.1.2	TEST INSTRUMENTS	91
5.1.3	TEST PROCEDURES.....	92
5.1.4	DEVIATION FROM TEST STANDARD	92
5.1.5	TEST SETUP	92
5.1.6	EUT OPERATING CONDITIONS.....	93
5.1.7	TEST RESULTS (MODE 1).....	94
5.1.8	TEST RESULTS (MODE 2).....	96
5.2	RADIATED AND BANDEDGE EMISSION MEASUREMENT.....	98



5.2.1	LIMITS OF RADIATED AND BANDEDGE EMISSION MEASUREMENT ...	98
5.2.2	TEST INSTRUMENTS	99
5.2.3	TEST PROCEDURES.....	100
5.2.4	DEVIATION FROM TEST STANDARD	100
5.2.5	TEST SETUP	101
5.2.6	EUT OPERATING CONDITIONS.....	101
5.2.7	TEST RESULTS (MODE 1).....	102
5.2.8	TEST RESULTS (MODE 2).....	115
5.3	6DB BANDWIDTH MEASUREMENT.....	118
5.3.1	LIMITS OF 6DB BANDWIDTH MEASUREMENT	118
5.3.2	TEST INSTRUMENTS	118
5.3.3	TEST PROCEDURE	118
5.3.4	DEVIATION FROM TEST STANDARD	118
5.3.5	TEST SETUP	118
5.3.6	EUT OPERATING CONDITIONS.....	119
5.3.7	TEST RESULTS (MODE 1).....	120
5.3.8	TEST RESULTS (MODE 2).....	122
5.4	CONDUCTED OUTPUT POWER MEASUREMENT	123
5.4.1	LIMITS OF CONDUCTED OUTPUT POWER MEASUREMENT	123
5.4.2	INSTRUMENTS	123
5.4.3	TEST PROCEDURES.....	123
5.4.4	DEVIATION FROM TEST STANDARD	124
5.4.5	TEST SETUP	124
5.4.6	EUT OPERATING CONDITIONS.....	124
5.4.7	TEST RESULTS (MODE 1).....	125
5.4.8	TEST RESULTS (MODE 2).....	127
5.5	POWER SPECTRAL DENSITY MEASUREMENT.....	128
5.5.1	LIMITS OF POWER SPECTRAL DENSITY MEASUREMENT	128
5.5.2	TEST INSTRUMENTS	128
5.5.3	TEST PROCEDURE	128
5.5.4	DEVIATION FROM TEST STANDARD	128
5.5.5	TEST SETUP	128
5.5.6	EUT OPERATING CONDITION	128
5.5.7	TEST RESULTS (MODE 1).....	129
5.5.8	TEST RESULTS (MODE 2).....	133
5.6	CONDUCTED OUT-BAND EMISSION MEASUREMENT.....	134
5.6.1	LIMITS OF CONDUCTED OUT-BAND EMISSION MEASUREMENT	134
5.6.2	TEST INSTRUMENTS	134
5.6.3	TEST PROCEDURE	134
5.6.4	DEVIATION FROM TEST STANDARD	135



A D T

5.6.5	TEST SETUP	135
5.6.6	EUT OPERATING CONDITION	135
5.6.7	TEST RESULTS.....	135
5.6.7.1	TEST RESULTS (MODE 1).....	136
5.6.7.2	TEST RESULTS (MODE 2).....	157
6.	PHOTOGRAPHS OF THE TEST CONFIGURATION.....	158
7.	INFORMATION ON THE TESTING LABORATORIES	159
8.	APPENDIX A - MODIFICATIONS RECORDERS FOR ENGINEERING CHANGES TO THE EUT BY THE LAB	160



A D T

RELEASE CONTROL RECORD

ISSUE NO.	REASON FOR CHANGE	DATE ISSUED
RF130725E01A	Original release	Feb. 17, 2014

1. CERTIFICATION

PRODUCT: Linksys Smart Wi-Fi Router AC1900
BRAND NAME: Linksys
MODEL NO.: EA6900 V1.1
TEST SAMPLE: ENGINEERING SAMPLE
APPLICANT: Linksys LLC
TESTED: July 26, 2013 to Jan. 17, 2014
STANDARDS: FCC Part 15, Subpart C (Section 15.247)
ANSI C63.10-2009

The above equipment (Model: EA6900 V1.1) has been tested by **Bureau Veritas Consumer Products Services (H.K.) Ltd., Taoyuan Branch**, and found compliance with the requirement of the above standards. The test record, data evaluation & Equipment Under Test (EUT) configurations represented herein are true and accurate accounts of the measurements of the sample's EMC characteristics under the conditions specified in this report.

PREPARED BY : Phoenix Huang , **DATE:** Feb. 17, 2014
(Phoenix Huang, Specialist)

APPROVED BY : May Chen , **DATE:** Feb. 17, 2014
(May Chen, Manager)



A D T

2. SUMMARY OF TEST RESULTS

The EUT has been tested according to the following specifications:

For 2.4GHz, 2400~2483.5MHz Band

APPLIED STANDARD: FCC PART 15, SUBPART C (SECTION 15.247)			
STANDARD SECTION	TEST TYPE	RESULT	REMARK
15.207	AC Power Conducted Emission	PASS	Meet the requirement of limit. Minimum passing margin is -6.81dB at 0.16172MHz
15.247(d) 15.209	Radiated Emissions	PASS	Meet the requirement of limit. Minimum passing margin is -0.1dB at 2390.00MHz, 2483.5MHz & 2486.00MHz.
15.247(d)	Band Edge Measurement	PASS	Meet the requirement of limit.
15.247(a)(2)	6dB bandwidth	PASS	Meet the requirement of limit.
15.247(b)	Conducted Output power	PASS	Meet the requirement of limit.
15.247(e)	Power Spectral Density	PASS	Meet the requirement of limit.
15.203	Antenna Requirement	PASS	Antenna connector is R-SMA not a standard connector.

For 5GHz, 5725~5850MHz Band

APPLIED STANDARD: FCC PART 15, SUBPART C (SECTION 15.247)			
STANDARD SECTION	TEST TYPE	RESULT	REMARK
15.207	AC Power Conducted Emission	PASS	Meet the requirement of limit. Minimum passing margin is -7.36dB at 0.16172MHz
15.247(d) 15.209	Radiated Emissions	PASS	Meet the requirement of limit. Minimum passing margin is -3.7dB at 43.93MHz.
15.247(d)	Band Edge Measurement	PASS	Meet the requirement of limit.
15.247(a)(2)	6dB bandwidth	PASS	Meet the requirement of limit.
15.247(b)	Conducted Output power	PASS	Meet the requirement of limit.
15.247(e)	Power Spectral Density	PASS	Meet the requirement of limit.
15.203	Antenna Requirement	PASS	Antenna connector is R-SMA not a standard connector.

NOTE:

The EUT was operating in 2.400 ~ 2.4835GHz, 5.15~5.25GHz and 5.725~5.850GHz frequencies band. This report was recorded the RF parameters including 2.400 ~ 2.4835GHz and 5.725~5.850GHz. For the 5.15~5.25GHz RF parameters was recorded in another test report.

2.1 MEASUREMENT UNCERTAINTY

Where relevant, the following measurement uncertainty levels have been estimated for tests performed on the EUT as specified in CISPR 16-4-2:

This uncertainty represents an expanded uncertainty expressed at approximately the 95% confidence level using a coverage factor of $k=2$.

Measurement	Value
Conducted emissions	2.98 dB
Radiated emissions (30MHz-1GHz)	4.53 dB
Radiated emissions (1GHz -6GHz)	3.72 dB
Radiated emissions (6GHz -18GHz)	4.00 dB
Radiated emissions (18GHz -40GHz)	4.11 dB

3. GENERAL INFORMATION

3.1 GENERAL DESCRIPTION OF EUT

PRODUCT	Linksys Smart Wi-Fi Router AC1900
MODEL NO.	EA6900 V1.1
POWER SUPPLY	DC 12V from power adapter
MODULATION TYPE	CCK, DQPSK, DBPSK for DSSS 64QAM, 16QAM, QPSK, BPSK for OFDM 256QAM for OFDM in 11ac mode and 11n (HT40) mode of 2.4GHz Band.
MODULATION TECHNOLOGY	DSSS,OFDM
TRANSFER RATE	802.11b: up to 11Mbps 802.11a / g: up to 54Mbps 802.11n: up to 450Mbps(HT40), up to 600Mbps(VHT40) 802.11ac: up to 1300Mbps
OPERATING FREQUENCY	For 15.407 5GHz: 5.18 ~ 5.24GHz
	For 15.247 2.4GHz: 2.412 ~ 2.462GHz 5GHz: 5.745 ~ 5.825GHz
NUMBER OF CHANNEL	For 15.407 4 for 802.11a, 802.11n (HT20), 802.11ac (VHT20) 2 for 802.11n (HT40), 802.11ac (VHT40) 1 for 802.11ac (VHT80)
	For 15.247 (2.4GHz) 11 for 802.11b, 802.11g, 802.11n(HT20), 802.11n_256QAM(VHT20) 7 for 802.11n(HT40), 802.11n_256QAM(VHT40) For 15.247 (5GHz) 5 for 802.11a, 802.11n (HT20), 802.11ac (VHT20) 2 for 802.11n (HT40), 802.11ac (VHT40) 1 for 802.11ac (VHT80)
MAXIMUM OUTPUT POWER	Please see NOTE



A D T

ANTENNA TYPE	Please see NOTE
DATA CABLE	NA
I/O PORTS	Refer to user's manual
ASSOCIATED DEVICES	Adapter x1

NOTE:

1. The EUT is a 2.4GHz & 5GHz WLAN device.
2. The maximum output power table as below table:

MAXIMUM OUTPUT POWER (mW)										
15.247 (2.4GHz)										
Test Mode	802.11b	802.11g			802.11n (HT20)			802.11n (HT40)		
1Tx	497.737	454.988								
3Tx					CDD	STBC	Beam forming	CDD	STBC	Beam forming
		986.826	986.826	986.826	336.396	417.997	336.396			
15.247 (5GHz)										
Test Mode	802.11a	802.11ac (VHT20)			802.11ac (VHT40)			802.11ac (VHT80)		
1Tx	409.261									
3Tx		CDD	STBC	Beam forming	CDD	STBC	Beam forming	CDD	STBC	Beam forming
		957.686	957.686	747.871	934.916	934.916	739.090	457.400	457.400	457.400
15.407										
Test Mode	802.11a	802.11ac (VHT20)			802.11ac (VHT40)			802.11ac (VHT80)		
1Tx	44.361									
3Tx		CDD	STBC	Beam forming	CDD	STBC	Beam forming	CDD	STBC	Beam forming
		44.417	44.417	44.417	45.834	45.834	45.834	40.331	47.399	40.331

3. The EUT has two different RJ45 XFRM Transformer types could be chosen and please refer the below table:

Type 1(Vendor: MINGTEK)			
Vendor P/N	Different	Vendor	Location
HN1878CG	TRANSFORMER VARIABLE COILS,DIP,350UH,HN1878CG	MINGTEK	T1
HN3678CG	TRANSFORMER VARIABLE COILS,DIP,350UH,HN3678CG	MINGTEK	T2, T3
Type 2(Vendor: MYJWD)			
Vendor P/N	Different	Vendor	Location
DG18107-1 G	TRANSFORMER,DIP,350UH,16.8*8.5*1 1.85MM,18PIN,DG18107-1 G	MYJWD	T1
DG36005-1 G	TRANSFORMER,DIP,350UH,32.7*8.5*1 1.85MM,36PIN	MYJWD	T2, T3

From the above types, the worst case was found in **Type 2(Vendor: MYJWD)**. Therefore only the test data of the type were recorded in this report.

4. The EUT must be supplied with a power adapter and following two different model names could be chosen:

No.	Brand	Model No.	Spec.
1	Ktec	KSAS0451200350HU	AC Input : 100-240V, 1.2A, 50-60Hz DC Output : 12V, 3.5A DC output cable(unshielded ,1.5m)
2	LEI	MU42-1120350-A1	AC Input : 100-240V, 1.5A, 50-60Hz DC Output : 12V, 3.5A DC output cable(unshielded ,1.5m)

From the above adapters, the worst radiated emission was found in **Adapter 2**. Therefore only the test data of the modes were recorded in this report.

5. The antennas provided to the EUT, please refer to the following table:

Transmitter Circuit	Brand	Antenna Type	Peak Gain(dBi) (Include cable loss)		Connector Type	Cable Loss (dB)	Cable Length (mm)
			For 2.4GHz (2.4GHz to 2.4835GHz)	For 5GHz (Band 1: 5.15 to 5.25GHz Band 4: 5.725 to 5.85GHz)			
Right Side Chain (0)	Galtronics	Dipole	1.3	5G Band1: 0.87 5G Band4: 1.95	R-SMA	NA	168
In center Chain (1)	Galtronics	Dipole	1.1	5G Band1: 0.47 5G Band4: 1.55	R-SMA	NA	262
Left Side Chain (2)	Galtronics	Dipole	1.1	5G Band1: 0.47 5G Band4: 1.55	R-SMA	NA	260

Note: From the above antennas, Chain (0) was selected as representative antenna for the 802.11a/b/g test and its data was recorded in this report.

6. The specifications of EUT listed as below:

MODULATION MODE	TX/RX FUNCTION
802.11b	1TX (Diversity) /3RX
802.11g	1TX (Diversity) /3RX
802.11n (HT20)	3TX/3RX (CDD Mode)
	3TX/3RX (STBC Mode)
	3TX/3RX (Beam forming Mode)
802.11n (HT40)	3TX/3RX (CDD Mode)
	3TX/3RX (STBC Mode)
	3TX/3RX (Beam forming Mode)
802.11a	1TX (Diversity) /3RX
802.11ac (VHT20)	3TX/3RX (CDD Mode)
	3TX/3RX (STBC Mode)
	3TX/3RX (Beam forming Mode)
802.11ac (VHT40)	3TX/3RX (CDD Mode)
	3TX/3RX (STBC Mode)
	3TX/3RX (Beam forming Mode)
802.11ac (VHT80)	3TX/3RX (CDD Mode)
	3TX/3RX (STBC Mode)
	3TX/3RX (Beam forming Mode)

Note: The modulation and bandwidth are similar for 802.11n mode for 20MHz (40MHz) and 802.11ac mode for 20MHz (40MHz), therefore investigated worst case to representative mode in test report. (Final test mode refer section 3.2.1)

7. When the EUT operating in 802.11n, the software operation, which is defined by manufacturer, MCS (Modulation and Coding Schemes) from 0 to 23.
8. When the EUT operating in 802.11ac and support 256QAM of VHT40 for 2.4GHz band, the software operation, which is defined by manufacturer, MCS (Modulation and Coding Schemes) from 0 to 9.
9. The above EUT information was declared by the manufacturer and for more detailed features description, please refer to the manufacturer's specifications or User's Manual.

3.2 DESCRIPTION OF TEST MODES

Operated in 2400 ~ 2483.5MHz band:

11 channels are provided for 802.11b, 802.11g, 802.11n (HT20):

CHANNEL	FREQUENCY	CHANNEL	FREQUENCY
1	2412MHz	7	2442MHz
2	2417MHz	8	2447MHz
3	2422MHz	9	2452MHz
4	2427MHz	10	2457MHz
5	2432MHz	11	2462MHz
6	2437MHz		

7 channels are provided for 802.11n (HT40):

CHANNEL	FREQUENCY	CHANNEL	FREQUENCY
3	2422MHz	7	2442MHz
4	2427MHz	8	2447MHz
5	2432MHz	9	2452MHz
6	2437MHz		

Operated in 5725 ~ 5850MHz band:

5 channels are provided for 802.11a, 802.11n (HT20), 802.11ac (VHT20):

CHANNEL	FREQUENCY	CHANNEL	FREQUENCY
149	5745 MHz	161	5805 MHz
153	5765 MHz	165	5825 MHz
157	5785 MHz		

2 channels are provided for 802.11n (HT40), 802.11ac (VHT40):

CHANNEL	FREQUENCY
151	5755 MHz
159	5795 MHz

1 channel is provided for 802.11ac (VHT80):

CHANNEL	FREQUENCY
155	5775 MHz

3.2.1 TEST MODE APPLICABILITY AND TESTED CHANNEL DETAIL

EUT CONFIGURE MODE	APPLICABLE TO					DESCRIPTION
	PLC	RE < 1G	RE ≥ 1G	APCM	OB	
1	√	√	√	√	√	3TX configuration (with Adapter 2)
2	√	-	-	-	-	3TX configuration (with Adapter 1)
	-	-	√	√	√	1TX configuration (with Adapter 2)

Where **PLC**: Power Line Conducted Emission **RE < 1G**: Radiated Emission below 1GHz
RE ≥ 1G: Radiated Emission above 1GHz **APCM**: Antenna Port Conducted Measurement
OB: Conducted Out-Band Emission Measurement

Note: 1. The EUT had been pre-tested on the positioned of each 2 axis. The worst case was found when positioned on **X-plane**.

POWER LINE CONDUCTED EMISSION TEST:

- Pre-Scan has been conducted to determine the worst-case mode from all possible combinations between available modulations, data rates and antenna ports (if EUT with antenna diversity architecture).
- Following channel(s) was (were) selected for the final test as listed below.

3TX CONFIGURATION					
CDD_MODE	AVAILABLE CHANNEL	TESTED CHANNEL	MODULATION TECHNOLOGY	MODULATION TYPE	DATA RATE (Mbps)
For 2.4 GHz 802.11n (HT20)	1 to 11	6	OFDM	BPSK	6.5
For 5 GHz 802.11n (HT20)	149 to 165	165	OFDM	BPSK	6.5

RADIATED EMISSION TEST (BELOW 1 GHz):

- Pre-Scan has been conducted to determine the worst-case mode from all possible combinations between available modulations, data rates and antenna ports (if EUT with antenna diversity architecture).
- Following channel(s) was (were) selected for the final test as listed below.

3TX CONFIGURATION					
CDD_MODE	AVAILABLE CHANNEL	TESTED CHANNEL	MODULATION TECHNOLOGY	MODULATION TYPE	DATA RATE (Mbps)
For 2.4 GHz 802.11n (HT20)	1 to 11	6	OFDM	BPSK	6.5
For 5 GHz 802.11ac (VHT20)	149 to 165	165	OFDM	BPSK	6.5

RADIATED EMISSION TEST (ABOVE 1 GHz):

- Pre-Scan has been conducted to determine the worst-case mode from all possible combinations between available modulations, data rates and antenna ports (if EUT with antenna diversity architecture).
- Following channel(s) was (were) selected for the final test as listed below.

3TX CONFIGURATION					
CDD & STBC_MODE	AVAILABLE CHANNEL	TESTED CHANNEL	MODULATION TECHNOLOGY	MODULATION TYPE	DATA RATE (Mbps)
For 2.4 GHz 802.11n (HT20)	1 to 11	1, 6, 11	OFDM	BPSK	6.5
For 2.4 GHz 802.11n (HT40)	3 to 9	3, 6, 9	OFDM	BPSK	13.5
For 5 GHz 802.11ac (VHT20)	149 to 165	149, 157, 165	OFDM	BPSK	6.5
For 5 GHz 802.11ac (VHT40)	151 to 159	151, 159	OFDM	BPSK	13.5
For 5 GHz 802.11ac (VHT80)	155	155	OFDM	BPSK	29.3
1TX CONFIGURATION					
MODE	AVAILABLE CHANNEL	TESTED CHANNEL	MODULATION TECHNOLOGY	MODULATION TYPE	DATA RATE (Mbps)
802.11b	1 to 11	1, 6, 11	DSSS	DBPSK	1
802.11g	1 to 11	1, 6, 11	OFDM	BPSK	6
802.11a	149 to 165	149, 157, 165	OFDM	BPSK	6

ANTENNA PORT CONDUCTED MEASUREMENT:

- Pre-Scan has been conducted to determine the worst-case mode from all possible combinations between available modulations, data rates and antenna ports (if EUT with antenna diversity architecture).
- Following channel(s) was (were) selected for the final test as listed below.

3TX CONFIGURATION					
CDD, STBC & Beam forming_MODE	AVAILABLE CHANNEL	TESTED CHANNEL	MODULATION TECHNOLOGY	MODULATION TYPE	DATA RATE (Mbps)
For 2.4 GHz 802.11n (HT20)	1 to 11	1, 6, 11	OFDM	BPSK	6.5
For 2.4 GHz 802.11n (HT40)	3 to 9	3, 6, 9	OFDM	BPSK	13.5
For 5 GHz 802.11ac (VHT20)	149 to 165	149, 157, 165	OFDM	BPSK	6.5
For 5 GHz 802.11ac (VHT40)	151 to 159	151, 159	OFDM	BPSK	13.5
For 5 GHz 802.11ac (VHT80)	155	155	OFDM	BPSK	29.3
1TX CONFIGURATION					
MODE	AVAILABLE CHANNEL	TESTED CHANNEL	MODULATION TECHNOLOGY	MODULATION TYPE	DATA RATE (Mbps)
802.11b	1 to 11	1, 6, 11	DSSS	DBPSK	1
802.11g	1 to 11	1, 6, 11	OFDM	BPSK	6
802.11a	149 to 165	149, 157, 165	OFDM	BPSK	6

CONDUCTED OUT-BAND EMISSION MEASUREMENT:

- Pre-Scan has been conducted to determine the worst-case mode from all possible combinations between available modulations, data rates and antenna ports (if EUT with antenna diversity architecture).
- Following channel(s) was (were) selected for the final test as listed below.

3TX CONFIGURATION					
CDD, STBC & Beam forming_MODE	AVAILABLE CHANNEL	TESTED CHANNEL	MODULATION TECHNOLOGY	MODULATION TYPE	DATA RATE (Mbps)
For 2.4 GHz 802.11n (HT20)	1 to 11	1, 6, 11	OFDM	BPSK	6.5
For 2.4 GHz 802.11n (HT40)	3 to 9	3, 6, 9	OFDM	BPSK	13.5
For 5 GHz 802.11ac (VHT20)	149 to 165	149, 157, 165	OFDM	BPSK	6.5
For 5 GHz 802.11ac (VHT40)	151 to 159	151, 159	OFDM	BPSK	13.5
For 5 GHz 802.11ac (VHT80)	155	155	OFDM	BPSK	29.3
1TX CONFIGURATION					
MODE	AVAILABLE CHANNEL	TESTED CHANNEL	MODULATION TECHNOLOGY	MODULATION TYPE	DATA RATE (Mbps)
802.11b	1 to 11	1, 6, 11	DSSS	DBPSK	1
802.11g	1 to 11	1, 6, 11	OFDM	BPSK	6
802.11a	149 to 165	149, 157, 165	OFDM	BPSK	6

TEST CONDITION:

APPLICABLE TO	ENVIRONMENTAL CONDITIONS	INPUT POWER	TESTED BY
PLC	26deg. C, 66%RH	120Vac, 60Hz	JyunChun Lin
RE<1G	22deg. C, 73%RH	120Vac, 60Hz	Andy Ho
RE ³ 1G	21deg. C, 67%RH	120Vac, 60Hz	Jason Huang
APCM	25deg. C, 60%RH	120Vac, 60Hz	Robert Cheng
OB	25deg. C, 60%RH	120Vac, 60Hz	Robert Cheng

3.3 GENERAL DESCRIPTION OF APPLIED STANDARDS

The EUT is a RF product. According to the specifications of the manufacturer, it must comply with the requirements of the following standards:

FCC Part 15, Subpart C. (15.247)

558074 D01 DTS Meas Guidance v03r01

662911 D01 Multiple Transmitter Output v02

ANSI C63.10-2009

All test items have been performed and recorded as per the above standards.

Note: The EUT has been verified to comply with the requirements of FCC Part 15, Subpart B, Class B (DoC). The test report has been issued separately.

3.4 DUTY CYCLE OF TEST SIGNAL

If duty cycle of test signal is $\geq 98\%$, duty factor is not required.

If duty cycle of test signal is $< 98\%$, duty factor shall be considered.

802.11b: Duty cycle = 1.205 ms/1.22 ms = 0.988

802.11g: Duty cycle = 2.054 ms/2.079 ms = 0.988

802.11n (HT20): Duty cycle = 1.914 ms/1.935 ms = 0.989

802.11n (HT40): Duty cycle = 0.942 ms/0.963 ms = 0.978, Duty factor = $10 * \log(1/0.978) = 0.1$

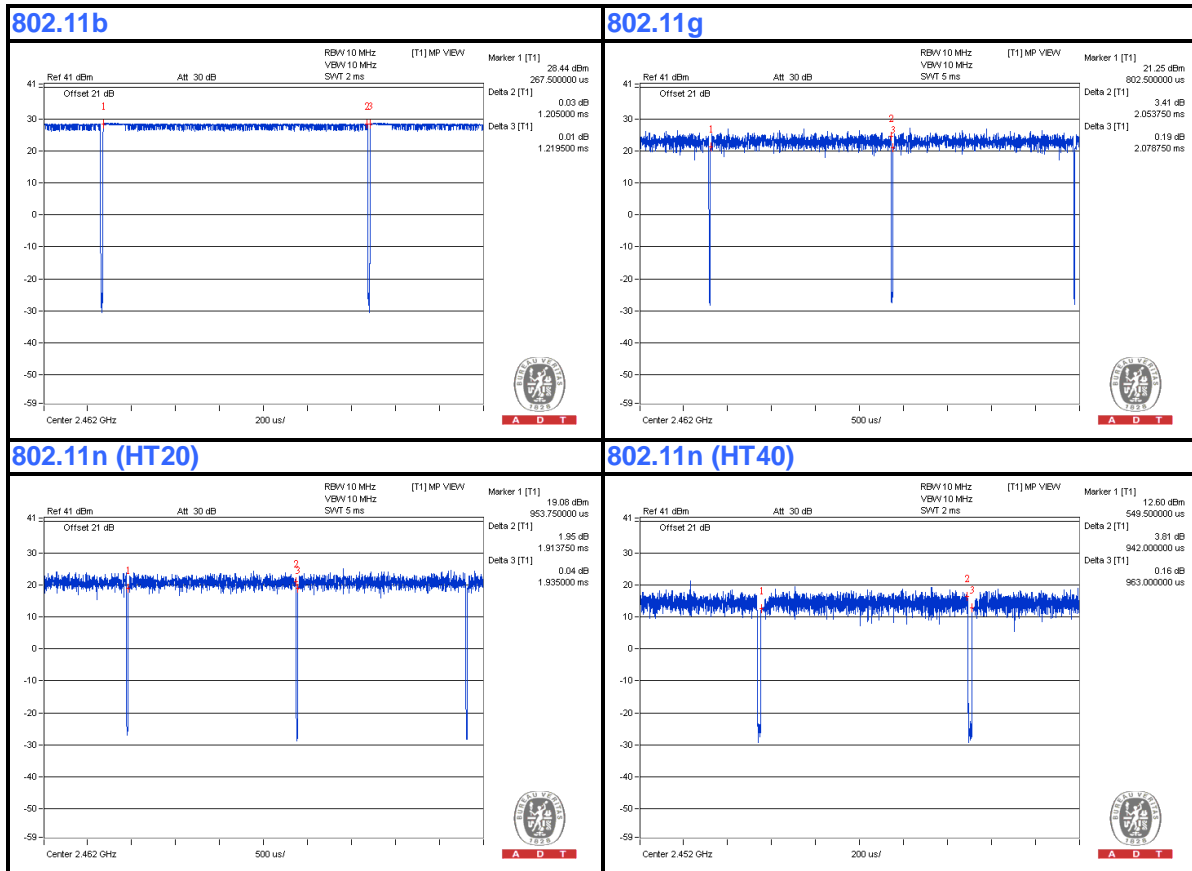

If duty cycle of test signal is $\geq 98\%$, duty factor is not required.

If duty cycle of test signal is $< 98\%$, duty factor shall be considered.

802.11a: Duty cycle = $2.064 \text{ ms} / 2.083 \text{ ms} = 0.991$

802.11ac (VHT20): Duty cycle = $1.925 \text{ ms} / 1.944 \text{ ms} = 0.99$

802.11ac (VHT40): Duty cycle = $0.951 \text{ ms} / 0.97 \text{ ms} = 0.98$

802.11ac (VHT80): Duty cycle = $0.46 \text{ ms} / 0.477 \text{ ms} = 0.964$, Duty factor = $10 * \log(1/0.964) = 0.16$

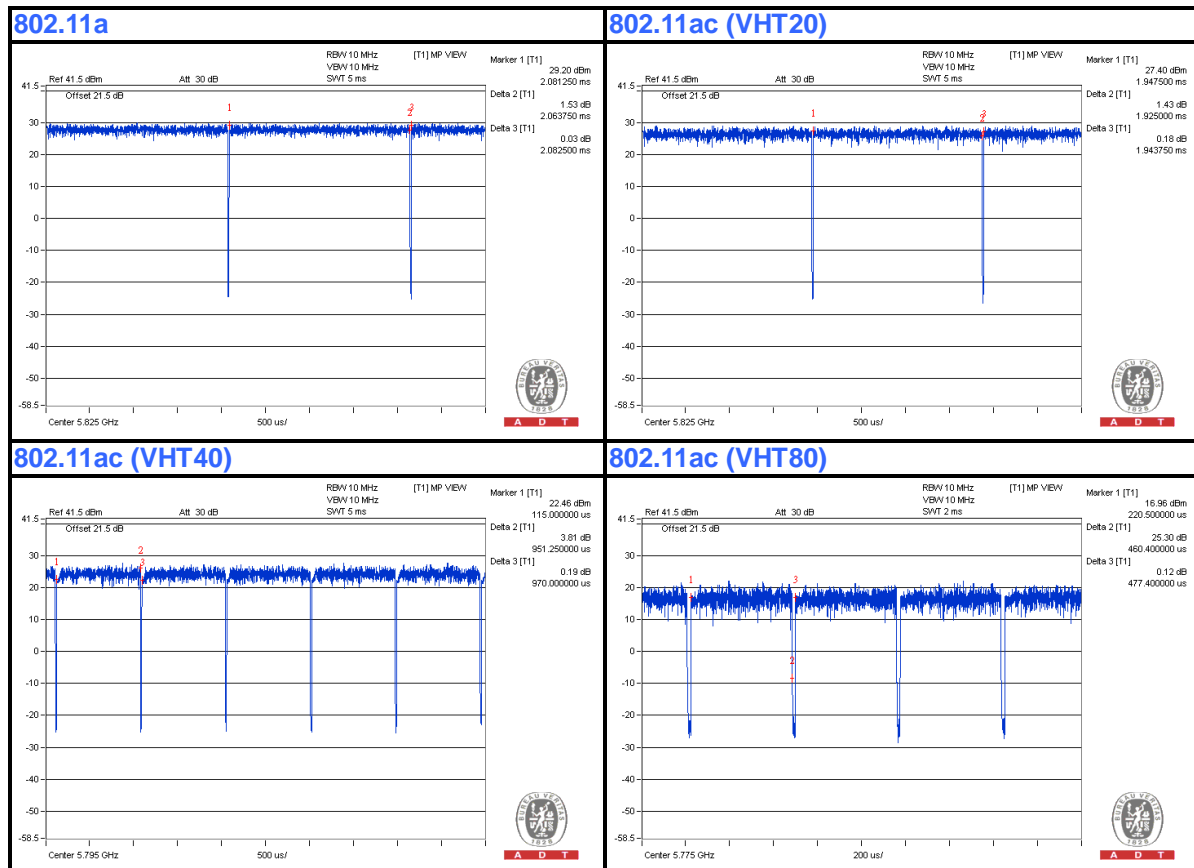



3.5 DESCRIPTION OF SUPPORT UNITS

The EUT has been tested as an independent unit together with other necessary accessories or support units. The following support units or accessories were used to form a representative test configuration during the tests.

NO.	PRODUCT	BRAND	MODEL NO.	SERIAL NO.	FCC ID
1	NOTEBOOK COMPUTER	DELL	PP32LA	FSLB32S	FCC DoC
2	NOTEBOOK COMPUTER	DELL	PP32LA	GSLB32S	FCC DoC
3	HUB	ZyXEL	ES-116P	S060H0200021 5	FCC DoC
4	iPod shuffle	Apple	MC749TA/A	CC4DMFJUDFD M	NA
5	External Hard Drive (for other test items)	WD	WDBACW0010H BK-SESN	WCAZAL62578 7	FCC DoC
	HDD (for conducted test)	WD	WDBACW0010H BK-SESN	WXK1A51E581 9	FCC DoC

NO.	SIGNAL CABLE DESCRIPTION OF THE ABOVE SUPPORT UNITS
1	UTP cable, 10m
2	UTP cable, 10m
3	UTP cable, 10m
4	USB cable, 0.1m
5	USB cable, 0.5m (for other test items)
	USB cable, 0.6m (for conducted test)

NOTE: All power cords of the above support units are non shielded (1.8m).

3.6 CONFIGURATION OF SYSTEM UNDER TEST

For Conducted Emission Test:

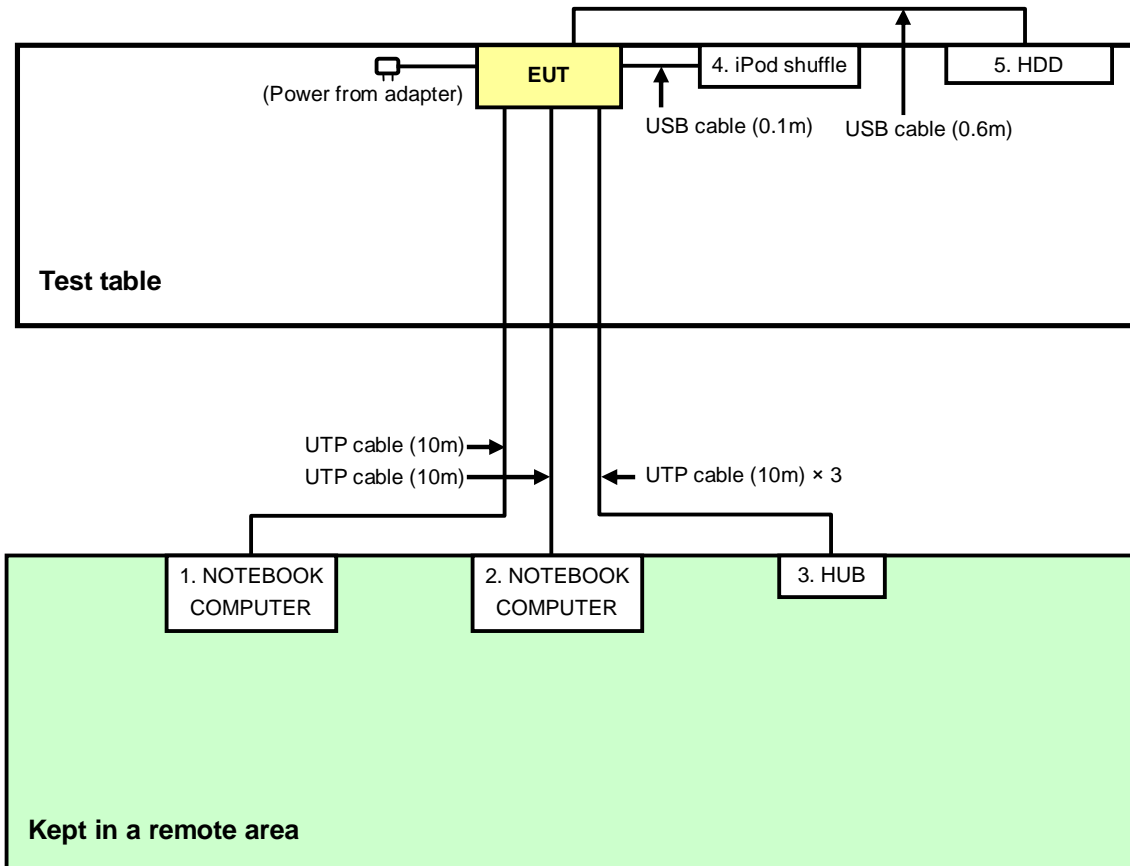

For other test items:

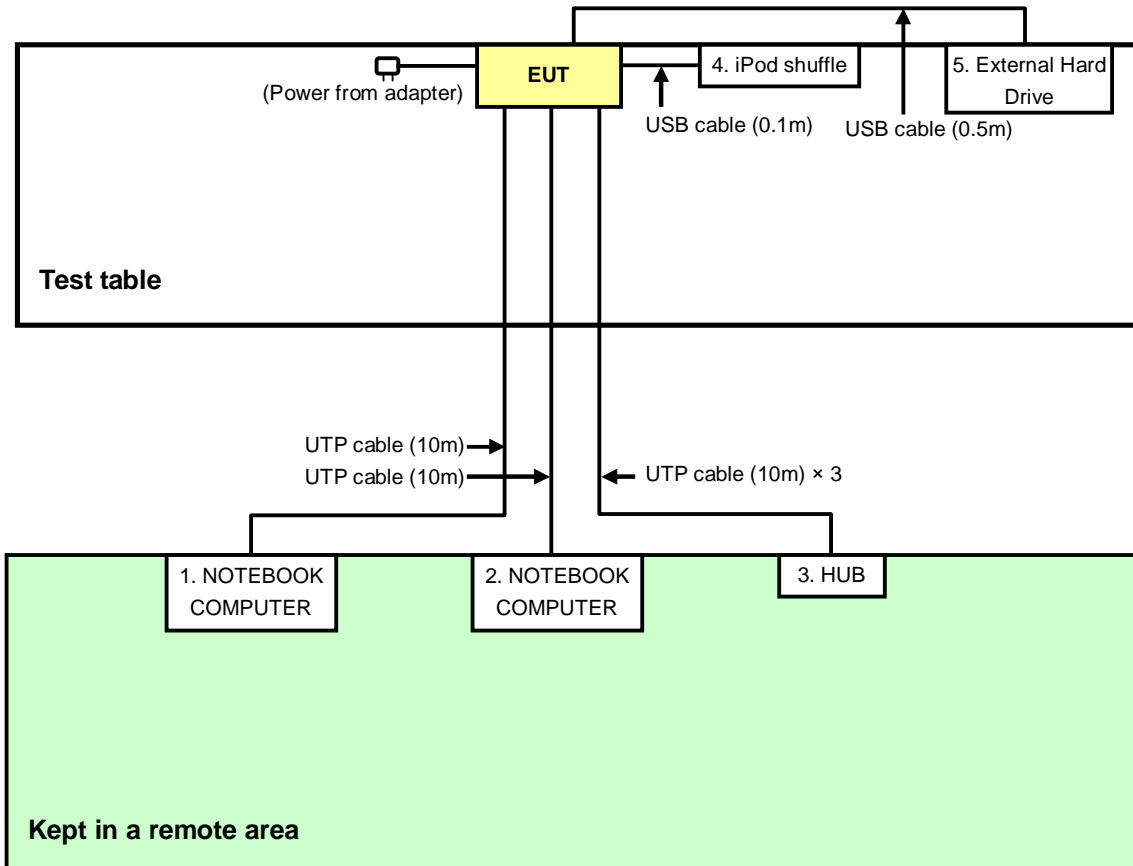

4. TEST TYPES AND RESULTS (FOR 2.4GHz, 2.400 ~ 2.4835GHz Band)

4.1 CONDUCTED EMISSION MEASUREMENT

4.1.1 LIMITS OF CONDUCTED EMISSION MEASUREMENT

FREQUENCY OF EMISSION (MHz)	CONDUCTED LIMIT (dB μ V)	
	Quasi-peak	Average
0.15-0.5	66 to 56	56 to 46
0.5-5	56	46
5-30	60	50

- NOTE:**
1. The lower limit shall apply at the transition frequencies.
 2. The limit decreases in line with the logarithm of the frequency in the range of 0.15 to 0.50 MHz.

4.1.2 TEST INSTRUMENTS

DESCRIPTION & MANUFACTURER	MODEL NO.	SERIAL NO.	CALIBRATED DATE	CALIBRATED UNTIL
Test Receiver ROHDE & SCHWARZ	ESCS 30	100375	Mar. 08, 2013	Mar. 07, 2014
Line-Impedance Stabilization Network (for EUT) SCHWARZBECK	NSLK8127	8127-522	Sep. 06, 2012	Sep. 05, 2013
Line-Impedance Stabilization Network (for Peripheral)	ENV216	100072	June 07, 2013	June 06, 2014
RF Cable (JYEBAO)	5DFB	COCCAB-001	Mar. 11, 2013	Mar. 10, 2014
50 ohms Terminator	50	EMC-3	Sep. 25, 2012	Sep. 24, 2013
Software ADT	BV ADT_Cond_V7.3.7. 3	NA	NA	NA

Note:

1. The calibration interval of the above test instruments is 12 months and the calibrations are traceable to NML/ROC and NIST/USA.
2. The test was performed in Shielded Room No. C.
3. The VCCI Con C Registration No. is C-3611.
4. Tested Date: July 26, 2013

4.1.3 TEST PROCEDURES

- The EUT was placed 0.4 meters from the conducting wall of the shielded room with EUT being connected to the power mains through a line impedance stabilization network (LISN). Other support units were connected to the power mains through another LISN.
- The two LISNs provide 50 ohm/ 50uH of coupling impedance for the measuring instrument.
- Both lines of the power mains connected to the EUT were checked for maximum conducted interference.
- The frequency range from 150kHz to 30MHz was searched. Emission levels under (Limit - 20dB) were not recorded.

NOTE:

- The resolution bandwidth of test receiver is 9kHz for Quasi-peak detection (QP) & Average detection (AV).

4.1.4 DEVIATION FROM TEST STANDARD

No deviation

4.1.5 TEST SETUP

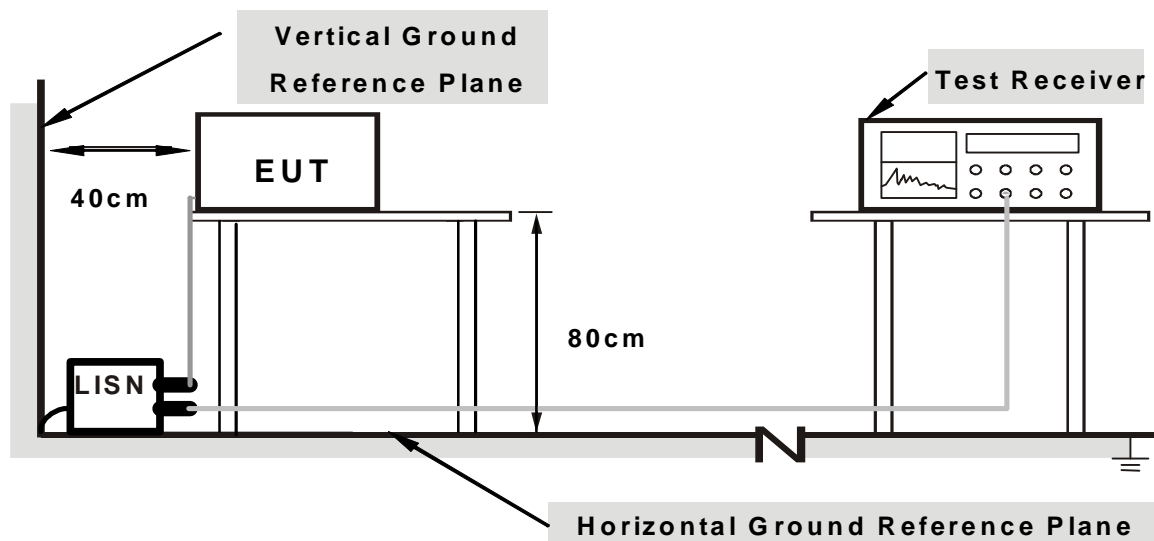

Note: 1.Support units were connected to second LISN.

For the actual test configuration, please refer to the related item – Photographs of the Test Configuration.

4.1.6 EUT OPERATING CONDITIONS

1. Placed the EUT on testing table.
2. Prepared computer system (support unit 1) to act as communication partner.
3. The communication partner run test program “MTool_2.0.0.8.msi.exe” to enable EUT under transmission/receiving condition continuously at specific channel frequency.

4.1.7 TEST RESULTS (MODE 1)

PHASE	Line (L)	DETECTOR FUNCTION	Quasi-Peak (QP) / Average (AV)
--------------	----------	--------------------------	--------------------------------

No	Freq. [MHz]	Corr. Factor (dB)	Reading Value [dB (uV)]		Emission Level [dB (uV)]		Limit [dB (uV)]		Margin (dB)	
			Q.P.	AV.	Q.P.	AV.	Q.P.	AV.	Q.P.	AV.
1	0.16172	0.13	58.17	48.43	58.30	48.56	65.38	55.38	-7.07	-6.81
2	0.19656	0.15	50.19	37.03	50.34	37.18	63.75	53.75	-13.42	-16.58
3	0.53672	0.21	37.41	31.98	37.62	32.19	56.00	46.00	-18.38	-13.81
4	2.20703	0.35	29.53	23.90	29.88	24.25	56.00	46.00	-26.12	-21.75
5	9.61328	0.87	34.17	29.38	35.04	30.25	60.00	50.00	-24.96	-19.75
6	17.68359	1.34	33.26	28.74	34.60	30.08	60.00	50.00	-25.40	-19.92

REMARKS:

1. Q.P. and AV. are abbreviations of quasi-peak and average individually.
2. The emission levels of other frequencies were very low against the limit.
3. Margin value = Emission Level – Limit value
4. Correction Factor = Insertion loss + Cable loss
5. Emission Level = Correction Factor + Reading Value

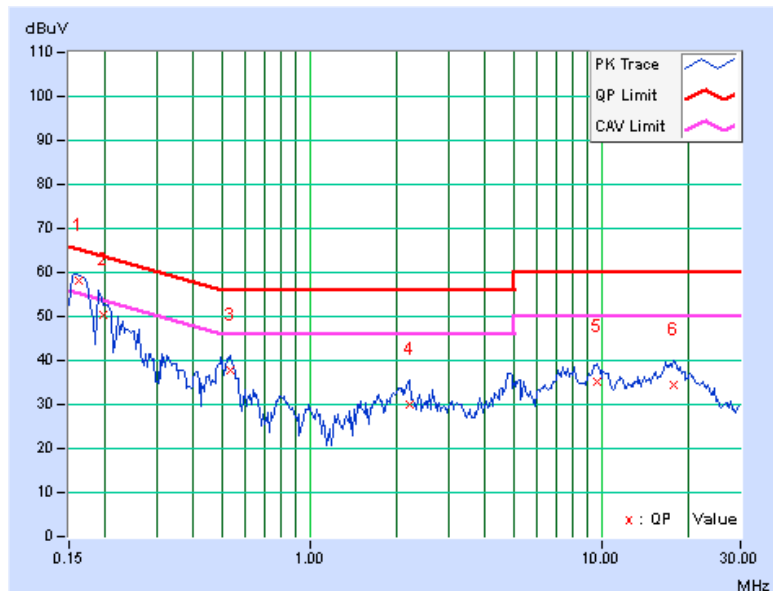

PHASE	Neutral (N)	DETECTOR FUNCTION	Quasi-Peak (QP) / Average (AV)
--------------	-------------	--------------------------	--------------------------------

No	Freq. [MHz]	Corr. Factor [dB]	Reading Value [dB (uV)]		Emission Level [dB (uV)]		Limit [dB (uV)]		Margin (dB)	
			Q.P.	AV.	Q.P.	AV.	Q.P.	AV.	Q.P.	AV.
1	0.16172	0.11	57.87	47.66	57.98	47.77	65.38	55.38	-7.39	-7.60
2	0.20078	0.13	50.98	40.86	51.11	40.99	63.58	53.58	-12.47	-12.59
3	0.52891	0.20	38.50	32.07	38.70	32.27	56.00	46.00	-17.30	-13.73
4	2.12891	0.31	32.14	26.43	32.45	26.74	56.00	46.00	-23.55	-19.26
5	7.50000	0.61	33.83	29.20	34.44	29.81	60.00	50.00	-25.56	-20.19
6	16.94141	1.02	32.45	27.54	33.47	28.56	60.00	50.00	-26.53	-21.44

REMARKS:

1. Q.P. and AV. are abbreviations of quasi-peak and average individually.
2. The emission levels of other frequencies were very low against the limit.
3. Margin value = Emission Level – Limit value
4. Correction Factor = Insertion loss + Cable loss
5. Emission Level = Correction Factor + Reading Value

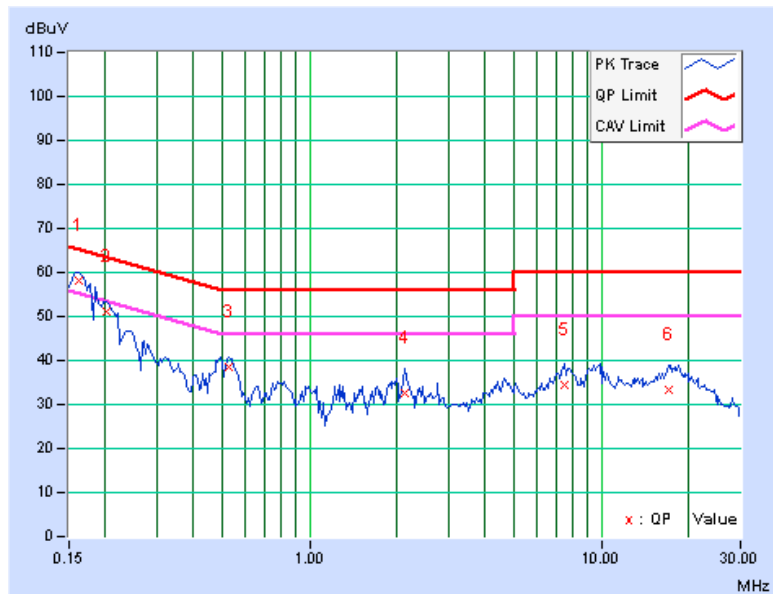

4.1.8 TEST RESULTS (MODE 2)

PHASE	Line (L)	DETECTOR FUNCTION	Quasi-Peak (QP) / Average (AV)
-------	----------	-------------------	--------------------------------

No	Freq. [MHz]	Corr. Factor (dB)	Reading Value [dB (uV)]		Emission Level [dB (uV)]		Limit [dB (uV)]		Margin (dB)	
			Q.P.	AV.	Q.P.	AV.	Q.P.	AV.	Q.P.	AV.
1	0.16562	0.14	52.93	41.10	53.07	41.24	65.18	55.18	-12.11	-13.94
2	0.22031	0.16	46.67	34.54	46.83	34.70	62.81	52.81	-15.98	-18.11
3	0.39219	0.20	41.02	30.19	41.22	30.39	58.02	48.02	-16.80	-17.63
4	0.47813	0.21	43.46	34.42	43.67	34.63	56.37	46.37	-12.70	-11.74
5	0.87656	0.24	36.42	26.74	36.66	26.98	56.00	46.00	-19.34	-19.02
6	2.08594	0.35	38.11	30.70	38.46	31.05	56.00	46.00	-17.54	-14.95

REMARKS:

1. Q.P. and AV. are abbreviations of quasi-peak and average individually.
2. The emission levels of other frequencies were very low against the limit.
3. Margin value = Emission Level – Limit value
4. Correction Factor = Insertion loss + Cable loss
5. Emission Level = Correction Factor + Reading Value

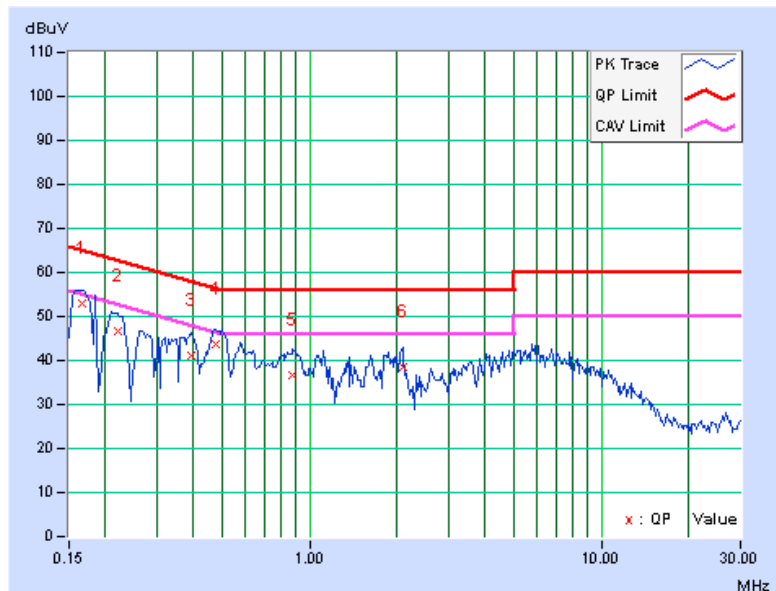

PHASE	Neutral (N)	DETECTOR FUNCTION	Quasi-Peak (QP) / Average (AV)
--------------	-------------	--------------------------	--------------------------------

No	Freq. [MHz]	Corr. Factor [dB]	Reading Value [dB (uV)]		Emission Level [dB (uV)]		Limit [dB (uV)]		Margin (dB)	
			Q.P.	AV.	Q.P.	AV.	Q.P.	AV.	Q.P.	AV.
1	0.16172	0.11	54.44	43.15	54.55	43.26	65.38	55.38	-10.82	-12.11
2	0.21641	0.13	47.95	35.85	48.08	35.98	62.96	52.96	-14.87	-16.97
3	0.45469	0.19	39.88	27.96	40.07	28.15	56.79	46.79	-16.72	-18.64
4	0.84141	0.21	32.10	21.41	32.31	21.62	56.00	46.00	-23.69	-24.38
5	1.95313	0.30	35.14	24.44	35.44	24.74	56.00	46.00	-20.56	-21.26
6	6.18359	0.54	33.40	25.53	33.94	26.07	60.00	50.00	-26.06	-23.93

REMARKS:

1. Q.P. and AV. are abbreviations of quasi-peak and average individually.
2. The emission levels of other frequencies were very low against the limit.
3. Margin value = Emission Level – Limit value
4. Correction Factor = Insertion loss + Cable loss
5. Emission Level = Correction Factor + Reading Value

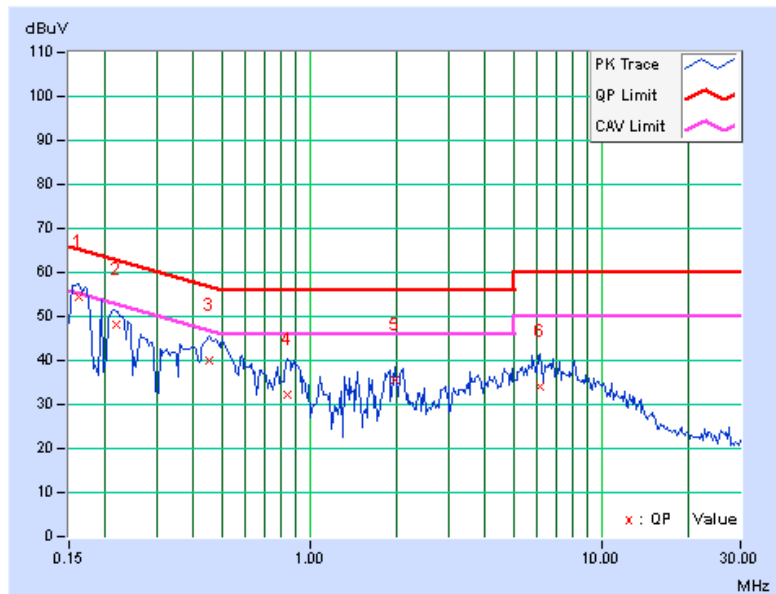

4.2 RADIATED EMISSION AND BANDEDGE MEASUREMENT

4.2.1 LIMITS OF RADIATED EMISSION AND BANDEDGE MEASUREMENT

Radiated emissions which fall in the restricted bands must comply with the radiated emission limits specified as below table. Other emissions shall be at least 30dB below the highest level of the desired power:

Frequencies (MHz)	Field strength (microvolts/meter)	Measurement distance (meters)
0.009-0.490	2400/F(kHz)	300
0.490-1.705	24000/F(kHz)	30
1.705-30.0	30	30
30-88	100	3
88-216	150	3
216-960	200	3
Above 960	500	3

NOTE:

1. The lower limit shall apply at the transition frequencies.
2. Emission level (dBuV/m) = 20 log Emission level (uV/m).
3. For frequencies above 1000MHz, the field strength limits are based on average detector, however, the peak field strength of any emission shall not exceed the maximum permitted average limits, specified above by more than 20dB under any condition of modulation.



A D T

4.2.2 TEST INSTRUMENTS

DESCRIPTION & MANUFACTURER	MODEL NO.	SERIAL NO.	CALIBRATED DATE	CALIBRATED UNTIL
MXE EMI Receiver Agilent	N9038A	MY50010156	Jan. 15, 2014	Jan. 14, 2015
Pre-Amplifier Mini-Circuits	ZFL-1000VH2 B	AMP-ZFL-04	Nov. 13, 2013	Nov. 12, 2014
Trilog Broadband Antenna SCHWARZBECK	VULB 9168	9168-361	Mar. 25, 2013	Mar. 24, 2014
RF Cable	NA	CHHCAB_001	Oct. 06, 2013	Oct. 05, 2014
Spectrum Analyzer R&S	FSV40	100964	July 15, 2013	July 14, 2014
Horn_Antenna AISI	AIH.8018	0000220091110	Dec. 06, 2013	Dec. 05, 2014
Pre-Amplifier Agilent	8449B	3008A01923	Oct. 29, 2013	Oct. 28, 2014
RF Cable	NA	RF104-205 RF104-207 RF104-202	Dec. 12, 2013	Dec. 11, 2014
Spectrum Analyzer Agilent	E4446A	MY48250253	Aug. 28, 2013	Aug. 27, 2014
Pre-Amplifier SPACEK LABS	SLKKa-48-6	9K16	Nov. 13, 2013	Nov. 12, 2014
Horn_Antenna SCHWARZBECK	BBHA 9170	9170-424	Oct. 08, 2013	Oct. 07, 2014
Software	ADT_Radiated _V8.7.07	NA	NA	NA
Antenna Tower & Turn Table CT	NA	NA	NA	NA

Note:

1. The calibration interval of the above test instruments is 12 months and the calibrations are traceable to NML/ROC and NIST/USA.
2. The horn antenna, preamplifier (model: 8449B) are used only for the measurement of emission frequency above 1GHz if tested.
- 3 The test was performed in 966 Chamber No. H.
4. The FCC Site Registration No. is 797305.
- 5 The CANADA Site Registration No. is IC 7450H-3.
- 6 Tested Date: Jan. 16 to 17, 2014

4.2.3 TEST PROCEDURES

- a. The EUT was placed on the top of a rotating table 0.8 meters above the ground at 3 meter chamber room for test. The table was rotated 360 degrees to determine the position of the highest radiation.
- b. The EUT was set 3 meters away from the interference-receiving antenna, which was mounted on the top of a variable-height antenna tower.
- c. The height of antenna is varied from one meter to four meters above the ground to determine the maximum value of the field strength. Both horizontal and vertical polarizations of the antenna are set to make the measurement.
- d. For each suspected emission, the EUT was arranged to its worst case and then the antenna was tuned to heights from 1 meter to 4 meters and the rotatable table was turned from 0 degrees to 360 degrees to find the maximum reading.
- e. The test-receiver system was set to quasi-peak detect function and specified bandwidth with maximum hold mode when the test frequency is below 1 GHz.
- f. The test-receiver system was set to peak and average detect function and specified bandwidth with maximum hold mode when the test frequency is above 1 GHz. If the peak reading value also meets average limit, measurement with the average detector is unnecessary.

Note:

1. The resolution bandwidth and video bandwidth of test receiver/spectrum analyzer is 120kHz for Quasi-peak detection (QP) at frequency below 1GHz.
2. The resolution bandwidth of test receiver/spectrum analyzer is 1 MHz and the video bandwidth is 3 MHz for Peak detection (PK) at frequency above 1GHz.
3. The resolution bandwidth of test receiver/spectrum analyzer is 1MHz and the video bandwidth is 3MHz for RMS Average (Duty cycle < 98%) for Average detection (AV) at frequency above 1GHz, then the measurement results was added to a correction factor ($10 \log(1/\text{duty cycle})$).
4. The resolution bandwidth of test receiver/spectrum analyzer is 1MHz and the video bandwidth is 10Hz (Duty cycle $\geq 98\%$) for Average detection (AV) at frequency above 1GHz.
5. All modes of operation were investigated and the worst-case emissions are reported.

4.2.4 DEVIATION FROM TEST STANDARD

No deviation

4.2.5 TEST SETUP

<Frequency Range below 1GHz>

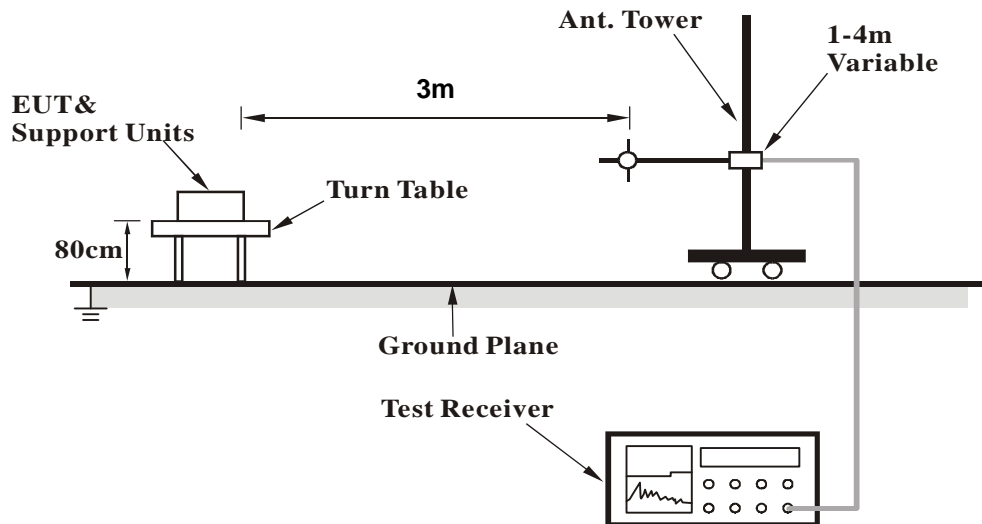

<Frequency Range above 1GHz>

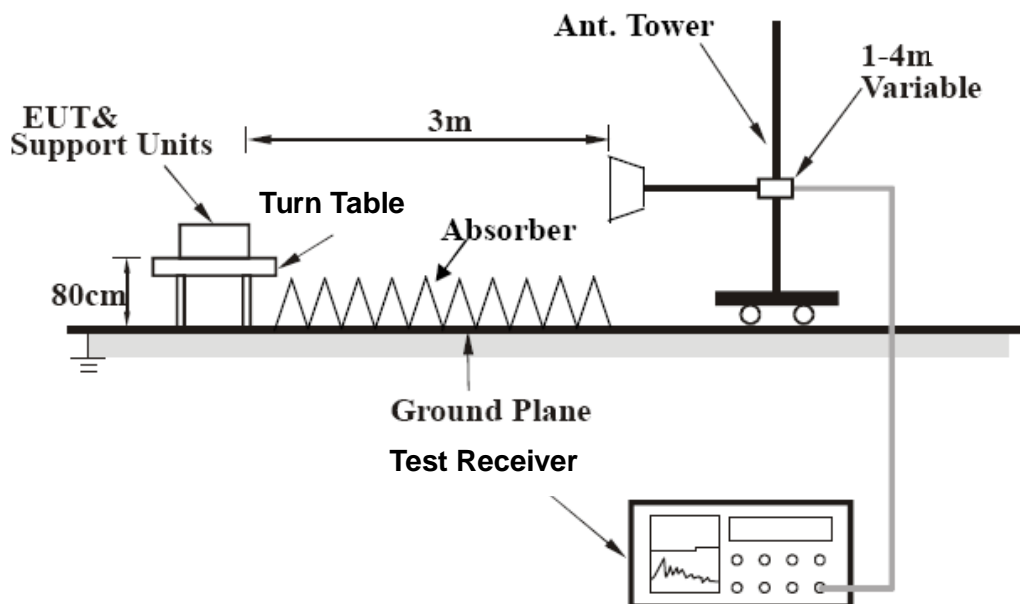

For the actual test configuration, please refer to the related item – Photographs of the Test Configuration.

4.2.6 EUT OPERATING CONDITIONS

Same as 4.1.6



A D T

4.2.7 TEST RESULTS (MODE 1)

CDD_MODE

BELOW 1GHz WORST-CASE DATA

802.11n (HT20)

CHANNEL	TX Channel 6	DETECTOR FUNCTION	Quasi-Peak (QP)
FREQUENCY RANGE	Below 1GHz		

ANTENNA POLARITY & TEST DISTANCE: HORIZONTAL AT 3 M

NO.	FREQ. (MHz)	EMISSION LEVEL (dBuV/m)	LIMIT (dBuV/m)	MARGIN (dB)	ANTENNA HEIGHT (m)	TABLE ANGLE (Degree)	RAW VALUE (dBuV)	CORRECTION FACTOR (dB/m)
1	93.63	31.5 QP	43.5	-12.0	2.00 H	303	49.61	-18.12
2	164.59	34.0 QP	43.5	-9.5	2.00 H	112	47.08	-13.09
3	209.74	38.6 QP	43.5	-4.9	1.50 H	89	54.46	-15.83
4	219.49	39.2 QP	46.0	-6.8	1.50 H	292	54.72	-15.53
5	294.66	39.0 QP	46.0	-7.0	1.00 H	297	50.81	-11.83
6	500.01	34.5 QP	46.0	-11.5	1.50 H	289	41.44	-6.91

ANTENNA POLARITY & TEST DISTANCE: VERTICAL AT 3 M

NO.	FREQ. (MHz)	EMISSION LEVEL (dBuV/m)	LIMIT (dBuV/m)	MARGIN (dB)	ANTENNA HEIGHT (m)	TABLE ANGLE (Degree)	RAW VALUE (dBuV)	CORRECTION FACTOR (dB/m)
1	35.43	35.3 QP	40.0	-4.7	1.00 V	148	48.85	-13.55
2	65.60	36.8 QP	40.0	-3.2	1.00 V	345	51.26	-14.49
3	219.83	35.0 QP	46.0	-11.0	1.00 V	280	50.53	-15.52
4	500.01	38.2 QP	46.0	-7.8	1.00 V	349	45.09	-6.91
5	666.66	33.7 QP	46.0	-12.3	1.50 V	360	37.38	-3.67
6	825.01	33.7 QP	46.0	-12.3	1.50 V	360	34.23	-0.52

REMARKS:

1. Emission Level(dBuV/m) = Raw Value(dBuV) + Correction Factor(dB/m)
2. Correction Factor(dB/m) = Antenna Factor(dB/m) + Cable Factor(dB) – Pre-Amplifier Factor(dB)
3. The other emission levels were very low against the limit.
4. Margin value = Emission Level – Limit value



A D T

CDD_MODE

802.11n (HT20)

CHANNEL	TX Channel 1	DETECTOR FUNCTION	Peak (PK)
FREQUENCY RANGE	1GHz ~ 25GHz		Average (AV)

ANTENNA POLARITY & TEST DISTANCE: HORIZONTAL AT 3 M

NO.	FREQ. (MHz)	EMISSION LEVEL (dBuV/m)	LIMIT (dBuV/m)	MARGIN (dB)	ANTENNA HEIGHT (m)	TABLE ANGLE (Degree)	RAW VALUE (dBuV)	CORRECTION FACTOR (dB/m)
1	2390.00	63.8 PK	74.0	-10.2	1.00 H	335	30.27	33.53
2	2390.00	45.5 AV	54.0	-8.5	1.00 H	335	11.97	33.53
3	*2412.00	105.7 PK			1.00 H	335	72.11	33.59
4	*2412.00	97.2 AV			1.00 H	335	63.61	33.59
5	4824.00	48.2 PK	74.0	-25.8	1.00 H	111	5.02	43.18
6	4824.00	35.7 AV	54.0	-18.3	1.00 H	111	-7.48	43.18

ANTENNA POLARITY & TEST DISTANCE: VERTICAL AT 3 M

NO.	FREQ. (MHz)	EMISSION LEVEL (dBuV/m)	LIMIT (dBuV/m)	MARGIN (dB)	ANTENNA HEIGHT (m)	TABLE ANGLE (Degree)	RAW VALUE (dBuV)	CORRECTION FACTOR (dB/m)
1	2390.00	73.8 PK	74.0	-0.2	1.26 V	284	40.27	33.53
2	2390.00	53.2 AV	54.0	-0.8	1.26 V	284	19.67	33.53
3	*2412.00	121.6 PK			1.26 V	284	88.01	33.59
4	*2412.00	111.4 AV			1.26 V	284	77.81	33.59
5	4824.00	48.5 PK	74.0	-25.5	1.10 V	282	5.32	43.18
6	4824.00	38.4 AV	54.0	-15.6	1.10 V	282	-4.78	43.18

REMARKS:

1. Emission Level(dBuV/m) = Raw Value(dBuV) + Correction Factor(dB/m)
2. Correction Factor(dB/m) = Antenna Factor(dB/m) + Cable Factor(dB) – Pre-Amplifier Factor(dB)
3. The other emission levels were very low against the limit.
4. Margin value = Emission Level – Limit value
5. " * ": Fundamental frequency.



A D T

CHANNEL	TX Channel 6	DETECTOR FUNCTION	Peak (PK)
FREQUENCY RANGE	1GHz ~ 25GHz		Average (AV)

ANTENNA POLARITY & TEST DISTANCE: HORIZONTAL AT 3 M

NO.	FREQ. (MHz)	EMISSION LEVEL (dBuV/m)	LIMIT (dBuV/m)	MARGIN (dB)	ANTENNA HEIGHT (m)	TABLE ANGLE (Degree)	RAW VALUE (dBuV)	CORRECTION FACTOR (dB/m)
1	2390.00	63.1 PK	74.0	-10.9	1.00 H	349	29.57	33.53
2	2390.00	45.4 AV	54.0	-8.6	1.00 H	349	11.87	33.53
3	*2437.00	115.2 PK			1.00 H	349	81.53	33.67
4	*2437.00	104.3 AV			1.00 H	349	70.63	33.67
5	2485.00	63.8 PK	74.0	-10.2	1.00 H	349	29.99	33.81
6	2485.00	47.2 AV	54.0	-6.8	1.00 H	349	13.39	33.81
7	4874.00	47.9 PK	74.0	-26.1	1.00 H	111	4.66	43.24
8	4874.00	35.6 AV	54.0	-18.4	1.00 H	111	-7.64	43.24
9	7311.00	55.7 PK	74.0	-18.3	1.02 H	119	7.63	48.07
10	7311.00	43.5 AV	54.0	-10.5	1.02 H	119	-4.57	48.07

ANTENNA POLARITY & TEST DISTANCE: VERTICAL AT 3 M

NO.	FREQ. (MHz)	EMISSION LEVEL (dBuV/m)	LIMIT (dBuV/m)	MARGIN (dB)	ANTENNA HEIGHT (m)	TABLE ANGLE (Degree)	RAW VALUE (dBuV)	CORRECTION FACTOR (dB/m)
1	2390.00	71.2 PK	74.0	-2.8	1.25 V	285	37.67	33.53
2	2390.00	53.5 AV	54.0	-0.5	1.25 V	285	19.97	33.53
3	*2437.00	123.9 PK			1.25 V	285	90.23	33.67
4	*2437.00	113.8 AV			1.25 V	285	80.13	33.67
5	2485.00	71.5 PK	74.0	-2.5	1.25 V	285	37.69	33.81
6	2485.00	53.8 AV	54.0	-0.2	1.25 V	285	19.99	33.81
7	4874.00	49.8 PK	74.0	-24.2	1.20 V	281	6.56	43.24
8	4874.00	36.8 AV	54.0	-17.2	1.20 V	281	-6.44	43.24
9	7311.00	56.5 PK	74.0	-17.5	1.00 V	141	8.43	48.07
10	7311.00	44.5 AV	54.0	-9.5	1.00 V	141	-3.57	48.07

REMARKS:

1. Emission Level(dBuV/m) = Raw Value(dBuV) + Correction Factor(dB/m)
2. Correction Factor(dB/m) = Antenna Factor(dB/m) + Cable Factor(dB) – Pre-Amplifier Factor(dB)
3. The other emission levels were very low against the limit.
4. Margin value = Emission Level – Limit value
5. " * ": Fundamental frequency.

CHANNEL	TX Channel 11	DETECTOR FUNCTION	Peak (PK)
FREQUENCY RANGE	1GHz ~ 25GHz		Average (AV)

ANTENNA POLARITY & TEST DISTANCE: HORIZONTAL AT 3 M

NO.	FREQ. (MHz)	EMISSION LEVEL (dBuV/m)	LIMIT (dBuV/m)	MARGIN (dB)	ANTENNA HEIGHT (m)	TABLE ANGLE (Degree)	RAW VALUE (dBuV)	CORRECTION FACTOR (dB/m)
1	*2462.00	107.8 PK			1.00 H	350	74.06	33.74
2	*2462.00	97.7 AV			1.00 H	350	63.96	33.74
3	2483.50	67.8 PK	74.0	-6.2	1.00 H	350	33.99	33.81
4	2483.50	50.6 AV	54.0	-3.4	1.00 H	350	16.79	33.81
5	4924.00	49.0 PK	74.0	-25.0	1.00 H	97	5.73	43.27
6	4924.00	36.6 AV	54.0	-17.4	1.00 H	97	-6.67	43.27
7	7386.00	55.6 PK	74.0	-18.4	1.00 H	111	7.20	48.40
8	7386.00	43.6 AV	54.0	-10.4	1.00 H	111	-4.80	48.40

ANTENNA POLARITY & TEST DISTANCE: VERTICAL AT 3 M

NO.	FREQ. (MHz)	EMISSION LEVEL (dBuV/m)	LIMIT (dBuV/m)	MARGIN (dB)	ANTENNA HEIGHT (m)	TABLE ANGLE (Degree)	RAW VALUE (dBuV)	CORRECTION FACTOR (dB/m)
1	*2462.00	118.8 PK			1.25 V	320	85.06	33.74
2	*2462.00	110.3 AV			1.25 V	320	76.56	33.74
3	2484.00	73.5 PK	74.0	-0.5	1.25 V	320	39.69	33.81
4	2484.00	53.3 AV	54.0	-0.7	1.25 V	320	19.49	33.81
5	4924.00	44.8 PK	74.0	-29.2	1.05 V	265	1.53	43.27
6	4924.00	35.5 AV	54.0	-18.5	1.05 V	265	-7.77	43.27
7	7386.00	57.5 PK	74.0	-16.5	1.01 V	153	9.10	48.40
8	7386.00	45.5 AV	54.0	-8.5	1.01 V	153	-2.90	48.40

REMARKS:

1. Emission Level(dBuV/m) = Raw Value(dBuV) + Correction Factor(dB/m)
2. Correction Factor(dB/m) = Antenna Factor(dB/m) + Cable Factor(dB) – Pre-Amplifier Factor(dB)
3. The other emission levels were very low against the limit.
4. Margin value = Emission Level – Limit value
5. " * " : Fundamental frequency.



A D T

802.11n (HT40)

CHANNEL	TX Channel 3	DETECTOR FUNCTION	Peak (PK)
FREQUENCY RANGE	1GHz ~ 25GHz		Average (AV)

ANTENNA POLARITY & TEST DISTANCE: HORIZONTAL AT 3 M								
NO.	FREQ. (MHz)	EMISSION LEVEL (dBuV/m)	LIMIT (dBuV/m)	MARGIN (dB)	ANTENNA HEIGHT (m)	TABLE ANGLE (Degree)	RAW VALUE (dBuV)	CORRECTION FACTOR (dB/m)
1	2390.00	58.2 PK	74.0	-15.8	1.20 H	54	24.67	33.53
2	2390.00	42.5 AV	54.0	-11.5	1.20 H	54	8.97	33.53
3	*2422.00	101.1 PK			1.20 H	54	67.48	33.62
4	*2422.00	92.6 AV			1.20 H	54	58.98	33.62
5	4844.00	48.4 PK	74.0	-25.6	1.00 H	95	5.20	43.20
6	4844.00	35.7 AV	54.0	-18.3	1.00 H	95	-7.50	43.20
7	7266.00	55.5 PK	74.0	-18.5	1.00 H	132	7.59	47.91
8	7266.00	43.4 AV	54.0	-10.6	1.00 H	132	-4.51	47.91

ANTENNA POLARITY & TEST DISTANCE: VERTICAL AT 3 M								
NO.	FREQ. (MHz)	EMISSION LEVEL (dBuV/m)	LIMIT (dBuV/m)	MARGIN (dB)	ANTENNA HEIGHT (m)	TABLE ANGLE (Degree)	RAW VALUE (dBuV)	CORRECTION FACTOR (dB/m)
1	2390.00	68.9 PK	74.0	-5.1	1.23 V	251	35.37	33.53
2	2390.00	53.9 AV	54.0	-0.1	1.23 V	251	20.37	33.53
3	*2422.00	112.8 PK			1.21 V	251	79.18	33.62
4	*2422.00	101.7 AV			1.21 V	251	68.08	33.62
5	4844.00	48.5 PK	74.0	-25.5	1.03 V	232	5.30	43.20
6	4844.00	36.5 AV	54.0	-17.5	1.03 V	232	-6.70	43.20
7	7266.00	53.1 PK	74.0	-20.9	1.02 V	174	5.19	47.91
8	7266.00	44.6 AV	54.0	-9.4	1.02 V	174	-3.31	47.91

REMARKS:

1. Emission Level(dBuV/m) = Raw Value(dBuV) + Correction Factor(dB/m)
2. Correction Factor(dB/m) = Antenna Factor(dB/m) + Cable Factor(dB) – Pre-Amplifier Factor(dB)
3. The other emission levels were very low against the limit.
4. Margin value = Emission Level – Limit value
5. " * ": Fundamental frequency.



A D T

CHANNEL	TX Channel 6	DETECTOR FUNCTION	Peak (PK)
FREQUENCY RANGE	1GHz ~ 25GHz		Average (AV)

ANTENNA POLARITY & TEST DISTANCE: HORIZONTAL AT 3 M

NO.	FREQ. (MHz)	EMISSION LEVEL (dBuV/m)	LIMIT (dBuV/m)	MARGIN (dB)	ANTENNA HEIGHT (m)	TABLE ANGLE (Degree)	RAW VALUE (dBuV)	CORRECTION FACTOR (dB/m)
1	2390.00	63.5 PK	74.0	-10.5	1.01 H	331	29.97	33.53
2	2390.00	43.8 AV	54.0	-10.2	1.01 H	331	10.27	33.53
3	*2437.00	106.3 PK			1.01 H	331	72.63	33.67
4	*2437.00	96.2 AV			1.01 H	331	62.53	33.67
5	2486.00	68.1 PK	74.0	-5.9	1.01 H	331	34.28	33.82
6	2486.00	46.8 AV	54.0	-7.2	1.01 H	331	12.98	33.82
7	4874.00	48.1 PK	74.0	-25.9	1.00 H	126	4.86	43.24
8	4874.00	35.6 AV	54.0	-18.4	1.00 H	126	-7.64	43.24
9	7311.00	55.4 PK	74.0	-18.6	1.02 H	111	7.33	48.07
10	7311.00	43.5 AV	54.0	-10.5	1.02 H	111	-4.57	48.07

ANTENNA POLARITY & TEST DISTANCE: VERTICAL AT 3 M

NO.	FREQ. (MHz)	EMISSION LEVEL (dBuV/m)	LIMIT (dBuV/m)	MARGIN (dB)	ANTENNA HEIGHT (m)	TABLE ANGLE (Degree)	RAW VALUE (dBuV)	CORRECTION FACTOR (dB/m)
1	2390.00	72.8 PK	74.0	-1.2	1.26 V	252	39.30	33.50
2	2390.00	53.3 AV	54.0	-0.7	1.26 V	252	19.80	33.50
3	*2437.00	115.7 PK			1.26 V	252	82.00	33.70
4	*2437.00	105.3 AV			1.26 V	252	71.60	33.70
5	2486.00	73.2 PK	74.0	-0.8	1.26 V	252	39.40	33.80
6	2486.00	53.9 AV	54.0	-0.1	1.26 V	252	20.10	33.80
7	4874.00	50.1 PK	74.0	-23.9	1.20 V	233	6.90	43.20
8	4874.00	38.9 AV	54.0	-15.1	1.20 V	233	-4.30	43.20
9	7311.00	56.5 PK	74.0	-17.5	1.23 V	120	8.40	48.10
10	7311.00	44.3 AV	54.0	-9.7	1.23 V	120	-3.80	48.10

REMARKS:

1. Emission Level(dBuV/m) = Raw Value(dBuV) + Correction Factor(dB/m)
2. Correction Factor(dB/m) = Antenna Factor(dB/m) + Cable Factor(dB) – Pre-Amplifier Factor(dB)
3. The other emission levels were very low against the limit.
4. Margin value = Emission Level – Limit value
5. " * ": Fundamental frequency.

CHANNEL	TX Channel 9	DETECTOR FUNCTION	Peak (PK)
FREQUENCY RANGE	1GHz ~ 25GHz		Average (AV)

ANTENNA POLARITY & TEST DISTANCE: HORIZONTAL AT 3 M

NO.	FREQ. (MHz)	EMISSION LEVEL (dBuV/m)	LIMIT (dBuV/m)	MARGIN (dB)	ANTENNA HEIGHT (m)	TABLE ANGLE (Degree)	RAW VALUE (dBuV)	CORRECTION FACTOR (dB/m)
1	*2452.00	103.5 PK			1.06 H	349	69.79	33.71
2	*2452.00	93.2 AV			1.06 H	349	59.49	33.71
3	2483.50	62.6 PK	74.0	-11.4	1.06 H	349	28.79	33.81
4	2483.50	47.9 AV	54.0	-6.1	1.06 H	349	14.09	33.81
5	4904.00	48.5 PK	74.0	-25.5	1.03 H	96	5.23	43.27
6	4904.00	35.9 AV	54.0	-18.1	1.03 H	96	-7.37	43.27
7	7356.00	56.3 PK	74.0	-17.7	1.00 H	126	8.03	48.27
8	7356.00	44.0 AV	54.0	-10.0	1.00 H	126	-4.27	48.27

ANTENNA POLARITY & TEST DISTANCE: VERTICAL AT 3 M

NO.	FREQ. (MHz)	EMISSION LEVEL (dBuV/m)	LIMIT (dBuV/m)	MARGIN (dB)	ANTENNA HEIGHT (m)	TABLE ANGLE (Degree)	RAW VALUE (dBuV)	CORRECTION FACTOR (dB/m)
1	*2452.00	112.5 PK			1.22 V	260	78.79	33.71
2	*2452.00	101.2 AV			1.22 V	260	67.49	33.71
3	2483.50	70.1 PK	74.0	-3.9	1.22 V	260	36.29	33.81
4	2483.50	53.9 AV	54.0	-0.1	1.22 V	260	20.09	33.81
5	4904.00	49.5 PK	74.0	-24.5	1.00 V	254	6.23	43.27
6	4904.00	36.8 AV	54.0	-17.2	1.00 V	254	-6.47	43.27
7	7356.00	58.2 PK	74.0	-15.8	1.00 V	94	9.93	48.27
8	7356.00	44.8 AV	54.0	-9.2	1.00 V	94	-3.47	48.27

REMARKS:

1. Emission Level(dBuV/m) = Raw Value(dBuV) + Correction Factor(dB/m)
2. Correction Factor(dB/m) = Antenna Factor(dB/m) + Cable Factor(dB) – Pre-Amplifier Factor(dB)
3. The other emission levels were very low against the limit.
4. Margin value = Emission Level – Limit value
5. " * ": Fundamental frequency.

STBC_MODE

802.11n (HT20)

CHANNEL	TX Channel 1	DETECTOR FUNCTION	Peak (PK)
FREQUENCY RANGE	1GHz ~ 25GHz		Average (AV)

ANTENNA POLARITY & TEST DISTANCE: HORIZONTAL AT 3 M

NO.	FREQ. (MHz)	EMISSION LEVEL (dBuV/m)	LIMIT (dBuV/m)	MARGIN (dB)	ANTENNA HEIGHT (m)	TABLE ANGLE (Degree)	RAW VALUE (dBuV)	CORRECTION FACTOR (dB/m)
1	2390.00	66.6 PK	74.0	-7.4	1.11 H	171	33.07	33.53
2	2390.00	47.6 AV	54.0	-6.4	1.11 H	171	14.07	33.53
3	*2412.00	105.9 PK			1.11 H	171	72.31	33.59
4	*2412.00	95.5 AV			1.11 H	171	61.91	33.59
5	4824.00	44.6 PK	74.0	-29.4	1.00 H	334	1.42	43.18
6	4824.00	33.1 AV	54.0	-20.9	1.00 H	334	-10.08	43.18

ANTENNA POLARITY & TEST DISTANCE: VERTICAL AT 3 M

NO.	FREQ. (MHz)	EMISSION LEVEL (dBuV/m)	LIMIT (dBuV/m)	MARGIN (dB)	ANTENNA HEIGHT (m)	TABLE ANGLE (Degree)	RAW VALUE (dBuV)	CORRECTION FACTOR (dB/m)
1	2390.00	73.2 PK	74.0	-0.8	1.19 V	272	39.67	33.53
2	2390.00	53.9 AV	54.0	-0.1	1.19 V	272	20.37	33.53
3	*2412.00	116.7 PK			1.21 V	272	83.11	33.59
4	*2412.00	106.2 AV			1.21 V	272	72.61	33.59
5	4824.00	47.7 PK	74.0	-26.3	1.00 V	84	4.52	43.18
6	4824.00	35.1 AV	54.0	-18.9	1.00 V	84	-8.08	43.18

REMARKS:

1. Emission Level(dBuV/m) = Raw Value(dBuV) + Correction Factor(dB/m)
2. Correction Factor(dB/m) = Antenna Factor(dB/m) + Cable Factor(dB) – Pre-Amplifier Factor(dB)
3. The other emission levels were very low against the limit.
4. Margin value = Emission Level – Limit value
5. " * ": Fundamental frequency.



A D T

CHANNEL	TX Channel 6	DETECTOR FUNCTION	Peak (PK)
FREQUENCY RANGE	1GHz ~ 25GHz		Average (AV)

ANTENNA POLARITY & TEST DISTANCE: HORIZONTAL AT 3 M

NO.	FREQ. (MHz)	EMISSION LEVEL (dBuV/m)	LIMIT (dBuV/m)	MARGIN (dB)	ANTENNA HEIGHT (m)	TABLE ANGLE (Degree)	RAW VALUE (dBuV)	CORRECTION FACTOR (dB/m)
1	2390.00	58.6 PK	74.0	-15.4	1.15 H	160	25.07	33.53
2	2390.00	42.5 AV	54.0	-11.5	1.15 H	160	8.97	33.53
3	*2437.00	111.9 PK			1.15 H	160	78.23	33.67
4	*2437.00	101.6 AV			1.15 H	160	67.93	33.67
5	2483.50	59.8 PK	74.0	-14.2	1.15 H	160	25.99	33.81
6	2483.50	44.5 AV	54.0	-9.5	1.15 H	160	10.69	33.81
7	4874.00	46.1 PK	74.0	-27.9	1.00 H	323	2.86	43.24
8	4874.00	34.3 AV	54.0	-19.7	1.00 H	323	-8.94	43.24
9	7311.00	55.8 PK	74.0	-18.2	1.22 H	281	7.73	48.07
10	7311.00	42.9 AV	54.0	-11.1	1.22 H	281	-5.17	48.07

ANTENNA POLARITY & TEST DISTANCE: VERTICAL AT 3 M

NO.	FREQ. (MHz)	EMISSION LEVEL (dBuV/m)	LIMIT (dBuV/m)	MARGIN (dB)	ANTENNA HEIGHT (m)	TABLE ANGLE (Degree)	RAW VALUE (dBuV)	CORRECTION FACTOR (dB/m)
1	2390.00	65.3 PK	74.0	-8.7	1.18 V	271	31.77	33.53
2	2390.00	48.9 AV	54.0	-5.1	1.18 V	271	15.37	33.53
3	*2437.00	122.6 PK			1.18 V	271	88.93	33.67
4	*2437.00	112.0 AV			1.18 V	271	78.33	33.67
5	2483.50	66.0 PK	74.0	-8.0	1.18 V	271	32.19	33.81
6	2483.50	50.7 AV	54.0	-3.3	1.18 V	271	16.89	33.81
7	4874.00	47.8 PK	74.0	-26.2	1.00 V	101	4.56	43.24
8	4874.00	35.1 AV	54.0	-18.9	1.00 V	101	-8.14	43.24
9	7311.00	54.7 PK	74.0	-19.3	1.03 V	135	6.63	48.07
10	7311.00	42.3 AV	54.0	-11.7	1.03 V	135	-5.77	48.07

REMARKS:

1. Emission Level(dBuV/m) = Raw Value(dBuV) + Correction Factor(dB/m)
2. Correction Factor(dB/m) = Antenna Factor(dB/m) + Cable Factor(dB) – Pre-Amplifier Factor(dB)
3. The other emission levels were very low against the limit.
4. Margin value = Emission Level – Limit value
5. " * ": Fundamental frequency.



CHANNEL	TX Channel 11	DETECTOR FUNCTION	Peak (PK)
FREQUENCY RANGE	1GHz ~ 25GHz		Average (AV)

ANTENNA POLARITY & TEST DISTANCE: HORIZONTAL AT 3 M

NO.	FREQ. (MHz)	EMISSION LEVEL (dBuV/m)	LIMIT (dBuV/m)	MARGIN (dB)	ANTENNA HEIGHT (m)	TABLE ANGLE (Degree)	RAW VALUE (dBuV)	CORRECTION FACTOR (dB/m)
1	*2462.00	103.2 PK			1.01 H	157	69.46	33.74
2	*2462.00	94.2 AV			1.01 H	157	60.46	33.74
3	2483.50	64.3 PK	74.0	-9.7	1.01 H	157	30.49	33.81
4	2483.50	46.7 AV	54.0	-7.3	1.01 H	157	12.89	33.81
5	4924.00	45.5 PK	74.0	-28.5	1.00 H	330	2.23	43.27
6	4924.00	33.9 AV	54.0	-20.1	1.00 H	330	-9.37	43.27
7	7386.00	55.8 PK	74.0	-18.2	1.12 H	294	7.40	48.40
8	7386.00	43.1 AV	54.0	-10.9	1.12 H	294	-5.30	48.40

ANTENNA POLARITY & TEST DISTANCE: VERTICAL AT 3 M

NO.	FREQ. (MHz)	EMISSION LEVEL (dBuV/m)	LIMIT (dBuV/m)	MARGIN (dB)	ANTENNA HEIGHT (m)	TABLE ANGLE (Degree)	RAW VALUE (dBuV)	CORRECTION FACTOR (dB/m)
1	*2462.00	114.2 PK			1.05 V	69	80.46	33.74
2	*2462.00	105.1 AV			1.05 V	69	71.36	33.74
3	2483.50	71.3 PK	74.0	-2.7	1.05 V	69	37.49	33.81
4	2483.50	53.3 AV	54.0	-0.7	1.05 V	69	19.49	33.81
5	4924.00	47.9 PK	74.0	-26.1	1.00 V	115	4.63	43.27
6	4924.00	35.3 AV	54.0	-18.7	1.00 V	115	-7.97	43.27
7	7386.00	54.0 PK	74.0	-20.0	1.02 V	110	5.60	48.40
8	7386.00	42.0 AV	54.0	-12.0	1.02 V	110	-6.40	48.40

REMARKS:

1. Emission Level(dBuV/m) = Raw Value(dBuV) + Correction Factor(dB/m)
2. Correction Factor(dB/m) = Antenna Factor(dB/m) + Cable Factor(dB) – Pre-Amplifier Factor(dB)
3. The other emission levels were very low against the limit.
4. Margin value = Emission Level – Limit value
5. " * ": Fundamental frequency.



A D T

802.11n (HT40)

CHANNEL	TX Channel 3	DETECTOR FUNCTION	Peak (PK)
FREQUENCY RANGE	1GHz ~ 25GHz		Average (AV)

ANTENNA POLARITY & TEST DISTANCE: HORIZONTAL AT 3 M								
NO.	FREQ. (MHz)	EMISSION LEVEL (dBuV/m)	LIMIT (dBuV/m)	MARGIN (dB)	ANTENNA HEIGHT (m)	TABLE ANGLE (Degree)	RAW VALUE (dBuV)	CORRECTION FACTOR (dB/m)
1	2390.00	63.6 PK	74.0	-10.4	1.00 H	156	30.07	33.53
2	2390.00	47.6 AV	54.0	-6.4	1.00 H	156	14.07	33.53
3	*2422.00	99.8 PK			1.00 H	156	66.18	33.62
4	*2422.00	92.8 AV			1.00 H	156	59.18	33.62
5	4844.00	45.0 PK	74.0	-29.0	1.00 H	331	1.80	43.20
6	4844.00	33.8 AV	54.0	-20.2	1.00 H	331	-9.40	43.20
7	7266.00	55.5 PK	74.0	-18.5	1.07 H	298	7.59	47.91
8	7266.00	42.8 AV	54.0	-11.2	1.07 H	298	-5.11	47.91

ANTENNA POLARITY & TEST DISTANCE: VERTICAL AT 3 M								
NO.	FREQ. (MHz)	EMISSION LEVEL (dBuV/m)	LIMIT (dBuV/m)	MARGIN (dB)	ANTENNA HEIGHT (m)	TABLE ANGLE (Degree)	RAW VALUE (dBuV)	CORRECTION FACTOR (dB/m)
1	2390.00	69.7 PK	74.0	-4.3	1.08 V	69	36.17	33.53
2	2390.00	53.9 AV	54.0	-0.1	1.08 V	69	20.37	33.53
3	*2422.00	110.0 PK			1.08 V	69	76.38	33.62
4	*2422.00	102.6 AV			1.08 V	69	68.98	33.62
5	4844.00	46.6 PK	74.0	-27.4	1.00 V	104	3.40	43.20
6	4844.00	34.3 AV	54.0	-19.7	1.00 V	104	-8.90	43.20
7	7266.00	54.3 PK	74.0	-19.7	1.06 V	132	6.39	47.91
8	7266.00	42.4 AV	54.0	-11.6	1.06 V	132	-5.51	47.91

REMARKS:

1. Emission Level(dBuV/m) = Raw Value(dBuV) + Correction Factor(dB/m)
2. Correction Factor(dB/m) = Antenna Factor(dB/m) + Cable Factor(dB) – Pre-Amplifier Factor(dB)
3. The other emission levels were very low against the limit.
4. Margin value = Emission Level – Limit value
5. " * ": Fundamental frequency.



A D T

CHANNEL	TX Channel 6	DETECTOR FUNCTION	Peak (PK)
FREQUENCY RANGE	1GHz ~ 25GHz		Average (AV)

ANTENNA POLARITY & TEST DISTANCE: HORIZONTAL AT 3 M

NO.	FREQ. (MHz)	EMISSION LEVEL (dBuV/m)	LIMIT (dBuV/m)	MARGIN (dB)	ANTENNA HEIGHT (m)	TABLE ANGLE (Degree)	RAW VALUE (dBuV)	CORRECTION FACTOR (dB/m)
1	2390.00	62.5 PK	74.0	-11.5	1.01 H	148	28.97	33.53
2	2390.00	45.6 AV	54.0	-8.4	1.01 H	148	12.07	33.53
3	*2437.00	103.3 PK			1.01 H	148	69.63	33.67
4	*2437.00	96.9 AV			1.01 H	148	63.23	33.67
5	2483.50	64.4 PK	74.0	-9.6	1.01 H	148	30.59	33.81
6	2483.50	47.1 AV	54.0	-6.9	1.01 H	148	13.29	33.81
7	4874.00	45.4 PK	74.0	-28.6	1.00 H	339	2.16	43.24
8	4874.00	33.6 AV	54.0	-20.4	1.00 H	339	-9.64	43.24
9	7311.00	55.1 PK	74.0	-18.9	1.16 H	269	7.03	48.07
10	7311.00	42.8 AV	54.0	-11.2	1.16 H	269	-5.27	48.07

ANTENNA POLARITY & TEST DISTANCE: VERTICAL AT 3 M

NO.	FREQ. (MHz)	EMISSION LEVEL (dBuV/m)	LIMIT (dBuV/m)	MARGIN (dB)	ANTENNA HEIGHT (m)	TABLE ANGLE (Degree)	RAW VALUE (dBuV)	CORRECTION FACTOR (dB/m)
1	2390.00	68.8 PK	74.0	-5.2	1.04 V	76	35.27	33.53
2	2390.00	51.6 AV	54.0	-2.4	1.04 V	76	18.07	33.53
3	*2437.00	113.6 PK			1.04 V	76	79.93	33.67
4	*2437.00	106.8 AV			1.04 V	76	73.13	33.67
5	2483.50	71.2 PK	74.0	-2.8	1.04 V	76	37.39	33.81
6	2483.50	53.9 AV	54.0	-0.1	1.04 V	76	20.09	33.81
7	4874.00	47.8 PK	74.0	-26.2	1.01 V	78	4.56	43.24
8	4874.00	34.8 AV	54.0	-19.2	1.01 V	78	-8.44	43.24
9	7311.00	54.5 PK	74.0	-19.5	1.08 V	144	6.43	48.07
10	7311.00	42.4 AV	54.0	-11.6	1.08 V	144	-5.67	48.07

REMARKS:

1. Emission Level(dBuV/m) = Raw Value(dBuV) + Correction Factor(dB/m)
2. Correction Factor(dB/m) = Antenna Factor(dB/m) + Cable Factor(dB) – Pre-Amplifier Factor(dB)
3. The other emission levels were very low against the limit.
4. Margin value = Emission Level – Limit value
5. " * ": Fundamental frequency.



A D T

CHANNEL	TX Channel 9	DETECTOR FUNCTION	Peak (PK)
FREQUENCY RANGE	1GHz ~ 25GHz		Average (AV)

ANTENNA POLARITY & TEST DISTANCE: HORIZONTAL AT 3 M

NO.	FREQ. (MHz)	EMISSION LEVEL (dBuV/m)	LIMIT (dBuV/m)	MARGIN (dB)	ANTENNA HEIGHT (m)	TABLE ANGLE (Degree)	RAW VALUE (dBuV)	CORRECTION FACTOR (dB/m)
1	*2452.00	99.9 PK			1.05 H	157	66.19	33.71
2	*2452.00	92.4 AV			1.05 H	157	58.69	33.71
3	2483.50	64.6 PK	74.0	-9.4	1.05 H	157	30.79	33.81
4	2483.50	48.0 AV	54.0	-6.0	1.05 H	157	14.19	33.81
5	4904.00	45.5 PK	74.0	-28.5	1.05 H	338	2.23	43.27
6	4904.00	33.7 AV	54.0	-20.3	1.05 H	338	-9.57	43.27
7	7356.00	55.6 PK	74.0	-18.4	1.15 H	305	7.33	48.27
8	7356.00	43.0 AV	54.0	-11.0	1.15 H	305	-5.27	48.27

ANTENNA POLARITY & TEST DISTANCE: VERTICAL AT 3 M

NO.	FREQ. (MHz)	EMISSION LEVEL (dBuV/m)	LIMIT (dBuV/m)	MARGIN (dB)	ANTENNA HEIGHT (m)	TABLE ANGLE (Degree)	RAW VALUE (dBuV)	CORRECTION FACTOR (dB/m)
1	*2452.00	109.7 PK			1.04 V	75	75.99	33.71
2	*2452.00	102.3 AV			1.04 V	75	68.59	33.71
3	2483.50	70.2 PK	74.0	-3.8	1.04 V	75	36.39	33.81
4	2483.50	53.8 AV	54.0	-0.2	1.04 V	75	19.99	33.81
5	4904.00	47.6 PK	74.0	-26.4	1.00 V	90	4.33	43.27
6	4904.00	34.9 AV	54.0	-19.1	1.00 V	90	-8.37	43.27
7	7356.00	54.5 PK	74.0	-19.5	1.04 V	112	6.23	48.27
8	7356.00	41.9 AV	54.0	-12.1	1.04 V	112	-6.37	48.27

REMARKS:

1. Emission Level(dBuV/m) = Raw Value(dBuV) + Correction Factor(dB/m)
2. Correction Factor(dB/m) = Antenna Factor(dB/m) + Cable Factor(dB) – Pre-Amplifier Factor(dB)
3. The other emission levels were very low against the limit.
4. Margin value = Emission Level – Limit value
5. " * ": Fundamental frequency.

4.2.8 TEST RESULTS (MODE 2)

ABOVE 1GHz DATA

802.11b

CHANNEL	TX Channel 1	DETECTOR FUNCTION	Peak (PK)
FREQUENCY RANGE	1GHz ~ 25GHz		Average (AV)

ANTENNA POLARITY & TEST DISTANCE: HORIZONTAL AT 3 M								
NO.	FREQ. (MHz)	EMISSION LEVEL (dBuV/m)	LIMIT (dBuV/m)	MARGIN (dB)	ANTENNA HEIGHT (m)	TABLE ANGLE (Degree)	RAW VALUE (dBuV)	CORRECTION FACTOR (dB/m)
1	2390.00	51.3 PK	74.0	-22.7	1.24 H	51	17.77	33.53
2	2390.00	42.5 AV	54.0	-11.5	1.24 H	51	8.97	33.53
3	*2412.00	104.1 PK			1.24 H	51	70.51	33.59
4	*2412.00	101.5 AV			1.24 H	51	67.91	33.59
5	4824.00	51.5 PK	74.0	-22.5	1.05 H	63	8.32	43.18
6	4824.00	40.9 AV	54.0	-13.1	1.05 H	63	-2.28	43.18
ANTENNA POLARITY & TEST DISTANCE: VERTICAL AT 3 M								
NO.	FREQ. (MHz)	EMISSION LEVEL (dBuV/m)	LIMIT (dBuV/m)	MARGIN (dB)	ANTENNA HEIGHT (m)	TABLE ANGLE (Degree)	RAW VALUE (dBuV)	CORRECTION FACTOR (dB/m)
1	2390.00	61.8 PK	74.0	-12.2	1.18 V	275	28.27	33.53
2	2390.00	53.5 AV	54.0	-0.5	1.18 V	275	19.97	33.53
3	*2412.00	118.7 PK			1.18 V	275	85.11	33.59
4	*2412.00	116.4 AV			1.18 V	275	82.81	33.59
5	4824.00	50.1 PK	74.0	-23.9	1.22 V	278	6.92	43.18
6	4824.00	36.8 AV	54.0	-17.2	1.22 V	278	-6.38	43.18

REMARKS:

1. Emission Level(dBuV/m) = Raw Value(dBuV) + Correction Factor(dB/m)
2. Correction Factor(dB/m) = Antenna Factor(dB/m) + Cable Factor(dB) – Pre-Amplifier Factor(dB)
3. The other emission levels were very low against the limit.
4. Margin value = Emission Level – Limit value
5. " * ": Fundamental frequency.



A D T

CHANNEL	TX Channel 6	DETECTOR FUNCTION	Peak (PK)
FREQUENCY RANGE	1GHz ~ 25GHz		Average (AV)

ANTENNA POLARITY & TEST DISTANCE: HORIZONTAL AT 3 M

NO.	FREQ. (MHz)	EMISSION LEVEL (dBuV/m)	LIMIT (dBuV/m)	MARGIN (dB)	ANTENNA HEIGHT (m)	TABLE ANGLE (Degree)	RAW VALUE (dBuV)	CORRECTION FACTOR (dB/m)
1	2390.00	48.5 PK	74.0	-25.5	1.16 H	53	14.97	33.53
2	2390.00	36.5 AV	54.0	-17.5	1.16 H	53	2.97	33.53
3	*2437.00	107.4 PK			1.16 H	53	73.73	33.67
4	*2437.00	105.1 AV			1.16 H	53	71.43	33.67
5	2483.50	49.1 PK	74.0	-24.9	1.16 H	53	15.29	33.81
6	2483.50	36.9 AV	54.0	-17.1	1.16 H	53	3.09	33.81
7	4874.00	51.8 PK	74.0	-22.2	1.04 H	77	8.56	43.24
8	4874.00	41.0 AV	54.0	-13.0	1.04 H	77	-2.24	43.24
9	7311.00	55.4 PK	74.0	-18.6	1.22 H	62	7.33	48.07
10	7311.00	43.0 AV	54.0	-11.0	1.22 H	62	-5.07	48.07

ANTENNA POLARITY & TEST DISTANCE: VERTICAL AT 3 M

NO.	FREQ. (MHz)	EMISSION LEVEL (dBuV/m)	LIMIT (dBuV/m)	MARGIN (dB)	ANTENNA HEIGHT (m)	TABLE ANGLE (Degree)	RAW VALUE (dBuV)	CORRECTION FACTOR (dB/m)
1	2390.00	57.2 PK	74.0	-16.8	1.19 V	273	23.67	33.53
2	2390.00	45.3 AV	54.0	-8.7	1.19 V	273	11.77	33.53
3	*2437.00	118.8 PK			1.19 V	273	85.13	33.67
4	*2437.00	116.5 AV			1.19 V	273	82.83	33.67
5	2483.50	58.5 PK	74.0	-15.5	1.19 V	273	24.69	33.81
6	2483.50	46.1 AV	54.0	-7.9	1.19 V	273	12.29	33.81
7	3655.00	47.9 PK	74.0	-26.1	1.03 V	284	10.31	37.59
8	3655.00	41.8 AV	54.0	-12.2	1.03 V	284	4.21	37.59
9	4874.00	48.3 PK	74.0	-25.7	1.00 V	232	5.06	43.24
10	4874.00	38.4 AV	54.0	-15.6	1.00 V	232	-4.84	43.24
11	7311.00	56.1 PK	74.0	-17.9	1.00 V	270	8.03	48.07
12	7311.00	44.5 AV	54.0	-9.5	1.00 V	270	-3.57	48.07

REMARKS:

1. Emission Level(dBuV/m) = Raw Value(dBuV) + Correction Factor(dB/m)
2. Correction Factor(dB/m) = Antenna Factor(dB/m) + Cable Factor(dB) – Pre-Amplifier Factor(dB)
3. The other emission levels were very low against the limit.
4. Margin value = Emission Level – Limit value
5. " * ": Fundamental frequency.



A D T

CHANNEL	TX Channel 11	DETECTOR FUNCTION	Peak (PK)
FREQUENCY RANGE	1GHz ~ 25GHz		Average (AV)

ANTENNA POLARITY & TEST DISTANCE: HORIZONTAL AT 3 M

NO.	FREQ. (MHz)	EMISSION LEVEL (dBuV/m)	LIMIT (dBuV/m)	MARGIN (dB)	ANTENNA HEIGHT (m)	TABLE ANGLE (Degree)	RAW VALUE (dBuV)	CORRECTION FACTOR (dB/m)
1	*2462.00	106.4 PK			1.52 H	200	72.66	33.74
2	*2462.00	104.1 AV			1.52 H	200	70.36	33.74
3	2483.50	53.2 PK	74.0	-20.8	1.52 H	200	19.39	33.81
4	2483.50	45.3 AV	54.0	-8.7	1.52 H	200	11.49	33.81
5	4924.00	51.8 PK	74.0	-22.2	1.00 H	305	8.53	43.27
6	4924.00	40.2 AV	54.0	-13.8	1.00 H	305	-3.07	43.27
7	7386.00	57.2 PK	74.0	-16.8	1.05 H	135	8.80	48.40
8	7386.00	44.6 AV	54.0	-9.4	1.05 H	135	-3.80	48.40

ANTENNA POLARITY & TEST DISTANCE: VERTICAL AT 3 M

NO.	FREQ. (MHz)	EMISSION LEVEL (dBuV/m)	LIMIT (dBuV/m)	MARGIN (dB)	ANTENNA HEIGHT (m)	TABLE ANGLE (Degree)	RAW VALUE (dBuV)	CORRECTION FACTOR (dB/m)
1	*2462.00	118.7 PK			1.16 V	274	84.96	33.74
2	*2462.00	116.5 AV			1.16 V	274	82.76	33.74
3	2483.50	63.7 PK	74.0	-10.3	1.18 V	275	29.89	33.81
4	2483.50	53.7 AV	54.0	-0.3	1.18 V	275	19.89	33.81
5	4924.00	49.4 PK	74.0	-24.6	1.00 V	301	6.13	43.27
6	4924.00	36.8 AV	54.0	-17.2	1.00 V	301	-6.47	43.27
7	7386.00	57.2 PK	74.0	-16.8	1.00 V	257	8.80	48.40
8	7386.00	44.3 AV	54.0	-9.7	1.00 V	257	-4.10	48.40

REMARKS:

1. Emission Level(dBuV/m) = Raw Value(dBuV) + Correction Factor(dB/m)
2. Correction Factor(dB/m) = Antenna Factor(dB/m) + Cable Factor(dB) – Pre-Amplifier Factor(dB)
3. The other emission levels were very low against the limit.
4. Margin value = Emission Level – Limit value
5. " * " : Fundamental frequency.



A D T

802.11g

CHANNEL	TX Channel 1	DETECTOR FUNCTION	Peak (PK)
FREQUENCY RANGE	1GHz ~ 25GHz		Average (AV)

ANTENNA POLARITY & TEST DISTANCE: HORIZONTAL AT 3 M

NO.	FREQ. (MHz)	EMISSION LEVEL (dBuV/m)	LIMIT (dBuV/m)	MARGIN (dB)	ANTENNA HEIGHT (m)	TABLE ANGLE (Degree)	RAW VALUE (dBuV)	CORRECTION FACTOR (dB/m)
1	2390.00	64.1 PK	74.0	-9.9	1.20 H	51	30.57	33.53
2	2390.00	43.8 AV	54.0	-10.2	1.20 H	51	10.27	33.53
3	*2412.00	103.9 PK			1.20 H	51	70.31	33.59
4	*2412.00	94.2 AV			1.20 H	51	60.61	33.59
5	4824.00	49.0 PK	74.0	-25.0	1.04 H	116	5.82	43.18
6	4824.00	36.5 AV	54.0	-17.5	1.04 H	116	-6.68	43.18

ANTENNA POLARITY & TEST DISTANCE: VERTICAL AT 3 M

NO.	FREQ. (MHz)	EMISSION LEVEL (dBuV/m)	LIMIT (dBuV/m)	MARGIN (dB)	ANTENNA HEIGHT (m)	TABLE ANGLE (Degree)	RAW VALUE (dBuV)	CORRECTION FACTOR (dB/m)
1	2390.00	73.8 PK	74.0	-0.2	1.18 V	276	40.27	33.53
2	2390.00	53.9 AV	54.0	-0.1	1.18 V	276	20.37	33.53
3	*2412.00	115.9 PK			1.18 V	276	82.31	33.59
4	*2412.00	105.3 AV			1.18 V	276	71.71	33.59
5	4824.00	47.9 PK	74.0	-26.1	1.02 V	273	4.72	43.18
6	4824.00	37.4 AV	54.0	-16.6	1.02 V	273	-5.78	43.18

REMARKS:

1. Emission Level(dBuV/m) = Raw Value(dBuV) + Correction Factor(dB/m)
2. Correction Factor(dB/m) = Antenna Factor(dB/m) + Cable Factor(dB) – Pre-Amplifier Factor(dB)
3. The other emission levels were very low against the limit.
4. Margin value = Emission Level – Limit value
5. " * ": Fundamental frequency.



A D T

CHANNEL	TX Channel 6	DETECTOR FUNCTION	Peak (PK)
FREQUENCY RANGE	1GHz ~ 25GHz		Average (AV)

ANTENNA POLARITY & TEST DISTANCE: HORIZONTAL AT 3 M

NO.	FREQ. (MHz)	EMISSION LEVEL (dBuV/m)	LIMIT (dBuV/m)	MARGIN (dB)	ANTENNA HEIGHT (m)	TABLE ANGLE (Degree)	RAW VALUE (dBuV)	CORRECTION FACTOR (dB/m)
1	2390.00	55.5 PK	74.0	-18.5	1.18 H	50	21.97	33.53
2	2390.00	41.2 AV	54.0	-12.8	1.18 H	50	7.67	33.53
3	*2437.00	109.1 PK			1.18 H	50	75.43	33.67
4	*2437.00	99.7 AV			1.18 H	50	66.03	33.67
5	2483.50	55.6 PK	74.0	-18.4	1.18 H	50	21.79	33.81
6	2483.50	41.4 AV	54.0	-12.6	1.18 H	50	7.59	33.81
7	4874.00	48.7 PK	74.0	-25.3	1.00 H	111	5.46	43.24
8	4874.00	36.1 AV	54.0	-17.9	1.00 H	111	-7.14	43.24
9	7311.00	55.8 PK	74.0	-18.2	1.00 H	126	7.73	48.07
10	7311.00	43.6 AV	54.0	-10.4	1.00 H	126	-4.47	48.07

ANTENNA POLARITY & TEST DISTANCE: VERTICAL AT 3 M

NO.	FREQ. (MHz)	EMISSION LEVEL (dBuV/m)	LIMIT (dBuV/m)	MARGIN (dB)	ANTENNA HEIGHT (m)	TABLE ANGLE (Degree)	RAW VALUE (dBuV)	CORRECTION FACTOR (dB/m)
1	2390.00	56.8 PK	74.0	-17.2	1.01 V	157	23.27	33.53
2	2390.00	45.8 AV	54.0	-8.2	1.01 V	157	12.27	33.53
3	*2437.00	120.7 PK			1.20 V	278	87.03	33.67
4	*2437.00	110.5 AV			1.20 V	278	76.83	33.67
5	2483.50	68.5 PK	74.0	-5.5	1.20 V	278	34.69	33.81
6	2483.50	50.9 AV	54.0	-3.1	1.20 V	278	17.09	33.81
7	4874.00	48.9 PK	74.0	-25.1	1.00 V	235	5.66	43.24
8	4874.00	36.8 AV	54.0	-17.2	1.00 V	235	-6.44	43.24
9	7311.00	56.1 PK	74.0	-17.9	1.00 V	184	8.03	48.07
10	7311.00	44.3 AV	54.0	-9.7	1.00 V	184	-3.77	48.07

REMARKS:

1. Emission Level(dBuV/m) = Raw Value(dBuV) + Correction Factor(dB/m)
2. Correction Factor(dB/m) = Antenna Factor(dB/m) + Cable Factor(dB) – Pre-Amplifier Factor(dB)
3. The other emission levels were very low against the limit.
4. Margin value = Emission Level – Limit value
5. " * ": Fundamental frequency.



A D T

CHANNEL	TX Channel 11	DETECTOR FUNCTION	Peak (PK)
FREQUENCY RANGE	1GHz ~ 25GHz		Average (AV)

ANTENNA POLARITY & TEST DISTANCE: HORIZONTAL AT 3 M

NO.	FREQ. (MHz)	EMISSION LEVEL (dBuV/m)	LIMIT (dBuV/m)	MARGIN (dB)	ANTENNA HEIGHT (m)	TABLE ANGLE (Degree)	RAW VALUE (dBuV)	CORRECTION FACTOR (dB/m)
1	*2462.00	102.5 PK			1.53 H	200	68.76	33.74
2	*2462.00	93.2 AV			1.53 H	200	59.46	33.74
3	2483.50	63.2 PK	74.0	-10.8	1.53 H	200	29.39	33.81
4	2483.50	44.3 AV	54.0	-9.7	1.53 H	200	10.49	33.81
5	3692.00	51.4 PK	74.0	-22.6	1.24 H	215	13.66	37.74
6	3692.00	41.2 AV	54.0	-12.8	1.24 H	215	3.46	37.74
7	4924.00	48.6 PK	74.0	-25.4	1.06 H	122	5.33	43.27
8	4924.00	36.2 AV	54.0	-17.8	1.06 H	122	-7.07	43.27
9	7386.00	55.9 PK	74.0	-18.1	1.01 H	139	7.50	48.40
10	7386.00	43.7 AV	54.0	-10.3	1.01 H	139	-4.70	48.40

ANTENNA POLARITY & TEST DISTANCE: VERTICAL AT 3 M

NO.	FREQ. (MHz)	EMISSION LEVEL (dBuV/m)	LIMIT (dBuV/m)	MARGIN (dB)	ANTENNA HEIGHT (m)	TABLE ANGLE (Degree)	RAW VALUE (dBuV)	CORRECTION FACTOR (dB/m)
1	*2462.00	116.2 PK			1.20 V	276	82.46	33.74
2	*2462.00	104.5 AV			1.20 V	276	70.76	33.74
3	2483.50	73.2 PK	74.0	-0.8	1.20 V	276	39.39	33.81
4	2483.50	53.9 AV	54.0	-0.1	1.20 V	276	20.09	33.81
5	3692.00	47.5 PK	74.0	-26.5	1.14 V	247	9.76	37.74
6	3692.00	42.3 AV	54.0	-11.7	1.14 V	247	4.56	37.74
7	4924.00	48.1 PK	74.0	-25.9	1.02 V	274	4.83	43.27
8	4924.00	36.7 AV	54.0	-17.3	1.02 V	274	-6.57	43.27
9	7386.00	57.6 PK	74.0	-16.4	1.08 V	188	9.20	48.40
10	7386.00	44.8 AV	54.0	-9.2	1.08 V	188	-3.60	48.40

REMARKS:

1. Emission Level(dBuV/m) = Raw Value(dBuV) + Correction Factor(dB/m)
2. Correction Factor(dB/m) = Antenna Factor(dB/m) + Cable Factor(dB) – Pre-Amplifier Factor(dB)
3. The other emission levels were very low against the limit.
4. Margin value = Emission Level – Limit value
5. " * ": Fundamental frequency.

4.3 6dB BANDWIDTH MEASUREMENT

4.3.1 LIMITS OF 6dB BANDWIDTH MEASUREMENT

The minimum of 6dB Bandwidth Measurement is 0.5 MHz.

4.3.2 TEST INSTRUMENTS

DESCRIPTION & MANUFACTURER	MODEL NO.	SERIAL NO.	CALIBRATED DATE	CALIBRATED UNTIL
Spectrum Analyzer R&S	FSP40	100036	Jan. 21, 2013	Jan. 20, 2014

Note:

1. The calibration interval of the above test instruments is 12 months and the calibrations are traceable to NML/ROC and NIST/USA.
2. Tested date : Jan. 17, 2014

4.3.3 TEST PROCEDURE

1. Set resolution bandwidth (RBW) = 100kHz
2. Set the video bandwidth (VBW) $\geq 3 \times$ RBW, Detector = Peak.
3. Trace mode = max hold.
4. Sweep = auto couple.
5. Measure the maximum width of the emission that is constrained by the frequencies associated with the two amplitude points (upper and lower) that are attenuated by 6 dB relative to the maximum level measured in the fundamental emission

4.3.4 DEVIATION FROM TEST STANDARD

No deviation

4.3.5 TEST SETUP

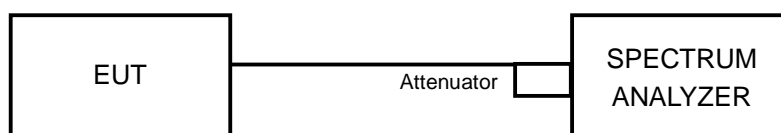

4.3.6 EUT OPERATING CONDITIONS

The software provided by client to enable the EUT under transmission condition continuously at lowest, middle and highest channel frequencies individually.



A D T

4.3.7 TEST RESULTS (MODE 1)

CDD_MODE						
CHANNEL	CHANNEL FREQUENCY (MHz)	6dB BANDWIDTH (MHz)			MINIMUM LIMIT (MHz)	PASS / FAIL
		CHAIN 0	CHAIN 1	CHAIN 2		
802.11n (HT20)						
1	2412	17.64	17.66	17.66	0.5	PASS
6	2437	17.64	17.66	17.66	0.5	PASS
11	2462	17.66	17.67	17.67	0.5	PASS
802.11n (HT40)						
3	2422	36.16	36.47	36.47	0.5	PASS
6	2437	36.04	36.52	36.49	0.5	PASS
9	2452	36.48	36.43	36.41	0.5	PASS

STBC_MODE						
CHANNEL	CHANNEL FREQUENCY (MHz)	6dB BANDWIDTH (MHz)			MINIMUM LIMIT (MHz)	PASS / FAIL
		CHAIN 0	CHAIN 1	CHAIN 2		
802.11n (HT20)						
1	2412	17.64	17.65	17.66	0.5	PASS
6	2437	17.64	17.66	17.66	0.5	PASS
11	2462	17.65	17.67	17.65	0.5	PASS
802.11n (HT40)						
3	2422	36.42	36.42	36.45	0.5	PASS
6	2437	36.16	36.46	36.48	0.5	PASS
9	2452	36.48	36.16	36.44	0.5	PASS

Beam forming_MODE						
CHANNEL	CHANNEL FREQUENCY (MHz)	6dB BANDWIDTH (MHz)			MINIMUM LIMIT (MHz)	PASS / FAIL
		CHAIN 0	CHAIN 1	CHAIN 2		
802.11n (HT20)						
1	2412	17.64	17.66	17.66	0.5	PASS
6	2437	17.64	17.66	17.66	0.5	PASS
11	2462	17.66	17.67	17.67	0.5	PASS
802.11n (HT40)						
3	2422	36.16	36.47	36.47	0.5	PASS
6	2437	36.04	36.52	36.49	0.5	PASS
9	2452	36.48	36.43	36.41	0.5	PASS

SPECTRUM PLOT OF WORST VALUE

CDD_MODE <802.11n (HT20)_Chain (0) / CH1> **CDD_MODE <802.11n (HT40)_Chain (0) / CH6>**

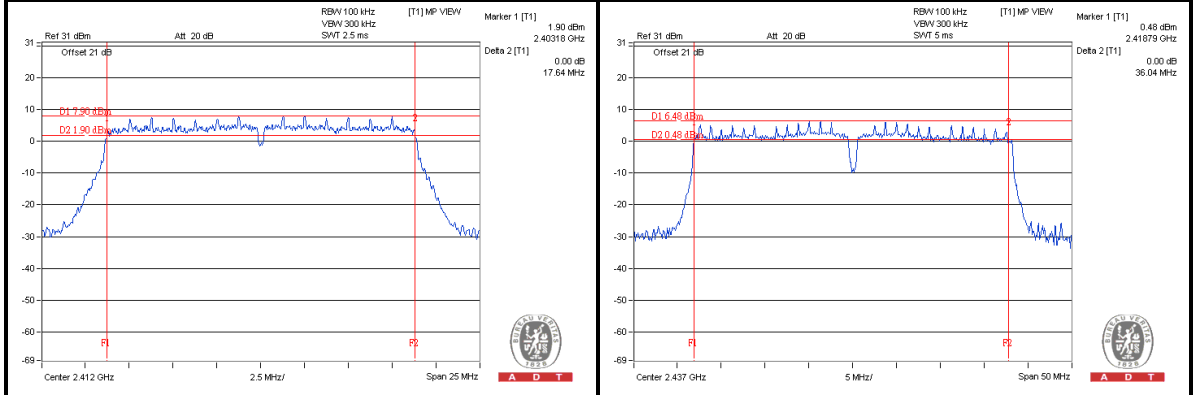

4.3.8 TEST RESULTS (MODE 2)

802.11b				
CHANNEL	FREQUENCY (MHz)	6dB BANDWIDTH (MHz)	MINIMUM LIMIT (MHz)	PASS / FAIL
1	2412	8.62	0.5	PASS
6	2437	8.64	0.5	PASS
11	2462	8.86	0.5	PASS
802.11g				
1	2412	16.39	0.5	PASS
6	2437	16.37	0.5	PASS
11	2462	16.42	0.5	PASS

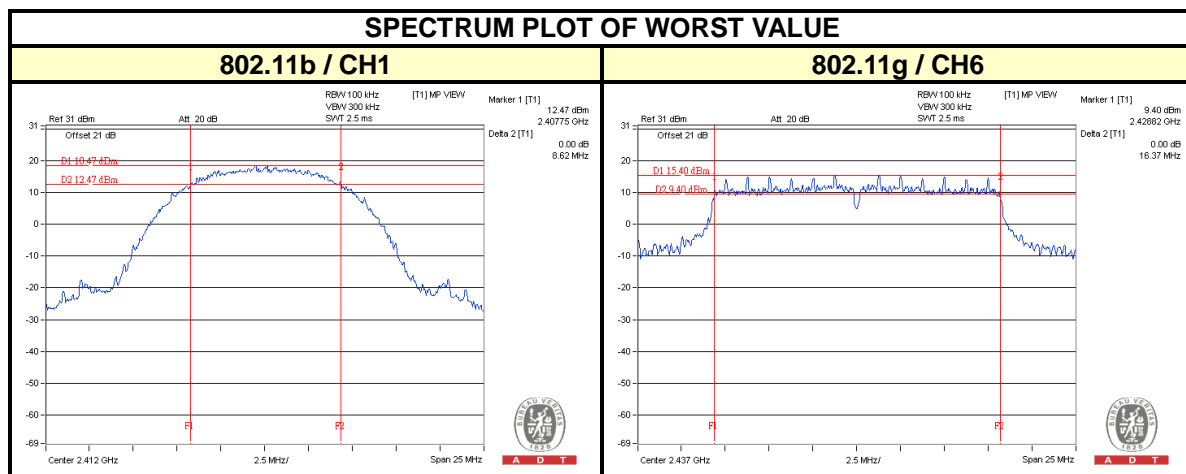

4.4 CONDUCTED OUTPUT POWER MEASUREMENT

4.4.1 LIMITS OF MAXIMUM OUTPUT POWER MEASUREMENT

For systems using digital modulation in the 2400–2483.5 MHz bands: 1 Watt (30dBm)

Per KDB 662911 D01 Multiple Transmitter Output Method of conducted output power measurement on IEEE 802.11 devices,

Array Gain = 0 dB (i.e., no array gain) for NANT \leq 4;

Array Gain = 0 dB (i.e., no array gain) for channel widths \geq 40 MHz for any NANT;

Array Gain = $5 \log(\text{NANT}/\text{NSS})$ dB or 3 dB, whichever is less for 20-MHz channel widths with NANT \geq 5.

For power measurements on all other devices: Array Gain = $10 \log(\text{NANT}/\text{NSS})$ dB.

4.4.2 INSTRUMENTS

DESCRIPTION & MANUFACTURER	MODEL NO.	SERIAL NO.	CALIBRATED DATE	CALIBRATED UNTIL
Power meter Anritsu	ML2495A	0824006	May 20, 2013	May 19, 2014
Power sensor Anritsu	MA2411B	0738172	May 20, 2013	May 19, 2014

Note:

1. The calibration interval of the above test instruments is 12 months and the calibrations are traceable to NML/ROC and NIST/USA.
2. Tested date : Jan. 17, 2014

4.4.3 TEST PROCEDURES

Method PM is used to perform output power measurement, trigger and gating function of wide band power meter is enabled to measure max output power of TX on burst. Duty factor is not added to measured value.

4.4.4 DEVIATION FROM TEST STANDARD

No deviation.

4.4.5 TEST SETUP

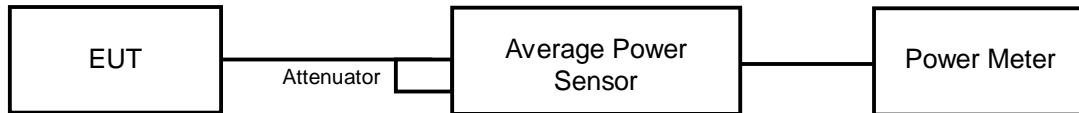

4.4.6 EUT OPERATING CONDITIONS

Same as Item 4.3.6



A D T

4.4.7 TEST RESULTS (MODE 1)

CDD_MODE								
CHANNEL	FREQUENCY (MHz)	AVERAGE POWER (dBm)			TOTAL POWER (mW)	TOTAL POWER (dBm)	LIMIT (dBm)	PASS / FAIL
		CHAIN 0	CHAIN 1	CHAIN 2				
802.11n (HT20)								
1	2412	19.33	19.45	19.47	262.321	24.19	30	PASS
6	2437	25.03	25.21	25.27	986.826	29.94	30	PASS
11	2462	18.15	18.33	18.41	202.733	23.07	30	PASS
802.11n (HT40)								
3	2422	16.69	16.71	16.87	142.188	21.53	30	PASS
6	2437	20.41	20.49	20.59	336.396	25.27	30	PASS
9	2452	16.17	16.15	16.31	125.366	20.98	30	PASS

STBC_MODE								
CHANNEL	FREQUENCY (MHz)	AVERAGE POWER (dBm)			TOTAL POWER (mW)	TOTAL POWER (dBm)	LIMIT (dBm)	PASS / FAIL
		CHAIN 0	CHAIN 1	CHAIN 2				
802.11n (HT20)								
1	2412	20.83	20.91	20.96	369.108	25.67	30	PASS
6	2437	25.03	25.21	25.27	986.826	29.94	30	PASS
11	2462	20.09	20.21	20.34	315.191	24.99	30	PASS
802.11n (HT40)								
3	2422	18.14	18.24	18.27	198.987	22.99	30	PASS
6	2437	21.37	21.42	21.53	417.997	26.21	30	PASS
9	2452	17.61	17.63	17.72	174.776	22.42	30	PASS

Beam forming_MODE								
CHANNEL	FREQUENCY (MHz)	AVERAGE POWER (dBm)			TOTAL POWER (mW)	TOTAL POWER (dBm)	LIMIT (dBm)	PASS / FAIL
		CHAIN 0	CHAIN 1	CHAIN 2				
802.11n (HT20)								
1	2412	19.33	19.45	19.47	262.321	24.19	30	PASS
6	2437	25.03	25.21	25.27	986.826	29.94	30	PASS
11	2462	18.15	18.33	18.41	202.733	23.07	30	PASS
802.11n (HT40)								
3	2422	16.69	16.71	16.87	142.188	21.53	30	PASS
6	2437	20.41	20.49	20.59	336.396	25.27	30	PASS
9	2452	16.17	16.15	16.31	125.366	20.98	30	PASS

NOTE: Directional gain = $10 \log[(10^{G1/20} + 10^{G2/20} + 10^{G3/20})^2 / 3] = 5.94\text{dBi} < 6\text{dBi}$, so the power limit shall not be reduced.



A D T

4.4.8 TEST RESULTS (MODE 2)

802.11b					
CHANNEL	FREQUENCY (MHz)	AVERAGE POWER (mW)	AVERAGE POWER (dBm)	LIMIT (dBm)	PASS/FAIL
1	2412	419.759	26.23	30	PASS
6	2437	497.737	26.97	30	PASS
11	2462	488.652	26.89	30	PASS
802.11g					
1	2412	130.918	21.17	30	PASS
6	2437	454.988	26.58	30	PASS
11	2462	115.611	20.63	30	PASS

4.5 POWER SPECTRAL DENSITY MEASUREMENT

4.5.1 LIMITS OF POWER SPECTRAL DENSITY MEASUREMENT

The Maximum of Power Spectral Density Measurement is 8dBm.

4.5.2 TEST INSTRUMENTS

DESCRIPTION & MANUFACTURER	MODEL NO.	SERIAL NO.	CALIBRATED DATE	CALIBRATED UNTIL
Spectrum Analyzer R&S	FSP 40	100036	Jan. 21, 2013	Jan. 20, 2014

Note:

1. The calibration interval of the above test instruments is 12 months and the calibrations are traceable to NML/ROC and NIST/USA.
2. Tested date : Jan. 17, 2014

4.5.3 TEST PROCEDURE

1. Set the RBW = 30 kHz, VBW =100 kHz, Detector = power averaging (RMS).
2. Ensure that the number of measurement points in the sweep $\geq 2 \times$ span/RBW
3. Sweep time = auto couple,
4. Employ trace averaging (RMS) mode over a minimum of 100 traces.
5. Use the peak marker function to determine the maximum amplitude level.

4.5.4 DEVIATION FROM TEST STANDARD

No deviation

4.5.5 TEST SETUP

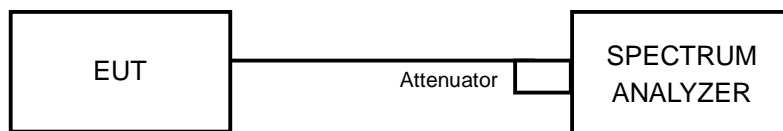

4.5.6 EUT OPERATING CONDITION

Same as Item 4.3.6



A D T

4.5.7 TEST RESULTS (MODE 1)

CDD_MODE

802.11n (HT20)

TX CHAIN	CHANNEL	FREQUENCY (MHz)	PSD (dBm)	10 log (N=3) dB	TOTAL PSD (dBm)	LIMIT (dBm)	PASS /FAIL
0	1	2412	-11.92	4.77	-7.15	8	PASS
	6	2437	-6.34	4.77	-1.57	8	PASS
	11	2462	-13.26	4.77	-8.49	8	PASS
1	1	2412	-12.25	4.77	-7.48	8	PASS
	6	2437	-4.87	4.77	-0.10	8	PASS
	11	2462	-12.73	4.77	-7.96	8	PASS
2	1	2412	-12.23	4.77	-7.46	8	PASS
	6	2437	-6.52	4.77	-1.75	8	PASS
	11	2462	-13.13	4.77	-8.36	8	PASS

NOTE: Directional gain = $10 \log[(10^{G1/20} + 10^{G2/20} + 10^{G3/20})^2 / 3] = 5.94\text{dBi} < 6\text{dBi}$, so the power density limit shall not be reduced.

802.11n (HT40)

TX CHAIN	CHANNEL	FREQ. (MHz)	PSD W/O DUTY FACTOR (dBm)	10 log (N=3) dB	DUTY FACTOR (dB)	TOTAL PSD WITH DUTY FACTOR (dBm)	LIMIT (dBm)	PASS /FAIL
0	3	2422	-15.72	4.77	0.1	-10.85	8	PASS
	6	2437	-11.59	4.77	0.1	-6.72	8	PASS
	9	2452	-16.32	4.77	0.1	-11.45	8	PASS
1	3	2422	-15.42	4.77	0.1	-10.55	8	PASS
	6	2437	-10.18	4.77	0.1	-5.31	8	PASS
	9	2452	-15.64	4.77	0.1	-10.77	8	PASS
2	3	2422	-15.95	4.77	0.1	-11.08	8	PASS
	6	2437	-12.38	4.77	0.1	-7.51	8	PASS
	9	2452	-15.81	4.77	0.1	-10.94	8	PASS

NOTE: 1. Directional gain = $10 \log[(10^{G1/20} + 10^{G2/20} + 10^{G3/20})^2 / 3] = 5.94\text{dBi} < 6\text{dBi}$, so the power density limit shall not be reduced.
 2. Refer to section 3.4 for duty cycle spectrum plot.



A D T

STBC_MODE

802.11n (HT20)							
TX CHAIN	CHANNEL	FREQUENCY (MHz)	PSD (dBm)	10 log (N=3) dB	TOTAL PSD (dBm)	LIMIT (dBm)	PASS /FAIL
0	1	2412	-10.33	4.77	-5.56	8	PASS
	6	2437	-6.34	4.77	-1.57	8	PASS
	11	2462	-11.11	4.77	-6.34	8	PASS
1	1	2412	-9.79	4.77	-5.02	8	PASS
	6	2437	-4.87	4.77	-0.10	8	PASS
	11	2462	-11.10	4.77	-6.33	8	PASS
2	1	2412	-10.15	4.77	-5.38	8	PASS
	6	2437	-6.52	4.77	-1.75	8	PASS
	11	2462	-10.36	4.77	-5.59	8	PASS

802.11n (HT40)								
TX CHAIN	CHANNEL	FREQ. (MHz)	PSD W/O DUTY FACTOR (dBm)	10 log (N=3) dB	DUTY FACTOR (dB)	TOTAL PSD WITH DUTY FACTOR (dBm)	LIMIT (dBm)	PASS /FAIL
0	3	2422	-14.06	4.77	0.1	-9.19	8	PASS
	6	2437	-10.77	4.77	0.1	-5.90	8	PASS
	9	2452	-14.63	4.77	0.1	-9.76	8	PASS
1	3	2422	-14.00	4.77	0.1	-9.13	8	PASS
	6	2437	-11.18	4.77	0.1	-6.31	8	PASS
	9	2452	-14.30	4.77	0.1	-9.43	8	PASS
2	3	2422	-14.54	4.77	0.1	-9.67	8	PASS
	6	2437	-11.23	4.77	0.1	-6.36	8	PASS
	9	2452	-14.41	4.77	0.1	-9.54	8	PASS

NOTE: 1. Directional gain = $10 \log[(10^{G1/20} + 10^{G2/20} + 10^{G3/20})^2 / 3] = 5.94\text{dBi} < 6\text{dBi}$, so the power density limit shall not be reduced.
 2. Refer to section 3.4 for duty cycle spectrum plot.



A D T

Beam forming_MODE

802.11n (HT20)

TX CHAIN	CHANNEL	FREQUENCY (MHz)	PSD (dBm)	10 log (N=3) dB	TOTAL PSD (dBm)	LIMIT (dBm)	PASS /FAIL
0	1	2412	-11.92	4.77	-7.15	8	PASS
	6	2437	-6.34	4.77	-1.57	8	PASS
	11	2462	-13.26	4.77	-8.49	8	PASS
1	1	2412	-12.25	4.77	-7.48	8	PASS
	6	2437	-4.87	4.77	-0.10	8	PASS
	11	2462	-12.73	4.77	-7.96	8	PASS
2	1	2412	-12.23	4.77	-7.46	8	PASS
	6	2437	-6.52	4.77	-1.75	8	PASS
	11	2462	-13.13	4.77	-8.36	8	PASS

NOTE: Directional gain = $10 \log[(10^{G1/20} + 10^{G2/20} + 10^{G3/20})^2 / 3] = 5.94\text{dBi} < 6\text{dBi}$, so the power density limit shall not be reduced.

802.11n (HT40)

TX CHAIN	CHANNEL	FREQ. (MHz)	PSD W/O DUTY FACTOR (dBm)	10 log (N=3) dB	DUTY FACTOR (dB)	TOTAL PSD WITH DUTY FACTOR (dBm)	LIMIT (dBm)	PASS /FAIL
0	3	2422	-15.72	4.77	0.1	-10.85	8	PASS
	6	2437	-11.59	4.77	0.1	-6.72	8	PASS
	9	2452	-16.32	4.77	0.1	-11.45	8	PASS
1	3	2422	-15.42	4.77	0.1	-10.55	8	PASS
	6	2437	-10.18	4.77	0.1	-5.31	8	PASS
	9	2452	-15.64	4.77	0.1	-10.77	8	PASS
2	3	2422	-15.95	4.77	0.1	-11.08	8	PASS
	6	2437	-12.38	4.77	0.1	-7.51	8	PASS
	9	2452	-15.81	4.77	0.1	-10.94	8	PASS

NOTE: 1. Directional gain = $10 \log[(10^{G1/20} + 10^{G2/20} + 10^{G3/20})^2 / 3] = 5.94\text{dBi} < 6\text{dBi}$, so the power density limit shall not be reduced.
 2. Refer to section 3.4 for duty cycle spectrum plot.



A D T

SPECTRUM PLOT OF WORST VALUE

CDD_MODE <802.11n (HT20)_Chain (1) / CH6>

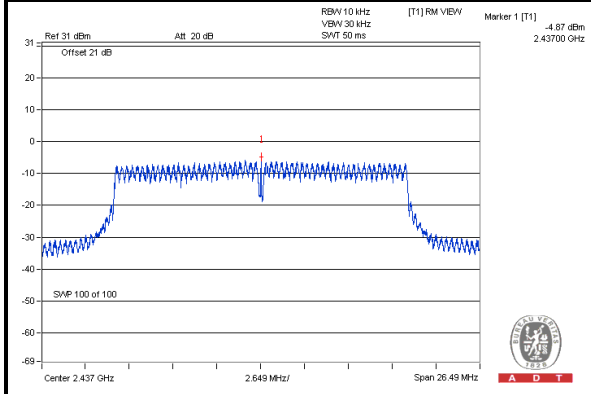

CDD_MODE <802.11n (HT40)_Chain (1) / CH6>

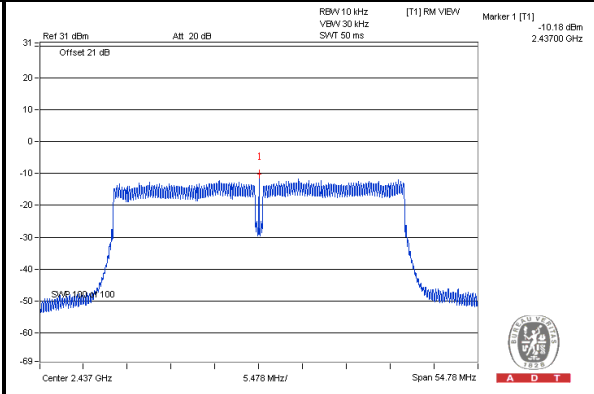



A D T

4.5.8 TEST RESULTS (MODE 2)

802.11b				
CHANNEL	FREQUENCY (MHz)	PSD (dBm)	LIMIT (dBm)	PASS /FAIL
1	2412	-2.50	8	PASS
6	2437	-1.67	8	PASS
11	2462	-2.48	8	PASS

802.11g				
CHANNEL	FREQUENCY (MHz)	PSD (dBm)	LIMIT (dBm)	PASS /FAIL
1	2412	-8.89	8	PASS
6	2437	-3.76	8	PASS
11	2462	-9.83	8	PASS

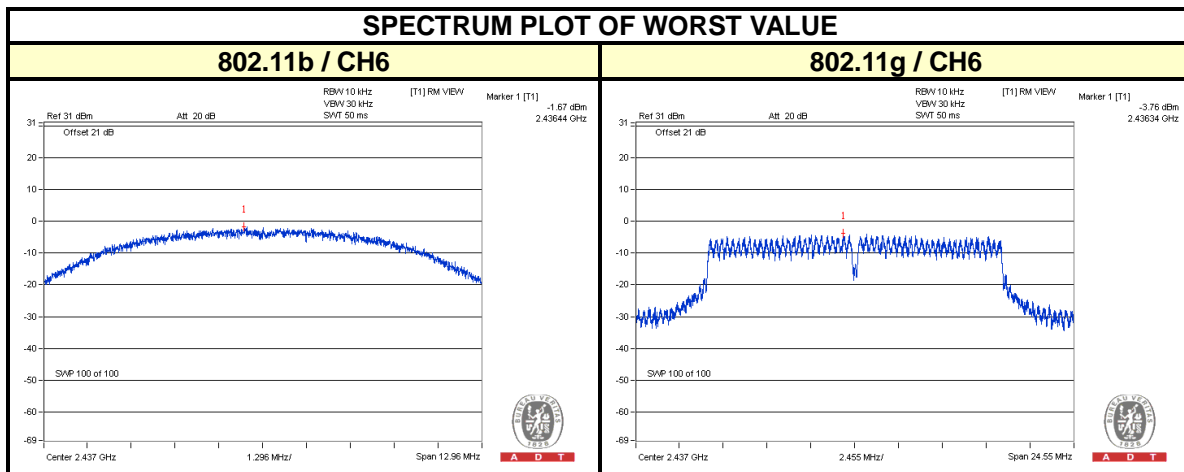

4.6 CONDUCTED OUT-BAND EMISSION MEASUREMENT

4.6.1 LIMITS OF CONDUCTED OUT-BAND EMISSION MEASUREMENT

Below 30dB of the highest emission level of operating band (in 100kHz Resolution Bandwidth).

4.6.2 TEST INSTRUMENTS

DESCRIPTION & MANUFACTURER	MODEL NO.	SERIAL NO.	CALIBRATED DATE	CALIBRATED UNTIL
Spectrum Analyzer R&S	FSP 40	100036	Jan. 21, 2013	Jan. 20, 2014

Note:

1. The calibration interval of the above test instruments is 12 months and the calibrations are traceable to NML/ROC and NIST/USA.
2. Tested date : Jan. 17, 2014

4.6.3 TEST PROCEDURE

Measurement Procedure - Reference Level

1. Set the RBW = 100 kHz.
2. Set the VBW \geq 300 kHz.
3. Detector = peak.
4. Sweep time = auto couple.
5. Trace mode = max hold.
6. Allow trace to fully stabilize.
7. Use the peak marker function to determine the maximum power level in any 100 kHz band segment within the fundamental EBW.

Measurement Procedure –Unwanted Emission Level

1. Set RBW = 100 kHz.
2. Set VBW \geq 300 kHz.
3. Set span to encompass the spectrum to be examined
4. Detector = peak.
5. Trace Mode = max hold.
6. Sweep = auto couple.

4.6.4 DEVIATION FROM TEST STANDARD

No deviation

4.6.5 TEST SETUP

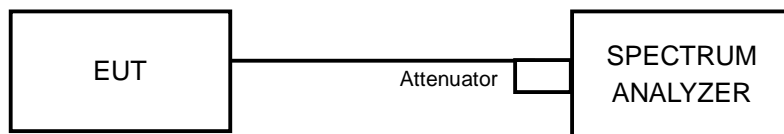

4.6.6 EUT OPERATING CONDITION

Same as Item 4.3.6

4.6.7 TEST RESULTS

The spectrum plots are attached on the following pages. D1 line indicates the highest level, and D2 line indicates the 30dB offset below D1. It shows compliance with the requirement.



A D T

4.6.7.1 TEST RESULTS (MODE 1) CDD_MODE<802.11n (HT20)>

Maximum REF

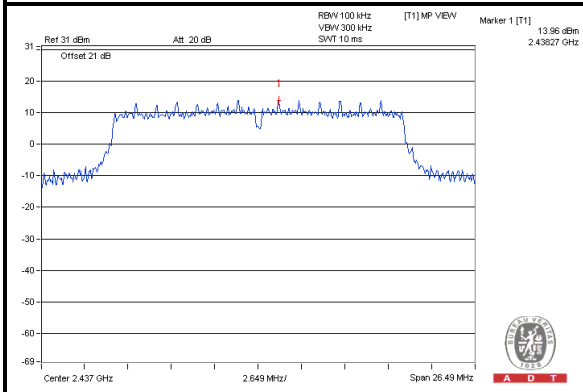

Chain (0)

CH 1

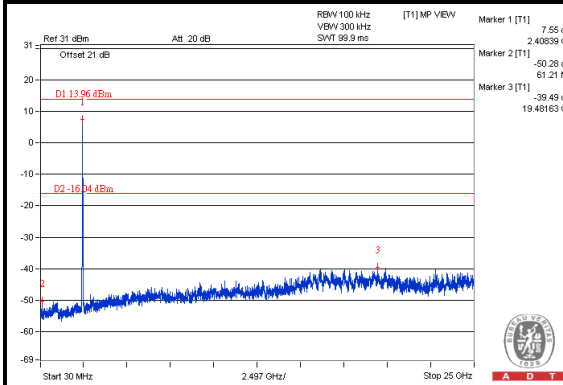

CH 6

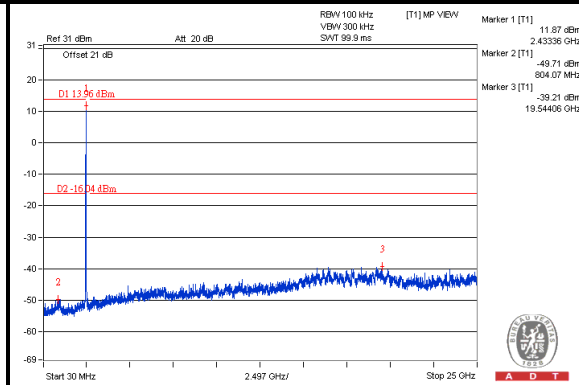

CH 11

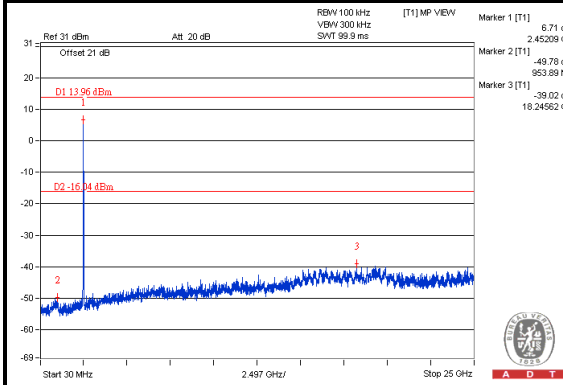

CH 1 Band edge

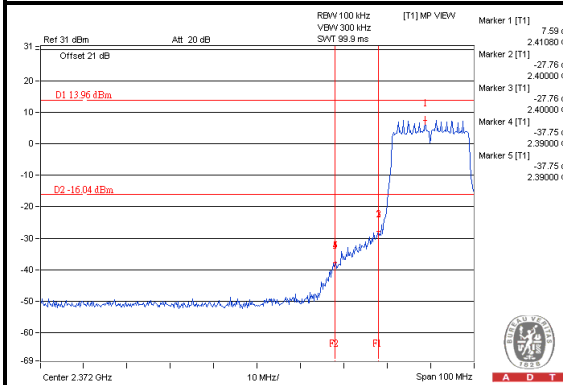

CH 11 Band edge

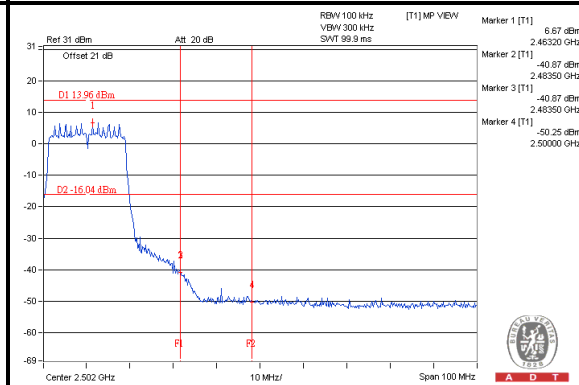



A D T

Chain (1)

CH 1

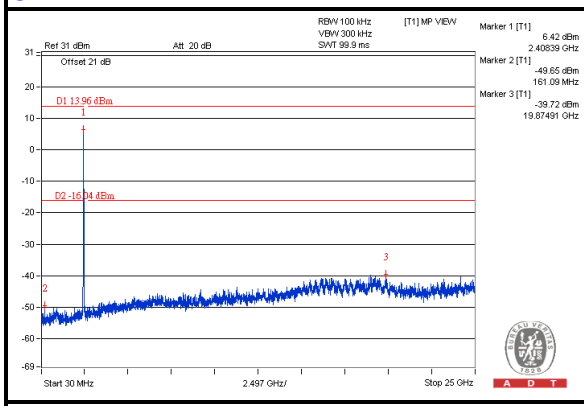

CH 6

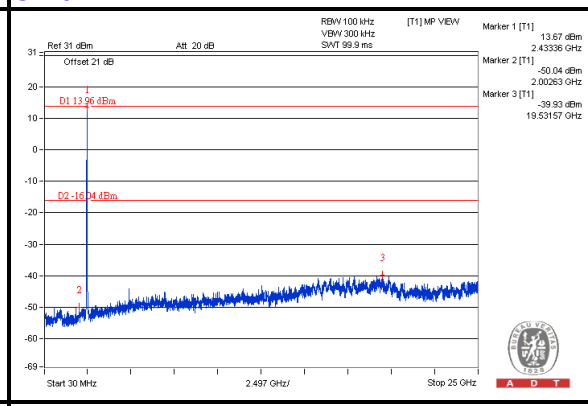

CH 11

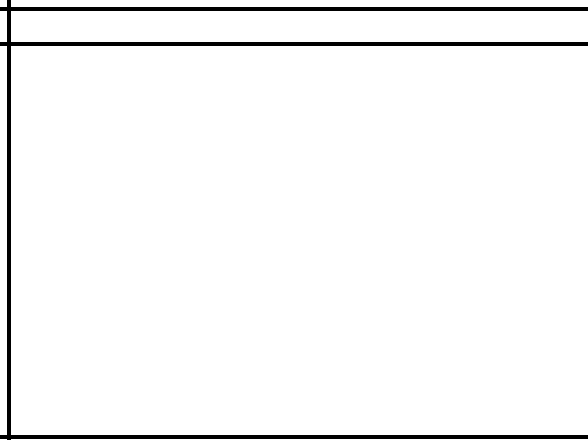
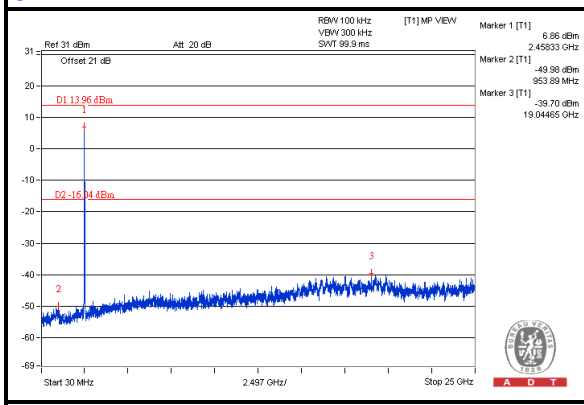

CH 1 Band edge

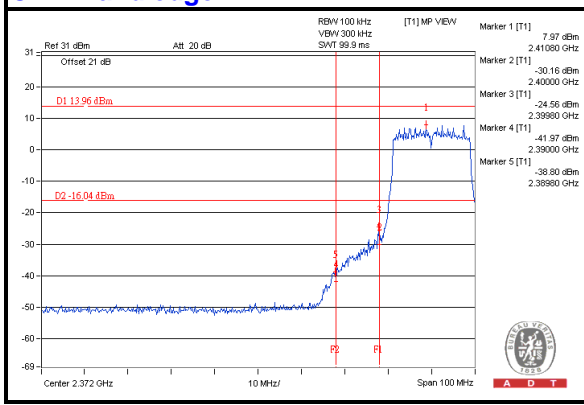

CH 11 Band edge

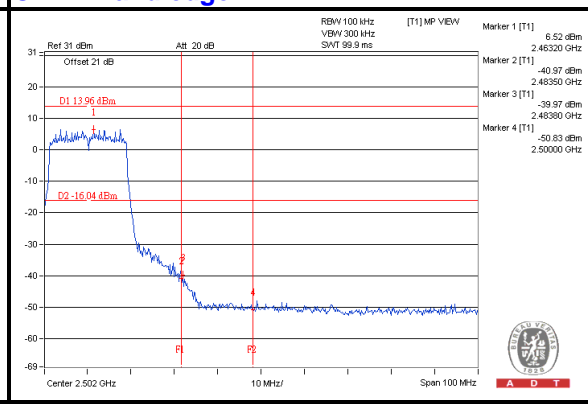



A D T

Chain (2)

CH 1

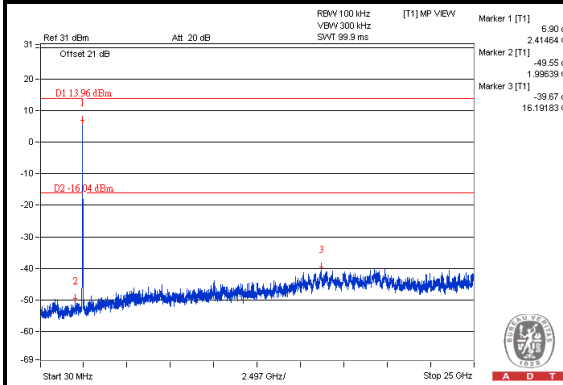

CH 6

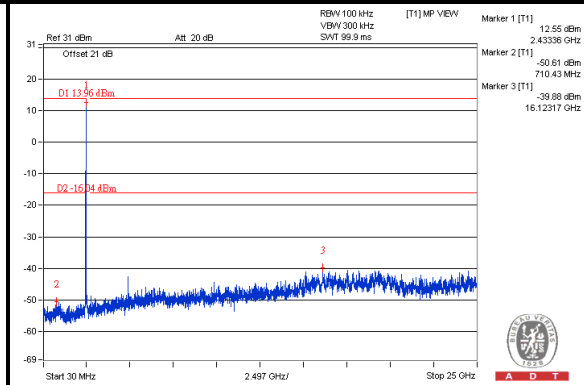

CH 11

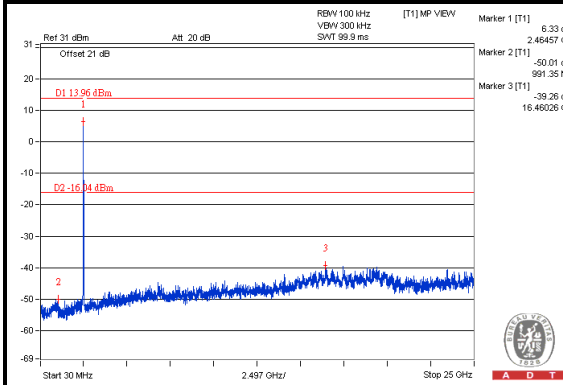

CH 1 Band edge

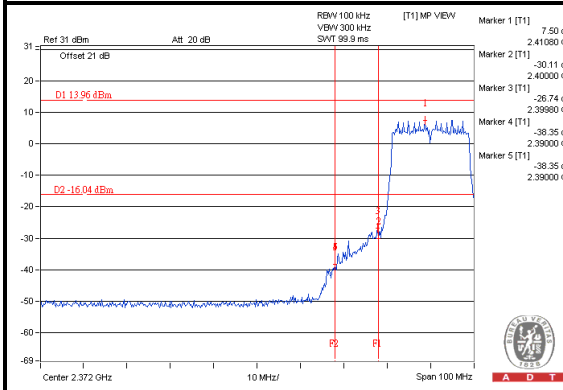

CH 11 Band edge

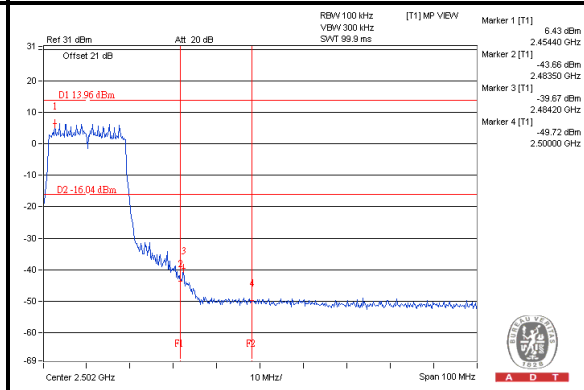



A D T

CDD_MODE<802.11n (HT40)>

Maximum REF

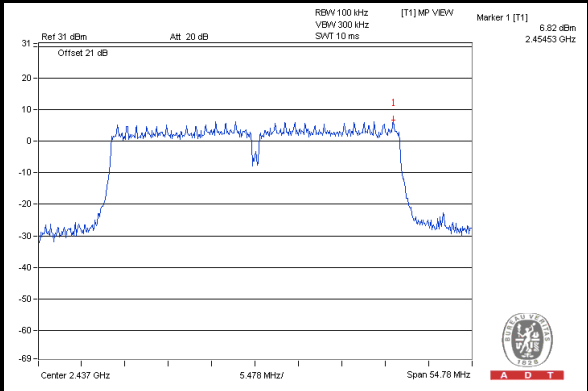

Chain (0)

CH 3

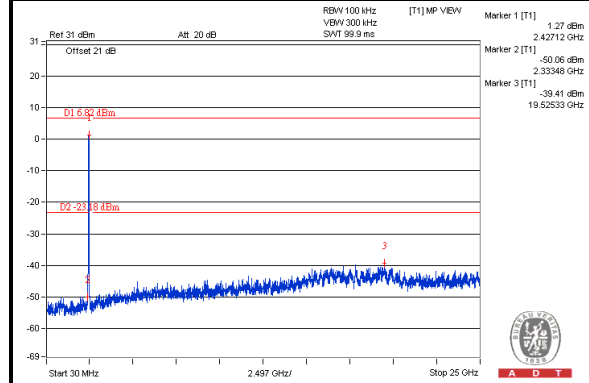

CH 6

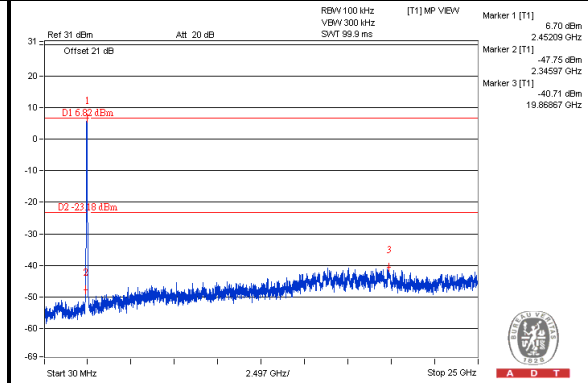

CH 9

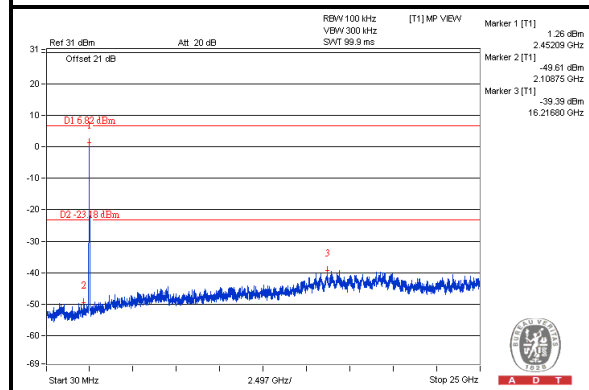

CH 3 Band edge

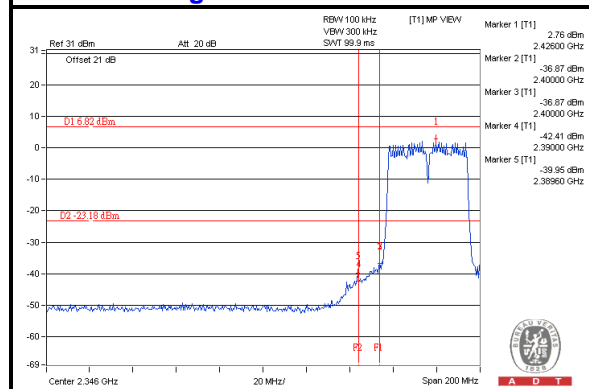

CH 9 Band edge

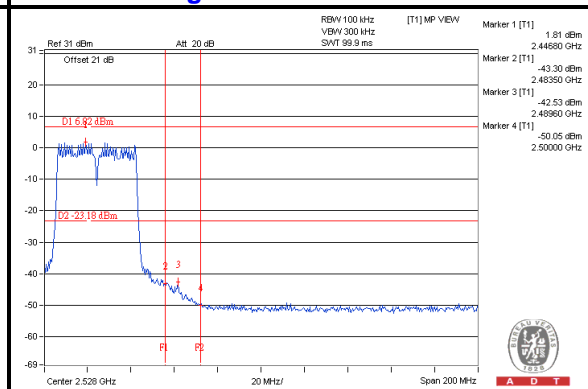



A D T

Chain (1)

CH 3

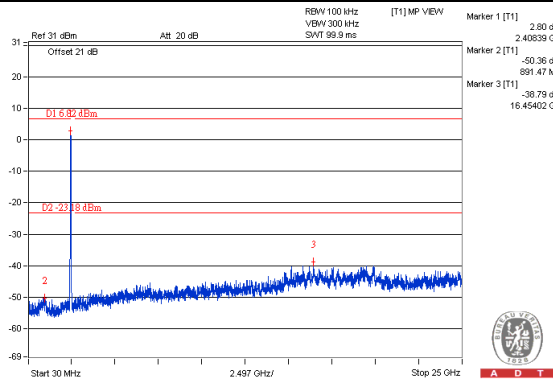

CH 6

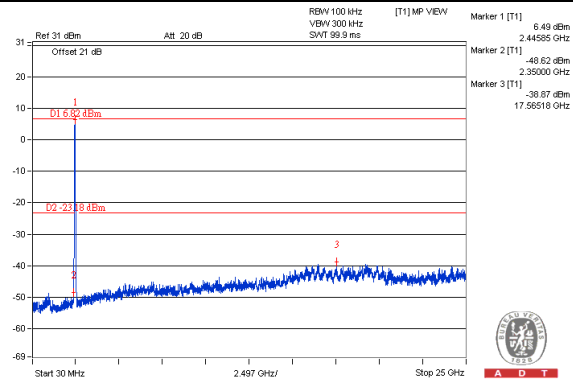

CH 9

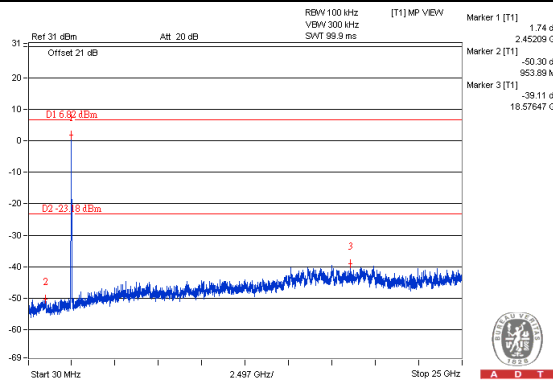

CH 3 Band edge

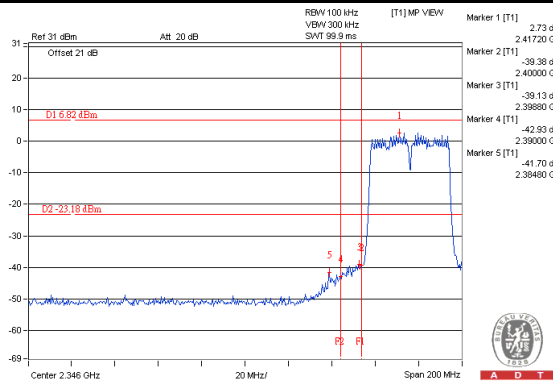

CH 9 Band edge

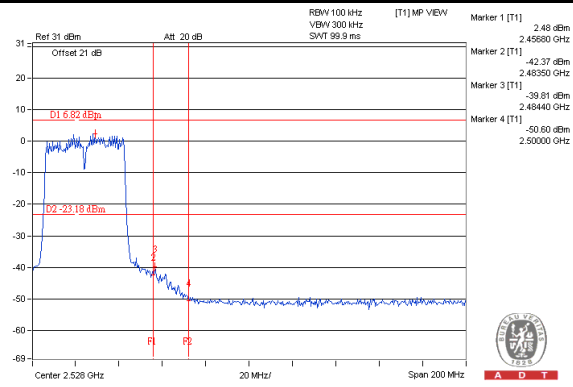



A D T

Chain (2)

CH 3

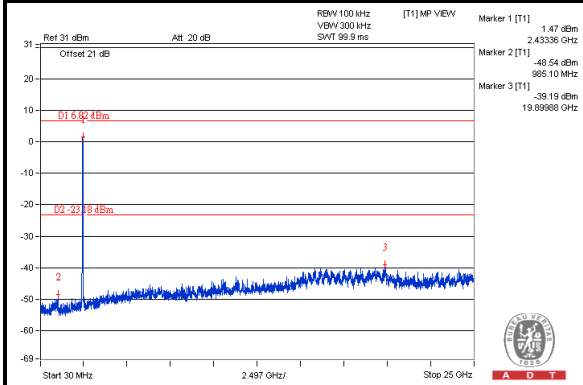

CH 6

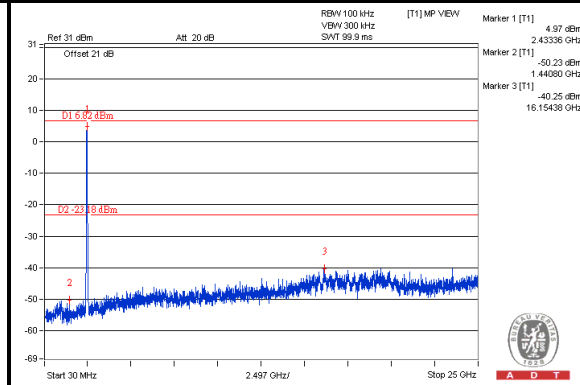

CH 9

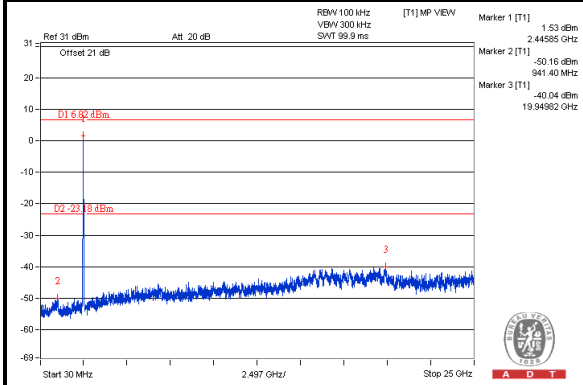

CH 3 Band edge

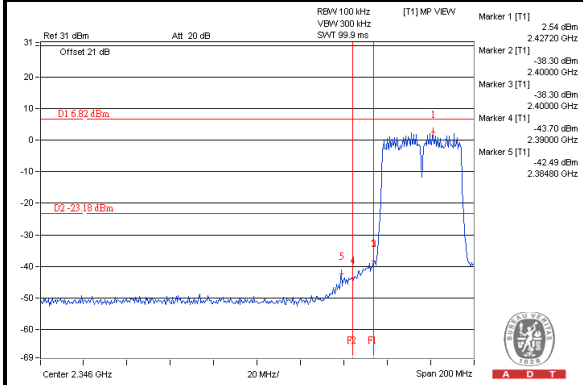

CH 9 Band edge

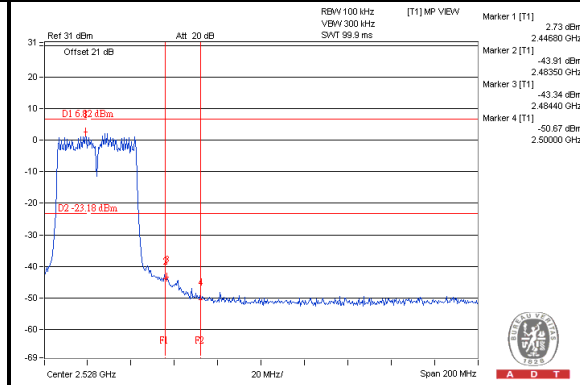



A D T

STBC_MODE<802.11n (HT20)>

Maximum REF

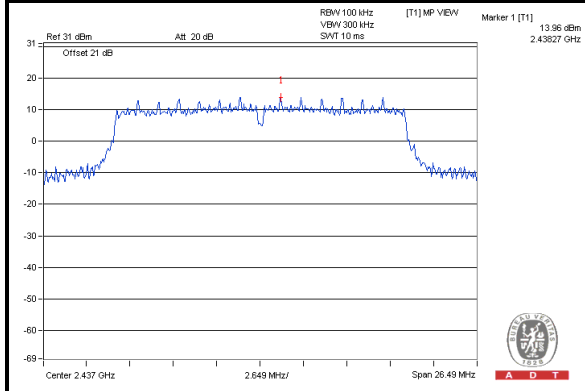

Chain (0)

CH 1

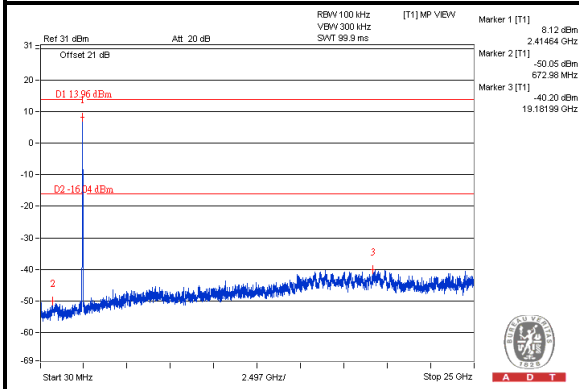

CH 6

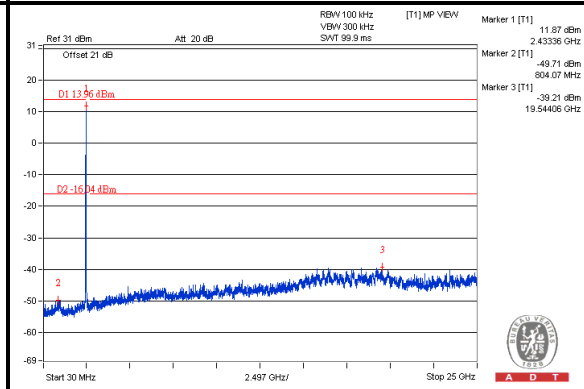

CH 11

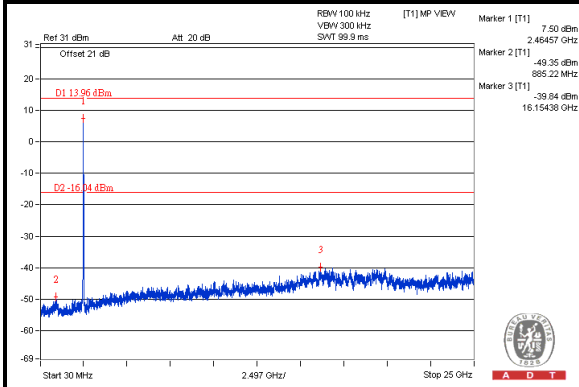

CH 1 Band edge

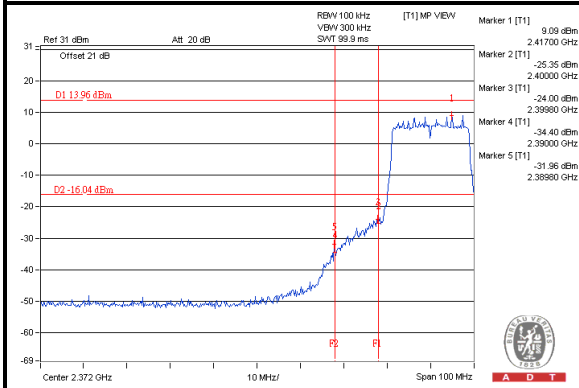

CH 11 Band edge

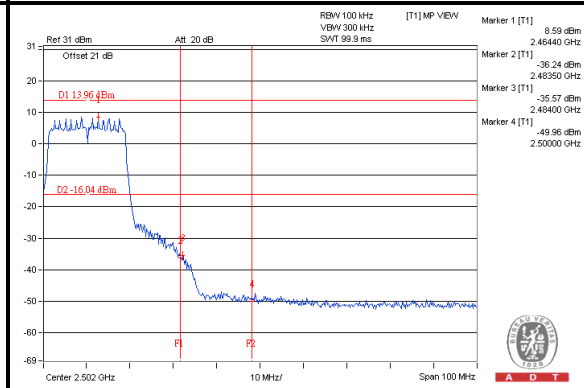



A D T

Chain (1)

CH 1

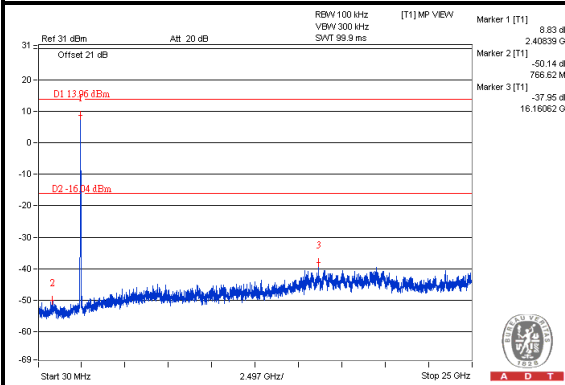

CH 6

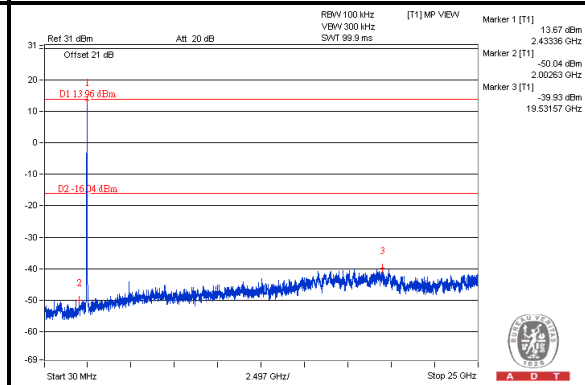

CH 11

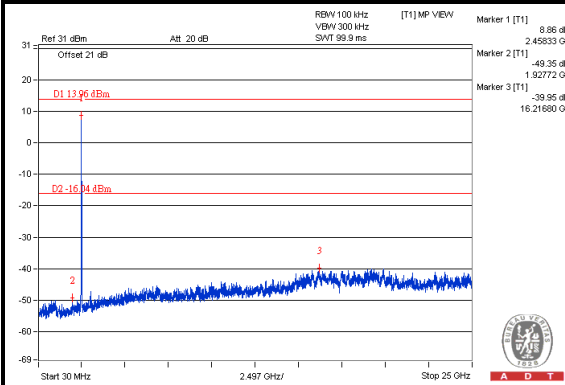

CH 1 Band edge

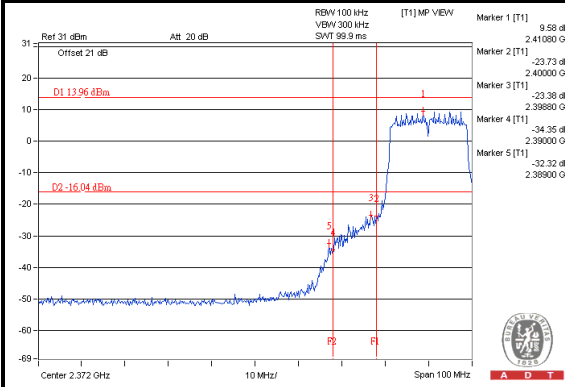

CH 11 Band edge

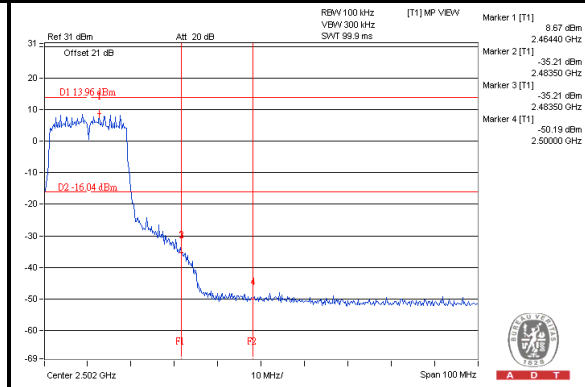



A D T

Chain (2)

CH 1

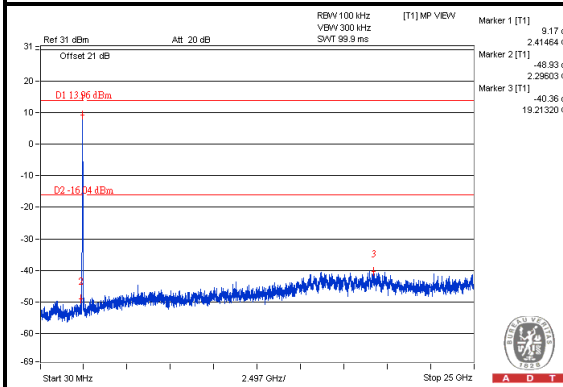

CH 6

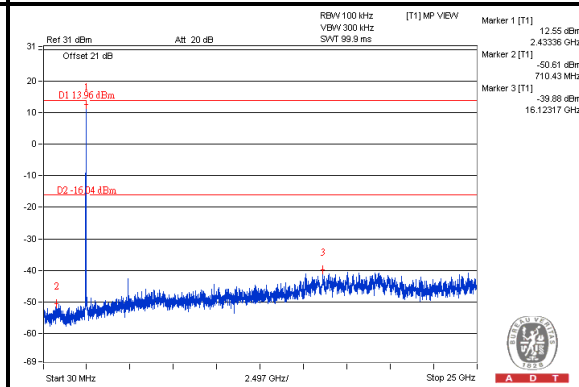

CH 11

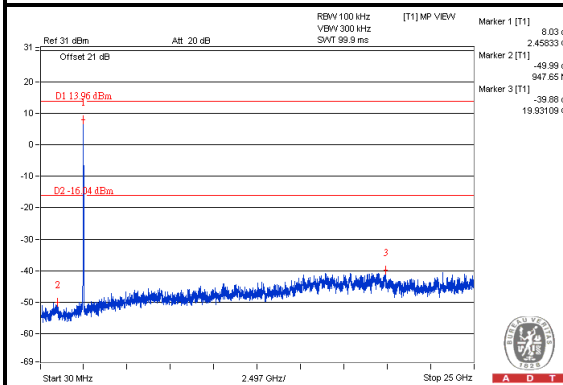

CH 1 Band edge

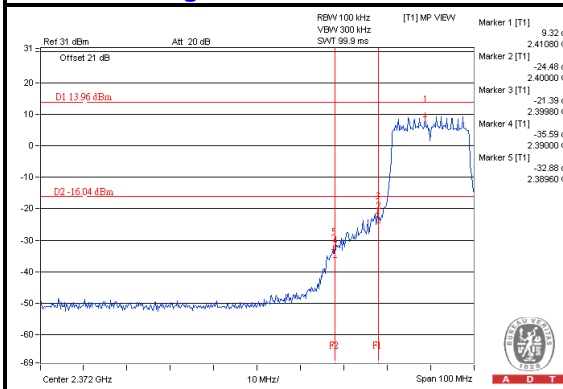

CH 11 Band edge

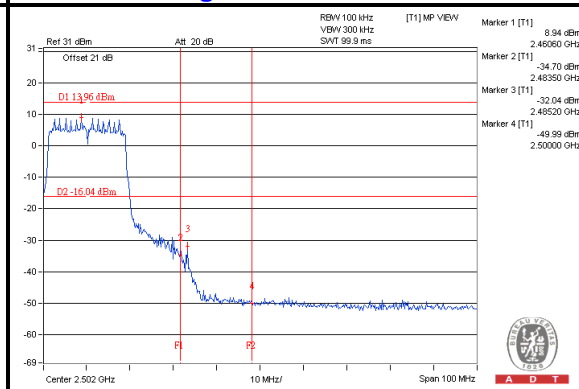



A D T

STBC_MODE<802.11n (HT40)>

Maximum REF

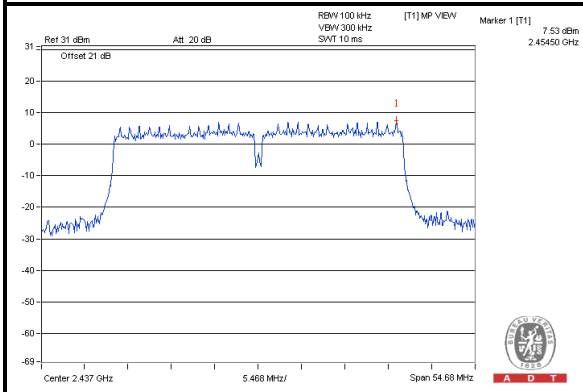

Chain (0)

CH 3

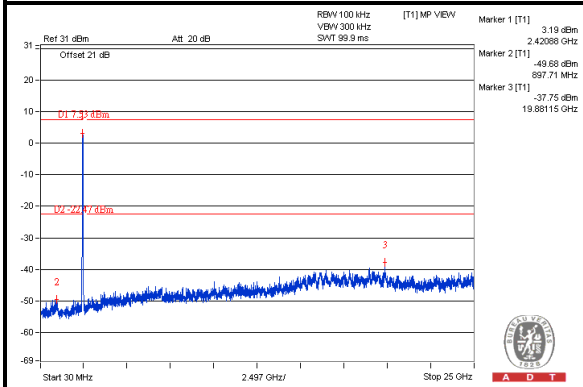

CH 6

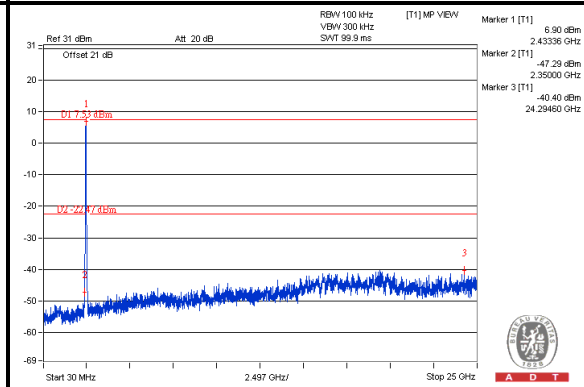

CH 9

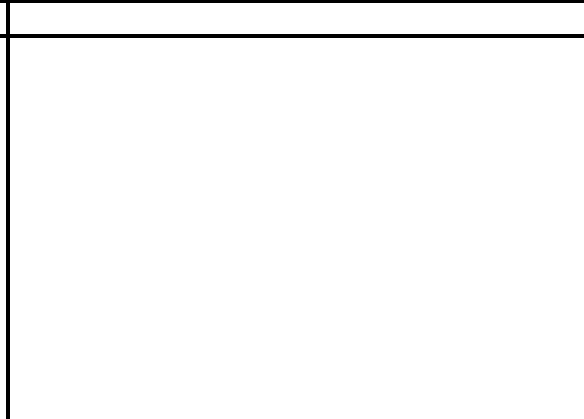
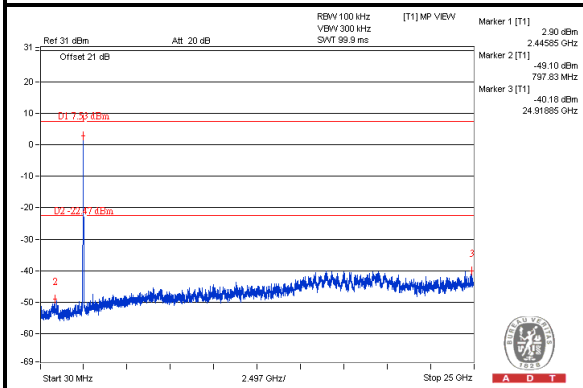

CH 3 Band edge

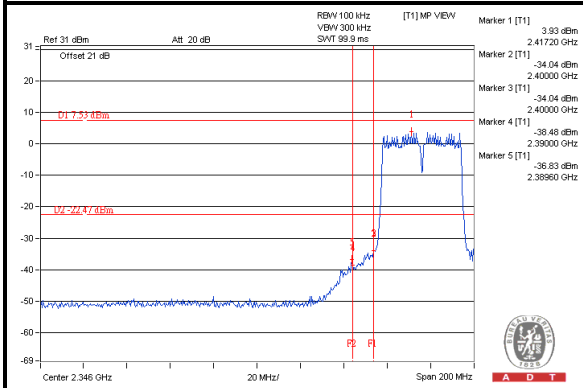

CH 9 Band edge

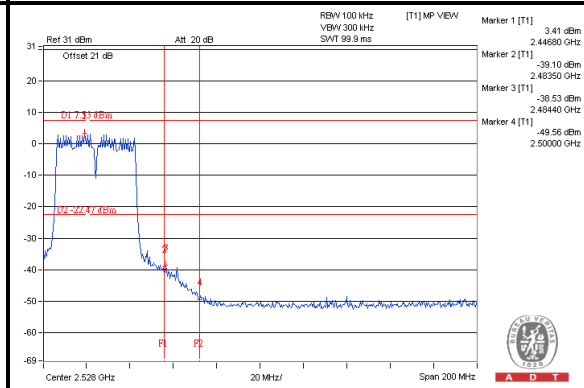



A D T

Chain (1)

CH 3

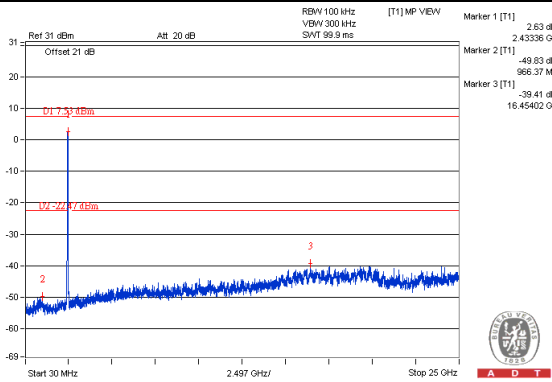

CH 6

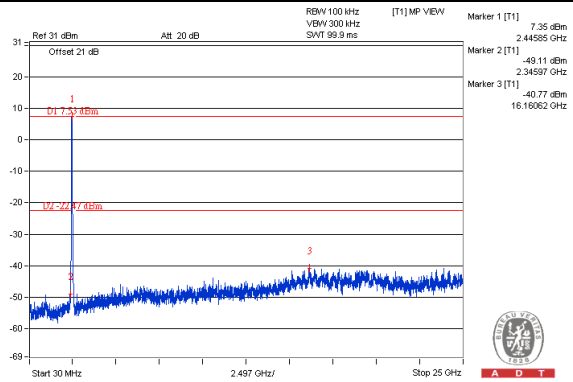

CH 9

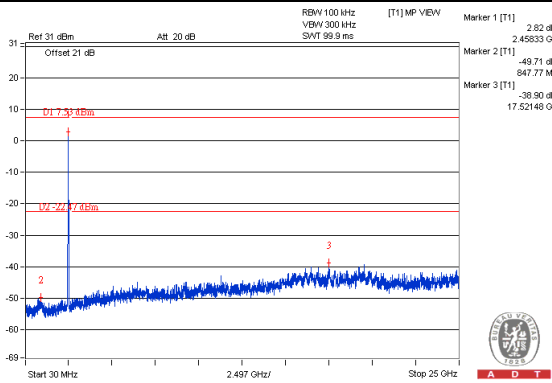

CH 3 Band edge

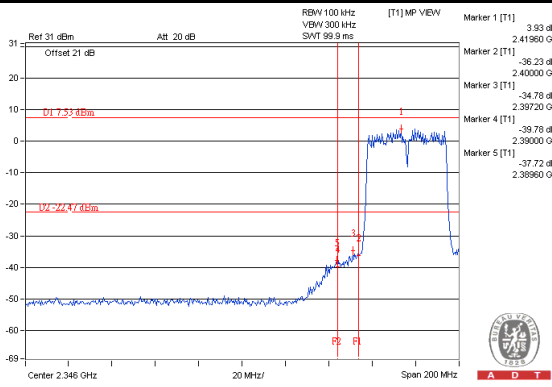

CH 9 Band edge

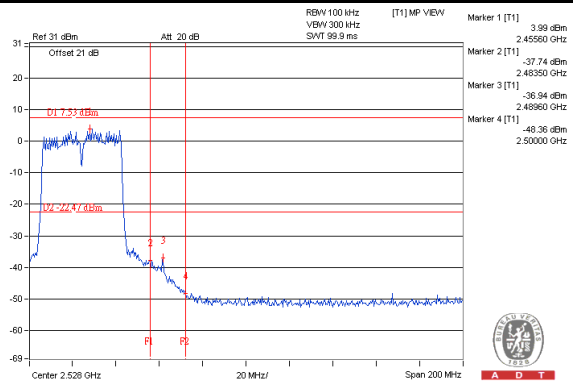



A D T

Chain (2)

CH 3

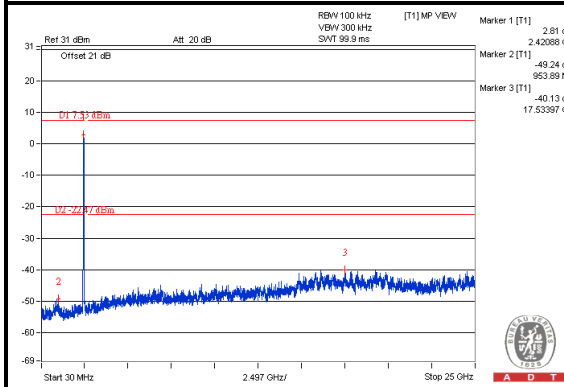

CH 6

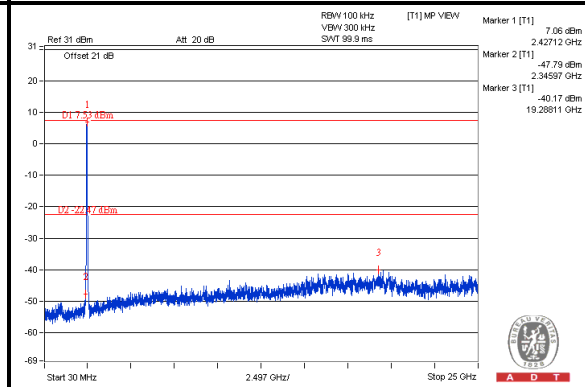

CH 9

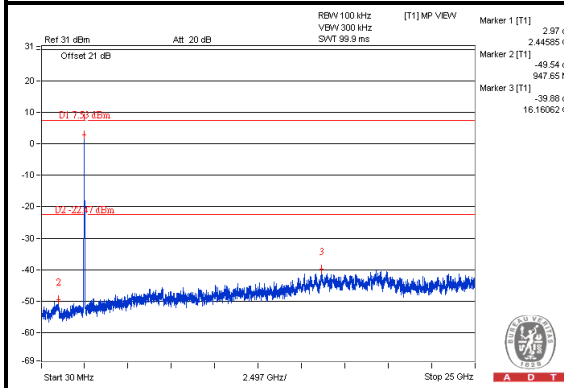

CH 3 Band edge

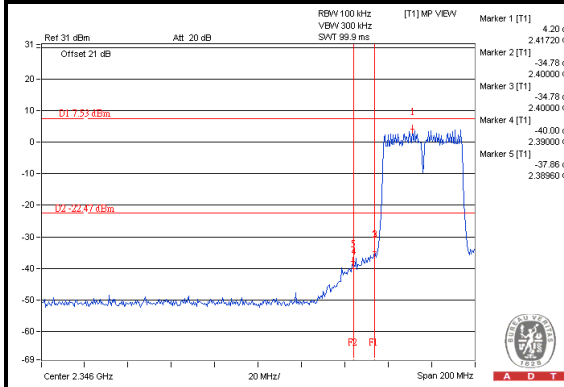

CH 9 Band edge

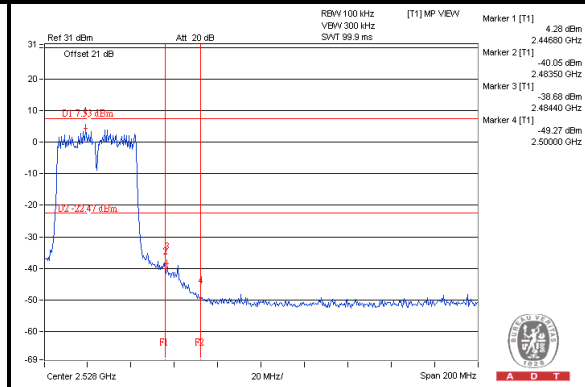



A D T

Beam forming_MODE<802.11n (HT20)>

Maximum REF

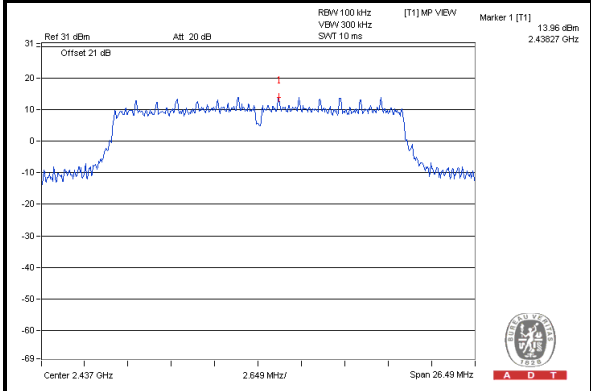

Chain (0)

CH 1

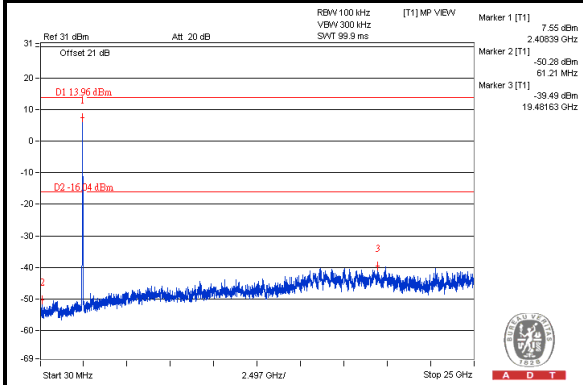

CH 6

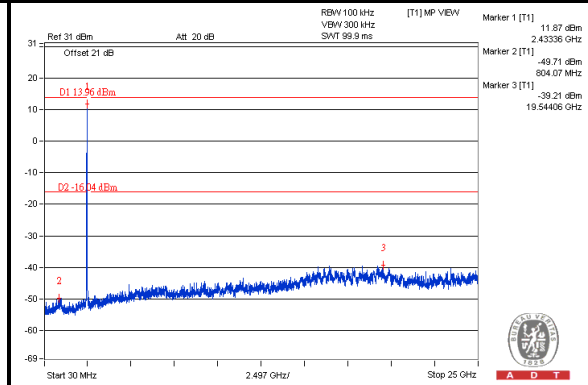

CH 11

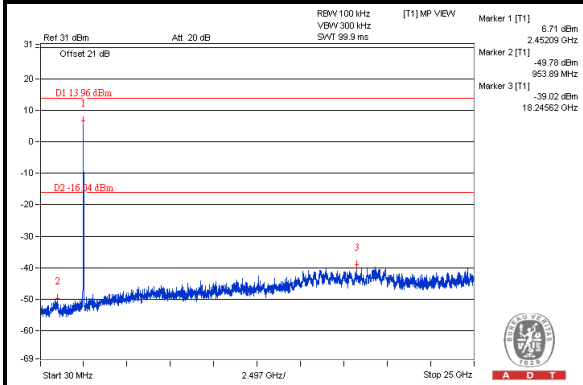

CH 1 Band edge

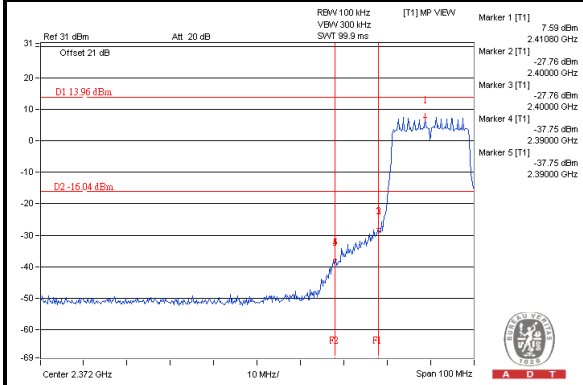

CH 11 Band edge

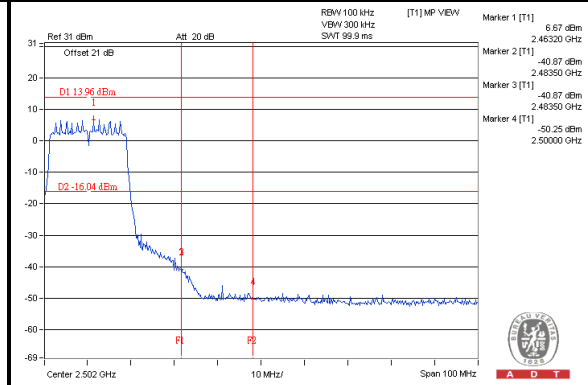



A D T

Chain (1)

CH 1

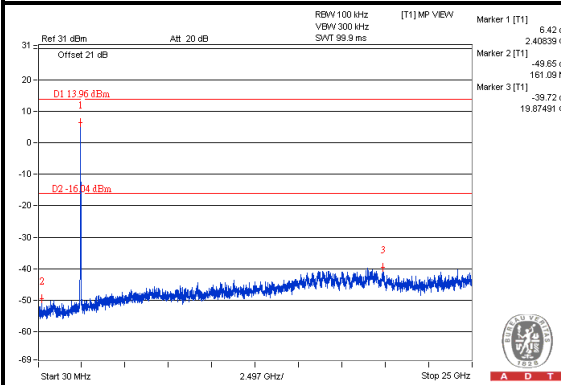

CH 6

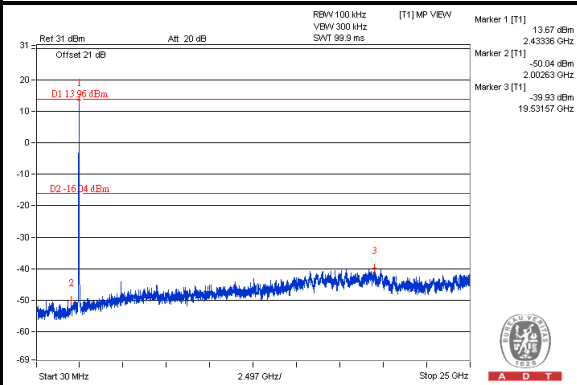

CH 11

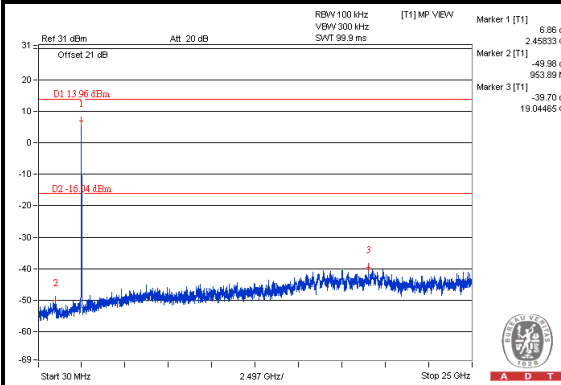

CH 11 Band edge

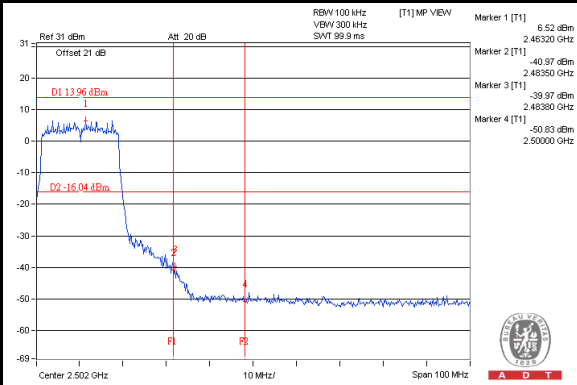

CH 1 Band edge

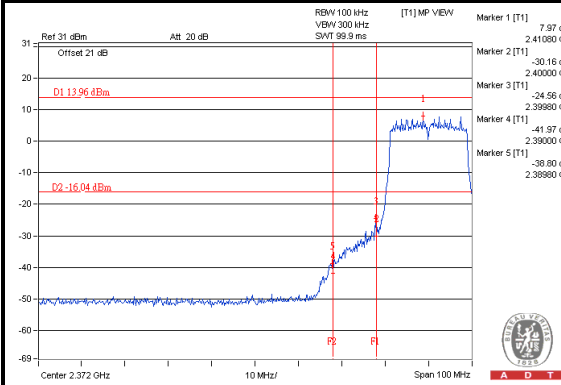

Chain (2)

CH 1

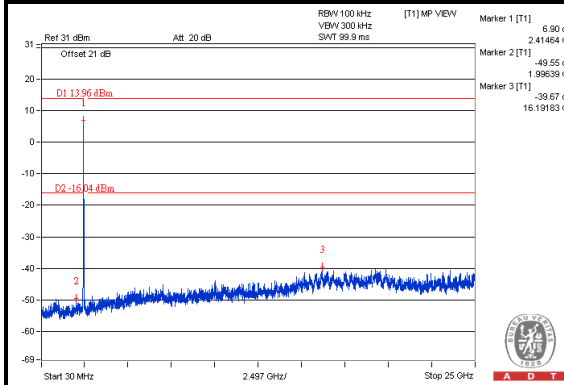

CH 6

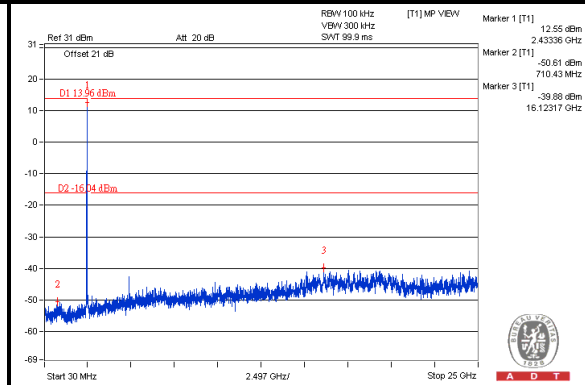

CH 11

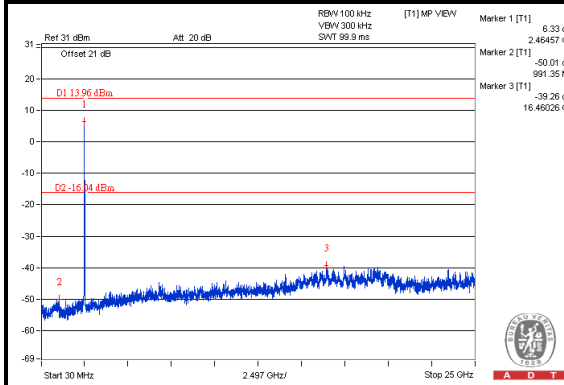

CH 1 Band edge

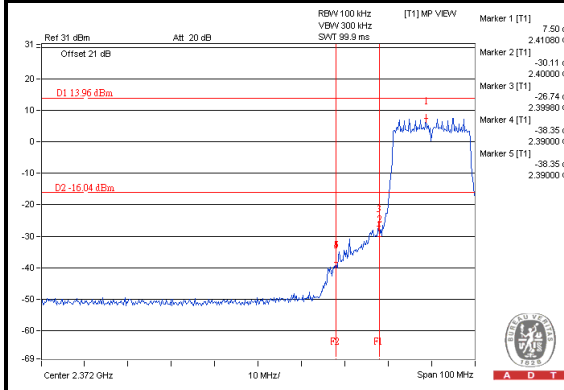

CH 11 Band edge

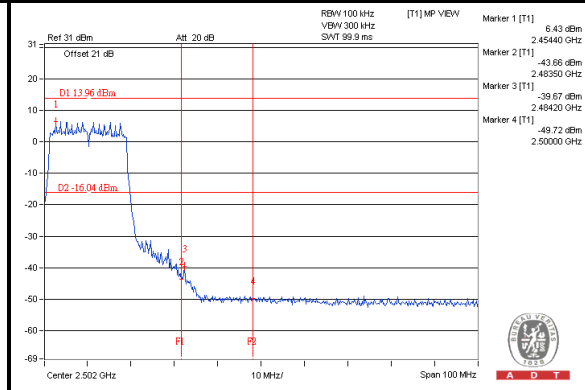



A D T

Beam forming_MODE<802.11n (HT40)>

Maximum REF

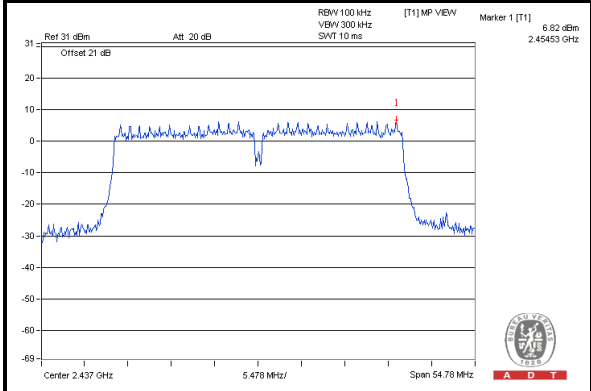

Chain (0)

CH 3

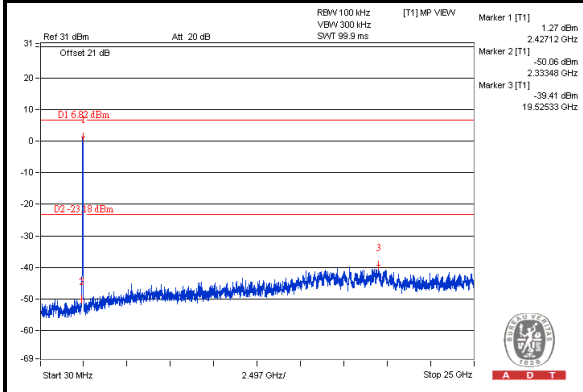

CH 6

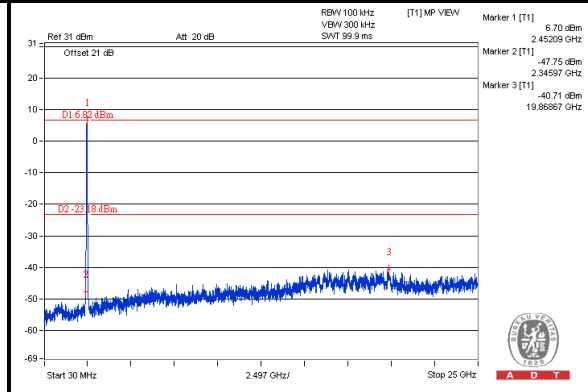

CH 9

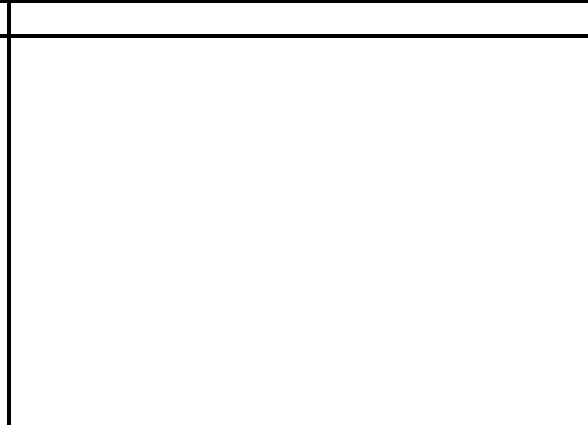
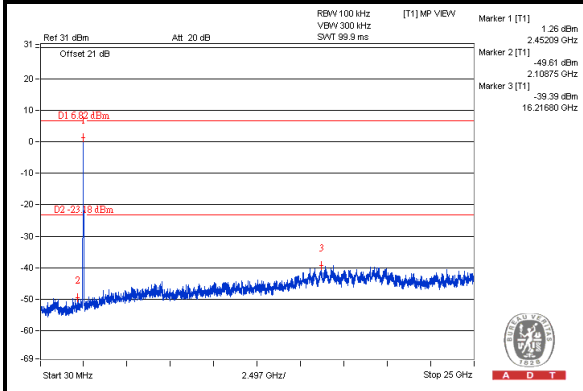

CH 3 Band edge

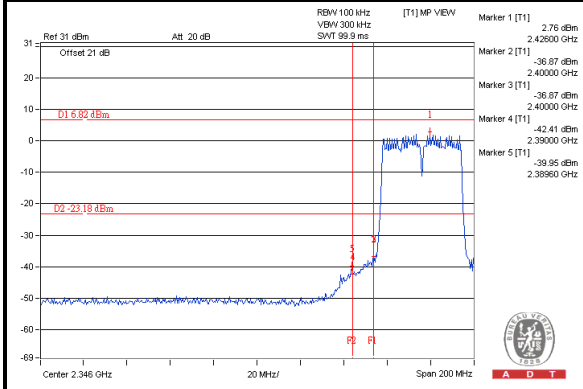

CH 9 Band edge

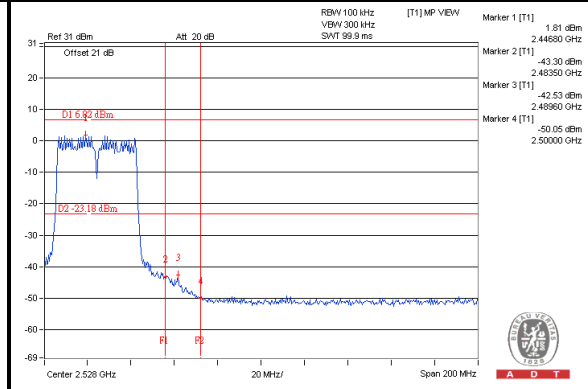



A D T

Chain (1)

CH 3

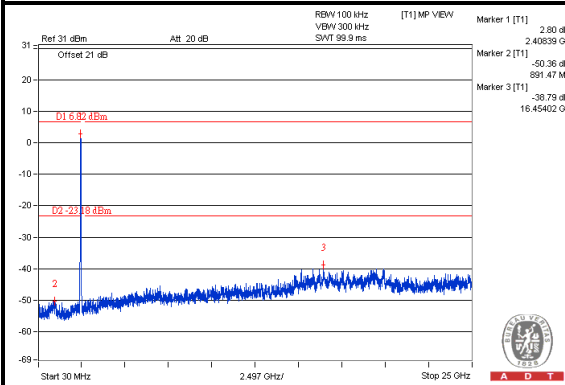

CH 6

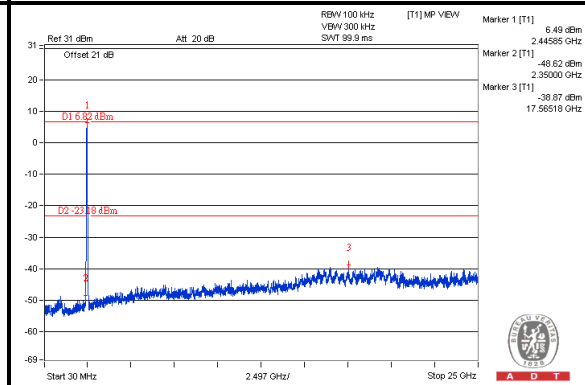

CH 9

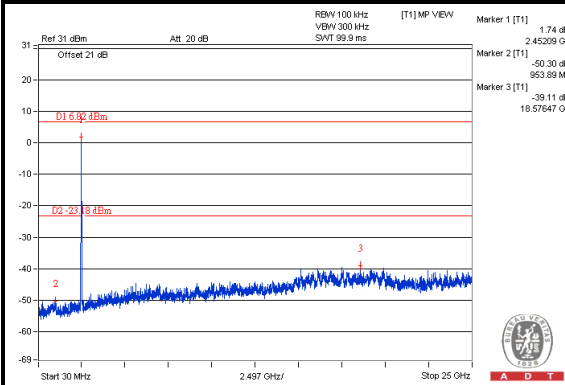

CH 3 Band edge

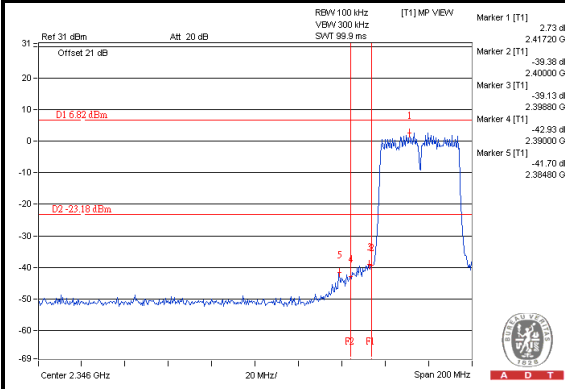

CH 9 Band edge

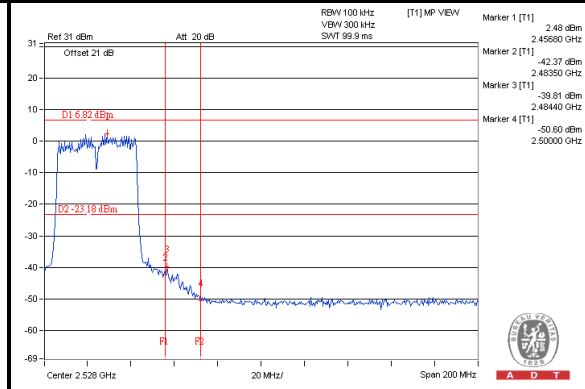

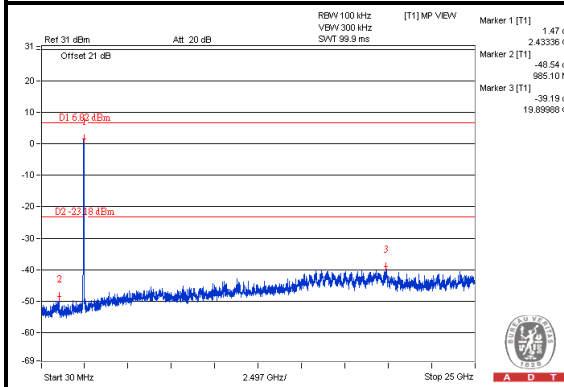
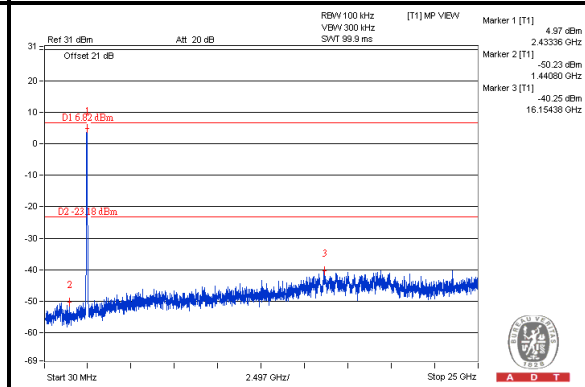
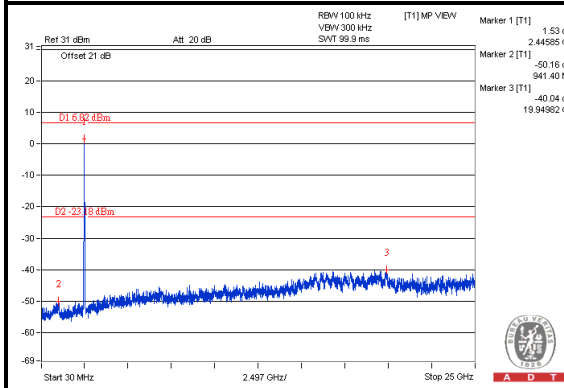
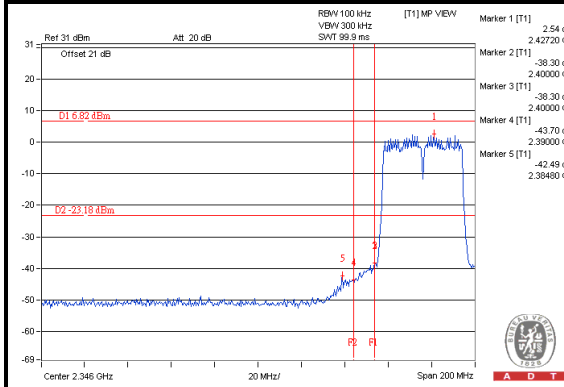
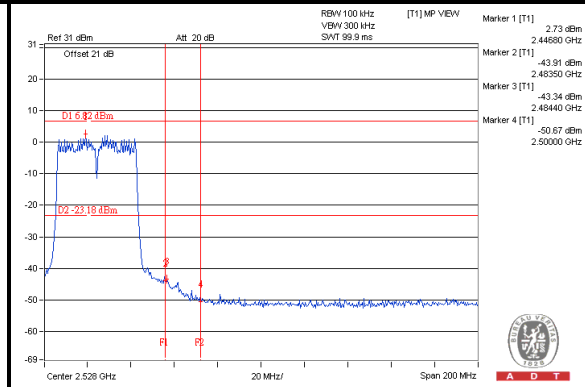
Chain (2)
CH 3

CH 6

CH 9

CH 3 Band edge

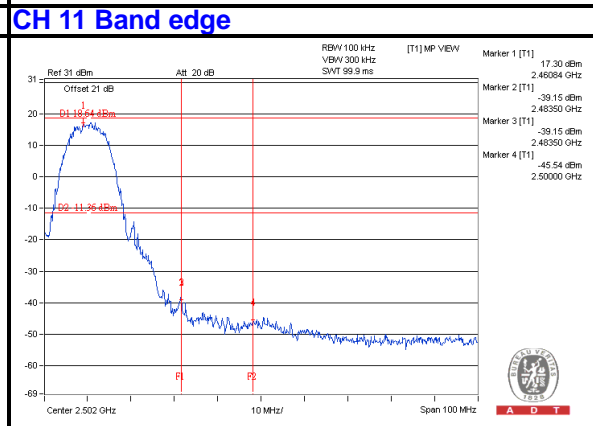
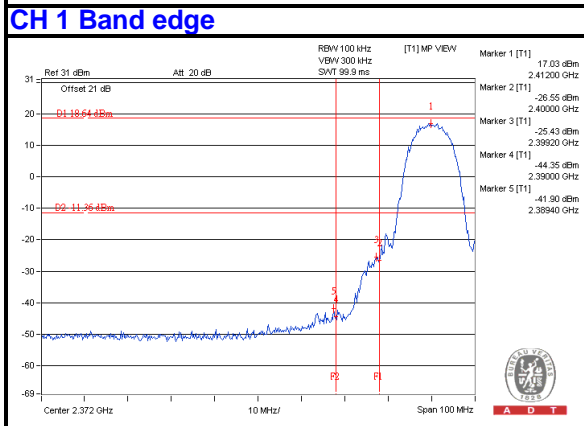
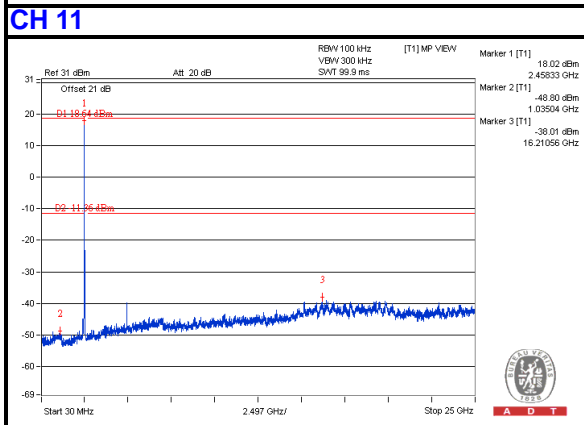
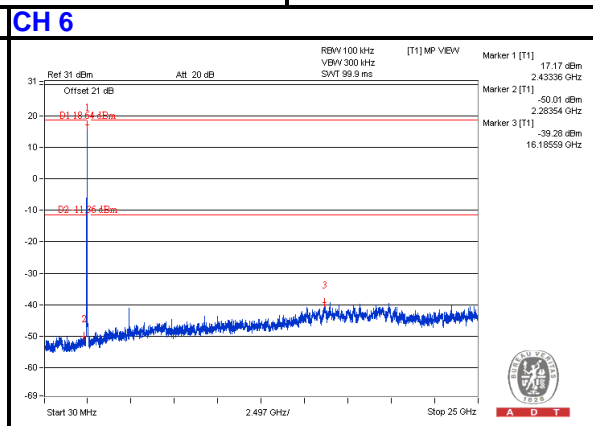
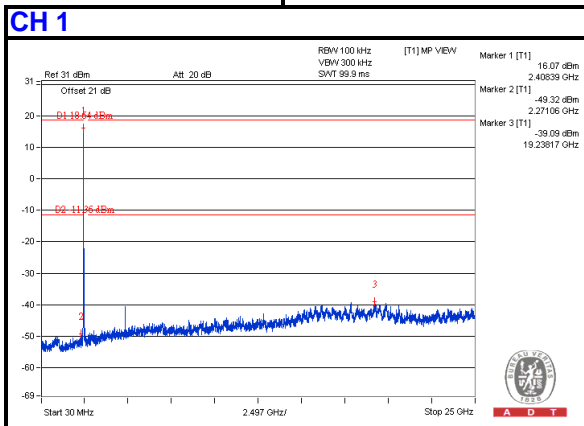
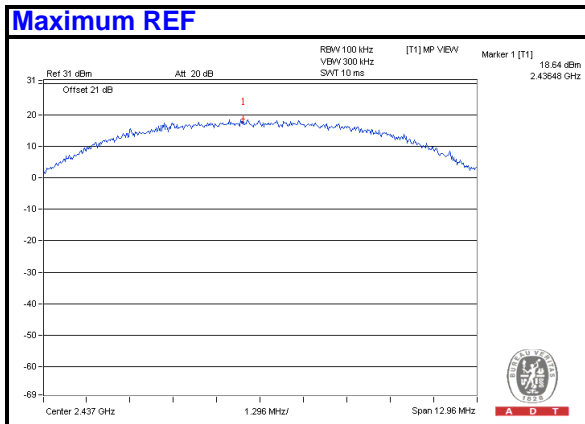
CH 9 Band edge



A D T

4.6.7.2 TEST RESULTS (MODE 2) 802.11b





A D T

802.11g

Maximum REF

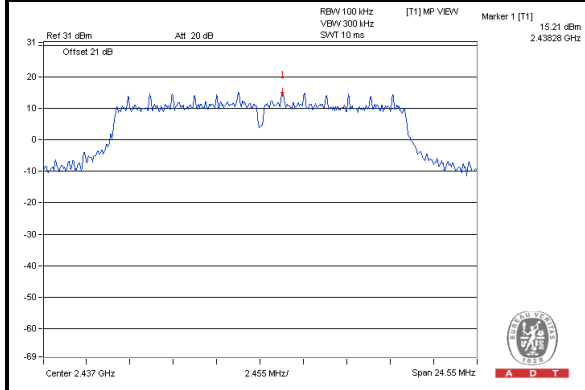

CH 1

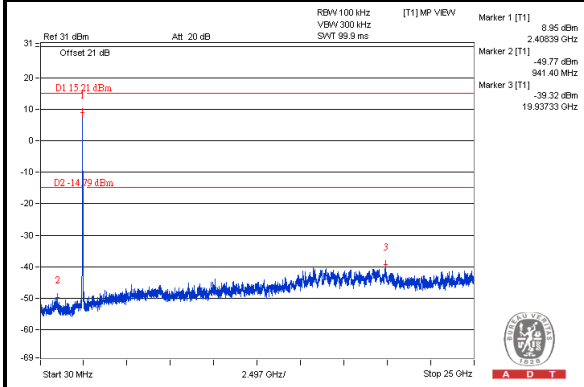

CH 6

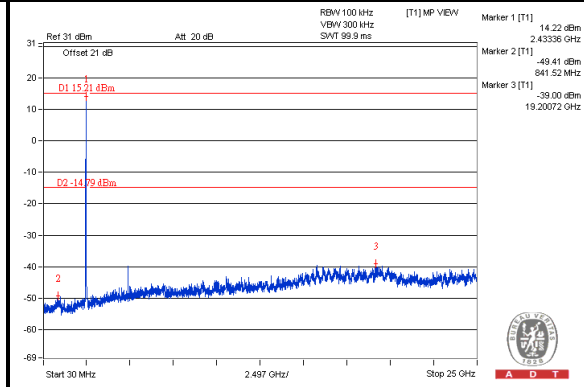

CH 11

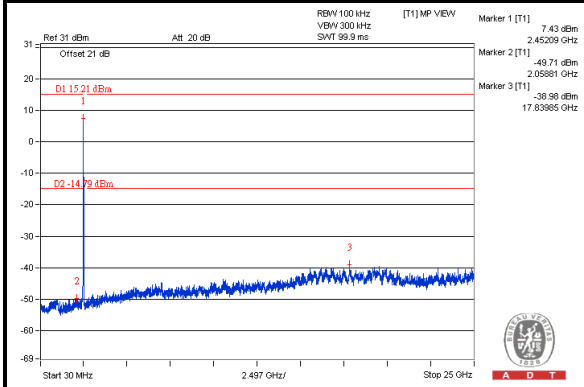

CH 1 Band edge

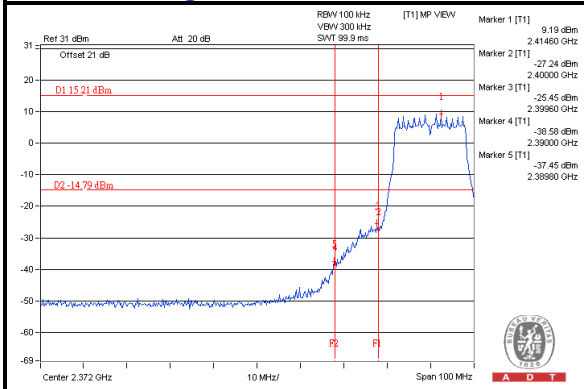

CH 11 Band edge

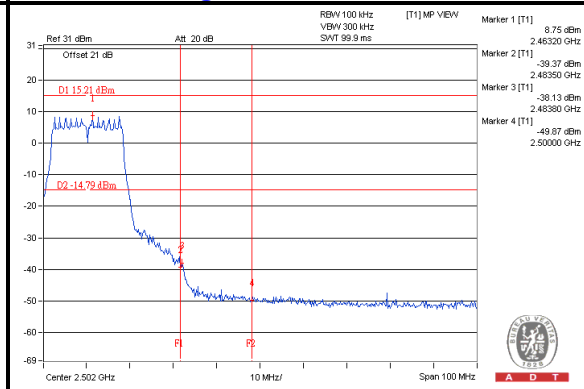



A D T

5. TEST TYPES AND RESULTS (FOR 5GHz, 5.725~5.850GHz Band)

5.1 CONDUCTED EMISSION MEASUREMENT

5.1.1 LIMITS OF CONDUCTED EMISSION MEASUREMENT

FREQUENCY OF EMISSION (MHz)	CONDUCTED LIMIT (dB μ V)	
	Quasi-peak	Average
0.15-0.5	66 to 56	56 to 46
0.5-5	56	46
5-30	60	50

- NOTE:** 1. The lower limit shall apply at the transition frequencies.
2. The limit decreases in line with the logarithm of the frequency in the range of 0.15 to 0.50 MHz.

5.1.2 TEST INSTRUMENTS

DESCRIPTION & MANUFACTURER	MODEL NO.	SERIAL NO.	CALIBRATED DATE	CALIBRATED UNTIL
Test Receiver ROHDE & SCHWARZ	ESCS 30	100375	Mar. 08, 2013	Mar. 07, 2014
Line-Impedance Stabilization Network (for EUT) SCHWARZBECK	NSLK8127	8127-522	Sep. 06, 2012	Sep. 05, 2013
Line-Impedance Stabilization Network (for Peripheral)	ENV216	100072	June 07, 2013	June 06, 2014
RF Cable (JYEBAO)	5DFB	COCCAB-001	Mar. 11, 2013	Mar. 10, 2014
50 ohms Terminator	50	EMC-3	Sep. 25, 2012	Sep. 24, 2013
Software ADT	BV ADT_Cond_V7.3.7. 3	NA	NA	NA

Note:

1. The calibration interval of the above test instruments is 12 months and the calibrations are traceable to NML/ROC and NIST/USA.
2. The test was performed in Shielded Room No. C.
3. The VCCI Con C Registration No. is C-3611.
4. Tested Date: July 26, 2013

5.1.3 TEST PROCEDURES

- a. The EUT was placed 0.4 meters from the conducting wall of the shielded room with EUT being connected to the power mains through a line impedance stabilization network (LISN). Other support units were connected to the power mains through another LISN.
- b. The two LISNs provide 50 ohm/ 50uH of coupling impedance for the measuring instrument.
- c. Both lines of the power mains connected to the EUT were checked for maximum conducted interference.
- d. The frequency range from 150kHz to 30MHz was searched. Emission levels under (Limit – 20dB) were not recorded.

NOTE:

1. The resolution bandwidth of test receiver is 9kHz for Quasi-peak detection (QP) & Average detection (AV).

5.1.4 DEVIATION FROM TEST STANDARD

No deviation

5.1.5 TEST SETUP

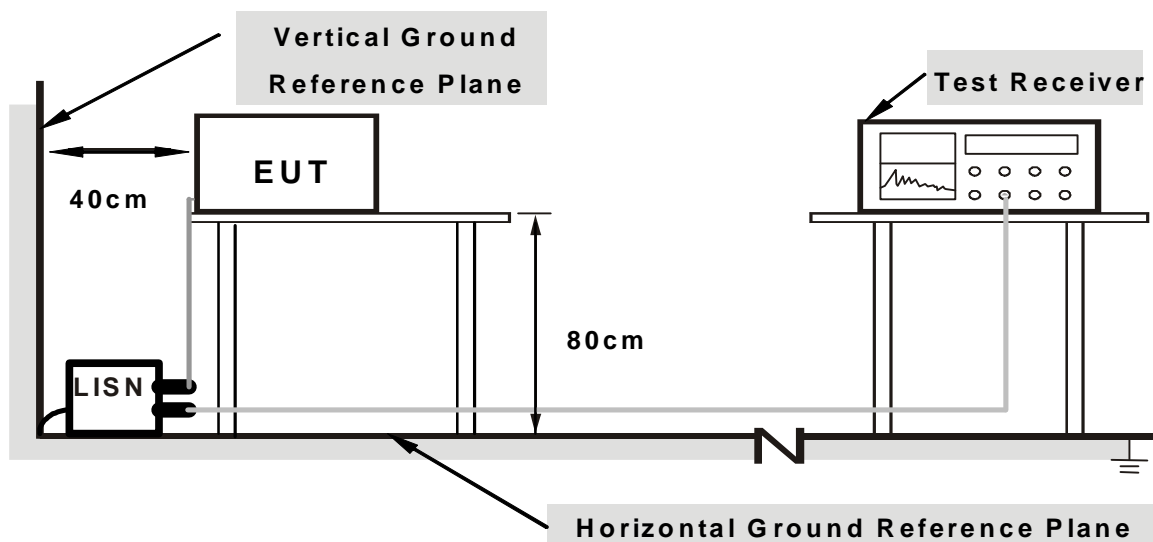

Note: 1.Support units were connected to second LISN.

For the actual test configuration, please refer to the related item – Photographs of the Test Configuration.

5.1.6 EUT OPERATING CONDITIONS

Same as the 4.1.6

5.1.7 TEST RESULTS (MODE 1)

PHASE	Line (L)	DETECTOR FUNCTION	Quasi-Peak (QP) / Average (AV)
--------------	----------	--------------------------	--------------------------------

No	Freq. [MHz]	Corr. Factor (dB)	Reading Value [dB (uV)]		Emission Level [dB (uV)]		Limit [dB (uV)]		Margin (dB)	
			Q.P.	AV.	Q.P.	AV.	Q.P.	AV.	Q.P.	AV.
1	0.16172	0.13	57.54	47.88	57.67	48.01	65.38	55.38	-7.70	-7.36
2	0.19297	0.15	49.91	35.83	50.06	35.98	63.91	53.91	-13.85	-17.93
3	0.28672	0.17	39.08	28.75	39.25	28.92	60.62	50.62	-21.37	-21.70
4	0.52891	0.21	37.65	31.74	37.86	31.95	56.00	46.00	-18.14	-14.05
5	9.73047	0.88	34.11	29.46	34.99	30.34	60.00	50.00	-25.01	-19.66
6	17.95703	1.35	33.44	28.49	34.79	29.84	60.00	50.00	-25.21	-20.16

REMARKS:

1. Q.P. and AV. are abbreviations of quasi-peak and average individually.
2. The emission levels of other frequencies were very low against the limit.
3. Margin value = Emission Level – Limit value
4. Correction Factor = Insertion loss + Cable loss
5. Emission Level = Correction Factor + Reading Value

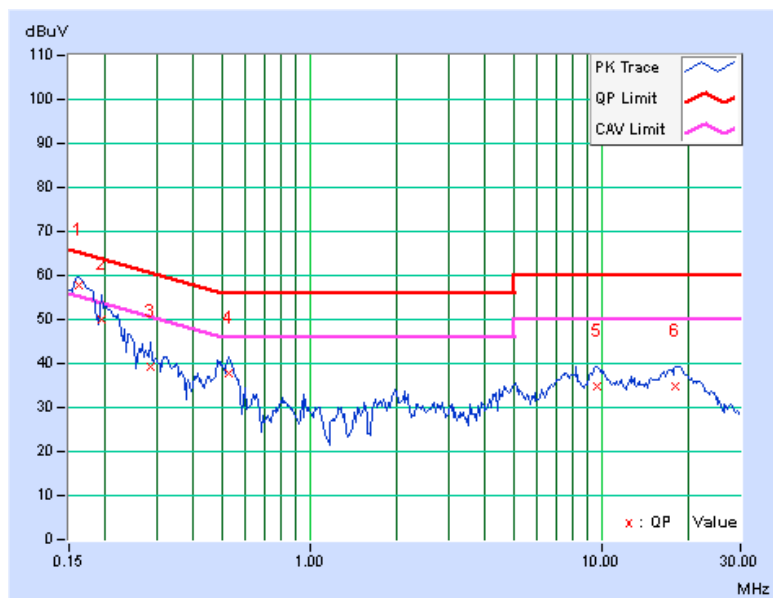

PHASE	Neutral (N)	DETECTOR FUNCTION	Quasi-Peak (QP) / Average (AV)
--------------	-------------	--------------------------	--------------------------------

No	Freq.	Corr.	Reading Value		Emission Level		Limit		Margin	
	[MHz]	Factor	[dB (uV)]		[dB (uV)]		[dB (uV)]		(dB)	
		(dB)	Q.P.	AV.	Q.P.	AV.	Q.P.	AV.	Q.P.	AV.
1	0.16172	0.11	57.64	47.59	57.75	47.70	65.38	55.38	-7.62	-7.67
2	0.19984	0.13	50.33	39.88	50.46	40.01	63.62	53.62	-13.16	-13.61
3	0.24375	0.14	43.82	33.31	43.96	33.45	61.97	51.97	-18.00	-18.51
4	0.53075	0.20	38.52	32.19	38.72	32.39	56.00	46.00	-17.28	-13.61
5	7.59766	0.62	33.70	29.17	34.32	29.79	60.00	50.00	-25.68	-20.21
6	17.64453	1.04	32.86	27.86	33.90	28.90	60.00	50.00	-26.10	-21.10

REMARKS:

1. Q.P. and AV. are abbreviations of quasi-peak and average individually.
2. The emission levels of other frequencies were very low against the limit.
3. Margin value = Emission Level – Limit value
4. Correction Factor = Insertion loss + Cable loss
5. Emission Level = Correction Factor + Reading Value

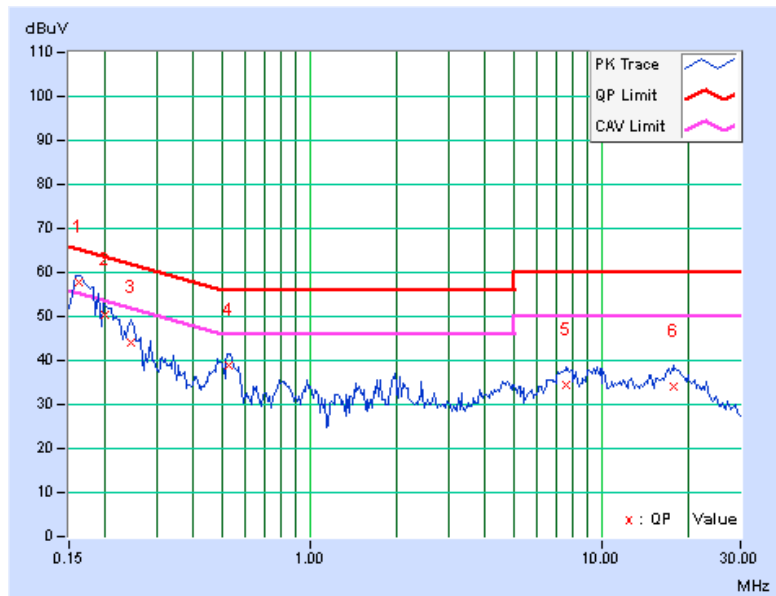

5.1.8 TEST RESULTS (MODE 2)

PHASE	Line (L)	DETECTOR FUNCTION	Quasi-Peak (QP) / Average (AV)
--------------	----------	--------------------------	--------------------------------

No	Freq.	Corr.	Reading Value		Emission Level		Limit		Margin	
	[MHz]	Factor	[dB (uV)]		[dB (uV)]		[dB (uV)]		(dB)	
		(dB)	Q.P.	AV.	Q.P.	AV.	Q.P.	AV.	Q.P.	AV.
1	0.16172	0.13	52.83	41.97	52.96	42.10	65.38	55.38	-12.41	-13.27
2	0.21641	0.15	46.89	35.67	47.04	35.82	62.96	52.96	-15.91	-17.13
3	0.36875	0.19	41.41	31.31	41.60	31.50	58.53	48.53	-16.93	-17.03
4	0.48203	0.21	43.24	33.75	43.45	33.96	56.30	46.30	-12.86	-12.35
5	0.58359	0.22	40.49	31.28	40.71	31.50	56.00	46.00	-15.29	-14.50
6	1.88672	0.33	39.89	32.03	40.22	32.36	56.00	46.00	-15.78	-13.64

REMARKS:

1. Q.P. and AV. are abbreviations of quasi-peak and average individually.
2. The emission levels of other frequencies were very low against the limit.
3. Margin value = Emission Level – Limit value
4. Correction Factor = Insertion loss + Cable loss
5. Emission Level = Correction Factor + Reading Value

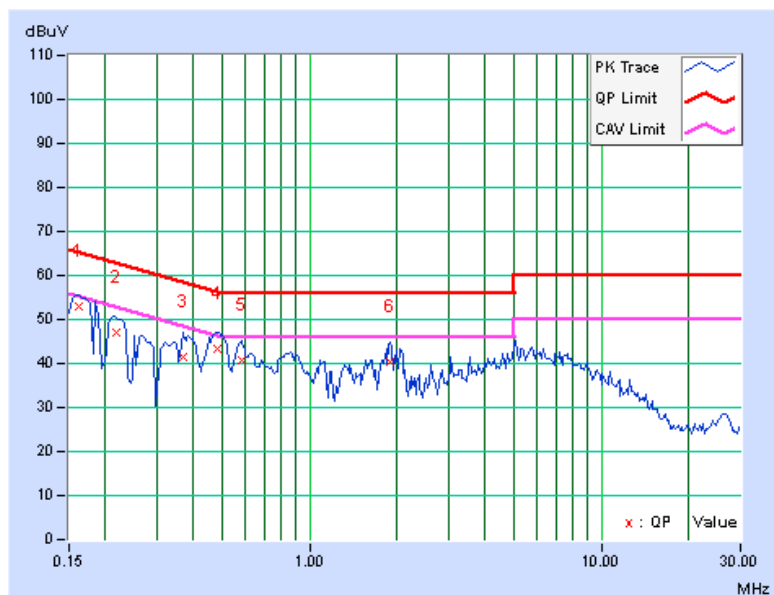

PHASE	Neutral (N)	DETECTOR FUNCTION	Quasi-Peak (QP) / Average (AV)
--------------	-------------	--------------------------	--------------------------------

No	Freq. [MHz]	Corr. Factor [dB]	Reading Value [dB (uV)]		Emission Level [dB (uV)]		Limit [dB (uV)]		Margin [dB]	
			Q.P.	AV.	Q.P.	AV.	Q.P.	AV.	Q.P.	AV.
1	0.16562	0.12	51.49	39.10	51.61	39.22	65.18	55.18	-13.57	-15.96
2	0.21250	0.13	46.18	33.71	46.31	33.84	63.11	53.11	-16.79	-19.26
3	0.46250	0.19	39.44	26.58	39.63	26.77	56.65	46.65	-17.01	-19.87
4	0.57969	0.20	35.88	26.29	36.08	26.49	56.00	46.00	-19.92	-19.51
5	1.98438	0.30	34.25	23.62	34.55	23.92	56.00	46.00	-21.45	-22.08
6	4.69531	0.47	32.19	23.40	32.66	23.87	56.00	46.00	-23.34	-22.13

REMARKS:

1. Q.P. and AV. are abbreviations of quasi-peak and average individually.
2. The emission levels of other frequencies were very low against the limit.
3. Margin value = Emission Level – Limit value
4. Correction Factor = Insertion loss + Cable loss
5. Emission Level = Correction Factor + Reading Value

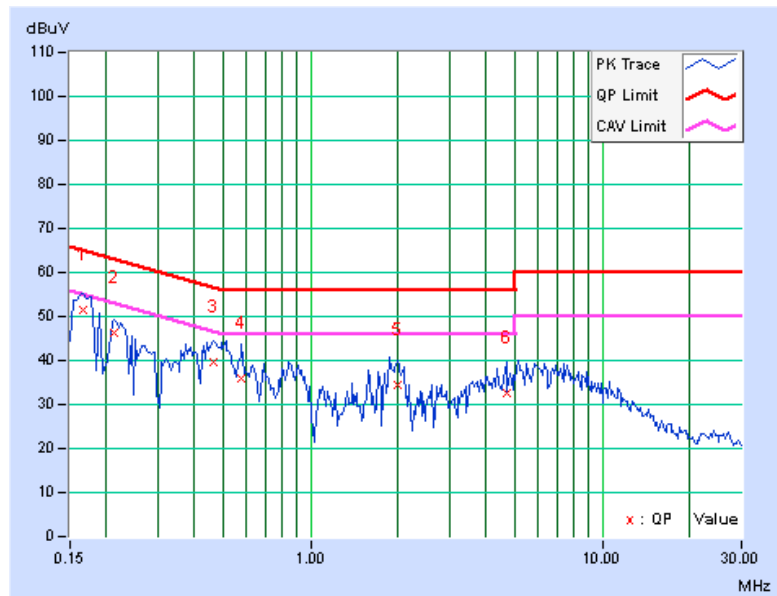

5.2 RADIATED AND BANDEDGE EMISSION MEASUREMENT

5.2.1 LIMITS OF RADIATED AND BANDEDGE EMISSION MEASUREMENT

Radiated emissions which fall in the restricted bands must comply with the radiated emission limits specified as below table. Other emissions shall be at least 30dB below the highest level of the desired power:

Frequencies (MHz)	Field strength (microvolts/meter)	Measurement distance (meters)
0.009-0.490	2400/F(kHz)	300
0.490-1.705	24000/F(kHz)	30
1.705-30.0	30	30
30-88	100	3
88-216	150	3
216-960	200	3
Above 960	500	3

NOTE:

1. The lower limit shall apply at the transition frequencies.
2. Emission level (dBuV/m) = 20 log Emission level (uV/m).
3. For frequencies above 1000MHz, the field strength limits are based on average detector, however, the peak field strength of any emission shall not exceed the maximum permitted average limits, specified above by more than 20dB under any condition of modulation.



A D T

5.2.2 TEST INSTRUMENTS

DESCRIPTION & MANUFACTURER	MODEL NO.	SERIAL NO.	CALIBRATED DATE	CALIBRATED UNTIL
MXE EMI Receiver Agilent	N9038A	MY50010156	Jan. 15, 2014	Jan. 14, 2015
Pre-Amplifier Mini-Circuits	ZFL-1000VH2 B	AMP-ZFL-04	Nov. 13, 2013	Nov. 12, 2014
Trilog Broadband Antenna SCHWARZBECK	VULB 9168	9168-361	Mar. 25, 2013	Mar. 24, 2014
RF Cable	NA	CHHCAB_001	Oct. 06, 2013	Oct. 05, 2014
Spectrum Analyzer R&S	FSV40	100964	July 15, 2013	July 14, 2014
Horn_Antenna AISL	AIH.8018	0000220091110	Dec. 06, 2013	Dec. 05, 2014
Pre-Amplifier Agilent	8449B	3008A01923	Oct. 29, 2013	Oct. 28, 2014
RF Cable	NA	RF104-205 RF104-207 RF104-202	Dec. 12, 2013	Dec. 11, 2014
Spectrum Analyzer Agilent	E4446A	MY48250253	Aug. 28, 2013	Aug. 27, 2014
Pre-Amplifier SPACEK LABS	SLKka-48-6	9K16	Nov. 13, 2013	Nov. 12, 2014
Horn_Antenna SCHWARZBECK	BBHA 9170	9170-424	Oct. 08, 2013	Oct. 07, 2014
Software	ADT_Radiated _V8.7.07	NA	NA	NA
Antenna Tower & Turn Table CT	NA	NA	NA	NA

Note:

1. The calibration interval of the above test instruments is 12 months and the calibrations are traceable to NML/ROC and NIST/USA.
2. The horn antenna, preamplifier (model: 8449B) are used only for the measurement of emission frequency above 1GHz if tested.
- 3 The test was performed in 966 Chamber No. H.
4. The FCC Site Registration No. is 797305.
- 5 The CANADA Site Registration No. is IC 7450H-3.
- 6 Tested Date: Jan. 16 to 17, 2014

5.2.3 TEST PROCEDURES

- a. The EUT was placed on the top of a rotating table 0.8 meters above the ground at 3 meter chamber room for test. The table was rotated 360 degrees to determine the position of the highest radiation.
- b. The EUT was set 3 meters away from the interference-receiving antenna, which was mounted on the top of a variable-height antenna tower.
- c. The height of antenna is varied from one meter to four meters above the ground to determine the maximum value of the field strength. Both horizontal and vertical polarizations of the antenna are set to make the measurement.
- d. For each suspected emission, the EUT was arranged to its worst case and then the antenna was tuned to heights from 1 meter to 4 meters and the rotatable table was turned from 0 degrees to 360 degrees to find the maximum reading.
- e. The test-receiver system was set to quasi-peak detect function and specified bandwidth with maximum hold mode when the test frequency is below 1 GHz.
- f. The test-receiver system was set to peak and average detect function and specified bandwidth with maximum hold mode when the test frequency is above 1 GHz. If the peak reading value also meets average limit, measurement with the average detector is unnecessary.

Note:

1. The resolution bandwidth and video bandwidth of test receiver/spectrum analyzer is 120kHz for Quasi-peak detection (QP) at frequency below 1GHz.
2. The resolution bandwidth of test receiver/spectrum analyzer is 1 MHz and the video bandwidth is 3 MHz for Peak detection (PK) at frequency above 1GHz.
3. The resolution bandwidth of test receiver/spectrum analyzer is 1MHz and the video bandwidth is 3MHz for RMS Average (Duty cycle < 98%) for Average detection (AV) at frequency above 1GHz, then the measurement results was added to a correction factor ($10 \log(1/\text{duty cycle})$).
4. The resolution bandwidth of test receiver/spectrum analyzer is 1MHz and the video bandwidth is 10Hz (Duty cycle $\geq 98\%$) for Average detection (AV) at frequency above 1GHz.
5. All modes of operation were investigated and the worst-case emissions are reported.

5.2.4 DEVIATION FROM TEST STANDARD

No deviation

5.2.5 TEST SETUP

<Frequency Range below 1GHz>

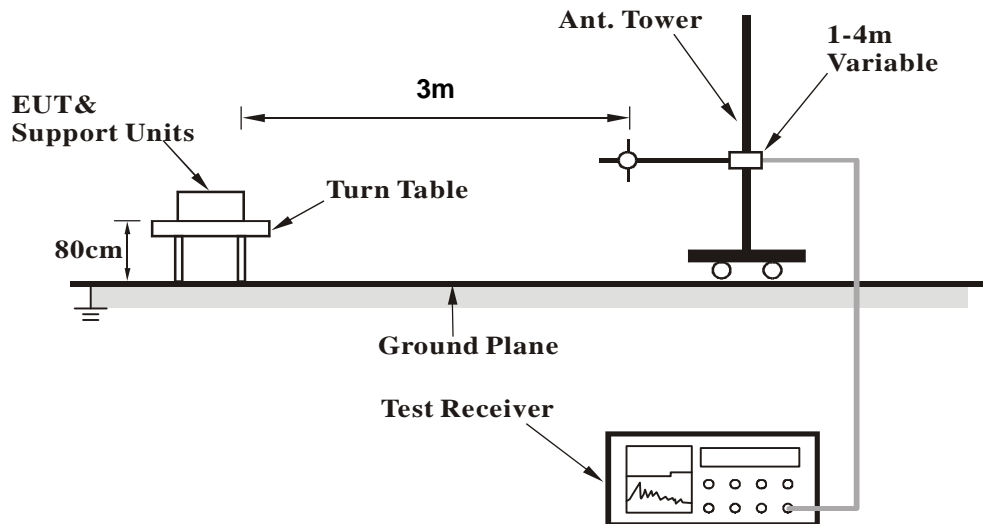

<Frequency Range above 1GHz>

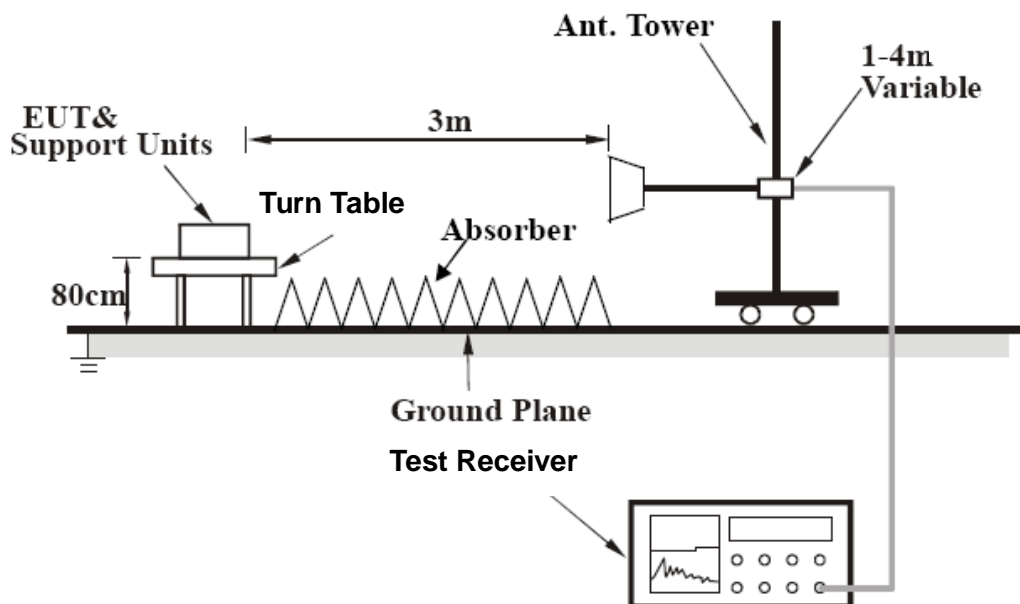

For the actual test configuration, please refer to the related item – Photographs of the Test Configuration.

5.2.6 EUT OPERATING CONDITIONS

Same as the 4.1.6

5.2.7 TEST RESULTS (MODE 1)

CDD_MODE

BELOW 1GHz WORST-CASE DATA

802.11ac (VHT20)

CHANNEL	TX Channel 165	DETECTOR FUNCTION	Quasi-Peak (QP)
FREQUENCY RANGE	Below 1GHz		

ANTENNA POLARITY & TEST DISTANCE: HORIZONTAL AT 3 M								
NO.	FREQ. (MHz)	EMISSION LEVEL (dBuV/m)	LIMIT (dBuV/m)	MARGIN (dB)	ANTENNA HEIGHT (m)	TABLE ANGLE (Degree)	RAW VALUE (dBuV)	CORRECTION FACTOR (dB/m)
1	89.03	31.9 QP	43.5	-11.6	2.00 H	157	50.47	-18.54
2	188.21	34.6 QP	43.5	-8.9	2.00 H	273	49.63	-15.00
3	209.16	38.3 QP	43.5	-5.2	2.00 H	263	54.10	-15.82
4	219.68	38.9 QP	46.0	-7.1	1.00 H	262	54.40	-15.52
5	296.07	38.5 QP	46.0	-7.5	1.00 H	290	50.29	-11.79
6	500.01	34.5 QP	46.0	-11.6	2.00 H	288	41.36	-6.91
ANTENNA POLARITY & TEST DISTANCE: VERTICAL AT 3 M								
NO.	FREQ. (MHz)	EMISSION LEVEL (dBuV/m)	LIMIT (dBuV/m)	MARGIN (dB)	ANTENNA HEIGHT (m)	TABLE ANGLE (Degree)	RAW VALUE (dBuV)	CORRECTION FACTOR (dB/m)
1	41.93	36.4 QP	40.0	-3.7	1.00 V	218	49.84	-13.49
2	65.79	35.3 QP	40.0	-4.7	1.00 V	322	49.93	-14.60
3	121.08	31.8 QP	43.5	-11.7	1.00 V	227	46.42	-14.65
4	229.43	33.0 QP	46.0	-13.0	1.00 V	258	48.11	-15.08
5	500.01	38.7 QP	46.0	-7.3	1.00 V	343	45.63	-6.91
6	940.59	34.1 QP	46.0	-11.9	1.00 V	181	32.89	1.25

REMARKS:

1. Emission Level(dBuV/m) = Raw Value(dBuV) + Correction Factor(dB/m)
2. Correction Factor(dB/m) = Antenna Factor(dB/m) + Cable Factor(dB) – Pre-Amplifier Factor(dB)
3. The other emission levels were very low against the limit.
4. Margin value = Emission Level – Limit value



A D T

CDD MODE

802.11ac (VHT20)

CHANNEL	TX Channel 149	DETECTOR FUNCTION	Peak (PK)
FREQUENCY RANGE	1GHz ~ 40GHz		Average (AV)

ANTENNA POLARITY & TEST DISTANCE: HORIZONTAL AT 3 M

NO.	FREQ. (MHz)	EMISSION LEVEL (dBuV/m)	LIMIT (dBuV/m)	MARGIN (dB)	ANTENNA HEIGHT (m)	TABLE ANGLE (Degree)	RAW VALUE (dBuV)	CORRECTION FACTOR (dB/m)
1	5460.00	55.3 PK	74.0	-18.7	1.01 H	2	11.22	44.08
2	5460.00	42.1 AV	54.0	-11.9	1.01 H	2	-1.98	44.08
3	*5745.00	112.5 PK			1.01 H	2	68.02	44.48
4	*5745.00	102.5 AV			1.01 H	2	58.02	44.48
5	11490.00	52.3 PK	74.0	-21.7	1.06 H	316	0.68	51.62
6	11490.00	39.7 AV	54.0	-14.3	1.06 H	316	-11.92	51.62

ANTENNA POLARITY & TEST DISTANCE: VERTICAL AT 3 M

NO.	FREQ. (MHz)	EMISSION LEVEL (dBuV/m)	LIMIT (dBuV/m)	MARGIN (dB)	ANTENNA HEIGHT (m)	TABLE ANGLE (Degree)	RAW VALUE (dBuV)	CORRECTION FACTOR (dB/m)
1	5460.00	57.9 PK	74.0	-16.1	1.00 V	319	13.82	44.08
2	5460.00	46.3 AV	54.0	-7.7	1.00 V	319	2.22	44.08
3	*5745.00	123.4 PK			1.00 V	319	78.92	44.48
4	*5745.00	113.1 AV			1.00 V	319	68.62	44.48
5	11490.00	57.8 PK	74.0	-16.2	1.49 V	187	6.18	51.62
6	11490.00	45.1 AV	54.0	-8.9	1.49 V	187	-6.52	51.62

REMARKS:

1. Emission Level(dBuV/m) = Raw Value(dBuV) + Correction Factor(dB/m)
2. Correction Factor(dB/m) = Antenna Factor(dB/m) + Cable Factor(dB) – Pre-Amplifier Factor(dB)
3. The other emission levels were very low against the limit.
4. Margin value = Emission Level – Limit value
5. " * ": Fundamental frequency.



A D T

CHANNEL	TX Channel 157	DETECTOR FUNCTION	Peak (PK)
FREQUENCY RANGE	1GHz ~ 40GHz		Average (AV)

ANTENNA POLARITY & TEST DISTANCE: HORIZONTAL AT 3 M

NO.	FREQ. (MHz)	EMISSION LEVEL (dBuV/m)	LIMIT (dBuV/m)	MARGIN (dB)	ANTENNA HEIGHT (m)	TABLE ANGLE (Degree)	RAW VALUE (dBuV)	CORRECTION FACTOR (dB/m)
1	*5785.00	112.5 PK			1.03 H	8	67.98	44.52
2	*5785.00	102.2 AV			1.03 H	8	57.68	44.52
3	11570.00	52.6 PK	74.0	-21.4	1.07 H	312	1.11	51.49
4	11570.00	40.1 AV	54.0	-13.9	1.07 H	312	-11.39	51.49

ANTENNA POLARITY & TEST DISTANCE: VERTICAL AT 3 M

NO.	FREQ. (MHz)	EMISSION LEVEL (dBuV/m)	LIMIT (dBuV/m)	MARGIN (dB)	ANTENNA HEIGHT (m)	TABLE ANGLE (Degree)	RAW VALUE (dBuV)	CORRECTION FACTOR (dB/m)
1	*5785.00	123.0 PK			1.00 V	309	78.48	44.52
2	*5785.00	112.7 AV			1.00 V	309	68.18	44.52
3	11570.00	57.3 PK	74.0	-16.7	1.60 V	184	5.81	51.49
4	11570.00	45.4 AV	54.0	-8.6	1.60 V	184	-6.09	51.49

REMARKS:

1. Emission Level(dBuV/m) = Raw Value(dBuV) + Correction Factor(dB/m)
2. Correction Factor(dB/m) = Antenna Factor(dB/m) + Cable Factor(dB) – Pre-Amplifier Factor(dB)
3. The other emission levels were very low against the limit.
4. Margin value = Emission Level – Limit value
5. " * ": Fundamental frequency.



A D T

CHANNEL	TX Channel 165	DETECTOR FUNCTION	Peak (PK)
FREQUENCY RANGE	1GHz ~ 40GHz		Average (AV)

ANTENNA POLARITY & TEST DISTANCE: HORIZONTAL AT 3 M

NO.	FREQ. (MHz)	EMISSION LEVEL (dBuV/m)	LIMIT (dBuV/m)	MARGIN (dB)	ANTENNA HEIGHT (m)	TABLE ANGLE (Degree)	RAW VALUE (dBuV)	CORRECTION FACTOR (dB/m)
1	*5825.00	111.4 PK			1.05 H	357	66.81	44.59
2	*5825.00	103.2 AV			1.05 H	357	58.61	44.59
3	11650.00	52.4 PK	74.0	-21.6	1.07 H	311	0.99	51.41
4	11650.00	39.6 AV	54.0	-14.4	1.07 H	311	-11.81	51.41

ANTENNA POLARITY & TEST DISTANCE: VERTICAL AT 3 M

NO.	FREQ. (MHz)	EMISSION LEVEL (dBuV/m)	LIMIT (dBuV/m)	MARGIN (dB)	ANTENNA HEIGHT (m)	TABLE ANGLE (Degree)	RAW VALUE (dBuV)	CORRECTION FACTOR (dB/m)
1	*5825.00	123.3 PK			1.00 V	325	78.71	44.59
2	*5825.00	113.2 AV			1.00 V	325	68.61	44.59
3	11650.00	57.7 PK	74.0	-16.3	1.69 V	190	6.29	51.41
4	11650.00	44.8 AV	54.0	-9.2	1.69 V	190	-6.61	51.41

REMARKS:

1. Emission Level(dBuV/m) = Raw Value(dBuV) + Correction Factor(dB/m)
2. Correction Factor(dB/m) = Antenna Factor(dB/m) + Cable Factor(dB) – Pre-Amplifier Factor(dB)
3. The other emission levels were very low against the limit.
4. Margin value = Emission Level – Limit value
5. " * ": Fundamental frequency.

802.11ac (VHT40)

CHANNEL	TX Channel 151	DETECTOR FUNCTION	Peak (PK)
FREQUENCY RANGE	1GHz ~ 40GHz		Average (AV)

ANTENNA POLARITY & TEST DISTANCE: HORIZONTAL AT 3 M

NO.	FREQ. (MHz)	EMISSION LEVEL (dBuV/m)	LIMIT (dBuV/m)	MARGIN (dB)	ANTENNA HEIGHT (m)	TABLE ANGLE (Degree)	RAW VALUE (dBuV)	CORRECTION FACTOR (dB/m)
1	5460.00	56.3 PK	74.0	-17.7	1.33 H	20	12.22	44.08
2	5460.00	43.2 AV	54.0	-10.8	1.33 H	20	-0.88	44.08
3	*5755.00	107.8 PK			1.33 H	20	63.31	44.49
4	*5755.00	100.2 AV			1.33 H	20	55.71	44.49
5	11510.00	53.2 PK	74.0	-20.8	1.06 H	140	1.59	51.61
6	11510.00	39.6 AV	54.0	-14.4	1.06 H	140	-12.01	51.61

ANTENNA POLARITY & TEST DISTANCE: VERTICAL AT 3 M

NO.	FREQ. (MHz)	EMISSION LEVEL (dBuV/m)	LIMIT (dBuV/m)	MARGIN (dB)	ANTENNA HEIGHT (m)	TABLE ANGLE (Degree)	RAW VALUE (dBuV)	CORRECTION FACTOR (dB/m)
1	5460.00	58.2 PK	74.0	-15.8	1.00 V	319	14.12	44.08
2	5460.00	45.3 AV	54.0	-8.7	1.00 V	319	1.22	44.08
3	*5755.00	119.8 PK			1.00 V	319	75.31	44.49
4	*5755.00	109.6 AV			1.00 V	319	65.11	44.49
5	11510.00	54.8 PK	74.0	-19.2	1.47 V	184	3.19	51.61
6	11510.00	42.7 AV	54.0	-11.3	1.47 V	184	-8.91	51.61

REMARKS:

1. Emission Level(dBuV/m) = Raw Value(dBuV) + Correction Factor(dB/m)
2. Correction Factor(dB/m) = Antenna Factor(dB/m) + Cable Factor(dB) – Pre-Amplifier Factor(dB)
3. The other emission levels were very low against the limit.
4. Margin value = Emission Level – Limit value
5. " * ": Fundamental frequency.



A D T

CHANNEL	TX Channel 159	DETECTOR FUNCTION	Peak (PK)
FREQUENCY RANGE	1GHz ~ 40GHz		Average (AV)

ANTENNA POLARITY & TEST DISTANCE: HORIZONTAL AT 3 M

NO.	FREQ. (MHz)	EMISSION LEVEL (dBuV/m)	LIMIT (dBuV/m)	MARGIN (dB)	ANTENNA HEIGHT (m)	TABLE ANGLE (Degree)	RAW VALUE (dBuV)	CORRECTION FACTOR (dB/m)
1	*5795.00	108.5 PK			1.29 H	33	63.96	44.54
2	*5795.00	100.6 AV			1.29 H	33	56.06	44.54
3	11590.00	53.1 PK	74.0	-20.9	1.12 H	132	1.66	51.44
4	11590.00	39.6 AV	54.0	-14.4	1.12 H	132	-11.84	51.44

ANTENNA POLARITY & TEST DISTANCE: VERTICAL AT 3 M

NO.	FREQ. (MHz)	EMISSION LEVEL (dBuV/m)	LIMIT (dBuV/m)	MARGIN (dB)	ANTENNA HEIGHT (m)	TABLE ANGLE (Degree)	RAW VALUE (dBuV)	CORRECTION FACTOR (dB/m)
1	*5795.00	119.9 PK			1.01 V	315	75.36	44.54
2	*5795.00	109.8 AV			1.01 V	315	65.26	44.54
3	11590.00	55.1 PK	74.0	-18.9	1.46 V	181	3.66	51.44
4	11590.00	43.2 AV	54.0	-10.8	1.46 V	181	-8.24	51.44

REMARKS:

1. Emission Level(dBuV/m) = Raw Value(dBuV) + Correction Factor(dB/m)
2. Correction Factor(dB/m) = Antenna Factor(dB/m) + Cable Factor(dB) – Pre-Amplifier Factor(dB)
3. The other emission levels were very low against the limit.
4. Margin value = Emission Level – Limit value
5. " * ": Fundamental frequency.



A D T

802.11ac (VHT80)

CHANNEL	TX Channel 155	DETECTOR FUNCTION	Peak (PK)
FREQUENCY RANGE	1GHz ~ 40GHz		Average (AV)

ANTENNA POLARITY & TEST DISTANCE: HORIZONTAL AT 3 M

NO.	FREQ. (MHz)	EMISSION LEVEL (dBUV/m)	LIMIT (dBUV/m)	MARGIN (dB)	ANTENNA HEIGHT (m)	TABLE ANGLE (Degree)	RAW VALUE (dBUV)	CORRECTION FACTOR (dB/m)
1	5460.00	56.8 PK	74.0	-17.2	1.14 H	19	12.72	44.08
2	5460.00	44.2 AV	54.0	-9.8	1.14 H	19	0.12	44.08
3	*5775.00	104.7 PK			1.14 H	19	60.18	44.52
4	*5775.00	97.5 AV			1.14 H	19	52.98	44.52
5	11550.00	53.2 PK	74.0	-20.8	1.09 H	116	1.68	51.52
6	11550.00	39.4 AV	54.0	-14.6	1.09 H	116	-12.12	51.52

ANTENNA POLARITY & TEST DISTANCE: VERTICAL AT 3 M

NO.	FREQ. (MHz)	EMISSION LEVEL (dBUV/m)	LIMIT (dBUV/m)	MARGIN (dB)	ANTENNA HEIGHT (m)	TABLE ANGLE (Degree)	RAW VALUE (dBUV)	CORRECTION FACTOR (dB/m)
1	5460.00	58.3 PK	74.0	-15.7	1.00 V	319	14.22	44.08
2	5460.00	46.8 AV	54.0	-7.2	1.00 V	319	2.72	44.08
3	*5775.00	117.3 PK			1.00 V	319	72.78	44.52
4	*5775.00	106.4 AV			1.00 V	319	61.88	44.52
5	11550.00	52.3 PK	74.0	-21.7	1.41 V	176	0.78	51.52
6	11550.00	41.5 AV	54.0	-12.5	1.41 V	176	-10.02	51.52

REMARKS:

1. Emission Level(dBUV/m) = Raw Value(dBUV) + Correction Factor(dB/m)
2. Correction Factor(dB/m) = Antenna Factor(dB/m) + Cable Factor(dB) – Pre-Amplifier Factor(dB)
3. The other emission levels were very low against the limit.
4. Margin value = Emission Level – Limit value
5. " * ": Fundamental frequency.



A D T

STBC_MODE

802.11ac (VHT20)

CHANNEL	TX Channel 149	DETECTOR FUNCTION	Peak (PK)
FREQUENCY RANGE	1GHz ~ 40GHz		Average (AV)

ANTENNA POLARITY & TEST DISTANCE: HORIZONTAL AT 3 M

NO.	FREQ. (MHz)	EMISSION LEVEL (dBuV/m)	LIMIT (dBuV/m)	MARGIN (dB)	ANTENNA HEIGHT (m)	TABLE ANGLE (Degree)	RAW VALUE (dBuV)	CORRECTION FACTOR (dB/m)
1	5460.00	57.3 PK	74.0	-16.7	1.00 H	162	13.22	44.08
2	5460.00	44.1 AV	54.0	-9.9	1.00 H	162	0.02	44.08
3	*5745.00	112.4 PK			1.00 H	162	67.92	44.48
4	*5745.00	102.3 AV			1.00 H	162	57.82	44.48
5	11490.00	54.1 PK	74.0	-19.9	1.00 H	24	2.48	51.62
6	11490.00	41.5 AV	54.0	-12.5	1.00 H	24	-10.12	51.62

ANTENNA POLARITY & TEST DISTANCE: VERTICAL AT 3 M

NO.	FREQ. (MHz)	EMISSION LEVEL (dBuV/m)	LIMIT (dBuV/m)	MARGIN (dB)	ANTENNA HEIGHT (m)	TABLE ANGLE (Degree)	RAW VALUE (dBuV)	CORRECTION FACTOR (dB/m)
1	5460.00	57.1 PK	74.0	-16.9	1.00 V	286	13.02	44.08
2	5460.00	44.5 AV	54.0	-9.5	1.00 V	286	0.42	44.08
3	*5745.00	121.3 PK			1.00 V	286	76.82	44.48
4	*5745.00	111.3 AV			1.00 V	286	66.82	44.48
5	11490.00	57.9 PK	74.0	-16.1	1.51 V	166	6.28	51.62
6	11490.00	45.2 AV	54.0	-8.8	1.51 V	166	-6.42	51.62

REMARKS:

1. Emission Level(dBuV/m) = Raw Value(dBuV) + Correction Factor(dB/m)
2. Correction Factor(dB/m) = Antenna Factor(dB/m) + Cable Factor(dB) – Pre-Amplifier Factor(dB)
3. The other emission levels were very low against the limit.
4. Margin value = Emission Level – Limit value
5. " * ": Fundamental frequency.



A D T

CHANNEL	TX Channel 157	DETECTOR FUNCTION	Peak (PK)
FREQUENCY RANGE	1GHz ~ 40GHz		Average (AV)

ANTENNA POLARITY & TEST DISTANCE: HORIZONTAL AT 3 M

NO.	FREQ. (MHz)	EMISSION LEVEL (dBuV/m)	LIMIT (dBuV/m)	MARGIN (dB)	ANTENNA HEIGHT (m)	TABLE ANGLE (Degree)	RAW VALUE (dBuV)	CORRECTION FACTOR (dB/m)
1	*5785.00	112.2 PK			1.04 H	174	67.68	44.52
2	*5785.00	102.4 AV			1.04 H	174	57.88	44.52
3	11570.00	53.7 PK	74.0	-20.3	1.00 H	29	2.21	51.49
4	11570.00	41.1 AV	54.0	-12.9	1.00 H	29	-10.39	51.49

ANTENNA POLARITY & TEST DISTANCE: VERTICAL AT 3 M

NO.	FREQ. (MHz)	EMISSION LEVEL (dBuV/m)	LIMIT (dBuV/m)	MARGIN (dB)	ANTENNA HEIGHT (m)	TABLE ANGLE (Degree)	RAW VALUE (dBuV)	CORRECTION FACTOR (dB/m)
1	*5785.00	121.5 PK			1.00 V	285	76.98	44.52
2	*5785.00	111.6 AV			1.00 V	285	67.08	44.52
3	11570.00	58.1 PK	74.0	-15.9	1.56 V	174	6.61	51.49
4	11570.00	45.4 AV	54.0	-8.6	1.56 V	174	-6.09	51.49

REMARKS:

1. Emission Level(dBuV/m) = Raw Value(dBuV) + Correction Factor(dB/m)
2. Correction Factor(dB/m) = Antenna Factor(dB/m) + Cable Factor(dB) – Pre-Amplifier Factor(dB)
3. The other emission levels were very low against the limit.
4. Margin value = Emission Level – Limit value
5. " * ": Fundamental frequency.



A D T

CHANNEL	TX Channel 165	DETECTOR FUNCTION	Peak (PK)
FREQUENCY RANGE	1GHz ~ 40GHz		Average (AV)

ANTENNA POLARITY & TEST DISTANCE: HORIZONTAL AT 3 M

NO.	FREQ. (MHz)	EMISSION LEVEL (dBuV/m)	LIMIT (dBuV/m)	MARGIN (dB)	ANTENNA HEIGHT (m)	TABLE ANGLE (Degree)	RAW VALUE (dBuV)	CORRECTION FACTOR (dB/m)
1	*5825.00	112.4 PK			1.01 H	164	67.81	44.59
2	*5825.00	102.6 AV			1.01 H	164	58.01	44.59
3	11650.00	54.5 PK	74.0	-19.5	1.00 H	28	3.09	51.41
4	11650.00	41.7 AV	54.0	-12.3	1.00 H	28	-9.71	51.41

ANTENNA POLARITY & TEST DISTANCE: VERTICAL AT 3 M

NO.	FREQ. (MHz)	EMISSION LEVEL (dBuV/m)	LIMIT (dBuV/m)	MARGIN (dB)	ANTENNA HEIGHT (m)	TABLE ANGLE (Degree)	RAW VALUE (dBuV)	CORRECTION FACTOR (dB/m)
1	*5825.00	121.2 PK			1.00 V	297	76.61	44.59
2	*5825.00	111.2 AV			1.00 V	297	66.61	44.59
3	11650.00	56.8 PK	74.0	-17.2	1.00 V	165	5.39	51.41
4	11650.00	44.3 AV	54.0	-9.7	1.00 V	165	-7.11	51.41

REMARKS:

1. Emission Level(dBuV/m) = Raw Value(dBuV) + Correction Factor(dB/m)
2. Correction Factor(dB/m) = Antenna Factor(dB/m) + Cable Factor(dB) – Pre-Amplifier Factor(dB)
3. The other emission levels were very low against the limit.
4. Margin value = Emission Level – Limit value
5. " * ": Fundamental frequency.



A D T

802.11ac (VHT40)

CHANNEL	TX Channel 151	DETECTOR FUNCTION	Peak (PK)
FREQUENCY RANGE	1GHz ~ 40GHz		Average (AV)

ANTENNA POLARITY & TEST DISTANCE: HORIZONTAL AT 3 M

NO.	FREQ. (MHz)	EMISSION LEVEL (dBuV/m)	LIMIT (dBuV/m)	MARGIN (dB)	ANTENNA HEIGHT (m)	TABLE ANGLE (Degree)	RAW VALUE (dBuV)	CORRECTION FACTOR (dB/m)
1	5460.00	56.9 PK	74.0	-17.1	1.02 H	165	12.82	44.08
2	5460.00	45.3 AV	54.0	-8.7	1.02 H	165	1.22	44.08
3	*5755.00	110.3 PK			1.02 H	165	65.81	44.49
4	*5755.00	100.1 AV			1.02 H	165	55.61	44.49
5	11510.00	54.1 PK	74.0	-19.9	1.00 H	31	2.49	51.61
6	11510.00	41.6 AV	54.0	-12.4	1.00 H	31	-10.01	51.61

ANTENNA POLARITY & TEST DISTANCE: VERTICAL AT 3 M

NO.	FREQ. (MHz)	EMISSION LEVEL (dBuV/m)	LIMIT (dBuV/m)	MARGIN (dB)	ANTENNA HEIGHT (m)	TABLE ANGLE (Degree)	RAW VALUE (dBuV)	CORRECTION FACTOR (dB/m)
1	5460.00	57.2 PK	74.0	-16.8	1.01 V	285	13.12	44.08
2	5460.00	44.7 AV	54.0	-9.3	1.01 V	285	0.62	44.08
3	*5755.00	119.1 PK			1.00 V	284	74.61	44.49
4	*5755.00	109.8 AV			1.00 V	284	65.31	44.49
5	11510.00	54.2 PK	74.0	-19.8	1.49 V	162	2.59	51.61
6	11510.00	42.1 AV	54.0	-11.9	1.49 V	162	-9.51	51.61

REMARKS:

1. Emission Level(dBuV/m) = Raw Value(dBuV) + Correction Factor(dB/m)
2. Correction Factor(dB/m) = Antenna Factor(dB/m) + Cable Factor(dB) – Pre-Amplifier Factor(dB)
3. The other emission levels were very low against the limit.
4. Margin value = Emission Level – Limit value
5. " * ": Fundamental frequency.



A D T

CHANNEL	TX Channel 159	DETECTOR FUNCTION	Peak (PK)
FREQUENCY RANGE	1GHz ~ 40GHz		Average (AV)

ANTENNA POLARITY & TEST DISTANCE: HORIZONTAL AT 3 M

NO.	FREQ. (MHz)	EMISSION LEVEL (dBuV/m)	LIMIT (dBuV/m)	MARGIN (dB)	ANTENNA HEIGHT (m)	TABLE ANGLE (Degree)	RAW VALUE (dBuV)	CORRECTION FACTOR (dB/m)
1	*5795.00	109.9 PK			1.01 H	164	65.36	44.54
2	*5795.00	100.0 AV			1.01 H	164	55.46	44.54
3	11590.00	53.9 PK	74.0	-20.1	1.03 H	42	2.46	51.44
4	11590.00	41.2 AV	54.0	-12.8	1.03 H	42	-10.24	51.44

ANTENNA POLARITY & TEST DISTANCE: VERTICAL AT 3 M

NO.	FREQ. (MHz)	EMISSION LEVEL (dBuV/m)	LIMIT (dBuV/m)	MARGIN (dB)	ANTENNA HEIGHT (m)	TABLE ANGLE (Degree)	RAW VALUE (dBuV)	CORRECTION FACTOR (dB/m)
1	*5795.00	119.2 PK			1.00 V	288	74.66	44.54
2	*5795.00	110.0 AV			1.00 V	288	65.46	44.54
3	11590.00	54.2 PK	74.0	-19.8	1.54 V	152	2.76	51.44
4	11590.00	42.3 AV	54.0	-11.7	1.54 V	152	-9.14	51.44

REMARKS:

1. Emission Level(dBuV/m) = Raw Value(dBuV) + Correction Factor(dB/m)
2. Correction Factor(dB/m) = Antenna Factor(dB/m) + Cable Factor(dB) – Pre-Amplifier Factor(dB)
3. The other emission levels were very low against the limit.
4. Margin value = Emission Level – Limit value
5. " * ": Fundamental frequency.

802.11ac (VHT80)

CHANNEL	TX Channel 155	DETECTOR FUNCTION	Peak (PK)
FREQUENCY RANGE	1GHz ~ 40GHz		Average (AV)

ANTENNA POLARITY & TEST DISTANCE: HORIZONTAL AT 3 M

NO.	FREQ. (MHz)	EMISSION LEVEL (dBuV/m)	LIMIT (dBuV/m)	MARGIN (dB)	ANTENNA HEIGHT (m)	TABLE ANGLE (Degree)	RAW VALUE (dBuV)	CORRECTION FACTOR (dB/m)
1	5460.00	56.3 PK	74.0	-17.7	1.00 H	166	12.22	44.08
2	5460.00	44.1 AV	54.0	-9.9	1.00 H	166	0.02	44.08
3	*5775.00	107.6 PK			1.00 H	166	63.08	44.52
4	*5775.00	99.1 AV			1.00 H	166	54.58	44.52
5	11550.00	54.0 PK	74.0	-20.0	1.00 H	36	2.48	51.52
6	11550.00	41.7 AV	54.0	-12.3	1.00 H	36	-9.82	51.52

ANTENNA POLARITY & TEST DISTANCE: VERTICAL AT 3 M

NO.	FREQ. (MHz)	EMISSION LEVEL (dBuV/m)	LIMIT (dBuV/m)	MARGIN (dB)	ANTENNA HEIGHT (m)	TABLE ANGLE (Degree)	RAW VALUE (dBuV)	CORRECTION FACTOR (dB/m)
1	5460.00	57.3 PK	74.0	-16.7	1.02 V	288	13.22	44.08
2	5460.00	44.9 AV	54.0	-9.1	1.02 V	288	0.82	44.08
3	*5775.00	116.2 PK			1.00 V	285	71.68	44.52
4	*5775.00	108.9 AV			1.00 V	285	64.38	44.52
5	11550.00	54.2 PK	74.0	-19.8	1.52 V	164	2.68	51.52
6	11550.00	42.4 AV	54.0	-11.6	1.52 V	164	-9.12	51.52

REMARKS:

1. Emission Level(dBuV/m) = Raw Value(dBuV) + Correction Factor(dB/m)
2. Correction Factor(dB/m) = Antenna Factor(dB/m) + Cable Factor(dB) – Pre-Amplifier Factor(dB)
3. The other emission levels were very low against the limit.
4. Margin value = Emission Level – Limit value
5. " * ": Fundamental frequency.

5.2.8 TEST RESULTS (MODE 2)

ABOVE 1GHz DATA

802.11a

CHANNEL	TX Channel 149	DETECTOR FUNCTION	Peak (PK)
FREQUENCY RANGE	1GHz ~ 40GHz		Average (AV)

ANTENNA POLARITY & TEST DISTANCE: HORIZONTAL AT 3 M								
NO.	FREQ. (MHz)	EMISSION LEVEL (dBuV/m)	LIMIT (dBuV/m)	MARGIN (dB)	ANTENNA HEIGHT (m)	TABLE ANGLE (Degree)	RAW VALUE (dBuV)	CORRECTION FACTOR (dB/m)
1	5460.00	54.5 PK	74.0	-19.5	1.05 H	20	10.42	44.08
2	5460.00	41.2 AV	54.0	-12.8	1.05 H	20	-2.88	44.08
3	*5745.00	100.2 PK			1.03 H	20	55.72	44.48
4	*5745.00	91.4 AV			1.03 H	20	46.92	44.48
5	11490.00	53.1 PK	74.0	-20.9	1.11 H	132	1.48	51.62
6	11490.00	39.4 AV	54.0	-14.6	1.11 H	132	-12.22	51.62

ANTENNA POLARITY & TEST DISTANCE: VERTICAL AT 3 M								
NO.	FREQ. (MHz)	EMISSION LEVEL (dBuV/m)	LIMIT (dBuV/m)	MARGIN (dB)	ANTENNA HEIGHT (m)	TABLE ANGLE (Degree)	RAW VALUE (dBuV)	CORRECTION FACTOR (dB/m)
1	5460.00	56.9 PK	74.0	-17.1	1.00 V	319	12.82	44.08
2	5460.00	44.7 AV	54.0	-9.3	1.00 V	319	0.62	44.08
3	*5745.00	117.6 PK			1.00 V	319	73.12	44.48
4	*5745.00	107.3 AV			1.00 V	319	62.82	44.48
5	11490.00	54.6 PK	74.0	-19.4	1.63 V	159	2.98	51.62
6	11490.00	41.8 AV	54.0	-12.2	1.63 V	159	-9.82	51.62

REMARKS:

1. Emission Level(dBuV/m) = Raw Value(dBuV) + Correction Factor(dB/m)
2. Correction Factor(dB/m) = Antenna Factor(dB/m) + Cable Factor(dB) – Pre-Amplifier Factor(dB)
3. The other emission levels were very low against the limit.
4. Margin value = Emission Level – Limit value
5. " * ": Fundamental frequency.



A D T

CHANNEL	TX Channel 157	DETECTOR FUNCTION	Peak (PK)
FREQUENCY RANGE	1GHz ~ 40GHz		Average (AV)

ANTENNA POLARITY & TEST DISTANCE: HORIZONTAL AT 3 M

NO.	FREQ. (MHz)	EMISSION LEVEL (dBuV/m)	LIMIT (dBuV/m)	MARGIN (dB)	ANTENNA HEIGHT (m)	TABLE ANGLE (Degree)	RAW VALUE (dBuV)	CORRECTION FACTOR (dB/m)
1	*5785.00	99.1 PK			1.15 H	21	54.58	44.52
2	*5785.00	90.5 AV			1.15 H	21	45.98	44.52
3	11570.00	52.6 PK	74.0	-21.4	1.05 H	141	1.11	51.49
4	11570.00	39.1 AV	54.0	-14.9	1.05 H	141	-12.39	51.49

ANTENNA POLARITY & TEST DISTANCE: VERTICAL AT 3 M

NO.	FREQ. (MHz)	EMISSION LEVEL (dBuV/m)	LIMIT (dBuV/m)	MARGIN (dB)	ANTENNA HEIGHT (m)	TABLE ANGLE (Degree)	RAW VALUE (dBuV)	CORRECTION FACTOR (dB/m)
1	*5785.00	118.2 PK			1.00 V	312	73.68	44.52
2	*5785.00	107.8 AV			1.00 V	312	63.28	44.52
3	11570.00	54.6 PK	74.0	-19.4	1.59 V	164	3.11	51.49
4	11570.00	41.8 AV	54.0	-12.2	1.59 V	164	-9.69	51.49

REMARKS:

1. Emission Level(dBuV/m) = Raw Value(dBuV) + Correction Factor(dB/m)
2. Correction Factor(dB/m) = Antenna Factor(dB/m) + Cable Factor(dB) – Pre-Amplifier Factor(dB)
3. The other emission levels were very low against the limit.
4. Margin value = Emission Level – Limit value
5. " * ": Fundamental frequency.



A D T

CHANNEL	TX Channel 165	DETECTOR FUNCTION	Peak (PK)
FREQUENCY RANGE	1GHz ~ 40GHz		Average (AV)

ANTENNA POLARITY & TEST DISTANCE: HORIZONTAL AT 3 M

NO.	FREQ. (MHz)	EMISSION LEVEL (dBuV/m)	LIMIT (dBuV/m)	MARGIN (dB)	ANTENNA HEIGHT (m)	TABLE ANGLE (Degree)	RAW VALUE (dBuV)	CORRECTION FACTOR (dB/m)
1	*5825.00	98.8 PK			1.10 H	35	54.21	44.59
2	*5825.00	90.3 AV			1.10 H	35	45.71	44.59
3	11650.00	53.6 PK	74.0	-20.4	1.06 H	128	2.19	51.41
4	11650.00	39.7 AV	54.0	-14.3	1.06 H	128	-11.71	51.41

ANTENNA POLARITY & TEST DISTANCE: VERTICAL AT 3 M

NO.	FREQ. (MHz)	EMISSION LEVEL (dBuV/m)	LIMIT (dBuV/m)	MARGIN (dB)	ANTENNA HEIGHT (m)	TABLE ANGLE (Degree)	RAW VALUE (dBuV)	CORRECTION FACTOR (dB/m)
1	*5825.00	117.3 PK			1.00 V	308	72.71	44.59
2	*5825.00	107.2 AV			1.00 V	308	62.61	44.59
3	11650.00	54.7 PK	74.0	-19.3	1.68 V	151	3.29	51.41
4	11650.00	42.1 AV	54.0	-11.9	1.68 V	151	-9.31	51.41

REMARKS:

1. Emission Level(dBuV/m) = Raw Value(dBuV) + Correction Factor(dB/m)
2. Correction Factor(dB/m) = Antenna Factor(dB/m) + Cable Factor(dB) – Pre-Amplifier Factor(dB)
3. The other emission levels were very low against the limit.
4. Margin value = Emission Level – Limit value
5. " * ": Fundamental frequency.

5.3 6dB BANDWIDTH MEASUREMENT

5.3.1 LIMITS OF 6dB BANDWIDTH MEASUREMENT

The minimum of 6dB Bandwidth Measurement is 0.5 MHz.

5.3.2 TEST INSTRUMENTS

DESCRIPTION & MANUFACTURER	MODEL NO.	SERIAL NO.	CALIBRATED DATE	CALIBRATED UNTIL
Spectrum Analyzer R&S	FSP40	100036	Jan. 21, 2013	Jan. 20, 2014

Note:

1. The calibration interval of the above test instruments is 12 months and the calibrations are traceable to NML/ROC and NIST/USA.
2. Tested date : Jan. 17, 2014

5.3.3 TEST PROCEDURE

1. Set resolution bandwidth (RBW) = 100kHz
2. Set the video bandwidth (VBW) $\geq 3 \times$ RBW, Detector = Peak.
3. Trace mode = max hold.
4. Sweep = auto couple.
5. Measure the maximum width of the emission that is constrained by the frequencies associated with the two amplitude points (upper and lower) that are attenuated by 6 dB relative to the maximum level measured in the fundamental emission

5.3.4 DEVIATION FROM TEST STANDARD

No deviation

5.3.5 TEST SETUP

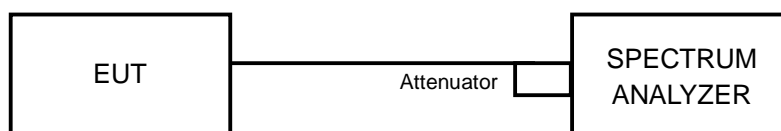

5.3.6 EUT OPERATING CONDITIONS

The software provided by client to enable the EUT under transmission condition continuously at lowest, middle and highest channel frequencies individually.



5.3.7 TEST RESULTS (MODE 1)

CDD_MODE						
CHANNEL	CHANNEL FREQUENCY (MHz)	6dB BANDWIDTH (MHz)			MINIMUM LIMIT (MHz)	PASS / FAIL
		CHAIN 0	CHAIN 1	CHAIN 2		
802.11ac (VHT20)						
149	5745	17.68	17.71	17.70	0.5	PASS
157	5785	17.64	17.66	17.65	0.5	PASS
165	5825	17.64	17.67	17.68	0.5	PASS
802.11ac (VHT40)						
151	5755	36.40	36.46	36.41	0.5	PASS
159	5795	36.42	36.49	36.49	0.5	PASS
802.11ac (VHT80)						
155	5775	76.18	76.04	76.17	0.5	PASS

STBC_MODE						
CHANNEL	CHANNEL FREQUENCY (MHz)	6dB BANDWIDTH (MHz)			MINIMUM LIMIT (MHz)	PASS / FAIL
		CHAIN 0	CHAIN 1	CHAIN 2		
802.11ac (VHT20)						
149	5745	17.68	17.71	17.70	0.5	PASS
157	5785	17.64	17.66	17.65	0.5	PASS
165	5825	17.64	17.67	17.68	0.5	PASS
802.11ac (VHT40)						
151	5755	36.40	36.46	36.41	0.5	PASS
159	5795	36.42	36.49	36.49	0.5	PASS
802.11ac (VHT80)						
155	5775	76.18	76.04	76.17	0.5	PASS

Beam forming_MODE						
CHANNEL	CHANNEL FREQUENCY (MHz)	6dB BANDWIDTH (MHz)			MINIMUM LIMIT (MHz)	PASS / FAIL
		CHAIN 0	CHAIN 1	CHAIN 2		
802.11ac (VHT20)						
149	5745	17.66	17.71	17.70	0.5	PASS
157	5785	17.65	17.67	17.67	0.5	PASS
165	5825	17.67	17.69	17.67	0.5	PASS
802.11ac (VHT40)						
151	5755	36.43	36.50	36.43	0.5	PASS
159	5795	36.48	36.46	36.48	0.5	PASS
802.11ac (VHT80)						
155	5775	76.18	76.04	76.17	0.5	PASS



A D T

SPECTRUM PLOT OF WORST VALUE

CDD_MODE <802.11ac (VHT20)_Chain (0) / CH157>

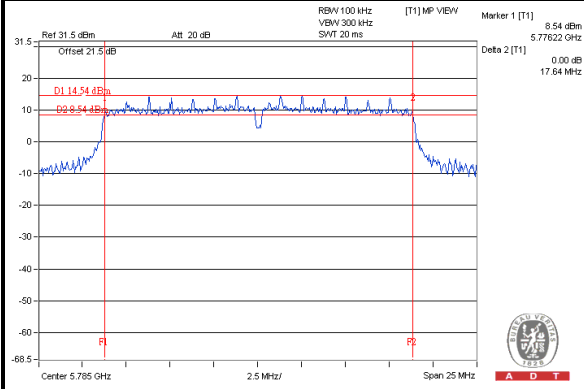

CDD_MODE <802.11ac (VHT40)_Chain (0) / CH151>

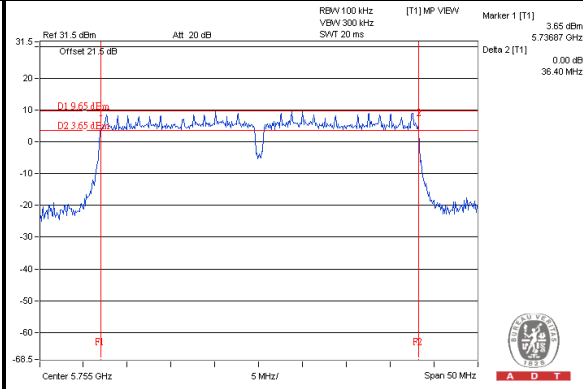

CDD_MODE <802.11ac (VHT80)_Chain (1) / CH155>

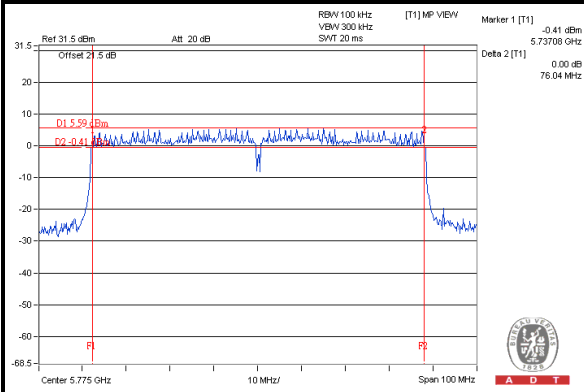

5.3.8 TEST RESULTS (MODE 2)

802.11a				
CHANNEL	FREQUENCY (MHz)	6dB BANDWIDTH (MHz)	MINIMUM LIMIT (MHz)	PASS / FAIL
149	5745	16.40	0.5	PASS
157	5785	16.38	0.5	PASS
165	5825	16.39	0.5	PASS

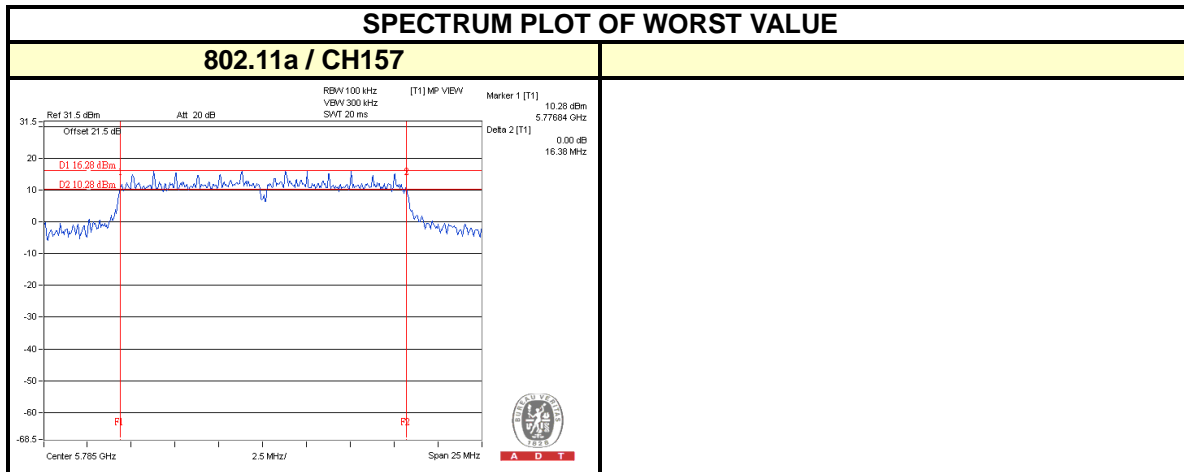

5.4 CONDUCTED OUTPUT POWER MEASUREMENT

5.4.1 LIMITS OF CONDUCTED OUTPUT POWER MEASUREMENT

For systems using digital modulation in the 5725 –5850 MHz band: 1 Watt (30dBm)

Per KDB 662911 D01 Multiple Transmitter Output Method of conducted output power measurement on IEEE 802.11 devices,

Array Gain = 0 dB (i.e., no array gain) for NANT \leq 4;

Array Gain = 0 dB (i.e., no array gain) for channel widths \geq 40 MHz for any NANT;

Array Gain = 5 log(NANT/NSS) dB or 3 dB, whichever is less for 20-MHz channel widths with NANT \geq 5.

For power measurements on all other devices: Array Gain = 10 log(NANT/NSS) dB.

5.4.2 INSTRUMENTS

DESCRIPTION & MANUFACTURER	MODEL NO.	SERIAL NO.	CALIBRATED DATE	CALIBRATED UNTIL
Power meter Anritsu	ML2495A	0824006	May 20, 2013	May 19, 2014
Power sensor Anritsu	MA2411B	0738172	May 20, 2013	May 19, 2014

Note:

1. The calibration interval of the above test instruments is 12 months and the calibrations are traceable to NML/ROC and NIST/USA.
2. Tested date : Jan. 17, 2014

5.4.3 TEST PROCEDURES

Method PM is used to perform output power measurement, trigger and gating function of wide band power meter is enabled to measure max output power of TX on burst. Duty factor is not added to measured value.

5.4.4 DEVIATION FROM TEST STANDARD

No deviation.

5.4.5 TEST SETUP

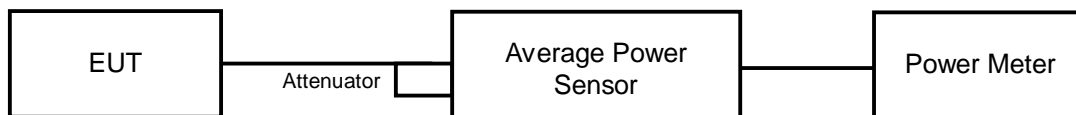

5.4.6 EUT OPERATING CONDITIONS

Same as Item 5.3.6

5.4.7 TEST RESULTS (MODE 1)

CDD_MODE								
CHANNEL	FREQUENCY (MHz)	AVERAGE POWER (dBm)			TOTAL POWER (mW)	TOTAL POWER (dBm)	LIMIT (dBm)	PASS / FAIL
		CHAIN 0	CHAIN 1	CHAIN 2				
802.11ac (VHT20)								
149	5745	23.82	24.25	24.01	758.832	28.80	30	PASS
157	5785	25.05	24.95	25.07	953.864	29.79	30	PASS
165	5825	25.08	24.91	25.13	957.686	29.81	30	PASS
802.11ac (VHT40)								
151	5755	22.93	23.10	23.17	608.001	27.84	30	PASS
159	5795	25.11	24.98	24.71	934.916	29.71	30	PASS
802.11ac (VHT80)								
155	5775	21.45	22.09	21.93	457.400	26.60	30	PASS

STBC_MODE								
CHANNEL	FREQUENCY (MHz)	AVERAGE POWER (dBm)			TOTAL POWER (mW)	TOTAL POWER (dBm)	LIMIT (dBm)	PASS / FAIL
		CHAIN 0	CHAIN 1	CHAIN 2				
802.11ac (VHT20)								
149	5745	23.82	24.25	24.01	758.832	28.80	30	PASS
157	5785	25.05	24.95	25.07	953.864	29.79	30	PASS
165	5825	25.08	24.91	25.13	957.686	29.81	30	PASS
802.11ac (VHT40)								
151	5755	22.93	23.10	23.17	608.001	27.84	30	PASS
159	5795	25.11	24.98	24.71	934.916	29.71	30	PASS
802.11ac (VHT80)								
155	5775	21.45	22.09	21.93	457.400	26.60	30	PASS



A D T

Beam forming_MODE								
CHANNEL	FREQUENCY (MHz)	AVERAGE POWER (dBm)			TOTAL POWER (mW)	TOTAL POWER (dBm)	LIMIT (dBm)	PASS / FAIL
		CHAIN 0	CHAIN 1	CHAIN 2				
802.11ac (VHT20)								
149	5745	23.79	24.21	23.89	747.871	28.74	29.54	PASS
157	5785	23.71	24.12	23.73	729.237	28.63	29.54	PASS
165	5825	23.71	24.05	23.76	726.744	28.61	29.54	PASS
802.11ac (VHT40)								
151	5755	22.41	23.60	22.57	583.985	27.66	29.54	PASS
159	5795	23.97	24.15	23.61	739.090	28.69	29.54	PASS
802.11ac (VHT80)								
155	5775	21.45	22.09	21.93	457.400	26.60	29.54	PASS
NOTE: Directional gain = $10 \log[(10^{G1/20} + 10^{G2/20} + 10^{G3/20})^2 / 3]$ = 6.46dBi > 6dBi , so the power limit shall be reduced to $30-(6.46-6) = 29.54$ dBm.								

5.4.8 TEST RESULTS (MODE 2)

802.11a					
CHANNEL	FREQUENCY (MHz)	AVERAGE POWER (mW)	AVERAGE POWER (dBm)	LIMIT (dBm)	PASS/FAIL
149	5745	260.016	24.15	30	PASS
157	5785	405.509	26.08	30	PASS
165	5825	409.261	26.12	30	PASS

5.5 POWER SPECTRAL DENSITY MEASUREMENT

5.5.1 LIMITS OF POWER SPECTRAL DENSITY MEASUREMENT

The Maximum of Power Spectral Density Measurement is 8dBm.

5.5.2 TEST INSTRUMENTS

DESCRIPTION & MANUFACTURER	MODEL NO.	SERIAL NO.	CALIBRATED DATE	CALIBRATED UNTIL
Spectrum Analyzer R&S	FSP 40	100036	Jan. 21, 2013	Jan. 20, 2014

Note:

1. The calibration interval of the above test instruments is 12 months and the calibrations are traceable to NML/ROC and NIST/USA.
2. Tested date : Jan. 17, 2014

5.5.3 TEST PROCEDURE

1. Set the RBW = 30 kHz, VBW =100 kHz, Detector = power averaging (RMS).
2. Ensure that the number of measurement points in the sweep $\geq 2 \times$ span/RBW
3. Sweep time = auto couple,
4. Employ trace averaging (RMS) mode over a minimum of 100 traces.
5. Use the peak marker function to determine the maximum amplitude level.

5.5.4 DEVIATION FROM TEST STANDARD

No deviation

5.5.5 TEST SETUP

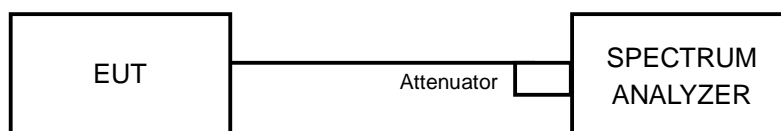

5.5.6 EUT OPERATING CONDITION

Same as Item 4.3.6



A D T

5.5.7 TEST RESULTS (MODE 1)

CDD_MODE

802.11ac (VHT20)							
TX CHAIN	CHANNEL	FREQUENCY (MHz)	PSD (dBm)	10 log (N=3) dB	TOTAL PSD (dBm)	LIMIT (dBm)	PASS /FAIL
0	149	5745	-7.55	4.77	-2.78	7.54	PASS
	157	5785	-5.94	4.77	-1.17	7.54	PASS
	165	5825	-5.80	4.77	-1.03	7.54	PASS
1	149	5745	-7.29	4.77	-2.52	7.54	PASS
	157	5785	-5.15	4.77	-0.38	7.54	PASS
	165	5825	-5.39	4.77	-0.62	7.54	PASS
2	149	5745	-7.28	4.77	-2.51	7.54	PASS
	157	5785	-5.04	4.77	-0.27	7.54	PASS
	165	5825	-5.58	4.77	-0.81	7.54	PASS

NOTE: Directional gain = $10 \log[(10^{G1/20} + 10^{G2/20} + 10^{G3/20})^2 / 3] = 6.46\text{dBi} > 6\text{dBi}$, so the power density limit shall be reduced to $8-(6.46-6) = 7.54\text{dBm}$.

802.11ac (VHT40)							
TX CHAIN	CHANNEL	FREQUENCY (MHz)	PSD (dBm)	10 log (N=3) dB	TOTAL PSD (dBm)	LIMIT (dBm)	PASS /FAIL
0	151	5755	-11.35	4.77	-6.58	7.54	PASS
	159	5795	-8.02	4.77	-3.25	7.54	PASS
1	151	5755	-11.13	4.77	-6.36	7.54	PASS
	159	5795	-7.74	4.77	-2.97	7.54	PASS
2	151	5755	-11.01	4.77	-6.24	7.54	PASS
	159	5795	-7.94	4.77	-3.17	7.54	PASS

NOTE: Directional gain = $10 \log[(10^{G1/20} + 10^{G2/20} + 10^{G3/20})^2 / 3] = 6.46\text{dBi} > 6\text{dBi}$, so the power density limit shall be reduced to $8-(6.46-6) = 7.54\text{dBm}$.

802.11ac (VHT80)								
TX CHAIN	CHANNEL	FREQ. (MHz)	PSD W/O DUTY FACTOR (dBm)	10 log (N=3) dB	DUTY FACTOR (dB)	TOTAL PSD WITH DUTY FACTOR (dBm)	LIMIT (dBm)	PASS /FAIL
0	155	5775	-15.68	4.77	0.16	-10.75	7.54	PASS
1	155	5775	-15.03	4.77	0.16	-10.10	7.54	PASS
2	155	5775	-14.95	4.77	0.16	-10.02	7.54	PASS

NOTE: 1. Directional gain = $10 \log[(10^{G1/20} + 10^{G2/20} + 10^{G3/20})^2 / 3] = 6.46\text{dBi} > 6\text{dBi}$, so the power density limit shall be reduced to $8-(6.46-6) = 7.54\text{dBm}$.
2. Refer to section 3.4 for duty cycle spectrum plot.



STBC_MODE

802.11ac (VHT20)							
TX CHAIN	CHANNEL	FREQUENCY (MHz)	PSD (dBm)	10 log (N=3) dB	TOTAL PSD (dBm)	LIMIT (dBm)	PASS /FAIL
0	149	5745	-7.55	4.77	-2.78	8	PASS
	157	5785	-5.94	4.77	-1.17	8	PASS
	165	5825	-5.80	4.77	-1.03	8	PASS
1	149	5745	-7.29	4.77	-2.52	8	PASS
	157	5785	-5.15	4.77	-0.38	8	PASS
	165	5825	-5.39	4.77	-0.62	8	PASS
2	149	5745	-7.28	4.77	-2.51	8	PASS
	157	5785	-5.04	4.77	-0.27	8	PASS
	165	5825	-5.58	4.77	-0.81	8	PASS

802.11ac (VHT40)							
TX CHAIN	CHANNEL	FREQUENCY (MHz)	PSD (dBm)	10 log (N=3) dB	TOTAL PSD (dBm)	LIMIT (dBm)	PASS /FAIL
0	151	5755	-11.35	4.77	-6.58	8	PASS
	159	5795	-8.02	4.77	-3.25	8	PASS
1	151	5755	-11.13	4.77	-6.36	8	PASS
	159	5795	-7.74	4.77	-2.97	8	PASS
2	151	5755	-11.01	4.77	-6.24	8	PASS
	159	5795	-7.94	4.77	-3.17	8	PASS

802.11ac (VHT80)								
TX CHAIN	CHANNEL	FREQ. (MHz)	PSD W/O DUTY FACTOR (dBm)	10 log (N=3) dB	DUTY FACTOR (dB)	TOTAL PSD WITH DUTY FACTOR (dBm)	LIMIT (dBm)	PASS /FAIL
0	155	5775	-15.68	4.77	0.16	-10.75	7.54	PASS
1	155	5775	-15.03	4.77	0.16	-10.10	7.54	PASS
2	155	5775	-14.95	4.77	0.16	-10.02	7.54	PASS

NOTE: 1. Refer to section 3.4 for duty cycle spectrum plot.



Beam forming_MODE

802.11ac (VHT20)							
TX CHAIN	CHANNEL	FREQUENCY (MHz)	PSD (dBm)	10 log (N=3) dB	TOTAL PSD (dBm)	LIMIT (dBm)	PASS /FAIL
0	149	5745	-7.63	4.77	-2.86	7.54	PASS
	157	5785	-7.16	4.77	-2.39	7.54	PASS
	165	5825	-6.85	4.77	-2.08	7.54	PASS
1	149	5745	-6.97	4.77	-2.20	7.54	PASS
	157	5785	-6.37	4.77	-1.60	7.54	PASS
	165	5825	-6.73	4.77	-1.96	7.54	PASS
2	149	5745	-7.65	4.77	-2.88	7.54	PASS
	157	5785	-7.11	4.77	-2.34	7.54	PASS
	165	5825	-6.74	4.77	-1.97	7.54	PASS

NOTE: Directional gain = $10 \log[(10^{G1/20} + 10^{G2/20} + 10^{G3/20})^2 / 3]$ = 6.46dBi > 6dBi , so the power density limit shall be reduced to 8-(6.46-6) = 7.54dBm.

802.11ac (VHT40)							
TX CHAIN	CHANNEL	FREQUENCY (MHz)	PSD (dBm)	10 log (N=3) dB	TOTAL PSD (dBm)	LIMIT (dBm)	PASS /FAIL
0	151	5755	-11.47	4.77	-6.70	7.54	PASS
	159	5795	-9.75	4.77	-4.98	7.54	PASS
1	151	5755	-11.21	4.77	-6.44	7.54	PASS
	159	5795	-9.39	4.77	-4.62	7.54	PASS
2	151	5755	-11.82	4.77	-7.05	7.54	PASS
	159	5795	-9.69	4.77	-4.92	7.54	PASS

NOTE: Directional gain = $10 \log[(10^{G1/20} + 10^{G2/20} + 10^{G3/20})^2 / 3]$ = 6.46dBi > 6dBi , so the power density limit shall be reduced to 8-(6.46-6) = 7.54dBm.

802.11ac (VHT80)								
TX CHAIN	CHANNEL	FREQ. (MHz)	PSD W/O DUTY FACTOR (dBm)	10 log (N=3) dB	DUTY FACTOR (dB)	TOTAL PSD WITH DUTY FACTOR (dBm)	LIMIT (dBm)	PASS /FAIL
0	155	5775	-15.68	4.77	0.16	-10.75	7.54	PASS
1	155	5775	-15.03	4.77	0.16	-10.10	7.54	PASS
2	155	5775	-14.95	4.77	0.16	-10.02	7.54	PASS

NOTE: 1. Directional gain = $10 \log[(10^{G1/20} + 10^{G2/20} + 10^{G3/20})^2 / 3]$ = 6.46dBi > 6dBi , so the power density limit shall be reduced to 8-(6.46-6) = 7.54dBm.
 2. Refer to section 3.4 for duty cycle spectrum plot.



A D T

SPECTRUM PLOT OF WORST VALUE

CDD_MODE <802.11ac (VHT20)_Chain (2) / CH157>

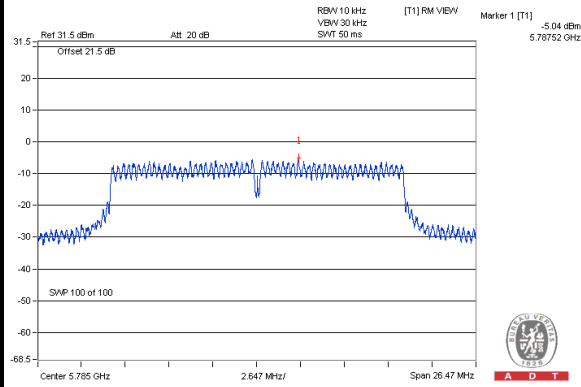

CDD_MODE <802.11ac (VHT40)_Chain (1) / CH159>

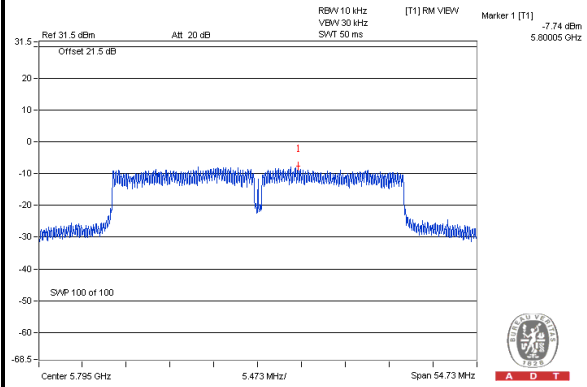

CDD_MODE <802.11ac (VHT80)_Chain (2) / CH155>

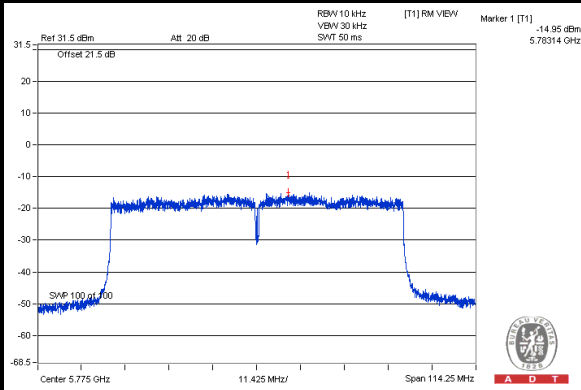



A D T

5.5.8 TEST RESULTS (MODE 2)

802.11a				
CHANNEL	FREQUENCY (MHz)	PSD (dBm)	LIMIT (dBm)	PASS /FAIL
149	5745	-5.98	8	PASS
157	5785	-3.64	8	PASS
165	5825	-3.67	8	PASS

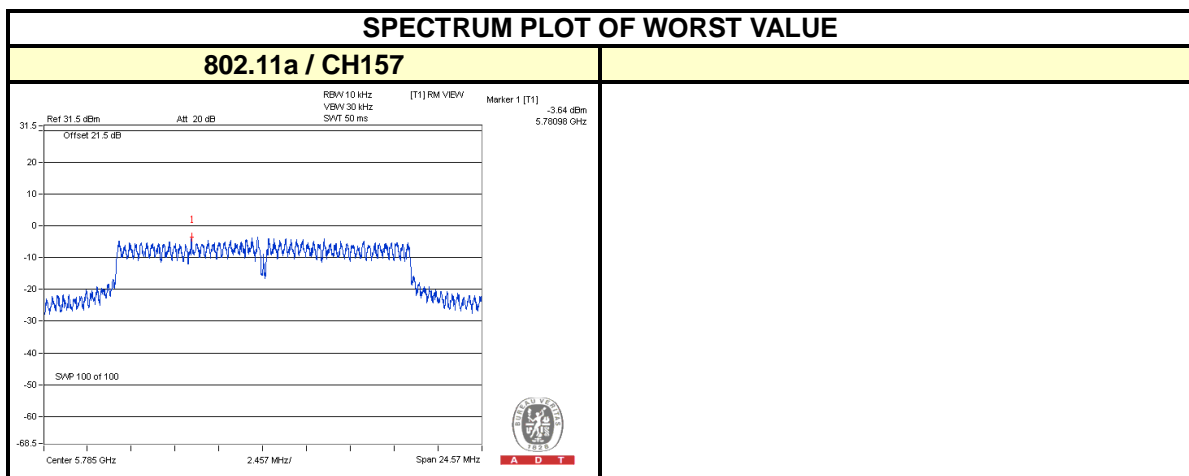



A D T

5.6 CONDUCTED OUT-BAND EMISSION MEASUREMENT

5.6.1 LIMITS OF CONDUCTED OUT-BAND EMISSION MEASUREMENT

Below 30dB of the highest emission level of operating band (in 100kHz Resolution Bandwidth).

5.6.2 TEST INSTRUMENTS

DESCRIPTION & MANUFACTURER	MODEL NO.	SERIAL NO.	CALIBRATED DATE	CALIBRATED UNTIL
Spectrum Analyzer R&S	FSP 40	100036	Jan. 21, 2013	Jan. 20, 2014

Note:

1. The calibration interval of the above test instruments is 12 months and the calibrations are traceable to NML/ROC and NIST/USA.
2. Tested date : Jan. 17, 2014

5.6.3 TEST PROCEDURE

Measurement Procedure - Reference Level

1. Set the RBW = 100 kHz.
2. Set the VBW \geq 300 kHz.
3. Detector = peak.
4. Sweep time = auto couple.
5. Trace mode = max hold.
6. Allow trace to fully stabilize.
7. Use the peak marker function to determine the maximum power level in any 100 kHz band segment within the fundamental EBW.

Measurement Procedure –Unwanted Emission Level

1. Set RBW = 100 kHz.
2. Set VBW \geq 300 kHz.
3. Set span to encompass the spectrum to be examined
4. Detector = peak.
5. Trace Mode = max hold.
6. Sweep = auto couple.

5.6.4 DEVIATION FROM TEST STANDARD

No deviation

5.6.5 TEST SETUP

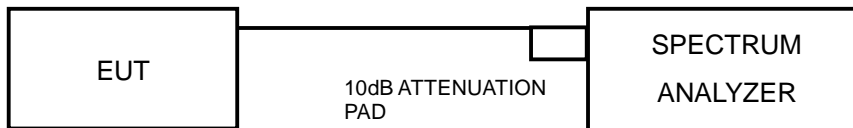

5.6.6 EUT OPERATING CONDITION

Same as Item 4.3.6

5.6.7 TEST RESULTS

The spectrum plots are attached on the following pages. D1 line indicates the highest level, and D2 line indicates the 30dB offset below D1. It shows compliance with the requirement.

5.6.7.1 TEST RESULTS (MODE 1)

CDD_MODE<802.11ac (VHT20)>

Maximum REF

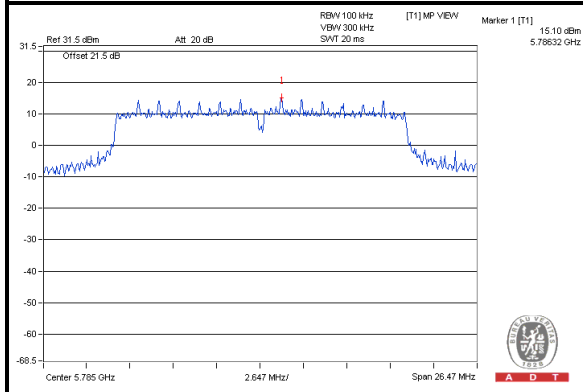

Chain (0)

CH 149

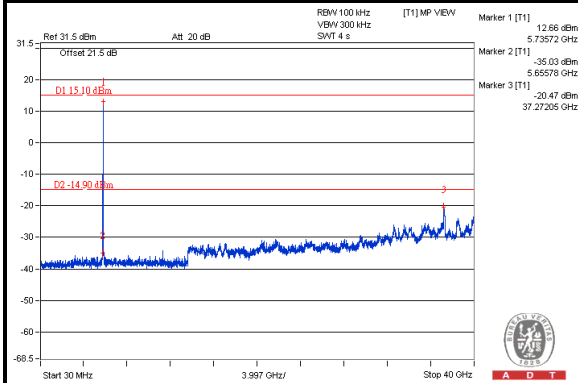

CH 157

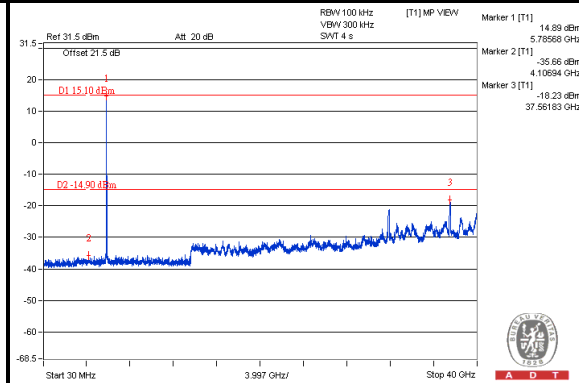

CH 165

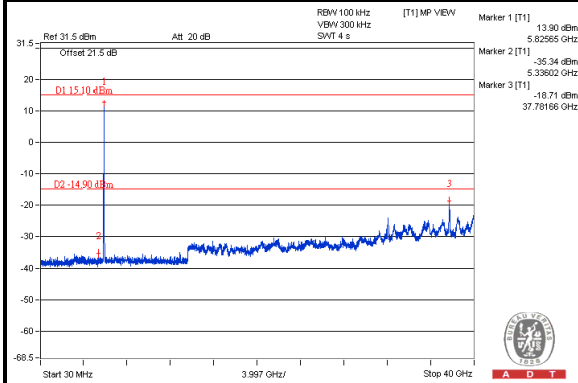

CH 149 Band edge

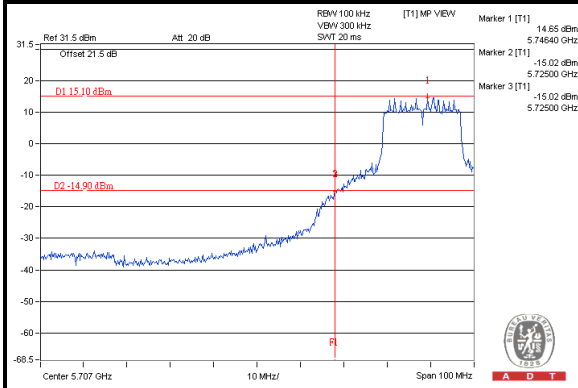

CH 165 Band edge

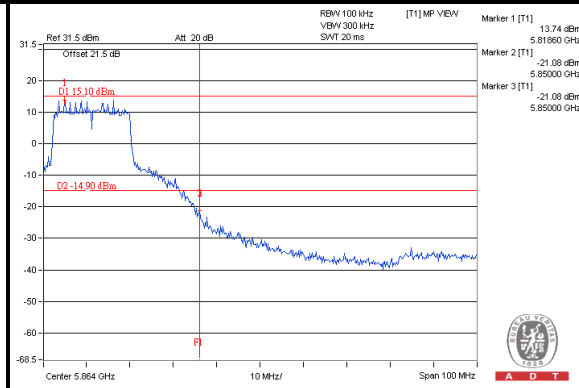



A D T

Chain (1)

CH 149

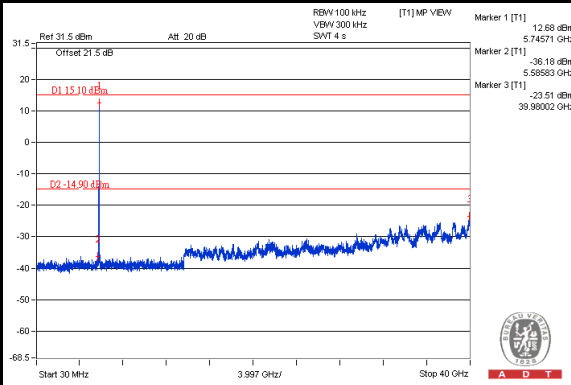

CH 157

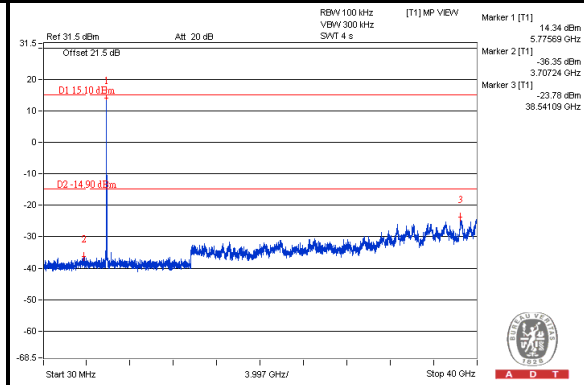

CH 165

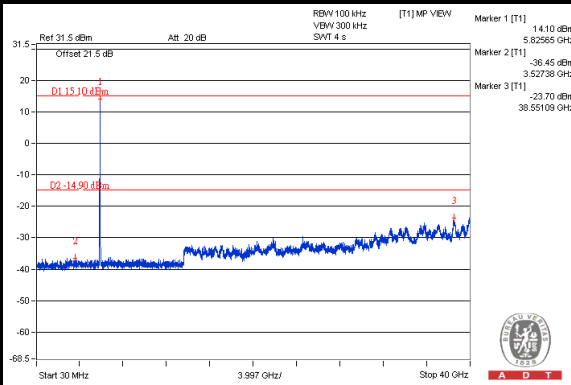

CH 149 Band edge

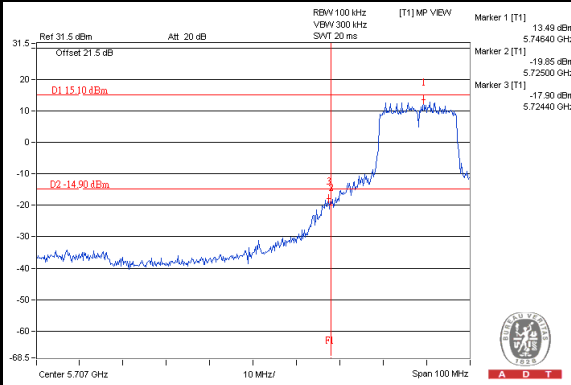

CH 165 Band edge

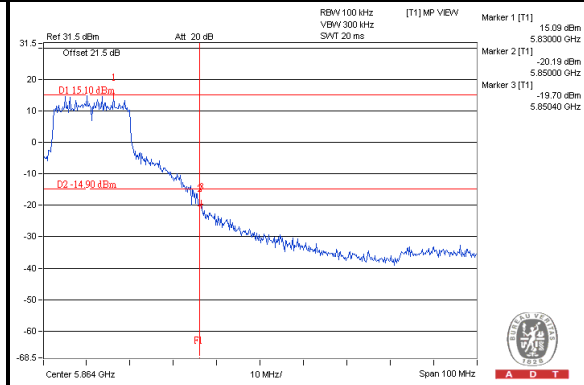



A D T

Chain (2)

CH 149

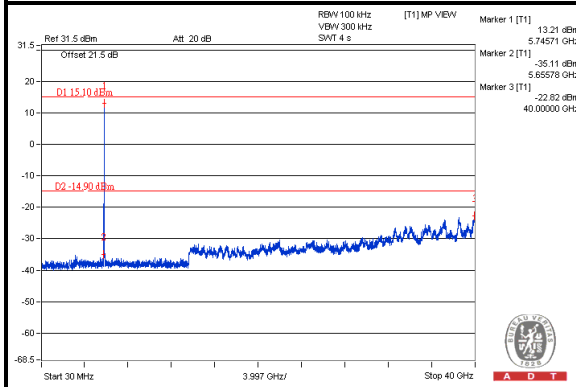

CH 157

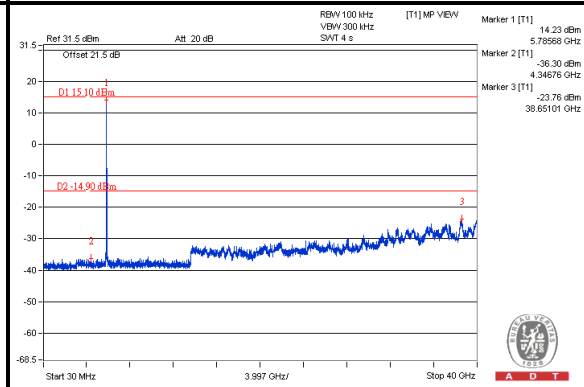

CH 165

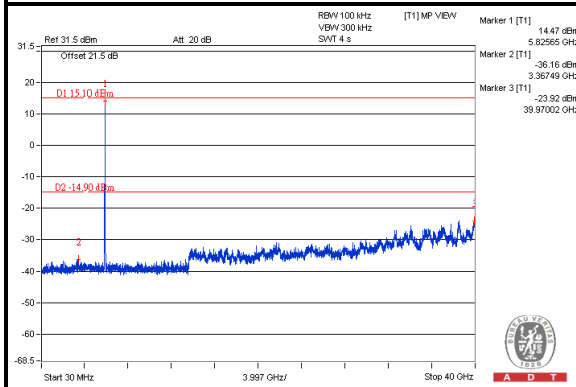

CH 149 Band edge

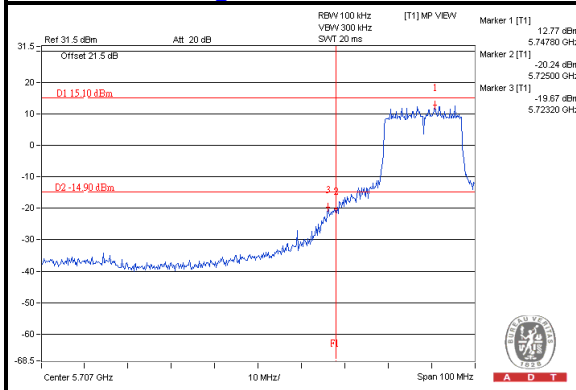

CH 165 Band edge

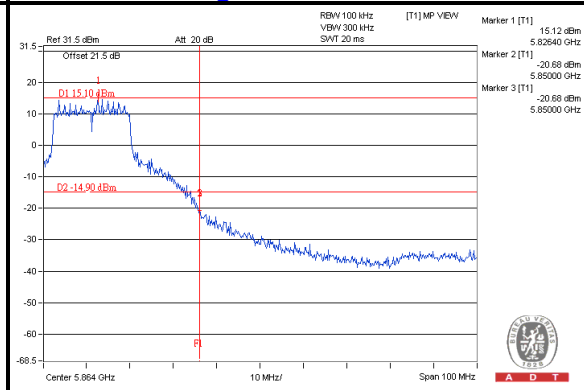



A D T

CDD_MODE<802.11ac (VHT40)>

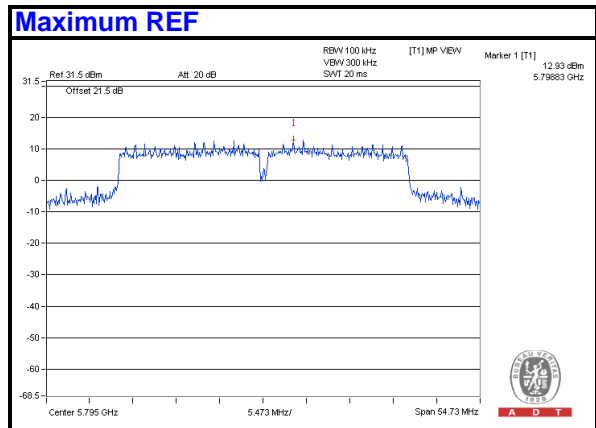

Chain (0)

CH 151

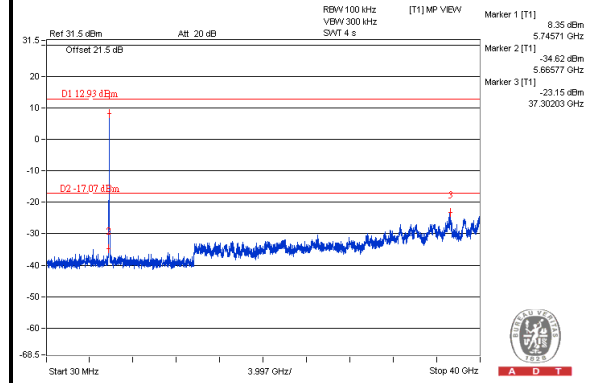

CH 159

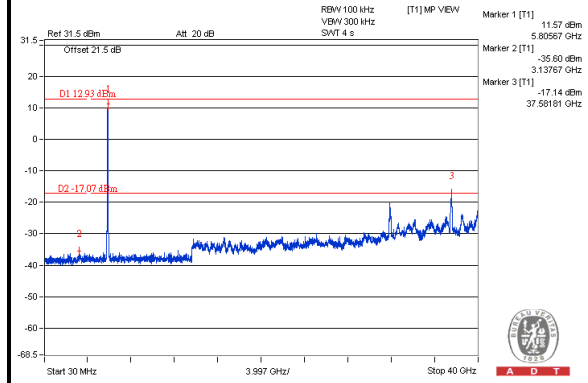

CH 151 Band edge

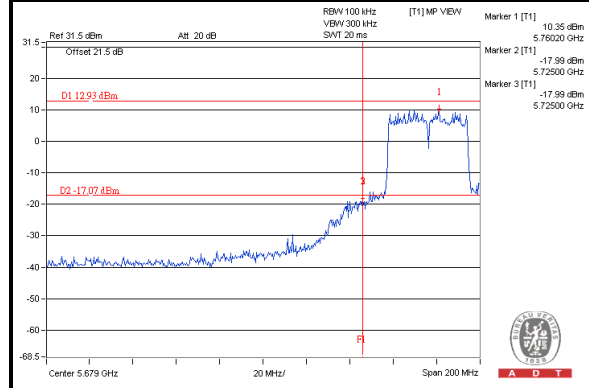

CH 159 Band edge

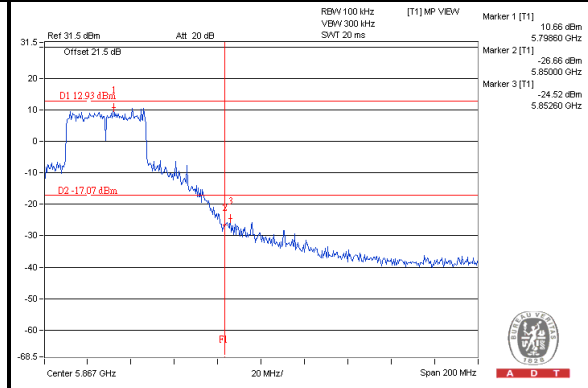



A D T

Chain (1)

CH 151

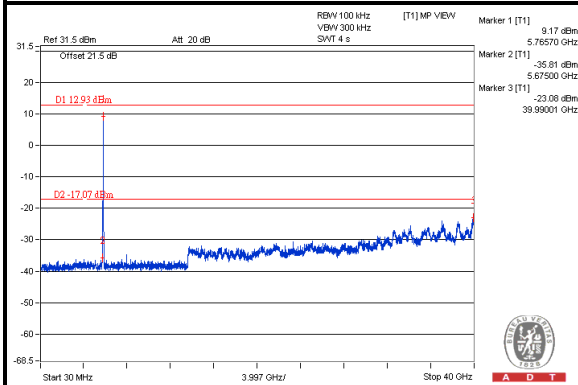

CH 159

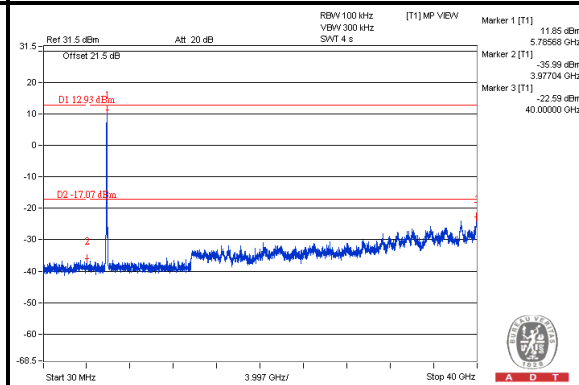

CH 151 Band edge

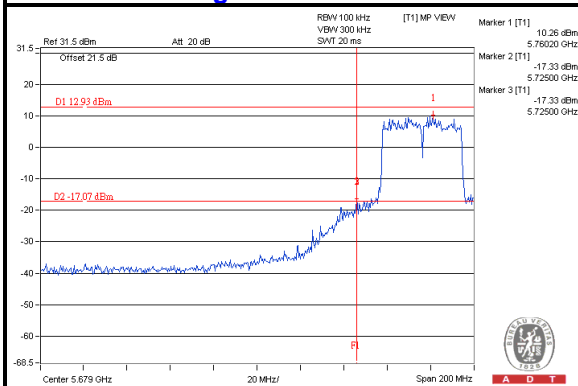

CH 159 Band edge

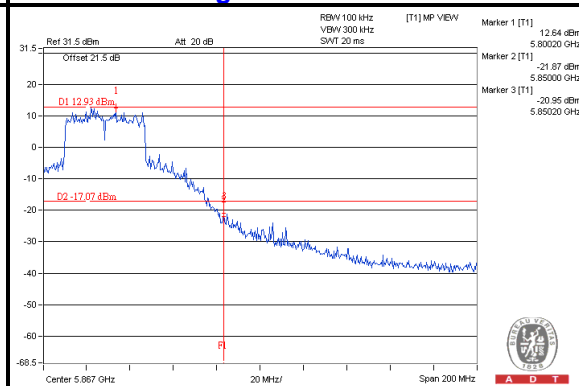

Chain (2)

CH 151

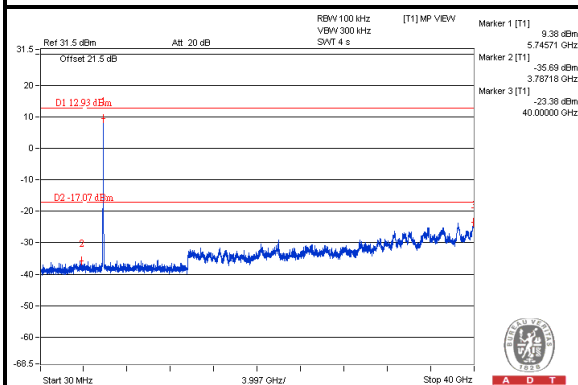

CH 159

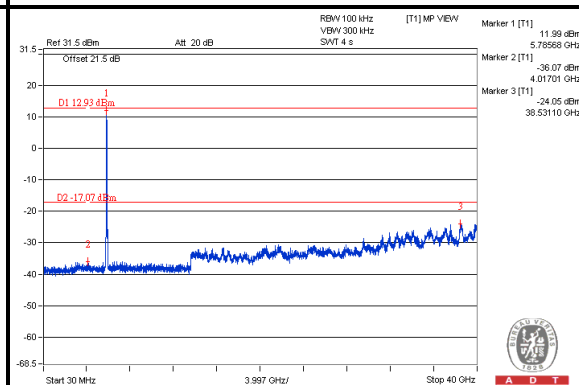

CH 151 Band edge

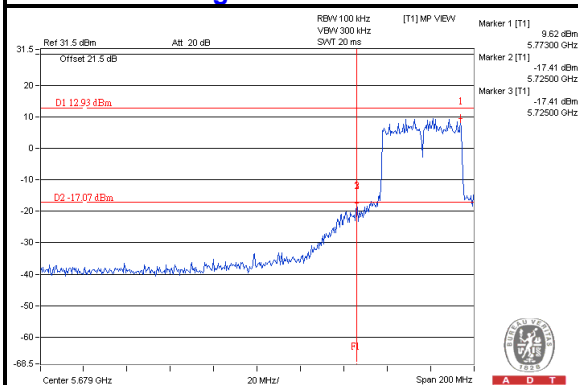

CH 159 Band edge

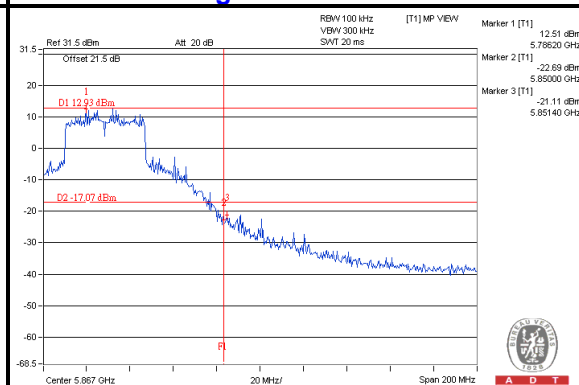



A D T

CDD_MODE<802.11ac (VHT80)>

Maximum REF

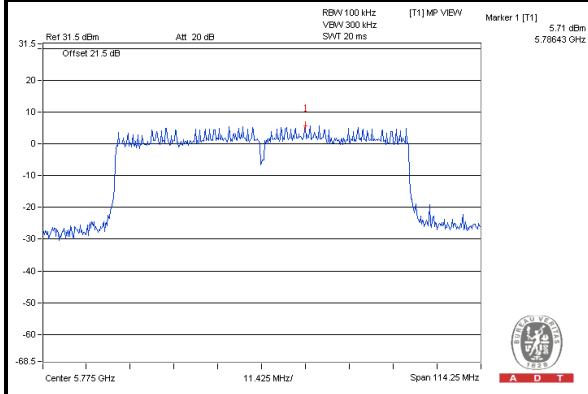

Chain (0) CH 155

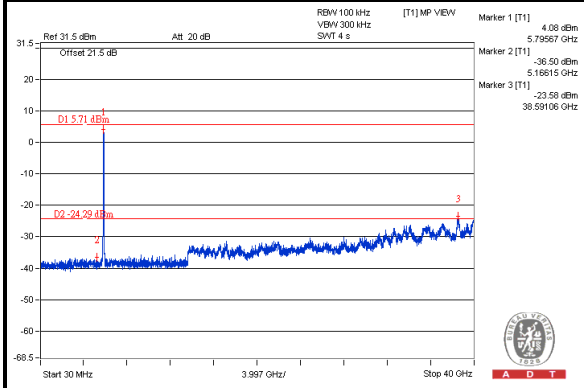

CH 155 Band edge (Left)

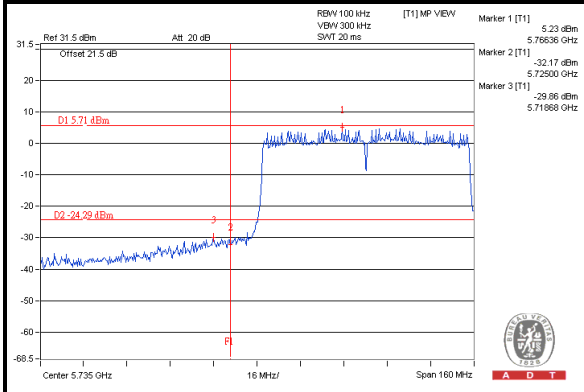

CH 155 Band edge (Right)

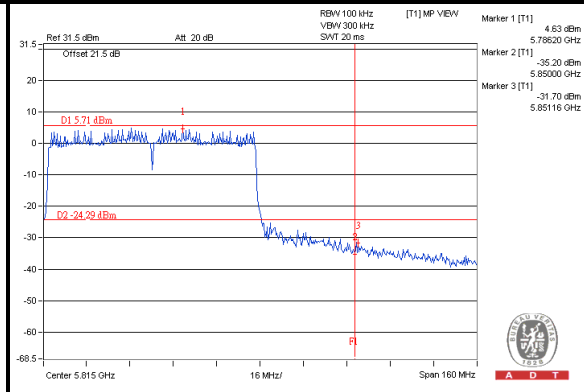

Chain (1)
CH 155

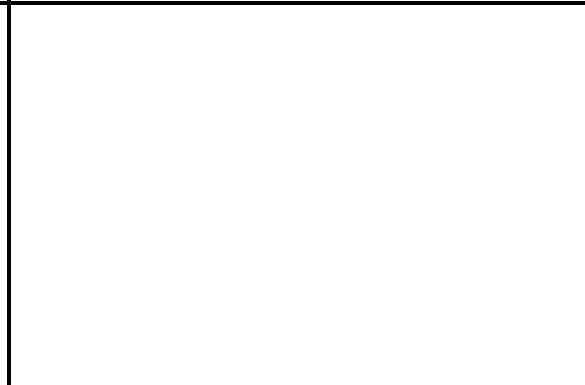
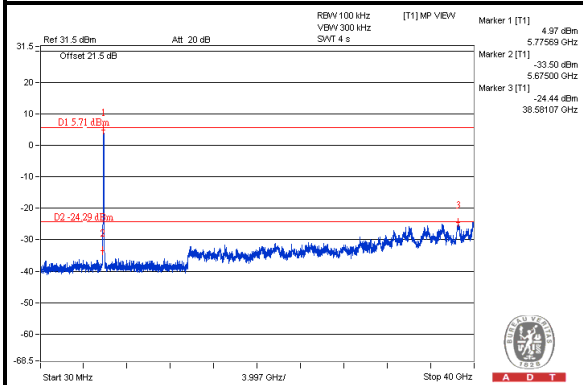

CH 155 Band edge (Left)

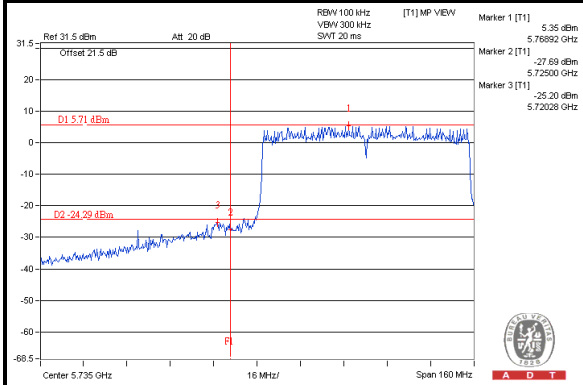

CH 155 Band edge (Right)

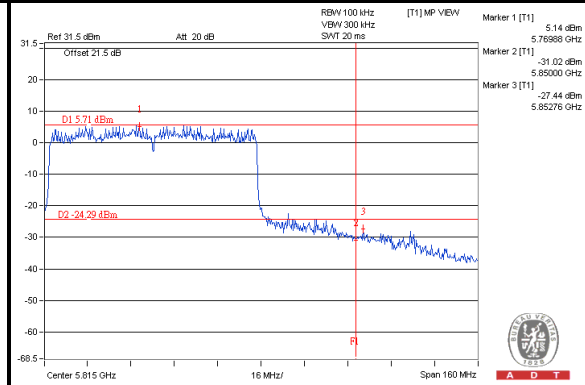

Chain (2)
CH 155

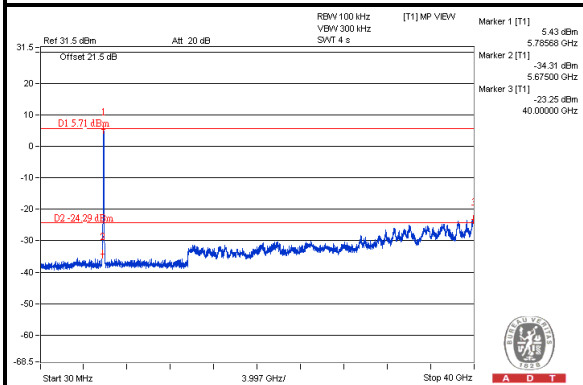

CH 155 Band edge (Left)

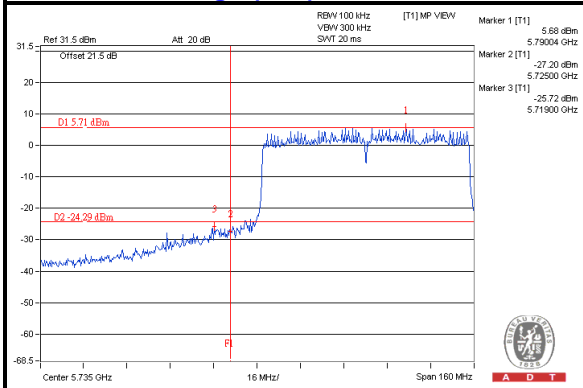

CH 155 Band edge (Right)

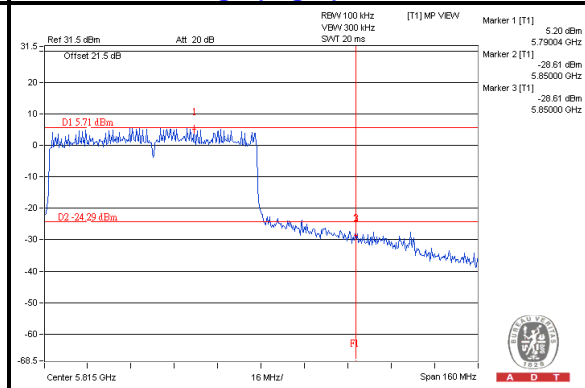



A D T

STBC_MODE<802.11ac (VHT20)>

Maximum REF

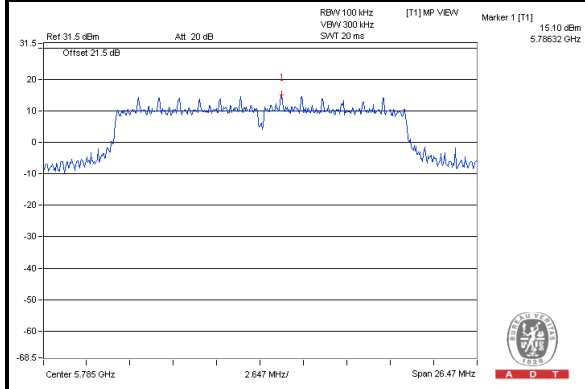

Chain (0)

CH 149

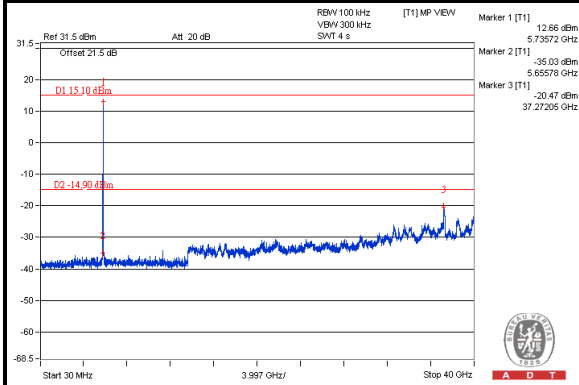

CH 157

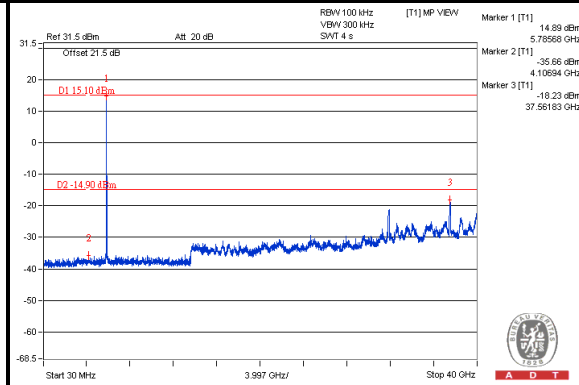

CH 165

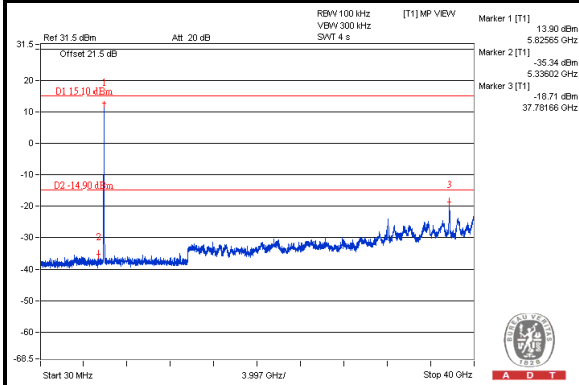

CH 149 Band edge

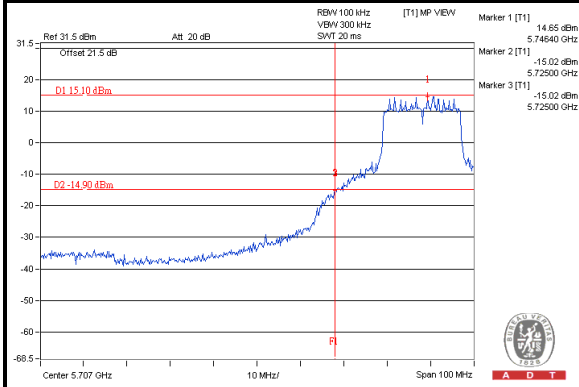

CH 165 Band edge

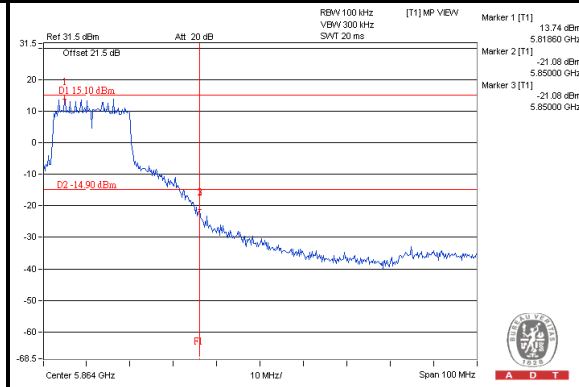



A D T

Chain (1)

CH 149

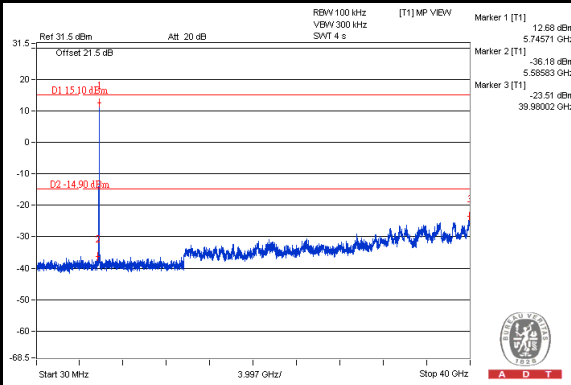

CH 157

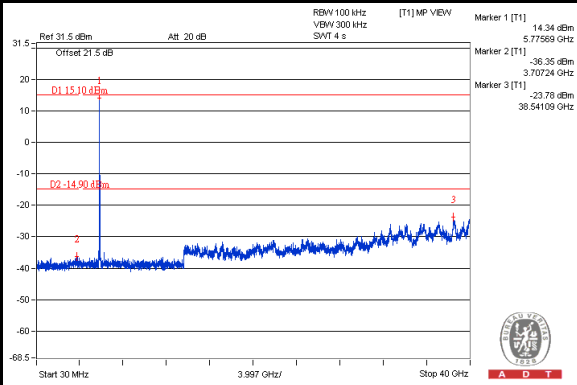

CH 165

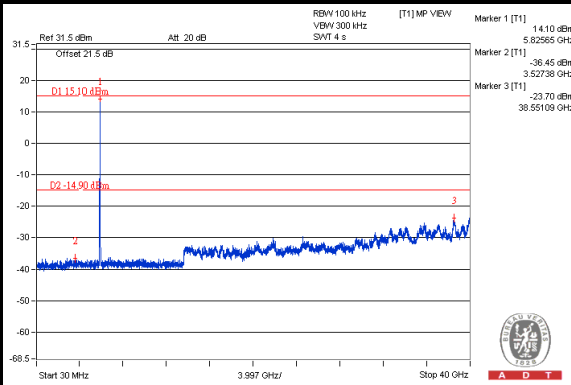

CH 149 Band edge

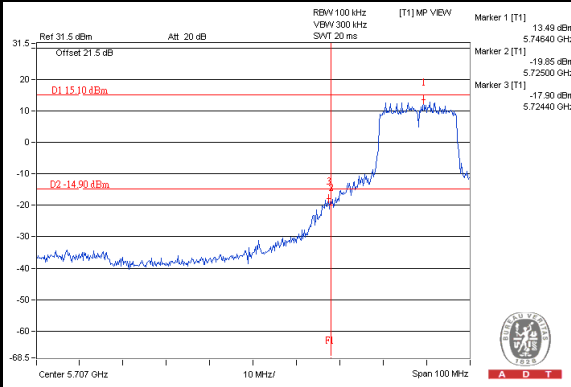

CH 165 Band edge

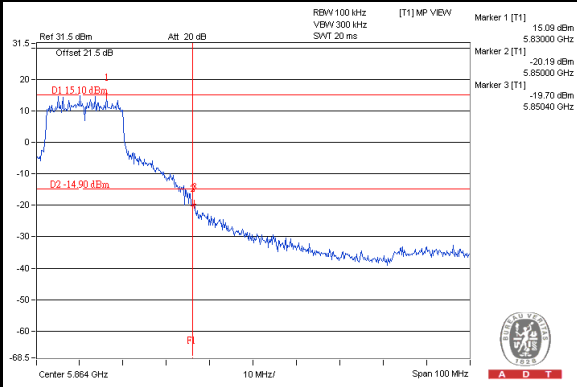



A D T

Chain (2)

CH 149

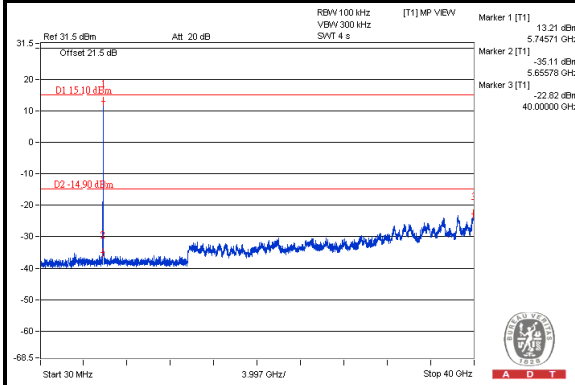

CH 157

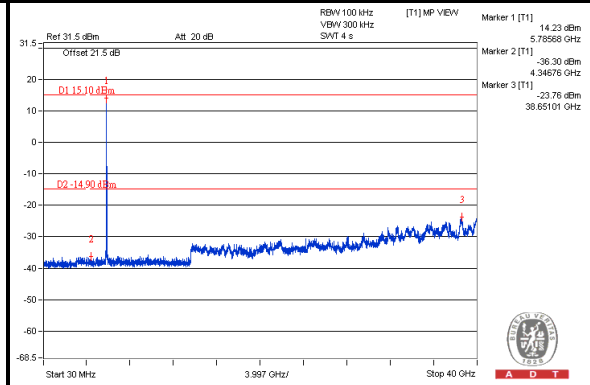

CH 165

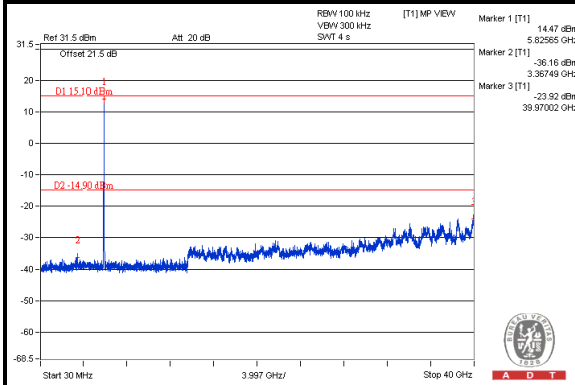

CH 149 Band edge

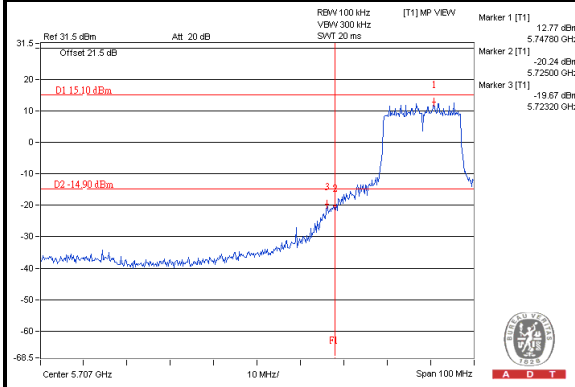

CH 165 Band edge

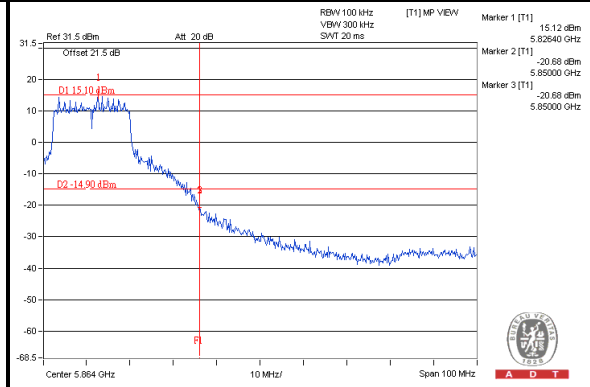



A D T

STBC_MODE<802.11ac (VHT40)>

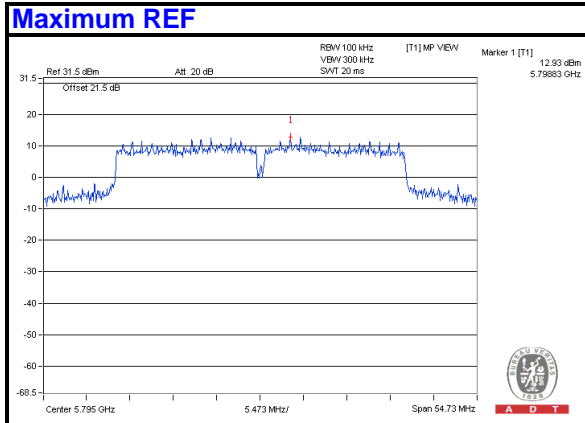

Chain (0)

CH 151

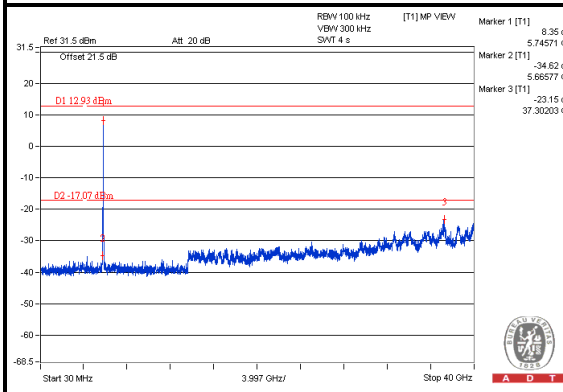

CH 159

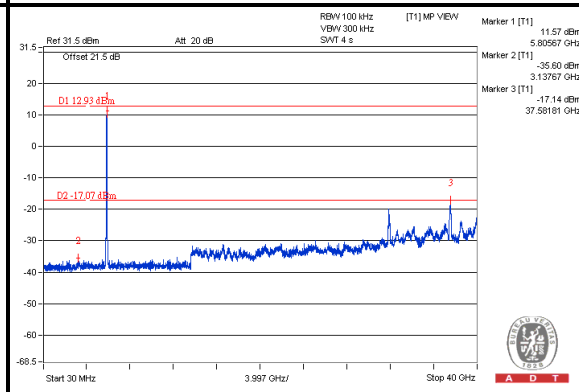

CH 151 Band edge

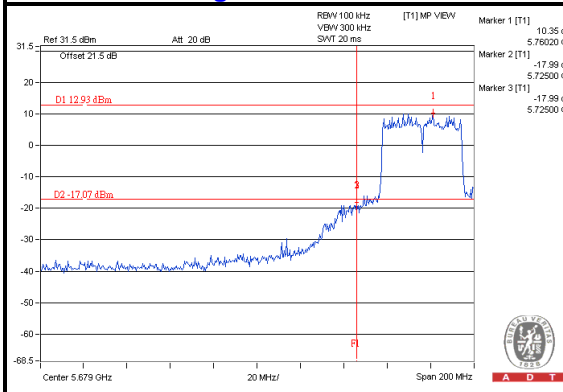

CH 159 Band edge

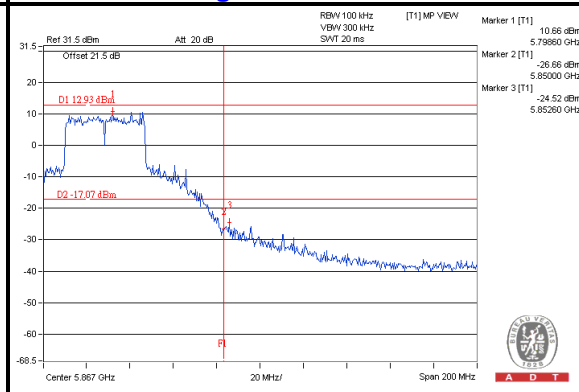



A D T

Chain (1)

CH 151

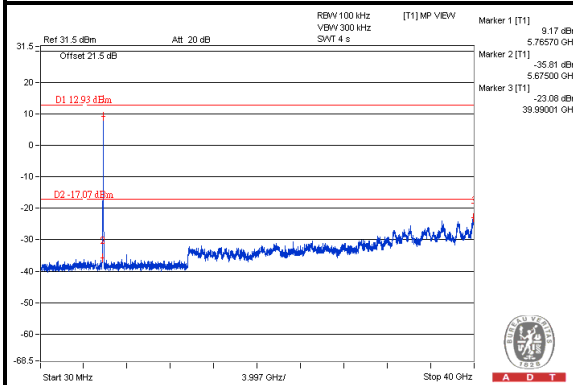

CH 159

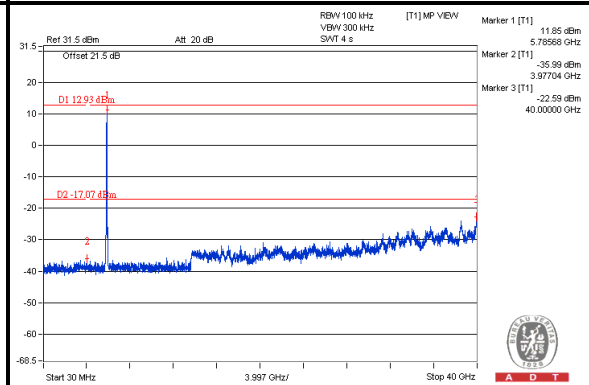

CH 151 Band edge

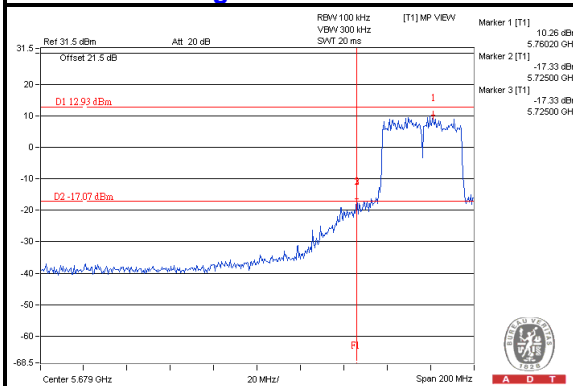

CH 159 Band edge

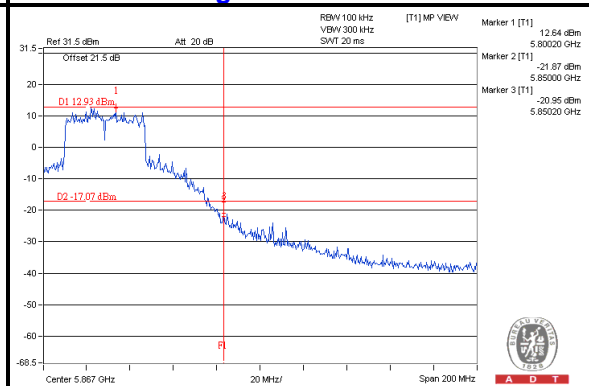

Chain (2)

CH 151

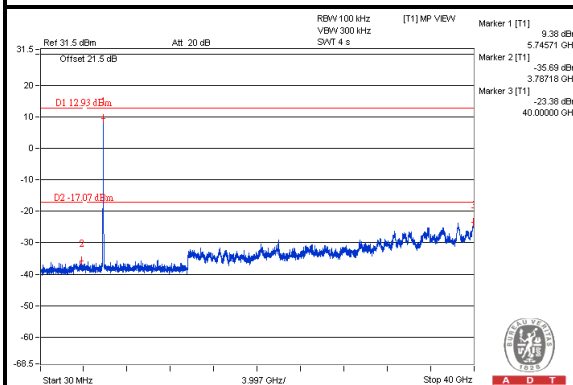

CH 159

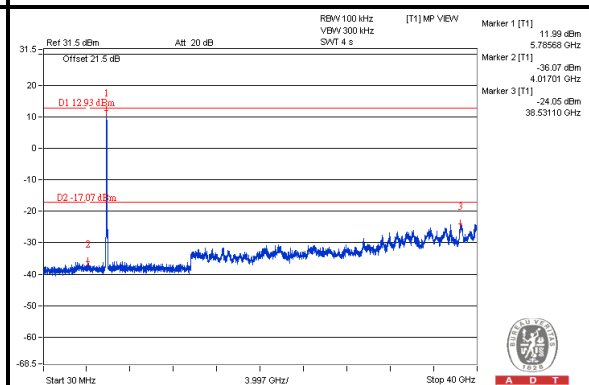

CH 151 Band edge

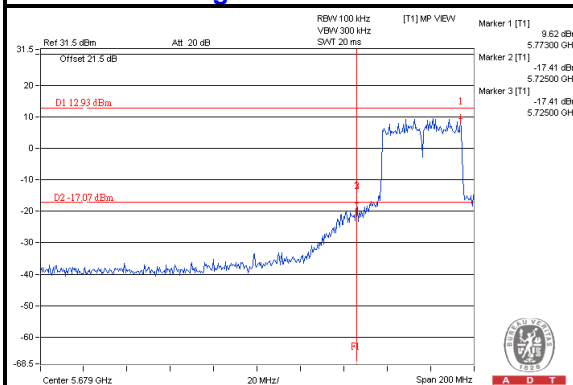

CH 159 Band edge

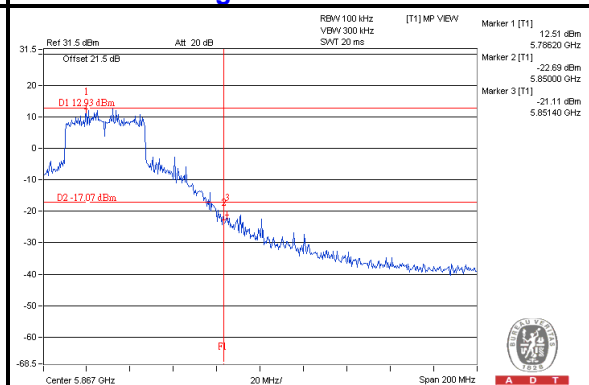



A D T

STBC_MODE<802.11ac (VHT80)>

Maximum REF

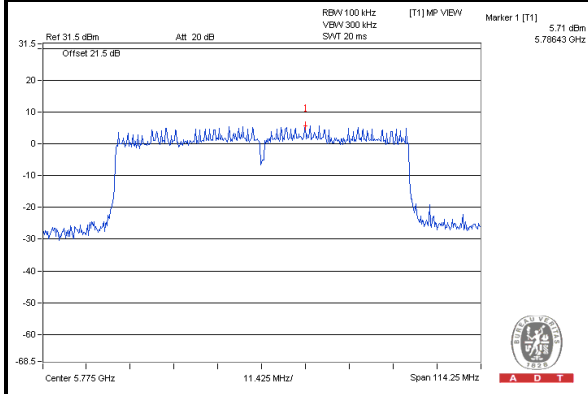

Chain (0) CH 155

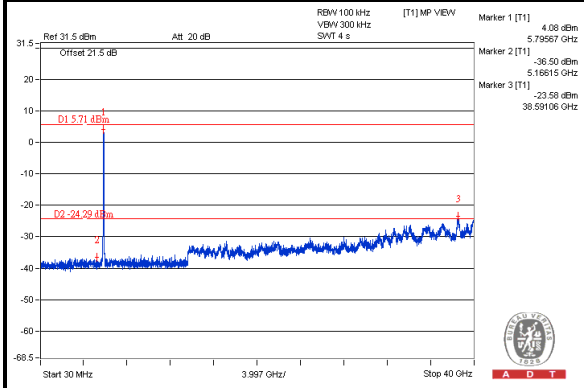

CH 155 Band edge (Left)

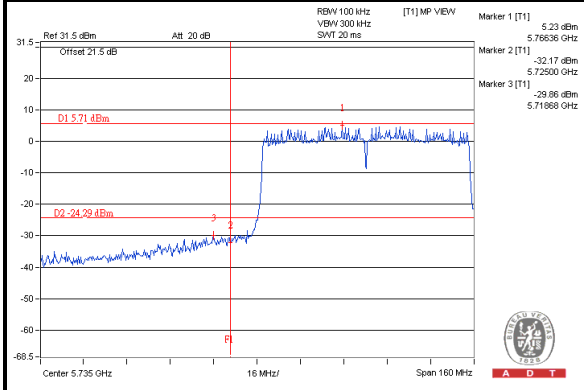

CH 155 Band edge (Right)

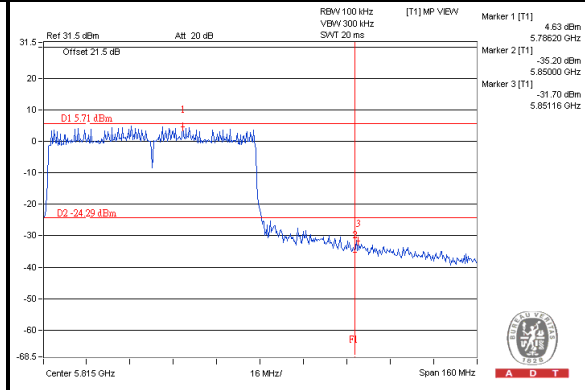

Chain (1)
CH 155

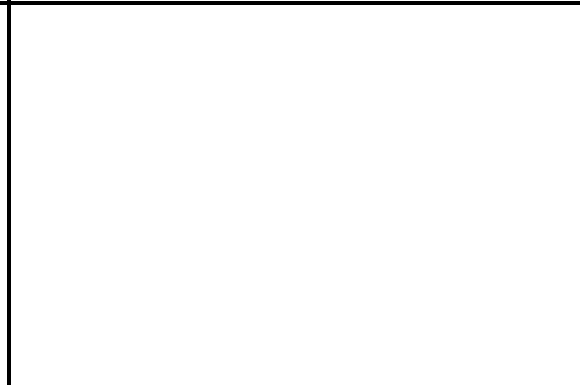
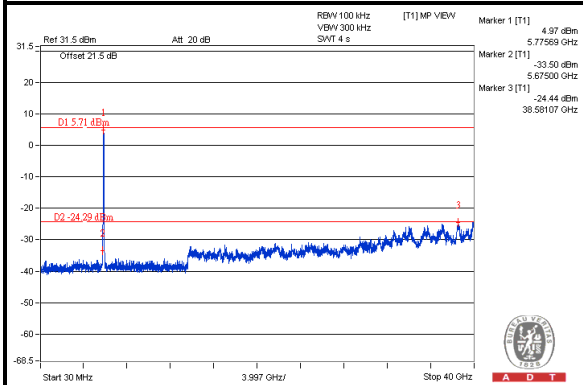

CH 155 Band edge (Left)

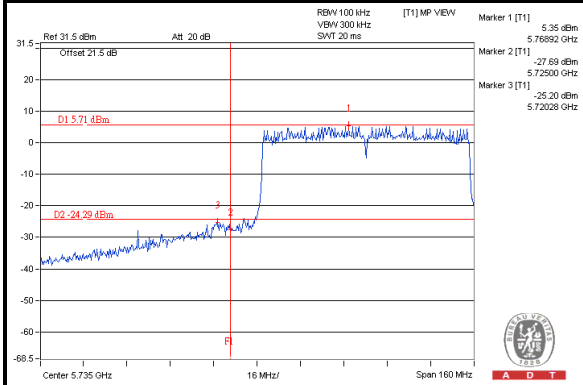

CH 155 Band edge (Right)

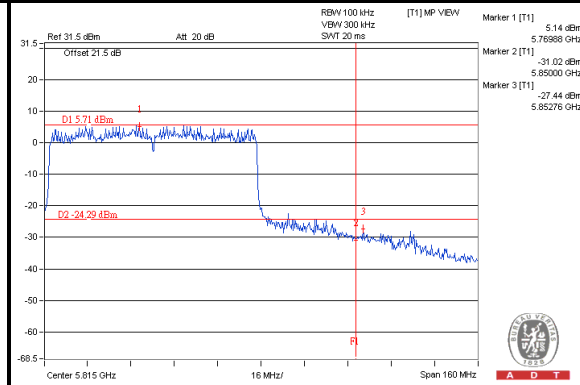

Chain (2)
CH 155

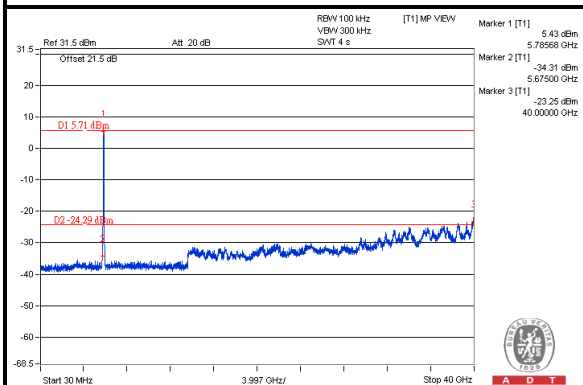

CH 155 Band edge (Left)

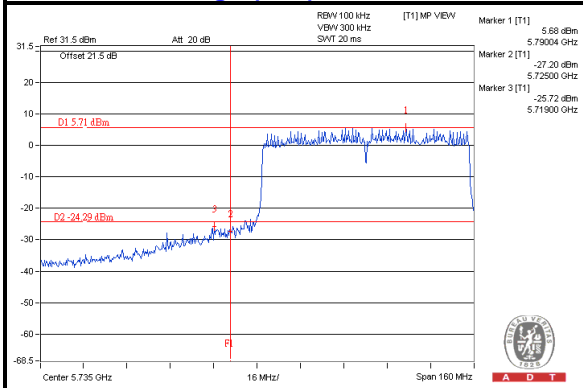

CH 155 Band edge (Right)

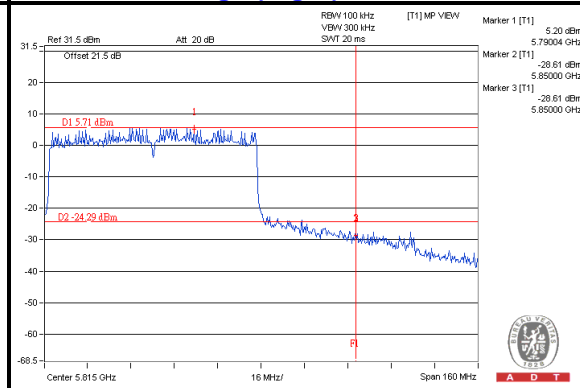



A D T

Beam forming_MODE<802.11ac (VHT20)>

Maximum REF

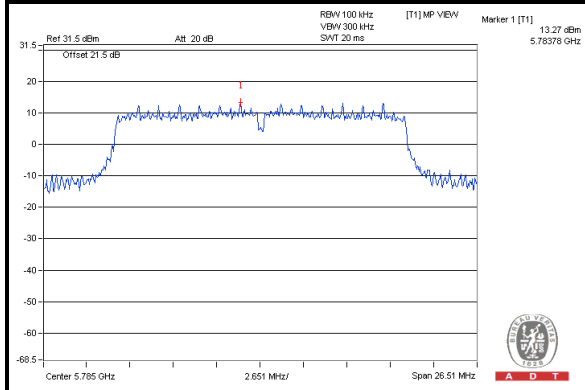

Chain (0)

CH 149

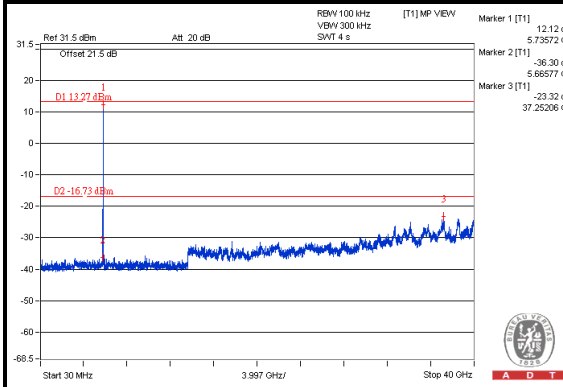

CH 157

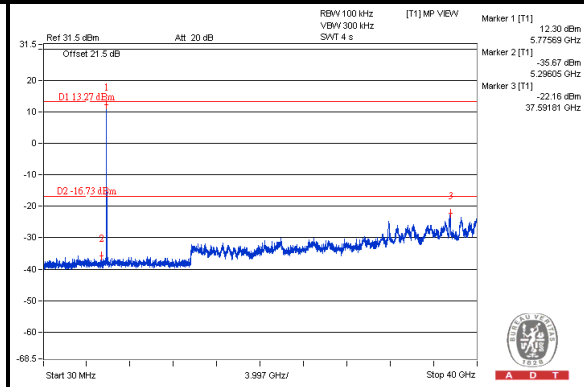

CH 165

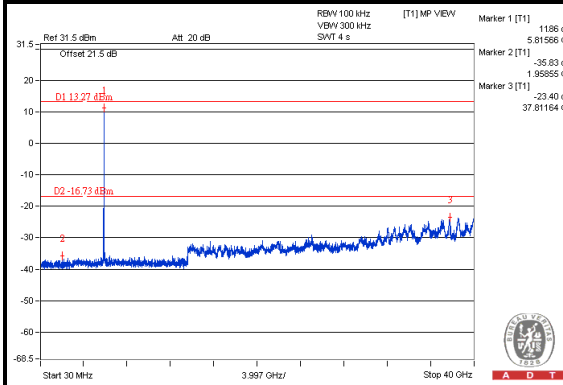

CH 149 Band edge

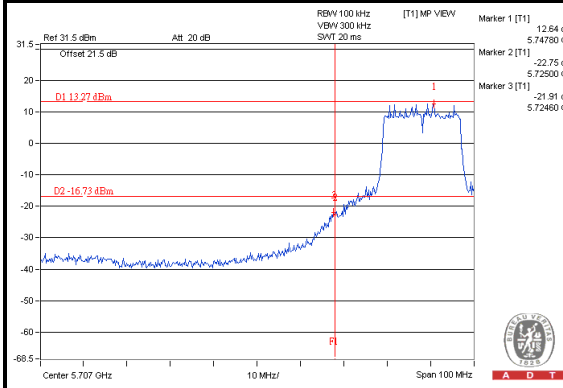

CH 165 Band edge

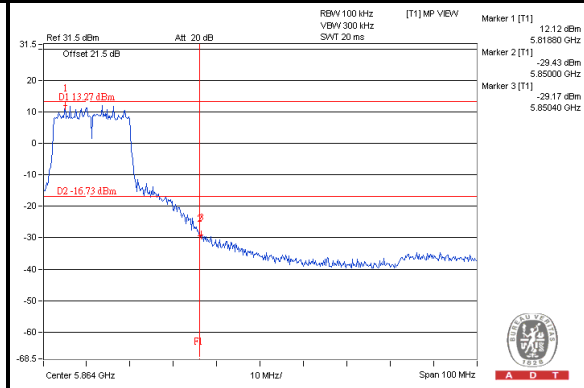



A D T

Chain (1) CH 149

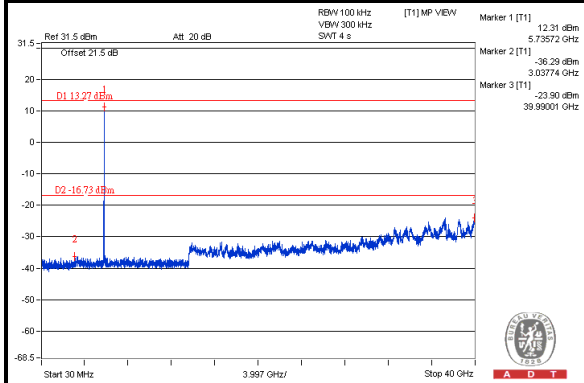

CH 157

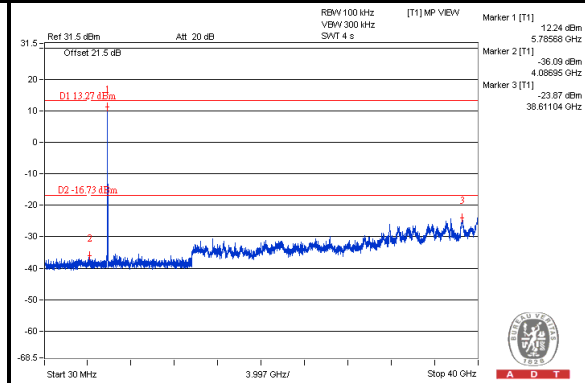

CH 165

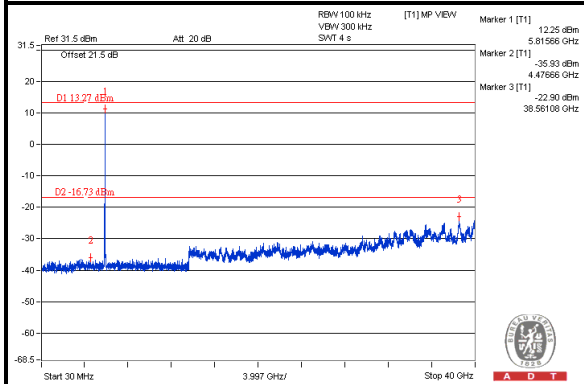

CH 149 Band edge

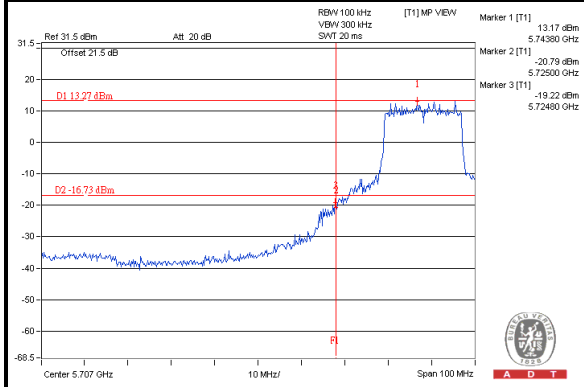

CH 165 Band edge

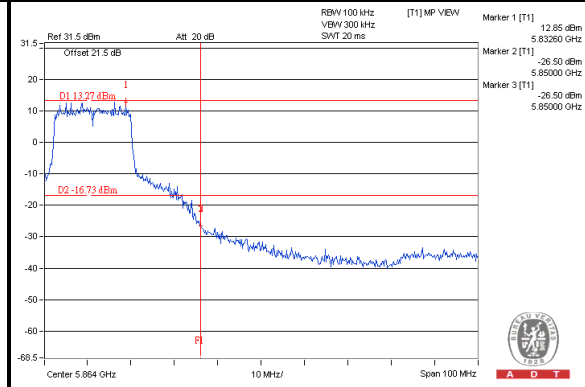



A D T

Chain (2)

CH 149

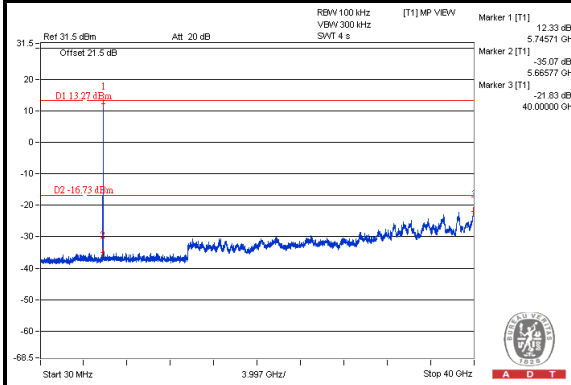

CH 157

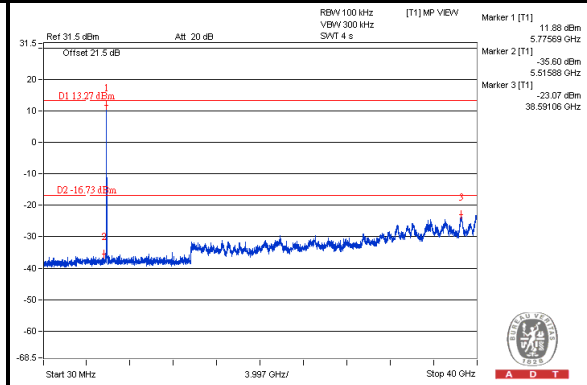

CH 165

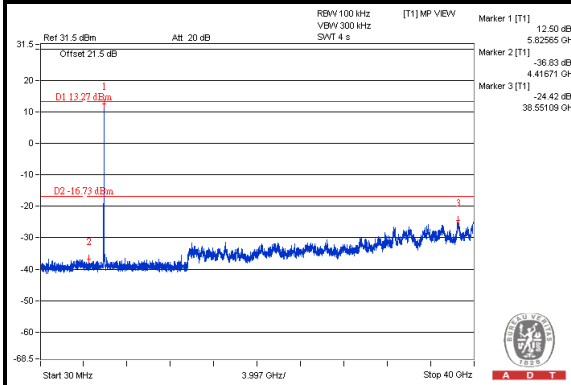

CH 149 Band edge

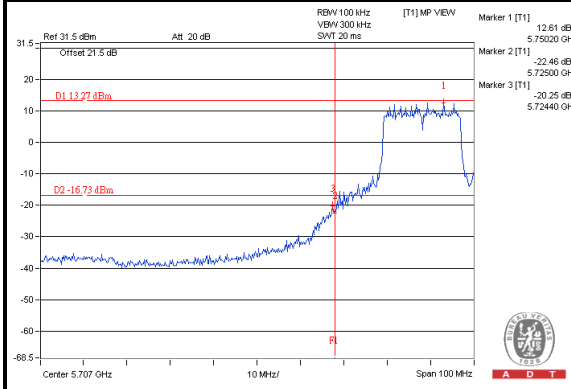

CH 165 Band edge

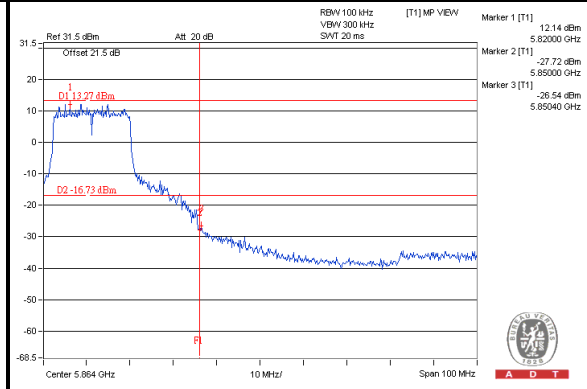



A D T

Beam forming_MODE<802.11ac (VHT40)>

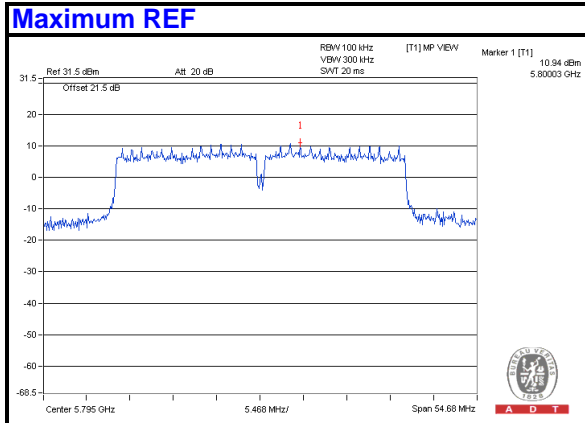

Chain (0)

CH 151

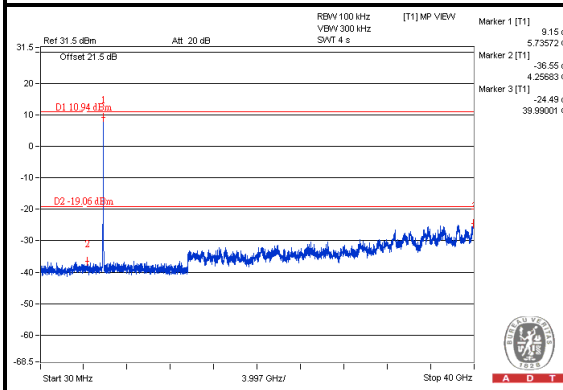

CH 159

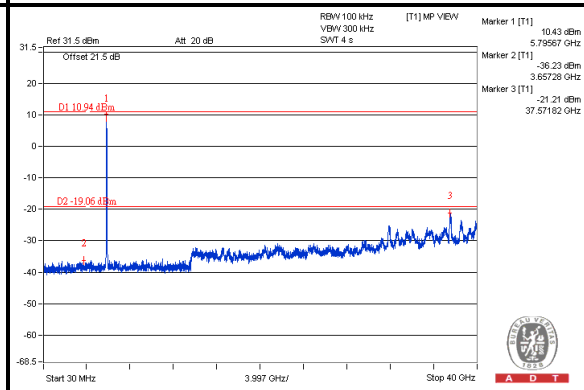

CH 151 Band edge

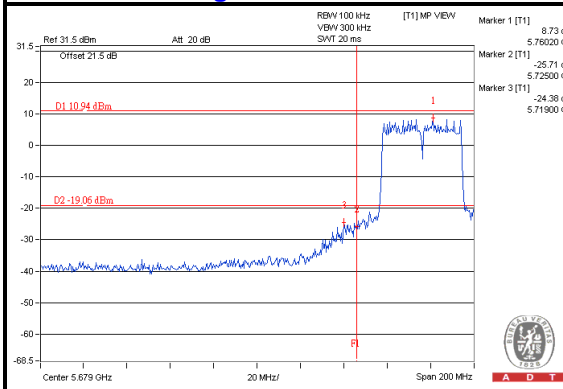

CH 159 Band edge

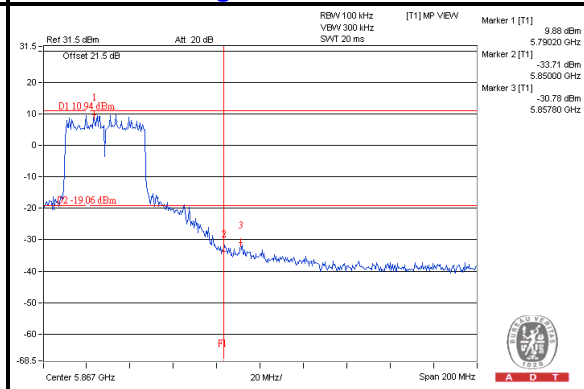



A D T

Chain (1)

CH 151

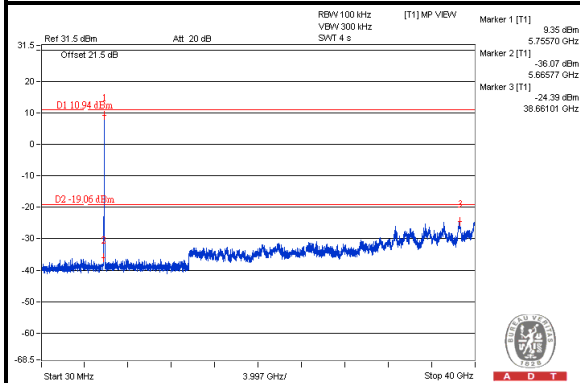

CH 159

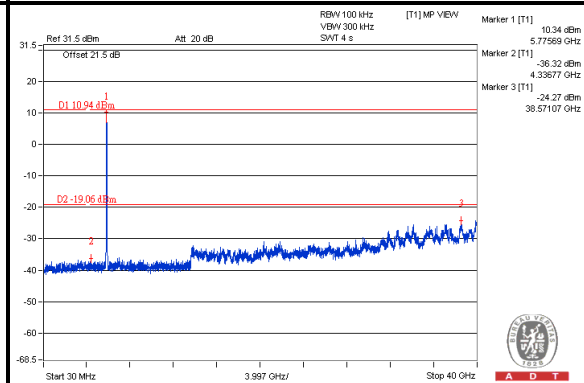

CH 151 Band edge

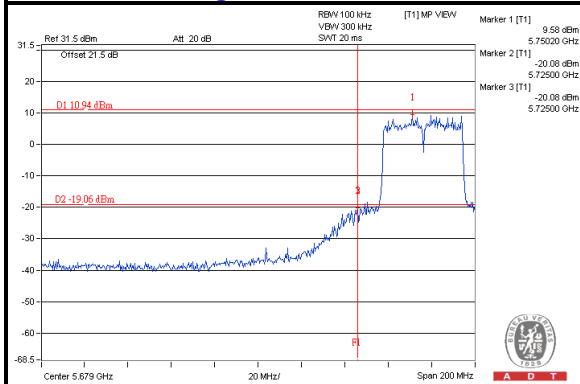

CH 159 Band edge

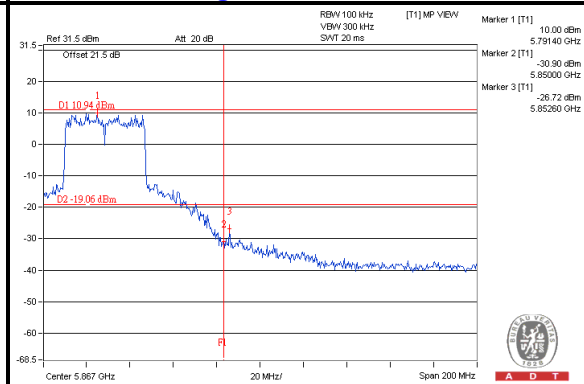

Chain (2)

CH 151

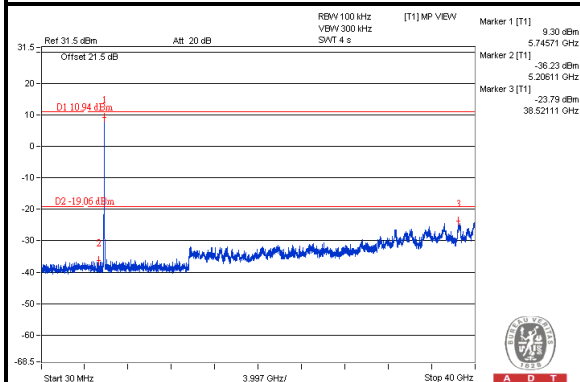

CH 159

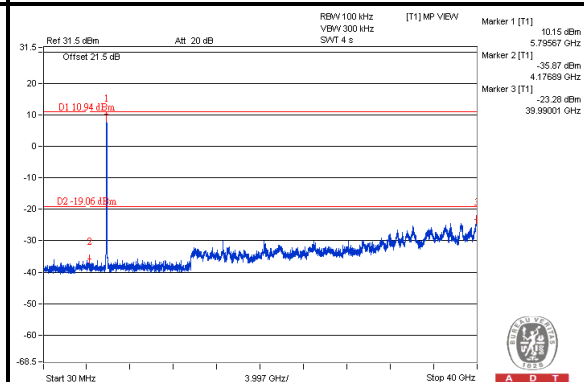

CH 151 Band edge

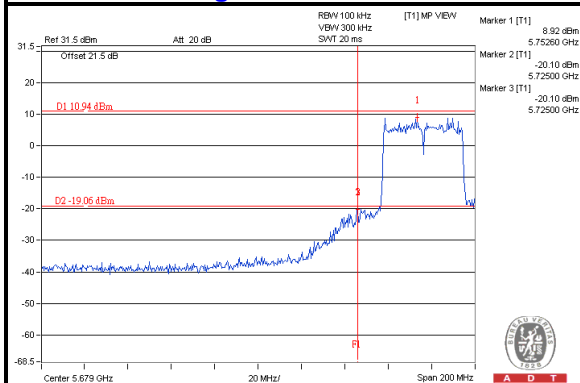

CH 159 Band edge

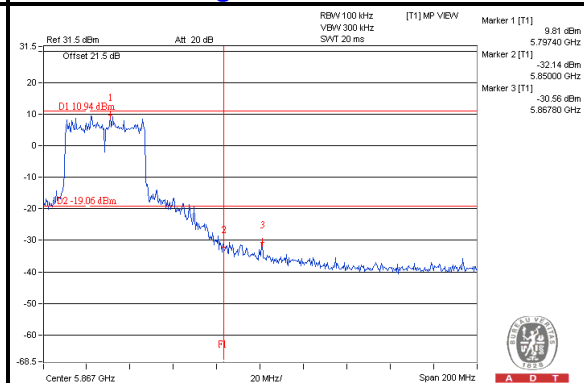



A D T

Beam forming_MODE<802.11ac (VHT80)>

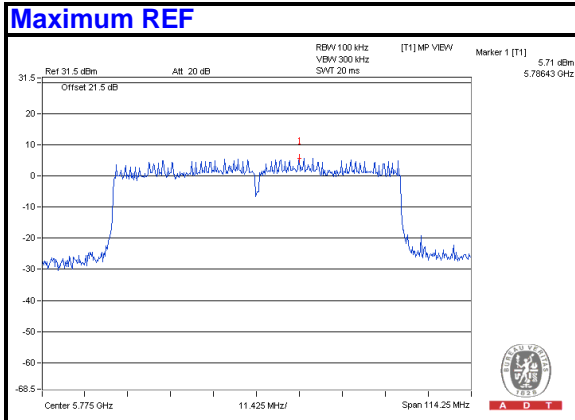

Chain (0) CH 155

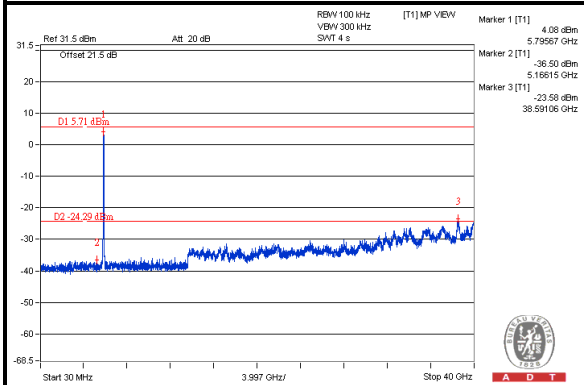

CH 155 Band edge (Left)

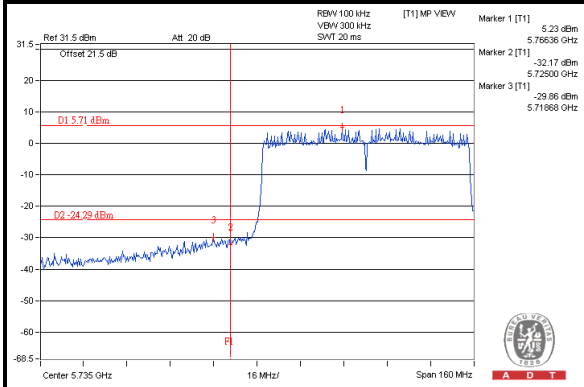

CH 155 Band edge (Right)

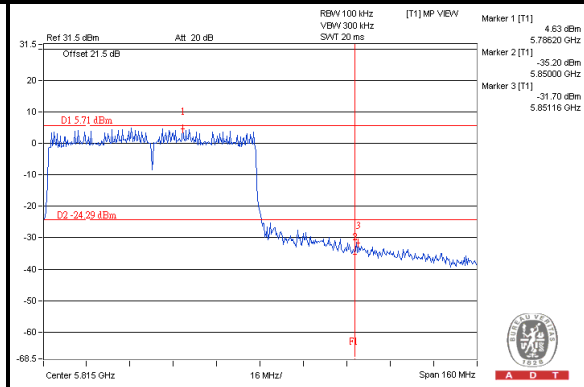

Chain (1)
CH 155

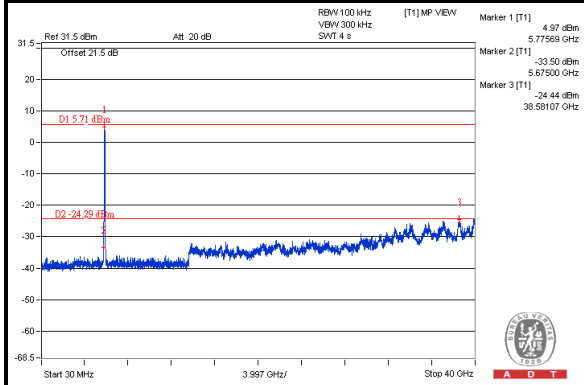

CH 155 Band edge (Left)

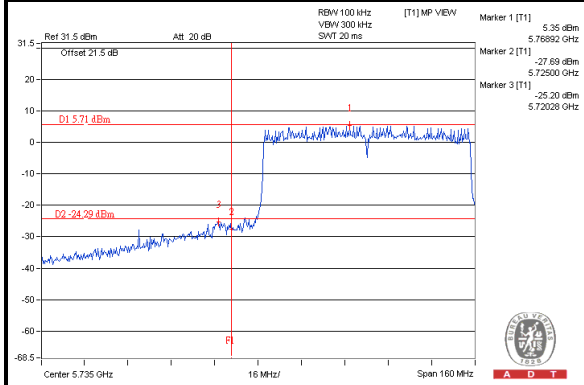

CH 155 Band edge (Right)

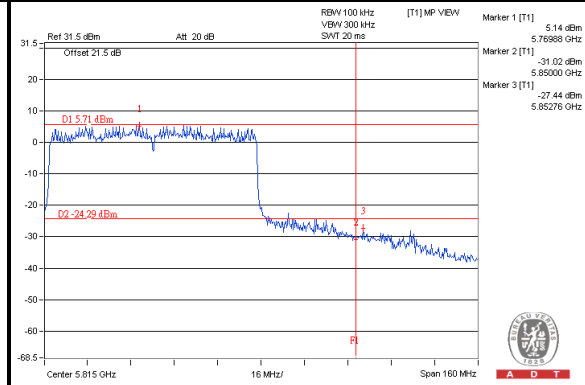

Chain (2)
CH 155

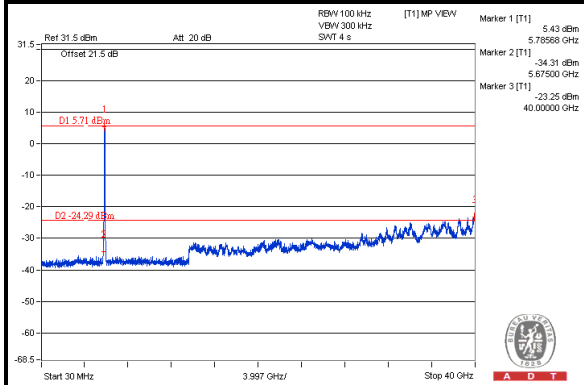

CH 155 Band edge (Left)

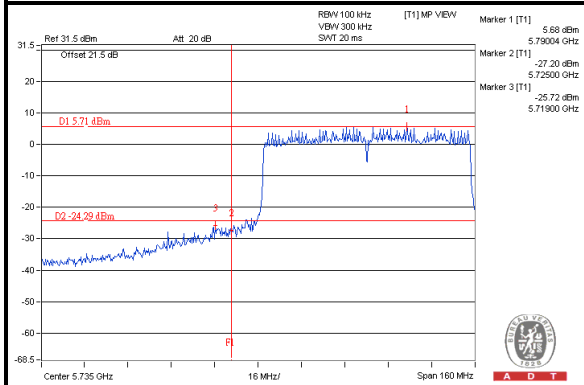

CH 155 Band edge (Right)

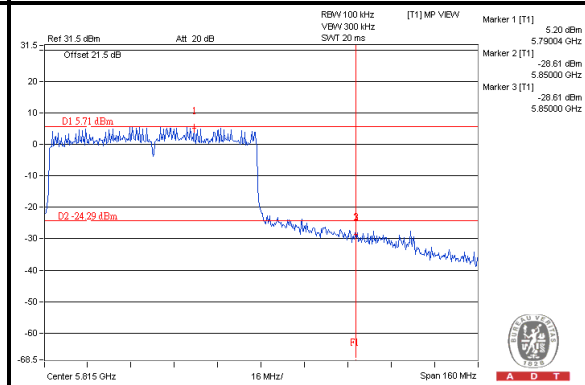



A D T

5.6.7.2 TEST RESULTS (MODE 2) 802.11a

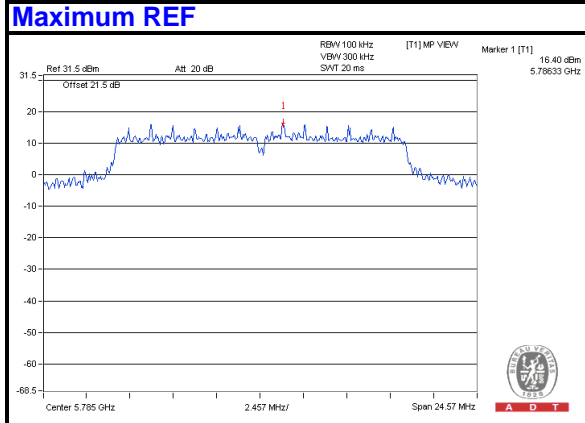

CH 149

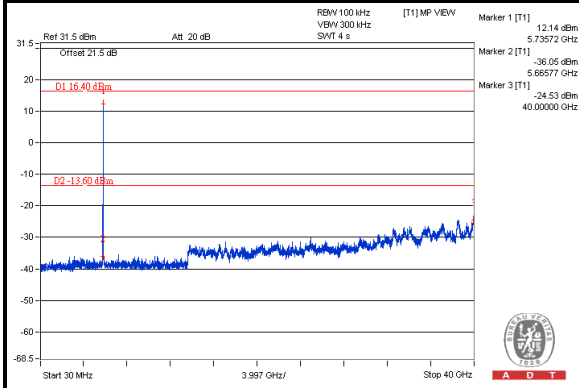

CH 157

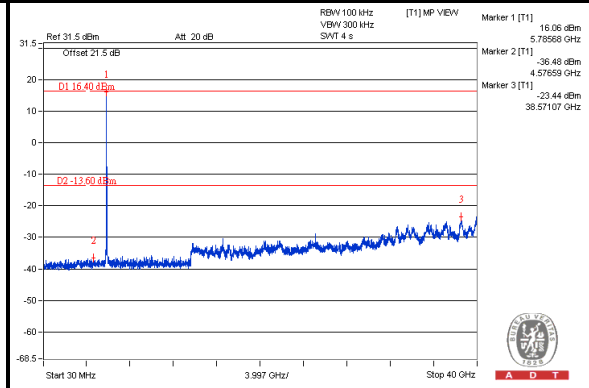

CH 165

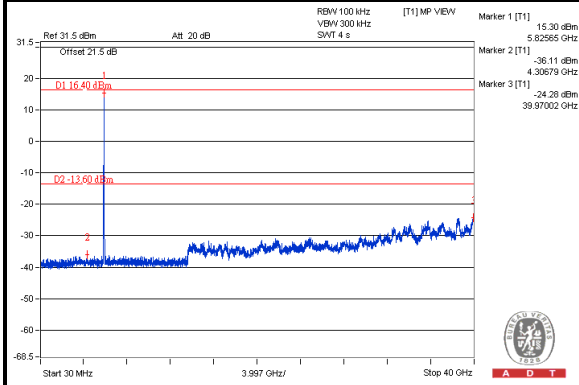

CH 149 Band edge

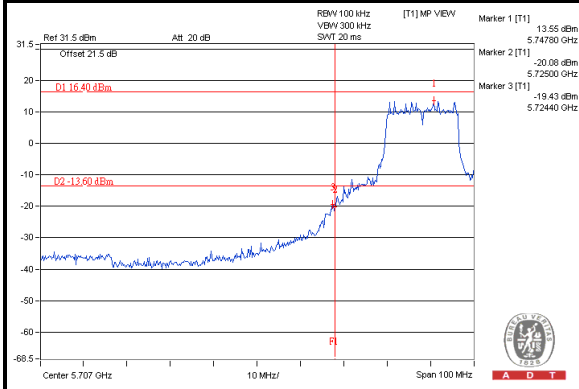

CH 165 Band edge

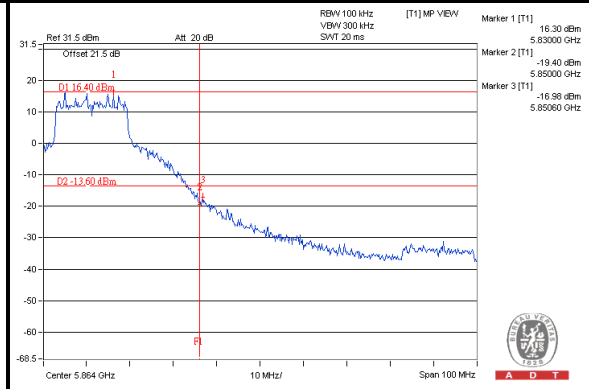



A D T

6. PHOTOGRAPHS OF THE TEST CONFIGURATION

Please refer to the attached file (Test Setup Photo).

7. INFORMATION ON THE TESTING LABORATORIES

We, Bureau Veritas Consumer Products Services (H.K.) Ltd., Taoyuan Branch, were founded in 1988 to provide our best service in EMC, Radio, Telecom and Safety consultation. Our laboratories are accredited and approved according to ISO/IEC 17025.

If you have any comments, please feel free to contact us at the following:

Linko EMC/RF Lab:

Tel: 886-2-26052180

Fax: 886-2-26052943

Hsin Chu EMC/RF Lab:

Tel: 886-3-5935343

Fax: 886-3-5935342

Hwa Ya EMC/RF/Safety/Telecom Lab:

Tel: 886-3-3183232

Fax: 886-3-3270892

Email: service.adt@tw.bureauveritas.com

Web Site: www.bureauveritas-adt.com

The address and road map of all our labs can be found in our web site also.



A D T

8. APPENDIX A - MODIFICATIONS RECORDERS FOR ENGINEERING CHANGES TO THE EUT BY THE LAB

No modifications were made to the EUT by the lab during the test.

--- END ---