

FCC Test Report

Report No.: RF121222E03D

FCC ID: Q87-EA6700

Test Model: EA6700

Received Date: May 09, 2016

Test Date: May 09 to 13, 2016

Issued Date: Aug. 19, 2016

Applicant: Linksys LLC

Address: 121 Theory Drive Irvine California 92617 United States

Issued By: Bureau Veritas Consumer Products Services (H.K.) Ltd., Taoyuan Branch
Hsin Chu Laboratory

Lab Address: E-2, No.1, Li Hsin 1st Road, Hsinchu Science Park, Hsinchu City 300,
Taiwan R.O.C.

Test Location (1): E-2, No.1, Li Hsin 1st Road, Hsinchu Science Park, Hsinchu City 300,
Taiwan R.O.C.

Test Location (2): No. 49, Ln. 206, Wende Rd., Shangshan Tsuen, Chiung Lin Hsiang, Hsin
Chu Hsien 307, Taiwan R.O.C.



This report is for your exclusive use. Any copying or replication of this report to or for any other person or entity, or use of our name or trademark, is permitted only with our prior written permission. This report sets forth our findings solely with respect to the test samples identified herein. The results set forth in this report are not indicative or representative of the quality or characteristics of the lot from which a test sample was taken or any similar or identical product unless specifically and expressly noted. Our report includes all of the tests requested by you and the results thereof based upon the information that you provided to us. You have 60 days from date of issuance of this report to notify us of any material error or omission caused by our negligence, provided, however, that such notice shall be in writing and shall specifically address the issue you wish to raise. A failure to raise such issue within the prescribed time shall constitute your unqualified acceptance of the completeness of this report, the tests conducted and the correctness of the report contents. Unless specific mention, the uncertainty of measurement has been explicitly taken into account to declare the compliance or non-compliance to the specification. The report must not be used by the client to claim product certification, approval, or endorsement by TAF or any government agencies.

Table of Contents

Report Issue History Record	4
Release Control Record	4
1 Certificate of Conformity	5
2 Summary of Test Results	6
2.1 Measurement Uncertainty	6
2.2 Modification Record	6
3 General Information	7
3.1 General Description of EUT	7
3.2 Description of Test Modes	11
3.2.1 Test Mode Applicability and Tested Channel Detail	12
3.3 Duty Cycle of Test Signal	14
3.4 Description of Support Units	15
3.4.1 Configuration of System under Test	16
3.5 General Description of Applied Standard	17
4 Test Types and Results	18
4.1 Radiated Emission and Bandedge Measurement	18
4.1.1 Limits of Radiated Emission and Bandedge Measurement	18
4.1.2 Test Instruments	19
4.1.3 Test Procedure	21
4.1.4 Deviation from Test Standard	21
4.1.5 Test Setup	22
4.1.6 EUT Operating Condition	22
4.1.7 Test Results	23
4.2 Transmit Power Measurement	33
4.2.1 Limits of Transmit Power Measurement	33
4.2.2 Test Setup	33
4.2.3 Test Instruments	33
4.2.4 Test Procedure	33
4.2.5 Deviation from Test Standard	33
4.2.6 EUT Operating Condition	34
4.2.7 Test Result	35
4.3 Occupied Bandwidth Measurement	36
4.3.1 Test Setup	36
4.3.2 Test Instruments	36
4.3.3 Test Procedure	36
4.4 Peak Power Spectral Density Measurement	38
4.4.1 Limits of Peak Power Spectral Density Measurement	38
4.4.2 Test Setup	38
4.4.3 Test Instruments	38
4.4.4 Test Procedure	38
4.4.5 Deviation from Test Standard	39
4.4.6 EUT Operating Condition	39
4.4.7 Test Results	40
4.5 Frequency Stability Measurement	42
4.5.1 Limits of Frequency Stability Measurement	42
4.5.2 Test Setup	42
4.5.3 Test Instruments	42
4.5.4 Test Procedure	42
4.5.5 Deviation from Test Standard	42
4.5.6 EUT Operating Condition	42
4.5.7 Test Results	43
4.6 6dB Bandwidth Measurement	44

4.6.1	Limits of 6dB Bandwidth Measurement.....	44
4.6.2	Test Setup.....	44
4.6.3	Test Instruments	44
4.6.4	Test Procedure	44
4.6.5	Deviation from Test Standard	44
4.6.6	EUT Operating Condition	44
4.6.7	Test Results	45
5	Pictures of Test Arrangements.....	47
	Annex A- Radiated Out of Band Emission (OOBE) Measurement (For U-NII-3 band)	48
	Appendix – Information on the Testing Laboratories	51

Report Issue History Record

Issue No.	Reason for Change	Date Issued
RF121222E03 RF121222E03-1	Original	Mar. 07, 2013
RF121222E03C	Upgraded the standard to section 15.407 under new rule for U-NII-1 and U-NII-3 band.	May 19, 2016
RF121222E03D	Upgraded the standard to section 15.407 under new rule (16-24) for U-NII-3 band.	Aug. 19, 2016

Release Control Record

Issue No.	Description	Date Issued
RF121222E03D	Original release.	Aug. 19, 2016

1 Certificate of Conformity

Product: Linksys Smart Wi-Fi Router AC1750

Brand: Linksys

Test Model: EA6700

Sample Status: ENGINEERING SAMPLE

Applicant: Linksys LLC

Test Date: May 09 to 13, 2016

Standard: 47 CFR FCC Part 15, Subpart E (Section 15.407)
ANSI C63.10: 2013

The above equipment has been tested by **Bureau Veritas Consumer Products Services (H.K.) Ltd., Taoyuan Branch**, and found compliance with the requirement of the above standards. The test record, data evaluation & Equipment Under Test (EUT) configurations represented herein are true and accurate accounts of the measurements of the sample's EMC characteristics under the conditions specified in this report.

Prepared by : Midoli Peng , **Date:** Aug. 19, 2016
Midoli Peng / Specialist

Approved by : May Chen , **Date:** Aug. 19, 2016
May Chen / Manager

2 Summary of Test Results

47 CFR FCC Part 15, Subpart E (Section 15.407)			
FCC Clause	Test Item	Result	Remarks
15.407(b) (1/2/3/4(i/ii)/6)	Radiated Emissions & Band Edge Measurement*	Pass	Meet the requirement of limit. Minimum passing margin is -6.1dB at 55.51MHz.
15.407(a)(1/2/3)	Max Average Transmit Power	Pass	Meet the requirement of limit.
---	Occupied Bandwidth Measurement	Pass	Meet the requirement
15.407(a)(1/2/3)	Peak Power Spectral Density	Pass	Meet the requirement of limit.
15.407(e)	6dB bandwidth	Pass	Meet the requirement of limit. (U-NII-3 Band only)
15.407(g)	Frequency Stability	Pass	Meet the requirement of limit.
15.203	Antenna Requirement	Pass	No antenna connector is used.

*For U-NII-3 band compliance with rule part 15.407(b)(4)(i), the OOB test plots were recorded in Annex A.

2.1 Measurement Uncertainty

Where relevant, the following measurement uncertainty levels have been estimated for tests performed on the EUT as specified in CISPR 16-4-2:

Measurement	Frequency	Expanded Uncertainty (k=2) (\pm)
Radiated Emissions up to 1 GHz	30MHz ~ 1GHz	5.31 dB
Radiated Emissions above 1 GHz	1GHz ~ 6GHz	3.43 dB
	6GHz ~ 18GHz	3.73 dB
	18GHz ~ 40GHz	4.11 dB

2.2 Modification Record

There were no modifications required for compliance.

3 General Information

3.1 General Description of EUT

Product	Linksys Smart Wi-Fi Router AC1750
Brand	Linksys
Test Model	EA6700
Status of EUT	ENGINEERING SAMPLE
Driver Version	v6.37.14.62
Power Supply Rating	DC 12V from power adapter
Modulation Type	CCK, DQPSK, DBPSK for DSSS 64QAM, 16QAM, QPSK, BPSK for OFDM 256QAM for OFDM in 11ac mode only
Modulation Technology	DSSS, OFDM
Transfer Rate	802.11b: up to 11Mbps 802.11a / g: up to 54Mbps 802.11n: up to 450Mbps 802.11ac: up to 1300Mbps
Operating Frequency	2.4GHz: 2.412GHz ~ 2.462GHz 5GHz: 5.18GHz ~ 5.24GHz, 5.745GHz ~ 5.825GHz
Number of Channel	2.4GHz: 11 for 802.11b, 802.11g, 802.11n (HT20) 7 for 802.11n (HT40) 5GHz: 9 for 802.11a, 802.11n (HT20), 802.11ac (VHT20) 4 for 802.11n (HT40), 802.11ac (VHT40) 2 for 802.11ac (VHT80)
Output Power	2.4GHz: 255.092mW 5GHz (5.18 ~ 5.24GHz): 543.153mW 5GHz (5.745 ~ 5.825GHz): 954.431mW
Antenna Type	Refer to Note
Antenna Connector	Refer to Note
Accessory Device	Adapter x1
Data Cable Supplied	NA

Note:

1. This report is prepared for FCC Class II change. The difference compared with the Report No.: RF121222E03C is as the following:
 - ◆ Upgrade the standard to section 15.407 under new rule (16-24) for U-NII-3 band.
2. According to above conditions, all test items of U-NII-3 band need to be performed, except for AC power conducted emission test item. And all data was verified to meet the requirements.
3. The EUT is a 2.4GHz & 5GHz WLAN device.
4. The EUT has a RJ45 XFRM Transformer types as following table:

Type 1(Vendor: MINGTEK)			
Vendor P/N	Different	Vendor	Location
HN1874CG	TRANSFORMER VARIABLE COILS,DIP,350UH,HN1874CG	MINGTEK	T1
HN3674CG	TRANSFORMER VARIABLE COILS,DIP,350UH,HN3674CG	MINGTEK	T2, T3

5. The EUT need to be supplied with power adapter as following table:

Brand	Model No.	Spec.
LEI	MU42-3120350-A1	AC Input : 100-240V, 1.5A, 50/60Hz DC Output : 12V, 3.5A DC cable(unshielded, 1.5m)

6. The antennas provided to the EUT, please refer to the following table:

For 2.4GHz						
Transmitter Circuit	Brand	Model	Antenna Type	Peak Gain(dBi) (Include cable loss)	Frequency range (MHz to MHz)	Connector Type
Left side Chain (1)	Galtronics	02100073-05389A1	Dipole	2.48	2400~2483.5	NA
Right side Chain (0)	Galtronics	02100073-05389A2	Dipole	3.15	2400~2483.5	NA
Front side Chain (2)	Galtronics	02100073-05389B1	Dipole	1.65	2400~2483.5	NA
For 5GHz (Band 1)						
Transmitter Circuit	Brand	Model	Antenna Type	Peak Gain(dBi) (Include cable loss)	Frequency range (MHz to MHz)	Connector Type
Left side Chain (1)	Galtronics	02102142-05389A2	Dipole	3.55	5150~5250	NA
Right side Chain (0)	Galtronics	02102142-05389A3	Dipole	4.29	5150~5250	NA
Front side Chain (2)	Galtronics	02102142-05389B1	Dipole	3.86	5150~5250	NA
For 5GHz (Band 4)						
Transmitter Circuit	Brand	Model	Antenna Type	Peak Gain(dBi) (Include cable loss)	Frequency range (MHz to MHz)	Connector Type
Left side Chain (1)	Galtronics	02102142-05389A2	Dipole	4.23	5725~5850	NA
Right side Chain (0)	Galtronics	02102142-05389A3	Dipole	4.79	5725~5850	NA
Front side Chain (2)	Galtronics	02102142-05389B1	Dipole	3.68	5725~5850	NA

Note: 1. According to the above antennas, there are three antennas will transmit simultaneously (one is Vertical and the others are Horizontal).

2. For 2.4GHz (1TX mode): Right side (chain 0) was chosen for final test.

3. For U-NII-1(1TX mode): Right side (chain 0) was chosen for final test.

4. For U-NII-3(1TX mode): Right side (chain 0) was chosen for final test.

7. The EUT incorporates a MIMO function.

MODULATION MODE	TX/RX FUNCTION
802.11b	1Tx/3Rx
802.11g	1Tx (Diversity)/3Rx
802.11n (HT20) <2.4GHz>	3Tx/3Rx
802.11n (HT40) <2.4GHz>	3Tx/3Rx
802.11a	1Tx (Diversity)/3Rx
802.11n (HT20) <5GHz>	3Tx/3Rx
802.11n (HT40) <5GHz>	3Tx/3Rx
802.11ac (VHT20)	3Tx/3Rx
802.11ac (VHT40)	3Tx/3Rx
802.11ac (VHT80)	3Tx/3Rx

Note: The modulation and bandwidth are similar for 802.11n mode for 20MHz (40MHz) and 802.11ac mode for 20MHz (40MHz), therefore investigated worst case to representative mode in test report. (Final test mode refer section 3.2.1)

8. Conducted emission and radiated emission of the simultaneous operation (2.4GHz & 5GHz) has been evaluated and no non-compliance was found.
9. When the EUT operating in 802.11n, the software operation, which is defined by manufacturer, MCS (Modulation and Coding Schemes) from 0 to 23.
10. When the EUT operating in 802.11ac, the software operation, which is defined by manufacturer, MCS (Modulation and Coding Schemes) from 0 to 9.
11. The above EUT information is declared by manufacturer and for more detailed features description, please refer to the manufacturer's specifications or user's manual.

3.2 Description of Test Modes

For 5745 ~ 5825MHz:

5 channels are provided for 802.11a, 802.11n (HT20), 802.11n (VHT20):

Channel	Frequency	Channel	Frequency
149	5745MHz	161	5805MHz
153	5765MHz	165	5825MHz
157	5785MHz		

2 channels are provided for 802.11n (HT40), 802.11n (VHT40):

Channel	Frequency	Channel	Frequency
151	5755MHz	159	5795MHz

1 channel is provided for 802.11n (VHT80):

Channel	Frequency
155	5775 MHz

3.2.1 Test Mode Applicability and Tested Channel Detail

EUT Configure Mode	Applicable To			Description
	RE \geq 1G	RE<1G	APCM	
-	√	√	√	-

Where **RE \geq 1G**: Radiated Emission above 1GHz **RE<1G**: Radiated Emission below 1GHz
APCM: Antenna Port Conducted Measurement

NOTE: 1. The test mode was reference to the worst case in the original test report.

Radiated Emission Test (Above 1GHz):

- Pre-Scan has been conducted to determine the worst-case mode from all possible combinations between available modulations, data rates and antenna ports (if EUT with antenna diversity architecture).
- Following channel(s) was (were) selected for the final test as listed below.

Mode	FREQ. Band (MHz)	Available Channel	Tested Channel	Modulation Technology	Modulation Type	Data Rate (Mbps)
802.11a	5745-5825	149 to 165	149, 157, 165	OFDM	BPSK	6
802.11n (VHT20)		149 to 165	149, 157, 165	OFDM	BPSK	6.5
802.11n (VHT40)		151 to 159	151, 159	OFDM	BPSK	13.5
802.11ac (VHT80)		155	5775	OFDM	BPSK	29.3

Radiated Emission Test (Below 1GHz):

- Pre-Scan has been conducted to determine the worst-case mode from all possible combinations between available modulations, data rates and antenna ports (if EUT with antenna diversity architecture).
- Following channel(s) was (were) selected for the final test as listed below.

Mode	FREQ. Band (MHz)	Available Channel	Tested Channel	Modulation Technology	Modulation Type	Data Rate (Mbps)
802.11ac (VHT20)	5745-5825	149 to 165	157	OFDM	BPSK	6.5

Antenna Port Conducted Measurement:

- This item includes all test value of each mode, but only includes spectrum plot of worst value of each mode.
- Pre-Scan has been conducted to determine the worst-case mode from all possible combinations between available modulations, data rates and antenna ports (if EUT with antenna diversity architecture).
- Following channel(s) was (were) selected for the final test as listed below.

Mode	FREQ. Band (MHz)	Available Channel	Tested Channel	Modulation Technology	Modulation Type	Data Rate (Mbps)
802.11a	5745-5825	149 to 165	149, 157, 165	OFDM	BPSK	6
802.11n (VHT20)		149 to 165	149, 157, 165	OFDM	BPSK	6.5
802.11n (VHT40)		151 to 159	151, 159	OFDM	BPSK	13.5
802.11ac (VHT80)		155	5775	OFDM	BPSK	29.3

Test Condition:

Applicable To	Environmental Conditions	Input Power	Tested By
RE \geq 1G	24deg. C, 74%RH	120Vac, 60Hz	Andy Ho
RE<1G	23deg. C, 68%RH	120Vac, 60Hz	Tim Ho
APCM	24deg. C, 64%RH	120Vac, 60Hz	Anderson Chen

3.3 Duty Cycle of Test Signal

If duty cycle of test signal is $\geq 98\%$, duty factor is not required.

If duty cycle of test signal is $< 98\%$, duty factor shall be considered.

802.11a: Duty cycle = $2.069 \text{ ms} / 2.096 \text{ ms} = 0.987$

802.11n (VHT20): Duty cycle = $1.918 \text{ ms} / 1.948 \text{ ms} = 0.985$

802.11n (VHT40): Duty cycle = $0.955 \text{ ms} / 0.973 \text{ ms} = 0.982$

802.11ac (VHT80): Duty cycle = $0.459 \text{ ms} / 0.482 \text{ ms} = 0.952$, Duty factor = $10 * \log(1/0.952) = 0.21$

802.11a

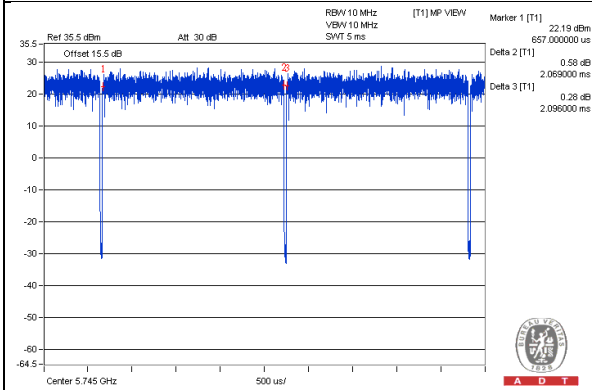

802.11n (VHT20)

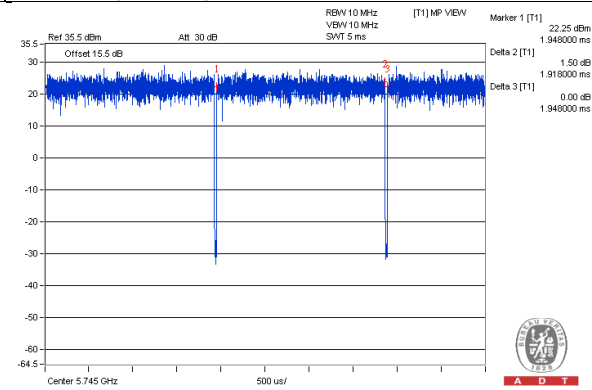

802.11n (VHT40)

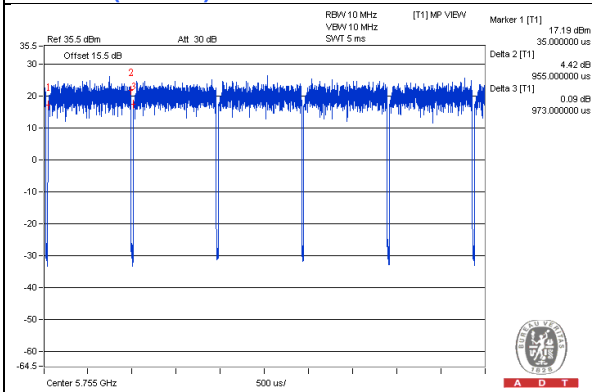

802.11ac (VHT80)

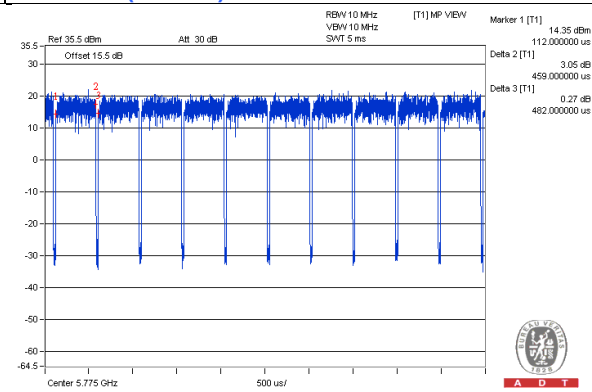

3.4 Description of Support Units

The EUT has been tested as an independent unit together with other necessary accessories or support units. The following support units or accessories were used to form a representative test configuration during the tests.

ID	Product	Brand	Model No.	Serial No.	FCC ID	Remarks
A.	iPod shuffle	Apple	MC749TA/A	CC4DMFJUDFDM	NA	Provided by Lab
B.	Notebook Computer	DELL	E5430	4YV4VY1	FCC DoC	Provided by Lab
C.	Notebook Computer	DELL	E5430	HYV4VY1	FCC DoC	Provided by Lab
D.	HUB	ZyXEL	ES-116P	S060H02000215	FCC DoC	Provided by Lab

Note:

1. All power cords of the above support units are non-shielded (1.8m).

ID	Descriptions	Qty.	Length (m)	Shielding (Yes/No)	Cores (Qty.)	Remarks
1.	USB cable	1	0.1	Yes	0	Provided by Lab
2.	RJ45 cable	1	10	No	0	Provided by Lab
3.	RJ45 cable	1	10	No	0	Provided by Lab
4.	RJ45 cable	3	10	No	0	Provided by Lab
5.	DC cable	1	1.5	No	0	Supplied by Client

3.4.1 Configuration of System under Test

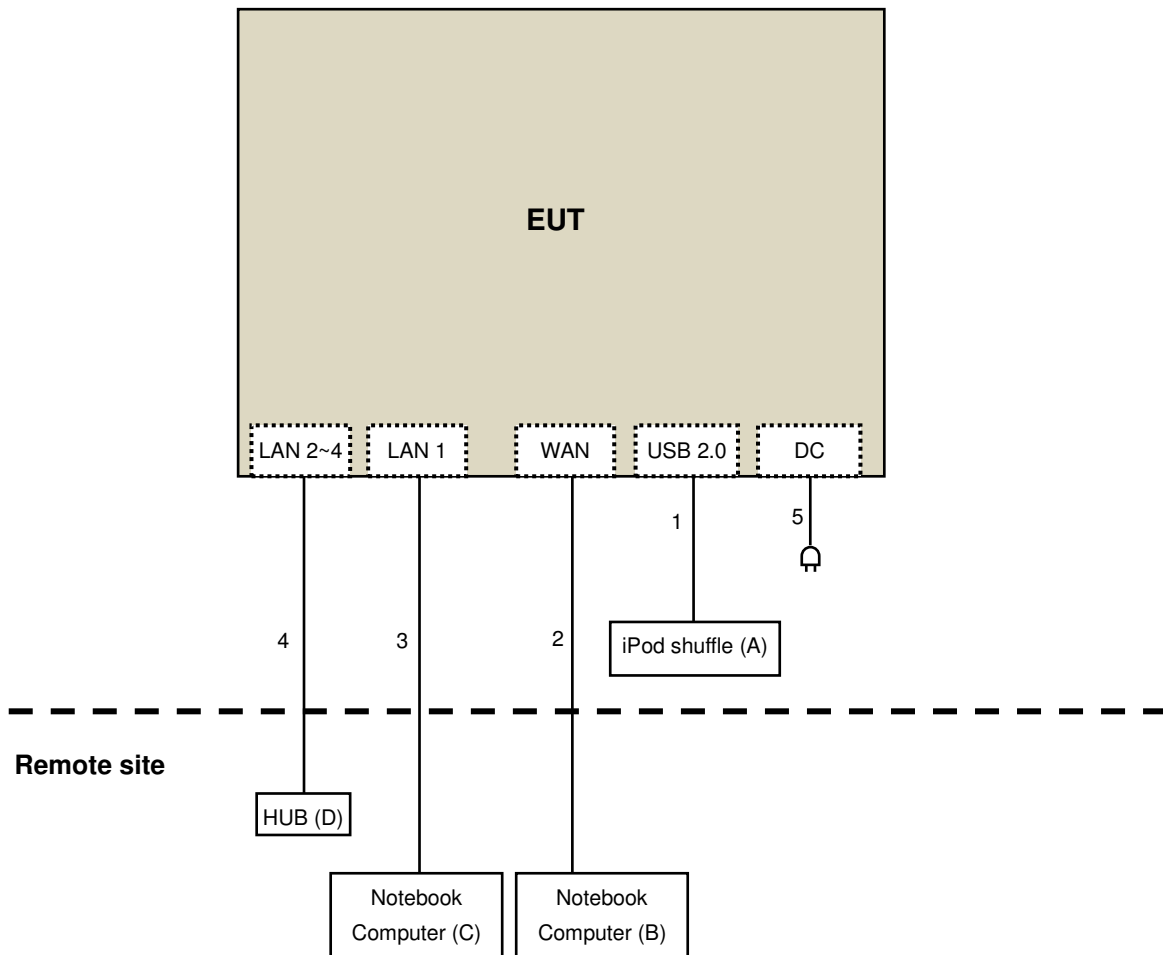

3.5 General Description of Applied Standard

The EUT is a RF Product. According to the specifications of the manufacturer, it must comply with the requirements of the following standards:

FCC Part 15, Subpart E (15.407)
KDB 789033 D02 General UNII Test Procedure New Rules v01r03
KDB 662911 D01 Multiple Transmitter Output v02r01
ANSI C63.10-2013

All test items have been performed and recorded as per the above standards.

NOTE: The EUT has been verified to comply with the requirements of FCC Part 15, Subpart B, Class B (DoC). The test report has been issued separately.

4 Test Types and Results

4.1 Radiated Emission and Bandedge Measurement

4.1.1 Limits of Radiated Emission and Bandedge Measurement

Radiated emissions which fall in the restricted bands must comply with the radiated emission limits specified as below table.

Frequencies (MHz)	Field Strength (microvolts/meter)	Measurement Distance (meters)
0.009 ~ 0.490	2400/F(kHz)	300
0.490 ~ 1.705	24000/F(kHz)	30
1.705 ~ 30.0	30	30
30 ~ 88	100	3
88 ~ 216	150	3
216 ~ 960	200	3
Above 960	500	3

NOTE:

1. The lower limit shall apply at the transition frequencies.
2. Emission level (dBuV/m) = 20 log Emission level (uV/m).
3. For frequencies above 1000MHz, the field strength limits are based on average detector, however, the peak field strength of any emission shall not exceed the maximum permitted average limits, specified above by more than 20dB under any condition of modulation.

Limits of unwanted emission out of the restricted bands

Applicable To		Limit	
KDB 789033 D02 General UNII Test Procedure New Rules v01r03		Field Strength at 3m	
		PK:74 (dBμV/m)	AV:54 (dBμV/m)
Frequency Band	Applicable To	EIRP Limit	Equivalent Field Strength at 3m
5150~5250 MHz	15.407(b)(1)	PK:-27 (dBm/MHz)	PK:68.2(dBμV/m)
5250~5350 MHz	15.407(b)(2)		
5470~5725 MHz	15.407(b)(3)		
5725~5850 MHz	<input checked="" type="checkbox"/> 15.407(b)(4)(i)	PK:-27 (dBm/MHz) ^{*1} PK:10 (dBm/MHz) ^{*2} PK:15.6 (dBm/MHz) ^{*3} PK:27 (dBm/MHz) ^{*4}	PK: 68.2(dBμV/m) ^{*1} PK:105.2 (dBμV/m) ^{*2} PK: 110.8(dBμV/m) ^{*3} PK:122.2 (dBμV/m) ^{*4}
	<input type="checkbox"/> 15.407(b)(4)(ii)	Emission limits in section 15.247(d)	
^{*1} beyond 75 MHz or more above of the band edge.		^{*2} below the band edge increasing linearly to 10 dBm/MHz at 25 MHz above.	
^{*3} below the band edge increasing linearly to a level of 15.6 dBm/MHz at 5 MHz above.		^{*4} from 5 MHz above or below the band edge increasing linearly to a level of 27 dBm/MHz at the band edge.	

Note:

The following formula is used to convert the equipment isotropic radiated power (eirp) to field strength:

$$E = \frac{1000000\sqrt{30P}}{3} \mu\text{V/m, where P is the eirp (Watts).}$$

4.1.2 Test Instruments

DESCRIPTION & MANUFACTURER	MODEL NO.	SERIAL NO.	CALIBRATED DATE	CALIBRATED UNTIL
Test Receiver Agilent	N9038A	MY50010156	Aug. 12, 2015	Aug. 11, 2016
Pre-Amplifier ^(*) EMCI	EMC001340	980142	Jan. 20, 2016	Jan. 19, 2018
Loop Antenna ^(*) Electro-Metrics	EM-6879	264	Dec. 16, 2014	Dec. 15, 2016
RF Cable	NA	LOOPCAB-001 LOOPCAB-002	Jan. 18, 2016	Jan. 17, 2017
Pre-Amplifier Mini-Circuits	ZFL-1000VH2 B	AMP-ZFL-05	May 07, 2016	May 06, 2017
Trilog Broadband Antenna SCHWARZBECK	VULB 9168	9168-156	Jan. 04, 2016	Jan. 03, 2017
RF Cable	8D	966-3-1 966-3-2 966-3-3	Apr. 02, 2016	Apr. 01, 2017
Horn_Antenna SCHWARZBECK	BBHA9120-D	9120D-406	Jan. 20, 2016	Jan. 19, 2017
Pre-Amplifier Agilent	8449B	3008A02465	Apr. 05, 2016	Apr. 04, 2017
RF Cable	EMC104-SM- SM-2000 EMC104-SM- SM-5000 EMC104-SM- SM-5000	150317 150321 150322	Mar. 30, 2016	Mar. 29, 2017
Spectrum Analyzer Keysight	N9030A	MY54490520	July 26, 2015	July 25, 2016
Pre-Amplifier EMCI	EMC184045	980143	Jan. 15, 2016	Jan. 14, 2017
Horn_Antenna SCHWARZBECK	BBHA 9170	BBHA9170608	Jan. 08, 2016	Jan. 07, 2017
RF Cable	SUCOFLEX 102	36432/2 36441/2	Jan. 16, 2016	Jan. 15, 2017
Software	ADT_Radiated _V8.7.07	NA	NA	NA
Antenna Tower & Turn Table Max-Full	MF-7802	MF780208406	NA	NA
Boresight Antenna Fixture	FBA-01	FBA-SIP01	NA	NA
Power meter Anritsu	ML2495A	0824006	May 25, 2015	May 24, 2016
Power sensor Anritsu	MA2411B	0738172	May 25, 2015	May 24, 2016
Spectrum Analyzer R&S	FSP40	100036	Jan. 27, 2016	Jan. 26, 2017
Temperature & Humidity Chamber TERCHY	MHU-225AU	911033	Dec. 03, 2015	Dec. 02, 2016

Note:

1. The calibration interval of the above test instruments is 12 months and the calibrations are traceable to NML/ROC and NIST/USA.
2. *The calibration interval of the above test instruments is 24 months and the calibrations are traceable to NML/ROC and NIST/USA.
3. Loop antenna was used for all emissions below 30 MHz.
4. The test was performed in 966 Chamber No. 3.
6. The FCC Site Registration No. is 147459
- 7 The CANADA Site Registration No. is 20331-1
- 5 Tested Date: May 09 to 13, 2016

4.1.3 Test Procedure

- a. The EUT was placed on the top of a rotating table 0.8 meters (for below 1GHz) / 1.5 meters (for above 1GHz) above the ground at 3 meter chamber room for test. The table was rotated 360 degrees to determine the position of the highest radiation.
- b. The EUT was set 3 meters away from the interference-receiving antenna, which was mounted on the top of a variable-height antenna tower.
- c. The height of antenna is varied from one meter to four meters above the ground to determine the maximum value of the field strength. Both horizontal and vertical polarizations of the antenna are set to make the measurement.
- d. For each suspected emission, the EUT was arranged to its worst case and then the antenna was tuned to heights from 1 meter to 4 meters and the rotatable table was turned from 0 degrees to 360 degrees to find the maximum reading.
- e. The test-receiver system was set to quasi-peak detect function and specified bandwidth with maximum hold mode when the test frequency is below 1 GHz.
- f. The test-receiver system was set to peak and average detect function and specified bandwidth with maximum hold mode when the test frequency is above 1 GHz. If the peak reading value also meets average limit, measurement with the average detector is unnecessary.

Note:

1. The resolution bandwidth and video bandwidth of test receiver/spectrum analyzer is 120kHz for Quasi-peak detection (QP) at frequency below 1GHz.
2. The resolution bandwidth of test receiver/spectrum analyzer is 1 MHz and the video bandwidth is 3 MHz for Peak detection (PK) at frequency above 1GHz.
3. The resolution bandwidth of test receiver/spectrum analyzer is 1MHz and the video bandwidth is 3MHz for RMS Average (Duty cycle < 98%) for Average detection (AV) at frequency above 1GHz, then the measurement results was added to a correction factor ($10 \log(1/\text{duty cycle})$).
4. The resolution bandwidth of test receiver/spectrum analyzer is 1MHz and the video bandwidth is 10Hz (Duty cycle $\geq 98\%$) for Average detection (AV) at frequency above 1GHz.
5. All modes of operation were investigated and the worst-case emissions are reported.

4.1.4 Deviation from Test Standard

No deviation.

4.1.5 Test Setup

<Frequency Range below 1GHz>

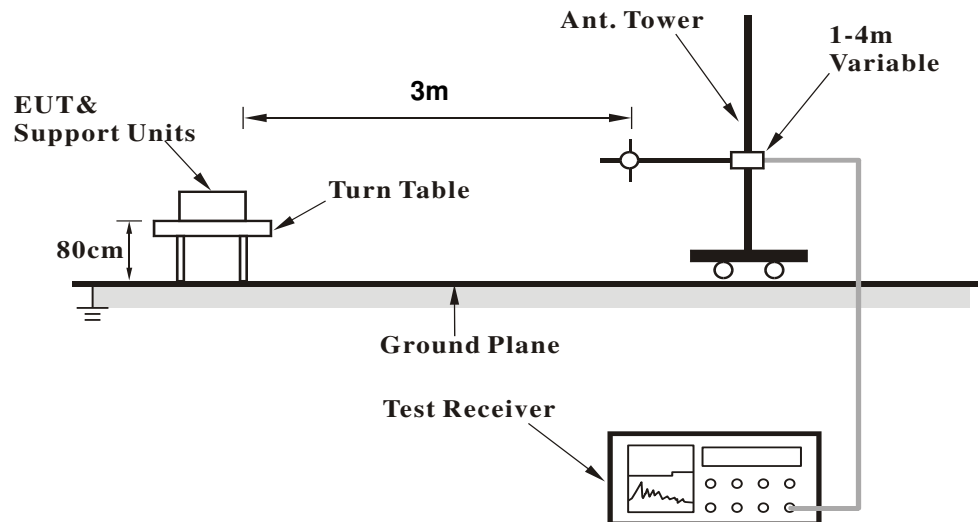

<Frequency Range above 1GHz>

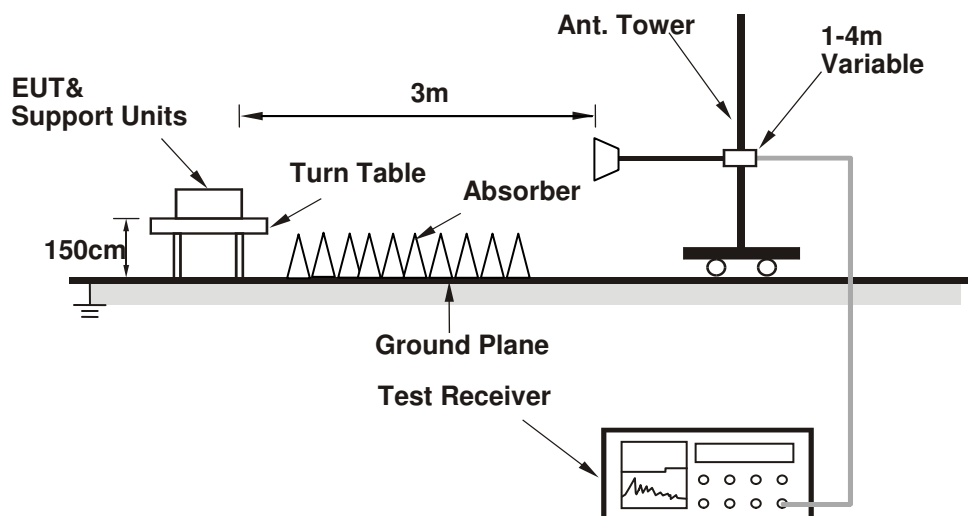

For the actual test configuration, please refer to the attached file (Test Setup Photo).

4.1.6 EUT Operating Condition

- Placed the EUT on testing table.
- Connect the EUT with the support unit A~B (Notebook Computer) which is placed in a remote area.
- The communication partner run test program "MTool 2.0.0.8" to enable EUT under transmission/receiving condition continuously at specific channel frequency.

4.1.7 Test Results

Above 1GHz Data :

802.11a

CHANNEL	TX Channel 149	DETECTOR FUNCTION	Peak (PK)
FREQUENCY RANGE	1GHz ~ 40GHz		Average (AV)

ANTENNA POLARITY & TEST DISTANCE: HORIZONTAL AT 3 M

NO.	FREQ. (MHz)	EMISSION LEVEL (dBuV/m)	LIMIT (dBuV/m)	MARGIN (dB)	ANTENNA HEIGHT (m)	TABLE ANGLE (Degree)	RAW VALUE (dBuV)	CORRECTION FACTOR (dB/m)
1	*5745.00	109.5 PK			1.39 H	80	105.31	4.19
2	*5745.00	99.6 AV			1.39 H	80	95.41	4.19
3	11490.00	53.7 PK	74.0	-20.3	1.25 H	83	38.53	15.17
4	11490.00	41.2 AV	54.0	-12.8	1.25 H	83	26.03	15.17
5	#17235.00	50.4 PK	74.0	-23.6	1.06 H	158	30.50	19.90
6	#17235.00	39.7 AV	54.0	-14.3	1.06 H	158	19.80	19.90

ANTENNA POLARITY & TEST DISTANCE: VERTICAL AT 3 M

NO.	FREQ. (MHz)	EMISSION LEVEL (dBuV/m)	LIMIT (dBuV/m)	MARGIN (dB)	ANTENNA HEIGHT (m)	TABLE ANGLE (Degree)	RAW VALUE (dBuV)	CORRECTION FACTOR (dB/m)
1	*5745.00	121.9 PK			1.14 V	113	117.71	4.19
2	*5745.00	112.0 AV			1.14 V	113	107.81	4.19
3	11490.00	57.4 PK	74.0	-16.6	1.03 V	14	42.23	15.17
4	11490.00	45.7 AV	54.0	-8.3	1.03 V	14	30.53	15.17
5	#17235.00	56.1 PK	74.0	-17.9	1.00 V	60	36.20	19.90
6	#17235.00	44.3 AV	54.0	-9.7	1.00 V	60	24.40	19.90

REMARKS:

1. Emission Level(dBuV/m) = Raw Value(dBuV) + Correction Factor(dB/m)
2. Correction Factor(dB/m) = Antenna Factor(dB/m) + Cable Factor(dB) – Pre-Amplifier Factor(dB)
3. The other emission levels were very low against the limit.
4. Margin value = Emission Level – Limit value
5. " * " : Fundamental frequency.
6. " # " : The radiated frequency is out of the restricted band.

CHANNEL	TX Channel 157	DETECTOR FUNCTION	Peak (PK)
FREQUENCY RANGE	1GHz ~ 40GHz		Average (AV)

ANTENNA POLARITY & TEST DISTANCE: HORIZONTAL AT 3 M

NO.	FREQ. (MHz)	EMISSION LEVEL (dBuV/m)	LIMIT (dBuV/m)	MARGIN (dB)	ANTENNA HEIGHT (m)	TABLE ANGLE (Degree)	RAW VALUE (dBuV)	CORRECTION FACTOR (dB/m)
1	*5785.00	108.6 PK			1.39 H	94	104.42	4.18
2	*5785.00	98.8 AV			1.39 H	94	94.62	4.18
3	11570.00	54.2 PK	74.0	-19.8	1.29 H	89	39.08	15.12
4	11570.00	41.6 AV	54.0	-12.4	1.29 H	89	26.48	15.12
5	#17355.00	50.3 PK	74.0	-23.7	1.06 H	148	29.86	20.44
6	#17355.00	39.8 AV	54.0	-14.2	1.06 H	148	19.36	20.44

ANTENNA POLARITY & TEST DISTANCE: VERTICAL AT 3 M

NO.	FREQ. (MHz)	EMISSION LEVEL (dBuV/m)	LIMIT (dBuV/m)	MARGIN (dB)	ANTENNA HEIGHT (m)	TABLE ANGLE (Degree)	RAW VALUE (dBuV)	CORRECTION FACTOR (dB/m)
1	*5785.00	121.0 PK			1.26 V	110	116.82	4.18
2	*5785.00	111.2 AV			1.26 V	110	107.02	4.18
3	11570.00	57.7 PK	74.0	-16.3	1.01 V	0	42.58	15.12
4	11570.00	45.8 AV	54.0	-8.2	1.01 V	0	30.68	15.12
5	#17355.00	56.1 PK	74.0	-17.9	1.04 V	72	35.66	20.44
6	#17355.00	44.4 AV	54.0	-9.6	1.04 V	72	23.96	20.44

REMARKS:

1. Emission Level(dBuV/m) = Raw Value(dBuV) + Correction Factor(dB/m)
2. Correction Factor(dB/m) = Antenna Factor(dB/m) + Cable Factor(dB) – Pre-Amplifier Factor(dB)
3. The other emission levels were very low against the limit.
4. Margin value = Emission Level – Limit value
5. " * ": Fundamental frequency.
6. " # ": The radiated frequency is out of the restricted band.

CHANNEL	TX Channel 165	DETECTOR FUNCTION	Peak (PK)
FREQUENCY RANGE	1GHz ~ 40GHz		Average (AV)

ANTENNA POLARITY & TEST DISTANCE: HORIZONTAL AT 3 M

NO.	FREQ. (MHz)	EMISSION LEVEL (dBuV/m)	LIMIT (dBuV/m)	MARGIN (dB)	ANTENNA HEIGHT (m)	TABLE ANGLE (Degree)	RAW VALUE (dBuV)	CORRECTION FACTOR (dB/m)
1	*5825.00	108.8 PK			1.38 H	78	104.58	4.22
2	*5825.00	98.8 AV			1.38 H	78	94.58	4.22
3	11650.00	54.2 PK	74.0	-19.8	1.28 H	90	39.20	15.00
4	11650.00	41.5 AV	54.0	-12.5	1.28 H	90	26.50	15.00
5	#17475.00	51.0 PK	74.0	-23.0	1.06 H	133	29.89	21.11
6	#17475.00	40.2 AV	54.0	-13.8	1.06 H	133	19.09	21.11

ANTENNA POLARITY & TEST DISTANCE: VERTICAL AT 3 M

NO.	FREQ. (MHz)	EMISSION LEVEL (dBuV/m)	LIMIT (dBuV/m)	MARGIN (dB)	ANTENNA HEIGHT (m)	TABLE ANGLE (Degree)	RAW VALUE (dBuV)	CORRECTION FACTOR (dB/m)
1	*5825.00	121.2 PK			1.15 V	112	116.98	4.22
2	*5825.00	111.2 AV			1.15 V	112	106.98	4.22
3	11650.00	57.0 PK	74.0	-17.0	1.03 V	4	42.00	15.00
4	11650.00	45.4 AV	54.0	-8.6	1.03 V	4	30.40	15.00
5	#17475.00	56.1 PK	74.0	-17.9	1.05 V	79	34.99	21.11
6	#17475.00	44.3 AV	54.0	-9.7	1.05 V	79	23.19	21.11

REMARKS:

1. Emission Level(dBuV/m) = Raw Value(dBuV) + Correction Factor(dB/m)
2. Correction Factor(dB/m) = Antenna Factor(dB/m) + Cable Factor(dB) – Pre-Amplifier Factor(dB)
3. The other emission levels were very low against the limit.
4. Margin value = Emission Level – Limit value
5. " * ": Fundamental frequency.
6. " # ": The radiated frequency is out of the restricted band.

802.11ac (VHT20)

CHANNEL	TX Channel 149	DETECTOR FUNCTION	Peak (PK)
FREQUENCY RANGE	1GHz ~ 40GHz		Average (AV)

ANTENNA POLARITY & TEST DISTANCE: HORIZONTAL AT 3 M

NO.	FREQ. (MHz)	EMISSION LEVEL (dBuV/m)	LIMIT (dBuV/m)	MARGIN (dB)	ANTENNA HEIGHT (m)	TABLE ANGLE (Degree)	RAW VALUE (dBuV)	CORRECTION FACTOR (dB/m)
1	*5745.00	109.7 PK			1.38 H	74	105.51	4.19
2	*5745.00	99.9 AV			1.38 H	74	95.71	4.19
3	11490.00	54.3 PK	74.0	-19.7	1.20 H	89	39.13	15.17
4	11490.00	41.5 AV	54.0	-12.5	1.20 H	89	26.33	15.17
5	#17235.00	51.7 PK	74.0	-22.3	1.01 H	112	31.80	19.90
6	#17235.00	41.1 AV	54.0	-12.9	1.01 H	112	21.20	19.90

ANTENNA POLARITY & TEST DISTANCE: VERTICAL AT 3 M

NO.	FREQ. (MHz)	EMISSION LEVEL (dBuV/m)	LIMIT (dBuV/m)	MARGIN (dB)	ANTENNA HEIGHT (m)	TABLE ANGLE (Degree)	RAW VALUE (dBuV)	CORRECTION FACTOR (dB/m)
1	*5745.00	122.1 PK			1.13 V	114	117.91	4.19
2	*5745.00	112.3 AV			1.13 V	114	108.11	4.19
3	11490.00	54.4 PK	74.0	-19.6	1.03 V	7	39.23	15.17
4	11490.00	42.2 AV	54.0	-11.8	1.03 V	7	27.03	15.17
5	#17235.00	54.3 PK	74.0	-19.7	1.00 V	76	34.40	19.90
6	#17235.00	42.2 AV	54.0	-11.8	1.00 V	76	22.30	19.90

REMARKS:

1. Emission Level(dBuV/m) = Raw Value(dBuV) + Correction Factor(dB/m)
2. Correction Factor(dB/m) = Antenna Factor(dB/m) + Cable Factor(dB) – Pre-Amplifier Factor(dB)
3. The other emission levels were very low against the limit.
4. Margin value = Emission Level – Limit value
5. " * ": Fundamental frequency.
6. " # ": The radiated frequency is out of the restricted band.

CHANNEL	TX Channel 157	DETECTOR FUNCTION	Peak (PK)
FREQUENCY RANGE	1GHz ~ 40GHz		Average (AV)

ANTENNA POLARITY & TEST DISTANCE: HORIZONTAL AT 3 M

NO.	FREQ. (MHz)	EMISSION LEVEL (dBuV/m)	LIMIT (dBuV/m)	MARGIN (dB)	ANTENNA HEIGHT (m)	TABLE ANGLE (Degree)	RAW VALUE (dBuV)	CORRECTION FACTOR (dB/m)
1	*5785.00	109.4 PK			1.40 H	73	105.22	4.18
2	*5785.00	99.5 AV			1.40 H	73	95.32	4.18
3	11570.00	53.6 PK	74.0	-20.4	1.17 H	76	38.48	15.12
4	11570.00	41.1 AV	54.0	-12.9	1.17 H	76	25.98	15.12
5	#17355.00	51.3 PK	74.0	-22.7	1.03 H	126	30.86	20.44
6	#17355.00	40.9 AV	54.0	-13.1	1.03 H	126	20.46	20.44

ANTENNA POLARITY & TEST DISTANCE: VERTICAL AT 3 M

NO.	FREQ. (MHz)	EMISSION LEVEL (dBuV/m)	LIMIT (dBuV/m)	MARGIN (dB)	ANTENNA HEIGHT (m)	TABLE ANGLE (Degree)	RAW VALUE (dBuV)	CORRECTION FACTOR (dB/m)
1	*5785.00	121.8 PK			1.14 V	113	117.62	4.18
2	*5785.00	111.9 AV			1.14 V	113	107.72	4.18
3	11570.00	56.8 PK	74.0	-17.2	1.03 V	7	41.68	15.12
4	11570.00	45.2 AV	54.0	-8.8	1.03 V	7	30.08	15.12
5	#17355.00	56.2 PK	74.0	-17.8	1.00 V	76	35.76	20.44
6	#17355.00	44.7 AV	54.0	-9.3	1.00 V	76	24.26	20.44

REMARKS:

1. Emission Level(dBuV/m) = Raw Value(dBuV) + Correction Factor(dB/m)
2. Correction Factor(dB/m) = Antenna Factor(dB/m) + Cable Factor(dB) – Pre-Amplifier Factor(dB)
3. The other emission levels were very low against the limit.
4. Margin value = Emission Level – Limit value
5. " * ": Fundamental frequency.
6. " # ": The radiated frequency is out of the restricted band.

CHANNEL	TX Channel 165	DETECTOR FUNCTION	Peak (PK)
FREQUENCY RANGE	1GHz ~ 40GHz		Average (AV)

ANTENNA POLARITY & TEST DISTANCE: HORIZONTAL AT 3 M

NO.	FREQ. (MHz)	EMISSION LEVEL (dBuV/m)	LIMIT (dBuV/m)	MARGIN (dB)	ANTENNA HEIGHT (m)	TABLE ANGLE (Degree)	RAW VALUE (dBuV)	CORRECTION FACTOR (dB/m)
1	*5825.00	108.8 PK			1.41 H	69	104.58	4.22
2	*5825.00	98.9 AV			1.41 H	69	94.68	4.22
3	11650.00	53.0 PK	74.0	-21.0	1.22 H	85	38.00	15.00
4	11650.00	40.7 AV	54.0	-13.3	1.22 H	85	25.70	15.00
5	#17475.00	51.4 PK	74.0	-22.6	1.00 H	116	30.29	21.11
6	#17475.00	40.9 AV	54.0	-13.1	1.00 H	116	19.79	21.11

ANTENNA POLARITY & TEST DISTANCE: VERTICAL AT 3 M

NO.	FREQ. (MHz)	EMISSION LEVEL (dBuV/m)	LIMIT (dBuV/m)	MARGIN (dB)	ANTENNA HEIGHT (m)	TABLE ANGLE (Degree)	RAW VALUE (dBuV)	CORRECTION FACTOR (dB/m)
1	*5825.00	121.2 PK			1.08 V	111	116.98	4.22
2	*5825.00	111.3 AV			1.08 V	111	107.08	4.22
3	11650.00	57.1 PK	74.0	-16.9	1.03 V	22	42.10	15.00
4	11650.00	45.2 AV	54.0	-8.8	1.03 V	22	30.20	15.00
5	#17475.00	56.4 PK	74.0	-17.6	1.00 V	83	35.29	21.11
6	#17475.00	44.9 AV	54.0	-9.1	1.00 V	83	23.79	21.11

REMARKS:

1. Emission Level(dBuV/m) = Raw Value(dBuV) + Correction Factor(dB/m)
2. Correction Factor(dB/m) = Antenna Factor(dB/m) + Cable Factor(dB) – Pre-Amplifier Factor(dB)
3. The other emission levels were very low against the limit.
4. Margin value = Emission Level – Limit value
5. " * ": Fundamental frequency.
6. " # ": The radiated frequency is out of the restricted band.

802.11ac (VHT40)

CHANNEL	TX Channel 151	DETECTOR FUNCTION	Peak (PK)
FREQUENCY RANGE	1GHz ~ 40GHz		Average (AV)

ANTENNA POLARITY & TEST DISTANCE: HORIZONTAL AT 3 M

NO.	FREQ. (MHz)	EMISSION LEVEL (dBuV/m)	LIMIT (dBuV/m)	MARGIN (dB)	ANTENNA HEIGHT (m)	TABLE ANGLE (Degree)	RAW VALUE (dBuV)	CORRECTION FACTOR (dB/m)
1	*5755.00	105.6 PK			1.36 H	76	101.42	4.18
2	*5755.00	95.4 AV			1.36 H	76	91.22	4.18
3	11510.00	53.4 PK	74.0	-20.6	1.22 H	90	38.26	15.14
4	11510.00	41.8 AV	54.0	-12.2	1.22 H	90	26.66	15.14
5	#17265.00	53.0 PK	74.0	-21.0	1.05 H	129	33.01	19.99
6	#17265.00	42.2 AV	54.0	-11.8	1.05 H	129	22.21	19.99

ANTENNA POLARITY & TEST DISTANCE: VERTICAL AT 3 M

NO.	FREQ. (MHz)	EMISSION LEVEL (dBuV/m)	LIMIT (dBuV/m)	MARGIN (dB)	ANTENNA HEIGHT (m)	TABLE ANGLE (Degree)	RAW VALUE (dBuV)	CORRECTION FACTOR (dB/m)
1	*5755.00	118.0 PK			1.17 V	114	113.82	4.18
2	*5755.00	107.8 AV			1.17 V	114	103.62	4.18
3	11510.00	57.3 PK	74.0	-16.7	1.11 V	45	42.16	15.14
4	11510.00	45.0 AV	54.0	-9.0	1.11 V	45	29.86	15.14
5	#17265.00	56.5 PK	74.0	-17.5	1.18 V	57	36.51	19.99
6	#17265.00	45.2 AV	54.0	-8.8	1.18 V	57	25.21	19.99

REMARKS:

1. Emission Level(dBuV/m) = Raw Value(dBuV) + Correction Factor(dB/m)
2. Correction Factor(dB/m) = Antenna Factor(dB/m) + Cable Factor(dB) – Pre-Amplifier Factor(dB)
3. The other emission levels were very low against the limit.
4. Margin value = Emission Level – Limit value
5. " * ": Fundamental frequency.
6. " # ": The radiated frequency is out of the restricted band.

CHANNEL	TX Channel 159	DETECTOR FUNCTION	Peak (PK)
FREQUENCY RANGE	1GHz ~ 40GHz		Average (AV)

ANTENNA POLARITY & TEST DISTANCE: HORIZONTAL AT 3 M

NO.	FREQ. (MHz)	EMISSION LEVEL (dBuV/m)	LIMIT (dBuV/m)	MARGIN (dB)	ANTENNA HEIGHT (m)	TABLE ANGLE (Degree)	RAW VALUE (dBuV)	CORRECTION FACTOR (dB/m)
1	*5795.00	107.1 PK			1.41 H	66	102.91	4.19
2	*5795.00	95.2 AV			1.41 H	66	91.01	4.19
3	11590.00	53.3 PK	74.0	-20.7	1.18 H	96	38.19	15.11
4	11590.00	41.8 AV	54.0	-12.2	1.18 H	96	26.69	15.11
5	#17385.00	53.0 PK	74.0	-21.0	1.01 H	129	32.38	20.62
6	#17385.00	42.2 AV	54.0	-11.8	1.01 H	129	21.58	20.62

ANTENNA POLARITY & TEST DISTANCE: VERTICAL AT 3 M

NO.	FREQ. (MHz)	EMISSION LEVEL (dBuV/m)	LIMIT (dBuV/m)	MARGIN (dB)	ANTENNA HEIGHT (m)	TABLE ANGLE (Degree)	RAW VALUE (dBuV)	CORRECTION FACTOR (dB/m)
1	*5795.00	119.5 PK			1.00 V	113	115.31	4.19
2	*5795.00	107.6 AV			1.00 V	113	103.41	4.19
3	11590.00	56.8 PK	74.0	-17.2	1.10 V	58	41.69	15.11
4	11590.00	44.7 AV	54.0	-9.3	1.10 V	58	29.59	15.11
5	#17385.00	56.2 PK	74.0	-17.8	1.22 V	51	35.58	20.62
6	#17385.00	44.9 AV	54.0	-9.1	1.22 V	51	24.28	20.62

REMARKS:

1. Emission Level(dBuV/m) = Raw Value(dBuV) + Correction Factor(dB/m)
2. Correction Factor(dB/m) = Antenna Factor(dB/m) + Cable Factor(dB) – Pre-Amplifier Factor(dB)
3. The other emission levels were very low against the limit.
4. Margin value = Emission Level – Limit value
5. " * ": Fundamental frequency.
6. " # ": The radiated frequency is out of the restricted band.

802.11ac (VHT80)

CHANNEL	TX Channel 155	DETECTOR FUNCTION	Peak (PK)
FREQUENCY RANGE	1GHz ~ 40GHz		Average (AV)

ANTENNA POLARITY & TEST DISTANCE: HORIZONTAL AT 3 M

NO.	FREQ. (MHz)	EMISSION LEVEL (dBuV/m)	LIMIT (dBuV/m)	MARGIN (dB)	ANTENNA HEIGHT (m)	TABLE ANGLE (Degree)	RAW VALUE (dBuV)	CORRECTION FACTOR (dB/m)
1	*5775.00	101.5 PK			1.22 H	178	97.32	4.18
2	*5775.00	89.7 AV			1.22 H	178	85.52	4.18
3	11550.00	53.8 PK	74.0	-20.2	1.18 H	89	38.68	15.12
4	11550.00	42.5 AV	54.0	-11.5	1.18 H	89	27.38	15.12
5	#17325.00	53.4 PK	74.0	-20.6	1.06 H	133	33.14	20.26
6	#17325.00	42.4 AV	54.0	-11.6	1.06 H	133	22.14	20.26

ANTENNA POLARITY & TEST DISTANCE: VERTICAL AT 3 M

NO.	FREQ. (MHz)	EMISSION LEVEL (dBuV/m)	LIMIT (dBuV/m)	MARGIN (dB)	ANTENNA HEIGHT (m)	TABLE ANGLE (Degree)	RAW VALUE (dBuV)	CORRECTION FACTOR (dB/m)
1	*5775.00	113.9 PK			1.00 V	232	109.72	4.18
2	*5775.00	102.1 AV			1.00 V	232	97.92	4.18
3	11550.00	57.2 PK	74.0	-16.8	1.11 V	49	42.08	15.12
4	11550.00	44.7 AV	54.0	-9.3	1.11 V	49	29.58	15.12
5	#17325.00	56.3 PK	74.0	-17.7	1.16 V	39	36.04	20.26
6	#17325.00	44.8 AV	54.0	-9.2	1.16 V	39	24.54	20.26

REMARKS:

1. Emission Level(dBuV/m) = Raw Value(dBuV) + Correction Factor(dB/m)
2. Correction Factor(dB/m) = Antenna Factor(dB/m) + Cable Factor(dB) – Pre-Amplifier Factor(dB)
3. The other emission levels were very low against the limit.
4. Margin value = Emission Level – Limit value
5. " * ": Fundamental frequency.
6. " # ": The radiated frequency is out of the restricted band.

Below 1GHz Data:

802.11ac (VHT20)

CHANNEL	TX Channel 157	DETECTOR FUNCTION	Quasi-Peak (QP)
FREQUENCY RANGE	Below 1GHz		

ANTENNA POLARITY & TEST DISTANCE: HORIZONTAL AT 3 M

NO.	FREQ. (MHz)	EMISSION LEVEL (dBuV/m)	LIMIT (dBuV/m)	MARGIN (dB)	ANTENNA HEIGHT (m)	TABLE ANGLE (Degree)	RAW VALUE (dBuV)	CORRECTION FACTOR (dB/m)
1	47.22	30.7 QP	40.0	-9.4	2.00 H	64	29.65	1.00
2	234.38	39.7 QP	46.0	-6.3	1.50 H	106	40.62	-0.94
3	280.25	37.5 QP	46.0	-8.5	1.00 H	282	36.19	1.34
4	400.09	38.7 QP	46.0	-7.3	1.00 H	221	34.68	4.06
5	533.29	36.2 QP	46.0	-9.8	1.00 H	19	29.20	6.97
6	879.87	37.1 QP	46.0	-8.9	1.00 H	202	24.29	12.83

ANTENNA POLARITY & TEST DISTANCE: VERTICAL AT 3 M

NO.	FREQ. (MHz)	EMISSION LEVEL (dBuV/m)	LIMIT (dBuV/m)	MARGIN (dB)	ANTENNA HEIGHT (m)	TABLE ANGLE (Degree)	RAW VALUE (dBuV)	CORRECTION FACTOR (dB/m)
1	55.51	33.9 QP	40.0	-6.1	1.00 V	83	33.07	0.80
2	88.89	34.1 QP	43.5	-9.4	1.00 V	247	39.04	-4.91
3	257.19	31.3 QP	46.0	-14.7	1.00 V	334	31.15	0.14
4	400.13	34.1 QP	46.0	-11.9	1.50 V	18	30.06	4.06
5	640.09	36.2 QP	46.0	-9.8	1.50 V	354	26.78	9.38
6	856.34	36.7 QP	46.0	-9.3	1.91 V	243	24.20	12.47

REMARKS:

1. Emission Level(dBuV/m) = Raw Value(dBuV) + Correction Factor(dB/m)
2. Correction Factor(dB/m) = Antenna Factor(dB/m) + Cable Factor(dB) – Pre-Amplifier Factor(dB)
3. The other emission levels were very low against the limit.
4. Margin value = Emission Level – Limit value

4.2 Transmit Power Measurement

4.2.1 Limits of Transmit Power Measurement

Operation Band	EUT Category		Limit
U-NII-1		Outdoor Access Point	1 Watt (30 dBm) (Max. e.i.r.p \leq 125mW(21 dBm) at any elevation angle above 30 degrees as measured from the horizon)
		Fixed point-to-point Access Point	1 Watt (30 dBm)
		Indoor Access Point	1 Watt (30 dBm)
		Mobile and Portable client device	250mW (24 dBm)
U-NII-2A			250mW (24 dBm) or 11 dBm+10 log B*
U-NII-2C			250mW (24 dBm) or 11 dBm+10 log B*
U-NII-3	√		1 Watt (30 dBm)

*B is the 26 dB emission bandwidth in megahertz

Per KDB 662911 Method of conducted output power measurement on IEEE 802.11 devices,

Array Gain = 0 dB (i.e., no array gain) for $N_{ANT} \leq 4$;

Array Gain = 0 dB (i.e., no array gain) for channel widths ≥ 40 MHz for any N_{ANT} ;

Array Gain = $5 \log(N_{ANT}/N_{SS})$ dB or 3 dB, whichever is less for 20-MHz channel widths with $N_{ANT} \geq 5$.

For power measurements on all other devices: Array Gain = $10 \log(N_{ANT}/N_{SS})$ dB.

4.2.2 Test Setup

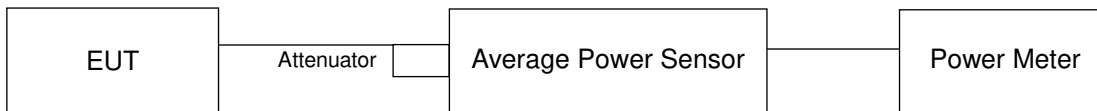

4.2.3 Test Instruments

Refer to section 4.1.2 to get information of above instrument.

4.2.4 Test Procedure

Method PM is used to perform output power measurement, trigger and gating function of wide band power meter is enabled to measure max output power of TX on burst. Duty factor is not added to measured value.

4.2.5 Deviation from Test Standard

No deviation.

4.2.6 EUT Operating Condition

The software provided by client to enable the EUT under transmission condition continuously at lowest, middle and highest channel frequencies individually.

4.2.7 Test Result

802.11a

Chan.	Chan. Freq. (MHz)	Average Power (mW)	Average Power (dBm)	Limit (dBm)	Pass / Fail
149	5745	343.558	25.36	30	Pass
157	5785	356.451	25.52	30	Pass
165	5825	349.14	25.43	30	Pass

802.11n (VHT20)

Chan.	Chan. Freq. (MHz)	Average Power (dBm)			Total Power (mW)	Total Power (dBm)	Limit (dBm)	Pass / Fail
		Chain 0	Chain 1	Chain 2				
149	5745	24.89	25.32	24.50	930.565	29.69	30	Pass
157	5785	24.92	25.46	24.66	954.431	29.80	30	Pass
165	5825	24.68	25.21	24.48	906.202	29.57	30	Pass

802.11n (VHT40)

Chan.	Chan. Freq. (MHz)	Average Power (dBm)			Total Power (mW)	Total Power (dBm)	Limit (dBm)	Pass / Fail
		Chain 0	Chain 1	Chain 2				
151	5755	24.74	25.39	24.56	929.55	29.68	30	Pass
159	5795	24.91	25.41	24.71	953.079	29.79	30	Pass

802.11ac (VHT80)

Chan.	Chan. Freq. (MHz)	Average Power (dBm)			Total Power (mW)	Total Power (dBm)	Limit (dBm)	Pass / Fail
		Chain 0	Chain 1	Chain 2				
155	5775	23.86	24.26	23.79	749.238	28.75	30	Pass

4.3 Occupied Bandwidth Measurement

4.3.1 Test Setup

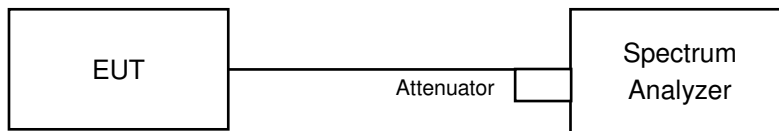

4.3.2 Test Instruments

Refer to section 4.1.2 to get information of above instrument.

4.3.3 Test Procedure

The transmitter output was connected to the spectrum analyzer through an attenuator. The bandwidth of the fundamental frequency was measured by spectrum analyzer with resolution bandwidth in the range of 1% to 5% of the anticipated emission bandwidth, and a video bandwidth at least 3x the resolution bandwidth and set the detector to SAMPLE. The width of a frequency band such that, below the lower and above the upper frequency limits, the mean powers emitted are each equal to a specified percentage 0.5 %of the total mean power of a given emission.

802.11a

Channel	Channel Frequency (MHz)	Occupied Bandwidth (MHz)
149	5745	17.40
157	5785	18.24
165	5825	17.76

802.11n (VHT20)

Channel	Channel Frequency (MHz)	Occupied Bandwidth (MHz)		
		Chain 0	Chain 1	Chain 2
149	5745	18.36	22.08	19.32
157	5785	18.60	23.16	18.72
165	5825	18.96	23.64	19.20

802.11n (VHT40)

Channel	Channel Frequency (MHz)	Occupied Bandwidth (MHz)		
		Chain 0	Chain 1	Chain 2
151	5755	38.20	44.20	38.00
159	5795	41.20	44.00	38.00

802.11n (VHT80)

Channel	Channel Frequency (MHz)	Occupied Bandwidth (MHz)		
		Chain 0	Chain 1	Chain 2
155	5775	76.08	76.56	76.32

Spectrum Plot of Worst Value

802.11a / CH157

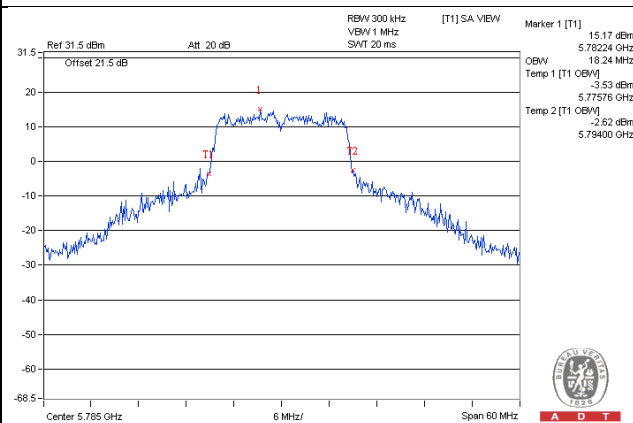

802.11n (VHT20)_Chain 1 / CH165

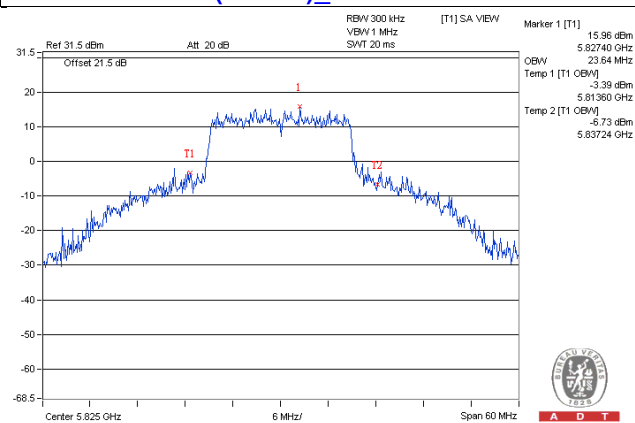

802.11n (VHT40)_Chain 1 / CH151

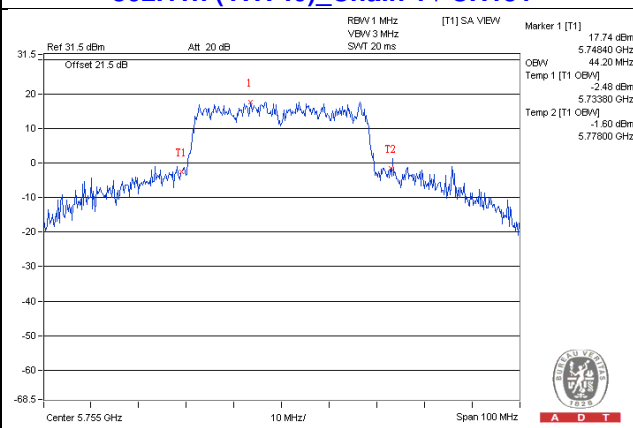

802.11n (VHT80)_Chain 1 / CH155

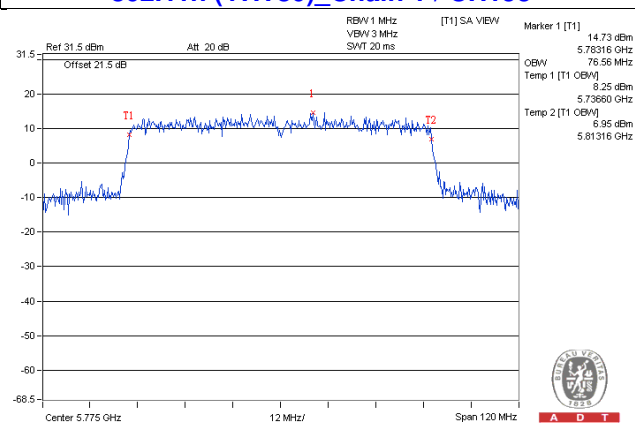

4.4 Peak Power Spectral Density Measurement

4.4.1 Limits of Peak Power Spectral Density Measurement

Operation Band	EUT Category		Limit
U-NII-1		Outdoor Access Point	17dBm/ MHz
		Fixed point-to-point Access Point	
		Indoor Access Point	
		Mobile and Portable client device	11dBm/ MHz
U-NII-2A			11dBm/ MHz
U-NII-2C			11dBm/ MHz
U-NII-3		√	30dBm/ 500kHz

4.4.2 Test Setup

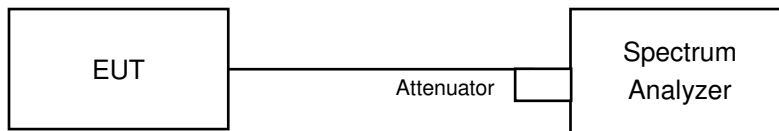

4.4.3 Test Instruments

Refer to section 4.1.2 to get information of above instrument.

4.4.4 Test Procedure

For 802.11a / 802.11ac (VHT20) / 802.11ac (VHT40)

1. Set span to encompass the entire emission bandwidth (EBW) of the signal.
2. Set RBW = 300 kHz, Set VBW ≥ 1 MHz, Detector = RMS
3. Use the peak marker function to determine the maximum power level in any 300 kHz band segment within the fundamental EBW.
4. Scale the observed power level to an equivalent value in 500 kHz by adjusting (reducing) the measured power by a bandwidth correction factor (BWCF) where $BWCF = 10\log(500\text{ kHz}/300\text{kHz})$
5. Sweep time = auto, trigger set to "free run".
6. Trace average at least 100 traces in power averaging mode.
7. Record the max value

For 802.11ac (VHT80)

1. Set span to encompass the entire emission bandwidth (EBW) of the signal.
2. Set RBW = 300 kHz, Set VBW ≥ 1 MHz, Detector = RMS
3. Use the peak marker function to determine the maximum power level in any 300 kHz band segment within the fundamental EBW.
4. Scale the observed power level to an equivalent value in 500 kHz by adjusting (reducing) the measured power by a bandwidth correction factor (BWCF) where $BWCF = 10\log(500\text{ kHz}/300\text{kHz})$
5. Sweep time = auto, trigger set to "free run".
6. Trace average at least 100 traces in power averaging mode.
7. Record the max value and add $10\log(1/\text{duty cycle})$

4.4.5 Deviation from Test Standard

No deviation.

4.4.6 EUT Operating Condition

Same as Item 4.3.6.

4.4.7 Test Results

802.11a

Chan.	Chan. Freq. (MHz)	PSD (dBm/300kHz)	PSD (dBm/500kHz)	Limit (dBm/500kHz)	Pass /Fail
149	5745	3.62	5.84	30	Pass
157	5785	3.28	5.50	30	Pass
165	5825	3.47	5.69	30	Pass

802.11n (VHT20)

TX chain	Chan.	Chan. Freq. (MHz)	PSD		10 log (N=3) dB	Total PSD (dBm/500kHz)	Limit (dBm/500kHz)	Pass /Fail
			(dBm/300kHz)	(dBm/500kHz)				
0	149	5745	3.32	5.54	4.77	10.31	28.48	Pass
	157	5785	3.34	5.56	4.77	10.33	28.48	Pass
	165	5825	2.97	5.19	4.77	9.96	28.48	Pass
1	149	5745	4.20	6.42	4.77	11.19	28.48	Pass
	157	5785	3.62	5.84	4.77	10.61	28.48	Pass
	165	5825	3.26	5.48	4.77	10.25	28.48	Pass
2	149	5745	2.91	5.13	4.77	9.90	28.48	Pass
	157	5785	2.70	4.92	4.77	9.69	28.48	Pass
	165	5825	2.82	5.04	4.77	9.81	28.48	Pass

Note: 1. Directional gain = $10 \log[(10^{G1/20} + 10^{G2/20})^2 / 2] = 7.52\text{dBi} > 6\text{dBi}$, therefore the limit needs to reduce, so the power density limit shall be reduced to $30 - (7.52 - 6) = 28.48\text{dBm}$.

802.11n (VHT40)

TX chain	Chan.	Chan. Freq. (MHz)	PSD		10 log (N=3) dB	Total PSD (dBm/500kHz)	Limit (dBm/500kHz)	Pass /Fail
			(dBm/300kHz)	(dBm/500kHz)				
0	151	5755	0.25	2.47	4.77	7.24	28.48	Pass
	159	5795	0.00	2.22	4.77	6.99	28.48	Pass
1	151	5755	0.55	2.77	4.77	7.54	28.48	Pass
	159	5795	-0.06	2.16	4.77	6.93	28.48	Pass
2	151	5755	-0.57	1.65	4.77	6.42	28.48	Pass
	159	5795	-0.19	2.03	4.77	6.80	28.48	Pass

Note: 1. Directional gain = $10 \log[(10^{G1/20} + 10^{G2/20})^2 / 2] = 7.52\text{dBi} > 6\text{dBi}$, therefore the limit needs to reduce, so the power density limit shall be reduced to $30 - (7.52 - 6) = 28.48\text{dBm}$.

802.11ac (VHT80)

TX chain	Channel	Freq. (MHz)	PSD (dBm/300kHz)	PSD (dBm/500kHz)	10 log (N=3) dB	Duty Factor (dB)	Total PSD (dBm/500kHz)	Limit (dBm/500kHz)	Pass /Fail
0	155	5775	-4.11	-1.89	4.77	0.21	3.09	28.48	Pass
1	155	5775	-3.03	-0.81	4.77	0.21	4.17	28.48	Pass
2	155	5775	-4.11	-1.89	4.77	0.21	3.09	28.48	Pass

Note: 1. Directional gain = $10 \log[(10^{G1/20} + 10^{G2/20})^2 / 2] = 7.52\text{dBi} > 6\text{dBi}$, therefore the limit needs to reduce, so the power density limit shall be reduced to $30 - (7.52 - 6) = 28.48\text{dBm}$.

2. Refer to section 3.3 for duty cycle spectrum plot.

Spectrum Plot of Worst Value

802.11a / CH149

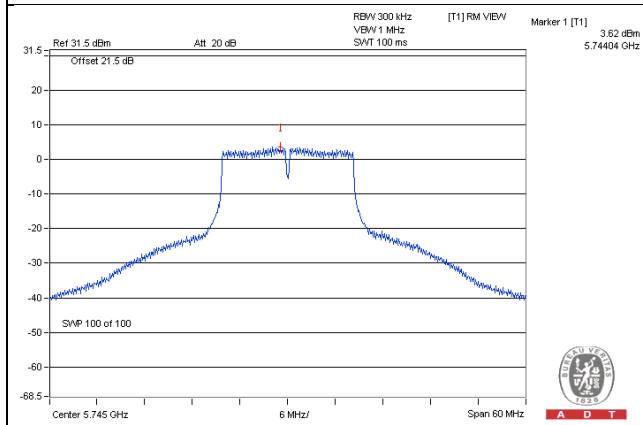

802.11n (VHT20)_Chain 1 / CH149

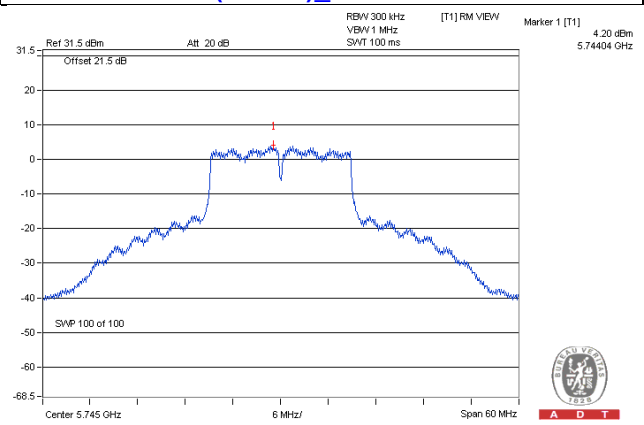

802.11n (VHT40)_Chain 1 / CH151

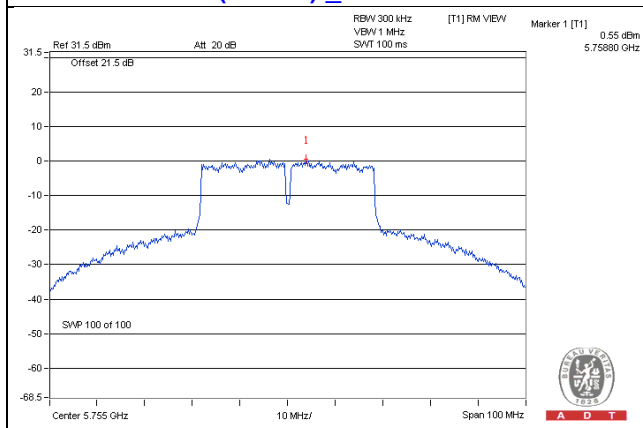

802.11ac (VHT80)_Chain 1 / CH155

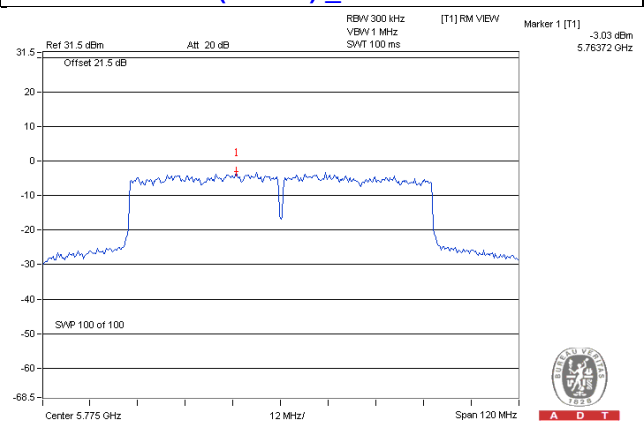

4.5 Frequency Stability Measurement

4.5.1 Limits of Frequency Stability Measurement

The frequency of the carrier signal shall be maintained within band of operation

4.5.2 Test Setup

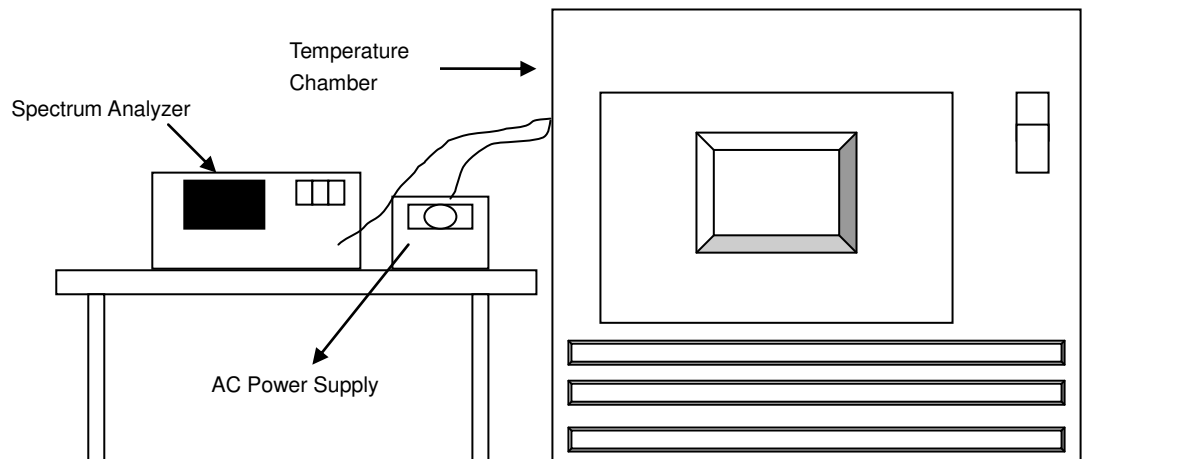

4.5.3 Test Instruments

Refer to section 4.1.2 to get information of above instrument.

4.5.4 Test Procedure

- The EUT was placed inside the environmental test chamber and powered by nominal AC voltage.
- Turn the EUT on and couple its output to a spectrum analyzer.
- Turn the EUT off and set the chamber to the highest temperature specified.
- Allow sufficient time (approximately 30 min) for the temperature of the chamber to stabilize, turn the EUT on and measure the operating frequency after 2, 5, and 10 Minutes.
- Repeat step 2 and 3 with the temperature chamber set to the lowest temperature.
- The test chamber was allowed to stabilize at +20 degree C for a minimum of 30 Minutes. The supply voltage was then adjusted on the EUT from 85% to 115% and the frequency record.

4.5.5 Deviation from Test Standard

No deviation.

4.5.6 EUT Operating Condition

Set the EUT transmit at un-modulation mode to test frequency stability.

4.5.7 Test Results

Frequency Stability Versus Temp.									
Operating Frequency: 5745 MHz									
TEMP. (°C)	Power Supply (Vac)	0 Minute		2 Minute		5 Minute		10 Minute	
		Measured Frequency (MHz)	Pass/Fail	Measured Frequency (MHz)	Pass/Fail	Measured Frequency (MHz)	Pass/Fail	Measured Frequency (MHz)	Pass/Fail
50	120	5744.9936	Pass	5744.9908	Pass	5744.991	Pass	5744.99	Pass
40	120	5744.9734	Pass	5744.9723	Pass	5744.9759	Pass	5744.9753	Pass
30	120	5745.0072	Pass	5745.0057	Pass	5745.0047	Pass	5745.0083	Pass
20	120	5745.0226	Pass	5745.0236	Pass	5745.0217	Pass	5745.0207	Pass
10	120	5744.9736	Pass	5744.9749	Pass	5744.9718	Pass	5744.9711	Pass
0	120	5745.0104	Pass	5745.0111	Pass	5745.0115	Pass	5745.0081	Pass
-10	120	5744.9866	Pass	5744.9901	Pass	5744.9879	Pass	5744.9879	Pass
-20	120	5744.9926	Pass	5744.99	Pass	5744.9915	Pass	5744.9918	Pass
-30	120	5745.0164	Pass	5745.0165	Pass	5745.0168	Pass	5745.0178	Pass

Frequency Stability Versus Voltage									
Operating Frequency: 5745 MHz									
TEMP. (°C)	Power Supply (Vac)	0 Minute		2 Minute		5 Minute		10 Minute	
		Measured Frequency (MHz)	Pass/Fail	Measured Frequency (MHz)	Pass/Fail	Measured Frequency (MHz)	Pass/Fail	Measured Frequency (MHz)	Pass/Fail
20	138	5745.0234	Pass	5745.0247	Pass	5745.0216	Pass	5745.0214	Pass
	120	5745.0226	Pass	5745.0236	Pass	5745.0217	Pass	5745.0207	Pass
	102	5745.0237	Pass	5745.023	Pass	5745.0208	Pass	5745.0209	Pass

4.6 6dB Bandwidth Measurement

4.6.1 Limits of 6dB Bandwidth Measurement

The minimum of 6dB Bandwidth Measurement is 0.5MHz.

4.6.2 Test Setup

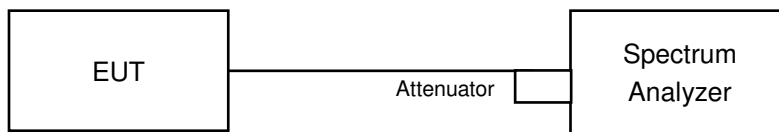

4.6.3 Test Instruments

Refer to section 4.1.2 to get information of above instrument.

4.6.4 Test Procedure

MEASUREMENT PROCEDURE REF

- a. Set resolution bandwidth (RBW) = 100kHz
- b. Set the video bandwidth (VBW) $\geq 3 \times$ RBW, Detector = Peak.
- c. Trace mode = max hold.
- d. Sweep = auto couple.
- e. Measure the maximum width of the emission that is constrained by the frequencies associated with the two amplitude points (upper and lower) that are attenuated by 6 dB relative to the maximum level measured in the fundamental emission

4.6.5 Deviation from Test Standard

No deviation.

4.6.6 EUT Operating Condition

The software provided by client to enable the EUT under transmission condition continuously at lowest, middle and highest channel frequencies individually.

4.6.7 Test Results

802.11a

Channel	Frequency (MHz)	6dB Bandwidth (MHz)	Minimum Limit (MHz)	Pass / Fail
149	5745	16.40	0.5	Pass
157	5785	16.38	0.5	Pass
165	5825	16.37	0.5	Pass

802.11n (VHT20)

Channel	Frequency (MHz)	6dB Bandwidth (MHz)			Minimum Limit (MHz)	Pass / Fail
		Chain 0	Chain 1	Chain 2		
149	5745	17.22	17.64	17.63	0.5	Pass
157	5785	16.92	17.63	17.65	0.5	Pass
165	5825	16.57	17.61	17.60	0.5	Pass

802.11n (VHT40)

Channel	Frequency (MHz)	6dB Bandwidth (MHz)			Minimum Limit (MHz)	Pass / Fail
		Chain 0	Chain 1	Chain 2		
151	5755	36.43	36.13	36.45	0.5	Pass
159	5795	36.44	36.43	36.44	0.5	Pass

802.11ac (VHT80)

Channel	Frequency (MHz)	6dB Bandwidth (MHz)			Minimum Limit (MHz)	Pass / Fail
		Chain 0	Chain 1	Chain 2		
155	5775	75.64	75.49	75.57	0.5	Pass

Spectrum Plot of Worst Value

802.11a / CH165

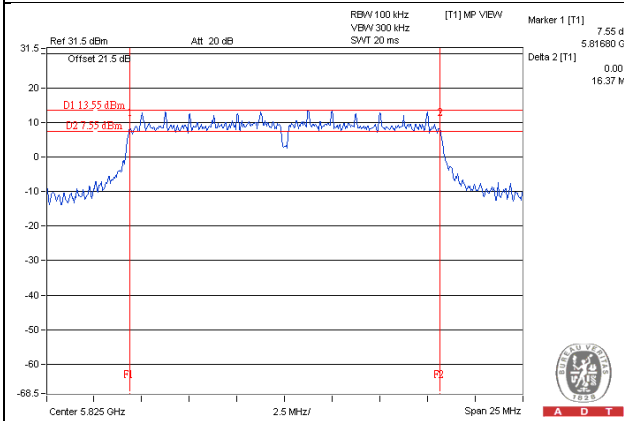

802.11n (VHT20)_Chain 0 / CH165

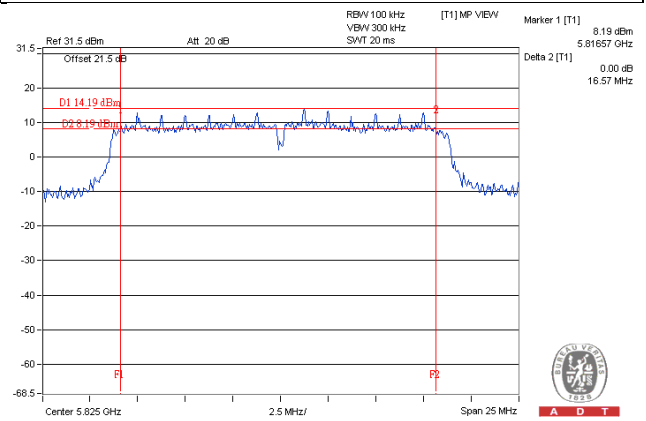

802.11n (VHT40)_Chain 1 / CH151

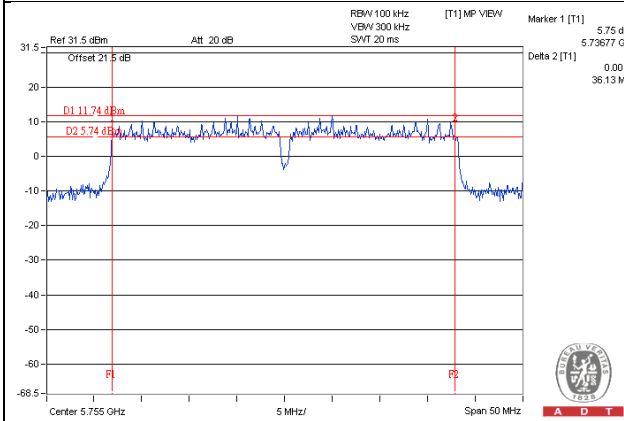

802.11ac (VHT80)_Chain 1 / CH155

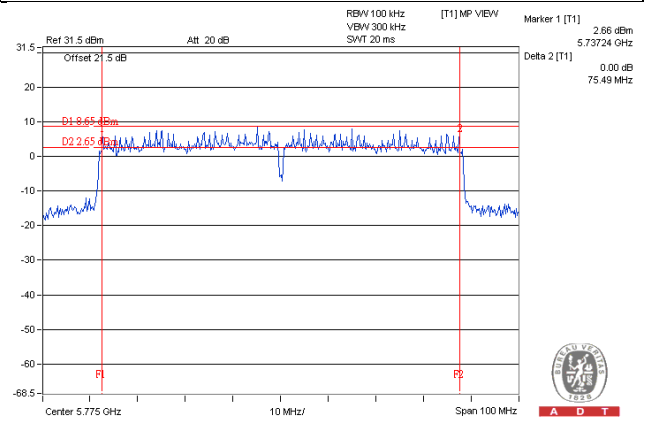

5 Pictures of Test Arrangements

Please refer to the attached file (Test Setup Photo).

Annex A- Radiated Out of Band Emission (OOBE) Measurement (For U-NII-3 band)

802.11a

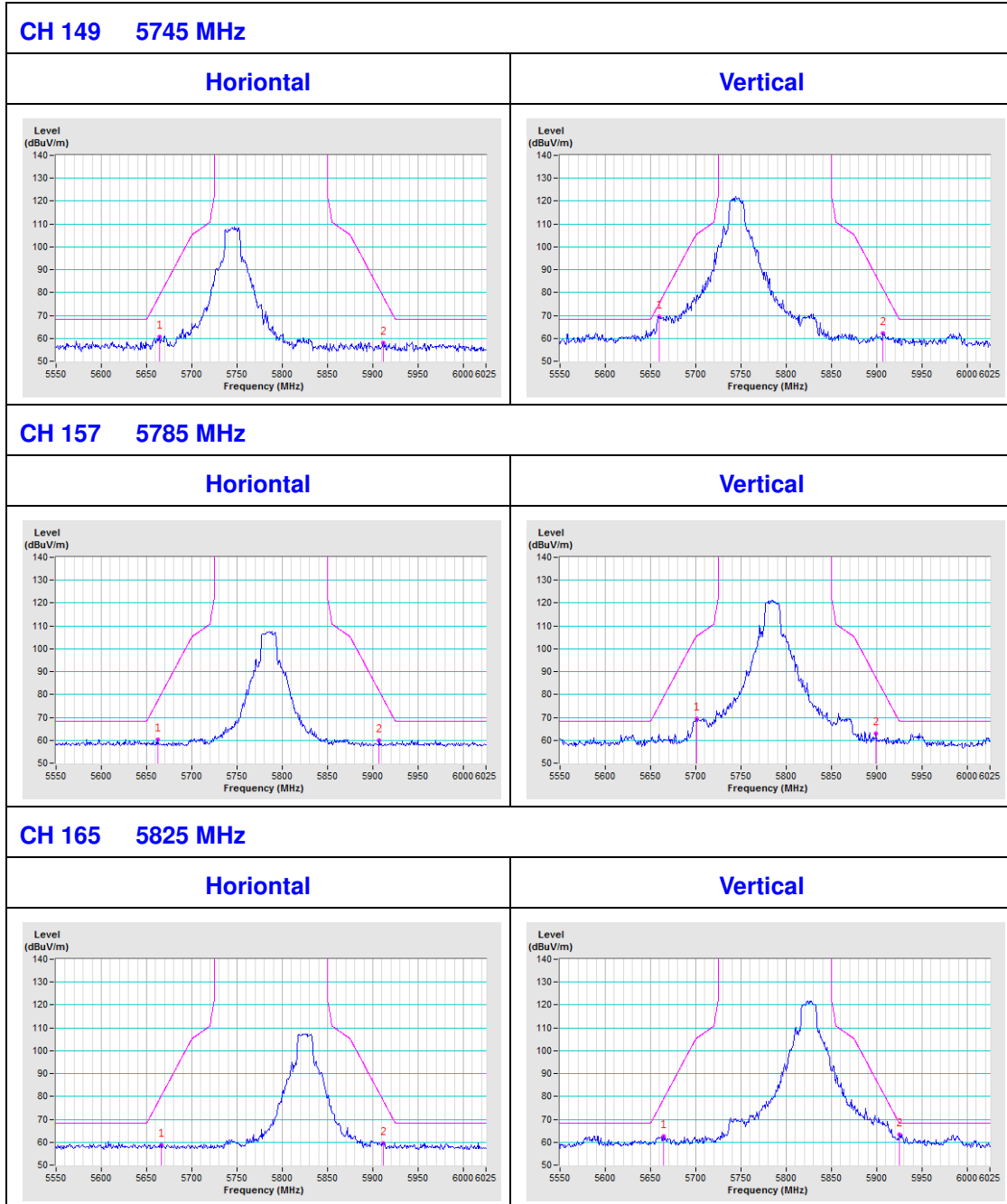

802.11ac (VHT20)

CH 149 5745 MHz

Horizontal

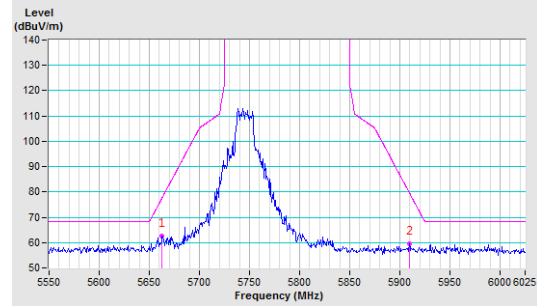

Vertical

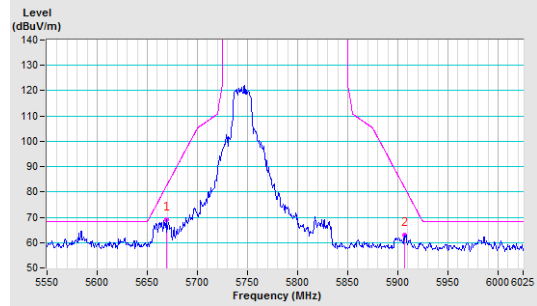

CH 157 5785 MHz

Horizontal

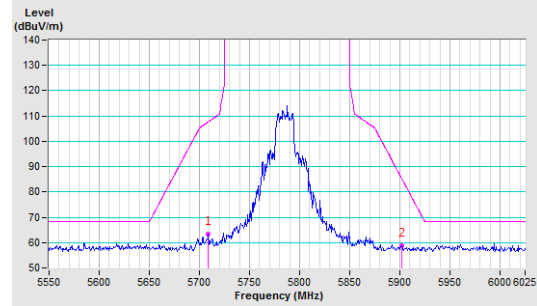

Vertical

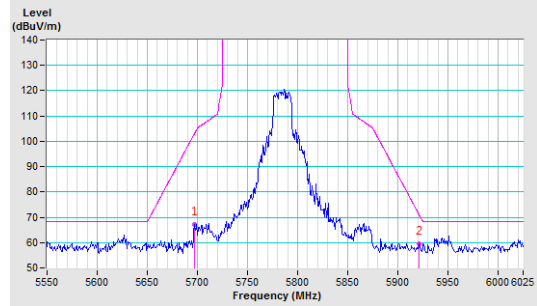

CH 165 5825 MHz

Horizontal

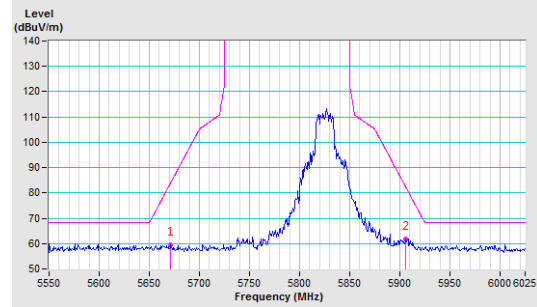

Vertical

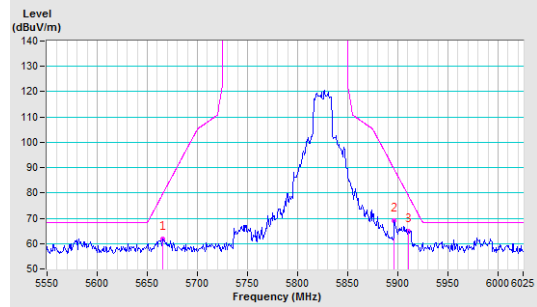

802.11ac (HT40)

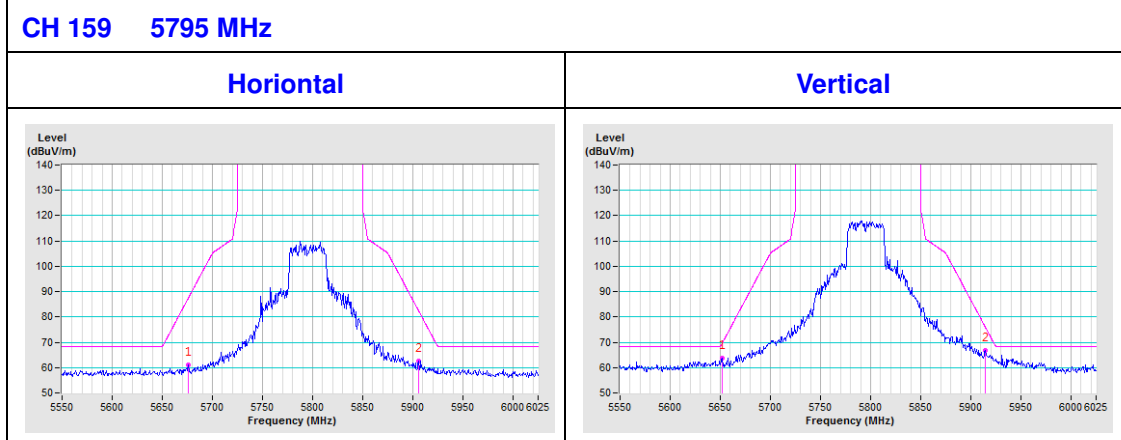
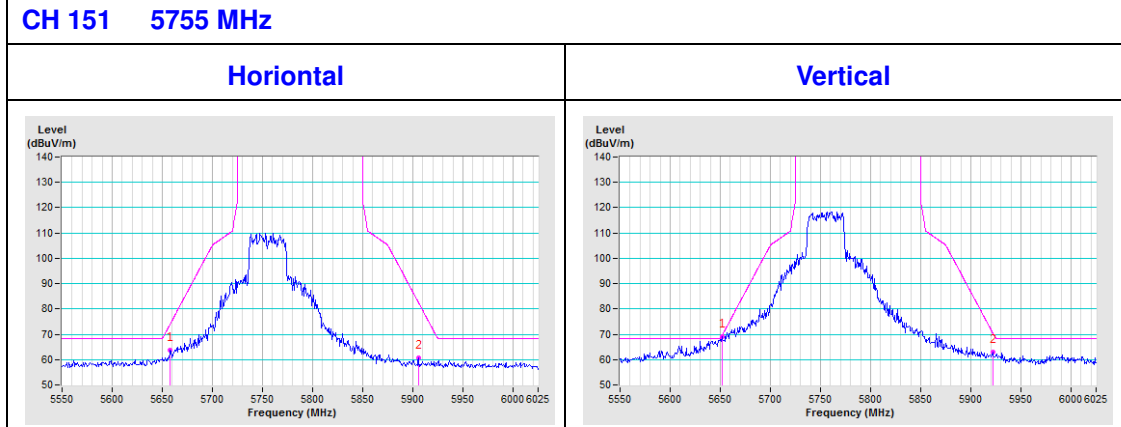

802.11ac (HT80)

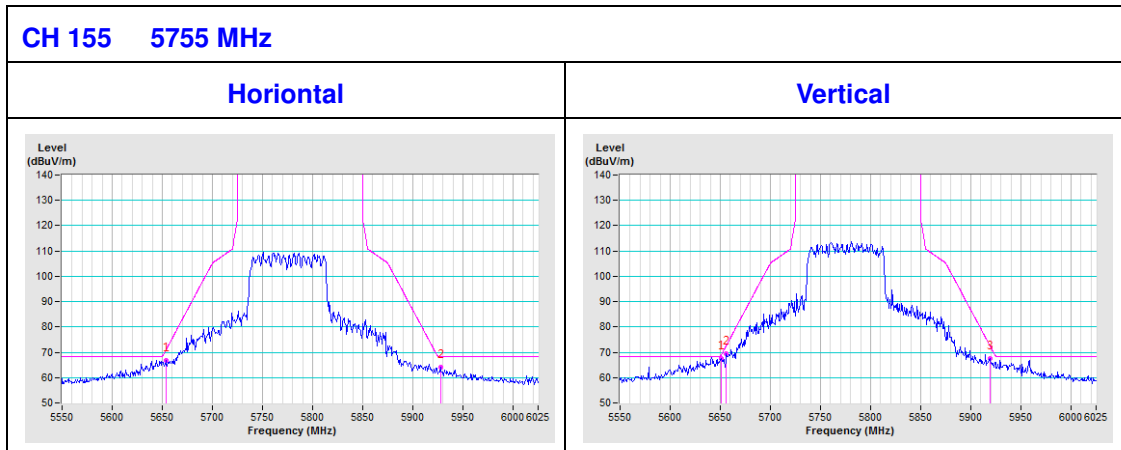

Appendix – Information on the Testing Laboratories

We, Bureau Veritas Consumer Products Services (H.K.) Ltd., Taoyuan Branch, were founded in 1988 to provide our best service in EMC, Radio, Telecom and Safety consultation. Our laboratories are accredited and approved according to ISO/IEC 17025.

If you have any comments, please feel free to contact us at the following:

Linko EMC/RF Lab

Tel: 886-2-26052180

Fax: 886-2-26051924

Hsin Chu EMC/RF/Telecom Lab

Tel: 886-3-6668565

Fax: 886-3-6668323

Hwa Ya EMC/RF/Safety Lab

Tel: 886-3-3183232

Fax: 886-3-3270892

Email: service.adt@tw.bureauveritas.com

Web Site: www.bureauveritas-adt.com

The address and road map of all our labs can be found in our web site also.

--- END ---