

## FCC Test Report

**Report No.:** RF121222E03C

**FCC ID:** Q87-EA6700

**Test Model:** EA6700

**Received Date:** Feb. 23, 2016

**Test Date:** Mar. 29 to Apr. 01, 2016

**Issued Date:** May 19, 2016

**Applicant:** Linksys LLC

**Address:** 121 Theory Drive Irvine California 92617 United State

**Issued By:** Bureau Veritas Consumer Products Services (H.K.) Ltd., Taoyuan Branch  
Hsin Chu Laboratory

**Lab Address:** E-2, No.1, Li Hsin 1st Road, Hsinchu Science Park, Hsinchu City 300,  
Taiwan R.O.C.

**Test Location (1):** E-2, No.1, Li Hsin 1st Road, Hsinchu Science Park, Hsinchu City 300,  
Taiwan R.O.C.

**Test Location (2):** No. 49, Ln. 206, Wende Rd., Shangshan Tsuen, Chiung Lin Hsiang, Hsin  
Chu Hsien 307, Taiwan R.O.C.



This report is for your exclusive use. Any copying or replication of this report to or for any other person or entity, or use of our name or trademark, is permitted only with our prior written permission. This report sets forth our findings solely with respect to the test samples identified herein. The results set forth in this report are not indicative or representative of the quality or characteristics of the lot from which a test sample was taken or any similar or identical product unless specifically and expressly noted. Our report includes all of the tests requested by you and the results thereof based upon the information that you provided to us. You have 60 days from date of issuance of this report to notify us of any material error or omission caused by our negligence, provided, however, that such notice shall be in writing and shall specifically address the issue you wish to raise. A failure to raise such issue within the prescribed time shall constitute your unqualified acceptance of the completeness of this report, the tests conducted and the correctness of the report contents. Unless specific mention, the uncertainty of measurement has been explicitly taken into account to declare the compliance or non-compliance to the specification. The report must not be used by the client to claim product certification, approval, or endorsement by TAF or any government agencies.

## Table of Contents

<b>Report Issue History Record .....</b>	<b>4</b>
<b>Release Control Record .....</b>	<b>4</b>
<b>1 Certificate of Conformity .....</b>	<b>5</b>
<b>2 Summary of Test Results .....</b>	<b>6</b>
2.1 Measurement Uncertainty .....	6
2.2 Modification Record .....	6
<b>3 General Information .....</b>	<b>7</b>
3.1 General Description of EUT .....	7
3.2 Description of Test Modes .....	11
3.2.1 Test Mode Applicability and Tested Channel Detail .....	12
3.3 Duty Cycle of Test Signal .....	14
3.4 Description of Support Units .....	15
3.4.1 Configuration of System under Test .....	16
3.5 General Description of Applied Standard .....	17
<b>4 Test Types and Results .....</b>	<b>18</b>
4.1 Radiated Emission and Bandedge Measurement .....	18
4.1.1 Limits of Radiated Emission and Bandedge Measurement .....	18
4.1.2 Test Instruments .....	19
4.1.3 Test Procedure .....	20
4.1.4 Deviation from Test Standard .....	20
4.1.5 Test Setup .....	21
4.1.6 EUT Operating Condition .....	21
4.1.7 Test Results .....	22
4.2 Conducted Emission Measurement .....	41
4.2.1 Limits of Conducted Emission Measurement .....	41
4.2.2 Test Instruments .....	41
4.2.3 Test Procedure .....	42
4.2.4 Deviation from Test Standard .....	42
4.2.5 Test Setup .....	42
4.2.6 EUT Operating Condition .....	42
4.2.7 Test Results .....	43
4.3 Transmit Power Measurement .....	45
4.3.1 Limits of Transmit Power Measurement .....	45
4.3.2 Test Setup .....	46
4.3.3 Test Instruments .....	46
4.3.4 Test Procedure .....	46
4.3.5 Deviation from Test Standard .....	46
4.3.6 EUT Operating Condition .....	46
4.3.7 Test Result .....	47
4.4 Peak Power Spectral Density Measurement .....	48
4.4.1 Limits of Peak Power Spectral Density Measurement .....	48
4.4.2 Test Setup .....	48
4.4.3 Test Instruments .....	48
4.4.4 Test Procedure .....	49
4.4.5 Deviation from Test Standard .....	49
4.4.6 EUT Operating Condition .....	49
4.4.7 Test Results .....	50
4.5 Frequency Stability Measurement .....	56
4.5.1 Limits of Frequency Stability Measurement .....	56
4.5.2 Test Setup .....	56
4.5.3 Test Instruments .....	56
4.5.4 Test Procedure .....	56



4.5.5	Deviation from Test Standard .....	56
4.5.6	EUT Operating Condition .....	56
4.5.7	Test Results .....	57
4.6	6dB Bandwidth Measurement .....	58
4.6.1	Limits of 6dB Bandwidth Measurement .....	58
4.6.2	Test Setup .....	58
4.6.3	Test Instruments .....	58
4.6.4	Test Procedure .....	58
4.6.5	Deviation from Test Standard .....	58
4.6.6	EUT Operating Condition .....	58
4.6.7	Test Results .....	59
<b>5</b>	<b>Pictures of Test Arrangements .....</b>	<b>61</b>
	<b>Appendix – Information on the Testing Laboratories .....</b>	<b>62</b>



### Report Issue History Record

Issue No.	Reason for Change	Date Issued
RF121222E03 RF121222E03-1	Original	Mar. 07, 2013
RF121222E03C	Upgraded the standard to section 15.407 under new rule for U-NII-1 and U-NII-3 band.	May 19, 2016

### Release Control Record

Issue No.	Description	Date Issued
RF121222E03C	Original release.	May 19, 2016

## 1 Certificate of Conformity

**Product:** Linksys Smart Wi-Fi Router AC1750

**Brand:** Linksys

**Test Model:** EA6700

**Sample Status:** ENGINEERING SAMPLE

**Applicant:** Linksys LLC

**Test Date:** Mar. 29 to Apr. 01, 2016

**Standard:** 47 CFR FCC Part 15, Subpart E (Section 15.407)  
ANSI C63.10: 2013

The above equipment has been tested by **Bureau Veritas Consumer Products Services (H.K.) Ltd., Taoyuan Branch**, and found compliance with the requirement of the above standards. The test record, data evaluation & Equipment Under Test (EUT) configurations represented herein are true and accurate accounts of the measurements of the sample's EMC characteristics under the conditions specified in this report.

**Prepared by :** Wendy Wu. , **Date:** May 19, 2016  
Wendy Wu / Specialist

**Approved by :** May Chen , **Date:** May 19, 2016  
May Chen / Manager

## 2 Summary of Test Results

47 CFR FCC Part 15, Subpart E (SECTION 15.407)			
FCC Clause	Test Item	Result	Remarks
15.407(b)(6)	AC Power Conducted Emissions	PASS	Meet the requirement of limit. Minimum passing margin is -10.19dB at 0.35313MHz.
15.407(b)(1/2/3/4/6)	Radiated Emissions & Band Edge Measurement	PASS	Meet the requirement of limit. Minimum passing margin is -0.1dB at 5150.00MHz, 5704.00MHz, 5860.00MHz and 5715.00MHz.
15.407(a)(1/2/3)	Max Average Transmit Power	PASS	Meet the requirement of limit.
15.407(a)(1/2/3)	Peak Power Spectral Density	PASS	Meet the requirement of limit.
15.407(e)	6dB bandwidth	PASS	Meet the requirement of limit. (U-NII-3 Band only)
15.407(g)	Frequency Stability	PASS	Meet the requirement of limit.
15.203	Antenna Requirement	PASS	No antenna connector is used.

### 2.1 Measurement Uncertainty

Where relevant, the following measurement uncertainty levels have been estimated for tests performed on the EUT as specified in CISPR 16-4-2:

Measurement	Frequency	Expanded Uncertainty (k=2) (±)
Conducted Emissions at mains ports	150kHz ~ 30MHz	2.86 dB
Radiated Emissions up to 1 GHz	30MHz ~ 1GHz	5.31 dB
Radiated Emissions above 1 GHz	1GHz ~ 6GHz	3.40 dB
	6GHz ~ 18GHz	3.73 dB
	18GHz ~ 40GHz	4.11 dB

### 2.2 Modification Record

There were no modifications required for compliance.

### 3 General Information

#### 3.1 General Description of EUT

Product	Linksys Smart Wi-Fi Router AC1750
Brand	Linksys
Test Model	EA6700
Series Model	NA
Status of EUT	ENGINEERING SAMPLE
Driver Version	v6.37.14.62
Power Supply Rating	DC 12V from power adapter
Modulation Type	CCK, DQPSK, DBPSK for DSSS 64QAM, 16QAM, QPSK, BPSK for OFDM 256QAM for OFDM in 11ac mode only
Modulation Technology	DSSS, OFDM
Transfer Rate	802.11b: up to 11Mbps 802.11a/g: up to 54Mbps 802.11n: up to 450Mbps 802.11ac: up to 1300Mbps
Operating Frequency	<b>For 15.407:</b> 5.18GHz ~ 5.24GHz, 5.745GHz ~ 5.825GHz
	<b>For 15.247:</b> 2.412 ~ 2.462GHz
Number of Channel	<b>For 15.407:</b> 802.11a, 802.11n (HT20), 802.11ac (VHT20): 9 802.11n (HT40), 802.11ac (VHT40): 4 802.11ac (VHT80): 2
	<b>For 15.247:</b> 802.11b, 802.11g, 802.11n (HT20): 11 802.11n (HT40): 7
Output Power	<b>For 15.407:</b> 817.427mW
	<b>For 15.247:</b> 255.092mW
Antenna Type	Refer to Note
Antenna Connector	Refer to Note
Accessory Device	Adapter x 1
Data Cable Supplied	NA

**Note:**

1. This is a supplementary report of Report No.: RF121222E03 and RF121222E03-1. The differences between them are as below information:

- ◆ Upgraded the standard to section 15.407 under new rule for U-NII-1 and U-NII-3 band.

- ◆ Added one new adapter as the following table:

Item	Brand	Model	Spec.
1	LEI	MU42-3120350-A1	AC Input : 100-240V, 1.5A, 50/60Hz DC Output : 12V, 3.5A DC cable(unshielded, 1.5m)

2. According to above conditions, all test items of U-NII-1 and U-NII-3 band need to be performed. And all data was verified to meet the requirements.

3. The EUT is a 2.4GHz & 5GHz WLAN device.

4. The EUT has a RJ45 XFRM Transformer types as following table:

Type 1(Vendor: MINGTEK)			
Vendor P/N	Different	Vendor	Location
HN1874CG	TRANSFORMER VARIABLE COILS,DIP,350UH,HN1874CG	MINGTEK	T1
HN3674CG	TRANSFORMER VARIABLE COILS,DIP,350UH,HN3674CG	MINGTEK	T2, T3



5. The antennas provided to the EUT, please refer to the following table:

<b>For 2.4GHz</b>						
Transmitter Circuit	Brand	Model	Antenna Type	Peak Gain(dBi) (Include cable loss )	Frequency range (MHz to MHz)	Connector Type
Left side Chain (1)	Galtronics	02100073-05389A1	Dipole	2.48	2400~2483.5	NA
Right side Chain (0)	Galtronics	02100073-05389A2	Dipole	3.15	2400~2483.5	NA
Front side Chain (2)	Galtronics	02100073-05389B1	Dipole	1.65	2400~2483.5	NA
<b>For 5GHz (Band 1)</b>						
Transmitter Circuit	Brand	Model	Antenna Type	Peak Gain(dBi) (Include cable loss )	Frequency range (MHz to MHz)	Connector Type
Left side Chain (1)	Galtronics	02102142-05389A2	Dipole	3.55	5150~5250	NA
Right side Chain (0)	Galtronics	02102142-05389A3	Dipole	4.29	5150~5250	NA
Front side Chain (2)	Galtronics	02102142-05389B1	Dipole	3.86	5150~5250	NA
<b>For 5GHz (Band 4)</b>						
Transmitter Circuit	Brand	Model	Antenna Type	Peak Gain(dBi) (Include cable loss )	Frequency range (MHz to MHz)	Connector Type
Left side Chain (1)	Galtronics	02102142-05389A2	Dipole	4.23	5725~5850	NA
Right side Chain (0)	Galtronics	02102142-05389A3	Dipole	4.79	5725~5850	NA
Front side Chain (2)	Galtronics	02102142-05389B1	Dipole	3.68	5725~5850	NA

Note: According to the above antennas, there are three antennas will transmit simultaneously (one is Vertical and the others are Horizontal).

6. The EUT incorporates a MIMO function.

<b>MODULATION MODE</b>	<b>TX/RX FUNCTION</b>
<b>802.11b</b>	1Tx/3Rx
<b>802.11g</b>	1Tx (Diversity)/3Rx
<b>802.11n (HT20)&lt;2.4GHz&gt;</b>	3Tx/3Rx
<b>802.11n (HT40) &lt;2.4GHz&gt;</b>	3Tx/3Rx
<b>802.11a</b>	1Tx (Diversity)/3Rx
<b>802.11n (HT20) &lt;5GHz&gt;</b>	3Tx/3Rx
<b>802.11n (HT40) &lt;5GHz&gt;</b>	3Tx/3Rx
<b>802.11ac (VHT20)</b>	3Tx/3Rx
<b>802.11ac (VHT40)</b>	3Tx/3Rx
<b>802.11ac (VHT80)</b>	3Tx/3Rx

Note: The modulation and bandwidth are similar for 802.11n mode for 20MHz (40MHz) and 802.11ac mode for 20MHz (40MHz), therefore investigated worst case to representative mode in test report. (Final test mode refer section 3.2.1)

7. Conducted emission and radiated emission of the simultaneous operation (2.4GHz & 5GHz) has been evaluated and no non-compliance was found.
8. When the EUT operating in 802.11n, the software operation, which is defined by manufacturer, MCS (Modulation and Coding Schemes) from 0 to 23.
9. When the EUT operating in 802.11ac, the software operation, which is defined by manufacturer, MCS (Modulation and Coding Schemes) from 0 to 9.
10. The above EUT information is declared by manufacturer and for more detailed features description, please refer to the manufacturer's specifications or user's manual.

### 3.2 Description of Test Modes

#### FOR 5180 ~ 5240MHz

4 channels are provided for 802.11a, 802.11n (HT20), 802.11ac (VHT20):

Channel	Frequency	Channel	Frequency
36	5180 MHz	44	5220 MHz
40	5200 MHz	48	5240 MHz

2 channels are provided for 802.11n (HT40), 802.11ac (VHT40):

Channel	Frequency	Channel	Frequency
38	5190 MHz	46	5230 MHz

1 channel is provided for 802.11ac (VHT80):

Channel	Frequency
42	5210MHz

#### FOR 5745 ~ 5825MHz:

5 channels are provided for 802.11a, 802.11n (HT20), 802.11ac (VHT20):

Channel	Frequency	Channel	Frequency
149	5745MHz	161	5805MHz
153	5765MHz	165	5825MHz
157	5785MHz		

2 channels are provided for 802.11n (HT40), 802.11ac (VHT40):

Channel	Frequency	Channel	Frequency
151	5755MHz	159	5795MHz

1 channel is provided for 802.11ac (VHT80):

Channel	Frequency
155	5775MHz

### 3.2.1 Test Mode Applicability and Tested Channel Detail

EUT CONFIGURE MODE	APPLICABLE TO				DESCRIPTION
	RE $\geq$ 1G	RE $<$ 1G	PLC	APCM	
-	√	√	√	√	-

Where **RE $\geq$ 1G**: Radiated Emission above 1GHz      **RE $<$ 1G**: Radiated Emission below 1GHz  
**PLC**: Power Line Conducted Emission      **APCM**: Antenna Port Conducted Measurement

**NOTE:**

1. The EUT had been pre-tested on the positioned of each 2 axis. The worst case was found when positioned on **X-plane**.

#### **Radiated Emission Test (Above 1GHz):**

- Pre-Scan has been conducted to determine the worst-case mode from all possible combinations between available modulations, data rates and antenna ports (if EUT with antenna diversity architecture).
- Following channel(s) was (were) selected for the final test as listed below.

MODE	FREQ. BAND (MHz)	AVAILABLE CHANNEL	TESTED CHANNEL	MODULATION TECHNOLOGY	MODULATION TYPE	DATA RATE (Mbps)
802.11a	5180-5240	36 to 48	36, 40, 48	OFDM	BPSK	6
802.11ac (VHT20)		36 to 48	36, 40, 48	OFDM	BPSK	6.5
802.11ac (VHT40)		38 to 46	38, 46	OFDM	BPSK	13.5
802.11ac (VHT80)		42	42	OFDM	BPSK	87.8
802.11a	5745-5825	149 to 165	149, 157, 165	OFDM	BPSK	6
802.11ac (VHT20)		149 to 165	149, 157, 165	OFDM	BPSK	6.5
802.11ac (VHT40)		151 to 159	151, 159	OFDM	BPSK	13.5
802.11ac (VHT80)		155	155	OFDM	BPSK	87.8

#### **Radiated Emission Test (Below 1GHz):**

- Pre-Scan has been conducted to determine the worst-case mode from all possible combinations between available modulations, data rates and antenna ports (if EUT with antenna diversity architecture).
- Following channel(s) was (were) selected for the final test as listed below.

MODE	FREQ. BAND (MHz)	AVAILABLE CHANNEL	TESTED CHANNEL	MODULATION TECHNOLOGY	MODULATION TYPE	DATA RATE (Mbps)
802.11ac (VHT20)	5745-5825	149 to 165	157	OFDM	BPSK	6.5

**Power Line Conducted Emission Test:**

- Pre-Scan has been conducted to determine the worst-case mode from all possible combinations between available modulations, data rates and antenna ports (if EUT with antenna diversity architecture).
- Following channel(s) was (were) selected for the final test as listed below.

MODE	FREQ. BAND (MHz)	AVAILABLE CHANNEL	TESTED CHANNEL	MODULATION TECHNOLOGY	MODULATION TYPE	DATA RATE (Mbps)
802.11ac (VHT20)	5745-5825	149 to 165	157	OFDM	BPSK	6.5

**Antenna Port Conducted Measurement:**

- This item includes all test value of each mode, but only includes spectrum plot of worst value of each mode.
- Pre-Scan has been conducted to determine the worst-case mode from all possible combinations between available modulations, data rates and antenna ports (if EUT with antenna diversity architecture).
- Following channel(s) was (were) selected for the final test as listed below.

MODE	FREQ. BAND (MHz)	AVAILABLE CHANNEL	TESTED CHANNEL	MODULATION TECHNOLOGY	MODULATION TYPE	DATA RATE (Mbps)
802.11a	5180-5240	36 to 48	36, 40, 48	OFDM	BPSK	6
802.11ac (VHT20)		36 to 48	36, 40, 48	OFDM	BPSK	6.5
802.11ac (VHT40)		38 to 46	38, 46	OFDM	BPSK	13.5
802.11ac (VHT80)		42	42	OFDM	BPSK	87.8
802.11a	5745-5825	149 to 165	149, 157, 165	OFDM	BPSK	6
802.11ac (VHT20)		149 to 165	149, 157, 165	OFDM	BPSK	6.5
802.11ac (VHT40)		151 to 159	151, 159	OFDM	BPSK	13.5
802.11ac (VHT80)		155	155	OFDM	BPSK	87.8

**Test Condition:**

APPLICABLE TO	ENVIRONMENTAL CONDITIONS	INPUT POWER	TESTED BY	TEST LOCATION
<b>RE<math>\geq</math>1G</b>	25deg. C, 72%RH	120Vac, 60Hz	Andy Ho	1
<b>RE<math>&lt;</math>1G</b>	23deg. C, 68%RH	120Vac, 60Hz	Andy Ho	1
<b>PLC</b>	20deg. C, 70%RH	120Vac, 60Hz	Wythe Lin	2
<b>APCM</b>	20deg. C, 62%RH	120Vac, 60Hz	Anderson Chen	1

### 3.3 Duty Cycle of Test Signal

If duty cycle of test signal is  $\geq 98\%$ , duty factor is not required.

If duty cycle of test signal is  $< 98\%$ , duty factor shall be considered.

**802.11a:** Duty cycle =  $2.062 \text{ ms} / 2.086 \text{ ms} = 0.988$

**802.11ac (VHT20):** Duty cycle =  $1.915 \text{ ms} / 1.942 \text{ ms} = 0.986$

**802.11ac (VHT40):** Duty cycle =  $0.947 \text{ ms} / 0.964 \text{ ms} = 0.982$

**802.11ac (VHT80):** Duty cycle =  $0.458 \text{ ms} / 0.48 \text{ ms} = 0.954$ , Duty factor =  $10 * \log(1/0.954) = 0.2$

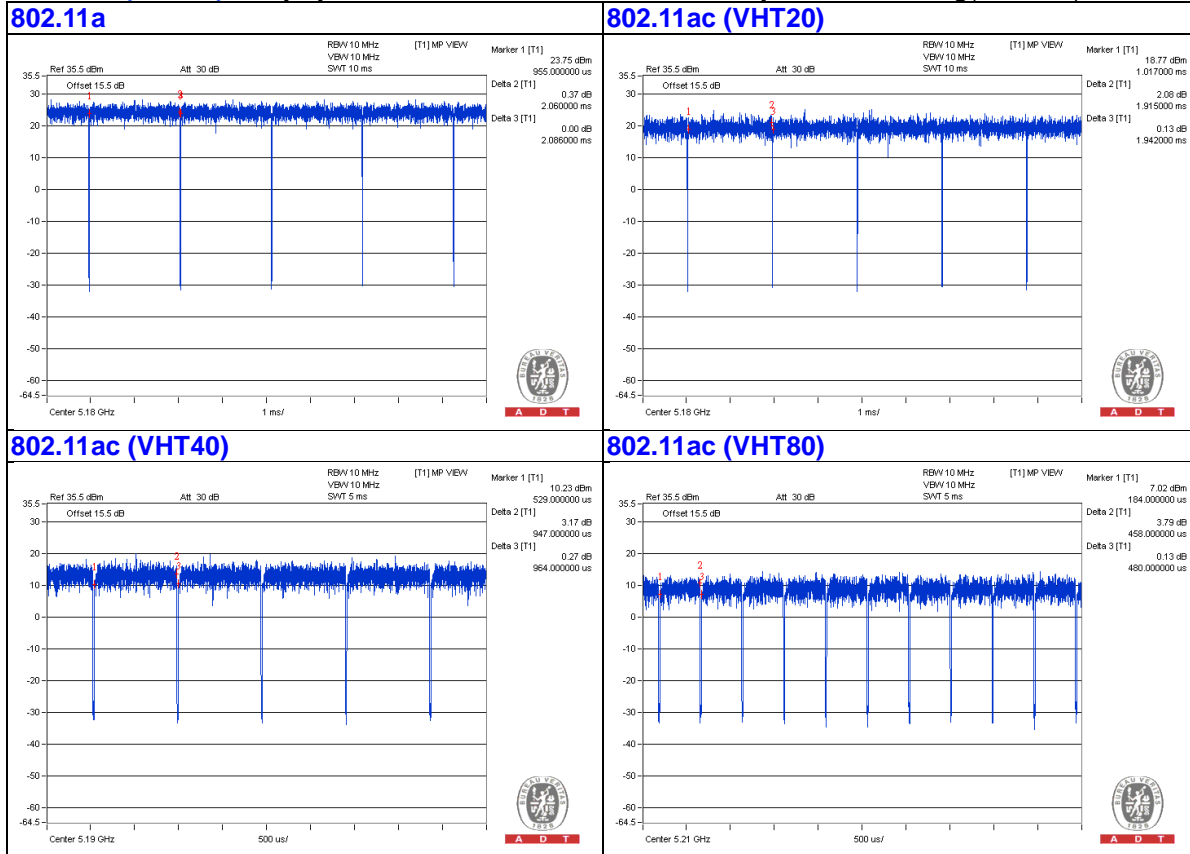

### 3.4 Description of Support Units

The EUT has been tested as an independent unit together with other necessary accessories or support units. The following support units or accessories were used to form a representative test configuration during the tests.

ID	Product	Brand	Model No.	Serial No.	FCC ID	Remarks
A.	iPod shuffle	Apple	MC749TA/A	CC4DMFJUDFDM	NA	Provided by Lab
B.	Notebook Computer	DELL	E5430	4YV4VY1	FCC DoC	Provided by Lab
C.	Notebook Computer	DELL	E5430	HYV4VY1	FCC DoC	Provided by Lab
D.	HUB	ZyXEL	ES-116P	S060H02000215	FCC DoC	Provided by Lab

Note:

1. All power cords of the above support units are non-shielded (1.8m).

ID	Descriptions	Qty.	Length (m)	Shielding (Yes/No)	Cores (Qty.)	Remarks
1.	USB cable	1	0.1	Yes	0	Provided by Lab
2.	RJ45 cable	1	10	No	0	Provided by Lab
3.	RJ45 cable	1	10	No	0	Provided by Lab
4.	RJ45 cable	3	10	No	0	Provided by Lab
5.	DC cable	1	1.5	No	0	Supplied by Client

Note: The core(s) is(are) originally attached to the cable(s).

### 3.4.1 Configuration of System under Test

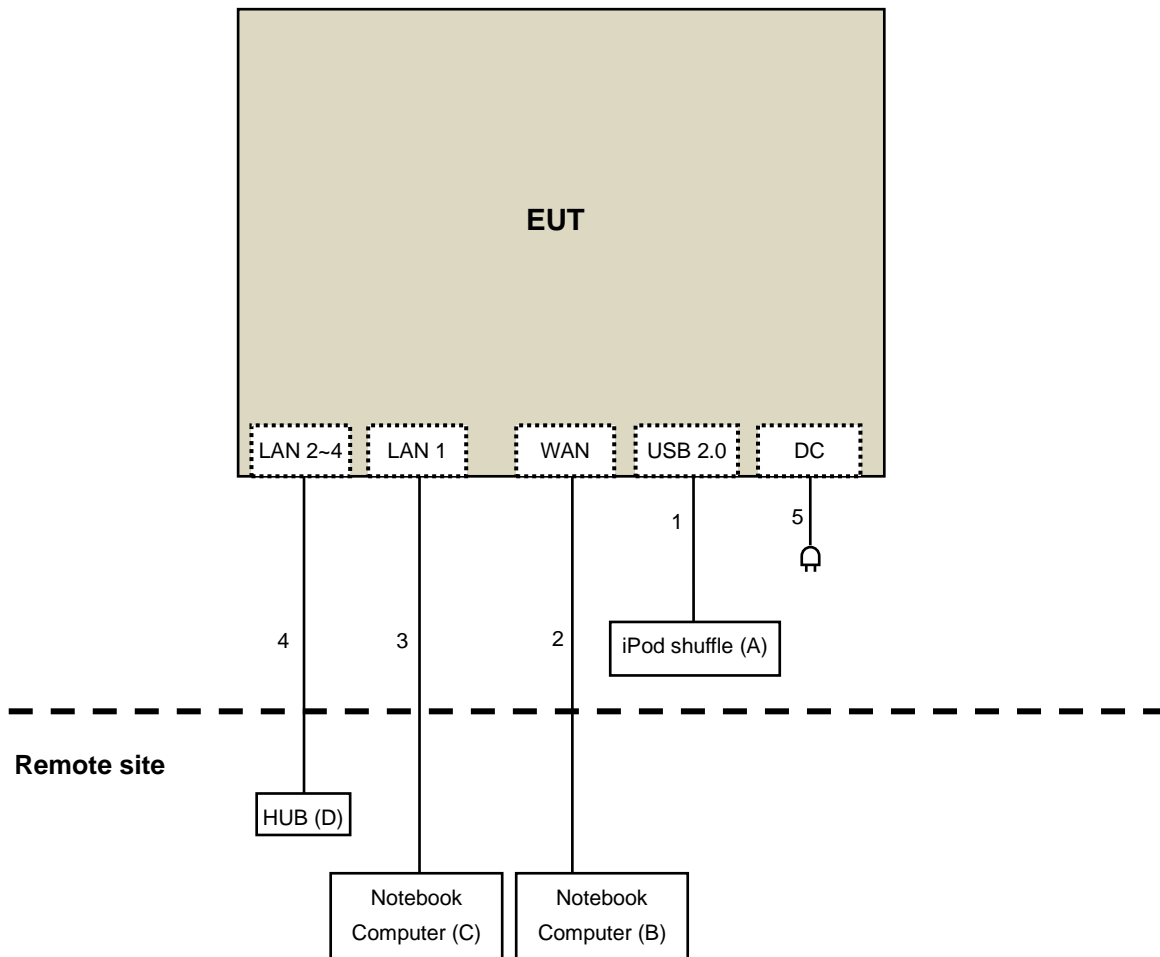



### 3.5 General Description of Applied Standard

The EUT is a RF Product. According to the specifications of the manufacturer, it must comply with the requirements of the following standards:

**FCC Part 15, Subpart E (15.407)**

**KDB 789033 D02 General UNII Test Procedure New Rules v01r01**

**KDB 662911 D01 Multiple Transmitter Output v02r01**

ANSI C63.10-2013

All test items have been performed and recorded as per the above standards.

**NOTE:** The EUT has been verified to comply with the requirements of FCC Part 15, Subpart B, Class B (DoC). The test report has been issued separately.

## 4 Test Types and Results

### 4.1 Radiated Emission and Bandedge Measurement

#### 4.1.1 Limits of Radiated Emission and Bandedge Measurement

Radiated emissions which fall in the restricted bands must comply with the radiated emission limits specified as below table.

Frequencies (MHz)	Field Strength (microvolts/meter)	Measurement Distance (meters)
0.009 ~ 0.490	2400/F(kHz)	300
0.490 ~ 1.705	24000/F(kHz)	30
1.705 ~ 30.0	30	30
30 ~ 88	100	3
88 ~ 216	150	3
216 ~ 960	200	3
Above 960	500	3

#### NOTE:

1. The lower limit shall apply at the transition frequencies.
2. Emission level (dBuV/m) = 20 log Emission level (uV/m).
3. For frequencies above 1000MHz, the field strength limits are based on average detector, however, the peak field strength of any emission shall not exceed the maximum permitted average limits, specified above by more than 20dB under any condition of modulation.

#### LIMITS OF UNWANTED EMISSION OUT OF THE RESTRICTED BANDS

APPLICABLE TO	LIMIT	
789033 D02 General UNII Test Procedure New Rules v01r01	FIELD STRENGTH AT 3m	
	PK:74 (dBμV/m)	AV:54 (dBμV/m)
APPLICABLE TO	EIRP LIMIT	EQUIVALENT FIELD STRENGTH AT 3m
15.407(b)(1)	PK:-27 (dBm/MHz)	PK:68.2(dBμV/m)
15.407(b)(2)		
15.407(b)(3)		
15.407(b)(4)	PK:-27 (dBm/MHz) <sup>*1</sup> PK:-17 (dBm/MHz) <sup>*2</sup>	PK: 68.2(dBμV/m) <sup>*1</sup> PK:78.2 (dBμV/m) <sup>*2</sup>

**NOTE:** <sup>\*1</sup> beyond 10MHz of the band edge <sup>\*2</sup> within 10 MHz of band edge

The following formula is used to convert the equipment isotropic radiated power (eirp) to field strength:

$$E = \frac{1000000\sqrt{30P}}{3} \mu\text{V/m, where P is the eirp (Watts).}$$



4.1.2 Test Instruments

DESCRIPTION & MANUFACTURER	MODEL NO.	SERIAL NO.	CALIBRATED DATE	CALIBRATED UNTIL
Test Receiver Agilent	N9038A	MY50010156	Aug. 12, 2015	Aug. 11, 2016
Pre-Amplifier <sup>(*)</sup> EMCI	EMC001340	980142	Jan. 20, 2016	Jan. 19, 2018
Loop Antenna <sup>(*)</sup> Electro-Metrics	EM-6879	264	Dec. 16, 2014	Dec. 15, 2016
RF Cable	NA	LOOPCAB-001 LOOPCAB-002	Jan. 18, 2016	Jan. 17, 2017
Pre-Amplifier Mini-Circuits	ZFL-1000VH2B	AMP-ZFL-07	May 08, 2015	May 07, 2016
Trilog Broadband Antenna SCHWARZBECK	VULB 9168	9168-156	Jan. 04, 2016	Jan. 03, 2017
RF Cable	8D	966-3-1 966-3-2 966-3-3	Apr. 02, 2016	Apr. 01, 2017
Horn_Antenna SCHWARZBECK	BBHA9120-D	9120D-406	Jan. 20, 2016	Jan. 19, 2017
Pre-Amplifier Agilent	8449B	3008A02465	Apr. 05, 2016	Apr. 04, 2017
RF Cable	EMC104-SM-SM-2000 EMC104-SM-SM-5000 EMC104-SM-SM-5000	150317 150321 150322	Mar. 30, 2016	Mar. 29, 2017
Spectrum Analyzer Keysight	N9030A	MY54490520	July 26, 2015	July 25, 2016
Pre-Amplifier EMCI	EMC184045	980143	Jan. 15, 2016	Jan. 14, 2017
Horn_Antenna SCHWARZBECK	BBHA 9170	BBHA9170608	Jan. 08, 2016	Jan. 07, 2017
RF Cable	SUCOFLEX 102	36432/2 36441/2	Jan. 16, 2016	Jan. 15, 2017
Software	ADT_Radiated_V8.7.07	NA	NA	NA
Antenna Tower & Turn Table CT	NA	NA	NA	NA
Boresight Antenna Fixture	NA	NA	NA	NA
SPECTRUM ANALYZER R&S	FSP 40	100060	May 08, 2015	May 07, 2016
Power meter Anritsu	ML2495A	1014008	Apr. 28, 2015	Apr. 27, 2016
Power sensor Anritsu	MA2411B	0917122	Apr. 28, 2015	Apr. 27, 2016
Temperature & Humidity Chamber GIANTFORCE	GTH-150-40-SP-AR	MAA0812-008	Jan. 15, 2016	Jan. 14, 2017

**Note:**

1. The calibration interval of the above test instruments is 12 months and the calibrations are traceable to NML/ROC and NIST/USA.
2. \*The calibration interval of the above test instruments is 24 months and the calibrations are traceable to NML/ROC and NIST/USA.
3. Loop antenna was used for all emissions below 30 MHz.
4. The test was performed in 966 Chamber No. 3.
5. The FCC Site Registration No. is 147459
6. The CANADA Site Registration No. is 20331-1
7. Tested Date: Mar. 29 to Apr. 01, 2016

#### 4.1.3 Test Procedure

- a. The EUT was placed on the top of a rotating table 0.8 meters (for below 1GHz) / 1.5 meters (for above 1GHz) above the ground at 3 meter chamber room for test. The table was rotated 360 degrees to determine the position of the highest radiation.
- b. The EUT was set 3 meters away from the interference-receiving antenna, which was mounted on the top of a variable-height antenna tower.
- c. The height of antenna is varied from one meter to four meters above the ground to determine the maximum value of the field strength. Both horizontal and vertical polarizations of the antenna are set to make the measurement.
- d. For each suspected emission, the EUT was arranged to its worst case and then the antenna was tuned to heights from 1 meter to 4 meters and the rotatable table was turned from 0 degrees to 360 degrees to find the maximum reading.
- e. The test-receiver system was set to quasi-peak detect function and specified bandwidth with maximum hold mode when the test frequency is below 1 GHz.
- f. The test-receiver system was set to peak and average detect function and specified bandwidth with maximum hold mode when the test frequency is above 1 GHz. If the peak reading value also meets average limit, measurement with the average detector is unnecessary.

#### Note:

1. The resolution bandwidth and video bandwidth of test receiver/spectrum analyzer is 120kHz for Quasi-peak detection (QP) at frequency below 1GHz.
2. The resolution bandwidth of test receiver/spectrum analyzer is 1 MHz and the video bandwidth is 3 MHz for Peak detection (PK) at frequency above 1GHz.
3. The resolution bandwidth of test receiver/spectrum analyzer is 1MHz and the video bandwidth is 3MHz for RMS Average (Duty cycle < 98%) for Average detection (AV) at frequency above 1GHz, then the measurement results was added to a correction factor ( $10 \log(1/\text{duty cycle})$ ).
4. The resolution bandwidth of test receiver/spectrum analyzer is 1MHz and the video bandwidth is 10Hz (Duty cycle  $\geq 98\%$ ) for Average detection (AV) at frequency above 1GHz.
5. All modes of operation were investigated and the worst-case emissions are reported.

#### 4.1.4 Deviation from Test Standard

No deviation.

#### 4.1.5 Test Setup

##### <Frequency Range below 1GHz>

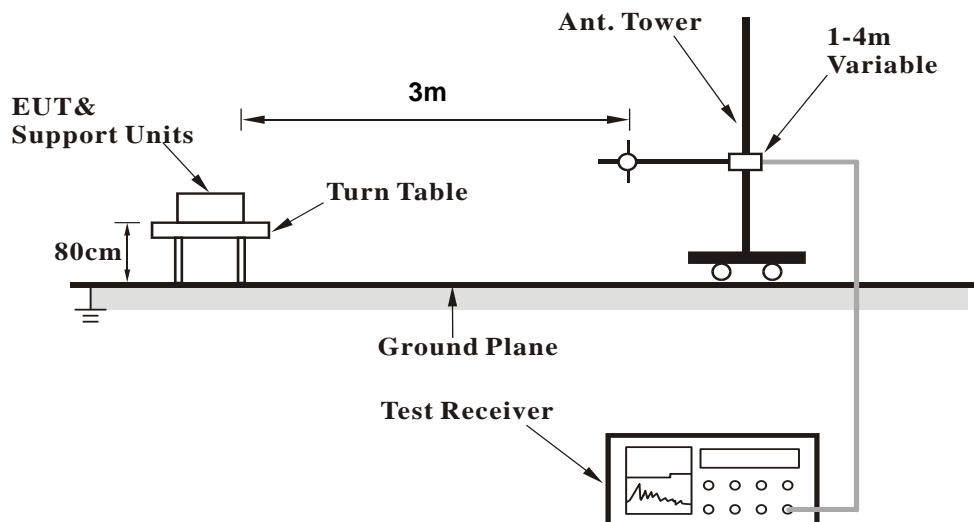

##### <Frequency Range above 1GHz>

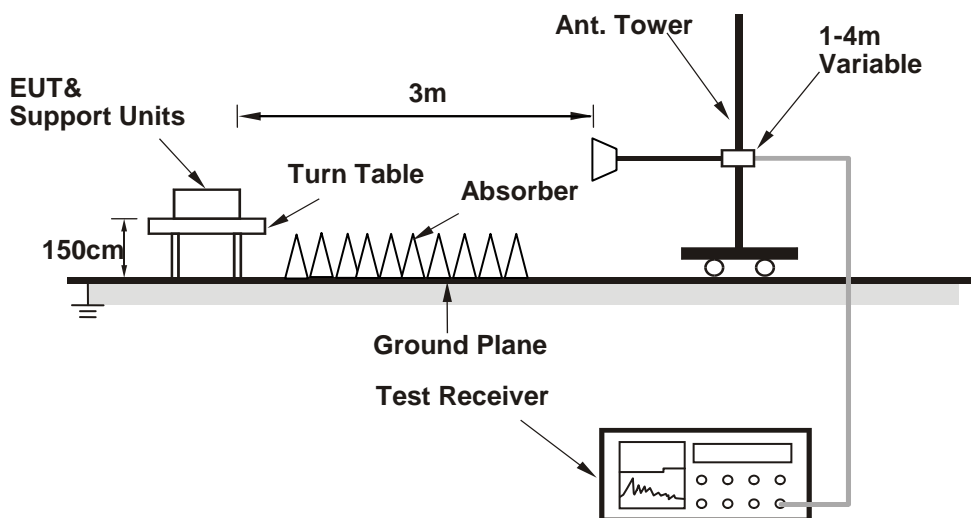

For the actual test configuration, please refer to the attached file (Test Setup Photo).

#### 4.1.6 EUT Operating Condition

1. Connect the EUT with the support unit B~C (Notebook Computer) which are placed on a testing table.
2. The communication partner run test program "MTool 2.0.0.8" to enable EUT under transmission/receiving condition continuously at specific channel frequency.

#### 4.1.7 Test Results

#### Above 1GHz Data:

#### 802.11a

<b>CHANNEL</b>	TX Channel 36	<b>DETECTOR FUNCTION</b>	Peak (PK)
<b>FREQUENCY RANGE</b>	1GHz ~ 40GHz		Average (AV)

#### ANTENNA POLARITY & TEST DISTANCE: HORIZONTAL AT 3 M

NO.	FREQ. (MHz)	EMISSION LEVEL (dBuV/m)	LIMIT (dBuV/m)	MARGIN (dB)	ANTENNA HEIGHT (m)	TABLE ANGLE (Degree)	RAW VALUE (dBuV)	CORRECTION FACTOR (dB/m)
1	5100.00	59.1 PK	74.0	-14.9	1.61 H	360	58.66	0.44
2	5100.00	48.7 AV	54.0	-5.3	1.61 H	360	48.26	0.44
3	5150.00	56.8 PK	74.0	-17.2	1.50 H	157	56.21	0.59
4	5150.00	45.1 AV	54.0	-8.9	1.50 H	157	44.51	0.59
5	*5180.00	107.1 PK			1.50 H	157	106.41	0.69
6	*5180.00	96.4 AV			1.50 H	157	95.71	0.69
7	#10360.00	53.3 PK	74.0	-20.7	1.11 H	98	42.58	10.72
8	#10360.00	40.5 AV	54.0	-13.5	1.11 H	98	29.78	10.72
9	15540.00	50.5 PK	74.0	-23.5	1.12 H	183	37.80	12.70
10	15540.00	39.5 AV	54.0	-14.5	1.12 H	183	26.80	12.70

#### ANTENNA POLARITY & TEST DISTANCE: VERTICAL AT 3 M

NO.	FREQ. (MHz)	EMISSION LEVEL (dBuV/m)	LIMIT (dBuV/m)	MARGIN (dB)	ANTENNA HEIGHT (m)	TABLE ANGLE (Degree)	RAW VALUE (dBuV)	CORRECTION FACTOR (dB/m)
1	5100.00	63.0 PK	74.0	-11.0	2.46 V	41	62.56	0.44
2	5100.00	53.0 AV	54.0	-1.0	2.46 V	41	52.56	0.44
3	5150.00	71.2 PK	74.0	-2.8	2.53 V	50	70.61	0.59
<b>4</b>	<b>5150.00</b>	<b>53.9 AV</b>	<b>54.0</b>	<b>-0.1</b>	<b>2.53 V</b>	<b>50</b>	<b>53.31</b>	<b>0.59</b>
5	*5180.00	115.2 PK			2.53 V	50	114.51	0.69
6	*5180.00	105.1 AV			2.53 V	50	104.41	0.69
7	#10360.00	58.2 PK	74.0	-15.8	1.00 V	19	47.48	10.72
8	#10360.00	46.5 AV	54.0	-7.5	1.00 V	19	35.78	10.72
9	15540.00	55.8 PK	74.0	-18.2	1.14 V	68	43.10	12.70
10	15540.00	44.0 AV	54.0	-10.0	1.14 V	68	31.30	12.70

#### REMARKS:

- Emission Level(dBuV/m) = Raw Value(dBuV) + Correction Factor(dB/m)
- Correction Factor(dB/m) = Antenna Factor(dB/m) + Cable Factor(dB) – Pre-Amplifier Factor(dB)
- The other emission levels were very low against the limit.
- Margin value = Emission Level – Limit value
- " \* ": Fundamental frequency.
- " # ": The radiated frequency is out of the restricted band.

<b>CHANNEL</b>	TX Channel 40	<b>DETECTOR FUNCTION</b>	Peak (PK)
<b>FREQUENCY RANGE</b>	1GHz ~ 40GHz		Average (AV)

**ANTENNA POLARITY & TEST DISTANCE: HORIZONTAL AT 3 M**

NO.	FREQ. (MHz)	EMISSION LEVEL (dBuV/m)	LIMIT (dBuV/m)	MARGIN (dB)	ANTENNA HEIGHT (m)	TABLE ANGLE (Degree)	RAW VALUE (dBuV)	CORRECTION FACTOR (dB/m)
1	5118.00	55.4 PK	74.0	-18.6	2.25 H	360	54.91	0.49
2	5118.00	47.6 AV	54.0	-6.4	2.25 H	360	47.11	0.49
3	*5200.00	107.8 PK			2.25 H	360	107.05	0.75
4	*5200.00	99.1 AV			2.25 H	360	98.35	0.75
5	#10400.00	53.9 PK	74.0	-20.1	1.16 H	90	42.86	11.04
6	#10400.00	41.0 AV	54.0	-13.0	1.16 H	90	29.96	11.04
7	15600.00	50.3 PK	74.0	-23.7	1.09 H	172	37.56	12.74
8	15600.00	39.5 AV	54.0	-14.5	1.09 H	172	26.76	12.74

**ANTENNA POLARITY & TEST DISTANCE: VERTICAL AT 3 M**

NO.	FREQ. (MHz)	EMISSION LEVEL (dBuV/m)	LIMIT (dBuV/m)	MARGIN (dB)	ANTENNA HEIGHT (m)	TABLE ANGLE (Degree)	RAW VALUE (dBuV)	CORRECTION FACTOR (dB/m)
1	5118.00	64.5 PK	74.0	-9.5	2.29 V	49	64.01	0.49
2	5118.00	53.8 AV	54.0	-0.2	2.29 V	49	53.31	0.49
3	*5200.00	116.3 PK			2.58 V	53	115.55	0.75
4	*5200.00	106.0 AV			2.58 V	53	105.25	0.75
5	#10400.00	57.8 PK	74.0	-16.2	1.00 V	28	46.76	11.04
6	#10400.00	46.4 AV	54.0	-7.6	1.00 V	28	35.36	11.04
7	15600.00	55.8 PK	74.0	-18.2	1.11 V	77	43.06	12.74
8	15600.00	44.0 AV	54.0	-10.0	1.11 V	77	31.26	12.74

**REMARKS:**

1. Emission Level(dBuV/m) = Raw Value(dBuV) + Correction Factor(dB/m)
2. Correction Factor(dB/m) = Antenna Factor(dB/m) + Cable Factor(dB) – Pre-Amplifier Factor(dB)
3. The other emission levels were very low against the limit.
4. Margin value = Emission Level – Limit value
5. " \* ": Fundamental frequency.
6. " # ": The radiated frequency is out of the restricted band.



<b>CHANNEL</b>	TX Channel 48	<b>DETECTOR FUNCTION</b>	Peak (PK)
<b>FREQUENCY RANGE</b>	1GHz ~ 40GHz		Average (AV)

**ANTENNA POLARITY & TEST DISTANCE: HORIZONTAL AT 3 M**

NO.	FREQ. (MHz)	EMISSION LEVEL (dBuV/m)	LIMIT (dBuV/m)	MARGIN (dB)	ANTENNA HEIGHT (m)	TABLE ANGLE (Degree)	RAW VALUE (dBuV)	CORRECTION FACTOR (dB/m)
1	*5240.00	106.4 PK			2.60 H	360	105.51	0.89
2	*5240.00	100.2 AV			2.60 H	360	99.31	0.89
3	5406.00	55.6 PK	74.0	-18.4	2.60 H	360	54.40	1.20
4	5406.00	43.1 AV	54.0	-10.9	2.60 H	360	41.90	1.20
5	#10480.00	54.1 PK	74.0	-19.9	1.22 H	98	43.27	10.83
6	#10480.00	41.5 AV	54.0	-12.5	1.22 H	98	30.67	10.83
7	15720.00	50.6 PK	74.0	-23.4	1.11 H	171	38.62	11.98
8	15720.00	39.9 AV	54.0	-14.1	1.11 H	171	27.92	11.98

**ANTENNA POLARITY & TEST DISTANCE: VERTICAL AT 3 M**

NO.	FREQ. (MHz)	EMISSION LEVEL (dBuV/m)	LIMIT (dBuV/m)	MARGIN (dB)	ANTENNA HEIGHT (m)	TABLE ANGLE (Degree)	RAW VALUE (dBuV)	CORRECTION FACTOR (dB/m)
1	*5240.00	117.1 PK			2.56 V	48	116.21	0.89
2	*5240.00	106.7 AV			2.56 V	48	105.81	0.89
3	5406.00	59.2 PK	74.0	-14.8	1.50 V	26	58.00	1.20
4	5406.00	49.1 AV	54.0	-4.9	1.50 V	26	47.90	1.20
5	#10480.00	57.6 PK	74.0	-16.4	1.06 V	14	46.77	10.83
6	#10480.00	46.0 AV	54.0	-8.0	1.06 V	14	35.17	10.83
7	15720.00	55.7 PK	74.0	-18.3	1.12 V	62	43.72	11.98
8	15720.00	43.8 AV	54.0	-10.2	1.12 V	62	31.82	11.98

**REMARKS:**

1. Emission Level(dBuV/m) = Raw Value(dBuV) + Correction Factor(dB/m)
2. Correction Factor(dB/m) = Antenna Factor(dB/m) + Cable Factor(dB) – Pre-Amplifier Factor(dB)
3. The other emission levels were very low against the limit.
4. Margin value = Emission Level – Limit value
5. " \* ": Fundamental frequency.
6. " # ": The radiated frequency is out of the restricted band.





<b>CHANNEL</b>	TX Channel 149	<b>DETECTOR FUNCTION</b>	Peak (PK)
<b>FREQUENCY RANGE</b>	1GHz ~ 40GHz		Average (AV)

**ANTENNA POLARITY & TEST DISTANCE: HORIZONTAL AT 3 M**

NO.	FREQ. (MHz)	EMISSION LEVEL (dBuV/m)	LIMIT (dBuV/m)	MARGIN (dB)	ANTENNA HEIGHT (m)	TABLE ANGLE (Degree)	RAW VALUE (dBuV)	CORRECTION FACTOR (dB/m)
1	#5666.00	56.7 PK	74.0	-17.3	2.64 H	360	55.06	1.64
2	#5666.00	49.1 AV	54.0	-4.9	2.64 H	360	47.46	1.64
3	#5715.00	59.8 PK	74.0	-14.2	2.34 H	360	58.10	1.70
4	#5715.00	46.8 AV	54.0	-7.2	2.34 H	360	45.10	1.70
5	#5725.00	64.7 PK	78.2	-13.5	2.34 H	360	62.99	1.71
6	*5745.00	105.3 PK			2.34 H	360	103.56	1.74
7	*5745.00	96.6 AV			2.34 H	360	94.86	1.74
8	11490.00	53.7 PK	74.0	-20.3	1.25 H	83	41.29	12.41
9	11490.00	41.2 AV	54.0	-12.8	1.25 H	83	28.79	12.41
10	#17235.00	50.4 PK	74.0	-23.6	1.06 H	158	33.68	16.72
11	#17235.00	39.7 AV	54.0	-14.3	1.06 H	158	22.98	16.72

**ANTENNA POLARITY & TEST DISTANCE: VERTICAL AT 3 M**

NO.	FREQ. (MHz)	EMISSION LEVEL (dBuV/m)	LIMIT (dBuV/m)	MARGIN (dB)	ANTENNA HEIGHT (m)	TABLE ANGLE (Degree)	RAW VALUE (dBuV)	CORRECTION FACTOR (dB/m)
1	#5666.00	63.1 PK	74.0	-10.9	1.00 V	36	61.46	1.64
2	#5666.00	52.5 AV	54.0	-1.5	1.00 V	36	50.86	1.64
3	#5715.00	68.1 PK	74.0	-5.9	1.27 V	34	66.40	1.70
4	#5715.00	50.2 AV	54.0	-3.8	1.27 V	34	48.50	1.70
5	#5725.00	78.0 PK	78.2	-0.2	1.27 V	34	76.29	1.71
6	*5745.00	113.6 PK			1.27 V	34	111.86	1.74
7	*5745.00	103.0 AV			1.27 V	34	101.26	1.74
8	11490.00	57.4 PK	74.0	-16.6	1.03 V	14	44.99	12.41
9	11490.00	45.7 AV	54.0	-8.3	1.03 V	14	33.29	12.41
10	#17235.00	56.1 PK	74.0	-17.9	1.00 V	60	39.38	16.72
11	#17235.00	44.3 AV	54.0	-9.7	1.00 V	60	27.58	16.72

**REMARKS:**

1. Emission Level(dBuV/m) = Raw Value(dBuV) + Correction Factor(dB/m)
2. Correction Factor(dB/m) = Antenna Factor(dB/m) + Cable Factor(dB) – Pre-Amplifier Factor(dB)
3. The other emission levels were very low against the limit.
4. Margin value = Emission Level – Limit value
5. " \* ": Fundamental frequency.
6. " # ": The radiated frequency is out of the restricted band.

<b>CHANNEL</b>	TX Channel 157	<b>DETECTOR FUNCTION</b>	Peak (PK)
<b>FREQUENCY RANGE</b>	1GHz ~ 40GHz		Average (AV)

**ANTENNA POLARITY & TEST DISTANCE: HORIZONTAL AT 3 M**

NO.	FREQ. (MHz)	EMISSION LEVEL (dBuV/m)	LIMIT (dBuV/m)	MARGIN (dB)	ANTENNA HEIGHT (m)	TABLE ANGLE (Degree)	RAW VALUE (dBuV)	CORRECTION FACTOR (dB/m)
1	#5704.00	63.4 PK	68.2	-4.8	2.39 H	360	61.72	1.68
2	*5785.00	109.6 PK			2.39 H	360	107.80	1.80
3	*5785.00	101.6 AV			2.39 H	360	99.80	1.80
4	#5863.00	63.1 PK	68.2	-5.1	2.39 H	360	61.28	1.82
5	11570.00	54.2 PK	74.0	-19.8	1.29 H	89	42.02	12.18
6	11570.00	41.6 AV	54.0	-12.4	1.29 H	89	29.42	12.18
7	#17355.00	50.3 PK	74.0	-23.7	1.06 H	148	33.03	17.27
8	#17355.00	39.8 AV	54.0	-14.2	1.06 H	148	22.53	17.27

**ANTENNA POLARITY & TEST DISTANCE: VERTICAL AT 3 M**

NO.	FREQ. (MHz)	EMISSION LEVEL (dBuV/m)	LIMIT (dBuV/m)	MARGIN (dB)	ANTENNA HEIGHT (m)	TABLE ANGLE (Degree)	RAW VALUE (dBuV)	CORRECTION FACTOR (dB/m)
1	#5704.00	68.1 PK	68.2	-0.1	1.00 V	36	66.42	1.68
2	*5785.00	117.8 PK			1.46 V	36	116.00	1.80
3	*5785.00	107.0 AV			1.46 V	36	105.20	1.80
4	#5863.00	67.3 PK	68.2	-0.9	1.00 V	30	65.48	1.82
5	11570.00	57.7 PK	74.0	-16.3	1.01 V	0	45.52	12.18
6	11570.00	45.8 AV	54.0	-8.2	1.01 V	0	33.62	12.18
7	#17355.00	56.1 PK	74.0	-17.9	1.04 V	72	38.83	17.27
8	#17355.00	44.4 AV	54.0	-9.6	1.04 V	72	27.13	17.27

**REMARKS:**

1. Emission Level(dBuV/m) = Raw Value(dBuV) + Correction Factor(dB/m)
2. Correction Factor(dB/m) = Antenna Factor(dB/m) + Cable Factor(dB) – Pre-Amplifier Factor(dB)
3. The other emission levels were very low against the limit.
4. Margin value = Emission Level – Limit value
5. " \* ": Fundamental frequency.
6. " # ": The radiated frequency is out of the restricted band.

<b>CHANNEL</b>	TX Channel 165	<b>DETECTOR FUNCTION</b>	Peak (PK)
<b>FREQUENCY RANGE</b>	1GHz ~ 40GHz		Average (AV)

**ANTENNA POLARITY & TEST DISTANCE: HORIZONTAL AT 3 M**

NO.	FREQ. (MHz)	EMISSION LEVEL (dBuV/m)	LIMIT (dBuV/m)	MARGIN (dB)	ANTENNA HEIGHT (m)	TABLE ANGLE (Degree)	RAW VALUE (dBuV)	CORRECTION FACTOR (dB/m)
1	*5825.00	106.4 PK			2.75 H	360	104.57	1.83
2	*5825.00	98.5 AV			2.75 H	360	96.67	1.83
3	#5850.00	60.2 PK	78.2	-18.0	2.75 H	360	58.38	1.82
4	#5860.00	60.6 PK	74.0	-13.4	2.75 H	360	58.78	1.82
5	#5860.00	52.0 AV	54.0	-2.0	2.75 H	360	50.18	1.82
6	#5904.00	58.6 PK	68.2	-9.6	2.75 H	360	56.77	1.83
7	11650.00	54.2 PK	74.0	-19.8	1.28 H	90	42.17	12.03
8	11650.00	41.5 AV	54.0	-12.5	1.28 H	90	29.47	12.03
9	#17475.00	51.0 PK	74.0	-23.0	1.06 H	133	33.24	17.76
10	#17475.00	40.2 AV	54.0	-13.8	1.06 H	133	22.44	17.76

**ANTENNA POLARITY & TEST DISTANCE: VERTICAL AT 3 M**

NO.	FREQ. (MHz)	EMISSION LEVEL (dBuV/m)	LIMIT (dBuV/m)	MARGIN (dB)	ANTENNA HEIGHT (m)	TABLE ANGLE (Degree)	RAW VALUE (dBuV)	CORRECTION FACTOR (dB/m)
1	*5825.00	116.1 PK			1.02 V	33	114.27	1.83
2	*5825.00	105.2 AV			1.02 V	33	103.37	1.83
3	#5850.00	77.0 PK	78.2	-1.2	1.02 V	33	75.18	1.82
4	#5860.00	72.9 PK	74.0	-1.1	1.02 V	33	71.08	1.82
<b>5</b>	<b>#5860.00</b>	<b>53.9 AV</b>	<b>54.0</b>	<b>-0.1</b>	<b>1.02 V</b>	<b>33</b>	<b>52.08</b>	<b>1.82</b>
6	#5904.00	65.4 PK	68.2	-2.8	1.06 V	27	63.57	1.83
7	11650.00	57.0 PK	74.0	-17.0	1.03 V	4	44.97	12.03
8	11650.00	45.4 AV	54.0	-8.6	1.03 V	4	33.37	12.03
9	#17475.00	56.1 PK	74.0	-17.9	1.05 V	79	38.34	17.76
10	#17475.00	44.3 AV	54.0	-9.7	1.05 V	79	26.54	17.76

**REMARKS:**

1. Emission Level(dBuV/m) = Raw Value(dBuV) + Correction Factor(dB/m)
2. Correction Factor(dB/m) = Antenna Factor(dB/m) + Cable Factor(dB) – Pre-Amplifier Factor(dB)
3. The other emission levels were very low against the limit.
4. Margin value = Emission Level – Limit value
5. " \* ": Fundamental frequency.
6. " # ": The radiated frequency is out of the restricted band.

**802.11ac (VHT20)**

<b>CHANNEL</b>	TX Channel 36	<b>DETECTOR FUNCTION</b>	Peak (PK)
<b>FREQUENCY RANGE</b>	1GHz ~ 40GHz		Average (AV)

**ANTENNA POLARITY & TEST DISTANCE: HORIZONTAL AT 3 M**

NO.	FREQ. (MHz)	EMISSION LEVEL (dBuV/m)	LIMIT (dBuV/m)	MARGIN (dB)	ANTENNA HEIGHT (m)	TABLE ANGLE (Degree)	RAW VALUE (dBuV)	CORRECTION FACTOR (dB/m)
1	5100.00	61.2 PK	74.0	-12.8	1.25 H	180	60.76	0.44
2	5100.00	50.9 AV	54.0	-3.1	1.25 H	180	50.46	0.44
3	5150.00	62.3 PK	74.0	-11.7	1.25 H	180	61.71	0.59
4	5150.00	49.9 AV	54.0	-4.1	1.25 H	180	49.31	0.59
5	*5180.00	114.4 PK			1.25 H	180	113.71	0.69
6	*5180.00	104.3 AV			1.25 H	180	103.61	0.69
7	#10360.00	53.9 PK	74.0	-20.1	1.25 H	51	43.18	10.72
8	#10360.00	40.8 AV	54.0	-13.2	1.25 H	51	30.08	10.72
9	15540.00	51.7 PK	74.0	-22.3	1.02 H	119	39.00	12.70
10	15540.00	40.8 AV	54.0	-13.2	1.02 H	119	28.10	12.70

**ANTENNA POLARITY & TEST DISTANCE: VERTICAL AT 3 M**

NO.	FREQ. (MHz)	EMISSION LEVEL (dBuV/m)	LIMIT (dBuV/m)	MARGIN (dB)	ANTENNA HEIGHT (m)	TABLE ANGLE (Degree)	RAW VALUE (dBuV)	CORRECTION FACTOR (dB/m)
1	5100.00	64.1 PK	74.0	-9.9	1.01 V	29	63.66	0.44
2	5100.00	53.6 AV	54.0	-0.4	1.01 V	29	53.16	0.44
3	5150.00	65.4 PK	74.0	-8.6	1.02 V	30	64.81	0.59
4	5150.00	51.8 AV	54.0	-2.2	1.02 V	30	51.21	0.59
5	*5180.00	114.5 PK			1.02 V	30	113.81	0.69
6	*5180.00	105.1 AV			1.02 V	30	104.41	0.69
7	#10360.00	56.5 PK	74.0	-17.5	1.06 V	35	45.78	10.72
8	#10360.00	43.9 AV	54.0	-10.1	1.06 V	35	33.18	10.72
9	15540.00	52.2 PK	74.0	-21.8	1.11 V	39	39.50	12.70
10	15540.00	40.5 AV	54.0	-13.5	1.11 V	39	27.80	12.70

**REMARKS:**

1. Emission Level(dBuV/m) = Raw Value(dBuV) + Correction Factor(dB/m)
2. Correction Factor(dB/m) = Antenna Factor(dB/m) + Cable Factor(dB) – Pre-Amplifier Factor(dB)
3. The other emission levels were very low against the limit.
4. Margin value = Emission Level – Limit value
5. " \* ": Fundamental frequency.
6. " # ": The radiated frequency is out of the restricted band.



<b>CHANNEL</b>	TX Channel 40	<b>DETECTOR FUNCTION</b>	Peak (PK)
<b>FREQUENCY RANGE</b>	1GHz ~ 40GHz		Average (AV)

**ANTENNA POLARITY & TEST DISTANCE: HORIZONTAL AT 3 M**

NO.	FREQ. (MHz)	EMISSION LEVEL (dBuV/m)	LIMIT (dBuV/m)	MARGIN (dB)	ANTENNA HEIGHT (m)	TABLE ANGLE (Degree)	RAW VALUE (dBuV)	CORRECTION FACTOR (dB/m)
1	5119.00	56.2 PK	74.0	-17.8	2.59 H	360	55.70	0.50
2	5119.00	48.2 AV	54.0	-5.8	2.59 H	360	47.70	0.50
3	*5200.00	112.5 PK			2.59 H	360	111.75	0.75
4	*5200.00	104.1 AV			2.59 H	360	103.35	0.75
5	5416.70	51.5 PK	74.0	-22.5	2.59 H	360	50.26	1.24
6	5416.70	42.4 AV	54.0	-11.6	2.59 H	360	41.16	1.24
7	#10400.00	53.6 PK	74.0	-20.4	1.29 H	66	42.56	11.04
8	#10400.00	40.8 AV	54.0	-13.2	1.29 H	66	29.76	11.04
9	15600.00	51.6 PK	74.0	-22.4	1.12 H	128	38.86	12.74
10	15600.00	40.7 AV	54.0	-13.3	1.12 H	128	27.96	12.74

**ANTENNA POLARITY & TEST DISTANCE: VERTICAL AT 3 M**

NO.	FREQ. (MHz)	EMISSION LEVEL (dBuV/m)	LIMIT (dBuV/m)	MARGIN (dB)	ANTENNA HEIGHT (m)	TABLE ANGLE (Degree)	RAW VALUE (dBuV)	CORRECTION FACTOR (dB/m)
1	5119.00	63.0 PK	74.0	-11.0	1.00 V	30	62.50	0.50
2	5119.00	53.5 AV	54.0	-0.5	1.00 V	30	53.00	0.50
3	*5200.00	115.9 PK			1.06 V	29	115.15	0.75
4	*5200.00	106.1 AV			1.06 V	29	105.35	0.75
5	5416.70	59.2 PK	74.0	-14.8	1.00 V	28	57.96	1.24
6	5416.70	52.1 AV	54.0	-1.9	1.00 V	28	50.86	1.24
7	#10400.00	56.5 PK	74.0	-17.5	1.02 V	43	45.46	11.04
8	#10400.00	43.8 AV	54.0	-10.2	1.02 V	43	32.76	11.04
9	15600.00	51.5 PK	74.0	-22.5	1.06 V	55	38.76	12.74
10	15600.00	40.1 AV	54.0	-13.9	1.06 V	55	27.36	12.74

**REMARKS:**

- Emission Level(dBuV/m) = Raw Value(dBuV) + Correction Factor(dB/m)
- Correction Factor(dB/m) = Antenna Factor(dB/m) + Cable Factor(dB) – Pre-Amplifier Factor(dB)
- The other emission levels were very low against the limit.
- Margin value = Emission Level – Limit value
- " \* ": Fundamental frequency.
- " # ": The radiated frequency is out of the restricted band.

<b>CHANNEL</b>	TX Channel 48	<b>DETECTOR FUNCTION</b>	Peak (PK)
<b>FREQUENCY RANGE</b>	1GHz ~ 40GHz		Average (AV)

**ANTENNA POLARITY & TEST DISTANCE: HORIZONTAL AT 3 M**

NO.	FREQ. (MHz)	EMISSION LEVEL (dBuV/m)	LIMIT (dBuV/m)	MARGIN (dB)	ANTENNA HEIGHT (m)	TABLE ANGLE (Degree)	RAW VALUE (dBuV)	CORRECTION FACTOR (dB/m)
1	*5240.00	115.1 PK			2.60 H	360	114.21	0.89
2	*5240.00	107.3 AV			2.60 H	360	106.41	0.89
3	5398.70	56.3 PK	74.0	-17.7	2.60 H	360	55.11	1.19
4	5398.70	46.6 AV	54.0	-7.4	2.60 H	360	45.41	1.19
5	5458.20	47.8 PK	74.0	-26.2	2.60 H	360	46.47	1.33
6	5458.20	40.5 AV	54.0	-13.5	2.60 H	360	39.17	1.33
7	#6986.90	50.9 PK	74.0	-23.1	1.26 H	175	45.59	5.31
8	#6986.90	44.2 AV	54.0	-9.8	1.26 H	175	38.89	5.31
9	#10480.00	53.9 PK	74.0	-20.1	1.26 H	82	43.07	10.83
10	#10480.00	41.2 AV	54.0	-12.8	1.26 H	82	30.37	10.83
11	15720.00	51.4 PK	74.0	-22.6	1.00 H	124	39.42	11.98
12	15720.00	40.6 AV	54.0	-13.4	1.00 H	124	28.62	11.98

**ANTENNA POLARITY & TEST DISTANCE: VERTICAL AT 3 M**

NO.	FREQ. (MHz)	EMISSION LEVEL (dBuV/m)	LIMIT (dBuV/m)	MARGIN (dB)	ANTENNA HEIGHT (m)	TABLE ANGLE (Degree)	RAW VALUE (dBuV)	CORRECTION FACTOR (dB/m)
1	*5240.00	118.3 PK			1.42 V	32	117.41	0.89
2	*5240.00	109.2 AV			1.42 V	32	108.31	0.89
3	5398.70	61.6 PK	74.0	-12.4	1.03 V	49	60.41	1.19
4	5398.70	51.4 AV	54.0	-2.6	1.03 V	49	50.21	1.19
5	5458.20	60.2 PK	74.0	-13.8	1.12 V	115	58.87	1.33
6	5458.20	50.7 AV	54.0	-3.3	1.12 V	115	49.37	1.33
7	#6986.90	56.2 PK	74.0	-17.8	1.15 V	35	50.89	5.31
8	#6986.90	52.4 AV	54.0	-1.6	1.15 V	35	47.09	5.31
9	#10480.00	56.2 PK	74.0	-17.8	1.00 V	48	45.37	10.83
10	#10480.00	43.7 AV	54.0	-10.3	1.00 V	48	32.87	10.83
11	15720.00	51.7 PK	74.0	-22.3	1.10 V	40	39.72	11.98
12	15720.00	40.2 AV	54.0	-13.8	1.10 V	40	28.22	11.98

**REMARKS:**

1. Emission Level(dBuV/m) = Raw Value(dBuV) + Correction Factor(dB/m)
2. Correction Factor(dB/m) = Antenna Factor(dB/m) + Cable Factor(dB) – Pre-Amplifier Factor(dB)
3. The other emission levels were very low against the limit.
4. Margin value = Emission Level – Limit value
5. " \* ": Fundamental frequency.
6. " # ": The radiated frequency is out of the restricted band.

<b>CHANNEL</b>	TX Channel 149	<b>DETECTOR FUNCTION</b>	Peak (PK)
<b>FREQUENCY RANGE</b>	1GHz ~ 40GHz		Average (AV)

**ANTENNA POLARITY & TEST DISTANCE: HORIZONTAL AT 3 M**

NO.	FREQ. (MHz)	EMISSION LEVEL (dBuV/m)	LIMIT (dBuV/m)	MARGIN (dB)	ANTENNA HEIGHT (m)	TABLE ANGLE (Degree)	RAW VALUE (dBuV)	CORRECTION FACTOR (dB/m)
1	#5664.20	56.4 PK	74.0	-17.6	2.57 H	342	54.77	1.63
2	#5664.20	49.5 AV	54.0	-4.5	2.57 H	342	47.87	1.63
3	#5715.00	59.4 PK	74.0	-14.6	2.57 H	342	57.70	1.70
4	#5715.00	52.1 AV	54.0	-1.9	2.57 H	342	50.40	1.70
5	#5725.00	61.6 PK	78.2	-16.6	2.57 H	342	59.89	1.71
6	*5745.00	106.5 PK			2.57 H	342	104.76	1.74
7	*5745.00	98.7 AV			2.57 H	342	96.96	1.74
8	11490.00	54.3 PK	74.0	-19.7	1.20 H	89	41.89	12.41
9	11490.00	41.5 AV	54.0	-12.5	1.20 H	89	29.09	12.41
10	#17235.00	51.7 PK	74.0	-22.3	1.01 H	112	34.98	16.72
11	#17235.00	41.1 AV	54.0	-12.9	1.01 H	112	24.38	16.72

**ANTENNA POLARITY & TEST DISTANCE: VERTICAL AT 3 M**

NO.	FREQ. (MHz)	EMISSION LEVEL (dBuV/m)	LIMIT (dBuV/m)	MARGIN (dB)	ANTENNA HEIGHT (m)	TABLE ANGLE (Degree)	RAW VALUE (dBuV)	CORRECTION FACTOR (dB/m)
1	#5664.20	62.5 PK	74.0	-11.5	1.02 V	114	60.87	1.63
2	#5664.20	52.4 AV	54.0	-1.6	1.02 V	114	50.77	1.63
3	#5715.00	66.1 PK	74.0	-7.9	1.13 V	113	64.40	1.70
4	#5715.00	50.8 AV	54.0	-3.2	1.13 V	113	49.10	1.70
5	#5725.00	77.6 PK	78.2	-0.6	1.13 V	113	75.89	1.71
6	*5745.00	115.4 PK			1.13 V	113	113.66	1.74
7	*5745.00	105.6 AV			1.13 V	113	103.86	1.74
8	11490.00	54.4 PK	74.0	-19.6	1.03 V	7	41.99	12.41
9	11490.00	42.2 AV	54.0	-11.8	1.03 V	7	29.79	12.41
10	#17235.00	54.3 PK	74.0	-19.7	1.00 V	76	37.58	16.72
11	#17235.00	42.2 AV	54.0	-11.8	1.00 V	76	25.48	16.72

**REMARKS:**

1. Emission Level(dBuV/m) = Raw Value(dBuV) + Correction Factor(dB/m)
2. Correction Factor(dB/m) = Antenna Factor(dB/m) + Cable Factor(dB) – Pre-Amplifier Factor(dB)
3. The other emission levels were very low against the limit.
4. Margin value = Emission Level – Limit value
5. " \* ": Fundamental frequency.
6. " # ": The radiated frequency is out of the restricted band.

<b>CHANNEL</b>	TX Channel 157	<b>DETECTOR FUNCTION</b>	Peak (PK)
<b>FREQUENCY RANGE</b>	1GHz ~ 40GHz		Average (AV)

**ANTENNA POLARITY & TEST DISTANCE: HORIZONTAL AT 3 M**

NO.	FREQ. (MHz)	EMISSION LEVEL (dBuV/m)	LIMIT (dBuV/m)	MARGIN (dB)	ANTENNA HEIGHT (m)	TABLE ANGLE (Degree)	RAW VALUE (dBuV)	CORRECTION FACTOR (dB/m)
1	#5706.80	62.2 PK	68.2	-6.0	2.71 H	334	60.52	1.68
2	*5785.00	113.7 PK			2.71 H	334	111.90	1.80
3	*5785.00	106.1 AV			2.71 H	334	104.30	1.80
4	#5850.00	62.5 PK	78.2	-15.7	2.71 H	334	60.68	1.82
5	#5866.50	64.2 PK	68.2	-4.0	2.71 H	334	62.37	1.83
6	11570.00	53.6 PK	74.0	-20.4	1.17 H	76	41.42	12.18
7	11570.00	41.1 AV	54.0	-12.9	1.17 H	76	28.92	12.18
8	#17355.00	51.3 PK	74.0	-22.7	1.03 H	126	34.03	17.27
9	#17355.00	40.9 AV	54.0	-13.1	1.03 H	126	23.63	17.27

**ANTENNA POLARITY & TEST DISTANCE: VERTICAL AT 3 M**

NO.	FREQ. (MHz)	EMISSION LEVEL (dBuV/m)	LIMIT (dBuV/m)	MARGIN (dB)	ANTENNA HEIGHT (m)	TABLE ANGLE (Degree)	RAW VALUE (dBuV)	CORRECTION FACTOR (dB/m)
1	#5706.80	68.0 PK	68.2	-0.2	1.35 V	116	66.32	1.68
2	*5785.00	121.6 PK			1.35 V	116	119.80	1.80
3	*5785.00	111.7 AV			1.35 V	116	109.90	1.80
4	#5850.00	69.8 PK	78.2	-8.4	1.35 V	116	67.98	1.82
5	#5866.50	68.0 PK	68.2	-0.2	1.27 V	115	66.17	1.83
6	11570.00	56.8 PK	74.0	-17.2	1.03 V	7	44.62	12.18
7	11570.00	45.2 AV	54.0	-8.8	1.03 V	7	33.02	12.18
8	#17355.00	56.2 PK	74.0	-17.8	1.00 V	76	38.93	17.27
9	#17355.00	44.7 AV	54.0	-9.3	1.00 V	76	27.43	17.27

**REMARKS:**

1. Emission Level(dBuV/m) = Raw Value(dBuV) + Correction Factor(dB/m)
2. Correction Factor(dB/m) = Antenna Factor(dB/m) + Cable Factor(dB) – Pre-Amplifier Factor(dB)
3. The other emission levels were very low against the limit.
4. Margin value = Emission Level – Limit value
5. " \* ": Fundamental frequency.
6. " # ": The radiated frequency is out of the restricted band.



<b>CHANNEL</b>	TX Channel 165	<b>DETECTOR FUNCTION</b>	Peak (PK)
<b>FREQUENCY RANGE</b>	1GHz ~ 40GHz		Average (AV)

**ANTENNA POLARITY & TEST DISTANCE: HORIZONTAL AT 3 M**

NO.	FREQ. (MHz)	EMISSION LEVEL (dBuV/m)	LIMIT (dBuV/m)	MARGIN (dB)	ANTENNA HEIGHT (m)	TABLE ANGLE (Degree)	RAW VALUE (dBuV)	CORRECTION FACTOR (dB/m)
1	*5825.00	112.4 PK			1.10 H	194	110.57	1.83
2	*5825.00	101.5 AV			1.10 H	194	99.67	1.83
3	#5850.00	68.8 PK	78.2	-9.4	2.61 H	335	66.98	1.82
4	#5860.00	58.7 PK	68.2	-9.5	2.61 H	335	56.88	1.82
5	#5906.50	58.3 PK	68.2	-9.9	2.61 H	335	56.47	1.83
6	11650.00	53.0 PK	74.0	-21.0	1.22 H	85	40.97	12.03
7	11650.00	40.7 AV	54.0	-13.3	1.22 H	85	28.67	12.03
8	#17475.00	51.4 PK	74.0	-22.6	1.00 H	116	33.64	17.76
9	#17475.00	40.9 AV	54.0	-13.1	1.00 H	116	23.14	17.76

**ANTENNA POLARITY & TEST DISTANCE: VERTICAL AT 3 M**

NO.	FREQ. (MHz)	EMISSION LEVEL (dBuV/m)	LIMIT (dBuV/m)	MARGIN (dB)	ANTENNA HEIGHT (m)	TABLE ANGLE (Degree)	RAW VALUE (dBuV)	CORRECTION FACTOR (dB/m)
1	*5825.00	117.4 PK			1.19 V	115	115.57	1.83
2	*5825.00	107.8 AV			1.19 V	115	105.97	1.83
3	#5850.00	75.8 PK	78.2	-2.4	1.19 V	115	73.98	1.82
4	#5860.00	67.7 PK	68.2	-0.5	1.19 V	115	65.88	1.82
5	#5906.50	65.5 PK	68.2	-2.7	1.15 V	117	63.67	1.83
6	11650.00	57.1 PK	74.0	-16.9	1.03 V	22	45.07	12.03
7	11650.00	45.2 AV	54.0	-8.8	1.03 V	22	33.17	12.03
8	#17475.00	56.4 PK	74.0	-17.6	1.00 V	83	38.64	17.76
9	#17475.00	44.9 AV	54.0	-9.1	1.00 V	83	27.14	17.76

**REMARKS:**

1. Emission Level(dBuV/m) = Raw Value(dBuV) + Correction Factor(dB/m)
2. Correction Factor(dB/m) = Antenna Factor(dB/m) + Cable Factor(dB) – Pre-Amplifier Factor(dB)
3. The other emission levels were very low against the limit.
4. Margin value = Emission Level – Limit value
5. " \* ": Fundamental frequency.
6. " # ": The radiated frequency is out of the restricted band.

**802.11ac (VHT40)**

<b>CHANNEL</b>	TX Channel 38	<b>DETECTOR FUNCTION</b>	Peak (PK)
<b>FREQUENCY RANGE</b>	1GHz ~ 40GHz		Average (AV)

**ANTENNA POLARITY & TEST DISTANCE: HORIZONTAL AT 3 M**

NO.	FREQ. (MHz)	EMISSION LEVEL (dBuV/m)	LIMIT (dBuV/m)	MARGIN (dB)	ANTENNA HEIGHT (m)	TABLE ANGLE (Degree)	RAW VALUE (dBuV)	CORRECTION FACTOR (dB/m)
1	5150.00	72.3 PK	74.0	-1.7	2.49 H	360	71.71	0.59
2	5150.00	52.7 AV	54.0	-1.3	2.49 H	360	52.11	0.59
3	*5190.00	105.5 PK			2.49 H	360	104.79	0.71
4	*5190.00	95.1 AV			2.49 H	360	94.39	0.71
5	5350.00	51.6 PK	74.0	-22.4	2.49 H	360	50.44	1.16
6	5350.00	40.3 AV	54.0	-13.7	2.49 H	360	39.14	1.16
7	#10380.00	53.2 PK	74.0	-20.8	1.22 H	85	42.31	10.89
8	#10380.00	41.1 AV	54.0	-12.9	1.22 H	85	30.21	10.89
9	15570.00	52.1 PK	74.0	-21.9	1.05 H	125	39.38	12.72
10	15570.00	41.3 AV	54.0	-12.7	1.05 H	125	28.58	12.72

**ANTENNA POLARITY & TEST DISTANCE: VERTICAL AT 3 M**

NO.	FREQ. (MHz)	EMISSION LEVEL (dBuV/m)	LIMIT (dBuV/m)	MARGIN (dB)	ANTENNA HEIGHT (m)	TABLE ANGLE (Degree)	RAW VALUE (dBuV)	CORRECTION FACTOR (dB/m)
1	5150.00	72.7 PK	74.0	-1.3	1.18 V	118	72.11	0.59
2	<b>5150.00</b>	<b>53.9 AV</b>	<b>54.0</b>	<b>-0.1</b>	<b>1.18 V</b>	<b>118</b>	<b>53.31</b>	<b>0.59</b>
3	*5190.00	110.1 PK			1.18 V	118	109.39	0.71
4	*5190.00	99.2 AV			1.18 V	118	98.49	0.71
5	5350.00	54.7 PK	74.0	-19.3	1.18 V	118	53.54	1.16
6	5350.00	43.2 AV	54.0	-10.8	1.18 V	118	42.04	1.16
7	#10380.00	57.0 PK	74.0	-17.0	1.08 V	21	46.11	10.89
8	#10380.00	45.0 AV	54.0	-9.0	1.08 V	21	34.11	10.89
9	15570.00	56.8 PK	74.0	-17.2	1.01 V	68	44.08	12.72
10	15570.00	45.4 AV	54.0	-8.6	1.01 V	68	32.68	12.72

**REMARKS:**

- Emission Level(dBuV/m) = Raw Value(dBuV) + Correction Factor(dB/m)
- Correction Factor(dB/m) = Antenna Factor(dB/m) + Cable Factor(dB) – Pre-Amplifier Factor(dB)
- The other emission levels were very low against the limit.
- Margin value = Emission Level – Limit value
- " \* ": Fundamental frequency.
- " # ": The radiated frequency is out of the restricted band.

<b>CHANNEL</b>	TX Channel 46	<b>DETECTOR FUNCTION</b>	Peak (PK)
<b>FREQUENCY RANGE</b>	1GHz ~ 40GHz		Average (AV)

**ANTENNA POLARITY & TEST DISTANCE: HORIZONTAL AT 3 M**

NO.	FREQ. (MHz)	EMISSION LEVEL (dBuV/m)	LIMIT (dBuV/m)	MARGIN (dB)	ANTENNA HEIGHT (m)	TABLE ANGLE (Degree)	RAW VALUE (dBuV)	CORRECTION FACTOR (dB/m)
1	5150.00	61.3 PK	74.0	-12.7	2.50 H	360	60.71	0.59
2	5150.00	50.5 AV	54.0	-3.5	2.50 H	360	49.91	0.59
3	*5230.00	110.5 PK			2.50 H	360	109.64	0.86
4	*5230.00	101.0 AV			2.50 H	360	100.14	0.86
5	5350.00	56.7 PK	74.0	-17.3	2.50 H	360	55.54	1.16
6	5350.00	45.1 AV	54.0	-8.9	2.50 H	360	43.94	1.16
7	#10460.00	53.3 PK	74.0	-20.7	1.24 H	96	42.43	10.87
8	#10460.00	41.4 AV	54.0	-12.6	1.24 H	96	30.53	10.87
9	15690.00	52.4 PK	74.0	-21.6	1.06 H	118	40.30	12.10
10	15690.00	41.7 AV	54.0	-12.3	1.06 H	118	29.60	12.10

**ANTENNA POLARITY & TEST DISTANCE: VERTICAL AT 3 M**

NO.	FREQ. (MHz)	EMISSION LEVEL (dBuV/m)	LIMIT (dBuV/m)	MARGIN (dB)	ANTENNA HEIGHT (m)	TABLE ANGLE (Degree)	RAW VALUE (dBuV)	CORRECTION FACTOR (dB/m)
1	5150.00	64.4 PK	74.0	-9.6	1.18 V	116	63.81	0.59
2	5150.00	53.4 AV	54.0	-0.6	1.18 V	116	52.81	0.59
3	*5230.00	115.1 PK			1.18 V	116	114.24	0.86
4	*5230.00	105.1 AV			1.18 V	116	104.24	0.86
5	5350.00	59.7 PK	74.0	-14.3	1.18 V	116	58.54	1.16
6	5350.00	48.2 AV	54.0	-5.8	1.18 V	116	47.04	1.16
7	#10460.00	56.8 PK	74.0	-17.2	1.05 V	33	45.93	10.87
8	#10460.00	44.6 AV	54.0	-9.4	1.05 V	33	33.73	10.87
9	15690.00	57.0 PK	74.0	-17.0	1.13 V	73	44.90	12.10
10	15690.00	45.5 AV	54.0	-8.5	1.13 V	73	33.40	12.10

**REMARKS:**

1. Emission Level(dBuV/m) = Raw Value(dBuV) + Correction Factor(dB/m)
2. Correction Factor(dB/m) = Antenna Factor(dB/m) + Cable Factor(dB) – Pre-Amplifier Factor(dB)
3. The other emission levels were very low against the limit.
4. Margin value = Emission Level – Limit value
5. " \* ": Fundamental frequency.
6. " # ": The radiated frequency is out of the restricted band.

<b>CHANNEL</b>	TX Channel 151	<b>DETECTOR FUNCTION</b>	Peak (PK)
<b>FREQUENCY RANGE</b>	1GHz ~ 40GHz		Average (AV)

**ANTENNA POLARITY & TEST DISTANCE: HORIZONTAL AT 3 M**

NO.	FREQ. (MHz)	EMISSION LEVEL (dBuV/m)	LIMIT (dBuV/m)	MARGIN (dB)	ANTENNA HEIGHT (m)	TABLE ANGLE (Degree)	RAW VALUE (dBuV)	CORRECTION FACTOR (dB/m)
1	#5715.00	70.3 PK	74.0	-3.7	2.55 H	360	68.60	1.70
2	#5715.00	51.0 AV	54.0	-3.0	2.55 H	360	49.30	1.70
3	#5725.00	67.0 PK	78.2	-11.2	2.55 H	360	65.29	1.71
4	*5755.00	107.4 PK			2.55 H	360	105.64	1.76
5	*5755.00	97.2 AV			2.55 H	360	95.44	1.76
6	11510.00	53.4 PK	74.0	-20.6	1.22 H	90	41.02	12.38
7	11510.00	41.8 AV	54.0	-12.2	1.22 H	90	29.42	12.38
8	#17265.00	53.0 PK	74.0	-21.0	1.05 H	129	36.20	16.80
9	#17265.00	42.2 AV	54.0	-11.8	1.05 H	129	25.40	16.80

**ANTENNA POLARITY & TEST DISTANCE: VERTICAL AT 3 M**

NO.	FREQ. (MHz)	EMISSION LEVEL (dBuV/m)	LIMIT (dBuV/m)	MARGIN (dB)	ANTENNA HEIGHT (m)	TABLE ANGLE (Degree)	RAW VALUE (dBuV)	CORRECTION FACTOR (dB/m)
1	#5715.00	73.4 PK	74.0	-0.6	1.29 V	116	71.70	1.70
2	#5715.00	53.9 AV	54.0	-0.1	1.29 V	116	52.20	1.70
3	#5725.00	74.2 PK	78.2	-4.0	1.29 V	116	72.49	1.71
4	*5755.00	112.0 PK			1.29 V	116	110.24	1.76
5	*5755.00	101.3 AV			1.29 V	116	99.54	1.76
6	11510.00	57.3 PK	74.0	-16.7	1.11 V	45	44.92	12.38
7	11510.00	45.0 AV	54.0	-9.0	1.11 V	45	32.62	12.38
8	#17265.00	56.5 PK	74.0	-17.5	1.18 V	57	39.70	16.80
9	#17265.00	45.2 AV	54.0	-8.8	1.18 V	57	28.40	16.80

**REMARKS:**

1. Emission Level(dBuV/m) = Raw Value(dBuV) + Correction Factor(dB/m)
2. Correction Factor(dB/m) = Antenna Factor(dB/m) + Cable Factor(dB) – Pre-Amplifier Factor(dB)
3. The other emission levels were very low against the limit.
4. Margin value = Emission Level – Limit value
5. " \* ": Fundamental frequency.
6. " # ": The radiated frequency is out of the restricted band.

<b>CHANNEL</b>	TX Channel 159	<b>DETECTOR FUNCTION</b>	Peak (PK)
<b>FREQUENCY RANGE</b>	1GHz ~ 40GHz		Average (AV)

**ANTENNA POLARITY & TEST DISTANCE: HORIZONTAL AT 3 M**

NO.	FREQ. (MHz)	EMISSION LEVEL (dBuV/m)	LIMIT (dBuV/m)	MARGIN (dB)	ANTENNA HEIGHT (m)	TABLE ANGLE (Degree)	RAW VALUE (dBuV)	CORRECTION FACTOR (dB/m)
1	*5795.00	110.0 PK			2.60 H	360	108.18	1.82
2	*5795.00	100.3 AV			2.60 H	360	98.48	1.82
3	#5850.00	69.2 PK	78.2	-9.0	2.60 H	360	67.38	1.82
4	#5860.00	60.5 PK	74.0	-13.5	2.60 H	360	58.68	1.82
5	#5860.00	50.9 AV	54.0	-3.1	2.60 H	360	49.08	1.82
6	11590.00	53.3 PK	74.0	-20.7	1.18 H	96	41.19	12.11
7	11590.00	41.8 AV	54.0	-12.2	1.18 H	96	29.69	12.11
8	#17385.00	53.0 PK	74.0	-21.0	1.01 H	129	35.54	17.46
9	#17385.00	42.2 AV	54.0	-11.8	1.01 H	129	24.74	17.46

**ANTENNA POLARITY & TEST DISTANCE: VERTICAL AT 3 M**

NO.	FREQ. (MHz)	EMISSION LEVEL (dBuV/m)	LIMIT (dBuV/m)	MARGIN (dB)	ANTENNA HEIGHT (m)	TABLE ANGLE (Degree)	RAW VALUE (dBuV)	CORRECTION FACTOR (dB/m)
1	*5795.00	114.6 PK			1.24 V	116	112.78	1.82
2	*5795.00	104.4 AV			1.24 V	116	102.58	1.82
3	#5850.00	76.4 PK	78.2	-1.8	1.24 V	116	74.58	1.82
4	#5860.00	67.7 PK	74.0	-6.3	1.24 V	116	65.88	1.82
5	#5860.00	53.8 AV	54.0	-0.2	1.24 V	116	51.98	1.82
6	11590.00	56.8 PK	74.0	-17.2	1.10 V	58	44.69	12.11
7	11590.00	44.7 AV	54.0	-9.3	1.10 V	58	32.59	12.11
8	#17385.00	56.2 PK	74.0	-17.8	1.22 V	51	38.74	17.46
9	#17385.00	44.9 AV	54.0	-9.1	1.22 V	51	27.44	17.46

**REMARKS:**

1. Emission Level(dBuV/m) = Raw Value(dBuV) + Correction Factor(dB/m)
2. Correction Factor(dB/m) = Antenna Factor(dB/m) + Cable Factor(dB) – Pre-Amplifier Factor(dB)
3. The other emission levels were very low against the limit.
4. Margin value = Emission Level – Limit value
5. " \* ": Fundamental frequency.
6. " # ": The radiated frequency is out of the restricted band.

**802.11ac (VHT80)**

<b>CHANNEL</b>	TX Channel 42	<b>DETECTOR FUNCTION</b>	Peak (PK)
<b>FREQUENCY RANGE</b>	1GHz ~ 40GHz		Average (AV)

**ANTENNA POLARITY & TEST DISTANCE: HORIZONTAL AT 3 M**

NO.	FREQ. (MHz)	EMISSION LEVEL (dBuV/m)	LIMIT (dBuV/m)	MARGIN (dB)	ANTENNA HEIGHT (m)	TABLE ANGLE (Degree)	RAW VALUE (dBuV)	CORRECTION FACTOR (dB/m)
1	5150.00	61.4 PK	74.0	-12.6	2.62 H	360	60.81	0.59
2	5150.00	50.8 AV	54.0	-3.2	2.62 H	360	50.21	0.59
3	*5210.00	100.4 PK			2.62 H	360	99.61	0.79
4	*5210.00	88.5 AV			2.62 H	360	87.71	0.79
5	5350.00	50.2 PK	74.0	-23.8	2.62 H	360	49.04	1.16
6	5350.00	39.5 AV	54.0	-14.5	2.62 H	360	38.34	1.16
7	#5788.00	56.7 PK	68.2	-11.5	2.62 H	360	54.90	1.80
8	#10420.00	53.5 PK	68.2	-14.7	1.20 H	96	42.51	10.99
9	15630.00	53.1 PK	74.0	-20.9	1.04 H	137	40.57	12.53
10	15630.00	42.1 AV	54.0	-11.9	1.04 H	137	29.57	12.53

**ANTENNA POLARITY & TEST DISTANCE: VERTICAL AT 3 M**

NO.	FREQ. (MHz)	EMISSION LEVEL (dBuV/m)	LIMIT (dBuV/m)	MARGIN (dB)	ANTENNA HEIGHT (m)	TABLE ANGLE (Degree)	RAW VALUE (dBuV)	CORRECTION FACTOR (dB/m)
1	5150.00	68.6 PK	74.0	-5.4	1.35 V	116	68.01	0.59
2	5150.00	53.7 AV	54.0	-0.3	1.35 V	116	53.11	0.59
3	*5210.00	105.0 PK			1.22 V	114	104.21	0.79
4	*5210.00	92.6 AV			1.22 V	114	91.81	0.79
5	5350.00	54.5 PK	74.0	-19.5	1.35 V	116	53.34	1.16
6	5350.00	42.0 AV	54.0	-12.0	1.35 V	116	40.84	1.16
7	#5788.00	63.8 PK	68.2	-4.4	1.22 V	114	62.00	1.80
8	#10420.00	57.6 PK	68.2	-10.6	1.07 V	60	46.61	10.99
9	15630.00	56.1 PK	74.0	-17.9	1.21 V	46	43.57	12.53
10	15630.00	44.9 AV	54.0	-9.1	1.21 V	46	32.37	12.53

**REMARKS:**

1. Emission Level(dBuV/m) = Raw Value(dBuV) + Correction Factor(dB/m)
2. Correction Factor(dB/m) = Antenna Factor(dB/m) + Cable Factor(dB) – Pre-Amplifier Factor(dB)
3. The other emission levels were very low against the limit.
4. Margin value = Emission Level – Limit value
5. " \* ": Fundamental frequency.
6. " # ": The radiated frequency is out of the restricted band.

<b>CHANNEL</b>	TX Channel 155	<b>DETECTOR FUNCTION</b>	Peak (PK)
<b>FREQUENCY RANGE</b>	1GHz ~ 40GHz		Average (AV)

**ANTENNA POLARITY & TEST DISTANCE: HORIZONTAL AT 3 M**

NO.	FREQ. (MHz)	EMISSION LEVEL (dBuV/m)	LIMIT (dBuV/m)	MARGIN (dB)	ANTENNA HEIGHT (m)	TABLE ANGLE (Degree)	RAW VALUE (dBuV)	CORRECTION FACTOR (dB/m)
1	5133.00	54.5 PK	74.0	-19.5	1.12 H	163	53.96	0.54
2	5133.00	46.6 AV	54.0	-7.4	1.12 H	163	46.06	0.54
3	#5715.00	66.1 PK	74.0	-7.9	1.12 H	163	64.40	1.70
4	#5715.00	51.2 AV	54.0	-2.8	1.12 H	163	49.50	1.70
5	#5725.00	66.0 PK	78.2	-12.2	1.12 H	163	64.29	1.71
6	*5775.00	103.3 PK			1.12 H	163	101.51	1.79
7	*5775.00	90.7 AV			1.12 H	163	88.91	1.79
8	#5850.00	62.0 PK	78.2	-16.2	1.12 H	163	60.18	1.82
9	#5860.00	61.2 PK	74.0	-12.8	1.12 H	164	59.38	1.82
10	#5860.00	47.8 AV	54.0	-6.2	1.12 H	164	45.98	1.82
11	11550.00	53.8 PK	74.0	-20.2	1.18 H	89	41.56	12.24
12	11550.00	42.5 AV	54.0	-11.5	1.18 H	89	30.26	12.24
13	#17325.00	53.4 PK	74.0	-20.6	1.06 H	133	36.35	17.05
14	#17325.00	42.4 AV	54.0	-11.6	1.06 H	133	25.35	17.05

**ANTENNA POLARITY & TEST DISTANCE: VERTICAL AT 3 M**

NO.	FREQ. (MHz)	EMISSION LEVEL (dBuV/m)	LIMIT (dBuV/m)	MARGIN (dB)	ANTENNA HEIGHT (m)	TABLE ANGLE (Degree)	RAW VALUE (dBuV)	CORRECTION FACTOR (dB/m)
1	5133.00	56.1 PK	74.0	-17.9	1.11 V	116	55.56	0.54
2	5133.00	49.4 AV	54.0	-4.6	1.11 V	116	48.86	0.54
3	#5715.00	69.1 PK	74.0	-4.9	1.27 V	115	67.40	1.70
<b>4</b>	<b>#5715.00</b>	<b>53.9 AV</b>	<b>54.0</b>	<b>-0.1</b>	<b>1.27 V</b>	<b>115</b>	<b>52.20</b>	<b>1.70</b>
5	#5725.00	69.3 PK	78.2	-8.9	1.27 V	115	67.59	1.71
6	*5775.00	108.4 PK			1.27 V	115	106.61	1.79
7	*5775.00	96.0 AV			1.27 V	115	94.22	1.79
8	#5850.00	67.0 PK	78.2	-11.2	1.27 V	115	65.18	1.82
9	#5860.00	66.5 PK	74.0	-7.5	1.27 V	115	64.68	1.82
10	#5860.00	51.8 AV	54.0	-2.2	1.27 V	115	49.98	1.82
11	11550.00	57.2 PK	74.0	-16.8	1.11 V	49	44.96	12.24
12	11550.00	44.7 AV	54.0	-9.3	1.11 V	49	32.46	12.24
13	#17325.00	56.3 PK	74.0	-17.7	1.16 V	39	39.25	17.05
14	#17325.00	44.8 AV	54.0	-9.2	1.16 V	39	27.75	17.05

**REMARKS:**

- Emission Level(dBuV/m) = Raw Value(dBuV) + Correction Factor(dB/m)
- Correction Factor(dB/m) = Antenna Factor(dB/m) + Cable Factor(dB) – Pre-Amplifier Factor(dB)
- The other emission levels were very low against the limit.
- Margin value = Emission Level – Limit value
- " \* ": Fundamental frequency.
- " # ": The radiated frequency is out of the restricted band.

**Below 1GHz Data:**
**802.11ac VHT20**

<b>CHANNEL</b>	TX Channel 157	<b>DETECTOR FUNCTION</b>	Quasi-Peak (QP)
<b>FREQUENCY RANGE</b>	30MHz ~ 1GHz		

**ANTENNA POLARITY & TEST DISTANCE: HORIZONTAL AT 3 M**

NO.	FREQ. (MHz)	EMISSION LEVEL (dBuV/m)	LIMIT (dBuV/m)	MARGIN (dB)	ANTENNA HEIGHT (m)	TABLE ANGLE (Degree)	RAW VALUE (dBuV)	CORRECTION FACTOR (dB/m)
1	47.29	30.7 QP	40.0	-9.3	2.00 H	70	29.70	1.01
2	234.45	39.8 QP	46.0	-6.2	1.50 H	93	40.69	-0.93
3	280.33	37.6 QP	46.0	-8.4	1.00 H	291	36.26	1.34
4	400.01	38.8 QP	46.0	-7.2	1.00 H	210	34.73	4.06
5	533.36	36.1 QP	46.0	-9.9	1.00 H	0	29.15	6.97
6	879.99	37.0 QP	46.0	-9.0	1.00 H	188	24.19	12.83

**ANTENNA POLARITY & TEST DISTANCE: VERTICAL AT 3 M**

NO.	FREQ. (MHz)	EMISSION LEVEL (dBuV/m)	LIMIT (dBuV/m)	MARGIN (dB)	ANTENNA HEIGHT (m)	TABLE ANGLE (Degree)	RAW VALUE (dBuV)	CORRECTION FACTOR (dB/m)
1	55.58	34.0 QP	40.0	-6.0	1.00 V	71	33.19	0.79
2	88.95	34.1 QP	43.5	-9.4	1.00 V	257	38.96	-4.90
3	257.25	31.4 QP	46.0	-14.7	1.00 V	340	31.20	0.15
4	400.01	34.0 QP	46.0	-12.0	1.50 V	0	29.95	4.06
5	640.01	36.3 QP	46.0	-9.7	1.50 V	360	26.88	9.38
6	856.42	36.8 QP	46.0	-9.2	2.00 V	255	24.29	12.47

**REMARKS:**

1. Emission Level(dBuV/m) = Raw Value(dBuV) + Correction Factor(dB/m)
2. Correction Factor(dB/m) = Antenna Factor(dB/m) + Cable Factor(dB) – Pre-Amplifier Factor(dB)
3. The other emission levels were very low against the limit.
4. Margin value = Emission Level – Limit value



## 4.2 Conducted Emission Measurement

### 4.2.1 Limits of Conducted Emission Measurement

Frequency (MHz)	Conducted Limit (dBuV)	
	Quasi-peak	Average
0.15 - 0.5	66 - 56	56 - 46
0.50 - 5.0	56	46
5.0 - 30.0	60	50

Note: 1. The lower limit shall apply at the transition frequencies.

2. The limit decreases in line with the logarithm of the frequency in the range of 0.15 to 0.50MHz.

### 4.2.2 Test Instruments

DESCRIPTION & MANUFACTURER	MODEL NO.	SERIAL NO.	CALIBRATED DATE	CALIBRATED UNTIL
Test Receiver R&S	ESCS 30	100375	May 06, 2015	May 05, 2016
Line-Impedance Stabilization Network (for EUT) SCHWARZBECK	NSLK-8127	8127-522	Sep. 01, 2015	Aug. 31, 2016
Line-Impedance Stabilization Network (for Peripheral ) R&S	ENV216	100072	June 11, 2015	June 10, 2016
RF Cable	5D-FB	COCCAB-001	Mar. 08, 2016	Mar. 07, 2017
50 ohms Terminator	N/A	EMC-03	Sep. 23, 2015	Sep. 22, 2016
50 ohms Terminator	N/A	EMC-02	Oct. 01, 2015	Sep. 30, 2016
50 ohms Terminator	E1-011315	13	Dec. 11 2015	Dec. 10 2016
Software BVADT	BVADT_Cond_ V7.3.7.3	NA	NA	NA

**Note:**

1. The calibration interval of the above test instruments are 12 months and the calibrations are traceable to NML/ROC and NIST/USA.
2. The test was performed in Shielded Room No. C.
3. The VCCI Con C Registration No. is C-3611.
4. Tested Date: Mar. 31, 2016

#### 4.2.3 Test Procedure

- a. The EUT was placed 0.4 meters from the conducting wall of the shielded room with EUT being connected to the power mains through a line impedance stabilization network (LISN). Other support units were connected to the power mains through another LISN. The two LISNs provide 50 ohm/ 50uH of coupling impedance for the measuring instrument.
- b. Both lines of the power mains connected to the EUT were checked for maximum conducted interference.
- c. The frequency range from 150kHz to 30MHz was searched. Emission levels under (Limit - 20dB) was not recorded.

**NOTE:** All modes of operation were investigated and the worst-case emissions are reported.

#### 4.2.4 Deviation from Test Standard

No deviation.

#### 4.2.5 Test Setup

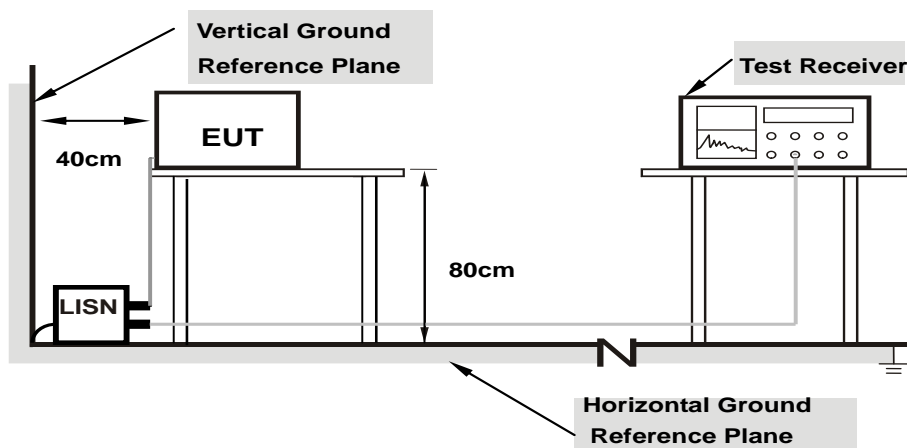

**Note: 1.Support units were connected to second LISN.**

For the actual test configuration, please refer to the attached file (Test Setup Photo).

#### 4.2.6 EUT Operating Condition

Same as 4.1.6.

4.2.7 Test Results

Phase	Line (L)	Detector Function	Quasi-Peak (QP) / Average (AV)
-------	----------	-------------------	--------------------------------

No	Freq. [MHz]	Corr.	Reading Value		Emission Level		Limit		Margin	
		Factor (dB)	[dB (uV)]		[dB (uV)]		[dB (uV)]		(dB)	
			Q.P.	AV.	Q.P.	AV.	Q.P.	AV.	Q.P.	AV.
1	0.15391	10.44	36.43	23.41	46.87	33.85	65.79	55.79	-18.91	-21.93
<b>2</b>	<b>0.35313</b>	<b>10.42</b>	<b>29.57</b>	<b>28.28</b>	<b>39.99</b>	<b>38.70</b>	<b>58.89</b>	<b>48.89</b>	<b>-18.90</b>	<b>-10.19</b>
3	2.26953	10.47	12.07	7.53	22.54	18.00	56.00	46.00	-33.46	-28.00
4	2.81641	10.52	14.07	9.06	24.59	19.58	56.00	46.00	-31.41	-26.42
5	9.46094	10.89	21.91	17.44	32.80	28.33	60.00	50.00	-27.20	-21.67
6	11.23828	11.00	22.53	18.25	33.53	29.25	60.00	50.00	-26.47	-20.75

REMARKS:

1. Q.P. and AV. are abbreviations of quasi-peak and average individually.
2. The emission levels of other frequencies were very low against the limit.
3. Margin value = Emission level - Limit value
4. Correction factor = Insertion loss + Cable loss
5. Emission Level = Correction Factor + Reading Value

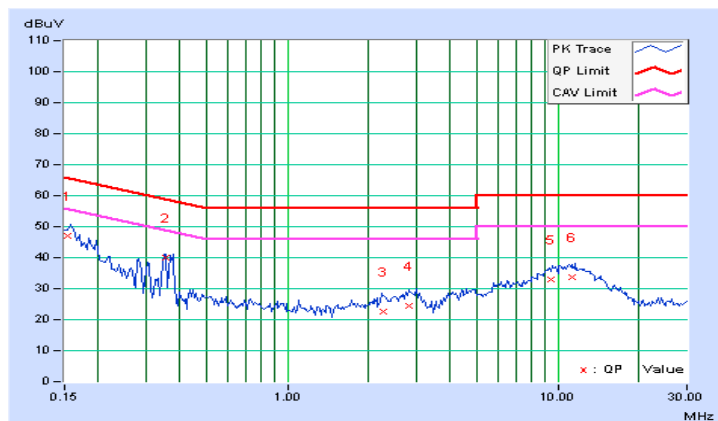

Phase	Neutral (N)	Detector Function	Quasi-Peak (QP) / Average (AV)
-------	-------------	-------------------	--------------------------------

No	Freq. [MHz]	Corr.	Reading Value		Emission Level		Limit		Margin	
		Factor	[dB (uV)]		[dB (uV)]		[dB (uV)]		(dB)	
		(dB)	Q.P.	AV.	Q.P.	AV.	Q.P.	AV.	Q.P.	AV.
1	0.15466	10.45	36.09	21.60	46.54	32.05	65.75	55.75	-19.21	-23.70
2	0.35313	10.47	24.23	22.68	34.70	33.15	58.89	48.89	-24.19	-15.74
3	0.35600	10.47	23.25	19.34	33.72	29.81	58.82	48.82	-25.10	-19.01
4	2.88528	10.60	15.04	9.36	25.64	19.96	56.00	46.00	-30.36	-26.04
5	4.39453	10.74	14.79	9.99	25.53	20.73	56.00	46.00	-30.47	-25.27
6	9.85156	10.93	22.30	17.86	33.23	28.79	60.00	50.00	-26.77	-21.21

**REMARKS:**

1. Q.P. and AV. are abbreviations of quasi-peak and average individually.
2. The emission levels of other frequencies were very low against the limit.
3. Margin value = Emission level - Limit value
4. Correction factor = Insertion loss + Cable loss
5. Emission Level = Correction Factor + Reading Value

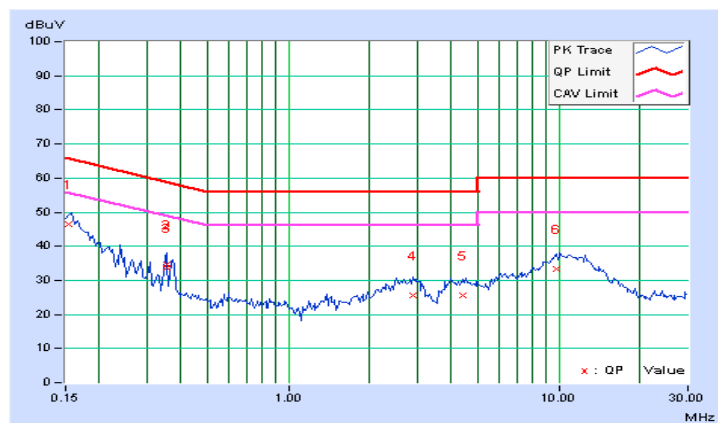

### 4.3 Transmit Power Measurement

#### 4.3.1 Limits of Transmit Power Measurement

Operation Band	EUT Category		LIMIT
U-NII-1		Outdoor Access Point	1 Watt (30 dBm) (Max. e.i.r.p $\leq$ 125mW(21 dBm) at any elevation angle above 30 degrees as measured from the horizon)
		Fixed point-to-point Access Point	1 Watt (30 dBm)
	√	Indoor Access Point	1 Watt (30 dBm)
		Mobile and Portable client device	250mW (24 dBm)
U-NII-2A			250mW (24 dBm) or 11 dBm+10 log B*
U-NII-2C			250mW (24 dBm) or 11 dBm+10 log B*
U-NII-3	√		1 Watt (30 dBm)

\*B is the 26 dB emission bandwidth in megahertz

Per KDB 662911 Method of conducted output power measurement on IEEE 802.11 devices,

Array Gain = 0 dB (i.e., no array gain) for  $N_{ANT} \leq 4$ ;

Array Gain = 0 dB (i.e., no array gain) for channel widths  $\geq 40$  MHz for any  $N_{ANT}$ ;

Array Gain =  $5 \log(N_{ANT}/N_{SS})$  dB or 3 dB, whichever is less for 20-MHz channel widths with  $N_{ANT} \geq 5$ .

For power measurements on all other devices: Array Gain =  $10 \log(N_{ANT}/N_{SS})$  dB.

#### 4.3.2 Test Setup

##### FOR POWER OUTPUT MEASUREMENT

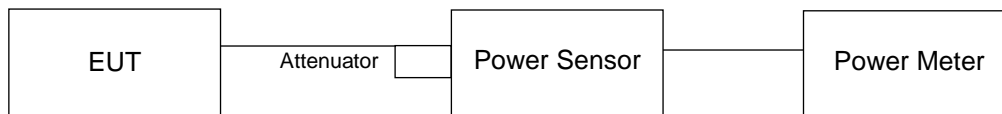

#### 4.3.3 Test Instruments

Refer to section 4.1.2 to get information of above instrument.

#### 4.3.4 Test Procedure

##### FOR POWER OUTPUT MEASUREMENT

Method PM is used to perform output power measurement, trigger and gating function of wide band power meter is enabled to measure max output power of TX on burst. Duty factor is not added to measured value.

#### 4.3.5 Deviation from Test Standard

No deviation.

#### 4.3.6 EUT Operating Condition

The software provided by client to enable the EUT under transmission condition continuously at lowest, middle and highest channel frequencies individually.

#### 4.3.7 Test Result

#### POWER OUTPUT:

##### 802.11a

Chan.	Chan. Freq. (MHz)	Average Power (mW)	Average Power (dBm)	Limit (dBm)	Pass / Fail
36	5180	218.273	23.39	30	Pass
40	5200	274.789	24.39	30	Pass
48	5240	435.512	26.39	30	Pass
149	5745	103.753	20.16	30	Pass
157	5785	356.451	25.52	30	Pass
165	5825	243.22	23.86	30	Pass

##### 802.11ac (VHT20)

Chan.	Chan. Freq. (MHz)	Average Power (dBm)			Total Power (mW)	Total Power (dBm)	Limit (dBm)	Pass / Fail
		Chain 0	Chain 1	Chain 2				
36	5180	19.85	19.02	17.08	227.454	23.57	30	Pass
40	5200	20.37	19.71	18.77	277.77	24.44	30	Pass
48	5240	23.32	22.21	21.59	525.336	27.20	30	Pass
149	5745	18.91	18.42	17.98	210.112	23.22	30	Pass
157	5785	25.01	24.49	23.41	817.427	29.12	30	Pass
165	5825	19.86	20.11	18.71	273.695	24.37	30	Pass

##### 802.11ac (VHT40)

Chan.	Chan. Freq. (MHz)	Average Power (dBm)			Total Power (mW)	Total Power (dBm)	Limit (dBm)	Pass / Fail
		Chain 0	Chain 1	Chain 2				
38	5190	16.45	15.92	14.92	114.287	20.58	30	Pass
46	5230	23.59	22.21	21.71	543.153	27.35	30	Pass
151	5755	17.59	17.35	16.11	152.569	21.83	30	Pass
159	5795	20.11	20.11	18.46	275.276	24.40	30	Pass

##### 802.11ac (VHT80)

Chan.	Chan. Freq. (MHz)	Average Power (dBm)			Total Power (mW)	Total Power (dBm)	Limit (dBm)	Pass / Fail
		Chain 0	Chain 1	Chain 2				
42	5210	15.61	15.41	14.61	100.053	20.00	30	Pass
155	5775	16.16	16.61	15.33	121.238	20.84	30	Pass

#### 4.4 Peak Power Spectral Density Measurement

##### 4.4.1 Limits of Peak Power Spectral Density Measurement

Operation Band	EUT Category		LIMIT
U-NII-1		Outdoor Access Point	17dBm/ MHz
		Fixed point-to-point Access Point	
	√	Indoor Access Point	
		Mobile and Portable client device	11dBm/ MHz
U-NII-2A	---		11dBm/ MHz
U-NII-2C	---		11dBm/ MHz
U-NII-3	√		30dBm/ 500kHz

##### 4.4.2 Test Setup

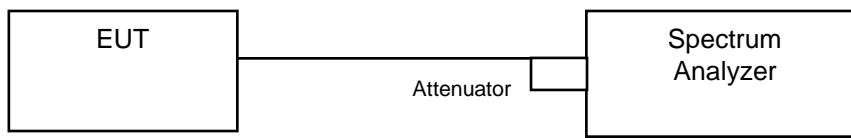

##### 4.4.3 Test Instruments

Refer to section 4.1.2 to get information of above instrument.



#### 4.4.4 Test Procedure

##### 802.11a, 802.11ac (VHT20), 802.11ac (VHT40)

###### For U-NII-1:

Using method SA-1

1. Set span to encompass the entire emission bandwidth (EBW) of the signal.
2. Set RBW = 1 MHz, Set VBW  $\geq$  3 MHz, Detector = RMS
3. Sweep time = auto, trigger set to "free run".
4. Trace average at least 100 traces in power averaging mode.
5. Record the max value

###### For U-NII-3:

1. Set span to encompass the entire emission bandwidth (EBW) of the signal.
2. Set RBW = 300 kHz, Set VBW  $\geq$  1 MHz, Detector = RMS
3. Use the peak marker function to determine the maximum power level in any 300 kHz band segment within the fundamental EBW.
4. Scale the observed power level to an equivalent value in 500 kHz by adjusting (reducing) the measured power by a bandwidth correction factor (BWCF) where  $BWCF = 10\log(500\text{ kHz}/300\text{ kHz})$
5. Sweep time = auto, trigger set to "free run".
6. Trace average at least 100 traces in power averaging mode.
7. Record the max value

##### 802.11ac (VHT40)

###### For U-NII-1:

Using method SA-2

1. Set span to encompass the entire emission bandwidth (EBW) of the signal.
2. Set RBW = 1 MHz, Set VBW  $\geq$  3 MHz, Detector = RMS
3. Sweep time = auto, trigger set to "free run".
4. Trace average at least 100 traces in power averaging mode.
5. Record the max value and add  $10\log(1/\text{duty cycle})$

**For U-NII-3:** Set span to encompass the entire emission bandwidth (EBW) of the signal.

1. Set RBW = 300 kHz, Set VBW  $\geq$  1 MHz, Detector = RMS
2. Use the peak marker function to determine the maximum power level in any 300 kHz band segment within the fundamental EBW.
3. Scale the observed power level to an equivalent value in 500 kHz by adjusting (reducing) the measured power by a bandwidth correction factor (BWCF) where  $BWCF = 10\log(500\text{ kHz}/300\text{ kHz})$
4. Sweep time = auto, trigger set to "free run".
5. Trace average at least 100 traces in power averaging mode.
6. Record the max value and add  $10\log(1/\text{duty cycle})$

#### 4.4.5 Deviation from Test Standard

No deviation.

#### 4.4.6 EUT Operating Condition

Same as Item 4.3.6.

#### 4.4.7 Test Results

##### For U-NII-1:

##### 802.11a

Chan.	Chan. Freq. (MHz)	PSD (dBm/MHz)	MAX. Limit (dBm/MHz)	Pass / Fail
36	5180	9.02	17	Pass
40	5200	10.55	17	Pass
48	5240	13.11	17	Pass

##### 802.11ac (VHT20)

Chan.	Chan. Freq. (MHz)	PSD (dBm/MHz)			Total Power Density (dBm/MHz)	MAX. Limit (dBm/MHz)	Pass / Fail
		Chain 0	Chain 1	Chain 2			
36	5180	3.52	3.46	2.18	7.87	16.06	Pass
40	5200	5.08	5.78	4.76	10.00	16.06	Pass
48	5240	8.86	9.35	8.20	13.60	16.06	Pass

- Note:** 1. Method a) of power density measurement of KDB 662911 is using for calculating total power density. Total power density is summing entire spectra across corresponding frequency bins on the various outputs by computer.
2. Directional gain =  $10 \log[(10^{G1/20} + 10^{G2/20})^2 / 2] = 6.94\text{dBi} > 6\text{dBi}$ , so the power density limit shall be reduced to  $17-(6.94-6) = 16.06\text{dBm}$ .

##### 802.11ac (VHT40)

Chan.	Chan. Freq. (MHz)	PSD (dBm/MHz)			Total Power Density (dBm/MHz)	MAX. Limit (dBm/MHz)	Pass / Fail
		Chain 0	Chain 1	Chain 2			
38	5190	-0.48	-2.03	-2.59	3.17	16.06	Pass
46	5230	5.59	6.28	5.23	10.49	16.06	Pass

- Note:** 1. Method a) of power density measurement of KDB 662911 is using for calculating total power density. Total power density is summing entire spectra across corresponding frequency bins on the various outputs by computer.
2. Directional gain =  $10 \log[(10^{G1/20} + 10^{G2/20})^2 / 2] = 6.94\text{dBi} > 6\text{dBi}$ , so the power density limit shall be reduced to  $17-(6.94-6) = 16.06\text{dBm}$ .

802.11ac (VHT80)

Chan.	Chan. Freq. (MHz)	PSD W/O Duty Factor (dBm)			Duty Factor (dB)	Total PSD With Duty Factor (dBm)	MAX. Limit (dBm)	Pass / Fail
		Chain 0	Chain 1	Chain 2				
42	5210	-5.33	-3.84	-4.85	0.20	0.35	16.06	Pass

- Note:**
- Method a) of power density measurement of KDB 662911 is using for calculating total power density. Total power density is summing entire spectra across corresponding frequency bins on the various outputs by computer.
  - Directional gain =  $10 \log[(10^{G1/20} + 10^{G2/20})^2 / 2] = 6.94\text{dBi} > 6\text{dBi}$  , so the power density limit shall be reduced to  $17-(6.94-6) = 16.06\text{dBm}$ .
  - Refer to section 3.3 for duty cycle spectrum plot.

Spectrum Plot of Worst Value

802.11a / CH48

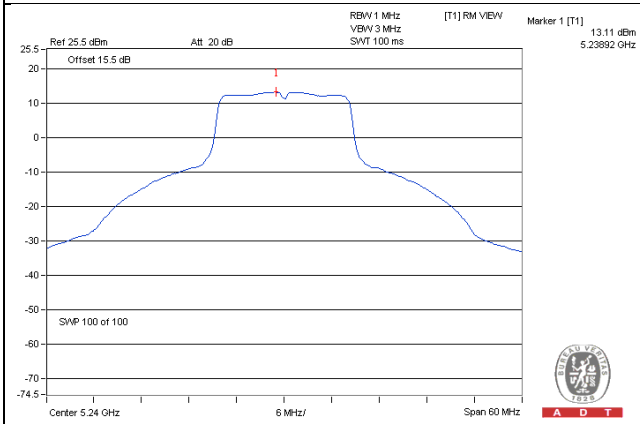

802.11ac (VHT20)\_Chain 1 / CH48

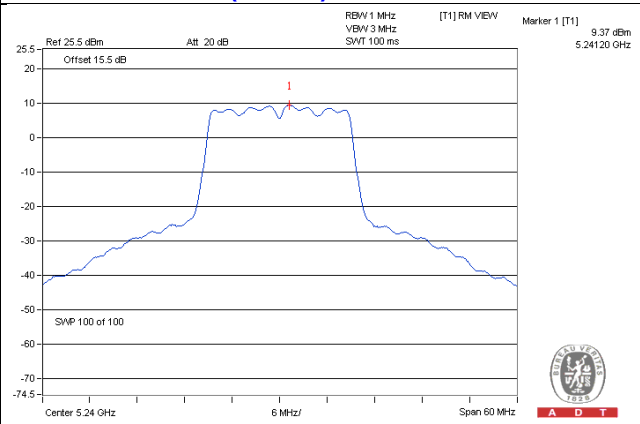

802.11ac (VHT40)\_Chain 0 / CH46

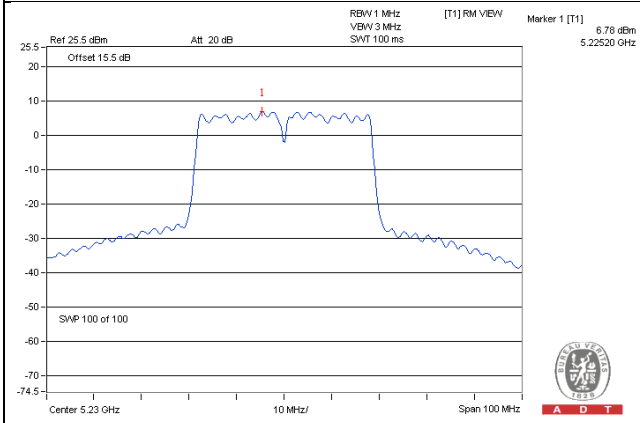

802.11ac (VHT80)\_Chain 1 / CH42

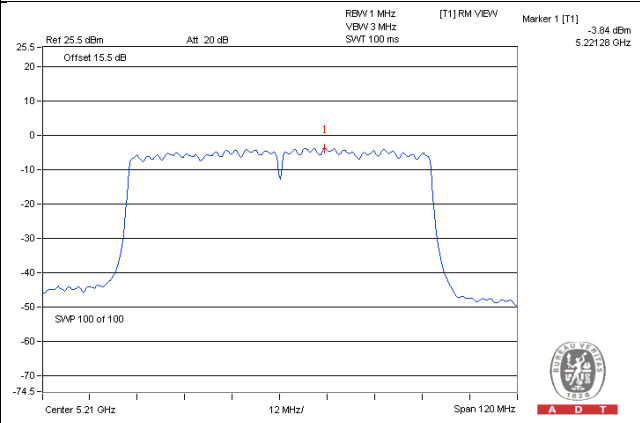

**For U-NII-3:**
**802.11a**

Chan.	Chan. Freq. (MHz)	PSD (dBm/300kHz)	PSD (dBm/500kHz)	Limit (dBm/500kHz)	Pass /Fail
149	5745	-0.13	2.09	30	Pass
157	5785	4.26	6.48	30	Pass
165	5825	2.74	4.96	30	Pass

**802.11ac (VHT20)**

TX chain	Channel	Freq. (MHz)	PSD (dBm/300kHz)	PSD (dBm/500kHz)	10 log (N=3) dB	Total PSD (dBm/500kHz)	Limit (dBm/500kHz)	Pass /Fail
0	149	5745	-2.06	0.16	4.77	4.93	28.48	Pass
	157	5785	3.22	5.44	4.77	10.21	28.48	Pass
	165	5825	-1.46	0.76	4.77	5.53	28.48	Pass
1	149	5745	-1.54	0.68	4.77	5.45	28.48	Pass
	157	5785	3.27	5.49	4.77	10.26	28.48	Pass
	165	5825	-0.64	1.58	4.77	6.35	28.48	Pass
2	149	5745	-3.72	-1.50	4.77	3.27	28.48	Pass
	157	5785	1.93	4.15	4.77	8.92	28.48	Pass
	165	5825	-2.47	-0.25	4.77	4.52	28.48	Pass

Note: 1. Directional gain =  $10 \log[(10^{G1/20} + 10^{G2/20})^2 / 2] = 7.52\text{dBi} > 6\text{dBi}$  , so the power density limit shall be reduced to  $30-(7.52-6) = 28.48\text{dBm}$ .

**802.11ac (VHT40)**

TX chain	Channel	Freq. (MHz)	PSD (dBm/300kHz)	PSD (dBm/500kHz)	10 log (N=3) dB	Total PSD (dBm/500kHz)	Limit (dBm/500kHz)	Pass /Fail
0	151	5755	-6.71	-4.49	4.77	0.28	28.48	Pass
	159	5795	-4.73	-2.51	4.77	2.26	28.48	Pass
1	151	5755	-6.53	-4.31	4.77	0.46	28.48	Pass
	159	5795	-4.61	-2.39	4.77	2.38	28.48	Pass
2	151	5755	-8.26	-6.04	4.77	-1.27	28.48	Pass
	159	5795	-6.26	-4.04	4.77	0.73	28.48	Pass

Note: 1. Directional gain =  $10 \log[(10^{G1/20} + 10^{G2/20})^2 / 2] = 7.52\text{dBi} > 6\text{dBi}$  , so the power density limit shall be reduced to  $30-(7.52-6) = 28.48\text{dBm}$ .

**802.11ac (VHT80)**

TX chain	Chan.	Chan. Freq. (MHz)	PSD W/O Duty Factor		10 log (N=3) dB	Duty Factor (dB)	Total PSD With Duty Factor (dBm/500kHz)	Limit (dBm/500kHz)	Pass /Fail
			(dBm/300kHz)	(dBm/500kHz)					
0	155	5775	-12.54	-10.32	4.77	0.20	-5.35	28.48	Pass
1	155	5775	-10.15	-7.93	4.77	0.20	-2.96	28.48	Pass
2	155	5775	-12.20	-9.98	4.77	0.20	-5.01	28.48	Pass

Note: 1. Directional gain =  $10 \log[(10^{G1/20} + 10^{G2/20})^2 / 2] = 7.52\text{dBi} > 6\text{dBi}$  , so the power density limit shall be reduced to  $30-(7.52-6) = 28.48\text{dBm}$ .

2. Refer to section 3.3 for duty cycle spectrum plot.

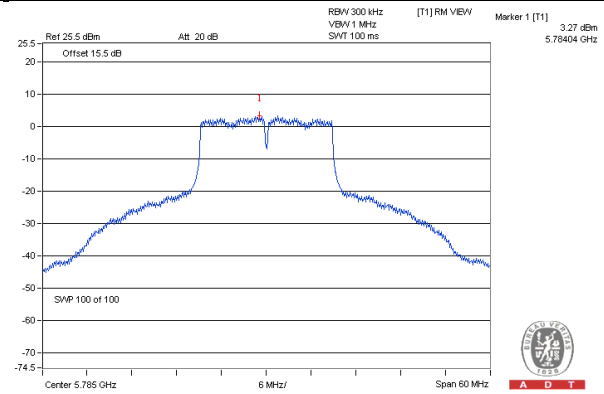
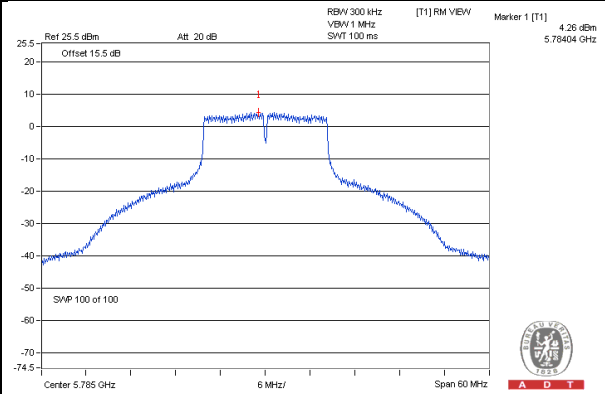
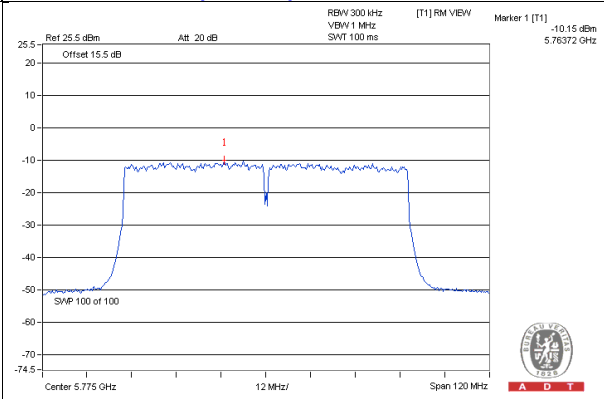
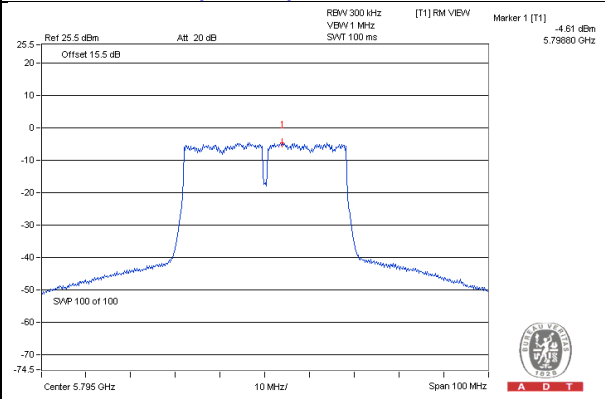
**Spectrum Plot of Worst Value****802.11a: CH 157****802.11a (VHT20) – Chain 1: CH 157****802.11ac (VHT40) – Chain 1: CH 159****802.11ac (VHT80) – Chain 1: CH 155**

## 4.5 Frequency Stability Measurement

### 4.5.1 Limits of Frequency Stability Measurement

The frequency of the carrier signal shall be maintained within band of operation

### 4.5.2 Test Setup

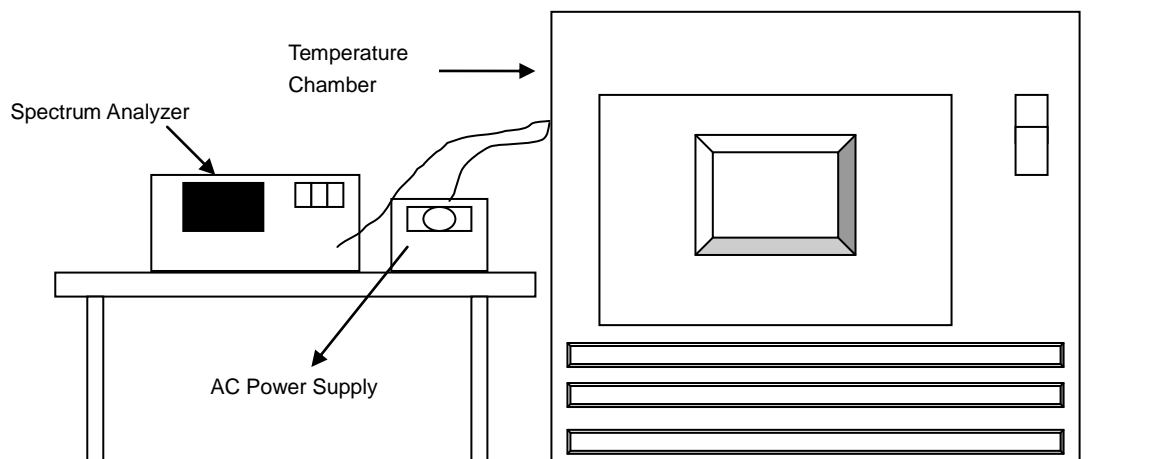

### 4.5.3 Test Instruments

Refer to section 4.1.2 to get information of above instrument.

### 4.5.4 Test Procedure

- The EUT was placed inside the environmental test chamber and powered by nominal AC voltage.
- Turn the EUT on and couple its output to a spectrum analyzer.
- Turn the EUT off and set the chamber to the highest temperature specified.
- Allow sufficient time (approximately 30 min) for the temperature of the chamber to stabilize, turn the EUT on and measure the operating frequency after 2, 5, and 10 minutes.
- Repeat step 2 and 3 with the temperature chamber set to the lowest temperature.
- The test chamber was allowed to stabilize at +20 degree C for a minimum of 30 minutes. The supply voltage was then adjusted on the EUT from 85% to 115% and the frequency record.

### 4.5.5 Deviation from Test Standard

No deviation.

### 4.5.6 EUT Operating Condition

Set the EUT transmit at un-modulation mode to test frequency stability.



**4.5.7 Test Results**

<b>FREQUENCY STABILITY VERSUS TEMP.</b>									
<b>OPERATING FREQUENCY: 5180MHz</b>									
<b>TEMP. (°C)</b>	<b>POWER SUPPLY (Vac)</b>	<b>0 MINUTE</b>		<b>2 MINUTE</b>		<b>5 MINUTE</b>		<b>10 MINUTE</b>	
		<b>Measured Frequency (MHz)</b>	<b>Frequency Drift (%)</b>	<b>Measured Frequency (MHz)</b>	<b>Frequency Drift (%)</b>	<b>Measured Frequency (MHz)</b>	<b>Frequency Drift (%)</b>	<b>Measured Frequency (MHz)</b>	<b>Frequency Drift (%)</b>
50	120	5179.9765	-0.00045	5179.9777	-0.00043	5179.9778	-0.00043	5179.9767	-0.00045
40	120	5180.0003	0.00001	5179.9988	-0.00002	5180.0012	0.00002	5179.996	-0.00008
30	120	5179.9882	-0.00023	5179.9906	-0.00018	5179.9927	-0.00014	5179.9923	-0.00015
20	120	5179.99	-0.00019	5179.9908	-0.00018	5179.9908	-0.00018	5179.9917	-0.00016
10	120	5179.9982	-0.00003	5179.9977	-0.00004	5180.0002	0.00000	5180.0002	0.00000
0	120	5180.0006	0.00001	5180.0009	0.00002	5179.999	-0.00002	5179.998	-0.00004
-10	120	5179.9904	-0.00019	5179.9885	-0.00022	5179.9889	-0.00021	5179.9901	-0.00019
-20	120	5179.9971	-0.00006	5179.9952	-0.00009	5179.9997	-0.00001	5179.9983	-0.00003
-30	120	5179.9977	-0.00004	5180.0011	0.00002	5180.002	0.00004	5180.0024	0.00005

<b>FREQUENCY STABILITY VERSUS VOLTAGE</b>									
<b>OPERATING FREQUENCY: 5180MHz</b>									
<b>TEMP. (°C)</b>	<b>POWER SUPPLY (Vac)</b>	<b>0 MINUTE</b>		<b>2 MINUTE</b>		<b>5 MINUTE</b>		<b>10 MINUTE</b>	
		<b>Measured Frequency (MHz)</b>	<b>Frequency Drift (%)</b>	<b>Measured Frequency (MHz)</b>	<b>Frequency Drift (%)</b>	<b>Measured Frequency (MHz)</b>	<b>Frequency Drift (%)</b>	<b>Measured Frequency (MHz)</b>	<b>Frequency Drift (%)</b>
20	138	5179.989	-0.00021	5179.9902	-0.00019	5179.9918	-0.00016	5179.9918	-0.00016
	120	5179.99	-0.00019	5179.9908	-0.00018	5179.9908	-0.00018	5179.9917	-0.00016
	102	5179.9893	-0.00021	5179.9906	-0.00018	5179.9905	-0.00018	5179.9907	-0.00018

## 4.6 6dB Bandwidth Measurement

### 4.6.1 Limits of 6dB Bandwidth Measurement

The minimum of 6dB Bandwidth Measurement is 0.5MHz.

### 4.6.2 Test Setup

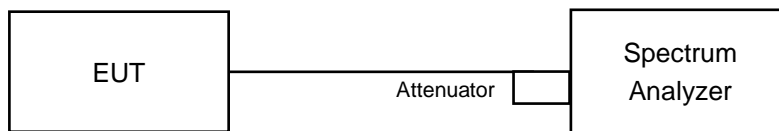

### 4.6.3 Test Instruments

Refer to section 4.1.2 to get information of above instrument.

### 4.6.4 Test Procedure

#### MEASUREMENT PROCEDURE REF

- a. Set resolution bandwidth (RBW) = 100kHz
- b. Set the video bandwidth (VBW)  $\geq 3 \times$  RBW, Detector = Peak.
- c. Trace mode = max hold.
- d. Sweep = auto couple.
- e. Measure the maximum width of the emission that is constrained by the frequencies associated with the two amplitude points (upper and lower) that are attenuated by 6 dB relative to the maximum level measured in the fundamental emission

### 4.6.5 Deviation from Test Standard

No deviation.

### 4.6.6 EUT Operating Condition

The software provided by client to enable the EUT under transmission condition continuously at lowest, middle and highest channel frequencies individually.

#### 4.6.7 Test Results

##### 802.11a

Channel	Frequency (MHz)	6dB Bandwidth (MHz)	Minimum Limit (MHz)	Pass / Fail
149	5745	16.38	0.5	Pass
157	5785	16.39	0.5	Pass
165	5825	16.38	0.5	Pass

##### 802.11ac (VHT20)

Channel	Frequency (MHz)	6dB Bandwidth (MHz)			Minimum Limit (MHz)	Pass / Fail
		Chain 0	Chain 1	Chain 2		
149	5745	17.23	17.67	17.67	0.5	Pass
157	5785	16.49	17.66	17.67	0.5	Pass
165	5825	17.09	17.64	17.65	0.5	Pass

##### 802.11ac (VHT40)

Channel	Frequency (MHz)	6dB Bandwidth (MHz)			Minimum Limit (MHz)	Pass / Fail
		Chain 0	Chain 1	Chain 2		
151	5755	36.44	36.45	36.46	0.5	Pass
159	5795	36.50	36.46	36.46	0.5	Pass

##### 802.11ac (VHT80)

Channel	Frequency (MHz)	6dB Bandwidth (MHz)			Minimum Limit (MHz)	Pass / Fail
		Chain 0	Chain 1	Chain 2		
155	5775	75.64	76.01	76.44	0.5	Pass

Spectrum Plot of Worst Value

802.11a / CH149

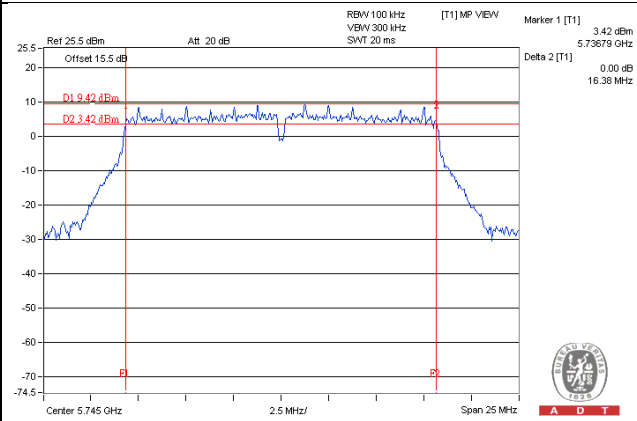

802.11ac (VHT20)\_Chain 0 / CH157

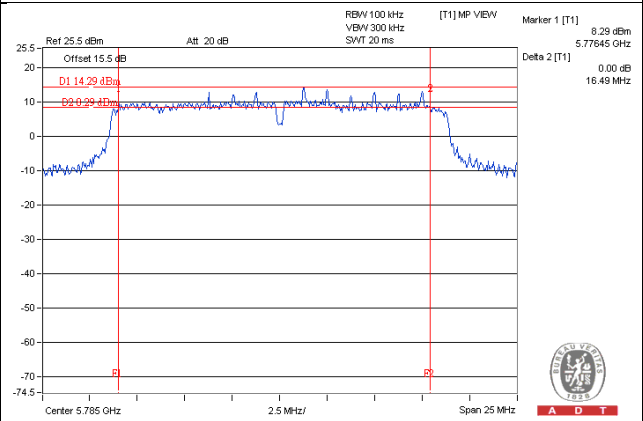

802.11ac (VHT40)\_Chain 0 / CH151

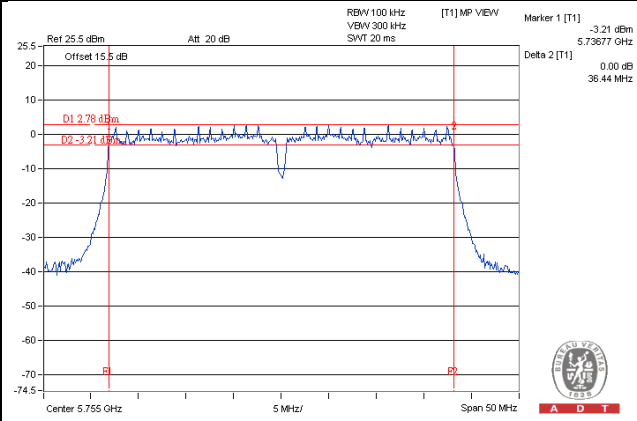

802.11ac (VHT80)\_Chain 0 / CH155

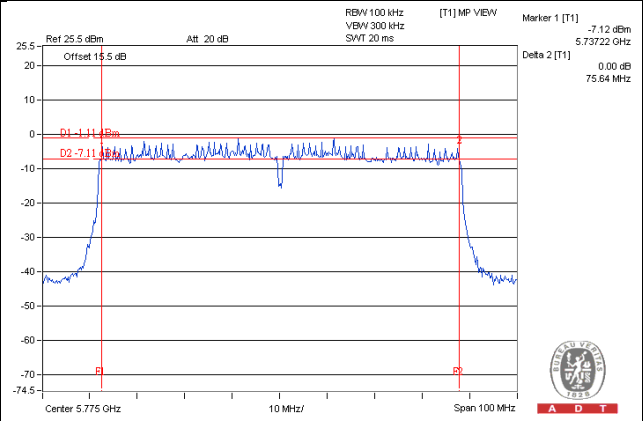

## 5 Pictures of Test Arrangements

Please refer to the attached file (Test Setup Photo).





## Appendix – Information on the Testing Laboratories

We, Bureau Veritas Consumer Products Services (H.K.) Ltd., Taoyuan Branch, were founded in 1988 to provide our best service in EMC, Radio, Telecom and Safety consultation. Our laboratories are accredited and approved according to ISO/IEC 17025.

If you have any comments, please feel free to contact us at the following:

**Linko EMC/RF Lab**

Tel: 886-2-26052180

Fax: 886-2-26051924

**Hsin Chu EMC/RF/Telecom Lab**

Tel: 886-3-6668565

Fax: 886-3-6668323

**Hwa Ya EMC/RF/Safety Lab**

Tel: 886-3-3183232

Fax: 886-3-3270892

**Email:** [service.adt@tw.bureauveritas.com](mailto:service.adt@tw.bureauveritas.com)

**Web Site:** [www.bureauveritas-adt.com](http://www.bureauveritas-adt.com)

The address and road map of all our labs can be found in our web site also.

--- END ---