



FCC TEST REPORT (15.247)

REPORT NO.: RF121222E03

MODEL NO.: EA6700

FCC ID: Q87-EA6700

RECEIVED: Dec. 22, 2012

TESTED: Jan. 02 to 08, 2013

ISSUED: Jan. 28, 2013

APPLICANT: Cisco Consumer Products LLC

ADDRESS: 121 Theory Drive Irvine California 92617
United States

ISSUED BY: Bureau Veritas Consumer Products Services
(H.K.) Ltd., Taoyuan Branch Hsin Chu Laboratory

LAB ADDRESS : No. 81-1, Lu Liao Keng, 9th Ling, Wu Lung Tsuen,
Chiung Lin Hsiang, Hsin Chu Hsien 307, Taiwan,
R.O.C.

TEST LOCATION (1): No. 81-1, Lu Liao Keng, 9th Ling, Wu Lung Tsuen,
Chiung Lin Hsiang, Hsin Chu Hsien 307, Taiwan,
R.O.C.

TEST LOCATION (2): No. 49, Ln. 206, Wende Rd., Shangshan Tsuen,
Chiung Lin Hsiang, Hsin Chu Hsien 307, Taiwan,
R.O.C.

This report should not be used by the client to claim product certification, approval, or endorsement by TAF or any government agencies.



This report is for your exclusive use. Any copying or replication of this report to or for any other person or entity, or use of our name or trademark, is permitted only with our prior written permission. This report sets forth our findings solely with respect to the test samples identified herein. The results set forth in this report are not indicative or representative of the quality or characteristics of the lot from which a test sample was taken or any similar or identical product unless specifically and expressly noted. Our report includes all of the tests requested by you and the results thereof based upon the information that you provided to us. You have 60 days from date of issuance of this report to notify us of any material error or omission caused by our negligence, provided, however, that such notice shall be in writing and shall specifically address the issue you wish to raise. A failure to raise such issue within the prescribed time shall constitute your unqualified acceptance of the completeness of this report, the tests conducted and the correctness of the report contents. Unless specific mention, the uncertainty of measurement has been explicitly taken into account to declare the compliance or non-compliance to the specification



A D T

Table of Contents

RELEASE CONTROL RECORD	5
1. CERTIFICATION	6
2. SUMMARY OF TEST RESULTS	7
2.1 MEASUREMENT UNCERTAINTY	8
3. GENERAL INFORMATION	9
3.1 GENERAL DESCRIPTION OF EUT	9
3.2 DESCRIPTION OF TEST MODES	13
3.2.1 TEST MODE APPLICABILITY AND TESTED CHANNEL DETAIL	14
3.3 GENERAL DESCRIPTION OF APPLIED STANDARDS	17
3.4 DESCRIPTION OF SUPPORT UNITS	18
3.5 CONFIGURATION OF SYSTEM UNDER TEST	19
4. TEST TYPES AND RESULTS (FOR 2.4GHZ, 2.400 ~ 2.4835GHZ BAND).....	21
4.1 CONDUCTED EMISSION MEASUREMENT	21
4.1.1 LIMITS OF CONDUCTED EMISSION MEASUREMENT	21
4.1.2 TEST INSTRUMENTS.....	21
4.1.3 TEST PROCEDURES	22
4.1.4 DEVIATION FROM TEST STANDARD	22
4.1.5 TEST SETUP	22
4.1.6 EUT OPERATING CONDITIONS	23
4.1.7 TEST RESULTS (MODE 1)	24
4.1.8 TEST RESULTS (MODE 2)	26
4.1.9 TEST RESULTS (MODE 3)	28
4.2 RADIATED EMISSION AND BANDEDGE MEASUREMENT	30
4.2.1 LIMITS OF RADIATED EMISSION AND BANDEDGE MEASUREMENT.....	30
4.2.2 TEST INSTRUMENTS.....	31
4.2.3 TEST PROCEDURES	32
4.2.4 DEVIATION FROM TEST STANDARD	32
4.2.5 TEST SETUP	33
4.2.6 EUT OPERATING CONDITIONS	33
4.2.7 TEST RESULTS	34
4.3 6DB BANDWIDTH MEASUREMENT	47
4.3.1 LIMITS OF 6DB BANDWIDTH MEASUREMENT	47
4.3.2 TEST INSTRUMENTS.....	47
4.3.3 TEST PROCEDURE.....	47
4.3.4 DEVIATION FROM TEST STANDARD	47
4.3.5 TEST SETUP	47
4.3.6 EUT OPERATING CONDITIONS	47
4.3.7 TEST RESULTS	48
4.4 CONDUCTED OUTPUT POWER MEASUREMENT	49
4.4.1 LIMITS OF MAXIMUM PEAK OUTPUT POWER MEASUREMENT	49
4.4.2 INSTRUMENTS.....	49
4.4.3 TEST PROCEDURES	50
4.4.4 DEVIATION FROM TEST STANDARD	50
4.4.5 TEST SETUP	50
4.4.6 EUT OPERATING CONDITIONS	50
4.4.7 TEST RESULTS	51
4.5 POWER SPECTRAL DENSITY MEASUREMENT.....	52
4.5.1 LIMITS OF POWER SPECTRAL DENSITY MEASUREMENT	52
4.5.2 TEST INSTRUMENTS.....	52
4.5.3 TEST PROCEDURE.....	52



A D T

4.5.4	DEVIATION FROM TEST STANDARD	52
4.5.5	TEST SETUP	52
4.5.6	EUT OPERATING CONDITION	52
4.5.7	TEST RESULTS	53
4.6	CONDUCTED OUT-BAND EMISSION MEASUREMENT	55
4.6.1	LIMITS OF CONDUCTED OUT-BAND EMISSION MEASUREMENT	55
4.6.2	TEST INSTRUMENTS	55
4.6.3	TEST PROCEDURE	55
4.6.4	DEVIATION FROM TEST STANDARD	56
4.6.5	TEST SETUP	56
4.6.6	EUT OPERATING CONDITION	56
4.6.7	TEST RESULTS	56
5.	TEST TYPES AND RESULTS (FOR 5GHZ, 5.725~5.850GHZ BAND)	65
5.1	CONDUCTED EMISSION MEASUREMENT	65
5.1.1	LIMITS OF CONDUCTED EMISSION MEASUREMENT	65
5.1.2	TEST INSTRUMENTS	65
5.1.3	TEST PROCEDURES	66
5.1.4	DEVIATION FROM TEST STANDARD	66
5.1.5	TEST SETUP	66
5.1.6	EUT OPERATING CONDITIONS	67
5.1.7	TEST RESULTS (MODE 1)	68
5.1.8	TEST RESULTS (MODE 2)	70
5.1.9	TEST RESULTS (MODE 3)	72
5.2	RADIATED AND BANDEDGE EMISSION MEASUREMENT	74
5.2.1	LIMITS OF RADIATED AND BANDEDGE EMISSION MEASUREMENT	74
5.2.2	TEST INSTRUMENTS	75
5.2.3	TEST PROCEDURES	77
5.2.4	DEVIATION FROM TEST STANDARD	77
5.2.5	TEST SETUP	78
5.2.6	EUT OPERATING CONDITIONS	78
5.2.7	TEST RESULTS	79
5.3	6DB BANDWIDTH MEASUREMENT	89
5.3.1	LIMITS OF 6DB BANDWIDTH MEASUREMENT	89
5.3.2	TEST INSTRUMENTS	89
5.3.3	TEST PROCEDURE	89
5.3.4	DEVIATION FROM TEST STANDARD	89
5.3.5	TEST SETUP	89
5.3.6	EUT OPERATING CONDITIONS	89
5.3.7	TEST RESULTS	90
5.4	CONDUCTED OUTPUT POWER MEASUREMENT	91
5.4.1	LIMITS OF CONDUCTED OUTPUT POWER MEASUREMENT	91
5.4.2	INSTRUMENTS	91
5.4.3	TEST PROCEDURES	92
5.4.4	DEVIATION FROM TEST STANDARD	92
5.4.5	TEST SETUP	92
5.4.6	EUT OPERATING CONDITIONS	92
5.4.7	TEST RESULTS	93
5.5	POWER SPECTRAL DENSITY MEASUREMENT	94
5.5.1	LIMITS OF POWER SPECTRAL DENSITY MEASUREMENT	94
5.5.2	TEST INSTRUMENTS	94
5.5.3	TEST PROCEDURE	94
5.5.4	DEVIATION FROM TEST STANDARD	94



A D T

5.5.5	TEST SETUP	94
5.5.6	EUT OPERATING CONDITION	94
5.5.7	TEST RESULTS	95
5.6	CONDUCTED OUT-BAND EMISSION MEASUREMENT	97
5.6.1	LIMITS OF CONDUCTED OUT-BAND EMISSION MEASUREMENT	97
5.6.2	TEST INSTRUMENTS	97
5.6.3	TEST PROCEDURE	97
5.6.4	DEVIATION FROM TEST STANDARD	98
5.6.5	TEST SETUP	98
5.6.6	EUT OPERATING CONDITION	98
5.6.7	TEST RESULTS	98
6.	PHOTOGRAPHS OF THE TEST CONFIGURATION	107
7.	INFORMATION ON THE TESTING LABORATORIES	108
8.	APPENDIX A - MODIFICATIONS RECORDERS FOR ENGINEERING CHANGES TO THE EUT BY THE LAB	109



A D T

RELEASE CONTROL RECORD

ISSUE NO.	REASON FOR CHANGE	DATE ISSUED
RF121222E03	Original release	Jan. 28, 2013



1. CERTIFICATION

PRODUCT: Linksys Smart Wi-Fi Router AC1750
BRAND NAME: Cisco
MODEL NO.: EA6700
TEST SAMPLE: ENGINEERING SAMPLE
APPLICANT: Cisco Consumer Products LLC
TESTED: Jan. 02 to 08, 2013
STANDARDS: FCC Part 15, Subpart C (Section 15.247)
ANSI C63.10-2009

The above equipment (Model: EA6700) has been tested by **Bureau Veritas Consumer Products Services (H.K.) Ltd., Taoyuan Branch**, and found compliance with the requirement of the above standards. The test record, data evaluation & Equipment Under Test (EUT) configurations represented herein are true and accurate accounts of the measurements of the sample's EMC characteristics under the conditions specified in this report.

PREPARED BY : Phoenix Huang , **DATE:** Jan. 28, 2013
(Phoenix Huang, Specialist)

APPROVED BY : May Chen , **DATE:** Jan. 28, 2013
(May Chen, Deputy Manager)



A D T

2. SUMMARY OF TEST RESULTS

The EUT has been tested according to the following specifications:

For 2.4GHz, 2400~2483.5MHz Band

APPLIED STANDARD: FCC PART 15, SUBPART C (SECTION 15.247)			
STANDARD SECTION	TEST TYPE	RESULT	REMARK
15.207	AC Power Conducted Emission	PASS	Meet the requirement of limit. Minimum passing margin is -6.82dB at 0.16172MHz
15.247(d) 15.209	Radiated Emissions	PASS	Meet the requirement of limit. Minimum passing margin is -0.5dB at 2390.00MHz & 2353.00MHz & 2483.50MHz & 2487.10MHz
15.247(d)	Band Edge Measurement	PASS	Meet the requirement of limit.
15.247(a)(2)	6dB bandwidth	PASS	Meet the requirement of limit.
15.247(b)	Conducted Output power	PASS	Meet the requirement of limit.
15.247(e)	Power Spectral Density	PASS	Meet the requirement of limit.
15.203	Antenna Requirement	PASS	No antenna connector is used.

For 5GHz, 5725~5850MHz Band

APPLIED STANDARD: FCC PART 15, SUBPART C (SECTION 15.247)			
STANDARD SECTION	TEST TYPE	RESULT	REMARK
15.207	AC Power Conducted Emission	PASS	Meet the requirement of limit. Minimum passing margin is -6.73dB at 0.15000MHz
15.247(d) 15.209	Radiated Emissions	PASS	Meet the requirement of limit. Minimum passing margin is -2.4dB at 5133.20MHz
15.247(d)	Band Edge Measurement	PASS	Meet the requirement of limit.
15.247(a)(2)	6dB bandwidth	PASS	Meet the requirement of limit.
15.247(b)	Conducted Output power	PASS	Meet the requirement of limit.
15.247(e)	Power Spectral Density	PASS	Meet the requirement of limit.
15.203	Antenna Requirement	PASS	No antenna connector is used.

NOTE: The EUT was operating in 2.400 ~ 2.4835GHz, 5.15~5.25GHz and 5.725~5.850GHz frequencies band. This report was recorded the RF parameters including 2.400 ~ 2.4835GHz and 5.725~5.850GHz. For the 5.15~5.25GHz RF parameters was recorded in another test report.



A D T

2.1 MEASUREMENT UNCERTAINTY

Where relevant, the following measurement uncertainty levels have been estimated for tests performed on the EUT as specified in CISPR 16-4-2:

This uncertainty represents an expanded uncertainty expressed at approximately the 95% confidence level using a coverage factor of $k=2$.

Measurement	Value
Conducted emissions	2.98 dB
Radiated emissions (30MHz-1GHz)	5.59 dB
Radiated emissions (1GHz -6GHz) for Chamber G	3.56 dB
Radiated emissions (1GHz -6GHz) for Chamber H	3.84 dB
Radiated emissions (6GHz -18GHz) for Chamber G	4.10 dB
Radiated emissions (6GHz -18GHz) for Chamber H	4.09 dB
Radiated emissions (18GHz -40GHz)	4.24 dB



A D T

3. GENERAL INFORMATION

3.1 GENERAL DESCRIPTION OF EUT

PRODUCT	Linksys Smart Wi-Fi Router AC1750
MODEL NO.	EA6700
POWER SUPPLY	DC 12V from power adapter
MODULATION TYPE	CCK, DQPSK, DBPSK for DSSS 64QAM, 16QAM, QPSK, BPSK for OFDM 256QAM for OFDM in 11ac mode only.
MODULATION TECHNOLOGY	DSSS,OFDM
TRANSFER RATE	802.11b: up to 11Mbps 802.11a / g: up to 54Mbps 802.11n: up to 450Mbps 802.11ac: up to 1300Mbps
OPERATING FREQUENCY	For 15.407 802.11a/n/ac: 5.18 ~ 5.24GHz
	For 15.247 802.11b/g/n: 2.412 ~ 2.462GHz 802.11a/n/ac: 5.745 ~ 5.825GHz
NUMBER OF CHANNEL	For 15.407 4 for 802.11a, 802.11n (HT20), 802.11ac (VHT20) 2 for 802.11n (HT40), 802.11ac (VHT40) 1 for 802.11ac (VHT80)
	For 15.247 (2.4GHz) 11 for 802.11b, 802.11g, 802.11n (HT20) 7 for 802.11n (HT40) For 15.247 (5GHz) 5 for 802.11a, 802.11n (HT20), 802.11ac (VHT20) 2 for 802.11n (HT40), 802.11ac (VHT40) 1 for 802.11ac (VHT80)

MAXIMUM OUTPUT POWER	For 15.407 802.11a: 30.339mW 802.11n (HT20): 24.162mW 802.11n (HT40): 32.947mW 802.11ac (VHT80): 21.881mW For 15.247 (2.4GHz) 802.11b: 118.850mW 802.11g: 118.304mW 802.11n (HT20): 255.092mW 802.11n (HT40): 60.441mW For 15.247 (5GHz) 802.11a: 167.494mW 802.11n (HT20): 456.334mW 802.11n (HT40): 418.595mW 802.11ac (VHT80): 207.629mW
ANTENNA TYPE	Please see NOTE
DATA CABLE	NA
I/O PORTS	Refer to user's manual
ASSOCIATED DEVICES	Adapter x1

NOTE:

1. The EUT is a 2.4GHz & 5GHz WLAN device.
2. The EUT has two different RJ45 XFRM Transformer types could be chosen and please refer the below table:

Type 1(Vendor: MINGTEK)			
Vendor P/N	Different	Vendor	Location
HN1874CG	TRANSFORMER VARIABLE COILS,DIP,350UH,HN1874CG	MINGTEK	T1
HN3674CG	TRANSFORMER VARIABLE COILS,DIP,350UH,HN3674CG	MINGTEK	T2, T3
Type 2(Vendor: MYJWD)			
Vendor P/N	Different	Vendor	Location
DG18107-1 G	TRANSFORMER,DIP,350UH,16.8*8.5*1 1.85MM,18PIN,DG18107-1 G	MYJWD	T1
DG36005-1 G	TRANSFORMER,DIP,350UH,32.7*8.5*1 1.85MM,36PIN	MYJWD	T2, T3

From the above transformer types, the worst case was found in **Type 2(Vendor: MYJWD)**. Therefore only the test data of the transformer types were recorded in this report.



A D T

3. The EUT must be supplied with a power adapter and following four different models could be chosen as following table:

No	Brand	Model No.	Spec.	Plug
1	Solytech	CAD4212CW-1	Input: 100-240V, 1.5A, 50-60Hz Output: 12V, 3.5A DC output cable (Unshielded, 1.5m)	US
2	Solytech	CAD4212LW-1	Input: 100-240V, 1.5A, 50-60Hz Output: 12V, 3.5A DC output cable (Unshielded, 1.5m)	Universal (US, EU, AU, UK)
3	Leader (LEI)	MU42-1120350-A1	Input: 100-240V, 1.5A, 50-60Hz Output: 12V, 3.5A DC output cable (Unshielded, 1.5m)	US
4	Leader (LEI)	IU42-1120350-WP	Input: 100-240V, 1.5A, 50-60Hz Output: 12V, 3.5A DC output cable (Unshielded, 1.5m)	Universal (US, EU, AU, UK)

Note: 1. Adapter 1 & 2 only different with plug.
 2. For radiated emissions test, the EUT was pre-tested with above Adapter 1, Adapter 3 & Adapter 4, the worst case was found in Adapter 3. Therefore only the test data of the Adapter 3 was recorded in this report.

4. The antenna provided to the EUT, please refer to the following table:

For 2.4GHz						
Transmitter Circuit	Brand	Model	Antenna Type	Peak Gain(dBi) (Include cable loss)	Frequency range (MHz to MHz)	Connector Type
Left side Chain (1)	Galtronics	02100073-05389A1	Dipole	2.48	2400~2483.5	NA
Right side Chain (0)	Galtronics	02100073-05389A2	Dipole	3.15	2400~2483.5	NA
Front side Chain (2)	Galtronics	02100073-05389B1	Dipole	1.65	2400~2483.5	NA
For 5GHz (Band 1)						
Transmitter Circuit	Brand	Model	Antenna Type	Peak Gain(dBi) (Include cable loss)	Frequency range (MHz to MHz)	Connector Type
Left side Chain (1)	Galtronics	02102142-05389A2	Dipole	3.55	5150~5250	NA
Right side Chain (0)	Galtronics	02102142-05389A3	Dipole	4.29	5150~5250	NA
Front side Chain (2)	Galtronics	02102142-05389B1	Dipole	3.86	5150~5250	NA

For 5GHz (Band 4)						
Transmitter Circuit	Brand	Model	Antenna Type	Peak Gain(dBi) (Include cable loss)	Frequency range (MHz to MHz)	Connector Type
Left side Chain (1)	Galtronics	02102142-05389A2	Dipole	4.23	5725~5850	NA
Right side Chain (0)	Galtronics	02102142-05389A3	Dipole	4.79	5725~5850	NA
Front side Chain (2)	Galtronics	02102142-05389B1	Dipole	3.68	5725~5850	NA

Note: According to the above antennas, there are three antennas will transmit simultaneously (one is Vertical and the others are Horizontal).

5. The EUT incorporates a MIMO function without beam forming.

MODULATION MODE	TX/RX FUNCTION
802.11b	1Tx/3Rx
802.11g	1Tx (Diversity)/3Rx
802.11n (HT20)<2.4GHz>	3Tx/3Rx
802.11n (HT40) <2.4GHz>	3Tx/3Rx
802.11a	1Tx (Diversity)/3Rx
802.11n (HT20) <5GHz>	3Tx/3Rx
802.11n (HT40) <5GHz>	3Tx/3Rx
802.11ac (VHT20)	3Tx/3Rx
802.11ac (VHT40)	3Tx/3Rx
802.11ac (VHT80)	3Tx/3Rx

Note: The modulation and bandwidth are similar for 802.11n mode for 20MHz (40MHz) and 802.11ac mode for 20MHz (40MHz), therefore investigated worst case to representative mode in test report. (Final test mode refer section 3.2.1)

6. Conducted emission and radiated emission of the simultaneous operation (2.4GHz & 5GHz) has been evaluated and no non-compliance was found.
7. When the EUT operating in 802.11n, the software operation, which is defined by manufacturer, MCS (Modulation and Coding Schemes) from 0 to 23.
8. When the EUT operating in 802.11ac, the software operation, which is defined by manufacturer, MCS (Modulation and Coding Schemes) from 0 to 9.
9. The above EUT information was declared by the manufacturer and for more detailed features description, please refer to the manufacturer's specifications or User's Manual.

3.2 DESCRIPTION OF TEST MODES

Operated in 2400 ~ 2483.5MHz band:

11 channels are provided for 802.11b, 802.11g, 802.11n (HT20):

CHANNEL	FREQUENCY	CHANNEL	FREQUENCY
1	2412MHz	7	2442MHz
2	2417MHz	8	2447MHz
3	2422MHz	9	2452MHz
4	2427MHz	10	2457MHz
5	2432MHz	11	2462MHz
6	2437MHz		

7 channels are provided for 802.11n (HT40):

CHANNEL	FREQUENCY	CHANNEL	FREQUENCY
3	2422MHz	7	2442MHz
4	2427MHz	8	2447MHz
5	2432MHz	9	2452MHz
6	2437MHz		

Operated in 5725 ~ 5850MHz band:

5 channels are provided for 802.11a, 802.11n (HT20), 802.11ac (VHT20):

CHANNEL	FREQUENCY	CHANNEL	FREQUENCY
149	5745 MHz	161	5805 MHz
153	5765 MHz	165	5825 MHz
157	5785 MHz		

2 channels are provided for 802.11n (HT40), 802.11ac (VHT40):

CHANNEL	FREQUENCY
151	5755 MHz
159	5795 MHz

1 channel is provided for 802.11ac (VHT80):

CHANNEL	FREQUENCY
155	5775 MHz

3.2.1 TEST MODE APPLICABILITY AND TESTED CHANNEL DETAIL

EUT CONFIGURE MODE	APPLICABLE TO					DESCRIPTION
	PLC	RE < 1G	RE ≥ 1G	APCM	OB	
1	√	√	√	√	√	Adapter 3
2	√	-	-	-	-	Adapter 1
3	√	-	-	-	-	Adapter 4

Where **PLC**: Power Line Conducted Emission **RE < 1G**: Radiated Emission below 1GHz
RE ≥ 1G: Radiated Emission above 1GHz **APCM**: Antenna Port Conducted Measurement
OB: Conducted Out-Band Emission Measurement

Note: The EUT had been pre-tested on the positioned of each 2 axis. The worst case was found when positioned on X-plane.

POWER LINE CONDUCTED EMISSION TEST:

- Pre-Scan has been conducted to determine the worst-case mode from all possible combinations between available modulations, data rates and antenna ports (if EUT with antenna diversity architecture).
- Following channel(s) was (were) selected for the final test as listed below.

MODE	AVAILABLE CHANNEL	TESTED CHANNEL	MODULATION TECHNOLOGY	MODULATION TYPE	DATA RATE (Mbps)
For 2.4 GHz 802.11n (HT20)	1 to 11	6	OFDM	BPSK	6.5
For 5 GHz 802.11n (HT20)	149 to 165	157	OFDM	BPSK	6.5

RADIATED EMISSION TEST (BELOW 1 GHz):

- Pre-Scan has been conducted to determine the worst-case mode from all possible combinations between available modulations, data rates and antenna ports (if EUT with antenna diversity architecture).
- Following channel(s) was (were) selected for the final test as listed below.

MODE	AVAILABLE CHANNEL	TESTED CHANNEL	MODULATION TECHNOLOGY	MODULATION TYPE	DATA RATE (Mbps)
For 2.4 GHz 802.11n (HT20)	1 to 11	6	OFDM	BPSK	6.5
For 5 GHz 802.11n (HT20)	149 to 165	157	OFDM	BPSK	6.5



A D T

RADIATED EMISSION TEST (ABOVE 1 GHz):

- Pre-Scan has been conducted to determine the worst-case mode from all possible combinations between available modulations, data rates and antenna ports (if EUT with antenna diversity architecture).
- Following channel(s) was (were) selected for the final test as listed below.

MODE	AVAILABLE CHANNEL	TESTED CHANNEL	MODULATION TECHNOLOGY	MODULATION TYPE	DATA RATE (Mbps)
802.11b	1 to 11	1, 6, 11	DSSS	DBPSK	1
802.11g	1 to 11	1, 6, 11	OFDM	BPSK	6
For 2.4 GHz 802.11n (HT20)	1 to 11	1, 6, 11	OFDM	BPSK	6.5
For 2.4 GHz 802.11n (HT40)	3 to 9	3, 6, 9	OFDM	BPSK	13.5
802.11a	149 to 165	149, 157, 165	OFDM	BPSK	6
For 5 GHz 802.11n (HT20)	149 to 165	149, 157, 165	OFDM	BPSK	6.5
For 5 GHz 802.11n (HT40)	151 to 159	151, 159	OFDM	BPSK	13.5
For 5 GHz 802.11ac (VHT80)	155	155	OFDM	BPSK	87.8

ANTENNA PORT CONDUCTED MEASUREMENT:

- Pre-Scan has been conducted to determine the worst-case mode from all possible combinations between available modulations, data rates and antenna ports (if EUT with antenna diversity architecture).
- Following channel(s) was (were) selected for the final test as listed below.

MODE	AVAILABLE CHANNEL	TESTED CHANNEL	MODULATION TECHNOLOGY	MODULATION TYPE	DATA RATE (Mbps)
802.11b	1 to 11	1, 6, 11	DSSS	DBPSK	1
802.11g	1 to 11	1, 6, 11	OFDM	BPSK	6
For 2.4 GHz 802.11n (HT20)	1 to 11	1, 6, 11	OFDM	BPSK	6.5
For 2.4 GHz 802.11n (HT40)	3 to 9	3, 6, 9	OFDM	BPSK	13.5
802.11a	149 to 165	149, 157, 165	OFDM	BPSK	6
For 5 GHz 802.11n (HT20)	149 to 165	149, 157, 165	OFDM	BPSK	6.5
For 5 GHz 802.11n (HT40)	151 to 159	151, 159	OFDM	BPSK	13.5
For 5 GHz 802.11ac (VHT80)	155	155	OFDM	BPSK	87.8



A D T

CONDUCTED OUT-BAND EMISSION MEASUREMENT:

- Pre-Scan has been conducted to determine the worst-case mode from all possible combinations between available modulations, data rates and antenna ports (if EUT with antenna diversity architecture).
- Following channel(s) was (were) selected for the final test as listed below.

MODE	AVAILABLE CHANNEL	TESTED CHANNEL	MODULATION TECHNOLOGY	MODULATION TYPE	DATA RATE (Mbps)
802.11b	1 to 11	1, 6, 11	DSSS	DBPSK	1
802.11g	1 to 11	1, 6, 11	OFDM	BPSK	6
For 2.4 GHz 802.11n (HT20)	1 to 11	1, 6, 11	OFDM	BPSK	6.5
For 2.4 GHz 802.11n (HT40)	3 to 9	3, 6, 9	OFDM	BPSK	13.5
802.11a	149 to 165	149, 157, 165	OFDM	BPSK	6
For 5 GHz 802.11n (HT20)	149 to 165	149, 157, 165	OFDM	BPSK	6.5
For 5 GHz 802.11n (HT40)	151 to 159	151, 159	OFDM	BPSK	13.5
For 5 GHz 802.11ac (VHT80)	155	155	OFDM	BPSK	87.8

TEST CONDITION:

APPLICABLE TO	ENVIRONMENTAL CONDITIONS	INPUT POWER	TESTED BY
PLC	25deg. C, 60%RH	120Vac, 60Hz	Timmy Hu
RE<1G	25deg. C, 66%RH	120Vac, 60Hz	Amos Chuang
	25deg. C, 66%RH	120Vac, 60Hz	Robert Cheng
RE ³ 1G	23deg. C, 65%RH	120Vac, 60Hz	Robert Cheng
	23deg. C, 69%RH	120Vac, 60Hz	Robert Cheng
APCM	25deg. C, 60%RH	120Vac, 60Hz	Amos Chuang
OB	25deg. C, 60%RH	120Vac, 60Hz	Amos Chuang

3.3 GENERAL DESCRIPTION OF APPLIED STANDARDS

The EUT is a RF product. According to the specifications of the manufacturer, it must comply with the requirements of the following standards:

FCC Part 15, Subpart C. (15.247)

558074 D01 DTS Meas Guidance

662911 D01 Multiple Transmitter Output

ANSI C63.10-2009

All test items have been performed and recorded as per the above standards.

Note: The EUT has been verified to comply with the requirements of FCC Part 15, Subpart B, Class B (DoC). The test report has been issued separately.



A D T

3.4 DESCRIPTION OF SUPPORT UNITS

The EUT has been tested as an independent unit together with other necessary accessories or support units. The following support units or accessories were used to form a representative test configuration during the tests.

NO.	PRODUCT	BRAND	MODEL NO.	SERIAL NO.	FCC ID
1	NOTEBOOK COMPUTER	DELL	PP32LA	FSLB32S	FCC DoC
2	NOTEBOOK COMPUTER	DELL	PP32LA	GSLB32S	FCC DoC
3	External Hard Drive (For Conducted Emission test)	WD	WDBACW0010H BK-SESN	WCAV5R678284	FCC DoC
	External Hard Drive (For Other test items)	WD	WDBACW0010H BK-SESN	WXK1A51E5819	FCC DoC
4	USB Flash Drive (For Conducted Emission test)	SanDisk	SDCZ2-512-A10	5485439362	FCC DoC
	iPod shuffle (For Other test items)	Apple	MC749TA/A	CC4DMFJUDFDM	NA
5	HUB	ZyXEL	ES-116P	S060H02000215	FCC DoC

NO.	SIGNAL CABLE DESCRIPTION OF THE ABOVE SUPPORT UNITS
1	UTP cable, 10m
2	UTP cable, 10m
3	USB cable, 1.5m (For Conducted Emission test)
	USB cable, 0.5m (For Other test items)
4	NA (For Conducted Emission test)
	USB cable, 0.1m (For Other test items)
5	UTP cable, 10m

NOTE: All power cords of the above support units are non shielded (1.8m).

3.5 CONFIGURATION OF SYSTEM UNDER TEST

For Conducted Emission test:

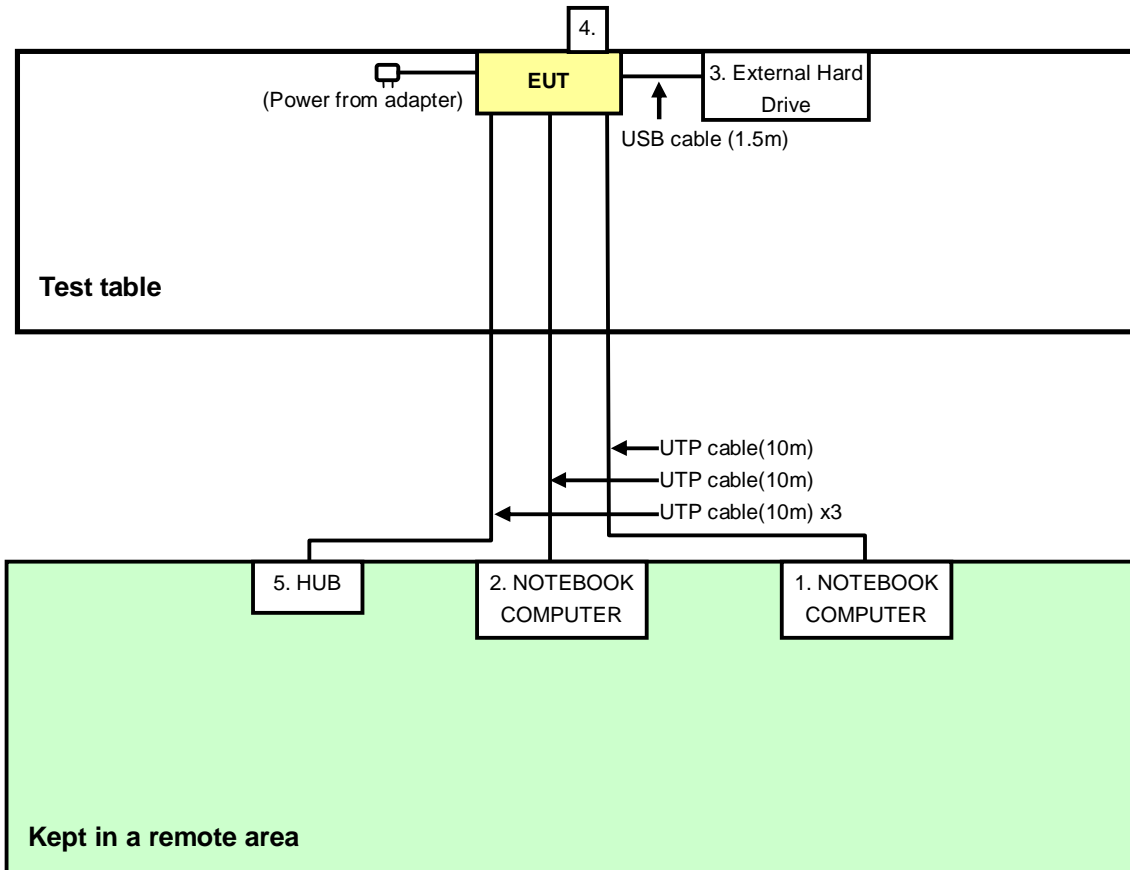

Note: Support unit 4 is USB Flash Drive

For other test items:

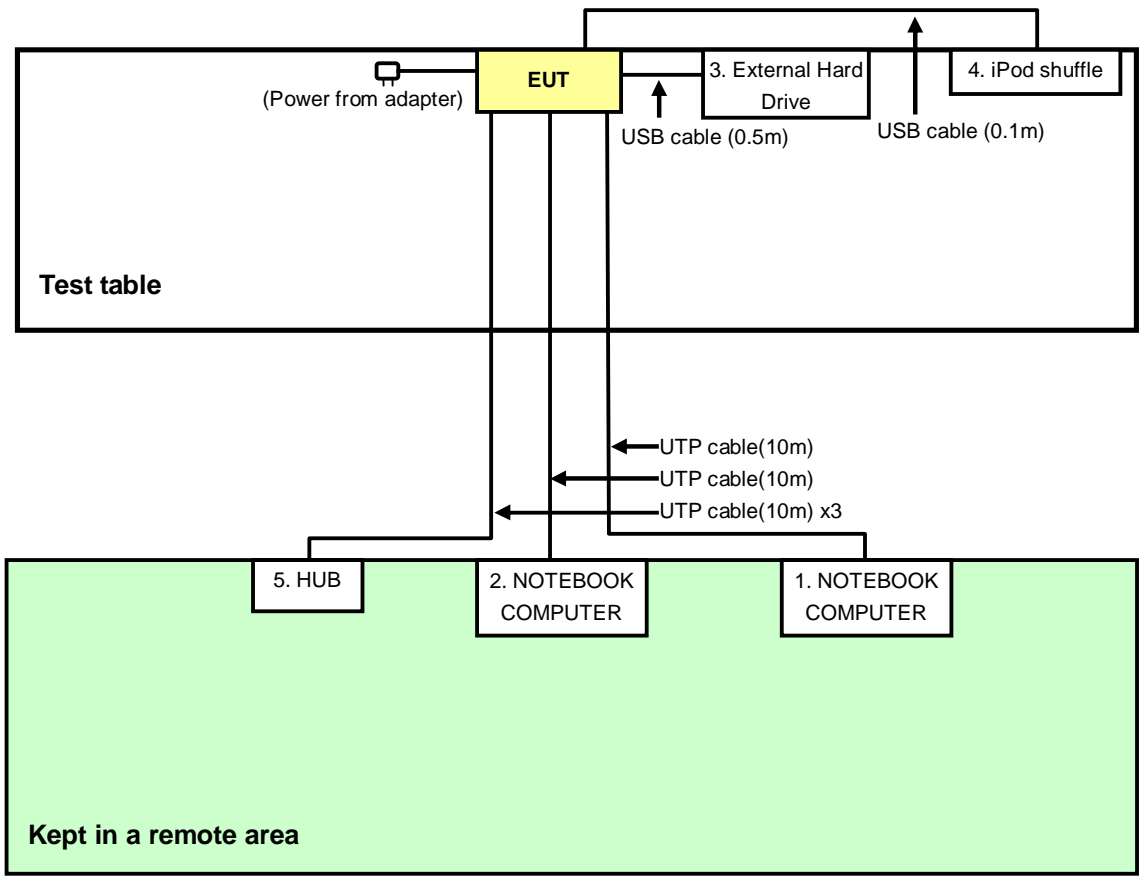



A D T

4. TEST TYPES AND RESULTS (FOR 2.4GHz, 2.400 ~ 2.4835GHz Band)

4.1 CONDUCTED EMISSION MEASUREMENT

4.1.1 LIMITS OF CONDUCTED EMISSION MEASUREMENT

FREQUENCY OF EMISSION (MHz)	CONDUCTED LIMIT (dB μ V)	
	Quasi-peak	Average
0.15-0.5	66 to 56	56 to 46
0.5-5	56	46
5-30	60	50

- NOTE:**
1. The lower limit shall apply at the transition frequencies.
 2. The limit decreases in line with the logarithm of the frequency in the range of 0.15 to 0.50 MHz.

4.1.2 TEST INSTRUMENTS

DESCRIPTION & MANUFACTURER	MODEL NO.	SERIAL NO.	CALIBRATED DATE	CALIBRATED UNTIL
Test Receiver ROHDE & SCHWARZ	ESCS 30	100287	Feb. 29, 2012	Feb. 28, 2013
Line-Impedance Stabilization Network (for EUT) SCHWARZBECK	NSLK 8127	8127-523	Sep. 19, 2012	Sep. 20, 2013
Line-Impedance Stabilization Network (for Peripheral) ROHDE & SCHWARZ	ESH3-Z5	848773/004	Oct. 29, 2012	Oct. 28, 2013
RF Cable (JYEBAO)	5DFB	COACAB-002	Aug. 05, 2012	Aug. 04, 2013
50 ohms Terminator	50	3	Oct. 23, 2012	Oct. 22, 2013
Software ADT	BV ADT_Cond_V7.3.7 .3	NA	NA	NA

Note:

1. The calibration interval of the above test instruments is 12 months and the calibrations are traceable to NML/ROC and NIST/USA.
2. The test was performed in Shielded Room No. A.
3. The VCCI Con A Registration No. is C-817.
4. Tested Date: Jan. 02, 2013

4.1.3 TEST PROCEDURES

- a. The EUT was placed 0.4 meters from the conducting wall of the shielded room with EUT being connected to the power mains through a line impedance stabilization network (LISN). Other support units were connected to the power mains through another LISN.
- b. The two LISNs provide 50 ohm/ 50uH of coupling impedance for the measuring instrument.
- c. Both lines of the power mains connected to the EUT were checked for maximum conducted interference.
- d. The frequency range from 150kHz to 30MHz was searched. Emission levels under (Limit - 20dB) were not recorded.

NOTE:

1. The resolution bandwidth of test receiver is 9kHz for Quasi-peak detection (QP) & Average detection (AV).

4.1.4 DEVIATION FROM TEST STANDARD

No deviation

4.1.5 TEST SETUP

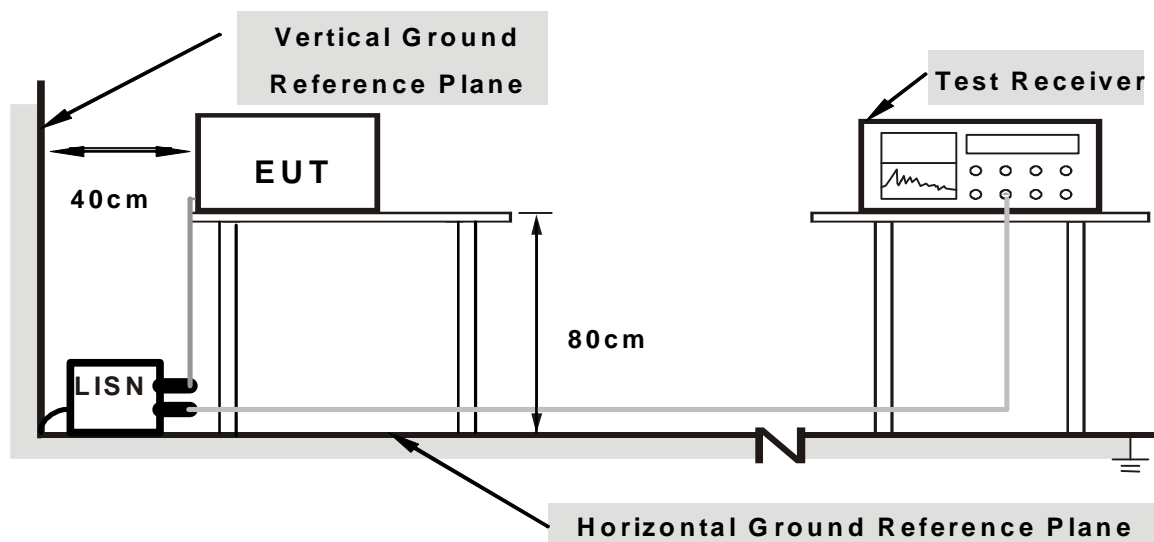

Note: 1. Support units were connected to second LISN.

For the actual test configuration, please refer to the related item – Photographs of the Test Configuration.



A D T

4.1.6 EUT OPERATING CONDITIONS

1. Connect the EUT with the support unit 1 (Notebook Computer) which is placed on a testing table.
2. The communication partner run test program "MTool V1.0.0.0.10.exe" to enable EUT under transmission/receiving condition continuously at specific channel frequency.

4.1.7 TEST RESULTS (MODE 1)

PHASE	Line (L)	DETECTOR FUNCTION	Quasi-Peak (QP) / Average (AV)
--------------	----------	--------------------------	--------------------------------

No	Freq. [MHz]	Corr. Factor (dB)	Reading Value		Emission Level		Limit		Margin	
			[dB (uV)]		[dB (uV)]		[dB (uV)]		(dB)	
			Q.P.	AV.	Q.P.	AV.	Q.P.	AV.	Q.P.	AV.
1	0.15292	0.10	58.24	47.89	58.34	47.99	65.84	55.84	-7.50	-7.85
2	0.17734	0.10	52.58	40.30	52.68	40.40	64.61	54.61	-11.93	-14.21
3	0.22812	0.12	45.57	26.49	45.69	26.61	62.52	52.52	-16.83	-25.91
4	0.32188	0.14	38.62	22.82	38.76	22.96	59.66	49.66	-20.90	-26.70
5	0.43516	0.16	36.35	20.78	36.51	20.94	57.15	47.15	-20.64	-26.21
6	0.48984	0.16	40.33	34.91	40.49	35.07	56.17	46.17	-15.68	-11.10
7	8.10547	0.49	40.82	35.83	41.31	36.32	60.00	50.00	-18.69	-13.68

REMARKS:

1. Q.P. and AV. are abbreviations of quasi-peak and average individually.
2. The emission levels of other frequencies were very low against the limit.
3. Margin value = Emission level - Limit value
4. Correction factor = Insertion loss + Cable loss
5. Emission Level = Correction Factor + Reading Value.

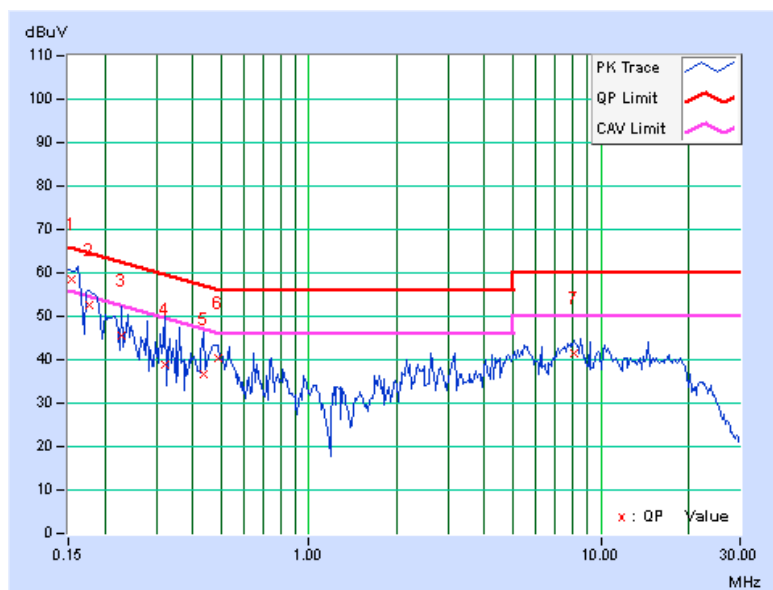

PHASE	Neutral (N)	DETECTOR FUNCTION	Quasi-Peak (QP) / Average (AV)
--------------	-------------	--------------------------	--------------------------------

No	Freq. [MHz]	Corr. Factor (dB)	Reading Value [dB (uV)]		Emission Level [dB (uV)]		Limit [dB (uV)]		Margin (dB)	
			Q.P.	AV.	Q.P.	AV.	Q.P.	AV.	Q.P.	AV.
	1	0.15000	0.14	58.51	48.00	58.65	48.14	66.00	56.00	-7.35
2	0.16562	0.15	49.69	41.25	49.84	41.40	65.18	55.18	-15.34	-13.78
3	0.18516	0.15	52.90	42.65	53.05	42.80	64.25	54.25	-11.20	-11.45
4	0.45078	0.19	37.87	32.95	38.06	33.14	56.86	46.86	-18.80	-13.72
5	3.37891	0.33	35.27	26.29	35.60	26.62	56.00	46.00	-20.40	-19.38
6	5.96875	0.41	37.72	30.81	38.13	31.22	60.00	50.00	-21.87	-18.78

REMARKS:

1. Q.P. and AV. are abbreviations of quasi-peak and average individually.
2. The emission levels of other frequencies were very low against the limit.
3. Margin value = Emission level - Limit value
4. Correction factor = Insertion loss + Cable loss
5. Emission Level = Correction Factor + Reading Value.

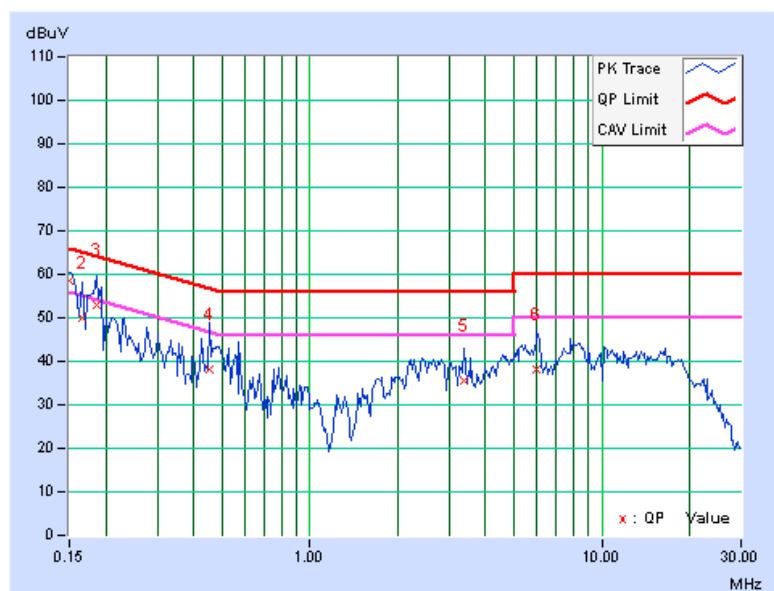

4.1.8 TEST RESULTS (MODE 2)

PHASE	Line (L)	DETECTOR FUNCTION	Quasi-Peak (QP) / Average (AV)
--------------	----------	--------------------------	--------------------------------

No	Freq. [MHz]	Corr. Factor (dB)	Reading Value [dB (uV)]		Emission Level [dB (uV)]		Limit [dB (uV)]		Margin (dB)	
			Q.P.	AV.	Q.P.	AV.	Q.P.	AV.	Q.P.	AV.
			1	0.16562	0.10	50.28	43.49	50.38	43.59	65.18
2	0.18906	0.11	45.57	35.44	45.68	35.55	64.08	54.08	-18.40	-18.53
3	0.22812	0.12	40.07	32.08	40.19	32.20	62.52	52.52	-22.33	-20.32
4	0.52109	0.16	35.15	32.07	35.31	32.23	56.00	46.00	-20.69	-13.77
5	0.61094	0.17	28.29	18.38	28.46	18.55	56.00	46.00	-27.54	-27.45
6	6.38672	0.42	31.73	27.55	32.15	27.97	60.00	50.00	-27.85	-22.03

REMARKS:

1. Q.P. and AV. are abbreviations of quasi-peak and average individually.
2. The emission levels of other frequencies were very low against the limit.
3. Margin value = Emission level - Limit value
4. Correction factor = Insertion loss + Cable loss
5. Emission Level = Correction Factor + Reading Value.

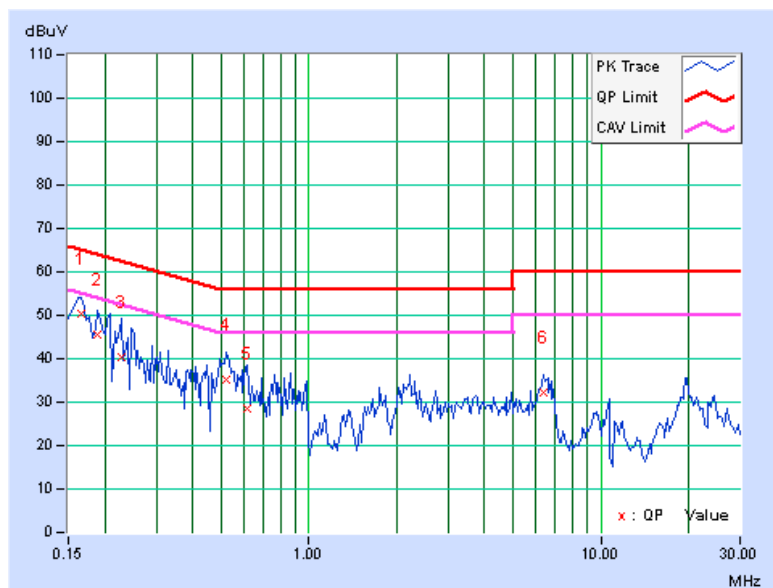

PHASE	Neutral (N)	DETECTOR FUNCTION	Quasi-Peak (QP) / Average (AV)
--------------	-------------	--------------------------	--------------------------------

No	Freq. [MHz]	Corr. Factor (dB)	Reading Value [dB (uV)]		Emission Level [dB (uV)]		Limit [dB (uV)]		Margin (dB)	
			Q.P.	AV.	Q.P.	AV.	Q.P.	AV.	Q.P.	AV.
	1	0.16562	0.15	50.22	43.59	50.37	43.74	65.18	55.18	-14.81
2	0.22031	0.15	42.56	24.75	42.71	24.90	62.81	52.81	-20.09	-27.90
3	0.52500	0.20	36.82	31.64	37.02	31.84	56.00	46.00	-18.98	-14.16
4	0.68906	0.20	29.66	22.99	29.86	23.19	56.00	46.00	-26.14	-22.81
5	2.19531	0.28	33.19	27.92	33.47	28.20	56.00	46.00	-22.53	-17.80
6	6.55859	0.43	36.42	30.85	36.85	31.28	60.00	50.00	-23.15	-18.72

REMARKS:

1. Q.P. and AV. are abbreviations of quasi-peak and average individually.
2. The emission levels of other frequencies were very low against the limit.
3. Margin value = Emission level - Limit value
4. Correction factor = Insertion loss + Cable loss
5. Emission Level = Correction Factor + Reading Value.

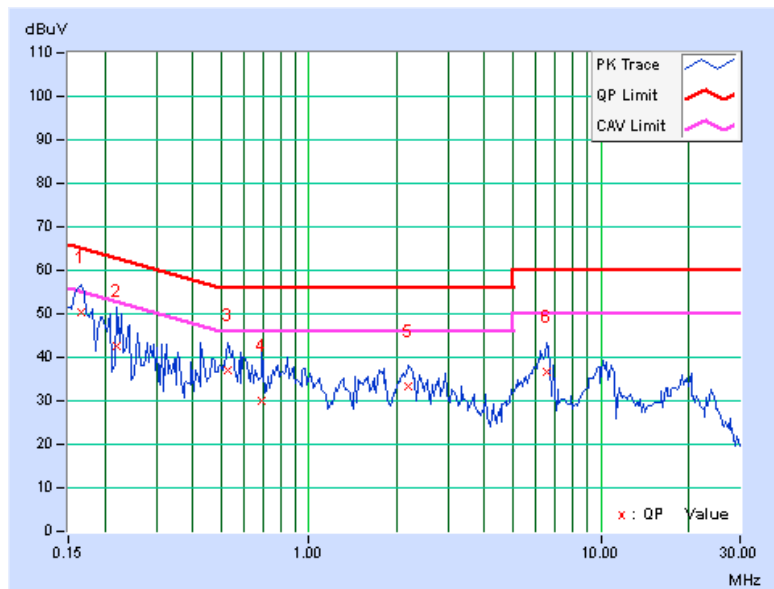



A D T

4.1.9 TEST RESULTS (MODE 3)

PHASE	Line (L)	DETECTOR FUNCTION	Quasi-Peak (QP) / Average (AV)
--------------	----------	--------------------------	--------------------------------

No	Freq. [MHz]	Corr. Factor (dB)	Reading Value		Emission Level		Limit		Margin	
			[dB (uV)]		[dB (uV)]		[dB (uV)]		(dB)	
			Q.P.	AV.	Q.P.	AV.	Q.P.	AV.	Q.P.	AV.
1	0.16172	0.10	58.46	48.22	58.56	48.32	65.38	55.38	-6.82	-7.06
2	0.18125	0.10	52.94	36.31	53.04	36.41	64.43	54.43	-11.38	-18.01
3	0.22422	0.12	47.34	36.13	47.46	36.25	62.66	52.66	-15.21	-16.42
4	0.54063	0.16	42.19	36.39	42.35	36.55	56.00	46.00	-13.65	-9.45
5	2.14844	0.24	37.95	32.58	38.19	32.82	56.00	46.00	-17.81	-13.18
6	7.25391	0.46	37.90	33.45	38.36	33.91	60.00	50.00	-21.64	-16.09

REMARKS:

1. Q.P. and AV. are abbreviations of quasi-peak and average individually.
2. The emission levels of other frequencies were very low against the limit.
3. Margin value = Emission level - Limit value
4. Correction factor = Insertion loss + Cable loss
5. Emission Level = Correction Factor + Reading Value.

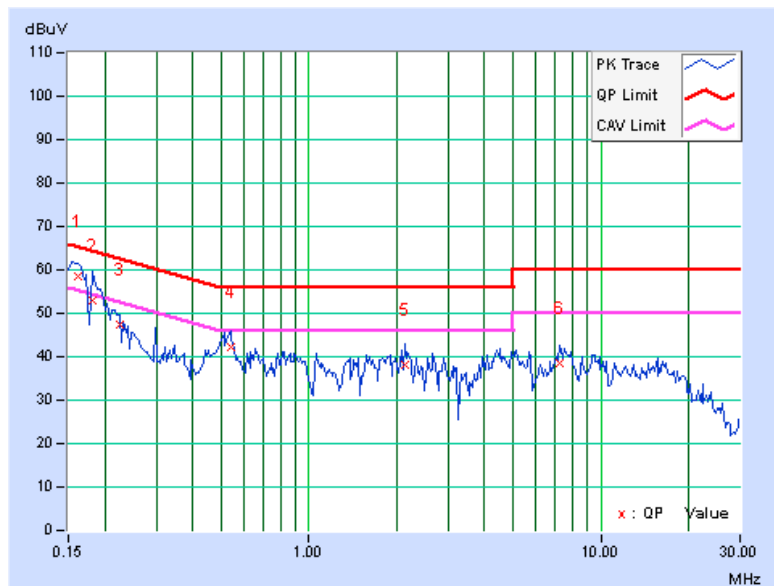

PHASE	Neutral (N)	DETECTOR FUNCTION	Quasi-Peak (QP) / Average (AV)
--------------	-------------	--------------------------	--------------------------------

No	Freq. [MHz]	Corr. Factor (dB)	Reading Value [dB (uV)]		Emission Level [dB (uV)]		Limit [dB (uV)]		Margin (dB)	
			Q.P.	AV.	Q.P.	AV.	Q.P.	AV.	Q.P.	AV.
	1	0.16172	0.15	58.30	48.06	58.45	48.21	65.38	55.38	-6.93
2	0.18906	0.15	53.34	41.52	53.49	41.67	64.08	54.08	-10.59	-12.41
3	0.20469	0.15	48.69	30.94	48.84	31.09	63.42	53.42	-14.58	-22.33
4	0.38047	0.19	29.87	21.13	30.06	21.32	58.27	48.27	-28.21	-26.95
5	0.50000	0.20	42.05	35.98	42.25	36.18	56.00	46.00	-13.75	-9.82
6	7.60156	0.46	36.92	32.10	37.38	32.56	60.00	50.00	-22.62	-17.44

REMARKS:

1. Q.P. and AV. are abbreviations of quasi-peak and average individually.
2. The emission levels of other frequencies were very low against the limit.
3. Margin value = Emission level - Limit value
4. Correction factor = Insertion loss + Cable loss
5. Emission Level = Correction Factor + Reading Value.

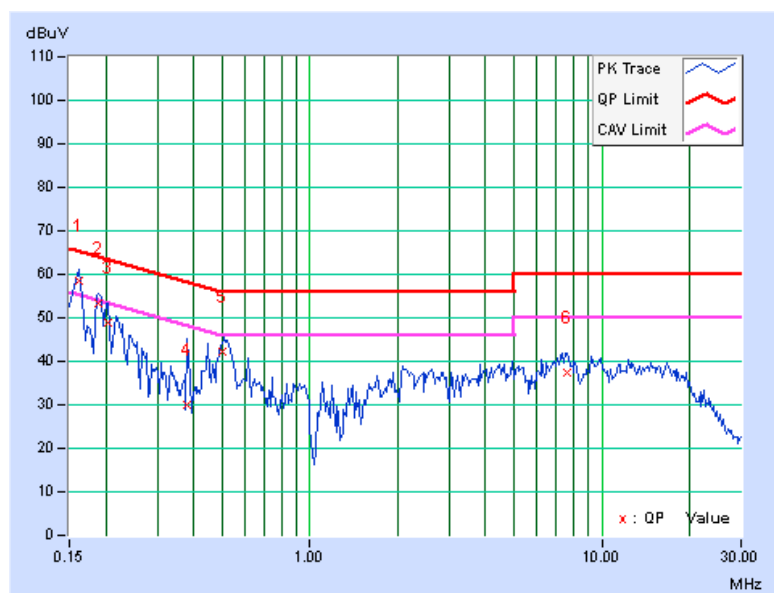

4.2 RADIATED EMISSION AND BANDEDGE MEASUREMENT

4.2.1 LIMITS OF RADIATED EMISSION AND BANDEDGE MEASUREMENT

Radiated emissions which fall in the restricted bands must comply with the radiated emission limits specified as below table. Other emissions shall be at least 30dB below the highest level of the desired power:

Frequencies (MHz)	Field strength (microvolts/meter)	Measurement distance (meters)
0.009-0.490	2400/F(kHz)	300
0.490-1.705	24000/F(kHz)	30
1.705-30.0	30	30
30-88	100	3
88-216	150	3
216-960	200	3
Above 960	500	3

NOTE:

1. The lower limit shall apply at the transition frequencies.
2. Emission level (dBuV/m) = 20 log Emission level (uV/m).
3. For frequencies above 1000MHz, the field strength limits are based on average detector, however, the peak field strength of any emission shall not exceed the maximum permitted average limits, specified above by more than 20dB under any condition of modulation.



A D T

4.2.2 TEST INSTRUMENTS

DESCRIPTION & MANUFACTURER	MODEL NO.	SERIAL NO.	CALIBRATED DATE	CALIBRATED UNTIL
Spectrum Analyzer Agilent	E4446A	MY48250254	July 09, 2012	July 08, 2013
Pre-Selector Agilent	N9039A	MY46520311	July 09, 2012	July 08, 2013
Signal Generator Agilent	N5181A	MY49060517	July 09, 2012	July 08, 2013
Pre-Amplifier Mini-Circuits	ZFL-1000VH2 B	AMP-ZFL-03	Nov. 14, 2012	Nov. 13, 2013
Pre-Amplifier Agilent	8449B	3008A02578	June 26, 2012	June 25, 2013
Pre-Amplifier SPACEK LABS	SLKKa-48-6	9K16	Nov. 14, 2012	Nov. 13, 2013
Trilog Broadband Antenna SCHWARZBECK	VULB 9168	9168-360	Apr. 09, 2012	Apr. 08, 2013
Horn_Antenna AISI	AIH.8018	0000320091110	Nov. 19, 2012	Nov. 18, 2013
Horn_Antenna SCHWARZBECK	BBHA 9170	9170-424	Oct. 12, 2012	Oct. 11, 2013
RF Cable	NA	RF104-201 RF104-203 RF104-204	Dec. 25, 2012	Dec. 24, 2013
RF Cable	NA	CHGCAB_001	Oct. 06, 2012	Oct. 05, 2013
Software	ADT_Radiated _V8.7.05	NA	NA	NA
Antenna Tower & Turn Table CT	NA	NA	NA	NA

Note:

1. The calibration interval of the above test instruments is 12 months and the calibrations are traceable to NML/ROC and NIST/USA.
2. The horn antenna, preamplifier (model: 8449B) are used only for the measurement of emission frequency above 1GHz if tested.
3. The test was performed in 966 Chamber No. G.
4. The FCC Site Registration No. is 966073.
5. The VCCI Site Registration No. is G-137.
6. The CANADA Site Registration No. is IC 7450H-2.
7. Tested Date: Jan. 04 to 05, 2013

4.2.3 TEST PROCEDURES

- a. The EUT was placed on the top of a rotating table 0.8 meters above the ground at 3 meter chamber room for test. The table was rotated 360 degrees to determine the position of the highest radiation.
- b. The EUT was set 3 meters away from the interference-receiving antenna, which was mounted on the top of a variable-height antenna tower.
- c. The height of antenna is varied from one meter to four meters above the ground to determine the maximum value of the field strength. Both horizontal and vertical polarizations of the antenna are set to make the measurement.
- d. For each suspected emission, the EUT was arranged to its worst case and then the antenna was tuned to heights from 1 meter to 4 meters and the rotatable table was turned from 0 degrees to 360 degrees to find the maximum reading.
- e. The test-receiver system was set to quasi-peak detect function and specified bandwidth with maximum hold mode when the test frequency is below 1 GHz.
- f. The test-receiver system was set to peak and average detect function and specified bandwidth with maximum hold mode when the test frequency is above 1 GHz. If the peak reading value also meets average limit, measurement with the average detector is unnecessary.

NOTE:

1. The resolution bandwidth and video bandwidth of test receiver/spectrum analyzer is 120kHz for Quasi-peak detection (QP) at frequency below 1GHz.
2. The resolution bandwidth of test receiver/spectrum analyzer is 1 MHz and the video bandwidth is 3 MHz for Peak detection (PK) at frequency above 1GHz.
3. The resolution bandwidth of test receiver/spectrum analyzer is 1 MHz and the video bandwidth is 10 Hz for Average detection (AV) at frequency above 1GHz.
4. All modes of operation were investigated and the worst-case emissions are reported.

4.2.4 DEVIATION FROM TEST STANDARD

No deviation

4.2.5 TEST SETUP

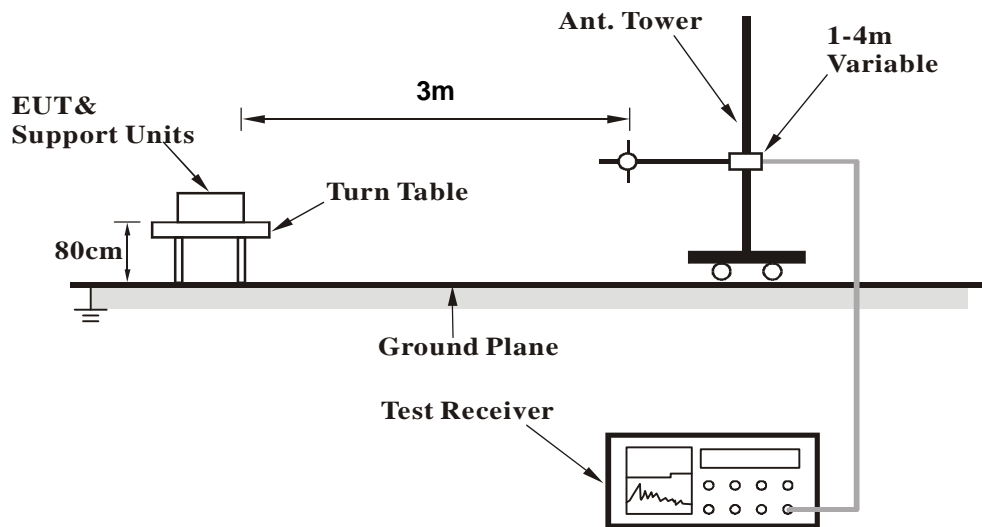

For the actual test configuration, please refer to the related item – Photographs of the Test Configuration.

4.2.6 EUT OPERATING CONDITIONS

Same as 4.1.6

4.2.7 TEST RESULTS

BELOW 1GHz WORST-CASE DATA

802.11n (HT20)

CHANNEL	TX Channel 6	DETECTOR FUNCTION	Quasi-Peak (QP)
FREQUENCY RANGE	Below 1GHz		

ANTENNA POLARITY & TEST DISTANCE: HORIZONTAL AT 3 M								
NO.	FREQ. (MHz)	EMISSION LEVEL (dBuV/m)	LIMIT (dBuV/m)	MARGIN (dB)	ANTENNA HEIGHT (m)	TABLE ANGLE (Degree)	RAW VALUE (dBuV)	CORRECTION FACTOR (dB/m)
1	73.93	27.5 QP	40.0	-12.5	1.00 H	201	16.06	11.48
2	106.74	29.4 QP	43.5	-14.2	1.50 H	323	18.56	10.79
3	233.81	37.1 QP	46.0	-9.0	1.00 H	91	24.41	12.64
4	270.28	27.0 QP	46.0	-19.0	1.00 H	299	12.86	14.12
5	356.73	28.3 QP	46.0	-17.7	1.00 H	255	11.59	16.75
6	533.30	41.5 QP	46.0	-4.5	1.50 H	24	20.29	21.17
ANTENNA POLARITY & TEST DISTANCE: VERTICAL AT 3 M								
NO.	FREQ. (MHz)	EMISSION LEVEL (dBuV/m)	LIMIT (dBuV/m)	MARGIN (dB)	ANTENNA HEIGHT (m)	TABLE ANGLE (Degree)	RAW VALUE (dBuV)	CORRECTION FACTOR (dB/m)
1	49.18	36.4 QP	40.0	-3.7	1.00 V	79	22.24	14.11
2	110.76	28.0 QP	43.5	-15.5	1.00 V	29	16.68	11.33
3	233.81	27.1 QP	46.0	-18.9	1.00 V	96	14.42	12.64
4	358.86	25.0 QP	46.0	-21.0	1.00 V	360	8.19	16.81
5	533.30	40.1 QP	46.0	-5.9	1.00 V	201	18.90	21.17
6	589.78	29.6 QP	46.0	-16.4	1.00 V	234	7.18	22.44

REMARKS:

1. Emission level (dBuV/m) = Raw Value (dBuV) + Correction Factor (dB/m).
2. Correction Factor (dB/m) = Antenna Factor (dB/m) + Cable Factor (dB).
3. The other emission levels were very low against the limit.
4. Margin value = Emission level – Limit value.



A D T

ABOVE 1GHz DATA

802.11b

CHANNEL	TX Channel 1	DETECTOR FUNCTION	Peak (PK)
FREQUENCY RANGE	1GHz ~ 25GHz		Average (AV)

ANTENNA POLARITY & TEST DISTANCE: HORIZONTAL AT 3 M

NO.	FREQ. (MHz)	EMISSION LEVEL (dBuV/m)	LIMIT (dBuV/m)	MARGIN (dB)	ANTENNA HEIGHT (m)	TABLE ANGLE (Degree)	RAW VALUE (dBuV)	CORRECTION FACTOR (dB/m)
1	2373.80	63.5 PK	74.0	-10.5	1.09 H	146	31.17	32.33
2	2373.80	52.5 AV	54.0	-1.5	1.09 H	146	20.17	32.33
3	*2412.00	112.4 PK			1.09 H	146	79.96	32.44
4	*2412.00	110.1 AV			1.09 H	146	77.66	32.44
5	4824.00	50.5 PK	74.0	-23.5	1.06 H	220	8.56	41.94
6	4824.00	38.8 AV	54.0	-15.2	1.06 H	220	-3.14	41.94

ANTENNA POLARITY & TEST DISTANCE: VERTICAL AT 3 M

NO.	FREQ. (MHz)	EMISSION LEVEL (dBuV/m)	LIMIT (dBuV/m)	MARGIN (dB)	ANTENNA HEIGHT (m)	TABLE ANGLE (Degree)	RAW VALUE (dBuV)	CORRECTION FACTOR (dB/m)
1	2373.80	57.2 PK	74.0	-16.8	1.41 V	47	24.87	32.33
2	2373.80	46.2 AV	54.0	-7.8	1.41 V	47	13.87	32.33
3	*2412.00	105.2 PK			1.41 V	47	72.76	32.44
4	*2412.00	102.4 AV			1.41 V	47	69.96	32.44
5	4824.00	51.7 PK	74.0	-22.3	1.02 V	289	9.76	41.94
6	4824.00	44.5 AV	54.0	-9.5	1.02 V	289	2.56	41.94

REMARKS:

1. Emission level (dBuV/m) = Raw Value (dBuV) + Correction Factor (dB/m).
2. Correction Factor (dB/m) = Antenna Factor (dB/m) + Cable Factor (dB).
3. The other emission levels were very low against the limit.
4. Margin value = Emission level – Limit value.
5. " * ": Fundamental frequency.



A D T

CHANNEL	TX Channel 6	DETECTOR FUNCTION	Peak (PK)
FREQUENCY RANGE	1GHz ~ 25GHz		Average (AV)

ANTENNA POLARITY & TEST DISTANCE: HORIZONTAL AT 3 M

NO.	FREQ. (MHz)	EMISSION LEVEL (dBuV/m)	LIMIT (dBuV/m)	MARGIN (dB)	ANTENNA HEIGHT (m)	TABLE ANGLE (Degree)	RAW VALUE (dBuV)	CORRECTION FACTOR (dB/m)
1	2390.00	62.9 PK	74.0	-11.1	1.09 H	146	30.52	32.38
2	2390.00	53.3 AV	54.0	-0.7	1.09 H	146	20.92	32.38
3	*2437.00	110.5 PK			1.09 H	146	77.99	32.51
4	*2437.00	108.2 AV			1.09 H	146	75.69	32.51
5	2483.50	58.1 PK	74.0	-15.9	1.09 H	146	25.47	32.63
6	2483.50	45.7 AV	54.0	-8.3	1.09 H	146	13.07	32.63
7	4874.00	50.4 PK	74.0	-23.6	1.00 H	211	8.41	41.99
8	4874.00	38.8 AV	54.0	-15.2	1.00 H	211	-3.19	41.99
9	7311.00	57.7 PK	74.0	-16.3	1.00 H	211	11.17	46.53
10	7311.00	44.9 AV	54.0	-9.1	1.00 H	211	-1.63	46.53

ANTENNA POLARITY & TEST DISTANCE: VERTICAL AT 3 M

NO.	FREQ. (MHz)	EMISSION LEVEL (dBuV/m)	LIMIT (dBuV/m)	MARGIN (dB)	ANTENNA HEIGHT (m)	TABLE ANGLE (Degree)	RAW VALUE (dBuV)	CORRECTION FACTOR (dB/m)
1	2357.00	57.8 PK	74.0	-16.2	1.31 V	15	25.53	32.27
2	2357.00	46.6 AV	54.0	-7.4	1.31 V	15	14.33	32.27
3	*2437.00	105.8 PK			1.31 V	15	73.29	32.51
4	*2437.00	103.5 AV			1.31 V	15	70.99	32.51
5	2483.50	57.9 PK	74.0	-16.1	1.32 V	5	25.27	32.63
6	2483.50	46.9 AV	54.0	-7.1	1.32 V	5	14.27	32.63
7	4874.00	51.7 PK	74.0	-22.3	1.00 V	297	9.71	41.99
8	4874.00	44.5 AV	54.0	-9.5	1.00 V	297	2.51	41.99
9	7311.00	57.8 PK	74.0	-16.2	1.00 V	296	11.27	46.53
10	7311.00	44.9 AV	54.0	-9.1	1.00 V	296	-1.63	46.53

REMARKS:

1. Emission level (dBuV/m) = Raw Value (dBuV) + Correction Factor (dB/m).
2. Correction Factor (dB/m) = Antenna Factor (dB/m) + Cable Factor (dB).
3. The other emission levels were very low against the limit.
4. Margin value = Emission level – Limit value.
5. " * ": Fundamental frequency.



A D T

CHANNEL	TX Channel 11	DETECTOR FUNCTION	Peak (PK)
FREQUENCY RANGE	1GHz ~ 25GHz		Average (AV)

ANTENNA POLARITY & TEST DISTANCE: HORIZONTAL AT 3 M

NO.	FREQ. (MHz)	EMISSION LEVEL (dBuV/m)	LIMIT (dBuV/m)	MARGIN (dB)	ANTENNA HEIGHT (m)	TABLE ANGLE (Degree)	RAW VALUE (dBuV)	CORRECTION FACTOR (dB/m)
1	2382.00	62.6 PK	74.0	-11.4	1.10 H	176	30.25	32.35
2	2382.00	52.6 AV	54.0	-1.4	1.10 H	176	20.25	32.35
3	*2462.00	115.8 PK			1.10 H	176	83.23	32.57
4	*2462.00	113.0 AV			1.10 H	176	80.43	32.57
5	2483.50	63.8 PK	74.0	-10.2	1.10 H	176	31.17	32.63
6	2483.50	53.0 AV	54.0	-1.0	1.10 H	176	20.37	32.63
7	4924.00	50.3 PK	74.0	-23.7	1.02 H	209	8.29	42.01
8	4924.00	38.4 AV	54.0	-15.6	1.02 H	209	-3.61	42.01
9	7386.00	57.3 PK	74.0	-16.7	1.00 H	205	10.57	46.73
10	7386.00	44.4 AV	54.0	-9.6	1.00 H	205	-2.33	46.73

ANTENNA POLARITY & TEST DISTANCE: VERTICAL AT 3 M

NO.	FREQ. (MHz)	EMISSION LEVEL (dBuV/m)	LIMIT (dBuV/m)	MARGIN (dB)	ANTENNA HEIGHT (m)	TABLE ANGLE (Degree)	RAW VALUE (dBuV)	CORRECTION FACTOR (dB/m)
1	2382.00	58.1 PK	74.0	-15.9	1.33 V	4	25.75	32.35
2	2382.00	46.8 AV	54.0	-7.2	1.33 V	4	14.45	32.35
3	*2462.00	110.2 PK			1.31 V	47	77.63	32.57
4	*2462.00	108.1 AV			1.31 V	47	75.53	32.57
5	2483.50	57.9 PK	74.0	-16.1	1.27 V	18	25.27	32.63
6	2483.50	46.9 AV	54.0	-7.1	1.27 V	18	14.27	32.63
7	4924.00	51.6 PK	74.0	-22.4	1.01 V	289	9.59	42.01
8	4924.00	44.5 AV	54.0	-9.5	1.01 V	289	2.49	42.01
9	7386.00	58.2 PK	74.0	-15.8	1.00 V	301	11.47	46.73
10	7386.00	45.2 AV	54.0	-8.8	1.00 V	301	-1.53	46.73

REMARKS:

1. Emission level (dBuV/m) = Raw Value (dBuV) + Correction Factor (dB/m).
2. Correction Factor (dB/m) = Antenna Factor (dB/m) + Cable Factor (dB).
3. The other emission levels were very low against the limit.
4. Margin value = Emission level – Limit value.
5. " * ": Fundamental frequency.



A D T

802.11g

CHANNEL	TX Channel 1	DETECTOR FUNCTION	Peak (PK)
FREQUENCY RANGE	1GHz ~ 25GHz		Average (AV)

ANTENNA POLARITY & TEST DISTANCE: HORIZONTAL AT 3 M

NO.	FREQ. (MHz)	EMISSION LEVEL (dBuV/m)	LIMIT (dBuV/m)	MARGIN (dB)	ANTENNA HEIGHT (m)	TABLE ANGLE (Degree)	RAW VALUE (dBuV)	CORRECTION FACTOR (dB/m)
1	2390.00	66.5 PK	74.0	-7.5	1.09 H	145	34.12	32.38
2	2390.00	53.5 AV	54.0	-0.5	1.09 H	145	21.12	32.38
3	*2412.00	109.2 PK			1.09 H	145	76.76	32.44
4	*2412.00	98.6 AV			1.09 H	145	66.16	32.44
5	4824.00	47.1 PK	74.0	-26.9	1.00 H	75	5.16	41.94
6	4824.00	34.8 AV	54.0	-19.2	1.00 H	75	-7.14	41.94

ANTENNA POLARITY & TEST DISTANCE: VERTICAL AT 3 M

NO.	FREQ. (MHz)	EMISSION LEVEL (dBuV/m)	LIMIT (dBuV/m)	MARGIN (dB)	ANTENNA HEIGHT (m)	TABLE ANGLE (Degree)	RAW VALUE (dBuV)	CORRECTION FACTOR (dB/m)
1	2390.00	58.5 PK	74.0	-15.5	1.34 V	52	26.12	32.38
2	2390.00	46.2 AV	54.0	-7.8	1.34 V	52	13.82	32.38
3	*2412.00	98.9 PK			1.33 V	52	66.46	32.44
4	*2412.00	89.5 AV			1.33 V	52	57.06	32.44
5	4824.00	48.3 PK	74.0	-25.7	1.00 V	125	6.36	41.94
6	4824.00	36.1 AV	54.0	-17.9	1.00 V	125	-5.84	41.94

REMARKS:

1. Emission level (dBuV/m) = Raw Value (dBuV) + Correction Factor (dB/m).
2. Correction Factor (dB/m) = Antenna Factor (dB/m) + Cable Factor (dB).
3. The other emission levels were very low against the limit.
4. Margin value = Emission level – Limit value.
5. " * ": Fundamental frequency.



A D T

CHANNEL	TX Channel 6	DETECTOR FUNCTION	Peak (PK)
FREQUENCY RANGE	1GHz ~ 25GHz		Average (AV)

ANTENNA POLARITY & TEST DISTANCE: HORIZONTAL AT 3 M

NO.	FREQ. (MHz)	EMISSION LEVEL (dBuV/m)	LIMIT (dBuV/m)	MARGIN (dB)	ANTENNA HEIGHT (m)	TABLE ANGLE (Degree)	RAW VALUE (dBuV)	CORRECTION FACTOR (dB/m)
1	2390.00	66.6 PK	74.0	-7.4	1.10 H	148	34.22	32.38
2	2390.00	53.5 AV	54.0	-0.5	1.10 H	148	21.12	32.38
3	*2437.00	116.9 PK			1.10 H	148	84.39	32.51
4	*2437.00	105.7 AV			1.10 H	148	73.19	32.51
5	2483.50	60.0 PK	74.0	-14.0	1.10 H	148	27.37	32.63
6	2483.50	47.7 AV	54.0	-6.3	1.10 H	148	15.07	32.63
7	4874.00	46.8 PK	74.0	-27.2	1.00 H	72	4.81	41.99
8	4874.00	34.9 AV	54.0	-19.1	1.00 H	72	-7.09	41.99
9	7311.00	56.3 PK	74.0	-17.7	1.10 H	214	9.77	46.53
10	7311.00	43.9 AV	54.0	-10.1	1.10 H	214	-2.63	46.53

ANTENNA POLARITY & TEST DISTANCE: VERTICAL AT 3 M

NO.	FREQ. (MHz)	EMISSION LEVEL (dBuV/m)	LIMIT (dBuV/m)	MARGIN (dB)	ANTENNA HEIGHT (m)	TABLE ANGLE (Degree)	RAW VALUE (dBuV)	CORRECTION FACTOR (dB/m)
1	2390.00	57.7 PK	74.0	-16.3	1.33 V	51	25.32	32.38
2	2390.00	46.7 AV	54.0	-7.3	1.33 V	51	14.32	32.38
3	*2437.00	107.8 PK			1.33 V	51	75.29	32.51
4	*2437.00	96.8 AV			1.33 V	51	64.29	32.51
5	2483.50	57.5 PK	74.0	-16.5	1.33 V	51	24.87	32.63
6	2483.50	46.5 AV	54.0	-7.5	1.33 V	51	13.87	32.63
7	4874.00	48.0 PK	74.0	-26.0	1.03 V	122	6.01	41.99
8	4874.00	35.7 AV	54.0	-18.3	1.03 V	122	-6.29	41.99
9	7311.00	56.0 PK	74.0	-18.0	1.00 V	215	9.47	46.53
10	7311.00	43.6 AV	54.0	-10.4	1.00 V	215	-2.93	46.53

REMARKS:

1. Emission level (dBuV/m) = Raw Value (dBuV) + Correction Factor (dB/m).
2. Correction Factor (dB/m) = Antenna Factor (dB/m) + Cable Factor (dB).
3. The other emission levels were very low against the limit.
4. Margin value = Emission level – Limit value.
5. " * ": Fundamental frequency.



A D T

CHANNEL	TX Channel 11	DETECTOR FUNCTION	Peak (PK)
FREQUENCY RANGE	1GHz ~ 25GHz		Average (AV)

ANTENNA POLARITY & TEST DISTANCE: HORIZONTAL AT 3 M

NO.	FREQ. (MHz)	EMISSION LEVEL (dBuV/m)	LIMIT (dBuV/m)	MARGIN (dB)	ANTENNA HEIGHT (m)	TABLE ANGLE (Degree)	RAW VALUE (dBuV)	CORRECTION FACTOR (dB/m)
1	*2462.00	109.6 PK			1.08 H	175	77.03	32.57
2	*2462.00	99.3 AV			1.08 H	175	66.73	32.57
3	2483.50	67.6 PK	74.0	-6.4	1.08 H	175	34.97	32.63
4	2483.50	52.7 AV	54.0	-1.3	1.08 H	175	20.07	32.63
5	4924.00	46.5 PK	74.0	-27.5	1.00 H	74	4.49	42.01
6	4924.00	34.7 AV	54.0	-19.3	1.00 H	74	-7.31	42.01
7	7386.00	55.5 PK	74.0	-18.5	1.14 H	219	8.77	46.73
8	7386.00	43.0 AV	54.0	-11.0	1.14 H	219	-3.73	46.73

ANTENNA POLARITY & TEST DISTANCE: VERTICAL AT 3 M

NO.	FREQ. (MHz)	EMISSION LEVEL (dBuV/m)	LIMIT (dBuV/m)	MARGIN (dB)	ANTENNA HEIGHT (m)	TABLE ANGLE (Degree)	RAW VALUE (dBuV)	CORRECTION FACTOR (dB/m)
1	*2462.00	100.5 PK			1.31 V	47	67.93	32.57
2	*2462.00	90.1 AV			1.31 V	47	57.53	32.57
3	2483.50	57.2 PK	74.0	-16.8	1.31 V	47	24.57	32.63
4	2483.50	46.5 AV	54.0	-7.5	1.31 V	47	13.87	32.63
5	4924.00	48.3 PK	74.0	-25.7	1.01 V	134	6.29	42.01
6	4924.00	35.8 AV	54.0	-18.2	1.01 V	134	-6.21	42.01
7	7386.00	56.0 PK	74.0	-18.0	1.04 V	213	9.27	46.73
8	7386.00	43.6 AV	54.0	-10.4	1.04 V	213	-3.13	46.73

REMARKS:

1. Emission level (dBuV/m) = Raw Value (dBuV) + Correction Factor (dB/m).
2. Correction Factor (dB/m) = Antenna Factor (dB/m) + Cable Factor (dB).
3. The other emission levels were very low against the limit.
4. Margin value = Emission level – Limit value.
5. " * " : Fundamental frequency.

802.11n (HT20)

CHANNEL	TX Channel 1	DETECTOR FUNCTION	Peak (PK)
FREQUENCY RANGE	1GHz ~ 25GHz		Average (AV)

ANTENNA POLARITY & TEST DISTANCE: HORIZONTAL AT 3 M								
NO.	FREQ. (MHz)	EMISSION LEVEL (dBuV/m)	LIMIT (dBuV/m)	MARGIN (dB)	ANTENNA HEIGHT (m)	TABLE ANGLE (Degree)	RAW VALUE (dBuV)	CORRECTION FACTOR (dB/m)
1	2390.00	68.5 PK	74.0	-5.5	1.10 H	146	36.12	32.38
2	2390.00	53.5 AV	54.0	-0.5	1.10 H	146	21.12	32.38
3	*2412.00	110.3 PK			1.10 H	145	77.86	32.44
4	*2412.00	99.0 AV			1.10 H	145	66.56	32.44
5	4824.00	46.9 PK	74.0	-27.1	1.00 H	68	4.96	41.94
6	4824.00	34.8 AV	54.0	-19.2	1.00 H	68	-7.14	41.94
ANTENNA POLARITY & TEST DISTANCE: VERTICAL AT 3 M								
NO.	FREQ. (MHz)	EMISSION LEVEL (dBuV/m)	LIMIT (dBuV/m)	MARGIN (dB)	ANTENNA HEIGHT (m)	TABLE ANGLE (Degree)	RAW VALUE (dBuV)	CORRECTION FACTOR (dB/m)
1	2390.00	62.7 PK	74.0	-11.3	1.00 V	22	30.32	32.38
2	2390.00	51.0 AV	54.0	-3.0	1.00 V	22	18.62	32.38
3	*2412.00	109.8 PK			1.24 V	38	77.36	32.44
4	*2412.00	100.3 AV			1.24 V	38	67.86	32.44
5	4824.00	48.6 PK	74.0	-25.4	1.00 V	138	6.66	41.94
6	4824.00	36.2 AV	54.0	-17.8	1.00 V	138	-5.74	41.94

REMARKS:

1. Emission level (dBuV/m) = Raw Value (dBuV) + Correction Factor (dB/m).
2. Correction Factor (dB/m) = Antenna Factor (dB/m) + Cable Factor (dB).
3. The other emission levels were very low against the limit.
4. Margin value = Emission level – Limit value.
5. " * ": Fundamental frequency.



A D T

CHANNEL	TX Channel 6	DETECTOR FUNCTION	Peak (PK)
FREQUENCY RANGE	1GHz ~ 25GHz		Average (AV)

ANTENNA POLARITY & TEST DISTANCE: HORIZONTAL AT 3 M

NO.	FREQ. (MHz)	EMISSION LEVEL (dBuV/m)	LIMIT (dBuV/m)	MARGIN (dB)	ANTENNA HEIGHT (m)	TABLE ANGLE (Degree)	RAW VALUE (dBuV)	CORRECTION FACTOR (dB/m)
1	2353.00	67.7 PK	74.0	-6.3	1.12 H	145	35.44	32.26
2	2353.00	53.5 AV	54.0	-0.5	1.12 H	145	21.24	32.26
3	*2437.00	116.3 PK			1.12 H	145	83.79	32.51
4	*2437.00	106.2 AV			1.12 H	145	73.69	32.51
5	4874.00	46.5 PK	74.0	-27.5	1.00 H	62	4.51	41.99
6	4874.00	34.4 AV	54.0	-19.6	1.00 H	62	-7.59	41.99
7	7311.00	55.7 PK	74.0	-18.3	1.10 H	219	9.17	46.53
8	7311.00	43.2 AV	54.0	-10.8	1.10 H	219	-3.33	46.53

ANTENNA POLARITY & TEST DISTANCE: VERTICAL AT 3 M

NO.	FREQ. (MHz)	EMISSION LEVEL (dBuV/m)	LIMIT (dBuV/m)	MARGIN (dB)	ANTENNA HEIGHT (m)	TABLE ANGLE (Degree)	RAW VALUE (dBuV)	CORRECTION FACTOR (dB/m)
1	2353.00	63.5 PK	74.0	-10.5	1.01 V	19	31.24	32.26
2	2353.00	51.5 AV	54.0	-2.5	1.01 V	19	19.24	32.26
3	*2437.00	117.0 PK			1.00 V	39	84.49	32.51
4	*2437.00	107.1 AV			1.00 V	39	74.59	32.51
5	4874.00	48.2 PK	74.0	-25.8	1.00 V	136	6.21	41.99
6	4874.00	35.8 AV	54.0	-18.2	1.00 V	136	-6.19	41.99
7	7311.00	56.0 PK	74.0	-18.0	1.07 V	205	9.47	46.53
8	7311.00	43.7 AV	54.0	-10.3	1.07 V	205	-2.83	46.53

REMARKS:

1. Emission level (dBuV/m) = Raw Value (dBuV) + Correction Factor (dB/m).
2. Correction Factor (dB/m) = Antenna Factor (dB/m) + Cable Factor (dB).
3. The other emission levels were very low against the limit.
4. Margin value = Emission level – Limit value.
5. " * ": Fundamental frequency.



A D T

CHANNEL	TX Channel 11	DETECTOR FUNCTION	Peak (PK)
FREQUENCY RANGE	1GHz ~ 25GHz		Average (AV)

ANTENNA POLARITY & TEST DISTANCE: HORIZONTAL AT 3 M

NO.	FREQ. (MHz)	EMISSION LEVEL (dBuV/m)	LIMIT (dBuV/m)	MARGIN (dB)	ANTENNA HEIGHT (m)	TABLE ANGLE (Degree)	RAW VALUE (dBuV)	CORRECTION FACTOR (dB/m)
1	*2462.00	110.6 PK			1.08 H	181	78.03	32.57
2	*2462.00	102.6 AV			1.08 H	181	70.03	32.57
3	2483.50	66.3 PK	74.0	-7.7	1.08 H	193	33.67	32.63
4	2483.50	53.5 AV	54.0	-0.5	1.08 H	193	20.87	32.63
5	4924.00	46.5 PK	74.0	-27.5	1.00 H	72	4.49	42.01
6	4924.00	34.5 AV	54.0	-19.5	1.00 H	72	-7.51	42.01
7	7386.00	56.0 PK	74.0	-18.0	1.07 H	214	9.27	46.73
8	7386.00	43.6 AV	54.0	-10.4	1.07 H	214	-3.13	46.73

ANTENNA POLARITY & TEST DISTANCE: VERTICAL AT 3 M

NO.	FREQ. (MHz)	EMISSION LEVEL (dBuV/m)	LIMIT (dBuV/m)	MARGIN (dB)	ANTENNA HEIGHT (m)	TABLE ANGLE (Degree)	RAW VALUE (dBuV)	CORRECTION FACTOR (dB/m)
1	*2462.00	111.3 PK			1.25 V	38	78.73	32.57
2	*2462.00	102.2 AV			1.25 V	38	69.63	32.57
3	2483.50	62.4 PK	74.0	-11.6	1.27 V	32	29.77	32.63
4	2483.50	52.0 AV	54.0	-2.0	1.27 V	32	19.37	32.63
5	4924.00	48.0 PK	74.0	-26.0	1.01 V	124	5.99	42.01
6	4924.00	35.4 AV	54.0	-18.6	1.01 V	124	-6.61	42.01
7	7386.00	55.6 PK	74.0	-18.4	1.08 V	194	8.87	46.73
8	7386.00	43.5 AV	54.0	-10.5	1.08 V	194	-3.23	46.73

REMARKS:

1. Emission level (dBuV/m) = Raw Value (dBuV) + Correction Factor (dB/m).
2. Correction Factor (dB/m) = Antenna Factor (dB/m) + Cable Factor (dB).
3. The other emission levels were very low against the limit.
4. Margin value = Emission level – Limit value.
5. " * ": Fundamental frequency.

802.11n (HT40)

CHANNEL	TX Channel 3	DETECTOR FUNCTION	Peak (PK)
FREQUENCY RANGE	1GHz ~ 25GHz		Average (AV)

ANTENNA POLARITY & TEST DISTANCE: HORIZONTAL AT 3 M								
NO.	FREQ. (MHz)	EMISSION LEVEL (dBuV/m)	LIMIT (dBuV/m)	MARGIN (dB)	ANTENNA HEIGHT (m)	TABLE ANGLE (Degree)	RAW VALUE (dBuV)	CORRECTION FACTOR (dB/m)
1	2390.00	68.9 PK	74.0	-5.1	1.10 H	146	36.92	31.98
2	2390.00	53.1 AV	54.0	-0.9	1.10 H	146	21.12	31.98
3	*2422.00	106.9 PK			1.10 H	146	74.82	32.08
4	*2422.00	96.2 AV			1.10 H	146	64.12	32.08
5	4844.00	46.4 PK	74.0	-27.6	1.00 H	88	6.77	39.63
6	4844.00	34.2 AV	54.0	-19.8	1.00 H	88	-5.43	39.63
7	7266.00	56.0 PK	74.0	-18.0	1.06 H	222	8.40	47.60
8	7266.00	43.4 AV	54.0	-10.6	1.06 H	222	-4.20	47.60
ANTENNA POLARITY & TEST DISTANCE: VERTICAL AT 3 M								
NO.	FREQ. (MHz)	EMISSION LEVEL (dBuV/m)	LIMIT (dBuV/m)	MARGIN (dB)	ANTENNA HEIGHT (m)	TABLE ANGLE (Degree)	RAW VALUE (dBuV)	CORRECTION FACTOR (dB/m)
1	2390.00	68.9 PK	74.0	-5.1	1.26 V	39	36.92	31.98
2	2390.00	52.7 AV	54.0	-1.3	1.26 V	39	20.72	31.98
3	*2422.00	103.5 PK			1.26 V	39	71.42	32.08
4	*2422.00	93.8 AV			1.26 V	39	61.72	32.08
5	4844.00	47.4 PK	74.0	-26.6	1.00 V	132	7.77	39.63
6	4844.00	34.9 AV	54.0	-19.1	1.00 V	132	-4.73	39.63
7	7266.00	55.4 PK	74.0	-18.6	1.04 V	186	7.80	47.60
8	7266.00	43.2 AV	54.0	-10.8	1.04 V	186	-4.40	47.60

REMARKS:

1. Emission level (dBuV/m) = Raw Value (dBuV) + Correction Factor (dB/m).
2. Correction Factor (dB/m) = Antenna Factor (dB/m) + Cable Factor (dB).
3. The other emission levels were very low against the limit.
4. Margin value = Emission level – Limit value.
5. " * ": Fundamental frequency.



A D T

CHANNEL	TX Channel 6	DETECTOR FUNCTION	Peak (PK)
FREQUENCY RANGE	1GHz ~ 25GHz		Average (AV)

ANTENNA POLARITY & TEST DISTANCE: HORIZONTAL AT 3 M

NO.	FREQ. (MHz)	EMISSION LEVEL (dBuV/m)	LIMIT (dBuV/m)	MARGIN (dB)	ANTENNA HEIGHT (m)	TABLE ANGLE (Degree)	RAW VALUE (dBuV)	CORRECTION FACTOR (dB/m)
1	2390.00	65.9 PK	74.0	-8.1	1.10 H	146	33.92	31.98
2	2390.00	53.1 AV	54.0	-0.9	1.10 H	146	21.12	31.98
3	*2437.00	112.1 PK			1.10 H	146	79.98	32.12
4	*2437.00	101.6 AV			1.10 H	146	69.48	32.12
5	4874.00	46.4 PK	74.0	-27.6	1.00 H	99	6.70	39.70
6	4874.00	34.0 AV	54.0	-20.0	1.00 H	99	-5.70	39.70
7	7311.00	55.7 PK	74.0	-18.3	1.00 H	226	8.11	47.59
8	7311.00	43.4 AV	54.0	-10.6	1.00 H	226	-4.19	47.59

ANTENNA POLARITY & TEST DISTANCE: VERTICAL AT 3 M

NO.	FREQ. (MHz)	EMISSION LEVEL (dBuV/m)	LIMIT (dBuV/m)	MARGIN (dB)	ANTENNA HEIGHT (m)	TABLE ANGLE (Degree)	RAW VALUE (dBuV)	CORRECTION FACTOR (dB/m)
1	2390.00	68.3 PK	74.0	-5.7	1.29 V	38	36.32	31.98
2	2390.00	52.2 AV	54.0	-1.8	1.29 V	38	20.22	31.98
3	*2437.00	109.6 PK			1.29 V	38	77.48	32.12
4	*2437.00	99.0 AV			1.29 V	38	66.88	32.12
5	4874.00	47.3 PK	74.0	-26.7	1.00 V	121	7.60	39.70
6	4874.00	34.7 AV	54.0	-19.3	1.00 V	121	-5.00	39.70
7	7311.00	55.6 PK	74.0	-18.4	1.02 V	190	8.01	47.59
8	7311.00	43.2 AV	54.0	-10.8	1.02 V	190	-4.39	47.59

REMARKS:

1. Emission level (dBuV/m) = Raw Value (dBuV) + Correction Factor (dB/m).
2. Correction Factor (dB/m) = Antenna Factor (dB/m) + Cable Factor (dB).
3. The other emission levels were very low against the limit.
4. Margin value = Emission level – Limit value.
5. " * ": Fundamental frequency.



A D T

CHANNEL	TX Channel 9	DETECTOR FUNCTION	Peak (PK)
FREQUENCY RANGE	1GHz ~ 25GHz		Average (AV)

ANTENNA POLARITY & TEST DISTANCE: HORIZONTAL AT 3 M

NO.	FREQ. (MHz)	EMISSION LEVEL (dBuV/m)	LIMIT (dBuV/m)	MARGIN (dB)	ANTENNA HEIGHT (m)	TABLE ANGLE (Degree)	RAW VALUE (dBuV)	CORRECTION FACTOR (dB/m)
1	*2452.00	108.8 PK			1.11 H	10	76.64	32.16
2	*2452.00	99.1 AV			1.11 H	10	66.94	32.16
3	2487.10	69.8 PK	74.0	-4.2	1.07 H	175	37.55	32.25
4	2487.10	53.5 AV	54.0	-0.5	1.07 H	175	21.25	32.25
5	4904.00	46.8 PK	74.0	-27.2	1.00 H	107	7.03	39.77
6	4904.00	34.4 AV	54.0	-19.6	1.00 H	107	-5.37	39.77
7	7356.00	55.3 PK	74.0	-18.7	1.00 H	212	7.75	47.55
8	7356.00	43.0 AV	54.0	-11.0	1.00 H	212	-4.55	47.55

ANTENNA POLARITY & TEST DISTANCE: VERTICAL AT 3 M

NO.	FREQ. (MHz)	EMISSION LEVEL (dBuV/m)	LIMIT (dBuV/m)	MARGIN (dB)	ANTENNA HEIGHT (m)	TABLE ANGLE (Degree)	RAW VALUE (dBuV)	CORRECTION FACTOR (dB/m)
1	*2452.00	107.5 PK			1.23 V	37	75.34	32.16
2	*2452.00	97.7 AV			1.23 V	37	65.54	32.16
3	2487.10	63.5 PK	74.0	-10.5	1.22 V	40	31.25	32.25
4	2487.10	53.3 AV	54.0	-0.7	1.22 V	40	21.05	32.25
5	4904.00	46.8 PK	74.0	-27.2	1.00 V	112	7.03	39.77
6	4904.00	34.2 AV	54.0	-19.8	1.00 V	112	-5.57	39.77
7	7356.00	55.0 PK	74.0	-19.0	1.00 V	202	7.45	47.55
8	7356.00	42.8 AV	54.0	-11.2	1.00 V	202	-4.75	47.55

REMARKS:

1. Emission level (dBuV/m) = Raw Value (dBuV) + Correction Factor (dB/m).
2. Correction Factor (dB/m) = Antenna Factor (dB/m) + Cable Factor (dB).
3. The other emission levels were very low against the limit.
4. Margin value = Emission level – Limit value.
5. " * " : Fundamental frequency.

4.3 6dB BANDWIDTH MEASUREMENT

4.3.1 LIMITS OF 6dB BANDWIDTH MEASUREMENT

The minimum of 6dB Bandwidth Measurement is 0.5 MHz.

4.3.2 TEST INSTRUMENTS

DESCRIPTION & MANUFACTURER	MODEL NO.	SERIAL NO.	CALIBRATED DATE	CALIBRATED UNTIL
R&S SPECTRUM ANALYZER	FSP40	100037	Nov. 01, 2012	Oct. 31, 2013

Note:

1. The calibration interval of the above test instruments is 12 months and the calibrations are traceable to NML/ROC and NIST/USA.
2. Tested date : Jan. 07, 2013

4.3.3 TEST PROCEDURE

1. Set resolution bandwidth (RBW) = approximately 1% of the emission bandwidth
2. Set the video bandwidth (VBW) $\geq 3 \times$ RBW, Detector = Peak.
3. Trace mode = max hold.
4. Sweep = auto couple.
5. Measure the maximum width of the emission that is constrained by the frequencies associated with the two amplitude points (upper and lower) that are attenuated by 6 dB relative to the maximum level measured in the fundamental emission

4.3.4 DEVIATION FROM TEST STANDARD

No deviation

4.3.5 TEST SETUP

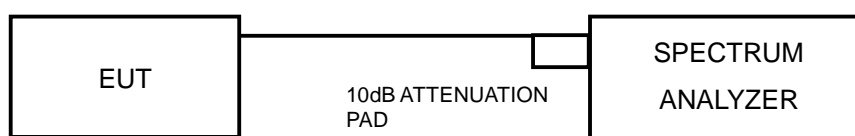

4.3.6 EUT OPERATING CONDITIONS

The software provided by client to enable the EUT under transmission condition continuously at lowest, middle and highest channel frequencies individually.



A D T

4.3.7 TEST RESULTS

802.11b

CHANNEL	FREQUENCY (MHz)	6dB BANDWIDTH (MHz)	MINIMUM LIMIT (MHz)	PASS / FAIL
1	2412	8.24	0.5	PASS
6	2437	8.38	0.5	PASS
11	2462	8.39	0.5	PASS

802.11g

CHANNEL	FREQUENCY (MHz)	6dB BANDWIDTH (MHz)	MINIMUM LIMIT (MHz)	PASS / FAIL
1	2412	16.52	0.5	PASS
6	2437	16.48	0.5	PASS
11	2462	16.48	0.5	PASS

802.11n (HT20)

CHANNEL	CHANNEL FREQUENCY (MHz)	6dB BANDWIDTH (MHz)			MINIMUM LIMIT (MHz)	PASS / FAIL
		CHAIN 0	CHAIN 1	CHAIN 2		
1	2412	17.69	17.70	17.66	0.5	PASS
6	2437	17.71	17.69	17.67	0.5	PASS
11	2462	17.63	17.68	17.70	0.5	PASS

802.11n (HT40)

CHANNEL	CHANNEL FREQUENCY (MHz)	6dB BANDWIDTH (MHz)			MINIMUM LIMIT (MHz)	PASS / FAIL
		CHAIN 0	CHAIN 1	CHAIN 2		
3	2422	36.20	36.44	36.47	0.5	PASS
6	2437	36.43	36.43	35.92	0.5	PASS
9	2452	35.90	36.44	36.46	0.5	PASS

4.4 CONDUCTED OUTPUT POWER MEASUREMENT

4.4.1 LIMITS OF MAXIMUM PEAK OUTPUT POWER MEASUREMENT

For systems using digital modulation in the 2400–2483.5 MHz band: 1 Watt (30dBm)

Per KDB 662911 D01 Multiple Transmitter Output v01r02 Method of conducted output power measurement on IEEE 802.11 devices,

Array Gain = 0 dB (i.e., no array gain) for NANT \leq 4;

Array Gain = 0 dB (i.e., no array gain) for channel widths \geq 40 MHz for any NANT;

Array Gain = 5 log(NANT/NSS) dB or 3 dB, whichever is less for 20-MHz channel widths with NANT \geq 5.

For power measurements on all other devices: Array Gain = 10 log(NANT/NSS) dB.

4.4.2 INSTRUMENTS

DESCRIPTION & MANUFACTURER	MODEL NO.	SERIAL NO.	CALIBRATED DATE	CALIBRATED UNTIL
R&S Spectrum Analyzer	FSP40	100037	Nov. 01, 2012	Oct. 31, 2013

Note:

1. The calibration interval of the above test instruments is 12 months and the calibrations are traceable to NML/ROC and NIST/USA.
2. Tested date : Jan. 07, 2013

4.4.3 TEST PROCEDURES

Follow FCC KDB 558074 DTS test procedure:
Measurement Procedure AVG1

1. Set the analyzer span to a minimum of 1.5 times the EBW.
2. Set RBW =1MHz.
3. Set the VBW $\geq 3 \times$ RBW.
4. Number of measurement points in the sweep $\geq 2 \times$ (span/RBW).
5. Sweep time = auto couple.
6. Detector = power averaging (RMS) or sample.
7. Employ trace averaging in power averaging (RMS) mode over a minimum of 100 traces.
8. Use the spectrum analyzer's integrated band power measurement function with band limits set equal to the EBW band edges.

4.4.4 DEVIATION FROM TEST STANDARD

No deviation.

4.4.5 TEST SETUP

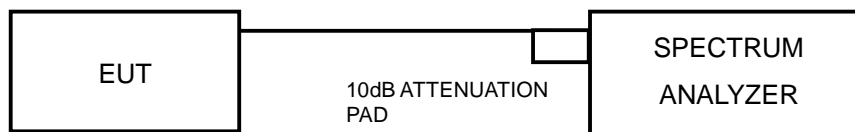

4.4.6 EUT OPERATING CONDITIONS

Same as Item 4.3.6



A D T

4.4.7 TEST RESULTS

802.11b

CHANNEL	FREQUENCY (MHz)	AVERAGE POWER (mW)	AVERAGE POWER (dBm)	LIMIT (dBm)	PASS/FAIL
1	2412	73.451	18.66	30	PASS
6	2437	101.158	20.05	30	PASS
11	2462	118.850	20.75	30	PASS

802.11g

CHANNEL	FREQUENCY (MHz)	AVERAGE POWER (mW)	AVERAGE POWER (dBm)	LIMIT (dBm)	PASS/FAIL
1	2412	18.239	12.61	30	PASS
6	2437	118.304	20.73	30	PASS
11	2462	20.606	13.14	30	PASS

802.11n (HT20)

CHAN.	FREQUENCY (MHz)	AVERAGE POWER (dBm)			TOTAL POWER (mW)	TOTAL POWER (dBm)	LIMIT (dBm)	PASS / FAIL
		CHAIN 0	CHAIN 1	CHAIN 2				
1	2412	10.81	10.64	10.54	34.962	15.44	30	PASS
6	2437	19.45	19.33	19.10	255.092	24.07	30	PASS
11	2462	13.66	13.54	13.01	65.820	18.18	30	PASS

802.11n (HT40)

CHAN.	FREQUENCY (MHz)	AVERAGE POWER (dBm)			TOTAL POWER (mW)	TOTAL POWER (dBm)	LIMIT (dBm)	PASS / FAIL
		CHAIN 0	CHAIN 1	CHAIN 2				
3	2422	8.98	8.23	7.13	19.724	12.95	30	PASS
6	2437	13.56	13.08	12.41	60.441	17.81	30	PASS
9	2452	12.06	9.32	9.27	33.073	15.19	30	PASS

4.5 POWER SPECTRAL DENSITY MEASUREMENT

4.5.1 LIMITS OF POWER SPECTRAL DENSITY MEASUREMENT

The Maximum of Power Spectral Density Measurement is 8dBm.

4.5.2 TEST INSTRUMENTS

DESCRIPTION & MANUFACTURER	MODEL NO.	SERIAL NO.	CALIBRATED DATE	CALIBRATED UNTIL
R&S Spectrum Analyzer	FSP40	100037	Nov. 01, 2012	Oct. 31, 2013

Note:

1. The calibration interval of the above test instruments is 12 months and the calibrations are traceable to NML/ROC and NIST/USA.
2. Tested date : Jan. 07, 2013

4.5.3 TEST PROCEDURE

1. Set the RBW = 3 kHz, VBW =10 kHz, Detector = power averaging (RMS) .
2. Ensure that the number of measurement points in the sweep $\geq 2 \times$ span/RBW
3. Sweep time = auto couple,
4. Employ trace averaging (RMS) mode over a minimum of 100 traces.
5. Use the peak marker function to determine the maximum amplitude level.

4.5.4 DEVIATION FROM TEST STANDARD

No deviation

4.5.5 TEST SETUP

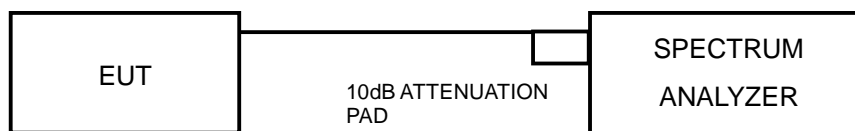

4.5.6 EUT OPERATING CONDITION

Same as Item 4.3.6



A D T

4.5.7 TEST RESULTS

802.11b

Channel	FREQUENCY (MHz)	PSD (dBm/3kHz)	Limit (dBm/3kHz)	PASS /FAIL
1	2412	-4.50	8	PASS
6	2437	-2.40	8	PASS
11	2462	-2.15	8	PASS

802.11g

Channel	FREQUENCY (MHz)	PSD (dBm/3kHz)	Limit (dBm/3kHz)	PASS /FAIL
1	2412	-12.56	8	PASS
6	2437	-4.73	8	PASS
11	2462	-12.04	8	PASS

802.11n (HT20)

TX chain	Channel	FREQ. (MHz)	PSD (dBm/3kHz)	10 log (N=3) dB	Total PSD (dBm/3kHz)	Limit (dBm/3kHz)	PASS /FAIL
0	1	2412	-14.37	4.77	-9.60	8	PASS
	6	2437	-7.18	4.77	-2.41	8	PASS
	11	2462	-11.62	4.77	-6.85	8	PASS
1	1	2412	-26.08	4.77	-21.31	8	PASS
	6	2437	-6.20	4.77	-1.43	8	PASS
	11	2462	-12.06	4.77	-7.29	8	PASS
2	1	2412	-14.59	4.77	-9.82	8	PASS
	6	2437	-6.34	4.77	-1.57	8	PASS
	11	2462	-12.38	4.77	-7.61	8	PASS

NOTE: Directional gain = $10 \log[(10^{G1/20} + 10^{G2/20})^2 / 2] = 5.83\text{dBi} < 6\text{dBi}$, so the power density limit shall not be reduced.



A D T

802.11n (HT40)

TX chain	Channel	FREQ. (MHz)	PSD (dBm/3kHz)	10 log (N=3) dB	Total PSD (dBm/3kHz)	Limit (dBm/3kHz)	PASS /FAIL
0	3	2422	-17.83	4.77	-13.06	8	PASS
	6	2437	-12.56	4.77	-7.79	8	PASS
	9	2452	-14.28	4.77	-9.51	8	PASS
1	3	2422	-17.91	4.77	-13.14	8	PASS
	6	2437	-12.96	4.77	-8.19	8	PASS
	9	2452	-15.02	4.77	-10.25	8	PASS
2	3	2422	-19.63	4.77	-14.86	8	PASS
	6	2437	-13.92	4.77	-9.15	8	PASS
	9	2452	-16.09	4.77	-11.32	8	PASS

NOTE: Directional gain = $10 \log[(10^{G1/20} + 10^{G2/20})^2 / 2] = 5.83\text{dBi} < 6\text{dBi}$, so the power density limit shall not be reduced.

4.6 CONDUCTED OUT-BAND EMISSION MEASUREMENT

4.6.1 LIMITS OF CONDUCTED OUT-BAND EMISSION MEASUREMENT

Below 30dB of the highest emission level of operating band (in 100kHz Resolution Bandwidth).

4.6.2 TEST INSTRUMENTS

DESCRIPTION & MANUFACTURER	MODEL NO.	SERIAL NO.	CALIBRATED DATE	CALIBRATED UNTIL
R&S Spectrum Analyzer	FSP40	100037	Nov. 01, 2012	Oct. 31, 2013

Note:

1. The calibration interval of the above test instruments is 12 months and the calibrations are traceable to NML/ROC and NIST/USA.
2. Tested date : Jan. 07, 2013

4.6.3 TEST PROCEDURE

Measurement Procedure - Reference Level

1. Set the RBW = 100 kHz.
2. Set the VBW \geq 300 kHz.
3. Detector = power average (RMS).
4. Manually set the sweep time to: $\geq 10 \times$ (number of measurement points in sweep) \times (transmission symbol period).
5. Perform the measurement over a single sweep.
6. Use the peak marker function to determine the maximum power level in any 100 kHz band segment within the fundamental EBW.

Measurement Procedure –Unwanted Emission Level

1. Set RBW = 100 kHz.
2. Set VBW \geq 300 kHz.
3. Set span to encompass the spectrum to be examined
4. Detector = power average (RMS).
5. Manually set the sweep time to $\geq 10 \times$ (number of measurement points in sweep) \times (transmission symbol period).
6. Perform the measurement over a single sweep.
7. Use the peak marker function to determine the maximum power level in any 100 kHz band segment within the fundamental EBW.

4.6.4 DEVIATION FROM TEST STANDARD

No deviation

4.6.5 TEST SETUP

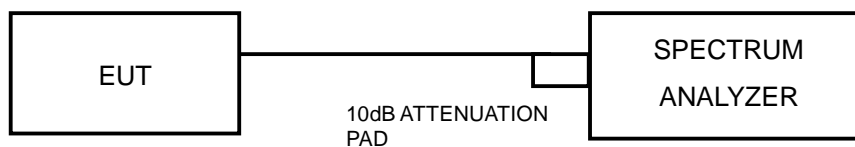

4.6.6 EUT OPERATING CONDITION

Same as Item 4.3.6

4.6.7 TEST RESULTS

The spectrum plots are attached on the following pages. D1 line indicates the highest level, and D2 line indicates the 30dB offset below D1. It shows compliance with the requirement.

802.11b:

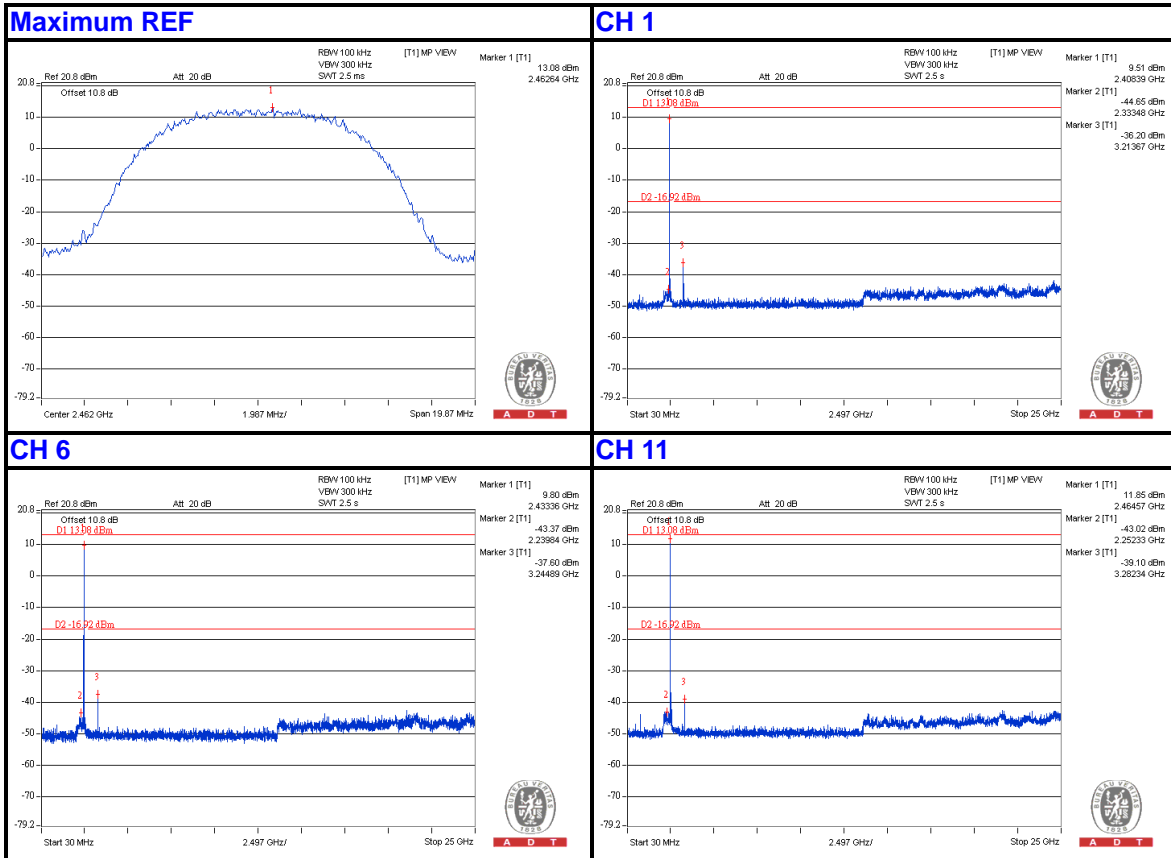



A D T

802.11g:

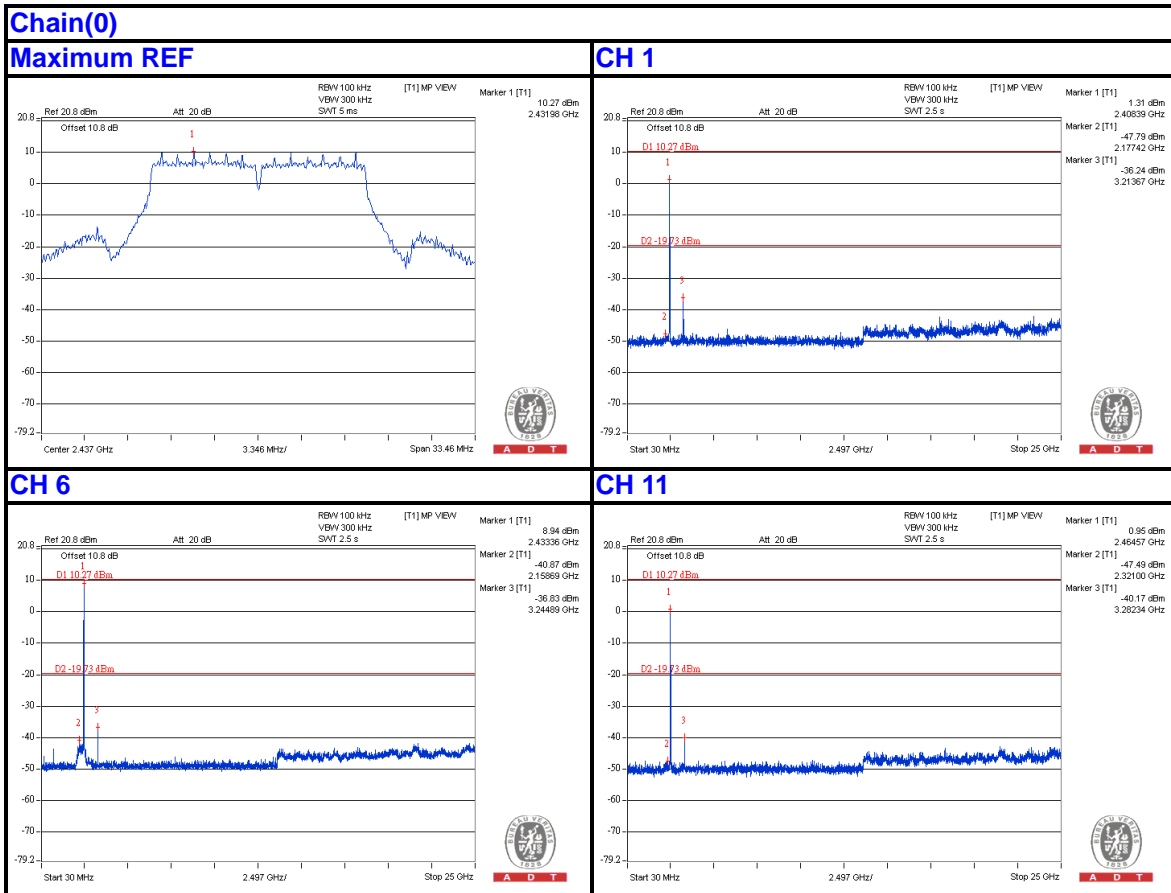



A D T

802.11n (HT20):

Chain(0)

Maximum REF

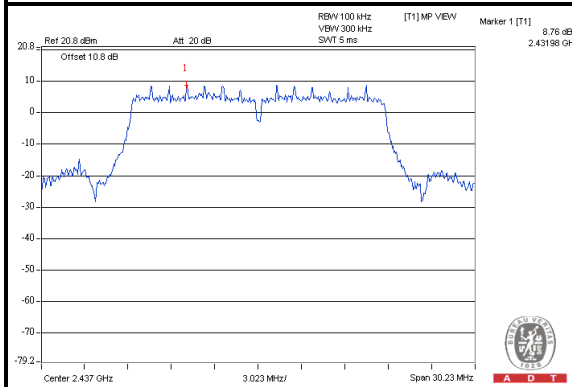

CH 1

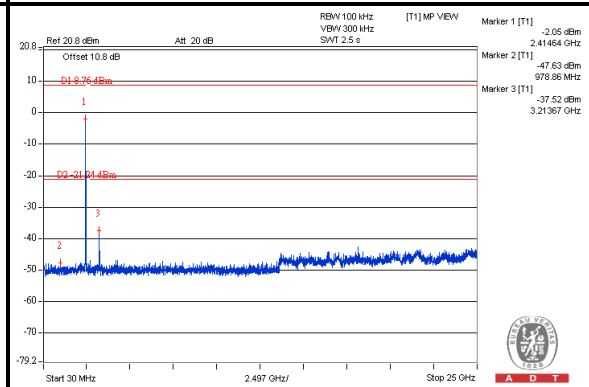

CH 6

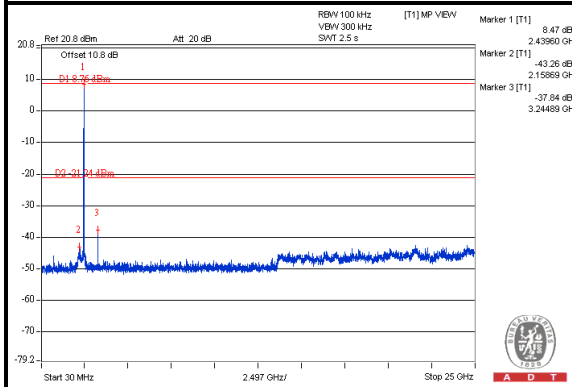

CH 11

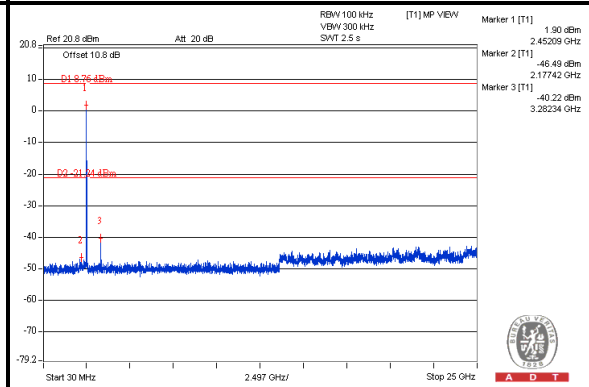



A D T

Chain(1)

Maximum REF

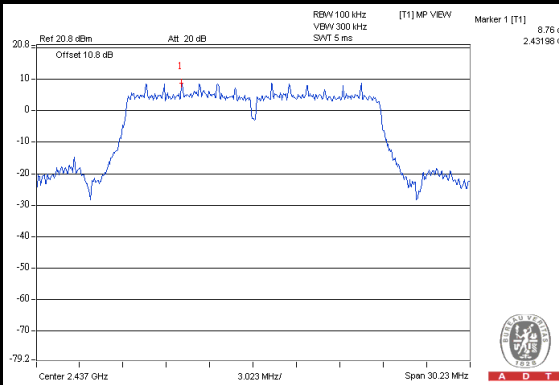

CH 1

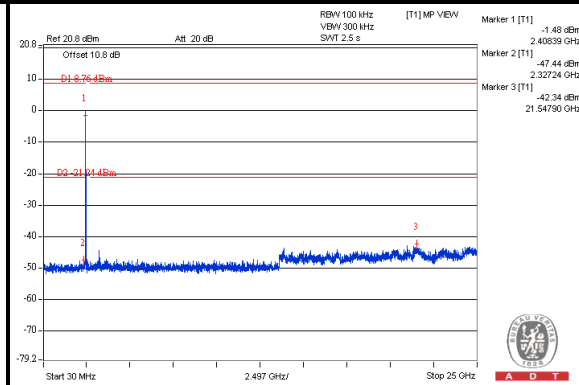

CH 6

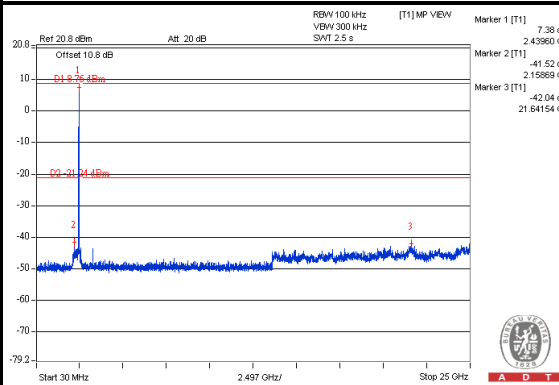

CH 11

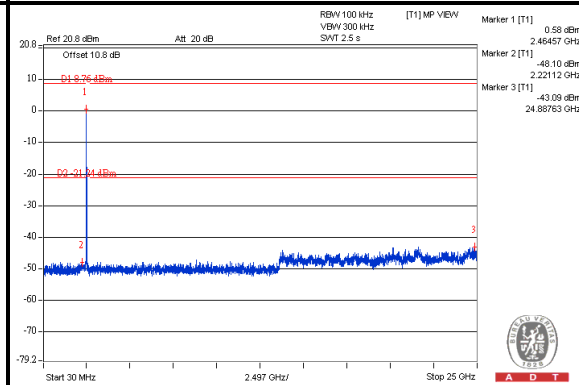



A D T

Chain(2)

Maximum REF

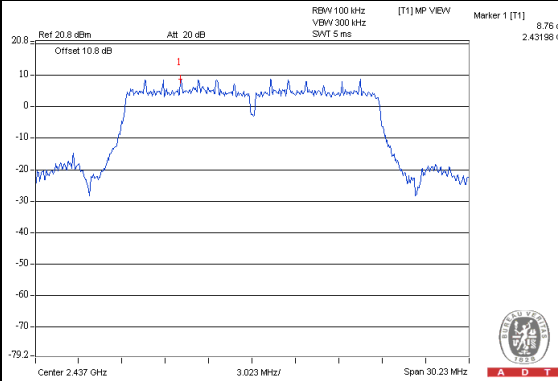

CH 1

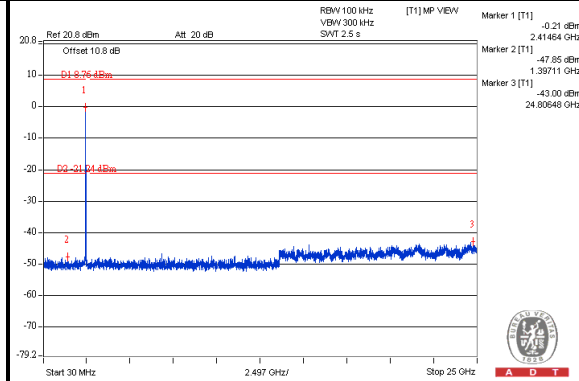

CH 6

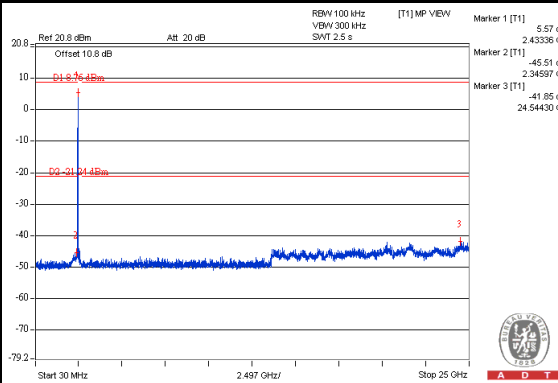

CH 11

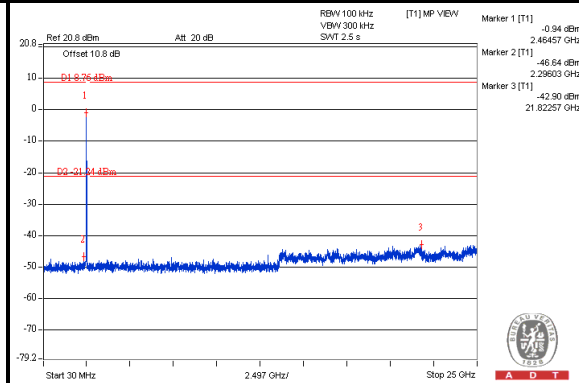



A D T

802.11n (HT40):

Chain(0)

Maximum REF

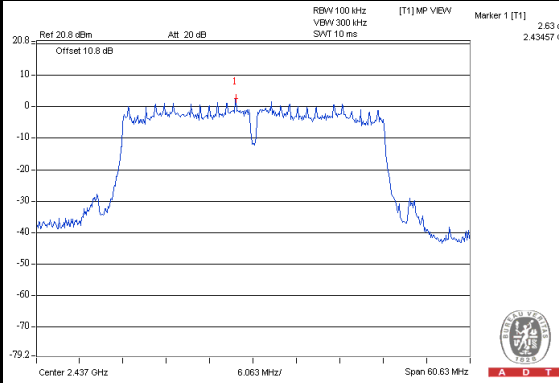

CH 3

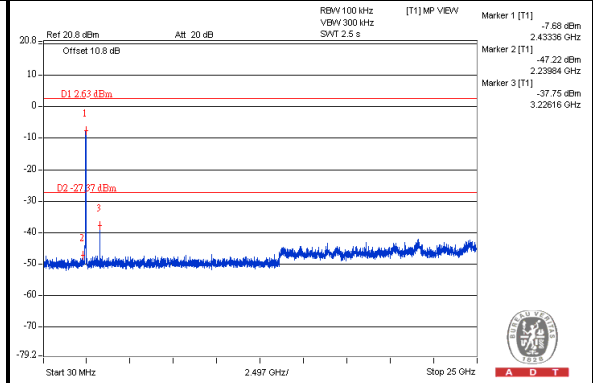

CH 6

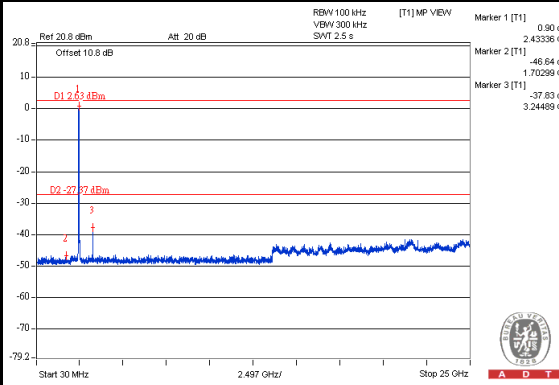

CH 9

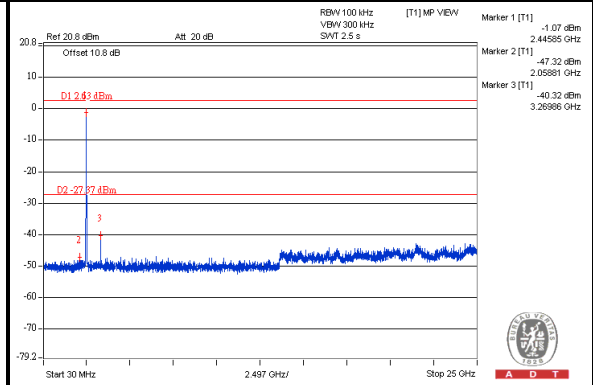



A D T

Chain(1)

Maximum REF

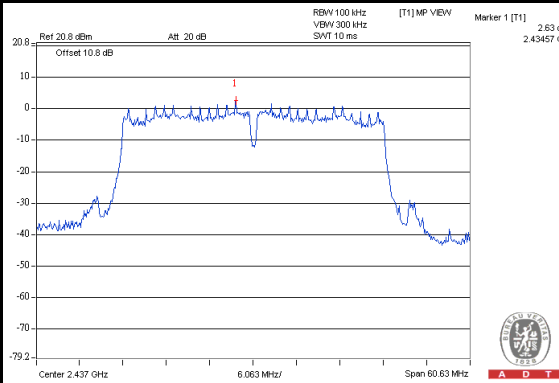

CH 3

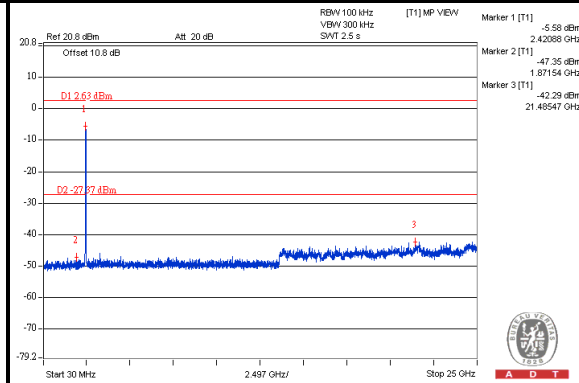

CH 6

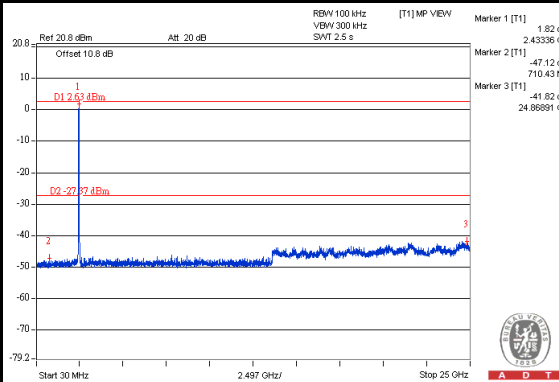

CH 9

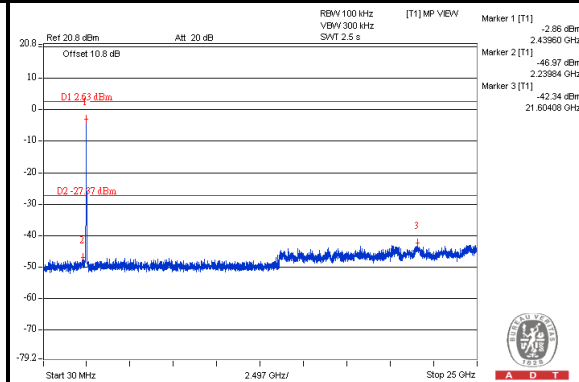



A D T

Chain(2)

Maximum REF

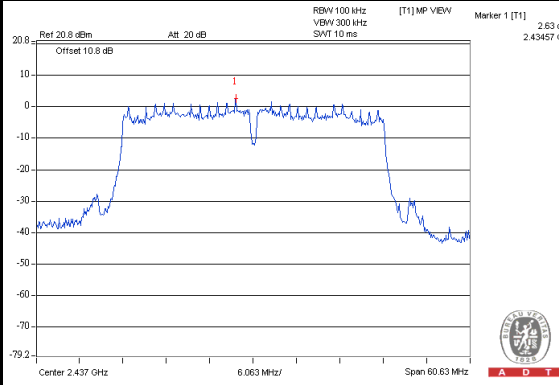

CH 3

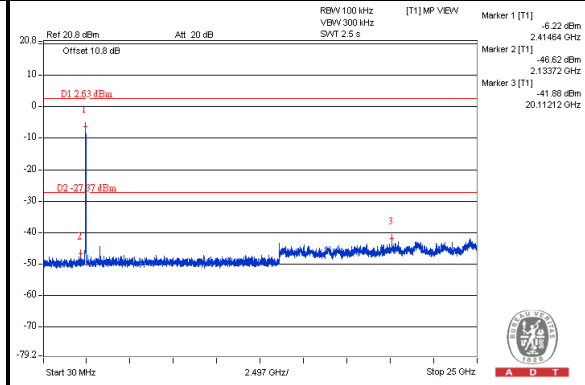

CH 6

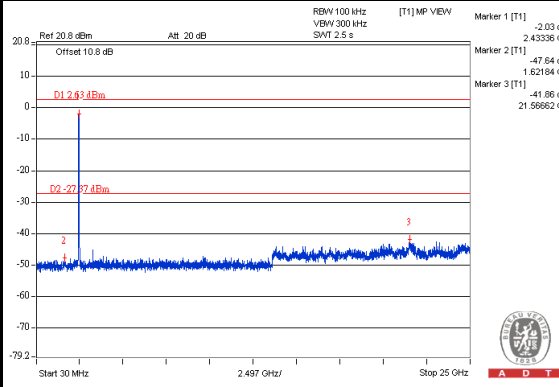

CH 9

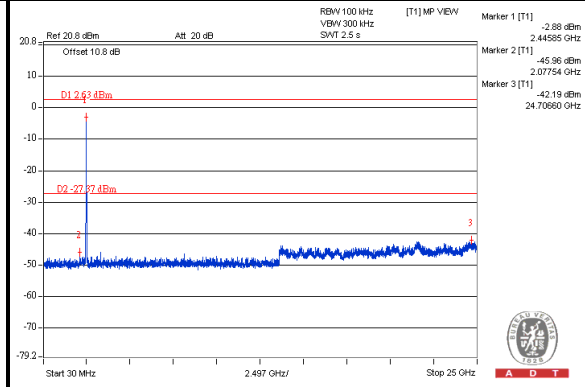



A D T

5. TEST TYPES AND RESULTS (FOR 5GHz, 5.725~5.850GHz Band)

5.1 CONDUCTED EMISSION MEASUREMENT

5.1.1 LIMITS OF CONDUCTED EMISSION MEASUREMENT

FREQUENCY OF EMISSION (MHz)	CONDUCTED LIMIT (dBµV)	
	Quasi-peak	Average
0.15-0.5	66 to 56	56 to 46
0.5-5	56	46
5-30	60	50

- NOTE:**
1. The lower limit shall apply at the transition frequencies.
 2. The limit decreases in line with the logarithm of the frequency in the range of 0.15 to 0.50 MHz.

5.1.2 TEST INSTRUMENTS

DESCRIPTION & MANUFACTURER	MODEL NO.	SERIAL NO.	CALIBRATED DATE	CALIBRATED UNTIL
Test Receiver ROHDE & SCHWARZ	ESCS 30	100287	Feb. 29, 2012	Feb. 28, 2013
Line-Impedance Stabilization Network (for EUT) SCHWARZBECK	NSLK 8127	8127-523	Sep. 19, 2012	Sep. 20, 2013
Line-Impedance Stabilization Network (for Peripheral) ROHDE & SCHWARZ	ESH3-Z5	848773/004	Oct. 29, 2012	Oct. 28, 2013
RF Cable (JYEBAO)	5DFB	COACAB-002	Aug. 05, 2012	Aug. 04, 2013
50 ohms Terminator	50	3	Oct. 23, 2012	Oct. 22, 2013
Software ADT	BV ADT_Cond_V7.3.7 .3	NA	NA	NA

Note:

1. The calibration interval of the above test instruments is 12 months and the calibrations are traceable to NML/ROC and NIST/USA.
2. The test was performed in Shielded Room No. A.
3. The VCCI Con A Registration No. is C-817.
4. Tested Date: Jan. 02, 2013

5.1.3 TEST PROCEDURES

- a. The EUT was placed 0.4 meters from the conducting wall of the shielded room with EUT being connected to the power mains through a line impedance stabilization network (LISN). Other support units were connected to the power mains through another LISN.
- b. The two LISNs provide 50 ohm/ 50uH of coupling impedance for the measuring instrument.
- c. Both lines of the power mains connected to the EUT were checked for maximum conducted interference.
- d. The frequency range from 150kHz to 30MHz was searched. Emission levels under (Limit – 20dB) were not recorded.

NOTE:

1. The resolution bandwidth of test receiver is 9kHz for Quasi-peak detection (QP) & Average detection (AV).

5.1.4 DEVIATION FROM TEST STANDARD

No deviation

5.1.5 TEST SETUP

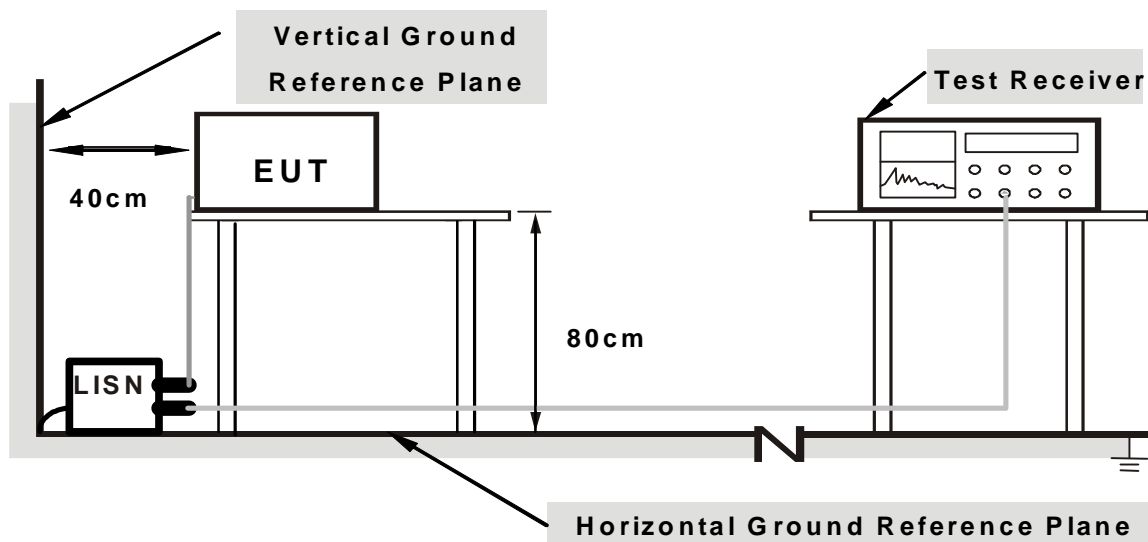

Note: 1.Support units were connected to second LISN.

For the actual test configuration, please refer to the related item – Photographs of the Test Configuration.

5.1.6 EUT OPERATING CONDITIONS

Same as the 4.1.6

5.1.7 TEST RESULTS (MODE 1)

PHASE	Line (L)	DETECTOR FUNCTION	Quasi-Peak (QP) / Average (AV)
--------------	----------	--------------------------	--------------------------------

No	Freq. [MHz]	Corr. Factor (dB)	Reading Value		Emission Level		Limit		Margin	
			[dB (uV)]		[dB (uV)]		[dB (uV)]		(dB)	
			Q.P.	AV.	Q.P.	AV.	Q.P.	AV.	Q.P.	AV.
1	0.15000	0.10	58.95	48.12	59.05	48.22	66.00	56.00	-6.95	-7.78
2	0.16562	0.10	50.98	41.05	51.08	41.15	65.18	55.18	-14.10	-14.03
3	0.18125	0.10	54.13	44.10	54.23	44.20	64.43	54.43	-10.19	-10.22
4	0.24375	0.12	45.55	34.91	45.67	35.03	61.97	51.97	-16.30	-16.94
5	0.26719	0.13	43.80	27.29	43.93	27.42	61.20	51.20	-17.28	-23.79
6	0.34141	0.15	38.70	24.94	38.85	25.09	59.17	49.17	-20.32	-24.08
7	0.45859	0.16	39.76	35.16	39.92	35.32	56.72	46.72	-16.80	-11.40

REMARKS:

1. Q.P. and AV. are abbreviations of quasi-peak and average individually.
2. The emission levels of other frequencies were very low against the limit.
3. Margin value = Emission level - Limit value
4. Correction factor = Insertion loss + Cable loss
5. Emission Level = Correction Factor + Reading Value.

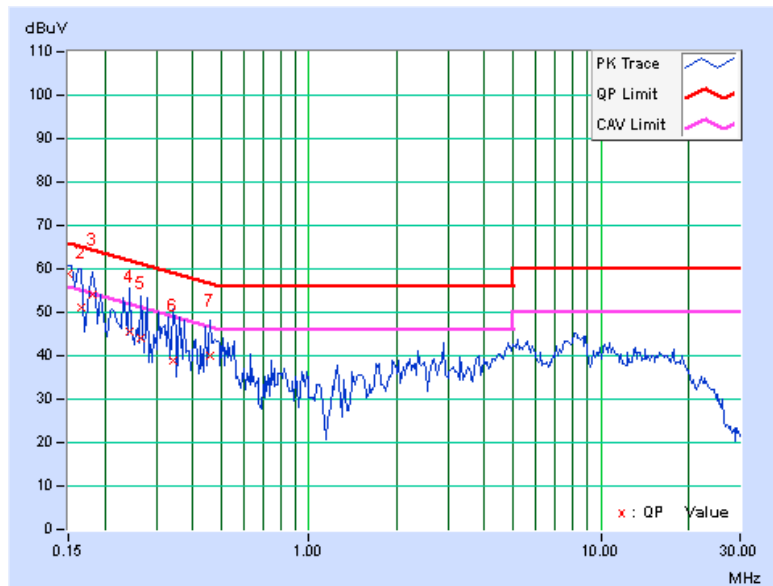

PHASE	Neutral (N)	DETECTOR FUNCTION	Quasi-Peak (QP) / Average (AV)
--------------	-------------	--------------------------	--------------------------------

No	Freq. [MHz]	Corr. Factor (dB)	Reading Value [dB (uV)]		Emission Level [dB (uV)]		Limit [dB (uV)]		Margin (dB)	
			Q.P.	AV.	Q.P.	AV.	Q.P.	AV.	Q.P.	AV.
	1	0.15000	0.14	59.13	48.96	59.27	49.10	66.00	56.00	-6.73
2	0.16562	0.15	48.04	41.72	48.19	41.87	65.18	55.18	-16.99	-13.31
3	0.18906	0.15	51.79	36.17	51.94	36.32	64.08	54.08	-12.14	-17.76
4	0.24766	0.16	43.70	32.20	43.86	32.36	61.84	51.84	-17.98	-19.48
5	0.30625	0.17	40.76	32.67	40.93	32.84	60.07	50.07	-19.14	-17.23
6	0.39219	0.19	34.38	24.03	34.57	24.22	58.02	48.02	-23.45	-23.80
7	4.92578	0.38	38.03	32.58	38.41	32.96	56.00	46.00	-17.59	-13.04

REMARKS:

1. Q.P. and AV. are abbreviations of quasi-peak and average individually.
2. The emission levels of other frequencies were very low against the limit.
3. Margin value = Emission level - Limit value
4. Correction factor = Insertion loss + Cable loss
5. Emission Level = Correction Factor + Reading Value.

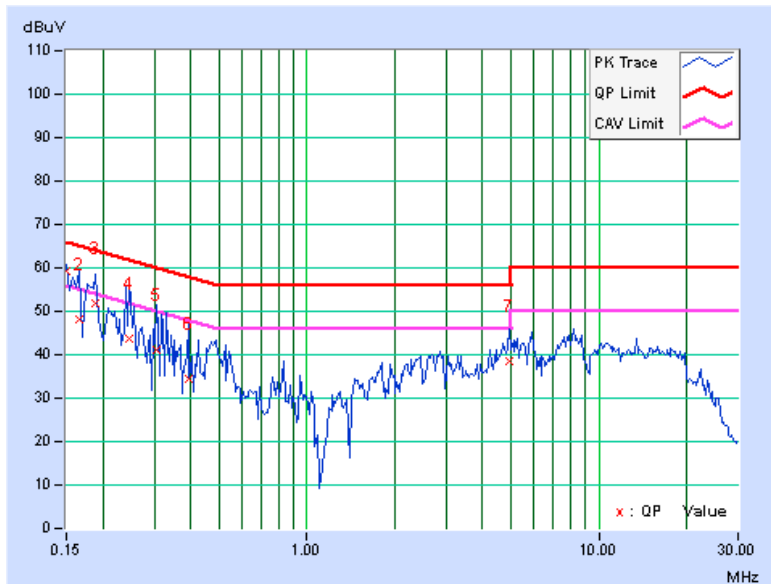

5.1.8 TEST RESULTS (MODE 2)

PHASE	Line (L)	DETECTOR FUNCTION	Quasi-Peak (QP) / Average (AV)
--------------	----------	--------------------------	--------------------------------

No	Freq. [MHz]	Corr. Factor (dB)	Reading Value [dB (uV)]		Emission Level [dB (uV)]		Limit [dB (uV)]		Margin (dB)	
			Q.P.	AV.	Q.P.	AV.	Q.P.	AV.	Q.P.	AV.
	1	0.16172	0.10	51.15	44.46	51.25	44.56	65.38	55.38	-14.13
2	0.21250	0.11	39.21	20.34	39.32	20.45	63.11	53.11	-23.78	-32.65
3	0.50938	0.16	34.89	23.05	35.05	23.21	56.00	46.00	-20.95	-22.79
4	0.88438	0.18	25.38	21.27	25.56	21.45	56.00	46.00	-30.44	-24.55
5	2.23438	0.24	31.12	26.07	31.36	26.31	56.00	46.00	-24.64	-19.69
6	6.80078	0.44	28.58	23.71	29.02	24.15	60.00	50.00	-30.98	-25.85

REMARKS:

1. Q.P. and AV. are abbreviations of quasi-peak and average individually.
2. The emission levels of other frequencies were very low against the limit.
3. Margin value = Emission level - Limit value
4. Correction factor = Insertion loss + Cable loss
5. Emission Level = Correction Factor + Reading Value.

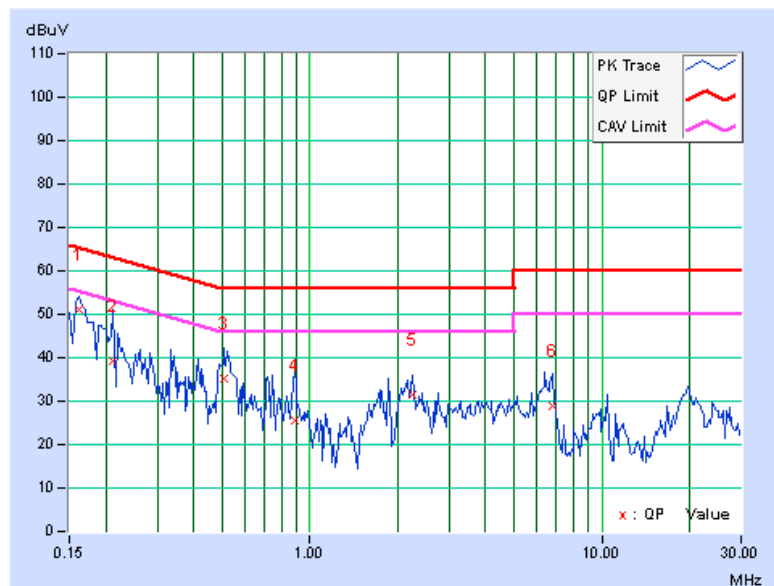

PHASE	Neutral (N)	DETECTOR FUNCTION	Quasi-Peak (QP) / Average (AV)
--------------	-------------	--------------------------	--------------------------------

No	Freq. [MHz]	Corr. Factor (dB)	Reading Value [dB (uV)]		Emission Level [dB (uV)]		Limit [dB (uV)]		Margin (dB)	
			Q.P.	AV.	Q.P.	AV.	Q.P.	AV.	Q.P.	AV.
	1	0.16598	0.15	50.02	43.10	50.17	43.25	65.16	55.16	-14.99
2	0.21250	0.15	44.66	22.70	44.81	22.85	63.11	53.11	-18.29	-30.25
3	0.22422	0.15	41.75	29.98	41.90	30.13	62.66	52.66	-20.76	-22.53
4	0.51328	0.20	34.71	26.42	34.91	26.62	56.00	46.00	-21.09	-19.38
5	0.60703	0.20	32.30	20.21	32.50	20.41	56.00	46.00	-23.50	-25.59
6	6.19922	0.42	35.95	31.46	36.37	31.88	60.00	50.00	-23.63	-18.12

REMARKS:

1. Q.P. and AV. are abbreviations of quasi-peak and average individually.
2. The emission levels of other frequencies were very low against the limit.
3. Margin value = Emission level - Limit value
4. Correction factor = Insertion loss + Cable loss
5. Emission Level = Correction Factor + Reading Value.

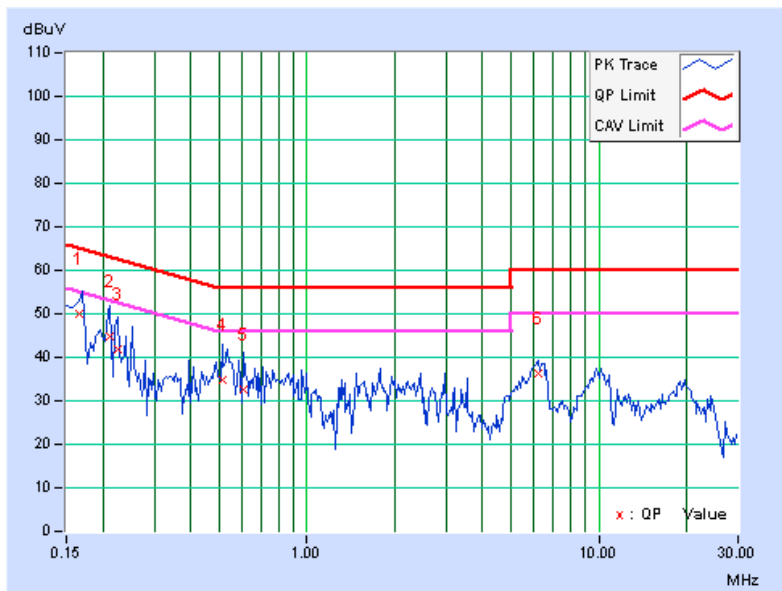

5.1.9 TEST RESULTS (MODE 3)

PHASE	Line (L)	DETECTOR FUNCTION	Quasi-Peak (QP) / Average (AV)
--------------	----------	--------------------------	--------------------------------

No	Freq. [MHz]	Corr. Factor (dB)	Reading Value [dB (uV)]		Emission Level [dB (uV)]		Limit [dB (uV)]		Margin (dB)	
			Q.P.	AV.	Q.P.	AV.	Q.P.	AV.	Q.P.	AV.
			1	0.15000	0.10	52.72	35.70	52.82	35.80	66.00
2	0.16562	0.10	56.09	45.96	56.19	46.06	65.18	55.18	-8.99	-9.12
3	0.19297	0.11	51.71	41.41	51.82	41.52	63.91	53.91	-12.09	-12.39
4	0.24375	0.12	40.63	25.80	40.75	25.92	61.97	51.97	-21.22	-26.05
5	0.53672	0.16	42.17	36.55	42.33	36.71	56.00	46.00	-13.67	-9.29
6	7.91406	0.48	36.00	31.26	36.48	31.74	60.00	50.00	-23.52	-18.26

REMARKS:

1. Q.P. and AV. are abbreviations of quasi-peak and average individually.
2. The emission levels of other frequencies were very low against the limit.
3. Margin value = Emission level - Limit value
4. Correction factor = Insertion loss + Cable loss
5. Emission Level = Correction Factor + Reading Value.

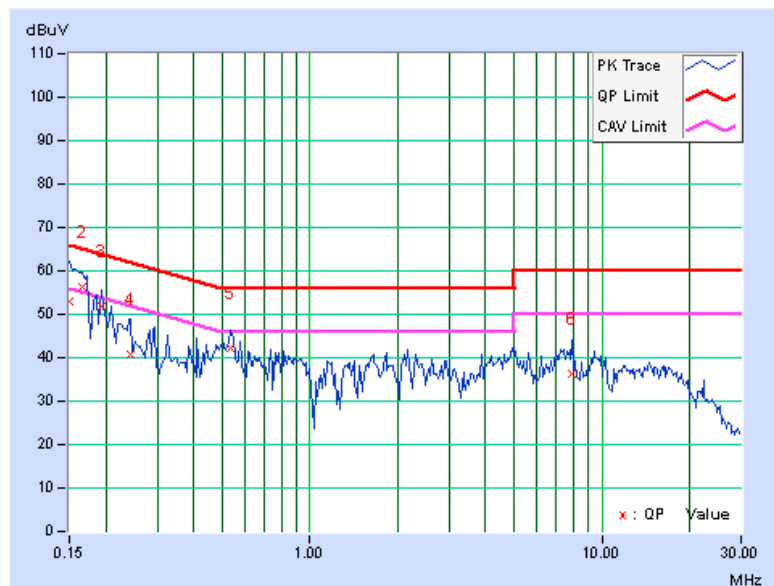

PHASE	Neutral (N)	DETECTOR FUNCTION	Quasi-Peak (QP) / Average (AV)
--------------	-------------	--------------------------	--------------------------------

No	Freq. [MHz]	Corr. Factor (dB)	Reading Value [dB (uV)]		Emission Level [dB (uV)]		Limit [dB (uV)]		Margin (dB)	
			Q.P.	AV.	Q.P.	AV.	Q.P.	AV.	Q.P.	AV.
	1	0.16172	0.15	57.62	48.48	57.77	48.63	65.38	55.38	-7.61
2	0.17734	0.15	52.96	33.52	53.11	33.67	64.61	54.61	-11.50	-20.94
3	0.18516	0.15	52.05	36.84	52.20	36.99	64.25	54.25	-12.05	-17.26
4	0.20078	0.15	49.57	35.01	49.72	35.16	63.58	53.58	-13.86	-18.42
5	0.50000	0.20	41.76	35.63	41.96	35.83	56.00	46.00	-14.04	-10.17
6	7.03516	0.45	37.10	32.06	37.55	32.51	60.00	50.00	-22.45	-17.49

REMARKS:

1. Q.P. and AV. are abbreviations of quasi-peak and average individually.
2. The emission levels of other frequencies were very low against the limit.
3. Margin value = Emission level - Limit value
4. Correction factor = Insertion loss + Cable loss
5. Emission Level = Correction Factor + Reading Value.

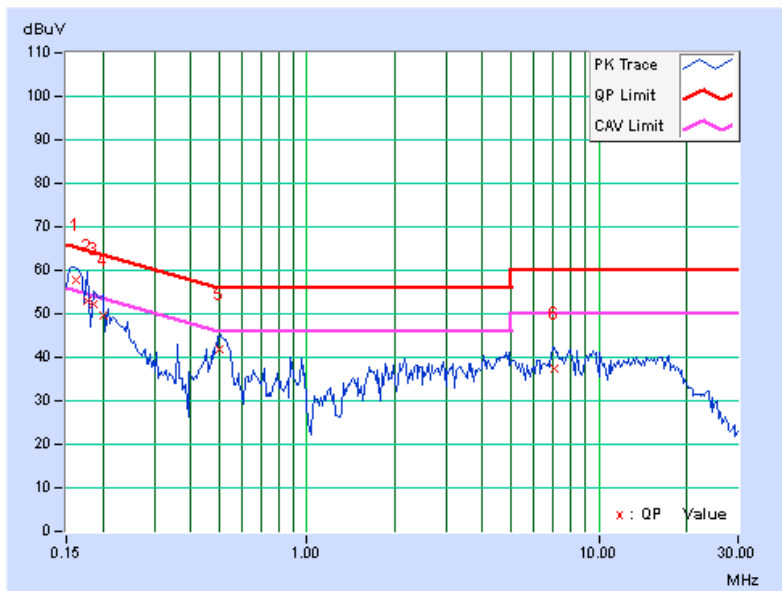

5.2 RADIATED AND BANDEDGE EMISSION MEASUREMENT

5.2.1 LIMITS OF RADIATED AND BANDEDGE EMISSION MEASUREMENT

Radiated emissions which fall in the restricted bands must comply with the radiated emission limits specified as below table. Other emissions shall be at least 30dB below the highest level of the desired power:

Frequencies (MHz)	Field strength (microvolts/meter)	Measurement distance (meters)
0.009-0.490	2400/F(kHz)	300
0.490-1.705	24000/F(kHz)	30
1.705-30.0	30	30
30-88	100	3
88-216	150	3
216-960	200	3
Above 960	500	3

NOTE:

1. The lower limit shall apply at the transition frequencies.
2. Emission level (dBuV/m) = 20 log Emission level (uV/m).
3. For frequencies above 1000MHz, the field strength limits are based on average detector, however, the peak field strength of any emission shall not exceed the maximum permitted average limits, specified above by more than 20dB under any condition of modulation.



A D T

5.2.2 TEST INSTRUMENTS

Below 1GHz test:

DESCRIPTION & MANUFACTURER	MODEL NO.	SERIAL NO.	CALIBRATED DATE	CALIBRATED UNTIL
Spectrum Analyzer Agilent	E4446A	MY48250254	July 09, 2012	July 08, 2013
Pre-Selector Agilent	N9039A	MY46520311	July 09, 2012	July 08, 2013
Signal Generator Agilent	N5181A	MY49060517	July 09, 2012	July 08, 2013
Pre-Amplifier Mini-Circuits	ZFL-1000VH2 B	AMP-ZFL-03	Nov. 14, 2012	Nov. 13, 2013
Pre-Amplifier Agilent	8449B	3008A02578	June 26, 2012	June 25, 2013
Pre-Amplifier SPACEK LABS	SLKka-48-6	9K16	Nov. 14, 2012	Nov. 13, 2013
Trilog Broadband Antenna SCHWARZBECK	VULB 9168	9168-360	Apr. 09, 2012	Apr. 08, 2013
Horn_Antenna AISi	AIH.8018	0000320091110	Nov. 19, 2012	Nov. 18, 2013
Horn_Antenna SCHWARZBECK	BBHA 9170	9170-424	Oct. 12, 2012	Oct. 11, 2013
RF Cable	NA	RF104-201 RF104-203 RF104-204	Dec. 25, 2012	Dec. 24, 2013
RF Cable	NA	CHGCAB_001	Oct. 06, 2012	Oct. 05, 2013
Software	ADT_Radiated _V8.7.05	NA	NA	NA
Antenna Tower & Turn Table CT	NA	NA	NA	NA

Note:

1. The calibration interval of the above test instruments is 12 months and the calibrations are traceable to NML/ROC and NIST/USA.
2. The horn antenna, preamplifier (model: 8449B) are used only for the measurement of emission frequency above 1GHz if tested.
- 3 The test was performed in 966 Chamber No. G.
4. The FCC Site Registration No. is 966073.
- 5 The VCCI Site Registration No. is G-137.
- 6 The CANADA Site Registration No. is IC 7450H-2.
- 7 Tested Date: Jan. 05, 2013



A D T

Above 1GHz test:

DESCRIPTION & MANUFACTURER	MODEL NO.	SERIAL NO.	CALIBRATED DATE	CALIBRATED UNTIL
Spectrum Analyzer Agilent	E4446A	MY48250253	Sep. 03, 2012	Sep. 02, 2013
Pre-Selector Agilent	N9039A	MY46520310	Sep. 03, 2012	Sep. 02, 2013
Signal Generator Agilent	N5181A	MY49060347	July 24, 2012	July 23, 2013
Pre-Amplifier Mini-Circuits	ZFL-1000VH2 B	AMP-ZFL-04	Nov. 14, 2012	Nov. 13, 2013
Pre-Amplifier Agilent	8449B	3008A02465	Feb. 27, 2012	Feb. 26, 2013
SPACEK LABS	SLKKa-48-6	9K16	Nov. 14, 2012	Nov. 13, 2013
Trilog Broadband Antenna SCHWARZBECK	VULB 9168	9168-361	Apr. 06, 2012	Apr. 05, 2013
Horn_Antenna AISI	AIH.8018	0000220091110	Nov. 27, 2012	Nov. 26, 2013
Horn_Antenna SCHWARZBECK	BBHA 9170	9170-424	Oct. 12, 2012	Oct. 11, 2013
RF Cable	NA	RF104-205 RF104-207 RF104-202	Dec. 25, 2012	Dec. 24, 2013
RF Cable	NA	CHHCAB_001	Oct. 07, 2012	Oct. 06, 2013
Software	ADT_Radiated _V8.7.05	NA	NA	NA
Antenna Tower & Turn Table CT	NA	NA	NA	NA

Note:

1. The calibration interval of the above test instruments is 12 months and the calibrations are traceable to NML/ROC and NIST/USA.
2. The horn antenna, preamplifier (model: 8449B) are used only for the measurement of emission frequency above 1GHz if tested.
- 3 The test was performed in 966 Chamber No. H.
4. The FCC Site Registration No. is 797305.
- 5 The CANADA Site Registration No. is IC 7450H-3.
- 6 Tested Date: Jan. 08, 2013

5.2.3 TEST PROCEDURES

- a. The EUT was placed on the top of a rotating table 0.8 meters above the ground at 3 meter chamber room for test. The table was rotated 360 degrees to determine the position of the highest radiation.
- b. The EUT was set 3 meters away from the interference-receiving antenna, which was mounted on the top of a variable-height antenna tower.
- c. The height of antenna is varied from one meter to four meters above the ground to determine the maximum value of the field strength. Both horizontal and vertical polarizations of the antenna are set to make the measurement.
- d. For each suspected emission, the EUT was arranged to its worst case and then the antenna was tuned to heights from 1 meter to 4 meters and the rotatable table was turned from 0 degrees to 360 degrees to find the maximum reading.
- e. The test-receiver system was set to quasi-peak detect function and specified bandwidth with maximum hold mode when the test frequency is below 1 GHz.
- f. The test-receiver system was set to peak and average detect function and specified bandwidth with maximum hold mode when the test frequency is above 1 GHz. If the peak reading value also meets average limit, measurement with the average detector is unnecessary.

NOTE:

1. The resolution bandwidth and video bandwidth of test receiver/spectrum analyzer is 120kHz for Quasi-peak detection (QP) at frequency below 1GHz.
2. The resolution bandwidth of test receiver/spectrum analyzer is 1 MHz and the video bandwidth is 3 MHz for Peak detection (PK) at frequency above 1GHz.
3. The resolution bandwidth of test receiver/spectrum analyzer is 1 MHz and the video bandwidth is 10 Hz for Average detection (AV) at frequency above 1GHz.
4. All modes of operation were investigated and the worst-case emissions are reported.

5.2.4 DEVIATION FROM TEST STANDARD

No deviation

5.2.5 TEST SETUP

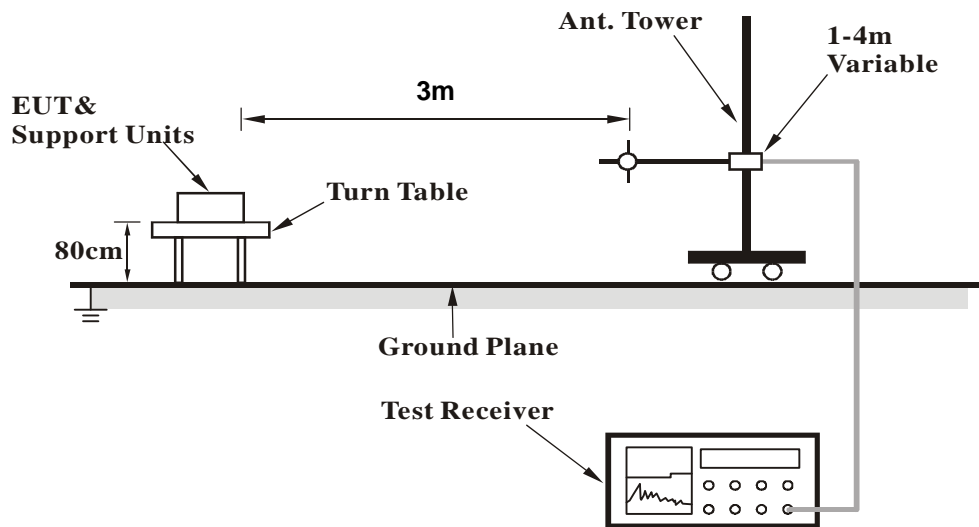

For the actual test configuration, please refer to the related item – Photographs of the Test Configuration.

5.2.6 EUT OPERATING CONDITIONS

Same as the 4.1.6

5.2.7 TEST RESULTS

BELOW 1GHz WORST-CASE DATA

802.11n (HT20)

CHANNEL	TX Channel 157	DETECTOR FUNCTION	Quasi-Peak (QP)
FREQUENCY RANGE	Below 1GHz		

ANTENNA POLARITY & TEST DISTANCE: HORIZONTAL AT 3 M

NO.	FREQ. (MHz)	EMISSION LEVEL (dBuV/m)	LIMIT (dBuV/m)	MARGIN (dB)	ANTENNA HEIGHT (m)	TABLE ANGLE (Degree)	RAW VALUE (dBuV)	CORRECTION FACTOR (dB/m)
1	73.50	27.5 QP	40.0	-12.6	1.24 H	210	15.85	11.60
2	106.50	29.0 QP	43.5	-14.6	1.20 H	142	18.20	10.75
3	233.30	37.0 QP	46.0	-9.0	1.04 H	210	24.36	12.62
4	268.00	26.9 QP	46.0	-19.1	1.24 H	135	12.87	14.04
5	356.30	28.3 QP	46.0	-17.7	1.35 H	241	11.54	16.74
6	531.00	40.5 QP	46.0	-5.5	1.65 H	135	19.39	21.12

ANTENNA POLARITY & TEST DISTANCE: VERTICAL AT 3 M

NO.	FREQ. (MHz)	EMISSION LEVEL (dBuV/m)	LIMIT (dBuV/m)	MARGIN (dB)	ANTENNA HEIGHT (m)	TABLE ANGLE (Degree)	RAW VALUE (dBuV)	CORRECTION FACTOR (dB/m)
1	49.10	36.3 QP	40.0	-3.7	1.42 V	25	22.17	14.11
2	110.70	28.0 QP	43.5	-15.6	1.35 V	78	16.63	11.32
3	233.20	27.0 QP	46.0	-19.0	1.34 V	65	14.38	12.61
4	358.50	24.9 QP	46.0	-21.1	1.41 V	35	8.14	16.80
5	532.00	40.0 QP	46.0	-6.0	1.75 V	71	18.88	21.14
6	589.71	29.6 QP	46.0	-16.4	1.35 V	77	7.13	22.43

REMARKS:

1. Emission level (dBuV/m) = Raw Value (dBuV) + Correction Factor (dB/m).
2. Correction Factor (dB/m) = Antenna Factor (dB/m) + Cable Factor (dB).
3. The other emission levels were very low against the limit.
4. Margin value = Emission level – Limit value.



A D T

ABOVE 1GHz DATA

802.11a

CHANNEL	TX Channel 149	DETECTOR FUNCTION	Peak (PK)
FREQUENCY RANGE	1GHz ~ 40GHz		Average (AV)

ANTENNA POLARITY & TEST DISTANCE: HORIZONTAL AT 3 M

NO.	FREQ. (MHz)	EMISSION LEVEL (dBuV/m)	LIMIT (dBuV/m)	MARGIN (dB)	ANTENNA HEIGHT (m)	TABLE ANGLE (Degree)	RAW VALUE (dBuV)	CORRECTION FACTOR (dB/m)
1	*5745.00	116.9 PK			1.00 H	183	73.42	43.48
2	*5745.00	107.2 AV			1.00 H	183	63.72	43.48
3	11490.00	57.9 PK	74.0	-16.1	1.00 H	125	7.72	50.18
4	11490.00	46.9 AV	54.0	-7.1	1.00 H	125	-3.28	50.18

ANTENNA POLARITY & TEST DISTANCE: VERTICAL AT 3 M

NO.	FREQ. (MHz)	EMISSION LEVEL (dBuV/m)	LIMIT (dBuV/m)	MARGIN (dB)	ANTENNA HEIGHT (m)	TABLE ANGLE (Degree)	RAW VALUE (dBuV)	CORRECTION FACTOR (dB/m)
1	*5745.00	117.9 PK			1.00 V	110	74.42	43.48
2	*5745.00	107.6 AV			1.00 V	110	64.12	43.48
3	11490.00	60.3 PK	74.0	-13.7	1.00 V	128	10.12	50.18
4	11490.00	50.1 AV	54.0	-3.9	1.00 V	128	-0.08	50.18

REMARKS:

1. Emission level (dBuV/m) = Raw Value (dBuV) + Correction Factor (dB/m).
2. Correction Factor (dB/m) = Antenna Factor (dB/m) + Cable Factor (dB).
3. The other emission levels were very low against the limit.
4. Margin value = Emission level – Limit value.
5. " * ": Fundamental frequency.
6. The limit value is defined as per 15.247.



A D T

CHANNEL	TX Channel 157	DETECTOR FUNCTION	Peak (PK)
FREQUENCY RANGE	1GHz ~ 40GHz		Average (AV)

ANTENNA POLARITY & TEST DISTANCE: HORIZONTAL AT 3 M

NO.	FREQ. (MHz)	EMISSION LEVEL (dBuV/m)	LIMIT (dBuV/m)	MARGIN (dB)	ANTENNA HEIGHT (m)	TABLE ANGLE (Degree)	RAW VALUE (dBuV)	CORRECTION FACTOR (dB/m)
1	*5785.00	117.2 PK			1.00 H	177	73.68	43.52
2	*5785.00	107.5 AV			1.00 H	177	63.98	43.52
3	11570.00	57.9 PK	74.0	-16.1	1.02 H	125	7.72	50.18
4	11570.00	47.0 AV	54.0	-7.0	1.02 H	125	-3.18	50.18

ANTENNA POLARITY & TEST DISTANCE: VERTICAL AT 3 M

NO.	FREQ. (MHz)	EMISSION LEVEL (dBuV/m)	LIMIT (dBuV/m)	MARGIN (dB)	ANTENNA HEIGHT (m)	TABLE ANGLE (Degree)	RAW VALUE (dBuV)	CORRECTION FACTOR (dB/m)
1	*5785.00	117.8 PK			1.01 V	104	74.28	43.52
2	*5785.00	107.5 AV			1.01 V	104	63.98	43.52
3	11570.00	59.7 PK	74.0	-14.3	1.05 V	127	9.52	50.18
4	11570.00	49.7 AV	54.0	-4.3	1.05 V	127	-0.48	50.18

REMARKS:

1. Emission level (dBuV/m) = Raw Value (dBuV) + Correction Factor (dB/m).
2. Correction Factor (dB/m) = Antenna Factor (dB/m) + Cable Factor (dB).
3. The other emission levels were very low against the limit.
4. Margin value = Emission level – Limit value.
5. " * ": Fundamental frequency.
6. The limit value is defined as per 15.247.



A D T

CHANNEL	TX Channel 165	DETECTOR FUNCTION	Peak (PK)
FREQUENCY RANGE	1GHz ~ 40GHz		Average (AV)

ANTENNA POLARITY & TEST DISTANCE: HORIZONTAL AT 3 M

NO.	FREQ. (MHz)	EMISSION LEVEL (dBuV/m)	LIMIT (dBuV/m)	MARGIN (dB)	ANTENNA HEIGHT (m)	TABLE ANGLE (Degree)	RAW VALUE (dBuV)	CORRECTION FACTOR (dB/m)
1	*5825.00	117.8 PK			1.00 H	173	74.19	43.61
2	*5825.00	107.9 AV			1.00 H	173	64.29	43.61
3	11650.00	57.9 PK	74.0	-16.1	1.01 H	112	7.48	50.42
4	11650.00	46.8 AV	54.0	-7.2	1.01 H	112	-3.62	50.42

ANTENNA POLARITY & TEST DISTANCE: VERTICAL AT 3 M

NO.	FREQ. (MHz)	EMISSION LEVEL (dBuV/m)	LIMIT (dBuV/m)	MARGIN (dB)	ANTENNA HEIGHT (m)	TABLE ANGLE (Degree)	RAW VALUE (dBuV)	CORRECTION FACTOR (dB/m)
1	*5825.00	118.1 PK			1.00 V	107	74.49	43.61
2	*5825.00	107.9 AV			1.00 V	107	64.29	43.61
3	11650.00	59.4 PK	74.0	-14.6	1.03 V	116	8.98	50.42
4	11650.00	49.5 AV	54.0	-4.5	1.03 V	116	-0.92	50.42

REMARKS:

1. Emission level (dBuV/m) = Raw Value (dBuV) + Correction Factor (dB/m).
2. Correction Factor (dB/m) = Antenna Factor (dB/m) + Cable Factor (dB).
3. The other emission levels were very low against the limit.
4. Margin value = Emission level – Limit value.
5. " * ": Fundamental frequency.
6. The limit value is defined as per 15.247.



A D T

802.11n (HT20)

CHANNEL	TX Channel 149	DETECTOR FUNCTION	Peak (PK)
FREQUENCY RANGE	1GHz ~ 40GHz		Average (AV)

ANTENNA POLARITY & TEST DISTANCE: HORIZONTAL AT 3 M

NO.	FREQ. (MHz)	EMISSION LEVEL (dBuV/m)	LIMIT (dBuV/m)	MARGIN (dB)	ANTENNA HEIGHT (m)	TABLE ANGLE (Degree)	RAW VALUE (dBuV)	CORRECTION FACTOR (dB/m)
1	*5745.00	116.6 PK			1.00 H	183	73.12	43.48
2	*5745.00	107.2 AV			1.00 H	183	63.72	43.48
3	11490.00	57.5 PK	74.0	-16.5	1.00 H	97	7.32	50.18
4	11490.00	46.7 AV	54.0	-7.3	1.00 H	97	-3.48	50.18

ANTENNA POLARITY & TEST DISTANCE: VERTICAL AT 3 M

NO.	FREQ. (MHz)	EMISSION LEVEL (dBuV/m)	LIMIT (dBuV/m)	MARGIN (dB)	ANTENNA HEIGHT (m)	TABLE ANGLE (Degree)	RAW VALUE (dBuV)	CORRECTION FACTOR (dB/m)
1	*5745.00	118.0 PK			1.00 V	112	74.52	43.48
2	*5745.00	107.9 AV			1.00 V	112	64.42	43.48
3	11490.00	59.7 PK	74.0	-14.3	1.05 V	106	9.52	50.18
4	11490.00	49.8 AV	54.0	-4.2	1.05 V	106	-0.38	50.18

REMARKS:

1. Emission level (dBuV/m) = Raw Value (dBuV) + Correction Factor (dB/m).
2. Correction Factor (dB/m) = Antenna Factor (dB/m) + Cable Factor (dB).
3. The other emission levels were very low against the limit.
4. Margin value = Emission level – Limit value.
5. " * ": Fundamental frequency.
6. The limit value is defined as per 15.247.



A D T

CHANNEL	TX Channel 157	DETECTOR FUNCTION	Peak (PK)
FREQUENCY RANGE	1GHz ~ 40GHz		Average (AV)

ANTENNA POLARITY & TEST DISTANCE: HORIZONTAL AT 3 M

NO.	FREQ. (MHz)	EMISSION LEVEL (dBuV/m)	LIMIT (dBuV/m)	MARGIN (dB)	ANTENNA HEIGHT (m)	TABLE ANGLE (Degree)	RAW VALUE (dBuV)	CORRECTION FACTOR (dB/m)
1	*5785.00	116.6 PK			1.00 H	198	73.08	43.52
2	*5785.00	107.2 AV			1.00 H	198	63.68	43.52
3	11570.00	57.7 PK	74.0	-16.3	1.00 H	99	7.52	50.18
4	11570.00	46.8 AV	54.0	-7.2	1.00 H	99	-3.38	50.18

ANTENNA POLARITY & TEST DISTANCE: VERTICAL AT 3 M

NO.	FREQ. (MHz)	EMISSION LEVEL (dBuV/m)	LIMIT (dBuV/m)	MARGIN (dB)	ANTENNA HEIGHT (m)	TABLE ANGLE (Degree)	RAW VALUE (dBuV)	CORRECTION FACTOR (dB/m)
1	*5785.00	118.1 PK			1.00 V	114	74.58	43.52
2	*5785.00	107.7 AV			1.00 V	114	64.18	43.52
3	11570.00	59.4 PK	74.0	-14.6	1.10 V	101	9.22	50.18
4	11570.00	49.5 AV	54.0	-4.5	1.10 V	101	-0.68	50.18

REMARKS:

1. Emission level (dBuV/m) = Raw Value (dBuV) + Correction Factor (dB/m).
2. Correction Factor (dB/m) = Antenna Factor (dB/m) + Cable Factor (dB).
3. The other emission levels were very low against the limit.
4. Margin value = Emission level – Limit value.
5. " * ": Fundamental frequency.
6. The limit value is defined as per 15.247.



A D T

CHANNEL	TX Channel 165	DETECTOR FUNCTION	Peak (PK)
FREQUENCY RANGE	1GHz ~ 40GHz		Average (AV)

ANTENNA POLARITY & TEST DISTANCE: HORIZONTAL AT 3 M

NO.	FREQ. (MHz)	EMISSION LEVEL (dBuV/m)	LIMIT (dBuV/m)	MARGIN (dB)	ANTENNA HEIGHT (m)	TABLE ANGLE (Degree)	RAW VALUE (dBuV)	CORRECTION FACTOR (dB/m)
1	*5825.00	116.4 PK			1.01 H	204	72.79	43.61
2	*5825.00	107.1 AV			1.01 H	204	63.49	43.61
3	11650.00	57.9 PK	74.0	-16.1	1.00 H	104	7.48	50.42
4	11650.00	46.8 AV	54.0	-7.2	1.00 H	104	-3.62	50.42

ANTENNA POLARITY & TEST DISTANCE: VERTICAL AT 3 M

NO.	FREQ. (MHz)	EMISSION LEVEL (dBuV/m)	LIMIT (dBuV/m)	MARGIN (dB)	ANTENNA HEIGHT (m)	TABLE ANGLE (Degree)	RAW VALUE (dBuV)	CORRECTION FACTOR (dB/m)
1	*5825.00	118.2 PK			1.00 V	102	74.59	43.61
2	*5825.00	107.8 AV			1.00 V	102	64.19	43.61
3	11650.00	58.8 PK	74.0	-15.2	1.14 V	106	8.38	50.42
4	11650.00	49.1 AV	54.0	-4.9	1.14 V	106	-1.32	50.42

REMARKS:

1. Emission level (dBuV/m) = Raw Value (dBuV) + Correction Factor (dB/m).
2. Correction Factor (dB/m) = Antenna Factor (dB/m) + Cable Factor (dB).
3. The other emission levels were very low against the limit.
4. Margin value = Emission level – Limit value.
5. " * ": Fundamental frequency.
6. The limit value is defined as per 15.247.



A D T

802.11n (HT40)

CHANNEL	TX Channel 151	DETECTOR FUNCTION	Peak (PK)
FREQUENCY RANGE	1GHz ~ 40GHz		Average (AV)

ANTENNA POLARITY & TEST DISTANCE: HORIZONTAL AT 3 M								
NO.	FREQ. (MHz)	EMISSION LEVEL (dBuV/m)	LIMIT (dBuV/m)	MARGIN (dB)	ANTENNA HEIGHT (m)	TABLE ANGLE (Degree)	RAW VALUE (dBuV)	CORRECTION FACTOR (dB/m)
1	*5755.00	113.9 PK			1.01 H	204	70.42	43.48
2	*5755.00	103.8 AV			1.01 H	204	60.32	43.48
3	11510.00	57.8 PK	74.0	-16.2	1.06 H	111	7.63	50.17
4	11510.00	46.5 AV	54.0	-7.5	1.06 H	111	-3.67	50.17
ANTENNA POLARITY & TEST DISTANCE: VERTICAL AT 3 M								
NO.	FREQ. (MHz)	EMISSION LEVEL (dBuV/m)	LIMIT (dBuV/m)	MARGIN (dB)	ANTENNA HEIGHT (m)	TABLE ANGLE (Degree)	RAW VALUE (dBuV)	CORRECTION FACTOR (dB/m)
1	*5755.00	114.2 PK			1.00 V	102	70.72	43.48
2	*5755.00	104.1 AV			1.00 V	102	60.62	43.48
3	11510.00	58.2 PK	74.0	-15.8	1.10 V	105	8.03	50.17
4	11510.00	48.7 AV	54.0	-5.3	1.10 V	105	-1.47	50.17

REMARKS:

1. Emission level (dBuV/m) = Raw Value (dBuV) + Correction Factor (dB/m).
2. Correction Factor (dB/m) = Antenna Factor (dB/m) + Cable Factor (dB).
3. The other emission levels were very low against the limit.
4. Margin value = Emission level – Limit value.
5. " * ": Fundamental frequency.
6. The limit value is defined as per 15.247.



A D T

CHANNEL	TX Channel 159	DETECTOR FUNCTION	Peak (PK)
FREQUENCY RANGE	1GHz ~ 40GHz		Average (AV)

ANTENNA POLARITY & TEST DISTANCE: HORIZONTAL AT 3 M

NO.	FREQ. (MHz)	EMISSION LEVEL (dBuV/m)	LIMIT (dBuV/m)	MARGIN (dB)	ANTENNA HEIGHT (m)	TABLE ANGLE (Degree)	RAW VALUE (dBuV)	CORRECTION FACTOR (dB/m)
1	*5795.00	114.1 PK			1.00 H	201	70.57	43.53
2	*5795.00	104.0 AV			1.00 H	201	60.47	43.53
3	11590.00	58.3 PK	74.0	-15.7	1.04 H	108	8.11	50.19
4	11590.00	46.9 AV	54.0	-7.1	1.04 H	108	-3.29	50.19

ANTENNA POLARITY & TEST DISTANCE: VERTICAL AT 3 M

NO.	FREQ. (MHz)	EMISSION LEVEL (dBuV/m)	LIMIT (dBuV/m)	MARGIN (dB)	ANTENNA HEIGHT (m)	TABLE ANGLE (Degree)	RAW VALUE (dBuV)	CORRECTION FACTOR (dB/m)
1	*5795.00	114.1 PK			1.01 V	97	70.57	43.53
2	*5795.00	104.1 AV			1.01 V	97	60.57	43.53
3	11590.00	58.7 PK	74.0	-15.3	1.16 V	92	8.51	50.19
4	11590.00	48.9 AV	54.0	-5.1	1.16 V	92	-1.29	50.19

REMARKS:

1. Emission level (dBuV/m) = Raw Value (dBuV) + Correction Factor (dB/m).
2. Correction Factor (dB/m) = Antenna Factor (dB/m) + Cable Factor (dB).
3. The other emission levels were very low against the limit.
4. Margin value = Emission level – Limit value.
5. " * ": Fundamental frequency.
6. The limit value is defined as per 15.247.



A D T

802.11ac (VHT80)

CHANNEL	TX Channel 155	DETECTOR FUNCTION	Peak (PK)
FREQUENCY RANGE	1GHz ~ 40GHz		Average (AV)

ANTENNA POLARITY & TEST DISTANCE: HORIZONTAL AT 3 M

NO.	FREQ. (MHz)	EMISSION LEVEL (dBuV/m)	LIMIT (dBuV/m)	MARGIN (dB)	ANTENNA HEIGHT (m)	TABLE ANGLE (Degree)	RAW VALUE (dBuV)	CORRECTION FACTOR (dB/m)
1	5133.20	58.5 PK	74.0	-15.5	1.17 H	104	15.98	42.52
2	5133.20	48.9 AV	54.0	-5.1	1.17 H	104	6.38	42.52
3	*5775.00	107.1 PK			1.00 H	201	63.59	43.51
4	*5775.00	96.3 AV			1.00 H	201	52.79	43.51
5	11550.00	58.4 PK	74.0	-15.6	1.00 H	112	8.22	50.18
6	11550.00	46.9 AV	54.0	-7.1	1.00 H	112	-3.28	50.18

ANTENNA POLARITY & TEST DISTANCE: VERTICAL AT 3 M

NO.	FREQ. (MHz)	EMISSION LEVEL (dBuV/m)	LIMIT (dBuV/m)	MARGIN (dB)	ANTENNA HEIGHT (m)	TABLE ANGLE (Degree)	RAW VALUE (dBuV)	CORRECTION FACTOR (dB/m)
1	5133.20	59.7 PK	74.0	-14.3	1.00 V	95	17.18	42.52
2	5133.20	51.6 AV	54.0	-2.4	1.00 V	95	9.08	42.52
3	*5775.00	107.5 PK			1.00 V	95	63.99	43.51
4	*5775.00	96.4 AV			1.00 V	95	52.89	43.51
5	11550.00	58.9 PK	74.0	-15.1	1.18 V	102	8.72	50.18
6	11550.00	49.2 AV	54.0	-4.8	1.18 V	102	-0.98	50.18

REMARKS:

1. Emission level (dBuV/m) = Raw Value (dBuV) + Correction Factor (dB/m).
2. Correction Factor (dB/m) = Antenna Factor (dB/m) + Cable Factor (dB).
3. The other emission levels were very low against the limit.
4. Margin value = Emission level – Limit value.
5. " * ": Fundamental frequency.
6. The limit value is defined as per 15.247.

5.3 6dB BANDWIDTH MEASUREMENT

5.3.1 LIMITS OF 6dB BANDWIDTH MEASUREMENT

The minimum of 6dB Bandwidth Measurement is 0.5 MHz.

5.3.2 TEST INSTRUMENTS

DESCRIPTION & MANUFACTURER	MODEL NO.	SERIAL NO.	CALIBRATED DATE	CALIBRATED UNTIL
R&S SPECTRUM ANALYZER	FSP40	100037	Nov. 01, 2012	Oct. 31, 2013

Note:

1. The calibration interval of the above test instruments is 12 months and the calibrations are traceable to NML/ROC and NIST/USA.
2. Tested date : Jan. 07, 2013

5.3.3 TEST PROCEDURE

1. Set resolution bandwidth (RBW) = approximately 1% of the emission bandwidth
2. Set the video bandwidth (VBW) $\geq 3 \times$ RBW, Detector = Peak.
3. Trace mode = max hold.
4. Sweep = auto couple.
5. Measure the maximum width of the emission that is constrained by the frequencies associated with the two amplitude points (upper and lower) that are attenuated by 6 dB relative to the maximum level measured in the fundamental emission

5.3.4 DEVIATION FROM TEST STANDARD

No deviation

5.3.5 TEST SETUP

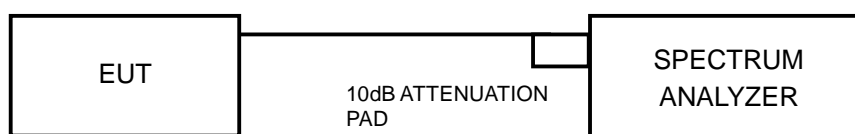

5.3.6 EUT OPERATING CONDITIONS

The software provided by client to enable the EUT under transmission condition continuously at lowest, middle and highest channel frequencies individually.



A D T

5.3.7 TEST RESULTS

802.11a

CHANNEL	FREQUENCY (MHz)	6dB BANDWIDTH (MHz)	MINIMUM LIMIT (MHz)	PASS / FAIL
149	5745	16.41	0.5	PASS
157	5785	16.43	0.5	PASS
165	5825	16.42	0.5	PASS

802.11n (HT20)

CHANNEL	CHANNEL FREQUENCY (MHz)	6dB BANDWIDTH (MHz)			MINIMUM LIMIT (MHz)	PASS / FAIL
		CHAIN 0	CHAIN 1	CHAIN 2		
149	5745	17.21	17.68	17.69	0.5	PASS
157	5785	17.36	17.67	17.68	0.5	PASS
165	5825	17.38	17.66	17.65	0.5	PASS

802.11n (HT40)

CHANNEL	CHANNEL FREQUENCY (MHz)	6dB BANDWIDTH (MHz)			MINIMUM LIMIT (MHz)	PASS / FAIL
		CHAIN 0	CHAIN 1	CHAIN 2		
151	5755	36.47	36.44	36.49	0.5	PASS
159	5795	36.48	36.45	36.47	0.5	PASS

802.11ac (VHT80)

CHANNEL	CHANNEL FREQUENCY (MHz)	6dB BANDWIDTH (MHz)			MINIMUM LIMIT (MHz)	PASS / FAIL
		CHAIN 0	CHAIN 1	CHAIN 2		
155	5775	75.90	75.99	76.47	0.5	PASS

5.4 CONDUCTED OUTPUT POWER MEASUREMENT

5.4.1 LIMITS OF CONDUCTED OUTPUT POWER MEASUREMENT

For systems using digital modulation in the 5725 –5850 MHz band: 1 Watt (30dBm)

Per KDB 662911 D01 Multiple Transmitter Output v01r02 Method of conducted output power measurement on IEEE 802.11 devices,

Array Gain = 0 dB (i.e., no array gain) for $NANT \leq 4$;

Array Gain = 0 dB (i.e., no array gain) for channel widths ≥ 40 MHz for any NANT;

Array Gain = $5 \log(NANT/NSS)$ dB or 3 dB, whichever is less for 20-MHz channel widths with $NANT \geq 5$.

For power measurements on all other devices: Array Gain = $10 \log(NANT/NSS)$ dB.

5.4.2 INSTRUMENTS

DESCRIPTION & MANUFACTURER	MODEL NO.	SERIAL NO.	CALIBRATED DATE	CALIBRATED UNTIL
R&S Spectrum Analyzer	FSP40	100037	Nov. 01, 2012	Oct. 31, 2013

Note:

1. The calibration interval of the above test instruments is 12 months and the calibrations are traceable to NML/ROC and NIST/USA.
2. Tested date : Jan. 07, 2013

5.4.3 TEST PROCEDURES

Follow FCC KDB 558074 DTS test procedure:
Measurement Procedure AVG1

1. Set the analyzer span to a minimum of 1.5 times the EBW.
2. Set RBW =1MHz.
3. Set the VBW $\geq 3 \times$ RBW.
4. Number of measurement points in the sweep $\geq 2 \times$ (span/RBW).
5. Sweep time = auto couple.
6. Detector = power averaging (RMS) or sample.
7. Employ trace averaging in power averaging (RMS) mode over a minimum of 100 traces.
8. Use the spectrum analyzer's integrated band power measurement function with band limits set equal to the EBW band edges.

5.4.4 DEVIATION FROM TEST STANDARD

No deviation.

5.4.5 TEST SETUP

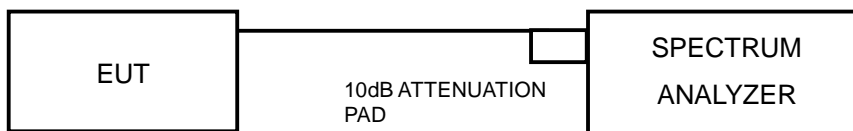

5.4.6 EUT OPERATING CONDITIONS

Same as Item 5.3.6



A D T

5.4.7 TEST RESULTS

802.11a

CHANNEL	FREQUENCY (MHz)	AVERAGE POWER (mW)	AVERAGE POWER (dBm)	LIMIT (dBm)	PASS/FAIL
149	5745	165.577	22.19	30	PASS
157	5785	167.494	22.24	30	PASS
165	5825	161.808	22.09	30	PASS

802.11n (HT20)

CHAN.	CHAN. FREQ. (MHz)	AVERAGE POWER (dBm)			TOTAL POWER (mW)	TOTAL POWER (dBm)	LIMIT (dBm)	PASS / FAIL
		CHAIN 0	CHAIN 1	CHAIN 2				
149	5745	21.97	21.40	21.41	433.793	26.37	30	PASS
157	5785	22.19	21.62	21.63	456.334	26.59	30	PASS
165	5825	21.84	21.38	21.41	428.518	26.32	30	PASS

802.11n (HT40)

CHAN.	CHAN. FREQ. (MHz)	AVERAGE POWER (dBm)			TOTAL POWER (mW)	TOTAL POWER (dBm)	LIMIT (dBm)	PASS / FAIL
		CHAIN 0	CHAIN 1	CHAIN 2				
151	5755	21.19	20.75	20.76	369.496	25.68	30	PASS
159	5795	21.62	21.50	21.21	418.595	26.22	30	PASS

802.11ac (VHT80)

CHAN.	CHAN. FREQ. (MHz)	AVERAGE POWER (dBm)			TOTAL POWER (mW)	TOTAL POWER (dBm)	LIMIT (dBm)	PASS / FAIL
		CHAIN 0	CHAIN 1	CHAIN 2				
155	5775	18.23	18.47	18.50	207.629	23.17	30	PASS

5.5 POWER SPECTRAL DENSITY MEASUREMENT

5.5.1 LIMITS OF POWER SPECTRAL DENSITY MEASUREMENT

The Maximum of Power Spectral Density Measurement is 8dBm.

5.5.2 TEST INSTRUMENTS

DESCRIPTION & MANUFACTURER	MODEL NO.	SERIAL NO.	CALIBRATED DATE	CALIBRATED UNTIL
R&S Spectrum Analyzer	FSP40	100037	Nov. 01, 2012	Oct. 31, 2013

Note:

1. The calibration interval of the above test instruments is 12 months and the calibrations are traceable to NML/ROC and NIST/USA.
2. Tested date : Jan. 07, 2013

5.5.3 TEST PROCEDURE

1. Set the RBW = 3 kHz, VBW =10 kHz, Detector = power averaging (RMS) .
2. Ensure that the number of measurement points in the sweep $\geq 2 \times \text{span/RBW}$
3. Sweep time = auto couple,
4. Employ trace averaging (RMS) mode over a minimum of 100 traces.
5. Use the peak marker function to determine the maximum amplitude level.

5.5.4 DEVIATION FROM TEST STANDARD

No deviation

5.5.5 TEST SETUP

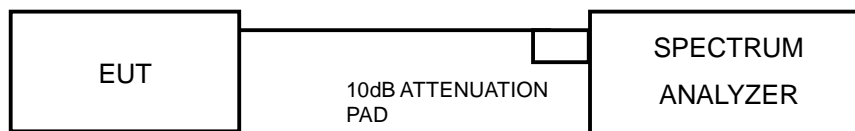

5.5.6 EUT OPERATING CONDITION

Same as Item 4.3.6



A D T

5.5.7 TEST RESULTS

802.11a

Channel	FREQUENCY (MHz)	PSD (dBm/3kHz)	Limit (dBm/3kHz)	PASS /FAIL
149	5745	-3.01	8	PASS
157	5785	-2.70	8	PASS
165	5825	-3.02	8	PASS

802.11n (HT20)

TX chain	Channel	FREQ. (MHz)	PSD (dBm/3kHz)	10 log (N=3) dB	Total PSD (dBm/3kHz)	Limit (dBm/3kHz)	PASS /FAIL
0	149	5745	-3.37	4.77	1.40	6.48	PASS
	157	5785	-3.54	4.77	1.23	6.48	PASS
	165	5825	-3.52	4.77	1.25	6.48	PASS
1	149	5745	-3.73	4.77	1.04	6.48	PASS
	157	5785	-3.65	4.77	1.12	6.48	PASS
	165	5825	-4.38	4.77	0.39	6.48	PASS
2	149	5745	-4.07	4.77	0.70	6.48	PASS
	157	5785	-3.96	4.77	0.81	6.48	PASS
	165	5825	-4.35	4.77	0.42	6.48	PASS

NOTE: Directional gain = $10 \log[(10^{G1/20} + 10^{G2/20})^2 / 2] = 7.52\text{dBi} > 6\text{dBi}$, so the power density limit shall be reduced to $8 - (7.52 - 6) = 6.48\text{dBm}$.



A D T

802.11n (HT40)

TX chain	Channel	FREQ. (MHz)	PSD (dBm/3kHz)	10 log (N=3) dB	Total PSD (dBm/3kHz)	Limit (dBm/3kHz)	PASS /FAIL
0	151	5755	-7.11	4.77	-2.34	6.48	PASS
	159	5795	-6.70	4.77	-1.93	6.48	PASS
1	151	5755	-7.46	4.77	-2.69	6.48	PASS
	159	5795	-6.85	4.77	-2.08	6.48	PASS
2	151	5755	-7.24	4.77	-2.47	6.48	PASS
	159	5795	-6.95	4.77	-2.18	6.48	PASS

NOTE: Directional gain = $10 \log[(10^{G1/20} + 10^{G2/20})^2 / 2] = 7.52\text{dBi} > 6\text{dBi}$, so the power density limit shall be reduced to $8-(7.52-6) = 6.48\text{dBm}$.

802.11ac (VHT80)

TX chain	Channel	FREQ. (MHz)	PSD (dBm/3kHz)	10 log (N=3) dB	Total PSD (dBm/3kHz)	Limit (dBm/3kHz)	PASS /FAIL
0	155	5775	-12.26	4.77	-7.49	6.48	PASS
1	155	5775	-12.06	4.77	-7.29	6.48	PASS
2	155	5775	-12.26	4.77	-7.49	6.48	PASS

NOTE: Directional gain = $10 \log[(10^{G1/20} + 10^{G2/20})^2 / 2] = 7.52\text{dBi} > 6\text{dBi}$, so the power density limit shall be reduced to $8-(7.52-6) = 6.48\text{dBm}$.

5.6 CONDUCTED OUT-BAND EMISSION MEASUREMENT

5.6.1 LIMITS OF CONDUCTED OUT-BAND EMISSION MEASUREMENT

Below 30dB of the highest emission level of operating band (in 100kHz Resolution Bandwidth).

5.6.2 TEST INSTRUMENTS

DESCRIPTION & MANUFACTURER	MODEL NO.	SERIAL NO.	CALIBRATED DATE	CALIBRATED UNTIL
R&S Spectrum Analyzer	FSP40	100037	Nov. 01, 2012	Oct. 31, 2013

Note:

1. The calibration interval of the above test instruments is 12 months and the calibrations are traceable to NML/ROC and NIST/USA.
2. Tested date : Jan. 07, 2013

5.6.3 TEST PROCEDURE

Measurement Procedure - Reference Level

1. Set the RBW = 100 kHz.
2. Set the VBW \geq 300 kHz.
3. Detector = peak.
4. Sweep time = auto couple.
5. Trace mode = max hold.
6. Allow trace to fully stabilize.
7. Use the peak marker function to determine the maximum power level in any 100 kHz band segment within the fundamental EBW.

Measurement Procedure –Unwanted Emission Level

1. Set RBW = 100 kHz.
2. Set VBW \geq 300 kHz.
3. Set span to encompass the spectrum to be examined
4. Detector = peak.
5. Trace Mode = max hold.
6. Sweep = auto couple.

5.6.4 DEVIATION FROM TEST STANDARD

No deviation

5.6.5 TEST SETUP

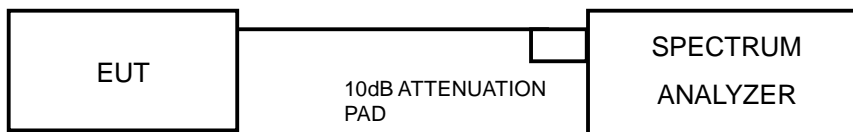

5.6.6 EUT OPERATING CONDITION

Same as Item 4.3.6

5.6.7 TEST RESULTS

The spectrum plots are attached on the following pages. D1 line indicates the highest level, and D2 line indicates the 30dB offset below D1. It shows compliance with the requirement.



A D T

802.11a

Maximum REF

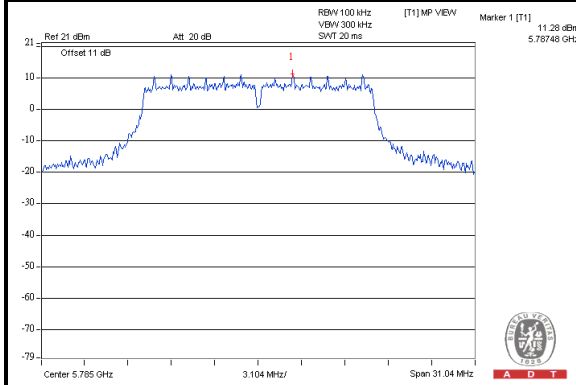

CH 149

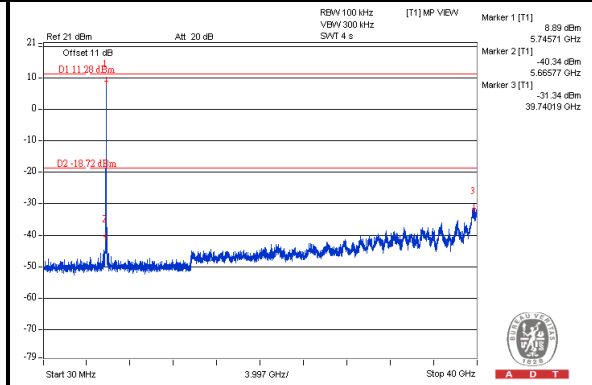

CH 157

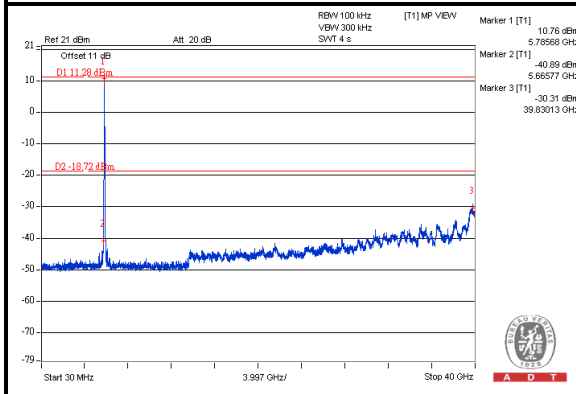

CH 165

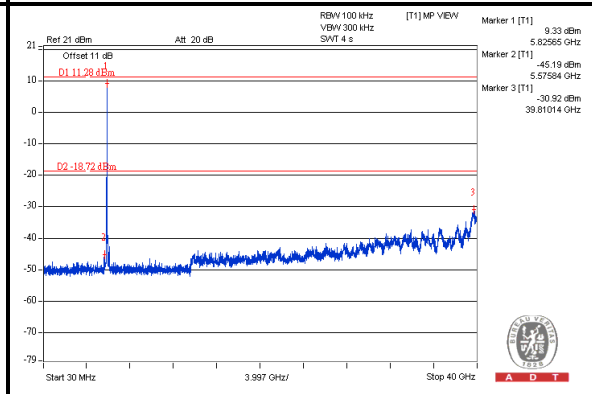



A D T

802.11n (HT20)

Chain(0)

Maximum REF

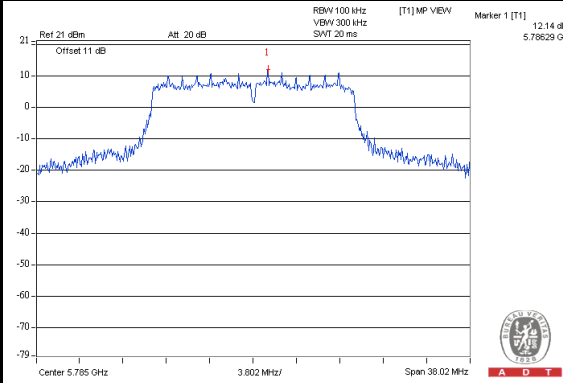

CH 149

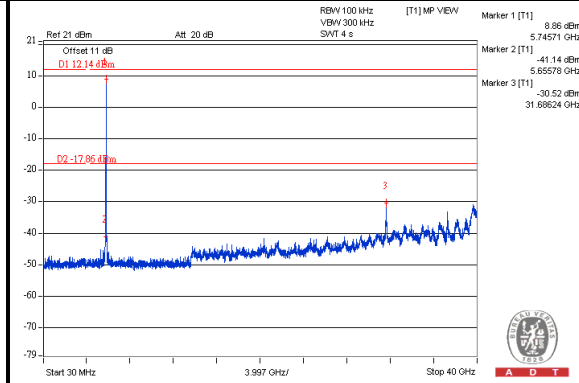

CH 157

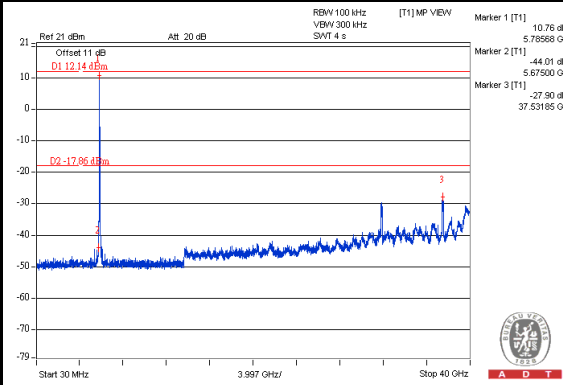

CH 165

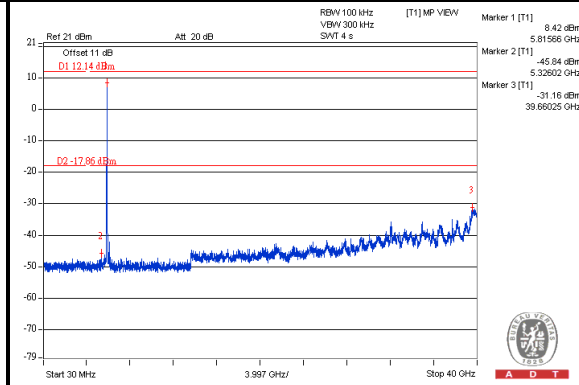



A D T

Chain(1)

Maximum REF

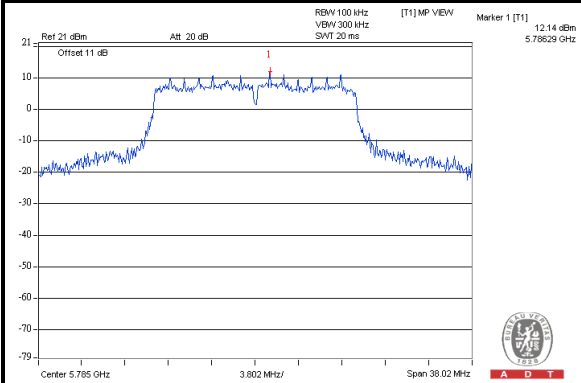

CH 149

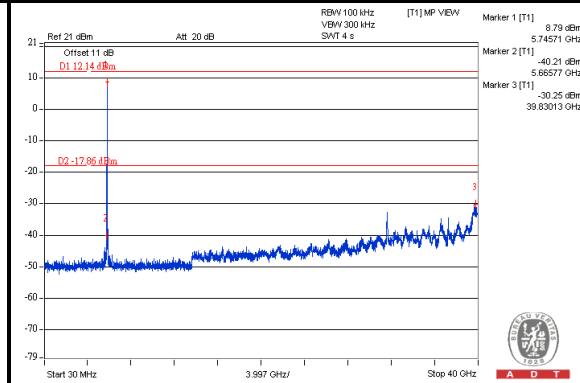

CH 157

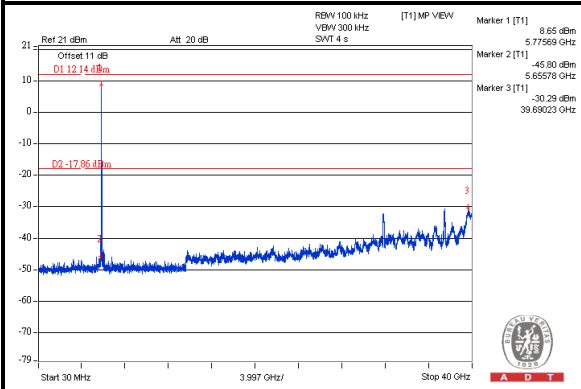

CH 165

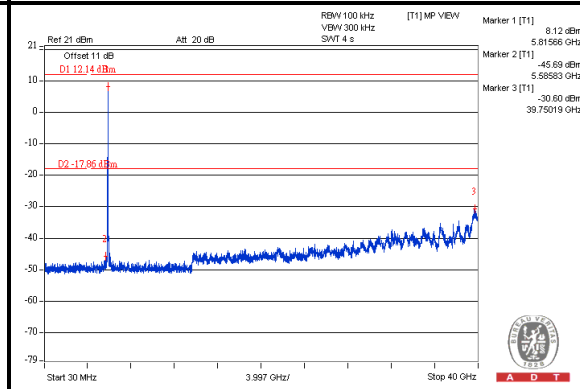



A D T

Chain(2)

Maximum REF

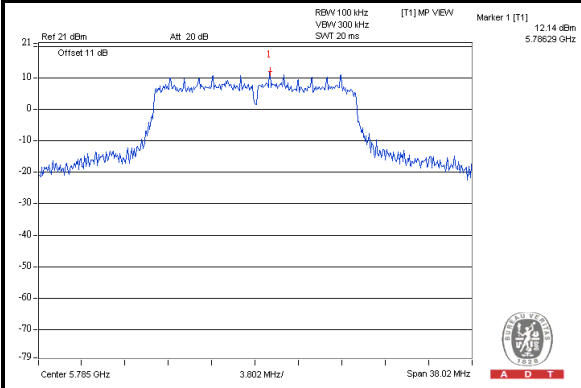

CH 149

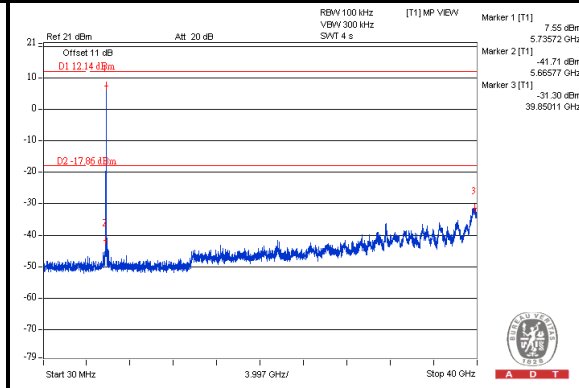

CH 157

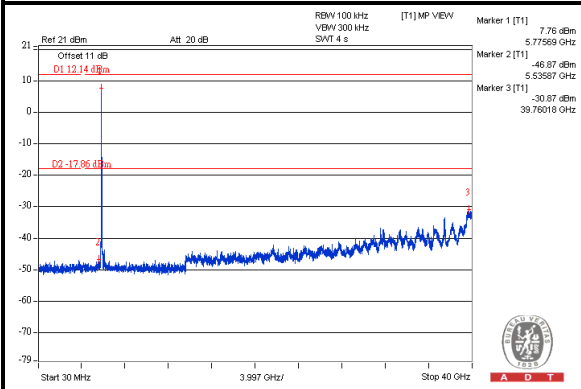

CH 165

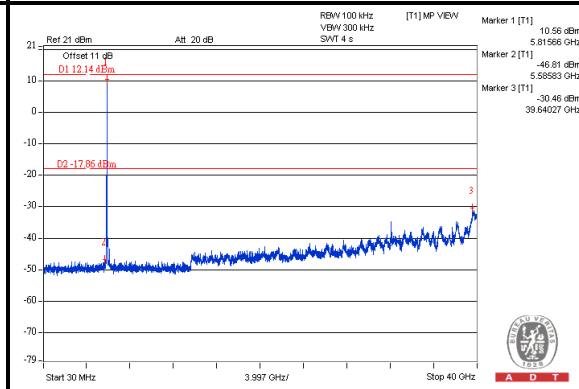



A D T

802.11n (HT40)

Chain(0)

Maximum REF

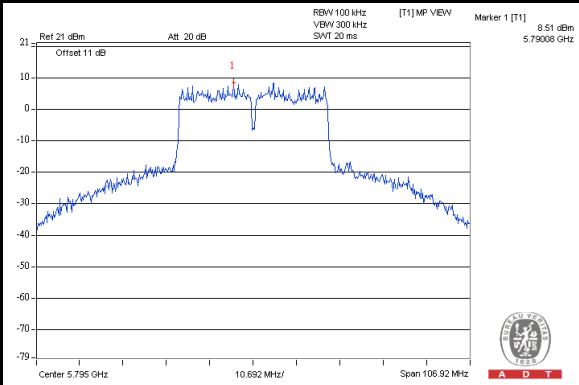

CH 151

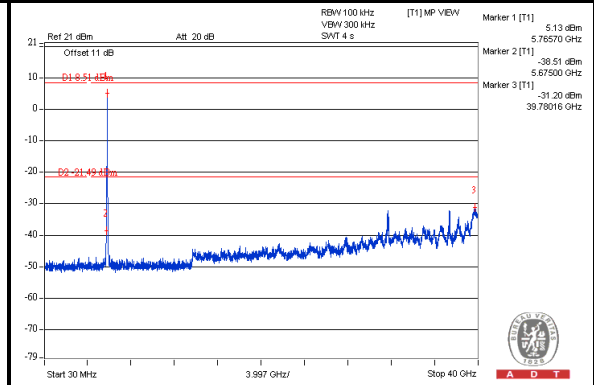

CH 159

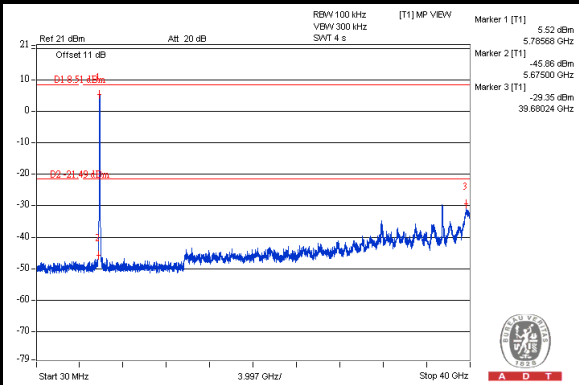



A D T

Chain(1)

Maximum REF

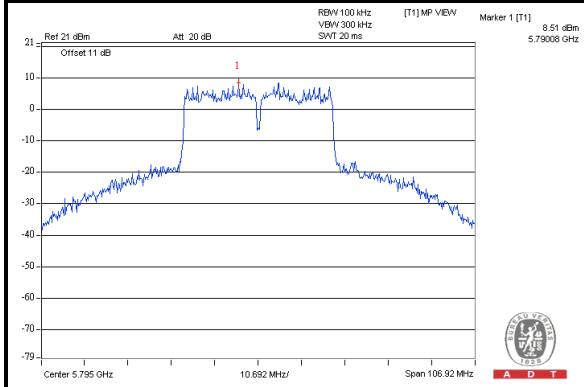

CH 151

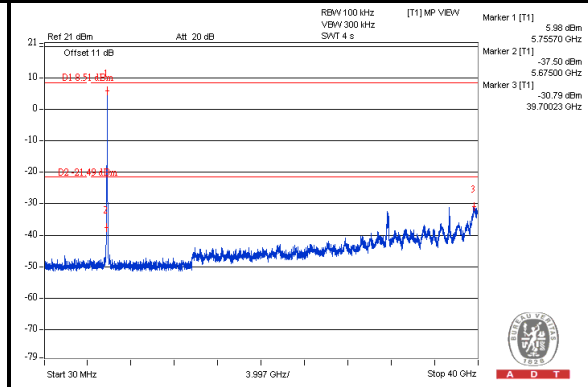

CH 159

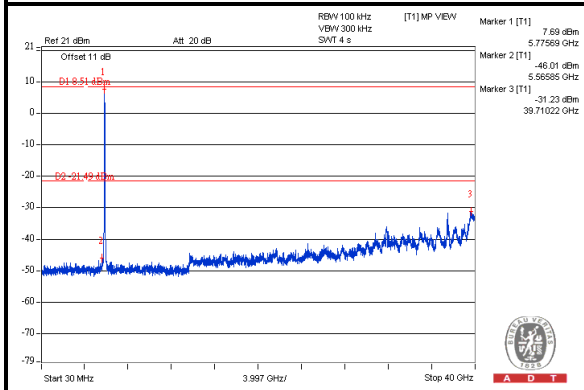



A D T

Chain(2)

Maximum REF

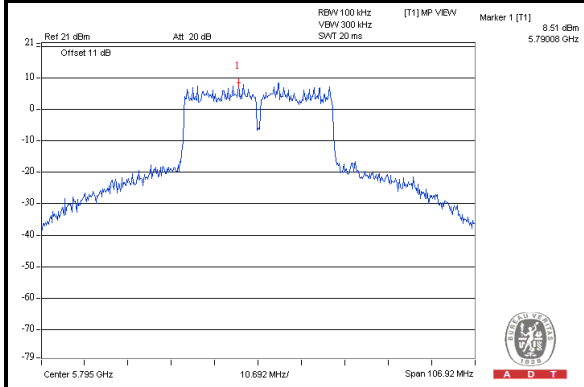

CH 151

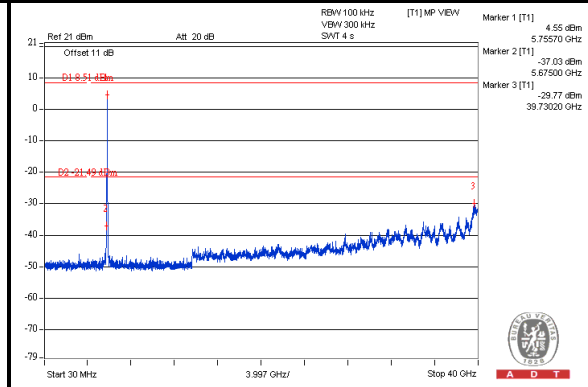

CH 159

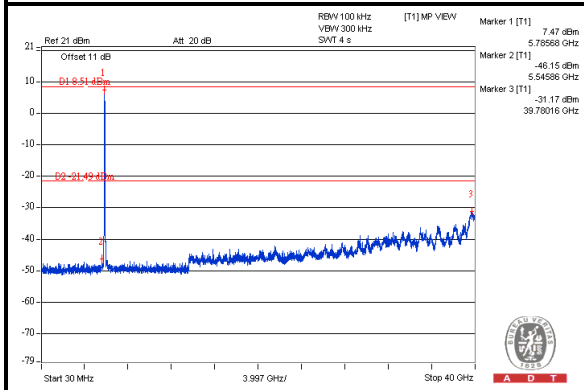



A D T

802.11ac (VHT80)

Chain(0)

Maximum REF

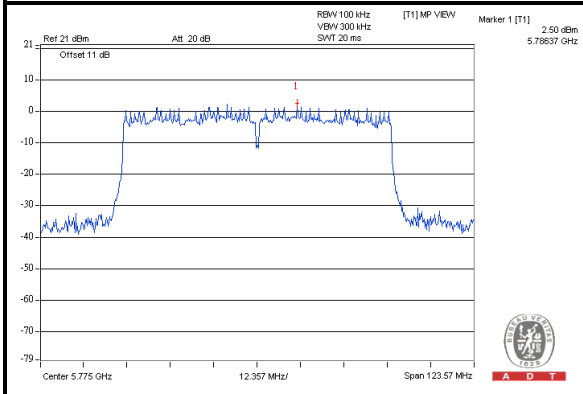

CH 155

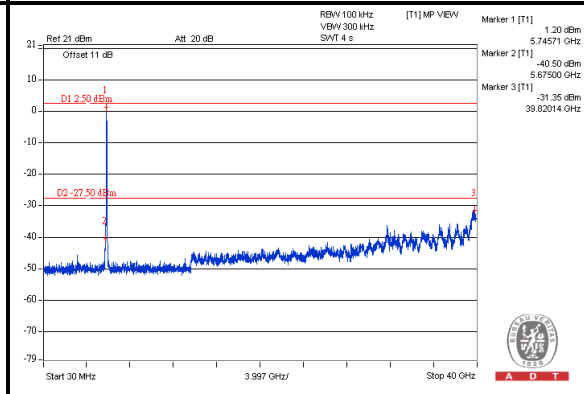

Chain(1)

Maximum REF

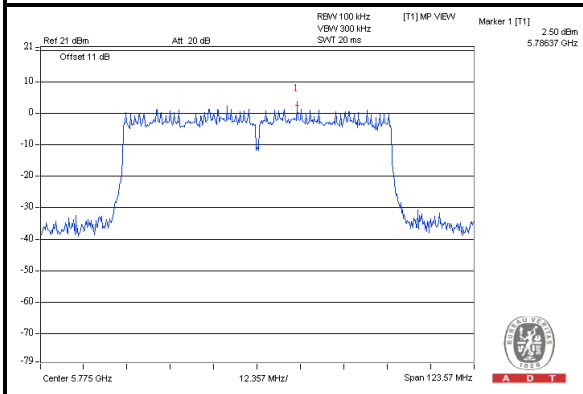

CH 155

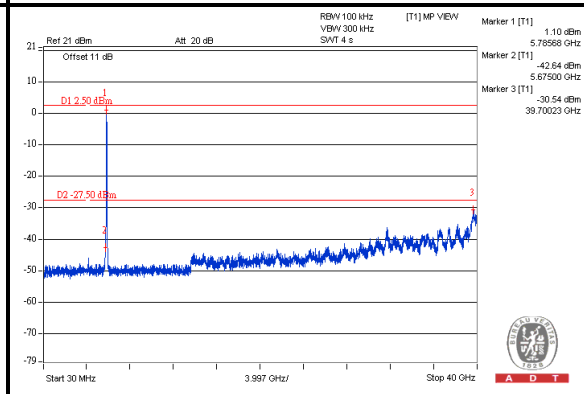

Chain(2)

Maximum REF

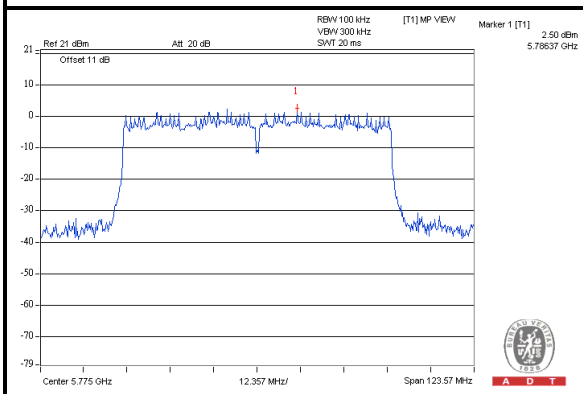

CH 155

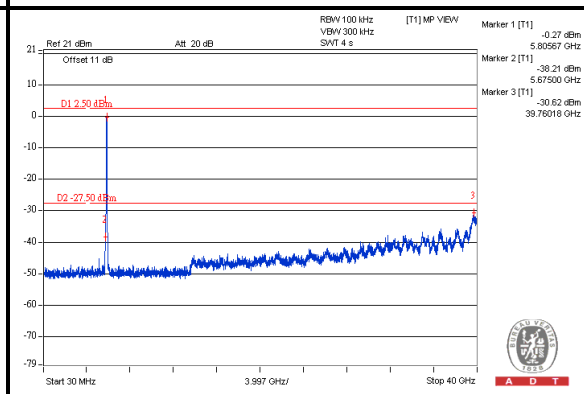



A D T

6. PHOTOGRAPHS OF THE TEST CONFIGURATION

Please refer to the attached file (Test Setup Photo).





7. INFORMATION ON THE TESTING LABORATORIES

We, Bureau Veritas Consumer Products Services (H.K.) Ltd., Taoyuan Branch, were founded in 1988 to provide our best service in EMC, Radio, Telecom and Safety consultation. Our laboratories are accredited and approved according to ISO/IEC 17025.

If you have any comments, please feel free to contact us at the following:

Linko EMC/RF Lab:

Tel: 886-2-26052180

Fax: 886-2-26052943

Hsin Chu EMC/RF Lab:

Tel: 886-3-5935343

Fax: 886-3-5935342

Hwa Ya EMC/RF/Safety/Telecom Lab:

Tel: 886-3-3183232

Fax: 886-3-3270892

Email: service.adt@tw.bureauveritas.com

Web Site: www.bureauveritas-adt.com

The address and road map of all our labs can be found in our web site also.



A D T

8. APPENDIX A - MODIFICATIONS RECORDERS FOR ENGINEERING CHANGES TO THE EUT BY THE LAB

No modifications were made to the EUT by the lab during the test.

--- END ---