



SPORTON International Inc.

No. 52, Hwa Ya 1st Rd., Kwei-Shan Hsiang, TaoYuan Hsien, Taiwan, R.O.C.
Ph: 886-3-327-3456 / FAX: 886-3-327-0973 / www.sporton.com.tw

FCC RADIO TEST REPORT

Applicant's company	Cisco Consumer Products LLC
Applicant Address	121 Theory Drive, Irvine, CA 92617, USA
FCC ID	Q87-EA6300

Product Name	Linksys Smart WiFi Router AC1200
Brand Name	Cisco
Model Name	EA6300
Test Rule Part(s)	47 CFR FCC Part 15 Subpart C § 15.247
Test Freq. Range	2400 ~ 2483.5MHz / 5725 ~ 5850MHz
Received Date	Nov. 16, 2012
Final Test Date	Dec. 05, 2012
Submission Type	Original Equipment



Statement

Test result included is only for the IEEE 802.11n, IEEE 802.11b/g part and IEEE 802.11a (5725 ~ 5850MHz) of the product.

The test result in this report refers exclusively to the presented test model / sample.

Without written approval of SPORTON International Inc., the test report shall not be reproduced except in full.

The measurements and test results shown in this test report were made in accordance with the procedures and found in compliance with the limit given in **ANSI C63.10-2009,**

47 CFR FCC Part 15 Subpart C, KDB 558074 D01 v02 and KDB 662911 D01 v01r02.

The test equipment used to perform the test is calibrated and traceable to NML/ROC.



Table of Contents

1. CERTIFICATE OF COMPLIANCE	1
2. SUMMARY OF THE TEST RESULT	2
3. GENERAL INFORMATION	3
3.1. Product Details	3
3.2. Accessories	7
3.3. Table for Filed Antenna	8
3.4. Table for Carrier Frequencies	9
3.5. Table for Test Modes	10
3.6. Table for Testing Locations.....	12
3.7. Table for Supporting Units	12
3.8. Table for Parameters of Test Software Setting	13
3.9. Test Configurations.....	15
4. TEST RESULT	18
4.1. AC Power Line Conducted Emissions Measurement	18
4.2. Maximum Conducted Output Power Measurement.....	30
4.3. Power Spectral Density Measurement.....	34
4.4. 6dB Spectrum Bandwidth Measurement	48
4.5. Radiated Emissions Measurement.....	57
4.6. Band Edge Emissions Measurement.....	97
4.7. Antenna Requirements	117
5. LIST OF MEASURING EQUIPMENTS	118
6. TEST LOCATION	120
7. TAF CERTIFICATE OF ACCREDITATION	121
APPENDIX A. PHOTOGRAPHS OF EUT	A1 ~ A26
APPENDIX B. TEST PHOTOS	B1 ~ B5
APPENDIX C. MAXIMUM PERMISSIBLE EXPOSURE	C1 ~ C3
APPENDIX D. CO-LOCATION REPORT	D1 ~ D3



History of This Test Report

REPORT NO.	VERSION	DESCRIPTION	ISSUED DATE
FR2N1647AA	Rev. 01	Initial issue of report	Dec. 10, 2012



1. CERTIFICATE OF COMPLIANCE

Product Name : Linksys Smart WiFi Router AC1200
Brand Name : Cisco
Model Name : EA6300
Applicant : Cisco Consumer Products LLC
Test Rule Part(s) : 47 CFR FCC Part 15 Subpart C § 15.247

Sporton International as requested by the applicant to evaluate the EMC performance of the product sample received on Nov. 16, 2012 would like to declare that the tested sample has been evaluated and found to be in compliance with the tested rule parts. The data recorded as well as the test configuration specified is true and accurate for showing the sample's EMC nature.

A handwritten signature in black ink that reads 'Jordan Hsiao' is written over a horizontal line.

Jordan Hsiao

SPORTON INTERNATIONAL INC.

2. SUMMARY OF THE TEST RESULT

Applied Standard: 47 CFR FCC Part 15 Subpart C				
Part	Rule Section	Description of Test	Result	Under Limit
4.1	15.207	AC Power Line Conducted Emissions	Complies	6.85 dB
4.2	15.247(b)(3)	Maximum Conducted Output Power	Complies	8.24 dB
4.3	15.247(e)	Power Spectral Density	Complies	10.92 dB
4.4	15.247(a)(2)	6dB Spectrum Bandwidth	Complies	-
4.5	15.247(d)	Radiated Emissions	Complies	3.00 dB
4.6	15.247(d)	Band Edge Emissions	Complies	0.06 dB
4.7	15.203	Antenna Requirements	Complies	-

Test Items	Uncertainty	Remark
AC Power Line Conducted Emissions	±2.3dB	Confidence levels of 95%
Maximum Conducted Output Power	±0.8dB	Confidence levels of 95%
Power Spectral Density	±0.5dB	Confidence levels of 95%
6dB Spectrum Bandwidth	±8.5×10 ⁻⁸	Confidence levels of 95%
Radiated Emissions (9kHz~30MHz)	±0.8dB	Confidence levels of 95%
Radiated Emissions (30MHz~1GHz)	±1.9dB	Confidence levels of 95%
Radiated / Band Edge Emissions (1GHz~18GHz)	±1.9dB	Confidence levels of 95%
Radiated Emissions (18GHz~40GHz)	±1.9dB	Confidence levels of 95%
Temperature	±0.7°C	Confidence levels of 95%
Humidity	±3.2%	Confidence levels of 95%
DC / AC Power Source	±1.4%	Confidence levels of 95%

3. GENERAL INFORMATION

3.1. Product Details

IEEE 802.11n/ac

Items	Description
Product Type	802.11n (2TX, 2RX), 802.11ac (2TX, 2RX)
Radio Type	Intentional Transceiver
Power Type	From Power Adapter
Modulation	see the below table for IEEE 802.11n/ac
Data Modulation	For 802.11n: OFDM (BPSK / QPSK / 16QAM / 64QAM) For 802.11ac: OFDM (BPSK / QPSK / 16QAM / 64QAM / 256QAM)
Data Rate (Mbps)	see the below table for IEEE 802.11n
Frequency Range	2400 ~ 2483.5MHz / 5725 ~ 5850MHz
Channel Number	For 2.4GHz Band: 11 for 20MHz bandwidth ; 7 for 40MHz bandwidth For 5GHz Band: 5 for 20MHz bandwidth ; 2 for 40MHz bandwidth ; 1 for 80MHz bandwidth
Channel Band Width (99%)	For 2.4GHz Band: MCS0 (20MHz): 16.80 MHz ; MCS0 (40MHz): 36.32 MHz For 5GHz Band: MCS0 (20MHz): 17.68 MHz ; MCS0 (40MHz): 36.48 MHz ; MCS0 (80MHz): 75.84 MHz
Maximum Conducted Output Power	For 2.4GHz Band: MCS0 (20MHz): 20.78 dBm ; MCS0 (40MHz): 16.28 dBm For 5GHz Band 11n: MCS0 (20MHz): 21.71 dBm ; MCS0 (40MHz): 21.70 dBm For 5GHz Band 11ac: MCS0 (20MHz): 21.66 dBm ; MCS0 (40MHz): 21.55 dBm MCS0 (80MHz): 20.88 dBm
Carrier Frequencies	Please refer to section 3.4
Antenna	Please refer to section 3.3

802.11a/b/g

Items	Description
Product Type	802.11b (1TX, 2RX), 802.11g (2TX, 2RX), 802.11a (2TX, 2RX)
Radio Type	Intentional Transceiver
Power Type	From Power Adapter
Modulation	DSSS for IEEE 802.11b ; OFDM for IEEE 802.11a/g
Data Modulation	DSSS (BPSK / QPSK / CCK) ; OFDM (BPSK / QPSK / 16QAM / 64QAM)
Data Rate (Mbps)	DSSS (1/ 2/ 5.5/11) ; OFDM (6/9/12/18/24/36/48/54)
Frequency Range	2400 ~ 2483.5MHz / 5725 ~ 5850MHz
Channel Number	11b/g: 11 ; 11a: 5
Channel Band Width (99%)	11b: 10.40 MHz ; 11g:16.08 MHz ; 11a: 16.48 MHz
Maximum Conducted Output Power	11b: 20.32 dBm ; 11g: 21.15 dBm ; 11a: 21.76 dBm
Carrier Frequencies	Please refer to section 3.4
Antenna	Please refer to section 3.3

Antenna & Band width

Antenna	Single (TX)	Two (TX)		
		20 MHz	40 MHz	80 MHz
IEEE 802.11a	X	V	X	X
IEEE 802.11b	V	X	X	X
IEEE 802.11g	X	V	X	X
IEEE 802.11n	X	V	V	X
IEEE 802.11ac	X	V	V	V

IEEE 802.11n spec

MCS Index	Nss	Modulation	R	NBPS	NCBPS		NDBPS		Datarate(Mbps)			
					20MHz	40MHz	20MHz	40MHz	800nsGI		400nsGI	
									20MHz	40MHz	20MHz	40MHz
0	1	BPSK	1/2	1	52	108	26	54	6.5	13.5	7.200	15
1	1	QPSK	1/2	2	104	216	52	108	13.0	27.0	14.400	30
2	1	QPSK	3/4	2	104	216	78	162	19.5	40.5	21.700	45
3	1	16-QAM	1/2	4	208	432	104	216	26.0	54.0	28.900	60
4	1	16-QAM	3/4	4	208	432	156	324	39.0	81.0	43.300	90
5	1	64-QAM	2/3	6	312	648	208	432	52.0	108.0	57.800	120
6	1	64-QAM	3/4	6	312	648	234	486	58.5	121.5	65.000	135
7	1	64-QAM	5/6	6	312	648	260	540	65.0	135.0	72.200	150
8	2	BPSK	1/2	1	104	216	52	108	13.0	27.0	14.444	30
9	2	QPSK	1/2	2	208	432	104	216	26.0	54.0	28.889	60
10	2	QPSK	3/4	2	208	432	156	324	39.0	81.0	43.333	90
11	2	16-QAM	1/2	4	416	864	208	432	52.0	108.0	57.778	120
12	2	16-QAM	3/4	4	416	864	312	648	78.0	162.0	86.667	180
13	2	64-QAM	2/3	6	624	1296	416	864	104.0	216.0	115.556	240
14	2	64-QAM	3/4	6	624	1296	468	972	117.0	243.0	130.000	270
15	2	64-QAM	5/6	6	624	1296	520	1080	130.0	270.0	144.444	300

Symbol	Explanation
NSS	Number of spatial streams
R	Code rate
NBPS	Number of coded bits per single carrier
NCBPS	Number of coded bits per symbol
NDBPS	Number of data bits per symbol
GI	guard interval

IEEE 802. 11a, 11n and 11ac Spec.

Worst Modulation Used for Conformance Testing				
Protocol	Number of Transmit Chains (NTX)	Data Rate / MCS	Worst Data Rate / MCS	Worst Modulation Mode
802.11a	2	6-54 Mbps	6Mbps	11A5.8G-20M
802.11n 20MHz	2	MCS 0-15	MCS 0	11N5.8G-20M
802.11n 40MHz	2	MCS 0-15	MCS 0	11N5.8G-40M
802.11ac 20MHz	2	MCS 0-9	MCS 0-Nss1	11AC5.8G-20M
802.11ac 40MHz	2	MCS 0-9	MCS 0-Nss1	11AC5.8G-40M
802.11ac 80MHz	2	MCS 0-9	MCS 0-Nss1	11AC5.8G-80M
Note 1: IEEE Std. 802.11-2007 modulation consists of IEEE Std. 802.11a-1999.				
Note 2: IEEE Std. 802.11n-2009 modulation consists of HT20 and HT40 (HT: High Throughput). Then EUT support HT20 and HT40. Worst modulation mode of Guard Interval (GI) is 400ns.				
Note 3: draft IEEE Std. 802.11ac-2012 modulation consists of VHT20, VHT40, VHT80 and VHT160. Then EUT support VHT20, VHT40, VHT80. (VHT: Very High Throughput).				
Note 4: Modulation modes consist of 11A5.2G-20M, 11A5.3G-20M, 11A5.6G-20M, 11A5.8G-20M, 11N5.2G-20M, 11N5.3G-20M, 11N5.6G-20M, 11N5.8G-20M, 11N5.2G-40M, 11N5.3G-40M, 11N5.6G-40M, 11N5.8G-40M, 11AC5.2G-20M, 11AC5.3G-20M, 11AC5.6G-20M, 11AC5.8G-20M, 11AC5.2G-40M, 11AC5.3G-40M, 11AC5.6G-40M, 11AC5.8G-40M, 11AC5.2G-80M, 11AC5.3G-80M, 11AC5.6G-80M, 11AC5.8G-80M,				
11A: IEEE 802.11a, 11N: IEEE 802.11n, 11AC: IEEE 802.11ac. 5.2G: 5.15-5.25 GHz band, 5.3G: 5.25-5.35 GHz band, 5.6G: 5.47-5.725 GHz band , 5.8G: 5.725-5.850GHz band				
20M/40M/80M: Channel Bandwidth 20MHz/40MHz/80MHz				

3.2. Accessories

Power	Brand	Model	Rating
Adapter 1 (Fixed plug)	APD	WA-24E12FU	INPUT: 100-240V~50-60Hz, 0.65A OUTPUT: 12V, 2A
Adapter 2 (Removable plug)	APD	WA-24E12	INPUT: 100-240V~50-60Hz, 0.65A OUTPUT: 12V, 2A
Adapter 3 (Fixed plug)	HON-KWANG	HK-AX-120A200-US	INPUT: 100-240V~50/60Hz, 0.8A OUTPUT: 12V, 2.0A
Adapter 4 (Removable plug)	HON-KWANG	HK-AX-120A200-CP	INPUT: 100-240V~50/60Hz, 0.8A OUTPUT: 12V, 2.0A
Adapter 5 (Fixed plug)	SOLYTECH	CAD2412 (Part No.: CAD2412C)	INPUT: 100-240V~1.0A, 50-60Hz OUTPUT: 12V, 2.0A Max. 24W
Adapter 6 (Fixed plug)	LEI	MU24-S120200-A1	INPUT: 100-240V~50/60Hz, 0.6A OUTPUT: 12V, 2.0A

3.3. Table for Filed Antenna

Ant.	Brand	Model Name	Antenna Type	Connector	Gain (dBi)		Remark
					2.4GHz	5GHz	
0	Galtronics	-	PIFA Antenna	I-PEX	2.62	-	TX/RX
1	Galtronics	-	PIFA Antenna	I-PEX	4.32	-	TX/RX
2	Galtronics	-	PIFA Antenna	I-PEX	-	5.47	TX/RX
3	Galtronics	-	PIFA Antenna	I-PEX	-	4.94	TX/RX

Note: The EUT has four antennas.

For 2.4GHz:

For IEEE 802.11b mode (1TX/2RX):

Only Ant. 0 can be used as transmitting antenna.

Ant. 0 and Ant. 1 could receive simultaneously.

For IEEE 802.11g/n mode (2TX/2RX):

Ant. 0 and Ant. 1 could transmit/receive the signal simultaneously.

For 5GHz:

For IEEE 802.11n mode (2TX/2RX):

Ant. 2 and Ant. 3 could transmit/receive the signal simultaneously.

For IEEE 802.11a mode (2TX/2RX):

Ant. 2 and Ant. 3 could transmit/receive the signal simultaneously.

For IEEE 802.11ac mode (2TX/2RX):

Ant. 2 and Ant. 3 could transmit/receive the signal simultaneously.

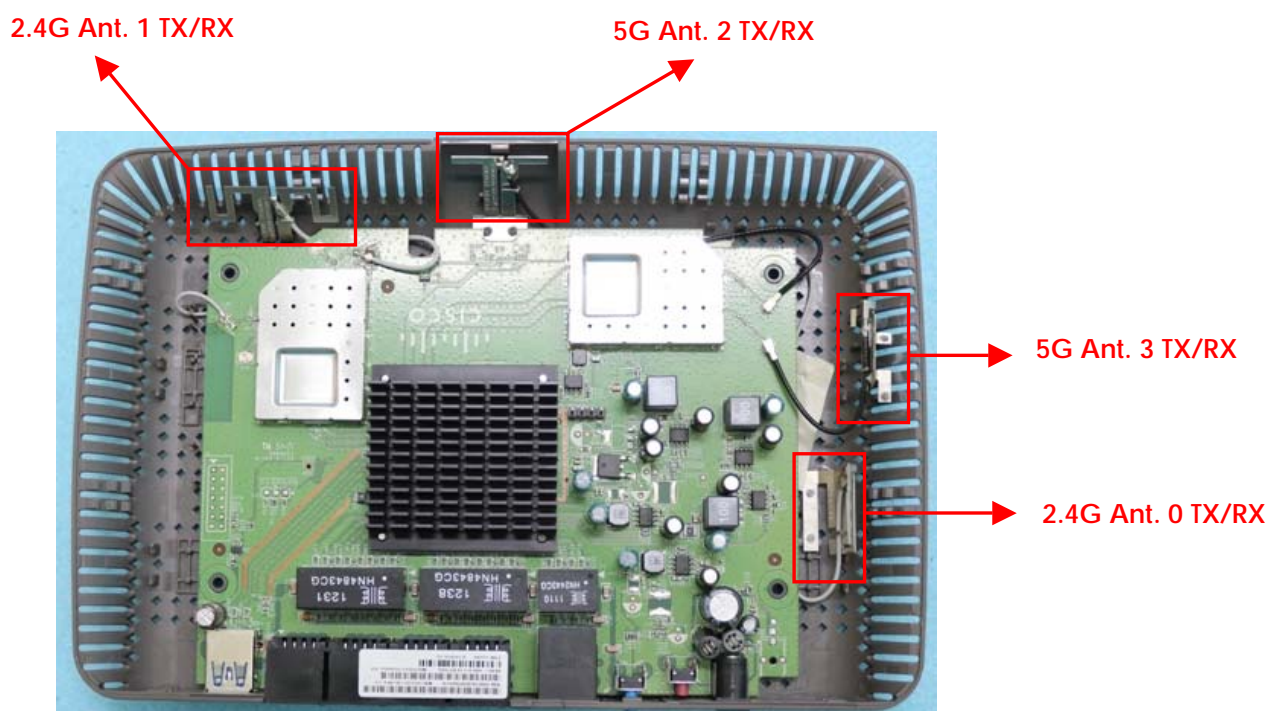

3.4. Table for Carrier Frequencies

For 2.4GHz Band:

There are two bandwidth systems.

For both 20MHz bandwidth systems, use Channel 1~Channel 11.

For both 40MHz bandwidth systems, use Channel 3~Channel 9.

Frequency Band	Channel No.	Frequency	Channel No.	Frequency
2400~2483.5MHz	1	2412 MHz	7	2442 MHz
	2	2417 MHz	8	2447 MHz
	3	2422 MHz	9	2452 MHz
	4	2427 MHz	10	2457 MHz
	5	2432 MHz	11	2462 MHz
	6	2437 MHz	-	-

For 5GHz Band:

There are three bandwidth systems.

For 20MHz bandwidth systems, use Channel 149, 153, 157, 161, 165.

For 40MHz bandwidth systems, use Channel 151, 159.

For 80MHz bandwidth systems, use Channel 155.

Frequency Band	Channel No.	Frequency	Channel No.	Frequency
5725~5850 MHz Band 4	149	5745 MHz	157	5785 MHz
	151	5755 MHz	159	5795 MHz
	153	5765 MHz	161	5805 MHz
	155	5775 MHz	165	5825 MHz

3.5. Table for Test Modes

Preliminary tests were performed in different data rate to find the worst radiated emission. The data rate shown in the table below is the worst-case rate with respect to the specific test item. Investigation has been done on all the possible configurations for searching the worst cases. The following table is a list of the test modes shown in this test report.

For 2.4GHz Band

Test Items	Mode	Data Rate	Channel	Antenna
AC Power Line Conducted Emissions	Normal Link	-	-	-
Maximum Conducted Output Power	MCS0/20MHz	6.5 Mbps	1/6/11	0+1
	MCS0/40MHz	13.5 Mbps	3/6/9	0+1
	11b/CCK	1 Mbps	1/6/11	0
	11g/BPSK	6 Mbps	1/6/11	0+1
Power Spectral Density	MCS0/20MHz	6.5 Mbps	1/6/11	0+1
	MCS0/40MHz	13.5 Mbps	3/6/9	0+1
	11b/CCK	1 Mbps	1/6/11	0
	11g/BPSK	6 Mbps	1/6/11	0+1
6dB Spectrum Bandwidth	MCS0/20MHz	6.5 Mbps	1/6/11	0+1
	MCS0/40MHz	13.5 Mbps	3/6/9	0+1
	11b/CCK	1 Mbps	1/6/11	0
	11g/BPSK	6 Mbps	1/6/11	0+1
Radiated Emissions Below 1GHz	Normal Link	-	-	-
Radiated Emissions Above 1GHz	MCS0/20MHz	6.5 Mbps	1/6/11	0+1
	MCS0/40MHz	13.5 Mbps	3/6/9	0+1
	11b/CCK	1 Mbps	1/6/11	0
	11g/BPSK	6 Mbps	1/6/11	0+1
Band Edge Emissions	MCS0/20MHz	6.5 Mbps	1/11	0+1
	MCS0/40MHz	13.5 Mbps	3/9	0+1
	11b/CCK	1 Mbps	1/11	0
	11g/BPSK	6 Mbps	1/11	0+1

For 5GHz Band

Test Items	Mode	Data Rate	Channel	Antenna
AC Power Line Conducted Emissions	Normal Link	-	-	-
Maximum Conducted Output Power	MCS0/20MHz	7.2 Mbps	149/157/165	2+3
	MCS0/40MHz	15 Mbps	151/159	2+3
	MCS0/80MHz	29.3 Mbps	155	2+3
	11a/BPSK	6 Mbps	149/157/165	2+3
Power Spectral Density	MCS0/20MHz	7.2 Mbps	149/157/165	2/3
	MCS0/40MHz	15 Mbps	151/159	2/3
	MCS0/80MHz	29.3 Mbps	155	2/3
	11a/BPSK	6 Mbps	149/157/165	2/3
6dB Spectrum Bandwidth	MCS0/20MHz	7.2 Mbps	149/157/165	2+3
	MCS0/40MHz	15 Mbps	151/159	2+3
	MCS0/80MHz	29.3 Mbps	155	2+3
	11a/BPSK	6 Mbps	149/157/165	2+3
Radiated Emissions Below 1GHz	Normal Link	-	-	-
Radiated Emissions Above 1GHz	MCS0/20MHz	7.2 Mbps	149/157/165	2/3
	MCS0/40MHz	15 Mbps	151/159	2/3
	MCS0/80MHz	29.3 Mbps	155	2/3
	11a/BPSK	6 Mbps	149/157/165	2/3
Band Edge Emissions	MCS0/20MHz	7.2 Mbps	149/157/165	2+3
	MCS0/40MHz	15 Mbps	151/159	2+3
	MCS0/80MHz	29.3 Mbps	155	2+3
	11a/BPSK	6 Mbps	149/157/165	2+3

The following test modes were performed for all tests:

For Conducted Emission and Radiated Emission test:

The difference among Adapter 1 and Adapter 2 is only different plug, only adapter 1 was selected to test and record in the report as a result.

Mode 1. Adapter 1 (APD WA-24E12FU)

Mode 2. Adapter 2 (HON-KWANG HK-AX-120A200-US)

Mode 3. Adapter 3 (HON-KWANG HK-AX-120A200-CP)

Mode 4. Adapter 4 (SOLYTECH CAD2412)

Mode 5. Adapter 5 (LEI MU24-S120200-A1)

<For MPE and Co-location Test>:

The EUT could be applied with 2.4GHz WLAN function and 5GHz WLAN function; therefore Maximum Permissible Exposure (Please refer to Appendix C) and Co-location (please refer to Appendix D) tests are added for simultaneously transmit between 2.4GHz WLAN function and 5GHz WLAN

function.

3.6. Table for Testing Locations

Test Site No.	Site Category	Location	FCC Reg. No.	IC File No.
03CH01-CB	SAC	Hsin Chu	262045	IC 4086D
CO01-CB	Conduction	Hsin Chu	262045	IC 4086D
TH01-CB	OVEN Room	Hsin Chu	-	-

Open Area Test Site (OATS); Semi Anechoic Chamber (SAC).

Please refer section 6 for Test Site Address.

3.7. Table for Supporting Units

Support Unit	Brand	Model	FCC ID
USB Disk	WD	WDBACY5000AWT	DoC
Notebook	DELL	M1330	E2K4965AGNM
Notebook	DELL	E6220	QDS-BRCM1005-D
Notebook	DELL	E6220	QDS-BRCM1005-D
Notebook	DELL	1340	E2K4965AGNM

3.8. Table for Parameters of Test Software Setting

During testing, Channel & Power Controlling Software provided by the customer was used to control the operating channel as well as the output power level. The RF output power selection is for the setting of RF output power expected by the customer and is going to be fixed on the firmware of the final end product.

For 2.4GHz Band

Power Parameters of IEEE 802.11n MCS0 20MHz

Test Software Version	Manual Toov Version 1.0.0.10		
Frequency	2412 MHz	2437 MHz	2462 MHz
MCS0 20MHz	51	75	49

Power Parameters of IEEE 802.11n MCS0 40MHz

Test Software Version	Manual Toov Version 1.0.0.10		
Frequency	2422 MHz	2437 MHz	2452 MHz
MCS0 40MHz	36	58	36

Power Parameters of IEEE 802.11b/g

Test Software Version	Manual Toov Version 1.0.0.10		
Frequency	2412 MHz	2437 MHz	2462 MHz
IEEE 802.11b	71	80	63
IEEE 802.11g	46	76	45

For 5GHz Band
Power Parameters of IEEE 802.11n MCS0 20MHz

Test Software Version	Manual Toov Version 1.0.0.10		
Frequency	5745 MHz	5785 MHz	5825 MHz
MCS0 20MHz	74	74	74

Power Parameters of IEEE 802.11n MCS0 40MHz

Test Software Version	Manual Toov Version 1.0.0.10	
Frequency	5755 MHz	5795 MHz
MCS0 40MHz	74	74

Power Parameters of IEEE 802.11ac MCS0 80MHz

Test Software Version	Manual Toov Version 1.0.0.10
Frequency	5775 MHz
MCS0 80MHz	74

Power Parameters of IEEE 802.11a

Test Software Version	Manual Toov Version 1.0.0.10		
Frequency	5745 MHz	5785 MHz	5825 MHz
IEEE 802.11a	74	74	74

During the test, "Manual Toov Version 1.0.0.10" under WIN XP was executed the test program to control the EUT continuously transmit RF signal.

3.9. Test Configurations

3.9.1. Radiation Emissions Test Configuration

Test Configuration: 30MHz~1GHz

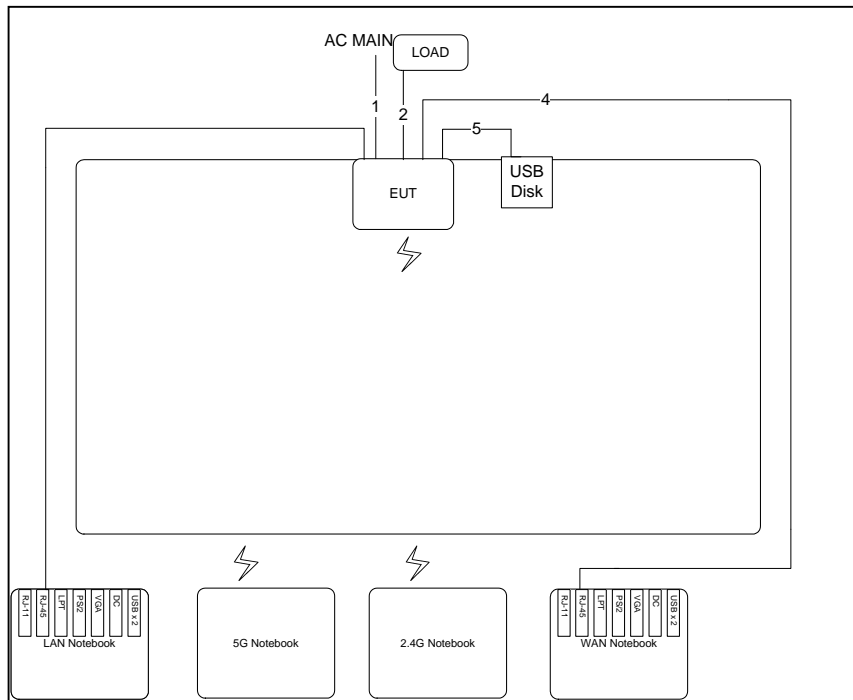

Item	Connection	Shield	Length
1	Power cable	No	1.5m
2	RJ-45 cable*3	No	1.5m
3	RJ-45 cable	No	10m
4	RJ-45 cable	No	10m
5	USB cable	No	0.4m

Test Configuration: above 1GHz

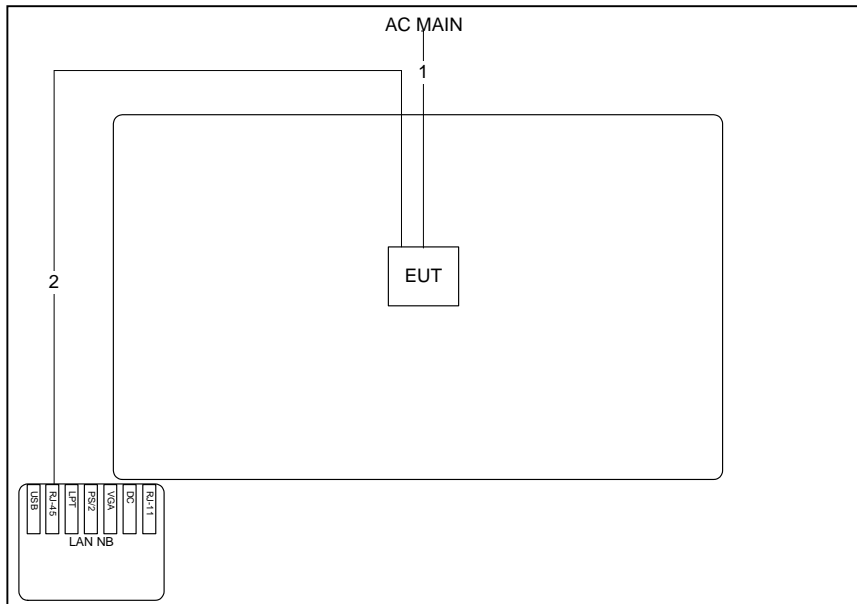

Item	Connection	Shield	Length
1	Power cable	No	1.5m
2	RJ-45 Cable	No	10m

3.9.2. AC Power Line Conduction Emissions Test Configuration

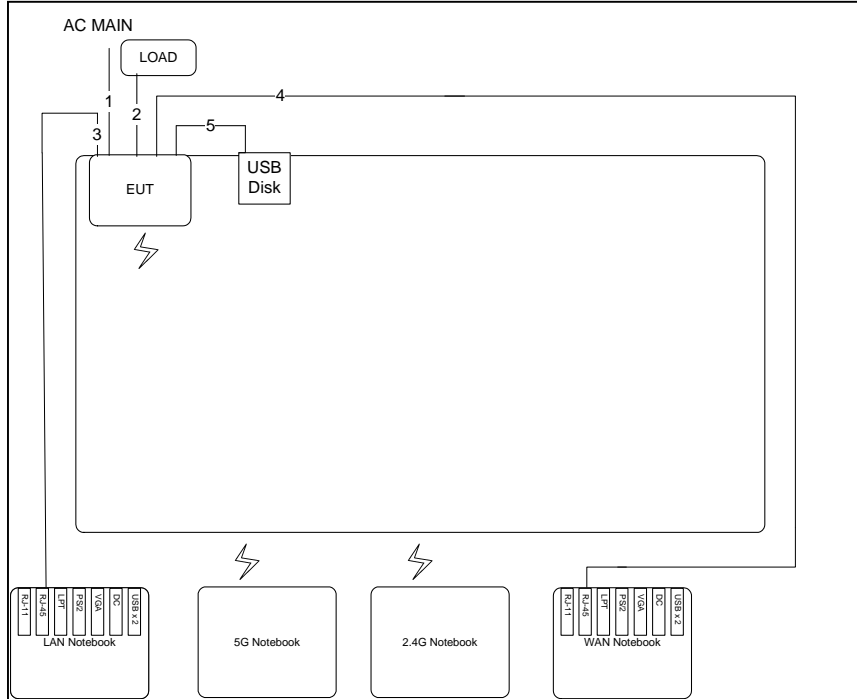

Item	Connection	Shield	Length
1	Power cable	No	1.5m
2	RJ-45 cable*3	No	1.5m
3	RJ-45 cable	No	10m
4	RJ-45 cable	No	10m
5	USB cable	No	0.4m

4. TEST RESULT

4.1. AC Power Line Conducted Emissions Measurement

4.1.1. Limit

For this product which is designed to be connected to the AC power line, the radio frequency voltage that is conducted back onto the AC power line on any frequency or frequencies within the band 150 kHz to 30 MHz shall not exceed below limits table.

Frequency (MHz)	QP Limit (dBuV)	AV Limit (dBuV)
0.15~0.5	66~56	56~46
0.5~5	56	46
5~30	60	50

4.1.2. Measuring Instruments and Setting

Please refer to section 5 of equipments list in this report. The following table is the setting of the receiver.

Receiver Parameters	Setting
Attenuation	10 dB
Start Frequency	0.15 MHz
Stop Frequency	30 MHz
IF Bandwidth	9 KHz

4.1.3. Test Procedures

1. Configure the EUT according to ANSI C63.10. The EUT or host of EUT has to be placed 0.4 meter far from the conducting wall of the shielding room and at least 80 centimeters from any other grounded conducting surface.
2. Connect EUT or host of EUT to the power mains through a line impedance stabilization network (LISN).
3. All the support units are connected to the other LISNs. The LISN should provide 50uH/50ohms coupling impedance.
4. The frequency range from 150 KHz to 30 MHz was searched.
5. Set the test-receiver system to Peak Detect Function and Specified Bandwidth with Maximum Hold Mode.
6. The measurement has to be done between each power line and ground at the power terminal.

4.1.4. Test Setup Layout

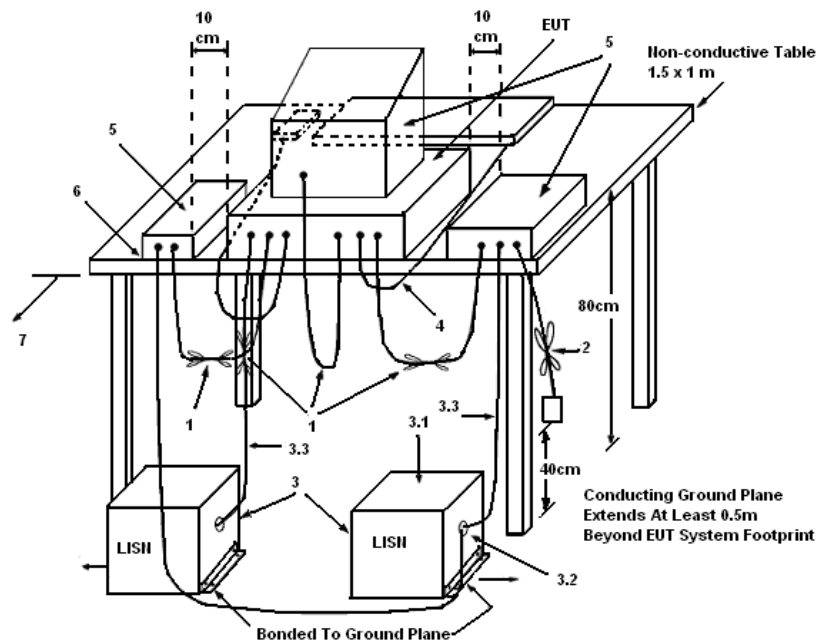

LEGEND:

- (1) Interconnecting cables that hang closer than 40 cm to the ground plane shall be folded back and forth in the center forming a bundle 30 to 40 cm long.
- (2) I/O cables that are not connected to a peripheral shall be bundled in the center. The end of the cable may be terminated, if required, using the correct terminating impedance. The overall length shall not exceed 1 m.
- (3) EUT connected to one LISN. Unused LISN measuring port connectors shall be terminated in 50 Ω. LISN can be placed on top of, or immediately beneath, reference ground plane.
 - (3.1) All other equipment powered from additional LISN(s).
 - (3.2) Multiple outlet strip can be used for multiple power cords of non-EUT equipment.
 - (3.3) LISN at least 80 cm from nearest part of EUT chassis.
- (4) Cables of hand-operated devices, such as keyboards, mice, etc., shall be placed as for normal use.
- (5) Non-EUT components of EUT system being tested.
- (6) Rear of EUT, including peripherals, shall all be aligned and flush with rear of tabletop.
- (7) Rear of tabletop shall be 40 cm removed from a vertical conducting plane that is bonded to the ground plane.

4.1.5. Test Deviation

There is no deviation with the original standard.

4.1.6. EUT Operation during Test

The EUT was placed on the test table and programmed in normal function.

4.1.7. Results of AC Power Line Conducted Emissions Measurement

Temperature	24°C	Humidity	52.8%
Test Engineer	Sollo Luo	Phase	Line
Configuration	Normal Link / Mode 1. Adapter 1 (APD WA-24E12FU)		

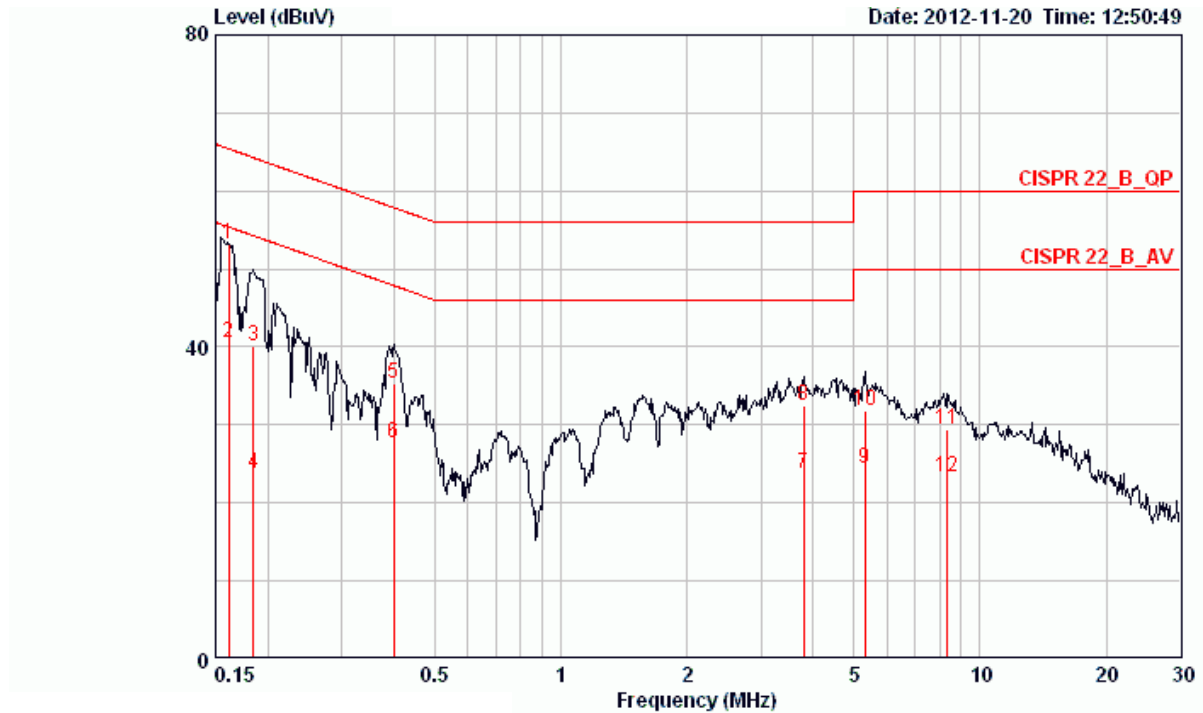

	Freq	Level	Over Limit	Limit Line	Read Level	LISN Factor	Cable Loss	Pol/Phase	Remark
	MHz	dBuV	dB	dBuV	dBuV	dB	dB		
1	0.16155	53.17	-12.21	65.38	52.81	0.16	0.20	LINE	QP
2	0.16155	40.48	-14.90	55.38	40.12	0.16	0.20	LINE	AVERAGE
3	0.18443	40.12	-24.16	64.28	39.77	0.15	0.20	LINE	QP
4	0.18443	23.77	-30.51	54.28	23.42	0.15	0.20	LINE	AVERAGE
5	0.39974	35.39	-22.47	57.86	35.04	0.15	0.20	LINE	QP
6	0.39974	27.79	-20.07	47.86	27.44	0.15	0.20	LINE	AVERAGE
7	3.799	23.80	-22.20	46.00	23.28	0.22	0.30	LINE	AVERAGE
8	3.799	32.53	-23.47	56.00	32.01	0.22	0.30	LINE	QP
9	5.305	24.33	-25.67	50.00	23.78	0.25	0.30	LINE	AVERAGE
10	5.305	31.75	-28.25	60.00	31.20	0.25	0.30	LINE	QP
11	8.367	29.44	-30.56	60.00	28.81	0.31	0.32	LINE	QP
12	8.367	23.32	-26.68	50.00	22.69	0.31	0.32	LINE	AVERAGE

Temperature	24°C	Humidity	52.8%
Test Engineer	Sollo Luo	Phase	Neutral
Configuration	Normal Link / Mode 1. Adapter 1 (APD WA-24E12FU)		



	Freq	Level	Over Limit	Limit Line	Read Level	LISN Factor	Cable Loss	Pol/Phase	Remark
	MHz	dBuV	dB	dBuV	dBuV	dB	dB		
1	0.15985	52.52	-12.95	65.47	52.24	0.08	0.20	NEUTRAL	QP
2	0.15985	38.29	-17.18	55.47	38.01	0.08	0.20	NEUTRAL	AVERAGE
3	0.19758	46.36	-17.35	63.71	46.08	0.08	0.20	NEUTRAL	QP
4	0.19758	36.04	-17.67	53.71	35.76	0.08	0.20	NEUTRAL	AVERAGE
5	0.22797	41.59	-20.93	62.52	41.31	0.08	0.20	NEUTRAL	QP
6	0.22797	29.18	-23.34	52.52	28.90	0.08	0.20	NEUTRAL	AVERAGE
7	0.41266	37.29	-20.30	57.59	37.01	0.08	0.20	NEUTRAL	QP
8	0.41266	28.01	-19.58	47.59	27.73	0.08	0.20	NEUTRAL	AVERAGE
9	1.317	24.73	-21.27	46.00	24.50	0.10	0.13	NEUTRAL	AVERAGE
10	1.317	32.22	-23.78	56.00	31.99	0.10	0.13	NEUTRAL	QP
11	3.661	23.96	-22.04	46.00	23.53	0.13	0.30	NEUTRAL	AVERAGE
12	3.661	31.08	-24.92	56.00	30.65	0.13	0.30	NEUTRAL	QP

Temperature	24°C	Humidity	52.8%
Test Engineer	Sollo Luo	Phase	Line
Configuration	Normal Link / Mode 2. Adapter 2(HON-KWANG HK-AX-120A200-US)		

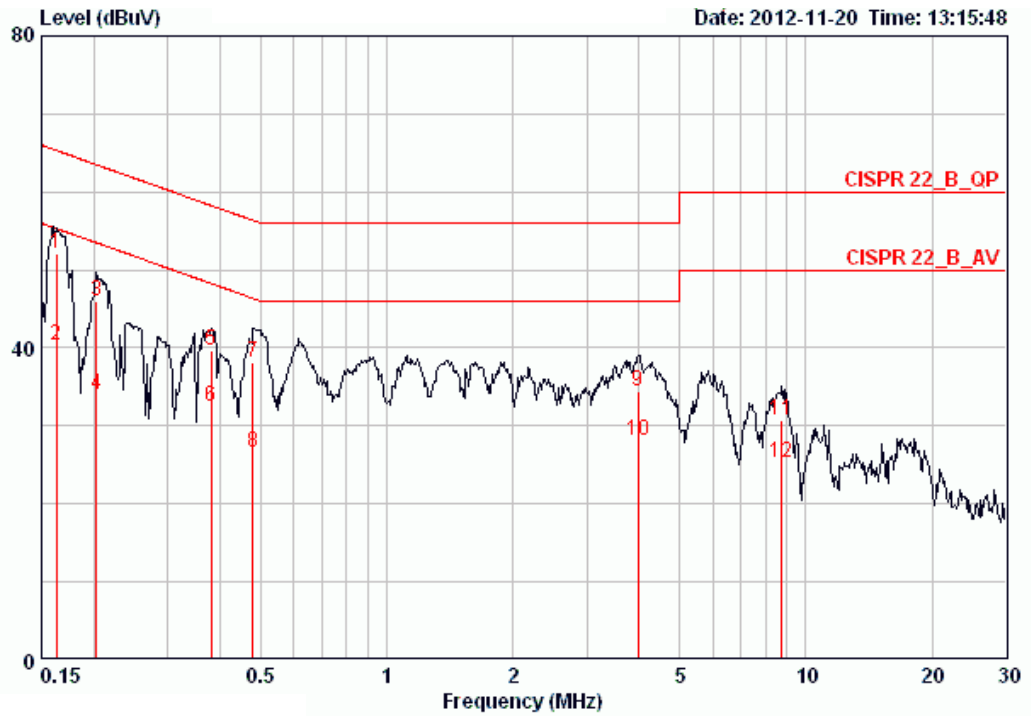

	Freq	Level	Over Limit	Limit Line	Read Level	LISN Factor	Cable Loss	Pol/Phase	Remark
	MHz	dBuV	dB	dBuV	dBuV	dB	dB		
1	0.16241	52.06	-13.28	65.34	51.70	0.16	0.20	LINE	QP
2	0.16241	40.23	-15.11	55.34	39.87	0.16	0.20	LINE	AVERAGE
3	0.20289	45.91	-17.58	63.49	45.56	0.15	0.20	LINE	QP
4	0.20289	33.97	-19.52	53.49	33.62	0.15	0.20	LINE	AVERAGE
5	0.38113	39.73	-18.52	58.25	39.38	0.15	0.20	LINE	QP
6	0.38113	32.43	-15.82	48.25	32.08	0.15	0.20	LINE	AVERAGE
7	0.47865	38.23	-18.14	56.36	37.94	0.15	0.13	LINE	QP
8	0.47865	26.68	-19.69	46.36	26.39	0.15	0.13	LINE	AVERAGE
9	3.985	34.54	-21.46	56.00	34.02	0.22	0.30	LINE	QP
10	3.985	28.03	-17.97	46.00	27.51	0.22	0.30	LINE	AVERAGE
11	8.776	30.66	-29.34	60.00	30.04	0.32	0.30	LINE	QP
12	8.776	25.38	-24.62	50.00	24.76	0.32	0.30	LINE	AVERAGE

Temperature	24°C	Humidity	52.8%
Test Engineer	Sollo Luo	Phase	Neutral
Configuration	Normal Link / Mode 2. Adapter 2(HON-KWANG HK-AX-120A200-US)		

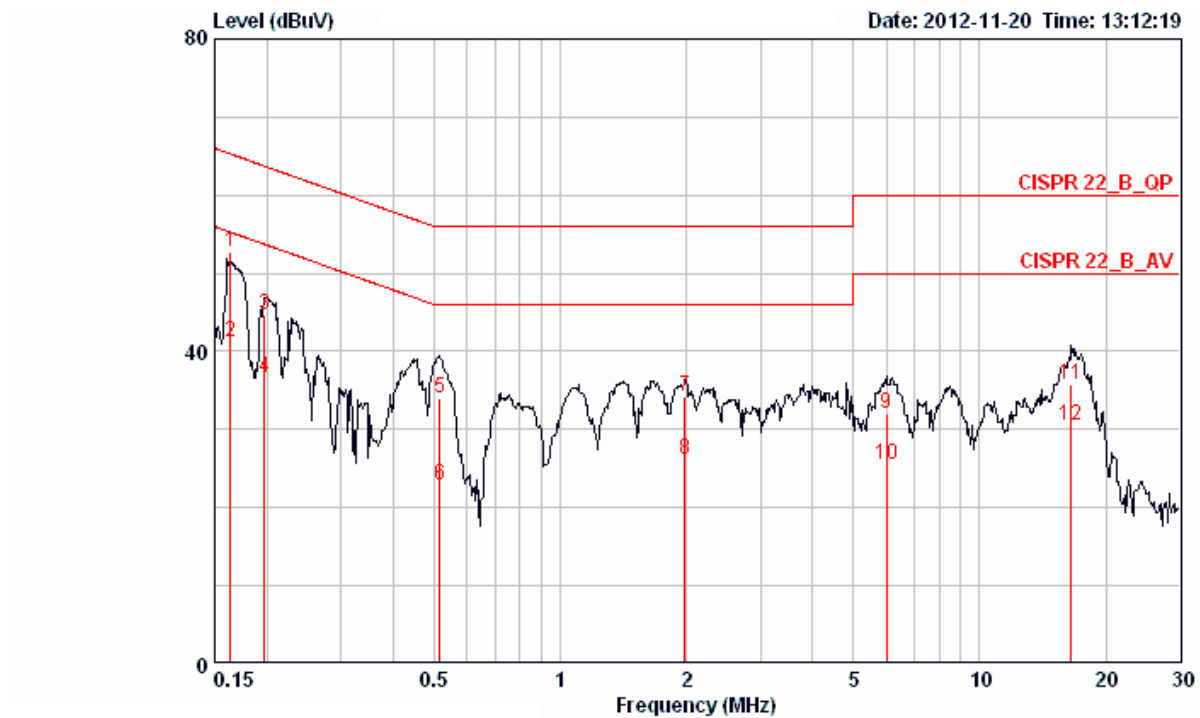

	Freq	Level	Over Limit	Limit Line	Read Level	LISN Factor	Cable Loss	Pol/Phase	Remark
	MHz	dBuV	dB	dBuV	dBuV	dB	dB		
1	0.16327	52.69	-12.61	65.30	52.41	0.08	0.20	NEUTRAL	QP
2	0.16327	41.11	-14.19	55.30	40.83	0.08	0.20	NEUTRAL	AVERAGE
3	0.19758	44.76	-18.95	63.71	44.48	0.08	0.20	NEUTRAL	QP
4	0.19758	36.62	-17.09	53.71	36.34	0.08	0.20	NEUTRAL	AVERAGE
5	0.51550	34.09	-21.91	56.00	33.81	0.08	0.20	NEUTRAL	QP
6	0.51550	22.87	-23.13	46.00	22.59	0.08	0.20	NEUTRAL	AVERAGE
7	1.980	34.15	-21.85	56.00	33.84	0.11	0.20	NEUTRAL	QP
8	1.980	26.12	-19.88	46.00	25.81	0.11	0.20	NEUTRAL	AVERAGE
9	5.993	32.14	-27.86	60.00	31.67	0.17	0.30	NEUTRAL	QP
10	5.993	25.60	-24.40	50.00	25.13	0.17	0.30	NEUTRAL	AVERAGE
11	16.573	35.67	-24.33	60.00	34.90	0.34	0.43	NEUTRAL	QP
12	16.573	30.46	-19.54	50.00	29.69	0.34	0.43	NEUTRAL	AVERAGE

Note:

Level = Read Level + LISN Factor + Cable Loss

Temperature	24°C	Humidity	52.8%
Test Engineer	Sollo Luo	Phase	Line
Configuration	Normal Link / Mode 3. Adapter 3(HON-KWANG HK-AX-120A200-CP)		

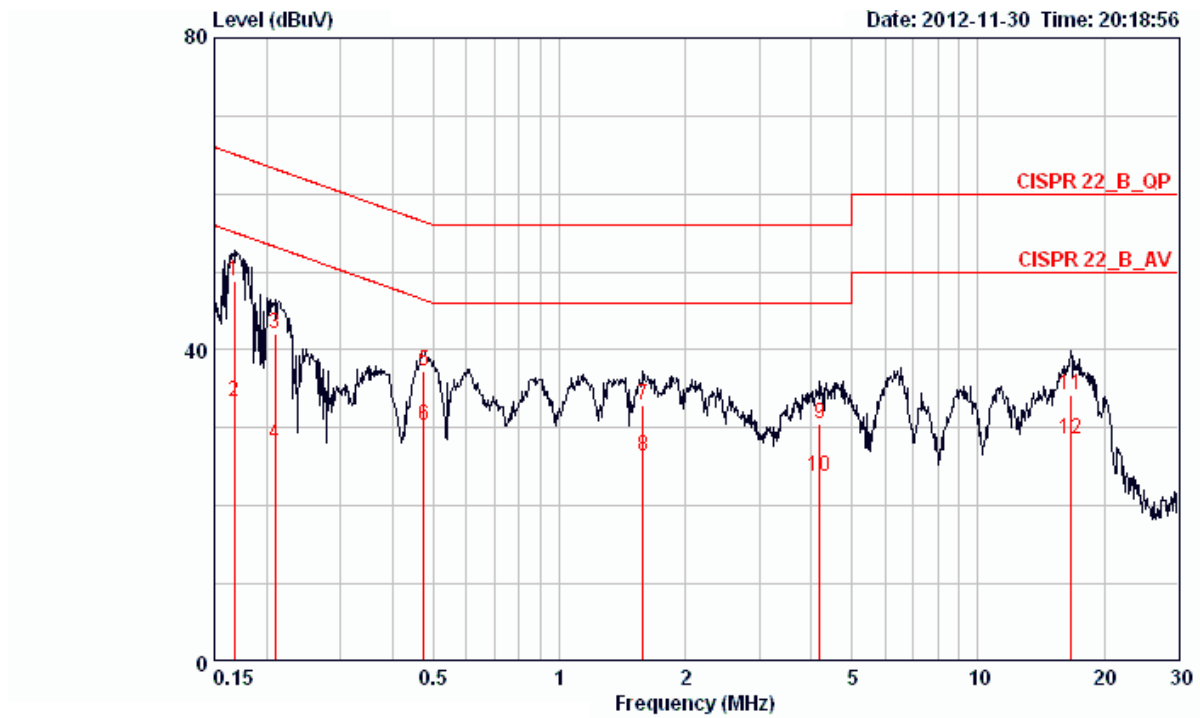

	Freq	Level	Over Limit	Limit Line	Read Level	LISN Factor	Cable Loss	Pol/Phase	Remark
	MHz	dBuV	dB	dBuV	dBuV	dB	dB		
1	0.16765	48.91	-16.17	65.08	48.55	0.16	0.20	LINE	QP
2	0.16765	33.45	-21.63	55.08	33.09	0.16	0.20	LINE	AVERAGE
3	0.20944	41.99	-21.24	63.23	41.64	0.15	0.20	LINE	QP
4	0.20944	27.98	-25.25	53.23	27.63	0.15	0.20	LINE	AVERAGE
5	0.47360	37.20	-19.25	56.45	36.88	0.15	0.17	LINE	QP
6	0.47360	30.22	-16.23	46.45	29.90	0.15	0.17	LINE	AVERAGE
7	1.585	32.93	-23.07	56.00	32.63	0.18	0.12	LINE	QP
8	1.585	26.28	-19.72	46.00	25.98	0.18	0.12	LINE	AVERAGE
9	4.180	30.57	-25.43	56.00	30.05	0.22	0.30	LINE	QP
10	4.180	23.82	-22.18	46.00	23.30	0.22	0.30	LINE	AVERAGE
11	16.661	34.25	-25.75	60.00	33.38	0.43	0.43	LINE	QP
12	16.661	28.53	-21.47	50.00	27.66	0.43	0.43	LINE	AVERAGE

Temperature	24°C	Humidity	52.8%
Test Engineer	Sollo Luo	Phase	Neutral
Configuration	Normal Link / Mode 3. Adapter 3(HON-KWANG HK-AX-120A200-CP)		

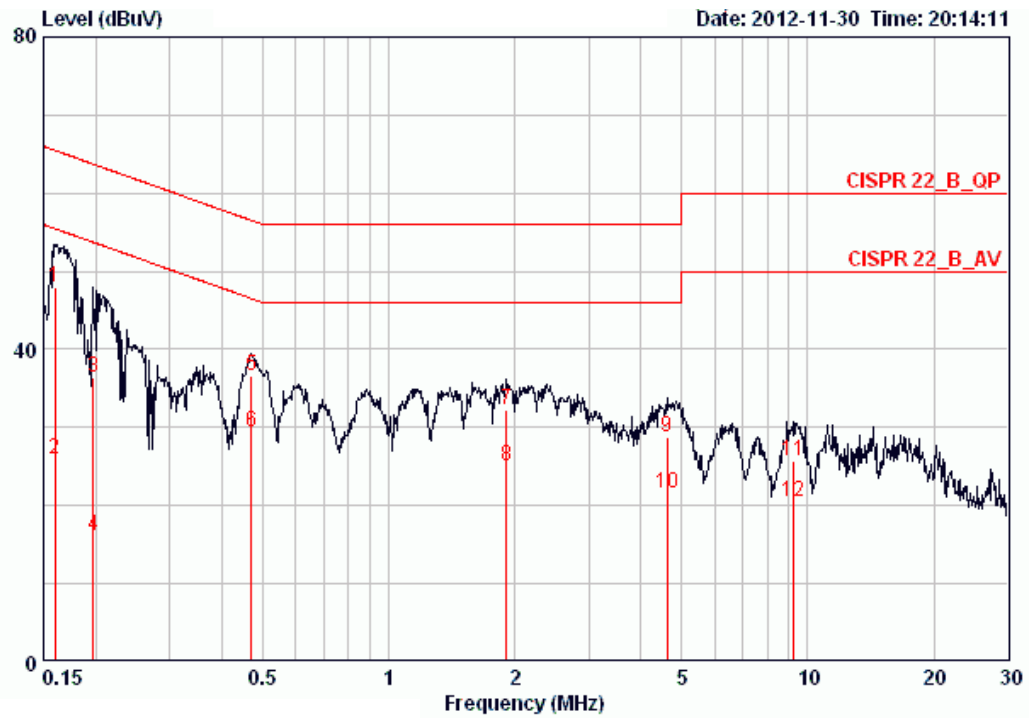

	Freq	Level	Over Limit	Limit Line	Read Level	LISN Factor	Cable Loss	Pol/Phase	Remark
	MHz	dBuV	dB	dBuV	dBuV	dB	dB		
1	0.15985	47.88	-17.59	65.47	47.60	0.08	0.20	NEUTRAL	QP
2	0.15985	25.98	-29.49	55.47	25.70	0.08	0.20	NEUTRAL	AVERAGE
3	0.19758	36.31	-27.40	63.71	36.03	0.08	0.20	NEUTRAL	QP
4	0.19758	16.16	-37.55	53.71	15.88	0.08	0.20	NEUTRAL	AVERAGE
5	0.47110	36.60	-19.89	56.49	36.32	0.08	0.20	NEUTRAL	QP
6	0.47110	29.34	-17.15	46.49	29.06	0.08	0.20	NEUTRAL	AVERAGE
7	1.908	32.16	-23.84	56.00	31.87	0.11	0.18	NEUTRAL	QP
8	1.908	25.03	-20.97	46.00	24.74	0.11	0.18	NEUTRAL	AVERAGE
9	4.622	28.74	-27.26	56.00	28.30	0.14	0.30	NEUTRAL	QP
10	4.622	21.49	-24.51	46.00	21.05	0.14	0.30	NEUTRAL	AVERAGE
11	9.253	25.83	-34.17	60.00	25.30	0.23	0.30	NEUTRAL	QP
12	9.253	20.56	-29.44	50.00	20.03	0.23	0.30	NEUTRAL	AVERAGE

Note:

Level = Read Level + LISN Factor + Cable Loss

Temperature	24°C	Humidity	52.8%
Test Engineer	Sollo Luo	Phase	Line
Configuration	Normal Link / Mode 4. Adapter 4(SOLYTECH CAD2412)		



	Freq	Level	Over Limit	Limit Line	Read Level	LISN Factor	Cable Loss	Pol/Phase	Remark
	MHz	dBuV	dB	dBuV	dBuV	dB	dB		
1	0.16589	53.84	-11.32	65.16	53.48	0.16	0.20	LINE	QP
2	0.16589	43.04	-12.12	55.16	42.68	0.16	0.20	LINE	AVERAGE
3	0.19758	50.98	-12.73	63.71	50.63	0.15	0.20	LINE	QP
4	0.19758	38.58	-15.13	53.71	38.23	0.15	0.20	LINE	AVERAGE
5	0.23040	45.01	-17.43	62.44	44.66	0.15	0.20	LINE	QP
6	0.23040	27.92	-24.52	52.44	27.57	0.15	0.20	LINE	AVERAGE
7	0.44916	29.79	-27.10	56.89	29.44	0.15	0.20	LINE	QP
8	0.44916	18.09	-28.80	46.89	17.74	0.15	0.20	LINE	AVERAGE
9	4.874	24.07	-31.93	56.00	23.53	0.24	0.30	LINE	QP
10	4.874	16.14	-29.86	46.00	15.60	0.24	0.30	LINE	AVERAGE
11	11.438	24.68	-35.32	60.00	23.92	0.36	0.40	LINE	QP
12	11.438	18.40	-31.60	50.00	17.64	0.36	0.40	LINE	AVERAGE

Temperature	24°C	Humidity	52.8%
Test Engineer	Sollo Luo	Phase	Neutral
Configuration	Normal Link / Mode 4. Adapter 4(SOLYTECH CAD2412)		

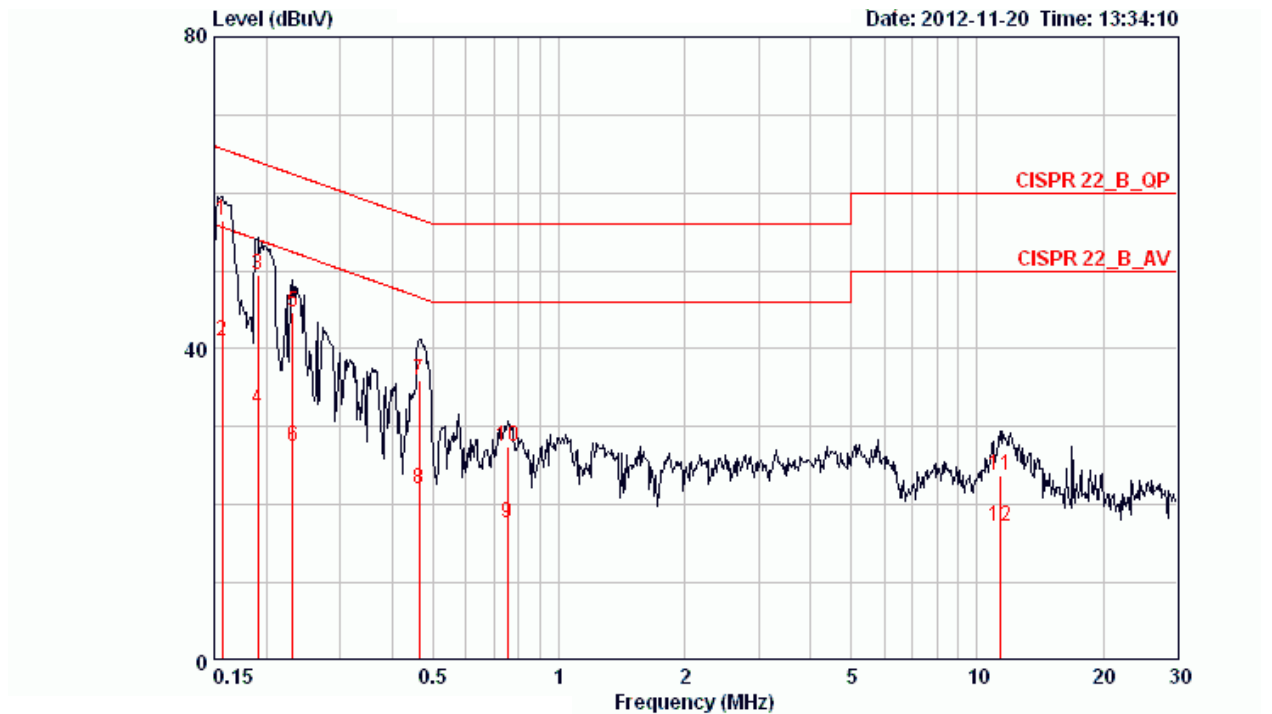

	Freq	Level	Over Limit	Limit Line	Read Level	LISN Factor	Cable Loss	Pol/Phase	Remark
	MHz	dBuV	dB	dBuV	dBuV	dB	dB		
1	0.15650	56.54	-9.11	65.65	56.26	0.08	0.20	NEUTRAL	QP
2	0.15650	40.88	-14.77	55.65	40.60	0.08	0.20	NEUTRAL	AVERAGE
3	0.19039	49.50	-14.52	64.02	49.22	0.08	0.20	NEUTRAL	QP
4	0.19039	32.18	-21.84	54.02	31.90	0.08	0.20	NEUTRAL	AVERAGE
5	0.23162	44.60	-17.79	62.39	44.32	0.08	0.20	NEUTRAL	QP
6	0.23162	27.49	-24.90	52.39	27.21	0.08	0.20	NEUTRAL	AVERAGE
7	0.46367	36.01	-20.62	56.63	35.73	0.08	0.20	NEUTRAL	QP
8	0.46367	21.95	-24.68	46.63	21.67	0.08	0.20	NEUTRAL	AVERAGE
9	0.75493	17.70	-28.30	46.00	17.41	0.09	0.20	NEUTRAL	AVERAGE
10	0.75493	27.45	-28.55	56.00	27.16	0.09	0.20	NEUTRAL	QP
11	11.317	23.86	-36.14	60.00	23.20	0.26	0.40	NEUTRAL	QP
12	11.317	17.13	-32.87	50.00	16.47	0.26	0.40	NEUTRAL	AVERAGE

Note:

Level = Read Level + LISN Factor + Cable Loss

Temperature	24°C	Humidity	52.8%
Test Engineer	Sollo Luo	Phase	Line
Configuration	Normal Link / Mode 5. Adapter 5(LEI MU24-S120200-A1)		

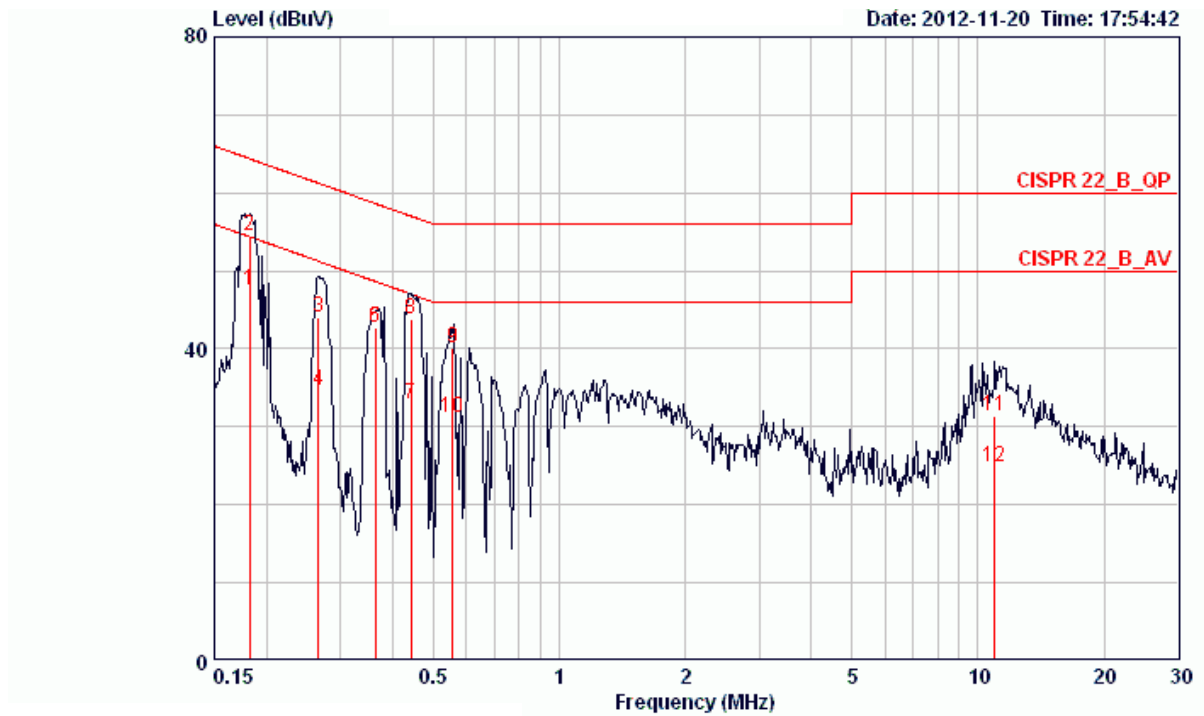

	Freq	Level	Over Limit	Limit Line	Read Level	LISN Factor	Cable Loss	Pol/Phase	Remark
	MHz	dBuV	dB	dBuV	dBuV	dB	dB		
1	0.18249	47.52	-6.85	54.37	47.17	0.15	0.20	LINE	AVERAGE
2	0.18249	54.58	-9.79	64.37	54.23	0.15	0.20	LINE	QP
3	0.26583	44.11	-17.14	61.25	43.76	0.15	0.20	LINE	QP
4	0.26583	34.74	-16.51	51.25	34.39	0.15	0.20	LINE	AVERAGE
5	0.36438	42.65	-15.98	58.63	42.30	0.15	0.20	LINE	QP
6	0.36438	42.71	-15.92	58.63	42.36	0.15	0.20	LINE	QP
7	0.44208	32.99	-14.03	47.02	32.64	0.15	0.20	LINE	AVERAGE
8	0.44208	43.73	-13.29	57.02	43.38	0.15	0.20	LINE	QP
9	0.55540	40.05	-15.96	56.00	39.69	0.16	0.20	LINE	QP
10	0.55540	31.22	-14.79	46.00	30.86	0.16	0.20	LINE	AVERAGE
11	10.963	31.34	-28.66	60.00	30.59	0.35	0.40	LINE	QP
12	10.963	24.93	-25.07	50.00	24.18	0.35	0.40	LINE	AVERAGE

Temperature	24°C	Humidity	52.8%
Test Engineer	Sollo Luo	Phase	Neutral
Configuration	Normal Link / Mode 5. Adapter 5(LEI MU24-S120200-A1)		

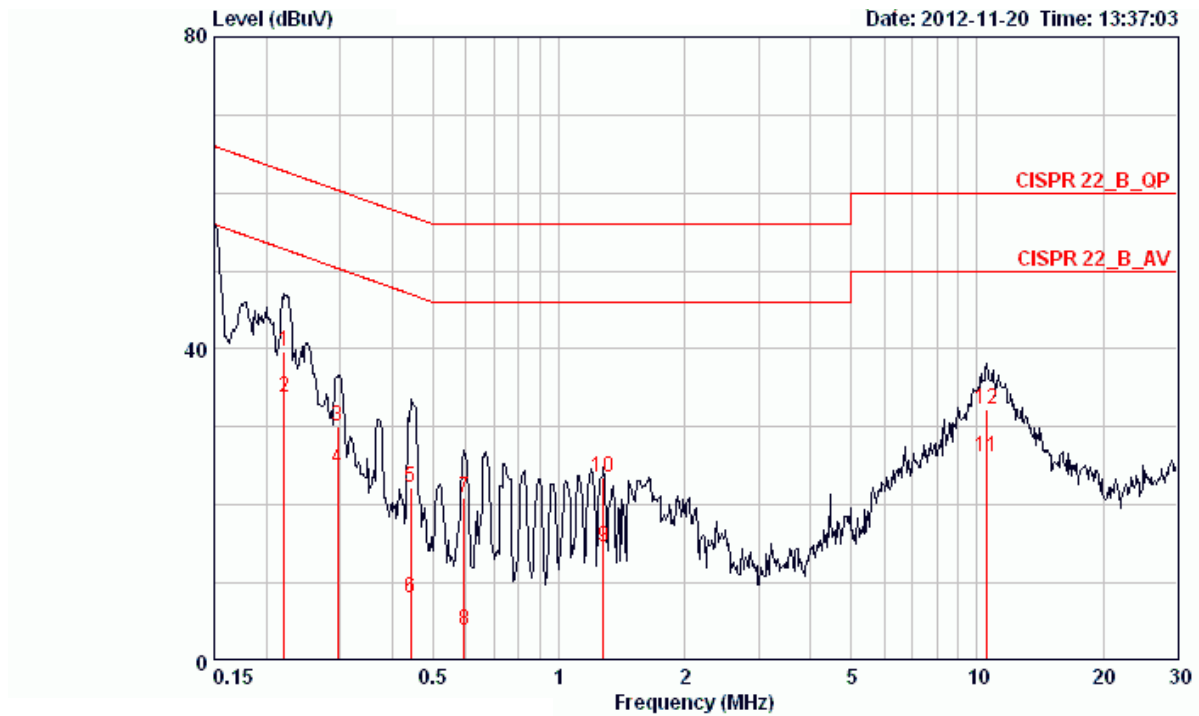

	Freq	Level	Over Limit	Limit Line	Read Level	LISN Factor	Cable Loss	Pol/Phase	Remark
	MHz	dBuV	dB	dBuV	dBuV	dB	dB		
1	0.22083	39.75	-23.04	62.79	39.47	0.08	0.20	NEUTRAL	QP
2	0.22083	33.79	-19.00	52.79	33.51	0.08	0.20	NEUTRAL	AVERAGE
3	0.29555	30.06	-30.31	60.37	29.78	0.08	0.20	NEUTRAL	QP
4	0.29555	24.55	-25.82	50.37	24.27	0.08	0.20	NEUTRAL	AVERAGE
5	0.44208	22.20	-34.82	57.02	21.92	0.08	0.20	NEUTRAL	QP
6	0.44208	8.04	-38.98	47.02	7.76	0.08	0.20	NEUTRAL	AVERAGE
7	0.59478	20.94	-35.06	56.00	20.66	0.08	0.20	NEUTRAL	QP
8	0.59478	3.92	-42.08	46.00	3.64	0.08	0.20	NEUTRAL	AVERAGE
9	1.276	14.51	-31.49	46.00	14.27	0.10	0.14	NEUTRAL	AVERAGE
10	1.276	23.58	-32.42	56.00	23.34	0.10	0.14	NEUTRAL	QP
11	10.564	26.15	-23.85	50.00	25.51	0.25	0.39	NEUTRAL	AVERAGE
12	10.564	32.19	-27.81	60.00	31.55	0.25	0.39	NEUTRAL	QP

Note:

Level = Read Level + LISN Factor + Cable Loss

4.2. Maximum Conducted Output Power Measurement

4.2.1. Limit

For systems using digital modulation in the 2400-2483.5MHz, the limit for output power is 30dBm. The limited has to be reduced by the amount in dB that the gain of the antenna exceed 6dBi. In case of point-to-point operation, the limit has to be reduced by 1dB for every 3dB that the directional gain of the antenna exceeds 6dBi. Systems operating in the 5725-5850 MHz band that are used exclusively for fixed, point-to-point operations may employ transmitting antennas with directional gain greater than 6 dBi without any corresponding reduction in transmitter output power.

4.2.2. Measuring Instruments and Setting

Please refer to section 5 of equipments list in this report. The following table is the setting of the power meter.

Power Meter Parameter	Setting
Detector	Average

4.2.3. Test Procedures

1. Test procedures refer KDB558074 v01 r02 section 8.2.3 option 3
2. This procedure provides an alternative for determining the RMS output power using a broadband RF average power meter with a thermocouple detector.

4.2.4. Test Setup Layout

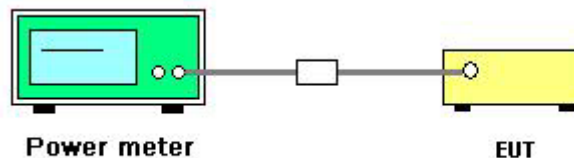

4.2.5. Test Deviation

There is no deviation with the original standard.

4.2.6. EUT Operation during Test

The EUT was programmed to be in continuously transmitting mode.

4.2.7. Test Result of Maximum Conducted Output Power

Temperature	25°C	Humidity	56%
Test Engineer	Benson Peng	Configurations	IEEE 802.11n/ac
Test Date	Dec. 04, 2012		

For 2.4GHz Band

Configuration IEEE 802.11n MCS0 20MHz / Ant. 0 + Ant. 1

Channel	Frequency	Conducted Power (dBm)		Total Conducted Power (dBm)	Max. Limit (dBm)	Result
		Ant. 0	Ant. 1			
1	2412 MHz	12.47	11.12	14.86	30.00	Complies
6	2437 MHz	18.25	17.24	20.78	30.00	Complies
11	2462 MHz	11.90	10.50	14.27	30.00	Complies

Configuration IEEE 802.11n MCS0 40MHz / Ant. 0 + Ant. 1

Channel	Frequency	Conducted Power (dBm)		Total Conducted Power (dBm)	Max. Limit (dBm)	Result
		Ant. 0	Ant. 1			
3	2422 MHz	8.27	7.81	11.06	30.00	Complies
6	2437 MHz	13.66	12.85	16.28	30.00	Complies
9	2452 MHz	8.02	7.71	10.88	30.00	Complies

For 5GHz Band

Configuration IEEE 802.11n MCS0 20MHz / Ant. 2 + Ant. 3

Channel	Frequency	Conducted Power (dBm)		Total Conducted Power (dBm)	Max. Limit (dBm)	Result
		Ant. 2	Ant. 3			
149	5745 MHz	18.64	18.61	21.64	30.00	Complies
157	5785 MHz	18.72	18.67	21.71	30.00	Complies
165	5825 MHz	18.73	18.65	21.70	30.00	Complies

Configuration IEEE 802.11n MCS0 40MHz / Ant. 2 + Ant. 3

Channel	Frequency	Conducted Power (dBm)		Total Conducted Power (dBm)	Max. Limit (dBm)	Result
		Ant. 2	Ant. 3			
151	5755 MHz	18.77	18.61	21.70	30.00	Complies
159	5795 MHz	18.73	18.59	21.67	30.00	Complies

Configuration IEEE 802.11ac MCS0 20MHz / Ant. 2 + Ant. 3

Channel	Frequency	Conducted Power (dBm)		Total Conducted Power (dBm)	Max. Limit (dBm)	Result
		Ant. 2	Ant. 3			
149	5745 MHz	18.74	18.55	21.66	30.00	Complies
157	5785 MHz	18.71	18.48	21.61	30.00	Complies
165	5825 MHz	18.58	18.41	21.51	30.00	Complies

Configuration IEEE 802.11ac MCS0 40MHz / Ant. 2 + Ant. 3

Channel	Frequency	Conducted Power (dBm)		Total Conducted Power (dBm)	Max. Limit (dBm)	Result
		Ant. 2	Ant. 3			
151	5755 MHz	18.65	18.43	21.55	30.00	Complies
159	5795 MHz	18.67	18.41	21.55	30.00	Complies

Configuration IEEE 802.11ac MCS0 80MHz / Ant. 2 + Ant. 3

Channel	Frequency	Conducted Power (dBm)		Total Conducted Power (dBm)	Max. Limit (dBm)	Result
		Ant. 2	Ant. 3			
155	5775 MHz	18.01	17.73	20.88	30.00	Complies

Temperature	25°C	Humidity	56%
Test Engineer	Benson Peng	Configurations	IEEE 802.11a/b/g
Test Date	Dec. 04, 2012		

Configuration IEEE 802.11b / Ant. 0

Channel	Frequency	Conducted Power (dBm)	Max. Limit (dBm)	Result
1	2412 MHz	17.78	30.00	Complies
6	2437 MHz	20.32	30.00	Complies
11	2462 MHz	14.73	30.00	Complies

Configuration IEEE 802.11g / Ant. 0 + Ant. 1

Channel	Frequency	Conducted Power (dBm)		Total Conducted Power (dBm)	Max. Limit (dBm)	Result
		Ant. 0	Ant. 1			
1	2412 MHz	11.22	10.26	13.78	30.00	Complies
6	2437 MHz	18.51	17.74	21.15	30.00	Complies
11	2462 MHz	10.38	9.76	13.09	30.00	Complies

Configuration IEEE 802.11a / Ant. 2 + Ant. 3

Channel	Frequency	Conducted Power (dBm)		Total Conducted Power (dBm)	Max. Limit (dBm)	Result
		Ant. 2	Ant. 3			
149	5745 MHz	18.78	18.72	21.76	30.00	Complies
157	5785 MHz	18.74	18.69	21.73	30.00	Complies
165	5825 MHz	18.71	18.67	21.70	30.00	Complies

4.3. Power Spectral Density Measurement

4.3.1. Limit

For digitally modulated systems, the power spectral density conducted from the intentional radiator to the antenna shall not be greater than 8dBm in any 3 kHz band during any time interval of continuous transmission.

4.3.2. Measuring Instruments and Setting

Please refer to section 5 of equipments list in this report. The following table is the setting of the spectrum analyzer.

Spectrum Parameter	Setting
Attenuation	Auto
Span Frequency	Set the span to 1.5 times the DTS channel bandwidth.
RB	100 kHz
VB	300 kHz
Detector	Peak
Trace	Max Hold
Sweep Time	Auto couple

4.3.3. Test Procedures

1. Test procedures refer KDB558074 v01 r02 section 9.1 option 1
2. Spectrum analyzer must be capable of utilizing a number of measurement points in each sweep that is greater than or equal to twice the span/RBW in order to ensure bin-to-bin spacing of $\leq RBW/2$ so that narrowband signals are not lost between frequency bins.
3. Use this procedure when the maximum conducted output power in the fundamental emission is used to demonstrate compliance. The EUT must be configured to transmit continuously at full power over the measurement duration.
4. Ensure that the number of measurement points in the sweep $\geq 2 \times \text{span}/\text{RBW}$ (use of a greater number of measurement points than this minimum requirement is recommended).
5. Use the peak marker function to determine the maximum level in any 100 kHz band segment within the fundamental EBW.
6. Scale the observed power level to an equivalent level in 3 kHz by adjusting (reducing) the measured power by a bandwidth correction factor (BWCF) where: $BWCF = 10\log(3 \text{ kHz}/100 \text{ kHz} = -15.2 \text{ dB})$.
7. The resulting PSD level must be $\leq 8 \text{ dBm}$.
8. When measuring power spectral density with multiple antenna systems, add every result of the values by mathematic formula.

4.3.4. Test Setup Layout

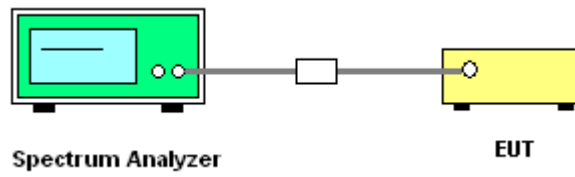

4.3.5. Test Deviation

There is no deviation with the original standard.

4.3.6. EUT Operation during Test

The EUT was programmed to be in continuously transmitting mode.

4.3.7. Test Result of Power Spectral Density

Temperature	25°C	Humidity	56%
Test Engineer	Benson Peng	Configurations	IEEE 802.11n
Test Date	Dec. 04, 2012		

For 2.4GHz Band

Configuration IEEE 802.11n MCS0 20MHz / Ant. 0 + Ant. 1

Channel	Frequency	Power Density (dBm/100kHz)		BWCF factor (100KHz to 3KHz)	Power Density (dBm/3kHz)		Single Port Limit (dBm/3kHz)	Result
		Ant. 0	Ant. 1		Ant. 0	Ant. 1		
1	2412 MHz	1.89	0.35	-15.23	-13.34	-14.88	4.99	Complies
6	2437 MHz	8.33	6.75	-15.23	-6.90	-8.48	4.99	Complies
11	2462 MHz	-1.97	-2.26	-15.23	-17.20	-17.49	4.99	Complies

Note: PSD Limit = (8dBm/MHz - (10log(2))) = 4.99dBm/MHz

Configuration IEEE 802.11n MCS0 40MHz / Ant. 0 + Ant. 1

Channel	Frequency	Power Density (dBm/100kHz)		BWCF factor (100KHz to 3KHz)	Power Density (dBm/3kHz)		Single Port Limit (dBm/3kHz)	Result
		Ant. 0	Ant. 1		Ant. 0	Ant. 1		
3	2422 MHz	-4.78	-5.26	-15.23	-20.01	-20.49	4.99	Complies
6	2437 MHz	0.65	0.06	-15.23	-14.58	-15.17	4.99	Complies
9	2452 MHz	-5.15	-5.50	-15.23	-20.38	-20.73	4.99	Complies

Note: PSD Limit = (8dBm/MHz - (10log(2))) = 4.99dBm/MHz

For 5GHz Band
Configuration IEEE 802.11n MCS0 20MHz / Ant. 2 + Ant. 3

Channel	Frequency	Power Density (dBm/100kHz)		BWCF factor (100KHz to 3KHz)	Power Density (dBm/3kHz)		Single Port Limit (dBm/3kHz)	Result
		Ant. 2	Ant. 3		Ant. 2	Ant. 3		
149	5745 MHz	7.96	7.85	-15.23	-7.27	-7.38	4.99	Complies
157	5785 MHz	7.81	7.65	-15.23	-7.42	-7.58	4.99	Complies
165	5825 MHz	7.84	7.77	-15.23	-7.39	-7.46	4.99	Complies

Note: PSD Limit = (8dBm/MHz - (10log(2))) = 4.99dBm/MHz

Configuration IEEE 802.11n MCS0 40MHz / Ant. 2 + Ant. 3

Channel	Frequency	Power Density (dBm/100kHz)		BWCF factor (100KHz to 3KHz)	Power Density (dBm/3kHz)		Single Port Limit (dBm/3kHz)	Result
		Ant. 2	Ant. 3		Ant. 2	Ant. 3		
151	5755 MHz	4.78	4.69	-15.23	-10.45	-10.54	4.99	Complies
159	5795 MHz	4.94	4.85	-15.23	-10.29	-10.38	4.99	Complies

Note: PSD Limit = (8dBm/MHz - (10log(2))) = 4.99dBm/MHz

Configuration IEEE 802.11ac MCS0 80MHz / Ant. 2 + Ant. 3

Channel	Frequency	Power Density (dBm/100kHz)		BWCF factor (100KHz to 3KHz)	Power Density (dBm/3kHz)		Single Port Limit (dBm/3kHz)	Result
		Ant. 2	Ant. 3		Ant. 2	Ant. 3		
155	5775 MHz	1.89	1.56	-15.23	-13.34	-13.67	4.99	Complies

Note: PSD Limit = (8dBm/MHz - (10log(2))) = 4.99dBm/MHz

Temperature	25°C	Humidity	56%
Test Engineer	Benson Peng	Configurations	IEEE 802.11a/b/g
Test Date	Dec. 04, 2012		

Configuration IEEE 802.11b / Ant. 0

Channel	Frequency	Power Density (dBm/100kHz)	BWCF factor (100KHz to 3KHz)	Power Density (dBm/3kHz)	Max. Limit (dBm/3kHz)	Result
1	2412 MHz	9.59	-15.23	-5.64	8.00	Complies
6	2437 MHz	12.31	-15.23	-2.92	8.00	Complies
11	2462 MHz	6.40	-15.23	-8.83	8.00	Complies

Configuration IEEE 802.11g / Ant. 0 + Ant. 1

Channel	Frequency	Power Density (dBm/100kHz)		BWCF factor (100KHz to 3KHz)	Power Density (dBm/3kHz)		Single Port Limit (dBm/3kHz)	Result
		Ant. 0	Ant. 1		Ant. 0	Ant. 1		
1	2412 MHz	1.06	-0.38	-15.23	-14.17	-15.61	4.99	Complies
6	2437 MHz	8.57	6.77	-15.23	-6.66	-8.46	4.99	Complies
11	2462 MHz	-0.78	-1.14	-15.23	-16.01	-16.37	4.99	Complies

Note: PSD Limit = $(8\text{dBm/MHz} - (10\log(2))) = 4.99\text{dBm/MHz}$

Configuration IEEE 802.11a / Ant. 2 + Ant. 3

Channel	Frequency	Power Density (dBm/100kHz)		BWCF factor (100KHz to 3KHz)	Power Density (dBm/3kHz)		Single Port Limit (dBm/3kHz)	Result
		Ant. 2	Ant. 3		Ant. 2	Ant. 3		
149	5745 MHz	8.40	7.81	-15.23	-6.83	-7.42	4.99	Complies
157	5785 MHz	8.21	7.97	-15.23	-7.02	-7.26	4.99	Complies
165	5825 MHz	8.05	7.83	-15.23	-7.18	-7.40	4.99	Complies

Note: PSD Limit = $(8\text{dBm/MHz} - (10\log(2))) = 4.99\text{dBm/MHz}$

All the test values were listed in the report.

For plots, only the channel with maximum results was shown.

Power Density Plot on Configuration IEEE 802.11n MCS0 20MHz / Ant. 0 / 2437 MHz

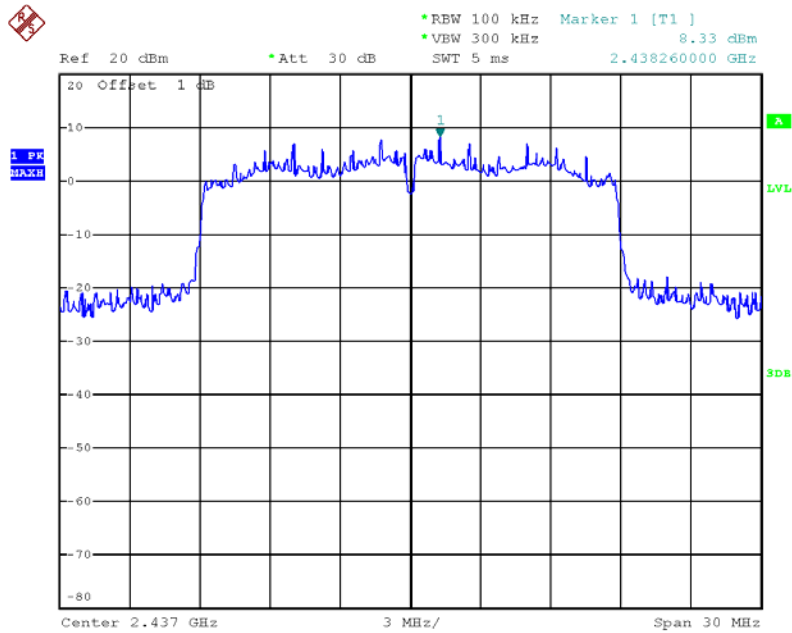

Date: 30.NOV.2012 17:24:12

Power Density Plot on Configuration IEEE 802.11n MCS0 20MHz / Ant. 1 / 2437 MHz

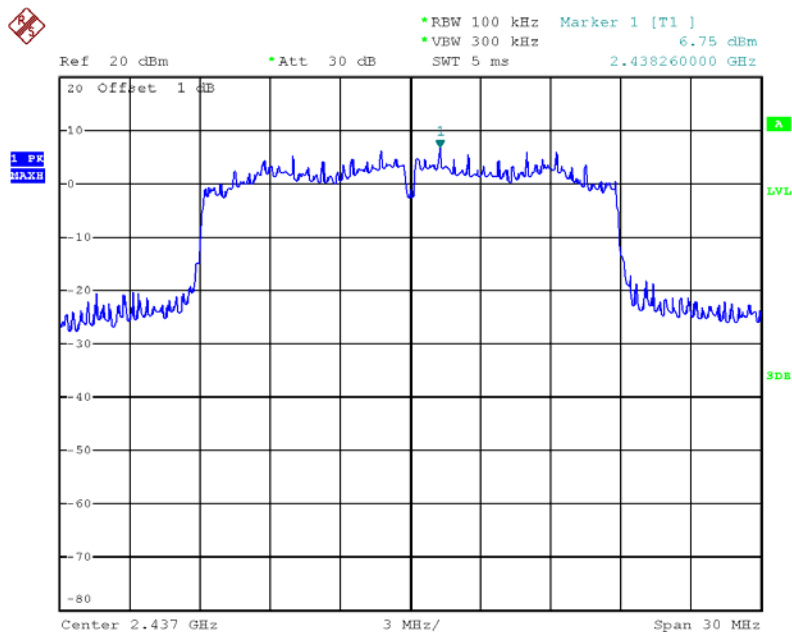

Date: 30.NOV.2012 17:31:24

Power Density Plot on Configuration IEEE 802.11n MCS0 40MHz / Ant. 0 / 2437 MHz

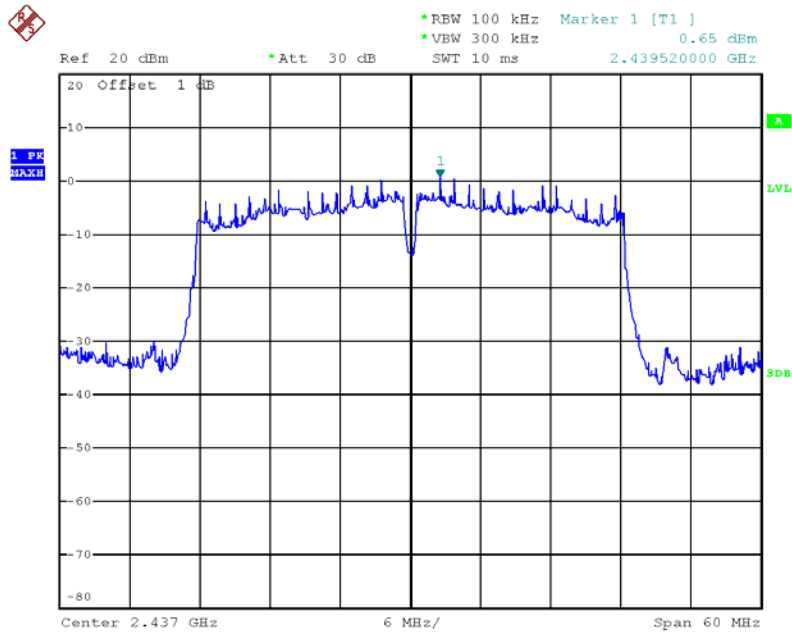

Date: 30.NOV.2012 17:26:12

Power Density Plot on Configuration IEEE 802.11n MCS0 40MHz / Ant. 1 / 2437 MHz

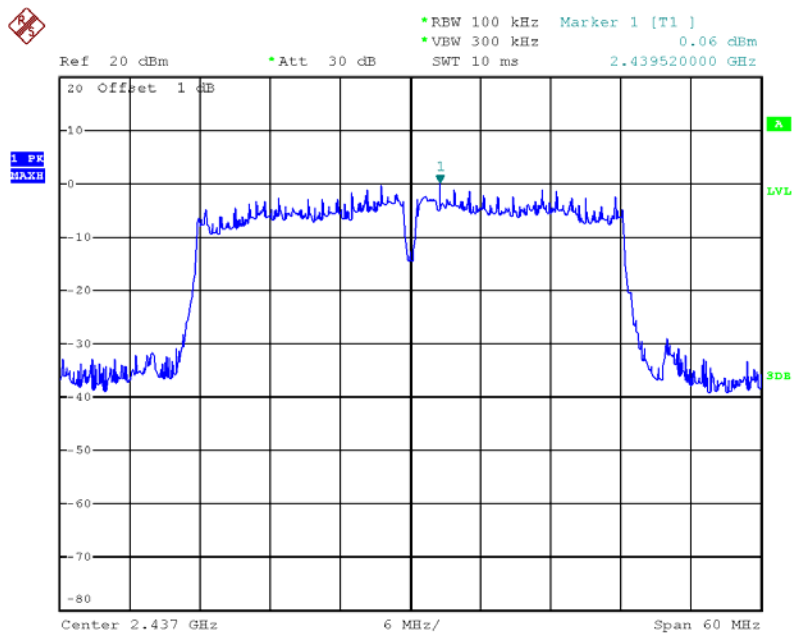

Date: 30.NOV.2012 17:29:08

Power Density Plot on Configuration IEEE 802.11n MCS0 20MHz / Ant. 2 / 5745 MHz

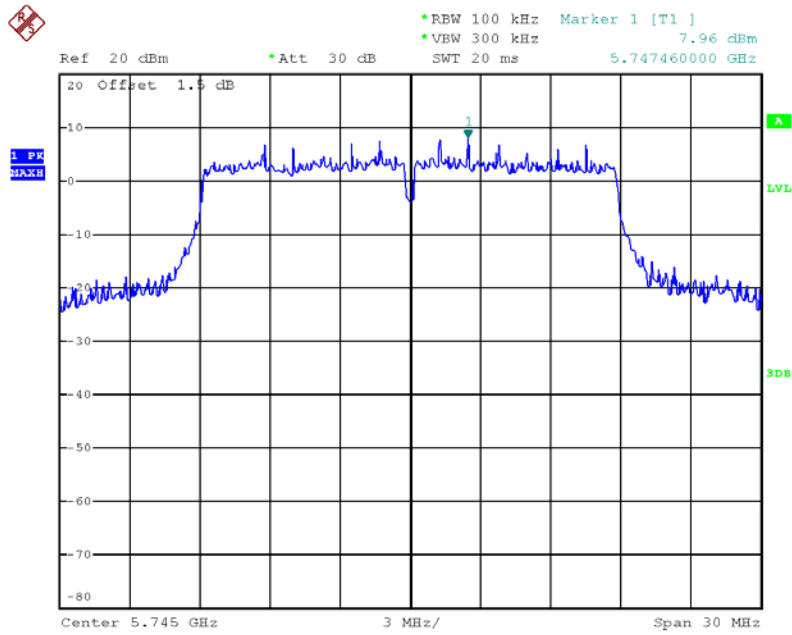

Date: 3.DEC.2012 22:22:21

Power Density Plot on Configuration IEEE 802.11n MCS0 20MHz / Ant. 3 / 5745 MHz

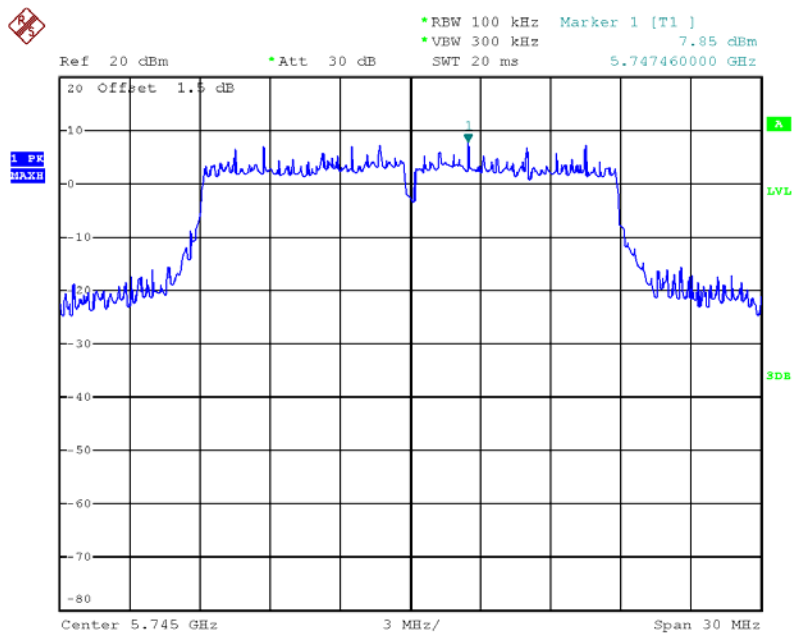

Date: 3.DEC.2012 22:28:09

Power Density Plot on Configuration IEEE 802.11n MCS0 40MHz / Ant. 2 / 5795 MHz

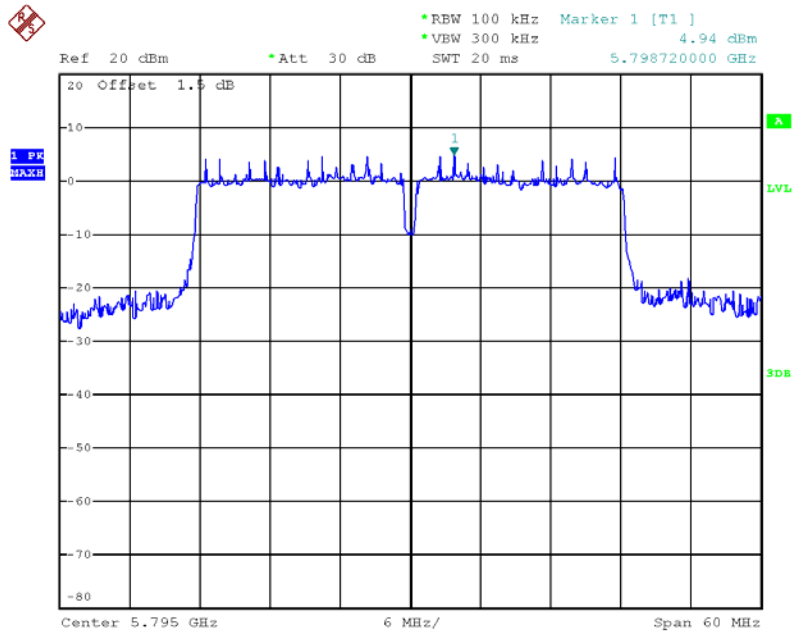

Date: 3.DEC.2012 22:24:06

Power Density Plot on Configuration IEEE 802.11n MCS0 40MHz / Ant. 3 / 5795 MHz

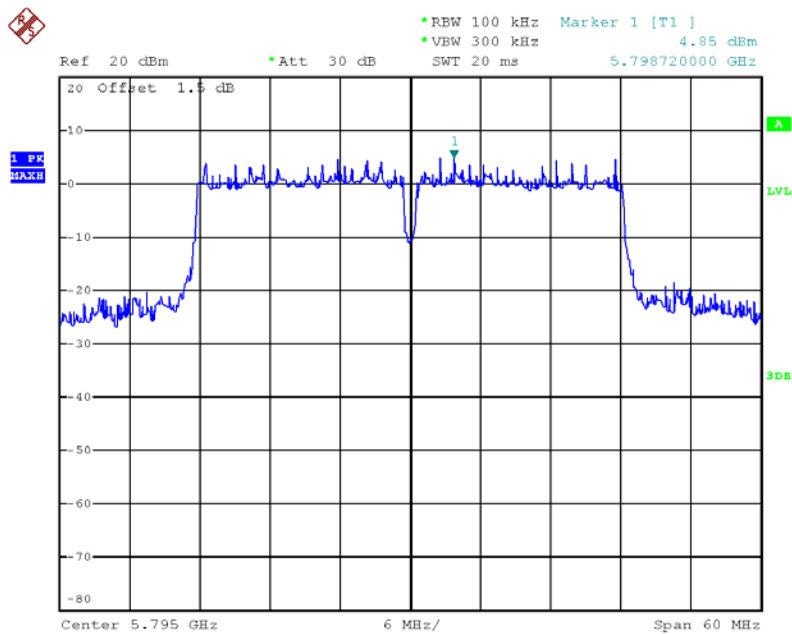

Date: 3.DEC.2012 22:27:08

Power Density Plot on Configuration IEEE 802.11ac MCS0 80MHz / Ant. 2 / 5775 MHz

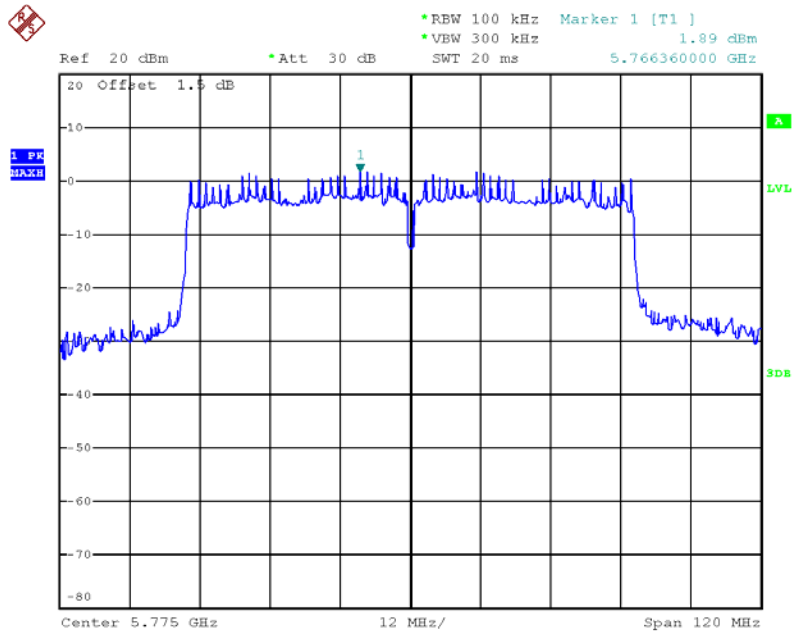

Date: 3.DEC.2012 22:25:06

Power Density Plot on Configuration IEEE 802.11ac MCS0 80MHz / Ant. 3 / 5775 MHz

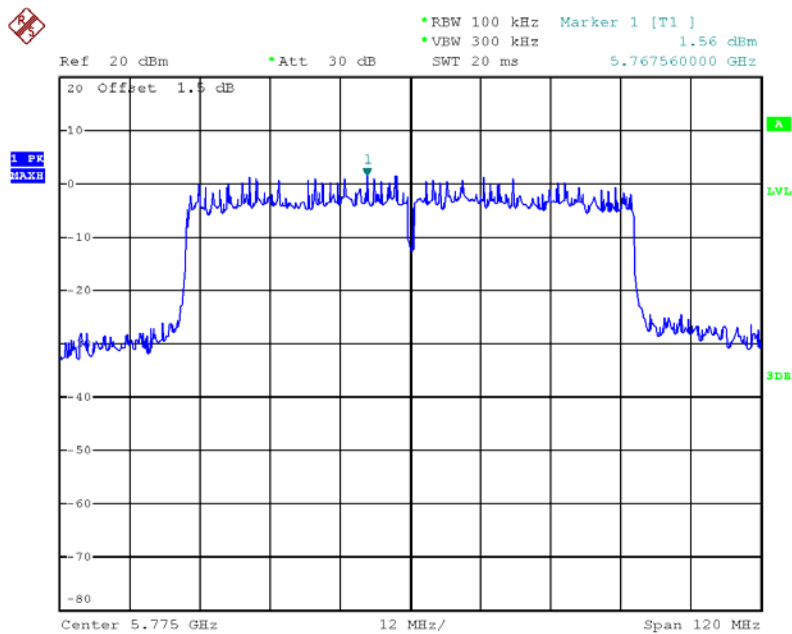

Date: 3.DEC.2012 22:25:27

Power Density Plot on Configuration IEEE 802.11b / Ant. 0 / 2437 MHz

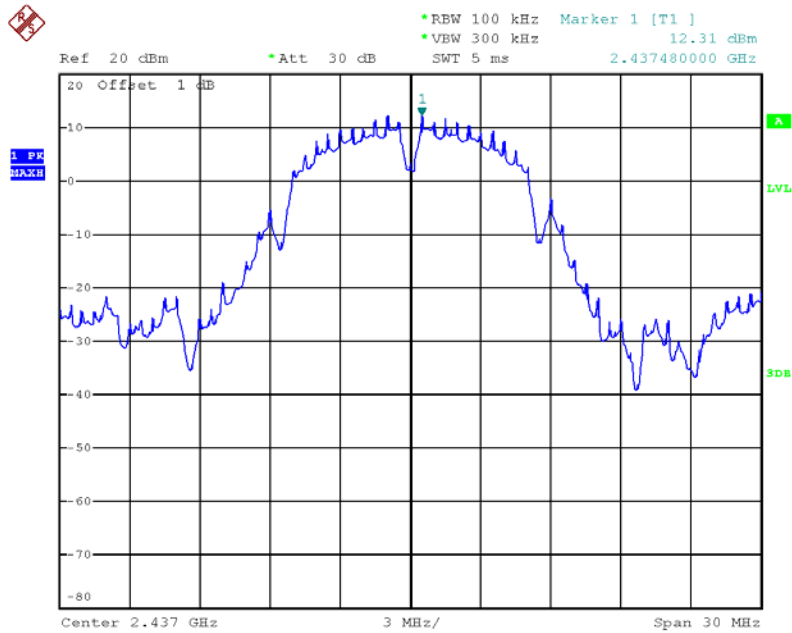

Date: 30.NOV.2012 17:19:38

Power Density Plot on Configuration IEEE 802.11g / Ant. 0 / 2437 MHz

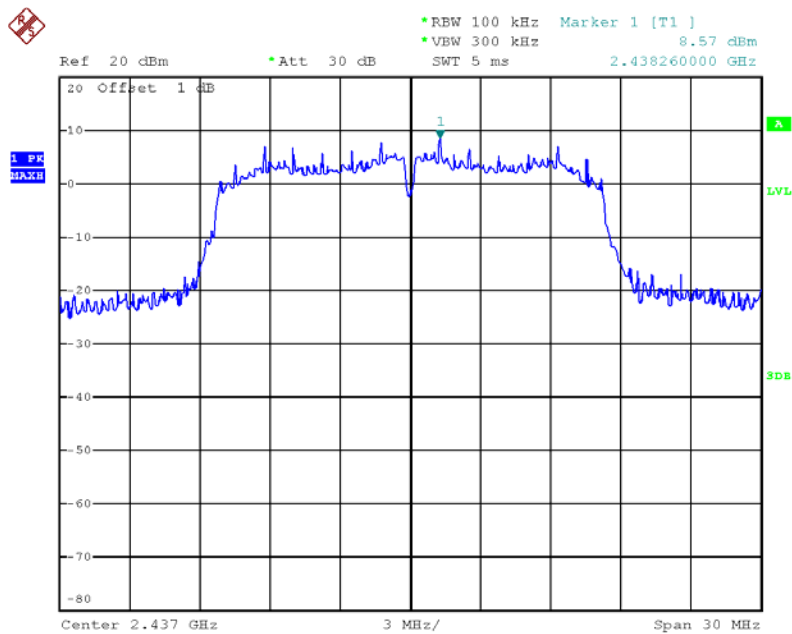

Date: 30.NOV.2012 17:21:40

Power Density Plot on Configuration IEEE 802.11g / Ant. 1 / 2437 MHz

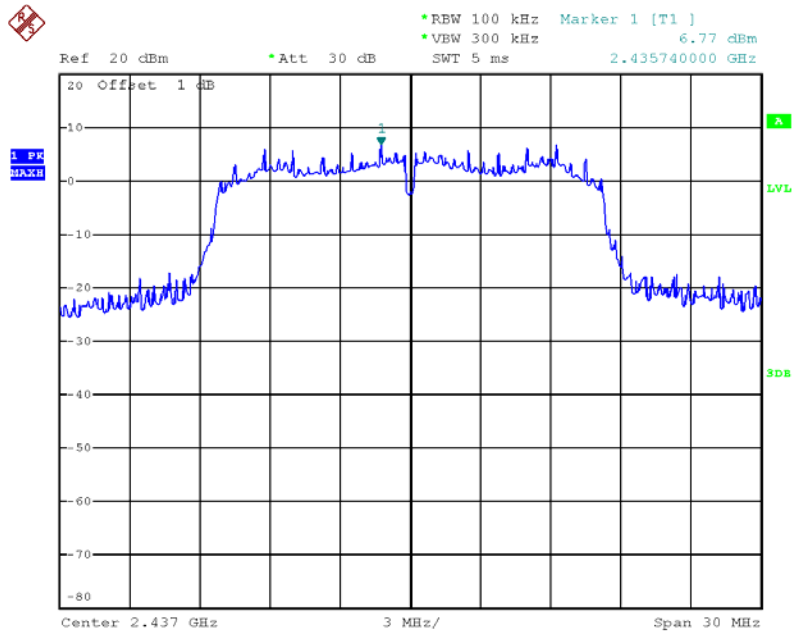

Date: 30.NOV.2012 17:33:14

Power Density Plot on Configuration IEEE 802.11a / Ant. 2 / 5745 MHz

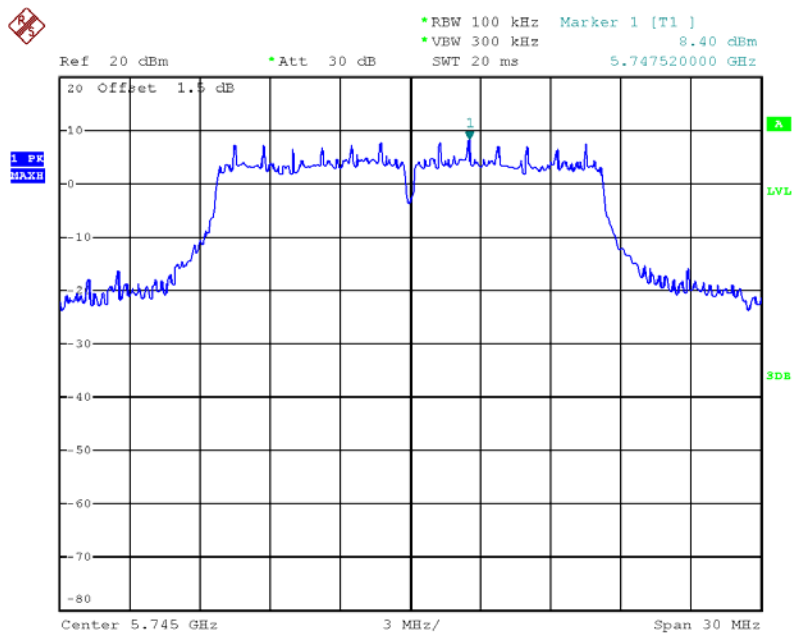

Date: 3.DEC.2012 22:19:36

Power Density Plot on Configuration IEEE 802.11a / Ant. 3 / 5785 MHz

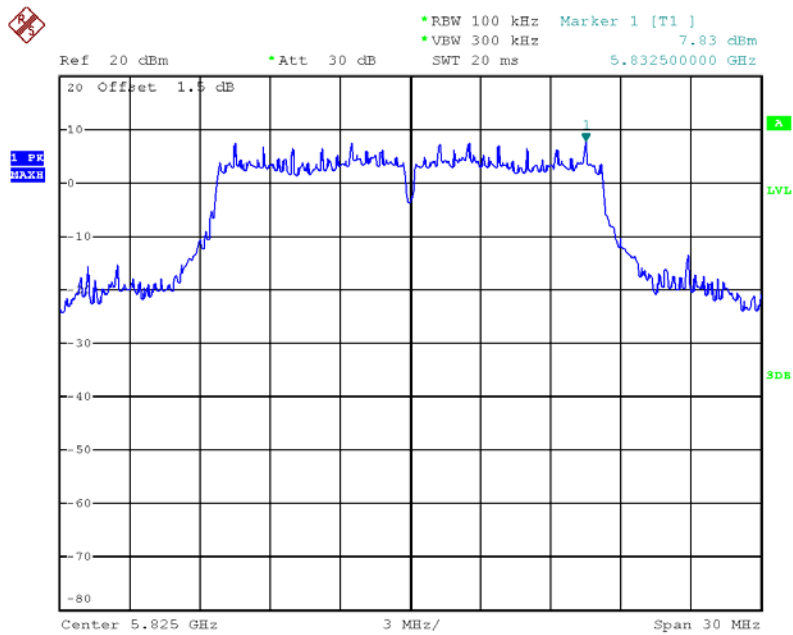

Date: 3.DEC.2012 22:30:33

4.4. 6dB Spectrum Bandwidth Measurement

4.4.1. Limit

For digital modulation systems, the minimum 6dB bandwidth shall be at least 500 kHz.

4.4.2. Measuring Instruments and Setting

Please refer to section 5 of equipments list in this report. The following table is the setting of spectrum analyzer.

Spectrum Parameters	Setting
Attenuation	Auto
Span Frequency	> 6dB Bandwidth
RB	Set resolution bandwidth (RBW) = 1-5% or DTS BW, not to exceed 100 kHz
VB	$\geq 3 \times \text{RBW}$
Detector	Peak
Trace	Max Hold
Sweep Time	Auto

4.4.3. Test Procedures

1. The transmitter output (antenna port) was connected to the spectrum analyzer in peak hold mode.
2. Test was performed in accordance with KDB 558074 Guidance for Performing Compliance Measurements on Digital Transmission Systems (DTS) Operating Under §15.247 section 5.1.1 EBW Measurement Procedure
3. Multiple antenna system was performed in accordance with KDB 662911 Emissions Testing of Transmitters with Multiple Outputs in the Same Band.
4. Measured the spectrum width with power higher than 6dB below carrier.

4.4.4. Test Setup Layout

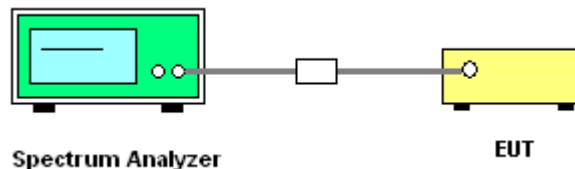

4.4.5. Test Deviation

There is no deviation with the original standard.

4.4.6. EUT Operation during Test

The EUT was programmed to be in continuously transmitting mode.



4.4.7. Test Result of 6dB Spectrum Bandwidth

Temperature	25°C	Humidity	56%
Test Engineer	Benson Peng	Configurations	IEEE 802.11n/ac
Test Date	Dec. 04, 2012		

For 2.4GHz Band

Configuration IEEE 802.11n MCS0 20MHz / Ant. 0 + Ant. 1

Channel	Frequency	6dB Bandwidth (MHz)	99% Occupied Bandwidth (MHz)	Min. Limit (kHz)	Test Result
1	2412 MHz	13.12	16.64	500	Complies
6	2437 MHz	13.20	16.80	500	Complies
11	2462 MHz	13.20	16.64	500	Complies

Configuration IEEE 802.11n MCS0 40MHz / Ant. 0 + Ant. 1

Channel	Frequency	6dB Bandwidth (MHz)	99% Occupied Bandwidth (MHz)	Min. Limit (kHz)	Test Result
3	2422 MHz	32.96	36.32	500	Complies
6	2437 MHz	35.20	36.32	500	Complies
9	2452 MHz	35.20	36.16	500	Complies

For 5GHz Band

Configuration IEEE 802.11n MCS0 20MHz / Ant. 2+ Ant. 3

Channel	Frequency	6dB Bandwidth (MHz)	99% Occupied Bandwidth (MHz)	Min. Limit (kHz)	Test Result
149	5745 MHz	16.72	17.68	500	Complies
157	5785 MHz	16.40	17.60	500	Complies
165	5825 MHz	16.16	17.68	500	Complies

Configuration IEEE 802.11n MCS0 40MHz / Ant. 2+ Ant. 3

Channel	Frequency	6dB Bandwidth (MHz)	99% Occupied Bandwidth (MHz)	Min. Limit (kHz)	Test Result
151	5755 MHz	36.16	36.32	500	Complies
159	5795 MHz	35.84	36.48	500	Complies

Configuration IEEE 802.11ac MCS0 80MHz / Ant. 2+ Ant. 3

Channel	Frequency	6dB Bandwidth (MHz)	99% Occupied Bandwidth (MHz)	Min. Limit (kHz)	Test Result
155	5775 MHz	72.96	75.84	500	Complies

Temperature	25°C	Humidity	56%
Test Engineer	Benson Peng	Configurations	IEEE 802.11a/b/g
Test Date	Dec. 04, 2012		

Configuration IEEE 802.11b / Ant. 0

Channel	Frequency	6dB Bandwidth (MHz)	99% Occupied Bandwidth (MHz)	Min. Limit (kHz)	Test Result
1	2412 MHz	8.00	10.16	500	Complies
6	2437 MHz	8.16	10.40	500	Complies
11	2462 MHz	8.00	10.08	500	Complies

Configuration IEEE 802.11g / Ant. 0+ Ant. 1

Channel	Frequency	6dB Bandwidth (MHz)	99% Occupied Bandwidth (MHz)	Min. Limit (kHz)	Test Result
1	2412 MHz	12.32	15.76	500	Complies
6	2437 MHz	12.64	16.08	500	Complies
11	2462 MHz	12.80	15.20	500	Complies

Configuration IEEE 802.11a / Ant. 2+ Ant. 3

Channel	Frequency	6dB Bandwidth (MHz)	99% Occupied Bandwidth (MHz)	Min. Limit (kHz)	Test Result
149	5745 MHz	12.32	16.48	500	Complies
157	5785 MHz	15.04	16.48	500	Complies
165	5825 MHz	12.32	16.48	500	Complies

Note: All the test values were listed in the report.

For plots, only the channel with maximum results was shown.

6 dB Bandwidth Plot on Configuration IEEE 802.11n MCS0 20MHz / Ant. 0 + Ant. 1 / 2437 MHz

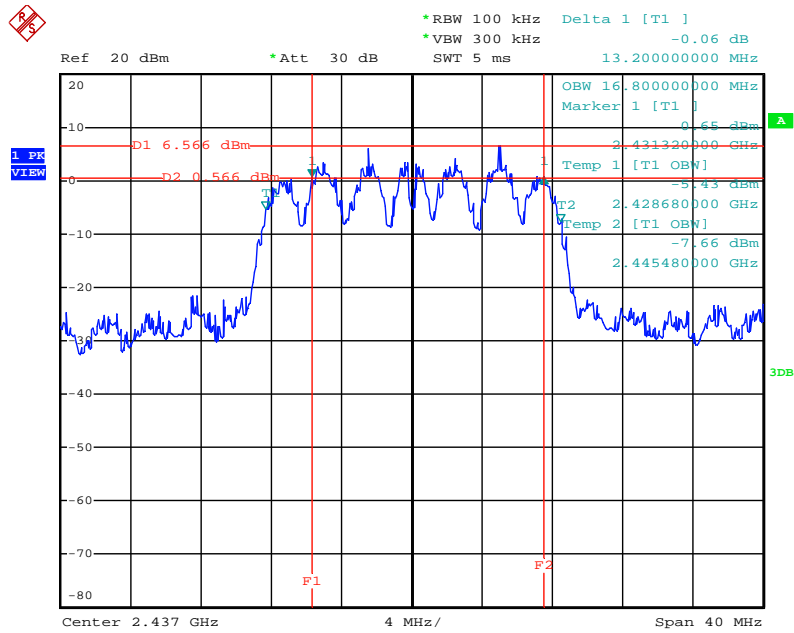

Date: 30.NOV.2012 18:05:18

6 dB Bandwidth Plot on Configuration IEEE 802.11n MCS0 40MHz / Ant. 0 + Ant. 1 / 2437 MHz

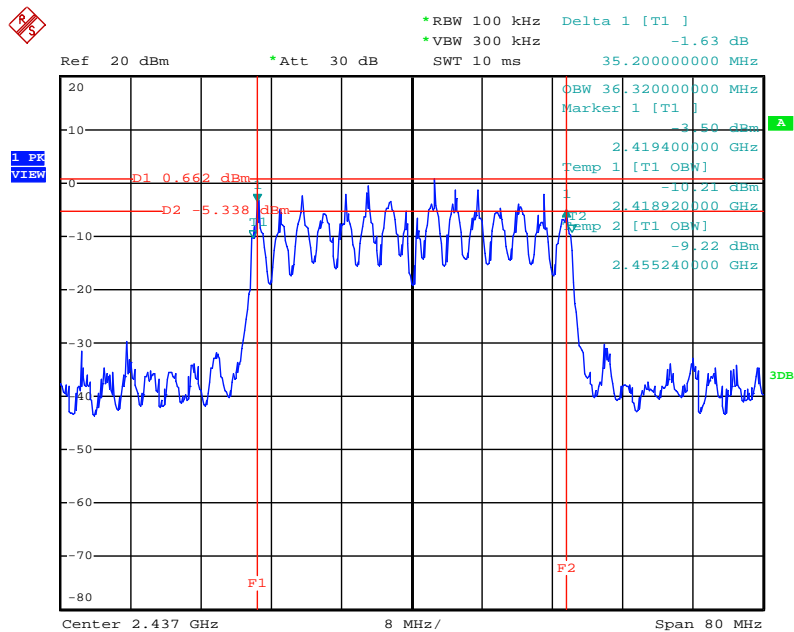

Date: 30.NOV.2012 18:07:06

6 dB Bandwidth Plot on Configuration IEEE 802.11n MCS0 20MHz / Ant. 2+ Ant. 3 / 5745 MHz

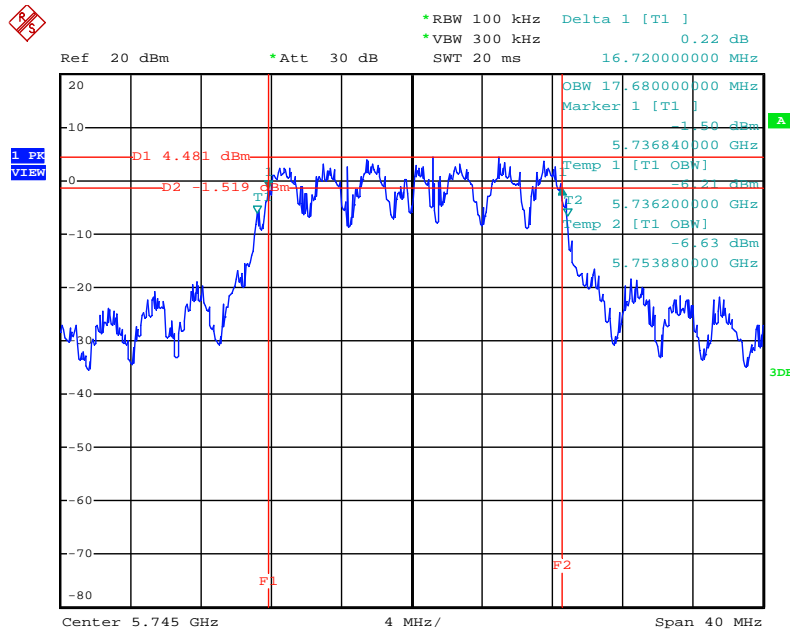

Date: 3.DEC.2012 22:50:25

6 dB Bandwidth Plot on Configuration IEEE 802.11n MCS0 40MHz / Ant. 2+ Ant. 3 / 5755 MHz

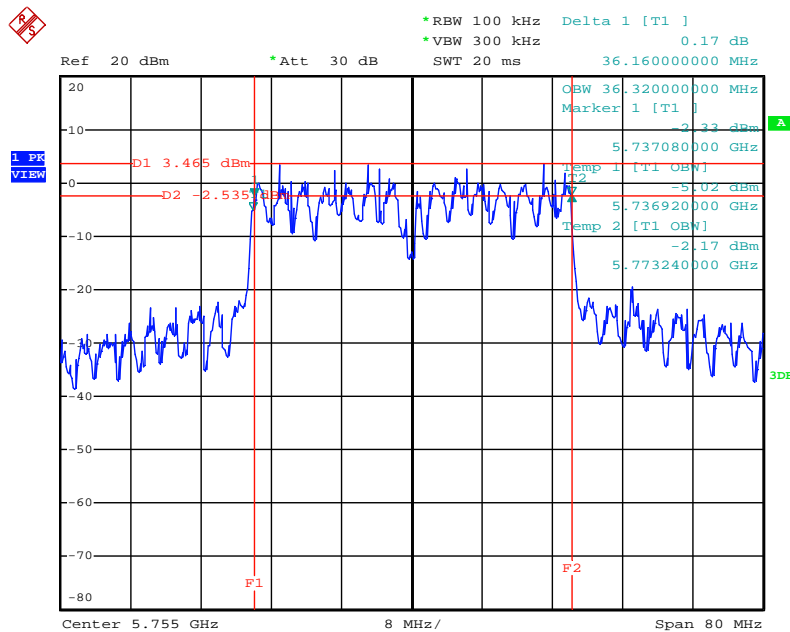

Date: 3.DEC.2012 22:50:58

6 dB Bandwidth Plot on Configuration IEEE 802.11ac MCS0 80MHz / Ant. 2+ Ant. 3 / 5755 MHz

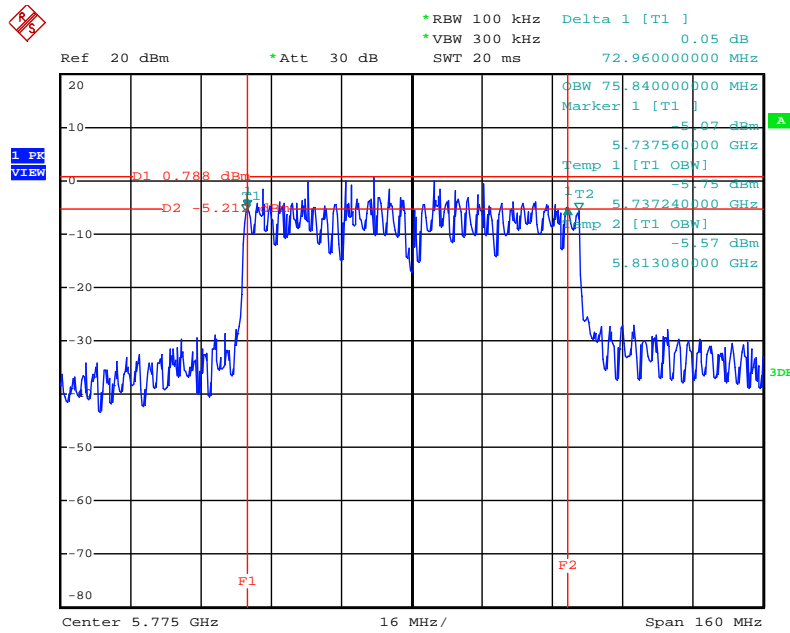

Date: 3.DEC.2012 22:53:13

6 dB Bandwidth Plot on Configuration IEEE 802.11a / Ant. 2 Ant. 3 / 5785 MHz

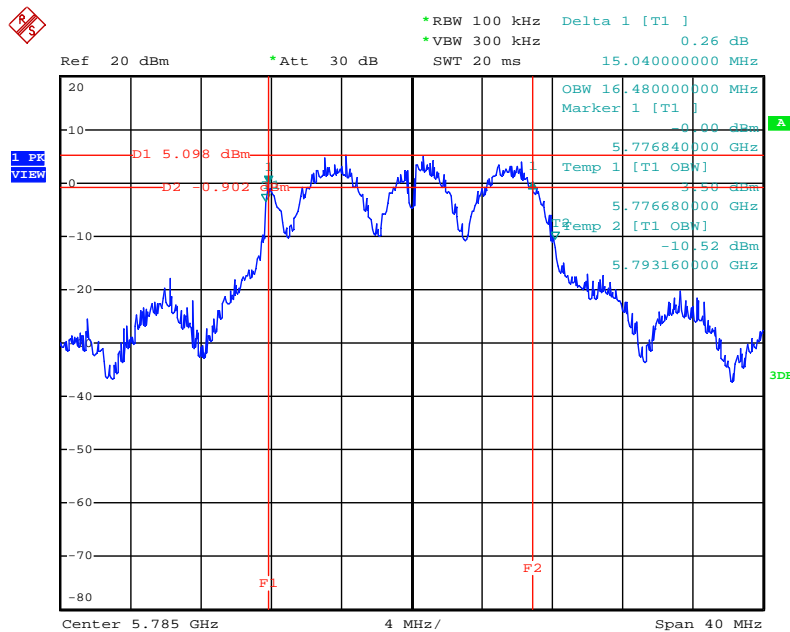

Date: 3.DEC.2012 22:48:04

6 dB Bandwidth Plot on Configuration IEEE 802.11b / Ant. 0 / 2437 MHz

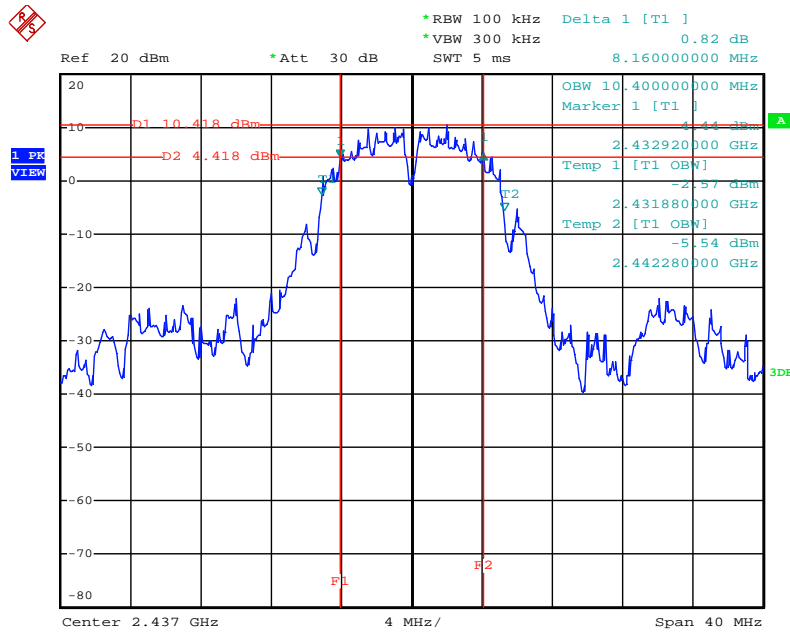

Date: 30.NOV.2012 17:55:42

6 dB Bandwidth Plot on Configuration IEEE 802.11g / Ant. 0+ Ant. 1 / 2462 MHz

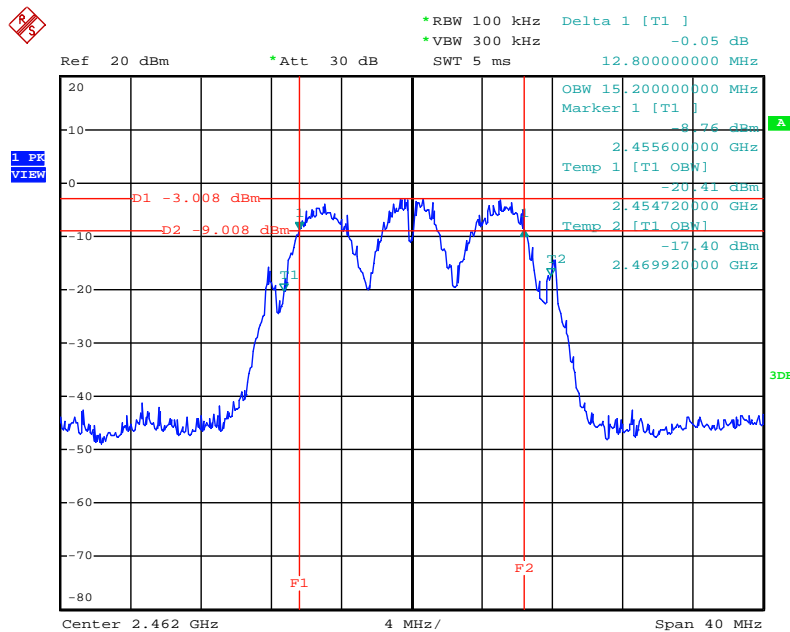

Date: 30.NOV.2012 18:04:10

4.5. Radiated Emissions Measurement

4.5.1. Limit

30dBc in any 100 kHz bandwidth outside the operating frequency band. In case the emission fall within the restricted band specified on 15.205(a), then the 15.209(a) limit in the table below has to be followed.

Frequencies (MHz)	Field Strength (micorvolts/meter)	Measurement Distance (meters)
0.009~0.490	2400/F(KHz)	300
0.490~1.705	24000/F(KHz)	30
1.705~30.0	30	30
30~88	100	3
88~216	150	3
216~960	200	3
Above 960	500	3

4.5.2. Measuring Instruments and Setting

Please refer to section 5 of equipments list in this report. The following table is the setting of spectrum analyzer and receiver.

Spectrum Parameter	Setting
Attenuation	Auto
Start Frequency	1GHz
Stop Frequency	10th carrier harmonic
RB / VB (Emission in restricted band)	1MHz / 3MHz for Peak, 1MHz / 10Hz for Average
RB / VB (Emission in non-restricted band)	1MHz / 3MHz for peak

Receiver Parameter	Setting
Attenuation	Auto
Start ~ Stop Frequency	9kHz~150kHz / RB 200Hz for QP
Start ~ Stop Frequency	150kHz~30MHz / RB 9kHz for QP
Start ~ Stop Frequency	30MHz~1GHz / RB 120kHz for QP

4.5.3. Test Procedures

1. Configure the EUT according to ANSI C63.10. The EUT was placed on the top of the turntable 0.8 meter above ground. The phase center of the receiving antenna mounted on the top of a height-variable antenna tower was placed 3 meters far away from the turntable.
2. Power on the EUT and all the supporting units. The turntable was rotated by 360 degrees to determine the position of the highest radiation.
3. The height of the broadband receiving antenna was varied between one meter and four meters above ground to find the maximum emissions field strength of both horizontal and vertical polarization.
4. For each suspected emissions, the antenna tower was scan (from 1 M to 4 M) and then the turntable was rotated (from 0 degree to 360 degrees) to find the maximum reading.
5. Set the test-receiver system to Peak or CISPR quasi-peak Detect Function with specified bandwidth under Maximum Hold Mode.
6. For emissions above 1GHz, use 1MHz VBW and 3MHz RBW for peak reading. Then 1MHz RBW and 10Hz VBW for average reading in spectrum analyzer.
7. When the radiated emissions limits are expressed in terms of the average value of the emissions, and pulsed operation is employed, the measurement field strength shall be determined by averaging over one complete pulse train, including blanking intervals, as long as the pulse train does not exceed 0.1 seconds. As an alternative (provided the transmitter operates for longer than 0.1 seconds) or in cases where the pulse train exceeds 0.1 seconds, the measured field strength shall be determined from the average absolute voltage during a 0.1 second interval during which the field strength is at its maximum value.
8. If the emissions level of the EUT in peak mode was 3 dB lower than the average limit specified, then testing will be stopped and peak values of EUT will be reported, otherwise, the emissions which do not have 3 dB margin will be repeated one by one using the quasi-peak method for below 1GHz.
9. For testing above 1GHz, the emissions level of the EUT in peak mode was lower than average limit (that means the emissions level in peak mode also complies with the limit in average mode), then testing will be stopped and peak values of EUT will be reported, otherwise, the emissions will be measured in average mode again and reported.
10. In case the emission is lower than 30MHz, loop antenna has to be used for measurement and the recorded data should be QP measured by receiver. High – Low scan is not required in this case.

4.5.4. Test Setup Layout

For radiated emissions below 1GHz

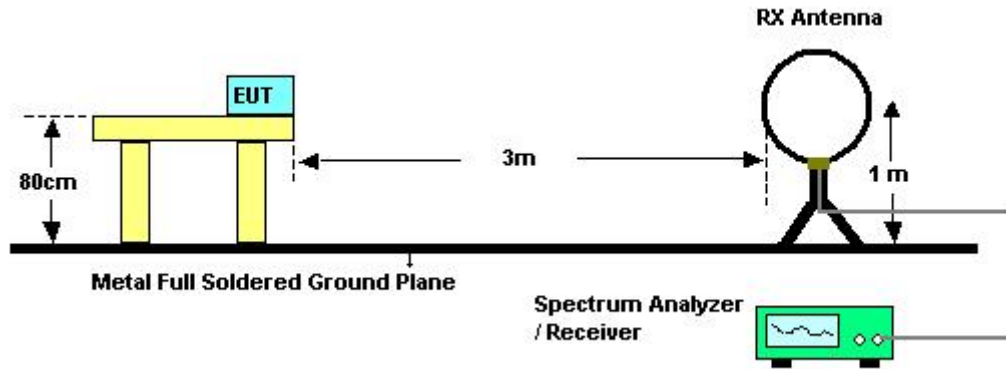

For radiated emissions above 1GHz

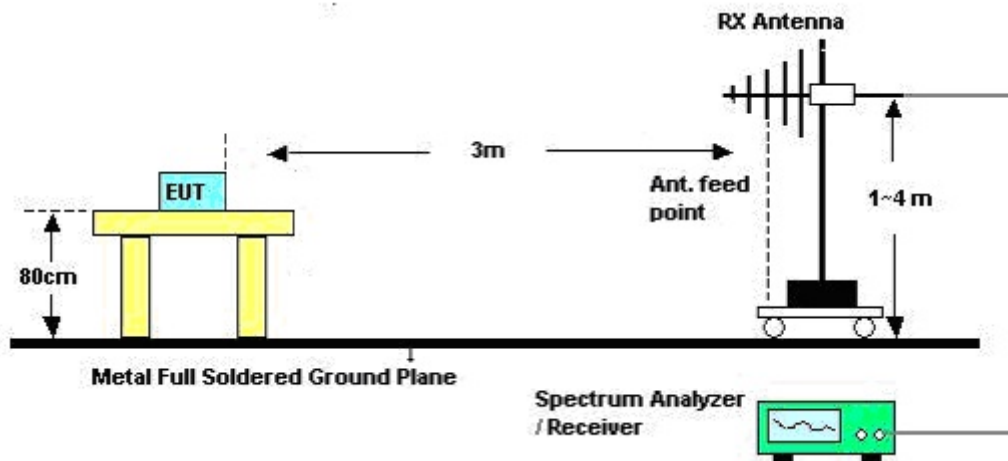

4.5.5. Test Deviation

There is no deviation with the original standard.

4.5.6. EUT Operation during Test

The EUT was programmed to be in continuously transmitting mode.

4.5.7. Results of Radiated Emissions (9kHz~30MHz)

Temperature	24.5°C	Humidity	57%
Test Engineer	Wen Chao	Configurations	Normal Link
Test Date	Dec. 04, 2012		

Freq. (MHz)	Level (dBuV)	Over Limit (dB)	Limit Line (dBuV)	Remark
-	-	-	-	See Note

Note:

The amplitude of spurious emissions that are attenuated by more than 20 dB below the permissible value has no need to be reported.

Distance extrapolation factor = $40 \log (\text{specific distance} / \text{test distance})$ (dB);

Limit line = specific limits (dBuV) + distance extrapolation factor.

4.5.8. Results of Radiated Emissions (30MHz~1GHz)

Temperature	24.5°C	Humidity	57%
Test Engineer	Wen Chao	Configurations	Normal Link / Mode 1. Adapter 1 (APD WA-24E12FU)

Horizontal

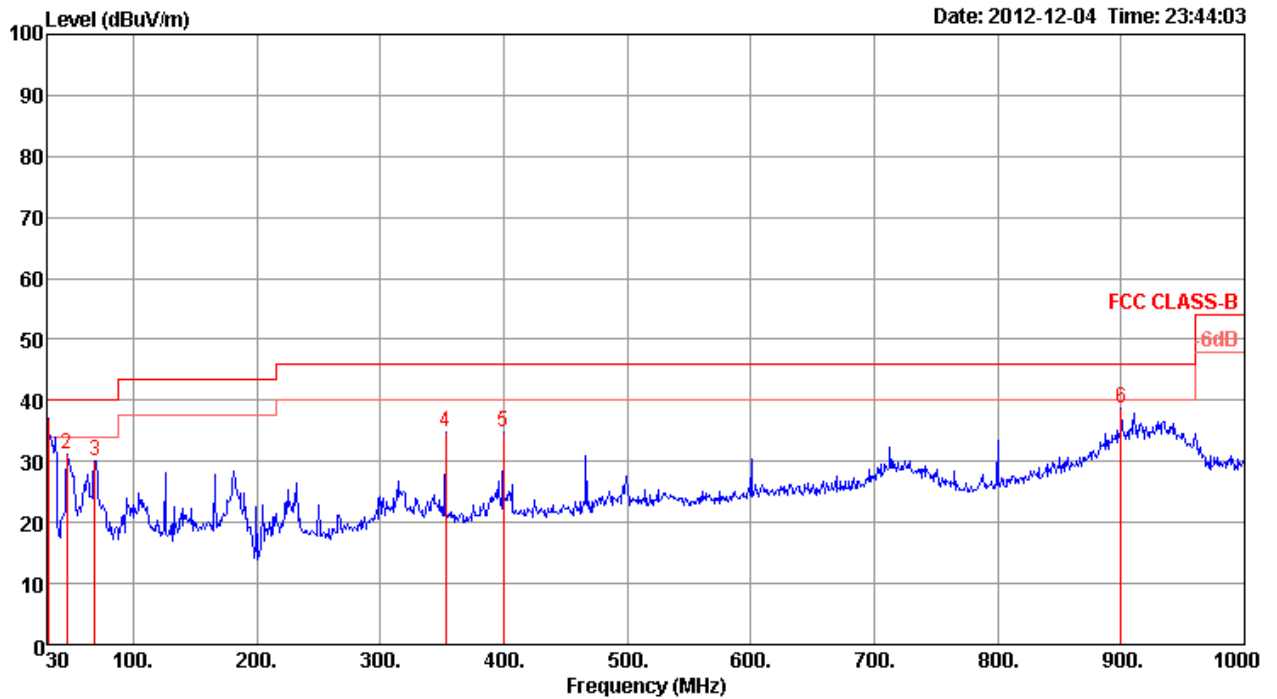

	Freq	Level	Limit	Over	Read	Cable	Antenna	Preamp	Remark	A/Pos	T/Pos	Pol/Phase
	MHz	dBuV/m	dBuV/m	dB	dBuV	dB	dB/m	dB		cm	deg	
1	30.97	37.00	40.00	-3.00	46.08	0.50	18.22	27.80	Peak	100	0	HORIZONTAL
2	46.49	31.07	40.00	-8.93	48.45	0.70	9.72	27.80	Peak	100	0	HORIZONTAL
3	68.80	30.13	40.00	-9.87	50.39	0.82	6.65	27.73	Peak	100	0	HORIZONTAL
4	353.01	34.72	46.00	-11.28	44.98	2.21	14.80	27.27	Peak	100	0	HORIZONTAL
5	399.57	34.93	46.00	-11.07	44.17	2.30	16.06	27.60	Peak	100	0	HORIZONTAL
6	900.09	38.60	46.00	-7.40	41.87	3.60	20.53	27.40	Peak	100	0	HORIZONTAL

Vertical

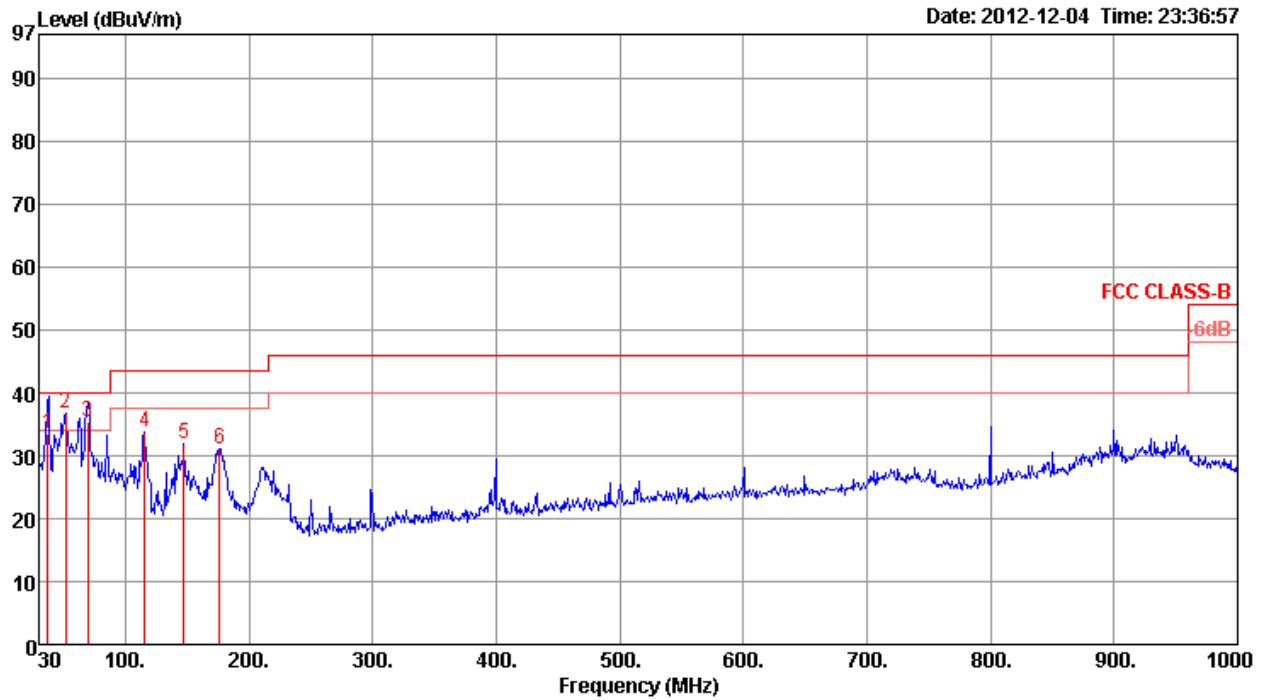

	Freq	Level	Limit	Over	Read	CableAntenna	Preamp		A/Pos	T/Pos	Pol/Phase
	MHz	dBuV/m	dBuV/m	dB	dBuV	dB	dB/m	dB	cm	deg	
1	37.54	33.62	40.00	-6.38	46.50	0.62	14.30	27.80	153	274	VERTICAL
2	51.34	36.66	40.00	-3.34	55.38	0.72	8.35	27.79	400	0	VERTICAL
3	69.53	35.32	40.00	-4.68	55.60	0.80	6.64	27.72	134	176	VERTICAL
4	115.36	33.71	43.50	-9.79	47.87	1.20	12.16	27.52	400	0	VERTICAL
5	147.37	31.87	43.50	-11.63	45.80	1.44	11.99	27.36	400	0	VERTICAL
6	176.47	31.02	43.50	-12.48	43.53	1.58	13.13	27.22	400	0	VERTICAL

Note:

The amplitude of spurious emissions that are attenuated by more than 20dB below the permissible value has no need to be reported.

Emission level (dBuV/m) = 20 log Emission level (uV/m).

Corrected Reading: Antenna Factor + Cable Loss + Read Level - Preamp Factor = Level.

Temperature	24.5°C	Humidity	57%
Test Engineer	Wen Chao	Configurations	Normal Link / Mode 2. Adapter 2 (HON-KWANG HK-AX-120A200-US)

Horizontal

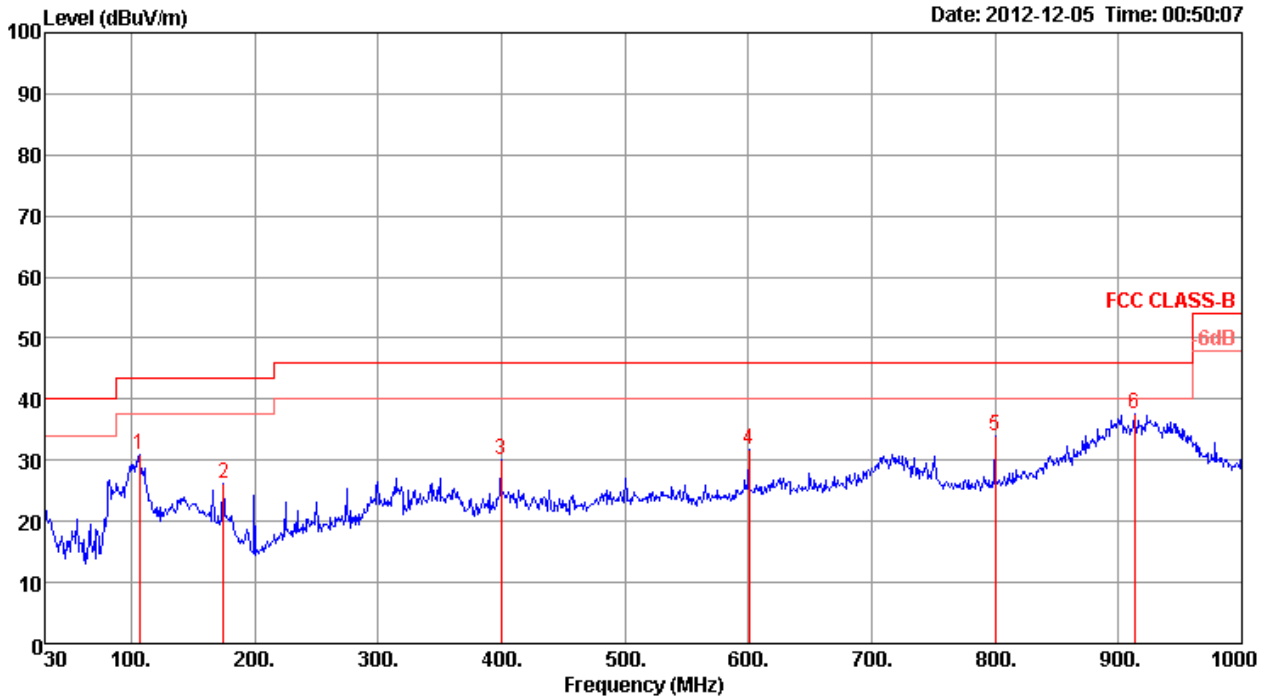

	Freq	Level	Limit	Over	Read	CableAntenna	Preamp	Remark	A/Pos	T/Pos	Pol/Phase
	MHz	dBuV/m	dBuV/m	dB	dBuV	dB	dB/m	dB	cm	deg	
1	106.63	30.79	43.50	-12.71	45.66	1.20	11.50	27.57 Peak	100	0	HORIZONTAL
2	174.53	26.10	43.50	-17.40	38.64	1.57	13.12	27.23 Peak	100	0	HORIZONTAL
3	399.57	30.10	46.00	-15.90	39.34	2.30	16.06	27.60 Peak	100	0	HORIZONTAL
4	600.36	31.63	46.00	-14.37	38.06	2.90	18.77	28.10 Peak	100	0	HORIZONTAL
5	800.18	33.94	46.00	-12.06	38.47	3.30	19.77	27.60 Peak	100	0	HORIZONTAL
6	912.70	37.71	46.00	-8.29	40.83	3.60	20.63	27.35 Peak	100	0	HORIZONTAL

Vertical

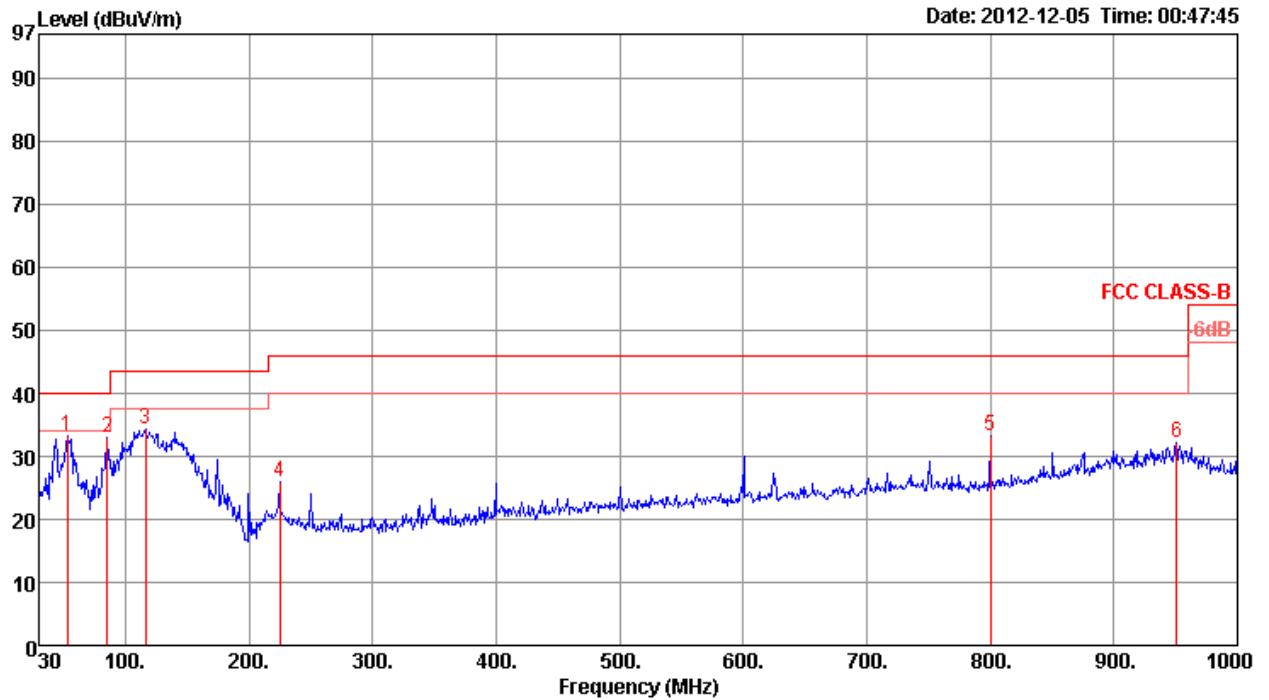

	Freq	Level	Limit	Over	Read	CableAntenna	Preamp		A/Pos	T/Pos	
	MHz	dBuV/m	dBuV/m	Limit	Level	Loss	Factor	Factor	Remark	cm	deg
				dB	dBuV	dB	dB/m	dB			
1	53.28	33.17	40.00	-6.83	52.20	0.76	8.00	27.79	Peak	400	0 VERTICAL
2	85.29	33.05	40.00	-6.95	51.54	1.10	8.07	27.66	Peak	400	0 VERTICAL
3	116.33	34.20	43.50	-9.30	48.28	1.20	12.24	27.52	Peak	400	0 VERTICAL
4	224.97	25.91	46.00	-20.09	40.25	1.80	10.91	27.05	Peak	400	0 VERTICAL
5	800.18	33.22	46.00	-12.78	37.75	3.30	19.77	27.60	Peak	400	0 VERTICAL
6	950.53	32.19	46.00	-13.81	34.88	3.60	20.91	27.20	Peak	400	0 VERTICAL

Note:

The amplitude of spurious emissions that are attenuated by more than 20dB below the permissible value has no need to be reported.

Emission level (dBuV/m) = 20 log Emission level (uV/m).

Corrected Reading: Antenna Factor + Cable Loss + Read Level - Preamp Factor = Level.

Temperature	23°C	Humidity	54%
Test Engineer	Wen Chao	Configurations	Normal Link / Mode 3. Adapter 3(HON-KWANG HK-AX-120A200-CP)

Horizontal

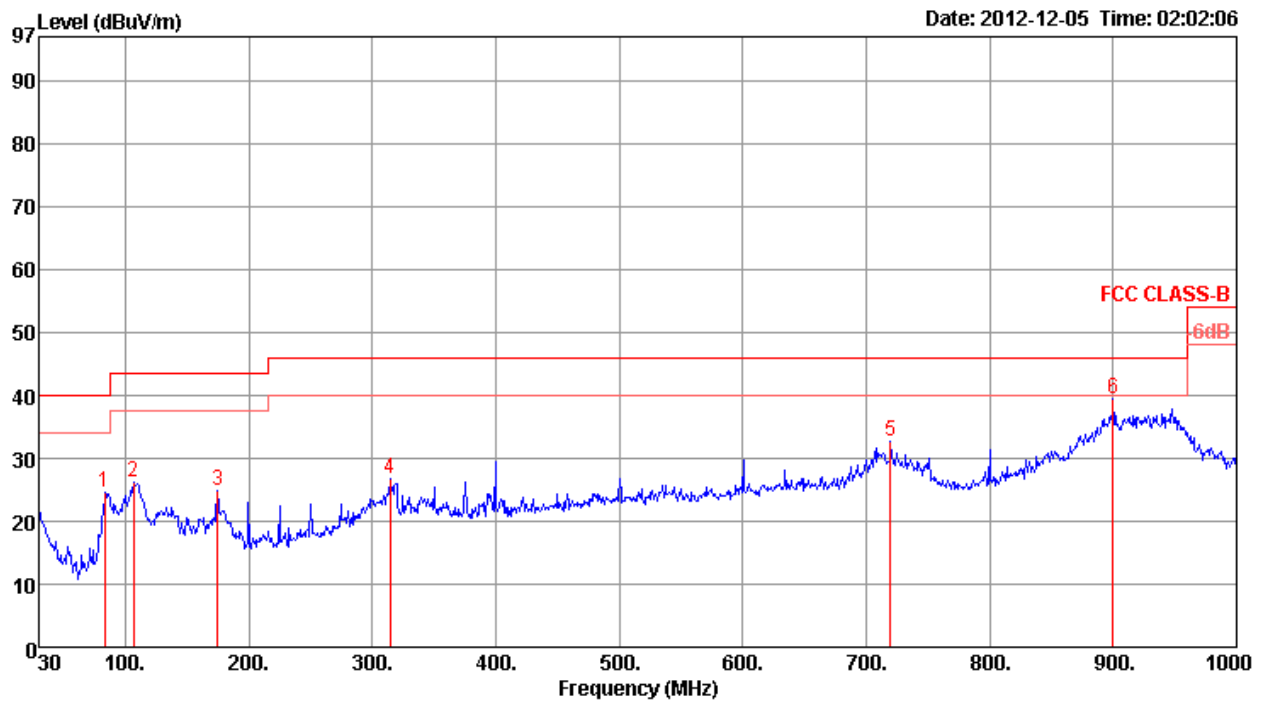

	Freq	Level	Limit	Over	Read	CableAntenna	Preamp	Remark	A/Pos	T/Pos	Pol/Phase
	MHz	dBuV/m	dBuV/m	dB	dBuV	dB	dB/m	dB	cm	deg	
1	83.35	24.52	40.00	-15.48	43.38	1.10	7.71	27.67 Peak	100	0	HORIZONTAL
2	106.63	26.08	43.50	-17.42	40.95	1.20	11.50	27.57 Peak	100	0	HORIZONTAL
3	174.53	24.81	43.50	-18.69	37.35	1.57	13.12	27.23 Peak	100	0	HORIZONTAL
4	314.21	26.85	46.00	-19.15	37.97	2.13	13.75	27.00 Peak	100	0	HORIZONTAL
5	719.67	32.80	46.00	-13.20	38.12	3.38	19.22	27.92 Peak	100	0	HORIZONTAL
6	900.09	39.50	46.00	-6.50	42.77	3.60	20.53	27.40 Peak	100	0	HORIZONTAL

Vertical

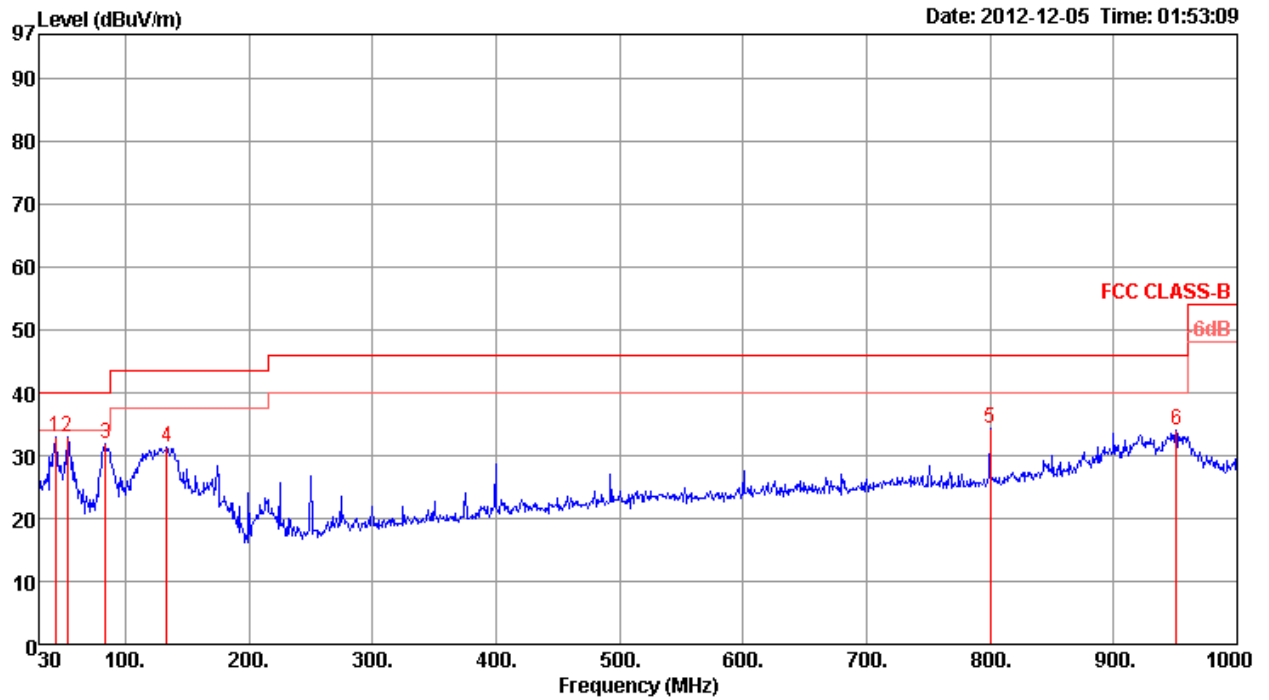

	Freq	Level	Limit	Over	Read	CableAntenna	Preamp		A/Pos	T/Pos	Pol/Phase
	MHz	dBuV/m	dBuV/m	dB	dBuV	dB	dB/m	dB	cm	deg	
1	43.58	32.96	40.00	-7.04	49.18	0.70	10.88	27.80	Peak	400	0 VERTICAL
2	53.28	33.10	40.00	-6.90	52.13	0.76	8.00	27.79	Peak	400	0 VERTICAL
3	84.32	31.77	40.00	-8.23	50.44	1.10	7.89	27.66	Peak	400	0 VERTICAL
4	133.79	31.36	43.50	-12.14	45.16	1.34	12.29	27.43	Peak	400	0 VERTICAL
5	800.18	34.29	46.00	-11.71	38.82	3.30	19.77	27.60	Peak	400	0 VERTICAL
6	950.53	34.11	46.00	-11.89	36.80	3.60	20.91	27.20	Peak	400	0 VERTICAL

Note:

The amplitude of spurious emissions that are attenuated by more than 20dB below the permissible value has no need to be reported.

Emission level (dBuV/m) = 20 log Emission level (uV/m).

Corrected Reading: Antenna Factor + Cable Loss + Read Level - Preamp Factor = Level.

Temperature	23°C	Humidity	54%
Test Engineer	Wen Chao	Configurations	Normal Link / Mode 4. Adapter 4 (SOLYTECH CAD2412)

Horizontal

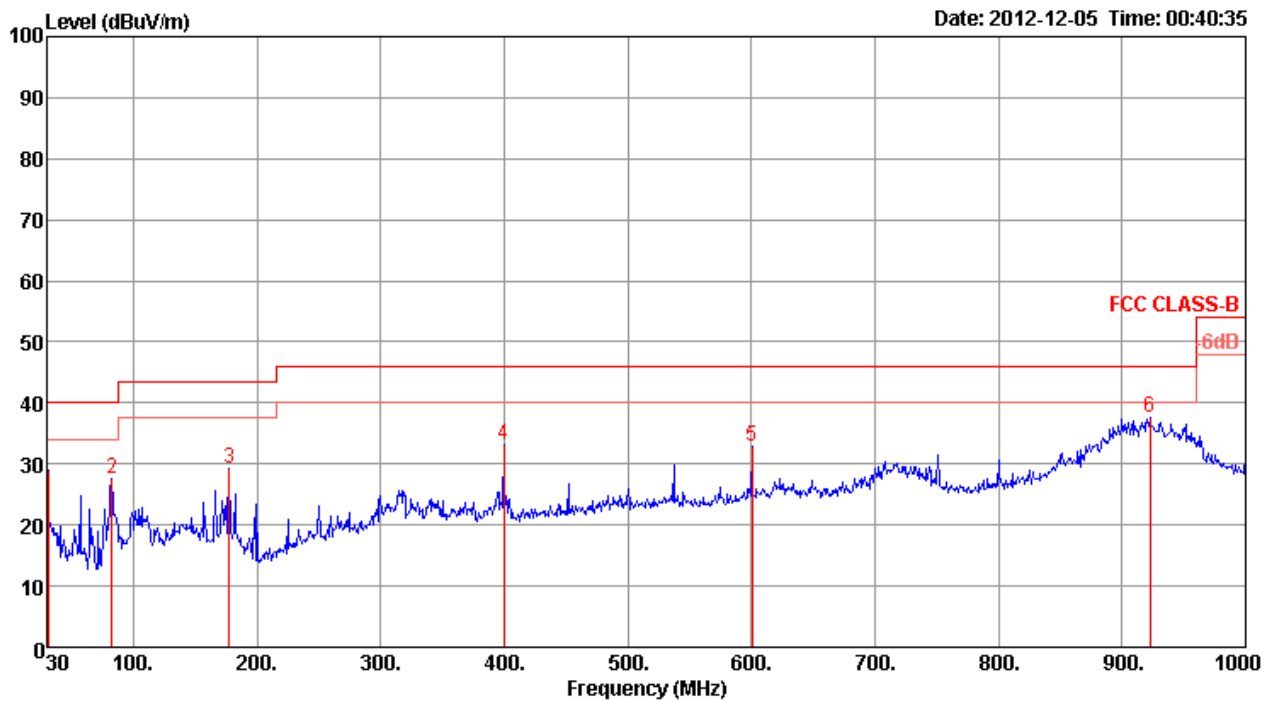

	Freq	Level	Limit	Over	Read	CableAntenna	Preamp	Remark	A/Pos	T/Pos	Pol/Phase
	MHz	dBuV/m	dBuV/m	dB	dBuV	dB	dB/m	dB	cm	deg	
1	30.97	28.88	40.00	-11.12	37.96	0.50	18.22	27.80 Peak	100	0	HORIZONTAL
2	82.38	27.52	40.00	-12.48	46.56	1.10	7.53	27.67 Peak	100	0	HORIZONTAL
3	177.44	29.24	43.50	-14.26	41.73	1.59	13.13	27.21 Peak	100	0	HORIZONTAL
4	399.57	33.28	46.00	-12.72	42.52	2.30	16.06	27.60 Peak	100	0	HORIZONTAL
5	600.36	32.76	46.00	-13.24	39.19	2.90	18.77	28.10 Peak	100	0	HORIZONTAL
6	922.40	37.58	46.00	-8.42	40.59	3.60	20.70	27.31 Peak	100	0	HORIZONTAL

Vertical

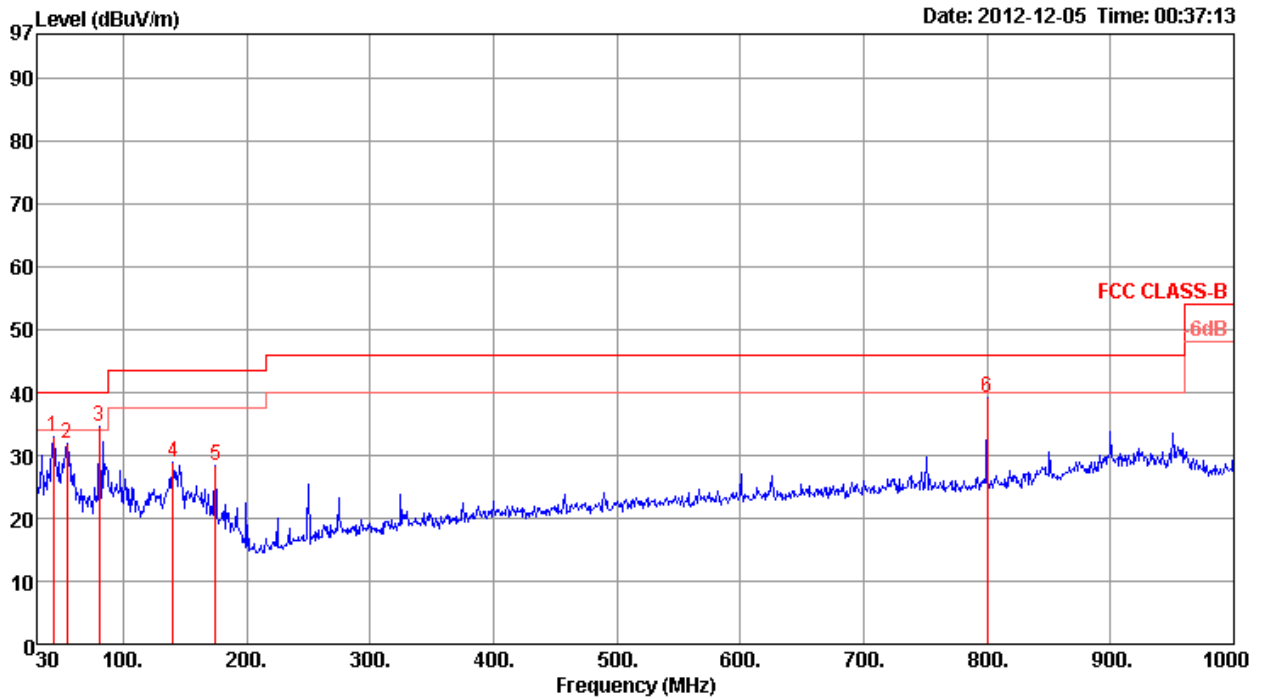

	Freq	Level	Limit Line	Over Limit	Read Level	CableAntenna Loss	Antenna Factor	Preamp Factor	Remark	A/Pos	T/Pos	Pol/Phase
	MHz	dBuV/m	dBuV/m	dB	dBuV	dB	dB/m	dB		cm	deg	
1	43.58	32.89	40.00	-7.11	49.11	0.70	10.88	27.80	Peak	400	0	VERTICAL
2	54.25	31.78	40.00	-8.22	50.95	0.78	7.83	27.78	Peak	400	0	VERTICAL
3	80.44	34.49	40.00	-5.51	53.90	1.10	7.17	27.68	Peak	400	0	VERTICAL
4	140.58	28.95	43.50	-14.55	42.64	1.40	12.30	27.39	Peak	400	0	VERTICAL
5	174.53	28.41	43.50	-15.09	40.95	1.57	13.12	27.23	Peak	400	0	VERTICAL
6	800.18	39.21	46.00	-6.79	43.74	3.30	19.77	27.60	Peak	400	0	VERTICAL

Note:

The amplitude of spurious emissions that are attenuated by more than 20dB below the permissible value has no need to be reported.

Emission level (dBuV/m) = 20 log Emission level (uV/m).

Corrected Reading: Antenna Factor + Cable Loss + Read Level - Preamp Factor = Level.

Temperature	23°C	Humidity	54%
Test Engineer	Wen Chao	Configurations	Normal Link / Mode 5. Adapter 5 (LEI MU24-S120200-A1)

Horizontal

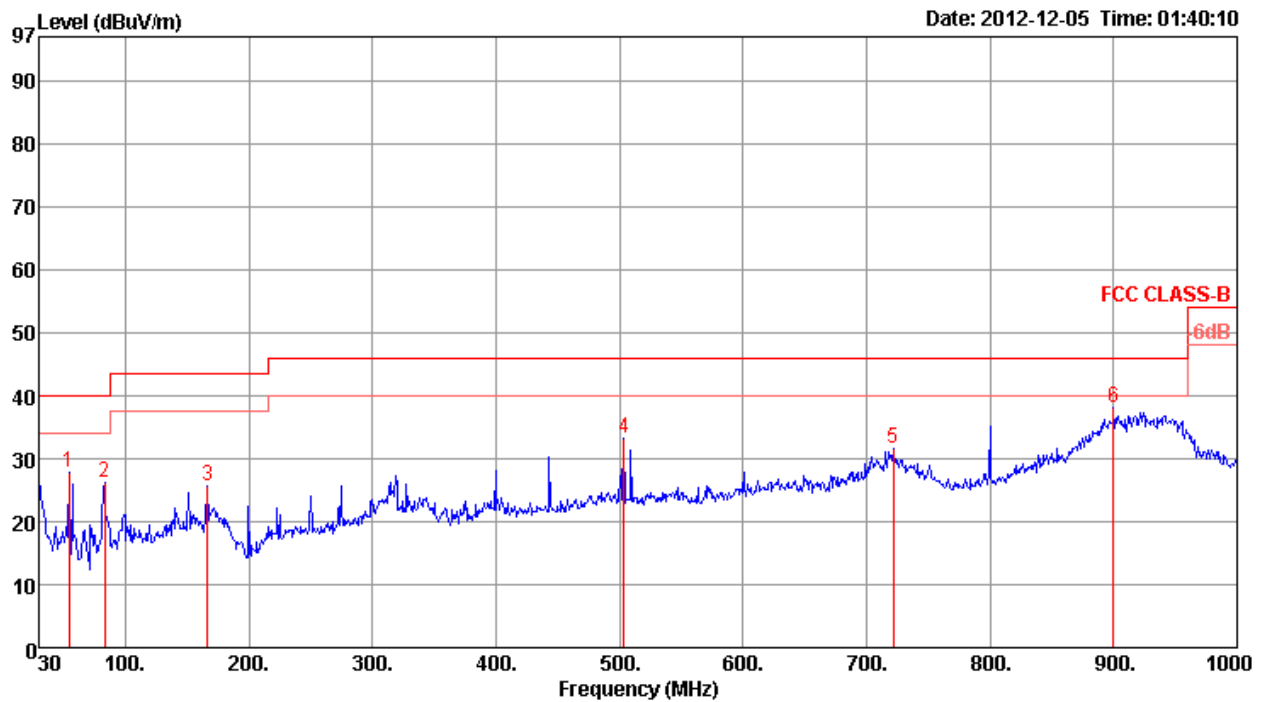

	Freq	Level	Limit	Over	Read	CableAntenna	Preamp	Remark	A/Pos	T/Pos	Pol/Phase
	MHz	dBuV/m	dBuV/m	dB	dBuV	dB	dB/m	dB	cm	deg	
1	54.25	27.71	40.00	-12.29	46.88	0.78	7.83	27.78 Peak	100	0	HORIZONTAL
2	83.35	26.16	40.00	-13.84	45.02	1.10	7.71	27.67 Peak	100	0	HORIZONTAL
3	166.77	25.74	43.50	-17.76	38.94	1.53	12.54	27.27 Peak	100	0	HORIZONTAL
4	503.36	33.36	46.00	-12.64	41.09	2.71	17.66	28.10 Peak	100	0	HORIZONTAL
5	721.61	31.54	46.00	-14.46	36.82	3.39	19.24	27.91 Peak	100	0	HORIZONTAL
6	900.09	38.09	46.00	-7.91	41.36	3.60	20.53	27.40 Peak	100	0	HORIZONTAL

Vertical

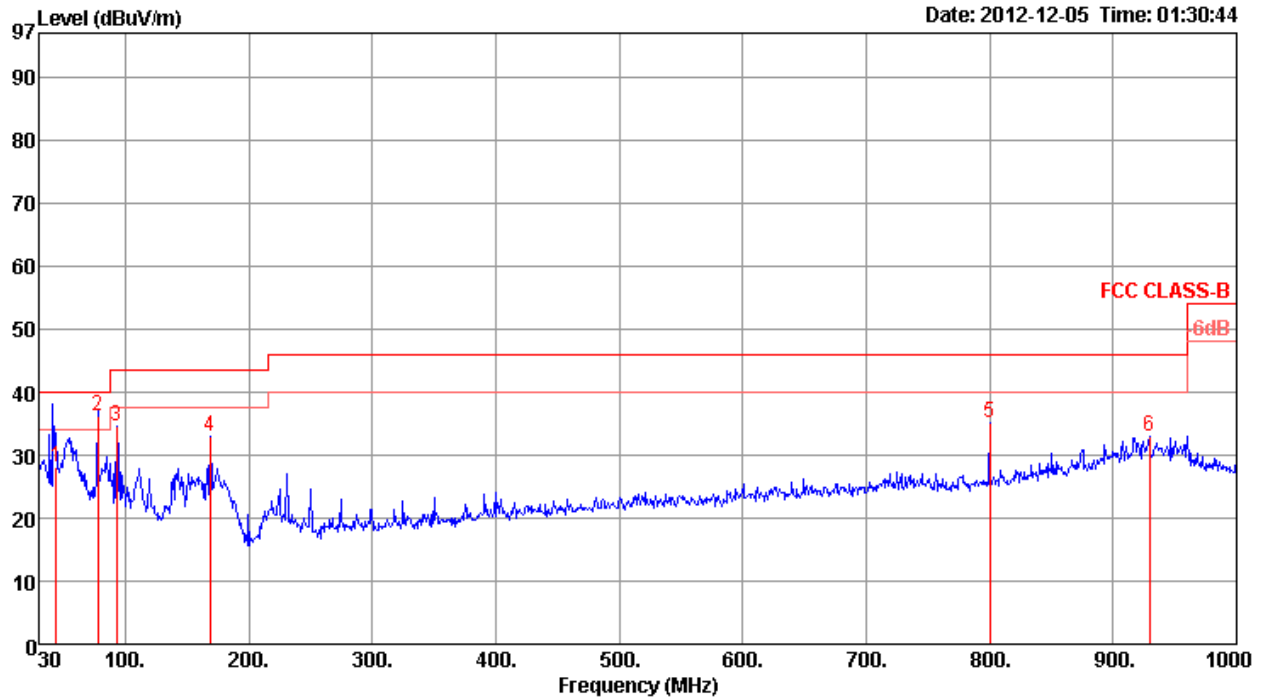

	Freq	Level	Limit	Over	Read	CableAntenna	Preamp	Remark	A/Pos	T/Pos	Pol/Phase
	MHz	dBuV/m	dBuV/m	dB	dBuV	dB	dB/m	dB	cm	deg	
1	43.76	28.08	40.00	-11.92	44.30	0.70	10.88	27.80 QP	100	52	VERTICAL
2	77.53	36.28	40.00	-3.72	55.94	1.00	7.03	27.69 Peak	400	0	VERTICAL
3	93.05	34.65	43.50	-8.85	51.60	1.10	9.58	27.63 Peak	400	0	VERTICAL
4	168.71	33.04	43.50	-10.46	46.07	1.54	12.68	27.25 Peak	400	0	VERTICAL
5	800.18	35.20	46.00	-10.80	39.73	3.30	19.77	27.60 Peak	400	0	VERTICAL
6	929.19	32.96	46.00	-13.04	35.89	3.60	20.75	27.28 Peak	400	0	VERTICAL

Note:

The amplitude of spurious emissions that are attenuated by more than 20dB below the permissible value has no need to be reported.

Emission level (dBuV/m) = 20 log Emission level (uV/m).

Corrected Reading: Antenna Factor + Cable Loss + Read Level - Preamp Factor = Level.

4.5.9. Results for Radiated Emissions (1GHz~10th Harmonic)

Temperature	24.5°C	Humidity	57%
Test Engineer	Wen Chao	Configurations	IEEE 802.11n MCS0 20MHz Ch 1 / Ant. 0 + Ant. 1
Test Date	Nov. 30, 2012		

Horizontal

	Freq	Level	Limit Line	Over Limit	Read Level	Cable Loss	Preamp Factor	Antenna Factor	T/Pos	A/Pos	Remark	Pol/Phase
	MHz	dBuV/m	dBuV/m	dB	dBuV	dB	dB	dB/m	deg	cm		
1 p	4799.00	44.67	74.00	-29.33	40.28	6.26	35.20	33.33	360	100	Peak	HORIZONTAL
2	4799.00	31.44	54.00	-22.56	27.05	6.26	35.20	33.33	360	100	Average	HORIZONTAL
3	4824.00	32.21	54.00	-21.79	27.75	6.27	35.20	33.39	360	100	Average	HORIZONTAL
4 a	4824.00	44.00	54.00	-10.00	39.54	6.27	35.20	33.39	360	100	Average	HORIZONTAL

Vertical

	Freq	Level	Limit Line	Over Limit	Read Level	Cable Loss	Preamp Factor	Antenna Factor	T/Pos	A/Pos	Remark	Pol/Phase
	MHz	dBuV/m	dBuV/m	dB	dBuV	dB	dB	dB/m	deg	cm		
1 a	4799.00	33.10	54.00	-20.90	28.71	6.26	35.20	33.33	34	100	Average	VERTICAL
2 p	4799.96	48.63	74.00	-25.37	44.24	6.26	35.20	33.33	34	100	Peak	VERTICAL
3	4824.00	43.31	74.00	-30.69	38.85	6.27	35.20	33.39	34	100	Peak	VERTICAL
4	4824.00	32.80	54.00	-21.20	28.34	6.27	35.20	33.39	34	100	Average	VERTICAL

Temperature	24.5°C	Humidity	57%
Test Engineer	Wen Chao	Configurations	IEEE 802.11n MCS0 20MHz Ch 6 / Ant. 0 + Ant. 1
Test Date	Nov. 30, 2012		

Horizontal

	Freq	Level	Limit	Over	Read	CableAntenna	Preamp	Remark	A/Pos	T/Pos	Pol/Phase
	MHz	dBuV/m	dBuV/m	dB	dBuV	dB	dB/m	dB	cm	deg	
1	4871.24	42.41	74.00	-31.59	40.95	3.33	33.16	35.03	100	296	HORIZONTAL
2	4878.90	30.19	54.00	-23.81	28.73	3.33	33.16	35.03	100	296	HORIZONTAL
3	7303.12	32.89	54.00	-21.11	28.31	4.06	35.92	35.40	100	131	HORIZONTAL
4	7311.19	45.06	74.00	-28.94	40.44	4.06	35.96	35.40	100	131	HORIZONTAL

Vertical

	Freq	Level	Limit	Over	Read	CableAntenna	Preamp	Remark	A/Pos	T/Pos	Pol/Phase
	MHz	dBuV/m	dBuV/m	dB	dBuV	dB	dB/m	dB	cm	deg	
1	4867.56	42.29	74.00	-31.71	40.87	3.33	33.12	35.03	100	330	VERTICAL
2	4875.15	31.10	54.00	-22.90	29.64	3.33	33.16	35.03	100	330	VERTICAL
3	7304.17	45.09	74.00	-28.91	40.51	4.06	35.92	35.40	100	57	VERTICAL
4	7312.57	32.90	54.00	-21.10	28.28	4.06	35.96	35.40	100	57	VERTICAL

Temperature	24.5°C	Humidity	57%
Test Engineer	Wen Chao	Configurations	IEEE 802.11n MCS0 20MHz Ch11 / Ant. 0 + Ant. 1
Test Date	Nov. 30, 2012		

Horizontal

	Freq	Level	Limit Line	Over Limit	Read Level	Cable Loss	Antenna Factor	Preamp Factor	Remark	A/Pos	T/Pos	Pol/Phase
	MHz	dBuV/m	dBuV/m	dB	dBuV	dB	dB/m	dB		cm	deg	
1	4926.53	29.22	54.00	-24.78	27.62	3.35	33.26	35.01	Average	100	149	HORIZONTAL
2	4926.68	42.14	74.00	-31.86	40.54	3.35	33.26	35.01	Peak	100	149	HORIZONTAL
3	7381.08	45.28	74.00	-28.72	40.53	4.06	36.09	35.40	Peak	100	222	HORIZONTAL
4	7383.64	33.11	54.00	-20.89	28.36	4.06	36.09	35.40	Average	100	222	HORIZONTAL

Vertical

	Freq	Level	Limit Line	Over Limit	Read Level	Cable Loss	Antenna Factor	Preamp Factor	Remark	A/Pos	T/Pos	Pol/Phase
	MHz	dBuV/m	dBuV/m	dB	dBuV	dB	dB/m	dB		cm	deg	
1	4920.46	41.41	74.00	-32.59	39.84	3.35	33.23	35.01	Peak	100	179	VERTICAL
2	4927.85	29.38	54.00	-24.62	27.78	3.35	33.26	35.01	Average	100	179	VERTICAL
3	7386.10	33.08	54.00	-20.92	28.33	4.06	36.09	35.40	Average	100	302	VERTICAL
4	7388.68	46.02	74.00	-27.98	41.27	4.06	36.09	35.40	Peak	100	302	VERTICAL

Note:

The amplitude of spurious emissions that are attenuated by more than 20dB below the permissible value has no need to be reported.

Emission level (dBuV/m) = 20 log Emission level (uV/m).

Corrected Reading: Antenna Factor + Cable Loss + Read Level - Preamp Factor = Level.

Temperature	24.5°C	Humidity	57%
Test Engineer	Wen Chao	Configurations	IEEE 802.11n MCS0 40MHz Ch 3 / Ant. 0 + Ant. 1
Test Date	Nov. 30, 2012		

Horizontal

	Freq	Level	Limit	Over	Read	Cable	Preamp	Antenna	T/Pos	A/Pos	Remark	Pol/Phase
	MHz	dBuV/m	dBuV/m	dB	dBuV	dB	dB	dB/m	deg	cm		
1 p	4844.00	44.41	74.00	-29.59	39.90	6.29	35.20	33.42	141	100	Peak	HORIZONTAL
2 a	4844.00	32.09	54.00	-21.91	27.58	6.29	35.20	33.42	141	100	Average	HORIZONTAL

Vertical

	Freq	Level	Limit	Over	Read	Cable	Preamp	Antenna	T/Pos	A/Pos	Remark	Pol/Phase
	MHz	dBuV/m	dBuV/m	dB	dBuV	dB	dB	dB/m	deg	cm		
1	4844.00	32.16	54.00	-21.84	27.65	6.29	35.20	33.42	112	130	Average	VERTICAL
2 a	4844.00	44.31	54.00	-9.69	39.80	6.29	35.20	33.42	112	130	Average	VERTICAL

Temperature	24.5°C	Humidity	57%
Test Engineer	Wen Chao	Configurations	IEEE 802.11n MCS0 40MHz Ch 6 / Ant. 0 + Ant. 1
Test Date	Nov. 30, 2012		

Horizontal

	Freq	Level	Limit Line	Over Limit	Read Level	CableAntenna Loss	Antenna Factor	Preamp Factor	Remark	A/Pos	T/Pos	PoI/Phase
	MHz	dBuV/m	dBuV/m	dB	dBuV	dB	dB/m	dB		cm	deg	
1	4869.37	29.41	54.00	-24.59	27.99	3.33	33.12	35.03	Average	100	69	HORIZONTAL
2	4872.54	41.64	74.00	-32.36	40.18	3.33	33.16	35.03	Peak	100	69	HORIZONTAL
3	7309.69	33.21	54.00	-20.79	28.59	4.06	35.96	35.40	Average	100	172	HORIZONTAL
4	7313.77	45.88	74.00	-28.12	41.26	4.06	35.96	35.40	Peak	100	172	HORIZONTAL

Vertical

	Freq	Level	Limit Line	Over Limit	Read Level	CableAntenna Loss	Antenna Factor	Preamp Factor	Remark	A/Pos	T/Pos	PoI/Phase
	MHz	dBuV/m	dBuV/m	dB	dBuV	dB	dB/m	dB		cm	deg	
1	4873.64	42.05	74.00	-31.95	40.59	3.33	33.16	35.03	Peak	100	86	VERTICAL
2	4875.81	29.43	54.00	-24.57	27.97	3.33	33.16	35.03	Average	100	86	VERTICAL
3	7310.36	33.11	54.00	-20.89	28.49	4.06	35.96	35.40	Average	100	231	VERTICAL
4	7310.81	44.97	74.00	-29.03	40.35	4.06	35.96	35.40	Peak	100	231	VERTICAL



Temperature	24.5°C	Humidity	57%
Test Engineer	Wen Chao	Configurations	IEEE 802.11n MCS0 40MHz Ch 9 / Ant. 0 + Ant. 1
Test Date	Nov. 30, 2012		

Horizontal

	Freq	Level	Limit Line	Over Limit	Read Level	Cable Loss	Antenna Factor	Preamp Factor	Remark	A/Pos	T/Pos	PoI/Phase
	MHz	dBuV/m	dBuV/m	dB	dBuV	dB	dB/m	dB		cm	deg	
1	4904.08	29.18	54.00	-24.82	27.67	3.34	33.19	35.02	Average	100	167	HORIZONTAL
2	4908.94	42.26	74.00	-31.74	40.71	3.34	33.23	35.02	Peak	100	167	HORIZONTAL
3	7351.24	45.30	74.00	-28.70	40.62	4.06	36.02	35.40	Peak	100	284	HORIZONTAL
4	7354.96	33.22	54.00	-20.78	28.54	4.06	36.02	35.40	Average	100	284	HORIZONTAL

Vertical

	Freq	Level	Limit Line	Over Limit	Read Level	Cable Loss	Antenna Factor	Preamp Factor	Remark	A/Pos	T/Pos	PoI/Phase
	MHz	dBuV/m	dBuV/m	dB	dBuV	dB	dB/m	dB		cm	deg	
1	4904.18	41.50	74.00	-32.50	39.99	3.34	33.19	35.02	Peak	100	104	VERTICAL
2	4906.10	29.28	54.00	-24.72	27.73	3.34	33.23	35.02	Average	100	104	VERTICAL
3	7352.57	33.13	54.00	-20.87	28.45	4.06	36.02	35.40	Average	100	172	VERTICAL
4	7355.20	45.63	74.00	-28.37	40.95	4.06	36.02	35.40	Peak	100	172	VERTICAL

Note:

The amplitude of spurious emissions that are attenuated by more than 20dB below the permissible value has no need to be reported.

Emission level (dBuV/m) = 20 log Emission level (uV/m).

Corrected Reading: Antenna Factor + Cable Loss + Read Level - Preamp Factor = Level.

Temperature	24.5°C	Humidity	57%
Test Engineer	Wen Chao	Configurations	IEEE 802.11n MCS0 20MHz CH 149 / Ant. 2 + Ant. 3
Test Date	Nov. 20, 2012		

Horizontal

	Freq	Level	Limit Line	Over Limit	Read Level	CableAntenna Loss	Antenna Factor	Preamp Factor	Remark	A/Pos	T/Pos	Pol/Phase
	MHz	dBuV/m	dBuV/m	dB	dBuV	dB	dB/m	dB		cm	deg	
1	11485.82	52.81	74.00	-21.19	44.20	5.11	38.78	35.28	Peak	100	131	HORIZONTAL
2	11490.98	39.95	54.00	-14.05	31.34	5.11	38.78	35.28	Average	100	131	HORIZONTAL

Vertical

	Freq	Level	Limit Line	Over Limit	Read Level	CableAntenna Loss	Antenna Factor	Preamp Factor	Remark	A/Pos	T/Pos	Pol/Phase
	MHz	dBuV/m	dBuV/m	dB	dBuV	dB	dB/m	dB		cm	deg	
1	11488.46	40.92	54.00	-13.08	32.31	5.11	38.78	35.28	Average	100	16	VERTICAL
2	11492.79	53.62	74.00	-20.38	45.01	5.11	38.78	35.28	Peak	100	16	VERTICAL

Temperature	24.5°C	Humidity	57%
Test Engineer	Wen Chao	Configurations	IEEE 802.11n MCS0 20MHz CH 157 / Ant. 2 + Ant. 3
Test Date	Nov. 20, 2012		

Horizontal

	Freq	Level	Limit	Over	Read	CableAntenna	Preamp	Remark	A/Pos	T/Pos	Pol/Phase
	MHz	dBuV/m	dBuV/m	dB	dBuV	dB	dB/m	dB	cm	deg	
1	11566.91	53.10	74.00	-20.90	44.45	5.13	38.82	35.30	Peak	100	268 HORIZONTAL
2	11570.74	40.18	54.00	-13.82	31.51	5.14	38.83	35.30	Average	100	268 HORIZONTAL

Vertical

	Freq	Level	Limit	Over	Read	CableAntenna	Preamp	Remark	A/Pos	T/Pos	Pol/Phase
	MHz	dBuV/m	dBuV/m	dB	dBuV	dB	dB/m	dB	cm	deg	
1	11568.43	53.13	74.00	-20.87	44.47	5.13	38.83	35.30	Peak	100	223 VERTICAL
2	11573.46	40.13	54.00	-13.87	31.46	5.14	38.83	35.30	Average	100	223 VERTICAL

Temperature	24.5°C	Humidity	57%
Test Engineer	Wen Chao	Configurations	IEEE 802.11n MCS0 20MHz CH 165 / Ant. 2 + Ant. 3
Test Date	Nov. 20, 2012		

Horizontal

	Freq	Level	Limit Line	Over Limit	Read Level	Cable Loss	Antenna Factor	Preamp Factor	Remark	A/Pos	T/Pos	Pol/Phase
	MHz	dBuV/m	dBuV/m	dB	dBuV	dB	dB/m	dB		cm	deg	
1	11646.22	52.79	74.00	-21.21	44.07	5.16	38.86	35.30	Peak	100	247	HORIZONTAL
2	11651.39	39.26	54.00	-14.74	30.54	5.16	38.86	35.30	Average	100	247	HORIZONTAL

Vertical

	Freq	Level	Limit Line	Over Limit	Read Level	Cable Loss	Antenna Factor	Preamp Factor	Remark	A/Pos	T/Pos	Pol/Phase
	MHz	dBuV/m	dBuV/m	dB	dBuV	dB	dB/m	dB		cm	deg	
1	11645.08	52.83	74.00	-21.17	44.11	5.16	38.86	35.30	Peak	100	78	VERTICAL
2	11650.37	40.02	54.00	-13.98	31.30	5.16	38.86	35.30	Average	100	78	VERTICAL

Note:

The amplitude of spurious emissions that are attenuated by more than 20dB below the permissible value has no need to be reported.

Emission level (dBuV/m) = 20 log Emission level (uV/m).

Corrected Reading: Antenna Factor + Cable Loss + Read Level - Preamp Factor = Level.

Temperature	24.5°C	Humidity	57%
Test Engineer	Wen Chao	Configurations	IEEE 802.11n MCS0 40MHz CH 151 / Ant. 2 + Ant. 3
Test Date	Nov. 20, 2012		

Horizontal

	Freq	Level	Limit Line	Over Limit	Read Level	CableAntenna Loss	Antenna Factor	Preamp Factor	Remark	A/Pos	T/Pos	Pol/Phase
	MHz	dBuV/m	dBuV/m	dB	dBuV	dB	dB/m	dB		cm	deg	
1	11506.55	52.91	74.00	-21.09	44.28	5.12	38.79	35.28	Peak	100	12	HORIZONTAL
2	11508.72	39.46	54.00	-14.54	30.83	5.12	38.79	35.28	Average	100	12	HORIZONTAL

Vertical

	Freq	Level	Limit Line	Over Limit	Read Level	CableAntenna Loss	Antenna Factor	Preamp Factor	Remark	A/Pos	T/Pos	Pol/Phase
	MHz	dBuV/m	dBuV/m	dB	dBuV	dB	dB/m	dB		cm	deg	
1	11505.34	53.40	74.00	-20.60	44.77	5.12	38.79	35.28	Peak	100	154	VERTICAL
2	11511.28	39.54	54.00	-14.46	30.91	5.12	38.79	35.28	Average	100	154	VERTICAL

Temperature	24.5°C	Humidity	57%
Test Engineer	Wen Chao	Configurations	IEEE 802.11n MCS0 40MHz CH 159 / Ant. 2 + Ant. 3
Test Date	Nov. 20, 2012		

Horizontal

	Freq	Level	Limit Line	Over Limit	Read Level	CableAntenna Loss	Antenna Factor	Preamp Factor	Remark	A/Pos	T/Pos	Pol/Phase
	MHz	dBuV/m	dBuV/m	dB	dBuV	dB	dB/m	dB		cm	deg	
1	11593.21	53.08	74.00	-20.92	44.41	5.14	38.83	35.30	Peak	100	195	HORIZONTAL
2	11593.86	39.56	54.00	-14.44	30.89	5.14	38.83	35.30	Average	100	195	HORIZONTAL

Vertical

	Freq	Level	Limit Line	Over Limit	Read Level	CableAntenna Loss	Antenna Factor	Preamp Factor	Remark	A/Pos	T/Pos	Pol/Phase
	MHz	dBuV/m	dBuV/m	dB	dBuV	dB	dB/m	dB		cm	deg	
1	11585.96	39.64	54.00	-14.36	30.97	5.14	38.83	35.30	Average	100	284	VERTICAL
2	11591.51	52.87	74.00	-21.13	44.20	5.14	38.83	35.30	Peak	100	284	VERTICAL

Note:

The amplitude of spurious emissions that are attenuated by more than 20dB below the permissible value has no need to be reported.

Emission level (dBuV/m) = 20 log Emission level (uV/m).

Corrected Reading: Antenna Factor + Cable Loss + Read Level - Preamp Factor = Level.

Temperature	24.5°C	Humidity	57%
Test Engineer	Wen Chao	Configurations	IEEE 802.11ac MCS0 20MHz CH 149 / Ant. 2 + Ant. 3
Test Date	Nov. 20, 2012		

Horizontal

	Freq	Level	Limit Line	Over Limit	Read Level	Cable Loss	Antenna Factor	Preamp Factor	Remark	A/Pos	T/Pos	Pol/Phase
	MHz	dBuV/m	dBuV/m	dB	dBuV	dB	dB/m	dB		cm	deg	
1	11488.51	39.59	54.00	-14.41	30.98	5.11	38.78	35.28	Average	100	13	HORIZONTAL
2	11490.19	52.91	74.00	-21.09	44.30	5.11	38.78	35.28	Peak	100	13	HORIZONTAL

Vertical

	Freq	Level	Limit Line	Over Limit	Read Level	Cable Loss	Antenna Factor	Preamp Factor	Remark	A/Pos	T/Pos	Pol/Phase
	MHz	dBuV/m	dBuV/m	dB	dBuV	dB	dB/m	dB		cm	deg	
1	11491.31	40.00	54.00	-14.00	31.39	5.11	38.78	35.28	Average	100	168	VERTICAL
2	11494.12	53.19	74.00	-20.81	44.57	5.12	38.78	35.28	Peak	100	168	VERTICAL

Temperature	24.5°C	Humidity	57%
Test Engineer	Wen Chao	Configurations	IEEE 802.11ac MCS0 20MHz CH 157 / Ant. 2 + Ant. 3
Test Date	Nov. 20, 2012		

Horizontal

	Freq	Level	Limit Line	Over Limit	Read Level	CableAntenna Loss	Antenna Factor	Preamp Factor	Remark	A/Pos	T/Pos	Pol/Phase
	MHz	dBuV/m	dBuV/m	dB	dBuV	dB	dB/m	dB		cm	deg	
1	11569.38	52.95	74.00	-21.05	44.29	5.13	38.83	35.30	Peak	100	191	HORIZONTAL
2	11573.80	39.51	54.00	-14.49	30.84	5.14	38.83	35.30	Average	100	191	HORIZONTAL

Vertical

	Freq	Level	Limit Line	Over Limit	Read Level	CableAntenna Loss	Antenna Factor	Preamp Factor	Remark	A/Pos	T/Pos	Pol/Phase
	MHz	dBuV/m	dBuV/m	dB	dBuV	dB	dB/m	dB		cm	deg	
1	11566.11	40.44	54.00	-13.56	31.79	5.13	38.82	35.30	Average	100	333	VERTICAL
2	11573.29	53.23	74.00	-20.77	44.56	5.14	38.83	35.30	Peak	100	333	VERTICAL

Temperature	24.5°C	Humidity	57%
Test Engineer	Wen Chao	Configurations	IEEE 802.11ac MCS0 20MHz CH 165 / Ant. 2 + Ant. 3
Test Date	Nov. 20, 2012		

Horizontal

	Freq	Level	Limit Line	Over Limit	Read Level	CableAntenna Loss	Antenna Factor	Preamp Factor	Remark	A/Pos	T/Pos	Pol/Phase
	MHz	dBuV/m	dBuV/m	dB	dBuV	dB	dB/m	dB		cm	deg	
1	11648.40	52.86	74.00	-21.14	44.14	5.16	38.86	35.30	Peak	100	72	HORIZONTAL
2	11652.55	39.25	54.00	-14.75	30.53	5.16	38.86	35.30	Average	100	72	HORIZONTAL

Vertical

	Freq	Level	Limit Line	Over Limit	Read Level	CableAntenna Loss	Antenna Factor	Preamp Factor	Remark	A/Pos	T/Pos	Pol/Phase
	MHz	dBuV/m	dBuV/m	dB	dBuV	dB	dB/m	dB		cm	deg	
1	11649.74	39.45	54.00	-14.55	30.73	5.16	38.86	35.30	Average	100	163	VERTICAL
2	11652.45	53.13	74.00	-20.87	44.41	5.16	38.86	35.30	Peak	100	163	VERTICAL

Note:

The amplitude of spurious emissions that are attenuated by more than 20dB below the permissible value has no need to be reported.

Emission level (dBuV/m) = 20 log Emission level (uV/m).

Corrected Reading: Antenna Factor + Cable Loss + Read Level - Preamp Factor = Level.

Temperature	24.5°C	Humidity	57%
Test Engineer	Wen Chao	Configurations	IEEE 802.11ac MCS0 40MHz CH 151 / Ant. 2 + Ant. 3
Test Date	Nov. 20, 2012		

Horizontal

	Freq	Level	Limit	Over	Read	CableAntenna	Preamp	Remark	A/Pos	T/Pos	Pol/Phase
	MHz	dBuV/m	dBuV/m	dB	dBuV	dB	dB/m	dB	cm	deg	
1	11507.69	39.51	54.00	-14.49	30.88	5.12	38.79	35.28	Average	100	220 HORIZONTAL
2	11512.60	53.15	74.00	-20.85	44.52	5.12	38.79	35.28	Peak	100	220 HORIZONTAL

Vertical

	Freq	Level	Limit	Over	Read	CableAntenna	Preamp	Remark	A/Pos	T/Pos	Pol/Phase
	MHz	dBuV/m	dBuV/m	dB	dBuV	dB	dB/m	dB	cm	deg	
1	11505.58	39.97	54.00	-14.03	31.34	5.12	38.79	35.28	Average	100	349 VERTICAL
2	11513.19	53.23	74.00	-20.77	44.60	5.12	38.79	35.28	Peak	100	349 VERTICAL

Temperature	24.5°C	Humidity	57%
Test Engineer	Wen Chao	Configurations	IEEE 802.11ac MCS0 40MHz CH 159 / Ant. 2 + Ant. 3
Test Date	Nov. 20, 2012		

Horizontal

	Freq	Level	Limit Line	Over Limit	Read Level	Cable Loss	Antenna Factor	Preamp Factor	Remark	A/Pos	T/Pos	Pol/Phase
	MHz	dBuV/m	dBuV/m	dB	dBuV	dB	dB/m	dB		cm	deg	
1	11588.89	53.42	74.00	-20.58	44.75	5.14	38.83	35.30	Peak	100	113	HORIZONTAL
2	11591.09	39.52	54.00	-14.48	30.85	5.14	38.83	35.30	Average	100	113	HORIZONTAL

Vertical

	Freq	Level	Limit Line	Over Limit	Read Level	Cable Loss	Antenna Factor	Preamp Factor	Remark	A/Pos	T/Pos	Pol/Phase
	MHz	dBuV/m	dBuV/m	dB	dBuV	dB	dB/m	dB		cm	deg	
1	11593.16	39.83	54.00	-14.17	31.16	5.14	38.83	35.30	Average	100	226	VERTICAL
2	11594.52	54.14	74.00	-19.86	45.47	5.14	38.83	35.30	Peak	100	226	VERTICAL

Note:

The amplitude of spurious emissions that are attenuated by more than 20dB below the permissible value has no need to be reported.

Emission level (dBuV/m) = 20 log Emission level (uV/m).

Corrected Reading: Antenna Factor + Cable Loss + Read Level - Preamp Factor = Level.

Temperature	24.5°C	Humidity	57%
Test Engineer	Wen Chao	Configurations	IEEE 802.11ac MCS0 80MHz CH 155 / Ant. 2 + Ant. 3
Test Date	Nov. 20, 2012		

Horizontal

	Freq	Level	Limit Line	Over Limit	Read Level	CableAntenna Loss	Antenna Factor	Preamp Factor	Remark	A/Pos	T/Pos	Pol/Phase
	MHz	dBuV/m	dBuV/m	dB	dBuV	dB	dB/m	dB		cm	deg	
1	11546.41	52.72	74.00	-21.28	44.08	5.13	38.81	35.30	Peak	100	198	HORIZONTAL
2	11548.77	39.16	54.00	-14.84	30.52	5.13	38.81	35.30	Average	100	198	HORIZONTAL

Vertical

	Freq	Level	Limit Line	Over Limit	Read Level	CableAntenna Loss	Antenna Factor	Preamp Factor	Remark	A/Pos	T/Pos	Pol/Phase
	MHz	dBuV/m	dBuV/m	dB	dBuV	dB	dB/m	dB		cm	deg	
1	11548.51	52.76	74.00	-21.24	44.12	5.13	38.81	35.30	Peak	100	18	VERTICAL
2	11554.73	39.27	54.00	-14.73	30.62	5.13	38.82	35.30	Average	100	18	VERTICAL

Note:

The amplitude of spurious emissions that are attenuated by more than 20dB below the permissible value has no need to be reported.

Emission level (dBuV/m) = 20 log Emission level (uV/m).

Corrected Reading: Antenna Factor + Cable Loss + Read Level - Preamp Factor = Level.

Temperature	24.5°C	Humidity	57%
Test Engineer	Wen Chao	Configurations	IEEE 802.11b CH 1 / Ant. 0
Test Date	Nov. 30, 2012		

Horizontal

	Freq	Level	Limit	Over	Read	Cable	Preamp	Antenna	T/Pos	A/Pos	Remark	Pol/Phase
	MHz	dBuV/m	dBuV/m	dB	dBuV	dB	dB	dB/m	deg	cm		
1 p	4824.00	42.75	74.00	-31.25	38.29	6.27	35.20	33.39	287	121	Peak	HORIZONTAL
2 a	4824.00	32.41	54.00	-21.59	27.95	6.27	35.20	33.39	287	121	Average	HORIZONTAL

Vertical

	Freq	Level	Limit	Over	Read	Cable	Antenna	Preamp	Remark	A/Pos	T/Pos	Pol/Phase
	MHz	dBuV/m	dBuV/m	dB	dBuV	dB	dB/m	dB		cm	deg	
1	4824.00	32.20	54.00	-21.80	27.74	6.27	33.39	35.20	Average	100	34	VERTICAL
2	4824.00	44.44	74.00	-29.56	39.98	6.27	33.39	35.20	Peak	100	34	VERTICAL

Temperature	24.5°C	Humidity	57%
Test Engineer	Wen Chao	Configurations	IEEE 802.11b CH 6 / Ant. 0
Test Date	Nov. 30, 2012		

Horizontal

	Freq	Level	Limit Line	Over Limit	Read Level	Cable Loss	Antenna Factor	Preamp Factor	Remark	A/Pos	T/Pos	Pol/Phase
	MHz	dBuV/m	dBuV/m	dB	dBuV	dB	dB/m	dB		cm	deg	
1	4873.96	38.63	54.00	-15.37	37.17	3.33	33.16	35.03	Average	100	334	HORIZONTAL
2	4874.03	46.08	74.00	-27.92	44.62	3.33	33.16	35.03	Peak	100	334	HORIZONTAL
3	7309.68	45.70	74.00	-28.30	41.08	4.06	35.96	35.40	Peak	100	193	HORIZONTAL
4	7309.89	32.76	54.00	-21.24	28.14	4.06	35.96	35.40	Average	100	193	HORIZONTAL

Vertical

	Freq	Level	Limit Line	Over Limit	Read Level	Cable Loss	Antenna Factor	Preamp Factor	Remark	A/Pos	T/Pos	Pol/Phase
	MHz	dBuV/m	dBuV/m	dB	dBuV	dB	dB/m	dB		cm	deg	
1	4873.89	47.02	74.00	-26.98	45.56	3.33	33.16	35.03	Peak	151	13	VERTICAL
2	4873.96	41.59	54.00	-12.41	40.13	3.33	33.16	35.03	Average	151	13	VERTICAL
3	7312.51	32.99	54.00	-21.01	28.37	4.06	35.96	35.40	Average	100	127	VERTICAL
4	7312.82	45.38	74.00	-28.62	40.76	4.06	35.96	35.40	Peak	100	127	VERTICAL

Temperature	24.5°C	Humidity	56.4%
Test Engineer	Wen Chao	Configurations	IEEE 802.11b CH 11 / Ant. 0
Test Date	Nov. 30, 2012		

Horizontal

	Freq	Level	Limit	Over	Read	Cable	Preamp	Antenna	T/Pos	A/Pos	Remark	Pol/Phase
	MHz	dBuV/m	dBuV/m	dB	dBuV	dB	dB	dB/m	deg	cm		
1 a	4918.15	31.86	54.00	-22.14	27.17	6.35	35.20	33.54	65	137	Average	HORIZONTAL
2 p	4921.52	45.99	74.00	-28.01	41.30	6.35	35.20	33.54	65	137	Peak	HORIZONTAL

Vertical

	Freq	Level	Limit	Over	Read	Cable	Antenna	Preamp	Remark	A/Pos	T/Pos	Pol/Phase
	MHz	dBuV/m	dBuV/m	dB	dBuV	dB	dB/m	dB		cm	deg	
1	4923.92	33.20	54.00	-20.80	28.47	6.35	33.58	35.20	Average	113	151	VERTICAL
2	4946.36	45.68	74.00	-28.32	40.91	6.36	33.61	35.20	Peak	113	151	VERTICAL

Note:

The amplitude of spurious emissions that are attenuated by more than 20dB below the permissible value has no need to be reported.

Emission level (dBuV/m) = 20 log Emission level (uV/m).

Corrected Reading: Antenna Factor + Cable Loss + Read Level - Preamp Factor = Level.

Temperature	24.5°C	Humidity	57%
Test Engineer	Wen Chao	Configurations	IEEE 802.11g CH 1 / Ant. 0 + Ant. 1
Test Date	Nov. 30, 2012		

Horizontal

	Freq	Level	Limit Line	Over Limit	Read Level	Cable Loss	Preamp Factor	Antenna Factor	T/Pos	A/Pos	Remark	Pol/Phase
	MHz	dBuV/m	dBuV/m	dB	dBuV	dB	dB	dB/m	deg	cm		
1 p	4824.00	42.74	74.00	-31.26	38.28	6.27	35.20	33.39	360	100	Peak	HORIZONTAL
2 a	4824.00	32.24	54.00	-21.76	27.78	6.27	35.20	33.39	360	100	Average	HORIZONTAL

Vertical

	Freq	Level	Limit Line	Over Limit	Read Level	Cable Loss	Antenna Factor	Preamp Factor	Remark	A/Pos	T/Pos	Pol/Phase
	MHz	dBuV/m	dBuV/m	dB	dBuV	dB	dB/m	dB		cm	deg	
1	4824.00	32.45	54.00	-21.55	27.99	6.27	33.39	35.20	Average	100	33	VERTICAL
2	4824.00	43.99	74.00	-30.01	39.53	6.27	33.39	35.20	Peak	100	33	VERTICAL

Temperature	24.5°C	Humidity	57%
Test Engineer	Wen Chao	Configurations	IEEE 802.11g CH 6 / Ant. 0 + Ant. 1
Test Date	Nov. 30, 2012		

Horizontal

	Freq	Level	Limit Line	Over Limit	Read Level	Cable Loss	Antenna Factor	Preamp Factor	Remark	A/Pos	T/Pos	Pol/Phase
	MHz	dBuV/m	dBuV/m	dB	dBuV	dB	dB/m	dB		cm	deg	
1	4869.77	42.31	74.00	-31.69	40.89	3.33	33.12	35.03	Peak	100	0	HORIZONTAL
2	4869.93	30.40	54.00	-23.60	28.98	3.33	33.12	35.03	Average	100	0	HORIZONTAL
3	7304.49	44.80	74.00	-29.20	40.22	4.06	35.92	35.40	Peak	100	295	HORIZONTAL
4	7305.52	32.72	54.00	-21.28	28.14	4.06	35.92	35.40	Average	100	295	HORIZONTAL

Vertical

	Freq	Level	Limit Line	Over Limit	Read Level	Cable Loss	Antenna Factor	Preamp Factor	Remark	A/Pos	T/Pos	Pol/Phase
	MHz	dBuV/m	dBuV/m	dB	dBuV	dB	dB/m	dB		cm	deg	
1	4874.74	44.88	74.00	-29.12	43.42	3.33	33.16	35.03	Peak	106	1	VERTICAL
2	4875.57	32.80	54.00	-21.20	31.34	3.33	33.16	35.03	Average	106	1	VERTICAL
3	7311.32	32.88	54.00	-21.12	28.26	4.06	35.96	35.40	Average	100	195	VERTICAL
4	7312.51	44.54	74.00	-29.46	39.92	4.06	35.96	35.40	Peak	100	195	VERTICAL

Temperature	24.5°C	Humidity	57%
Test Engineer	Wen Chao	Configurations	IEEE 802.11g CH 11 / Ant. 0 + Ant. 1
Test Date	Nov. 30, 2012		

Horizontal

	Freq	Level	Limit Line	Over Limit	Read Level	Cable Loss	Preamp Factor	Antenna Factor	T/Pos	A/Pos	Remark	Pol/Phase
	MHz	dBuV/m	dBuV/m	dB	dBuV	dB	dB	dB/m	deg	cm		
1 p	4924.00	42.94	74.00	-31.06	38.21	6.35	35.20	33.58	153	110	Peak	HORIZONTAL
2 a	4924.00	32.12	54.00	-21.88	27.39	6.35	35.20	33.58	153	110	Average	HORIZONTAL

Vertical

	Freq	Level	Limit Line	Over Limit	Read Level	Cable Loss	Preamp Factor	Antenna Factor	T/Pos	A/Pos	Remark	Pol/Phase
	MHz	dBuV/m	dBuV/m	dB	dBuV	dB	dB	dB/m	deg	cm		
1 p	4924.00	43.93	74.00	-30.07	39.20	6.35	35.20	33.58	84	126	Peak	VERTICAL
2 a	4924.00	31.68	54.00	-22.32	26.95	6.35	35.20	33.58	84	126	Average	VERTICAL

Note:

The amplitude of spurious emissions that are attenuated by more than 20dB below the permissible value has no need to be reported.

Emission level (dBuV/m) = 20 log Emission level (uV/m).

Corrected Reading: Antenna Factor + Cable Loss + Read Level - Preamp Factor = Level.

Temperature	24.5°C	Humidity	57%
Test Engineer	Wen Chao	Configurations	IEEE 802.11a CH 149 / Ant. 2 + Ant. 3
Test Date	Nov. 20, 2012		

Horizontal

	Freq	Level	Limit Line	Over Limit	Read Level	CableAntenna Loss	Antenna Factor	Preamp Factor	Remark	A/Pos	T/Pos	Pol/Phase
	MHz	dBuV/m	dBuV/m	dB	dBuV	dB	dB/m	dB		cm	deg	
1	11487.87	53.23	74.00	-20.77	44.62	5.11	38.78	35.28	Peak	100	130	HORIZONTAL
2	11493.13	39.69	54.00	-14.31	31.08	5.11	38.78	35.28	Average	100	130	HORIZONTAL

Vertical

	Freq	Level	Limit Line	Over Limit	Read Level	CableAntenna Loss	Antenna Factor	Preamp Factor	Remark	A/Pos	T/Pos	Pol/Phase
	MHz	dBuV/m	dBuV/m	dB	dBuV	dB	dB/m	dB		cm	deg	
1	11487.68	53.03	74.00	-20.97	44.42	5.11	38.78	35.28	Peak	100	348	VERTICAL
2	11490.91	41.09	54.00	-12.91	32.48	5.11	38.78	35.28	Average	100	348	VERTICAL

Temperature	24.5°C	Humidity	57%
Test Engineer	Wen Chao	Configurations	IEEE 802.11a CH 157 / Ant. 2 + Ant. 3
Test Date	Nov. 20, 2012		

Horizontal

	Freq	Level	Limit Line	Over Limit	Read Level	CableAntenna Loss	Antenna Factor	Preamp Factor	Remark	A/Pos	T/Pos	Pol/Phase
	MHz	dBuV/m	dBuV/m	dB	dBuV	dB	dB/m	dB		cm	deg	
1	11569.09	52.56	74.00	-21.44	43.90	5.13	38.83	35.30	Peak	100	15	HORIZONTAL
2	11572.42	39.37	54.00	-14.63	30.70	5.14	38.83	35.30	Average	100	15	HORIZONTAL

Vertical

	Freq	Level	Limit Line	Over Limit	Read Level	CableAntenna Loss	Antenna Factor	Preamp Factor	Remark	A/Pos	T/Pos	Pol/Phase
	MHz	dBuV/m	dBuV/m	dB	dBuV	dB	dB/m	dB		cm	deg	
1	11571.41	40.01	54.00	-13.99	31.34	5.14	38.83	35.30	Average	100	190	VERTICAL
2	11572.02	52.97	74.00	-21.03	44.30	5.14	38.83	35.30	Peak	100	190	VERTICAL

Temperature	24.5°C	Humidity	57%
Test Engineer	Wen Chao	Configurations	IEEE 802.11a CH 165 / Ant. 2 + Ant. 3
Test Date	Nov. 20, 2012		

Horizontal

	Freq	Level	Limit Line	Over Limit	Read Level	CableAntenna Loss	Antenna Factor	Preamp Factor	Remark	A/Pos	T/Pos	Pol/Phase
	MHz	dBuV/m	dBuV/m	dB	dBuV	dB	dB/m	dB		cm	deg	
1	11640.04	50.60	74.00	-23.40	41.88	5.16	38.86	35.30	Peak	100	260	HORIZONTAL
2	11659.72	37.70	54.00	-16.30	28.98	5.16	38.86	35.30	Average	100	260	HORIZONTAL

Vertical

	Freq	Level	Limit Line	Over Limit	Read Level	CableAntenna Loss	Antenna Factor	Preamp Factor	Remark	A/Pos	T/Pos	Pol/Phase
	MHz	dBuV/m	dBuV/m	dB	dBuV	dB	dB/m	dB		cm	deg	
1	11651.28	38.38	54.00	-15.62	29.66	5.16	38.86	35.30	Average	100	11	VERTICAL
2	11658.92	50.58	74.00	-23.42	41.86	5.16	38.86	35.30	Peak	100	11	VERTICAL

Note:

The amplitude of spurious emissions that are attenuated by more than 20dB below the permissible value has no need to be reported.

Emission level (dBuV/m) = 20 log Emission level (uV/m).

Corrected Reading: Antenna Factor + Cable Loss + Read Level - Preamp Factor = Level.

4.6. Band Edge Emissions Measurement

4.6.1. Limit

30dBc in any 100 kHz bandwidth outside the operating frequency band. In case the emission fall within the restricted band specified on 15.205(a), then the 15.209(a) limit in the table below has to be followed.

Frequencies (MHz)	Field Strength (micorvolts/meter)	Measurement Distance (meters)
0.009~0.490	2400/F(KHz)	300
0.490~1.705	24000/F(KHz)	30
1.705~30.0	30	30
30~88	100	3
88~216	150	3
216~960	200	3
Above 960	500	3

4.6.2. Measuring Instruments and Setting

Please refer to section 5 of equipments list in this report. The following table is the setting of the spectrum analyzer.

Spectrum Parameter	Setting
Attenuation	Auto
Span Frequency	100 MHz
RB / VB (Emission in restricted band)	1MHz / 3MHz for Peak, 1 MHz / 10Hz for Average
RB / VB (Emission in non-restricted band)	100 KHz / 300 KHz for Peak

4.6.3. Test Procedures

- The test procedure is the same as section 4.5.3, only the frequency range investigated is limited to 100MHz around bandedges.

4.6.4. Test Setup Layout

This test setup layout is the same as that shown in section 4.5.4.

4.6.5. Test Deviation

There is no deviation with the original standard.

4.6.6. EUT Operation during Test

The EUT was programmed to be in continuously transmitting mode.

4.6.7. Test Result of Band Edge and Fundamental Emissions

Temperature	24.5°C	Humidity	57%
Test Engineer	Wen Chao	Configurations	IEEE 802.11n MCS0 20MHz Ch 1, 6, 11 / Ant. 0 + Ant. 1
Test Date	Nov. 30, 2012		

Channel 1

	Freq	Level	Limit Line	Over Limit	Read Level	Cable Loss	Preamp Factor	Antenna Factor	T/Pos	A/Pos	Remark	Pol/Phase
	MHz	dBuV/m	dBuV/m	dB	dBuV	dB	dB	dB/m	deg	cm		
1 !	2390.00	72.68	74.00	-1.32	40.29	4.34	0.00	28.05	265	101	Peak	VERTICAL
2 !	2390.00	53.90	54.00	-0.10	21.51	4.34	0.00	28.05	265	101	Average	VERTICAL
3 p	2410.72	109.55	74.00			4.34	0.00	28.09	265	101	Peak	VERTICAL
4 a	2410.72	98.74	54.00			4.34	0.00	28.09	265	101	Average	VERTICAL

Item 3, 4 are the fundamental frequency at 2412 MHz.

Channel 6

	Freq	Level	Limit Line	Over Limit	Read Level	Cable Loss	Antenna Factor	Preamp Factor	Remark	A/Pos	T/Pos	Pol/Phase
	MHz	dBuV/m	dBuV/m	dB	dBuV	dB	dB/m	dB		cm	deg	
1	2389.68	67.19	74.00	-6.81	36.81	2.21	28.17	0.00	Peak	100	338	HORIZONTAL
2	2390.00	52.05	54.00	-1.95	21.66	2.22	28.17	0.00	Average	100	338	HORIZONTAL
3	2437.32	105.43	54.00			2.23	28.29	0.00	Average	100	338	HORIZONTAL
4	2437.32	115.91	74.00			2.23	28.29	0.00	Peak	100	338	HORIZONTAL
5	2484.46	53.19	54.00	-0.81	22.55	2.26	28.38	0.00	Average	100	338	HORIZONTAL
6	2484.46	70.61	74.00	-3.39	39.97	2.26	28.38	0.00	Peak	100	338	HORIZONTAL

Item 3, 4 are the fundamental frequency at 2437MHz.

Channel 11

	Freq	Level	Limit Line	Over Limit	Read Level	Cable Loss	Preamp Factor	Antenna Factor	T/Pos	A/Pos	Remark	Pol/Phase
	MHz	dBuV/m	dBuV/m	dB	dBuV	dB	dB	dB/m	deg	cm		
1 a	2461.04	96.08	54.00			4.38	0.00	28.22	262	100	Average	VERTICAL
2 p	2461.36	106.58	74.00			4.38	0.00	28.22	262	100	Peak	VERTICAL
3 !	2483.50	53.15	54.00	-0.85	20.49	4.40	0.00	28.26	262	100	Average	VERTICAL
4 !	2483.66	69.17	74.00	-4.83	36.51	4.40	0.00	28.26	262	100	Peak	VERTICAL

Item 1, 2 are the fundamental frequency at 2462 MHz.

Temperature	24.5°C	Humidity	57%
Test Engineer	Wen Chao	Configurations	IEEE 802.11n MCS0 40MHz Ch 3, 6, 9 / Ant. 0 + Ant. 1
Test Date	Nov. 30, 2012		

Channel 3

	Freq	Level	Limit Line	Over Limit	Read Level	Cable Loss	Preamp Factor	Antenna Factor	T/Pos	A/Pos	Remark	Pol/Phase
	MHz	dBuV/m	dBuV/m	dB	dBuV	dB	dB	dB/m	deg	cm		
1	! 2388.72	69.34	74.00	-4.66	36.95	4.34	0.00	28.05	342	100	Peak	HORIZONTAL
2	! 2390.00	53.32	54.00	-0.68	20.93	4.34	0.00	28.05	342	100	Average	HORIZONTAL
3	p 2420.72	107.37	74.00			4.36	0.00	28.13	342	100	Peak	HORIZONTAL
4	a 2423.92	95.21	54.00			4.36	0.00	28.13	342	100	Average	HORIZONTAL

Item 3, 4 are the fundamental frequency at 2422 MHz.

Channel 6

	Freq	Level	Limit Line	Over Limit	Read Level	Cable Loss	Antenna Factor	Preamp Factor	Remark	A/Pos	T/Pos	Pol/Phase
	MHz	dBuV/m	dBuV/m	dB	dBuV	dB	dB/m	dB		cm	deg	
1	2389.36	53.85	54.00	-0.15	23.47	2.21	28.17	0.00	Average	100	322	HORIZONTAL
2	2390.00	71.79	74.00	-2.21	41.40	2.22	28.17	0.00	Peak	100	322	HORIZONTAL
3	2438.60	97.23	54.00			2.23	28.29	0.00	Average	100	322	HORIZONTAL
4	2438.60	109.72	74.00			2.23	28.29	0.00	Peak	100	322	HORIZONTAL
5	2483.50	52.54	54.00	-1.46	21.90	2.26	28.38	0.00	Average	100	322	HORIZONTAL
6	2483.50	69.29	74.00	-4.71	38.65	2.26	28.38	0.00	Peak	100	322	HORIZONTAL

Item 3, 4 are the fundamental frequency at 2437MHz.

Channel 9

	Freq	Level	Limit Line	Over Limit	Read Level	Cable Loss	Preamp Factor	Antenna Factor	T/Pos	A/Pos	Remark	Pol/Phase
	MHz	dBuV/m	dBuV/m	dB	dBuV	dB	dB	dB/m	deg	cm		
1	a 2450.08	96.00	54.00			4.38	0.00	28.18	341	100	Average	HORIZONTAL
2	p 2450.72	108.49	74.00			4.38	0.00	28.18	341	100	Peak	HORIZONTAL
3	! 2484.78	53.94	54.00	-0.06	21.28	4.40	0.00	28.26	341	100	Average	HORIZONTAL
4	! 2489.59	70.85	74.00	-3.15	38.13	4.42	0.00	28.30	341	100	Peak	HORIZONTAL

Item 1, 2 are the fundamental frequency at 2452 MHz.

Note:

Emission level (dBuV/m) = 20 log Emission level (uV/m).

Corrected Reading: Antenna Factor + Cable Loss + Read Level - Preamp Factor = Level.

Temperature	24.5°C	Humidity	57%
Test Engineer	Wen Chao	Configurations	IEEE 802.11b CH 1, 6, 11 / Ant. 0
Test Date	Nov. 30, 2012		

Channel 1

	Freq	Level	Limit	Over	Read	Cable	Preamp	Antenna	T/Pos	A/Pos	Remark	Pol/Phase
	MHz	dBuV/m	dBuV/m	dB	dBuV	dB	dB	dB/m	deg	cm		
1	2389.36	62.29	74.00	-11.71	29.90	4.34	0.00	28.05	268	105	Peak	VERTICAL
2	2390.00	52.46	54.00	-1.54	20.07	4.34	0.00	28.05	268	105	Average	VERTICAL
3	2411.04	111.08	74.00			4.34	0.00	28.09	268	105	Peak	VERTICAL
4	2411.20	107.62	54.00			4.34	0.00	28.09	268	105	Average	VERTICAL

Item 3, 4 are the fundamental frequency at 2412 MHz.

Channel 6

	Freq	Level	Limit	Over	Read	Cable	Antenna	Preamp	Remark	A/Pos	T/Pos	Pol/Phase
	MHz	dBuV/m	dBuV/m	dB	dBuV	dB	dB/m	dB		cm	deg	
1	2389.36	55.68	74.00	-18.32	25.30	2.21	28.17	0.00	Peak	100	356	HORIZONTAL
2	2390.00	43.65	54.00	-10.35	13.26	2.22	28.17	0.00	Average	100	356	HORIZONTAL
3	2436.04	111.64	74.00			2.23	28.29	0.00	Peak	100	356	HORIZONTAL
4	2436.20	107.76	54.00			2.23	28.29	0.00	Average	100	356	HORIZONTAL
5	2483.50	40.96	54.00	-13.04	10.32	2.26	28.38	0.00	Average	100	356	HORIZONTAL
6	2483.50	51.00	74.00	-23.00	20.36	2.26	28.38	0.00	Peak	100	356	HORIZONTAL

Item 3, 4 are the fundamental frequency at 2437 MHz.

Channel 11

	Freq	Level	Limit	Over	Read	Cable	Preamp	Antenna	T/Pos	A/Pos	Remark	Pol/Phase
	MHz	dBuV/m	dBuV/m	dB	dBuV	dB	dB	dB/m	deg	cm		
1	2461.20	104.38	54.00			4.38	0.00	28.22	280	100	Average	VERTICAL
2	2462.96	108.23	74.00			4.40	0.00	28.22	280	100	Peak	VERTICAL
3	2483.50	53.52	54.00	-0.48	20.86	4.40	0.00	28.26	280	100	Average	VERTICAL
4	2484.14	63.95	74.00	-10.05	31.29	4.40	0.00	28.26	280	100	Peak	VERTICAL

Item 1, 2 are the fundamental frequency at 2462 MHz.

Temperature	24.5°C	Humidity	57%
Test Engineer	Wen Chao	Configurations	IEEE 802.11g CH 1, 6, 11 / Ant. 0 + Ant. 1
Test Date	Nov. 30, 2012		

Channel 1

	Freq	Level	Limit	Over	Read	Cable	Preamp	Antenna	T/Pos	A/Pos	Remark	Pol/Phase
	MHz	dBuV/m	dBuV/m	dB	dBuV	dB	dB	dB/m	deg	cm		
1 !	2388.72	70.48	74.00	-3.52	38.09	4.34	0.00	28.05	350	100	Peak	HORIZONTAL
2 !	2390.00	53.88	54.00	-0.12	21.49	4.34	0.00	28.05	350	100	Average	HORIZONTAL
3 p	2412.64	113.64	74.00			4.36	0.00	28.09	350	100	Peak	HORIZONTAL
4 a	2412.64	102.93	54.00			4.36	0.00	28.09	350	100	Average	HORIZONTAL

Item 3, 4 are the fundamental frequency at 2412 MHz.

Channel 6

	Freq	Level	Limit	Over	Read	Cable	Antenna	Preamp	Remark	A/Pos	T/Pos	Pol/Phase
	MHz	dBuV/m	dBuV/m	dB	dBuV	dB	dB/m	dB		cm	deg	
1	2388.72	51.62	54.00	-2.38	21.24	2.21	28.17	0.00	Average	100	340	HORIZONTAL
2	2388.72	67.46	74.00	-6.54	37.08	2.21	28.17	0.00	Peak	100	340	HORIZONTAL
3	2437.64	107.08	54.00			2.23	28.29	0.00	Average	100	340	HORIZONTAL
4	2437.64	116.69	74.00			2.23	28.29	0.00	Peak	100	340	HORIZONTAL
5	2486.39	53.62	54.00	-0.38	22.94	2.26	28.42	0.00	Average	100	340	HORIZONTAL
6	2487.67	70.04	74.00	-3.96	39.36	2.26	28.42	0.00	Peak	100	340	HORIZONTAL

Item 3, 4 are the fundamental frequency at 2437 MHz.

Channel 11

	Freq	Level	Limit	Over	Read	Cable	Preamp	Antenna	T/Pos	A/Pos	Remark	Pol/Phase
	MHz	dBuV/m	dBuV/m	dB	dBuV	dB	dB	dB/m	deg	cm		
1 a	2462.48	101.56	54.00			4.38	0.00	28.22	349	100	Average	HORIZONTAL
2 p	2467.77	112.41	74.00			4.40	0.00	28.22	349	100	Peak	HORIZONTAL
3 !	2483.50	53.94	54.00	-0.06	21.28	4.40	0.00	28.26	349	100	Average	HORIZONTAL
4 !	2483.98	72.72	74.00	-1.28	40.06	4.40	0.00	28.26	349	100	Peak	HORIZONTAL

Item 1, 2 are the fundamental frequency at 2462 MHz.

Note:

Emission level (dBuV/m) = 20 log Emission level (uV/m).

Corrected Reading: Antenna Factor + Cable Loss + Read Level - Preamp Factor = Level.

For Emission not in Restricted Band

Plot on Configuration IEEE 802.11n MCS0 20MHz / Reference Level

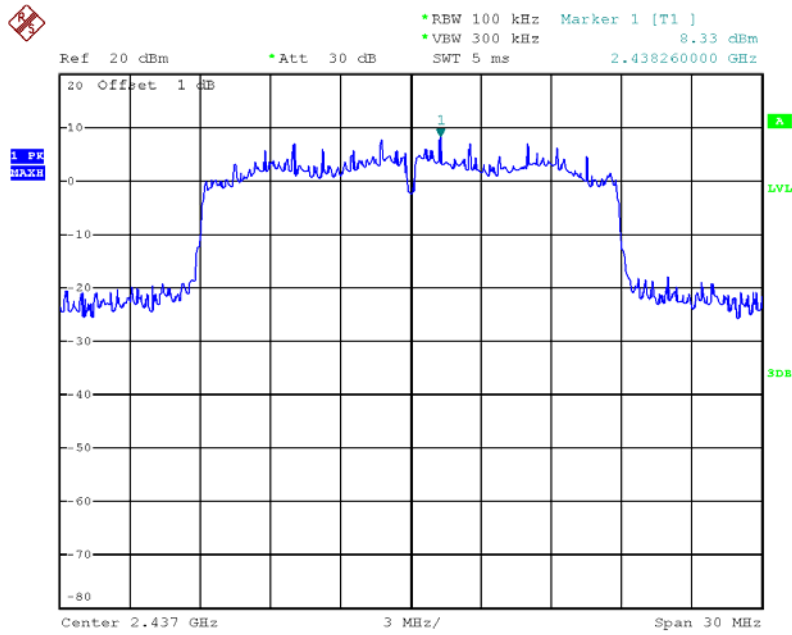

Date: 30.NOV.2012 17:24:12

Plot on Configuration IEEE 802.11n MCS0 20MHz / CH 1 (down 30dBc)

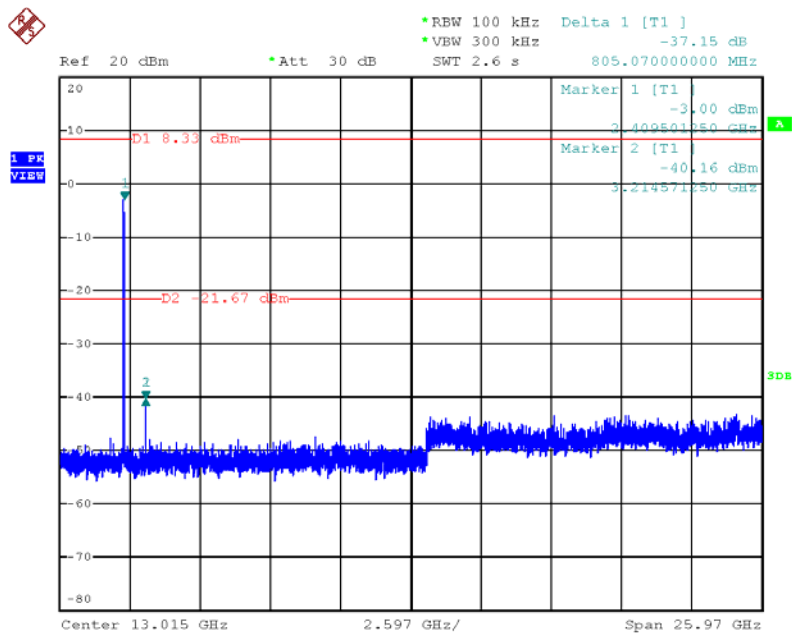

Date: 30.NOV.2012 17:47:16

Plot on Configuration IEEE 802.11n MCS0 20MHz / CH 6 (down 30dBc)

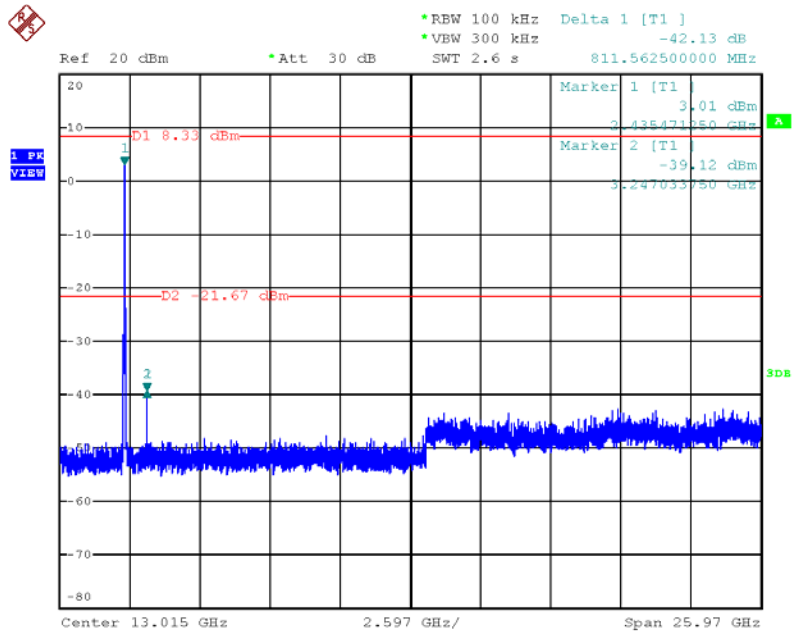

Date: 30.NOV.2012 17:47:44

Plot on Configuration IEEE 802.11n MCS0 20MHz / CH 11 (down 30dBc)

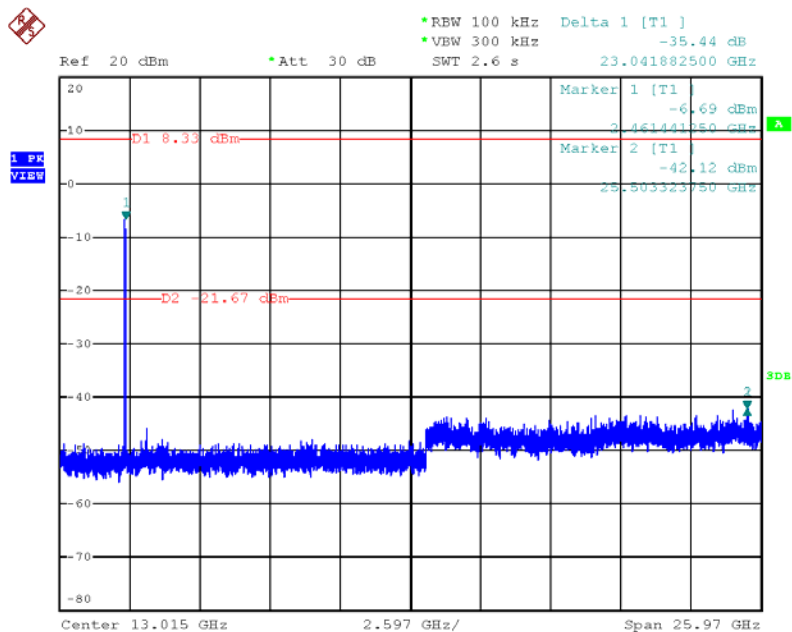

Date: 30.NOV.2012 17:48:19

Plot on Configuration IEEE 802.11n MCS0 40MHz / Reference Level

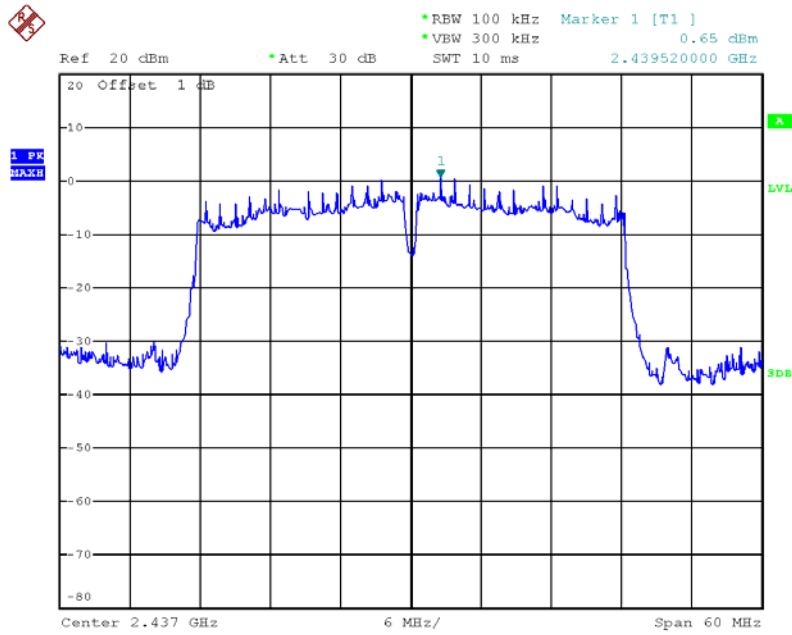

Date: 30.NOV.2012 17:26:12

Plot on Configuration IEEE 802.11n MCS0 40MHz / CH 3 (down 30dBc)

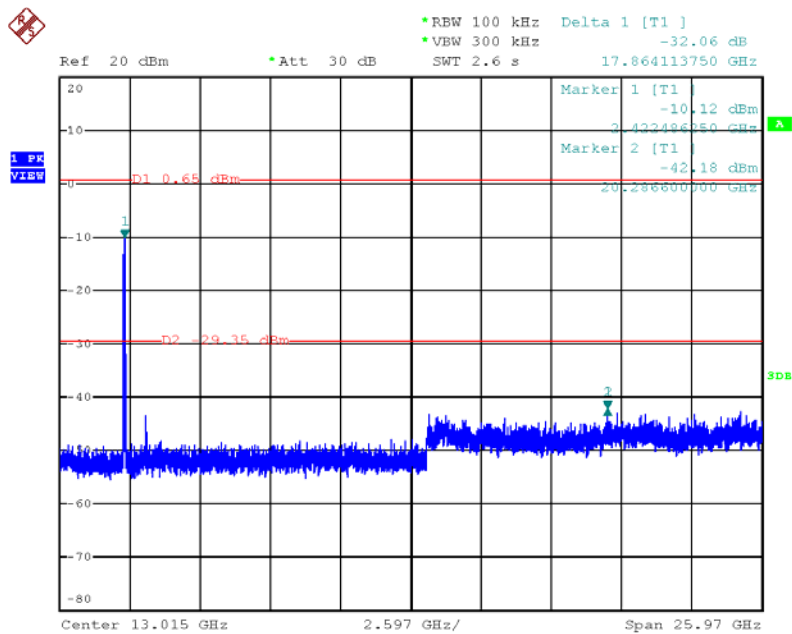

Date: 30.NOV.2012 17:49:37

Plot on Configuration IEEE 802.11n MCS0 40MHz / CH 6 (down 30dBc)

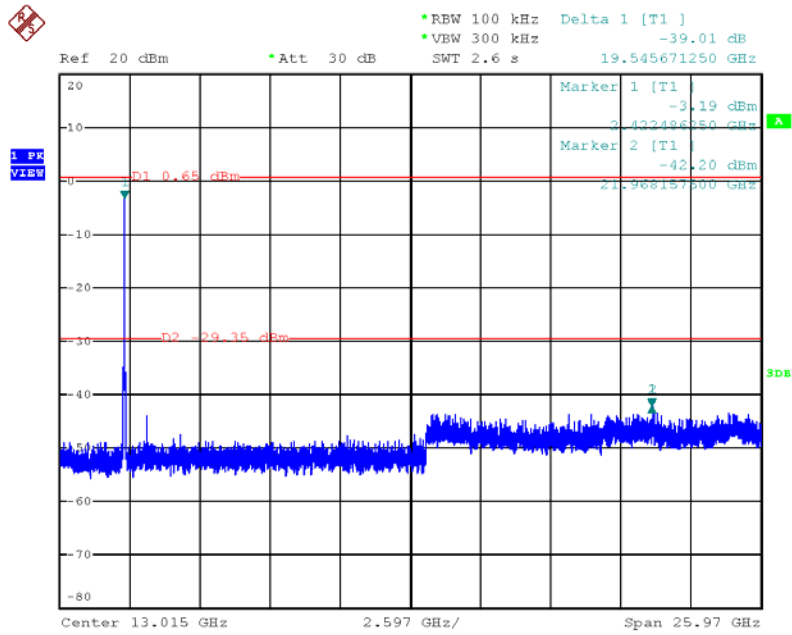

Date: 30.NOV.2012 17:50:05

Plot on Configuration IEEE 802.11n MCS0 40MHz / CH 9 (down 30dBc)

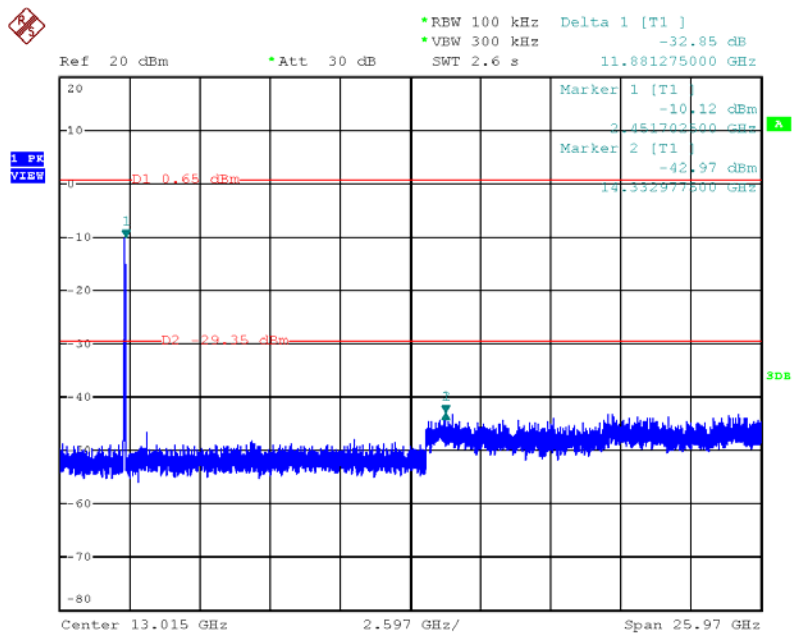

Date: 30.NOV.2012 17:50:38

Plot on Configuration IEEE 802.11n MCS0 20MHz / Reference Level

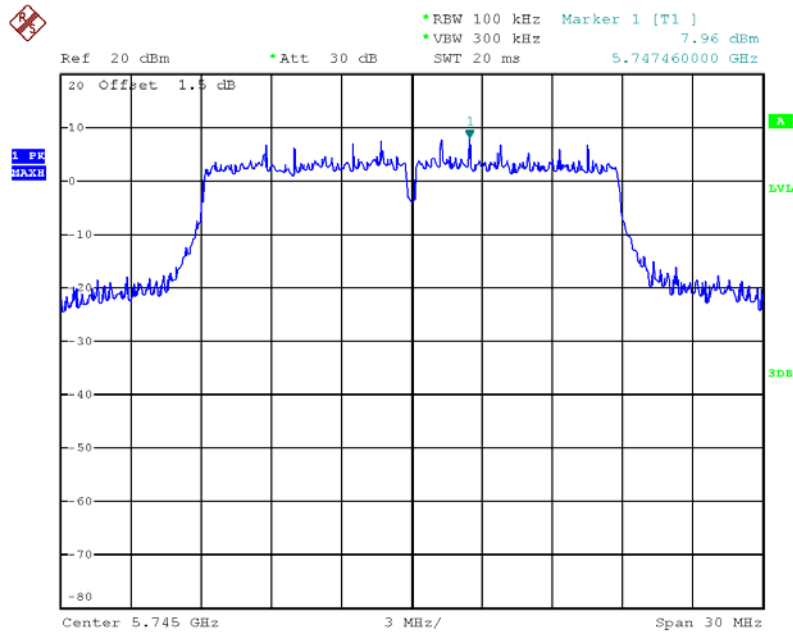

Date: 3.DEC.2012 22:22:21

Plot on Configuration IEEE 802.11n MCS0 20MHz / CH 149 (down 30dBc)

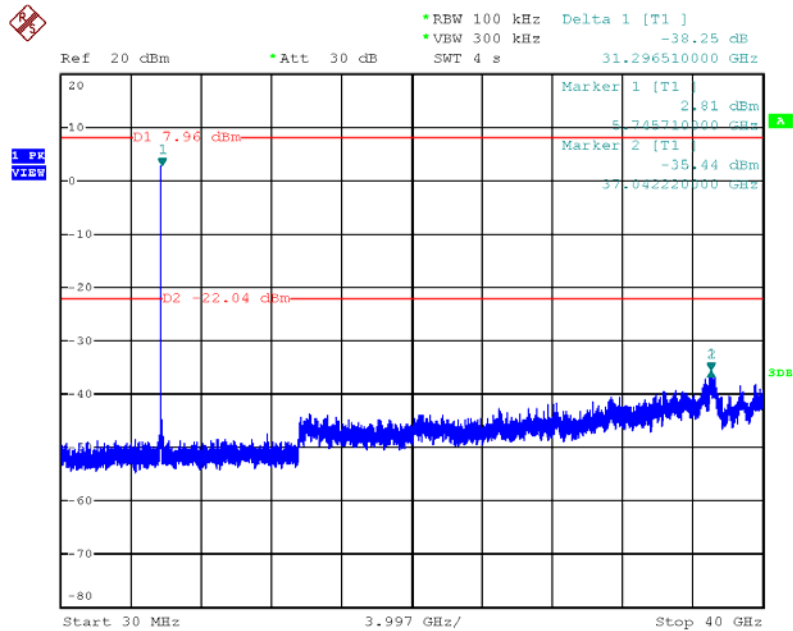

Date: 3.DEC.2012 22:37:01

Plot on Configuration IEEE 802.11n MCS0 20MHz / CH 157 (down 30dBc)

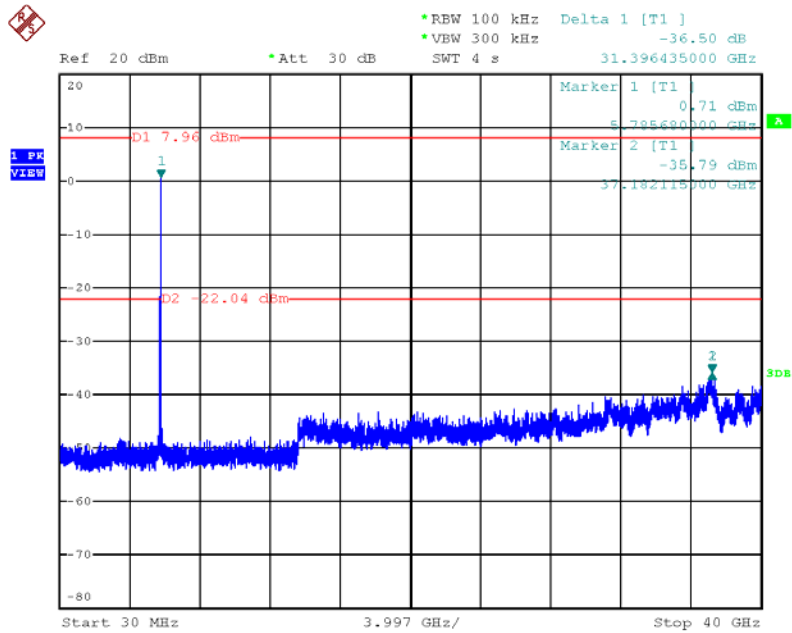

Date: 3.DEC.2012 22:37:24

Plot on Configuration IEEE 802.11n MCS0 20MHz / CH 165 (down 30dBc)

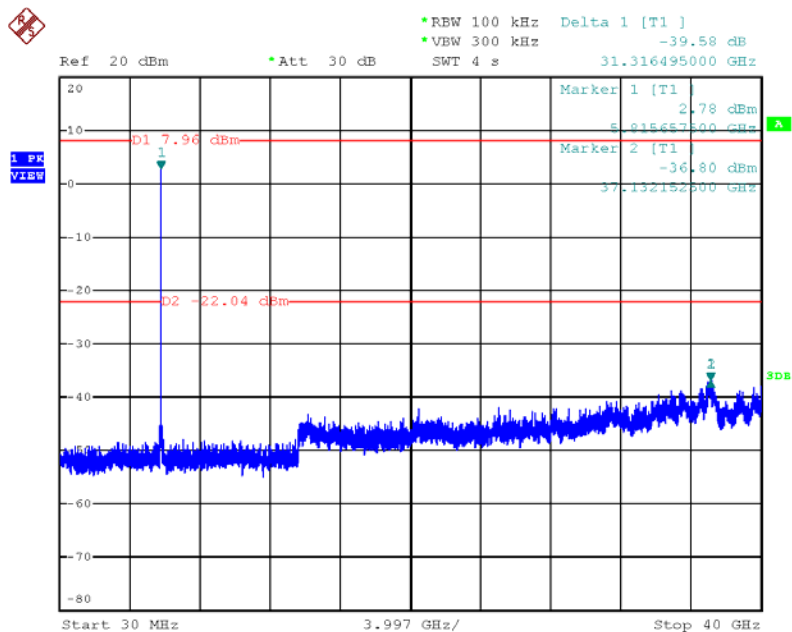

Date: 3.DEC.2012 22:37:47

Plot on Configuration IEEE 802.11n MCS0 40MHz / Reference Level

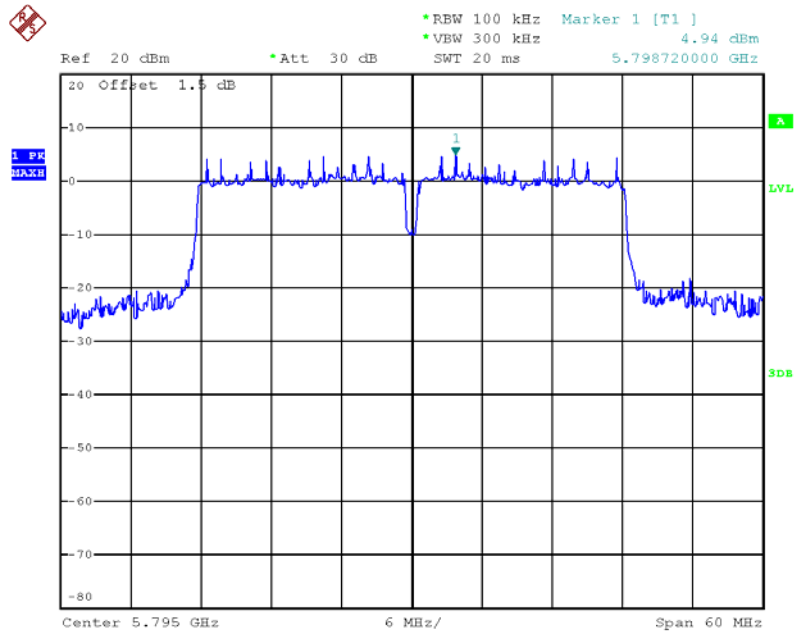

Date: 3.DEC.2012 22:24:06

Plot on Configuration IEEE 802.11n MCS0 40MHz / CH 151 (down 30dBc)

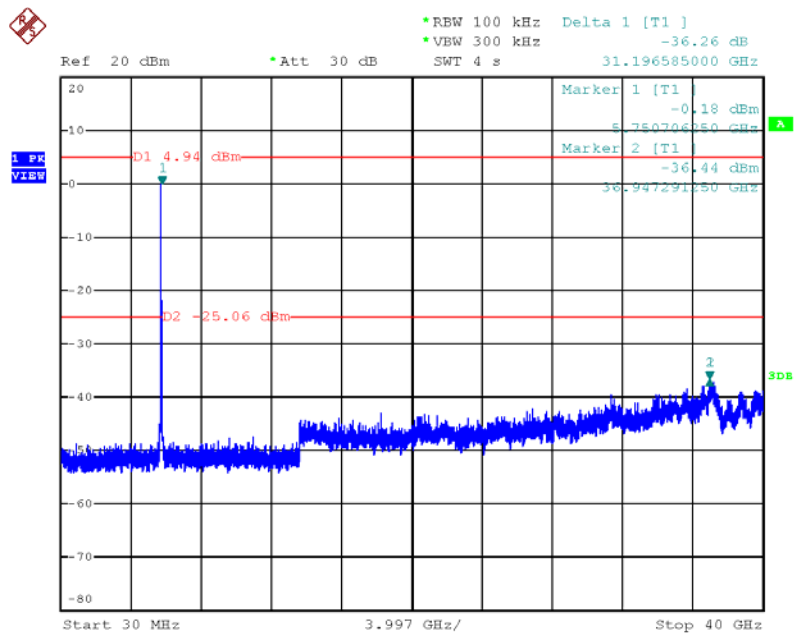

Date: 3.DEC.2012 22:40:20

Plot on Configuration IEEE 802.11n MCS0 40MHz / CH 159 (down 30dBc)

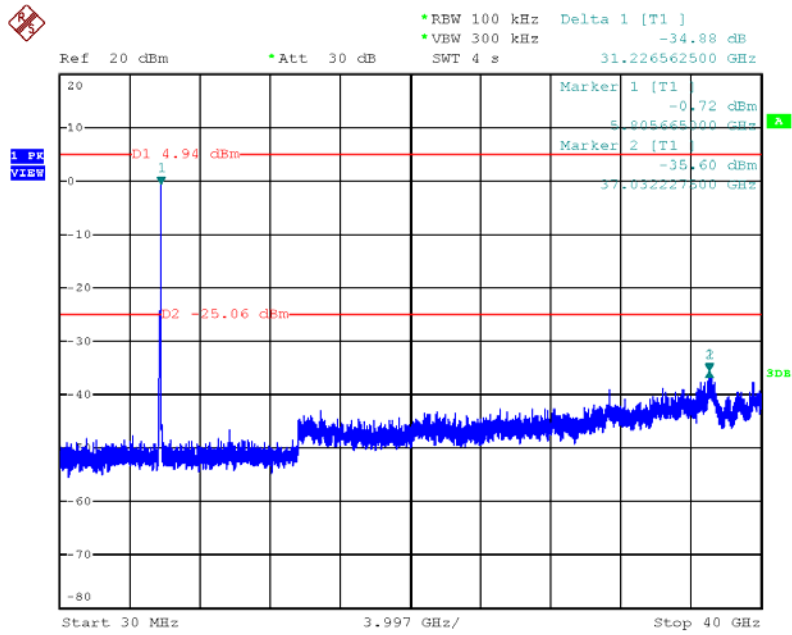

Date: 3.DEC.2012 22:40:44

Plot on Configuration IEEE 802.11b / Reference Level

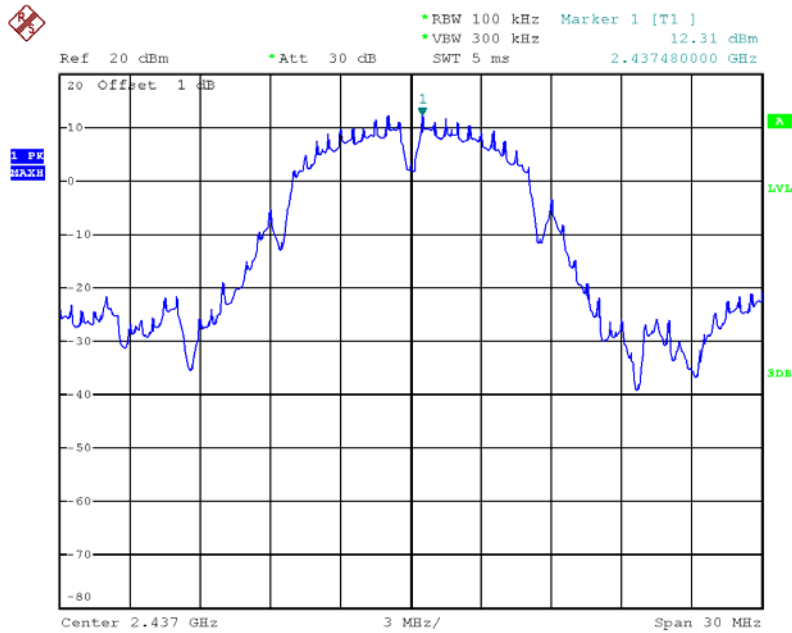

Date: 30.NOV.2012 17:19:38

Plot on Configuration IEEE 802.11b / CH 1 (down 30dBc)

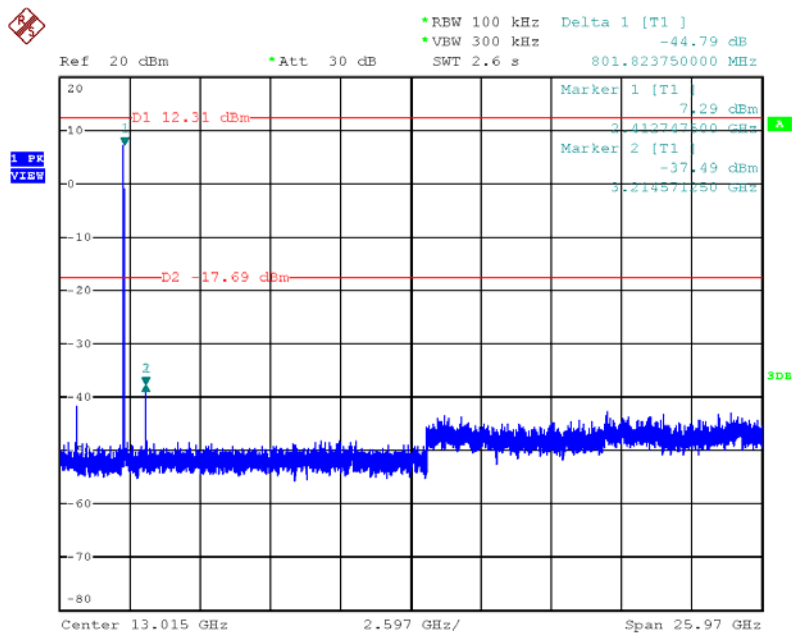

Date: 30.NOV.2012 17:39:56

Plot on Configuration IEEE 802.11b / CH 6 (down 30dBc)

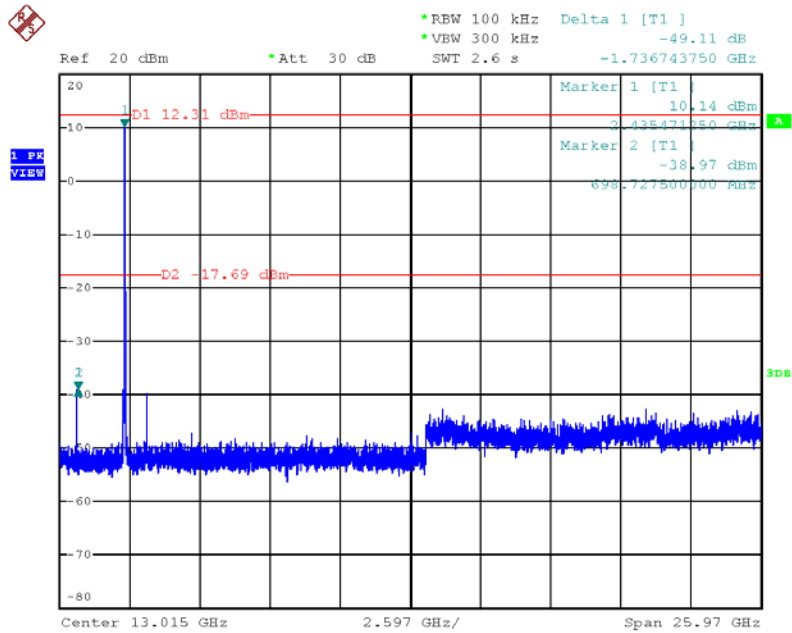

Date: 30.NOV.2012 17:40:34

Plot on Configuration IEEE 802.11b / CH 11 (down 30dBc)

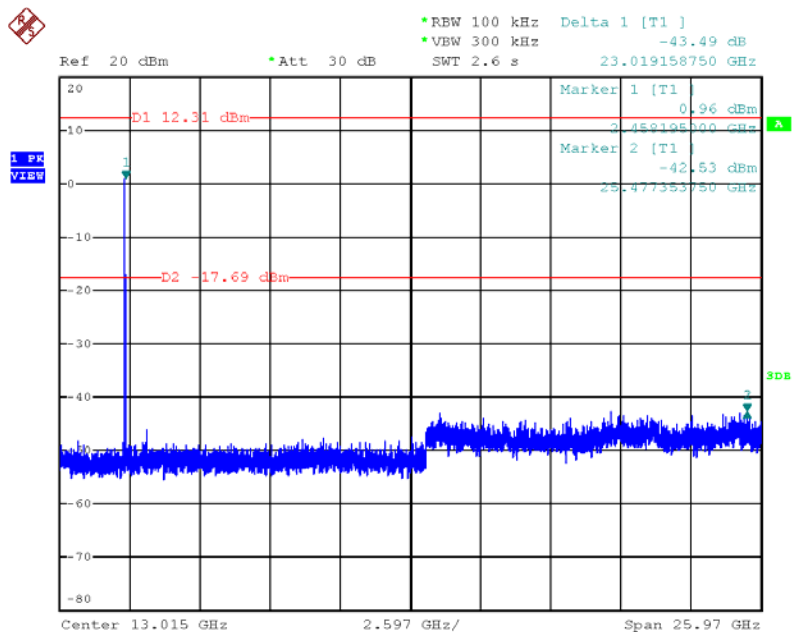

Date: 30.NOV.2012 17:41:12

Plot on Configuration IEEE 802.11g / Reference Level

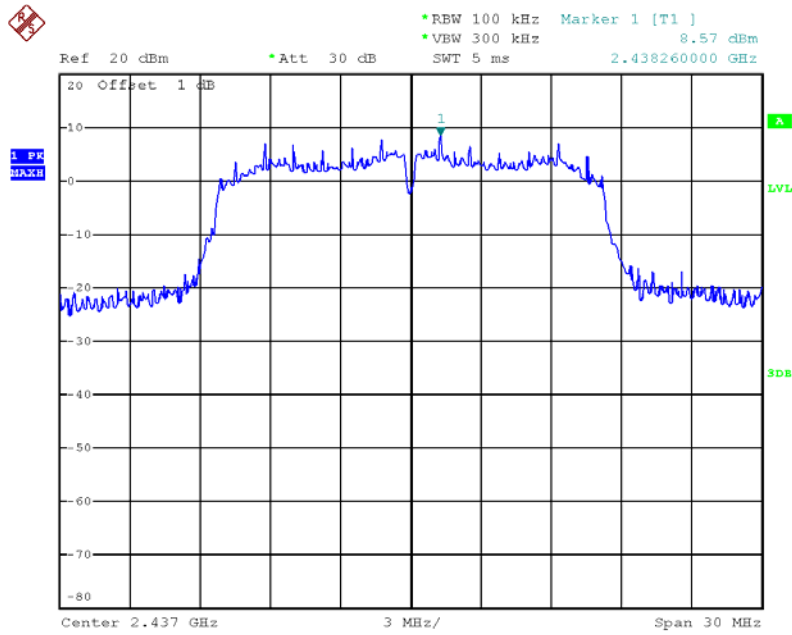

Date: 30.NOV.2012 17:21:40

Plot on Configuration IEEE 802.11g / CH 1 (down 30dBc)

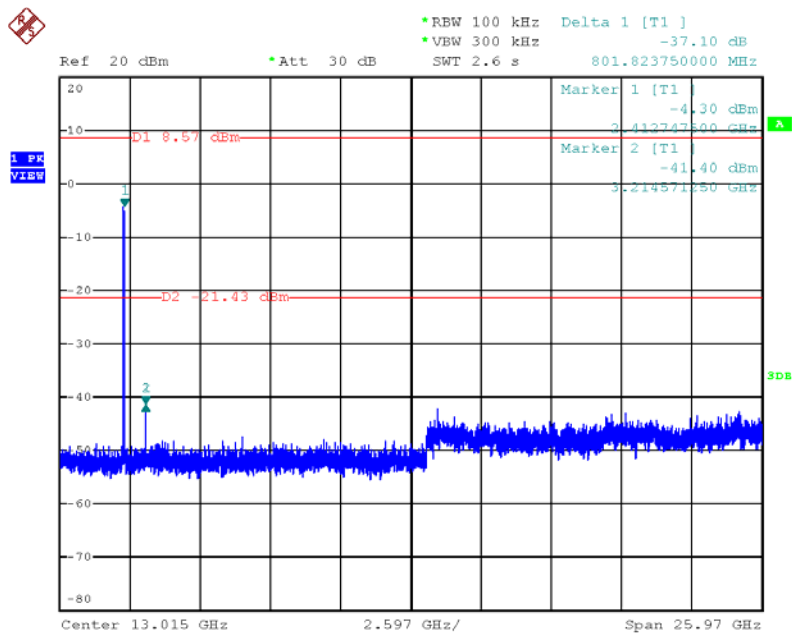

Date: 30.NOV.2012 17:42:32

Plot on Configuration IEEE 802.11g / CH 6 (down 30dBc)

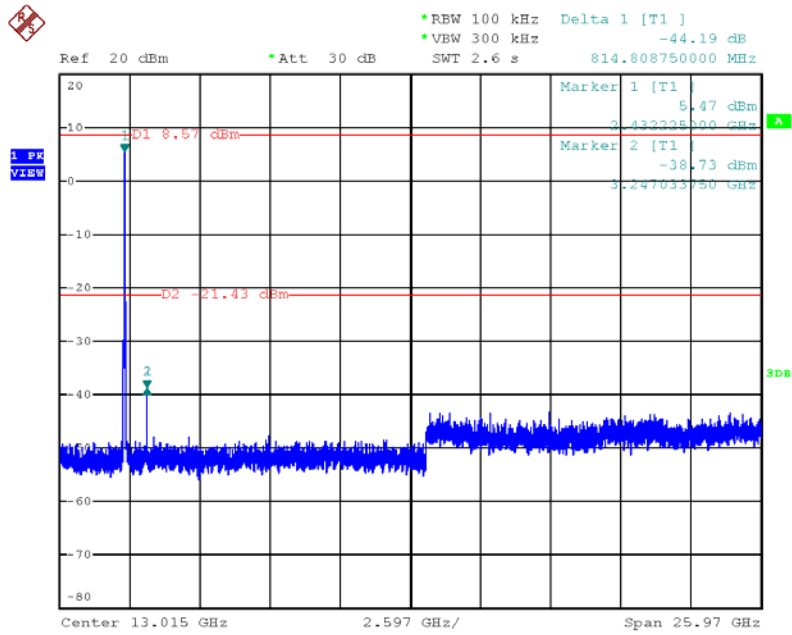

Date: 30.NOV.2012 17:44:45

Plot on Configuration IEEE 802.11g / CH 11 (down 30dBc)

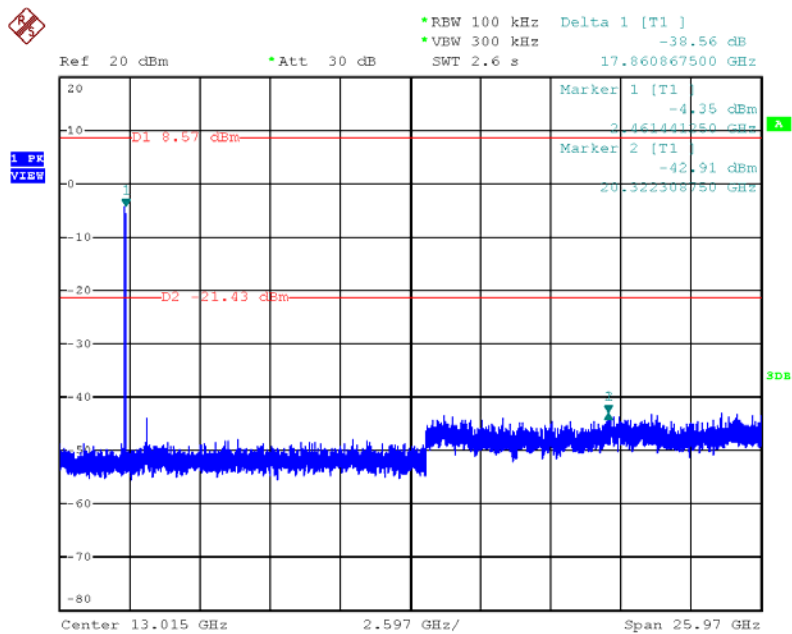

Date: 30.NOV.2012 17:45:35

Plot on Configuration IEEE 802.11a / Reference Level

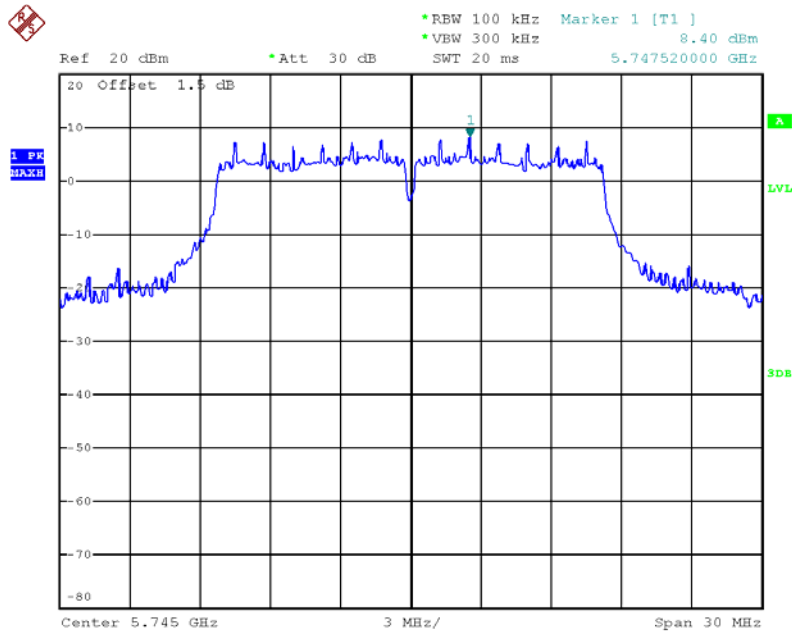

Date: 3.DEC.2012 22:19:36

Plot on Configuration IEEE 802.11a / CH 149 (down 30dBc)

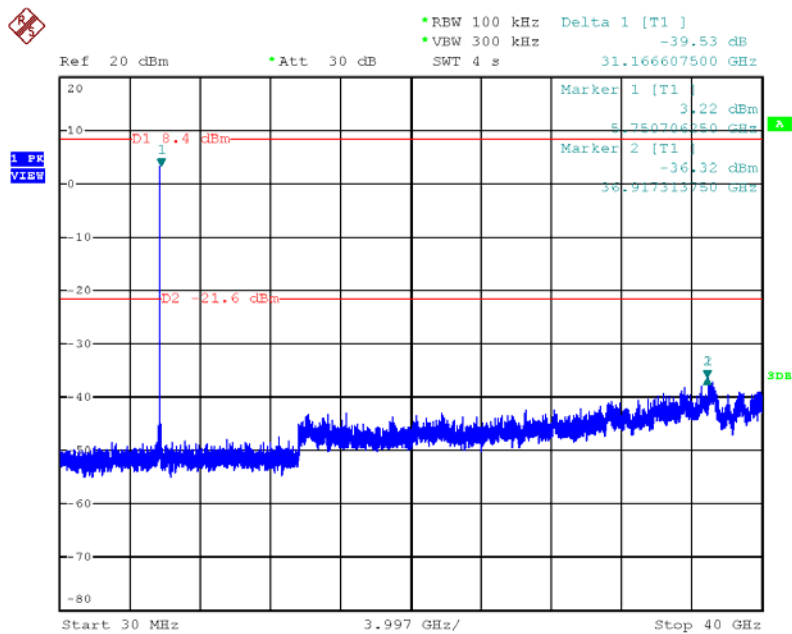

Date: 3.DEC.2012 22:34:57

Plot on Configuration IEEE 802.11a / CH 157 (down 30dBc)

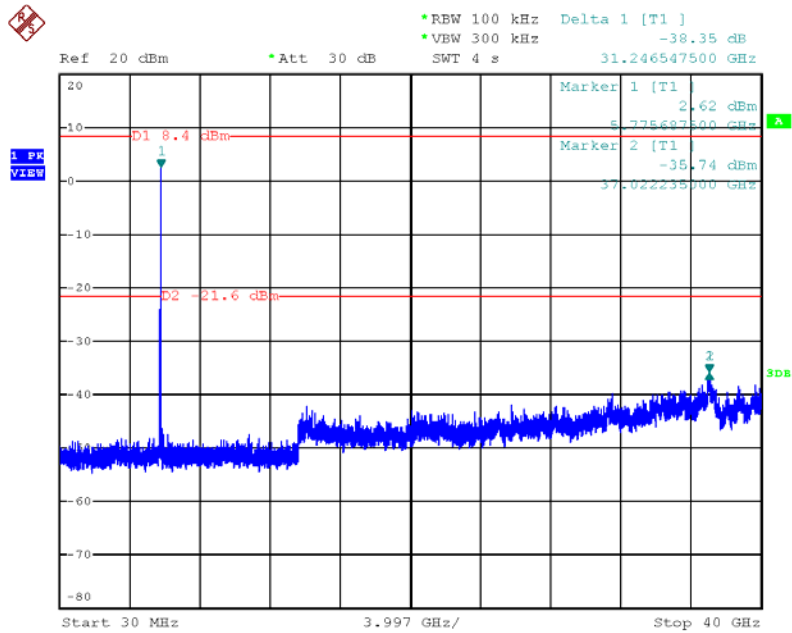

Date: 3.DEC.2012 22:35:20

Plot on Configuration IEEE 802.11a / CH 165 (down 30dBc)

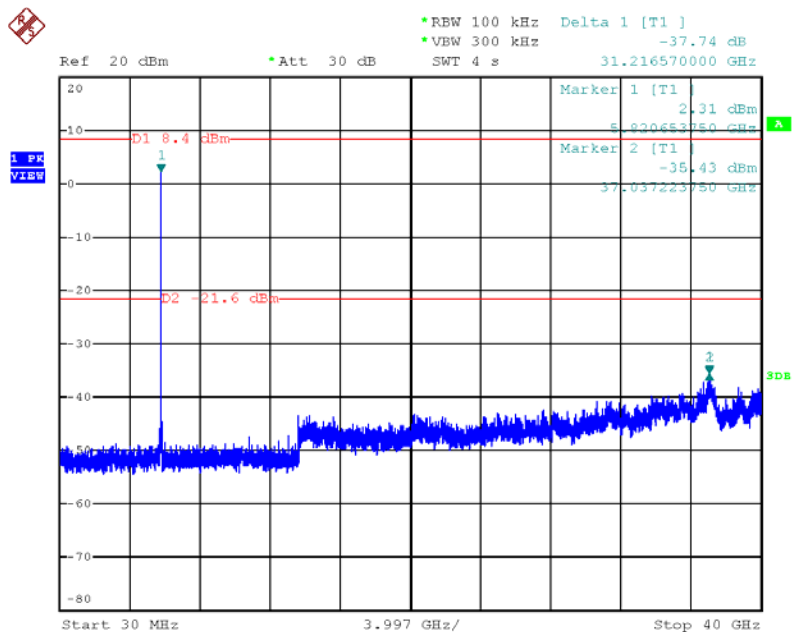

Date: 3.DEC.2012 22:35:44

4.7. Antenna Requirements

4.7.1. Limit

Except for special regulations, the Low-power Radio-frequency Devices must not be equipped with any jacket for installing an antenna with extension cable. An intentional radiator shall be designed to ensure that no antenna other than that furnished by the responsible party shall be used with the device. The use of a permanently attached antenna or of an antenna that uses a unique coupling to the intentional radiator shall be considered sufficient to comply with the provisions of this Section. The manufacturer may design the unit so that the user can replace a broken antenna, but the use of a standard antenna jack or electrical connector is prohibited. Further, this requirement does not apply to intentional radiators that must be professionally installed.

4.7.2. Antenna Connector Construction

Please refer to section 3.3 in this test report; antenna connector complied with the requirements.

5. LIST OF MEASURING EQUIPMENTS

Instrument	Manufacturer	Model No.	Serial No.	Characteristics	Calibration Date	Remark
EMI Test Receiver	R&S	ESCS 30	100377	9kHz ~ 2.75GHz	Oct. 23, 2012	Conduction (CO01-CB)
LISN	F.C.C.	FCC-LISN-50-16-2	04083	150kHz ~ 100MHz	Nov.26, 2012	Conduction (CO01-CB)
V- LISN	Schwarzbeck	NSLK 8127	8127-478	9kHz ~ 30MHz	Jun. 22, 2012	Conduction (CO01-CB)
Capacitive Voltage Probe	SCHAFFNER	CVP2200A	18697	150kHz~30MHz	Oct. 23, 2012	Conduction (CO01-CB)
RF Current Probe	SOLAR.	9208-1	041039	9kHz~30MHz	Sep. 18, 2012	Conduction (CO01-CB)
Impulsbegrenzer Pulse Limiter	Rohde&Schwarz	ESH3-Z2	100430	9kHz~30MHz	Feb. 03, 2012	Conduction (CO01-CB)
Impedance stabilization network	TESEQ	ISN T400A	24854	150kHz ~ 230MHz	Oct. 22, 2012	Conduction (CO01-CB)
Impedance stabilization network	TESEQ	ISN T800	24557	150kHz ~ 230MHz	Oct. 22, 2012	Conduction (CO01-CB)
Coupling Decoupling Network	TESEQ	ST08	24348	150kHz ~ 230MHz	Dec. 03, 2012	Conduction (CO01-CB)
Current Probe	Kyoritsu	KCT-2504	8S-2773-6	0.1MHz~30MHz	Feb. 08, 2012	Conduction (CO01-CB)
T-ISN	Kyoritsu	KNW-2242	8S-2802-5	0.15MHz~30MHz	Sep. 18, 2012	Conduction (CO01-CB)
EM Koppelzange	TESEQ	KEMZ 801	17029	0.15MHz~30MHz	Sep. 19, 2012	Conduction (CO01-CB)
Coupling and Decoupling Network	TESEQ	ISN PLC 25-30	23390	0.15MHz~30MHz	Sep. 18, 2012	Conduction (CO01-CB)
Coupling and Decoupling Network	TESEQ	ISN PLC 25-25	26476	0.15MHz~30MHz	Feb. 09, 2012	Conduction (CO01-CB)
COND Cable	Woken	Cable	01	0.15MHz~30MHz	Dec. 4, 2012	Conduction (CO01-CB)
Software	Audix	E3	5.410e	----	----	Conduction (CO01-CB)
Signal analyzer	R&S	FSV40	100979	9KHz~40GHz	Oct. 08, 2012	Conducted (TH01-CB)
Temp. and Humidity Chamber	Ten Billion	TTH-D3SP	TBN-931011	-30~100 degree	Jun. 05, 2012	Conducted (TH01-CB)
RF Power Divider	HP	11636A	00306	2GHz ~ 18GHz	N/A	Conducted (TH01-CB)
RF Power Splitter	Anaren	44100	1839	2GHz ~ 18GHz	N/A	Conducted (TH01-CB)
RF Power Splitter	Anaren	42100	17930	2GHz ~ 18GHz	N/A	Conducted (TH01-CB)
RF Cable-high	Woken	High Cable-7	-	1 GHz – 26.5 GHz	Nov. 17, 2012	Conducted (TH01-CB)
RF Cable-high	Woken	High Cable-8	-	1 GHz – 26.5 GHz	Nov. 17, 2012	Conducted (TH01-CB)
RF Cable-high	Woken	High Cable-9	-	1 GHz – 26.5 GHz	Nov. 17, 2012	Conducted (TH01-CB)
RF Cable-high	Woken	High Cable-10	-	1 GHz – 26.5 GHz	Nov. 17, 2012	Conducted (TH01-CB)

Instrument	Manufacturer	Model No.	Serial No.	Characteristics	Calibration Date	Remark
RF Cable-high	Woken	High Cable-11	-	1 GHz – 26.5 GHz	Nov. 17, 2012	Conducted (TH01-CB)
RF Cable-high	Woken	High Cable-12	-	1 GHz – 26.5 GHz	Nov. 17, 2012	Conducted (TH01-CB)
RF Cable-high	Woken	High Cable-13	-	1 GHz – 26.5 GHz	Nov. 17, 2012	Conducted (TH01-CB)
Power Sensor	Anritsu	MA2411B	0917223	300MHz~40GHz	Oct. 31, 2012	Conducted (TH01-CB)
Power Meter	Anritsu	ML2495A	1035008	300MHz~40GHz	Oct. 31, 2012	Conducted (TH01-CB)
BILOG ANTENNA	Schaffner	CBL6112D	22021	20MHz ~ 2GHz	Jan. 11, 2012	Radiation (03CH01-CB)
Horn Antenna	EMCO	3115	00075790	750MHz~18GHz	Nov. 25, 2012	Radiation (03CH01-CB)
Horn Antenna	SCHWARZBEAK	BBHA 9170	BBHA9170252	15GHz ~ 40GHz	Nov. 22, 2012	Radiation (03CH01-CB)
Pre-Amplifier	Agilent	8447D	2944A10784	9kHz ~ 1.3GHz	Feb. 03, 2012	Radiation (03CH01-CB)
Pre-Amplifier	Agilent	8449B	3008A02310	1GHz ~ 26.5GHz	Nov. 23, 2012	Radiation (03CH01-CB)
Pre-Amplifier	WM	TF-130N-R1	923365	26.5GHz ~ 40GHz	Jul. 31, 2012	Radiation (03CH01-CB)
Spectrum analyzer	R&S	FSP40	100304	9kHz ~ 40GHz	Dec. 14, 2011	Radiation (03CH01-CB)
EMI Test Receiver	R&S	ESCS 30	100355	9KHz ~ 2.75GHz	Mar. 20, 2012	Radiation (03CH01-CB)
Loop Antenna	Teseq	HLA 6120	24155	9 kHz - 30 MHz	Oct. 29, 2012*	Radiation (03CH01-CB)
Turn Table	INN CO	CO 2000	N/A	0 ~ 360 degree	N/A	Radiation (03CH01-CB)
Antenna Mast	INN CO	CO2000	N/A	1 m - 4 m	N/A	Radiation (03CH01-CB)
RF Cable-low	Woken	Low Cable-1	N/A	30 MHz - 1 GHz	Nov. 17, 2012	Radiation (03CH01-CB)
RF Cable-high	Woken	High Cable-1	N/A	1 GHz – 26.5 GHz	Nov. 17, 2012	Radiation (03CH01-CB)
RF Cable-high	Woken	High Cable-2	N/A	1 GHz – 26.5 GHz	Nov. 17, 2012	Radiation (03CH01-CB)
RF Cable-high	Woken	High Cable-3	N/A	1 GHz - 40 GHz	Nov. 17, 2012	Radiation (03CH01-CB)
RF Cable-high	Woken	High Cable-4	N/A	1 GHz - 40 GHz	Nov. 17, 2012	Radiation (03CH01-CB)

Note: Calibration Interval of instruments listed above is one year.

“*” Calibration Interval of instruments listed above is two years.

NCR means Non-Calibration required.

6. TEST LOCATION

SHIJR	ADD : 6Fl., No. 106, Sec. 1, Shintai 5th Rd., Shijr City, Taipei, Taiwan 221, R.O.C. TEL : 886-2-2696-2468 FAX : 886-2-2696-2255
HWA YA	ADD : No. 52, Hwa Ya 1st Rd., Kwei-Shan Hsiang, Tao Yuan Hsien, Taiwan, R.O.C. TEL : 886-3-327-3456 FAX : 886-3-318-0055
LINKOU	ADD : No. 30-2, Dingfu Tsuen, Linkou Shiang, Taipei, Taiwan 244, R.O.C TEL : 886-2-2601-1640 FAX : 886-2-2601-1695
DUNGHU	ADD : No. 3, Lane 238, Kangle St., Neihu Chiu, Taipei, Taiwan 114, R.O.C. TEL : 886-2-2631-4739 FAX : 886-2-2631-9740
JUNGHE	ADD : 7Fl., No. 758, Jungjeng Rd., Junghe City, Taipei, Taiwan 235, R.O.C. TEL : 886-2-8227-2020 FAX : 886-2-8227-2626
NEIHU	ADD : 4Fl., No. 339, Hsin Hu 2 nd Rd., Taipei 114, Taiwan, R.O.C. TEL : 886-2-2794-8886 FAX : 886-2-2794-9777
JHUBEI	ADD : No.8, Lane 724, Bo-ai St., Jhubei City, HsinChu County 302, Taiwan, R.O.C. TEL : 886-3-656-9065 FAX : 886-3-656-9085

7. TAF CERTIFICATE OF ACCREDITATION



Certificate No. : L1190-110702

財團法人全國認證基金會
Taiwan Accreditation Foundation

Certificate of Accreditation

This is to certify that

Sporton International Inc.
EMC & Wireless Communications Laboratory
No.52, Hwa Ya 1st Road, Hwa Ya Technology Park, Kwei-Shan Hsiang, Tao Yuan Hsien,
Taiwan, R.O.C.

is accredited in respect of laboratory

Accreditation Criteria	: ISO/IEC 17025:2005
Accreditation Number	: 1190
Originally Accredited	: December 15, 2003
Effective Period	: January 10, 2010 to January 09, 2013
Accredited Scope	: Testing Field, see described in the Appendix
Specific Accreditation Program	: Accreditation Program for Designated Testing Laboratory for Commodities Inspection Accreditation Program for Telecommunication Equipment Testing Laboratory Accreditation Program for BSMI Mutual Recognition Arrangement with Foreign Authorities

Jay-San Chen
President, Taiwan Accreditation Foundation
Date : July 02, 2011

P1, total 22 pages

The Appendix forms an integral part of this Certificate, which shall be invalid when use without the Appendix