



FCC TEST REPORT (15.407)

REPORT NO.: RF110714C16D-1

MODEL NO.: EA4500

FCC ID: Q87-EA4500

RECEIVED: July 26, 2011

TESTED: July 26 to Aug. 09, 2011

ISSUED: Jan. 10, 2012

APPLICANT: Cisco Consumer Products LLC

ADDRESS: 121 Theory Drive Irvine California 92617
United States

ISSUED BY: Bureau Veritas Consumer Products Services
(H.K.) Ltd., Taoyuan Branch Hsin Chu Laboratory

LAB ADDRESS : No. 81-1, Lu Liao Keng, 9th Ling,Wu Lung Tsuen,
Chiung Lin Hsiang, Hsin Chu Hsien 307, Taiwan

TEST LOCATION (1): No. 81-1, Lu Liao Keng, 9th Ling,Wu Lung Tsuen,
Chiung Lin Hsiang, Hsin Chu Hsien 307, Taiwan

TEST LOCATION (2): No. 49, Ln. 206, Wende Rd., Shangshan Tsuen,
Chiung Lin Hsiang, Hsin Chu Hsien 307, Taiwan

This test report consists of 80 pages in total. It may be duplicated completely for legal use with the approval of the applicant. It should not be reproduced except in full, without the written approval of our laboratory. The client should not use it to claim product certification, approval, or endorsement by TAF or any government agencies. The test results in the report only apply to the tested sample.





A D T

Table of Contents

RELEASE CONTROL RECORD	4
1. CERTIFICATION	5
2. SUMMARY OF TEST RESULTS	6
2.1 MEASUREMENT UNCERTAINTY	7
3. GENERAL INFORMATION	8
3.1 GENERAL DESCRIPTION OF EUT	8
3.2 DESCRIPTION OF TEST MODES	11
3.2.1 TEST MODE APPLICABILITY AND TESTED CHANNEL DETAIL:	12
3.3 GENERAL DESCRIPTION OF APPLIED STANDARDS	15
3.4 DESCRIPTION OF SUPPORT UNITS.....	16
3.5 CONFIGURATION OF SYSTEM UNDER TEST	17
4. TEST TYPES AND RESULTS	19
4.1 CONDUCTED EMISSION MEASUREMENT	19
4.1.1 LIMITS OF CONDUCTED EMISSION MEASUREMENT	19
4.1.2 TEST INSTRUMENTS.....	19
4.1.3 TEST PROCEDURES	20
4.1.4 DEVIATION FROM TEST STANDARD	20
4.1.5 TEST SETUP	21
4.1.6 EUT OPERATING CONDITIONS	21
4.1.7 TEST RESULTS (MODE 1)	22
4.1.8 TEST RESULTS (MODE 2)	24
4.2 RADIATED EMISSION MEASUREMENT	26
4.2.1 LIMITS OF RADIATED EMISSION MEASUREMENT	26
4.2.2 LIMITS OF UNWANTED EMISSION OUT OF THE RESTRICTED BANDS.....	27
4.2.3 TEST INSTRUMENTS.....	28
4.2.4 TEST PROCEDURES	29
4.2.5 DEVIATION FROM TEST STANDARD	29
4.2.6 TEST SETUP	30
4.2.7 EUT OPERATING CONDITION.....	30
4.2.8 TEST RESULTS	31
4.3 OUTPUT TRANSMIT POWER MEASUREMENT	52
4.3.1 LIMITS OF OUTPUT TRANSMIT POWER MEASUREMENT	52
4.3.2 TEST INSTRUMENTS.....	52
4.3.3 TEST PROCEDURE.....	53
4.3.4 DEVIATION FROM TEST STANDARD	53
4.3.5 TEST SETUP	53
4.3.6 EUT OPERATING CONDITIONS	53
4.3.7 TEST RESULTS	54
4.4 PEAK POWER EXCURSION MEASUREMENT	60
4.4.1 LIMITS OF PEAK POWER EXCURSION MEASUREMENT	60



A D T

4.4.2	TEST INSTRUMENTS.....	60
4.4.3	TEST PROCEDURE.....	60
4.4.4	DEVIATION FROM TEST STANDARD.....	60
4.4.5	TEST SETUP.....	61
4.4.6	EUT OPERATING CONDITIONS.....	61
4.4.7	TEST RESULTS.....	62
4.5	PEAK POWER SPECTRAL DENSITY MEASUREMENT.....	65
4.5.1	LIMITS OF PEAK POWER SPECTRAL DENSITY MEASUREMENT.....	65
4.5.2	TEST INSTRUMENTS.....	65
4.5.3	TEST PROCEDURES.....	65
4.5.4	DEVIATION FROM TEST STANDARD.....	65
4.5.5	TEST SETUP.....	65
4.5.6	EUT OPERATING CONDITIONS.....	65
4.5.7	TEST RESULTS.....	66
4.6	FREQUENCY STABILITY.....	69
4.6.1	LIMITS OF FREQUENCY STABILITY MEASUREMENT.....	69
4.6.2	TEST INSTRUMENTS.....	69
4.6.3	TEST PROCEDURE.....	69
4.6.4	DEVIATION FROM TEST STANDARD.....	70
4.6.5	TEST SETUP.....	70
4.6.6	EUT OPERATING CONDITION.....	70
4.6.7	TEST RESULTS.....	71
4.7	CONDUCTED OUT-BAND EMISSION MEASUREMENT.....	72
4.7.1	TEST INSTRUMENTS.....	72
4.7.2	TEST PROCEDURE.....	72
4.7.3	EUT OPERATING CONDITION.....	72
4.7.4	TEST RESULTS.....	72
5.	INFORMATION ON THE TESTING LABORATORIES.....	79
6.	APPENDIX A - MODIFICATIONS RECORDERS FOR ENGINEERING CHANGES TO THE EUT BY THE LAB.....	80



A D T

RELEASE CONTROL RECORD

ISSUE NO.	REASON FOR CHANGE	DATE ISSUED
RF110714C16D-1	Original release	Jan. 10, 2012



A D T

1. CERTIFICATION

PRODUCT: 802.11 a/b/g/n AP
BRAND NAME: Cisco
MODEL NO.: EA4500
TEST SAMPLE: ENGINEERING SAMPLE
APPLICANT: Cisco Consumer Products LLC
TESTED: July 26 to Aug. 09, 2011
STANDARDS: FCC Part 15, Subpart E (Section 15.407)
ANSI C63.4-2003
ANSI C63.10-2009

The above equipment (Model: EA4500) has been tested by **Bureau Veritas Consumer Products Services (H.K.) Ltd., Taoyuan Branch**, and found compliance with the requirement of the above standards. The test record, data evaluation & Equipment Under Test (EUT) configurations represented herein are true and accurate accounts of the measurements of the sample's EMC characteristics under the conditions specified in this report.

PREPARED BY : Phoenix Huang , **DATE:** Jan. 10, 2012
(Phoenix Huang, Specialist)

APPROVED BY : May Chen , **DATE:** Jan. 10, 2012
(May Chen, Deputy Manager)

2. SUMMARY OF TEST RESULTS

The EUT has been tested according to the following specifications:

For [802.11a](#)

APPLIED STANDARD: FCC Part 15, Subpart E (Section 15.407)			
Standard Section	Test Type	Result	Remark
15.407(b)(5)	AC Power Conducted Emission	PASS	Meet the requirement of limit. Minimum passing margin is -6.79dB at 0.180MHz
15.407(b)(1/2/3) (b)(5)	Electric Field Strength Spurious Emissions, 30MHz ~ 40000MHz	PASS	Meet the requirement of limit. Minimum passing margin is -2.6dB at 15600.00MHz
15.407(a)(1/2/3)	Output Transmit Power	PASS	Meet the requirement of limit.
15.407(a)(6)	Peak Power Excursion	PASS	Meet the requirement of limit.
15.407(a)(1/2/3)	Peak Power Spectral Density	PASS	Meet the requirement of limit.
15.407(g)	Frequency Stability	PASS	Meet the requirement of limit.
15.203	Antenna Requirement	PASS	Antenna connector is UFL not a standard connector.

NOTE:

1. The EUT was operating in 2400 ~ 2483.5MHz, 5.15~5.25GHz and 5.725~5.850GHz frequencies band. This report was recorded the RF parameters including 5.15~5.25GHz. For the 2400 ~ 2483.5MHz and 5.725~5.850GHz RF parameters was recorded in another test report.



A D T

2.1 MEASUREMENT UNCERTAINTY

Where relevant, the following measurement uncertainty levels have been estimated for tests performed on the EUT as specified in CISPR 16-4-2:

This uncertainty represents an expanded uncertainty expressed at approximately the 95% confidence level using a coverage factor of $k=2$.

Measurement	Value
Conducted emissions	2.45 dB
Radiated emissions (30MHz-1GHz)	3.89 dB
Radiated emissions (1GHz -18GHz)	2.19 dB
Radiated emissions (18GHz -40GHz)	2.56 dB



A D T

3. GENERAL INFORMATION

3.1 GENERAL DESCRIPTION OF EUT

PRODUCT	802.11 a/b/g/n AP
MODEL NO.	EA4500
FCC ID	Q87-EA4500
POWER SUPPLY	DC 12V from power adapter
MODULATION TYPE	CCK, DQPSK, DBPSK for DSSS 64QAM, 16QAM, QPSK, BPSK for OFDM
MODULATION TECHNOLOGY	DSSS, OFDM
TRANSFER RATE	■802.11b: Up to 11Mbps ■802.11g: Up to 54Mbps ■802.11a: Up to 54Mbps ■802.11n: Up to 450Mbps.
OPERATING FREQUENCY	For 15.407 5GHz: 5.18 ~ 5.24GHz For 15.247 2.4GHz: 2.412 ~ 2.462GHz 5GHz: 5.745 ~ 5.825GHz
NUMBER OF CHANNEL	For 15.407 4 for 802.11a, 802.11n (20MHz) 2 for 802.11n (40MHz) For 15.247(2.4GHz) 11 for 802.11b, 802.11g, 802.11n (20MHz) 7 for 802.11n (40MHz) For 15.247(5GHz) 5 for 802.11a, 802.11n (20MHz) 2 for 802.11n (40MHz)
MAXIMUM OUTPUT POWER	For 15.407 802.11a: 24.6mW 802.11n (20MHz): 29.6mW 802.11n (40MHz): 48.3 mW For 15.247(2.4GHz) 802.11b: 498.1mW 802.11g: 628.2mW 802.11n (20MHz): 682.2mW 802.11n (40MHz): 171.4mW For 15.247(5GHz) 802.11a: 434.6mW 802.11n (20MHz): 431.0mW 802.11n (40MHz): 464.6mW

ANTENNA TYPE	Please see NOTE
DATA CABLE	NA
I/O PORTS	Ethernet port x 4 Internet port x 1 USB port x 1
ASSOCIATED DEVICES	Adapter x 1 (DC cable, unshielded, 1.5m)

NOTE:

- There are six antennas provided to this EUT, please refer to the following table:

For 2.4GHz				
Transmitter Circuit	Freq.(MHz)	Peak Gain (dBi)	Antenna Type	Connector Type
Chain (0)	2400	3.31	PIFA	UFL
	2450	2.27	PIFA	UFL
	2500	2.27	PIFA	UFL
Chain (1)	2400	3.45	PIFA	UFL
	2450	2.99	PIFA	UFL
	2500	2.81	PIFA	UFL
Chain (2)	2400	1.82	PIFA	UFL
	2450	1.96	PIFA	UFL
	2500	1.85	PIFA	UFL
For 5GHz				
Transmitter Circuit	Freq.(MHz)	Peak Gain (dBi)	Antenna Type	Connector Type
Chain (0)	5150	3.71	PIFA	UFL
	5350	3.05	PIFA	UFL
	5600	3.00	PIFA	UFL
	5730	3.39	PIFA	UFL
	5850	3.62	PIFA	UFL
Chain (1)	5150	3.28	PIFA	UFL
	5350	3.60	PIFA	UFL
	5600	3.29	PIFA	UFL
	5730	2.95	PIFA	UFL
	5850	2.65	PIFA	UFL
Chain (2)	5150	3.71	PIFA	UFL
	5350	3.40	PIFA	UFL
	5600	3.71	PIFA	UFL
	5730	4.27	PIFA	UFL
	5850	3.91	PIFA	UFL

2. The EUT incorporates a MIMO function. Physically, the EUT provides three completed transmitters and three receivers.

MODULATION MODE	TX FUNCTION
802.11b	3TX / 3RX
802.11g	3TX / 3RX
802.11a	Band 1: 2TX / 3RX
	Band 4: 3TX / 3RX
802.11n (20MHz)	3TX / 3RX
802.11n (40MHz)	3TX / 3RX

Note: It will be fixed on chain 0 & chain 2 in 2TX.

3. The EUT must be supplied with a power adapter and following two different model names could be chosen:

Adapter 1		
Brand	Model No.	Spec.
LEADER ELECTRONICS INC.	MU24-B120200-A1	AC I/P: 100-240Vac, 50/60Hz 1.0A DC O/P: 12Vdc, 2A
Adapter 2		
Brand	Model No.	Spec.
SOLYTECH ENTERPRISE CORPORATION	CAD2412	AC I/P: 100-240Vac, 50-60Hz, 1.0A DC O/P: 12Vdc, 2.0A

4. The EUT was pre-tested in chamber under the following modes:

Test Mode	Description
Mode A	Adapter 1
Mode B	Adapter 2

From the above modes, the radiated emission worse case was found in **Mode A**.

Therefore only the test data of the mode was recorded in this report.

5. Conducted emission and Radiated emission of the simultaneous operation has been evaluated and no non-compliance found.
6. The EUT is 3 * 3 spatial MIMO (3Tx & 3Rx) without beam forming function.
7. The EUT incorporates CDD function with 802.11a, 802.11b, 802.11g.
8. When the EUT operating in 802.11n, the software operation, which is defined by manufacturer, MCS (Modulation and Coding Schemes) from 0 to 23.
9. The above EUT information was declared by the manufacturer and for more detailed features description, please refer to the manufacturer's specifications or User's Manual.



A D T

3.2 DESCRIPTION OF TEST MODES

Operated in 5150MHz ~ 5250MHz bands:

Four channels are provided for 802.11a and 802.11n (20MHz):

CHANNEL	FREQUENCY
36	5180 MHz
40	5200 MHz
44	5220 MHz
48	5240 MHz

Two channels are provided for 802.11n (40MHz):

CHANNEL	FREQUENCY
38	5190 MHz
46	5230 MHz

3.2.1 TEST MODE APPLICABILITY AND TESTED CHANNEL DETAIL:

EUT CONFIGURE MODE	APPLICABLE TO					DESCRIPTION
	PLC	RE < 1G	RE ≥ 1G	APCM	OB	
MODE 1	√	√	√	√	√	Adapter 1
MODE 2	√	-	-	-	-	Adapter 2

Where **PLC**: Power Line Conducted Emission **RE < 1G**: Radiated Emission below 1GHz
RE ≥ 1G: Radiated Emission above 1GHz **APCM**: Antenna Port Conducted Measurement
OB: Conducted Out-Band Emission Measurement

POWER LINE CONDUCTED EMISSION TEST:

- Pre-Scan has been conducted to determine the worst-case mode from all possible combinations between available modulations, data rates and antenna ports (if EUT with antenna diversity architecture).
- Following channel(s) was (were) selected for the final test as listed below.

MODE	AVAILABLE CHANNEL	TESTED CHANNEL	MODULATION TECHNOLOGY	MODULATION TYPE	DATA RATE (MBPS)
802.11n (20MHz)	36 to 48	40	OFDM	BPSK	6.5

RADIATED EMISSION TEST (BELOW 1 GHz):

- Pre-Scan has been conducted to determine the worst-case mode from all possible combinations between available modulations, data rates and antenna ports (if EUT with antenna diversity architecture).
- Following channel(s) was (were) selected for the final test as listed below.

MODE	AVAILABLE CHANNEL	TESTED CHANNEL	MODULATION TECHNOLOGY	MODULATION TYPE	DATA RATE (Mbps)
802.11n (20MHz)	36 to 48	40	OFDM	BPSK	6.5

RADIATED EMISSION TEST (ABOVE 1 GHz):

- Pre-Scan has been conducted to determine the worst-case mode from all possible combinations between available modulations, data rates and antenna ports (if EUT with antenna diversity architecture).
- Following channel(s) was (were) selected for the final test as listed below.

MODE	AVAILABLE CHANNEL	TESTED CHANNEL	MODULATION TECHNOLOGY	MODULATION TYPE	DATA RATE (Mbps)
802.11a	36 to 48	36, 40, 48	OFDM	BPSK	6
802.11n (20MHz)	36 to 48	36, 40, 48	OFDM	BPSK	6.5
802.11n (40MHz)	38 to 46	38, 46	OFDM	BPSK	13.5

ANTENNA PORT CONDUCTED MEASUREMENT:

- This item includes all test value of each mode, but only includes spectrum plot of worst value of each mode.
- Pre-Scan has been conducted to determine the worst-case mode from all possible combinations between available modulations, data rates and antenna ports (if EUT with antenna diversity architecture).
- Following channel(s) was (were) selected for the final test as listed below.

MODE	AVAILABLE CHANNEL	TESTED CHANNEL	MODULATION TECHNOLOGY	MODULATION TYPE	DATA RATE (Mbps)
802.11a	36 to 48	36, 40, 48	OFDM	BPSK	6
802.11n (20MHz)	36 to 48	36, 40, 48	OFDM	BPSK	6.5
802.11n (40MHz)	38 to 46	38, 46	OFDM	BPSK	13.5

※ Bandwidth as show worst chain in report base on preliminary measurement.

CONDUCTED OUT-BAND EMISSION MEASUREMENT:

- Pre-Scan has been conducted to determine the worst-case mode from all possible combinations between available modulations, data rates and antenna ports (if EUT with antenna diversity architecture).
- Following channel(s) was (were) selected for the final test as listed below.

MODE	AVAILABLE CHANNEL	TESTED CHANNEL	MODULATION TECHNOLOGY	MODULATION TYPE	DATA RATE (Mbps)
802.11a	36 to 48	36, 40, 48	OFDM	BPSK	6
802.11n (20MHz)	36 to 48	36, 40, 48	OFDM	BPSK	6.5
802.11n (40MHz)	38 to 46	38, 46	OFDM	BPSK	13.5

TEST CONDITION:

APPLICABLE TO	ENVIRONMENTAL CONDITIONS	INPUT POWER	TESTED BY
PLC	25deg. C, 68%RH	120Vac, 60Hz	Eagle Chen
	27deg. C, 55%RH	120Vac, 60Hz	Kyle Huang
RE ³ 1G	25deg. C, 65%RH	120Vac, 60Hz	Nelson Teng
RE<1G	26deg. C, 74%RH	120Vac, 60Hz	Rex Huang
APCM	25deg. C, 60%RH	120Vac, 60Hz	Rex Huang
OB	25deg. C, 60%RH	120Vac, 60Hz	Rex Huang

3.3 GENERAL DESCRIPTION OF APPLIED STANDARDS

The EUT is a RF product. According to the specifications of the manufacturer, it must comply with the requirements of the following standards:

FCC Part 15, Subpart E (15.407)

ANSI C63.4-2003

ANSI C63.10-2009

All test items have been performed and recorded as per the above standards.

NOTE: The EUT has been verified to comply with the requirements of FCC Part 15, Subpart B, Class B (DoC). The test report has been issued separately.



A D T

3.4 DESCRIPTION OF SUPPORT UNITS

The EUT has been tested as an independent unit together with other necessary accessories or support units. The following support units or accessories were used to form a representative test configuration during the tests.

NO.	PRODUCT	BRAND	MODEL NO.	SERIAL NO.	FCC ID
1	NOTEBOOK COMPUTER	DELL	PP32LA	FSLB32S	FCC DoC
2	NOTEBOOK COMPUTER	DELL	PP32LA	GSLB32S	FCC DoC
3	HUB	ZyXEL	ES-116P	S060H0200021 5	FCC DoC
4	iPod shuffle	Apple	MC749TA/A	CC4DMFJUDFD M	NA
	iPod nano (For Conducted emission test)	APPLE	A1199	YM712NB3VQ5	FCC DoC

NO.	SIGNAL CABLE DESCRIPTION OF THE ABOVE SUPPORT UNITS
1	UTP cable, 10m
2	UTP cable, 10m
3	UTP cable, 10m
4	USB Cable W/O Core ,0.1m
	1 m shielded cable, terminated with USB connector, w/o core.

NOTE: All power cords of the above support units are non shielded (1.8m).

3.5 CONFIGURATION OF SYSTEM UNDER TEST

For Conducted Emission test:

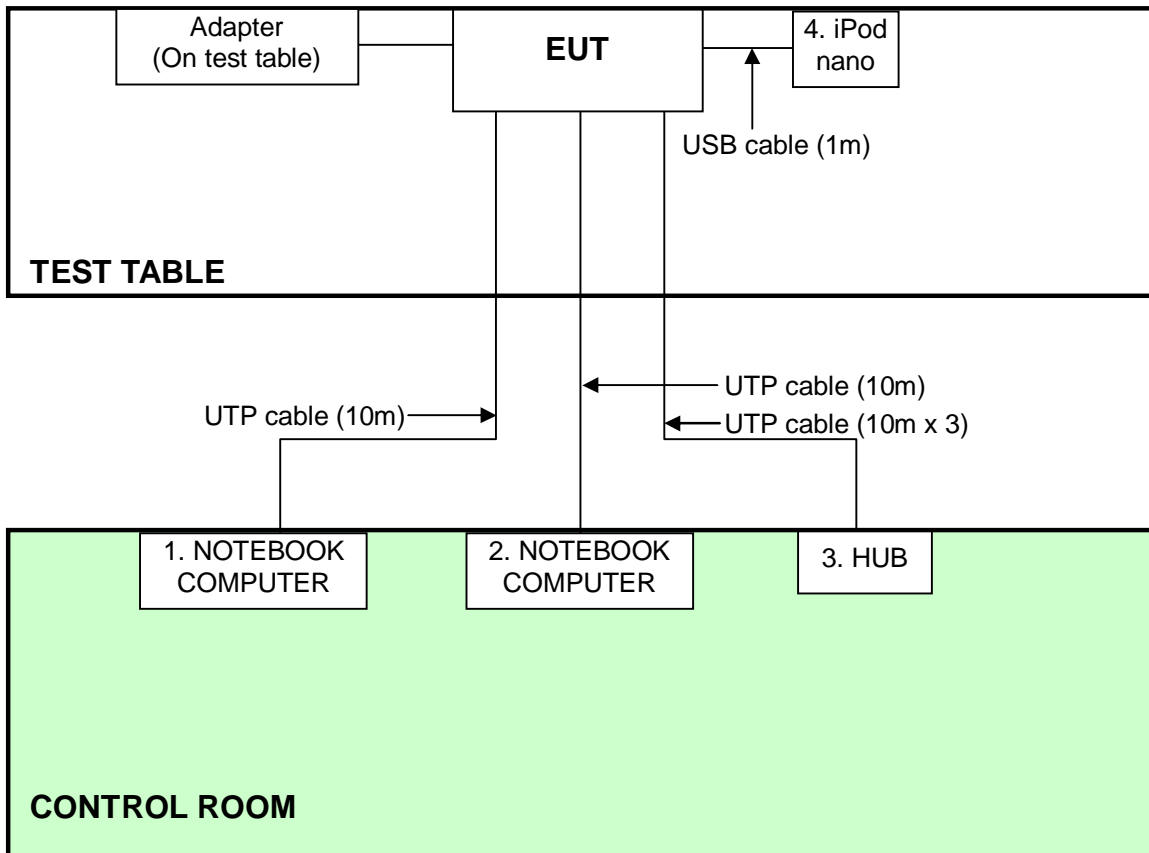

For Radiated Emission test:

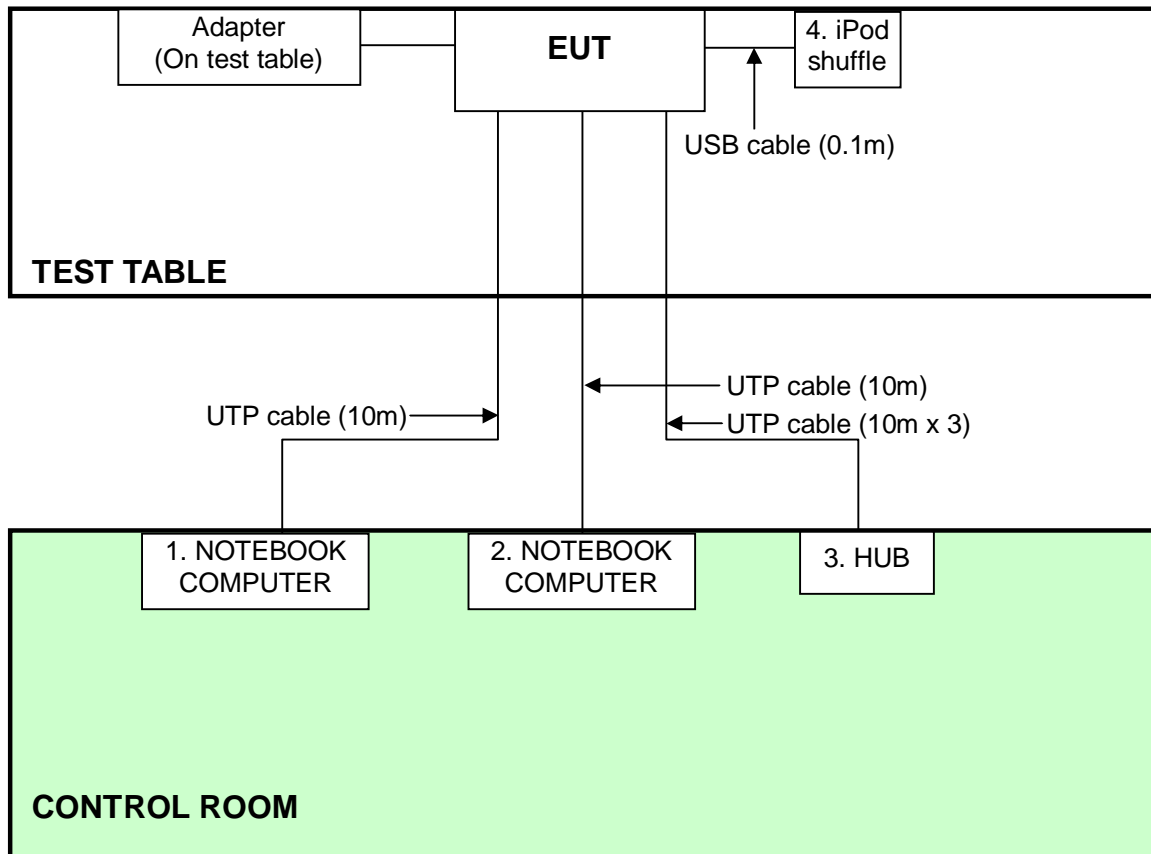



A D T

4. TEST TYPES AND RESULTS

4.1 CONDUCTED EMISSION MEASUREMENT

4.1.1 LIMITS OF CONDUCTED EMISSION MEASUREMENT

FREQUENCY OF EMISSION (MHz)	CONDUCTED LIMIT (dB μ V)	
	Quasi-peak	Average
0.15-0.5	66 to 56	56 to 46
0.5-5	56	46
5-30	60	50

- NOTE:**
1. The lower limit shall apply at the transition frequencies.
 2. The limit decreases in line with the logarithm of the frequency in the range of 0.15 to 0.50 MHz.
 3. All emanations from a class A/B digital device or system, including any network of conductors and apparatus connected thereto, shall not exceed the level of field strengths specified above.

4.1.2 TEST INSTRUMENTS

Test date: July 26 to Aug. 03, 2011

DESCRIPTION & MANUFACTURER	MODEL NO.	SERIAL NO.	CALIBRATED DATE	CALIBRATED UNTIL
ROHDE & SCHWARZ Test Receiver	ESCS 30	100287	Mar. 02, 2011	Mar. 01, 2012
Line-Impedance Stabilization Network (for EUT)	NSLK 8127	8127-523	Sep. 17, 2010	Sep. 16, 2011
Line-Impedance Stabilization Network (for Peripheral)	ENV-216	100072	June 10, 2011	June 09, 2012
RF Cable (JYEBAO)	5DFB	CONCAB-003	Aug. 06, 2010	Aug. 05, 2011
50 ohms Terminator	50	3	Nov. 03, 2010	Nov. 02, 2011
Software	BV ADT_Cond_V7.3.7	NA	NA	NA

Note:

1. The calibration interval of the above test instruments is 12 months and the calibrations are traceable to NML/ROC and NIST/USA.
2. The test was performed in Shielded Room No. A.
3. The VCCI Con A Registration No. is C-817.



A D T

4.1.3 TEST PROCEDURES

- a. The EUT was placed 0.4 meters from the conducting wall of the shielded room with EUT being connected to the power mains through a line impedance stabilization network (LISN). Other support units were connected to the power mains through another LISN. The two LISNs
- b. provide 50 ohm/ 50uH of coupling impedance for the measuring instrument.
- c. Both lines of the power mains connected to the EUT were checked for maximum conducted interference.
- d. The frequency range from 150kHz to 30MHz was searched. Emission level under (Limit – 20dB) was not recorded.

4.1.4 DEVIATION FROM TEST STANDARD

No deviation

4.1.5 TEST SETUP

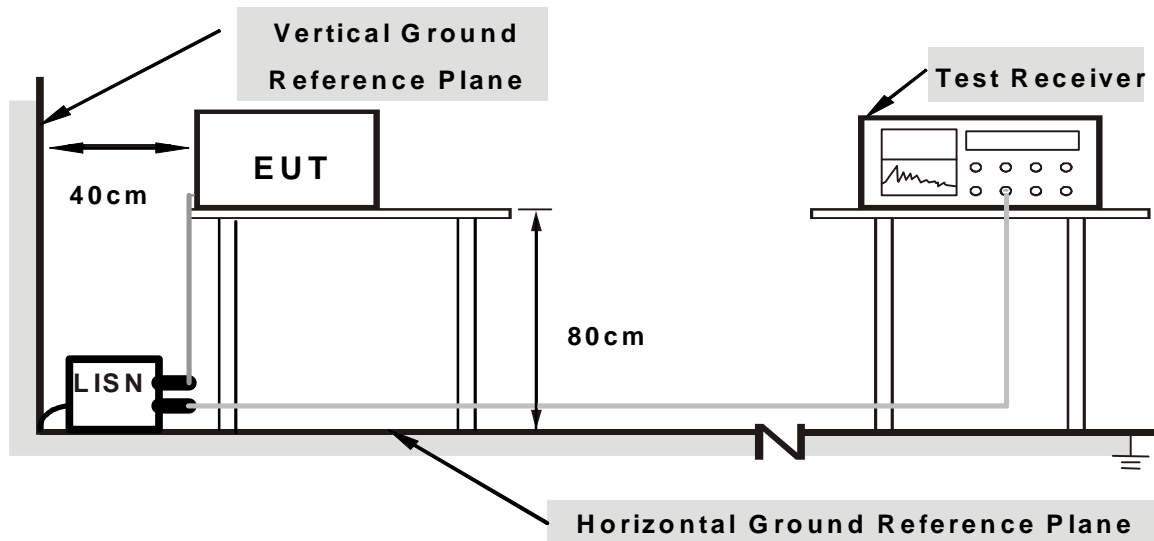

Note: 1. Support units were connected to second LISN.

2. Both of LISNs (AMN) are 80 cm from EUT and at least 80 from other units and other metal planes

For the actual test configuration, please refer to the related item – Photographs of the Test Configuration.

4.1.6 EUT OPERATING CONDITIONS

1. Placed the EUT on testing table.
2. Prepared computer system (support unit 1) to act as communication partner and placed it outside of testing area.
3. The communication partners ran test program “DutApiClient_Udp.exe” to enable EUT under transmission/receiving condition continuously via one UTP cable transmission.

4.1.7 TEST RESULTS (MODE 1)

PHASE	Line (L)	6dB BANDWIDTH	9 kHz
--------------	----------	----------------------	-------

No	Freq. [MHz]	Corr. Factor (dB)	Reading Value		Emission Level		Limit		Margin	
			[dB (uV)]		[dB (uV)]		[dB (uV)]		(dB)	
			Q.P.	AV.	Q.P.	AV.	Q.P.	AV.	Q.P.	AV.
1	0.158	0.36	49.84	23.15	50.20	23.51	65.58	55.58	-15.37	-32.06
2	0.166	0.36	55.27	30.91	55.63	31.27	65.15	55.15	-9.52	-23.88
3	0.181	0.36	57.21	47.17	57.57	47.53	64.43	54.43	-6.86	-6.90
4	0.216	0.36	46.88	18.93	47.24	19.29	62.96	52.96	-15.71	-33.66
5	0.236	0.36	49.70	38.89	50.06	39.25	62.24	52.24	-12.18	-12.99
6	0.318	0.37	31.24	12.94	31.61	13.31	59.76	49.76	-28.15	-36.45
7	0.350	0.37	40.96	28.59	41.33	28.96	58.95	48.95	-17.63	-20.00
8	0.978	0.42	34.26	21.83	34.68	22.25	56.00	46.00	-21.32	-23.75

- REMARKS:**
1. Q.P. and AV. are abbreviations of quasi-peak and average individually.
 2. The emission levels of other frequencies were very low against the limit.
 3. Margin value = Emission level - Limit value
 4. Correction factor = Insertion loss + Cable loss
 5. Emission Level = Correction Factor + Reading Value.

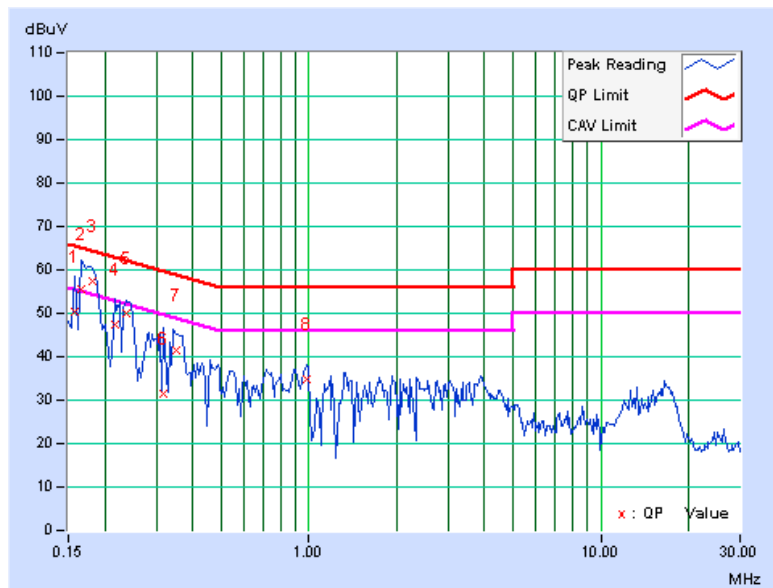

PHASE	Neutral (N)	6dB BANDWIDTH	9 kHz
--------------	-------------	----------------------	-------

No	Freq. [MHz]	Corr. Factor (dB)	Reading Value		Emission Level		Limit		Margin	
			[dB (uV)]		[dB (uV)]		[dB (uV)]		(dB)	
			Q.P.	AV.	Q.P.	AV.	Q.P.	AV.	Q.P.	AV.
1	0.158	0.10	47.39	24.19	47.49	24.29	65.58	55.58	-18.09	-31.29
2	0.166	0.10	55.19	31.15	55.29	31.25	65.18	55.18	-9.89	-23.93
3	0.180	0.10	57.37	47.60	57.47	47.70	64.50	54.50	-7.02	-6.79
4	0.216	0.11	44.81	20.21	44.92	20.32	62.96	52.96	-18.03	-32.63
5	0.236	0.11	49.66	39.64	49.77	39.75	62.24	52.24	-12.47	-12.49
6	0.357	0.12	41.76	34.33	41.88	34.45	58.80	48.80	-16.92	-14.35
7	0.978	0.18	34.32	22.54	34.50	22.72	56.00	46.00	-21.50	-23.28

- REMARKS:**
1. Q.P. and AV. are abbreviations of quasi-peak and average individually.
 2. The emission levels of other frequencies were very low against the limit.
 3. Margin value = Emission level - Limit value
 4. Correction factor = Insertion loss + Cable loss
 5. Emission Level = Correction Factor + Reading Value.

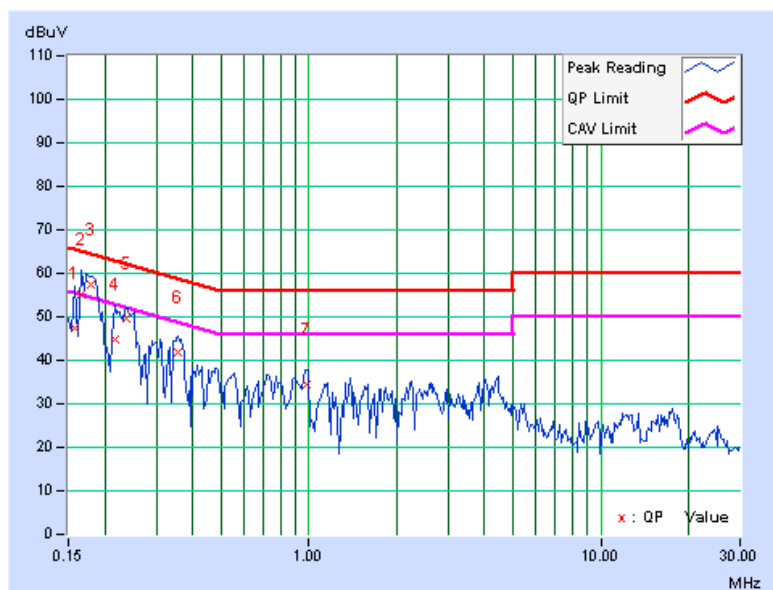

4.1.8 TEST RESULTS (MODE 2)

PHASE	Line (L)	6dB BANDWIDTH	9 kHz
--------------	----------	----------------------	-------

No	Freq.	Corr.	Reading Value		Emission Level		Limit		Margin	
	[MHz]	Factor	[dB (uV)]		[dB (uV)]		[dB (uV)]		(dB)	
		(dB)	Q.P.	AV.	Q.P.	AV.	Q.P.	AV.	Q.P.	AV.
1	0.150	0.37	55.20	43.19	55.57	43.56	66.00	56.00	-10.43	-12.44
2	0.185	0.36	49.04	36.02	49.40	36.38	64.25	54.25	-14.85	-17.87
3	0.220	0.36	42.86	27.70	43.22	28.06	62.81	52.81	-19.59	-24.75
4	0.455	0.37	37.53	29.86	37.90	30.23	56.79	46.79	-18.88	-16.55
5	0.607	0.39	30.76	23.37	31.15	23.76	56.00	46.00	-24.85	-22.24
6	10.754	0.94	29.87	21.86	30.81	22.80	60.00	50.00	-29.19	-27.20

- REMARKS:**
1. Q.P. and AV. are abbreviations of quasi-peak and average individually.
 2. The emission levels of other frequencies were very low against the limit.
 3. Margin value = Emission level - Limit value
 4. Correction factor = Insertion loss + Cable loss
 5. Emission Level = Correction Factor + Reading Value.

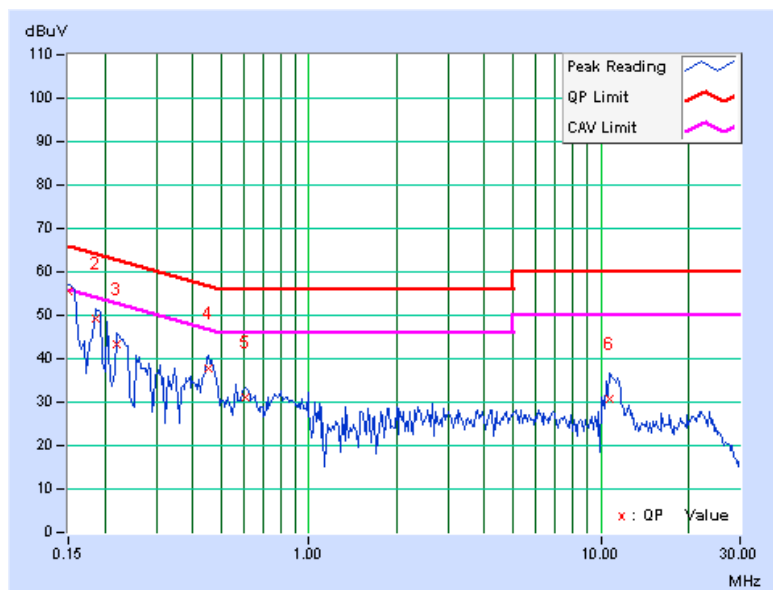

PHASE	Neutral (N)	6dB BANDWIDTH	9 kHz
--------------	-------------	----------------------	-------

No	Freq. [MHz]	Corr. Factor (dB)	Reading Value		Emission Level		Limit		Margin	
			[dB (uV)]		[dB (uV)]		[dB (uV)]		(dB)	
			Q.P.	AV.	Q.P.	AV.	Q.P.	AV.	Q.P.	AV.
1	0.150	0.10	54.82	42.91	54.92	43.01	66.00	56.00	-11.08	-12.99
2	0.170	0.10	43.69	19.12	43.79	19.22	64.98	54.98	-21.19	-35.76
3	0.209	0.11	39.61	17.58	39.72	17.69	63.26	53.26	-23.54	-35.57
4	0.455	0.13	38.18	30.72	38.31	30.85	56.79	46.79	-18.48	-15.94
5	0.916	0.17	27.70	18.25	27.87	18.42	56.00	46.00	-28.13	-27.58
6	10.789	0.76	30.24	22.54	31.00	23.30	60.00	50.00	-29.00	-26.70

- REMARKS:**
1. Q.P. and AV. are abbreviations of quasi-peak and average individually.
 2. The emission levels of other frequencies were very low against the limit.
 3. Margin value = Emission level - Limit value
 4. Correction factor = Insertion loss + Cable loss
 5. Emission Level = Correction Factor + Reading Value.

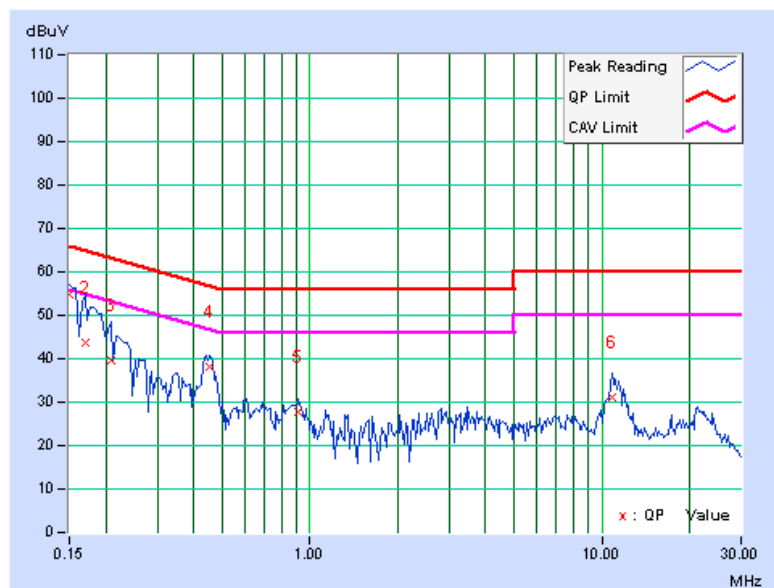



A D T

4.2 RADIATED EMISSION MEASUREMENT

4.2.1 LIMITS OF RADIATED EMISSION MEASUREMENT

Emissions radiated outside of the specified bands, shall be according to the general radiated limits in 15.209 as following:

Frequencies (MHz)	Field strength (microvolts/meter)	Measurement distance (meters)
0.009-0.490	2400/F(kHz)	300
0.490-1.705	24000/F(kHz)	30
1.705-30.0	30	30
30-88	100	3
88-216	150	3
216-960	200	3
Above 960	500	3

NOTE:

1. The lower limit shall apply at the transition frequencies.
2. Emission level (dBuV/m) = 20 log Emission level (uV/m).
3. As shown in 15.35(b), for frequencies above 1000MHz, the field strength limits are based on average detector, however, the peak field strength of any emission shall not exceed the maximum permitted average limits, specified above by more than 20dB under any condition of modulation.
4. Section 15.205 restricted bands of operation shall compliance with the limits in Section 15.209.



A D T

4.2.2 LIMITS OF UNWANTED EMISSION OUT OF THE RESTRICTED BANDS

Frequencies (MHz)	EIRP Limit (dBm)	Equivalent Field Strength at 3m (dB μ V/m) *note 3
5150~5250	-27	68.3
5250~5350	-27	68.3
5470~5725	-27	68.3
5725~5825	-27 *note 1	68.3
	-17 *note 2	78.3

NOTE:

1. For frequencies 10MHz or greater above or below the band edge.
2. All emissions within the frequency range from the band edge to 10MHz above or below the band edge.
3. The following formula is used to convert the equipment isotropic radiated power (eirp) to field strength

$$E = \frac{1000000\sqrt{30P}}{3} \mu\text{V/m, where P is the eirp (Watts)}$$



A D T

4.2.3 TEST INSTRUMENTS

Test date: Aug. 09, 2011

DESCRIPTION & MANUFACTURER	MODEL NO.	SERIAL NO.	CALIBRATED DATE	CALIBRATED UNTIL
Agilent Spectrum Analyzer	E4446A	MY48250253	Aug. 23, 2010	Aug. 22, 2011
Agilent Pre-Selector	N9039A	MY46520310	Aug. 23, 2010	Aug. 22, 2011
Agilent Signal Generator	N5181A	MY49060347	July 25, 2011	July 24, 2012
LIG NEX1 Test Receiver	ER-265	L09068005	Oct. 25, 2010	Oct. 24, 2011
Mini-Circuits Pre-Amplifier	ZFL-1000VH2B	AMP-ZFL-04	Nov. 16, 2010	Nov. 15, 2011
Agilent Pre-Amplifier	8449B	3008A02465	Feb. 28, 2011	Feb. 27, 2012
Miteq Pre-Amplifier	AFS33-1800265 0-30-8P-44	881786	NA	NA
SCHWARZBECK Trilog Broadband Antenna	VULB 9168	9168-361	Apr. 14, 2011	Apr. 13, 2012
AISI Horn_Antenna	AIH.8018	000022009111 0	Nov. 22, 2010	Nov. 21, 2011
SCHWARZBECK Horn_Antenna	BBHA 9170	9170-424	Oct. 08, 2010	Oct. 07, 2011
RF CABLE	NA	RF104-205 RF104-207 RF104-202	Dec. 28, 2010	Dec. 27, 2011
RF Cable	NA	CHHCAB_001	NA	NA
Software	ADT_Radiated_V8.7.05	NA	NA	NA
CT Antenna Tower & Turn Table	NA	NA	NA	NA

- Note: 1. The calibration interval of the above test instruments is 12 months and the calibrations are traceable to NML/ROC and NIST/USA.
2. The horn antenna, preamplifier (model: 8449B) are used only for the measurement of emission frequency above 1GHz if tested.
3. The test was performed in 966 Chamber No. H.
4. The FCC Site Registration No. is 797305.
5. The CANADA Site Registration No. is IC 7450H-3.

4.2.4 TEST PROCEDURES

- a. The EUT was placed on the top of a rotating table 0.8 meters above the ground at 3 meters chamber test. The table was rotated 360 degrees to determine the position of the highest radiation.
- b. The EUT was set 3 meters away from the interference-receiving antenna, which was mounted on the top of a variable-height antenna tower.
- c. The height of antenna is varied from one meter to four meters above the ground to determine the maximum value of the field strength. Both horizontal and vertical polarizations of the antenna are set to make the measurement.
- d. For each suspected emission, the EUT was arranged to its worst case and then the antenna was tuned to heights from 1 meter to 4 meters and the rotatable table was turned from 0 degrees to 360 degrees to find the maximum reading.
- e. The test-receiver system was set to quasi-peak detect function and specified bandwidth with maximum hold mode when the test frequency is below 1 GHz.
- f. The test-receiver system was set to peak and average detect function and specified bandwidth with maximum hold mode when the test frequency is above 1 GHz. If the peak reading value also meets average limit, measurement with the average detector is unnecessary.

NOTE:

1. The resolution bandwidth and video bandwidth of test receiver/spectrum analyzer is 120kHz for Quasi-peak detection (QP) at frequency below 1GHz.
2. The resolution bandwidth of test receiver/spectrum analyzer is 1 MHz and the video bandwidth is 3 MHz for Peak detection (PK) at frequency above 1GHz.
3. The resolution bandwidth of test receiver/spectrum analyzer is 1 MHz and the video bandwidth is 10 Hz for Average detection (AV) at frequency above 1GHz.

4.2.5 DEVIATION FROM TEST STANDARD

No deviation

4.2.6 TEST SETUP

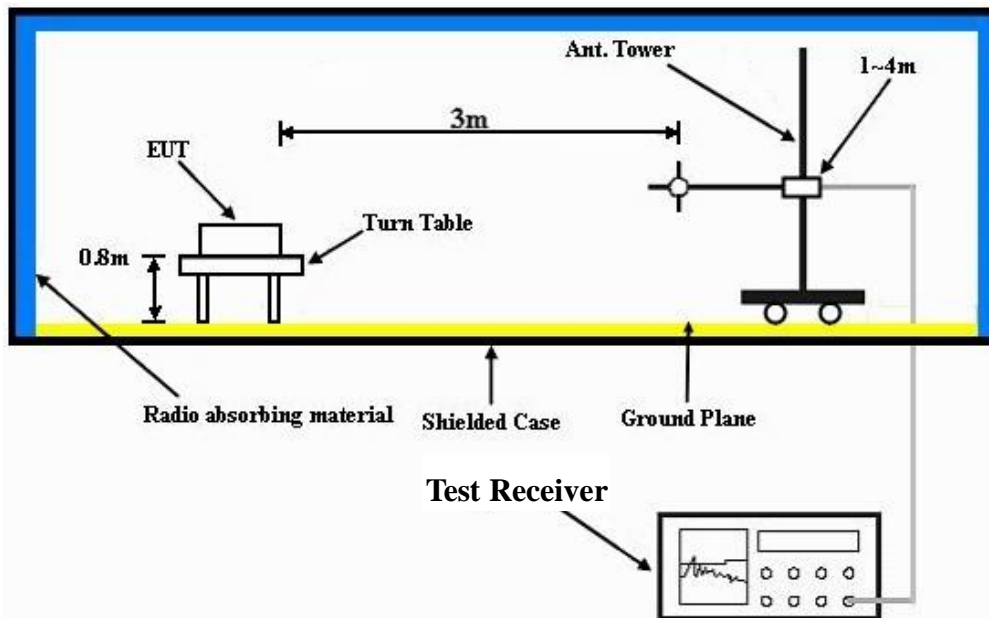

For the actual test configuration, please refer to the related item – Photographs of the Test Configuration.

4.2.7 EUT OPERATING CONDITION

1. Placed the EUT on testing table.
2. Prepared computer system (support unit 1) to act as communication partner and placed it outside of testing area.
3. The communication partners ran test program “DutApiClient_Udp.exe” to enable EUT under transmission/receiving condition continuously via one UTP cable transmission.

4.2.8 TEST RESULTS

BELOW 1GHz WORST-CASE DATA : 802.11n (20MHz) OFDM MODULATION

EUT TEST CONDITION		MEASUREMENT DETAIL	
CHANNEL	Channel 40	FREQUENCY RANGE	Below 1000MHz
INPUT POWER	120Vac / 60Hz	DETECTOR FUNCTION	Quasi-Peak
ENVIRONMENTAL CONDITIONS	26deg. C, 74%RH	TESTED BY	Rex Huang

ANTENNA POLARITY & TEST DISTANCE: HORIZONTAL AT 3 M								
NO.	FREQ. (MHz)	EMISSION LEVEL (dBuV/m)	LIMIT (dBuV/m)	MARGIN (dB)	ANTENNA HEIGHT (m)	TABLE ANGLE (Degree)	RAW VALUE (dBuV)	CORRECTION FACTOR (dB/m)
1	249.77	28.6 QP	46.0	-17.4	1.25 H	101	15.55	13.03
2	375.78	36.4 QP	46.0	-9.6	1.00 H	69	19.62	16.81
3	500.99	38.4 QP	46.0	-7.6	2.00 H	5	18.87	19.55
4	624.84	28.1 QP	46.0	-17.9	1.50 H	9	6.35	21.73
5	750.20	29.3 QP	46.0	-16.8	1.00 H	341	5.98	23.27
6	875.99	30.3 QP	46.0	-15.7	1.25 H	5	4.85	25.48
ANTENNA POLARITY & TEST DISTANCE: VERTICAL AT 3 M								
NO.	FREQ. (MHz)	EMISSION LEVEL (dBuV/m)	LIMIT (dBuV/m)	MARGIN (dB)	ANTENNA HEIGHT (m)	TABLE ANGLE (Degree)	RAW VALUE (dBuV)	CORRECTION FACTOR (dB/m)
1	48.98	34.1 QP	40.0	-5.9	1.00 V	360	19.91	14.21
2	62.01	35.8 QP	40.0	-4.2	2.00 V	123	22.62	13.16
3	119.69	36.5 QP	43.5	-7.1	1.00 V	100	24.11	12.34
4	375.56	30.6 QP	46.0	-15.4	1.25 V	321	13.79	16.80
5	415.00	35.6 QP	46.0	-10.4	1.00 V	360	17.93	17.67
6	500.55	34.4 QP	46.0	-11.6	1.75 V	322	14.89	19.54

- REMARKS:**
1. Emission level (dBuV/m) = Raw Value (dBuV) + Correction Factor (dB/m).
 2. Correction Factor (dB/m) = Antenna Factor (dB/m) + Cable Factor (dB).
 3. The other emission levels were very low against the limit.
 4. Margin value = Emission level – Limit value.



A D T

ABOVE 1GHz WORST-CASE DATA

802.11a OFDM MODULATION

EUT TEST CONDITION		MEASUREMENT DETAIL	
CHANNEL	Channel 36	FREQUENCY RANGE	1 ~ 40GHz
INPUT POWER	120Vac / 60Hz	DETECTOR FUNCTION	Peak (PK) Average (AV)
ENVIRONMENTAL CONDITIONS	25deg. C, 65%RH	TESTED BY	Nelson Teng

ANTENNA POLARITY & TEST DISTANCE: HORIZONTAL AT 3 M

NO.	FREQ. (MHz)	EMISSION LEVEL (dBuV/m)	LIMIT (dBuV/m)	MARGIN (dB)	ANTENNA HEIGHT (m)	TABLE ANGLE (Degree)	RAW VALUE (dBuV)	CORRECTION FACTOR (dB/m)
1	5147.80	58.6 PK	74.0	-15.4	1.00 H	249	18.20	40.40
2	5147.80	45.9 AV	54.0	-8.1	1.00 H	249	5.50	40.40
3	*5180.00	105.3 PK			1.00 H	249	64.85	40.45
4	*5180.00	96.4 AV			1.00 H	249	55.95	40.45
5	#10360.00	54.9 PK	68.3	-13.4	1.00 H	116	8.09	46.81
6	15540.00	61.8 PK	74.0	-12.2	1.00 H	61	10.63	51.17
7	15540.00	48.9 AV	54.0	-5.1	1.00 H	61	-2.27	51.17

ANTENNA POLARITY & TEST DISTANCE: VERTICAL AT 3 M

NO.	FREQ. (MHz)	EMISSION LEVEL (dBuV/m)	LIMIT (dBuV/m)	MARGIN (dB)	ANTENNA HEIGHT (m)	TABLE ANGLE (Degree)	RAW VALUE (dBuV)	CORRECTION FACTOR (dB/m)
1	5148.90	59.1 PK	74.0	-14.9	1.00 V	299	18.70	40.40
2	5148.90	47.1 AV	54.0	-6.9	1.00 V	299	6.70	40.40
3	*5180.00	108.3 PK			1.00 V	298	67.85	40.45
4	*5180.00	99.5 AV			1.00 V	298	59.05	40.45
5	#10360.00	54.7 PK	68.3	-13.6	1.00 V	131	7.89	46.81
6	15540.00	60.6 PK	74.0	-13.4	1.00 V	88	9.43	51.17
7	15540.00	48.7 AV	54.0	-5.3	1.00 V	88	-2.47	51.17

- REMARKS:**
1. Emission level (dBuV/m) = Raw Value (dBuV) + Correction Factor (dB/m).
 2. Correction Factor (dB/m) = Antenna Factor (dB/m) + Cable Factor (dB).
 3. The other emission levels were very low against the limit.
 4. Margin value = Emission level – Limit value.
 5. “ * “: Fundamental frequency.
 6. "#":The radiated frequency is out the restricted band.



A D T

EUT TEST CONDITION		MEASUREMENT DETAIL	
CHANNEL	Channel 40	FREQUENCY RANGE	1 ~ 40GHz
INPUT POWER	120Vac / 60Hz	DETECTOR FUNCTION	Peak (PK) Average (AV)
ENVIRONMENTAL CONDITIONS	25deg. C, 65%RH	TESTED BY	Nelson Teng

ANTENNA POLARITY & TEST DISTANCE: HORIZONTAL AT 3 M								
NO.	FREQ. (MHz)	EMISSION LEVEL (dBuV/m)	LIMIT (dBuV/m)	MARGIN (dB)	ANTENNA HEIGHT (m)	TABLE ANGLE (Degree)	RAW VALUE (dBuV)	CORRECTION FACTOR (dB/m)
1	*5200.00	105.1 PK			1.00 H	240	64.61	40.49
2	*5200.00	96.4 AV			1.00 H	240	55.91	40.49
3	#10400.00	55.5 PK	68.3	-12.8	1.01 H	130	8.65	46.85
4	15600.00	62.1 PK	74.0	-11.9	1.05 H	60	10.82	51.28
5	15600.00	49.0 AV	54.0	-5.0	1.05 H	60	-2.28	51.28

ANTENNA POLARITY & TEST DISTANCE: VERTICAL AT 3 M								
NO.	FREQ. (MHz)	EMISSION LEVEL (dBuV/m)	LIMIT (dBuV/m)	MARGIN (dB)	ANTENNA HEIGHT (m)	TABLE ANGLE (Degree)	RAW VALUE (dBuV)	CORRECTION FACTOR (dB/m)
1	*5200.00	108.0 PK			1.00 V	298	67.51	40.49
2	*5200.00	98.5 AV			1.00 V	298	58.01	40.49
3	#10400.00	53.6 PK	68.3	-14.7	1.00 V	154	6.75	46.85
4	15600.00	61.1 PK	74.0	-12.9	1.00 V	97	9.82	51.28
5	15600.00	49.1 AV	54.0	-4.9	1.00 V	97	-2.18	51.28

- REMARKS:**
1. Emission level (dBuV/m) = Raw Value (dBuV) + Correction Factor (dB/m).
 2. Correction Factor (dB/m) = Antenna Factor (dB/m) + Cable Factor (dB).
 3. The other emission levels were very low against the limit.
 4. Margin value = Emission level – Limit value.
 5. “ * “: Fundamental frequency.
 6. “ # “: The radiated frequency is out the restricted band.



A D T

EUT TEST CONDITION		MEASUREMENT DETAIL	
CHANNEL	Channel 48	FREQUENCY RANGE	1 ~ 40GHz
INPUT POWER	120Vac / 60Hz	DETECTOR FUNCTION	Peak (PK) Average (AV)
ENVIRONMENTAL CONDITIONS	25deg. C, 65%RH	TESTED BY	Nelson Teng

ANTENNA POLARITY & TEST DISTANCE: HORIZONTAL AT 3 M								
NO.	FREQ. (MHz)	EMISSION LEVEL (dBuV/m)	LIMIT (dBuV/m)	MARGIN (dB)	ANTENNA HEIGHT (m)	TABLE ANGLE (Degree)	RAW VALUE (dBuV)	CORRECTION FACTOR (dB/m)
1	*5240.00	106.9 PK			1.00 H	247	66.34	40.56
2	*5240.00	98.4 AV			1.00 H	247	57.84	40.56
3	5356.42	60.1 PK	74.0	-13.9	1.00 H	247	19.33	40.77
4	5352.42	46.8 AV	54.0	-7.2	1.00 H	247	6.03	40.77
5	#10480.00	55.9 PK	68.3	-12.4	1.04 H	135	8.99	46.91
6	15720.00	61.9 PK	74.0	-12.1	1.07 H	63	10.28	51.62
7	15720.00	49.0 AV	54.0	-5.0	1.07 H	63	-2.62	51.62

ANTENNA POLARITY & TEST DISTANCE: VERTICAL AT 3 M								
NO.	FREQ. (MHz)	EMISSION LEVEL (dBuV/m)	LIMIT (dBuV/m)	MARGIN (dB)	ANTENNA HEIGHT (m)	TABLE ANGLE (Degree)	RAW VALUE (dBuV)	CORRECTION FACTOR (dB/m)
1	*5240.00	108.2 PK			1.00 V	323	67.64	40.56
2	*5240.00	99.0 AV			1.00 V	323	58.44	40.56
3	5355.13	59.2 PK	74.0	-14.8	1.00 V	322	18.43	40.77
4	5355.13	46.8 AV	54.0	-7.2	1.00 V	322	6.03	40.77
5	#10480.00	54.0 PK	68.3	-14.3	1.06 V	158	7.09	46.91
6	15720.00	61.1 PK	74.0	-12.9	1.01 V	95	9.48	51.62
7	15720.00	49.3 AV	54.0	-4.7	1.01 V	95	-2.32	51.62

- REMARKS:**
1. Emission level (dBuV/m) = Raw Value (dBuV) + Correction Factor (dB/m).
 2. Correction Factor (dB/m) = Antenna Factor (dB/m) + Cable Factor (dB).
 3. The other emission levels were very low against the limit.
 4. Margin value = Emission level – Limit value.
 5. “ * “: Fundamental frequency.
 6. “#“: The radiated frequency is out the restricted band.



A D T

RESTRICTED BANDEDGE (802.11a MODE, CH36, HORIZONTAL)

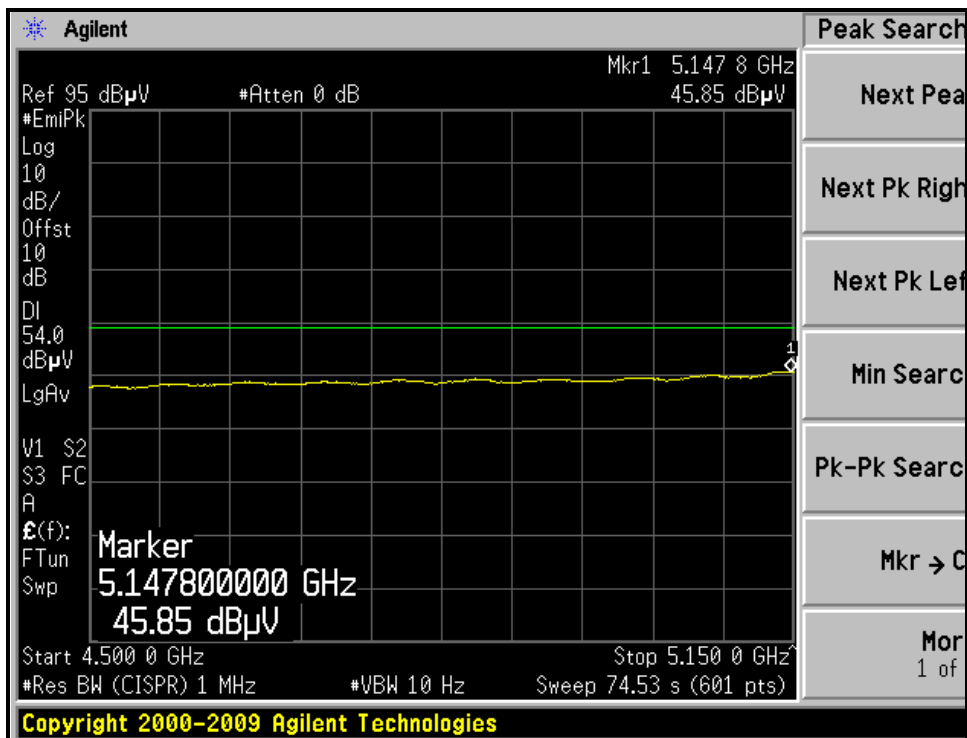
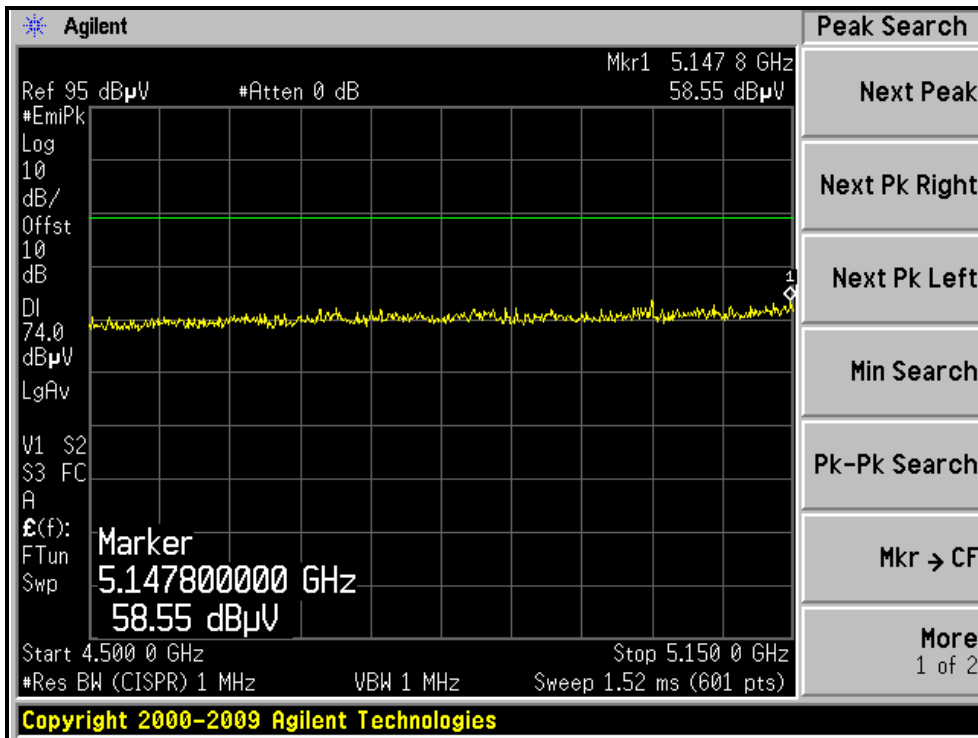



A D T

RESTRICTED BANDEDGE (802.11a MODE, CH36, VERTICAL)

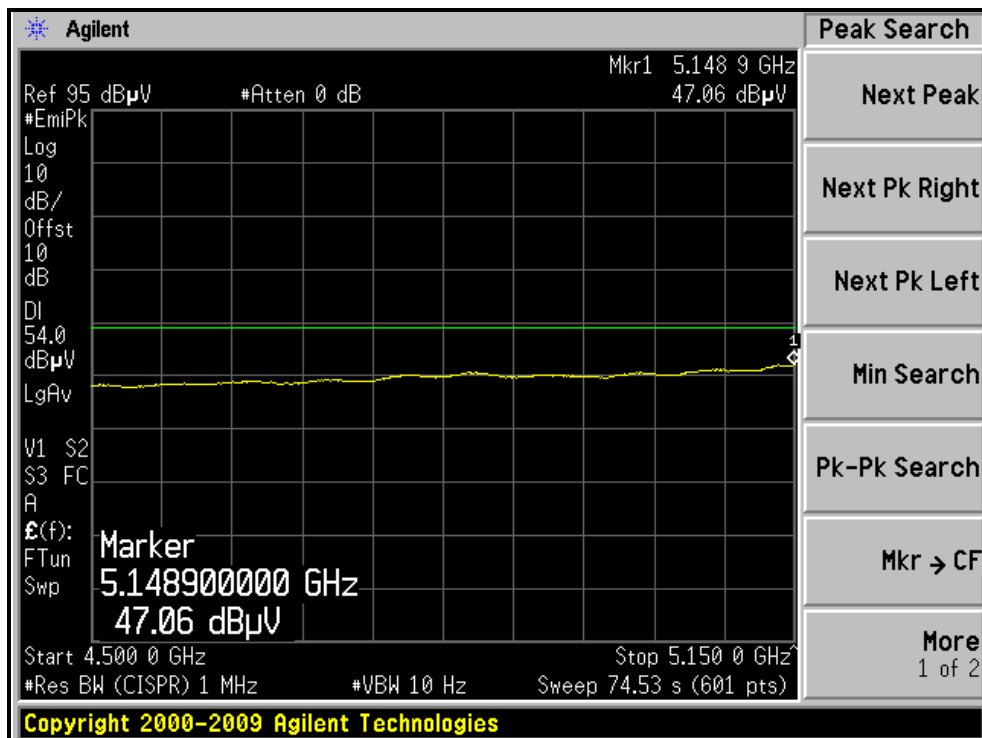
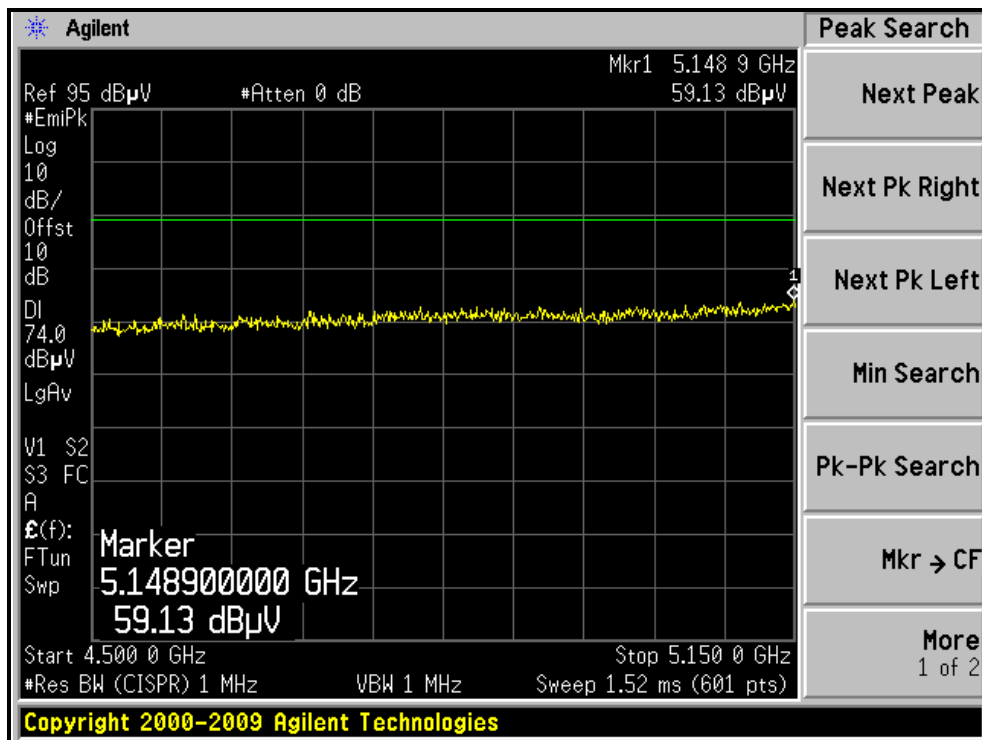



A D T

RESTRICTED BANDEDGE (802.11a MODE, CH48, HORIZONTAL)

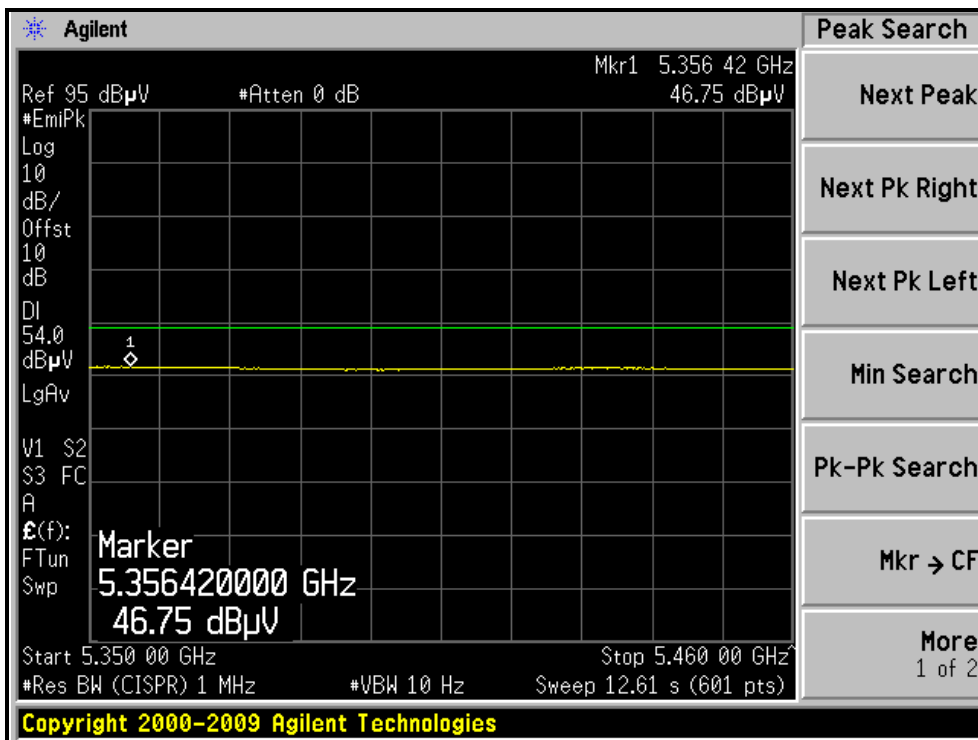
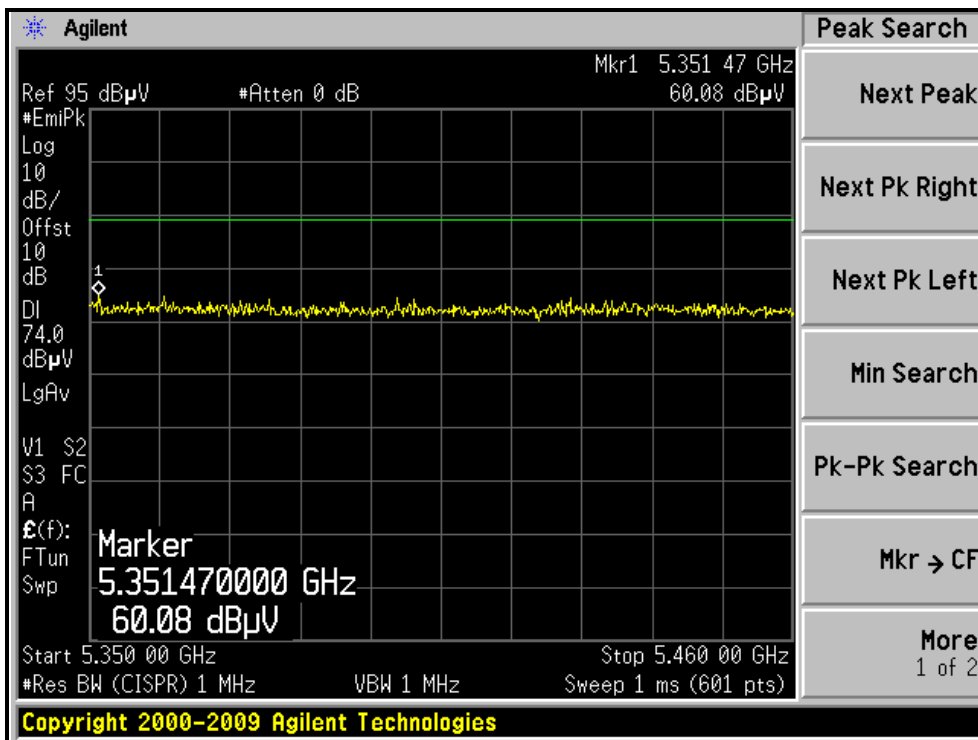



A D T

RESTRICTED BANDEDGE (802.11a MODE, CH48, VERTICAL)

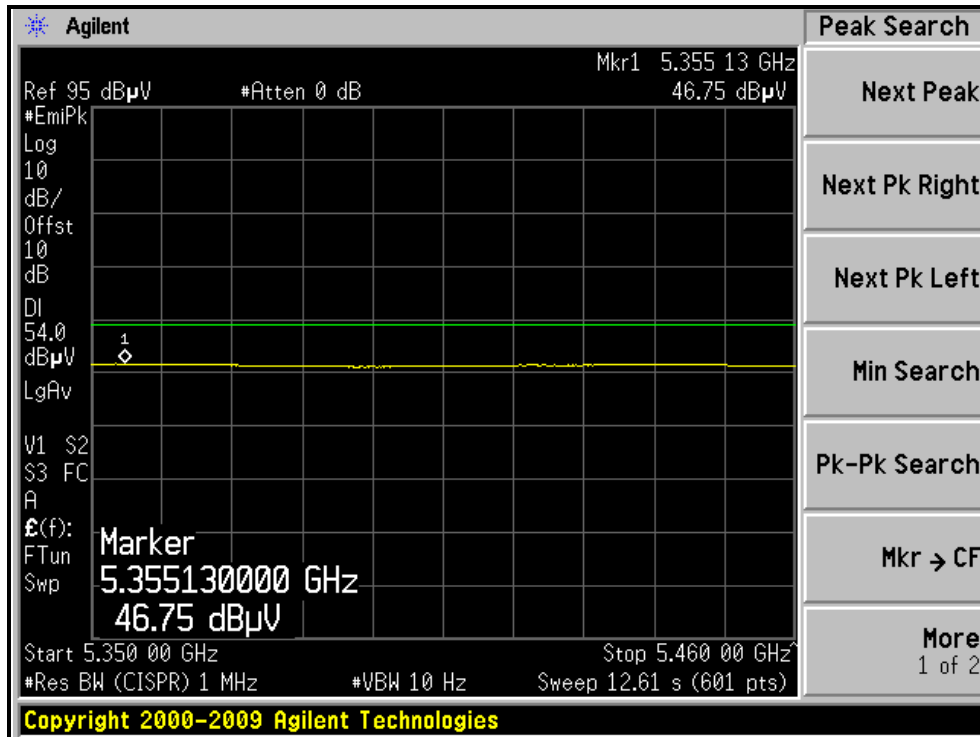
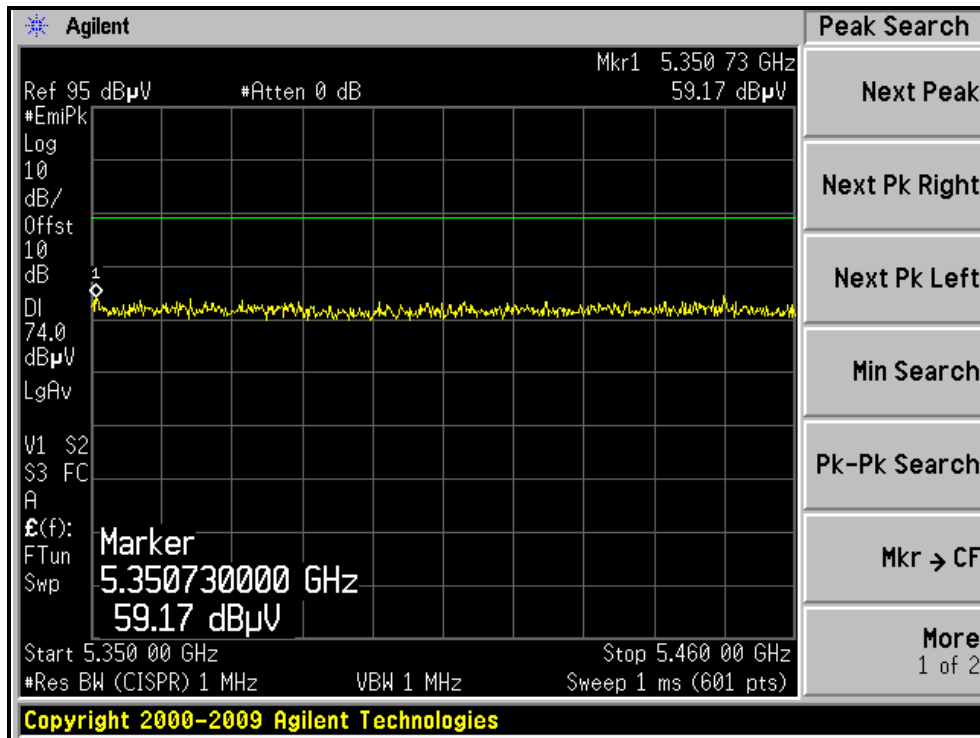

802.11n (20MHz) OFDM MODULATION

EUT TEST CONDITION		MEASUREMENT DETAIL	
CHANNEL	Channel 36	FREQUENCY RANGE	1 ~ 40GHz
INPUT POWER	120Vac / 60Hz	DETECTOR FUNCTION	Peak (PK) Average (AV)
ENVIRONMENTAL CONDITIONS	25deg. C, 65%RH	TESTED BY	Nelson Teng

ANTENNA POLARITY & TEST DISTANCE: HORIZONTAL AT 3 M								
NO.	FREQ. (MHz)	EMISSION LEVEL (dBuV/m)	LIMIT (dBuV/m)	MARGIN (dB)	ANTENNA HEIGHT (m)	TABLE ANGLE (Degree)	RAW VALUE (dBuV)	CORRECTION FACTOR (dB/m)
1	5150.00	55.7 PK	74.0	-18.3	1.30 H	292	15.30	40.40
2	5150.00	45.9 AV	54.0	-8.1	1.30 H	292	5.50	40.40
3	*5180.00	102.7 PK			1.30 H	292	62.25	40.45
4	*5180.00	93.7 AV			1.30 H	292	53.25	40.45
5	#10360.00	55.1 PK	68.3	-13.2	1.00 H	136	8.29	46.81
6	15540.00	61.7 PK	74.0	-12.3	1.04 H	48	10.53	51.17
7	15540.00	48.9 AV	54.0	-5.1	1.04 H	48	-2.27	51.17

ANTENNA POLARITY & TEST DISTANCE: VERTICAL AT 3 M								
NO.	FREQ. (MHz)	EMISSION LEVEL (dBuV/m)	LIMIT (dBuV/m)	MARGIN (dB)	ANTENNA HEIGHT (m)	TABLE ANGLE (Degree)	RAW VALUE (dBuV)	CORRECTION FACTOR (dB/m)
1	5148.90	58.5 PK	74.0	-15.5	1.00 V	75	18.10	40.40
2	5148.90	46.5 AV	54.0	-7.5	1.00 V	75	6.10	40.40
3	*5180.00	106.8 PK			1.00 V	75	66.35	40.45
4	*5180.00	97.9 AV			1.00 V	75	57.45	40.45
5	#10360.00	53.4 PK	68.3	-14.9	1.06 V	159	6.59	46.81
6	15540.00	61.5 PK	74.0	-12.5	1.00 V	87	10.33	51.17
7	15540.00	49.6 AV	54.0	-4.4	1.00 V	87	-1.57	51.17

- REMARKS:**
1. Emission level (dBuV/m) = Raw Value (dBuV) + Correction Factor (dB/m).
 2. Correction Factor (dB/m) = Antenna Factor (dB/m) + Cable Factor (dB).
 3. The other emission levels were very low against the limit.
 4. Margin value = Emission level – Limit value.
 5. “ * “: Fundamental frequency.
 6. "#":The radiated frequency is out the restricted band.



A D T

EUT TEST CONDITION		MEASUREMENT DETAIL	
CHANNEL	Channel 40	FREQUENCY RANGE	1 ~ 40GHz
INPUT POWER	120Vac / 60Hz	DETECTOR FUNCTION	Peak (PK) Average (AV)
ENVIRONMENTAL CONDITIONS	25deg. C, 65%RH	TESTED BY	Nelson Teng

ANTENNA POLARITY & TEST DISTANCE: HORIZONTAL AT 3 M

NO.	FREQ. (MHz)	EMISSION LEVEL (dBuV/m)	LIMIT (dBuV/m)	MARGIN (dB)	ANTENNA HEIGHT (m)	TABLE ANGLE (Degree)	RAW VALUE (dBuV)	CORRECTION FACTOR (dB/m)
1	*5200.00	103.9 PK			1.24 H	291	63.41	40.49
2	*5200.00	94.8 AV			1.24 H	291	54.31	40.49
3	#10400.00	54.7 PK	68.3	-13.6	1.03 H	114	7.85	46.85
4	15600.00	63.9 PK	74.0	-10.1	1.05 H	121	12.62	51.28
5	15600.00	51.3 AV	54.0	-2.7	1.05 H	121	0.02	51.28

ANTENNA POLARITY & TEST DISTANCE: VERTICAL AT 3 M

NO.	FREQ. (MHz)	EMISSION LEVEL (dBuV/m)	LIMIT (dBuV/m)	MARGIN (dB)	ANTENNA HEIGHT (m)	TABLE ANGLE (Degree)	RAW VALUE (dBuV)	CORRECTION FACTOR (dB/m)
1	*5200.00	104.8 PK			1.00 V	292	64.31	40.49
2	*5200.00	96.2 AV			1.00 V	292	55.71	40.49
3	#10400.00	54.7 PK	68.3	-13.6	1.02 V	143	7.85	46.85
4	15600.00	63.8 PK	74.0	-10.2	1.04 V	100	12.52	51.28
5	15600.00	51.4 AV	54.0	-2.6	1.04 V	100	0.12	51.28

- REMARKS:**
1. Emission level (dBuV/m) = Raw Value (dBuV) + Correction Factor (dB/m).
 2. Correction Factor (dB/m) = Antenna Factor (dB/m) + Cable Factor (dB).
 3. The other emission levels were very low against the limit.
 4. Margin value = Emission level – Limit value.
 5. “ * “: Fundamental frequency.
 6. “ # “: The radiated frequency is out the restricted band.



A D T

EUT TEST CONDITION		MEASUREMENT DETAIL	
CHANNEL	Channel 48	FREQUENCY RANGE	1 ~ 40GHz
INPUT POWER	120Vac / 60Hz	DETECTOR FUNCTION	Peak (PK) Average (AV)
ENVIRONMENTAL CONDITIONS	25deg. C, 65%RH	TESTED BY	Nelson Teng

ANTENNA POLARITY & TEST DISTANCE: HORIZONTAL AT 3 M								
NO.	FREQ. (MHz)	EMISSION LEVEL (dBuV/m)	LIMIT (dBuV/m)	MARGIN (dB)	ANTENNA HEIGHT (m)	TABLE ANGLE (Degree)	RAW VALUE (dBuV)	CORRECTION FACTOR (dB/m)
1	*5240.00	104.3 PK			1.31 H	294	63.74	40.56
2	*5240.00	95.3 AV			1.31 H	294	54.74	40.56
3	5350.00	57.2 PK	74.0	-16.8	1.30 H	292	16.43	40.77
4	5350.00	46.0 AV	54.0	-8.0	1.30 H	292	5.23	40.77
5	#10480.00	56.1 PK	68.3	-12.2	1.03 H	106	9.19	46.91
6	15720.00	61.9 PK	74.0	-12.1	1.07 H	114	10.28	51.62
7	15720.00	48.9 AV	54.0	-5.1	1.07 H	114	-2.72	51.62
ANTENNA POLARITY & TEST DISTANCE: VERTICAL AT 3 M								
NO.	FREQ. (MHz)	EMISSION LEVEL (dBuV/m)	LIMIT (dBuV/m)	MARGIN (dB)	ANTENNA HEIGHT (m)	TABLE ANGLE (Degree)	RAW VALUE (dBuV)	CORRECTION FACTOR (dB/m)
1	*5240.00	108.2 PK			1.00 V	296	67.64	40.56
2	*5240.00	99.2 AV			1.00 V	296	58.64	40.56
3	5353.12	59.4 PK	74.0	-14.6	1.00 V	296	18.63	40.77
4	5353.12	47.0 AV	54.0	-7.0	1.00 V	296	6.23	40.77
5	#10480.00	53.5 PK	68.3	-14.8	1.06 V	135	6.59	46.91
6	15720.00	61.1 PK	74.0	-12.9	1.02 V	164	9.48	51.62
7	15720.00	48.9 AV	54.0	-5.1	1.02 V	164	-2.72	51.62

- REMARKS:**
1. Emission level (dBuV/m) = Raw Value (dBuV) + Correction Factor (dB/m).
 2. Correction Factor (dB/m) = Antenna Factor (dB/m) + Cable Factor (dB).
 3. The other emission levels were very low against the limit.
 4. Margin value = Emission level – Limit value.
 5. “ * “: Fundamental frequency.
 6. “#“: The radiated frequency is out the restricted band.



A D T

RESTRICTED BANDEDGE (802.11n (20MHz) MODE,CH36, HORIZONTAL)

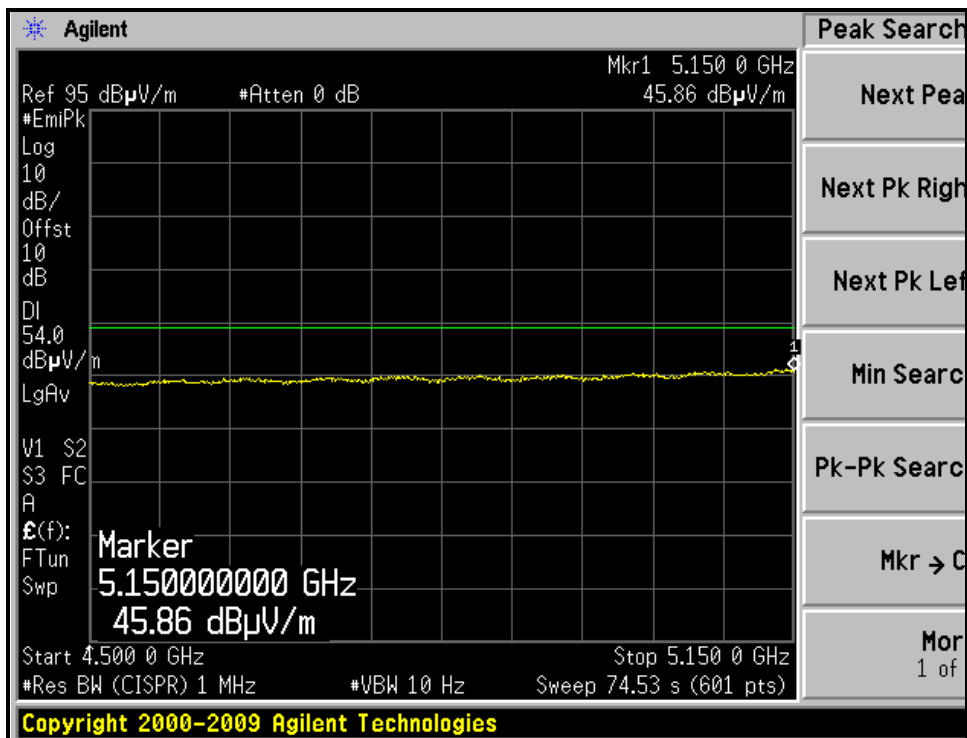
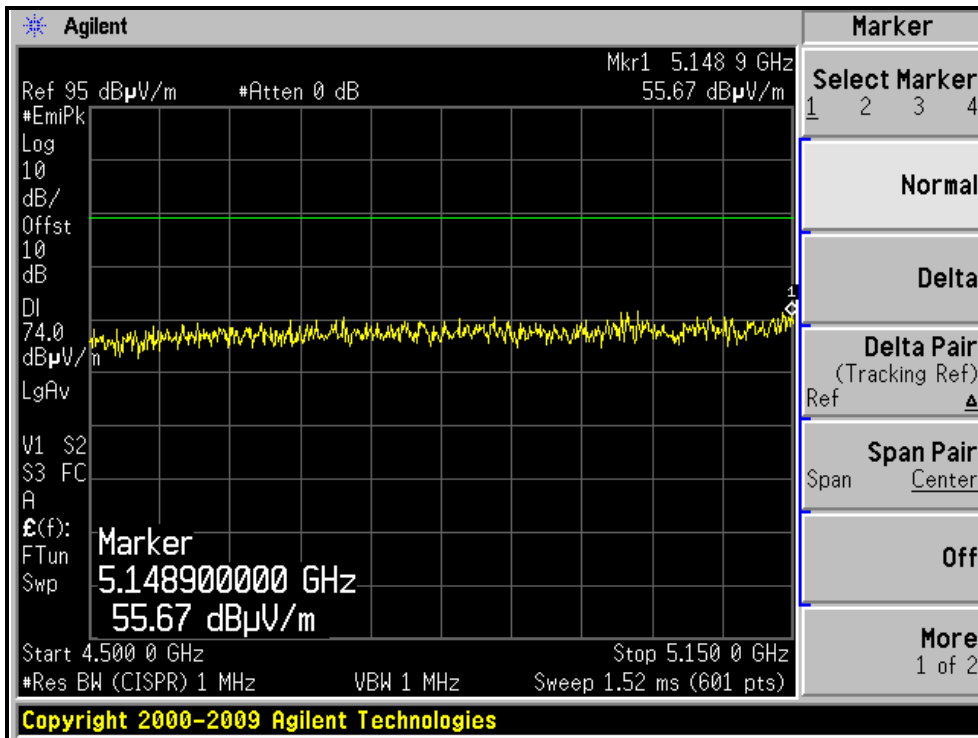



A D T

RESTRICTED BANDEDGE (802.11n (20MHz) MODE,CH36, VERTICAL)

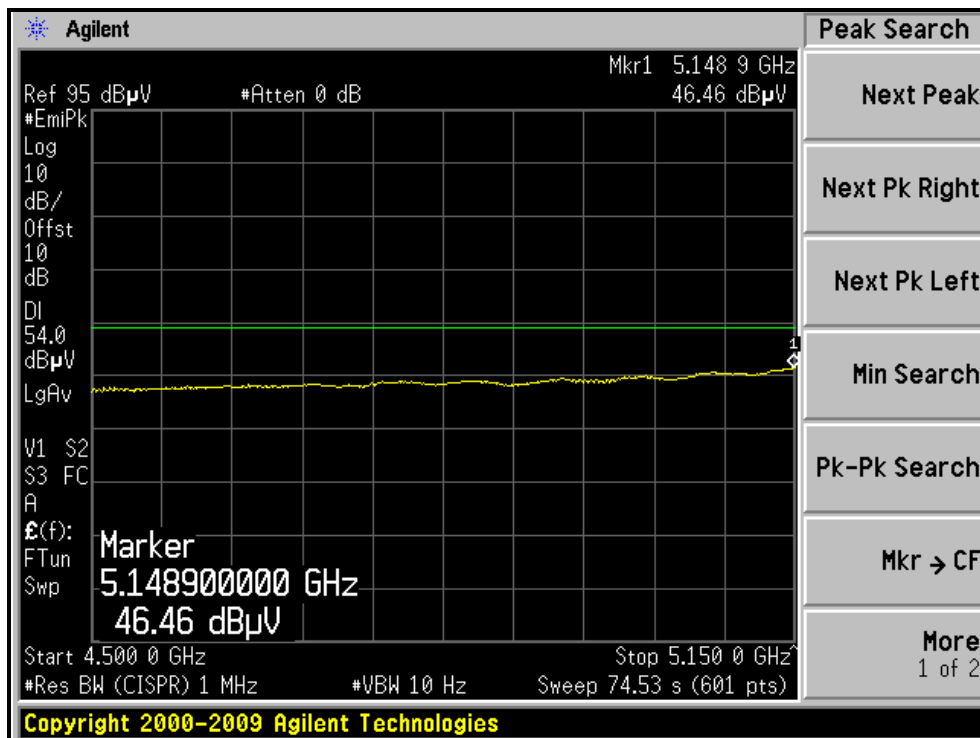
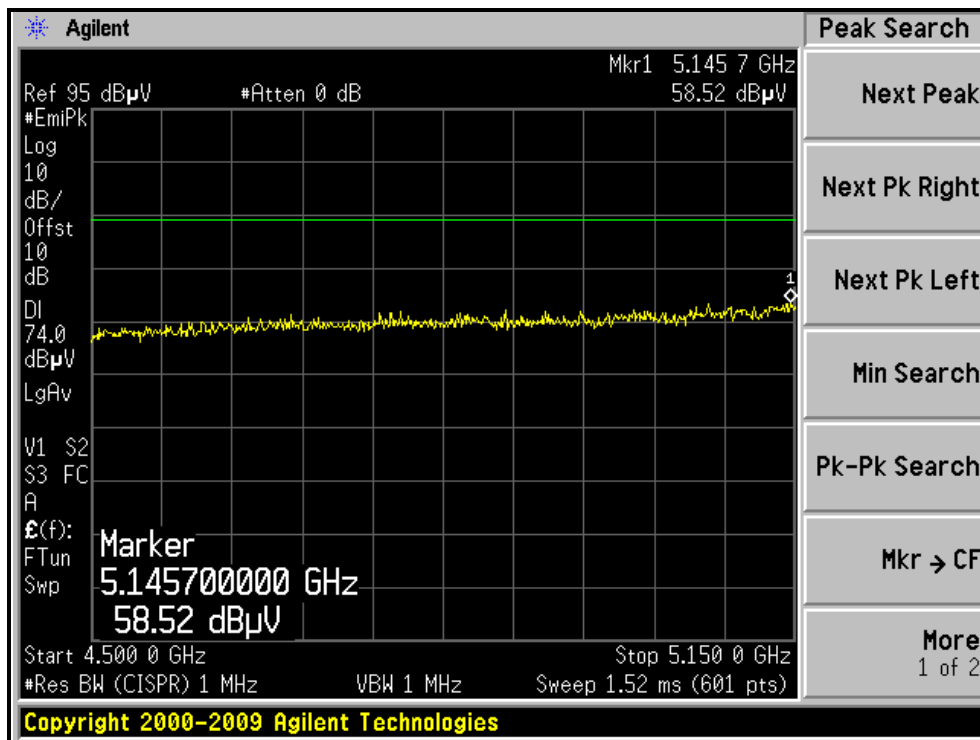



A D T

RESTRICTED BANDEDGE (802.11n (20MHz) MODE,CH48, HORIZONTAL)

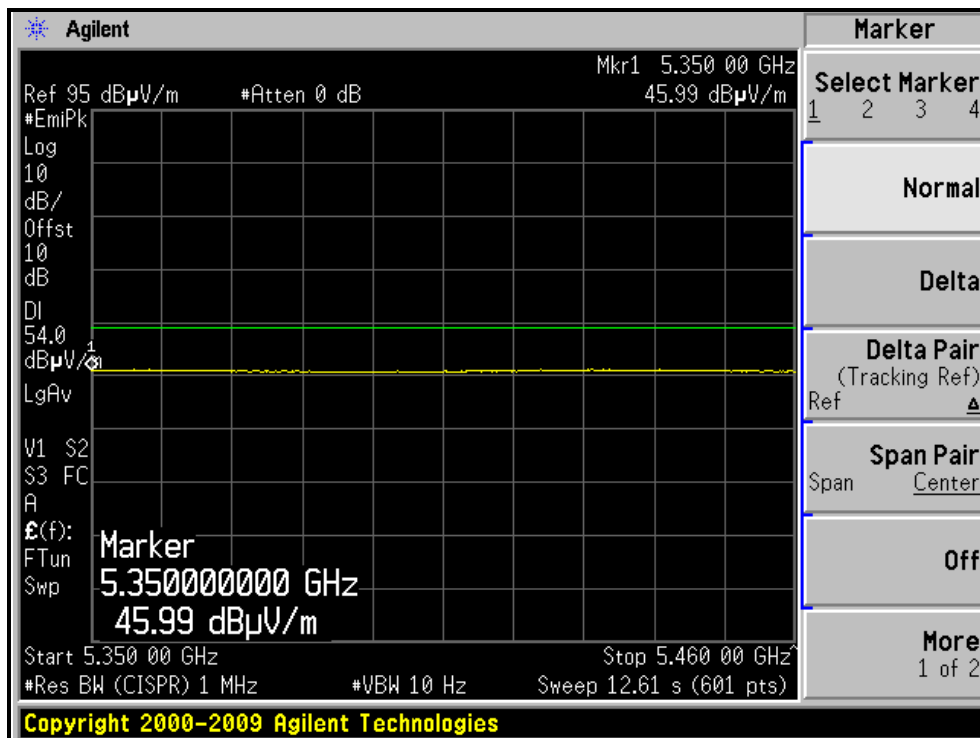
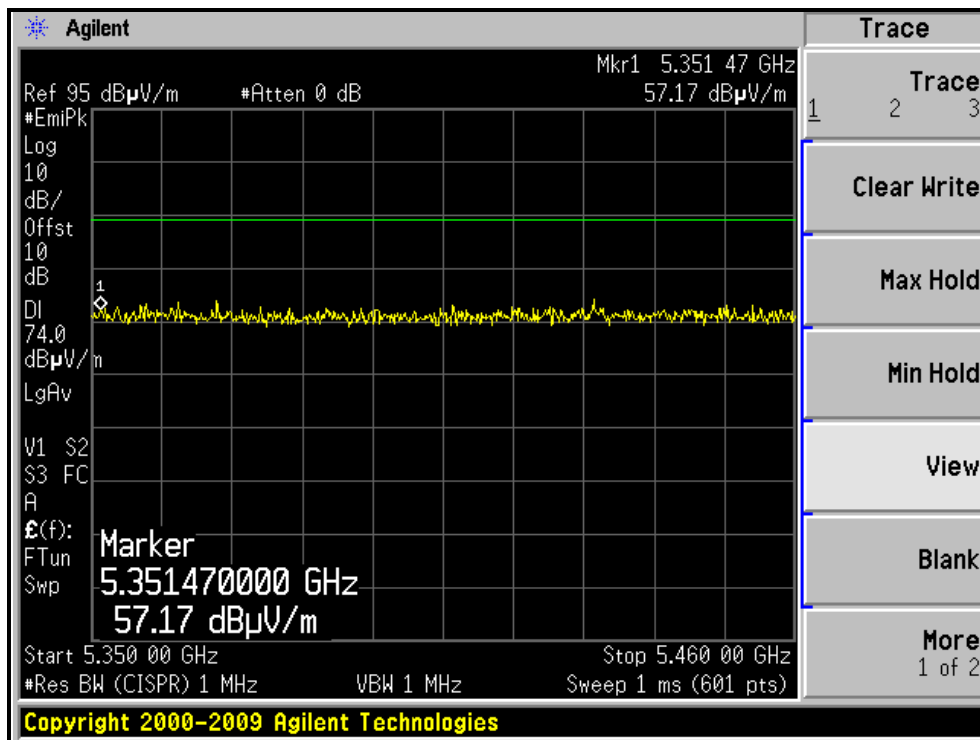



A D T

RESTRICTED BANDEDGE (802.11n (20MHz) MODE,CH48, VERTICAL)

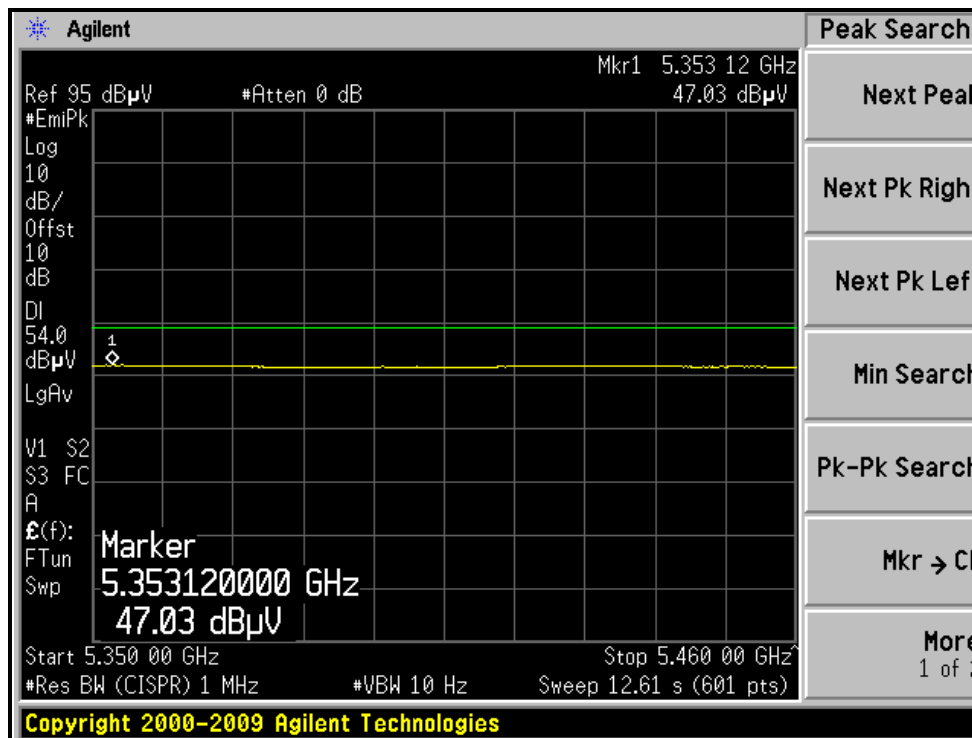
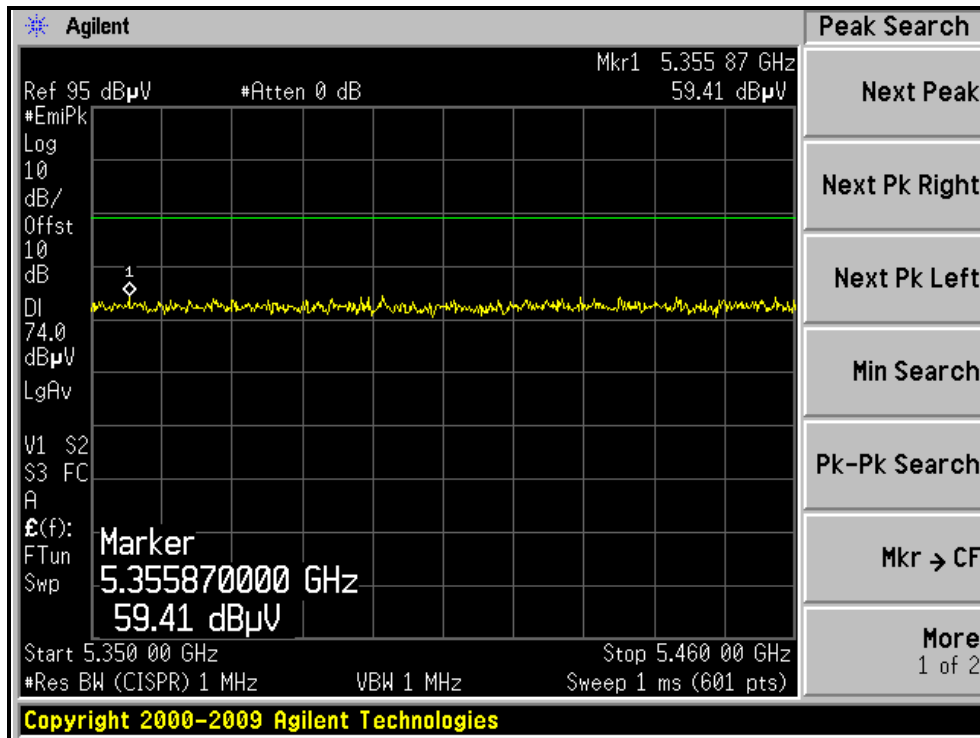



A D T

802.11n (40MHz) OFDM MODULATION

EUT TEST CONDITION		MEASUREMENT DETAIL	
CHANNEL	Channel 38	FREQUENCY RANGE	1 ~ 40GHz
INPUT POWER	120Vac / 60Hz	DETECTOR FUNCTION	Peak (PK) Average (AV)
ENVIRONMENTAL CONDITIONS	25deg. C, 65%RH	TESTED BY	Nelson Teng

ANTENNA POLARITY & TEST DISTANCE: HORIZONTAL AT 3 M								
NO.	FREQ. (MHz)	EMISSION LEVEL (dBuV/m)	LIMIT (dBuV/m)	MARGIN (dB)	ANTENNA HEIGHT (m)	TABLE ANGLE (Degree)	RAW VALUE (dBuV)	CORRECTION FACTOR (dB/m)
1	5150.00	56.2 PK	74.0	-17.8	1.30 H	294	15.80	40.40
2	5150.00	47.0 AV	54.0	-7.0	1.30 H	294	6.60	40.40
3	*5190.00	101.2 PK			1.30 H	292	60.73	40.47
4	*5190.00	93.6 AV			1.30 H	292	53.13	40.47
5	#10380.00	56.1 PK	68.3	-12.2	1.01 H	133	9.27	46.83
6	15570.00	62.5 PK	74.0	-11.5	1.03 H	82	11.28	51.22
7	15570.00	49.2 AV	54.0	-4.8	1.03 H	82	-2.02	51.22

ANTENNA POLARITY & TEST DISTANCE: VERTICAL AT 3 M								
NO.	FREQ. (MHz)	EMISSION LEVEL (dBuV/m)	LIMIT (dBuV/m)	MARGIN (dB)	ANTENNA HEIGHT (m)	TABLE ANGLE (Degree)	RAW VALUE (dBuV)	CORRECTION FACTOR (dB/m)
1	5150.00	63.5 PK	74.0	-10.5	1.00 V	74	23.10	40.40
2	5150.00	50.3 AV	54.0	-3.7	1.00 V	74	9.90	40.40
3	*5190.00	107.5 PK			1.00 V	300	67.03	40.47
4	*5190.00	98.7 AV			1.00 V	300	58.23	40.47
5	#10380.00	53.6 PK	68.3	-14.7	1.03 V	135	6.77	46.83
6	15570.00	61.0 PK	74.0	-13.0	1.02 V	81	9.78	51.22
7	15570.00	48.9 AV	54.0	-5.1	1.02 V	81	-2.32	51.22

- REMARKS:**
1. Emission level (dBuV/m) = Raw Value (dBuV) + Correction Factor (dB/m).
 2. Correction Factor (dB/m) = Antenna Factor (dB/m) + Cable Factor (dB).
 3. The other emission levels were very low against the limit.
 4. Margin value = Emission level – Limit value.
 5. “ * “: Fundamental frequency.
 6. “#“: The radiated frequency is out the restricted band.



A D T

EUT TEST CONDITION		MEASUREMENT DETAIL	
CHANNEL	Channel 46	FREQUENCY RANGE	1 ~ 40GHz
INPUT POWER	120Vac / 60Hz	DETECTOR FUNCTION	Peak (PK) Average (AV)
ENVIRONMENTAL CONDITIONS	25deg. C, 65%RH	TESTED BY	Nelson Teng

ANTENNA POLARITY & TEST DISTANCE: HORIZONTAL AT 3 M								
NO.	FREQ. (MHz)	EMISSION LEVEL (dBuV/m)	LIMIT (dBuV/m)	MARGIN (dB)	ANTENNA HEIGHT (m)	TABLE ANGLE (Degree)	RAW VALUE (dBuV)	CORRECTION FACTOR (dB/m)
1	*5230.00	100.3 PK			1.31 H	294	59.76	40.54
2	*5230.00	92.4 AV			1.31 H	294	51.86	40.54
3	5350.00	57.1 PK	74.0	-16.9	1.30 H	292	16.33	40.77
4	5350.00	47.1 AV	54.0	-6.9	1.30 H	292	6.33	40.77
5	#10460.00	55.8 PK	68.3	-12.5	1.04 H	131	8.90	46.90
6	15690.00	61.7 PK	74.0	-12.3	1.03 H	88	10.16	51.54
7	15690.00	48.9 AV	54.0	-5.1	1.03 H	88	-2.64	51.54

ANTENNA POLARITY & TEST DISTANCE: VERTICAL AT 3 M								
NO.	FREQ. (MHz)	EMISSION LEVEL (dBuV/m)	LIMIT (dBuV/m)	MARGIN (dB)	ANTENNA HEIGHT (m)	TABLE ANGLE (Degree)	RAW VALUE (dBuV)	CORRECTION FACTOR (dB/m)
1	*5230.00	106.2 PK			1.00 V	290	65.66	40.54
2	*5230.00	97.3 AV			1.00 V	290	56.76	40.54
3	5354.22	60.6 PK	74.0	-13.4	1.00 V	294	19.83	40.77
4	5354.22	47.9 AV	54.0	-6.1	1.00 V	294	7.13	40.77
5	#10460.00	53.3 PK	68.3	-15.0	1.00 V	131	6.40	46.90
6	15690.00	61.8 PK	74.0	-12.2	1.05 V	92	10.26	51.54
7	15690.00	49.6 AV	54.0	-4.4	1.05 V	92	-1.94	51.54

- REMARKS:**
1. Emission level (dBuV/m) = Raw Value (dBuV) + Correction Factor (dB/m).
 2. Correction Factor (dB/m) = Antenna Factor (dB/m) + Cable Factor (dB).
 3. The other emission levels were very low against the limit.
 4. Margin value = Emission level – Limit value.
 5. “ * “: Fundamental frequency.
 6. “#“: The radiated frequency is out the restricted band.



A D T

RESTRICTED BANDEDGE (802.11n (40MHz) MODE, CH38, HORIZONTAL)

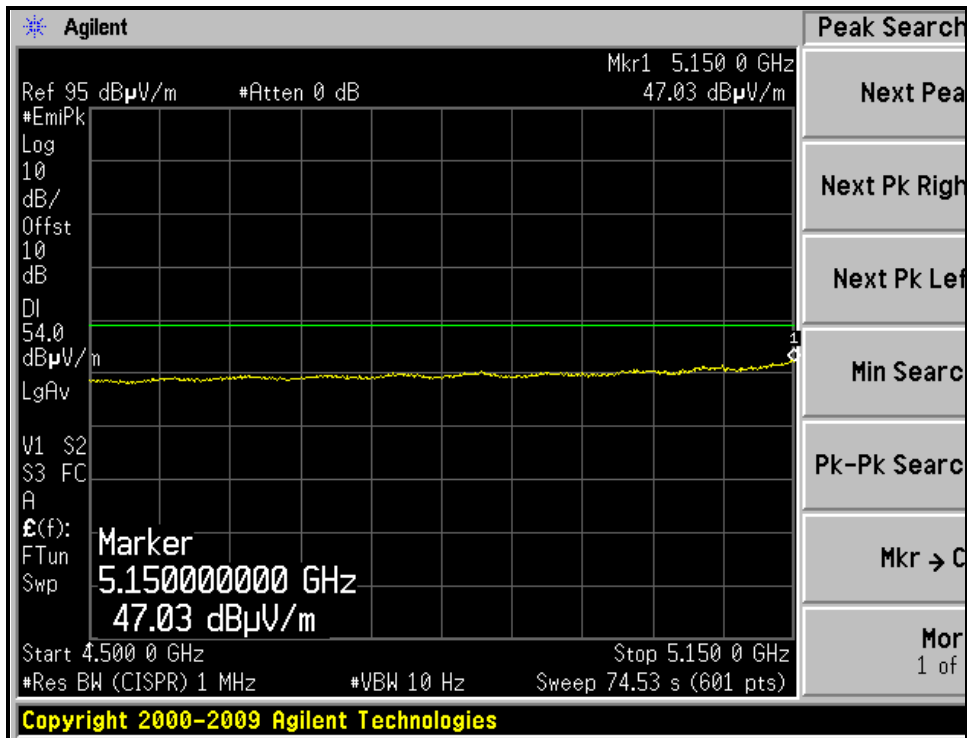
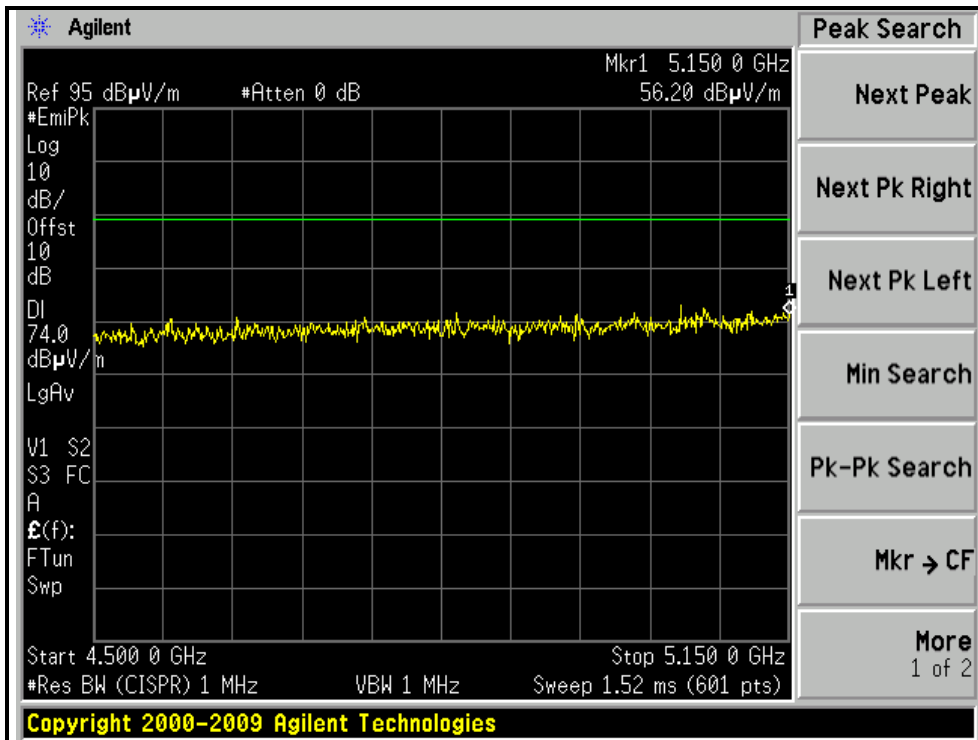



A D T

RESTRICTED BANDEDGE (802.11n (40MHz) MODE,CH38, VERTICAL)

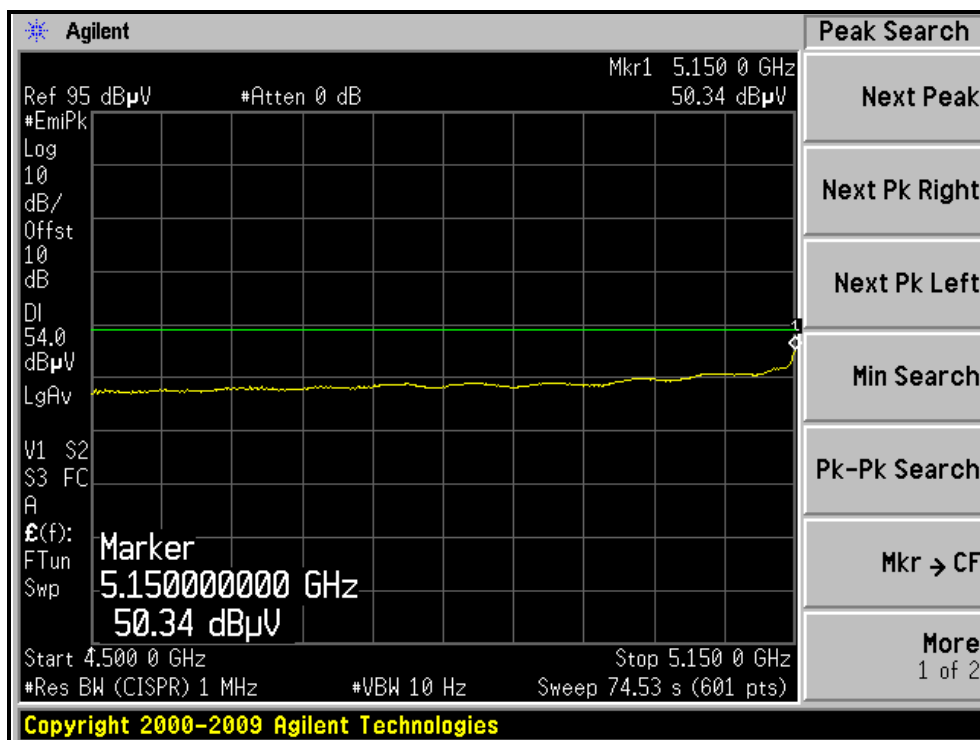
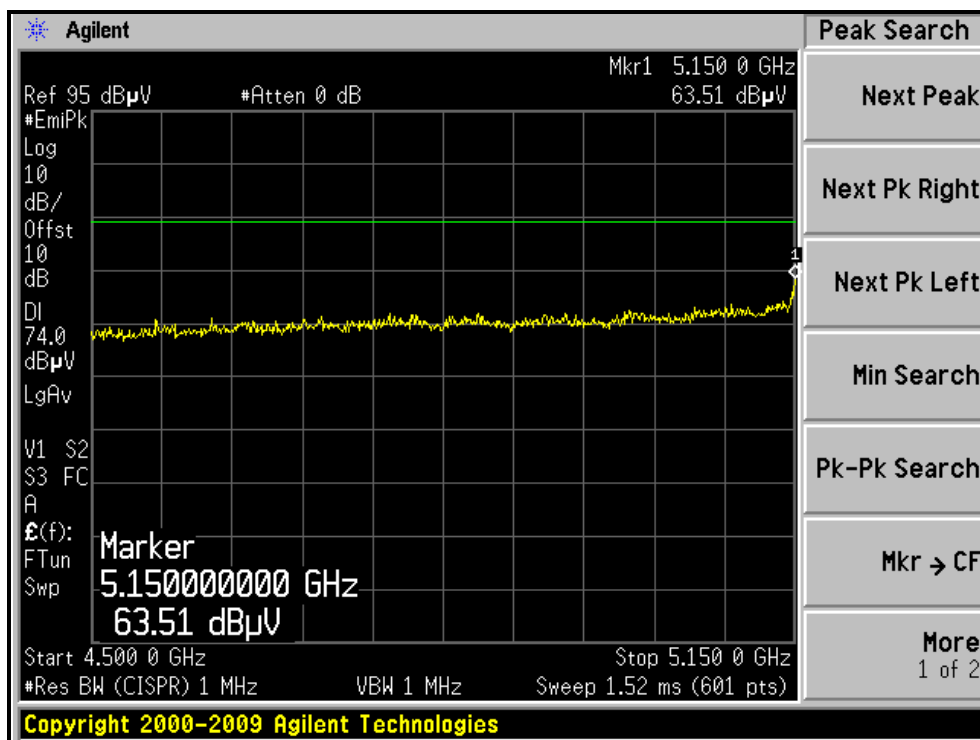



A D T

RESTRICTED BANDEDGE (802.11n (40MHz) MODE, CH46, HORIZONTAL)

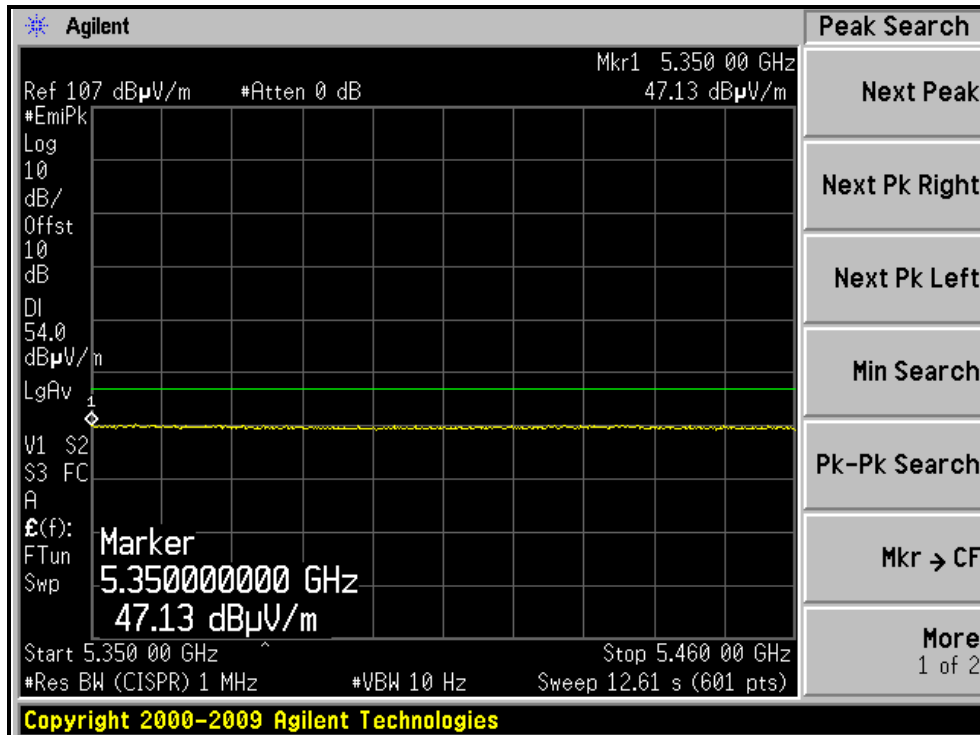
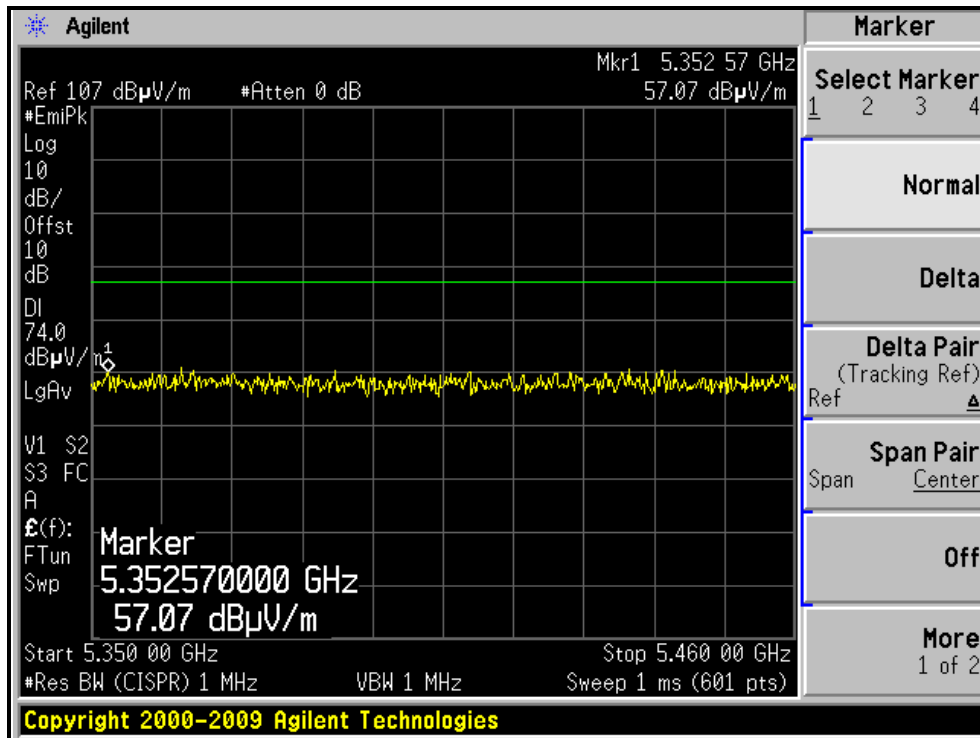

RESTRICTED BANDEDGE (802.11n (40MHz) MODE, CH46, VERTICAL)

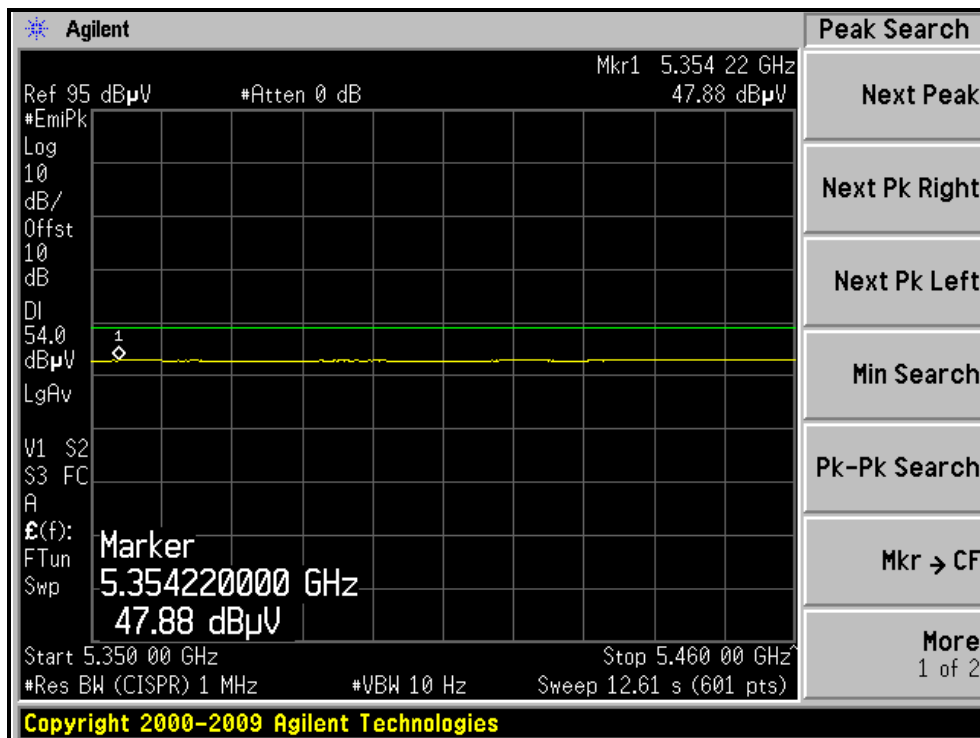
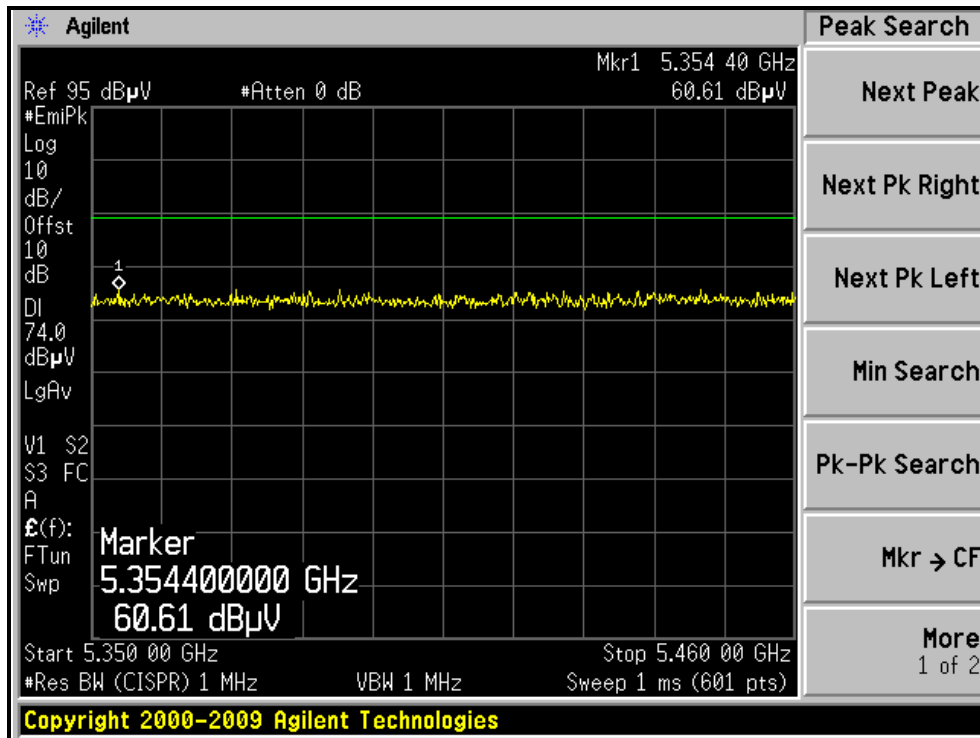



A D T

4.3 OUTPUT TRANSMIT POWER MEASUREMENT

4.3.1 LIMITS OF OUTPUT TRANSMIT POWER MEASUREMENT

Frequency Band	Limit
5.15 – 5.25GHz	The lesser of 50mW (17dBm) or 4dBm + 10logB
5.25 – 5.35GHz	The lesser of 250mW (24dBm) or 11dBm + 10logB
5.47 – 5.725GHz	The lesser of 250mW (24dBm) or 11dBm + 10logB
5.725 – 5.825GHz	The lesser of 1W (30dBm) or 17dBm + 10logB

NOTE: Where B is the 26dB emission bandwidth in MHz.

4.3.2 TEST INSTRUMENTS

Test date: Aug. 08, 2011

DESCRIPTION & MANUFACTURER	MODEL NO.	SERIAL NO.	CALIBRATED DATE	CALIBRATED UNTIL
Spectrum Analyzer	E4446A	MY48250254	July 12, 2011	July 11, 2012

NOTE: The calibration interval of the above test instruments is 12 months and the calibrations are traceable to NML/ROC and NIST/USA.

4.3.3 TEST PROCEDURE

1. The transmitter output was connected to the spectrum analyzer.
2. Set span to encompass the entire emission bandwidth of the signal.
3. Set RBW to 1MHz, VBW to 3MHz.
4. Using the spectrum analyzer's channel power measurement function to measure the output power.

NOTE:

The test is performed in accordance with FCC Public Notice: APPENDIX A Guidelines for Assessing Unlicensed National Information Infrastructure (U-NII) Devices – Part 15, Subpart E, August 2002.

The transmitter output operates continuously therefore Method # 1 is used.

4.3.4 DEVIATION FROM TEST STANDARD

No deviation

4.3.5 TEST SETUP

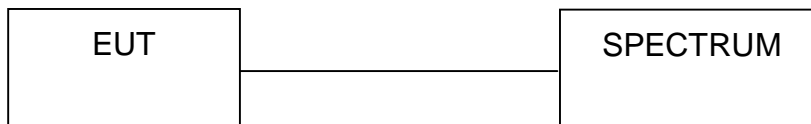

4.3.6 EUT OPERATING CONDITIONS

The software provided by client to enable the EUT under transmission condition continuously at specific channel frequencies individually.



A D T

4.3.7 TEST RESULTS

802.11a OFDM MODULATION:

CHANNEL	CHANNEL FREQUENCY (MHz)	OUTPUT POWER (dBm)		TOTAL OUTPUT POWER (mW)	TOTAL OUTPUT POWER (dBm)	OUTPUT POWER LIMIT (dBm)	PASS / FAIL
		CHAIN(0)	CHAIN(2)				
36	5180	10.7	10.8	23.8	13.8	16.3	PASS
40	5200	10.8	10.9	24.3	13.9	16.3	PASS
48	5240	11.1	10.7	24.6	13.9	16.3	PASS

$$\text{Directional gain} = 10 \log[(10^{G1/20} + 10^{G2/20})^2 / 2]$$

Effective Legacy Gain (dBi) = 6.7

The effective legacy gain is 6.7dBi, therefore the limit needs to reduce.

CHANNEL	CHANNEL FREQUENCY (MHz)	26dBc OCCUPIED BANDWIDTH (MHz)	
		CHAIN(0)	CHAIN(2)
36	5180	19.67	19.42
40	5200	19.75	19.42
48	5240	19.92	19.42

NOTE: The 26dBc Occupied Bandwidth plot, please refer to the following pages.

Power Output:
For CHAIN(0)
CH48

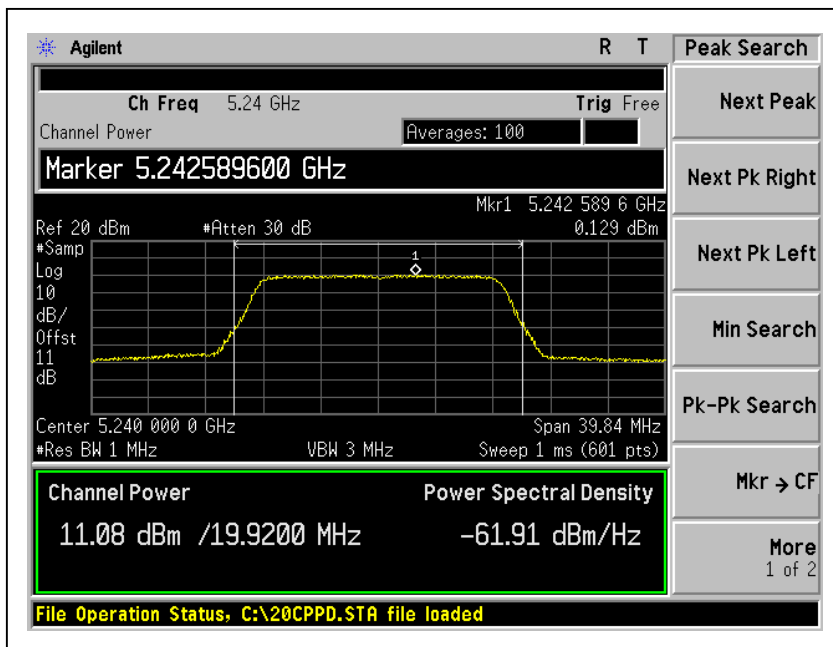

26dB Occupied Bandwidth:
CH48

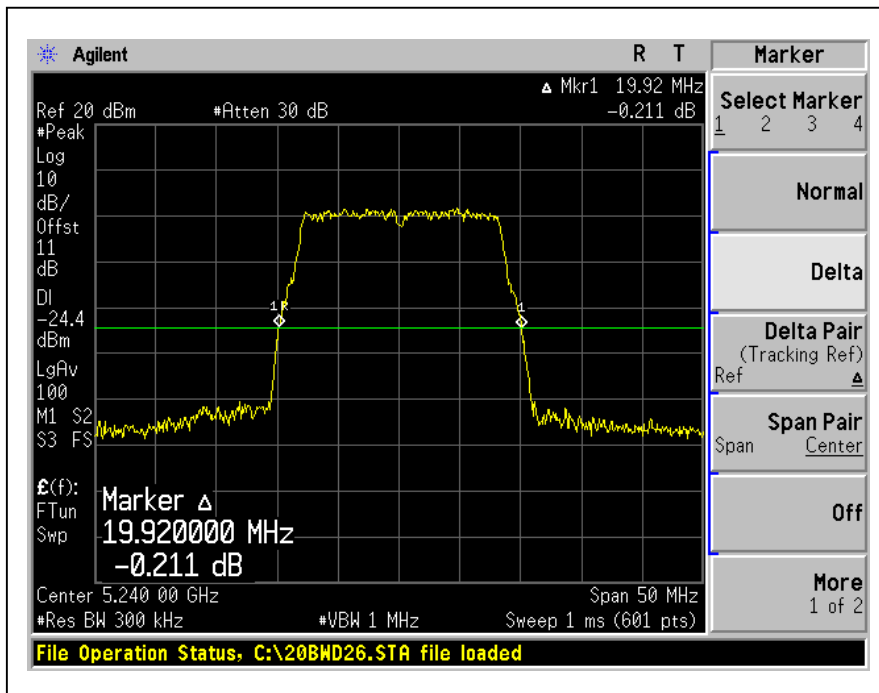



802.11n (20MHz) OFDM MODULATION:

CHANNEL	CHANNEL FREQUENCY (MHz)	OUTPUT POWER (dBm)			TOTAL OUTPUT POWER (mW)	TOTAL OUTPUT POWER (dBm)	OUTPUT POWER LIMIT (dBm)	PASS / FAIL
		CHAIN(0)	CHAIN(1)	CHAIN(2)				
36	5180	9.7	9.7	10.1	28.9	14.6	17	PASS
40	5200	10.0	10.0	9.8	29.6	14.7	17	PASS
48	5240	10.0	10.0	9.6	29.1	14.6	17	PASS

CHANNEL	CHANNEL FREQUENCY (MHz)	26dBc OCCUPIED BANDWIDTH (MHz)		
		CHAIN(0)	CHAIN(1)	CHAIN(2)
36	5180	20.17	20.33	20.17
40	5200	20.17	20.17	20.25
48	5240	20.25	20.25	20.17

NOTE: The 26dBc Occupied Bandwidth plot, please refer to the following pages.

Power Output:
For CHAIN(2)
CH36

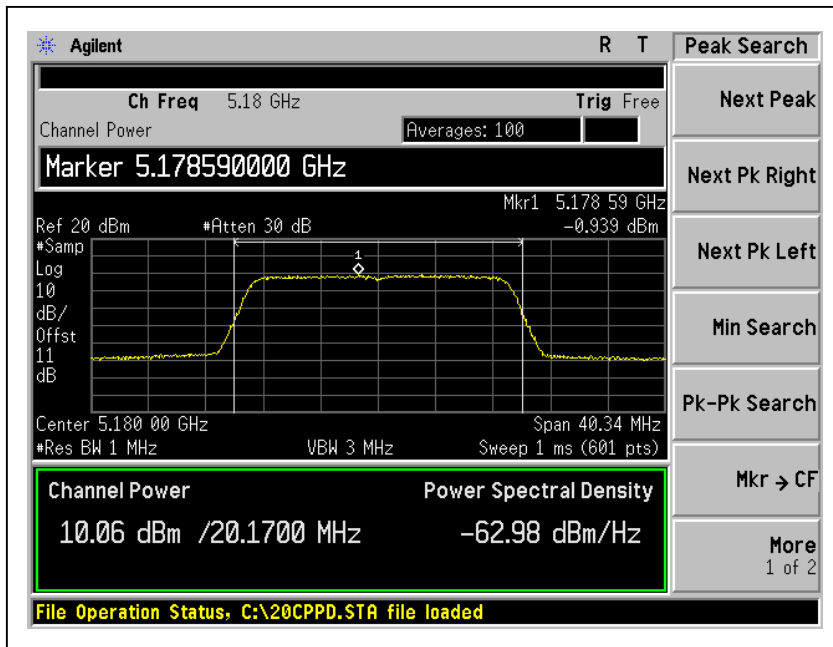

26dB Occupied Bandwidth:
CH36

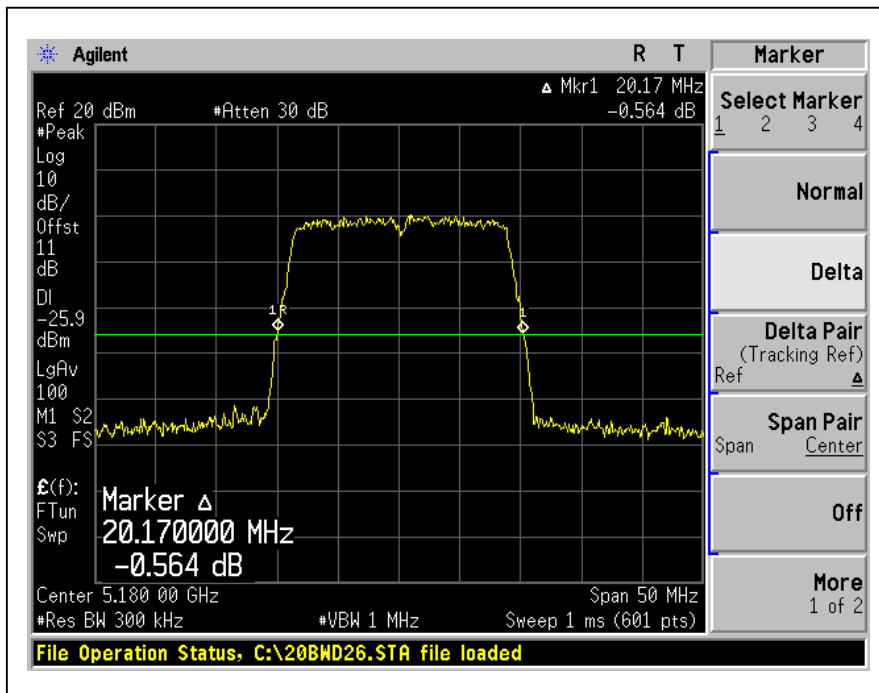



A D T

802.11n (40MHz) OFDM MODULATION:

CHANNEL	CHANNEL FREQUENCY (MHz)	OUTPUT POWER (dBm)			TOTAL OUTPUT POWER (mW)	TOTAL OUTPUT POWER (dBm)	OUTPUT POWER LIMIT (dBm)	PASS / FAIL
		CHAIN(0)	CHAIN(1)	CHAIN(2)				
38	5190	12.1	12.0	12.1	48.3	16.8	17	PASS
46	5230	12.1	11.9	12.0	47.6	16.8	17	PASS

CHANNEL	CHANNEL FREQUENCY (MHz)	26dBc OCCUPIED BANDWIDTH (MHz)		
		CHAIN(0)	CHAIN(1)	CHAIN(2)
38	5190	39.83	40.00	40.17
46	5230	39.67	40.00	40.00

NOTE: The 26dBc Occupied Bandwidth plot, please refer to the following pages.



A D T

Power Output:
For CHAIN(0)
CH38

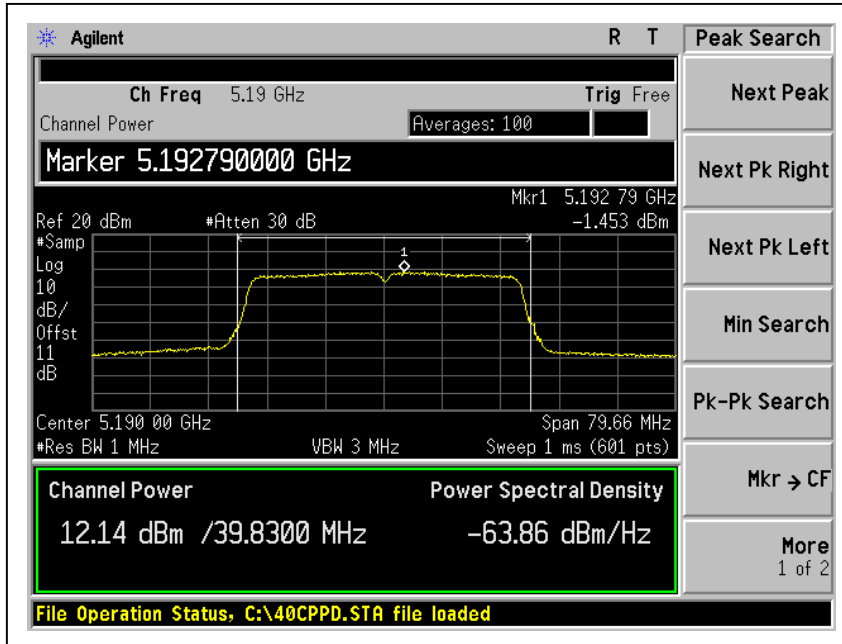

26dB Occupied Bandwidth:
CH38

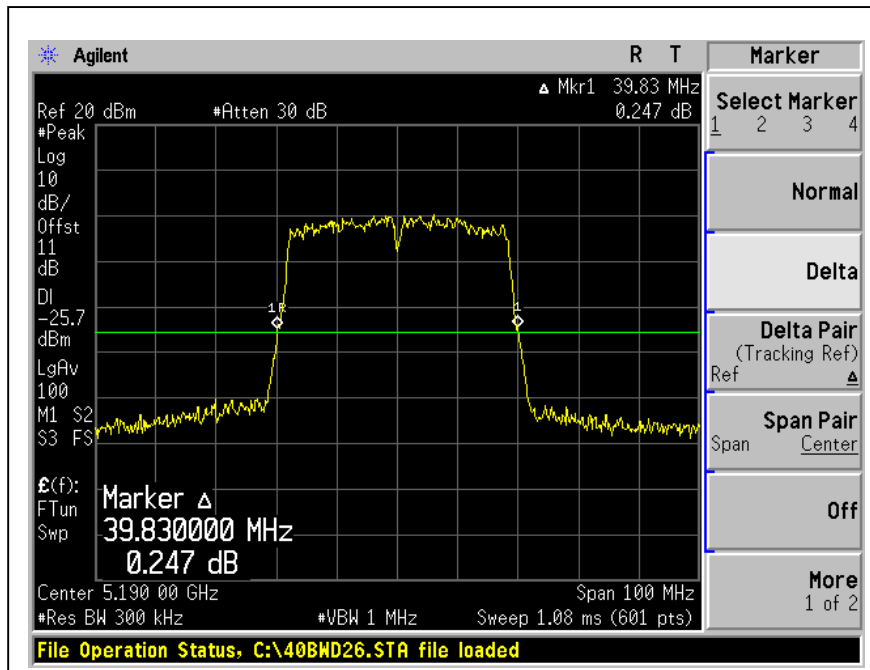

4.4 PEAK POWER EXCURSION MEASUREMENT

4.4.1 LIMITS OF PEAK POWER EXCURSION MEASUREMENT

Frequency Band	Limit
5.15 – 5.25 GHz	13dB
5.25 – 5.35 GHz	13dB
5.47 – 5.725GHz	13dB
5.725 – 5.825 GHz	13dB

4.4.2 TEST INSTRUMENTS

Test date: Aug. 08, 2011

DESCRIPTION & MANUFACTURER	MODEL NO.	SERIAL NO.	CALIBRATED DATE	CALIBRATED UNTIL
Spectrum Analyzer	E4446A	MY48250254	July 12, 2011	July 11, 2012

NOTE: The calibration interval of the above test instruments is 12 months and the calibrations are traceable to NML/ROC and NIST/USA.

4.4.3 TEST PROCEDURE

1. Connect the cable from the spectrum analyzer to the EUT antenna port using an appropriate RF attenuator.
2. Verify the antenna port selected is the active one if the system has more than one antenna.
3. Verify the unlicensed wireless device is set to operate at 100 % duty cycle at the maximum allowed power for operation.
4. Testing shall be done on the center frequency of each U-NII band.
5. Set the spectrum analyzer span to view the entire emission bandwidth. The largest difference between the following two traces must be 13 dB for all frequencies across the emission bandwidth.
 - a. First trace: set RBW = 1 MHz, VBW = 3 MHz with peak detector and max hold settings.
 - b. Second trace: set RBW = 1 MHz, VBW = 3 MHz with sample detector and trace average across 100 traces in power averaging mode.

4.4.4 DEVIATION FROM TEST STANDARD

No deviation

4.4.5 TEST SETUP

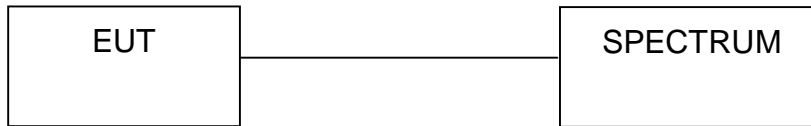

4.4.6 EUT OPERATING CONDITIONS

The software provided by client to enable the EUT under transmission condition continuously at specific channel frequencies individually.



A D T

4.4.7 TEST RESULTS

802.11a OFDM MODULATION

CHANNEL	CHANNEL FREQUENCY (MHz)	PEAK POWER EXCURSION (dB)		PEAK to AVERAGE EXCURSION LIMIT (dB)	PASS/FAIL
		CHAIN(0)	CHAIN(2)		
36	5180	8.2	9.1	13	PASS
40	5200	6.9	7.7	13	PASS
48	5240	8.4	9.9	13	PASS

For CHAIN(2)
CH48

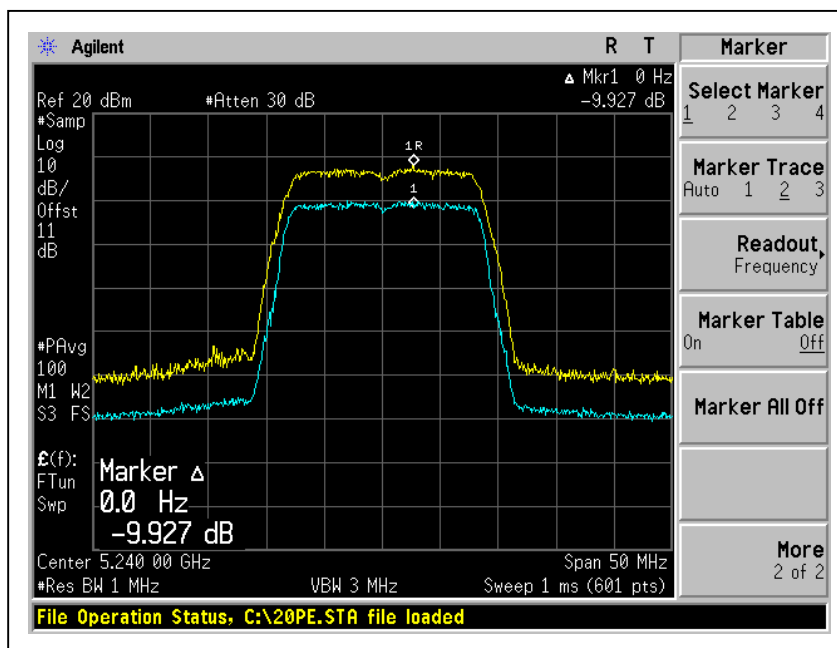



A D T

802.11n (20MHz) OFDM MODULATION:

CHANNEL	CHANNEL FREQUENCY (MHz)	PEAK POWER EXCURSION (dB)			PEAK to AVERAGE EXCURSION LIMIT (dB)	PASS/FAIL
		CHAIN(0)	CHAIN(1)	CHAIN(2)		
36	5180	8.5	8.6	7.7	13	PASS
40	5200	8.9	8.5	8.2	13	PASS
48	5240	8.4	8.4	7.9	13	PASS

For CHAIN(0)
CH40

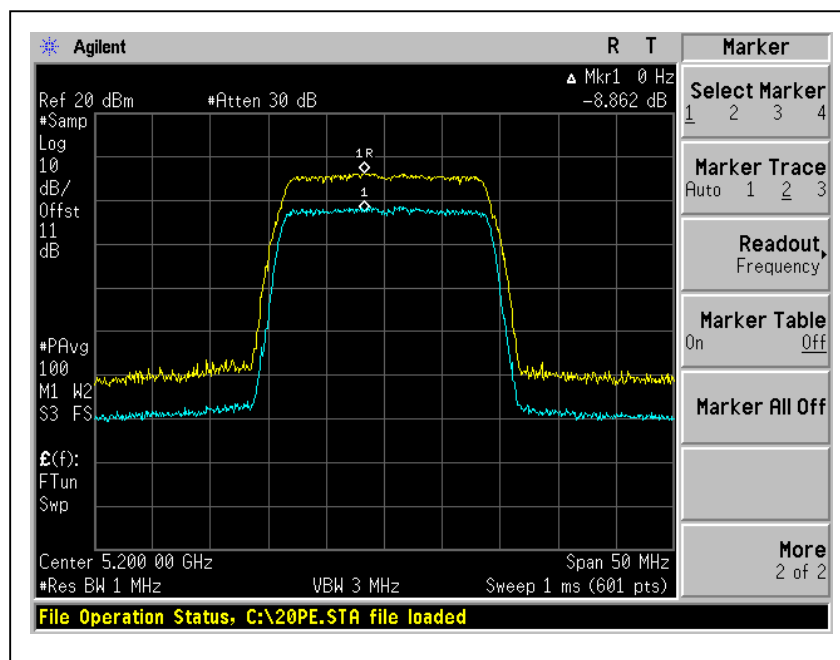



A D T

802.11n (40MHz) OFDM MODULATION:

CHANNEL	CHANNEL FREQUENCY (MHz)	PEAK POWER EXCURSION (dB)			PEAK to AVERAGE EXCURSION LIMIT (dB)	PASS/FAIL
		CHAIN(0)	CHAIN(1)	CHAIN(2)		
38	5190	7.9	7.8	8.3	13	PASS
46	5230	7.8	8.5	8.8	13	PASS

For CHAIN(2)
CH46

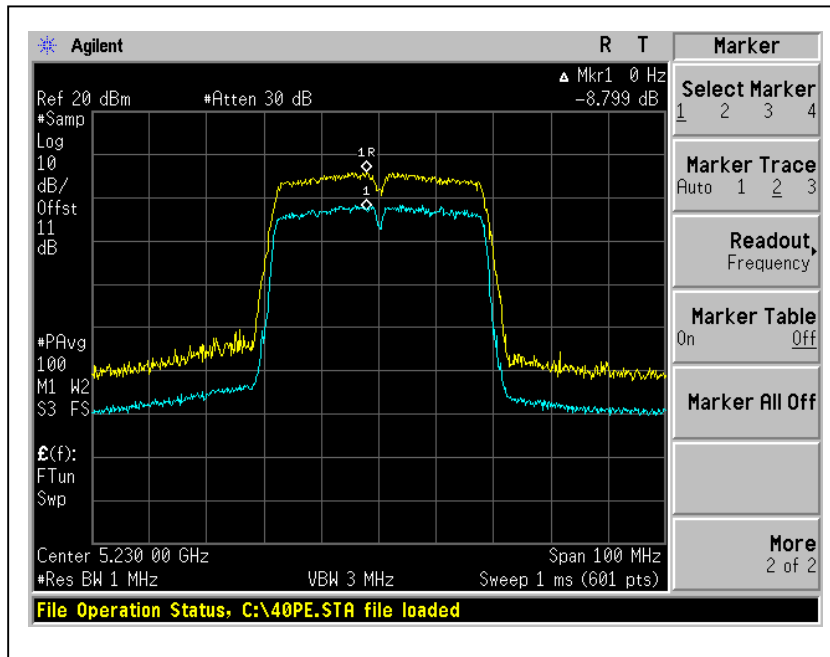

4.5 PEAK POWER SPECTRAL DENSITY MEASUREMENT

4.5.1 LIMITS OF PEAK POWER SPECTRAL DENSITY MEASUREMENT

Frequency Band	Limit
5.15 ~ 5.25GHz	4dBm
5.25 ~ 5.35GHz	11dBm
5.47 ~ 5.725GHz	11dBm
5.725 ~ 5.825GHz	17dBm

4.5.2 TEST INSTRUMENTS

Test date: Aug. 08, 2011

DESCRIPTION & MANUFACTURER	MODEL NO.	SERIAL NO.	CALIBRATED DATE	CALIBRATED UNTIL
Spectrum Analyzer	E4446A	MY48250254	July 12, 2011	July 11, 2012

NOTE: The calibration interval of the above test instruments is 12 months and the calibrations are traceable to NML/ROC and NIST/USA.

4.5.3 TEST PROCEDURES

1. The transmitter output was connected to the spectrum analyzer.
2. Set RBW=1MHz, VBW=3MHz. The PPSD is the highest level found across the emission in any 1MHz band.

4.5.4 DEVIATION FROM TEST STANDARD

No deviation

4.5.5 TEST SETUP

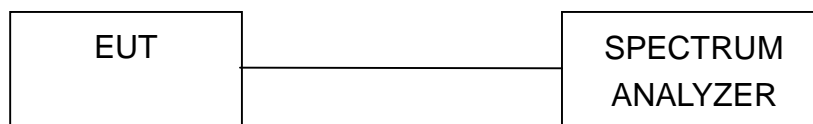

4.5.6 EUT OPERATING CONDITIONS

Same as 4.3.6

4.5.7 TEST RESULTS

802.11a OFDM MODULATION

CHANNEL	CHANNEL FREQUENCY (MHz)	RF POWER LEVEL IN 1MHz BW (dBm)		TOTAL POWER DENSITY (dBm)	MAXIMUM LIMIT (dBm)	PASS / FAIL
		CHAIN(0)	CHAIN(2)			
36	5180	-0.1	0.0	3.0	3.3	PASS
40	5200	0.0	-0.1	3.0	3.3	PASS
48	5240	0.1	-0.2	3.0	3.3	PASS

Directional gain = $10 \log[(10^{G1/20} + 10^{G2/20})^2 / 2]$

Effective Legacy Gain (dBi) = 6.7

The effective legacy gain is 6.7dBi, therefore the limit needs to reduce.

For CHAIN(0)
CH48

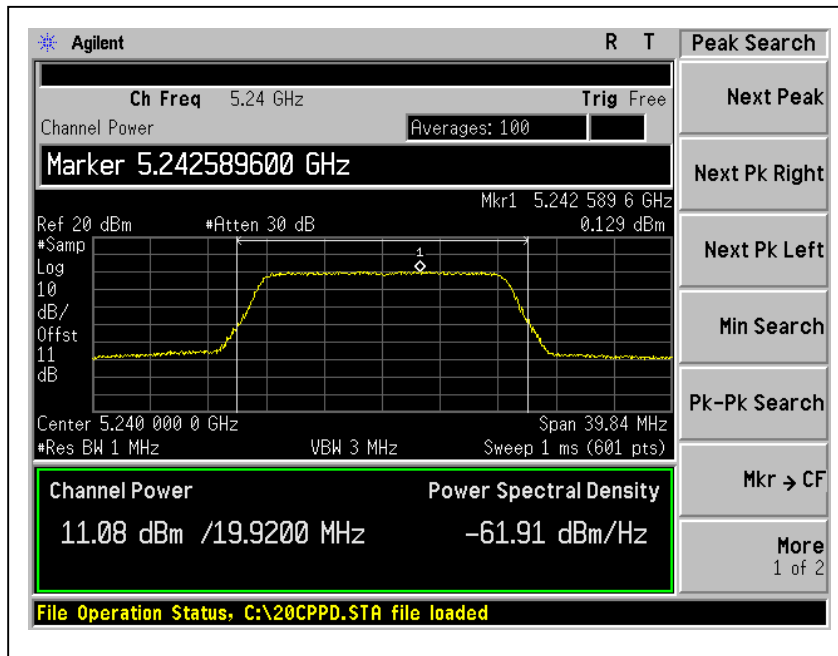



A D T

802.11n (20MHz) OFDM MODULATION:

CHANNEL	CHANNEL FREQUENCY (MHz)	RF POWER LEVEL IN 1MHz BW (dBm)			TOTAL POWER DENSITY (dBm)	MAXIMUM LIMIT (dBm)	PASS / FAIL
		CHAIN(0)	CHAIN(1)	CHAIN(2)			
36	5180	-1.1	-1.2	-0.9	3.7	4	PASS
40	5200	-1.1	-1.0	-1.1	3.7	4	PASS
48	5240	-1.0	-1.0	-1.3	3.7	4	PASS

For CHAIN(2)
CH36

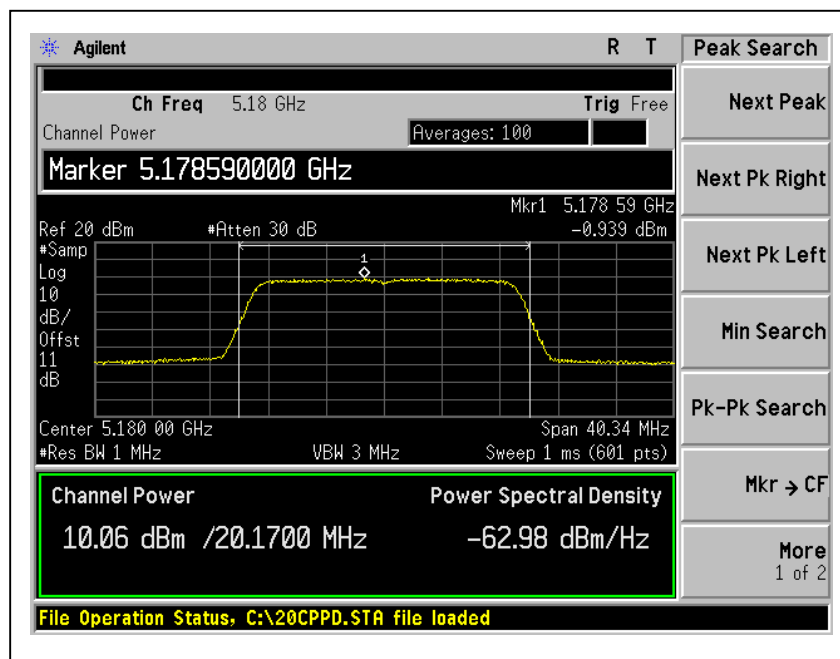



A D T

802.11n (40MHz) OFDM MODULATION:

CHANNEL	CHANNEL FREQUENCY (MHz)	RF POWER LEVEL IN 1MHz BW (dBm)			TOTAL POWER DENSITY (dBm)	MAXIMUM LIMIT (dBm)	PASS / FAIL
		CHAIN(0)	CHAIN(1)	CHAIN(2)			
38	5190	-1.5	-1.7	-1.7	3.1	4	PASS
46	5230	-1.4	-1.7	-1.9	3.1	4	PASS

For CHAIN(0)
CH46

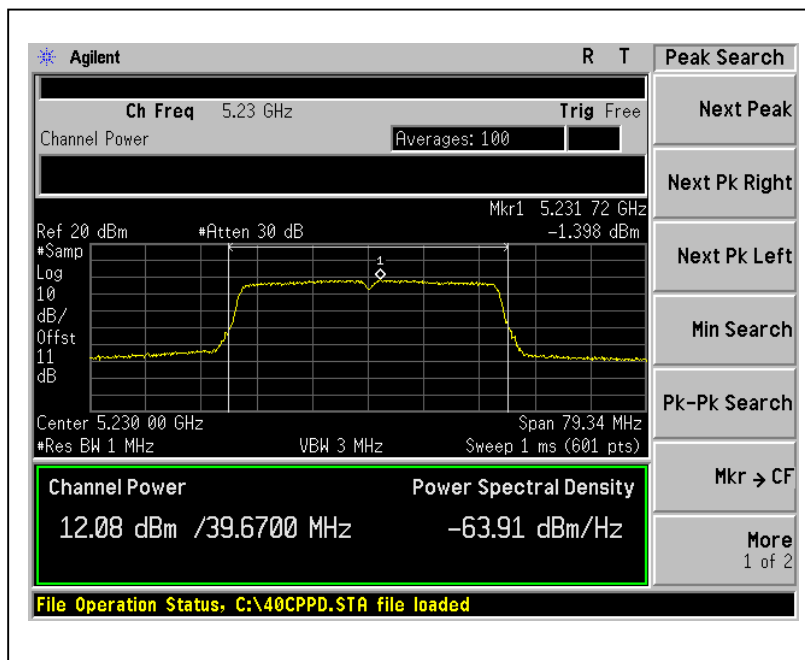

4.6 FREQUENCY STABILITY

4.6.1 LIMITS OF FREQUENCY STABILITY MEASUREMENT

The frequency tolerance of the carrier signal shall be maintained within the band of the operating frequency over a temperature variation of –30 degrees to 50 degrees C at normal supply voltage, and for a variation in the primary supply voltage from 85% to 115% of the rated supply voltage at a temperature of 20 degrees C.

4.6.2 TEST INSTRUMENTS

Test date: Aug. 08, 2011

DESCRIPTION & MANUFACTURER	MODEL NO.	SERIAL NO.	CALIBRATED DATE	CALIBRATED UNTIL
R&S Spectrum Analyzer	FSP 40	100060	May 11, 2011	May 10, 2012

NOTE: The calibration interval of the above test instruments is 12 months and the calibrations are traceable to NML/ROC and NIST/USA.

4.6.3 TEST PROCEDURE

1. The EUT was placed inside the environmental test chamber and powered by nominal AC voltage.
2. Turn the EUT on and couple its output to a spectrum analyzer.
3. Turn the EUT off and set the chamber to the highest temperature specified.
4. Allow sufficient time (approximately 30 min) for the temperature of the chamber to stabilize, turn the EUT on and measure the operating frequency after 2, 5, and 10 minutes.
5. Repeat step 2 and 3 with the temperature chamber set to the lowest temperature.
6. The test chamber was allowed to stabilize at +20 degree C for a minimum of 30 minutes. The supply voltage was then adjusted on the EUT from 85% to 115% and the frequency record.

4.6.4 DEVIATION FROM TEST STANDARD

No deviation

4.6.5 TEST SETUP

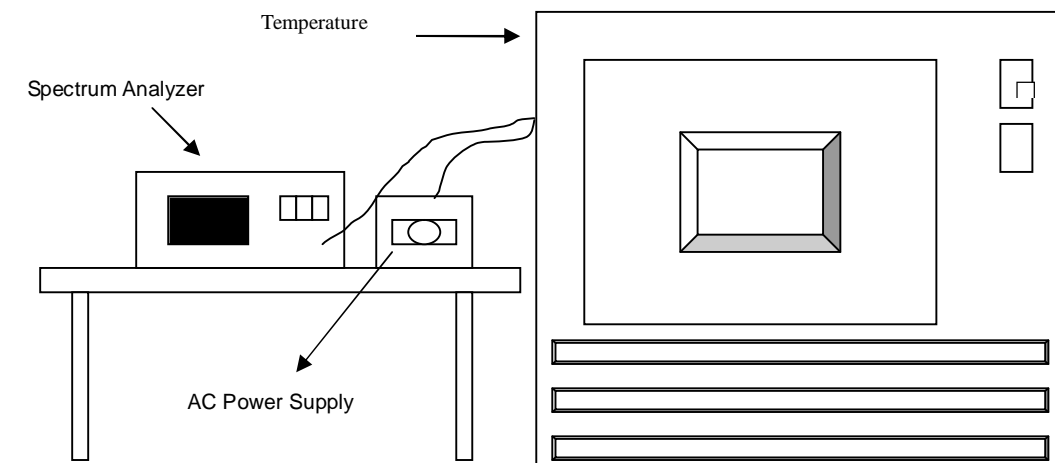

4.6.6 EUT OPERATING CONDITION

The software provided by client to enable the EUT under transmission condition continuously at specific channel frequencies individually.



A D T

4.6.7 TEST RESULTS

Operating frequency: 5240MHz									
Temp. (°C)	Power supply (VAC)	0 minute		2 minute		5 minute		10 minute	
		(MHz)	(ppm)	(MHz)	(ppm)	(MHz)	(ppm)	(MHz)	(ppm)
50	138	5239.9875	-2.3855	5239.9847	-2.9198	5239.9842	-3.0153	5239.9818	-3.4733
	120	5239.9886	-2.1756	5239.9849	-2.8817	5239.9838	-3.0916	5239.9812	-3.5878
	102	5239.9881	-2.2710	5239.9853	-2.8053	5239.9845	-2.9580	5239.981	-3.6260
40	138	5240.0097	1.8511	5240.009	1.7176	5240.0077	1.4695	5240.0118	2.2519
	120	5240.0087	1.6603	5240.0089	1.6985	5240.007	1.3359	5240.0121	2.3092
	102	5240.0096	1.8321	5240.0107	2.0420	5240.0072	1.3740	5240.0131	2.5000
30	138	5240.0105	2.0038	5240.0112	2.1374	5240.0147	2.8053	5240.011	2.0992
	120	5240.0116	2.2137	5240.0119	2.2710	5240.0151	2.8817	5240.0105	2.0038
	102	5240.0111	2.1183	5240.0112	2.1374	5240.0156	2.9771	5240.0117	2.2328
20	138	5239.9816	-3.5115	5239.9802	-3.7786	5239.985	-2.8626	5239.9879	-2.3092
	120	5239.9822	-3.3969	5239.9802	-3.7786	5239.9846	-2.9389	5239.9876	-2.3664
	102	5239.982	-3.4351	5239.9817	-3.4924	5239.9853	-2.8053	5239.9877	-2.3473
10	138	5240.0139	2.6527	5240.0152	2.9008	5240.0147	2.8053	5240.0123	2.3473
	120	5240.015	2.8626	5240.015	2.8626	5240.0138	2.6336	5240.0123	2.3473
	102	5240.0155	2.9580	5240.0153	2.9198	5240.0138	2.6336	5240.0105	2.0038
0	138	5239.9777	-4.2557	5239.9802	-3.7786	5239.982	-3.4351	5239.9864	-2.5954
	120	5239.9774	-4.3130	5239.9792	-3.9695	5239.9822	-3.3969	5239.9855	-2.7672
	102	5239.9779	-4.2176	5239.9801	-3.7977	5239.9826	-3.3206	5239.9848	-2.9008
-10	138	5239.9861	-2.6527	5239.9845	-2.9580	5239.9882	-2.2519	5239.9845	-2.9580
	120	5239.9863	-2.6145	5239.9839	-3.0725	5239.9881	-2.2710	5239.9843	-2.9962
	102	5239.9862	-2.6336	5239.9842	-3.0153	5239.9883	-2.2328	5239.9853	-2.8053
-20	138	5239.9855	-2.7672	5239.9853	-2.8053	5239.9859	-2.6908	5239.9877	-2.3473
	120	5239.9861	-2.6527	5239.9847	-2.9198	5239.9859	-2.6908	5239.9874	-2.4046
	102	5239.9859	-2.6908	5239.9855	-2.7672	5239.9858	-2.7099	5239.9885	-2.1947
-30	138	5239.985	-2.8626	5239.9833	-3.1870	5239.9854	-2.7863	5239.9833	-3.1870
	120	5239.9845	-2.9580	5239.9841	-3.0344	5239.9844	-2.9771	5239.9823	-3.3779
	102	5239.9839	-3.0725	5239.9846	-2.9389	5239.9849	-2.8817	5239.9839	-3.0725



A D T

4.7 CONDUCTED OUT-BAND EMISSION MEASUREMENT

4.7.1 TEST INSTRUMENTS

Test date: Aug. 08, 2011

DESCRIPTION & MANUFACTURER	MODEL NO.	SERIAL NO.	CALIBRATED DATE	CALIBRATED UNTIL
Spectrum Analyzer	FSP 40	100060	May 11, 2011	May 10, 2012

NOTE: The calibration interval of the above test instruments is 12 months and the calibrations are traceable to NML/ROC and NIST/USA.

4.7.2 TEST PROCEDURE

The transmitter output was connected to the spectrum analyzer via a low loss cable. Set RBW of spectrum analyzer to 1MHz with suitable frequency span including 100MHz or 200MHz bandwidth from band edge. The band edges was measured and recorded.

4.7.3 EUT OPERATING CONDITION

The software provided by client to enable the EUT under transmission condition continuously at specific channel frequencies individually.

4.7.4 TEST RESULTS

For 5.15 to 5.25GHz band:

The spectrum plots (Peak RBW=1MHz, VBW=3MHz) are attached on the following pages.

Performing measurements: Measure and add 10 log(N) dB 802.11a OFDM modulation

CH36

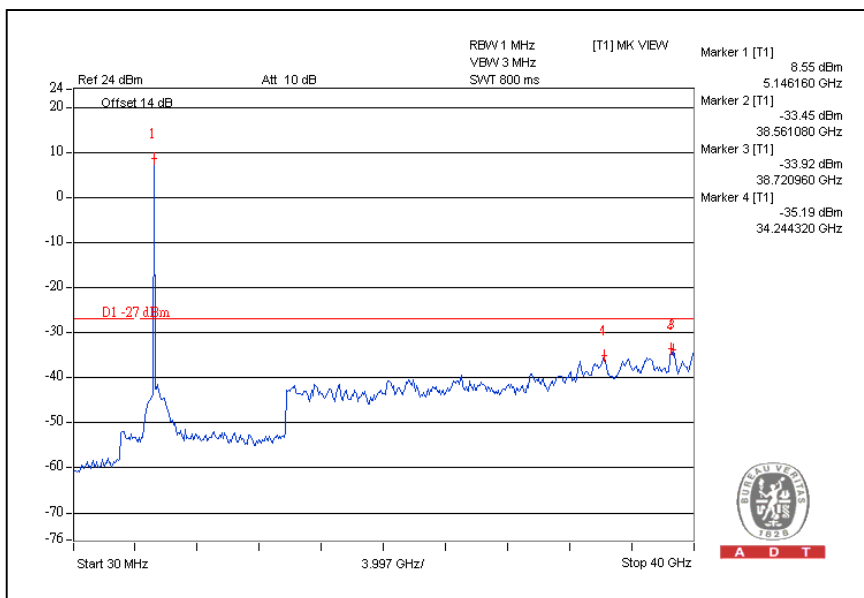
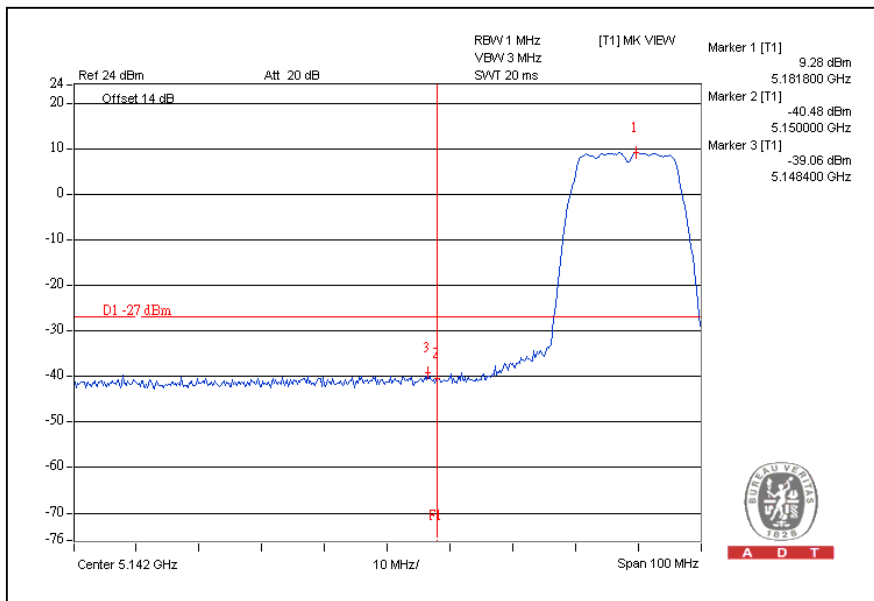

CH48

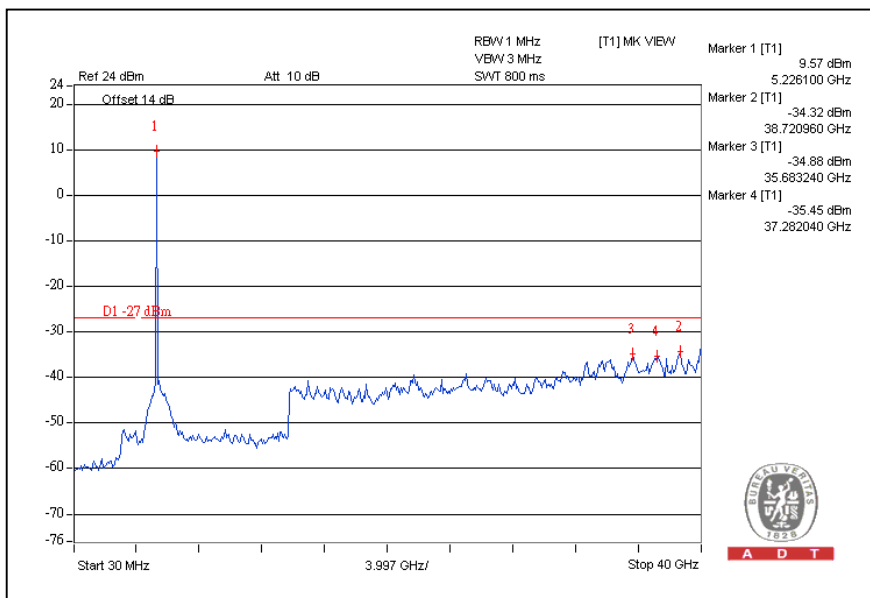
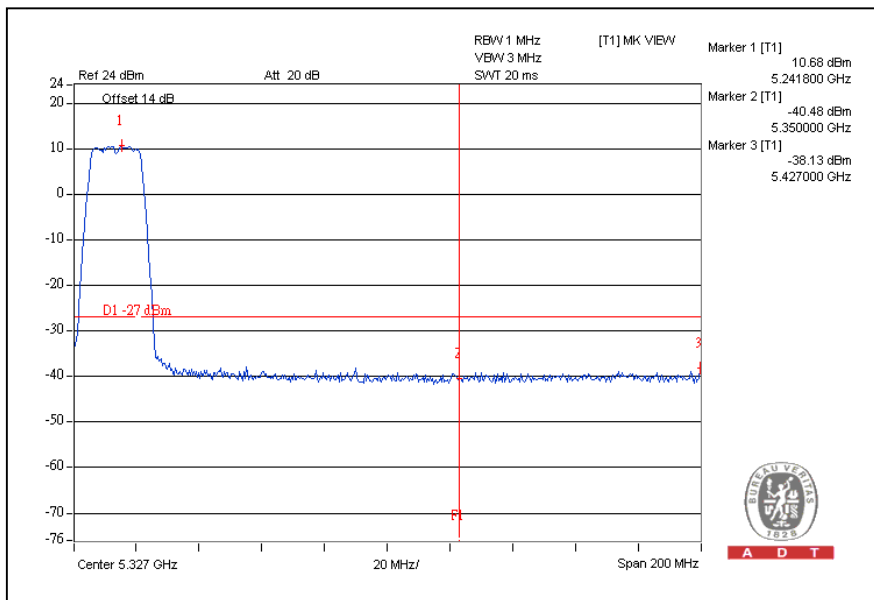



A D T

802.11n (20MHz) OFDM MODULATION:

CH36

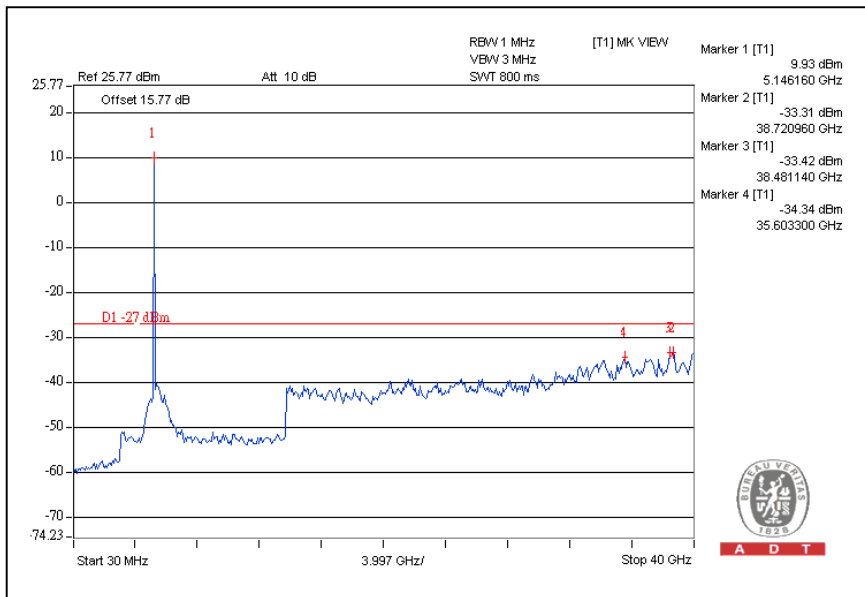
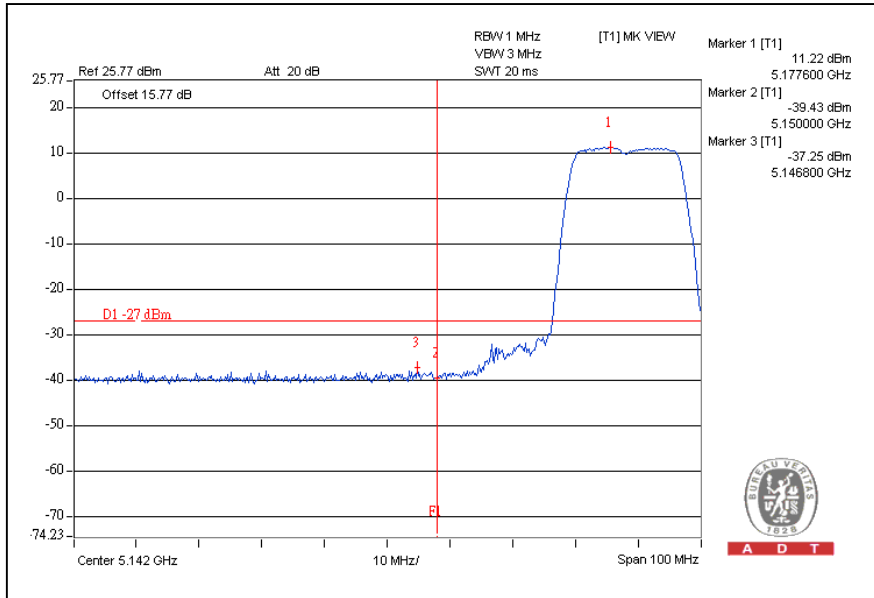



A D T

CH48

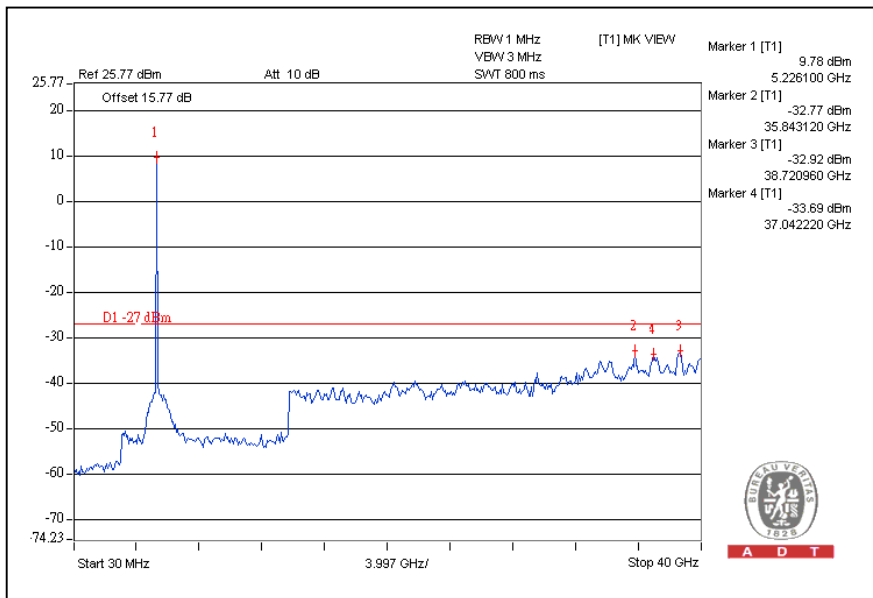
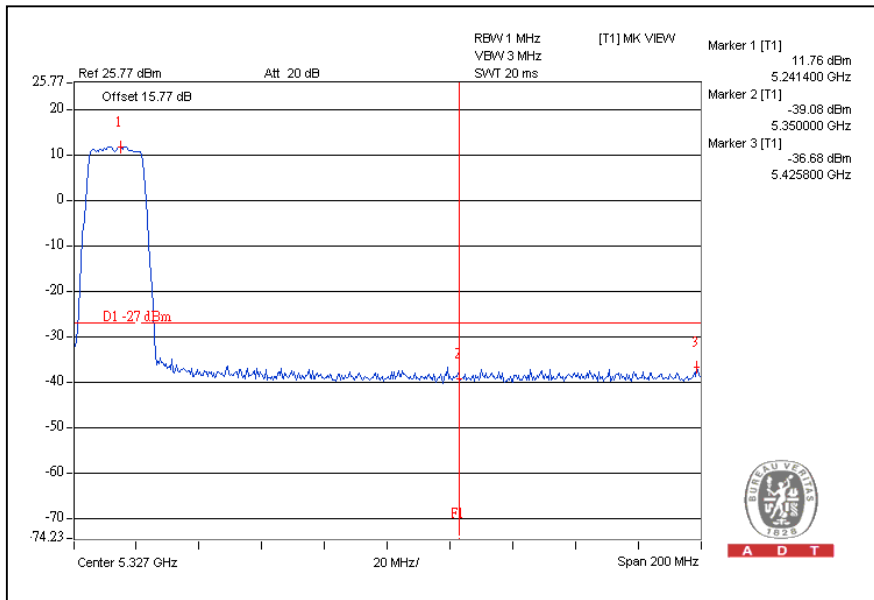



A D T

802.11n (40MHz) OFDM MODULATION:

CH38

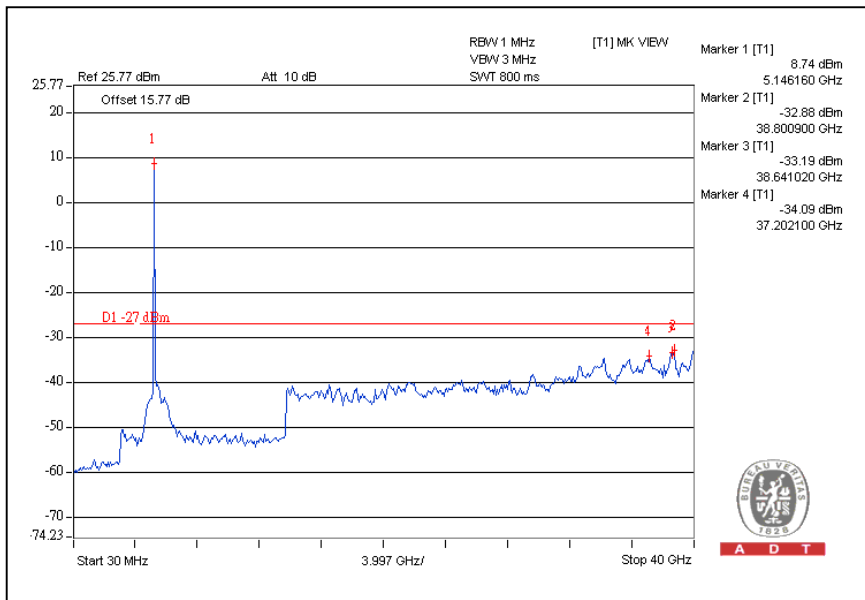
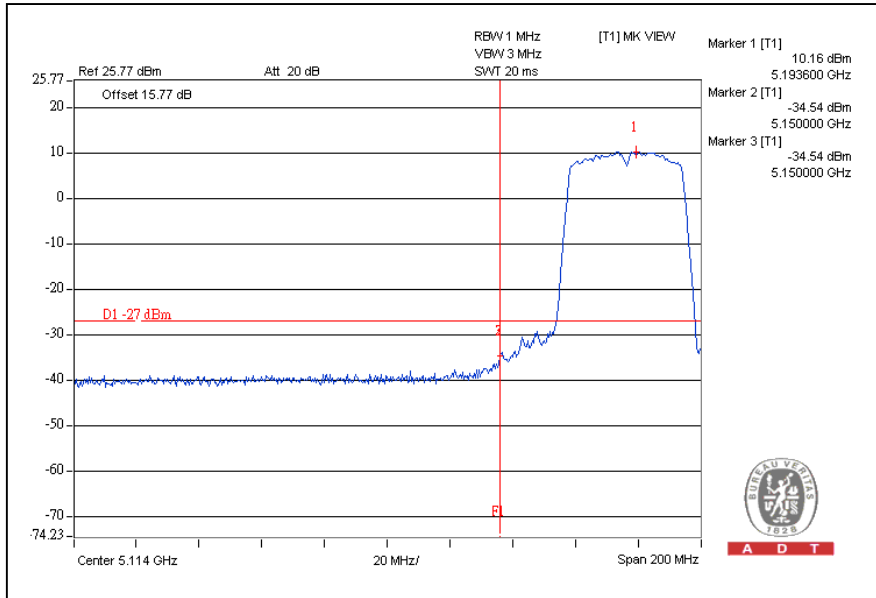



A D T

CH46

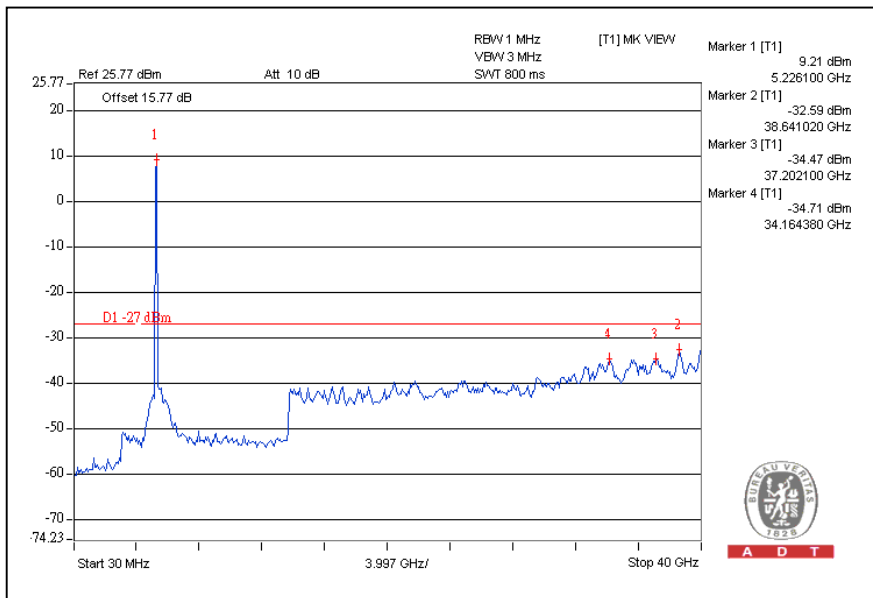
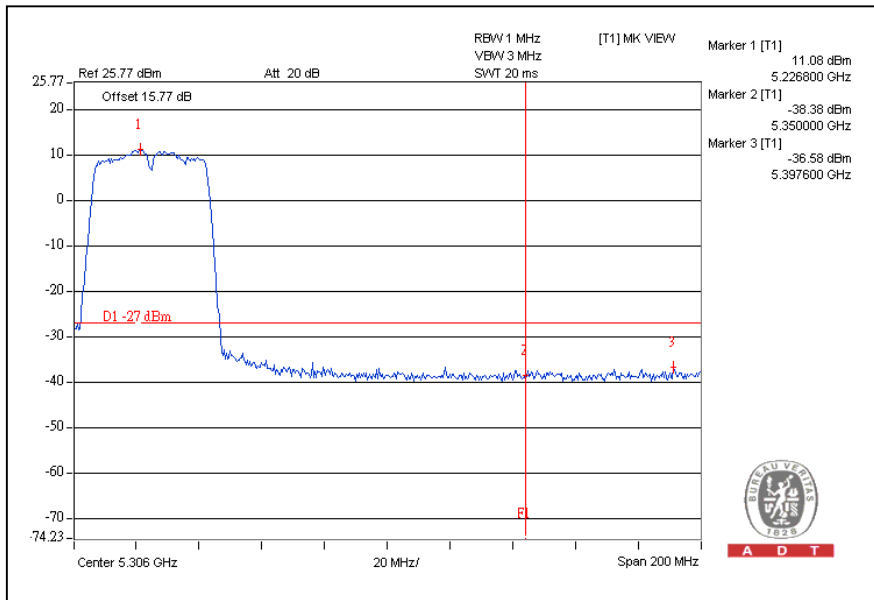



5. INFORMATION ON THE TESTING LABORATORIES

We, Bureau Veritas Consumer Products Services (H.K.) Ltd., Taoyuan Branch, were founded in 1988 to provide our best service in EMC, Radio, Telecom and Safety consultation. Our laboratories are accredited and approved according to ISO/IEC 17025.

Copies of accreditation and authorization certificates of our laboratories obtained from approval agencies can be downloaded from our web site:

www.adt.com.tw/index.5.phtml.

If you have any comments, please feel free to contact us at the following:

Linko EMC/RF Lab:

Tel: 886-2-26052180

Fax: 886-2-26052943

Hsin Chu EMC/RF Lab:

Tel: 886-3-5935343

Fax: 886-3-5935342

Hwa Ya EMC/RF/Safety/Telecom Lab:

Tel: 886-3-3183232

Fax: 886-3-3185050

Email: service.adt@tw.bureauveritas.com

Web Site: www.adt.com.tw

The address and road map of all our labs can be found in our web site also.



A D T

6.APPENDIX A - MODIFICATIONS RECORDERS FOR ENGINEERING CHANGES TO THE EUT BY THE LAB

No modifications were made to the EUT by the lab during the test.

--- END ---