



A D T

FCC TEST REPORT (15.247)

REPORT NO.: RF111116C06

MODEL NO.: EA3500

FCC ID: Q87-EA3500

RECEIVED: Nov. 16, 2011

TESTED: Dec. 12 to 16, 2011

ISSUED: Jan. 10, 2012

APPLICANT: Cisco Consumer Products LLC

ADDRESS: 121 Theory Drive Irvine California 92617
United States

ISSUED BY: Bureau Veritas Consumer Products Services
(H.K.) Ltd., Taoyuan Branch Hsin Chu Laboratory

LAB ADDRESS : No. 81-1, Lu Liao Keng, 9th Ling, Wu Lung Tsuen,
Chiung Lin Hsiang, Hsin Chu Hsien 307, Taiwan

TEST LOCATION (1): No. 81-1, Lu Liao Keng, 9th Ling, Wu Lung Tsuen,
Chiung Lin Hsiang, Hsin Chu Hsien 307, Taiwan

TEST LOCATION (2): No. 49, Ln. 206, Wende Rd., Shangshan Tsuen,
Chiung Lin Hsiang, Hsin Chu Hsien 307, Taiwan

This test report consists of 126 pages in total. It may be duplicated completely for legal use with the approval of the applicant. It should not be reproduced except in full, without the written approval of our laboratory. The client should not use it to claim product certification, approval, or endorsement by TAF or any government agencies. The test results in the report only apply to the tested sample.





A D T

Table of Contents

RELEASE CONTROL RECORD	5
1. CERTIFICATION	6
2. SUMMARY OF TEST RESULTS	7
2.1 MEASUREMENT UNCERTAINTY	9
3. GENERAL INFORMATION	10
3.1 GENERAL DESCRIPTION OF EUT	10
3.2 DESCRIPTION OF TEST MODES	14
3.2.1 TEST MODE APPLICABILITY AND TESTED CHANNEL DETAIL	15
3.3 GENERAL DESCRIPTION OF APPLIED STANDARDS	18
3.4 DESCRIPTION OF SUPPORT UNITS.....	19
3.5 CONFIGURATION OF SYSTEM UNDER TEST	20
4. TEST TYPES AND RESULTS (802.11b & g, 2400 ~ 2483.5MHz Band)	22
4.1 CONDUCTED EMISSION MEASUREMENT	22
4.1.1 LIMITS OF CONDUCTED EMISSION MEASUREMENT	22
4.1.2 TEST INSTRUMENTS.....	22
4.1.3 TEST PROCEDURES	23
4.1.4 DEVIATION FROM TEST STANDARD	23
4.1.5 TEST SETUP	24
4.1.6 EUT OPERATING CONDITIONS	24
4.1.7 TEST RESULTS (MODE 1)	25
4.1.8 TEST RESULTS (MODE 2)	27
4.2 RADIATED EMISSION MEASUREMENT	29
4.2.1 LIMITS OF RADIATED EMISSION MEASUREMENT	29
4.2.2 TEST INSTRUMENTS.....	30
4.2.3 TEST PROCEDURES	32
4.2.4 DEVIATION FROM TEST STANDARD	32
4.2.5 TEST SETUP	33
4.2.6 EUT OPERATING CONDITIONS	33
4.2.7 TEST RESULTS	34
4.3 6dB BANDWIDTH MEASUREMENT	63
4.3.1 LIMITS OF 6dB BANDWIDTH MEASUREMENT	63
4.3.2 TEST INSTRUMENTS.....	63
4.3.3 TEST PROCEDURE.....	63
4.3.4 DEVIATION FROM TEST STANDARD	63
4.3.5 TEST SETUP	63
4.3.6 EUT OPERATING CONDITIONS	63
4.3.7 TEST RESULTS	64
4.4 MAXIMUM PEAK OUTPUT POWER.....	68
4.4.1 LIMITS OF MAXIMUM PEAK OUTPUT POWER MEASUREMENT	68
4.4.2 INSTRUMENTS.....	68



4.4.3	TEST PROCEDURES	68
4.4.4	DEVIATION FROM TEST STANDARD	68
4.4.5	TEST SETUP	68
4.4.6	EUT OPERATING CONDITIONS	69
4.4.7	TEST RESULTS	70
4.5	POWER SPECTRAL DENSITY MEASUREMENT	72
4.5.1	LIMITS OF POWER SPECTRAL DENSITY MEASUREMENT	72
4.5.2	TEST INSTRUMENTS.....	72
4.5.3	TEST PROCEDURE.....	72
4.5.4	DEVIATION FROM TEST STANDARD	72
4.5.5	TEST SETUP	72
4.5.6	EUT OPERATING CONDITION.....	72
4.5.7	TEST RESULTS	73
4.6	CONDUCTED OUT-BAND EMISSION MEASUREMENT.....	77
4.6.1	LIMITS OF CONDUCTED OUT-BAND EMISSION MEASUREMENT.....	77
4.6.2	TEST INSTRUMENTS.....	77
4.6.3	TEST PROCEDURE.....	77
4.6.4	DEVIATION FROM TEST STANDARD	77
4.6.5	EUT OPERATING CONDITION.....	77
4.6.6	TEST RESULTS	77
5.	TEST TYPES AND RESULTS (802.11a, 5725~5850MHz Band).....	86
5.1	CONDUCTED EMISSION MEASUREMENT	86
5.1.1	LIMITS OF CONDUCTED EMISSION MEASUREMENT	86
5.1.2	TEST INSTRUMENTS.....	86
5.1.3	TEST PROCEDURES	87
5.1.4	DEVIATION FROM TEST STANDARD	87
5.1.5	TEST SETUP	88
5.1.6	EUT OPERATING CONDITIONS	88
5.1.7	TEST RESULTS (MODE 1)	89
5.1.8	TEST RESULTS (MODE 2)	91
5.2	RADIATED EMISSION MEASUREMENT	93
5.2.1	LIMITS OF RADIATED EMISSION MEASUREMENT.....	93
5.2.2	TEST INSTRUMENTS.....	94
5.2.3	TEST PROCEDURES	96
5.2.4	DEVIATION FROM TEST STANDARD	96
5.2.5	TEST SETUP	97
5.2.6	EUT OPERATING CONDITIONS	97
5.2.7	TEST RESULTS	98
5.3	6dB BANDWIDTH MEASUREMENT	107
5.3.1	LIMITS OF 6dB BANDWIDTH MEASUREMENT	107
5.3.2	TEST INSTRUMENTS.....	107
5.3.3	TEST PROCEDURE.....	107



A D T

5.3.4	DEVIATION FROM TEST STANDARD	107
5.3.5	TEST SETUP	107
5.3.6	EUT OPERATING CONDITIONS	107
5.3.7	TEST RESULTS	108
5.4	MAXIMUM PEAK OUTPUT POWER.....	111
5.4.1	LIMITS OF MAXIMUM PEAK OUTPUT POWER MEASUREMENT	111
5.4.2	INSTRUMENTS.....	111
5.4.3	TEST PROCEDURES	111
5.4.4	DEVIATION FROM TEST STANDARD	111
5.4.5	TEST SETUP	111
5.4.6	EUT OPERATING CONDITIONS	112
5.4.7	TEST RESULTS	113
5.5	POWER SPECTRAL DENSITY MEASUREMENT	114
5.5.1	LIMITS OF POWER SPECTRAL DENSITY MEASUREMENT	114
5.5.2	TEST INSTRUMENTS.....	114
5.5.3	TEST PROCEDURE.....	114
5.5.4	DEVIATION FROM TEST STANDARD	114
5.5.5	TEST SETUP	114
5.5.6	EUT OPERATING CONDITION.....	114
5.5.7	TEST RESULTS	115
5.6	CONDUCTED OUT-BAND EMISSION MEASUREMENT	118
5.6.1	LIMITS OF CONDUCTED OUT-BAND EMISSION MEASUREMENT.....	118
5.6.2	TEST INSTRUMENTS.....	118
5.6.3	TEST PROCEDURE.....	118
5.6.4	DEVIATION FROM TEST STANDARD	118
5.6.5	EUT OPERATING CONDITION	118
5.6.6	TEST RESULTS	118
6.	INFORMATION ON THE TESTING LABORATORIES	125
7.	APPENDIX A - MODIFICATIONS RECORDERS FOR ENGINEERING CHANGES TO THE EUT BY THE LAB.....	126



A D T

RELEASE CONTROL RECORD

ISSUE NO.	REASON FOR CHANGE	DATE ISSUED
RF111116C06	Original release	Jan. 10, 2012



A D T

1. CERTIFICATION

PRODUCT: High Performance Dual-Band N Router
BRAND NAME: CISCO
MODEL NO.: EA3500
TEST SAMPLE: ENGINEERING SAMPLE
APPLICANT: Cisco Consumer Products LLC
TESTED: Dec. 12 to 16, 2011
STANDARDS: FCC Part 15, Subpart C (Section 15.247)
ANSI C63.4-2003
ANSI C63.10-2009

The above equipment (Model: EA3500) has been tested by **Bureau Veritas Consumer Products Services (H.K.) Ltd., Taoyuan Branch**, and found compliance with the requirement of the above standards. The test record, data evaluation & Equipment Under Test (EUT) configurations represented herein are true and accurate accounts of the measurements of the sample's EMC characteristics under the conditions specified in this report.

PREPARED BY : Phoenix Huang , **DATE:** Jan. 10, 2012
(Phoenix Huang, Specialist)

APPROVED BY : May Chen , **DATE:** Jan. 10, 2012
(May Chen, Deputy Manager)

2. SUMMARY OF TEST RESULTS

The EUT has been tested according to the following specifications:

For 2.4GHz, 2412~2462MHz Band

APPLIED STANDARD: FCC Part 15, Subpart C			
Standard Section	Test Type and Limit	Result	Remark
15.207	AC Power Conducted Emission	PASS	Meet the requirement of limit. Minimum passing margin is -5.49dB at 0.162MHz
15.247(a)(2)	Spectrum Bandwidth of a Direct Sequence Spread Spectrum System Limit: min. 500kHz	PASS	Meet the requirement of limit.
15.247(b)	Maximum Peak Output Power Limit: max. 30dBm	PASS	Meet the requirement of limit.
15.247(d)	Radiated Emissions Limit: Table 15.209	PASS	Meet the requirement of limit. Minimum passing margin is -0.6dB at 2390.00MHz
15.247(e)	Power Spectral Density Limit: max. 8dBm	PASS	Meet the requirement of limit.
15.247(d)	Conducted Out-Band Emission Measurement Limit: 20dB less than the peak value of fundamental frequency	PASS	Meet the requirement of limit.
15.203	Antenna Requirement	PASS	Antenna connector is UFL not a standard connector.



A D T

For 5GHz, 5725~5850MHz Band

APPLIED STANDARD: FCC Part 15, Subpart C			
Standard Section	Test Type and Limit	Result	Remark
15.207	AC Power Conducted Emission	PASS	Meet the requirement of limit. Minimum passing margin is -5.96dB at 0.162MHz
15.247(a)(2)	Spectrum Bandwidth of a Direct Sequence Spread Spectrum System Limit: min. 500kHz	PASS	Meet the requirement of limit.
15.247(b)	Maximum Peak Output Power Limit: max. 30dBm	PASS	Meet the requirement of limit.
15.247(d)	Radiated Emissions Limit: Table 15.209	PASS	Meet the requirement of limit. Minimum passing margin is -3.8dB at 64.90MHz
15.247(e)	Power Spectral Density Limit: max. 8dBm	PASS	Meet the requirement of limit.
15.247(d)	Conducted Out-Band Emission Measurement Limit: 20dB less than the peak value of fundamental frequency	PASS	Meet the requirement of limit.
15.203	Antenna Requirement	PASS	Antenna connector is UFL not a standard connector.

NOTE:

1. The EUT was operating in 2400 ~ 2483.5MHz, 5.15~5.25GHz and 5.725~5.850GHz frequencies band. This report was recorded the RF parameters including 2400 ~ 2483.5MHz and 5.725~5.850GHz. For the 5.15~5.25GHz RF parameters was recorded in another test report.



A D T

2.

2.1 MEASUREMENT UNCERTAINTY

Where relevant, the following measurement uncertainty levels have been estimated for tests performed on the EUT as specified in CISPR 16-4-2:

This uncertainty represents an expanded uncertainty expressed at approximately the 95% confidence level using a coverage factor of $k=2$.

Measurement	Value
Conducted emissions	2.45 dB
Radiated emissions (30MHz-1GHz)	3.89 dB
Radiated emissions (1GHz -18GHz)	2.19 dB
Radiated emissions (18GHz -40GHz)	2.56 dB



A D T

3. GENERAL INFORMATION

3.1 GENERAL DESCRIPTION OF EUT

PRODUCT	High Performance Dual-Band N Router
MODEL NO.	EA3500
FCC ID	Q87-EA3500
POWER SUPPLY	DC 12V from power adapter
MODULATION TYPE	CCK, DQPSK, DBPSK for DSSS 64QAM, 16QAM, QPSK, BPSK for OFDM
MODULATION TECHNOLOGY	DSSS, OFDM
TRANSFER RATE	802.11b: up to 11Mbps 802.11a / g: up to 54Mbps 802.11n: up to 450Mbps
OPERATING FREQUENCY	For 15.407 5GHz: 5.18 ~ 5.24GHz
	For 15.247 2.4GHz: 2.412 ~ 2.462GHz 5GHz: 5.745 ~ 5.825GHz
NUMBER OF CHANNEL	For 15.407 4 for 802.11a, 802.11n (20MHz) 2 for 802.11n (40MHz)
	For 15.247(2.4GHz) 11 for 802.11b, 802.11g, 802.11n (20MHz) 7 for 802.11n (40MHz)
	For 15.247(5GHz) 5 for 802.11a, 802.11n (20MHz) 2 for 802.11n (40MHz)



MAXIMUM OUTPUT POWER	For 15.407 802.11a: 38.2mW 802.11n (20MHz): 44.8mW 802.11n (40MHz): 48.3mW For 15.247(2.4GHz) 802.11b: 365.5mW 802.11g: 458.3mW 802.11n (20MHz): 479.8mW 802.11n (40MHz): 222.0mW For 15.247(5GHz) 802.11a: 423.9mW 802.11n (20MHz): 440.5mW 802.11n (40MHz): 485.8mW
ANTENNA TYPE	Please see NOTE
DATA CABLE	NA
I/O PORTS	Ethernet x 4 Internet x 1 USB x 1
ASSOCIATED DEVICES	Adapter x 1

NOTE:

1. There are six antennas provided to this EUT, please refer to the following table:

For 2.4GHz				
Transmitter Circuit	Freq.(MHz)	Peak Gain (dBi)	Antenna Type	Connector Type
Chain (0) <Left>	2400	3.55	PIFA	UFL
	2450	3.67	PIFA	UFL
	2500	3.43	PIFA	UFL
Chain (1) <Front>	2400	4.77	PIFA	UFL
	2450	4.95	PIFA	UFL
	2500	4.60	PIFA	UFL
Chain (2) <Right>	2400	2.21	PIFA	UFL
	2450	2.69	PIFA	UFL
	2500	2.68	PIFA	UFL
For 5GHz				
Transmitter Circuit	Freq.(MHz)	Peak Gain (dBi)	Antenna Type	Connector Type
Chain (0) <Left>	5150	2.44	PIFA	UFL
	5350	2.99	PIFA	UFL
	5600	2.99	PIFA	UFL
	5730	1.94	PIFA	UFL
	5850	3.23	PIFA	UFL
Chain (1) <Front>	5150	3.50	PIFA	UFL
	5350	3.23	PIFA	UFL
	5600	3.39	PIFA	UFL
	5730	3.42	PIFA	UFL
	5850	3.88	PIFA	UFL
Chain (2) <Right>	5150	4.24	PIFA	UFL
	5350	4.39	PIFA	UFL
	5600	4.73	PIFA	UFL
	5730	4.15	PIFA	UFL
	5850	4.46	PIFA	UFL

2. The EUT incorporates a MIMO function. Physically, the EUT provides three completed transmitters and three receivers.

MODULATION MODE	TX FUNCTION
802.11b	2TX / 3RX
802.11g	2TX / 3RX
802.11a	Band 1: 2TX / 3RX
	Band 4: 3TX / 3RX
802.11n (20MHz) for 2.4GHz	2TX / 3RX
802.11n (40MHz) for 2.4GHz	2TX / 3RX
802.11n (20MHz) for 5GHz	3TX / 3RX
802.11n (40MHz) for 5GHz	3TX / 3RX

Note: It will be fixed on chain 0 & chain 2 in 2TX.

3. The EUT must be supplied with a power adapter and following two different model names could be chosen:

Adapter 1		
Brand	Model No.	Spec.
LEI	MU24-B120200-A1	AC I/P: 100-240V~, 50/60Hz 1.0A DC O/P: 12Vdc, 2A
Adapter 2		
Brand	Model No.	Spec.
SOLYTECH ENTERPRISE CORPORATION	CAD2412	AC I/P: 100-240V~, 50-60Hz, 1.0A DC O/P: 12Vdc, 2.0A Max.24W

From the above adapters, Adapter 1 was selected as representative adapter for the radiated test and their data were recorded in this report.

4. Spurious emission of the simultaneous operation (2.4GHz & 5GHz) has been evaluated and no non-compliance was found.
5. The EUT is 3 * 3 spatial MIMO (3Tx & 3Rx) without beam forming function.
6. The EUT incorporates CDD function with 802.11a, 802.11b, 802.11g.
7. When the EUT operating in 802.11n, the software operation, which is defined by manufacturer, MCS (Modulation and Coding Schemes) from 0 to 23.
8. The above EUT information was declared by the manufacturer and for more detailed features description, please refer to the manufacturer's specifications or User's Manual.

3.2 DESCRIPTION OF TEST MODES

Operated in 2400 ~ 2483.5MHz band:

Eleven channels are provided for 802.11b, 802.11g, 802.11n (20MHz):

CHANNEL	FREQUENCY	CHANNEL	FREQUENCY
1	2412MHz	7	2442MHz
2	2417MHz	8	2447MHz
3	2422MHz	9	2452MHz
4	2427MHz	10	2457MHz
5	2432MHz	11	2462MHz
6	2437MHz		

Seven channels are provided for 802.11n (40MHz):

CHANNEL	FREQUENCY	CHANNEL	FREQUENCY
3	2422MHz	7	2442MHz
4	2427MHz	8	2447MHz
5	2432MHz	9	2452MHz
6	2437MHz		

Operated in 5725 ~ 5850MHz band:

Five channels are provided for 802.11a, 802.11n (20MHz):

CHANNEL	FREQUENCY	CHANNEL	FREQUENCY
149	5745 MHz	161	5805 MHz
153	5765 MHz	165	5825 MHz
157	5785 MHz		

Two channels are provided for 802.11n (40MHz):

CHANNEL	FREQUENCY
151	5755 MHz
159	5795 MHz

3.2.1 TEST MODE APPLICABILITY AND TESTED CHANNEL DETAIL

EUT CONFIGURE MODE	APPLICABLE TO					DESCRIPTION
	PLC	RE < 1G	RE ≥ 1G	APCM	OB	
1	√	√	√	√	√	Adapter 1
2	√	-	-	-	-	Adapter 2

Where **PLC**: Power Line Conducted Emission **RE < 1G**: Radiated Emission below 1GHz
RE ≥ 1G: Radiated Emission above 1GHz **APCM**: Antenna Port Conducted Measurement
OB: Conducted Out-Band Emission Measurement

POWER LINE CONDUCTED EMISSION TEST:

- Pre-Scan has been conducted to determine the worst-case mode from all possible combinations between available modulations, data rates and antenna ports (if EUT with antenna diversity architecture).
- Following channel(s) was (were) selected for the final test as listed below.

MODE	AVAILABLE CHANNEL	TESTED CHANNEL	MODULATION TECHNOLOGY	MODULATION TYPE	DATA RATE (Mbps)
For 2.4 GHz 802.11n (20MHz)	1 to 11	6	OFDM	BPSK	6.5
For 5 GHz 802.11n (20MHz)	149 to 165	149	OFDM	BPSK	6.5

RADIATED EMISSION TEST (BELOW 1 GHz):

- Pre-Scan has been conducted to determine the worst-case mode from all possible combinations between available modulations, data rates and antenna ports (if EUT with antenna diversity architecture).
- Following channel(s) was (were) selected for the final test as listed below.

MODE	AVAILABLE CHANNEL	TESTED CHANNEL	MODULATION TECHNOLOGY	MODULATION TYPE	DATA RATE (Mbps)
For 2.4 GHz 802.11n (20MHz)	1 to 11	6	OFDM	BPSK	6.5
For 5 GHz 802.11n (20MHz)	149 to 165	149	OFDM	BPSK	6.5

RADIATED EMISSION TEST (ABOVE 1 GHz):

- Pre-Scan has been conducted to determine the worst-case mode from all possible combinations between available modulations, data rates and antenna ports (if EUT with antenna diversity architecture).
- Following channel(s) was (were) selected for the final test as listed below.

MODE	AVAILABLE CHANNEL	TESTED CHANNEL	MODULATION TECHNOLOGY	MODULATION TYPE	DATA RATE (Mbps)
802.11b	1 to 11	1, 6, 11	DSSS	DBPSK	1
802.11g	1 to 11	1, 6, 11	OFDM	BPSK	6
For 2.4 GHz 802.11n (20MHz)	1 to 11	1, 6, 11	OFDM	BPSK	6.5
For 2.4 GHz 802.11n (40MHz)	3 to 9	3, 6, 9	OFDM	BPSK	13.5
802.11a	149 to 165	149, 157, 165	OFDM	BPSK	6
For 5 GHz 802.11n (20MHz)	149 to 165	149, 157, 165	OFDM	BPSK	6.5
For 5 GHz 802.11n (40MHz)	151 to 159	151, 159	OFDM	BPSK	13.5

ANTENNA PORT CONDUCTED MEASUREMENT:

- This item includes all test value of each mode, but only includes spectrum plot of worst value of each mode.
- Pre-Scan has been conducted to determine the worst-case mode from all possible combinations between available modulations, data rates and antenna ports (if EUT with antenna diversity architecture).
- Following channel(s) was (were) selected for the final test as listed below.

MODE	AVAILABLE CHANNEL	TESTED CHANNEL	MODULATION TECHNOLOGY	MODULATION TYPE	DATA RATE (Mbps)
802.11b	1 to 11	1, 6, 11	DSSS	DBPSK	1
802.11g	1 to 11	1, 6, 11	OFDM	BPSK	6
For 2.4 GHz 802.11n (20MHz)	1 to 11	1, 6, 11	OFDM	BPSK	6.5
For 2.4 GHz 802.11n (40MHz)	3 to 9	3, 6, 9	OFDM	BPSK	13.5
802.11a	149 to 165	149, 157, 165	OFDM	BPSK	6
For 5 GHz 802.11n (20MHz)	149 to 165	149, 157, 165	OFDM	BPSK	6.5
For 5 GHz 802.11n (40MHz)	151 to 159	151, 159	OFDM	BPSK	13.5



A D T

CONDUCTED OUT-BAND EMISSION MEASUREMENT:

- Pre-Scan has been conducted to determine the worst-case mode from all possible combinations between available modulations, data rates and antenna ports (if EUT with antenna diversity architecture).
- Following channel(s) was (were) selected for the final test as listed below.

MODE	AVAILABLE CHANNEL	TESTED CHANNEL	MODULATION TECHNOLOGY	MODULATION TYPE	DATA RATE (Mbps)
802.11b	1 to 11	1, 11	DSSS	DBPSK	1
802.11g	1 to 11	1, 11	OFDM	BPSK	6
For 2.4 GHz 802.11n (20MHz)	1 to 11	1, 11	OFDM	BPSK	6.5
For 2.4 GHz 802.11n (40MHz)	3 to 9	3, 9	OFDM	BPSK	13.5
802.11a	149 to 165	149, 165	OFDM	BPSK	6
For 5 GHz 802.11n (20MHz)	149 to 165	149, 165	OFDM	BPSK	6.5
For 5 GHz 802.11n (40MHz)	151 to 159	151, 159	OFDM	BPSK	13.5

TEST CONDITION:

APPLICABLE TO	ENVIRONMENTAL CONDITIONS	INPUT POWER	TESTED BY
PLC	24deg. C, 68%RH	120Vac, 60Hz	Andy Ho
RE<1G	22deg. C, 70%RH	120Vac, 60Hz	Nelson Teng
RE ³ 1G	26deg. C, 68%RH	120Vac, 60Hz	Nelson Teng
	26deg. C, 68%RH	120Vac, 60Hz	Evan Huang
APCM	25deg. C, 60%RH	120Vac, 60Hz	Kent Liu
OB	25deg. C, 60%RH	120Vac, 60Hz	Kent Liu

3.3 GENERAL DESCRIPTION OF APPLIED STANDARDS

The EUT is a RF product. According to the specifications of the manufacturer, it must comply with the requirements of the following standards:

FCC Part 15, Subpart C. (15.247)

ANSI C63.4-2003

ANSI C63.10-2009

All test items have been performed and recorded as per the above standards.

NOTE: The EUT has been verified to comply with the requirements of FCC Part 15, Subpart B, Class B (DoC). The test report has been issued separately.



A D T

3.4 DESCRIPTION OF SUPPORT UNITS

The EUT has been tested as an independent unit together with other necessary accessories or support units. The following support units or accessories were used to form a representative test configuration during the tests.

For Conducted Emission test					
NO.	PRODUCT	BRAND	MODEL NO.	SERIAL NO.	FCC ID
1	NOTEBOOK COMPUTER	DELL	PP18L	4799903248	FCC DoC
2	NOTEBOOK COMPUTER	DELL	PP27L	7YLB32S	FCC DoC
3	SWITCH	HP	NA	NA	NA
4	USB Flash Drive	SanDisk	SDCZ2-512-A10	5472260816	FCC DoC
For Radiated Emission test					
NO.	PRODUCT	BRAND	MODEL NO.	SERIAL NO.	FCC ID
1	NOTEBOOK COMPUTER	DELL	PP32LA	FSLB32S	FCC DoC
2	NOTEBOOK COMPUTER	DELL	PP32LA	GSLB32S	FCC DoC
3	HUB	ZyXEL	ES-116P	S060H0200021 5	FCC DoC
4	iPod shuffle	Apple	MC749TA/A	CC4DMFJUDFD M	NA

For Conducted Emission test	
NO.	SIGNAL CABLE DESCRIPTION OF THE ABOVE SUPPORT UNITS
1	UTP cable, 10m
2	UTP cable, 10m
3	UTP cable, 10m
4	NA
For Radiated Emission test	
NO.	SIGNAL CABLE DESCRIPTION OF THE ABOVE SUPPORT UNITS
1	UTP cable, 10m
2	UTP cable, 10m
3	UTP cable, 10m
4	USB Cable, 0.1m

NOTE: All power cords of the above support units are non shielded (1.8m).

3.5 CONFIGURATION OF SYSTEM UNDER TEST

For Conducted Emission test :

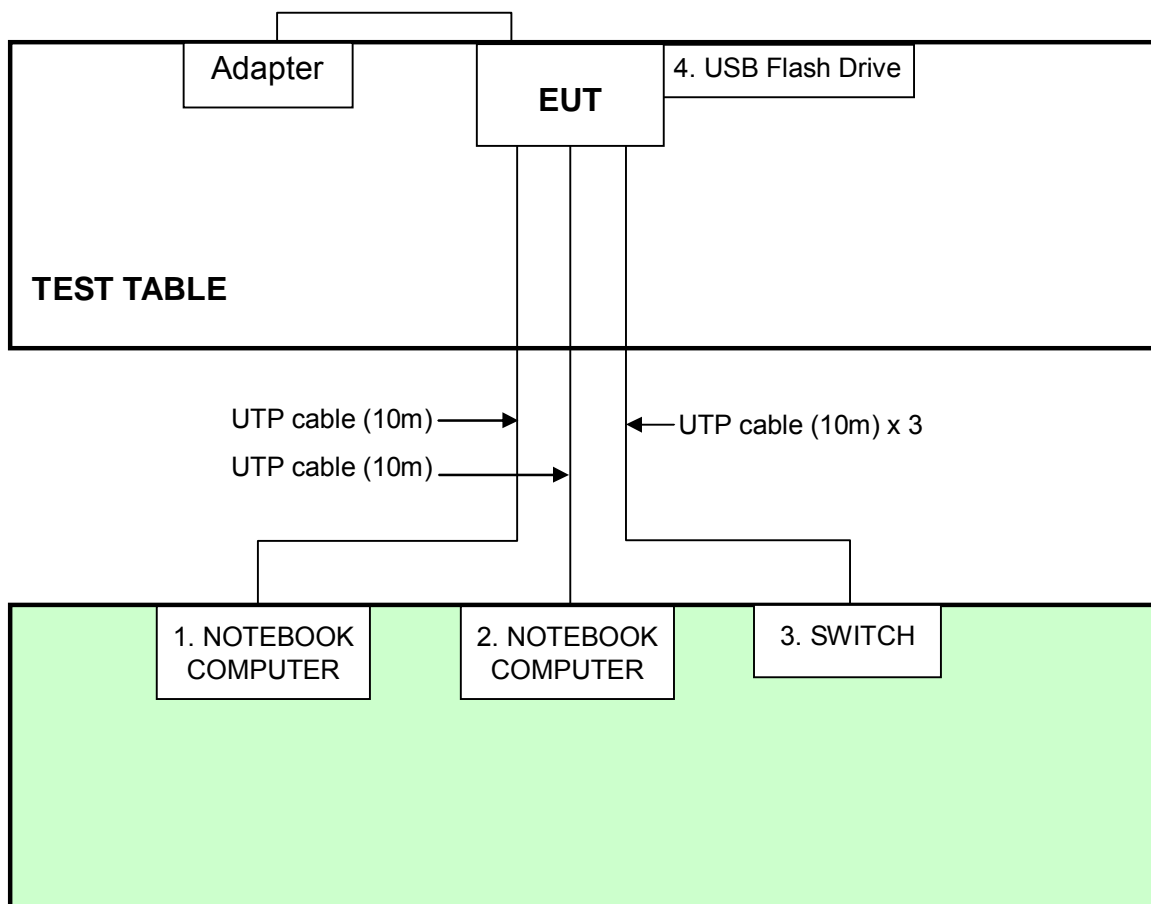

For Radiated Emission test:

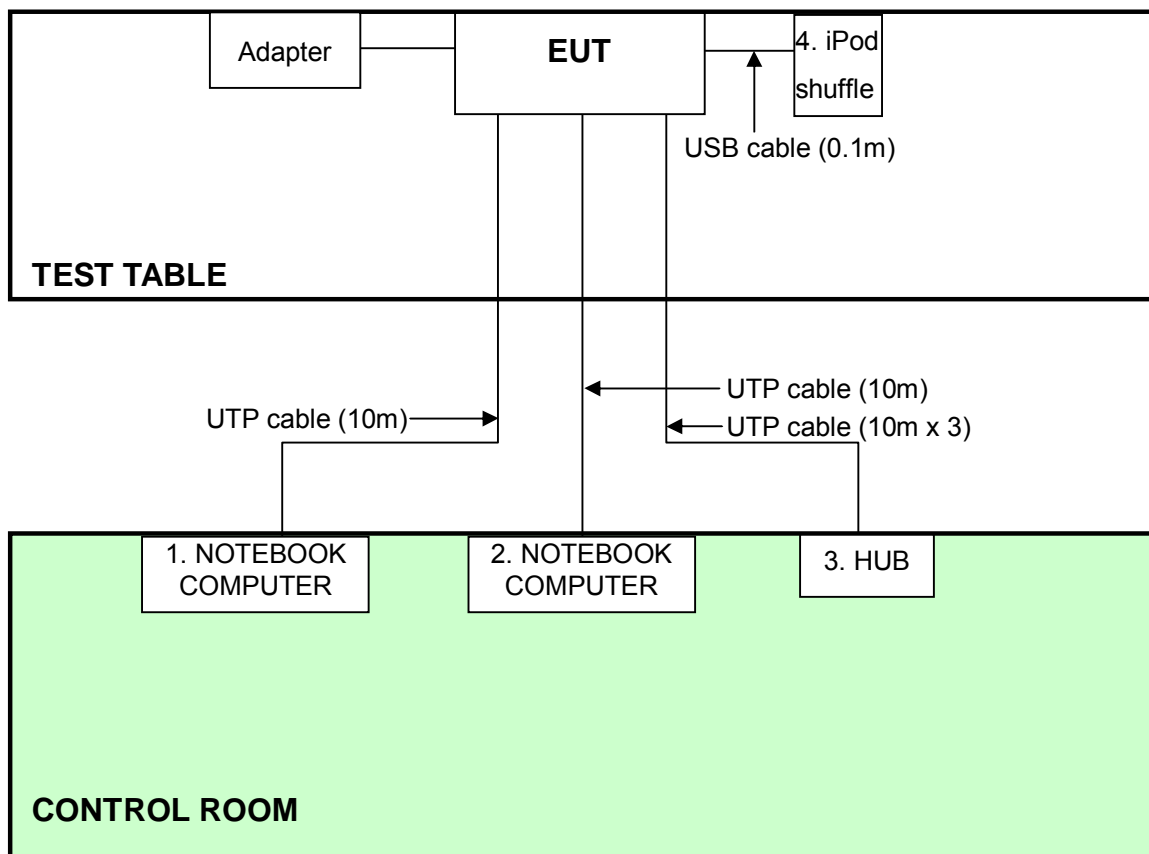

4. TEST TYPES AND RESULTS (2400 ~ 2483.5MHz Band)

4.1 CONDUCTED EMISSION MEASUREMENT

4.1.1 LIMITS OF CONDUCTED EMISSION MEASUREMENT

FREQUENCY OF EMISSION (MHz)	CONDUCTED LIMIT (dB μ V)	
	Quasi-peak	Average
0.15-0.5	66 to 56	56 to 46
0.5-5	56	46
5-30	60	50

- NOTE:**
1. The lower limit shall apply at the transition frequencies.
 2. The limit decreases in line with the logarithm of the frequency in the range of 0.15 to 0.50 MHz.
 3. All emanations from a class A/B digital device or system, including any network of conductors and apparatus connected thereto, shall not exceed the level of field strengths specified above.

4.1.2 TEST INSTRUMENTS

Test date: Dec. 12, 2011

DESCRIPTION & MANUFACTURER	MODEL NO.	SERIAL NO.	CALIBRATED DATE	CALIBRATED UNTIL
Test Receiver	ESCS 30	100375	Mar. 09, 2011	Mar. 08, 2012
Line-Impedance Stabilization Network (for EUT)	NSLK 8127	8127-522	Sep. 07, 2011	Sep. 06, 2012
Line-Impedance Stabilization Network (for Peripheral)	ESH3-Z5	848773/004	Nov. 01, 2011	Oct. 31, 2012
RF Cable (JYEBAO)	5DFB	COCCAB-002	Aug. 29, 2011	Aug. 28, 2012
50 ohms Terminator	50	3	Nov. 02, 2011	Nov. 01, 2012
Software	BV ADT_Cond_V7.3.7	NA	NA	NA

Note:

1. The calibration interval of the above test instruments is 12 months and the calibrations are traceable to NML/ROC and NIST/USA.
2. The test was performed in Shielded Room No. C.
3. The VCCI Con C Registration No. is C-3611.

4.1.3 TEST PROCEDURES

- a. The EUT was placed 0.4 meters from the conducting wall of the shielded room with EUT being connected to the power mains through a line impedance stabilization network (LISN). Other support units were connected to the power mains through another LISN. The two LISNs provide 50 ohm/ 50uH of coupling impedance for the measuring instrument.
- b. Both lines of the power mains connected to the EUT were checked for maximum conducted interference.
- c. The frequency range from 150kHz to 30MHz was searched. Emission levels under (Limit - 20dB) were not recorded.

4.1.4 DEVIATION FROM TEST STANDARD

No deviation

4.1.5 TEST SETUP

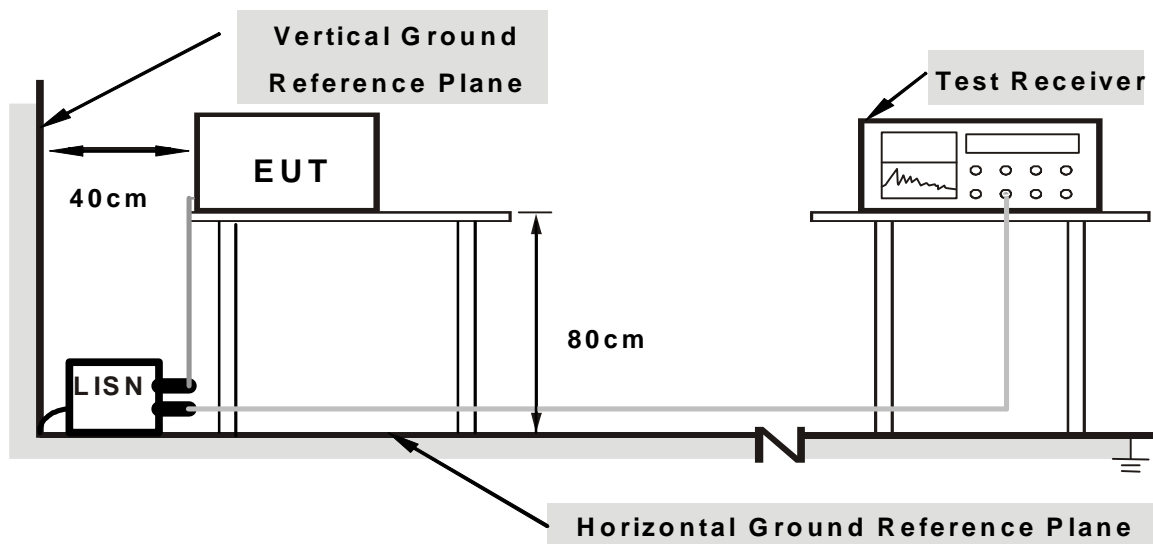

Note: 1.Support units were connected to second LISN.

2.Both of LISNs (AMN) are 80 cm from EUT and at least 80 from other units and other metal planes

For the actual test configuration, please refer to the related item – Photographs of the Test Configuration.

4.1.6 EUT OPERATING CONDITIONS

1. Connect the EUT with the support unit 1 (Notebook Computer) which is placed on a testing table.
2. The communication partner run test program “DutApiClient Udp.exe” to enable EUT under transmission/receiving condition continuously at specific channel frequency.

4.1.7 TEST RESULTS (MODE 1)

PHASE	Line (L)	6dB BANDWIDTH	9 kHz
--------------	----------	----------------------	-------

No	Freq. [MHz]	Corr. Factor (dB)	Reading Value [dB (uV)]		Emission Level [dB (uV)]		Limit [dB (uV)]		Margin (dB)	
			Q.P.	AV.	Q.P.	AV.	Q.P.	AV.	Q.P.	AV.
	1	0.162	0.09	59.79	49.74	59.88	49.83	65.38	55.38	-5.49
2	0.177	0.10	49.60	26.68	49.70	26.78	64.61	54.61	-14.91	-27.83
3	0.216	0.11	51.54	42.54	51.65	42.65	62.96	52.96	-11.30	-10.30
4	0.267	0.12	45.78	37.25	45.90	37.37	61.20	51.20	-15.30	-13.83
5	0.330	0.13	42.10	32.70	42.23	32.83	59.46	49.46	-17.23	-16.63
6	0.377	0.14	41.61	35.36	41.75	35.50	58.35	48.35	-16.61	-12.86
7	3.195	0.35	31.42	19.27	31.77	19.62	56.00	46.00	-24.23	-26.38

- REMARKS:**
1. Q.P. and AV. are abbreviations of quasi-peak and average individually.
 2. The emission levels of other frequencies were very low against the limit.
 3. Margin value = Emission level - Limit value
 4. Correction factor = Insertion loss + Cable loss
 5. Emission Level = Correction Factor + Reading Value.

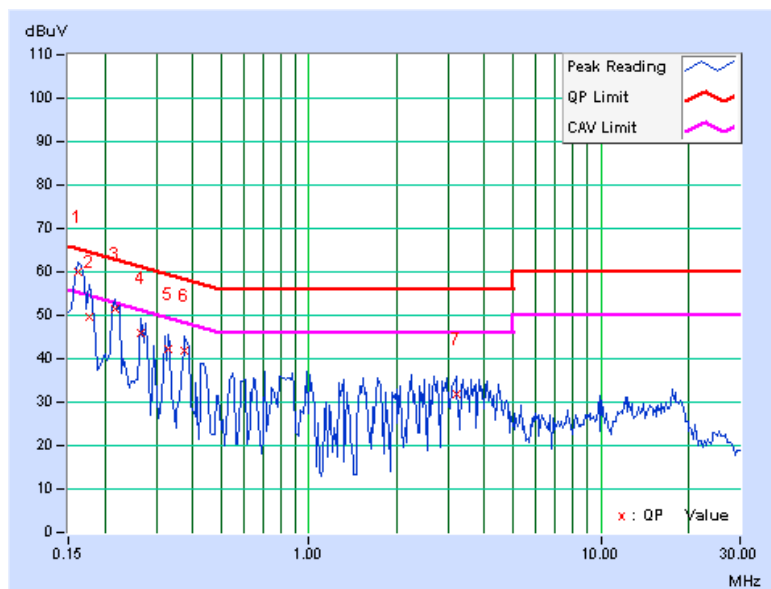



A D T

PHASE	Neutral (N)	6dB BANDWIDTH	9 kHz
-------	-------------	---------------	-------

No	Freq. [MHz]	Corr. Factor (dB)	Reading Value [dB (uV)]		Emission Level [dB (uV)]		Limit [dB (uV)]		Margin (dB)	
			Q.P.	AV.	Q.P.	AV.	Q.P.	AV.	Q.P.	AV.
	1	0.166	0.08	59.17	48.25	59.25	48.33	65.18	55.18	-5.92
2	0.216	0.10	51.58	42.16	51.68	42.26	62.96	52.96	-11.27	-10.69
3	0.274	0.11	46.07	39.08	46.18	39.19	61.01	51.01	-14.83	-11.82
4	0.326	0.12	41.82	33.53	41.94	33.65	59.56	49.56	-17.62	-15.91
5	0.382	0.13	41.71	36.08	41.84	36.21	58.23	48.23	-16.40	-12.03
6	0.955	0.15	25.76	6.68	25.91	6.83	56.00	46.00	-30.09	-39.17
7	4.176	0.32	32.46	19.67	32.78	19.99	56.00	46.00	-23.22	-26.01

- REMARKS:**
1. Q.P. and AV. are abbreviations of quasi-peak and average individually.
 2. The emission levels of other frequencies were very low against the limit.
 3. Margin value = Emission level - Limit value
 4. Correction factor = Insertion loss + Cable loss
 5. Emission Level = Correction Factor + Reading Value.

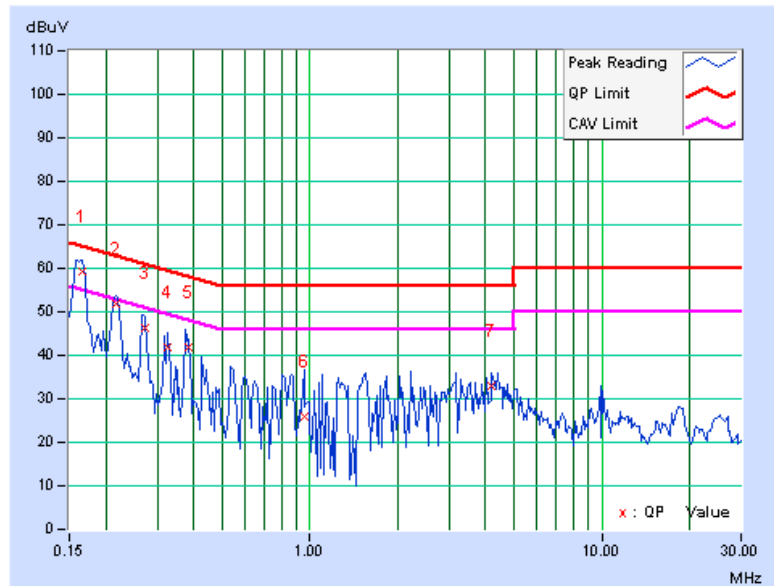

4.1.8 TEST RESULTS (MODE 2)

PHASE	Line (L)	6dB BANDWIDTH	9 kHz
--------------	----------	----------------------	-------

No	Freq. [MHz]	Corr. Factor (dB)	Reading Value		Emission Level		Limit		Margin	
			[dB (uV)]		[dB (uV)]		[dB (uV)]		(dB)	
			Q.P.	AV.	Q.P.	AV.	Q.P.	AV.	Q.P.	AV.
1	0.150	0.09	53.62	39.85	53.71	39.94	66.00	56.00	-12.29	-16.06
2	0.158	0.09	48.82	29.96	48.91	30.05	65.58	55.58	-16.67	-25.53
3	0.177	0.10	49.44	34.92	49.54	35.02	64.61	54.61	-15.07	-19.59
4	0.201	0.11	39.29	20.62	39.40	20.73	63.58	53.58	-24.18	-32.85
5	0.216	0.11	44.30	32.32	44.41	32.43	62.96	52.96	-18.54	-20.52
6	0.463	0.15	37.48	30.30	37.63	30.45	56.65	46.65	-19.02	-16.20
7	3.234	0.35	25.16	16.50	25.51	16.85	56.00	46.00	-30.49	-29.15
8	11.691	0.79	31.00	24.90	31.79	25.69	60.00	50.00	-28.21	-24.31

- REMARKS:**
1. Q.P. and AV. are abbreviations of quasi-peak and average individually.
 2. The emission levels of other frequencies were very low against the limit.
 3. Margin value = Emission level - Limit value
 4. Correction factor = Insertion loss + Cable loss
 5. Emission Level = Correction Factor + Reading Value.

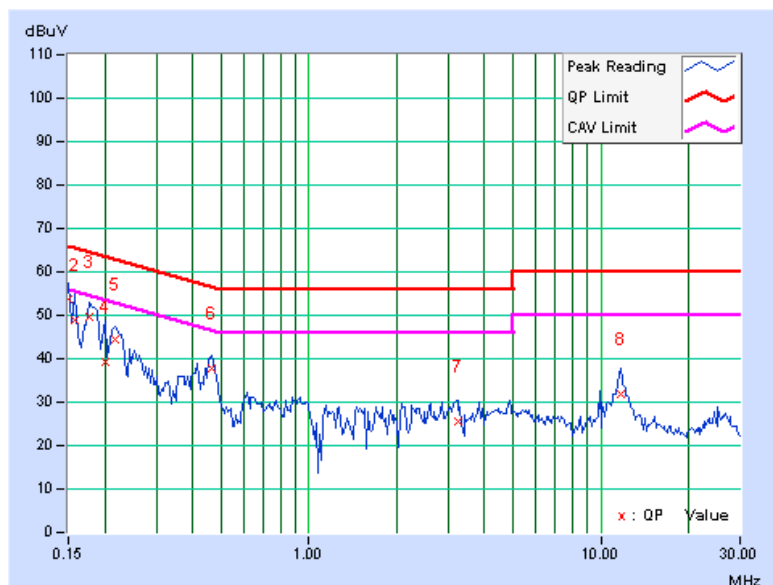

PHASE	Neutral (N)	6dB BANDWIDTH	9 kHz
--------------	-------------	----------------------	-------

No	Freq. [MHz]	Corr. Factor (dB)	Reading Value [dB (uV)]		Emission Level [dB (uV)]		Limit [dB (uV)]		Margin (dB)	
			Q.P.	AV.	Q.P.	AV.	Q.P.	AV.	Q.P.	AV.
	1	0.154	0.08	53.16	36.10	53.24	36.18	65.79	55.79	-12.55
2	0.185	0.09	48.39	35.26	48.48	35.35	64.25	54.25	-15.77	-18.90
3	0.224	0.10	42.31	28.52	42.41	28.62	62.66	52.66	-20.25	-24.04
4	0.463	0.13	37.58	30.38	37.71	30.51	56.65	46.65	-18.94	-16.14
5	9.902	0.59	29.16	25.63	29.75	26.22	60.00	50.00	-30.25	-23.78
6	11.621	0.66	31.01	24.99	31.67	25.65	60.00	50.00	-28.33	-24.35

- REMARKS:**
1. Q.P. and AV. are abbreviations of quasi-peak and average individually.
 2. The emission levels of other frequencies were very low against the limit.
 3. Margin value = Emission level - Limit value
 4. Correction factor = Insertion loss + Cable loss
 5. Emission Level = Correction Factor + Reading Value.

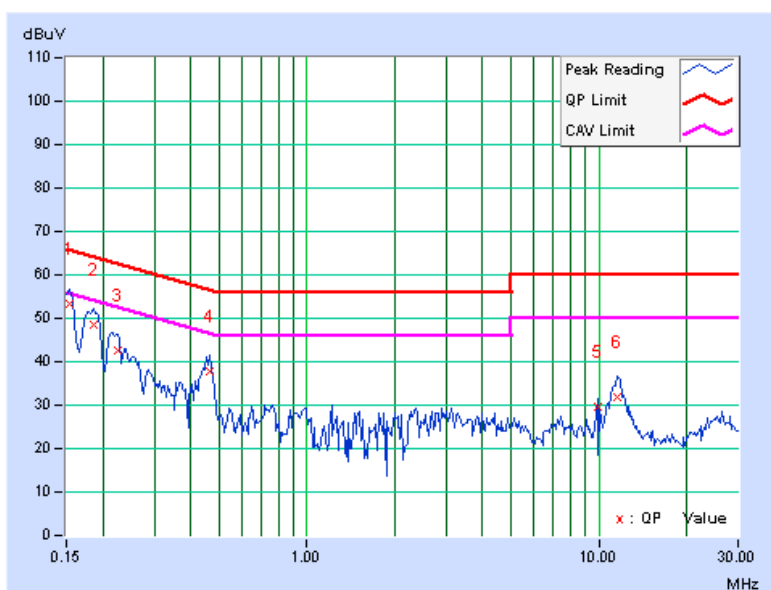

4.2 RADIATED EMISSION MEASUREMENT

4.2.1 LIMITS OF RADIATED EMISSION MEASUREMENT

Emissions radiated outside of the specified bands, shall be according to the general radiated limits in 15.209 as following:

Frequencies (MHz)	Field strength (microvolts/meter)	Measurement distance (meters)
0.009-0.490	2400/F(kHz)	300
0.490-1.705	24000/F(kHz)	30
1.705-30.0	30	30
30-88	100	3
88-216	150	3
216-960	200	3
Above 960	500	3

NOTE:

1. The lower limit shall apply at the transition frequencies.
2. Emission level (dBuV/m) = 20 log Emission level (uV/m).
3. As shown in 15.35(b), for frequencies above 1000MHz, the field strength limits are based on average detector, however, the peak field strength of any emission shall not exceed the maximum permitted average limits, specified above by more than 20dB under any condition of modulation.
4. Section 15.205 restricted bands of operation shall compliance with the limits in Section 15.209.



A D T

4.2.2 TEST INSTRUMENTS

For Below 1GHz: (Test date: Dec. 14, 2011)

DESCRIPTION & MANUFACTURER	MODEL NO.	SERIAL NO.	CALIBRATED DATE	CALIBRATED UNTIL
Agilent Spectrum Analyzer	E4446A	MY48250253	Aug. 29, 2011	Aug. 28, 2012
Agilent Pre-Selector	N9039A	MY46520310	Aug. 29, 2011	Aug. 28, 2012
Agilent Signal Generator	N5181A	MY49060347	July 25, 2011	July 24, 2012
Mini-Circuits Pre-Amplifier	ZFL-1000VH2B	AMP-ZFL-04	Nov. 15, 2011	Nov. 14, 2012
Agilent Pre-Amplifier	8449B	3008A02465	Feb. 28, 2011	Feb. 27, 2012
SPACEK LABS	SLKKa-48-6	9K16	Nov. 15, 2011	Nov. 14, 2012
SCHWARZBECK Trilog Broadband Antenna	VULB 9168	9168-361	Apr. 14, 2011	Apr. 13, 2012
AISI Horn_Antenna	AIH.8018	0000220091110	Nov. 23, 2011	Nov. 22, 2012
SCHWARZBECK Horn_Antenna	BBHA 9170	9170-424	Oct. 07, 2011	Oct. 06, 2012
RF CABLE	NA	RF104-205 RF104-207 RF104-202	Dec. 28, 2010	Dec. 27, 2011
RF Cable	NA	CHHCAB_001	Oct. 08, 2011	Oct. 07, 2012
Software	ADT_Radiated_V8.7.05	NA	NA	NA
CT Antenna Tower & Turn Table	NA	NA	NA	NA

Note: 1. The calibration interval of the above test instruments is 12 months and the calibrations are traceable to NML/ROC and NIST/USA.

2. The horn antenna, preamplifier (model: 8449B) are used only for the measurement of emission frequency above 1GHz if tested.

3. The test was performed in 966 Chamber No. H.

4. The FCC Site Registration No. is 797305.

5. The CANADA Site Registration No. is IC 7450H-3.



A D T

For Above 1GHz: (Test date: Dec. 16, 2011)

DESCRIPTION & MANUFACTURER	MODEL NO.	SERIAL NO.	CALIBRATED DATE	CALIBRATED UNTIL
Agilent Spectrum Analyzer	E4446A	MY48250254	July 12, 2011	July 11, 2012
Agilent Pre-Selector	N9039A	MY46520311	July 12, 2011	July 11, 2012
Agilent Signal Generator	N5181A	MY49060517	July 12, 2011	July 11, 2012
Mini-Circuits Pre-Amplifier	ZFL-1000VH2B	AMP-ZFL-03	Nov. 15, 2011	Nov. 14, 2012
Agilent Pre-Amplifier	8449B	3008A02578	July 04, 2011	July 03, 2012
SPACEK LABS	SLKKa-48-6	9K16	Nov. 15, 2011	Nov. 14, 2012
SCHWARZBECK Trilog Broadband Antenna	VULB 9168	9168-360	Apr. 14, 2011	Apr. 13, 2012
AISI Horn_Antenna	AIH.8018	0000320091110	Nov. 14, 2011	Nov. 13, 2012
SCHWARZBECK Horn_Antenna	BBHA 9170	9170-424	Oct. 07, 2011	Oct. 06, 2012
RF CABLE	NA	RF104-201 RF104-203 RF104-204	Dec. 27, 2010	Dec. 26, 2011
RF Cable	NA	CHGCAB_001	Oct. 07, 2011	Oct. 06, 2012
Software	ADT_Radiated_V8.7.05	NA	NA	NA
CT Antenna Tower & Turn Table	NA	NA	NA	NA

- Note: 1. The calibration interval of the above test instruments is 12 months and the calibrations are traceable to NML/ROC and NIST/USA.
2. The horn antenna, preamplifier (model: 8449B) are used only for the measurement of emission frequency above 1GHz if tested.
3. The test was performed in 966 Chamber No. G.
4. The FCC Site Registration No. is 966073.
5. The VCCI Site Registration No. is G-137.
6. The CANADA Site Registration No. is IC 7450H-2.

4.2.3 TEST PROCEDURES

- a. The EUT was placed on the top of a rotating table 0.8 meters above the ground at 3 meter chamber room. The table was rotated 360 degrees to determine the position of the highest radiation.
- b. The EUT was set 3 meters away from the interference-receiving antenna, which was mounted on the top of a variable-height antenna tower.
- c. The height of antenna is varied from one meter to four meters above the ground to determine the maximum value of the field strength. Both horizontal and vertical polarizations of the antenna are set to make the measurement.
- d. For each suspected emission, the EUT was arranged to its worst case and then the antenna was tuned to heights from 1 meter to 4 meters and the rotatable table was turned from 0 degrees to 360 degrees to find the maximum reading.
- e. The test-receiver system was set to quasi-peak detect function and specified bandwidth with maximum hold mode when the test frequency is below 1 GHz.
- f. The test-receiver system was set to peak and average detect function and specified bandwidth with maximum hold mode when the test frequency is above 1 GHz. If the peak reading value also meets average limit, measurement with the average detector is unnecessary.

NOTE:

1. The resolution bandwidth and video bandwidth of test receiver/spectrum analyzer is 120kHz for Quasi-peak detection (QP) at frequency below 1GHz.
2. The resolution bandwidth of test receiver/spectrum analyzer is 1 MHz and the video bandwidth is 3 MHz for Peak detection (PK) at frequency above 1GHz.
3. The resolution bandwidth of test receiver/spectrum analyzer is 1 MHz and the video bandwidth is 10 Hz for Average detection (AV) at frequency above 1GHz.

4.2.4 DEVIATION FROM TEST STANDARD

No deviation

4.2.5 TEST SETUP

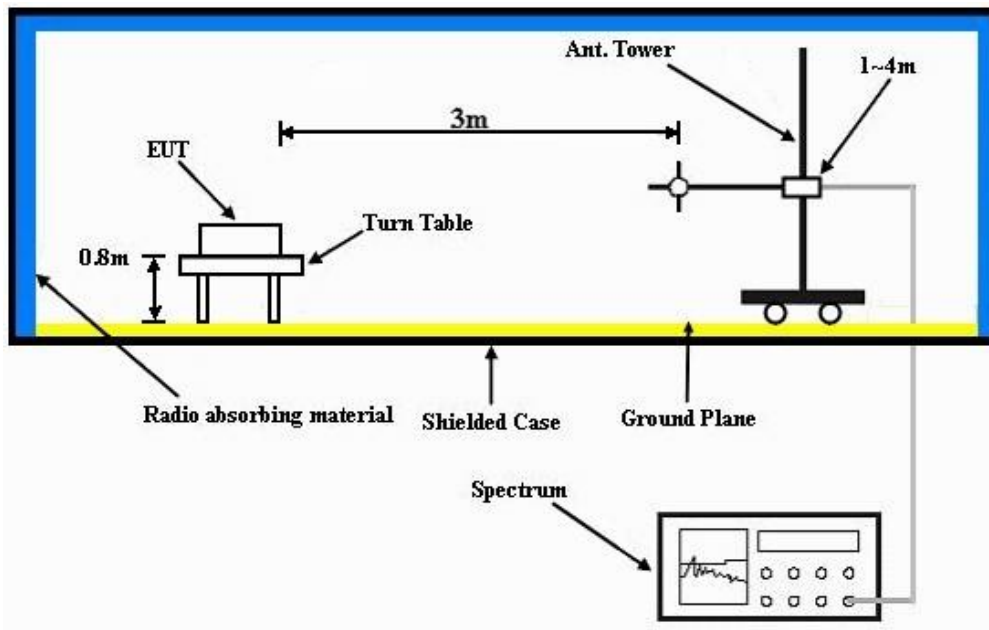

For the actual test configuration, please refer to the related item – Photographs of the Test Configuration.

4.2.6 EUT OPERATING CONDITIONS

Same as 4.1.6

4.2.7 TEST RESULTS

BELOW 1GHz WORST-CASE DATA : 802.11n (20MHz) OFDM MODULATION

EUT TEST CONDITION		MEASUREMENT DETAIL	
CHANNEL	Channel 6	FREQUENCY RANGE	Below 1000MHz
INPUT POWER	120Vac / 60Hz	DETECTOR FUNCTION	Quasi-Peak
ENVIRONMENTAL CONDITIONS	22deg. C, 70%RH	TESTED BY	Nelson Teng

ANTENNA POLARITY & TEST DISTANCE: HORIZONTAL AT 3 M								
NO.	FREQ. (MHz)	EMISSION LEVEL (dBuV/m)	LIMIT (dBuV/m)	MARGIN (dB)	ANTENNA HEIGHT (m)	TABLE ANGLE (Degree)	RAW VALUE (dBuV)	CORRECTION FACTOR (dB/m)
1	86.01	30.5 QP	40.0	-9.5	1.75 H	267	21.50	8.96
2	196.03	33.4 QP	43.5	-10.2	1.75 H	281	21.68	11.67
3	250.03	35.1 QP	46.0	-10.9	1.00 H	272	21.86	13.28
4	375.08	38.6 QP	46.0	-7.4	1.00 H	247	21.47	17.11
5	500.02	35.2 QP	46.0	-10.8	2.00 H	79	15.17	20.06
6	1000.00	33.5 QP	54.0	-20.5	1.25 H	360	5.24	28.30
ANTENNA POLARITY & TEST DISTANCE: VERTICAL AT 3 M								
NO.	FREQ. (MHz)	EMISSION LEVEL (dBuV/m)	LIMIT (dBuV/m)	MARGIN (dB)	ANTENNA HEIGHT (m)	TABLE ANGLE (Degree)	RAW VALUE (dBuV)	CORRECTION FACTOR (dB/m)
1	64.93	36.2 QP	40.0	-3.8	1.25 V	313	23.29	12.89
2	250.03	37.4 QP	46.0	-8.6	1.50 V	281	24.12	13.28
3	375.08	35.3 QP	46.0	-10.7	1.25 V	259	18.21	17.11
4	500.02	34.5 QP	46.0	-11.5	1.50 V	295	14.46	20.06
5	625.07	36.4 QP	46.0	-9.6	1.00 V	321	13.94	22.42
6	1000.00	32.5 QP	54.0	-21.5	1.00 V	192	4.19	28.30

- REMARKS:**
1. Emission level (dBuV/m) = Raw Value (dBuV) + Correction Factor (dB/m).
 2. Correction Factor (dB/m) = Antenna Factor (dB/m) + Cable Factor (dB).
 3. The other emission levels were very low against the limit.
 4. Margin value = Emission level – Limit value.



A D T

ABOVE 1GHz WORST-CASE DATA

802.11b DSSS MODULATION

EUT TEST CONDITION		MEASUREMENT DETAIL	
CHANNEL	Channel 1	FREQUENCY RANGE	1 ~ 25GHz
INPUT POWER	120Vac / 60Hz	DETECTOR FUNCTION	Peak (PK) Average (AV)
ENVIRONMENTAL CONDITIONS	26deg. C, 68%RH	TESTED BY	Nelson Teng

ANTENNA POLARITY & TEST DISTANCE: HORIZONTAL AT 3 M

NO.	FREQ. (MHz)	EMISSION LEVEL (dBuV/m)	LIMIT (dBuV/m)	MARGIN (dB)	ANTENNA HEIGHT (m)	TABLE ANGLE (Degree)	RAW VALUE (dBuV)	CORRECTION FACTOR (dB/m)
1	2386.10	62.8 PK	74.0	-11.2	1.00 H	71	31.16	31.64
2	2386.10	52.4 AV	54.0	-1.6	1.00 H	71	20.76	31.64
3	*2412.00	113.1 PK			1.00 H	71	81.37	31.73
4	*2412.00	110.8 AV			1.00 H	71	79.07	31.73
5	4824.00	55.0 PK	74.0	-19.0	1.32 H	105	16.03	38.97
6	4824.00	50.6 AV	54.0	-3.4	1.32 H	105	11.63	38.97

ANTENNA POLARITY & TEST DISTANCE: VERTICAL AT 3 M

NO.	FREQ. (MHz)	EMISSION LEVEL (dBuV/m)	LIMIT (dBuV/m)	MARGIN (dB)	ANTENNA HEIGHT (m)	TABLE ANGLE (Degree)	RAW VALUE (dBuV)	CORRECTION FACTOR (dB/m)
1	2389.20	60.6 PK	74.0	-13.4	1.00 V	74	28.95	31.65
2	2389.20	51.2 AV	54.0	-2.8	1.00 V	74	19.55	31.65
3	*2412.00	112.0 PK			1.00 V	72	80.27	31.73
4	*2412.00	109.9 AV			1.00 V	72	78.17	31.73
5	4824.00	54.3 PK	74.0	-19.7	1.00 V	135	15.33	38.97
6	4824.00	49.7 AV	54.0	-4.3	1.00 V	135	10.73	38.97

- REMARKS:**
1. Emission level (dBuV/m) = Raw Value (dBuV) + Correction Factor (dB/m).
 2. Correction Factor (dB/m) = Antenna Factor (dB/m) + Cable Factor (dB).
 3. The other emission levels were very low against the limit.
 4. Margin value = Emission level – Limit value.
 5. “ * “: Fundamental frequency.



A D T

EUT TEST CONDITION		MEASUREMENT DETAIL	
CHANNEL	Channel 6	FREQUENCY RANGE	1 ~ 25GHz
INPUT POWER	120Vac / 60Hz	DETECTOR FUNCTION	Peak (PK) Average (AV)
ENVIRONMENTAL CONDITIONS	26deg. C, 68%RH	TESTED BY	Nelson Teng

ANTENNA POLARITY & TEST DISTANCE: HORIZONTAL AT 3 M								
NO.	FREQ. (MHz)	EMISSION LEVEL (dBuV/m)	LIMIT (dBuV/m)	MARGIN (dB)	ANTENNA HEIGHT (m)	TABLE ANGLE (Degree)	RAW VALUE (dBuV)	CORRECTION FACTOR (dB/m)
1	*2437.00	114.6 PK			1.00 H	69	82.79	31.81
2	*2437.00	112.6 AV			1.00 H	69	80.79	31.81
3	4874.00	55.6 PK	74.0	-18.4	1.00 H	85	16.46	39.14
4	4874.00	51.8 AV	54.0	-2.2	1.00 H	85	12.66	39.14
5	7311.00	62.7 PK	74.0	-11.3	1.03 H	102	16.07	46.63
6	7311.00	50.5 AV	54.0	-3.5	1.03 H	102	3.87	46.63
ANTENNA POLARITY & TEST DISTANCE: VERTICAL AT 3 M								
NO.	FREQ. (MHz)	EMISSION LEVEL (dBuV/m)	LIMIT (dBuV/m)	MARGIN (dB)	ANTENNA HEIGHT (m)	TABLE ANGLE (Degree)	RAW VALUE (dBuV)	CORRECTION FACTOR (dB/m)
1	*2437.00	111.1 PK			1.00 V	14	79.29	31.81
2	*2437.00	109.2 AV			1.00 V	14	77.39	31.81
3	4874.00	53.8 PK	74.0	-20.2	1.00 V	97	14.66	39.14
4	4874.00	49.3 AV	54.0	-4.7	1.00 V	97	10.16	39.14
5	7311.00	52.1 PK	74.0	-21.9	1.03 V	137	5.47	46.63
6	7311.00	38.9 AV	54.0	-15.1	1.03 V	137	-7.73	46.63

- REMARKS:**
1. Emission level (dBuV/m) = Raw Value (dBuV) + Correction Factor (dB/m).
 2. Correction Factor (dB/m) = Antenna Factor (dB/m) + Cable Factor (dB).
 3. The other emission levels were very low against the limit.
 4. Margin value = Emission level – Limit value.
 5. “ * “: Fundamental frequency.



A D T

EUT TEST CONDITION		MEASUREMENT DETAIL	
CHANNEL	Channel 11	FREQUENCY RANGE	1 ~ 25GHz
INPUT POWER	120Vac / 60Hz	DETECTOR FUNCTION	Peak (PK) Average (AV)
ENVIRONMENTAL CONDITIONS	26deg. C, 68%RH	TESTED BY	Nelson Teng

ANTENNA POLARITY & TEST DISTANCE: HORIZONTAL AT 3 M								
NO.	FREQ. (MHz)	EMISSION LEVEL (dBuV/m)	LIMIT (dBuV/m)	MARGIN (dB)	ANTENNA HEIGHT (m)	TABLE ANGLE (Degree)	RAW VALUE (dBuV)	CORRECTION FACTOR (dB/m)
1	*2462.00	114.7 PK			1.00 H	110	82.81	31.89
2	*2462.00	112.5 AV			1.00 H	110	80.61	31.89
3	2484.70	63.3 PK	74.0	-10.7	1.00 H	110	31.33	31.97
4	2484.70	50.9 AV	54.0	-3.1	1.00 H	110	18.93	31.97
5	4924.00	55.1 PK	74.0	-18.9	1.00 H	99	15.79	39.31
6	4924.00	50.7 AV	54.0	-3.3	1.00 H	99	11.39	39.31
7	7386.00	51.7 PK	74.0	-22.3	1.31 H	142	5.10	46.60
8	7386.00	39.6 AV	54.0	-14.4	1.31 H	142	-7.00	46.60
ANTENNA POLARITY & TEST DISTANCE: VERTICAL AT 3 M								
NO.	FREQ. (MHz)	EMISSION LEVEL (dBuV/m)	LIMIT (dBuV/m)	MARGIN (dB)	ANTENNA HEIGHT (m)	TABLE ANGLE (Degree)	RAW VALUE (dBuV)	CORRECTION FACTOR (dB/m)
1	*2462.00	110.5 PK			1.00 V	79	78.61	31.89
2	*2462.00	108.5 AV			1.00 V	79	76.61	31.89
3	2488.26	60.0 PK	74.0	-14.0	1.02 V	88	28.02	31.98
4	2488.26	47.7 AV	54.0	-6.3	1.02 V	88	15.72	31.98
5	4924.00	50.9 PK	74.0	-23.1	1.00 V	103	11.59	39.31
6	4924.00	44.3 AV	54.0	-9.7	1.00 V	103	4.99	39.31
7	7386.00	52.5 PK	74.0	-21.5	1.02 V	144	5.90	46.60
8	7386.00	39.2 AV	54.0	-14.8	1.02 V	144	-7.40	46.60

- REMARKS:**
1. Emission level (dBuV/m) = Raw Value (dBuV) + Correction Factor (dB/m).
 2. Correction Factor (dB/m) = Antenna Factor (dB/m) + Cable Factor (dB).
 3. The other emission levels were very low against the limit.
 4. Margin value = Emission level – Limit value.
 5. “ * “: Fundamental frequency.

RESTRICTED BANDEDGE (802.11b MODE, CH1, HORIZONTAL)

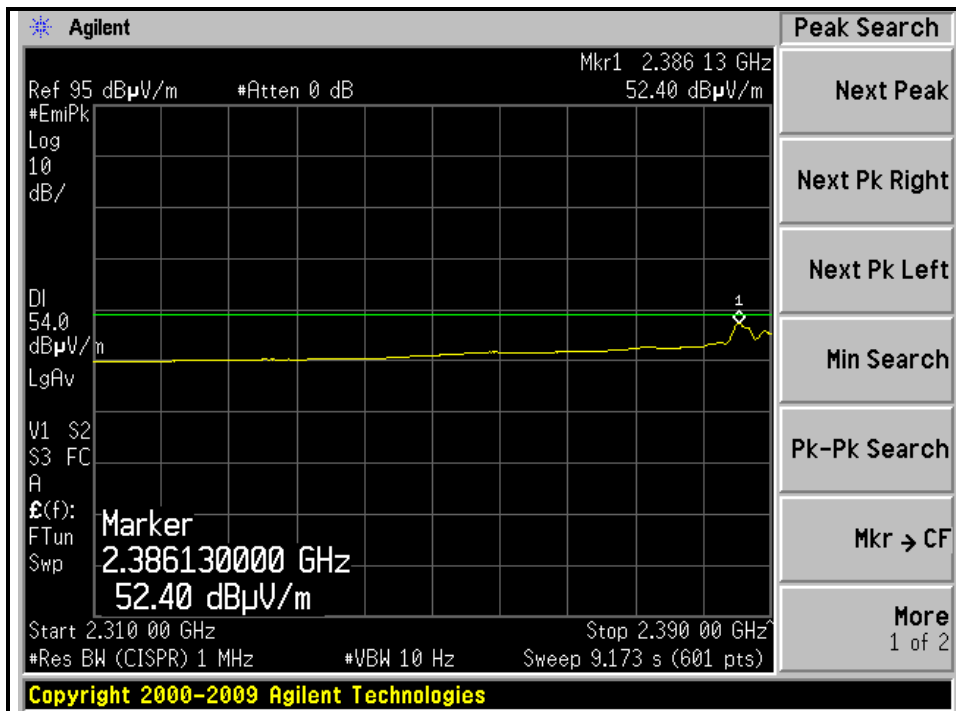
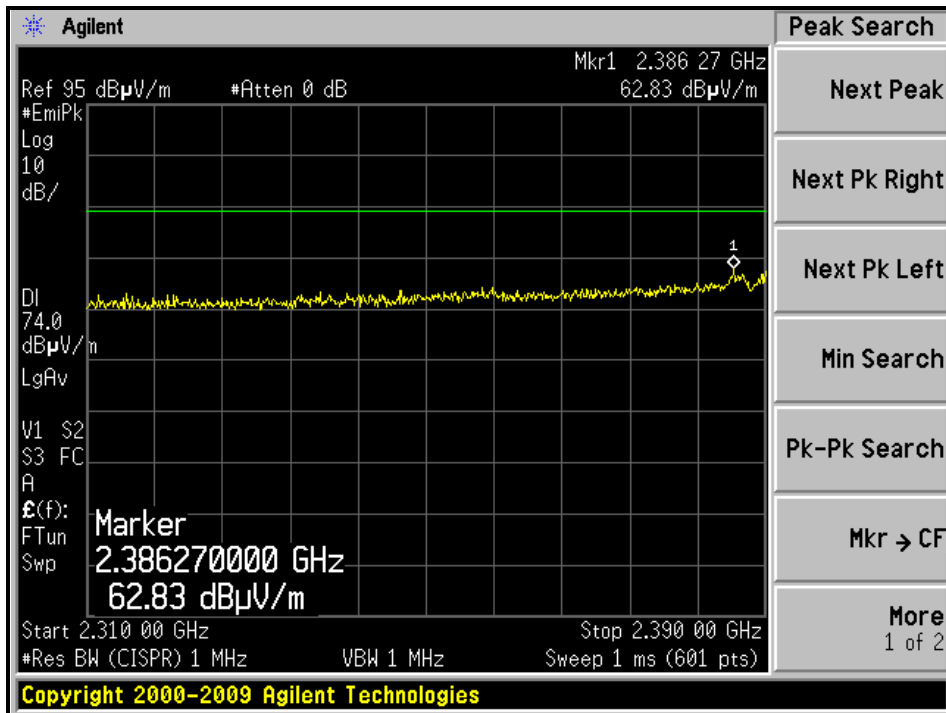

RESTRICTED BANDEDGE (802.11b MODE, CH1, VERTICAL)

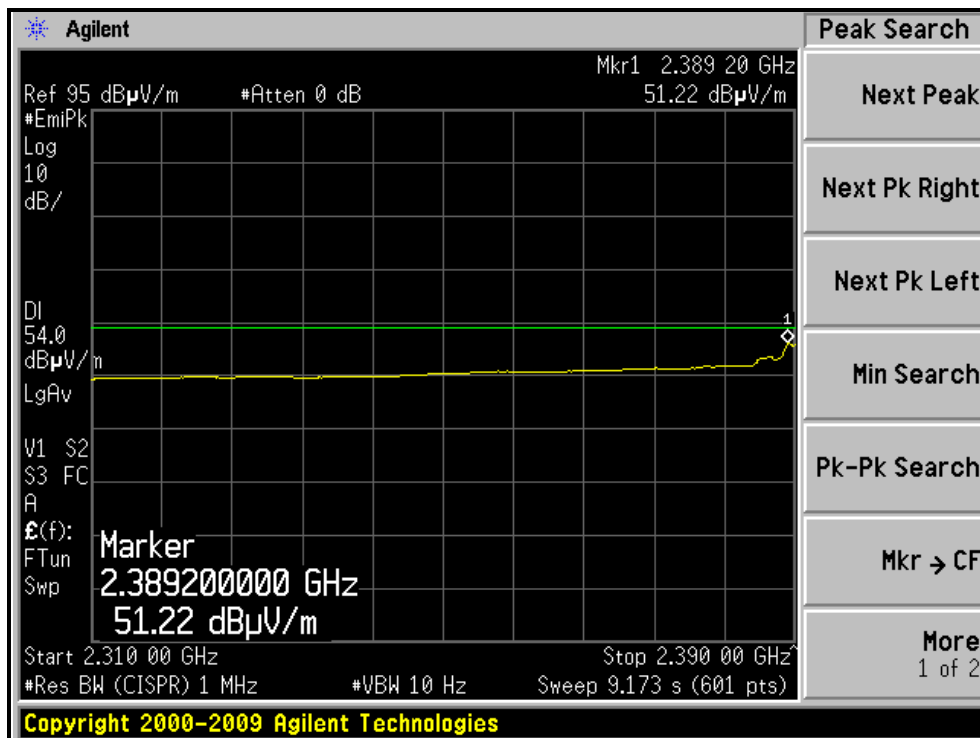
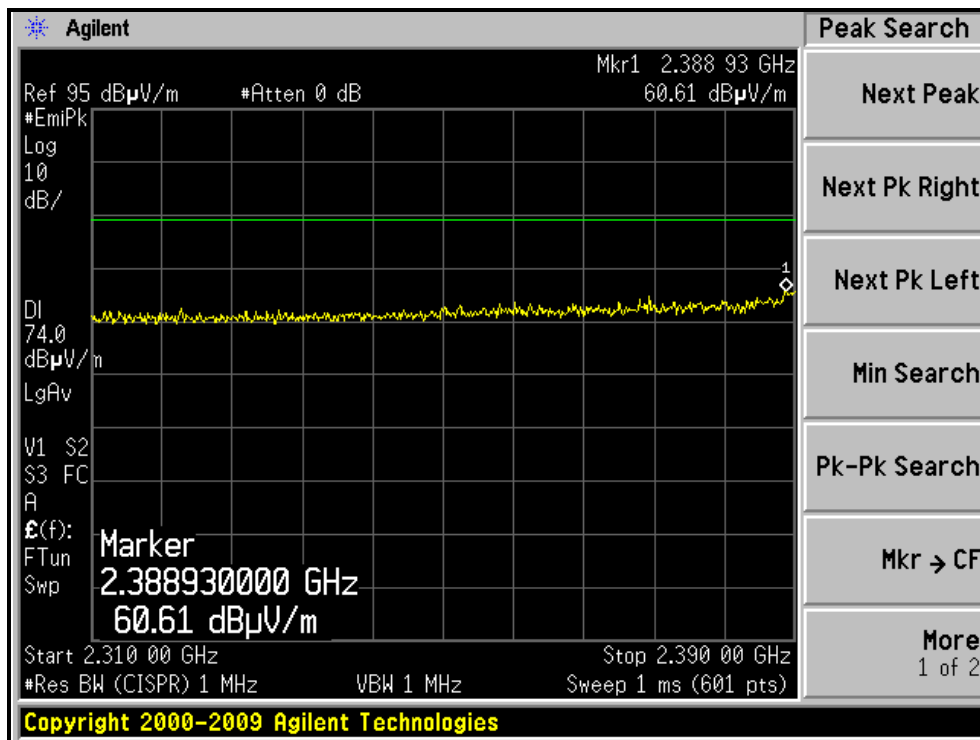

RESTRICTED BANDEDGE (802.11b MODE, CH11, HORIZONTAL)

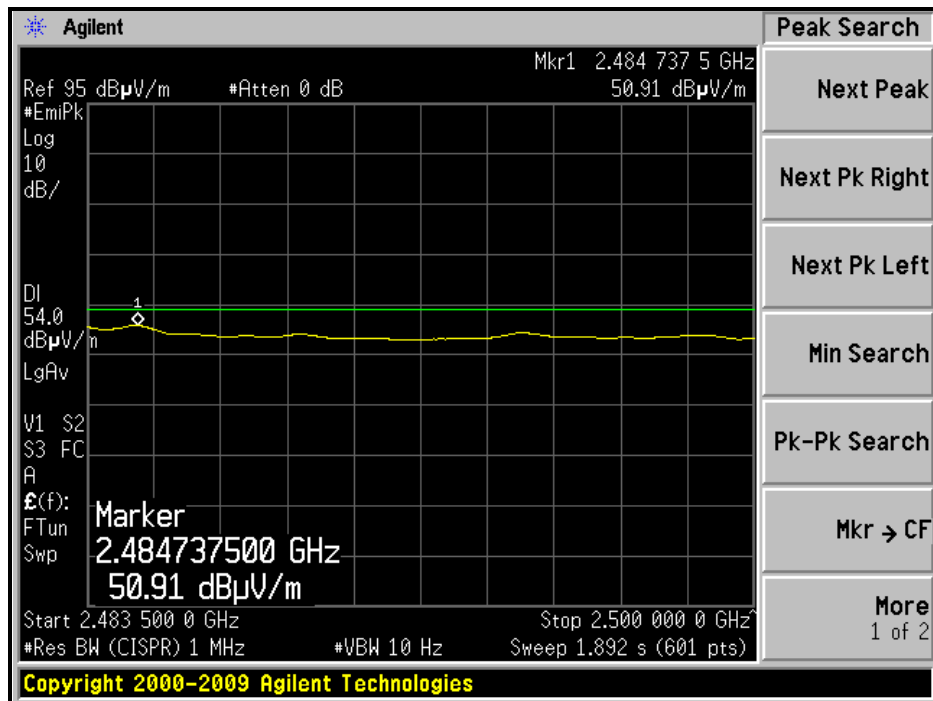
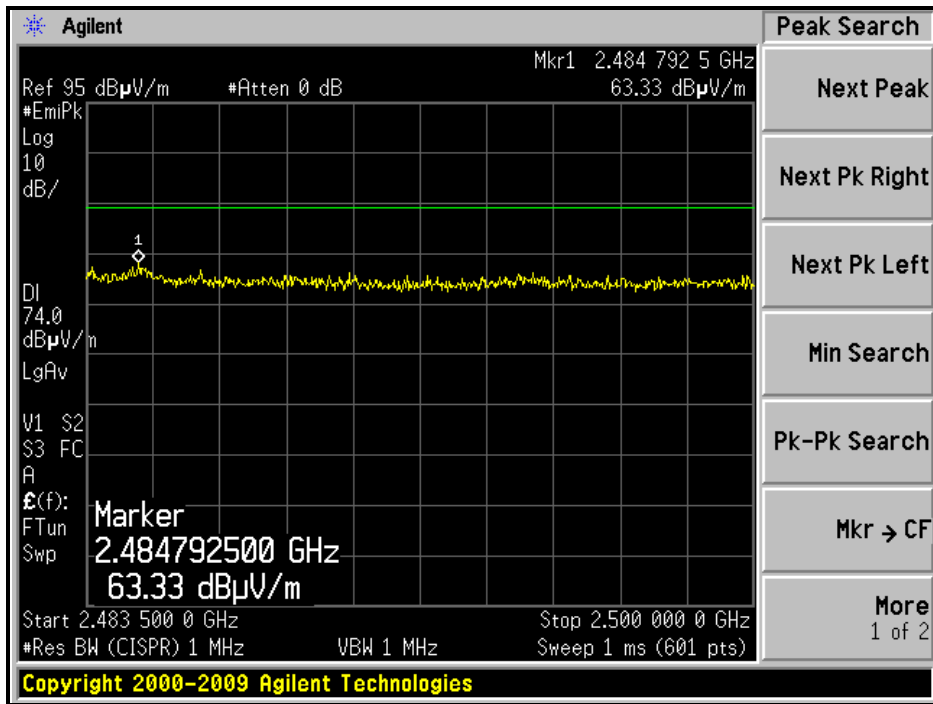



A D T

RESTRICTED BANDEDGE (802.11b MODE, CH11, VERTICAL)

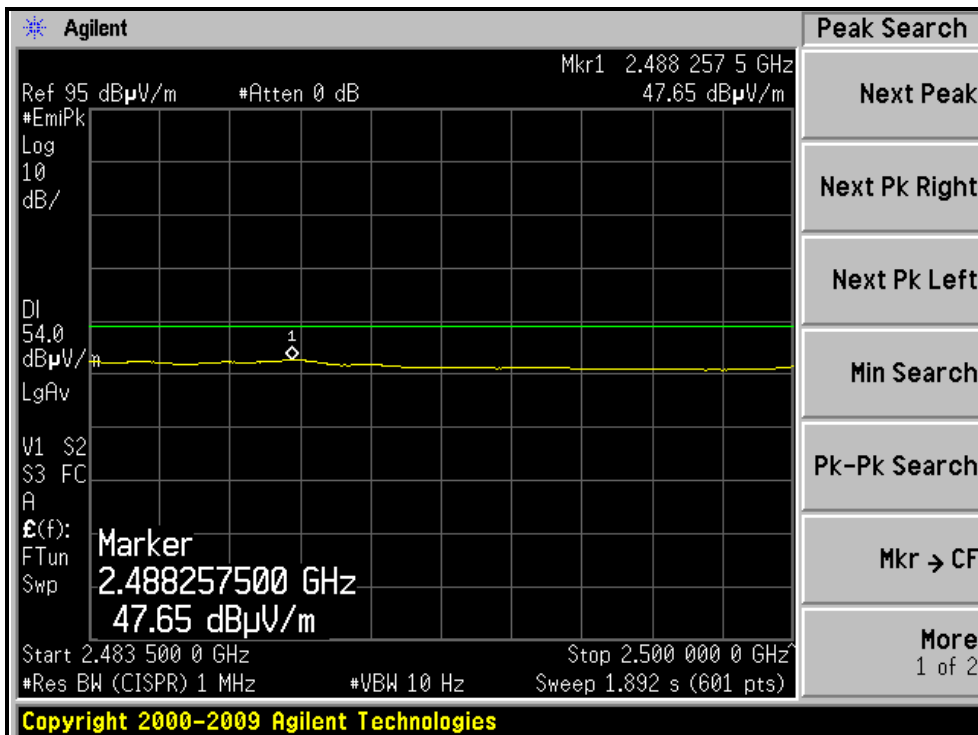
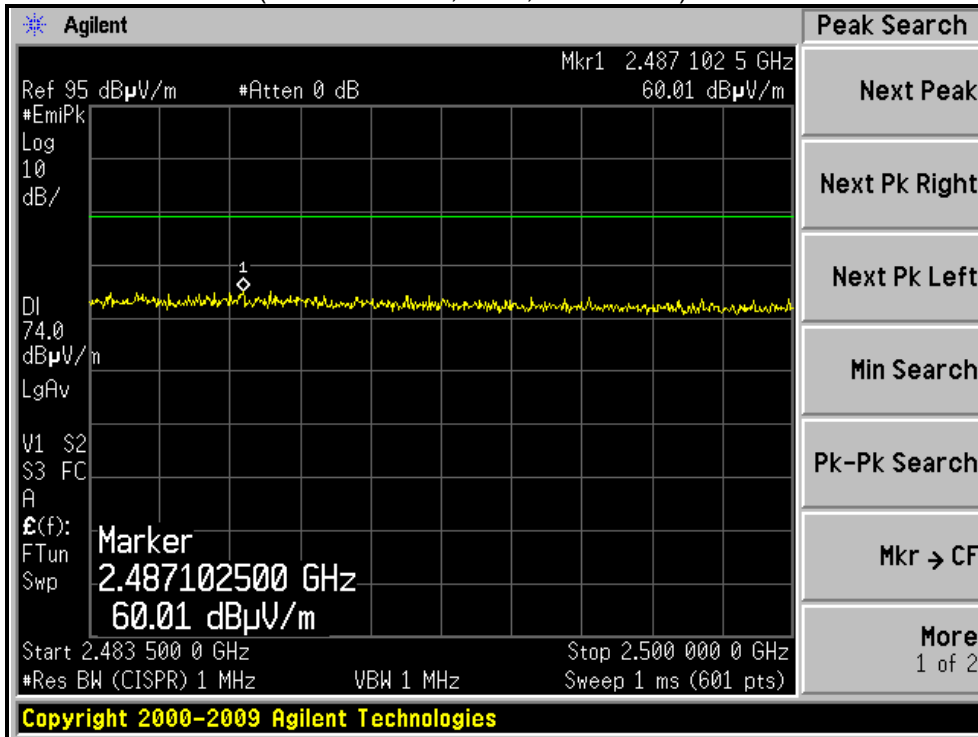



A D T

802.11g OFDM MODULATION

EUT TEST CONDITION		MEASUREMENT DETAIL	
CHANNEL	Channel 1	FREQUENCY RANGE	1 ~ 25GHz
INPUT POWER	120Vac / 60Hz	DETECTOR FUNCTION	Peak (PK) Average (AV)
ENVIRONMENTAL CONDITIONS	26deg. C, 68%RH	TESTED BY	Nelson Teng

ANTENNA POLARITY & TEST DISTANCE: HORIZONTAL AT 3 M

NO.	FREQ. (MHz)	EMISSION LEVEL (dBuV/m)	LIMIT (dBuV/m)	MARGIN (dB)	ANTENNA HEIGHT (m)	TABLE ANGLE (Degree)	RAW VALUE (dBuV)	CORRECTION FACTOR (dB/m)
1	2390.00	70.3 PK	74.0	-3.7	1.00 H	104	38.64	31.66
2	2390.00	53.2 AV	54.0	-0.7	1.00 H	104	21.54	31.66
3	*2412.00	110.8 PK			1.00 H	105	79.07	31.73
4	*2412.00	102.4 AV			1.00 H	105	70.67	31.73
5	4824.00	49.2 PK	74.0	-24.8	1.33 H	118	10.23	38.97
6	4824.00	35.8 AV	54.0	-18.2	1.33 H	118	-3.17	38.97

ANTENNA POLARITY & TEST DISTANCE: VERTICAL AT 3 M

NO.	FREQ. (MHz)	EMISSION LEVEL (dBuV/m)	LIMIT (dBuV/m)	MARGIN (dB)	ANTENNA HEIGHT (m)	TABLE ANGLE (Degree)	RAW VALUE (dBuV)	CORRECTION FACTOR (dB/m)
1	2390.00	66.2 PK	74.0	-7.8	1.08 V	71	34.54	31.66
2	2390.00	50.1 AV	54.0	-3.9	1.08 V	71	18.44	31.66
3	*2412.00	109.3 PK			1.03 V	83	77.57	31.73
4	*2412.00	99.4 AV			1.03 V	83	67.67	31.73
5	4824.00	48.8 PK	74.0	-25.2	1.01 V	150	9.83	38.97
6	4824.00	35.7 AV	54.0	-18.3	1.01 V	150	-3.27	38.97

- REMARKS:**
1. Emission level (dBuV/m) = Raw Value (dBuV) + Correction Factor (dB/m).
 2. Correction Factor (dB/m) = Antenna Factor (dB/m) + Cable Factor (dB).
 3. The other emission levels were very low against the limit.
 4. Margin value = Emission level – Limit value.
 5. “ * “: Fundamental frequency.



A D T

EUT TEST CONDITION		MEASUREMENT DETAIL	
CHANNEL	Channel 6	FREQUENCY RANGE	1 ~ 25GHz
INPUT POWER	120Vac / 60Hz	DETECTOR FUNCTION	Peak (PK) Average (AV)
ENVIRONMENTAL CONDITIONS	26deg. C, 68%RH	TESTED BY	Nelson Teng

ANTENNA POLARITY & TEST DISTANCE: HORIZONTAL AT 3 M

NO.	FREQ. (MHz)	EMISSION LEVEL (dBuV/m)	LIMIT (dBuV/m)	MARGIN (dB)	ANTENNA HEIGHT (m)	TABLE ANGLE (Degree)	RAW VALUE (dBuV)	CORRECTION FACTOR (dB/m)
1	2390.00	66.2 PK	74.0	-7.8	1.00 H	103	34.54	31.66
2	2390.00	52.9 AV	54.0	-1.1	1.00 H	103	21.24	31.66
3	*2437.00	117.3 PK			1.00 H	105	85.49	31.81
4	*2437.00	108.3 AV			1.00 H	105	76.49	31.81
5	4874.00	50.1 PK	74.0	-23.9	1.04 H	72	10.96	39.14
6	4874.00	35.9 AV	54.0	-18.1	1.04 H	72	-3.24	39.14
7	7311.00	52.6 PK	74.0	-21.4	1.02 H	110	5.97	46.63
8	7311.00	38.9 AV	54.0	-15.1	1.02 H	110	-7.73	46.63

ANTENNA POLARITY & TEST DISTANCE: VERTICAL AT 3 M

NO.	FREQ. (MHz)	EMISSION LEVEL (dBuV/m)	LIMIT (dBuV/m)	MARGIN (dB)	ANTENNA HEIGHT (m)	TABLE ANGLE (Degree)	RAW VALUE (dBuV)	CORRECTION FACTOR (dB/m)
1	*2437.00	115.8 PK			1.05 V	79	83.99	31.81
2	*2437.00	105.9 AV			1.05 V	79	74.09	31.81
3	4874.00	49.0 PK	74.0	-25.0	1.03 V	102	9.86	39.14
4	4874.00	35.8 AV	54.0	-18.2	1.03 V	102	-3.34	39.14
5	7311.00	51.3 PK	74.0	-22.7	1.00 V	137	4.67	46.63
6	7311.00	38.8 AV	54.0	-15.2	1.00 V	137	-7.83	46.63

- REMARKS:**
1. Emission level (dBuV/m) = Raw Value (dBuV) + Correction Factor (dB/m).
 2. Correction Factor (dB/m) = Antenna Factor (dB/m) + Cable Factor (dB).
 3. The other emission levels were very low against the limit.
 4. Margin value = Emission level – Limit value.
 5. “ * “: Fundamental frequency.



A D T

EUT TEST CONDITION		MEASUREMENT DETAIL	
CHANNEL	Channel 11	FREQUENCY RANGE	1 ~ 25GHz
INPUT POWER	120Vac / 60Hz	DETECTOR FUNCTION	Peak (PK) Average (AV)
ENVIRONMENTAL CONDITIONS	26deg. C, 68%RH	TESTED BY	Nelson Teng

ANTENNA POLARITY & TEST DISTANCE: HORIZONTAL AT 3 M								
NO.	FREQ. (MHz)	EMISSION LEVEL (dBuV/m)	LIMIT (dBuV/m)	MARGIN (dB)	ANTENNA HEIGHT (m)	TABLE ANGLE (Degree)	RAW VALUE (dBuV)	CORRECTION FACTOR (dB/m)
1	*2462.00	111.6 PK			1.00 H	104	79.71	31.89
2	*2462.00	102.8 AV			1.00 H	104	70.91	31.89
3	2483.61	71.4 PK	74.0	-2.6	1.00 H	110	39.43	31.97
4	2483.61	53.3 AV	54.0	-0.7	1.00 H	110	21.33	31.97
5	4924.00	47.9 PK	74.0	-26.1	1.06 H	91	8.59	39.31
6	4924.00	34.1 AV	54.0	-19.9	1.06 H	91	-5.21	39.31
7	7386.00	53.2 PK	74.0	-20.8	1.27 H	129	6.60	46.60
8	7386.00	38.9 AV	54.0	-15.1	1.27 H	129	-7.70	46.60
ANTENNA POLARITY & TEST DISTANCE: VERTICAL AT 3 M								
NO.	FREQ. (MHz)	EMISSION LEVEL (dBuV/m)	LIMIT (dBuV/m)	MARGIN (dB)	ANTENNA HEIGHT (m)	TABLE ANGLE (Degree)	RAW VALUE (dBuV)	CORRECTION FACTOR (dB/m)
1	*2462.00	109.8 PK			1.02 V	87	77.91	31.89
2	*2462.00	100.4 AV			1.02 V	87	68.51	31.89
3	2483.50	69.2 PK	74.0	-4.8	1.01 V	86	37.23	31.97
4	2483.50	51.6 AV	54.0	-2.4	1.01 V	86	19.63	31.97
5	4924.00	47.6 PK	74.0	-26.4	1.02 V	101	8.29	39.31
6	4924.00	34.1 AV	54.0	-19.9	1.02 V	101	-5.21	39.31
7	7386.00	52.9 PK	74.0	-21.1	1.08 V	128	6.30	46.60
8	7386.00	38.9 AV	54.0	-15.1	1.08 V	128	-7.70	46.60

- REMARKS:**
1. Emission level (dBuV/m) = Raw Value (dBuV) + Correction Factor (dB/m).
 2. Correction Factor (dB/m) = Antenna Factor (dB/m) + Cable Factor (dB).
 3. The other emission levels were very low against the limit.
 4. Margin value = Emission level – Limit value.
 5. “ * “: Fundamental frequency.

RESTRICTED BANDEDGE (802.11g MODE, CH1, HORIZONTAL)

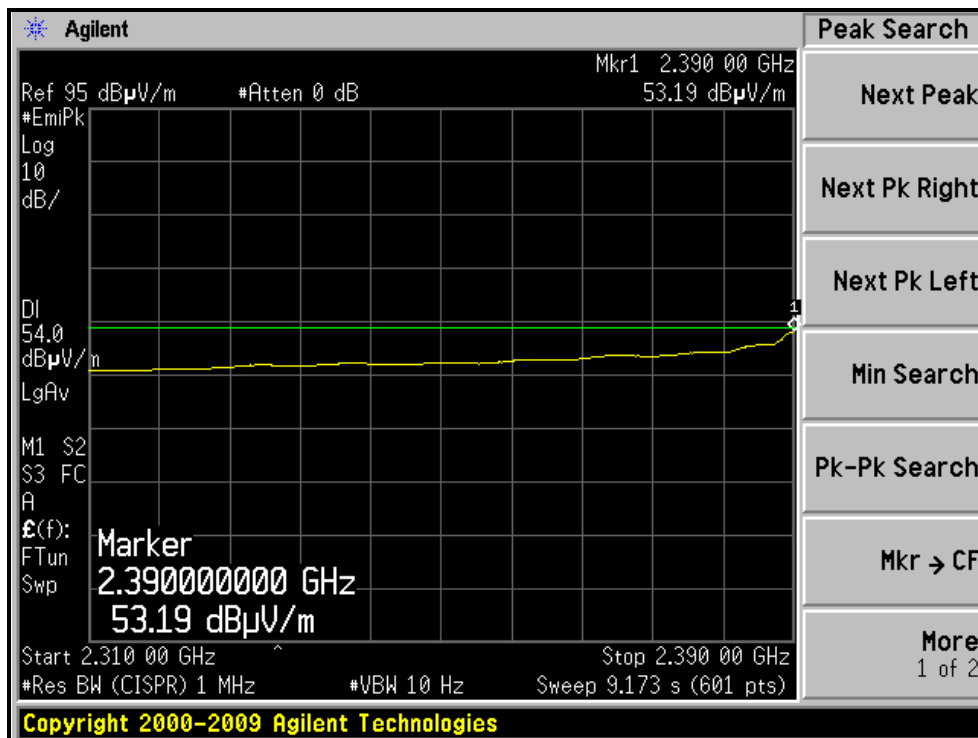
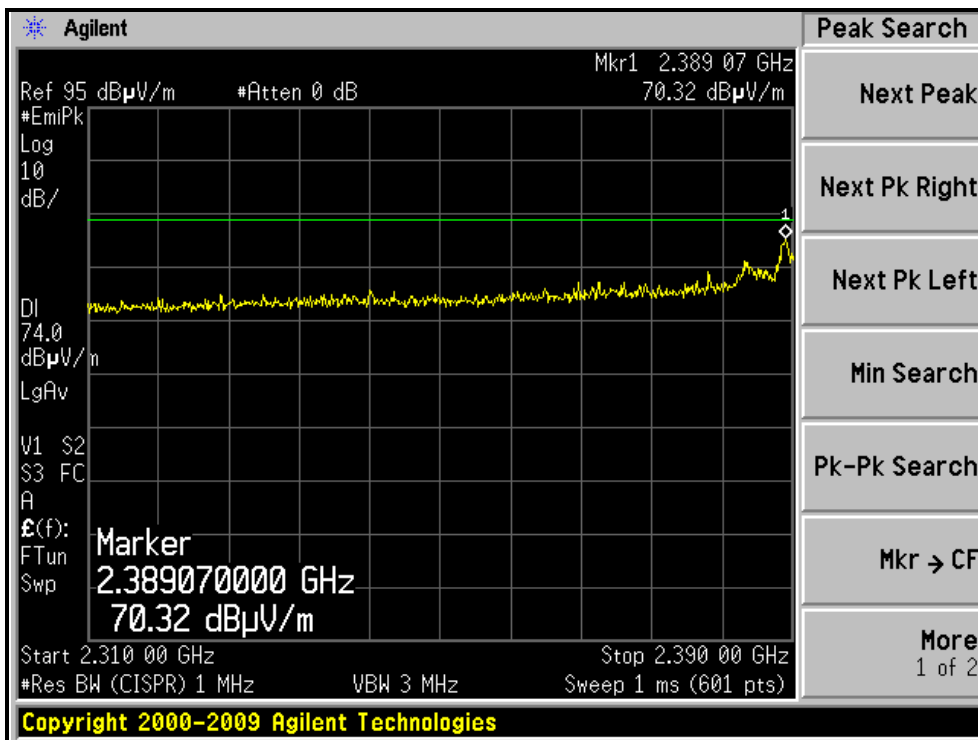

RESTRICTED BANDEDGE (802.11g MODE, CH1, VERTICAL)

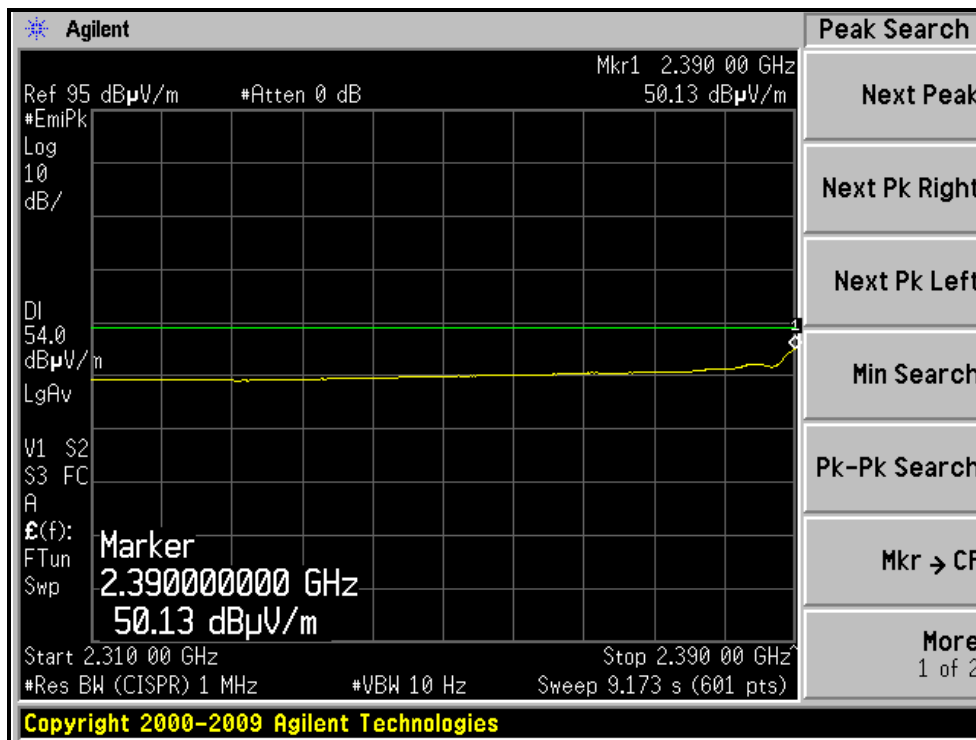
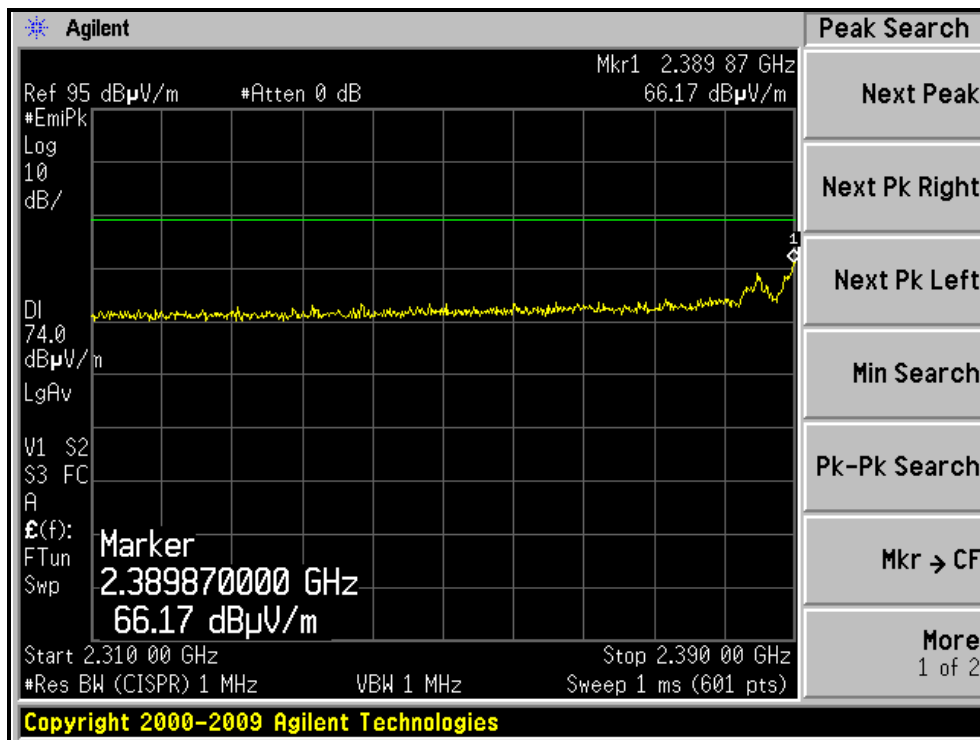

RESTRICTED BANDEDGE (802.11g MODE, CH11, HORIZONTAL)

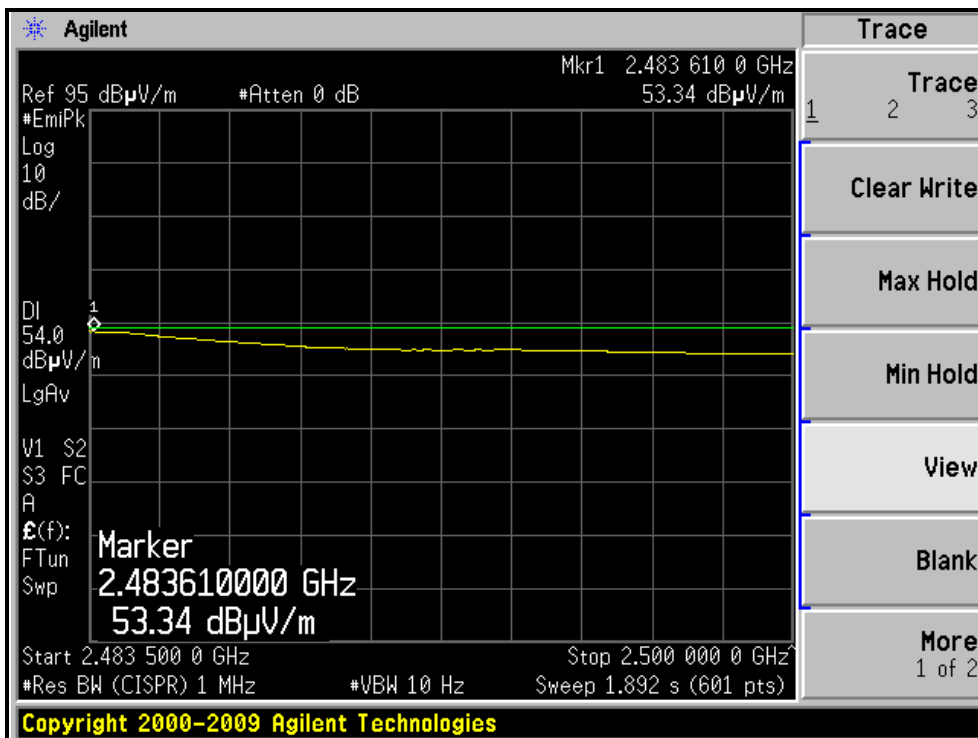
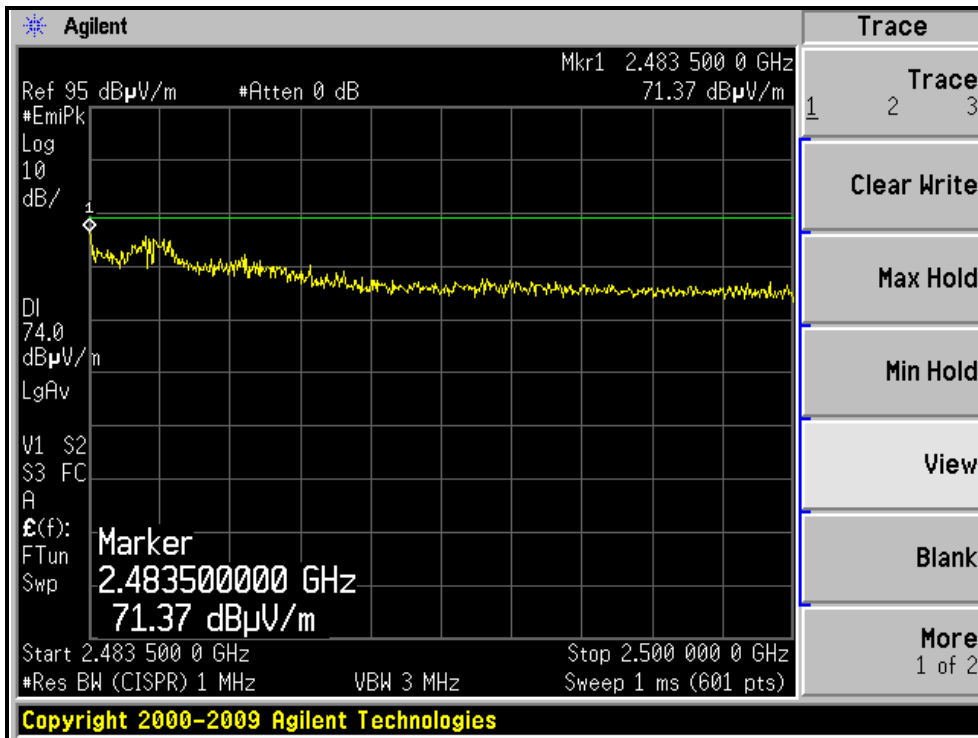



A D T

RESTRICTED BANDEDGE (802.11g MODE, CH11, VERTICAL)

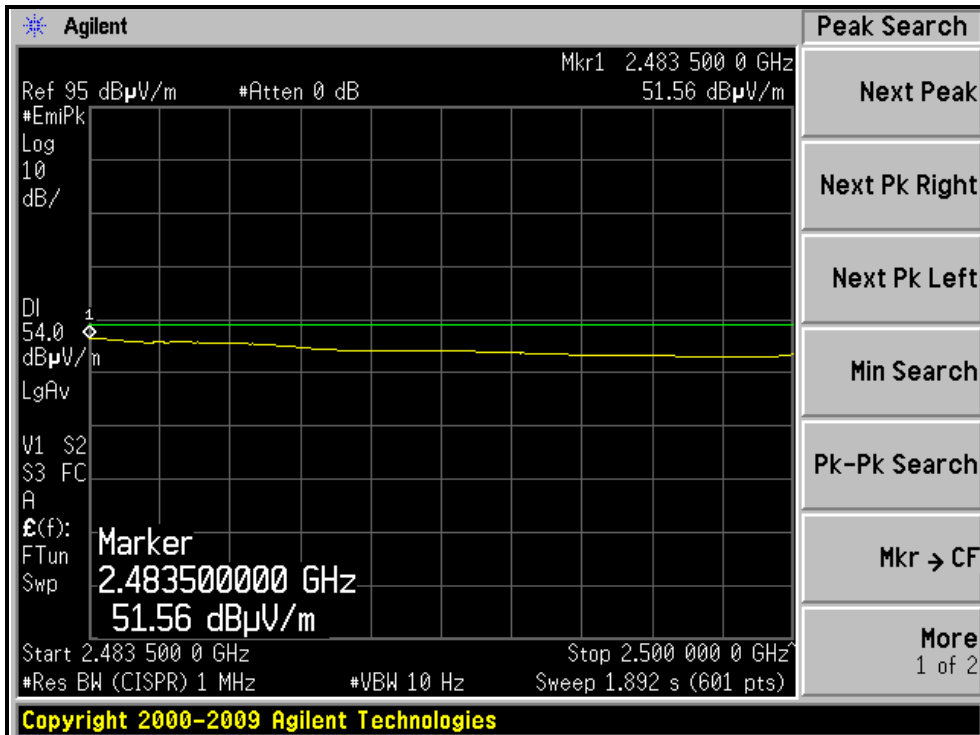
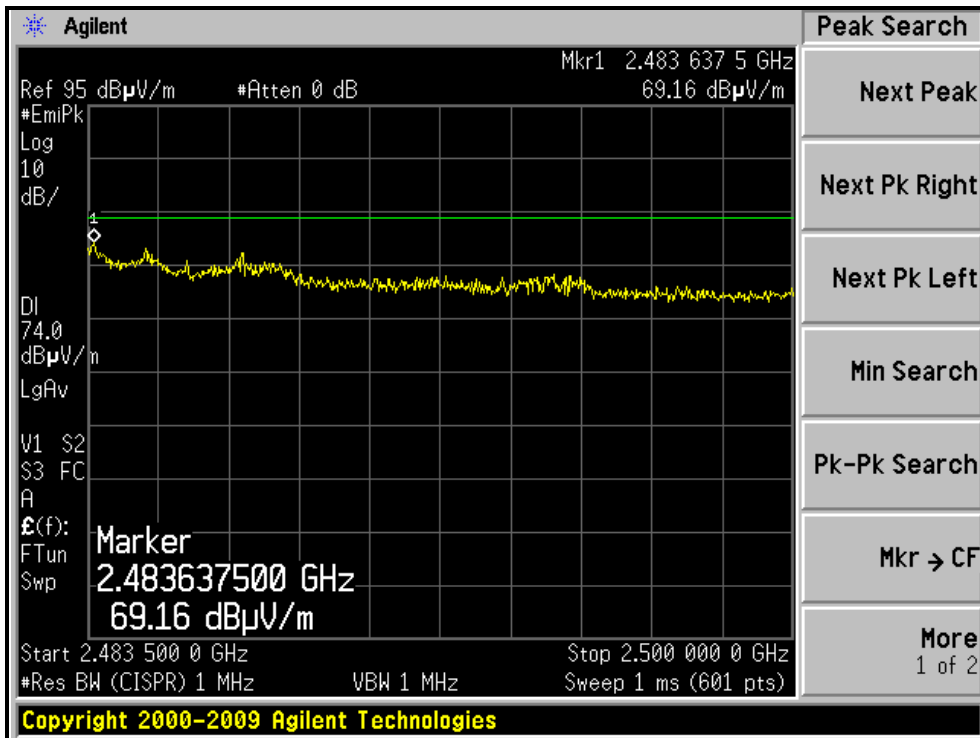



A D T

802.11n (20MHz) OFDM MODULATION

EUT TEST CONDITION		MEASUREMENT DETAIL	
CHANNEL	Channel 1	FREQUENCY RANGE	1 ~ 25GHz
INPUT POWER	120Vac / 60Hz	DETECTOR FUNCTION	Peak (PK) Average (AV)
ENVIRONMENTAL CONDITIONS	26deg. C, 68%RH	TESTED BY	Nelson Teng

ANTENNA POLARITY & TEST DISTANCE: HORIZONTAL AT 3 M								
NO.	FREQ. (MHz)	EMISSION LEVEL (dBuV/m)	LIMIT (dBuV/m)	MARGIN (dB)	ANTENNA HEIGHT (m)	TABLE ANGLE (Degree)	RAW VALUE (dBuV)	CORRECTION FACTOR (dB/m)
1	2390.00	68.3 PK	74.0	-5.7	1.00 H	106	36.64	31.66
2	2390.00	52.8 AV	54.0	-1.2	1.00 H	106	21.14	31.66
3	*2412.00	109.2 PK			1.00 H	105	77.47	31.73
4	*2412.00	99.9 AV			1.00 H	105	68.17	31.73
5	4824.00	49.4 PK	74.0	-24.6	1.31 H	121	10.43	38.97
6	4824.00	35.8 AV	54.0	-18.2	1.31 H	121	-3.17	38.97
ANTENNA POLARITY & TEST DISTANCE: VERTICAL AT 3 M								
NO.	FREQ. (MHz)	EMISSION LEVEL (dBuV/m)	LIMIT (dBuV/m)	MARGIN (dB)	ANTENNA HEIGHT (m)	TABLE ANGLE (Degree)	RAW VALUE (dBuV)	CORRECTION FACTOR (dB/m)
1	2390.00	66.8 PK	74.0	-7.2	1.00 V	145	35.14	31.66
2	2390.00	50.5 AV	54.0	-3.5	1.00 V	145	18.84	31.66
3	*2412.00	108.2 PK			1.05 V	87	76.47	31.73
4	*2412.00	98.1 AV			1.05 V	87	66.37	31.73
5	4824.00	49.5 PK	74.0	-24.5	1.28 V	121	10.53	38.97
6	4824.00	35.8 AV	54.0	-18.2	1.28 V	121	-3.17	38.97

- REMARKS:**
1. Emission level (dBuV/m) = Raw Value (dBuV) + Correction Factor (dB/m).
 2. Correction Factor (dB/m) = Antenna Factor (dB/m) + Cable Factor (dB).
 3. The other emission levels were very low against the limit.
 4. Margin value = Emission level – Limit value.
 5. “ * “: Fundamental frequency.



A D T

EUT TEST CONDITION		MEASUREMENT DETAIL	
CHANNEL	Channel 6	FREQUENCY RANGE	1 ~ 25GHz
INPUT POWER	120Vac / 60Hz	DETECTOR FUNCTION	Peak (PK) Average (AV)
ENVIRONMENTAL CONDITIONS	26deg. C, 68%RH	TESTED BY	Nelson Teng

ANTENNA POLARITY & TEST DISTANCE: HORIZONTAL AT 3 M								
NO.	FREQ. (MHz)	EMISSION LEVEL (dBuV/m)	LIMIT (dBuV/m)	MARGIN (dB)	ANTENNA HEIGHT (m)	TABLE ANGLE (Degree)	RAW VALUE (dBuV)	CORRECTION FACTOR (dB/m)
1	2390.00	69.7 PK	74.0	-4.3	1.00 H	103	38.04	31.66
2	2390.00	53.4 AV	54.0	-0.6	1.00 H	103	21.74	31.66
3	*2437.00	117.0 PK			1.00 H	107	85.19	31.81
4	*2437.00	107.9 AV			1.00 H	107	76.09	31.81
5	4874.00	49.6 PK	74.0	-24.4	1.07 H	59	10.46	39.14
6	4874.00	35.6 AV	54.0	-18.4	1.07 H	59	-3.54	39.14
7	7311.00	52.7 PK	74.0	-21.3	1.04 H	113	6.07	46.63
8	7311.00	39.2 AV	54.0	-14.8	1.04 H	113	-7.43	46.63
ANTENNA POLARITY & TEST DISTANCE: VERTICAL AT 3 M								
NO.	FREQ. (MHz)	EMISSION LEVEL (dBuV/m)	LIMIT (dBuV/m)	MARGIN (dB)	ANTENNA HEIGHT (m)	TABLE ANGLE (Degree)	RAW VALUE (dBuV)	CORRECTION FACTOR (dB/m)
1	*2437.00	116.3 PK			1.07 V	71	84.49	31.81
2	*2437.00	106.3 AV			1.07 V	71	74.49	31.81
3	4874.00	48.5 PK	74.0	-25.5	1.00 V	98	9.36	39.14
4	4874.00	35.3 AV	54.0	-18.7	1.00 V	98	-3.84	39.14
5	7311.00	51.9 PK	74.0	-22.1	1.05 V	147	5.27	46.63
6	7311.00	39.3 AV	54.0	-14.7	1.05 V	147	-7.33	46.63

- REMARKS:**
1. Emission level (dBuV/m) = Raw Value (dBuV) + Correction Factor (dB/m).
 2. Correction Factor (dB/m) = Antenna Factor (dB/m) + Cable Factor (dB).
 3. The other emission levels were very low against the limit.
 4. Margin value = Emission level – Limit value.
 5. “ * “: Fundamental frequency.



A D T

EUT TEST CONDITION		MEASUREMENT DETAIL	
CHANNEL	Channel 11	FREQUENCY RANGE	1 ~ 25GHz
INPUT POWER	120Vac / 60Hz	DETECTOR FUNCTION	Peak (PK) Average (AV)
ENVIRONMENTAL CONDITIONS	26deg. C, 68%RH	TESTED BY	Nelson Teng

ANTENNA POLARITY & TEST DISTANCE: HORIZONTAL AT 3 M

NO.	FREQ. (MHz)	EMISSION LEVEL (dBuV/m)	LIMIT (dBuV/m)	MARGIN (dB)	ANTENNA HEIGHT (m)	TABLE ANGLE (Degree)	RAW VALUE (dBuV)	CORRECTION FACTOR (dB/m)
1	*2462.00	112.1 PK			1.00 H	109	80.21	31.89
2	*2462.00	102.3 AV			1.00 H	109	70.41	31.89
3	2484.16	73.1 PK	74.0	-0.9	1.00 H	109	41.13	31.97
4	2484.16	53.0 AV	54.0	-1.0	1.00 H	109	21.03	31.97
5	4924.00	48.4 PK	74.0	-25.6	1.03 H	85	9.09	39.31
6	4924.00	34.5 AV	54.0	-19.5	1.03 H	85	-4.81	39.31
7	7386.00	52.9 PK	74.0	-21.1	1.24 H	114	6.30	46.60
8	7386.00	38.6 AV	54.0	-15.4	1.24 H	114	-8.00	46.60

ANTENNA POLARITY & TEST DISTANCE: VERTICAL AT 3 M

NO.	FREQ. (MHz)	EMISSION LEVEL (dBuV/m)	LIMIT (dBuV/m)	MARGIN (dB)	ANTENNA HEIGHT (m)	TABLE ANGLE (Degree)	RAW VALUE (dBuV)	CORRECTION FACTOR (dB/m)
1	*2462.00	110.6 PK			1.06 V	93	78.71	31.89
2	*2462.00	100.7 AV			1.06 V	93	68.81	31.89
3	2484.10	70.9 PK	74.0	-3.1	1.24 V	24	38.93	31.97
4	2484.10	52.1 AV	54.0	-1.9	1.24 V	24	20.13	31.97
5	4924.00	48.0 PK	74.0	-26.0	1.00 V	100	8.69	39.31
6	4924.00	34.5 AV	54.0	-19.5	1.00 V	100	-4.81	39.31
7	7386.00	52.6 PK	74.0	-21.4	1.03 V	128	6.00	46.60
8	7386.00	38.8 AV	54.0	-15.2	1.03 V	128	-7.80	46.60

- REMARKS:**
1. Emission level (dBuV/m) = Raw Value (dBuV) + Correction Factor (dB/m).
 2. Correction Factor (dB/m) = Antenna Factor (dB/m) + Cable Factor (dB).
 3. The other emission levels were very low against the limit.
 4. Margin value = Emission level – Limit value.
 5. “ * “: Fundamental frequency.



A D T

RESTRICTED BANDEDGE (802.11n (20MHz) MODE,CH1, HORIZONTAL)

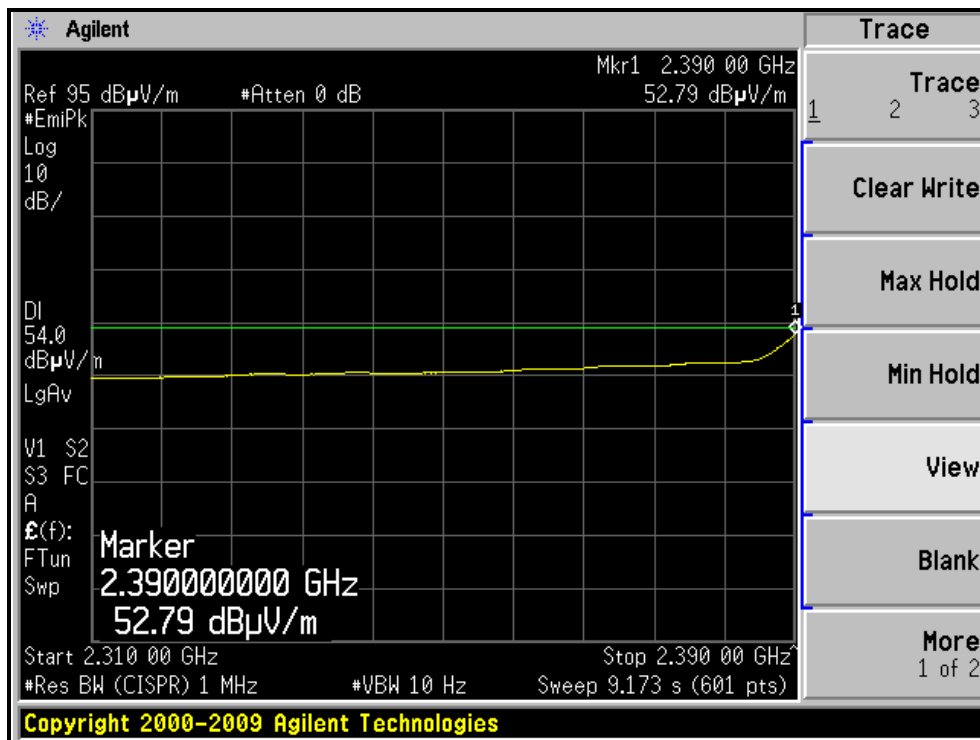
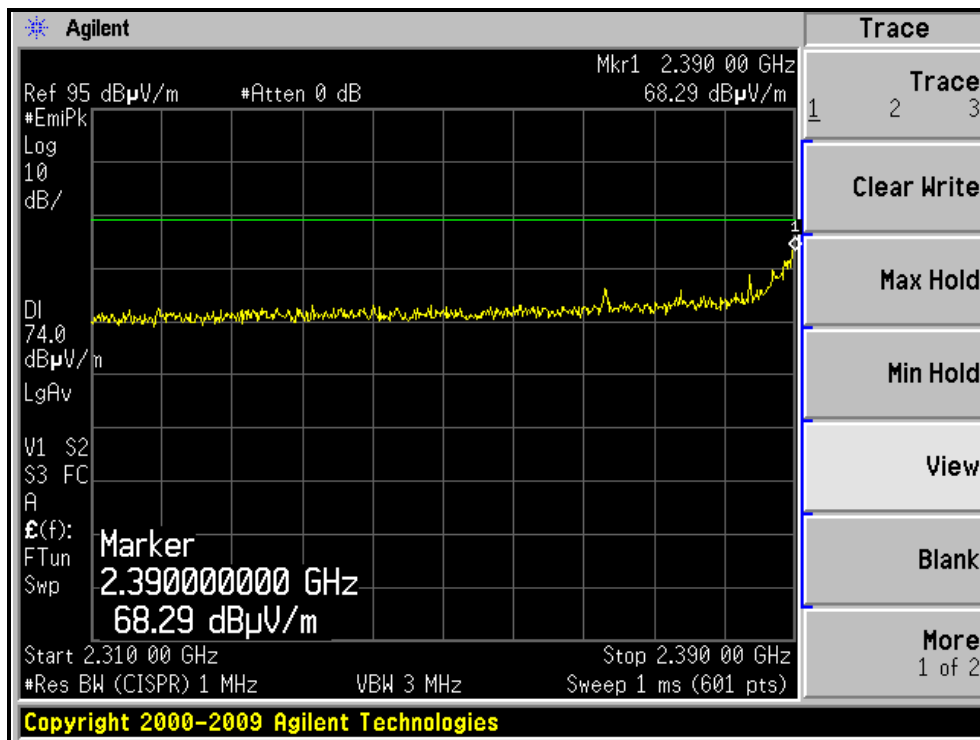



A D T

RESTRICTED BANDEDGE (802.11n (20MHz) MODE,CH1, VERTICAL)

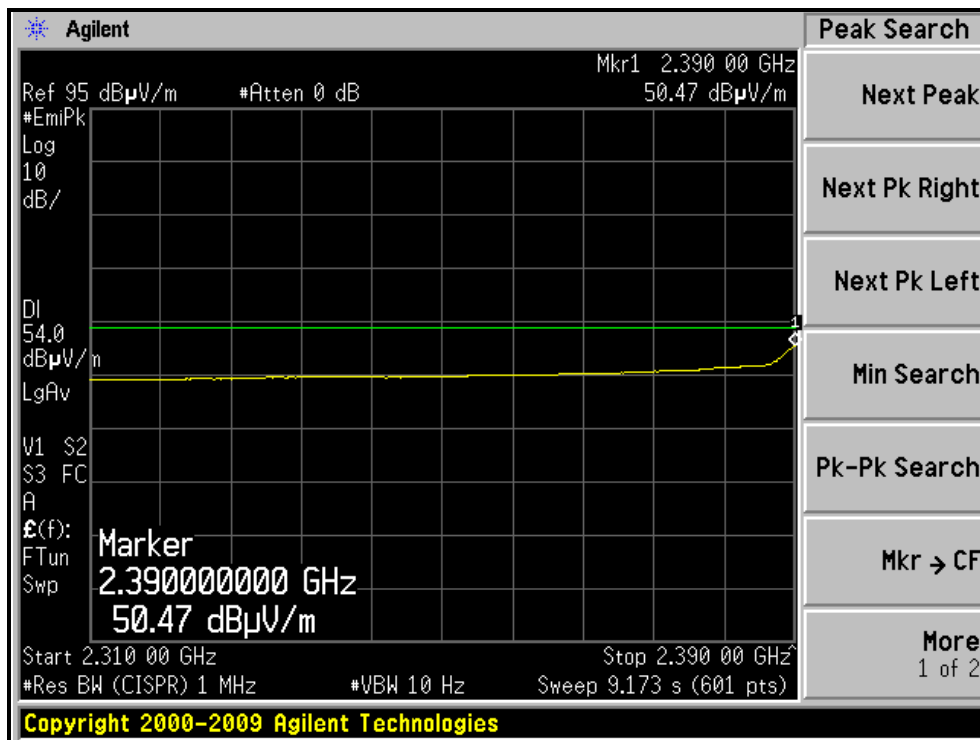
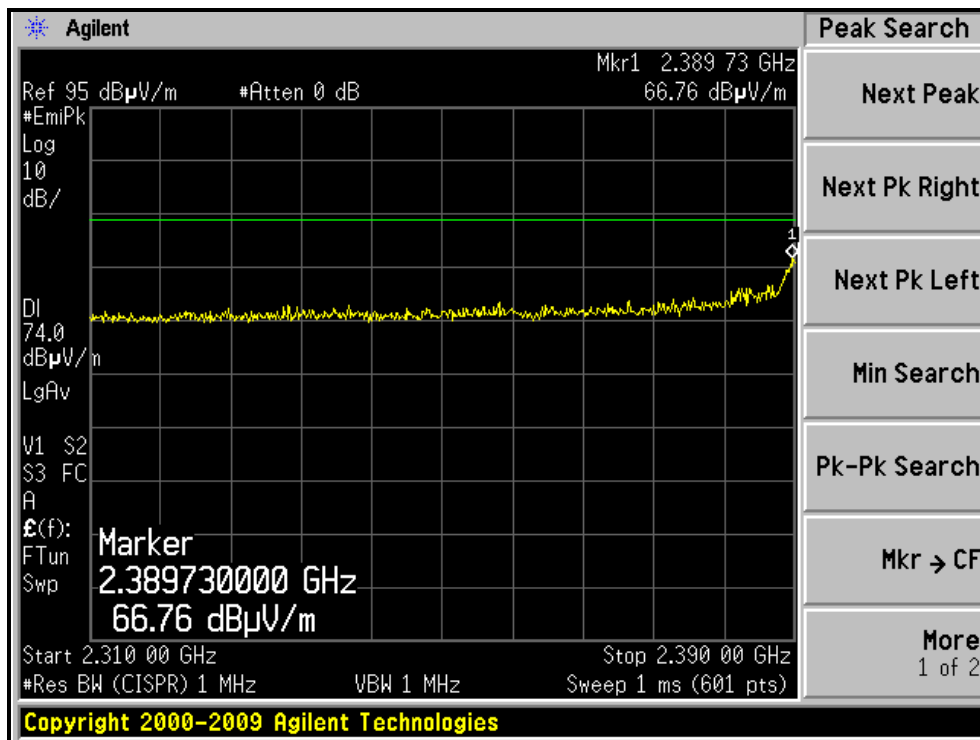



A D T

RESTRICTED BANDEDGE (802.11n (20MHz) MODE,CH11, HORIZONTAL)

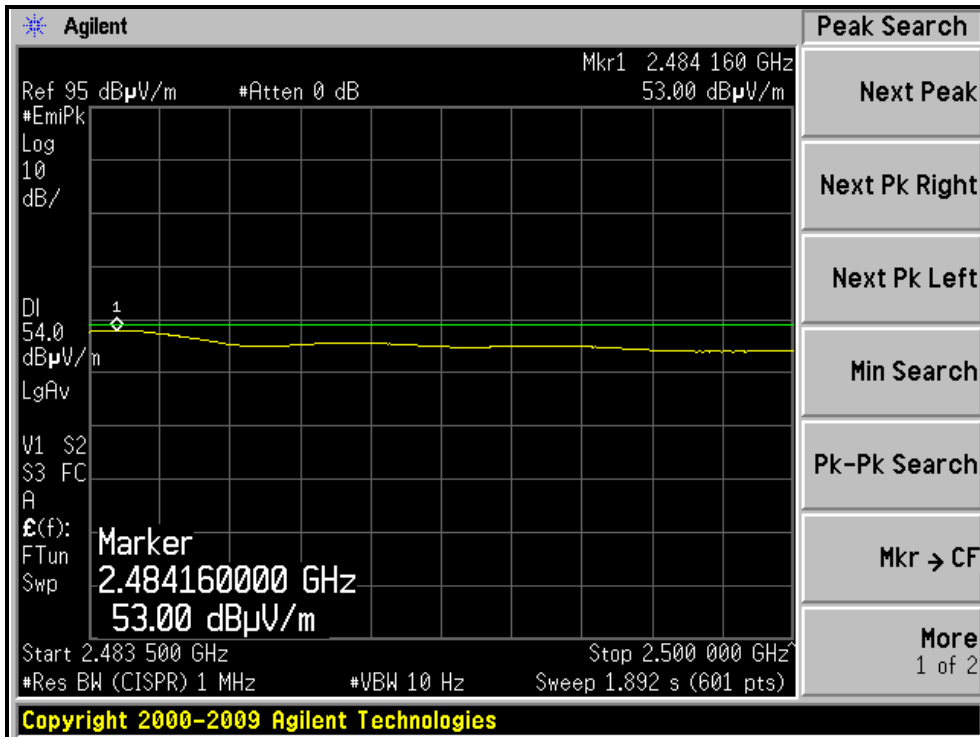
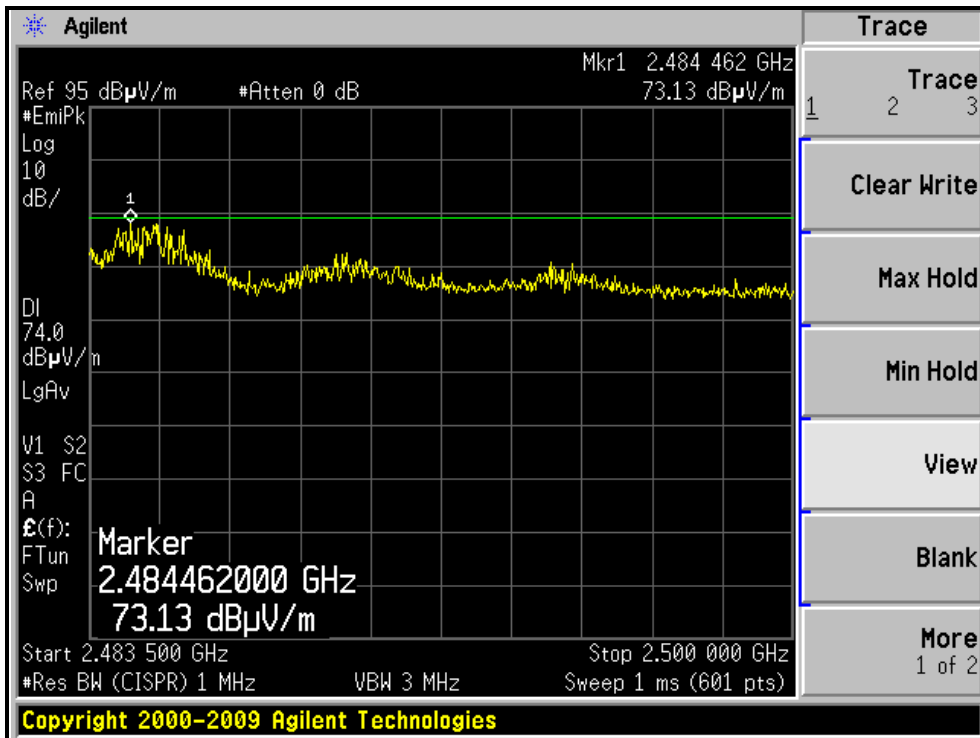



A D T

RESTRICTED BANDEDGE (802.11n (20MHz) MODE,CH11, VERTICAL)

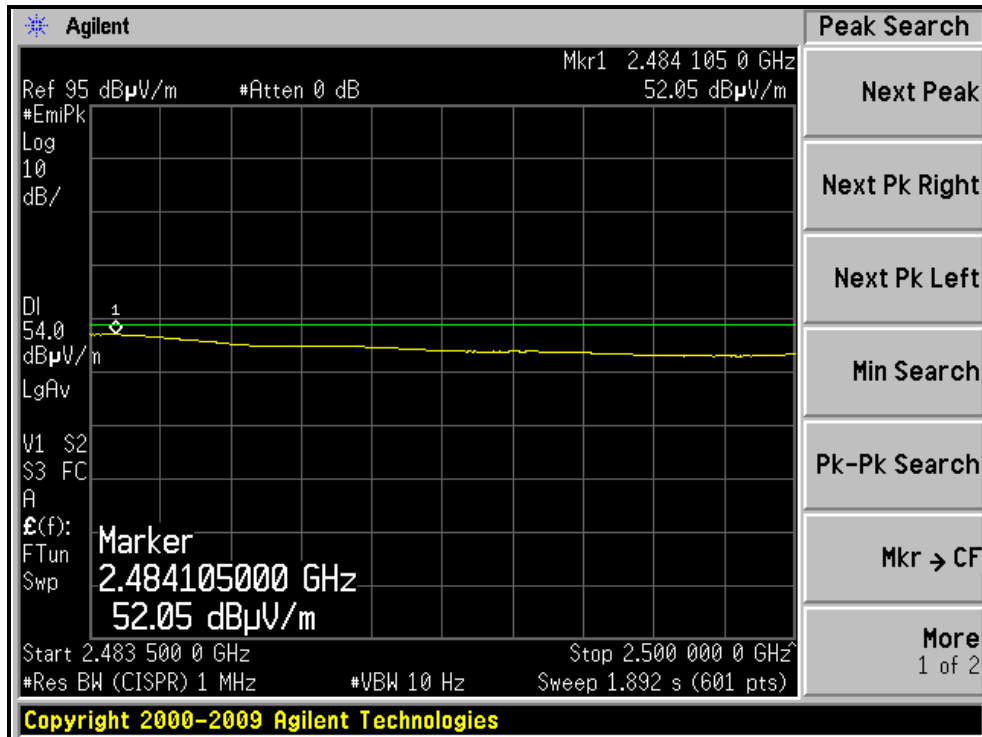
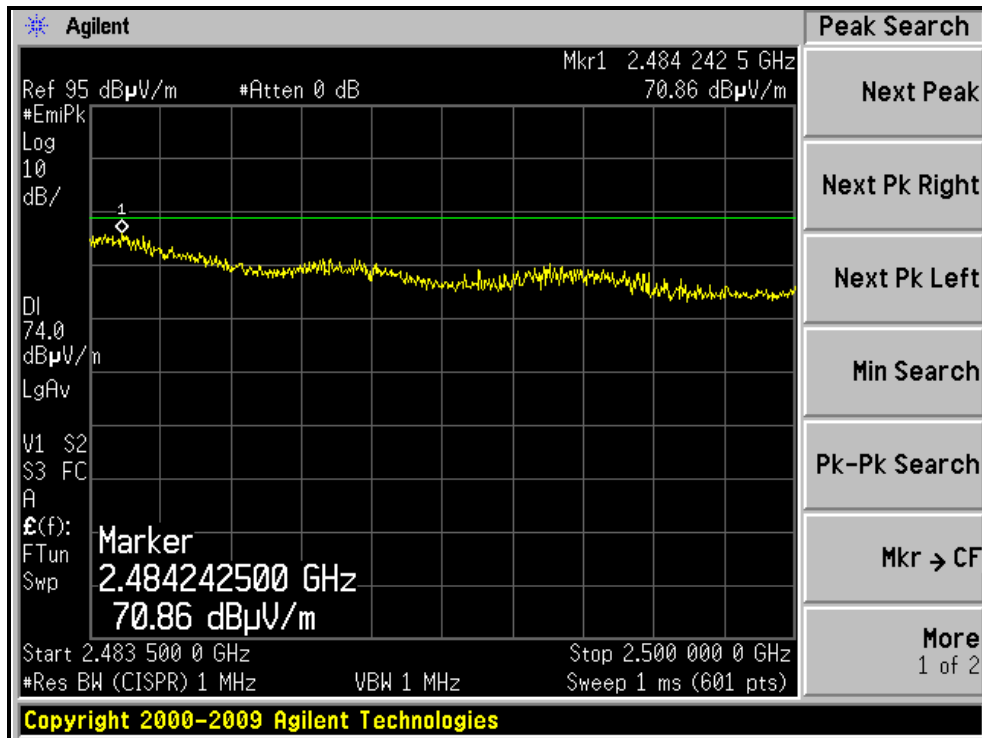



A D T

802.11n (40MHz) OFDM MODULATION

EUT TEST CONDITION		MEASUREMENT DETAIL	
CHANNEL	Channel 3	FREQUENCY RANGE	1 ~ 25GHz
INPUT POWER	120Vac / 60Hz	DETECTOR FUNCTION	Peak (PK) Average (AV)
ENVIRONMENTAL CONDITIONS	26deg. C, 68%RH	TESTED BY	Nelson Teng

ANTENNA POLARITY & TEST DISTANCE: HORIZONTAL AT 3 M								
NO.	FREQ. (MHz)	EMISSION LEVEL (dBuV/m)	LIMIT (dBuV/m)	MARGIN (dB)	ANTENNA HEIGHT (m)	TABLE ANGLE (Degree)	RAW VALUE (dBuV)	CORRECTION FACTOR (dB/m)
1	2390.00	66.8 PK	74.0	-7.2	1.00 H	103	35.14	31.66
2	2390.00	52.9 AV	54.0	-1.1	1.00 H	103	21.24	31.66
3	*2422.00	104.5 PK			1.00 H	105	72.74	31.76
4	*2422.00	95.5 AV			1.00 H	105	63.78	31.76
5	4844.00	48.2 PK	74.0	-25.8	1.31 H	134	9.16	39.04
6	4844.00	34.5 AV	54.0	-19.5	1.31 H	134	-4.54	39.04
7	7266.00	51.7 PK	74.0	-22.3	1.00 H	124	5.03	46.67
8	7266.00	38.1 AV	54.0	-15.9	1.00 H	124	-8.57	46.67
ANTENNA POLARITY & TEST DISTANCE: VERTICAL AT 3 M								
NO.	FREQ. (MHz)	EMISSION LEVEL (dBuV/m)	LIMIT (dBuV/m)	MARGIN (dB)	ANTENNA HEIGHT (m)	TABLE ANGLE (Degree)	RAW VALUE (dBuV)	CORRECTION FACTOR (dB/m)
1	2390.00	62.2 PK	74.0	-11.8	1.04 V	13	30.54	31.66
2	2390.00	50.6 AV	54.0	-3.4	1.04 V	13	18.94	31.66
3	*2422.00	103.2 PK			1.03 V	81	71.44	31.76
4	*2422.00	93.1 AV			1.03 V	81	61.34	31.76
5	4844.00	47.1 PK	74.0	-26.9	1.27 V	124	8.06	39.04
6	4844.00	34.5 AV	54.0	-19.5	1.27 V	124	-4.54	39.04
7	7266.00	51.1 PK	74.0	-22.9	1.03 V	148	4.43	46.67
8	7266.00	38.1 AV	54.0	-15.9	1.03 V	148	-8.57	46.67

- REMARKS:**
1. Emission level (dBuV/m) = Raw Value (dBuV) + Correction Factor (dB/m).
 2. Correction Factor (dB/m) = Antenna Factor (dB/m) + Cable Factor (dB).
 3. The other emission levels were very low against the limit.
 4. Margin value = Emission level – Limit value.
 5. “ * “: Fundamental frequency.



A D T

EUT TEST CONDITION		MEASUREMENT DETAIL	
CHANNEL	Channel 6	FREQUENCY RANGE	1 ~ 25GHz
INPUT POWER	120Vac / 60Hz	DETECTOR FUNCTION	Peak (PK) Average (AV)
ENVIRONMENTAL CONDITIONS	26deg. C, 68%RH	TESTED BY	Nelson Teng

ANTENNA POLARITY & TEST DISTANCE: HORIZONTAL AT 3 M								
NO.	FREQ. (MHz)	EMISSION LEVEL (dBuV/m)	LIMIT (dBuV/m)	MARGIN (dB)	ANTENNA HEIGHT (m)	TABLE ANGLE (Degree)	RAW VALUE (dBuV)	CORRECTION FACTOR (dB/m)
1	2390.00	66.5 PK	74.0	-7.5	1.00 H	104	34.84	31.66
2	2390.00	53.4 AV	54.0	-0.6	1.00 H	104	21.74	31.66
3	*2437.00	108.5 PK			1.00 H	105	76.69	31.81
4	*2437.00	99.8 AV			1.00 H	105	67.99	31.81
5	4874.00	50.1 PK	74.0	-23.9	1.03 H	67	10.96	39.14
6	4874.00	35.8 AV	54.0	-18.2	1.03 H	67	-3.34	39.14
7	7311.00	52.7 PK	74.0	-21.3	1.03 H	104	6.07	46.63
8	7311.00	39.2 AV	54.0	-14.8	1.03 H	104	-7.43	46.63
ANTENNA POLARITY & TEST DISTANCE: VERTICAL AT 3 M								
NO.	FREQ. (MHz)	EMISSION LEVEL (dBuV/m)	LIMIT (dBuV/m)	MARGIN (dB)	ANTENNA HEIGHT (m)	TABLE ANGLE (Degree)	RAW VALUE (dBuV)	CORRECTION FACTOR (dB/m)
1	*2437.00	107.7 PK			1.00 V	71	75.89	31.81
2	*2437.00	97.5 AV			1.00 V	71	65.69	31.81
3	4874.00	48.3 PK	74.0	-25.7	1.00 V	95	9.16	39.14
4	4874.00	35.2 AV	54.0	-18.8	1.00 V	95	-3.94	39.14
5	7311.00	52.3 PK	74.0	-21.7	1.03 V	133	5.67	46.63
6	7311.00	39.6 AV	54.0	-14.4	1.03 V	133	-7.03	46.63

- REMARKS:**
1. Emission level (dBuV/m) = Raw Value (dBuV) + Correction Factor (dB/m).
 2. Correction Factor (dB/m) = Antenna Factor (dB/m) + Cable Factor (dB).
 3. The other emission levels were very low against the limit.
 4. Margin value = Emission level – Limit value.
 5. “ * “: Fundamental frequency.



A D T

EUT TEST CONDITION		MEASUREMENT DETAIL	
CHANNEL	Channel 9	FREQUENCY RANGE	1 ~ 25GHz
INPUT POWER	120Vac / 60Hz	DETECTOR FUNCTION	Peak (PK) Average (AV)
ENVIRONMENTAL CONDITIONS	26deg. C, 68%RH	TESTED BY	Nelson Teng

ANTENNA POLARITY & TEST DISTANCE: HORIZONTAL AT 3 M

NO.	FREQ. (MHz)	EMISSION LEVEL (dBuV/m)	LIMIT (dBuV/m)	MARGIN (dB)	ANTENNA HEIGHT (m)	TABLE ANGLE (Degree)	RAW VALUE (dBuV)	CORRECTION FACTOR (dB/m)
1	*2452.00	108.9 PK			1.00 H	110	77.04	31.86
2	*2452.00	99.8 AV			1.00 H	110	67.94	31.86
3	2484.13	69.2 PK	74.0	-4.8	1.00 H	110	37.23	31.97
4	2484.13	53.1 AV	54.0	-0.9	1.00 H	110	21.13	31.97
5	4904.00	48.9 PK	74.0	-25.1	1.05 H	83	9.66	39.24
6	4904.00	34.9 AV	54.0	-19.1	1.05 H	83	-4.34	39.24
7	7356.00	52.6 PK	74.0	-21.4	1.25 H	122	5.99	46.61
8	7356.00	38.3 AV	54.0	-15.7	1.25 H	122	-8.31	46.61

ANTENNA POLARITY & TEST DISTANCE: VERTICAL AT 3 M

NO.	FREQ. (MHz)	EMISSION LEVEL (dBuV/m)	LIMIT (dBuV/m)	MARGIN (dB)	ANTENNA HEIGHT (m)	TABLE ANGLE (Degree)	RAW VALUE (dBuV)	CORRECTION FACTOR (dB/m)
1	*2452.00	107.2 PK			1.30 V	70	75.34	31.86
2	*2452.00	97.2 AV			1.30 V	70	65.34	31.86
3	2484.29	69.6 PK	74.0	-4.4	1.25 V	24	37.63	31.97
4	2484.29	51.5 AV	54.0	-2.5	1.25 V	24	19.53	31.97
5	4904.00	48.0 PK	74.0	-26.0	1.00 V	87	8.76	39.24
6	4904.00	34.6 AV	54.0	-19.4	1.00 V	87	-4.64	39.24
7	7356.00	52.1 PK	74.0	-21.9	1.02 V	120	5.49	46.61
8	7356.00	38.3 AV	54.0	-15.7	1.02 V	120	-8.31	46.61

- REMARKS:**
1. Emission level (dBuV/m) = Raw Value (dBuV) + Correction Factor (dB/m).
 2. Correction Factor (dB/m) = Antenna Factor (dB/m) + Cable Factor (dB).
 3. The other emission levels were very low against the limit.
 4. Margin value = Emission level – Limit value.
 5. “ * “: Fundamental frequency.



A D T

RESTRICTED BANDEDGE (802.11n (40MHz) MODE,CH3, HORIZONTAL)

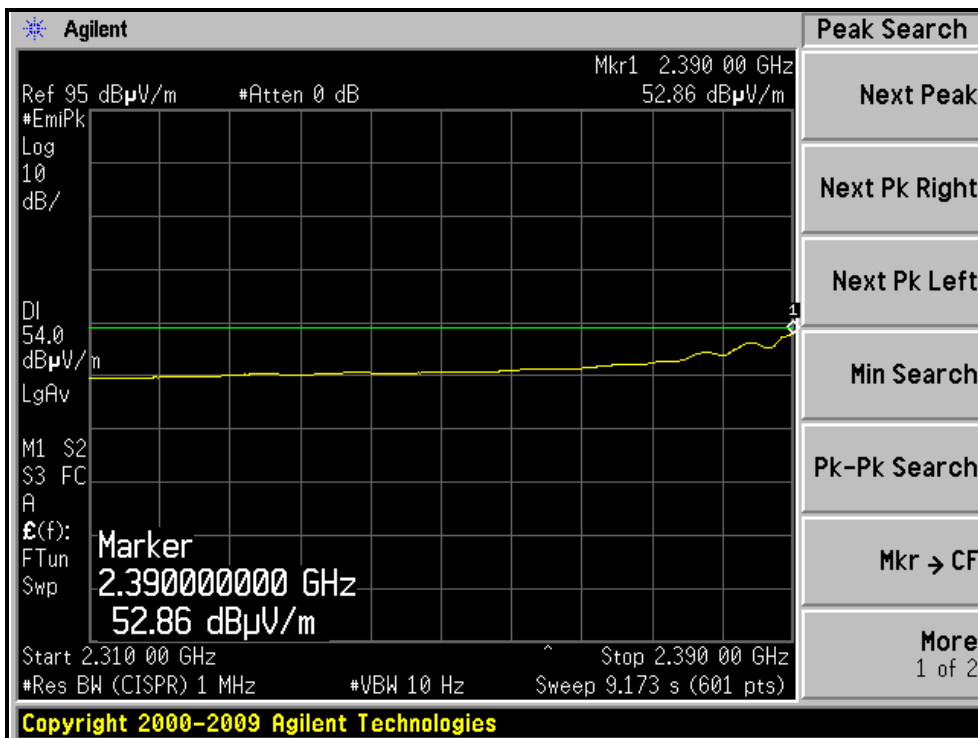
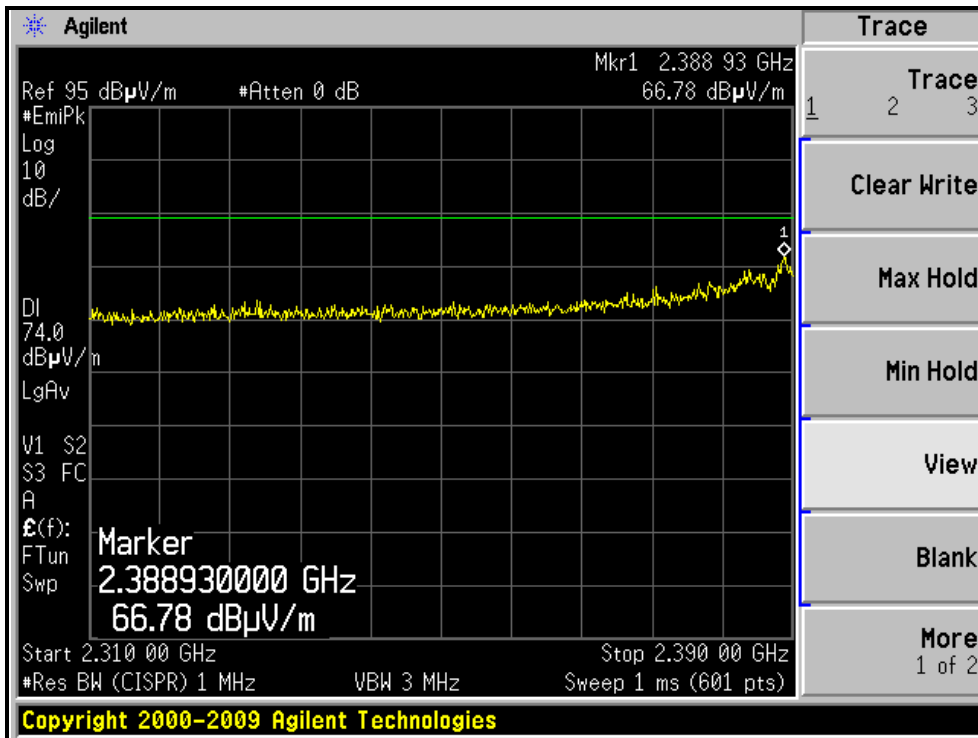



A D T

RESTRICTED BANDEDGE (802.11n (40MHz) MODE,CH3, VERTICAL)

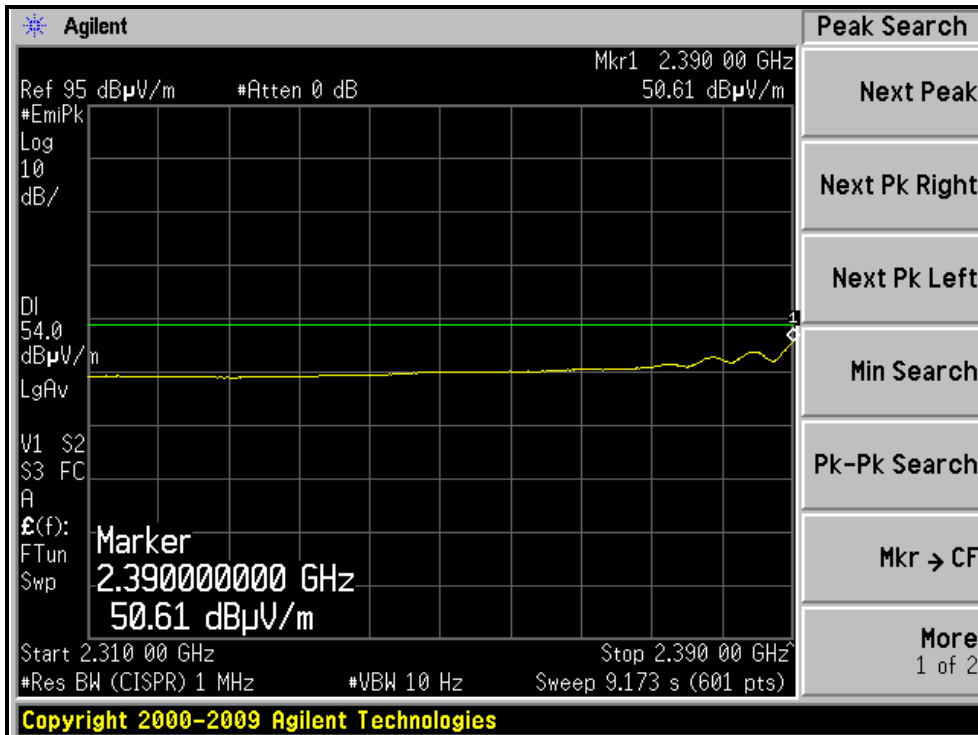
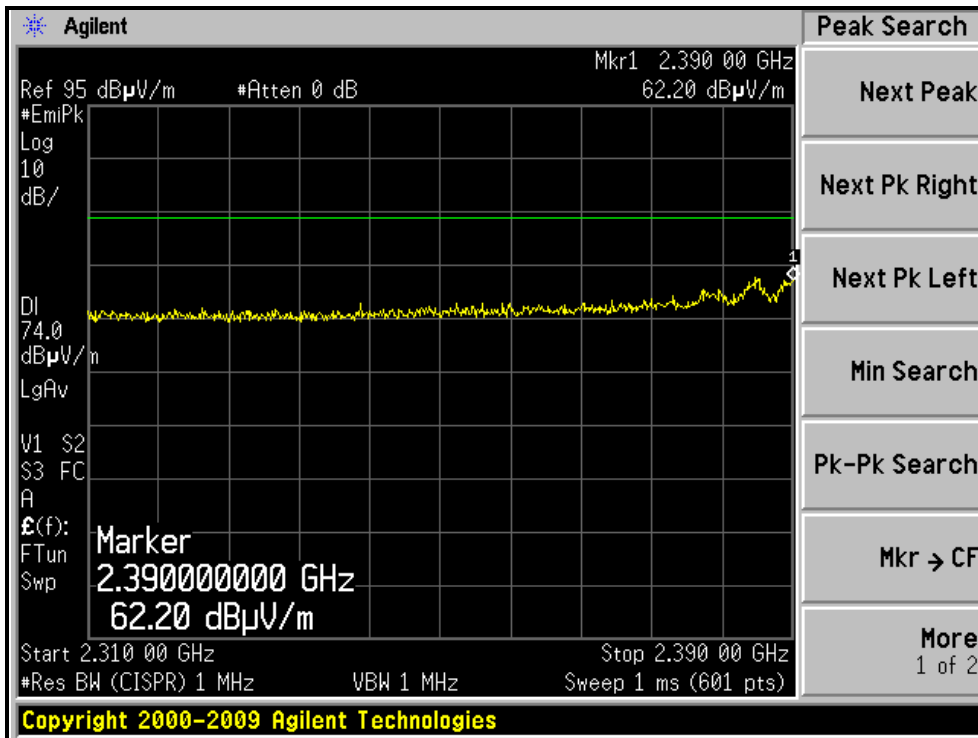

RESTRICTED BANDEDGE (802.11n (40MHz) MODE,CH9, HORIZONTAL)

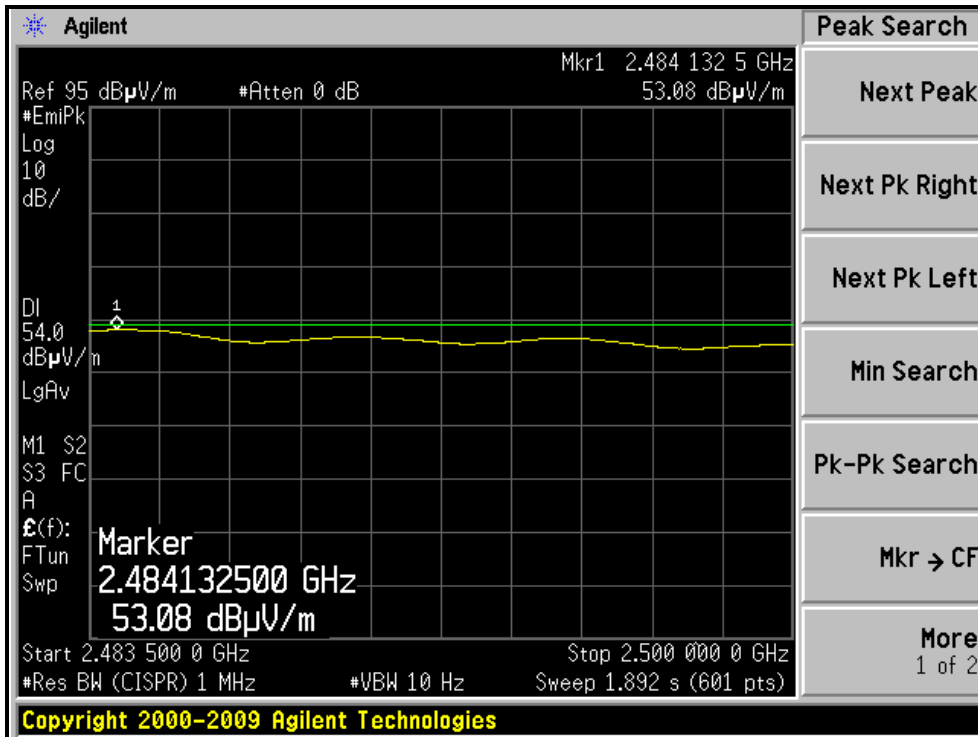
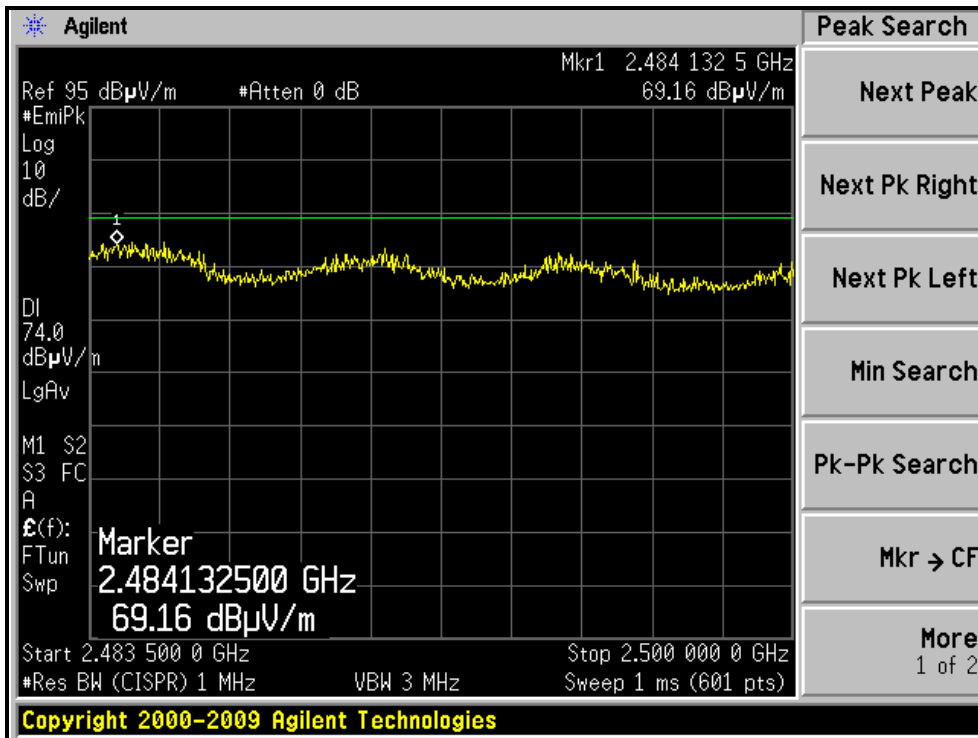

RESTRICTED BANDEDGE (802.11n (40MHz) MODE,CH9, VERTICAL)

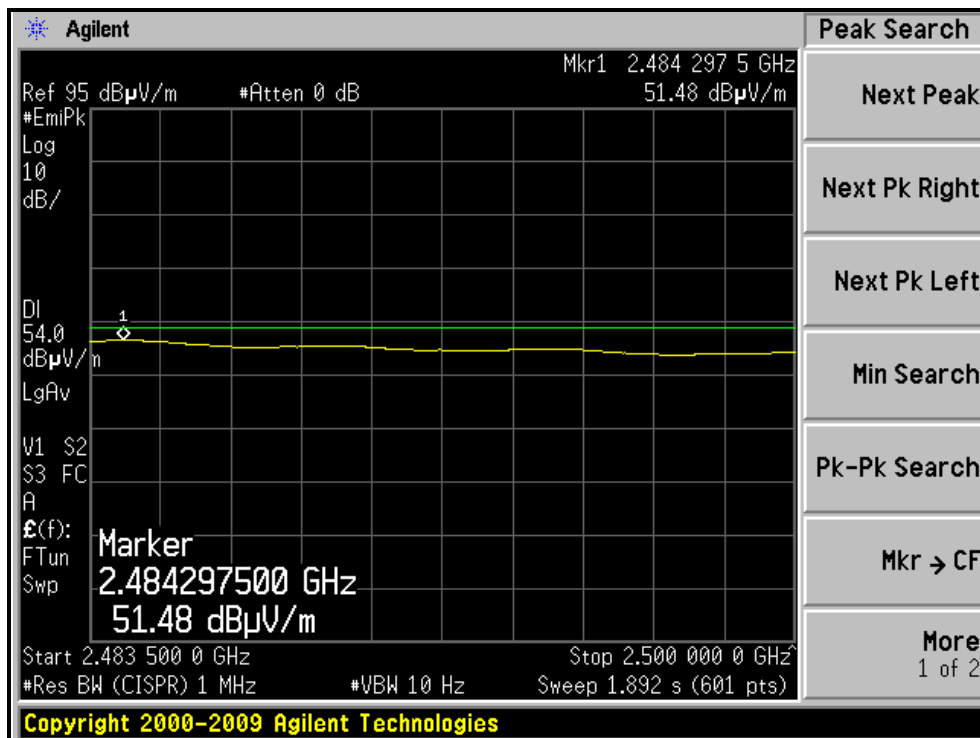
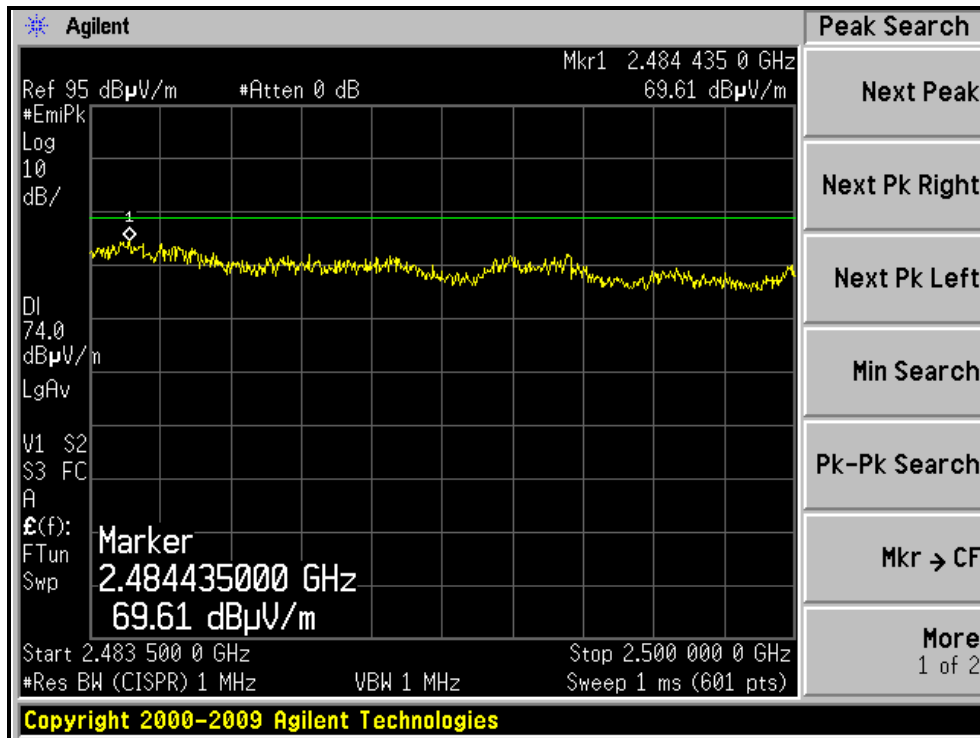

4.3 6dB BANDWIDTH MEASUREMENT

4.3.1 LIMITS OF 6dB BANDWIDTH MEASUREMENT

The minimum of 6dB Bandwidth Measurement is 0.5 MHz.

4.3.2 TEST INSTRUMENTS

Test date: Dec. 16, 2011

DESCRIPTION & MANUFACTURER	MODEL NO.	SERIAL NO.	CALIBRATED DATE	CALIBRATED UNTIL
R&S Spectrum Analyzer	FSP 40	100060	May 11, 2011	May 10, 2012

NOTE: The calibration interval of the above test instruments is 12 months and the calibrations are traceable to NML/ROC and NIST/USA.

4.3.3 TEST PROCEDURE

The transmitter output was connected to the spectrum analyzer through an attenuator. The bandwidth of the fundamental frequency was measured by spectrum analyzer with 100kHz RBW and 300kHz VBW. The 6dB bandwidth is defined as the total spectrum the power of which is higher than peak power minus 6dB.

4.3.4 DEVIATION FROM TEST STANDARD

No deviation

4.3.5 TEST SETUP



4.3.6 EUT OPERATING CONDITIONS

The software provided by client to enable the EUT under transmission condition continuously at lowest, middle and highest channel frequencies individually.



A D T

4.3.7 TEST RESULTS

802.11b DSSS MODULATION:

CHANNEL	CHANNEL FREQUENCY (MHz)	6dB BANDWIDTH (MHz)		MINIMUM LIMIT (MHz)	PASS / FAIL
		CHAIN(0)	CHAIN(2)		
1	2412	9.69	9.33	0.5	PASS
6	2437	10.43	10.47	0.5	PASS
11	2462	10.40	9.97	0.5	PASS

CHAIN(2)

CH6

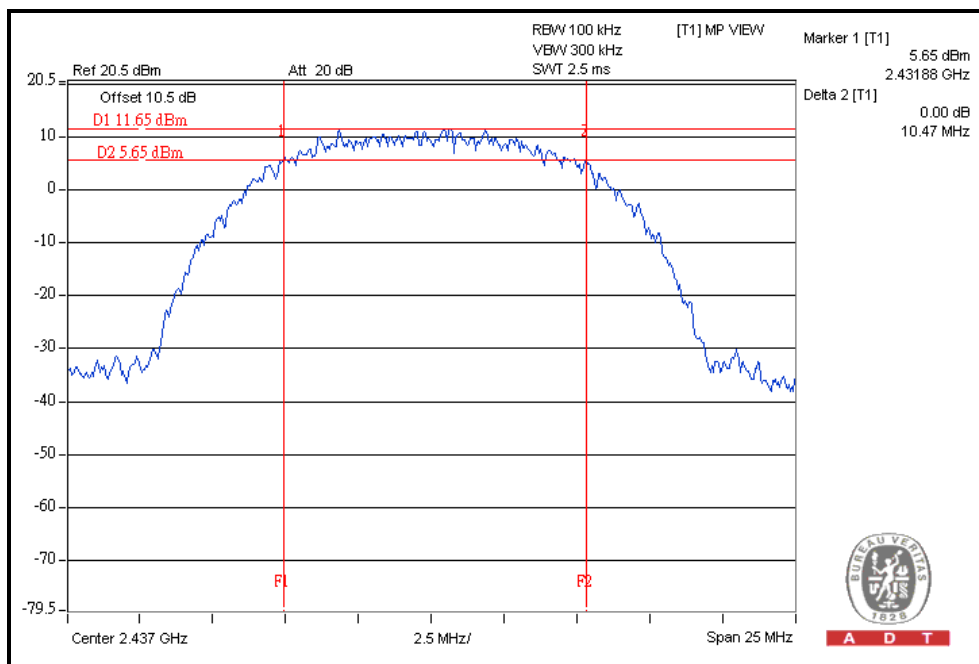



A D T

802.11g OFDM MODULATION:

CHANNEL	CHANNEL FREQUENCY (MHz)	6dB BANDWIDTH (MHz)		MINIMUM LIMIT (MHz)	PASS / FAIL
		CHAIN(0)	CHAIN(2)		
1	2412	16.62	16.59	0.5	PASS
6	2437	16.57	16.57	0.5	PASS
11	2462	16.56	16.57	0.5	PASS

CHAIN(0)

CH1

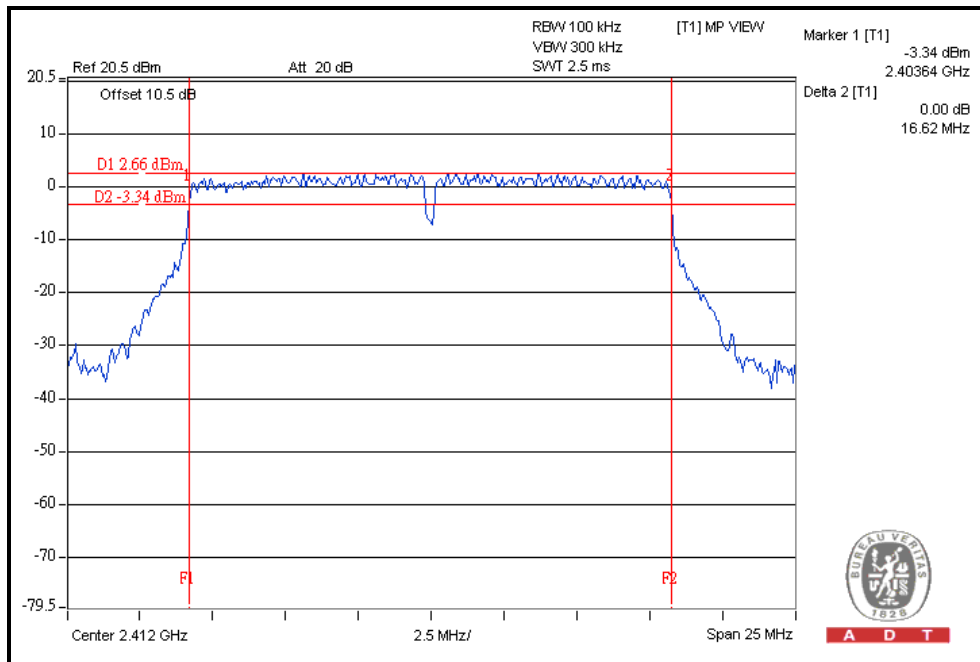

802.11n (20MHz) OFDM modulation:

CHANNEL	CHANNEL FREQUENCY (MHz)	6dB BANDWIDTH (MHz)		MINIMUM LIMIT (MHz)	PASS / FAIL
		CHAIN(0)	CHAIN(2)		
1	2412	17.82	17.80	0.5	PASS
6	2437	17.85	17.82	0.5	PASS
11	2462	17.86	17.84	0.5	PASS

For CHAIN(0)

CH11

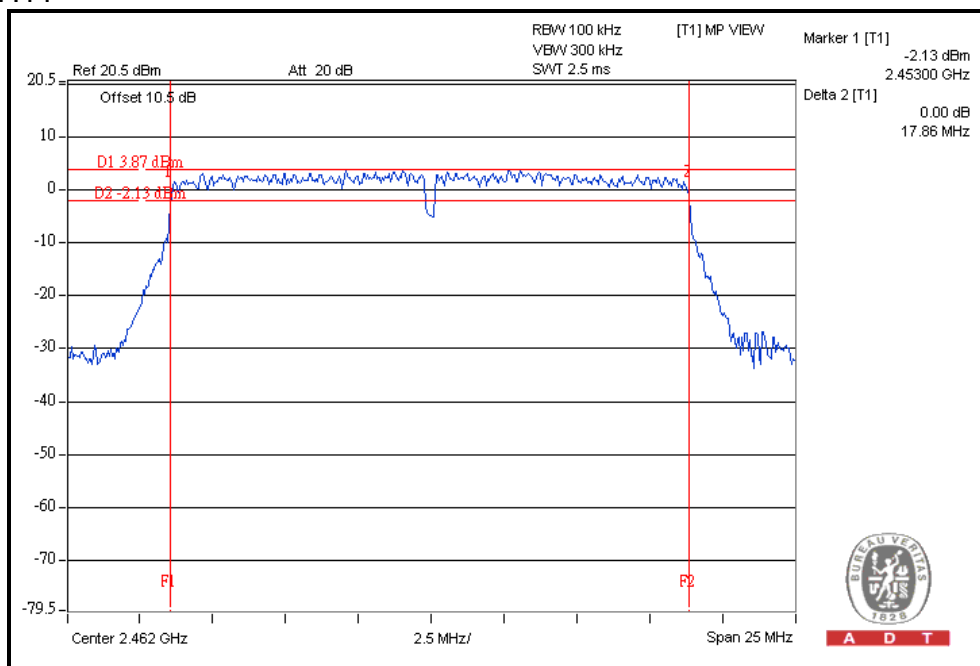

802.11n (40MHz) OFDM MODULATION:

CHANNEL	CHANNEL FREQUENCY (MHz)	6dB BANDWIDTH (MHz)		MINIMUM LIMIT (MHz)	PASS / FAIL
		CHAIN(0)	CHAIN(2)		
3	2422	36.48	36.54	0.5	PASS
6	2437	36.49	36.56	0.5	PASS
9	2452	36.55	36.56	0.5	PASS

For CHAIN(2)

CH6

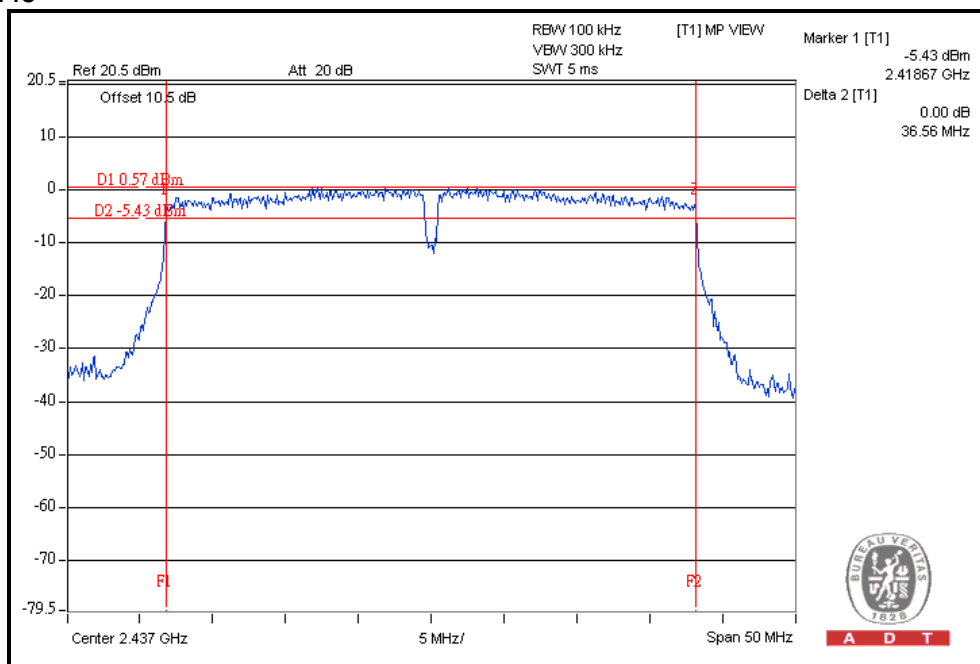

4.4 MAXIMUM PEAK OUTPUT POWER

4.4.1 LIMITS OF MAXIMUM PEAK OUTPUT POWER MEASUREMENT

The Maximum Peak Output Power Measurement is 30dBm.

4.4.2 INSTRUMENTS

Test date: Dec. 16, 2011

DESCRIPTION & MANUFACTURER	MODEL NO.	SERIAL NO.	CALIBRATED DATE	CALIBRATED UNTIL
Agilent SIGNAL GENERATOR	E8257C	MY43320668	Dec. 27, 2010	Dec. 26, 2011
TEKTRONIX OSCILLOSCOPE	TDS 5104	BO51450	May. 17, 2011	May. 16, 2012
NARDA DETECTOR	4503A	FSCM99899	NA	NA

NOTE: The calibration interval of the above test instruments is 12 months and the calibrations are traceable to NML/ROC and NIST/USA.

4.4.3 TEST PROCEDURES

1. A detector was used on the output port of the EUT. An oscilloscope was used to read the response of the detector.
2. Replaced the EUT by the signal generator. The center frequency of the S.G was adjusted to the center frequency of the measured channel.
3. Adjusted the power to have the same reading on oscilloscope. Record the power level.

4.4.4 DEVIATION FROM TEST STANDARD

No deviation

4.4.5 TEST SETUP

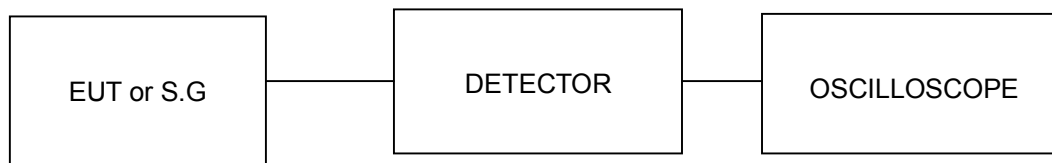

4.4.6 EUT OPERATING CONDITIONS

Same as Item 4.3.6



A D T

4.4.7 TEST RESULTS

802.11b DSSS MODULATION:

CHANNEL	CHANNEL FREQUENCY (MHz)	PEAK POWER OUTPUT (dBm)		TOTAL PEAK POWER (mW)	TOTAL PEAK POWER (dBm)	PEAK POWER LIMIT (dBm)	PASS / FAIL
		CHAIN(0)	CHAIN(2)				
1	2412	23.0	22.2	365.5	25.6	29.78	PASS
6	2437	23.0	22.2	365.5	25.6	29.78	PASS
11	2462	21.6	21.1	273.4	24.4	29.78	PASS

$$\text{Directional gain} = 10 \log[(10^{G1/20} + 10^{G2/20})^2 / 2]$$

Effective Legacy Gain (dBi) = 6.22

The effective legacy gain is 6.22dBi, therefore the limit needs to reduce.

802.11g OFDM MODULATION:

CHANNEL	CHANNEL FREQUENCY (MHz)	PEAK POWER OUTPUT (dBm)		TOTAL PEAK POWER (mW)	TOTAL PEAK POWER (dBm)	PEAK POWER LIMIT (dBm)	PASS / FAIL
		CHAIN(0)	CHAIN(2)				
1	2412	19.2	19.5	172.3	22.4	29.78	PASS
6	2437	23.7	23.5	458.3	26.6	29.78	PASS
11	2462	20.4	19.9	207.4	23.2	29.78	PASS

$$\text{Directional gain} = 10 \log[(10^{G1/20} + 10^{G2/20})^2 / 2]$$

Effective Legacy Gain (dBi) = 6.22

The effective legacy gain is 6.22dBi, therefore the limit needs to reduce.



A D T

802.11n (20MHz) OFDM MODULATION:

CHANNEL	CHANNEL FREQUENCY (MHz)	PEAK POWER OUTPUT (dBm)		TOTAL PEAK POWER (mW)	TOTAL PEAK POWER (dBm)	PEAK POWER LIMIT (dBm)	PASS / FAIL
		CHAIN(0)	CHAIN(2)				
1	2412	18.8	18.6	148.3	21.7	30	PASS
6	2437	23.8	23.8	479.8	26.8	30	PASS
11	2462	20.6	20.1	217.1	23.4	30	PASS

802.11n (40MHz) OFDM MODULATION:

CHANNEL	CHANNEL FREQUENCY (MHz)	PEAK POWER OUTPUT (dBm)		TOTAL PEAK POWER (mW)	TOTAL PEAK POWER (dBm)	PEAK POWER LIMIT (dBm)	PASS / FAIL
		CHAIN(0)	CHAIN(2)				
3	2422	16.5	16.2	86.4	19.4	30	PASS
6	2437	20.6	20.3	222.0	23.5	30	PASS
9	2452	20.2	20.2	209.4	23.2	30	PASS

4.5 POWER SPECTRAL DENSITY MEASUREMENT

4.5.1 LIMITS OF POWER SPECTRAL DENSITY MEASUREMENT

The Maximum of Power Spectral Density Measurement is 8dBm.

4.5.2 TEST INSTRUMENTS

Test date: Dec. 16, 2011

DESCRIPTION & MANUFACTURER	MODEL NO.	SERIAL NO.	CALIBRATED DATE	CALIBRATED UNTIL
R&S Spectrum Analyzer	FSP 40	100060	May 11, 2011	May 10, 2012

NOTE: The calibration interval of the above test instruments is 12 months and the calibrations are traceable to NML/ROC and NIST/USA.

4.5.3 TEST PROCEDURE

The transmitter output was connected to the spectrum analyzer through an attenuator, the bandwidth of the fundamental frequency was measured with the spectrum analyzer using 3kHz RBW and 30kHz VBW, set sweep time = span/3kHz. The power spectral density was measured and recorded. The sweep time is allowed to be longer than span/3kHz for a full response of the mixer in the spectrum analyzer.

4.5.4 DEVIATION FROM TEST STANDARD

No deviation

4.5.5 TEST SETUP

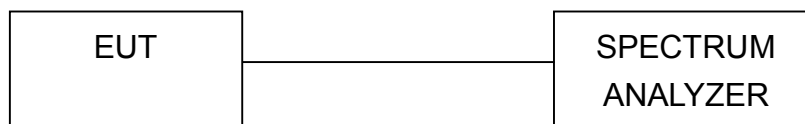

4.5.6 EUT OPERATING CONDITION

Same as Item 4.3.6



A D T

4.5.7 TEST RESULTS

802.11b DSSS MODULATION:

chain	CHAN.	CHAN. FREQ. (MHz)	RF POWER LEVEL IN 3kHz BW (dBm)		TOTAL POWER DENSITY (dBm)	MAX. LIMIT (dBm)	PASS / FAIL
			Measured	10 log (N=2) dB			
0	1	2412	-3.0	3.0	0.0	7.78	PASS
	6	2437	-0.5	3.0	2.5	7.78	PASS
	11	2462	-2.3	3.0	0.7	7.78	PASS
2	1	2412	-1.3	3.0	1.7	7.78	PASS
	6	2437	-1.7	3.0	1.3	7.78	PASS
	11	2462	-2.5	3.0	0.6	7.78	PASS

Directional gain = $10 \log[(10^{G1/20} + 10^{G2/20})^2 / 2]$

Effective Legacy Gain (dBi) = 6.22

The effective legacy gain is 6.22dBi, therefore the limit needs to reduce.

CHAIN(0)

CH6

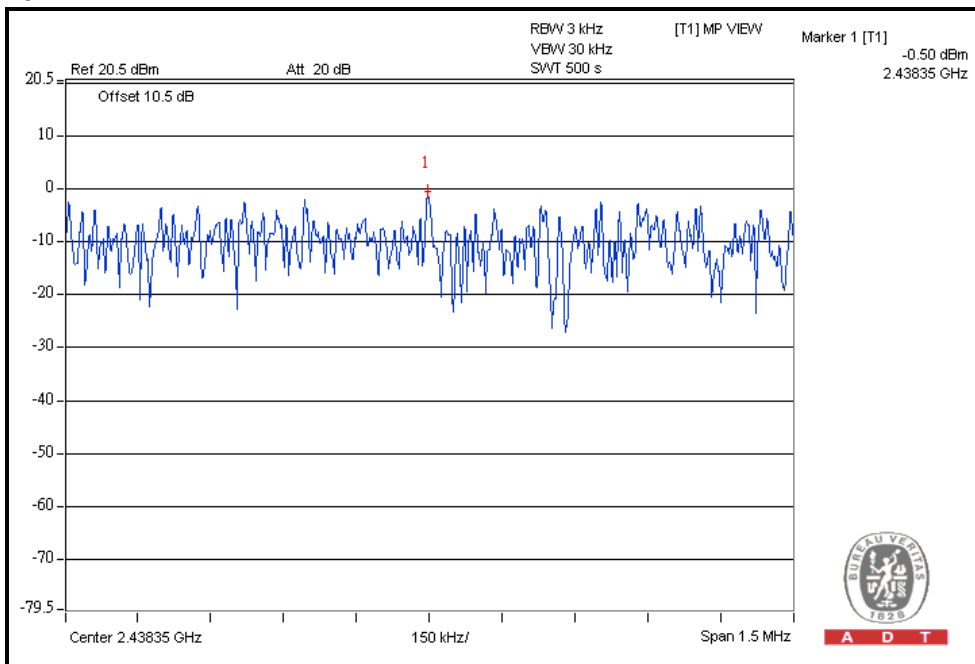

A D T

802.11g OFDM MODULATION:

chain	CHAN.	CHAN. FREQ. (MHz)	RF POWER LEVEL IN 3kHz BW (dBm)		TOTAL POWER DENSITY (dBm)	MAX. LIMIT (dBm)	PASS / FAIL
			Measured	10 log (N=2) dB			
0	1	2412	-11.3	3.0	-8.3	7.78	PASS
	6	2437	-6.9	3.0	-3.9	7.78	PASS
	11	2462	-10.5	3.0	-7.5	7.78	PASS
2	1	2412	-12.4	3.0	-9.4	7.78	PASS
	6	2437	-7.5	3.0	-4.5	7.78	PASS
	11	2462	-11.4	3.0	-8.4	7.78	PASS

Directional gain = $10 \log[(10^{G1/20} + 10^{G2/20})^2 / 2]$

Effective Legacy Gain (dBi) = 6.22

The effective legacy gain is 6.22dBi, therefore the limit needs to reduce.

CHAIN(0)

CH6

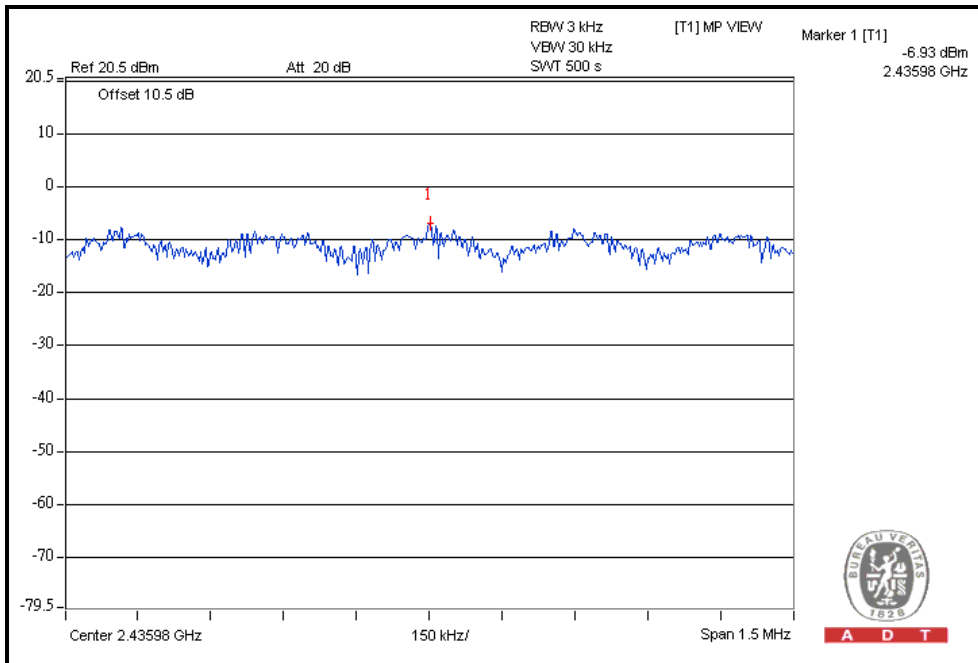



A D T

802.11n (20MHz) OFDM MODULATION:

chain	CHAN.	CHAN. FREQ. (MHz)	RF POWER LEVEL IN 3kHz BW (dBm)		TOTAL POWER DENSITY (dBm)	MAX. LIMIT (dBm)	PASS / FAIL
			Measured	10 log (N=2) dB			
0	1	2412	-10.0	3.0	-7.0	8	PASS
	6	2437	-4.1	3.0	-1.1	8	PASS
	11	2462	-7.8	3.0	-4.8	8	PASS
2	1	2412	-9.9	3.0	-6.9	8	PASS
	6	2437	-4.5	3.0	-1.5	8	PASS
	11	2462	-7.2	3.0	-4.2	8	PASS

For CHAIN(0)

CH6

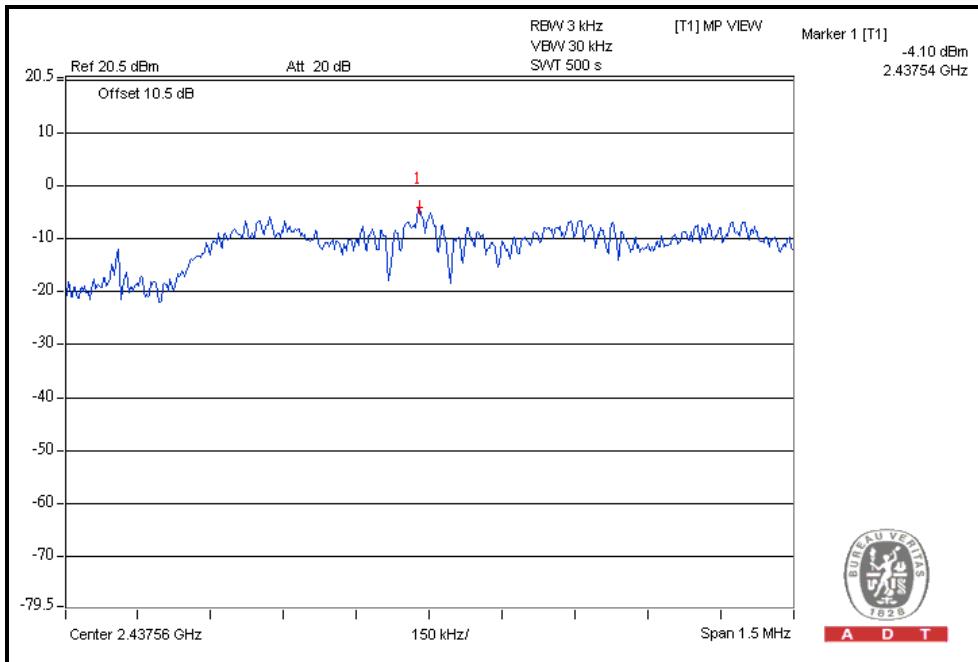



A D T

802.11n (40MHz) OFDM MODULATION:

chain	CHAN.	CHAN. FREQ. (MHz)	RF POWER LEVEL IN 3kHz BW (dBm)		TOTAL POWER DENSITY (dBm)	MAX. LIMIT (dBm)	PASS / FAIL
			Measured	10 log (N=2) dB			
0	3	2422	-14.9	3.0	-11.9	8	PASS
	6	2437	-11.1	3.0	-8.1	8	PASS
	9	2452	-13.6	3.0	-10.6	8	PASS
2	3	2422	-15.3	3.0	-12.3	8	PASS
	6	2437	-10.2	3.0	-7.2	8	PASS
	9	2452	-11.2	3.0	-8.2	8	PASS

For CHAIN(2)

CH6

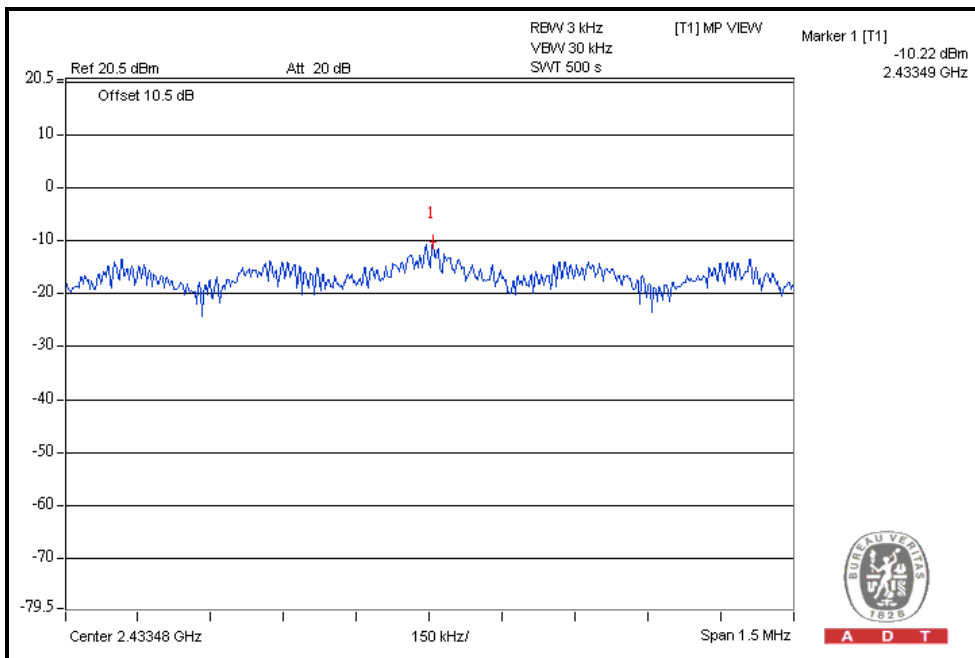

4.6 CONDUCTED OUT-BAND EMISSION MEASUREMENT

4.6.1 LIMITS OF CONDUCTED OUT-BAND EMISSION MEASUREMENT

Below -20dB of the highest emission level of operating band (in 100kHz Resolution Bandwidth).

4.6.2 TEST INSTRUMENTS

Test date: Dec. 16, 2011

DESCRIPTION & MANUFACTURER	MODEL NO.	SERIAL NO.	CALIBRATED DATE	CALIBRATED UNTIL
R&S Spectrum Analyzer	FSP 40	100060	May 11, 2011	May 10, 2012

NOTE: The calibration interval of the above test instruments is 12 months and the calibrations are traceable to NML/ROC and NIST/USA.

4.6.3 TEST PROCEDURE

The transmitter output was connected to the spectrum analyzer via a low loss cable. Set RBW of spectrum analyzer to 100kHz and VBW of spectrum analyzer to 300kHz with suitable frequency span including 100MHz or 200MHz bandwidth from band edge. The band edges was measured and recorded.

The spectrum plots (RBW = 100kHz, VBW = 300kHz) are attached on the following pages.

4.6.4 DEVIATION FROM TEST STANDARD

No deviation

4.6.5 EUT OPERATING CONDITION

Same as Item 4.3.6

4.6.6 TEST RESULTS

The spectrum plots are attached on the following images. D1 line indicates the highest level, and D2 line indicates the 20dB offset below D1. It shows compliance with the requirement in part 15.247(d).



A D T

Performing measurements: Measure and add 10 log(N) dB 802.11b DSSS MODULATION:

CH1

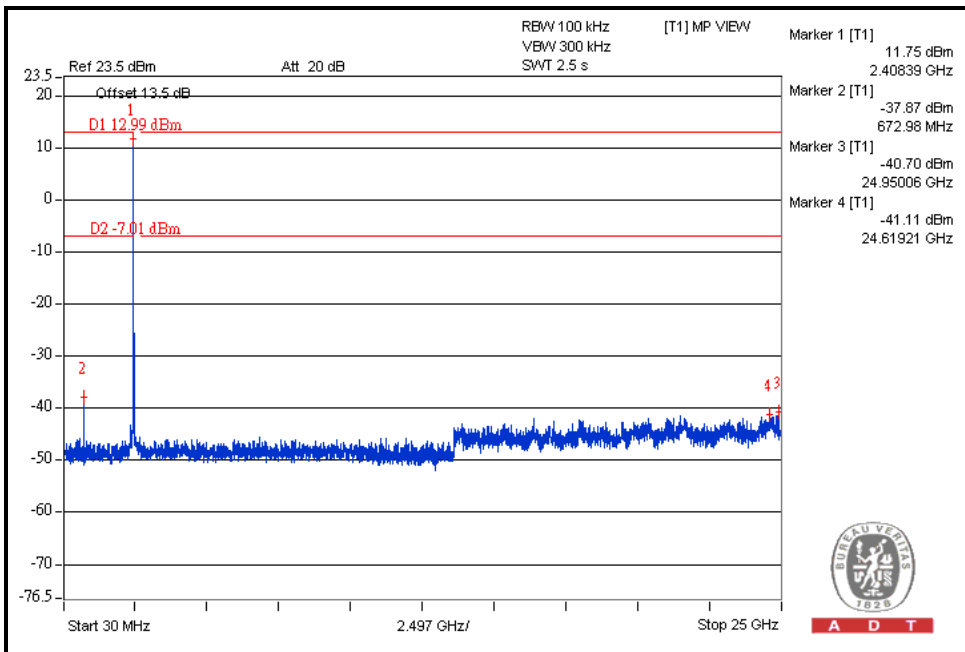
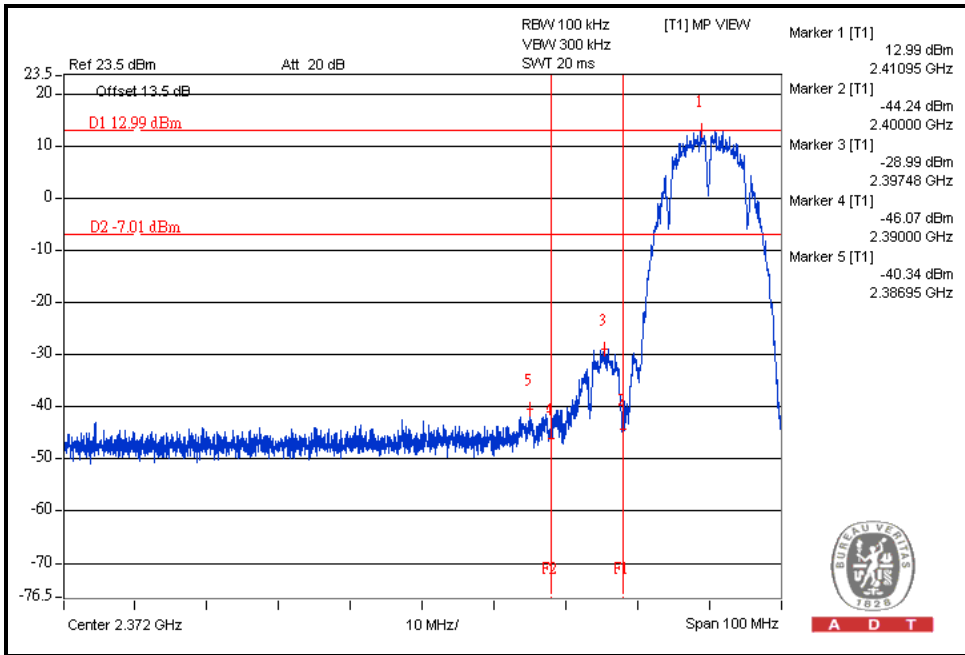



A D T

CH11

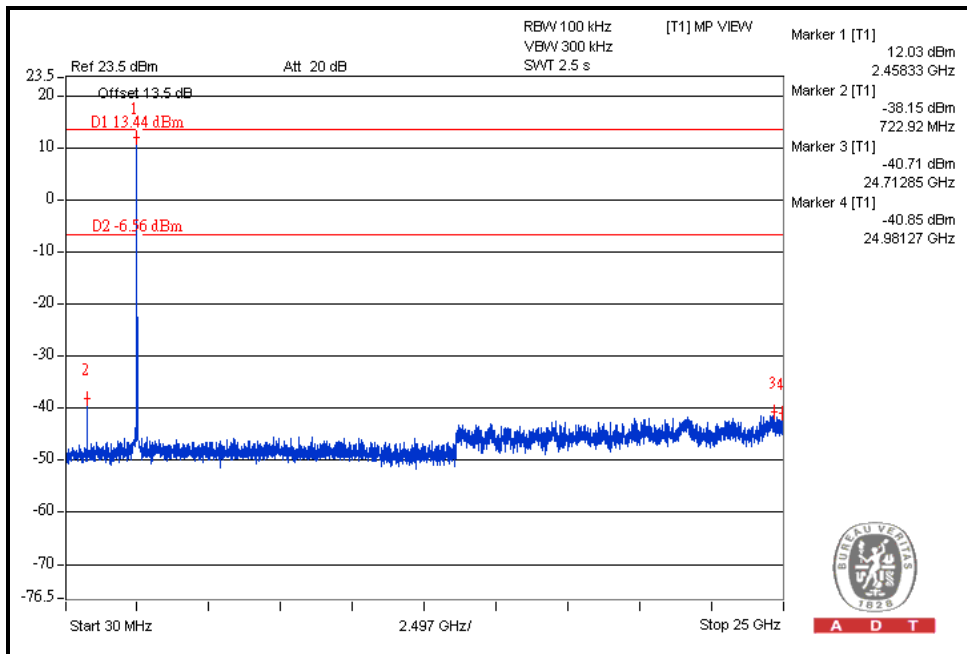
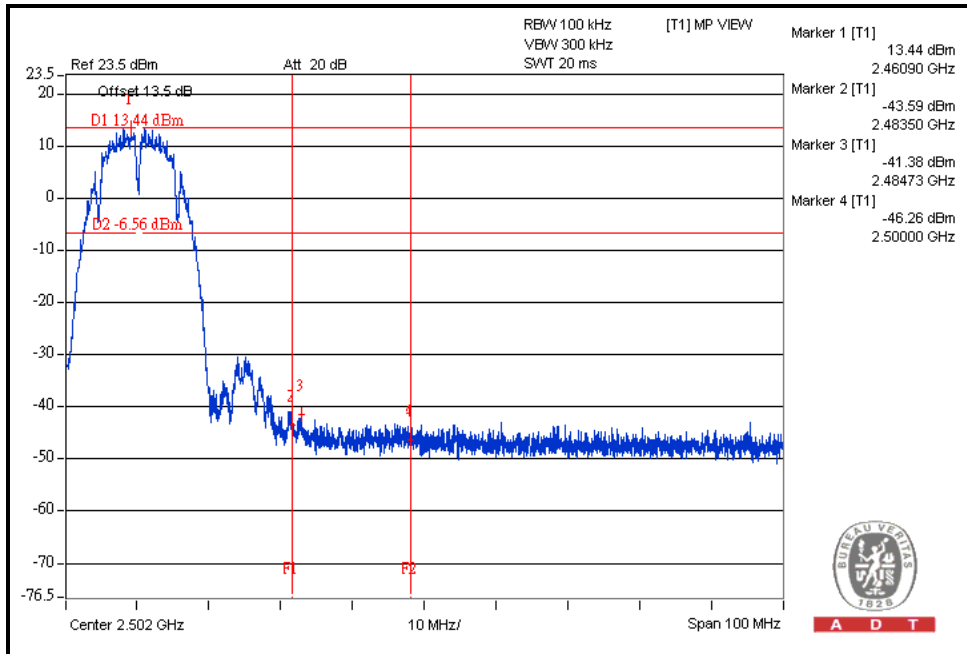

802.11g OFDM MODULATION:

CH1

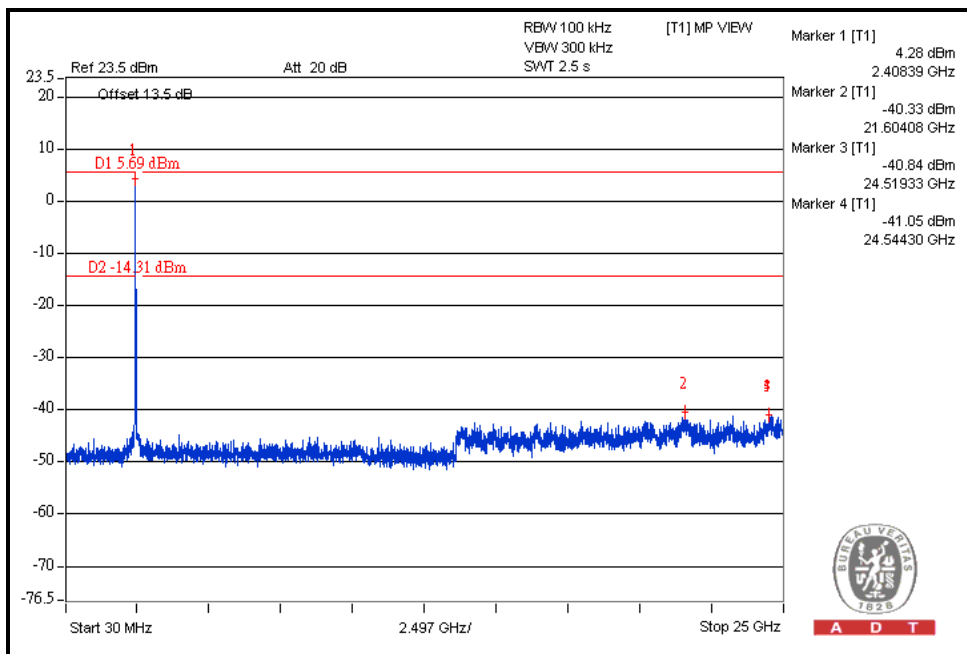
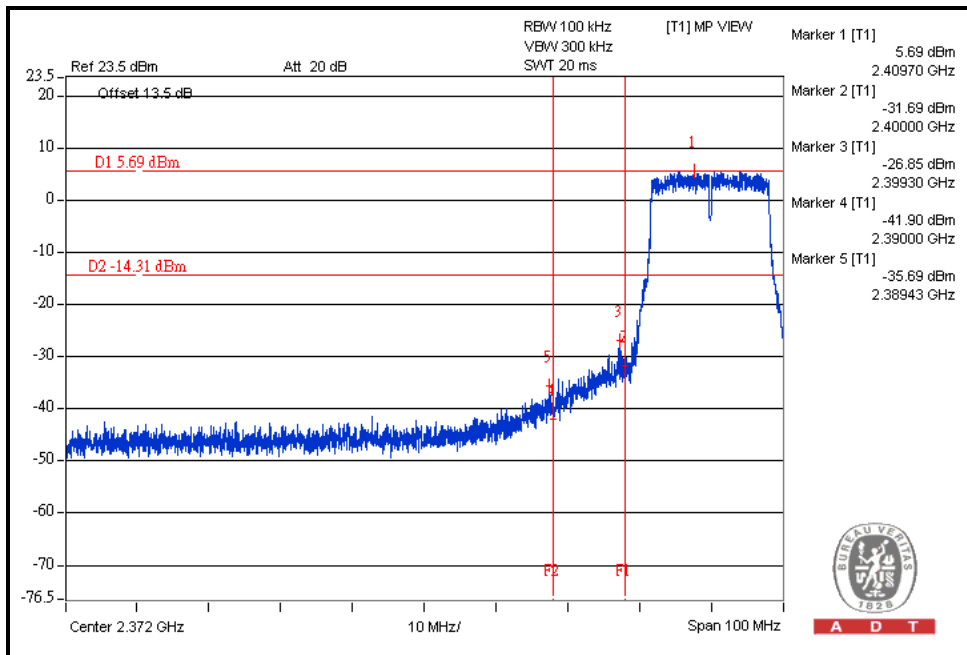



A D T

CH11

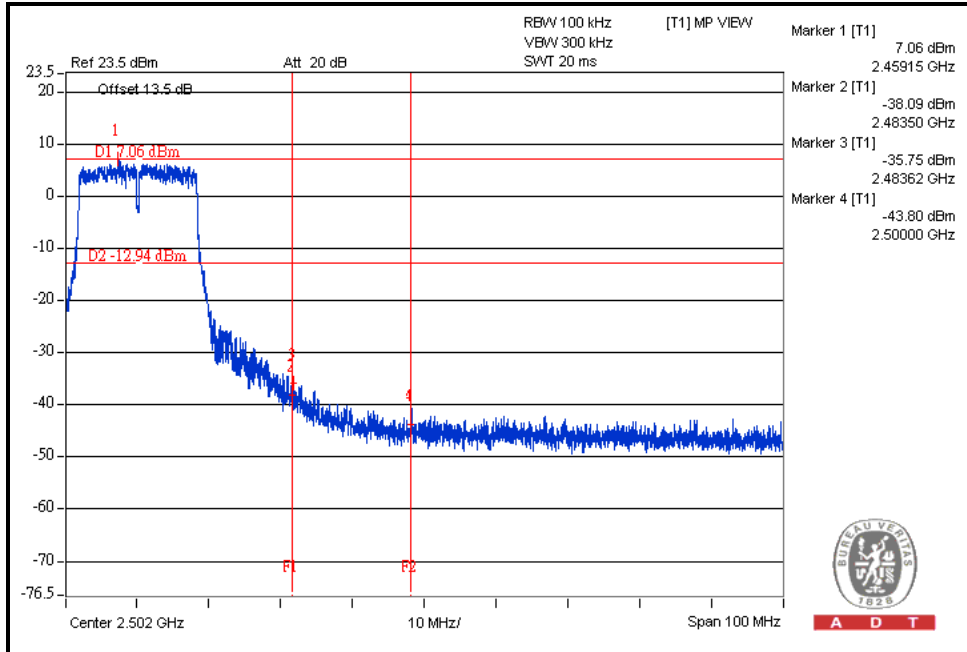

A D T

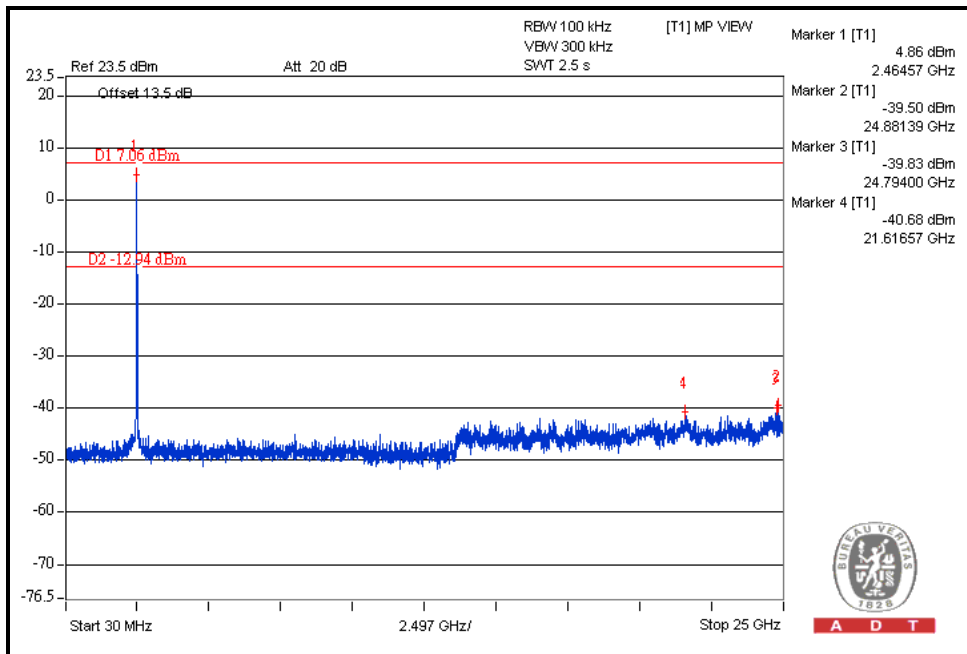

A D T



A D T

802.11n (20MHz) OFDM MODULATION:

CH1

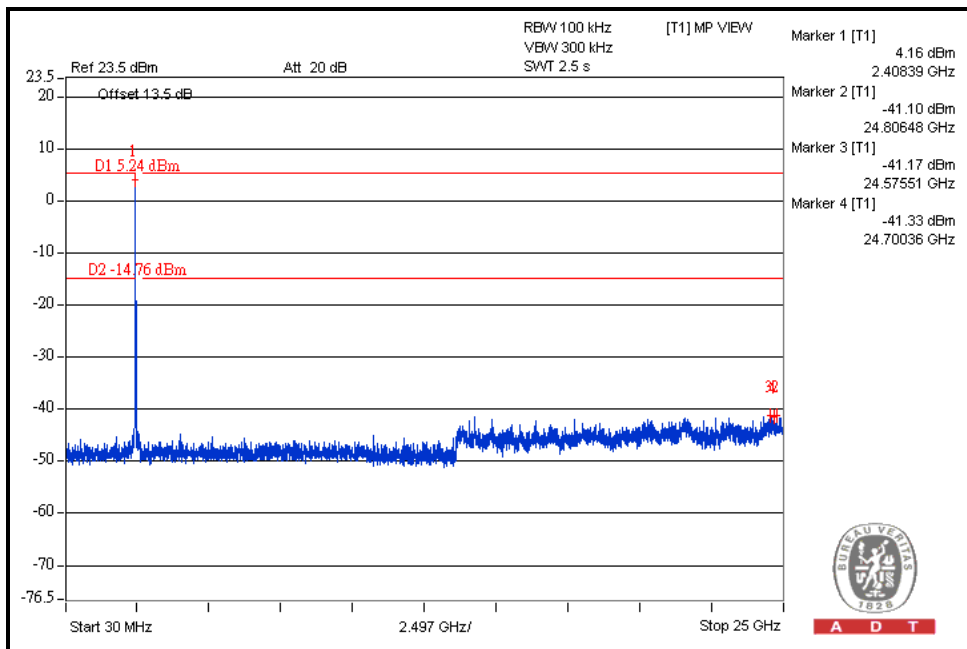
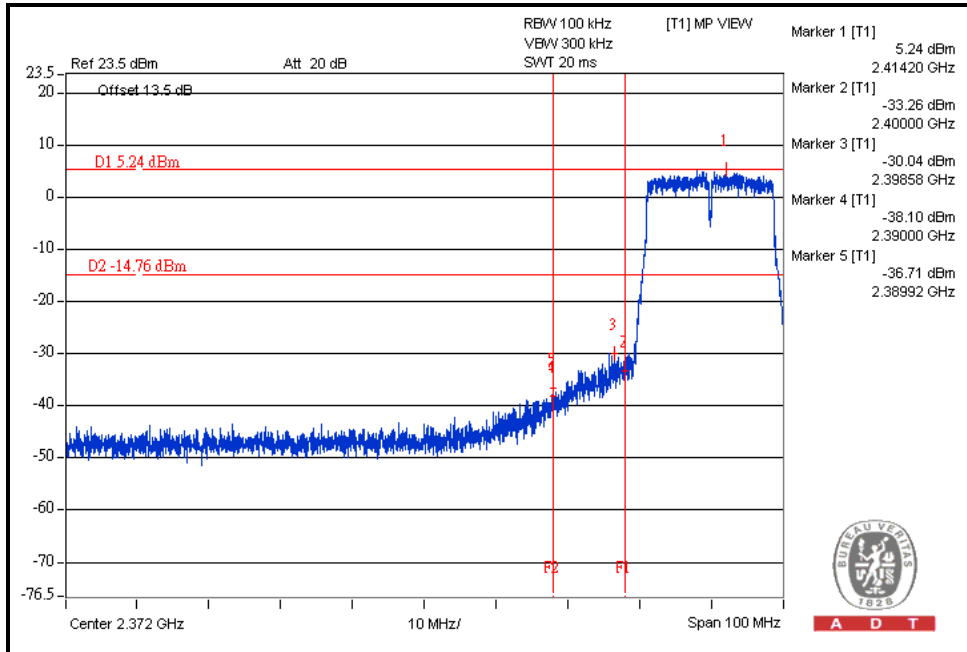



A D T

CH11

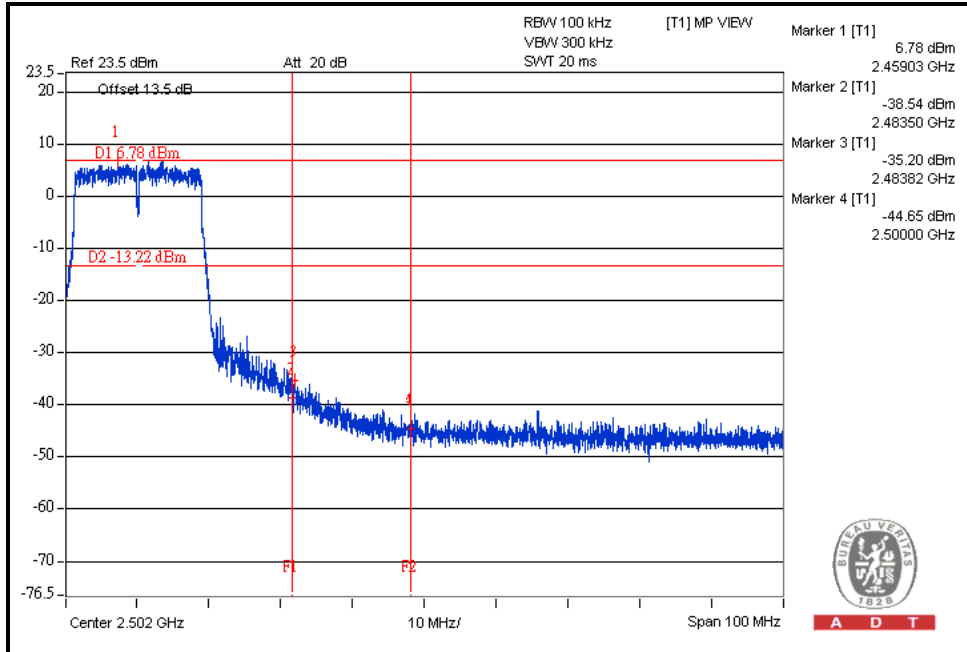

A D T

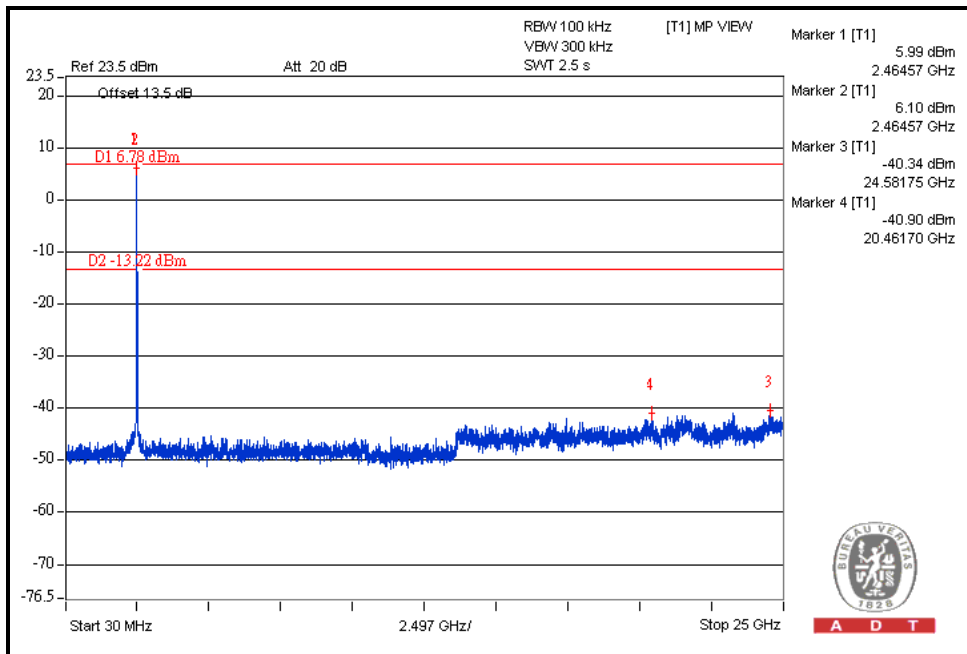

A D T



A D T

802.11n (40MHz) OFDM MODULATION:

CH3

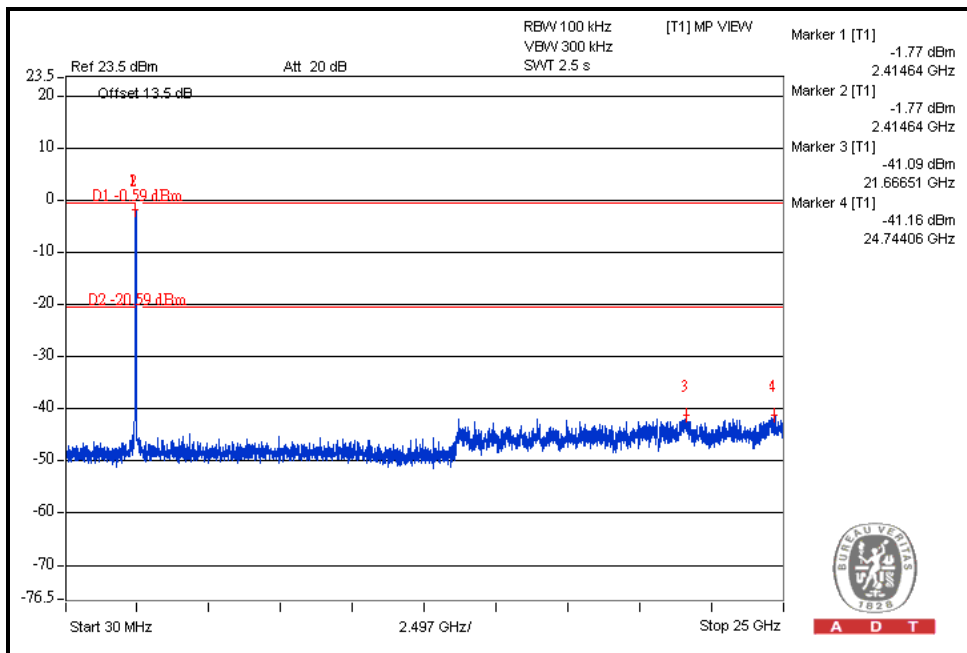
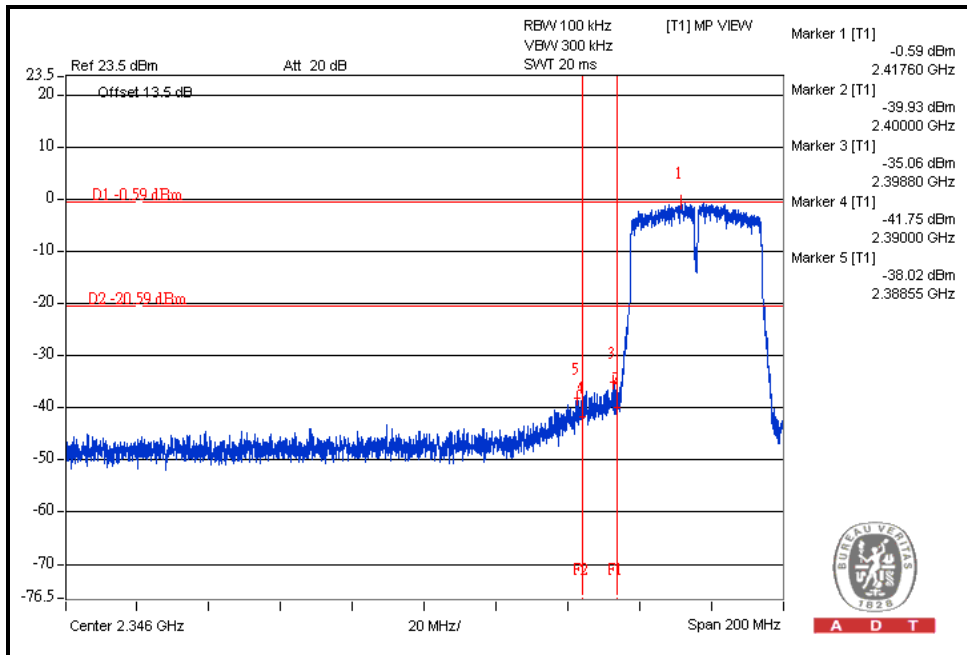



A D T

CH9

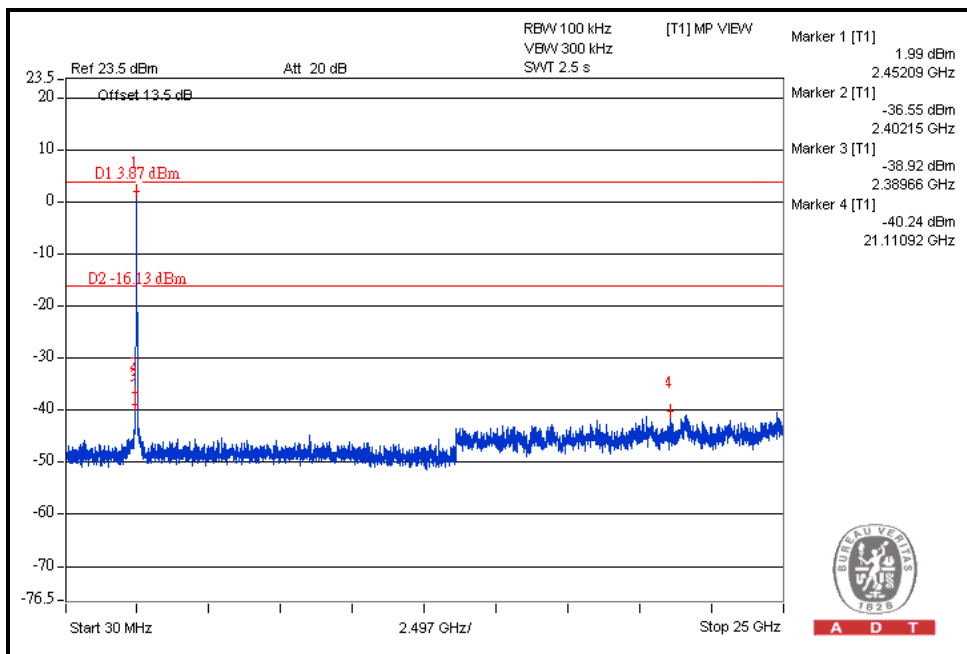
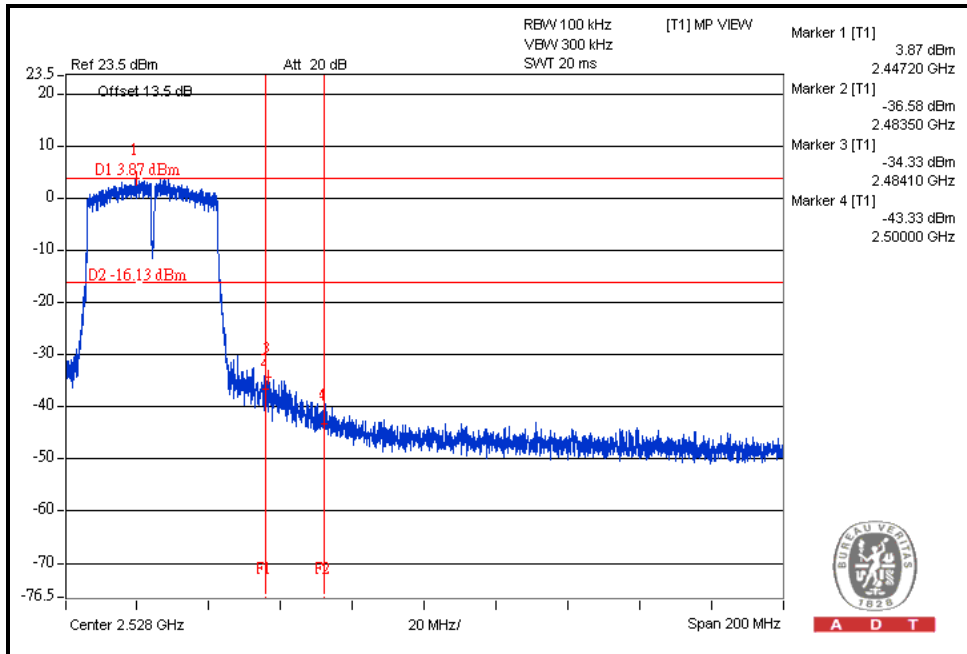

5. TEST TYPES AND RESULTS (5725~5850MHz Band)

5.1 CONDUCTED EMISSION MEASUREMENT

5.1.1 LIMITS OF CONDUCTED EMISSION MEASUREMENT

FREQUENCY OF EMISSION (MHz)	CONDUCTED LIMIT (dB μ V)	
	Quasi-peak	Average
0.15-0.5	66 to 56	56 to 46
0.5-5	56	46
5-30	60	50

- NOTE:**
1. The lower limit shall apply at the transition frequencies.
 2. The limit decreases in line with the logarithm of the frequency in the range of 0.15 to 0.50 MHz.
 3. All emanations from a class A/B digital device or system, including any network of conductors and apparatus connected thereto, shall not exceed the level of field strengths specified above.

5.1.2 TEST INSTRUMENTS

Test date: Dec. 12, 2011

DESCRIPTION & MANUFACTURER	MODEL NO.	SERIAL NO.	CALIBRATED DATE	CALIBRATED UNTIL
Test Receiver	ESCS 30	100375	Mar. 09, 2011	Mar. 08, 2012
Line-Impedance Stabilization Network (for EUT)	NSLK 8127	8127-522	Sep. 07, 2011	Sep. 06, 2012
Line-Impedance Stabilization Network (for Peripheral)	ESH3-Z5	848773/004	Nov. 01, 2011	Oct. 31, 2012
RF Cable (JYEBAO)	5DFB	COCCAB-002	Aug. 29, 2011	Aug. 28, 2012
50 ohms Terminator	50	3	Nov. 02, 2011	Nov. 01, 2012
Software	BV ADT_Cond_V7.3.7	NA	NA	NA

Note:

1. The calibration interval of the above test instruments is 12 months and the calibrations are traceable to NML/ROC and NIST/USA.
2. The test was performed in Shielded Room No. C.
- 3 The VCCI Con C Registration No. is C-3611.



A D T

5.1.3 TEST PROCEDURES

- a. The EUT was placed 0.4 meters from the conducting wall of the shielded room with EUT being connected to the power mains through a line impedance stabilization network (LISN). Other support units were connected to the power mains through another LISN. The two LISNs provide 50 ohm/ 50uH of coupling impedance for the measuring instrument.
- b. Both lines of the power mains connected to the EUT were checked for maximum conducted interference.
- c. The frequency range from 150kHz to 30MHz was searched. Emission levels under (Limit – 20dB) were not recorded.

5.1.4 DEVIATION FROM TEST STANDARD

No deviation

5.1.5 TEST SETUP

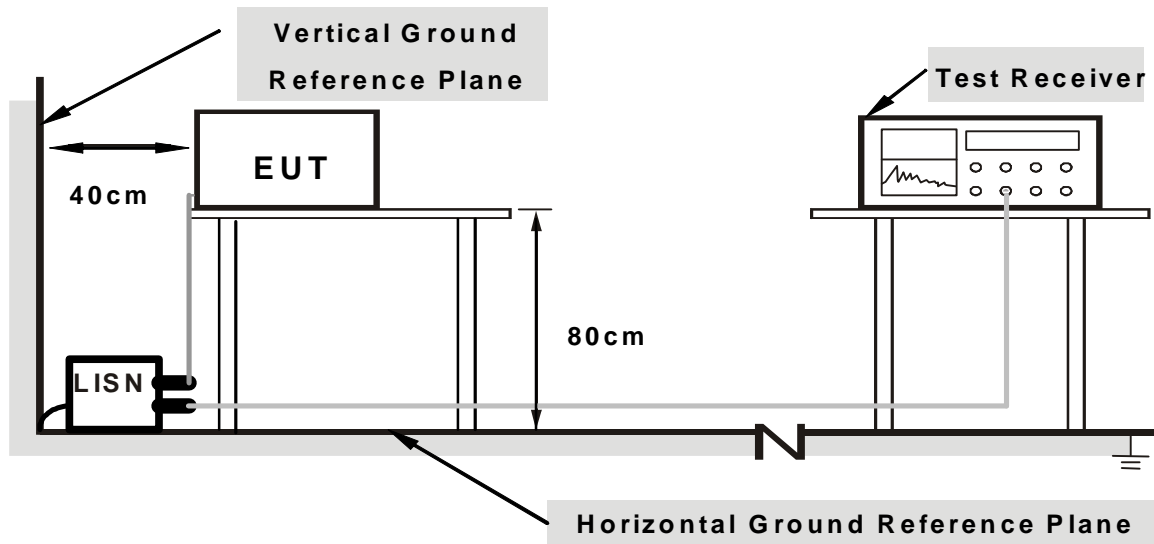

- Note:**
1. Support units were connected to second LISN.
 2. Both of LISNs (AMN) are 80 cm from EUT and at least 80 from other units and other metal planes

For the actual test configuration, please refer to the related item – Photographs of the Test Configuration.

5.1.6 EUT OPERATING CONDITIONS

Same as the 4.1.6

5.1.7 TEST RESULTS (MODE 1)

PHASE	Line (L)	6dB BANDWIDTH	9 kHz
--------------	----------	----------------------	-------

No	Freq. [MHz]	Corr. Factor (dB)	Reading Value		Emission Level		Limit		Margin	
			[dB (uV)]		[dB (uV)]		[dB (uV)]		(dB)	
			Q.P.	AV.	Q.P.	AV.	Q.P.	AV.	Q.P.	AV.
1	0.162	0.09	59.23	48.95	59.32	49.04	65.38	55.38	-6.05	-6.33
2	0.216	0.11	51.05	41.92	51.16	42.03	62.96	52.96	-11.79	-10.92
3	0.232	0.11	37.55	23.34	37.66	23.45	62.38	52.38	-24.71	-28.92
4	0.274	0.12	45.74	39.43	45.86	39.55	61.01	51.01	-15.15	-11.46
5	0.334	0.13	40.81	29.57	40.94	29.70	59.36	49.36	-18.42	-19.66
6	0.377	0.14	41.45	35.17	41.59	35.31	58.35	48.35	-16.77	-13.05
7	3.941	0.40	30.88	18.69	31.28	19.09	56.00	46.00	-24.72	-26.91

- REMARKS:**
1. Q.P. and AV. are abbreviations of quasi-peak and average individually.
 2. The emission levels of other frequencies were very low against the limit.
 3. Margin value = Emission level - Limit value
 4. Correction factor = Insertion loss + Cable loss
 5. Emission Level = Correction Factor + Reading Value.

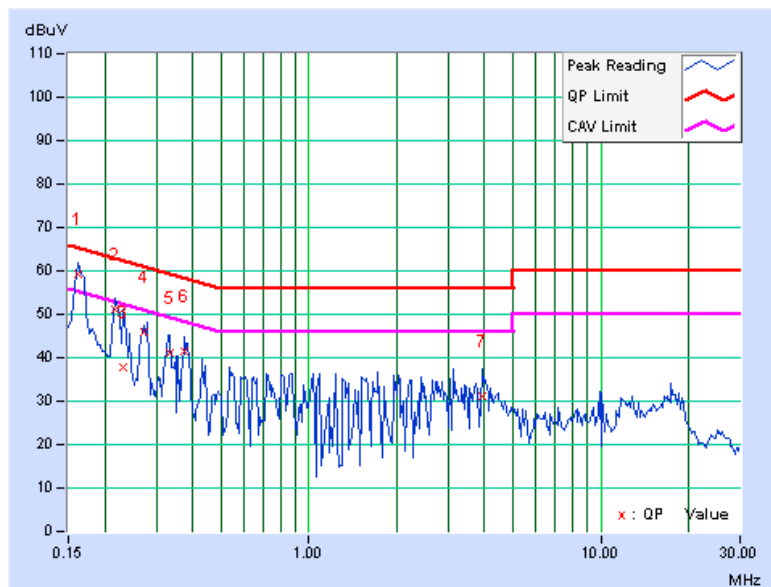

PHASE	Neutral (N)	6dB BANDWIDTH	9 kHz
-------	-------------	---------------	-------

No	Freq. [MHz]	Corr. Factor (dB)	Reading Value [dB (uV)]		Emission Level [dB (uV)]		Limit [dB (uV)]		Margin (dB)	
			Q.P.	AV.	Q.P.	AV.	Q.P.	AV.	Q.P.	AV.
	1	0.162	0.08	59.33	49.19	59.41	49.27	65.38	55.38	-5.96
2	0.181	0.09	49.04	28.20	49.13	28.29	64.43	54.43	-15.30	-26.14
3	0.217	0.10	51.07	41.94	51.17	42.04	62.93	52.93	-11.76	-10.89
4	0.274	0.11	45.76	39.12	45.87	39.23	61.00	51.00	-15.13	-11.77
5	0.377	0.13	42.10	35.96	42.23	36.09	58.35	48.35	-16.13	-12.27
6	3.953	0.31	31.62	20.07	31.93	20.38	56.00	46.00	-24.07	-25.62

- REMARKS:**
1. Q.P. and AV. are abbreviations of quasi-peak and average individually.
 2. The emission levels of other frequencies were very low against the limit.
 3. Margin value = Emission level - Limit value
 4. Correction factor = Insertion loss + Cable loss
 5. Emission Level = Correction Factor + Reading Value.

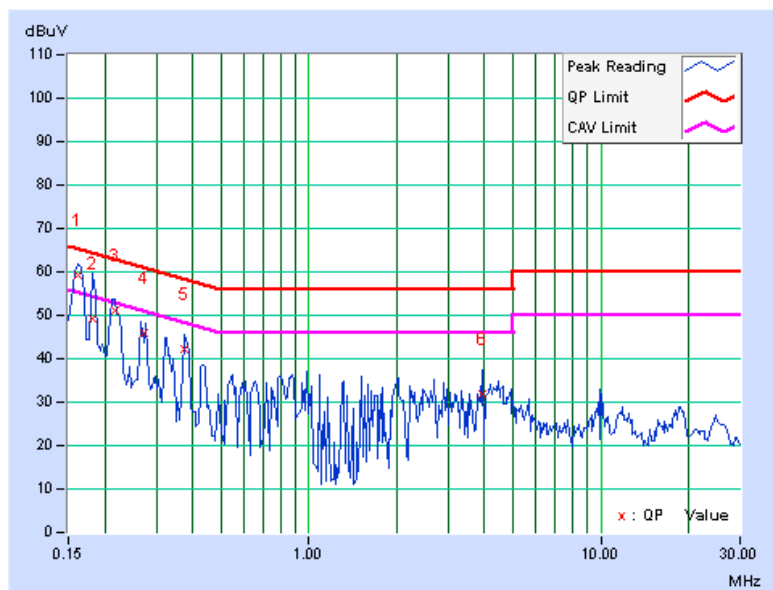

5.1.8 TEST RESULTS (MODE 2)

PHASE	Line (L)	6dB BANDWIDTH	9 kHz
--------------	----------	----------------------	-------

No	Freq. [MHz]	Corr. Factor (dB)	Reading Value [dB (uV)]		Emission Level [dB (uV)]		Limit [dB (uV)]		Margin (dB)	
			Q.P.	AV.	Q.P.	AV.	Q.P.	AV.	Q.P.	AV.
			1	0.150	0.09	54.31	40.04	54.40	40.13	66.00
2	0.177	0.10	49.90	35.43	50.00	35.53	64.61	54.61	-14.61	-19.08
3	0.193	0.11	47.63	29.42	47.74	29.53	63.91	53.91	-16.17	-24.38
4	0.224	0.11	42.71	28.71	42.82	28.82	62.66	52.66	-19.84	-23.84
5	0.263	0.12	37.03	23.67	37.15	23.79	61.33	51.33	-24.18	-27.54
6	0.459	0.14	37.30	28.84	37.44	28.98	56.72	46.72	-19.27	-17.73
7	11.926	0.80	30.73	24.79	31.53	25.59	60.00	50.00	-28.47	-24.41

- REMARKS:**
1. Q.P. and AV. are abbreviations of quasi-peak and average individually.
 2. The emission levels of other frequencies were very low against the limit.
 3. Margin value = Emission level - Limit value
 4. Correction factor = Insertion loss + Cable loss
 5. Emission Level = Correction Factor + Reading Value.

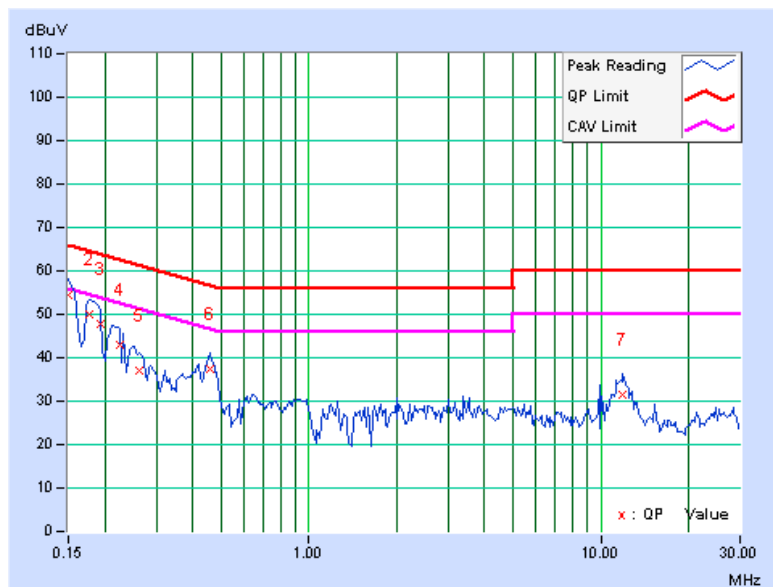

PHASE	Neutral (N)	6dB BANDWIDTH	9 kHz
--------------	-------------	----------------------	-------

No	Freq. [MHz]	Corr. Factor (dB)	Reading Value [dB (uV)]		Emission Level [dB (uV)]		Limit [dB (uV)]		Margin (dB)	
			Q.P.	AV.	Q.P.	AV.	Q.P.	AV.	Q.P.	AV.
	1	0.154	0.08	54.19	36.52	54.27	36.60	65.79	55.79	-11.52
2	0.181	0.09	50.85	38.21	50.94	38.30	64.43	54.43	-13.49	-16.13
3	0.189	0.09	49.22	33.29	49.31	33.38	64.08	54.08	-14.76	-20.69
4	0.213	0.10	45.49	31.50	45.59	31.60	63.11	53.11	-17.52	-21.51
5	0.455	0.13	37.25	26.60	37.38	26.73	56.79	46.79	-19.41	-20.06
6	2.176	0.20	22.58	13.57	22.78	13.77	56.00	46.00	-33.22	-32.23
7	11.867	0.67	31.00	24.76	31.67	25.43	60.00	50.00	-28.33	-24.57

- REMARKS:**
1. Q.P. and AV. are abbreviations of quasi-peak and average individually.
 2. The emission levels of other frequencies were very low against the limit.
 3. Margin value = Emission level - Limit value
 4. Correction factor = Insertion loss + Cable loss
 5. Emission Level = Correction Factor + Reading Value.

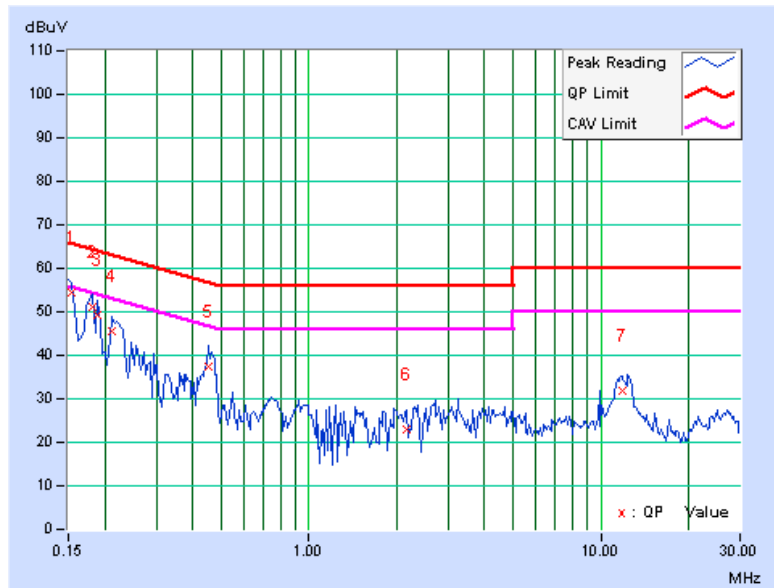



A D T

5.2 RADIATED EMISSION MEASUREMENT

5.2.1 LIMITS OF RADIATED EMISSION MEASUREMENT

Emissions radiated outside of the specified bands, shall be according to the general radiated limits in 15.209 as following:

Frequencies (MHz)	Field strength (microvolts/meter)	Measurement distance (meters)
0.009-0.490	2400/F(kHz)	300
0.490-1.705	24000/F(kHz)	30
1.705-30.0	30	30
30-88	100	3
88-216	150	3
216-960	200	3
Above 960	500	3

NOTE:

1. The lower limit shall apply at the transition frequencies.
2. Emission level (dBuV/m) = 20 log Emission level (uV/m).
3. As shown in 15.35(b), for frequencies above 1000MHz, the field strength limits are based on average detector, however, the peak field strength of any emission shall not exceed the maximum permitted average limits, specified above by more than 20dB under any condition of modulation.
4. Section 15.205 restricted bands of operation shall compliance with the limits in Section 15.209.



A D T

5.2.2 TEST INSTRUMENTS

For Below 1GHz: (Test date: Dec. 14, 2011)

DESCRIPTION & MANUFACTURER	MODEL NO.	SERIAL NO.	CALIBRATED DATE	CALIBRATED UNTIL
Agilent Spectrum Analyzer	E4446A	MY48250253	Aug. 29, 2011	Aug. 28, 2012
Agilent Pre-Selector	N9039A	MY46520310	Aug. 29, 2011	Aug. 28, 2012
Agilent Signal Generator	N5181A	MY49060347	July 25, 2011	July 24, 2012
Mini-Circuits Pre-Amplifier	ZFL-1000VH2B	AMP-ZFL-04	Nov. 15, 2011	Nov. 14, 2012
Agilent Pre-Amplifier	8449B	3008A02465	Feb. 28, 2011	Feb. 27, 2012
SPACEK LABS	SLKKa-48-6	9K16	Nov. 15, 2011	Nov. 14, 2012
SCHWARZBECK Trilog Broadband Antenna	VULB 9168	9168-361	Apr. 14, 2011	Apr. 13, 2012
AISI Horn_Antenna	AIH.8018	0000220091110	Nov. 23, 2011	Nov. 22, 2012
SCHWARZBECK Horn_Antenna	BBHA 9170	9170-424	Oct. 07, 2011	Oct. 06, 2012
RF CABLE	NA	RF104-205 RF104-207 RF104-202	Dec. 28, 2010	Dec. 27, 2011
RF Cable	NA	CHHCAB_001	Oct. 08, 2011	Oct. 07, 2012
Software	ADT_Radiated_V8.7.05	NA	NA	NA
CT Antenna Tower & Turn Table	NA	NA	NA	NA

Note: 1. The calibration interval of the above test instruments is 12 months and the calibrations are traceable to NML/ROC and NIST/USA.

2. The horn antenna, preamplifier (model: 8449B) are used only for the measurement of emission frequency above 1GHz if tested.

3. The test was performed in 966 Chamber No. H.

4. The FCC Site Registration No. is 797305.

5. The CANADA Site Registration No. is IC 7450H-3.



A D T

For Above 1GHz: (Test date: Dec. 16, 2011)

DESCRIPTION & MANUFACTURER	MODEL NO.	SERIAL NO.	CALIBRATED DATE	CALIBRATED UNTIL
Agilent Spectrum Analyzer	E4446A	MY48250254	July 12, 2011	July 11, 2012
Agilent Pre-Selector	N9039A	MY46520311	July 12, 2011	July 11, 2012
Agilent Signal Generator	N5181A	MY49060517	July 12, 2011	July 11, 2012
Mini-Circuits Pre-Amplifier	ZFL-1000VH2B	AMP-ZFL-03	Nov. 15, 2011	Nov. 14, 2012
Agilent Pre-Amplifier	8449B	3008A02578	July 04, 2011	July 03, 2012
SPACEK LABS	SLKKa-48-6	9K16	Nov. 15, 2011	Nov. 14, 2012
SCHWARZBECK Trilog Broadband Antenna	VULB 9168	9168-360	Apr. 14, 2011	Apr. 13, 2012
AISI Horn_Antenna	AIH.8018	0000320091110	Nov. 14, 2011	Nov. 13, 2012
SCHWARZBECK Horn_Antenna	BBHA 9170	9170-424	Oct. 07, 2011	Oct. 06, 2012
RF CABLE	NA	RF104-201 RF104-203 RF104-204	Dec. 27, 2010	Dec. 26, 2011
RF Cable	NA	CHGCAB_001	Oct. 07, 2011	Oct. 06, 2012
Software	ADT_Radiated_V8.7.05	NA	NA	NA
CT Antenna Tower & Turn Table	NA	NA	NA	NA

- Note: 1. The calibration interval of the above test instruments is 12 months and the calibrations are traceable to NML/ROC and NIST/USA.
2. The horn antenna, preamplifier (model: 8449B) are used only for the measurement of emission frequency above 1GHz if tested.
3. The test was performed in 966 Chamber No. G.
4. The FCC Site Registration No. is 966073.
5. The VCCI Site Registration No. is G-137.
6. The CANADA Site Registration No. is IC 7450H-2.



A D T

5.2.3 TEST PROCEDURES

- a. The EUT was placed on the top of a rotating table 0.8 meters above the ground at a 3 meter chamber room. The table was rotated 360 degrees to determine the position of the highest radiation.
- b. The EUT was set 3 meters away from the interference-receiving antenna, which was mounted on the top of a variable-height antenna tower.
- c. The height of antenna is varied from one meter to four meters above the ground to determine the maximum value of the field strength. Both horizontal and vertical polarizations of the antenna are set to make the measurement.
- d. For each suspected emission, the EUT was arranged to its worst case and then the antenna was tuned to heights from 1 meter to 4 meters and the rotatable table was turned from 0 degrees to 360 degrees to find the maximum reading.
- e. The test-receiver system was set to quasi-peak detect function and specified bandwidth with maximum hold mode when the test frequency is below 1 GHz.
- f. The test-receiver system was set to peak and average detect function and specified bandwidth with maximum hold mode when the test frequency is above 1 GHz. If the peak reading value also meets average limit, measurement with the average detector is unnecessary.

NOTE:

1. The resolution bandwidth and video bandwidth of test receiver/spectrum analyzer is 120kHz for Quasi-peak detection (QP) at frequency below 1GHz.
2. The resolution bandwidth of test receiver/spectrum analyzer is 1 MHz and the video bandwidth is 3 MHz for Peak detection (PK) at frequency above 1GHz.
3. The resolution bandwidth of test receiver/spectrum analyzer is 1 MHz and the video bandwidth is 10 Hz for Average detection (AV) at frequency above 1GHz.

5.2.4 DEVIATION FROM TEST STANDARD

No deviation

5.2.5 TEST SETUP

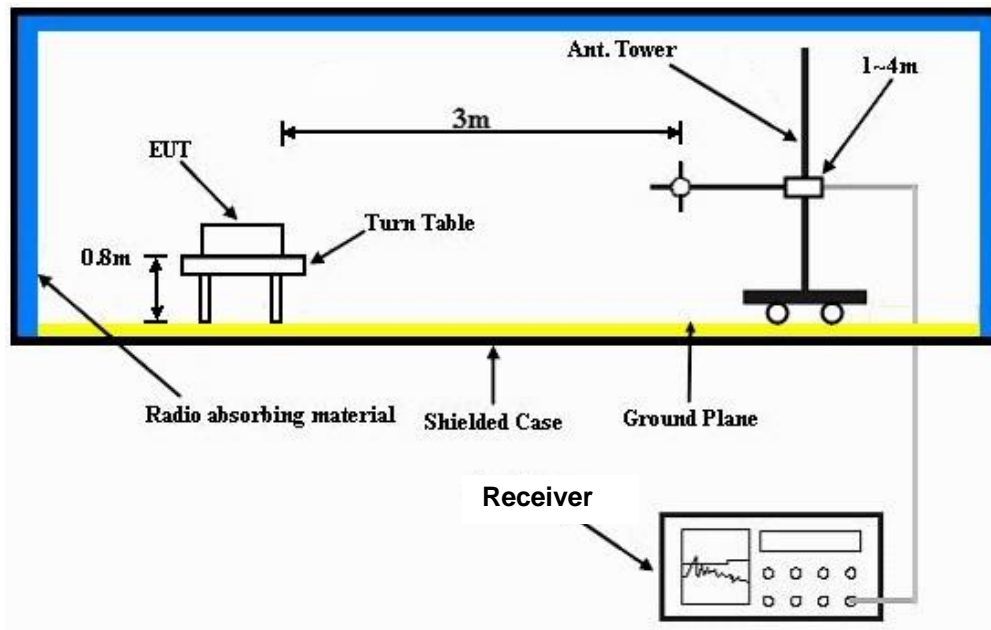

For the actual test configuration, please refer to the related item – Photographs of the Test Configuration.

5.2.6 EUT OPERATING CONDITIONS

Same as the 4.1.6

5.2.7 TEST RESULTS

BELOW 1GHz WORST-CASE DATA : 802.11n (20MHz) OFDM MODULATION

EUT TEST CONDITION		MEASUREMENT DETAIL	
CHANNEL	Channel 149	FREQUENCY RANGE	Below 1000MHz
INPUT POWER	120Vac / 60Hz	DETECTOR FUNCTION	Quasi-Peak
ENVIRONMENTAL CONDITIONS	22deg. C, 70%RH	TESTED BY	Nelson Teng

ANTENNA POLARITY & TEST DISTANCE: HORIZONTAL AT 3 M								
NO.	FREQ. (MHz)	EMISSION LEVEL (dBuV/m)	LIMIT (dBuV/m)	MARGIN (dB)	ANTENNA HEIGHT (m)	TABLE ANGLE (Degree)	RAW VALUE (dBuV)	CORRECTION FACTOR (dB/m)
1	86.23	31.1 QP	40.0	-8.9	1.50 H	265	22.18	8.93
2	195.24	33.4 QP	43.5	-10.1	1.75 H	282	21.69	11.73
3	250.13	35.2 QP	46.0	-10.8	1.00 H	250	21.95	13.29
4	375.00	38.6 QP	46.0	-7.4	1.00 H	242	21.50	17.11
5	500.15	35.3 QP	46.0	-10.7	2.00 H	80	15.27	20.06
6	1000.00	34.1 QP	54.0	-19.9	1.25 H	0	5.80	28.30
ANTENNA POLARITY & TEST DISTANCE: VERTICAL AT 3 M								
NO.	FREQ. (MHz)	EMISSION LEVEL (dBuV/m)	LIMIT (dBuV/m)	MARGIN (dB)	ANTENNA HEIGHT (m)	TABLE ANGLE (Degree)	RAW VALUE (dBuV)	CORRECTION FACTOR (dB/m)
1	64.90	36.2 QP	40.0	-3.8	1.25 V	317	23.29	12.90
2	250.00	37.6 QP	46.0	-8.4	1.50 V	288	24.34	13.28
3	375.11	35.4 QP	46.0	-10.6	1.25 V	251	18.31	17.11
4	500.07	34.7 QP	46.0	-11.4	1.50 V	295	14.59	20.06
5	625.17	36.4 QP	46.0	-9.6	1.00 V	322	13.96	22.42
6	1000.00	33.2 QP	54.0	-20.8	1.00 V	100	4.87	28.30

- REMARKS:**
1. Emission level (dBuV/m) = Raw Value (dBuV) + Correction Factor (dB/m).
 2. Correction Factor (dB/m) = Antenna Factor (dB/m) + Cable Factor (dB).
 3. The other emission levels were very low against the limit.
 4. Margin value = Emission level – Limit value.



A D T

ABOVE 1GHz WORST-CASE DATA

802.11a OFDM MODULATION

EUT TEST CONDITION		MEASUREMENT DETAIL	
CHANNEL	Channel 149	FREQUENCY RANGE	1 ~ 40GHz
INPUT POWER	120Vac / 60Hz	DETECTOR FUNCTION	Peak (PK) Average (AV)
ENVIRONMENTAL CONDITIONS	26deg. C, 68%RH	TESTED BY	Evan Huang

ANTENNA POLARITY & TEST DISTANCE: HORIZONTAL AT 3 M

NO.	FREQ. (MHz)	EMISSION LEVEL (dBuV/m)	LIMIT (dBuV/m)	MARGIN (dB)	ANTENNA HEIGHT (m)	TABLE ANGLE (Degree)	RAW VALUE (dBuV)	CORRECTION FACTOR (dB/m)
1	*5745.00	113.0 PK			1.00 H	112	71.45	41.55
2	*5745.00	104.4 AV			1.00 H	112	62.85	41.55
3	11490.00	55.8 PK	74.0	-18.2	1.21 H	36	8.09	47.71
4	11490.00	43.6 AV	54.0	-10.4	1.21 H	36	-4.11	47.71

ANTENNA POLARITY & TEST DISTANCE: VERTICAL AT 3 M

NO.	FREQ. (MHz)	EMISSION LEVEL (dBuV/m)	LIMIT (dBuV/m)	MARGIN (dB)	ANTENNA HEIGHT (m)	TABLE ANGLE (Degree)	RAW VALUE (dBuV)	CORRECTION FACTOR (dB/m)
1	*5745.00	117.6 PK			1.15 V	298	76.05	41.55
2	*5745.00	108.7 AV			1.15 V	298	67.15	41.55
3	11490.00	56.9 PK	74.0	-17.1	1.08 V	338	9.19	47.71
4	11490.00	45.7 AV	54.0	-8.3	1.08 V	338	-2.01	47.71

- REMARKS:**
1. Emission level (dBuV/m) = Raw Value (dBuV) + Correction Factor (dB/m).
 2. Correction Factor (dB/m) = Antenna Factor (dB/m) + Cable Factor (dB).
 3. The other emission levels were very low against the limit.
 4. Margin value = Emission level – Limit value.
 5. “ * “: Fundamental frequency.
 6. The limit value is defined as per 15.247.



A D T

EUT TEST CONDITION		MEASUREMENT DETAIL	
CHANNEL	Channel 157	FREQUENCY RANGE	1 ~ 40GHz
INPUT POWER	120Vac / 60Hz	DETECTOR FUNCTION	Peak (PK) Average (AV)
ENVIRONMENTAL CONDITIONS	26deg. C, 68%RH	TESTED BY	Evan Huang

ANTENNA POLARITY & TEST DISTANCE: HORIZONTAL AT 3 M								
NO.	FREQ. (MHz)	EMISSION LEVEL (dBuV/m)	LIMIT (dBuV/m)	MARGIN (dB)	ANTENNA HEIGHT (m)	TABLE ANGLE (Degree)	RAW VALUE (dBuV)	CORRECTION FACTOR (dB/m)
1	*5785.00	112.8 PK			1.03 H	98	71.12	41.68
2	*5785.00	104.1 AV			1.03 H	98	62.42	41.68
3	11570.00	56.8 PK	74.0	-17.2	1.15 H	127	9.05	47.75
4	11570.00	44.3 AV	54.0	-9.7	1.15 H	127	-3.45	47.75

ANTENNA POLARITY & TEST DISTANCE: VERTICAL AT 3 M								
NO.	FREQ. (MHz)	EMISSION LEVEL (dBuV/m)	LIMIT (dBuV/m)	MARGIN (dB)	ANTENNA HEIGHT (m)	TABLE ANGLE (Degree)	RAW VALUE (dBuV)	CORRECTION FACTOR (dB/m)
1	*5785.00	118.1 PK			1.21 V	293	76.42	41.68
2	*5785.00	109.0 AV			1.21 V	293	67.32	41.68
3	11570.00	57.1 PK	74.0	-16.9	1.05 V	248	9.35	47.75
4	11570.00	44.6 AV	54.0	-9.4	1.05 V	248	-3.15	47.75

- REMARKS:**
1. Emission level (dBuV/m) = Raw Value (dBuV) + Correction Factor (dB/m).
 2. Correction Factor (dB/m) = Antenna Factor (dB/m) + Cable Factor (dB).
 3. The other emission levels were very low against the limit.
 4. Margin value = Emission level – Limit value.
 5. “ * “: Fundamental frequency.
 6. The limit value is defined as per 15.247.



A D T

EUT TEST CONDITION		MEASUREMENT DETAIL	
CHANNEL	Channel 165	FREQUENCY RANGE	1 ~ 40GHz
INPUT POWER	120Vac / 60Hz	DETECTOR FUNCTION	Peak (PK) Average (AV)
ENVIRONMENTAL CONDITIONS	26deg. C, 68%RH	TESTED BY	Evan Huang

ANTENNA POLARITY & TEST DISTANCE: HORIZONTAL AT 3 M								
NO.	FREQ. (MHz)	EMISSION LEVEL (dBuV/m)	LIMIT (dBuV/m)	MARGIN (dB)	ANTENNA HEIGHT (m)	TABLE ANGLE (Degree)	RAW VALUE (dBuV)	CORRECTION FACTOR (dB/m)
1	*5825.00	115.0 PK			1.45 H	109	73.22	41.78
2	*5825.00	106.1 AV			1.45 H	109	64.32	41.78
3	11650.00	56.7 PK	74.0	-17.3	1.35 H	287	8.87	47.83
4	11650.00	44.0 AV	54.0	-10.0	1.35 H	287	-3.83	47.83
ANTENNA POLARITY & TEST DISTANCE: VERTICAL AT 3 M								
NO.	FREQ. (MHz)	EMISSION LEVEL (dBuV/m)	LIMIT (dBuV/m)	MARGIN (dB)	ANTENNA HEIGHT (m)	TABLE ANGLE (Degree)	RAW VALUE (dBuV)	CORRECTION FACTOR (dB/m)
1	*5825.00	119.6 PK			1.47 V	292	77.82	41.78
2	*5825.00	110.4 AV			1.47 V	292	68.62	41.78
3	11650.00	57.2 PK	74.0	-16.8	1.15 V	131	9.37	47.83
4	11650.00	44.7 AV	54.0	-9.3	1.15 V	131	-3.13	47.83

- REMARKS:**
1. Emission level (dBuV/m) = Raw Value (dBuV) + Correction Factor (dB/m).
 2. Correction Factor (dB/m) = Antenna Factor (dB/m) + Cable Factor (dB).
 3. The other emission levels were very low against the limit.
 4. Margin value = Emission level – Limit value.
 5. “ * “: Fundamental frequency.
 6. The limit value is defined as per 15.247.



A D T

802.11n (20MHz) OFDM MODULATION

EUT TEST CONDITION		MEASUREMENT DETAIL	
CHANNEL	Channel 149	FREQUENCY RANGE	1 ~ 40GHz
INPUT POWER	120Vac / 60Hz	DETECTOR FUNCTION	Peak (PK) Average (AV)
ENVIRONMENTAL CONDITIONS	26deg. C, 68%RH	TESTED BY	Evan Huang

ANTENNA POLARITY & TEST DISTANCE: HORIZONTAL AT 3 M								
NO.	FREQ. (MHz)	EMISSION LEVEL (dBuV/m)	LIMIT (dBuV/m)	MARGIN (dB)	ANTENNA HEIGHT (m)	TABLE ANGLE (Degree)	RAW VALUE (dBuV)	CORRECTION FACTOR (dB/m)
1	*5745.00	113.3 PK			1.06 H	111	71.75	41.55
2	*5745.00	104.3 AV			1.06 H	111	62.75	41.55
3	11490.00	56.8 PK	74.0	-17.2	1.38 H	274	9.09	47.71
4	11490.00	44.2 AV	54.0	-9.8	1.38 H	274	-3.51	47.71
ANTENNA POLARITY & TEST DISTANCE: VERTICAL AT 3 M								
NO.	FREQ. (MHz)	EMISSION LEVEL (dBuV/m)	LIMIT (dBuV/m)	MARGIN (dB)	ANTENNA HEIGHT (m)	TABLE ANGLE (Degree)	RAW VALUE (dBuV)	CORRECTION FACTOR (dB/m)
1	*5745.00	117.2 PK			1.07 V	299	75.65	41.55
2	*5745.00	108.2 AV			1.07 V	299	66.65	41.55
3	11490.00	56.2 PK	74.0	-17.8	1.14 V	21	8.49	47.71
4	11490.00	45.0 AV	54.0	-9.0	1.14 V	21	-2.71	47.71

- REMARKS:**
1. Emission level (dBuV/m) = Raw Value (dBuV) + Correction Factor (dB/m).
 2. Correction Factor (dB/m) = Antenna Factor (dB/m) + Cable Factor (dB).
 3. The other emission levels were very low against the limit.
 4. Margin value = Emission level – Limit value.
 5. “ * “: Fundamental frequency.
 6. The limit value is defined as per 15.247.



A D T

EUT TEST CONDITION		MEASUREMENT DETAIL	
CHANNEL	Channel 157	FREQUENCY RANGE	1 ~ 40GHz
INPUT POWER	120Vac / 60Hz	DETECTOR FUNCTION	Peak (PK) Average (AV)
ENVIRONMENTAL CONDITIONS	26deg. C, 68%RH	TESTED BY	Evan Huang

ANTENNA POLARITY & TEST DISTANCE: HORIZONTAL AT 3 M								
NO.	FREQ. (MHz)	EMISSION LEVEL (dBuV/m)	LIMIT (dBuV/m)	MARGIN (dB)	ANTENNA HEIGHT (m)	TABLE ANGLE (Degree)	RAW VALUE (dBuV)	CORRECTION FACTOR (dB/m)
1	*5785.00	112.5 PK			1.00 H	85	70.82	41.68
2	*5785.00	103.6 AV			1.00 H	85	61.92	41.68
3	11570.00	56.6 PK	74.0	-17.4	1.19 H	121	8.85	47.75
4	11570.00	44.3 AV	54.0	-9.7	1.19 H	121	-3.45	47.75

ANTENNA POLARITY & TEST DISTANCE: VERTICAL AT 3 M								
NO.	FREQ. (MHz)	EMISSION LEVEL (dBuV/m)	LIMIT (dBuV/m)	MARGIN (dB)	ANTENNA HEIGHT (m)	TABLE ANGLE (Degree)	RAW VALUE (dBuV)	CORRECTION FACTOR (dB/m)
1	*5785.00	117.9 PK			1.16 V	298	76.22	41.68
2	*5785.00	108.8 AV			1.16 V	298	67.12	41.68
3	11570.00	56.9 PK	74.0	-17.1	1.08 V	257	9.15	47.75
4	11570.00	44.2 AV	54.0	-9.8	1.08 V	257	-3.55	47.75

- REMARKS:**
1. Emission level (dBuV/m) = Raw Value (dBuV) + Correction Factor (dB/m).
 2. Correction Factor (dB/m) = Antenna Factor (dB/m) + Cable Factor (dB).
 3. The other emission levels were very low against the limit.
 4. Margin value = Emission level – Limit value.
 5. “ * ”: Fundamental frequency.
 6. The limit value is defined as per 15.247.



A D T

EUT TEST CONDITION		MEASUREMENT DETAIL	
CHANNEL	Channel 165	FREQUENCY RANGE	1 ~ 40GHz
INPUT POWER	120Vac / 60Hz	DETECTOR FUNCTION	Peak (PK) Average (AV)
ENVIRONMENTAL CONDITIONS	26deg. C, 68%RH	TESTED BY	Evan Huang

ANTENNA POLARITY & TEST DISTANCE: HORIZONTAL AT 3 M								
NO.	FREQ. (MHz)	EMISSION LEVEL (dBuV/m)	LIMIT (dBuV/m)	MARGIN (dB)	ANTENNA HEIGHT (m)	TABLE ANGLE (Degree)	RAW VALUE (dBuV)	CORRECTION FACTOR (dB/m)
1	*5825.00	114.4 PK			1.40 H	110	72.62	41.78
2	*5825.00	105.3 AV			1.40 H	110	63.52	41.78
3	11650.00	57.4 PK	74.0	-16.6	1.42 H	292	9.57	47.83
4	11650.00	44.1 AV	54.0	-9.9	1.42 H	292	-3.73	47.83

ANTENNA POLARITY & TEST DISTANCE: VERTICAL AT 3 M								
NO.	FREQ. (MHz)	EMISSION LEVEL (dBuV/m)	LIMIT (dBuV/m)	MARGIN (dB)	ANTENNA HEIGHT (m)	TABLE ANGLE (Degree)	RAW VALUE (dBuV)	CORRECTION FACTOR (dB/m)
1	*5825.00	119.3 PK			1.48 V	292	77.52	41.78
2	*5825.00	110.3 AV			1.48 V	292	68.52	41.78
3	11650.00	57.9 PK	74.0	-16.1	1.10 V	194	10.07	47.83
4	11650.00	44.3 AV	54.0	-9.7	1.10 V	194	-3.53	47.83

- REMARKS:**
1. Emission level (dBuV/m) = Raw Value (dBuV) + Correction Factor (dB/m).
 2. Correction Factor (dB/m) = Antenna Factor (dB/m) + Cable Factor (dB).
 3. The other emission levels were very low against the limit.
 4. Margin value = Emission level – Limit value.
 5. “ * “: Fundamental frequency.
 6. The limit value is defined as per 15.247.



A D T

802.11n (40MHz) OFDM MODULATION

EUT TEST CONDITION		MEASUREMENT DETAIL	
CHANNEL	Channel 151	FREQUENCY RANGE	1 ~ 40GHz
INPUT POWER	120Vac / 60Hz	DETECTOR FUNCTION	Peak (PK) Average (AV)
ENVIRONMENTAL CONDITIONS	26deg. C, 68%RH	TESTED BY	Evan Huang

ANTENNA POLARITY & TEST DISTANCE: HORIZONTAL AT 3 M								
NO.	FREQ. (MHz)	EMISSION LEVEL (dBuV/m)	LIMIT (dBuV/m)	MARGIN (dB)	ANTENNA HEIGHT (m)	TABLE ANGLE (Degree)	RAW VALUE (dBuV)	CORRECTION FACTOR (dB/m)
1	*5755.00	111.0 PK			1.42 H	110	69.41	41.59
2	*5755.00	102.2 AV			1.42 H	110	60.61	41.59
3	11510.00	57.1 PK	74.0	-16.9	1.25 H	291	9.38	47.72
4	11510.00	44.5 AV	54.0	-9.5	1.25 H	291	-3.22	47.72
ANTENNA POLARITY & TEST DISTANCE: VERTICAL AT 3 M								
NO.	FREQ. (MHz)	EMISSION LEVEL (dBuV/m)	LIMIT (dBuV/m)	MARGIN (dB)	ANTENNA HEIGHT (m)	TABLE ANGLE (Degree)	RAW VALUE (dBuV)	CORRECTION FACTOR (dB/m)
1	*5755.00	115.0 PK			1.02 V	276	73.41	41.59
2	*5755.00	106.5 AV			1.02 V	276	64.91	41.59
3	11510.00	56.8 PK	74.0	-17.2	1.08 V	36	9.08	47.72
4	11510.00	45.6 AV	54.0	-8.4	1.08 V	36	-2.12	47.72

- REMARKS:**
1. Emission level (dBuV/m) = Raw Value (dBuV) + Correction Factor (dB/m).
 2. Correction Factor (dB/m) = Antenna Factor (dB/m) + Cable Factor (dB).
 3. The other emission levels were very low against the limit.
 4. Margin value = Emission level – Limit value.
 5. “ * “: Fundamental frequency.
 6. The limit value is defined as per 15.247.



A D T

EUT TEST CONDITION		MEASUREMENT DETAIL	
CHANNEL	Channel 159	FREQUENCY RANGE	1 ~ 40GHz
INPUT POWER	120Vac / 60Hz	DETECTOR FUNCTION	Peak (PK) Average (AV)
ENVIRONMENTAL CONDITIONS	26deg. C, 68%RH	TESTED BY	Evan Huang

ANTENNA POLARITY & TEST DISTANCE: HORIZONTAL AT 3 M								
NO.	FREQ. (MHz)	EMISSION LEVEL (dBuV/m)	LIMIT (dBuV/m)	MARGIN (dB)	ANTENNA HEIGHT (m)	TABLE ANGLE (Degree)	RAW VALUE (dBuV)	CORRECTION FACTOR (dB/m)
1	*5795.00	112.2 PK			1.45 H	108	70.50	41.70
2	*5795.00	103.6 AV			1.45 H	108	61.90	41.70
3	11590.00	57.6 PK	74.0	-16.4	1.25 H	248	9.84	47.76
4	11590.00	44.5 AV	54.0	-9.5	1.25 H	248	-3.26	47.76

ANTENNA POLARITY & TEST DISTANCE: VERTICAL AT 3 M								
NO.	FREQ. (MHz)	EMISSION LEVEL (dBuV/m)	LIMIT (dBuV/m)	MARGIN (dB)	ANTENNA HEIGHT (m)	TABLE ANGLE (Degree)	RAW VALUE (dBuV)	CORRECTION FACTOR (dB/m)
1	*5795.00	115.8 PK			1.00 V	277	74.10	41.70
2	*5795.00	107.0 AV			1.00 V	277	65.30	41.70
3	11590.00	57.7 PK	74.0	-16.3	1.17 V	184	9.94	47.76
4	11590.00	44.6 AV	54.0	-9.4	1.17 V	184	-3.16	47.76

- REMARKS:**
1. Emission level (dBuV/m) = Raw Value (dBuV) + Correction Factor (dB/m).
 2. Correction Factor (dB/m) = Antenna Factor (dB/m) + Cable Factor (dB).
 3. The other emission levels were very low against the limit.
 4. Margin value = Emission level – Limit value.
 5. “ * “: Fundamental frequency.
 6. The limit value is defined as per 15.247.

5.3 6dB BANDWIDTH MEASUREMENT

5.3.1 LIMITS OF 6dB BANDWIDTH MEASUREMENT

The minimum of 6dB Bandwidth Measurement is 0.5 MHz.

5.3.2 TEST INSTRUMENTS

Test date: Dec. 16, 2011

DESCRIPTION & MANUFACTURER	MODEL NO.	SERIAL NO.	CALIBRATED DATE	CALIBRATED UNTIL
R&S Spectrum Analyzer	FSP 40	100060	May 11, 2011	May 10, 2012

NOTE: The calibration interval of the above test instruments is 12 months and the calibrations are traceable to NML/ROC and NIST/USA.

5.3.3 TEST PROCEDURE

The transmitter output was connected to the spectrum analyzer through an attenuator. The bandwidth of the fundamental frequency was measured by spectrum analyzer with 100kHz RBW and 300kHz VBW. The 6dB bandwidth is defined as the total spectrum the power of which is higher than peak power minus 6dB.

5.3.4 DEVIATION FROM TEST STANDARD

No deviation

5.3.5 TEST SETUP

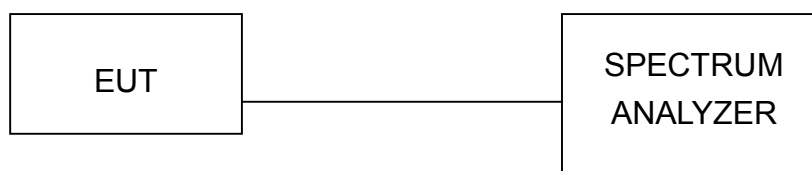

5.3.6 EUT OPERATING CONDITIONS

The software provided by client to enable the EUT under transmission condition continuously at lowest, middle and highest channel frequencies individually.



A D T

5.3.7 TEST RESULTS

802.11a OFDM MODULATION:

CHANNEL	CHANNEL FREQUENCY (MHz)	6dB BANDWIDTH (MHz)			MINIMUM LIMIT (MHz)	PASS / FAIL
		CHAIN(0)	CHAIN(1)	CHAIN(2)		
149	5745	16.60	16.58	16.62	0.5	PASS
157	5785	16.56	16.48	16.55	0.5	PASS
165	5825	16.50	16.56	16.61	0.5	PASS

CHAIN(2)

CH149

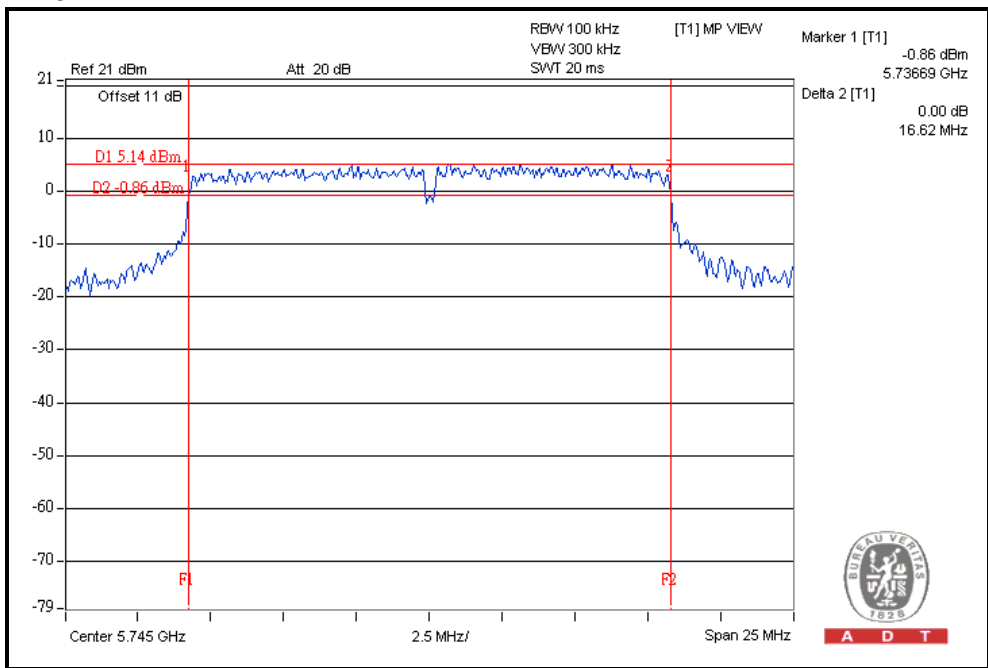



A D T

802.11n (20MHz) OFDM MODULATION:

CHANNEL	CHANNEL FREQUENCY (MHz)	6dB BANDWIDTH (MHz)			MINIMUM LIMIT (MHz)	PASS / FAIL
		CHAIN(0)	CHAIN(1)	CHAIN(2)		
149	5745	17.85	17.81	17.84	0.5	PASS
157	5785	17.79	17.76	17.83	0.5	PASS
165	5825	17.80	17.85	17.85	0.5	PASS

For CHAIN(2)

CH165

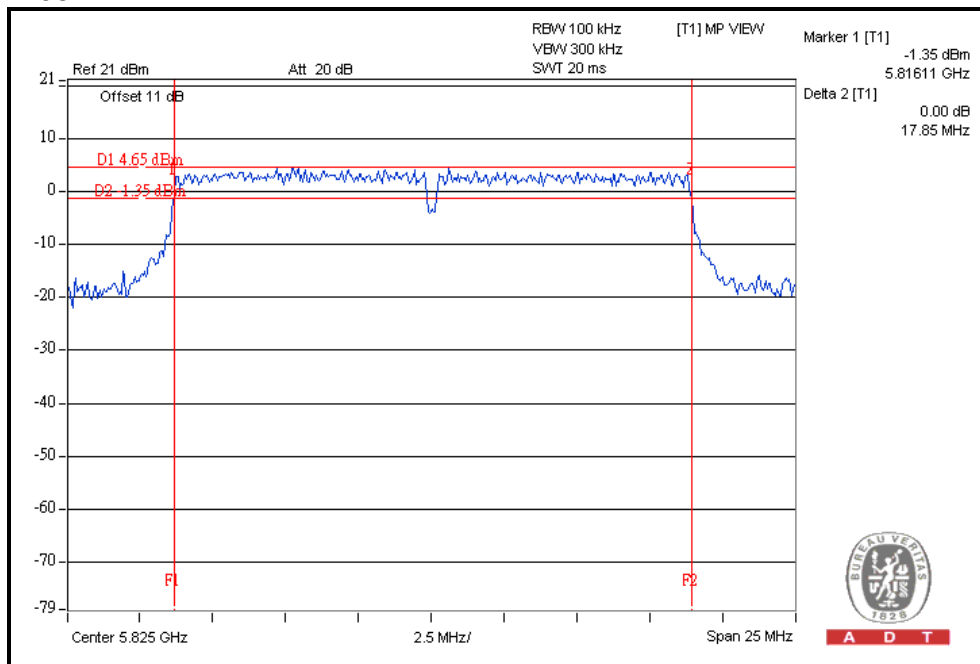



A D T

802.11n (40MHz) OFDM MODULATION:

CHANNEL	CHANNEL FREQUENCY (MHz)	6dB BANDWIDTH (MHz)			MINIMUM LIMIT (MHz)	PASS / FAIL
		CHAIN(0)	CHAIN(1)	CHAIN(2)		
151	5755	36.53	36.48	36.54	0.5	PASS
159	5795	36.60	36.60	36.58	0.5	PASS

For CHAIN(0)

CH159

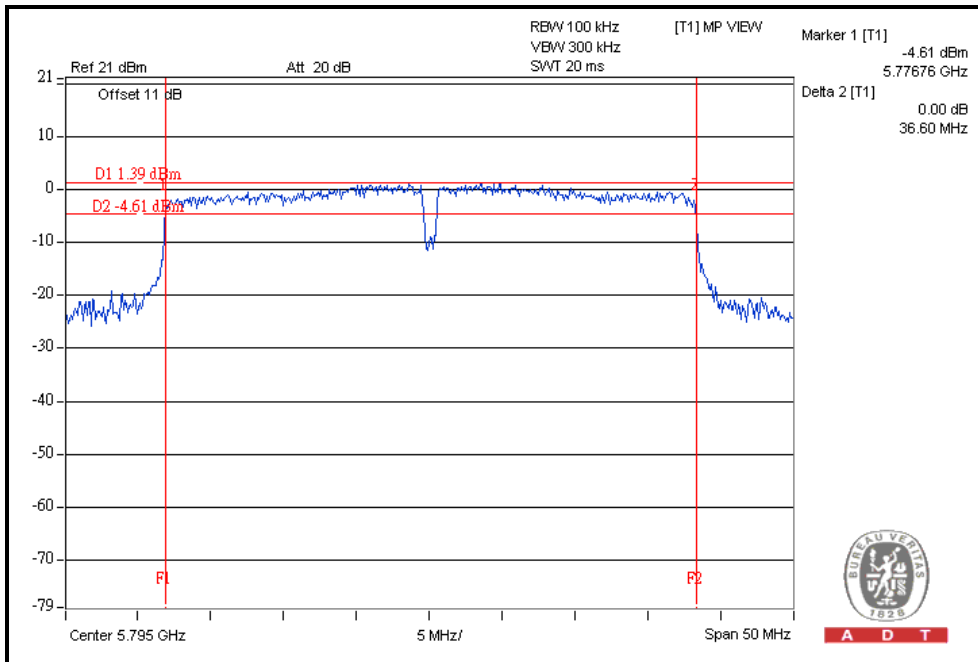



A D T

5.4 MAXIMUM PEAK OUTPUT POWER

5.4.1 LIMITS OF MAXIMUM PEAK OUTPUT POWER MEASUREMENT

The Maximum Peak Output Power Measurement is 30dBm.

5.4.2 INSTRUMENTS

Test date: Dec. 16, 2011

DESCRIPTION & MANUFACTURER	MODEL NO.	SERIAL NO.	CALIBRATED DATE	CALIBRATED UNTIL
Agilent SIGNAL GENERATOR	E8257C	MY43320668	Dec. 27, 2010	Dec. 26, 2011
TEKTRONIX OSCILLOSCOPE	TDS 5104	BO51450	May. 17, 2011	May. 16, 2012
NARDA DETECTOR	4503A	FSCM99899	NA	NA

NOTE: The calibration interval of the above test instruments is 12 months and the calibrations are traceable to NML/ROC and NIST/USA.

5.4.3 TEST PROCEDURES

1. A detector was used on the output port of the EUT. An oscilloscope was used to read the response of the detector.
2. Replaced the EUT by the signal generator. The center frequency of the S.G was adjusted to the center frequency of the measured channel.
3. Adjusted the power to have the same reading on oscilloscope. Record the power level.

5.4.4 DEVIATION FROM TEST STANDARD

No deviation

5.4.5 TEST SETUP

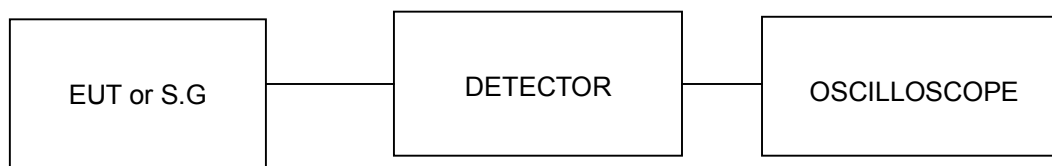



5.4.6 EUT OPERATING CONDITIONS

Same as Item 4.3.6

5.4.7 TEST RESULTS

802.11a OFDM MODULATION:

CHANNEL	CHANNEL FREQUENCY (MHz)	PEAK POWER OUTPUT (dBm)			TOTAL PEAK POWER (mW)	TOTAL PEAK POWER (dBm)	PEAK POWER LIMIT (dBm)	PASS / FAIL
		CHAIN(0)	CHAIN(1)	CHAIN(2)				
149	5745	21.3	20.9	22.2	423.9	26.3	27.36	PASS
157	5785	21.3	20.9	22.2	423.9	26.3	27.36	PASS
165	5825	21.3	20.6	21.7	397.6	26.0	27.36	PASS

Directional gain = $10 \log[(10^{G1/20} + 10^{G2/20} + 10^{G3/20})^2 / 3]$

Effective Legacy Gain (dBi) = 8.64

The effective legacy gain is 8.64dBi, therefore the limit needs to reduce.

802.11n (20MHz) OFDM MODULATION:

CHANNEL	CHANNEL FREQUENCY (MHz)	PEAK POWER OUTPUT (dBm)			TOTAL PEAK POWER (mW)	TOTAL PEAK POWER (dBm)	PEAK POWER LIMIT (dBm)	PASS / FAIL
		CHAIN(0)	CHAIN(1)	CHAIN(2)				
149	5745	21.2	21.3	22.4	440.5	26.4	30	PASS
157	5785	21.3	21.0	22.4	434.6	26.4	30	PASS
165	5825	21.7	20.9	22.1	433.1	26.4	30	PASS

802.11n (40MHz) OFDM MODULATION:

CHANNEL	CHANNEL FREQUENCY (MHz)	PEAK POWER OUTPUT (dBm)			TOTAL PEAK POWER (mW)	TOTAL PEAK POWER (dBm)	PEAK POWER LIMIT (dBm)	PASS / FAIL
		CHAIN(0)	CHAIN(1)	CHAIN(2)				
151	5755	21.8	21.3	23.0	485.8	26.9	30	PASS
159	5795	21.6	21.5	22.4	459.6	26.6	30	PASS

5.5 POWER SPECTRAL DENSITY MEASUREMENT

5.5.1 LIMITS OF POWER SPECTRAL DENSITY MEASUREMENT

The Maximum of Power Spectral Density Measurement is 8dBm.

5.5.2 TEST INSTRUMENTS

Test date: Dec. 16, 2011

DESCRIPTION & MANUFACTURER	MODEL NO.	SERIAL NO.	CALIBRATED DATE	CALIBRATED UNTIL
R&S Spectrum Analyzer	FSP 40	100060	May 11, 2011	May 10, 2012

NOTE: The calibration interval of the above test instruments is 12 months and the calibrations are traceable to NML/ROC and NIST/USA.

5.5.3 TEST PROCEDURE

The transmitter output was connected to the spectrum analyzer through an attenuator, the bandwidth of the fundamental frequency was measured with the spectrum analyzer using 3 kHz RBW and 30 kHz VBW, set sweep time = span/3 kHz. The power spectral density was measured and recorded.

The sweep time is allowed to be longer than span/3 kHz for a full response of the mixer in the spectrum analyzer.

5.5.4 DEVIATION FROM TEST STANDARD

No deviation

5.5.5 TEST SETUP



5.5.6 EUT OPERATING CONDITION

Same as Item 4.3.6



A D T

5.5.7 TEST RESULTS

802.11a OFDM MODULATION:

chain	CHAN.	CHAN. FREQ. (MHz)	RF POWER LEVEL IN 3kHz BW (dBm)		TOTAL POWER DENSITY (dBm)	MAX. LIMIT (dBm)	PASS / FAIL
			Measured	10 log (N=3) dB			
0	149	5745	-10.7	4.8	-5.9	5.36	PASS
	157	5785	-10.4	4.8	-5.6	5.36	PASS
	165	5825	-10.6	4.8	-5.8	5.36	PASS
1	149	5745	-10.2	4.8	-5.4	5.36	PASS
	157	5785	-9.7	4.8	-4.9	5.36	PASS
	165	5825	-10.5	4.8	-5.7	5.36	PASS
2	149	5745	-7.9	4.8	-3.1	5.36	PASS
	157	5785	-7.6	4.8	-2.8	5.36	PASS
	165	5825	-10.3	4.8	-5.5	5.36	PASS

Directional gain = $10 \log[(10^{G1/20} + 10^{G2/20} + 10^{G3/20})^2 / 3]$

Effective Legacy Gain (dBi) = 8.64

The effective legacy gain is 8.64dBi, therefore the limit needs to reduce.

CHAIN(2)

CH157

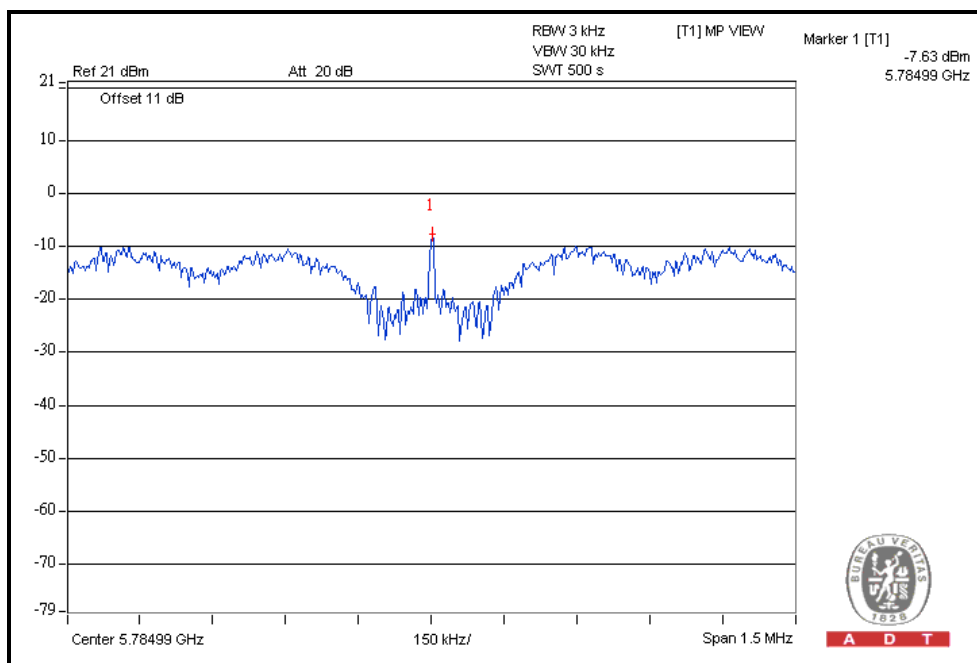

A D T



A D T

802.11n (20MHz) OFDM MODULATION:

chain	CHAN.	CHAN. FREQ. (MHz)	RF POWER LEVEL IN 3kHz BW (dBm)		TOTAL POWER DENSITY (dBm)	MAX. LIMIT (dBm)	PASS / FAIL
			Measured	10 log (N=3) dB			
0	149	5745	-9.1	4.8	-4.3	8	PASS
	157	5785	-8.2	4.8	-3.4	8	PASS
	165	5825	-7.9	4.8	-3.1	8	PASS
1	149	5745	-6.5	4.8	-1.7	8	PASS
	157	5785	-6.5	4.8	-1.7	8	PASS
	165	5825	-7.8	4.8	-3.0	8	PASS
2	149	5745	-6.8	4.8	-2.0	8	PASS
	157	5785	-5.8	4.8	-1.0	8	PASS
	165	5825	-6.9	4.8	-2.1	8	PASS

For CHAIN(2)

CH157

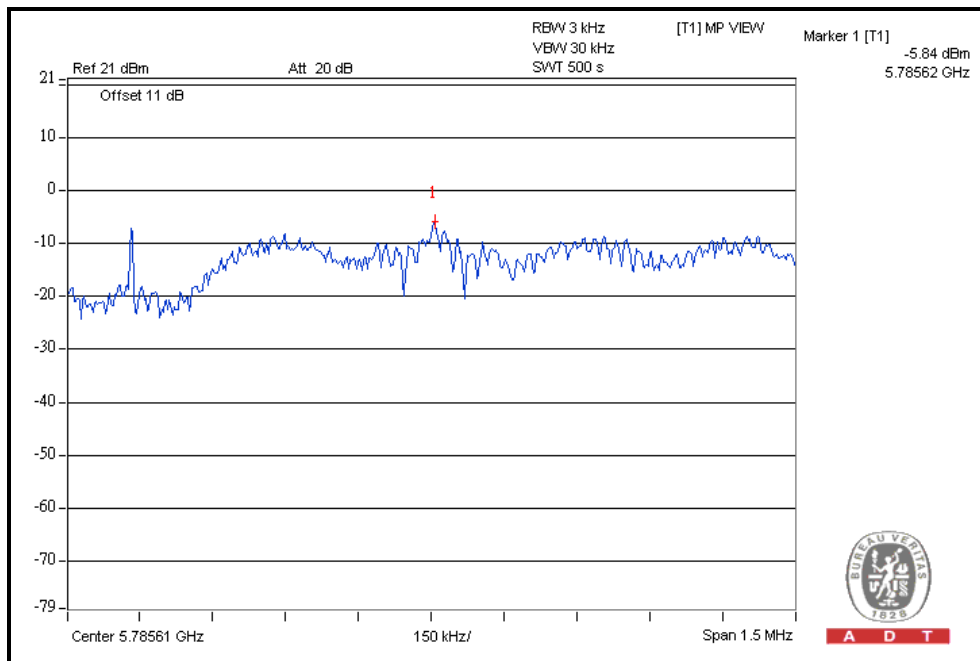

A D T

802.11n (40MHz) OFDM MODULATION:

chain	CHAN.	CHAN. FREQ. (MHz)	RF POWER LEVEL IN 3kHz BW (dBm)		TOTAL POWER DENSITY (dBm)	MAX. LIMIT (dBm)	PASS / FAIL
			Measured	10 log (N=3) dB			
0	151	5755	-10.9	4.8	-6.1	8	PASS
	159	5795	-11.5	4.8	-6.7	8	PASS
1	151	5755	-11.3	4.8	-6.5	8	PASS
	159	5795	-12.0	4.8	-7.2	8	PASS
2	151	5755	-8.7	4.8	-3.9	8	PASS
	159	5795	-7.9	4.8	-3.1	8	PASS

For CHAIN(2)

CH159

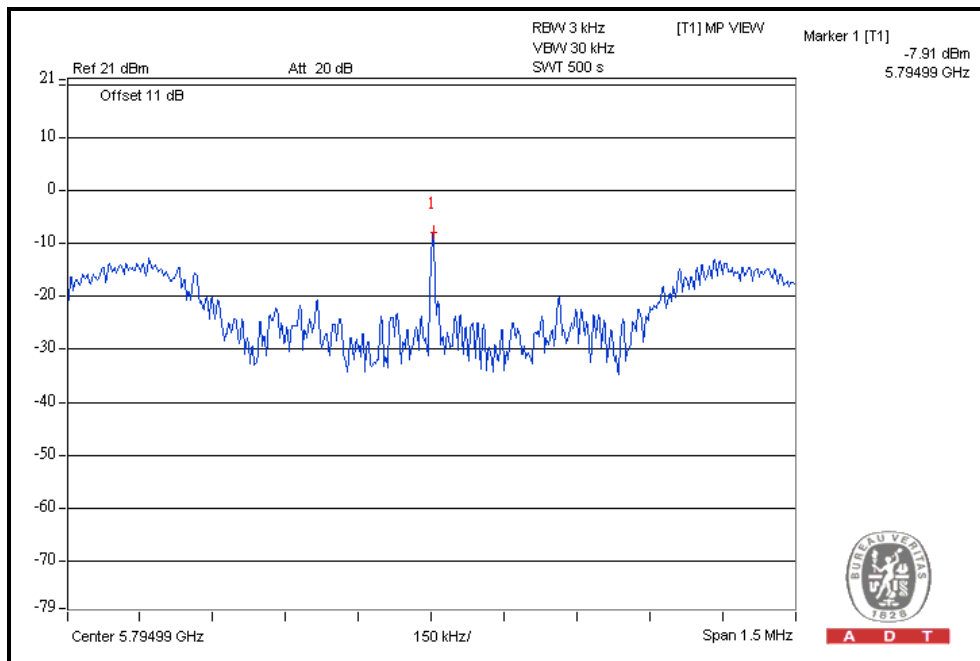

5.6 CONDUCTED OUT-BAND EMISSION MEASUREMENT

5.6.1 LIMITS OF CONDUCTED OUT-BAND EMISSION MEASUREMENT

Below -20dB of the highest emission level of operating band (in 100kHz Resolution Bandwidth).

5.6.2 TEST INSTRUMENTS

Test date: Dec. 16, 2011

DESCRIPTION & MANUFACTURER	MODEL NO.	SERIAL NO.	CALIBRATED DATE	CALIBRATED UNTIL
R&S Spectrum Analyzer	FSP 40	100060	May 11, 2011	May 10, 2012

NOTE: The calibration interval of the above test instruments is 12 months and the calibrations are traceable to NML/ROC and NIST/USA.

5.6.3 TEST PROCEDURE

The transmitter output was connected to the spectrum analyzer via a low loss cable. Set RBW of spectrum analyzer to 100 kHz with suitable frequency span including 100MHz or 200MHz bandwidth from band edge. The band edges was measured and recorded.

5.6.4 DEVIATION FROM TEST STANDARD

No deviation

5.6.5 EUT OPERATING CONDITION

Same as Item 4.3.6

5.6.6 TEST RESULTS

The spectrum plots are attached on the following pages. D2 line indicates the highest level, D1 line indicates the 20dB offset below D2. It shows compliance with the requirement in part 15.247(d).



A D T

Performing measurements: Measure and add 10 log(N) dB 802.11a OFDM modulation

CH149

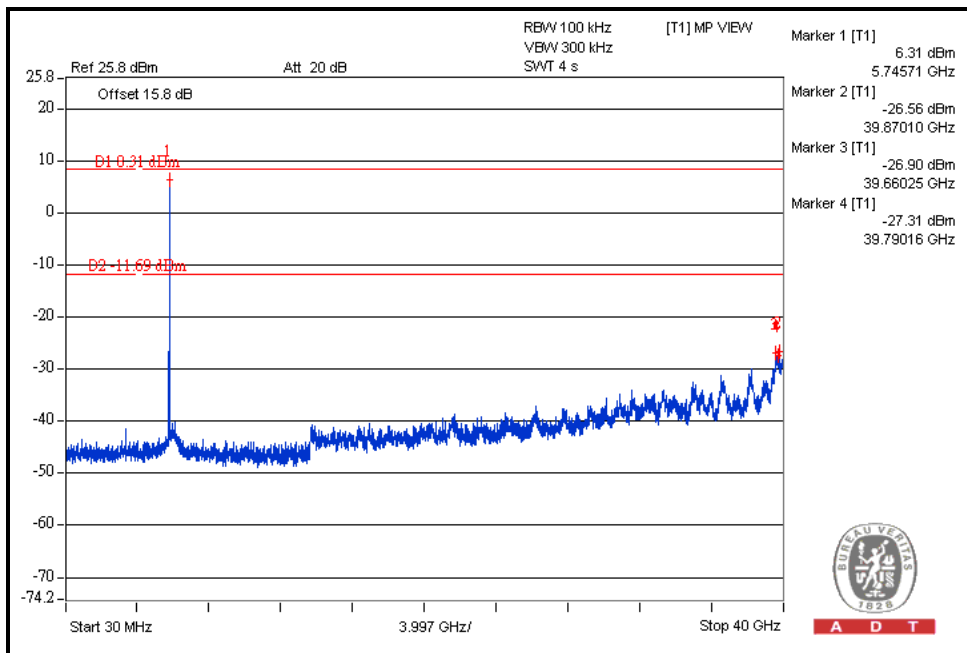
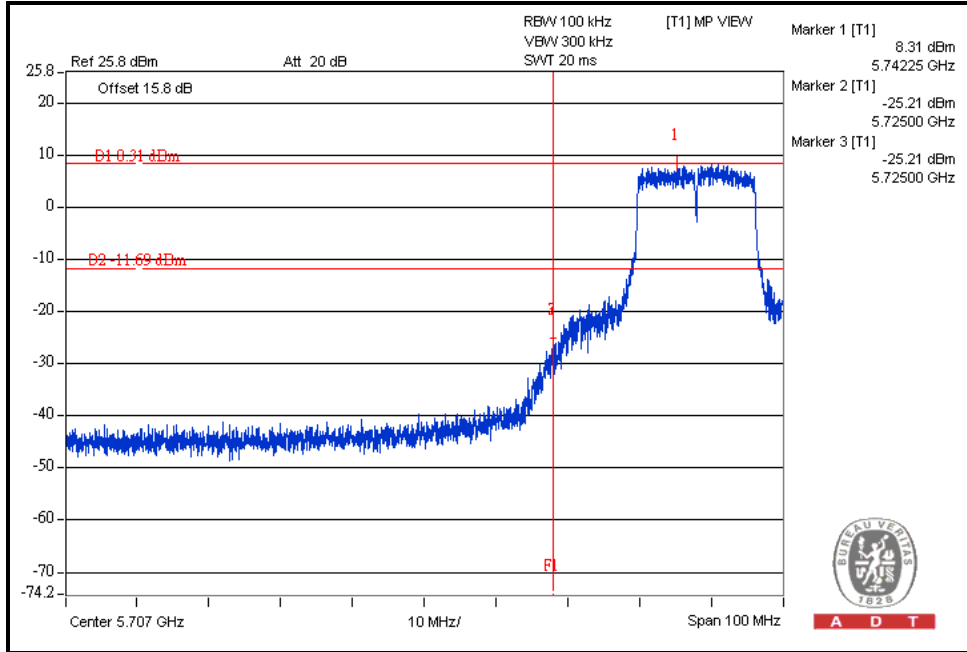



A D T

CH165

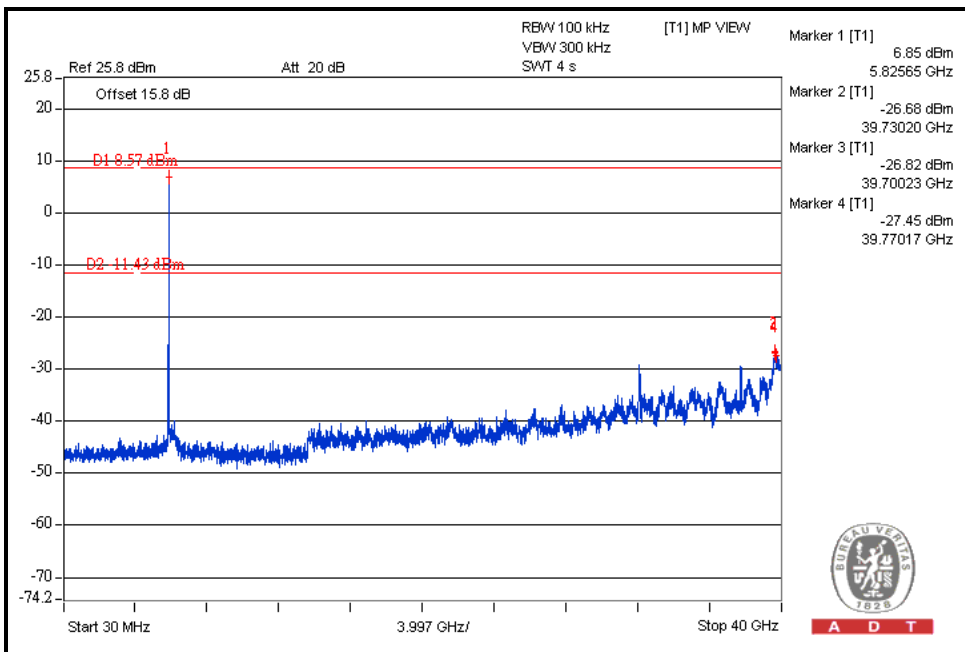
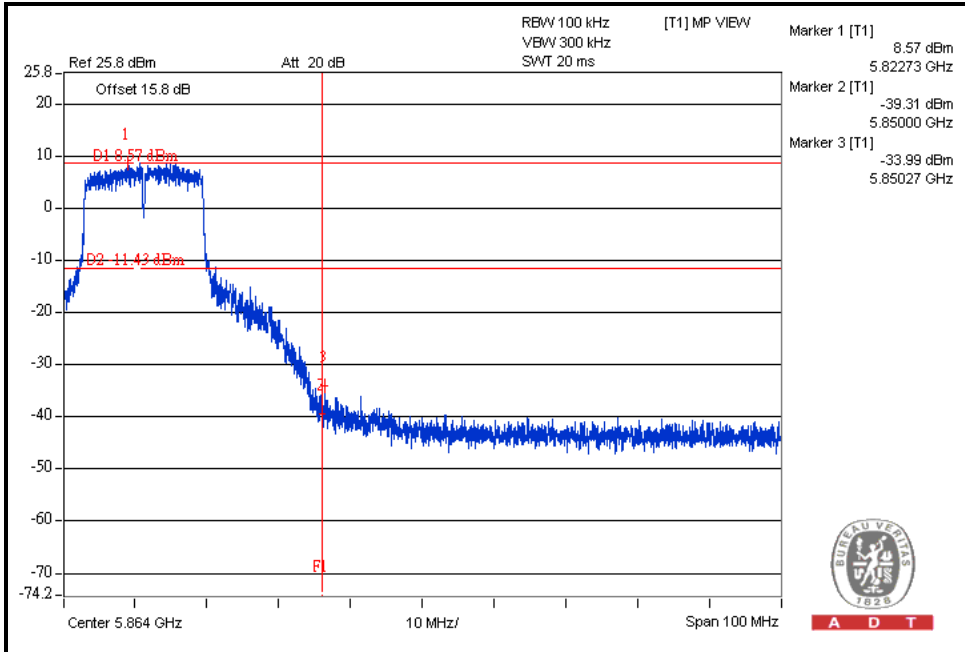



A D T

802.11n (20MHz) OFDM MODULATION:

CH149

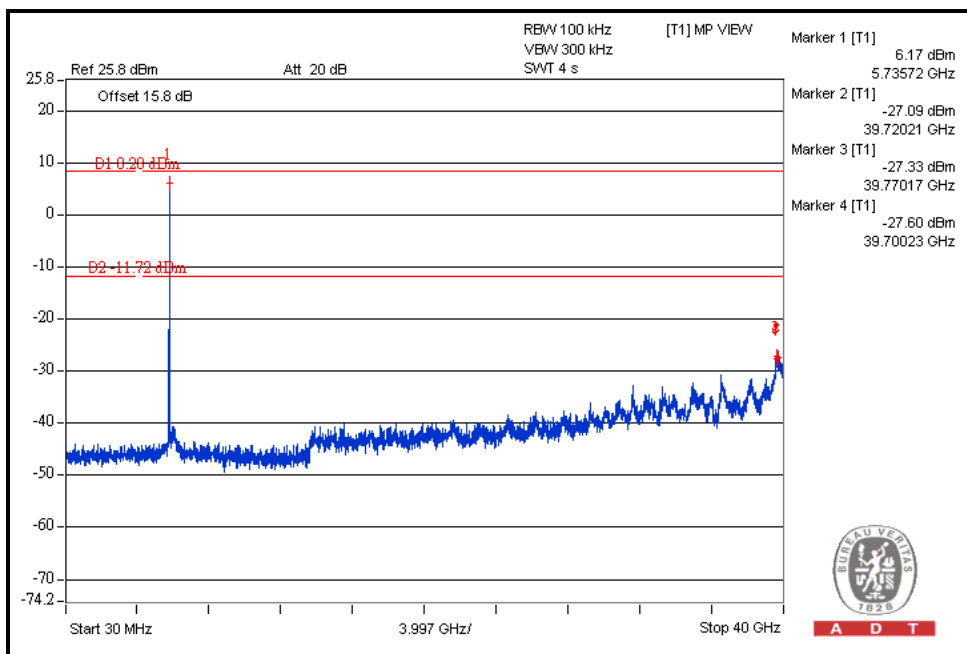
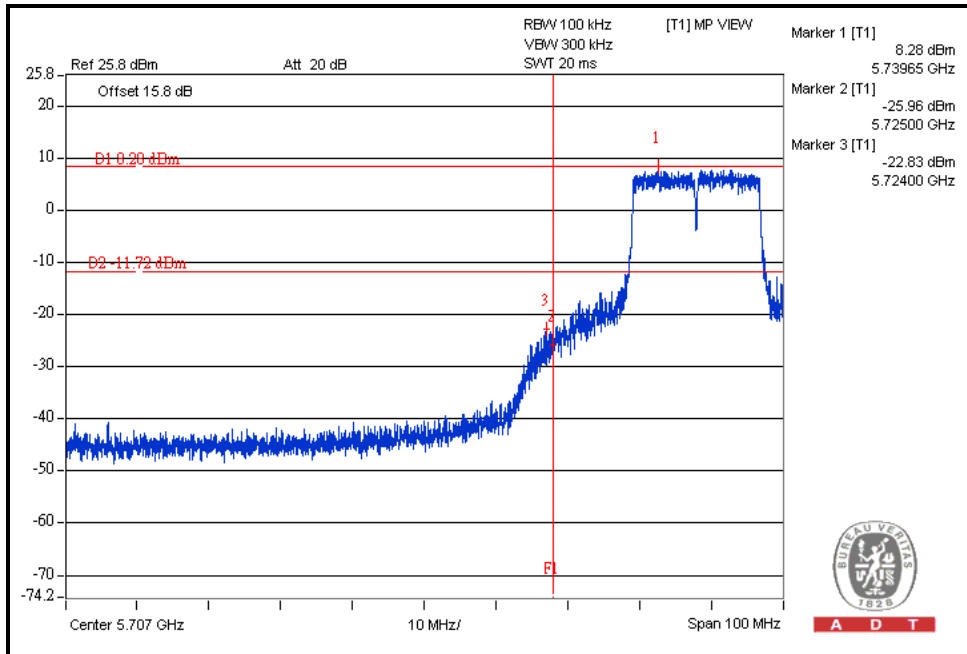



A D T

CH165

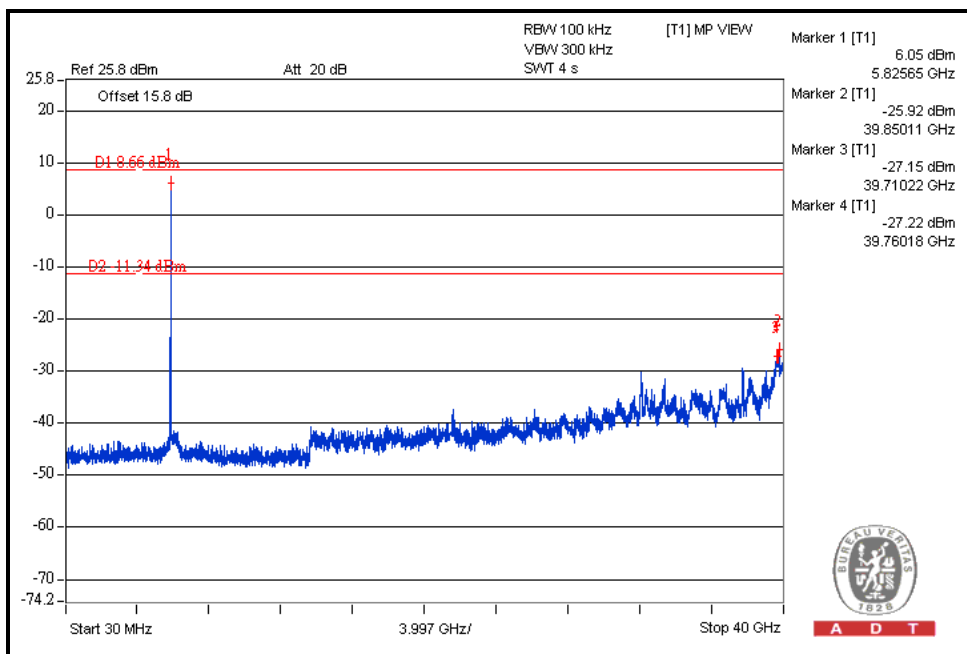
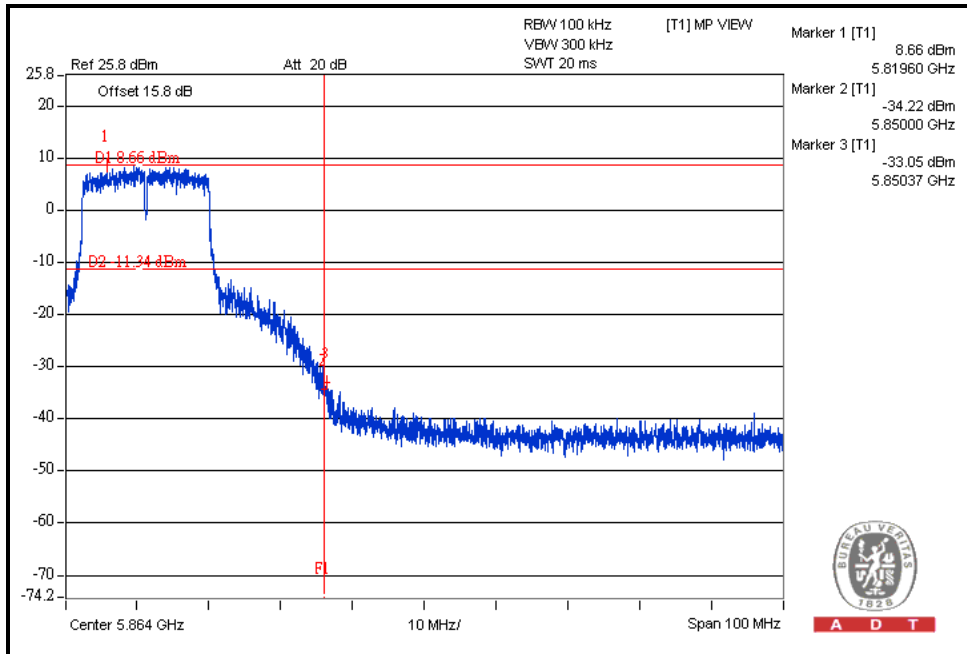



A D T

802.11n (40MHz) OFDM MODULATION:

CH151

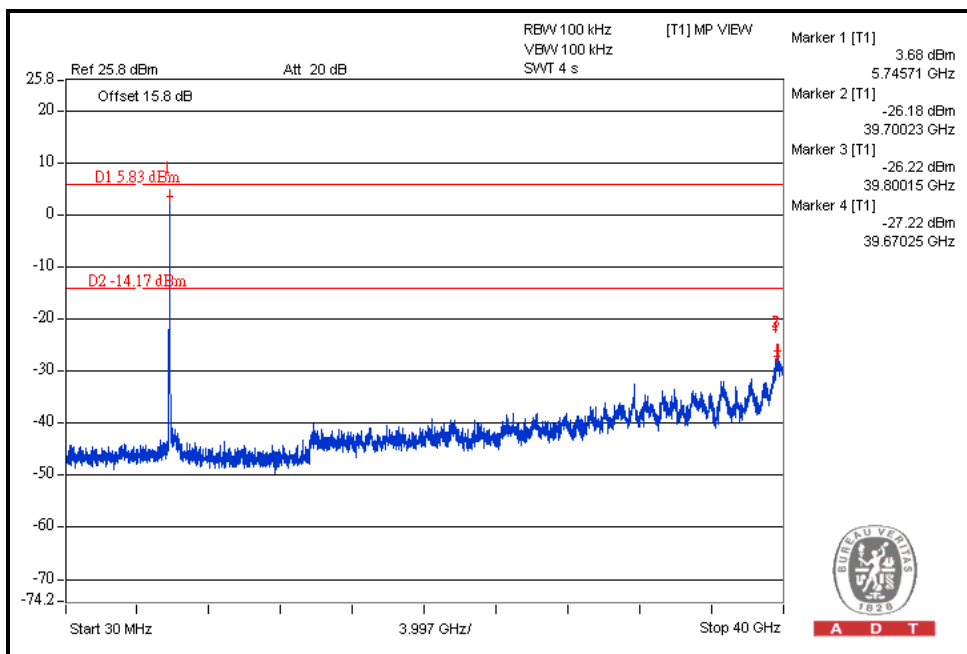
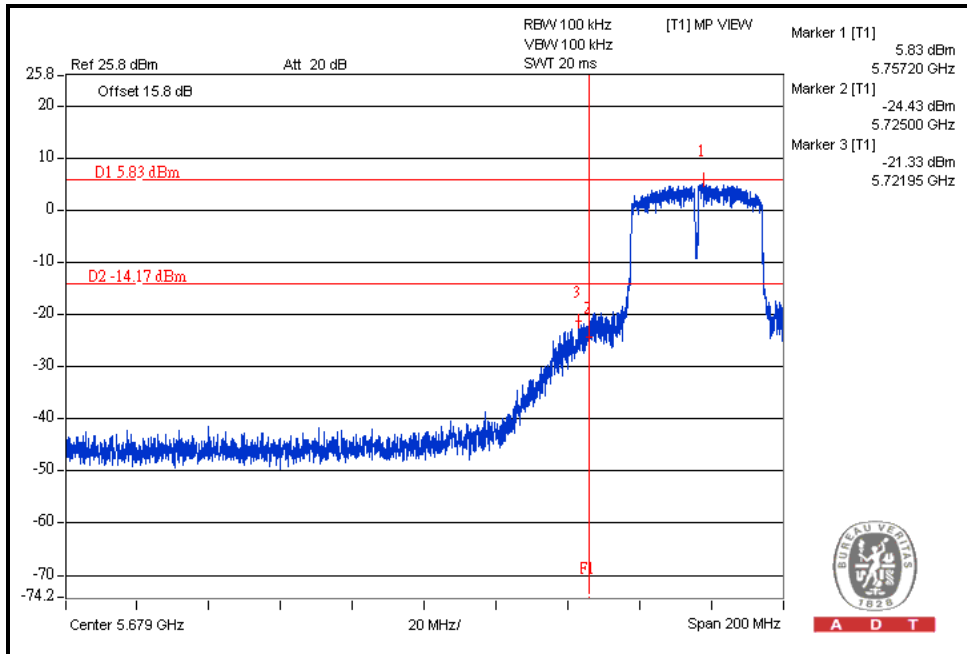



A D T

CH159

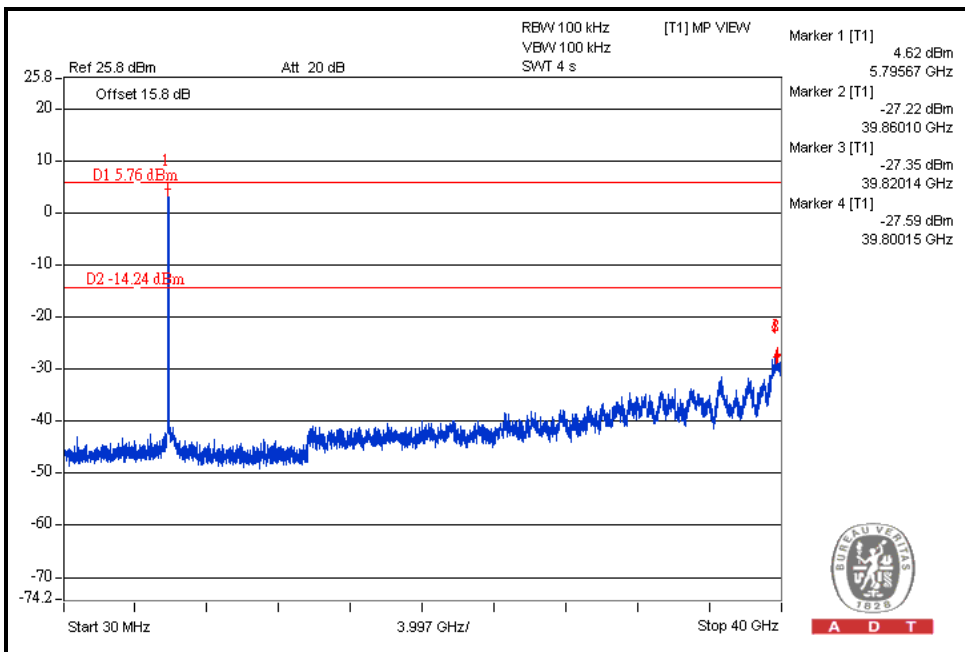
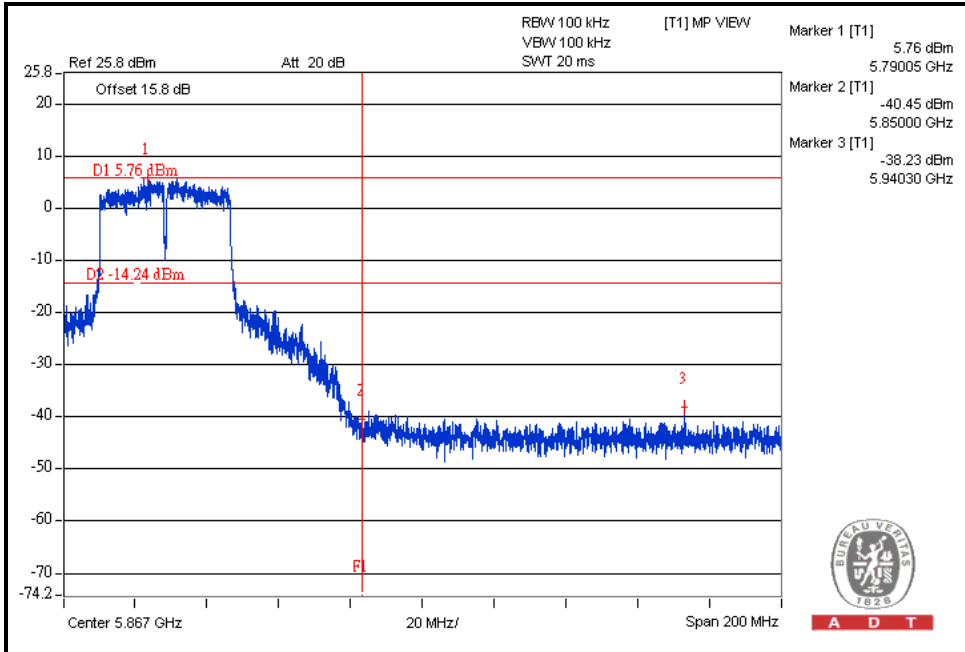



6. INFORMATION ON THE TESTING LABORATORIES

We, Bureau Veritas Consumer Products Services (H.K.) Ltd., Taoyuan Branch, were founded in 1988 to provide our best service in EMC, Radio, Telecom and Safety consultation. Our laboratories are accredited and approved according to ISO/IEC 17025.

Copies of accreditation and authorization certificates of our laboratories obtained from approval agencies can be downloaded from our web site:

www.adt.com.tw/index.5.phtml.

If you have any comments, please feel free to contact us at the following:

Linko EMC/RF Lab:

Tel: 886-2-26052180

Fax: 886-2-26052943

Hsin Chu EMC/RF Lab:

Tel: 886-3-5935343

Fax: 886-3-5935342

Hwa Ya EMC/RF/Safety/Telecom Lab:

Tel: 886-3-3183232

Fax: 886-3-3185050

Email: service.adt@tw.bureauveritas.com

Web Site: www.adt.com.tw

The address and road map of all our labs can be found in our web site also.



A D T

7.APPENDIX A - MODIFICATIONS RECORDERS FOR ENGINEERING CHANGES TO THE EUT BY THE LAB

No modifications were made to the EUT by the lab during the test.

--- END ---